

**EJX910A and EJX930A  
Multivariable Transmitter  
Modbus Communication Type**

IM 01C25R05-01EN

**vigilantplant**<sup>®</sup>

***DPharp***  
*FOR THE DIGITAL WORLD*

# EJX910A and EJX930A

## Multivariable Transmitter

### Modbus Communication Type

IM 01C25R05-01EN 1st Edition

## Contents

<b>1.</b>	<b>Introduction.....</b>	<b>1-1</b>
■	<b>Regarding This Manual .....</b>	<b>1-1</b>
1.1	<b>Safe Use of This Product .....</b>	<b>1-1</b>
1.2	<b>Warranty.....</b>	<b>1-2</b>
1.3	<b>ATEX Documentation .....</b>	<b>1-3</b>
<b>2.</b>	<b>Connection.....</b>	<b>2-1</b>
2.1	<b>Connection with the Modbus Host .....</b>	<b>2-1</b>
2.1.1	The Hardware Switch .....	2-1
2.1.2	Wiring .....	2-2
2.2	<b>Integral Indicator Display When Powering On .....</b>	<b>2-3</b>
2.3	<b>Set the parameters using DTM.....</b>	<b>2-4</b>
<b>3.</b>	<b>Parameter Setting.....</b>	<b>3-1</b>
3.1	<b>Menu Tree .....</b>	<b>3-1</b>
3.2	<b>Communication Setup.....</b>	<b>3-6</b>
3.3	<b>Basic Setup.....</b>	<b>3-7</b>
3.3.1	Tag and Device Information .....	3-7
3.3.2	Process Variables .....	3-7
3.3.3	Measuring Range .....	3-7
3.3.4	Units .....	3-8
3.3.5	Damping Time Constant Setup.....	3-8
3.3.6	Differential Pressure Signal Low Cut Mode Setup .....	3-8
3.3.7	Impulse Line Connection Orientation Setup.....	3-8
3.4	<b>Detailed Setup .....</b>	<b>3-9</b>
3.4.1	Static Pressure Setup .....	3-9
3.4.2	External Temperature Fixation Mode.....	3-9
3.4.3	Integral Indicator Setup.....	3-9
3.4.4	Sensor Trim.....	3-11
3.4.5	External Switch Mode .....	3-12
3.4.6	Software Write Protection .....	3-13
3.4.7	Alarm.....	3-13
3.4.8	Simulation and Squawk .....	3-14

---

<b>4.</b>	<b>Diagnostics .....</b>	<b>4-1</b>
<b>4.1</b>	<b>Self-Diagnostics.....</b>	<b>4-1</b>
4.1.1	Identify Problems by Using the Configuration Tool.....	4-1
4.1.2	Checking with Integral Indicator.....	4-1
4.1.3	Status Information .....	4-1
<b>4.2</b>	<b>Alarms and Countermeasures .....</b>	<b>4-2</b>
<b>5.</b>	<b>Modbus Communication .....</b>	<b>5-1</b>
<b>5.1</b>	<b>General .....</b>	<b>5-1</b>
<b>5.2</b>	<b>Message construction.....</b>	<b>5-1</b>
<b>5.3</b>	<b>Broadcast.....</b>	<b>5-1</b>
<b>5.4</b>	<b>Function code.....</b>	<b>5-1</b>
5.4.1	01 (0x01) Read Coils .....	5-1
5.4.2	02 (0x02) Read Discrete Inputs .....	5-2
5.4.3	03 (0x03) Read Holding Registers.....	5-2
5.4.4	04 (0x04) Read Input Registers.....	5-2
5.4.5	05 (0x05) Write Single Coil .....	5-2
5.4.6	08 (0x08) Diagnostics .....	5-3
5.4.7	16 (0x10) Write Multiple registers .....	5-3
<b>5.5</b>	<b>Response error code .....</b>	<b>5-3</b>
<b>5.6</b>	<b>Data format .....</b>	<b>5-4</b>
<b>5.7</b>	<b>Address Map.....</b>	<b>5-4</b>
5.7.1	Address Map (Basic Information) .....	5-5
5.7.2	Address Map (Detail Information).....	5-6
5.7.3	Enumeration table list .....	5-14
<b>6.</b>	<b>Modbus Communication Troubleshooting .....</b>	<b>6-1</b>
	<b>Revision Information .....</b>	<b>i</b>

# 1. Introduction

Thank you for purchasing the DPharp EJX multivariable transmitter.

EJX multivariable transmitters are precisely calibrated at the factory before shipment. To ensure both safety and efficiency, please read this manual carefully before operating the instrument.

This manual describes the Modbus protocol communication functions of the EJX multivariable transmitter and explains how to set the parameters for EJX multivariable transmitters.

For information on the installation, wiring, and maintenance of EJX multivariable transmitters, please refer to the user's manual.

EJX910A/ EJX930A	IM 01C25R01-01E
------------------	-----------------

## ■ Regarding This Manual

- This manual should be provided to the end user.
- The contents of this manual are subject to change without prior notice.
- All rights reserved. No part of this manual may be reproduced in any form without Yokogawa's written permission.
- Yokogawa makes no warranty of any kind with regard to this manual, including, but not limited to, implied warranty of merchantability and fitness for a particular purpose.
- If any question arises or errors are found, or if any information is missing from this manual, please inform the nearest Yokogawa sales office.
- The specifications covered by this manual are limited to those for the standard type under the specified model number break-down and do not cover custom-made instruments.
- Please note that changes in the specifications, construction, or component parts of the instrument may not immediately be reflected in this manual at the time of change, provided that postponement of revisions will not cause difficulty to the user from a functional or performance standpoint.

- The following safety symbols are used in this manual:



### WARNING

Indicates a potentially hazardous situation which, if not avoided, could result in death or serious injury.



### CAUTION

Indicates a potentially hazardous situation which, if not avoided, may result in minor or moderate injury. It may also be used to alert against unsafe practices.



### IMPORTANT

Indicates that operating the hardware or software in this manner may damage it or lead to system failure.



### NOTE

Draws attention to information essential for understanding the operation and features.

## 1.1 Safe Use of This Product

For the safety of the operator and to protect the instrument and the system, please be sure to follow this manual's safety instructions when handling this instrument. If these instructions are not heeded, the protection provided by this instrument may be impaired. In this case, Yokogawa cannot guarantee that the instrument can be safely operated. Please pay special attention to the following points:

### (a) Installation

- This instrument may only be installed by an engineer or technician who has an expert knowledge of this device. Operators are not allowed to carry out installation unless they meet this condition.

- With high process temperatures, care must be taken not to burn yourself by touching the instrument or its casing.
- Never loosen the process connector nuts when the instrument is installed in a process. This can lead to a sudden, explosive release of process fluids.
- When draining condensate from the pressure detector section, take appropriate precautions to prevent the inhalation of harmful vapors and the contact of toxic process fluids with the skin or eyes.
- When removing the instrument from a hazardous process, avoid contact with the process fluid and the interior of the meter.
- All installation shall comply with local installation requirements and the local electrical code.

**(b) Wiring**

- The instrument must be installed by an engineer or technician who has an expert knowledge of this instrument. Operators are not permitted to carry out wiring unless they meet this condition.
- Before connecting the power cables, please confirm that there is no current flowing through the cables and that the power supply to the instrument is switched off.

**(c) Operation**

- Wait 10 min. after the power is turned off before opening the covers.

**(d) Maintenance**

- Please carry out only the maintenance procedures described in this manual. If you require further assistance, please contact the nearest Yokogawa office.
- Care should be taken to prevent the build up of dust or other materials on the display glass and the name plate. To clean these surfaces, use a soft, dry cloth.

**(e) Modification**

- Yokogawa will not be liable for malfunctions or damage resulting from any modification made to this instrument by the customer.

## 1.2 Warranty

- The warranty shall cover the period noted on the quotation presented to the purchaser at the time of purchase. Problems occurring during the warranty period shall basically be repaired free of charge.
- If any problems are experienced with this instrument, the customer should contact the Yokogawa representative from which this instrument was purchased or the nearest Yokogawa office.
- If a problem arises with this instrument, please inform us of the nature of the problem and the circumstances under which it developed, including the model specification and serial number. Any diagrams, data and other information you can include in your communication will also be helpful.
- The party responsible for the cost of fixing the problem shall be determined by Yokogawa following an investigation conducted by Yokogawa.
- The purchaser shall bear the responsibility for repair costs, even during the warranty period, if the malfunction is due to:
  - Improper and/or inadequate maintenance by the purchaser.
  - Malfunction or damage due to a failure to handle, use, or store the instrument in accordance with the design specifications.
  - Use of the product in question in a location not conforming to the standards specified by Yokogawa, or due to improper maintenance of the installation location.
  - Failure or damage due to modification or repair by any party except Yokogawa or an approved representative of Yokogawa.
  - Malfunction or damage from improper relocation of the product in question after delivery.
  - Reason of force majeure such as fires, earthquakes, storms/floods, thunder/lightening, or other natural disasters, or disturbances, riots, warfare, or radioactive contamination.

## 1.3 ATEX Documentation

This is only applicable to the countries in European Union.

<p><b>GB</b> All instruction manuals for ATEX Ex related products are available in English, German and French. Should you require Ex related instructions in your local language, you are to contact your nearest Yokogawa office or representative.</p>	<p><b>SK</b> Všetky návody na obsluhu pre prístroje s ATEX Ex sú k dispozícii v jazyku anglickom, nemeckom a francúzskom. V prípade potreby návodu pre Ex-prístroje vo Vašom národnom jazyku, skontaktujte prosím miestnu kanceláriu firmy Yokogawa.</p>
<p><b>DK</b> Alle brugervejledninger for produkter relateret til ATEX Ex er tilgængelige på engelsk, tysk og fransk. Skulle De ønske yderligere oplysninger om håndtering af Ex produkter på eget sprog, kan De rette henvendelse herom til den nærmeste Yokogawa afdeling eller forhandler.</p>	<p><b>CZ</b> Všechny uživatelské příručky pro výrobky, na něž se vztahuje nevybušné schválení ATEX Ex, jsou dostupné v angličtině, němčině a francouzštině. Požadujete-li pokyny týkající se výrobků s nevybušným schválením ve vašem lokálním jazyku, kontaktujte prosím vaši nejbližší reprezentační kancelář Yokogawa.</p>
<p><b>I</b> Tutti i manuali operativi di prodotti ATEX contrassegnati con Ex sono disponibili in inglese, tedesco e francese. Se si desidera ricevere i manuali operativi di prodotti Ex in lingua locale, mettersi in contatto con l'ufficio Yokogawa più vicino o con un rappresentante.</p>	<p><b>LT</b> Visos gaminių ATEX Ex kategorijos Eksploatavimo instrukcijos teikiami anglų, vokiečių ir prancūzų kalbomis. Norėdami gauti prietaisų Ex dokumentaciją kitomis kalbomis susisiekite su artimiausiu bendrovės "Yokogawa" biuru arba atstovu.</p>
<p><b>E</b> Todos los manuales de instrucciones para los productos antiexplosivos de ATEX están disponibles en inglés, alemán y francés. Si desea solicitar las instrucciones de estos artículos antiexplosivos en su idioma local, deberá ponerse en contacto con la oficina o el representante de Yokogawa más cercano.</p>	<p><b>LV</b> Visas ATEX Ex kategorijas izstrādājumu Lietošanas instrukcijas tiek piegādātas angļu, vācu un franču valodās. Ja vēlaties saņemt Ex ierīšu dokumentāciju citā valodā, Jums ir jāsazinās ar firmas Jokogava (Yokogawa) tuvāko ofisu vai pārstāvi.</p>
<p><b>NL</b> Alle handleidingen voor producten die te maken hebben met ATEX explosiebeveiliging (Ex) zijn verkrijgbaar in het Engels, Duits en Frans. Neem, indien u aanwijzingen op het gebied van explosiebeveiliging nodig hebt in uw eigen taal, contact op met de dichtstbijzijnde vestiging van Yokogawa of met een vertegenwoordiger.</p>	<p><b>EST</b> Kõik ATEX Ex toodete kasutamisujuhendid on esitatud inglise, saksa ja prantsuse keeles. Ex seadmete muukeelse dokumentatsiooni saamiseks pöörduge lähima lokagava (Yokogawa) kontori või esindaja poole.</p>
<p><b>SF</b> Kaikkien ATEX Ex -tyyppisten tuotteiden käyttöohjeet ovat saatavilla englannin-, saksan- ja ranskankielisinä. Mikäli tarvitsette Ex -tyyppisten tuotteiden ohjeita omalla paikallisella kielellänne, ottakaa yhteyttä lähimpään Yokogawa-toimistoon tai -edustajaan.</p>	<p><b>PL</b> Wszystkie instrukcje obsługi dla urządzeń w wykonaniu przeciwwybuchowym Ex, zgodnych z wymaganiami ATEX, dostępne są w języku angielskim, niemieckim i francuskim. Jeżeli wymagana jest instrukcja obsługi w Państwa lokalnym języku, prosimy o kontakt z najbliższym biurem Yokogawy.</p>
<p><b>P</b> Todos os manuais de instruções referentes aos produtos Ex da ATEX estão disponíveis em Inglês, Alemão e Francês. Se necessitar de instruções na sua língua relacionadas com produtos Ex, deverá entrar em contacto com a delegação mais próxima ou com um representante da Yokogawa.</p>	<p><b>SLO</b> Vsi predpisi in navodila za ATEX Ex sorodni pridelki so pri roki v angleščini, nemščini ter francoščini. Če so Ex sorodna navodila potrebna v vašem tujejnem jeziku, kontaktirajte vaš najbližji Yokogawa office ili predstavnika.</p>
<p><b>F</b> Tous les manuels d'instruction des produits ATEX Ex sont disponibles en langue anglaise, allemande et française. Si vous nécessitez des instructions relatives aux produits Ex dans votre langue, veuillez bien contacter votre représentant Yokogawa le plus proche.</p>	<p><b>H</b> Az ATEX Ex műszerek gépkönyveit angol, német és francia nyelven adjuk ki. Amennyiben helyi nyelven kérjük az Ex eszközök leírásait, kérjük keressék fel a legközelebbi Yokogawa irodát, vagy képviselőt.</p>
<p><b>D</b> Alle Betriebsanleitungen für ATEX Ex bezogene Produkte stehen in den Sprachen Englisch, Deutsch und Französisch zur Verfügung. Sollten Sie die Betriebsanleitungen für Ex-Produkte in Ihrer Landessprache benötigen, setzen Sie sich bitte mit Ihrem örtlichen Yokogawa-Vertreter in Verbindung.</p>	<p><b>BG</b> Всички упътвания за продукти от серията ATEX Ex се предлагат на английски, немски и френски език. Ако се нуждаете от упътвания за продукти от серията Ex на родния ви език, се свържете с най-близкия офис или представителство на фирма Yokogawa.</p>
<p><b>S</b> Alla instruktionsböcker för ATEX Ex (explosionssäkra) produkter är tillgängliga på engelska, tyska och franska. Om Ni behöver instruktioner för dessa explosionssäkra produkter på annat språk, skall Ni kontakta närmaste Yokogawakontor eller representant.</p>	<p><b>RO</b> Toate manualele de instructiuni pentru produsele ATEX Ex sunt in limba engleza, germana si franceza. In cazul in care doriti instructiunile in limba locala, trebuie sa contactati cel mai apropiat birou sau reprezentant Yokogawa.</p>
<p><b>GR</b> Όλα τα εγχειρίδια λειτουργίας των προϊόντων με ATEX Ex διατίθενται στα Αγγλικά, Γερμανικά και Γαλλικά. Σε περίπτωση που χρειάζεστε οδηγίες σχετικά με Ex στην τοπική γλώσσα παρακαλούμε επικοινωνήστε με το πλησιέστερο γραφείο της Yokogawa ή αντιπρόσωπο της.</p>	<p><b>M</b> Il-manwali kollha ta' l-istruzzjonijiet għal prodotti marbuta ma' ATEX Ex huma disponibbli bi-Ingliż, bi-Ġermaniż u bi-Franċiż. Jekk tkun teħtieġ struzzjonijiet marbuta ma' Ex fil-lingwa lokali tiegħek, għandek tikkuntattja l-ill-eqreb rappreżentant jew uffċju ta' Yokogawa.</p>

# 2. Connection

## 2.1 Connection with the Modbus Host

### 2.1.1 The Hardware Switch

The Hardware switch is located in the CPU Board Assembly. In order to accessing the switch, removing the LCD Board is required. Refer to IM 01C25R01-01E “EJX910A and EJX930A Multivariable Transmitters” Chapter 9 for detail instruction.

#### (1) Termination

The RS-485 bus requires Line Termination near each of the 2 Ends of the Bus, and not allowed to place more than 2. By using hardware switch, “the bus end” is settable. This switch decides “the bus end” or “the not bus end” on the RS-485 line. If the hardware switch is ON, “the bus end” is selected. If it is OFF, the mode is “the not bus end”.

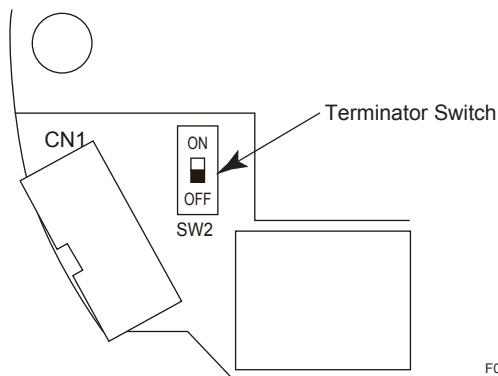

Terminator Mode	Position of “ON” and “OFF”
Bus End	ON: Upper side
Not Bus End *	OFF: Lower side

\*: Factory default setting.

#### (2) Baud Rate

By using hardware switch, the baud rate is settable. The combinations of ON and OFF corresponds to each baud rate. After turning on the power supply, the selected baud rate is activated.

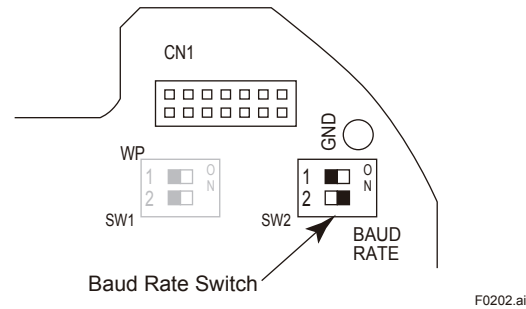

Baud rate [bps]	Combinations of “ON” and “OFF”	
	1 (Upper side)	2 (Lower Side)
1200	OFF	OFF
4800	ON	OFF
9600*	OFF	ON
19200	ON	ON

\*: Factory default setting.

#### (3) Write Protect Hardware Switch

There is a slide switch on the CPU assembly board. Write protection function is activated which disables all the write possible parameters change through communication.

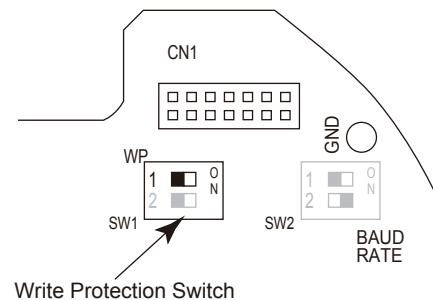

Hardware write protection switch (WP)		
Write Protection Switch (1) Position	1  ON	1  ON
Write Protection	NO* (Write enabled)	YES (Write disabled)

\*: Factory default setting.

F0203.ai

**2.1.2 Wiring**

**(1) Terminal Wiring**

Fig 2.1 shows the instruction of terminal wiring (Power supply and 2-wire RS-485). Power must be supplied after all wirings are finished.

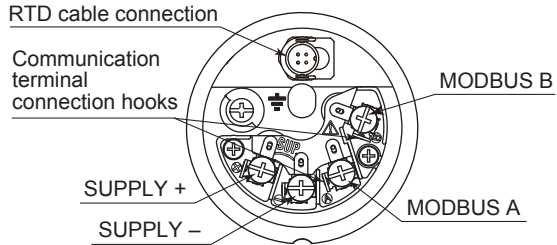

**Terminal Wiring**

SUPPLY + -	Power supply terminals
MODBUS A B	Modbus communication (RS-485) terminals
⏏	Ground terminal

F0204.ai

**Figure 2.1 Terminal Wiring (Power supply and 2-wire RS-485)**

**(2) Power Supply**

The transmitter requires between 9 and 30 V dc with less than 2% ripple, and sufficient current capacity.



**IMPORTANT**

Do not connect power wiring to the MODBUS(RS-485) terminals. It may damage EJX Multivariable Transmitter.



**NOTE**

The EJX Multivariable Transmitter power supply is not electrically isolated from the RS-485 bus.

**(3) Cable**

Balanced pairs should be used. AWG 20 or thicker should be used for over 300 m.

**(4) Grounding**

Grounding is always required for the proper operation of transmitters. Refer to IM 01C25R01-01E “EJX910A and EJX930A Multivariable Transmitters” Chapter 7.

**(5) Multi drop communication**

Up to 32 EJX Multivariable Transmitters can be connected on RS-485 bus. Refer to Figure 2.2 for Multi drop connection.

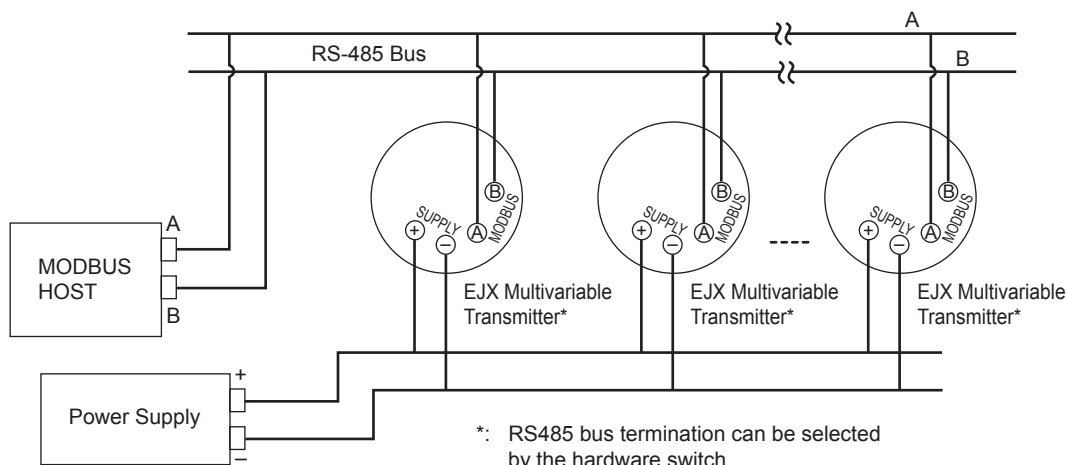

\*: RS485 bus termination can be selected by the hardware switch.

F0205.ai

**Figure 2.2 Multi drop connection**



**(6) Connecting RS-485 USB Adaptor to EJX Multivariable Transmitter**

For configuration of EJX Multivariable Transmitter using DTM on PC, RS-485 USB Adaptor is required to connect transmitter to PC. Connecting RS-485 USB Adaptor to EJX Multivariable Transmitter is described using BLACK BOX "SP390A-R2" isolated RS485 USB Adaptor as an example in Figure 2.3 and Figure 2.4.

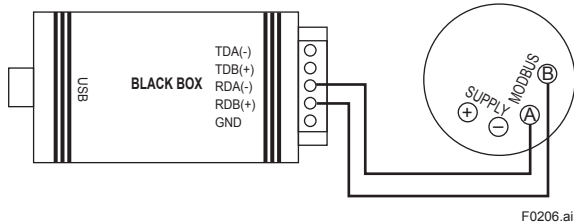

BLACK BOX "SP390A-R2" Isolated RS485 USB Adaptor	EJX Multivariable Transmitter
RDA(-)	MODBUS A
RDB(+)	MODBUS B

Figure 2.3 RS-485 USB Adaptor connection

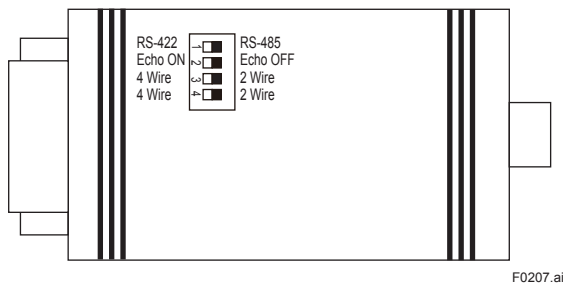

1 (RS422/RS485)	RS-485
2 (Echo ON/OFF)	Echo OFF
3 (4 Wire/ 2 Wire)	2 Wire
4 (4 Wire/ 2 Wire)	2 Wire

Figure 2.4 RS-485 USB Adaptor Setting



**IMPORTANT**

Do not connect MODBUS(RS-485) wiring to Power terminals. It may damage RS-485 adaptor.



**NOTE**

We recommend isolated RS485 USB Adaptor for connecting PC to EJX Multivariable Transmitter.

**2.2 Integral Indicator Display When Powering On**

For models with the integral indicator code "D", the display shows all segments in the LCD and device/communication information sequentially.

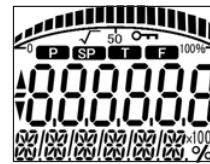

All segments display



Model name (3 s)

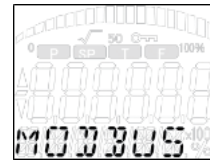

Communication Protocol (3 s)



Device Revision (3 s)

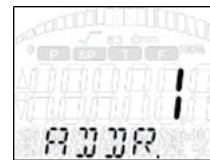

Slave Address (3 s)



Serial information (3 s)  
E.g.:  
Baud rate: 9600 [bps]  
Data Length: 8 [bit]  
Parity: Even  
Stop Bit: 1

F0208.ai



**NOTE**

LCD display can be set to all segments display only.

• Procedure to call up the display

[Root Menu] → Detailed setup → Display condition → Chg power on info

On	Show all segments display and device/communication information display when powering on.
Off	Show all segments display when powering on.

## 2.3 Set the parameters using DTM

When configure the parameters using FieldMate, use the DTM (Device Type Manager) shown in the Table 2.1.

Table 2.1 DTM

DTM		EJX multivariable transmitters		
Name	Revision	Model Name	Device Type	Device Revision
EJX910 Modbus DTM	3.1.1.0*1 or later	EJX910A EJX930A	EJX910 (0x0054)	1

\*1: The DTM corresponding to this revision is included in Yokogawa Modbus DTM Library 1.1 or later.



### NOTE

The DTM revision can be confirmed by “DTM setup”.

Device Files is a Media included in FieldMate. The user registration site provides Device Files with the latest update programs.

(URL: <https://voc.yokogawa.co.jp/PMK/>)

In case update, following operation by “DTM setup” is required.

- Update DTM catalog
- Assign corresponding DTM to the device (refer to Table 2.1)

Refer to FieldMate Instruction Manual for detail.

# 3. Parameter Setting

## 3.1 Menu Tree

■ DTM

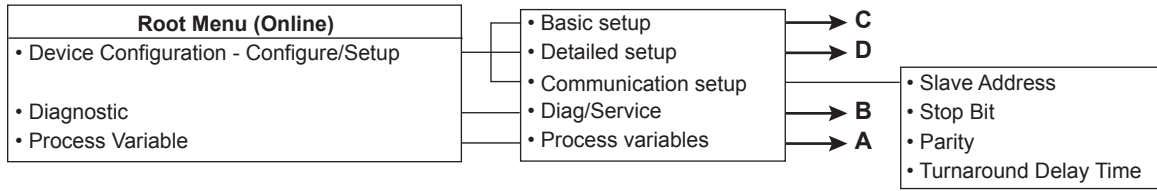

F0301-01.ai

A

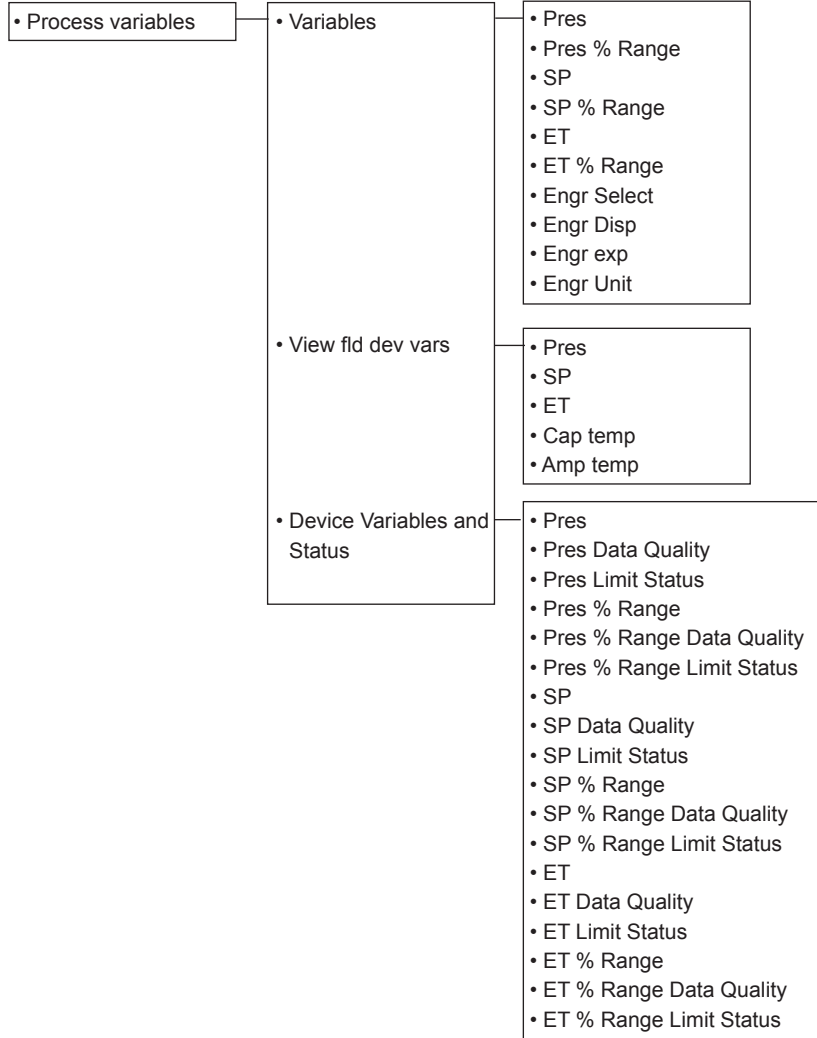

F0301-02.ai

**B**

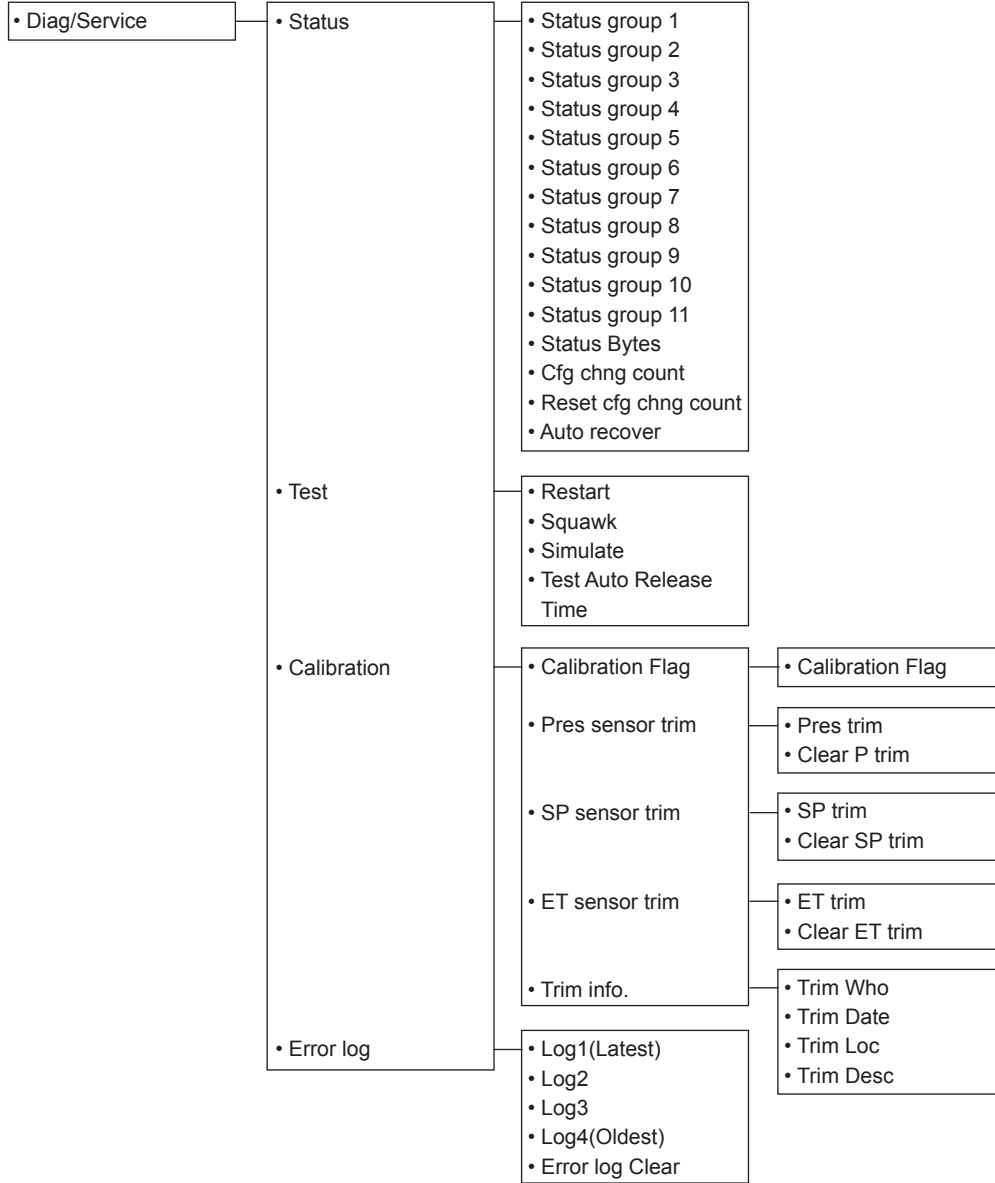

F0301-03.ai

**C**

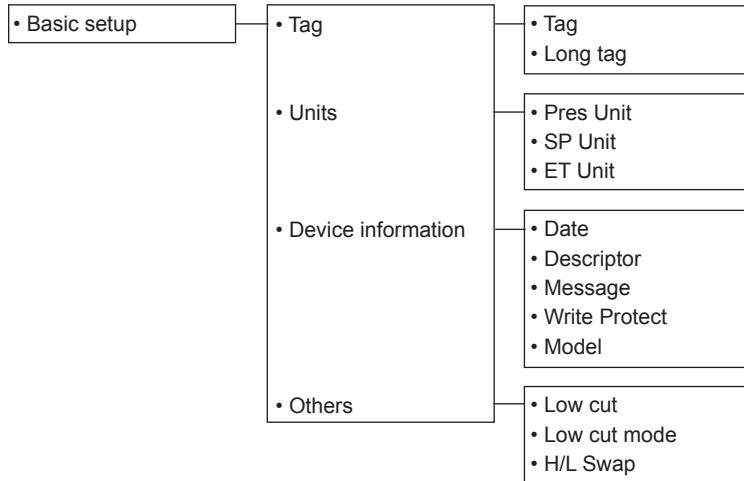

F0301-04ai

D

• Detailed setup

• Sensors

• Pres  
• SP  
• ET  
• Cap temp  
• Amp temp

• Pres LRV  
• Pres URV  
• Pres Unit  
• Pres LSL  
• Pres USL  
• Pres Min span  
• Pres Damp  
• Low cut  
• Low cut mode  
• H/L Swap

• Signal condition

• DP Setup

• SP LRV  
• SP URV  
• SP Unit  
• SP LSL  
• SP USL  
• SP Min span  
• SP Damp  
• A/G Select  
• SP H/L Select  
• Atm. Pres Value  
• Auto Atm. Pres

• SP Setup

• ET Setup

• ET LRV  
• ET URV  
• ET Unit  
• ET LSL  
• ET USL  
• ET Min span  
• ET Damp  
• ET Fixed  
• Fixed ET Val

• Output condition

• Process variables

• Pres  
• Pres % Range  
• SP  
• SP % Range  
• ET  
• ET % Range  
• Engr Select  
• Engr Disp  
• Engr exp  
• Engr Unit

• Process Alerts

• Pres Alert  
• SP Alert  
• ET Alert

• Pres Alert Mode  
• Pres Hi Alert Val  
• Pres Lo Alert Val

• SP Alert Mode  
• SP Hi Alert Val  
• SP Lo Alert Val

• ET Alert Mode  
• ET Hi Alert Val  
• ET Lo Alert Val

• Display condition  
• Device information  
• Test Key  
• Flow Simulation

→ See E

→ See F

F0301-05.ai

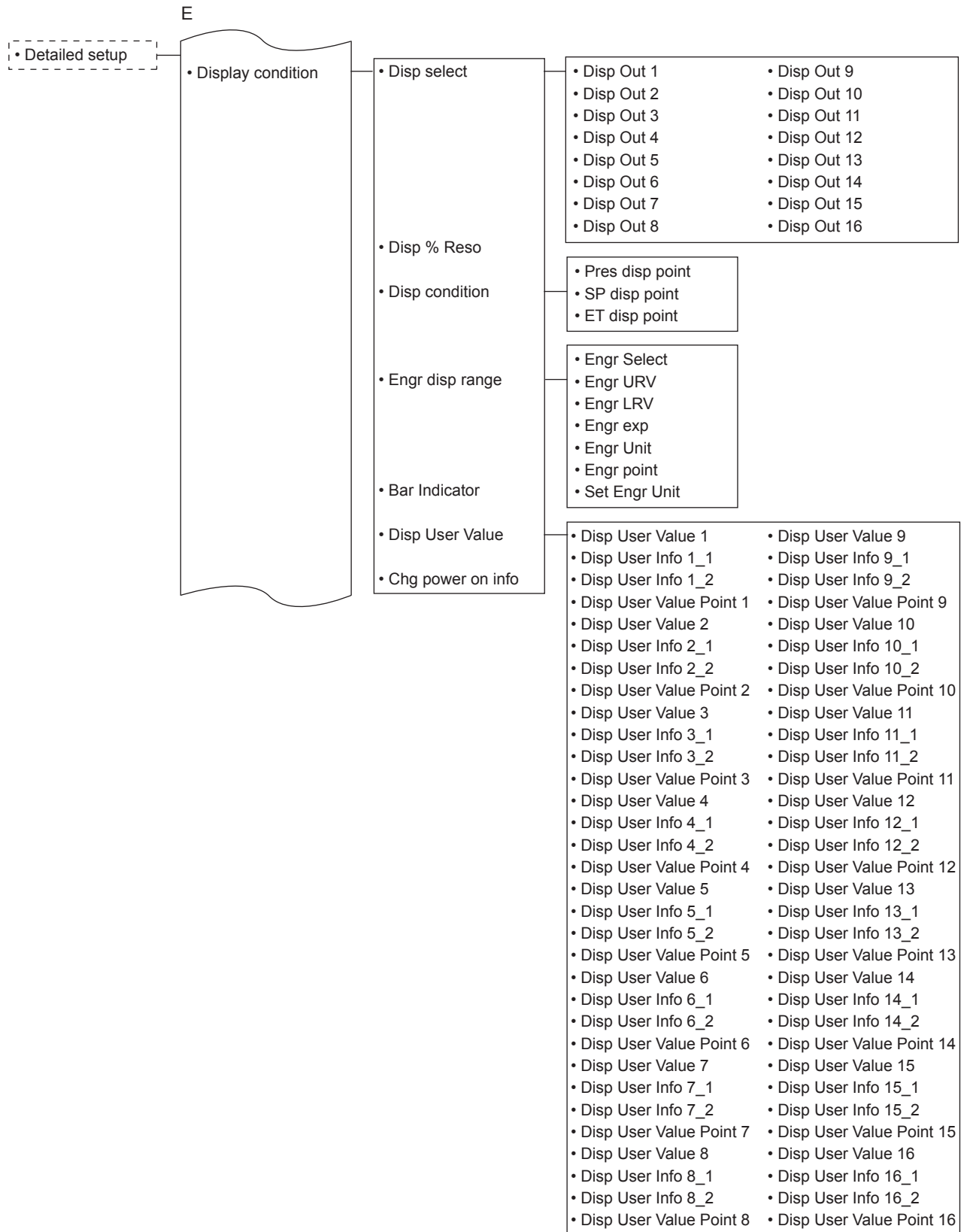

F0301-06.ai

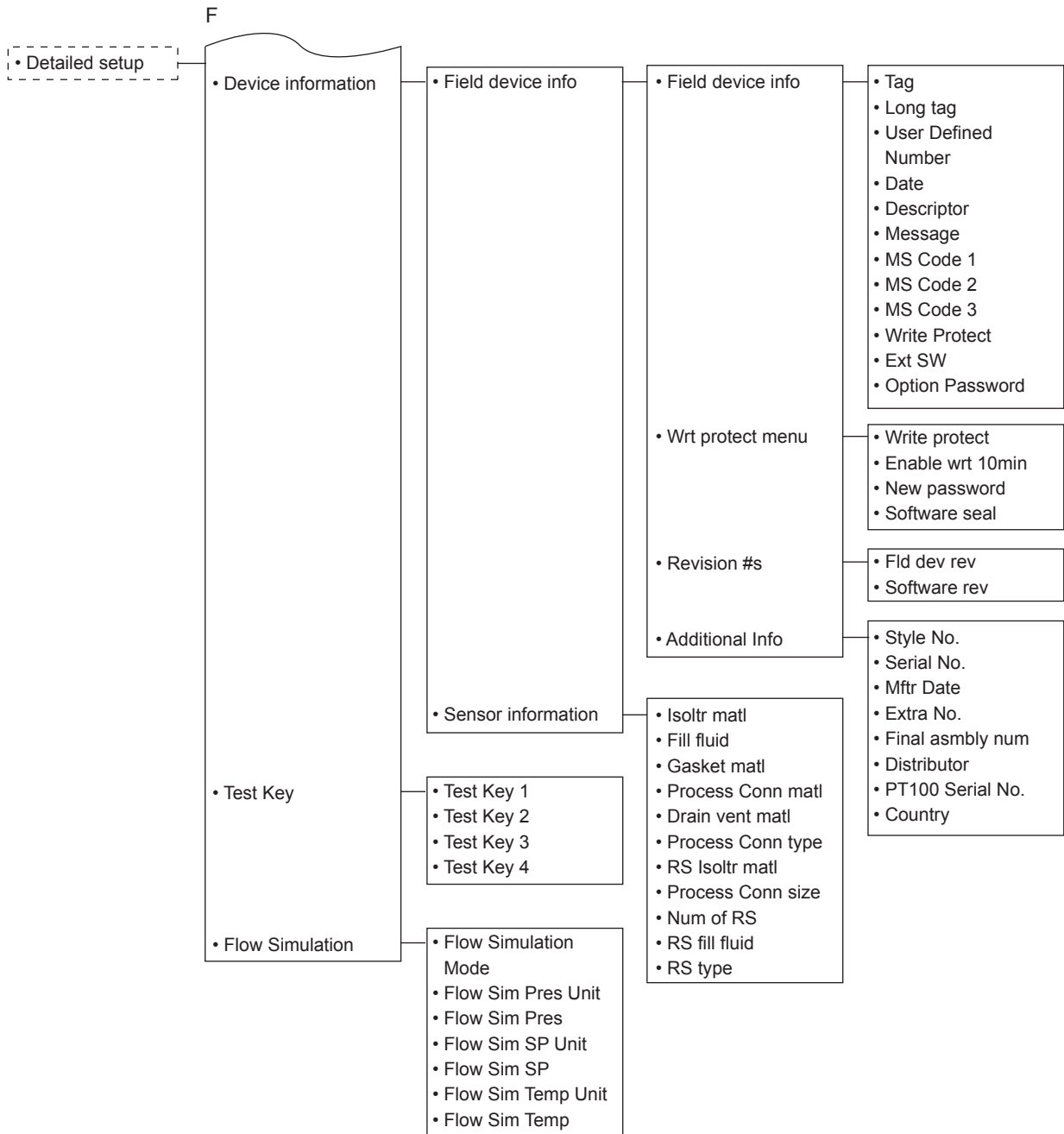

F0301-07.ai



**IMPORTANT**

After setting and sending data with the configuration tool, wait 30 seconds before turning off the transmitter. If it is turned off too soon, the settings will not be stored in the transmitter.

**3.2 Communication Setup**

This section shows how to confirm and change the EJX Multivariable Transmitter parameters for Modbus communication. The setting is activated after powering on except “Turnaround Delay Time” and “Bus termination”.

- Procedure to call up the display

Item	Procedure
Slave Address	[Root Menu] → Communication setup
Stop Bit	[Root Menu] → Communication setup
Parity	[Root Menu] → Communication setup
Turnaround Delay Time	[Root Menu] → Communication setup
Baud rate [Hardware Switch]	Refer to 2.1.1 The Hardware Switch
Bus termination [Hardware Switch]	Refer to 2.1.1 The Hardware Switch

**(1) Slave Address**

EJX Multivariable Transmitter slave address is set by this parameter in order to identify the slave device from the Modbus host. This parameter should not be set as same address from multiple devices under the multi drop connection. Address can be selected from 1\* to 247.

**(2) Stop Bit**

Select Modbus communication Stop Bit from 1bit\*/2bit

**(3) Parity**

Select Modbus communication Parity from none\*/even/odd

**(4) Turnaround Delay Time**

The waiting time (ms) between receiving the request from the host and starting the response from the device is set by this parameter. The actual response time of the device is “communication process time”<sup>(①)</sup> + “Turnaround Delay Time”<sup>(②)</sup>. When set to 10 ms\* which is lower limit, the response time is only “communication process time”. Refer Figure 3.1.

\*: Factory default setting.



**NOTE**

- We recommend that host timeout period is set larger than 3 s when transmitted data size is big.
- We recommend that the host communication period<sup>(③)</sup> between receiving the response from the device and sending the request to the device is set larger than 100 ms under the multi drop connection. Refer Figure 3.1.

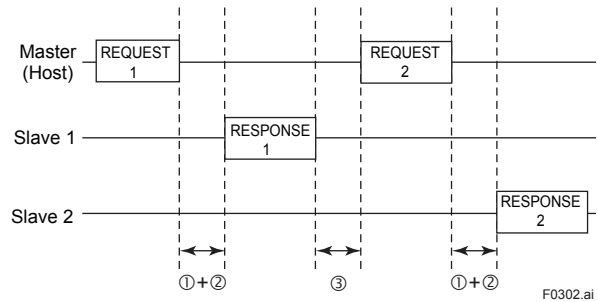

Figure 3.1



### 3.3 Basic Setup

#### 3.3.1 Tag and Device Information

If there are specified when ordering, the desired Tag No. and device information are set and shipped. Tag No. and device information can be checked as follows.

- Procedure to call up the display

Item	Procedure
Tag	[Root Menu] → Basic setup → Tag → Tag
Long Tag	[Root Menu] → Basic setup → Tag → Long Tag
Descriptor	[Root Menu] → Basic setup → Device information → Descriptor
Message	[Root Menu] → Basic setup → Device information → Message
Date	[Root Menu] → Basic setup → Device information → Date

When the Tag No. and device information are changed, input them based on the following limitations.

Item	Limitations
Tag	Up to 8 characters or numbers*1
Long tag	Up to 32 characters or numbers*2
Descriptor	Up to 16 characters or numbers*1
Message	Up to 32 characters or numbers*1
Date	mm/dd/yyyy - mm: month (2 digits) - dd: days (2 digits) - yyyy: years (4 digits)

\*1: The characters bounded by the thick line in the following table can be used.

\*2: All characters in the following table can be used.

SP	!	"	#	\$	%	&	'	(	)	*	+	,	-	.	/
0	1	2	3	4	5	6	7	8	9	:	;	<	=	>	?
@	A	B	C	D	E	F	G	H	I	J	K	L	M	N	O
P	Q	R	S	T	U	V	W	X	Y	Z	[	\	]	^	_
`	a	b	c	d	e	f	g	h	i	j	k	l	m	n	o
p	q	r	s	t	u	v	w	x	y	z	{		}	~	

\*: SP shows one-byte space

#### 3.3.2 Process Variables

Process Variables and Status are monitored by following menus. The status information is explained in "4. Diagnostics."

- Procedure to call up the display

Item	Procedure
• Press, SP, ET • % range of Press, SP, ET	[Root Menu]
Process Variables and Status	[Root Menu] → Process variables → Process variables → Device Variable and Status

#### 3.3.3 Measuring Range

This section shows how to confirm and change the parameters for measuring range of differential pressure, static pressure, and external temperature, and also unit and damping time constant.

These parameters are set at the factory before shipment if specified at the time of order.

Follow the procedure below to change them.

About the differential pressure, static pressure and external temperature, settable range are shown on the parameters of LSL (Lower settable limit), USL (Upper settable limit) and Min span (Minimum span). Set the data within the range.

- Procedure to call up the display

Call up and setting of differential pressure related parameters	
[Root Menu] → Detailed setup → Signal condition → DP Setup →	
→ Pres LRV	Lower range value for differential pressure
→ Pres URV	Upper range value for differential pressure
→ Pres Unit	Unit for differential pressure
→ Pres Damp	Damping time constant for differential pressure

Call up and setting of static pressure related parameters	
[Root Menu] → Detailed setup → Signal condition → SP Setup →	
→ SP LRV	Lower range value for static pressure
→ SP URV	Upper range value for static pressure
→ SP Unit	Unit for static pressure
→ SP Damp	Damping time constant for static pressure

Call up and setting of external temperature related parameters	
[Root Menu] → Detailed setup → Signal condition → ET Setup →	
→ ET LRV	Lower range value for external temperature
→ ET URV	Upper range value for external temperature
→ ET Unit	Unit for external temperature
→ ET Damp	Damping time constant for external temperature

### 3.3.4 Units

Refer to the subsection 3.3.3 to call up the display. Select the unit from displayed list as shown below.

#### (1) Unit list of differential pressure

mmH<sub>2</sub>O, mmH<sub>2</sub>O@68degF, mmHg, Torr, MPa, kPa, Pa, mbar, bar, gf/cm<sup>2</sup>, kgf/cm<sup>2</sup>, inH<sub>2</sub>O, inH<sub>2</sub>O@68degF, inHg, ftH<sub>2</sub>O, ftH<sub>2</sub>O@68degF, psi, atm, hPa

Note that the Yokogawa default setting for the standard temperature is 4°C (39.2°F). For the units of mmH<sub>2</sub>O, inH<sub>2</sub>O, and ftH<sub>2</sub>O, the pressure varies according to the standard temperature definition. Select the appropriate unit with @68degF when a standard temperature of 20°C (68°F) is required.

#### (2) Unit list of static pressure

mmH<sub>2</sub>O, mmH<sub>2</sub>O@68degF, mmHg, Torr, MPa, kPa, Pa, mbar, bar, gf/cm<sup>2</sup>, kgf/cm<sup>2</sup>, inH<sub>2</sub>O, inH<sub>2</sub>O@68degF, inHg, ftH<sub>2</sub>O, ftH<sub>2</sub>O@68degF, psi, atm, hPa

#### (3) Unit list of temperature

degC, degF, Kelvin

### 3.3.5 Damping Time Constant Setup

Any number from 0.00 to 100.00 can be set for the amplifier damping time constant of process variables.

Refer to subsection 3.3.3 to call up the display.

Damping time constant is set as shown in the following table at the factory when the instrument is shipped, but in case of the option code /CE is specified, the damping time constant is set as specified in the order.

Process variables	Factory default value
Differential pressure	2s
Static pressure	1s
External temperature	1s



### NOTE

The damping time constant for the amplifier assembly can be set here. The damping time constant for the entire transmitter is the sum of the values for the amplifier assembly and the capsule assembly.

About the value for the capsule assembly, refer to the User's Manual for EJX910/EJX930 (IM 01C25R01-01E) or General Specifications (GS 01C25R01-01EN, GS 01C25R04-01EN).

### 3.3.6 Differential Pressure Signal Low Cut Mode Setup

Low cut mode can be used to stabilize the differential pressure output signal near the zero point. The Low cut is applied to the differential pressure used to flow calculation. The low cut point can be set from 0 to 20% of output. (Hysteresis for the cut point: ±10% of the cut point )

Follow the procedure below to change the Low cut mode and Low cut point.

- Procedure to call up the display

[Root Menu] → Basic setup → Others →	
→ Low cut	Set from 0 to 20% of output
→ Low cut mode	Select "On" or "Off"

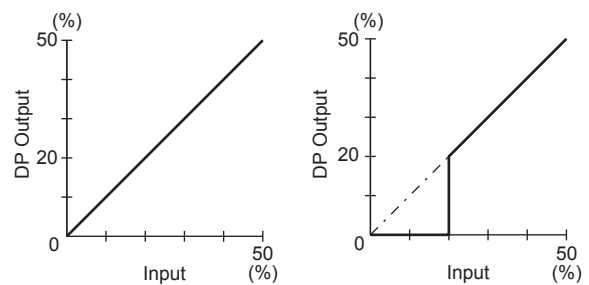

For low cut in Off mode

For low cut in On mode

F0303.ai

Figure 3.2 Low Cut Mode

The low cut point has hysteresis so that the output around the point is behaved as below figure.

<Example>

Low cut mode: On  
Low cut: 20.00%

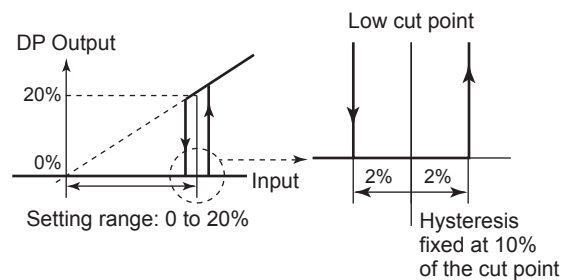

F0304.ai

### 3.3.7 Impulse Line Connection Orientation Setup

This function reverses the impulse line orientation. This function is used when the high pressure side impulse line and the low pressure side impulse line are connected reverse by mistake.

Follow the procedure below to assign the high pressure impulse line to the L side of the transmitter.

- Procedure to call up the display

[Root Menu] → Basic setup → Others →	
→ H/L Swap	Select "Normal" or "Reverse"

### 3.4 Detailed Setup

#### 3.4.1 Static Pressure Setup

##### (1) Selection of Gauge pressure and Absolute pressure

Either the gauge pressure or absolute pressure can be selected to display on the LCD display. Absolute pressure is selected when the instrument is shipped.

- Procedure to call up the display

[Root Menu] → Detailed setup → Signal condition → SP Setup →	
→ A / G Select	Select "Gauge" or "Absolute"

##### (2) Selection of pressure side

Either the high or low pressure side of capsule can be selected to monitor the static pressure. High pressure side is selected when the instrument is shipped.

- Procedure to call up the display

[Root Menu] → Detailed setup → Signal condition → SP Setup →	
→ SP H/L Select	Select "High" or "Low"

#### 3.4.2 External Temperature Fixation Mode

The external temperature can be fixed with this mode. The parameter setting to enter the Fixation Mode when the RTD sensor is disconnected is also possible.







- Procedure to call up the display

[Root Menu] → Detailed setup → Signal condition → ET Setup →	
→ ET Fixed	Select "No", "Yes" or "FALL BACK" No: Shows process temperature value Yes: Fix the temperature value FALL BACK: Fix the temperature value when the RTD sensor is disconnected.
→ Fixed ET Val	Set the fixed temperature value

#### 3.4.3 Integral Indicator Setup

The following displays are available for integral indicator. A cycle can be shown by assigning variables to the parameters at **Disp select**.

- Input differential pressure
- Input static pressure
- Input external temperature
- User setting of Engineering Unit and Scale
- External input values and information (16 items)

Available displays	Description and related parameters
Input differential pressure (Pres) 	Indicates values of input differential pressure with the indication limits -99999 to 99999.  PRES 45.6 kPa
Input static pressure (SP) 	Indicates values of input static pressure with the indication limits -99999 to 99999.  SP 6.178 MPa
Input ext. temperature (ET) 	Indicates values of input external temperature with the indication limits -99999 to 99999.  ET 22.95 degC
User setting of Engineering Unit and Scale (Engr Disp) 	Indicates values depending on the engineering range ( <b>Engr LRV</b> and <b>Engr URV</b> ) with the unit ( <b>Engr Unit</b> ).  Engr LRV 0.0 Engr URV 45.0 Engr exp x100 Engr Unit m3/min Engr point 1
External input value and information1 	Indicates 16 external input values and information1. Information1 can be used e.g. the kind of external input value.  Disp User Value1: 6.178 Disp User Infol_1: FLOW
External input value and information2 	Indicates 16 external input values and information2. Information2 can be used e.g. the unit of external input value. The external input value during the information1 continues to display during the information2 display.  Disp User Infol_2: g/s

F0305.ai

See (a) through (e) for the setting procedures.

**a. Display Selection**

At **Disp select**, select the variable that the parameter Disp 1 will display on the integral indicator.

- Procedure to call up the display

<b>[Root Menu]</b> → Detailed setup → Display condition → Disp select →	
→ Disp Out 1	Select desired display from five kinds of displays shown above.

Set Disp OUT 2 to 16 in the same way if necessary. "Not used" is also displayed as a selection item.

**b. Cyclic Display**

Displays can be displayed cyclically in the order of the parameter number.

**c. Display Resolution**

User can change the position of decimal point which is shown on the integral indicator.

- Procedure to call up the **Disp % reso** display

<b>[Root Menu]</b> → Detailed setup → Display condition →	
→ Disp % Reso	Select the decimal point position of % Normal: Display one digit below the decimal point High Resolution: Display two digits below the decimal point

- Procedure to call up the **Pres disp point, SP disp point** and **ET disp point** display

<b>[Root Menu]</b> → Detailed setup → Display condition → Disp Condition →	
→ Pres disp point	Select the decimal point position of differential pressure (0, 1, 2, 3 or 4)
→ SP disp point	Select the decimal point position of static pressure (0, 1, 2, 3 or 4)
→ ET disp point	Select the decimal point position of external temperature (0, 1, 2, 3 or 4)

**d. User Setting of Engineering Unit and Scale**

**Engr disp range** parameters allow the engineering unit and scale to be displayed. At **Set Engr Unit**, the following engineering units can be selected from a list.

- Procedure to call up the display

<b>[Root Menu]</b> → Detailed setup → Display condition → Engr disp range	
→ Set Engr Unit	Select the engineering unit
→ Engr LRV	Lower range value
→ Engr URV	Upper range value
→ Engr exp	Exponents for user scale display
→ Engr point	Decimal point position for user scale display
→ Engr unit	Confirm and set unit
→ Engr Select	Select the target of Engineering unit

Select the engineering unit from the list. Available units are shown below

kPa	ftH <sub>2</sub> O	NI/min
MPa	gf/cm <sup>2</sup>	Nm <sup>3</sup> /h
mbar	kgf/cm <sup>2</sup>	Nm <sup>3</sup> /min
bar	kg/cm <sup>2</sup> G	ACFH
psi	kg/cm <sup>2</sup> A	ACFM
psia	atm	CFH
mmH <sub>2</sub> O	kg/h	SCFM
mmHg	t/h	GPH
mmHgA	m <sup>3</sup> /h	GPM
mmAq	m <sup>3</sup> /min	m
mmWG	l/h	mm
Torr	l/min	in
inH <sub>2</sub> O	kl/h	ft
inHg	kl/min	kg/m <sup>3</sup>
inHgA	NI/h	g/cm <sup>3</sup>

At **Engr Unit** parameter, user can confirm and set your own unit also.

Up to eight alphanumeric characters, spaces or one slash (/) can be input at **Engr Unit**; only the first six are displayed on the integral indicator.

- Procedure to call up the display

<b>[Root Menu]</b> → Detailed setup → Display condition → Engr disp range →	
→ Engr Unit	Set your own unit

Note that following symbols are not available:

# % & < > . \* : + - , ' ( )

The integral indicator shows "-----" when these symbols or more than two slashes are entered.

**e. External input values and information**

16 external input values corresponds to "**Disp User Value 1-16**" selection lists and they can be selected from 16 integral indicator display "**Disp Out 1-16**" parameters. Regarding the Procedure to call up the display, refer to "a. Display Selection".

External input value can be set to floating variable parameter "**Disp User Value 1-16**" parameters and external input information1 can be set to 8 characters variable "**Disp User Info 1\_1-16\_1**" parameters.

External input information2 can be set into 8 characters variable "**Disp User Info 1\_2-16\_2**." User can change the position of decimal point which is shown on the integral indicator by "**Disp User Value Point 1-16**" parameters.

- Procedure to call up the display

[Root Menu] → Detailed setup → Display condition → Disp User Value	
→ Disp User Value 1-16	External input value (16 items)
→ Disp User Info 1_1-16_1	External input information1* e.g. the kind of external input value (16 items)
→ Disp User Info 1_2-16_2	External input information2* e.g. the unit of external input value (16 items)
→ Disp User Value Point 1-16	The position of decimal point is selected from the list. <ul style="list-style-type: none"> <li>• Integer</li> <li>• 1 Down to 1 place of decimals</li> <li>• 2 Down to 2 places of decimals</li> <li>• 3 Down to 3 places of decimals</li> <li>• 4 Down to 4 places of decimals</li> </ul>

- \*: The characters which can be displayed are:
- Alphanumeric (upper case and lower case)
  - Space
  - - (minus)
  - . (period)
  - / (slash)
- The displayed character length is
- 6 characters without "." or "/"
  - 7 characters if one "." or "/" is included.

### 3.4.4 Sensor Trim

EJX multivariable transmitter is factory characterized. Factory characterization is the process of comparing a known pressure input with the output of each transmitter sensor module over the entire pressure and temperature operating range. During the characterization process, this comparison information is stored in the transmitter EEPROM. In operation, the transmitter uses this factory-stored curve to produce a process variable output (PV), in engineering units, dependent on the pressure input.

The sensor trim procedure allows you to adjust for local conditions, changing how the transmitter calculates process variables. There are two ways to trim the sensor: a zero trim and a full sensor trim. A zero trim is a one-point adjustment typically used to compensate for mounting position effects or zero shifts caused by static pressure. A full sensor trim is a two-point process, in which two accurate end-point pressures are applied (equal to or greater than the range values), and all output is linearized between them.

#### Full Sensor Trim—Auto Trim and Manual Trim

Full sensor trim is carried out by performing **Auto, Lower Pt** followed by **Auto, Upper Pt**.

Also, you can manually perform the trimming procedure with **Manual, Lower Pt** and **Manual, Upper Pt**.

The full sensor trim is a two-point adjustment, and the lower point adjustment should always be performed before the upper point adjustment in order to maintain the pitch between the zero and 100% points within the calibration range.

In the manual method, the reference pressure should also be applied to the transmitter at both the lower and upper points. Without the reference pressure, **Manual, Lower Pt** and **Manual, Upper Pt** may not represent the correct value for each adjustment point.

#### (1) Auto Sensor Trim

Applying reference pressure of 0% and 100% of the measurement range to the transmitter, adjust the lower and upper points automatically.

- Procedure to call up the display

[Root Menu] → Diag/Service → Calibration → Pres sensor trim → Pres trim →	
→ Auto, Lower Pt	Auto trim for 0% point
→ Auto, Upper Pt	Auto trim for 100% point

#### (2) Manual Sensor Trim

Using the example below, follow the steps to perform the full sensor trim by manually. The Pres LTD (Manual, Lower Pt) and Pres UTD (Manual, Upper Pt) represent the previously adjusted values

Example: For the range of 1000 to 3000 mmH<sub>2</sub>O  
**Pres LTD (Manual, Lower Pt) = -4.0 mmH<sub>2</sub>O**  
**Pres UTD (Manual, Upper Pt) = -3.0 mmH<sub>2</sub>O**

<1> Call up the **Manual, Lower Pt**.

- Procedure to call up the display

[Root Menu] → Diag/Service → Calibration → Pres sensor trim → Pres trim →	
→ Manual, Lower Pt	Manual trim for 0% point
→ Manual, Upper Pt	Manual trim for 100% point

<2> Suppose that a standard pressure of 1000 mmH<sub>2</sub>O is applied and the value of the "Pres for trim" is 994.0. Correct for this output error of 6 mmH<sub>2</sub>O by adding 6 mmH<sub>2</sub>O to **Pres LTD (Manual, Lower Pt)**.

$$-4.0 + 6.0 = +2.0$$

<3> Enter the correction value of “2” to the **Pres LTD (Manual, Lower Pt)**.

<4> Call up the **Pres UTD (Manual, Upper Pt)**.

<5> Suppose that a standard pressure of 3000 mmH<sub>2</sub>O is applied and the value of the Pres for trim is 3015.0. Firstly, obtain the slope error for the span as follows;

$$\begin{aligned} \text{Slope Error} &= \frac{\text{Applied Pressure Value} - \text{Value of Pres for Trim}}{\text{Applied Pressure Value}} \times (\text{URV} - \text{LRV}) \\ &= \frac{3000 - 3015}{3000} \times (3000 - 1000) = -10 \end{aligned}$$

Then correct for this slope error of -10 by adding -10 to **Pres UTD (Manual, Upper Pt)**.  
-3.0 + (-10.0) = -13.0

<6> Enter the correction value of “-13” to the **Pres UTD (Manual, Upper Pt)**.

### (3) Sensor Trim for Static Pressure or External Temperature

For the EJX multivariable transmitter, full sensor trim of the static pressure or external temperature is performed in the same way as with the differential pressure.

- Procedure to call up the display for static pressure

[Root Menu] → Diag/Service → Calibration → SP sensor trim → SP trim →	
→ Auto, Lower Pt	Auto trim for 0% point
→ Auto, Upper Pt	Auto trim for 100% point
→ Manual, Lower Pt	Manual trim for 0% point
→ Manual, Upper Pt	Manual trim for 100% point

- Procedure to call up the display for external temperature

[Root Menu] → Diag/Service → Calibration → ET Sensor trim → ET trim →	
→ Auto, Lower Pt	Auto trim for 0% point
→ Auto, Upper Pt	Auto trim for 100% point
→ Manual, Lower Pt	Manual trim for 0% point
→ Manual, Upper Pt	Manual trim for 100% point

### (4) Reset Trim Adjustment to Factory Setting

The **Clear P trim**, **Clear SP trim** and **Clear ET trim** commands can reset the trim adjustment to the initial calibrated values that were set. The amount of the adjustment performed with the external zero-adjustment screw is returned to the initial setting as well.

- Procedure to call up the display for differential pressure

[Root Menu] → Diag/Service → Calibration → Pres Sensor trim → Clear P trim → Execute
--

- Procedure to call up the display for static pressure

[Root Menu] → Diag/Service → Calibration → SP Sensor trim → Clear SP trim → Execute
---

- Procedure to call up the display for external temperature

[Root Menu] → Diag/Service → Calibration → ET Sensor trim → Clear ET trim → Execute
---

### (5) Calibration flag

When the **Calibration Flag** parameter is set, the corresponding status bit in **Status Bits** and **Status Bytes** parameter in Address Map (Basic Information) will turn ON. The **Calibration Flag** parameter is used only for informational use and does not affect the internal operation of the EJX Multivariable transmitter. Regarding the **Calibration Flag** parameter, refer to 4.1.1.

- Procedure to call up the display

[Root Menu] → Diag/Service → Calibration → Calibration Flag	
→ Calibration Flag	Flag the transmitter is in a calibration State.

### 3.4.5 External Switch Mode

Follow the procedure below to enable or inhibit zero point adjustment by means of the zero-adjustment screw on the transmitter.

This is set to “Disable” when the instrument is shipped.

To change the mode, follow the procedure below.

- Procedure to call up the display

[Root Menu] → Detailed setup → Device information → Field device info → Ext SW	
Enabled	Enable the external zero point adjustment
Disabled	Disable the external zero point adjustment

**3.4.6 Software Write Protection**

EJX multivariable transmitter configured data is saved by using a write protection function. The write protection status is set to “Yes” when 8 alphanumeric characters are entered in the **New password** field and transferred to the transmitter.

When write protection is set to “Yes,” the transmitter does not accept all the write possible parameters changes. When the same eight alphanumeric string entered in the **New password** field is also entered in the **Enable wrt 10min** field and transferred to the transmitter, it will be possible to change transmitter parameters during a 10 minute period.

To change the transmitter from the write protection “Yes” status back to write protection “No” status, use **Enable wrt 10min** to first release the write protection function and then enter eight spaces in the **New password** field.

- Procedure to call up the display

[Root Menu] → Detailed setup → Device information → Field device info → Wrt protect menu →	
→ Write Protect	Display current protect mode (Yes: protected, No: not protected)
→ Enable wrt 10 min	Release the protect function for 10 min.
→ New password	Set the new password or change the password

**3.4.7 Alarm**

The function is used to display the alarm codes when the input differential pressure exceeds the specified value within the calibration range. The same is available for the input static pressure and external temperature. Refer to Table 4.1 Alarm Message Summary for the specific alarm code to be generated.

**(1) Alarm Setting**

Select the process variable at **Process Alert** which the alarm is set, then set the alert mode for that value.

- Procedure to call up the display

[Root Menu] → Detailed setup → Output condition → Process Alerts →	
Selection of the process variable for alarm	→ Pres Alert Mode: Differential pressure
	→ SP Alert Mode: Static pressure
	→ ET Alert Mode: External temperature
Selection of alert mode	Off: Disable the alert function
	Hi AI Detect: High side alert detection
	Lo AI Detect: Low side alert detection
	Hi/Lo AI Detect: High and Low side alert detection

**(2) Threshold Level Setting**

Set the threshold of high and low alert value for alarm generation.

- Procedure to call up the display

[Root Menu] → Detailed setup → Output condition → Process Alerts →	
Parameter	Detail
→ Pres Hi Alert Val	Set the threshold value of upper side for differential pressure
→ Pres Lo Alert Val	Set the threshold value of lower side for differential pressure
→ SP Hi Alert Val	Set the threshold value of upper side for static pressure
→ SP Lo Alert Val	Set the threshold value of lower side for static pressure
→ ET Hi Alert Val	Set the threshold value of upper side for external temperature
→ ET Lo Alert Val	Set the threshold value of lower side for external temperature

3.4.8 Simulation and Squawk



**NOTE**

Flow Simulation Mode, and Device Variable Simulation Function continue for a given holding time, then is released automatically. Even if the configuration tool power supply is turned off or the communication cable is disconnected, the test output will continue for that time.

The holding time can be selected from 10 min\*, 30 min, 60 min, 3 hour, 6 hour or 12 hour.

\*: Default value.

- Procedure to call up the display

[Root Menu] → Diag/Service → Test  
→ Test Auto Release Time

(1) Flow Simulation Mode

The pseudo values instead of using actual measurements of differential pressure, static pressure, and external temperature can be used.

This is called “flow simulation mode.”

The output value becomes the simulation value and the LCD continuously displays the simulation value and alarm (AL.90 SIM) in alternating sequence.

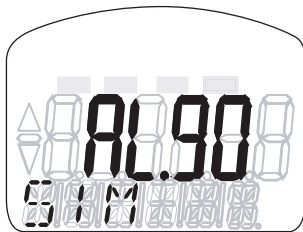

F0306.ai

Select the desired simulation mode from the list below, and set the unit and value.

- Procedure to call up the display

[Root Menu] → Detailed setup → Flow Simulation →		
→ Flow Simulation Mode  (Select the combination of pseudo variables)	Off:	–
	ON: DP	Differential pressure only
	ON: SP	Static pressure only
	ON: DP SP	Differential pressure and static pressure
	ON: ET	External temperature only
	ON: DP ET	Differential pressure and external temperature
	ON: SP ET	Static pressure and external temperature
	ON: DP SP ET	Differential pressure, static pressure and external temperature
→ Flow Sim Pres Unit	Check Flow Calc	Differential pressure, static pressure, and external temperature without damping
→ Flow Sim Pres	Select the unit for the differential pressure	
→ Flow Sim Pres	Set the differential pressure value for simulation	
It is similar about SP and ET.		



**NOTE**

The output process value while simulation can be monitored by LCD and through communication as follows.

Process value	Output value
DP	Simulation value according to simulation mode
SP	Simulation value according to simulation mode
ET	Simulation value according to simulation mode

Following function is reflected while simulation.

Simulation value	Function
DP/SP/ET	Measuring Range (LRV/URV) Alarm Status Output Damping Time*
DP	Low Cut Mode

\*: When “Check Flow Calc” is selected, damping is ignored.

If one of the following alarm occurs while simulation, all of the output data are held to the value before alarm occurs.

- AL.01 (CAP. ERR)
- AL.02 (AMP. ERR)
- AL.03 (ET. ERR)



**(2) Device Variable Simulation Function**

Using the simulation function, the output signal can be confirmed by setting any value and status to the selected device variable.

Call up the parameter and follow the message shown.

After completing the step 5, the simulation starts. Integral indicator shows output and alarm (AL.91) alternately.

- Procedure of device variable simulation

Step 1	Call up the parameter	[Root Menu] → Diag/Service → Test → Simulate
2	Selection of Device Variable	Select one parameter from the list below Off Pres SP ET
3	Setting of Value	Input the simulate value
4	Setting of Data quality	Select one parameter from the list below Bad Poor accuracy Manual / Fixed Good
5	Setting of Limit status	Select one parameter from the list below Not limited Low limited High limited Constant



**NOTE**

- All the simulations for differential pressure, static pressure and external temperature, are reflected to the output. Accordingly, LCD display, and communication output are directly corresponded to the simulate value. The alarm output is also available according to the simulate value.
- Damping is applicable for differential pressure, static pressure, and external temperature simulation.

**(3) Squawk**

This feature can be used to identify the communicating transmitter by remotely causing LCD to display the particular pattern as shown in the Figure 3.3.

“SQUAWK” continues for approximately 10 seconds, then is released automatically.

- Procedure to call up the **Squawk** display

[Root Menu] → Diag/Service → Test → Squawk

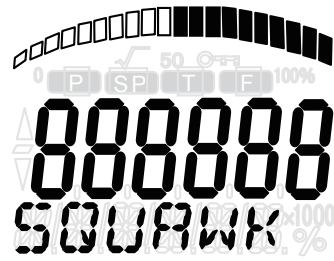

F0307.ai

Figure 3.3 LCD display for Squawk

# 4. Diagnostics

## 4.1 Self-Diagnostics

### 4.1.1 Identify Problems by Using the Configuration Tool

The configuration tool can be used to run self-diagnostics on a transmitter and check for incorrect data settings.

The **Status** menu is available for self-diagnostics.

If the specific diagnostic item is known for the check, you can directly call up the item by using the **Status** menu.

The status is categorized from 1 to 11. See Table 4.1 to determine the status group. Show an example below to confirm the status of Status group 1.

- Procedure to call up the **Status** display

[Root Menu] → Diag/Service → Status → Status group 1

If no error is detected, check mark is cleared on the configuration tool.

If there is an error, “check mark” is displayed on the configuration tool, and a countermeasure for that error is necessary.

In addition to **Status group 1-11** parameters, **Status Bytes** parameter in Address Map (Basic Information) is available.

[Root Menu] →Diag/Service → Status	
→ Status Bytes	Status information only mapped in Address Map (Basic Information)

### 4.1.2 Checking with Integral Indicator



#### NOTE

If an error is detected by running self-diagnostics, an error number is displayed on the integral indicator. If there is more than one error, the error number changes at three-second intervals. See Table 4.1 regarding the alarm codes.



F0401.ai

Figure 4.1 Integral Indicator

### 4.1.3 Status Information

- (1) Data quality and Limit status  
EJX multivariable transmitter can handle Device Variables (DP(Pres), SP, ET. Each variable contains data quality and limit status for providing useful status about the data value. The data quality is normally “Good”. However, in the case of a sensor failure or out of measurement range, it turns to “Bad” or “Poor Accuracy”. The limit status indicates whether the data value is limited (i.e., not responding to the process). When the limit status is “Constant”, the value will not be changed. For detail, refer to Table 4.1 and 4.2.

- Procedure to call up the display

[Device Variables]

[Root Menu] → Process variables → Device variables and Status →	
→ Press Data Quality	Good, Poor Accuracy, Manual/Fixed, or Bad is displayed.
→ press Limit Status	Constant, Low Limit, High Limit, or Not Limited is displayed.
It is the same about the SP and ET.	

- (2) Configuration Change Counter  
The Configuration Change Counter is incremented once for every user action that changes the device’s configuration or calibration. This value is never reset or written and maintained even if power is removed from the device.

- Procedure to call up the display

[Root Menu] → Diag/Service → Status →	
→ Cfg chng count	The configuration change times are counted.

- (3) Reset Configuration Change Counter  
Configuration Change Counter can be reset by this method.

- Procedure to call up the display

[Root Menu] → Diag/Service → Status → Reset Cfg Chng Count

## 4.2 Alarms and Countermeasures

Table 4.1 Alarm Message Summary

Integral Indicator	DTM display	Status group	Cause	Countermeasure	Value and Status (Data Quality and Limit Status)					
					Differential Pressure (DP)	Static Pressure (SP)	External Temperature (ET)	DP %	SP %	ET %
AL.01 CAP.ERR	P sensor error	1	Sensor problem.	Replace capsule if the error recurs after the transmitter is restarted.	Value: Hold value Status: Bad and Constant (0x30)			Value: Hold value Status: Bad and Constant (0x30)		
	CT sensor error		Capsule temperature sensor problem.	Replace capsule.	Value: Hold value Status: Bad and Constant (0x30)			Value: Hold value Status: Bad and Constant (0x30)		
	Cap EEPROM error		Capsule EEPROM problem.		Value: Hold value Status: Bad and Constant (0x30)			Value: Hold value Status: Bad and Constant (0x30)		
AL.02 AMP.ERR	Amp EEPROM error	2	Amplifier EEPROM problem.	Replace amplifier.	Value: Hold value Status: Bad and Constant (0x30)			Value: Hold value Status: Bad and Constant (0x30)		
	CPU board error		Amplifier problem.		Value: Hold value Status: Bad and Constant (0x30)			Value: Hold value Status: Bad and Constant (0x30)		
	ET module Com error	4			Value: Hold value Status: Bad and Constant (0x30)			Value: Hold value Status: Bad and Constant (0x30)		
	ET module error		Value: Hold value Status: Bad and Constant (0x30)			Value: Hold value Status: Bad and Constant (0x30)				
AL.03 ET. ERR*	ET sensor error		External temperature sensor disconnection.	Check external temperature sensor.	Value: Hold value Status: Bad and Constant (0x30)			Value: Hold value Status: Bad and Constant (0x30)		

\*: When ET is set as "Fixed" or "Fall back", this alarm does not occur.

Integral Indicator	DTM display	Status group	Cause	Countermeasure	Value and Status (Data Quality and Limit Status)									
					Differential Pressure (DP)	Static Pressure (SP)	External Temperature (ET)	DP %	SP %	ET %				
AL.10 PRESS	P outside limit	3	Differential pressure is outside measurement range limit of capsule.	Check input or replace capsule when necessary.	Value: Measured value Status: Poor Accuracy and Not Limited (0x40)	Value: Measured value Status: Good and Not Limited (0xC0)	Value: Measured value Status: Poor Accuracy and Not Limited (0x40)	Value: Measured value Status: Good and Not Limited (0xC0)	Value: Measured value Status: Good and Not Limited (0xC0)					
AL.11 ST.PRSS	SP outside limit		Static pressure exceeds limit.											
AL.12 CAP.TMP	CT outside limit		Capsule temperature is outside range (-50 to 130°C).	Use heat insulation or make lagging to keep temperature within range.										
AL.13 AMP.TMP	AT outside limit		Amplifier temperature is outside range (-50 to 95°C).							Value: Measured value Status: Good and Not Limited (0xC0)	Value: Measured value Status: Good and Not Limited (0xC0)			
AL.14 EXT.TMP	ET outside limit		External temperature is outside range.	Value: Measured value Status: Good and Not Limited (0xC0)								Value: Measured value Status: Poor Accuracy and Not Limited (0x40)	Value: Measured value Status: Good and Not Limited (0xC0)	Value: Measured value Status: Poor Accuracy and Not Limited (0x40)
AL.15 EXT.TMP	OHM outside limit		External temperature sensor resistance is out specification.											
AL.30 PRS.RNG	P over range	4	Differential pressure exceeds specified range.	Check input and range setting, and change them as needed.	Value: Measured value Status: Good and Not Limited (0xC0)	Value: Measured value Status: Good and Not Limited (0xC0)	Value: Hold value Status: Bad and Constant (0x30)	Value: Measured value Status: Good and Not Limited (0xC0)						
AL.31 SP. RNG	SP over range		Static pressure exceeds specified range.						Value: Measured value Status: Good and Not Limited (0xC0)	Value: Hold value Status: Bad and Constant (0x30)	Value: Measured value Status: Good and Not Limited (0xC0)			
AL.33 ET. RNG	ET over range		External temperature exceeds specified range.									Value: Measured value Status: Good and Not Limited (0xC0)	Value: Hold value Status: Bad and Constant (0x30)	

Integral Indicator	DTM display	Status group	Cause	Countermeasure	Value and Status (Data Quality and Limit Status)					
					Differential Pressure (DP)	Static Pressure (SP)	External Temperature (ET)	DP %	SP %	ET %
AL.35 P. HI	P high alarm	5	Input pressure exceeds specified threshold.	Check input.	Value: Measured value Status: Good and Not Limited (0xC0)			Value: Measured value Status: Good and Not Limited (0xC0)		
AL.36 P. LO	P low alarm									
AL.37 SP. HI	SP high alarm		Input static pressure exceeds specified threshold.							
AL.38 SP. LO	SP low alarm									
AL.43 ET. HI	ET high alarm	8	Input external temperature exceeds specified threshold.							
AL.44 ET. LO	ET low alarm									
AL.50 P. LRV	Illegal P LRV	6	Specified value is outside of setting range.	Check settings and change them as needed.	Value: Measured value Status: Good and Not Limited (0xC0)			Value: Hold value Status: Bad and Constant (0x30)	Value: Measured value Status: Good and Not Limited (0xC0)	
AL.51 P. URV	Illegal P URV									
AL.52 P. SPN	Illegal P SPAN									
AL.53 P. ADJ	P SPAN trim err			Adjust settings and change them as needed.	Value: Measured value Status: Poor Accuracy and Not Limited (0x40)	Value: Measured value Status: Good and Not Limited (0xC0)	Value: Measured value Status: Poor Accuracy and Not Limited (0x40)	Value: Measured value Status: Good and Not Limited (0xC0)		
	P ZERO trim err									
AL.54 SP. RNG	Illegal SP LRV			Check settings and change them as needed.	Value: Measured value Status: Good and Not Limited (0xC0)			Value: Measured value Status: Good and Not Limited (0xC0)	Value: Hold value Status: Bad and Constant (0x30)	Value: Measured value Status: Good and Not Limited (0xC0)
	Illegal SP URV									
	Illegal SP SPAN									

Integral Indicator	DTM display	Status group	Cause	Countermeasure	Value and Status (Data Quality and Limit Status)					
					Differential Pressure (DP)	Static Pressure (SP)	External Temperature (ET)	DP %	SP %	ET %
AL.55 SP.ADJ	SP SPAN trim err	7	Specified value is outside of setting range.	Adjust settings and change them as needed.	Value: Measured value Status: Good and Not Limited (0xC0)	Value: Measured value Status: Poor Accuracy and Not Limited (0x40)	Value: Measured value Status: Good and Not Limited (0xC0)	Value: Measured value Status: Good and Not Limited (0xC0)	Value: Measured value Status: Poor Accuracy and Not Limited (0x40)	Value: Measured value Status: Good and Not Limited (0xC0)
	SP ZERO trim err									
AL.56 ET.RNG	Illegal ET LRV	8		Check settings and change them as needed.	Value: Measured value Status: Good and Not Limited (0xC0)			Value: Measured value Status: Good and Not Limited (0xC0)		Value: Hold value Status: Bad and Constant (0x30)
	Illegal ET URV									
	Illegal ET SPAN									
AL.57 ET.ADJ	ET SPAN trim err	7		Adjust settings and change them as needed.	Value: Measured value Status: Good and Not Limited (0xC0)		Value: Measured value Status: Poor Accuracy and Not Limited (0x40)	Value: Measured value Status: Good and Not Limited (0xC0)		Value: Measured value Status: Poor Accuracy and Not Limited (0x40)
	ET ZERO trim err									
---	ET Fixed Mode	11	Under Temperature Fix Mode. PV is ET	Leave from Temperature Fix Mode.	Value: Measured value Status: Good and Not Limited (0xC0)		Value: Hold value Status: Good and Constant (0xF0)	Value: Measured value Status: Good and Not Limited (0xC0)		Value: Hold value Status: Good and Constant (0xF0)
AL.79 OV.DISP	(None)	(None)	Displayed value exceeds limit.	Check settings and change them as needed.	Value: Measured value Status: Good and Not Limited (0xC0)			Value: Measured value Status: Good and Not Limited (0xC0)		
AL.90 SIM	Flow Simulation mode	5	Under Simulation Mode for flow.	Check Simulation Mode.	Value: Measured value Status: Good and Not Limited (0xC0) or Value: Simulation value Status: Manual/Fixed and Constant (0xB0)			Value: Measured value Status: Good and Not Limited (0xC0) or Value: Simulation value Status: Manual/Fixed and Constant (0xB0)		
AL.91 P.SIM	P Simulate Mode	11	Under Simulation Mode for device variables.	Check Simulation Mode	Value and Status: Pressure simulation value	Value: Measured value Status: Good and Not Limited (0xC0)		unsupported		
AL.91 SP.SIM	SP Simulate Mode					Value and Status: Static Pressure simulation value				
AL.91 ET.SIM	ET Simulate Mode				Value: Measured value Status: Good and Not Limited (0xC0)	Value and Status: Temperature simulation value				

**Table 4.2 Data Quality and Limit Status**

<b>Data Quality</b>	<b>Description</b>
Good	The value may be used in control.
Poor Accuracy	The quality of the value is less than normal, but the value may still be useful.
Manual / Fixed	The value is manually fixed.
Bad	The value is not useful.

<b>Limit Status</b>	<b>Description</b>
Constant	The value cannot be changed, no matter what the process does.
Low Limited	The value is out of the high or low limit.
High Limited	
Not Limited	The value is free to change.

# 5. Modbus Communication

## 5.1 General

EJX Multivariable transmitter can communicate with the Modbus host.

**Table 5.1 Modbus specification**

Item	Description
Communication protocol	2-wire half duplex RS-485 Modbus
Flow control	None
Baud rate	1200, 4800, 9600*, 19200
Start bit	1 bit (Fixed)
Stop bit	1 bit*, 2 bits
Parity bit	Odd, Even, None*
Transfer mode	RTU (Remote Terminal Unit) Data length: 8 bits LSB (Least significant bit sent first)
Slave address	1* to 247
Support function	1: Read Coils 2: Read Discrete Inputs 3: Read Holding Registers 4: Read Input Register 5: Write Single Coil 8: Diagnostic (00: Return Query Data) 16: Write Multiple registers 43: Read device Identification
Max transmission frame size	200 byte
Turnaround Delay Time	10* to 200 ms

\*: Factory default setting

## 5.2 Message construction

The message transmitted from host is constructed as below.

#	Name	Size	Contents
1	Slave address	1 byte	The number host system distinguish the slave device (1 to 247)
2	Function code	1 byte	The function code from host
3	Data	0 to 196 bytes	Specify register address, number or data according to the function code.
4	Error check	2 byte	cyclic redundancy check (CRC-16)

## 5.3 Broadcast

Broadcast is a function receiving a command from all devices connected under multi drop mode.

- (1) Broadcast is executed by setting 0x00 to slave address.
- (2) This message function is executed regardless of device slave address.
- (3) This message is used only for write function.
- (4) No response is returned from the slave device.

## 5.4 Function code

### 5.4.1 01 (0x01) Read Coils

Specified quantity of Coil contents is read from Specified Starting Address.

Not corresponding to Broadcast.

#### Request

Items	Size [byte]	Data
Address	1	1 to 247
Function code	1	0x01
Starting Address	2	0x0000 to 0xFFFF
Quantity of coils	2	-
CRC	2	-

#### Response

Items	Size [byte]	Data
Address	1	1 to 247
Function code	1	0x01
Byte count	1	N *1
Coil Status *2	N *1	-
CRC	2	-

\*1: N is 1 when quantity of coils is less than or equal to 8.

\*2: e.g. When reading address is 1000 – 1007, MSB is 1007 and LSB is 1000.



### 5.4.2 02 (0x02) Read Discrete Inputs

Specified quantity of Discrete Inputs contents is read from Specified Starting Address.  
Not corresponding to Broadcast.

#### Request

Items	Size [byte]	Data
Address	1	1 to 247
Function code	1	0x02
Starting Address	2	0x0000 to 0xFFFF
Quantity of Inputs	2	-
CRC	2	-

#### Response

Items	Size [byte]	Data
Address	1	1 to 247
Function code	1	0x02
Byte count	1	N *1
Input Status *2	N *1	
CRC	2	-

- \*1: N is 1 when quantity of Discrete Inputs is less than or equal to 8.
- \*2: e.g. When reading address is 1000 – 1007, MSB is 1007 and LSB is 1000.

### 5.4.3 03 (0x03) Read Holding Registers

Specified quantity of Holding Registers contents is read from Specified Starting Address.  
Not corresponding to Broadcast.

#### Request

Items	Size [byte]	Data
Address	1	1 to 247
Function code	1	0x03
Starting Address	2	0x0000 to 0xFFFF
Quantity of Registers	2	-
CRC	2	-

#### Response

Items	Size [byte]	Data
Address	1	1 to 247
Function code	1	0x03
Byte count	1	N*1×2
Register value *2	N*1×2	
CRC	2	-

- \*1: N: The quantity specified by the Quantity of Registers.
- \*2: Transmitted by the order: Upper- Lower from the specified Starting Address.  
E.g. 10 in FLOAT format, Transmit order is as 0x41200000.

### 5.4.4 04 (0x04) Read Input Registers

Specified quantity of Input Registers contents is read from Specified Starting Address.  
Not corresponding to Broadcast.

#### Request

Items	Size [byte]	Data
Address	1	1 to 247
Function code	1	0x04
Starting Address	2	0x0000 to 0xFFFF
Quantity of Registers	2	-
CRC	2	-

#### Response

Items	Size [byte]	Data
Address	1	1 to 247
Function code	1	0x04
Byte count	1	N*1×2
Register value *2	N*1×2	
CRC	2	-

- \*1: N: The quantity specified by the Quantity of Registers.
- \*2: Transmitted by the order: Upper- Lower from the specified Starting Address.  
E.g. 10 in FLOAT format, Transmit order is as 0x41200000.

### 5.4.5 05 (0x05) Write Single Coil

Write data to Coil of Specified Output Address.  
Corresponding to Broadcast.

#### Request

Items	Size [byte]	Data
Address	1	1 to 247
Function code	1	0x05
Output Address	2	0x0000 to 0xFFFF
Output Value	2	0x0000 or 0xFF00 *1
CRC	2	-

- \*1: OFF; 0x0000, ON; 0xFF00

#### Response

Items	Size [byte]	Data
Address	1	1 to 247
Function code	1	0x05
Output Address	2	0x0000 to 0xFFFF
Output Value	2	0x0000 or 0xFF00
CRC	2	-

### 5.4.6 08 (0x08) Diagnostics

Support only Return Query Data which reply receiving data.

Not corresponding to Broadcast.

#### Request

Items	Size [byte]	Data
Address	1	1 to 247
Function code	1	0x08
Sub-function	2	0x0000 *1
Data	N	Any
CRC	2	-

\*1: 0x0000; Support only Return Query Data

#### Response

Items	Size [byte]	Data
Address	1	1 to 247
Function code	1	0x08
Register Address	2	0x0000
Register Value	N	Request Data
CRC	2	-

### 5.4.7 16 (0x10) Write Multiple registers

Write data to Holding Registers from the Specified Starting Address to specified quantity.

Corresponding to Broadcast.

#### Request

Items	Size [byte]	Data
Address	1	1 to 247
Function code	1	0x10
Starting Address	2	0x0000 to 0xFFFF
Quantity of Registers	2	-
Byte Count	1	N*1×2
Registers Value *2	N*1×2	value
CRC	2	-

\*1: N: The quantity specified by the Quantity of Registers.

\*2: Transmitted by the order: Upper- Lower from the specified Starting Address.  
E.g. 10 in FLOAT format, Transmit order is as 0x41200000.

#### Response

Items	Size [byte]	Data
Address	1	1 to 247
Function code	1	0x10
Starting Address	2	0x0000 to 0xFFFF
Quantity of Registers	2	-
CRC	2	-

## 5.5 Response error code

### (1) The message format at error

The device returns the following message without any operation when incompatibility exists in the message other than communication error.

#### Response

Items	Size [byte]	Data
Address	1	1 to 247
Error code	1	*1
Exception code	1	Refer to following exception code
CRC	2	-

\*1: Error code  
Received Function Code(Hex) + 80(Hex) is entered  
E.g. When exception is detected in function code 0x01, Error Code is set to 0x81.

### (2) Exception code

Error code	Name	Meaning
0x01	ILLEGAL FUNCTION	Function code does not exist
0x02	ILLEGAL DATA ADDRESS	Specified address is out of range
0x03	ILLEGAL DATA VALUE	Specified data is out of quantity
0x04	SLAVE DEVICE FAILURE	Failure during response process (CAP, AMP EEPROM Failure(AL.01, AL.02))
0x06	SLAVE DEVICE BUSY	Cannot respond because of under processing

## 5.6 Data format

### (1) USIGN INTEGER FORMAT

This format is used for integer data.

There are a number of 8 bit values that are stored in 16 bit registers. The 8 bit value is stored in the Least Significant Byte of the 16 bit register. E.g. 0x24 is stored as 0x0024.

### (2) IEEE 754 FLOATING POINT FORMAT

Floating point values are stored as single precision IEEE 754 floating point numbers. Since IEEE 754 floating point numbers are 32 bits long. Data is stored in the order of MSB (Most significant byte) first.

E.g. 100.25 is stored as 0x42C88000.

### (3) DATE FORMAT

This format is used for date information.

Date: DD, Month: MM, Year: YY is stored as 0x00DDMMYY.

Year: YY means the offset year from Year 1900.

E.g. 30th September 2013 is stored as 0x001E0971.

## 5.7 Address Map

Address map consists of Basic Information and Detail Information.

Category	Address Type	Address (Decimal)
Basic Information	Coils	0003 to 0033
	Discrete Inputs	0050 to 0075
	Input Registers / Holding Registers	0001 to 0454
Detail Information	Coils	1001 to 1005
	Discrete Inputs	1001 to 1088
	Input Registers	1001 to 1316
	Holding Registers	1001 to 2117



### NOTE

- Some data is mapped in both area of Basic Information and Detail Information.
- Enumeration table list is described commonly both for Basic Information and Detail Information.
- The data of Input Register and Holding Register in Basic Information area can be read by both function codes.
- In order to access 0001 parameter, set 0000 in communication frame.
- The return value is uncertain when communicated to address which is not written in the map.

## 5.7.1 Address Map (Basic Information)

Address	Label used in DTM	Address Type	Access Type	Char/Date	Read/Write	Enum list	Default Value*1	Unit	Valid Range	IM Chapter
0003	Calibration Flag	Coil	SINGLE BIT	-	W	Table 1	0	-	0x0000, 0xFF00	3.4.4
0031	Clear P trim	Coil	SINGLE BIT	-	W	Table 1	0	-	0x0000, 0xFF00	3.4.4
0032	Clear SP trim	Coil	SINGLE BIT	-	W	Table 1	0	-	0x0000, 0xFF00	3.4.4
0033	Clear ET trim	Coil	SINGLE BIT	-	W	Table 1	0	-	0x0000, 0xFF00	3.4.4
0050-0075	Status Bits	Discrete Input	SINGLE BIT×26	-	R	Table 2	0	-	-	4.1.1
0001	Distributor	Input Register	USIGN8	-	R	-	0x0037	-	-	
0002	Device Type	Input Register	USIGN8	-	R	-	0x0054	-	-	
0003	Device rev	Input Register	USIGN8	-	R	-	-	-	-	
0016	Slave Address	Holding Register	USIGN8	-	W	-	0x0001	-	1 to 247	3.2
0401	Pres	Input Register	FLOAT	-	R	-	-	-	-	3.3.2
0403	SP	Input Register	FLOAT	-	R	-	-	-	-	3.3.2
0405	ET	Input Register	FLOAT	-	R	-	-	-	-	3.3.2
0407-0410	Status Bytes	Input Register	USIGN32×2	-	R	Table 2	-	-	-	4.1.1
0413	Pres USL	Input Register	FLOAT	-	R	-	100.0	kPa	-	
0415	Pres LSL	Input Register	FLOAT	-	R	-	-100.0	kPa	-	
0417	Pres URV	Holding Register	FLOAT	-	W	-	100.0	kPa	-110 to 110	3.3.3
0419	Pres LRV	Holding Register	FLOAT	-	W	-	0.0	kPa	-110 to 110	3.3.3
0421	SP USL	Input Register	FLOAT	-	R	-	25.0	MPa	-	
0423	SP LSL	Input Register	FLOAT	-	R	-	0.0	MPa	-	
0425	SP URV	Holding Register	FLOAT	-	W	-	16.0	MPa	-2.5 to 27.5	3.3.3
0427	SP LRV	Holding Register	FLOAT	-	W	-	0.0	MPa	-2.5 to 27.5	3.3.3
0429	ET USL	Input Register	FLOAT	-	R	-	850.0	°C	-	
0431	ET LSL	Input Register	FLOAT	-	R	-	-200.0	°C	-	
0433	ET URV	Holding Register	FLOAT	-	W	-	850.0	°C	-210 to 860	3.3.3
0435	ET LRV	Holding Register	FLOAT	-	W	-	-200.0	°C	-210 to 860	3.3.3
0437	Pres trim Auto Lower Pt	Holding Register	FLOAT	-	W	-	-	-	With in adjustable range	3.4.4
0439	Pres trim Auto Upper Pt	Holding Register	FLOAT	-	W	-	-	-	With in adjustable range	3.4.4
0441	Pres Damp	Holding Register	FLOAT	-	W	-	2.0	s	0 to 100	3.3.5
0443	SP trim Auto Lower Pt	Holding Register	FLOAT	-	W	-	-	-	With in adjustable range	3.4.4
0445	SP trim Auto Upper Pt	Holding Register	FLOAT	-	W	-	-	-	With in adjustable range	3.4.4
0447	SP Damp	Holding Register	FLOAT	-	W	-	1.0	s	0 to 100	3.3.5
0449	ET trim Auto Lower Pt	Holding Register	FLOAT	-	W	-	-	-	With in adjustable range	3.4.4
0451	ET trim Auto Upper Pt	Holding Register	FLOAT	-	W	-	-	-	With in adjustable range	3.4.4
0453	ET Damp	Holding Register	FLOAT	-	W	-	1.0	s	0 to 100	3.3.5

\*1: This value is factory default of M range measurement span without order specification.

### 5.7.2 Address Map (Detail Information)

Address	Label used in DTM	Address Type	Access Type	Char/Date	Read/Write	Enum list	Default Value*1	Unit	Valid Range	IM Chapter
1001	Restart	Coil	SINGLE BIT	-	W	Table 1	0	-	0x0000, 0xFF00	
1002	Squawk	Coil	SINGLE BIT	-	W	Table 1	0	-	0x0000, 0xFF00	3.4.8
1003	Error log Clear	Coil	SINGLE BIT	-	W	Table 1	0	-	0x0000, 0xFF00	
1004	Auto Atm. Pres	Coil	SINGLE BIT	-	W	Table 1	0	-	0x0000, 0xFF00	
1005	Reset cfg chng count	Coil	SINGLE BIT	-	W	Table 1	0	-	0x0000, 0xFF00	4.1.3
1001-1008	Status group 1	Discrete Input	SINGLE BIT×8	-	R	Table 6	-	-	-	4.1.1
1009-1016	Status group 2	Discrete Input	SINGLE BIT×8	-	R	Table 7	-	-	-	4.1.1
1017-1024	Status group 3	Discrete Input	SINGLE BIT×8	-	R	Table 8	-	-	-	4.1.1
1025-1032	Status group 4	Discrete Input	SINGLE BIT×8	-	R	Table 9	-	-	-	4.1.1
1033-1040	Status group 5	Discrete Input	SINGLE BIT×8	-	R	Table 10	-	-	-	4.1.1
1041-1048	Status group 6	Discrete Input	SINGLE BIT×8	-	R	Table 11	-	-	-	4.1.1
1049-1056	Status group 7	Discrete Input	SINGLE BIT×8	-	R	Table 12	-	-	-	4.1.1
1057-1064	Status group 8	Discrete Input	SINGLE BIT×8	-	R	Table 13	-	-	-	4.1.1
1065-1072	Status group 9	Discrete Input	SINGLE BIT×8	-	R	Table 14	-	-	-	4.1.1
1073-1080	Status group 10	Discrete Input	SINGLE BIT×8	-	R	Table 15	-	-	-	4.1.1
1081-1088	Status group 11	Discrete Input	SINGLE BIT×8	-	R	Table 16	-	-	-	4.1.1
1001	Distributor	Input Register	USIGN16	-	R	-	0x0037	-	-	
1002	Device Type Code	Input Register	USIGN16	-	R	-	0x0054	-	-	
1003	Fld dev rev	Input Register	USIGN8	-	R	-	-	-	-	
1004	Software rev	Input Register	FLOAT	-	R	-	-	-	-	
1006-1013	Model	Input Register	USIGN32×4	ASCII	R	-	-	-	-	
1014	Write protect	Input Register	USIGN8	-	R	Table 31	0x0000	-	-	3.4.6
1015	Software seal	Input Register	USIGN8	-	R	Table 32	0x0001	-	-	
1025	Cfg chng count	Input Register	USIGN8	-	R	-	-	-	-	4.1.3
1101	Pres	Input Register	FLOAT	-	R	-	-	-	-	3.3.2
1103	SP	Input Register	FLOAT	-	R	-	-	-	-	3.3.2
1105	ET	Input Register	FLOAT	-	R	-	-	-	-	3.3.2
1107	Pres Data Quality Pres Limit Status SP Data Quality SP Limit Status	Input Register	USIGN16	-	R	Table 5	-	-	-	4.1.3
1108	ET Data Quality ET Limit Status Reserved	Input Register	USIGN16	-	R	Table 5	-	-	-	4.1.3
1109	Status group 1 Status group 2	Input Register	USIGN16	-	R	Table 6 Table 7	-	-	-	4.1.1
1110	Status group 3 Status group 4	Input Register	USIGN16	-	R	Table 8 Table 9	-	-	-	4.1.1
1111	Status group 5 Status group 6	Input Register	USIGN16	-	R	Table 10 Table 11	-	-	-	4.1.1

\*1: This value is factory default of M range measurement span without order specification.

\*2: Upper case character can be used. Lower-case is translated to upper case.

Address	Label used in DTM	Address Type	Access Type	Char/ Date	Read/ Write	Enum list	Default Value*1	Unit	Valid Range	IM Chapter
1112	Status group 7 Status group 8	Input Register	USIGN16	-	R	Table 12 Table 13	-	-	-	4.1.1
1113	Status group 9 Status group 10	Input Register	USIGN16	-	R	Table 14 Table 15	-	-	-	4.1.1
1114	Status group 11 Reserved	Input Register	USIGN16	-	R	Table 16	-	-	-	4.1.1
1121	Pres % Range	Input Register	FLOAT	-	R	-	-	-	-	3.3.2
1123	SP % Range	Input Register	FLOAT	-	R	-	-	-	-	3.3.2
1125	ET % Range	Input Register	FLOAT	-	R	-	-	-	-	3.3.2
1127	Pres % Range Data Quality Pres % Range Limit Status SP % Range Data Quality SP % Range Limit Status	Input Register	USIGN16	-	R	Table 5	-	-	-	4.1.3
1128	ET % Range Data Quality ET % Range Limit Status Reserved	Input Register	USIGN16	-	R	Table 5	-	-	-	4.1.3
1129	Cap temp	Input Register	FLOAT	-	R	-	-	-	-	
1131	Amp temp	Input Register	FLOAT	-	R	-	-	-	-	
1133	Engr Disp	Input Register	FLOAT	-	R	-	-	-	-	
1301- 1304	Log1(Latest)	Input Register	USIGN32×2	-	R	Table 20	-	-	-	
1305- 1308	Log2	Input Register	USIGN32×2	-	R	Table 20	-	-	-	
1309- 1312	Log3	Input Register	USIGN32×2	-	R	Table 20	-	-	-	
1313- 1316	Log4(Oldest)	Input Register	USIGN32×2	-	R	Table 20	-	-	-	
1001- 1004	Tag	Holding Register	USIGN32×2	ASCII*2	W	-	-	-	-	3.3.1
1005- 1012	Descriptor	Holding Register	USIGN32×4	ASCII*2	W	-	spaces	-	-	3.3.1
1013	Date	Holding Register	USIGN32	Date	W	-	0x00010164	-	-	3.3.1
1015- 1030	Long tag	Holding Register	USIGN32×8	ASCII	W	-	-	-	-	3.3.1
1031	User Defined Number	Holding Register	USIGN16	-	W	-	0x0000	-	-	
1032- 1047	Message	Holding Register	USIGN32×8	ASCII*2	W	-	spaces	-	-	3.3.1
1048- 1063	MS Code 1	Holding Register	USIGN32×8	ASCII*2	W	-	-	-	-	
1064- 1079	MS Code 2	Holding Register	USIGN32×8	ASCII*2	W	-	-	-	-	
1080- 1095	MS Code 3	Holding Register	USIGN32×8	ASCII*2	W	-	-	-	-	
1096- 1099	Enable wrt 10min	Holding Register	USIGN32×2	ASCII*2	W	-	spaces	-	-	3.4.6
1100- 1103	New password	Holding Register	USIGN32×2	ASCII*2	W	-	spaces	-	-	3.4.6
1104- 1119	Option Password	Holding Register	USIGN32×8	ASCII	W	-	spaces	-	-	
1120	Style No.	Holding Register	FLOAT	-	R	-	-	-	-	
1122	Mfr Date	Holding Register	USIGN32	Date	R	-	-	-	-	
1124- 1131	Serial No.	Holding Register	USIGN32×4	ASCII*2	R	-	-	-	-	

\*1: This value is factory default of M range measurement span without order specification.

\*2: Upper case character can be used. Lower-case is translated to upper case.

Address	Label used in DTM	Address Type	Access Type	Char/Date	Read/Write	Enum list	Default Value*1	Unit	Valid Range	IM Chapter
1132-1139	Extra No.	Holding Register	USIGN32×4	ASCII*2	R	-	spaces	-	-	
1140	Final assembly num	Holding Register	USIGN24	-	W	-	0x00000000	-	-	
1142-1149	PT100 Serial No.	Holding Register	USIGN32×4	ASCII*2	W	-	spaces	-	-	
1150	Country	Holding Register	USIGN16	ASCII	W	-	"JP"	-	-	
1151	Auto recover	Holding Register	USIGN8	-	W	Table 33	0x0001	-	0 to 1	
1152	Isoltr matl	Holding Register	USIGN8	-	W	Table 34	-	-	With in enum list	
1153	Fill fluid	Holding Register	USIGN8	-	W	Table 35	-	-	With in enum list	
1154	Gasket matl	Holding Register	USIGN8	-	W	Table 36	-	-	With in enum list	
1155	Process Conn matl	Holding Register	USIGN8	-	W	Table 37	-	-	With in enum list	
1156	Drain vent matl	Holding Register	USIGN8	-	W	Table 38	-	-	With in enum list	
1157	Process Conn type	Holding Register	USIGN8	-	W	Table 39	-	-	With in enum list	
1158	RS isoltr matl	Holding Register	USIGN8	-	W	Table 40	-	-	With in enum list	
1159	Process Conn size	Holding Register	USIGN8	-	W	Table 41	-	-	With in enum list	
1160	Num of RS	Holding Register	USIGN8	-	W	Table 42	-	-	With in enum list	
1161	RS fill fluid	Holding Register	USIGN8	-	W	Table 43	-	-	With in enum list	
1162	RS type	Holding Register	USIGN8	-	W	Table 44	-	-	With in enum list	
1351	Slave Address	Holding Register	USIGN8	-	W	-	0x0001	-	1 to 247	3.2
1352	Stop Bit	Holding Register	USIGN8	-	W	Table 55	0x0000	-	0 to 1	3.2
1353	Parity	Holding Register	USIGN8	-	W	Table 56	0x0000	-	0 to 2	3.2
1354	Turnaround Delay Time	Holding Register	USIGN16	-	W	-	0x000A	-	0x000A to 0x00C8	3.2
1401	Pres Unit	Holding Register	USIGN8	-	W	Table 60	0x000C	-	With in enum list	3.3.4
1402	SP Unit	Holding Register	USIGN8	-	W	Table 61	0x00ED	-	With in enum list	3.3.4
1403	ET Unit	Holding Register	USIGN8	-	W	Table 62	0x0020	-	With in enum list	3.3.4
1421	SP H/L Select	Holding Register	USIGN8	-	W	Table 70	0x0000	-	0 to 1	3.4.1
1422	A/G Select	Holding Register	USIGN8	-	W	Table 71	0x0001	-	0 to 1	3.4.1
1423	Atm. Pres Value	Holding Register	FLOAT	-	W	-	0.101325	MPa	-2.5 to 27.5	
1451	Pres URV	Holding Register	FLOAT	-	W	-	100.0	kPa	-110 to 110	3.3.3
1453	Pres LRV	Holding Register	FLOAT	-	W	-	0.0	kPa	-110 to 110	3.3.3
1455	SP URV	Holding Register	FLOAT	-	W	-	16.0	MPa	-2.5 to 27.5	3.3.3
1457	SP LRV	Holding Register	FLOAT	-	W	-	0.0	MPa	-2.5 to 27.5	3.3.3
1459	ET URV	Holding Register	FLOAT	-	W	-	850.0	°C	-210 to 860	3.3.3

\*1: This value is factory default of M range measurement span without order specification.

\*2: Upper case character can be used. Lower-case is translated to upper case.

Address	Label used in DTM	Address Type	Access Type	Char/ Date	Read/ Write	Enum list	Default Value*1	Unit	Valid Range	IM Chapter
1461	ET LRV	Holding Register	FLOAT	-	W	-	-200.0	°C	-210 to 860	3.3.3
1463	Pres USL	Holding Register	FLOAT	-	R	-	100.0	kPa	-	
1465	Pres LSL	Holding Register	FLOAT	-	R	-	-100.0	kPa	-	
1467	Pres Min span	Holding Register	FLOAT	-	R	-	0.5	kPa	-	
1469	SP USL	Holding Register	FLOAT	-	R	-	25.0	MPa	-	
1471	SP LSL	Holding Register	FLOAT	-	R	-	0.0	MPa	-	
1473	SP Min span	Holding Register	FLOAT	-	R	-	1.0	MPa	-	
1475	ET USL	Holding Register	FLOAT	-	R	-	850.0	°C	-	
1477	ET LSL	Holding Register	FLOAT	-	R	-	-200.0	°C	-	
1479	ET Min Span	Holding Register	FLOAT	-	R	-	10.0	°C	-	
1551	Pres Damp	Holding Register	FLOAT	-	W	-	2.0	s	0 to 100	3.3.5
1553	SP Damp	Holding Register	FLOAT	-	W	-	1.0	s	0 to 100	3.3.5
1555	ET Damp	Holding Register	FLOAT	-	W	-	1.0	s	0 to 100	3.3.5
1601	Pres trim Auto Upper Pt	Holding Register	FLOAT	-	W	-	-	-	With in adjustable range	
1603	Pres trim Auto Lower Pt	Holding Register	FLOAT	-	W	-	-	-	With in adjustable range	
1605	Pres trim Manual Upper Pt	Holding Register	FLOAT	-	W	-	-	-	With in adjustable range	3.4.4
1607	Pres trim Manual Lower Pt	Holding Register	FLOAT	-	W	-	-	-	With in adjustable range	3.4.4
1609	SP trim Auto Upper Pt	Holding Register	FLOAT	-	W	-	-	-	With in adjustable range	3.4.4
1611	SP trim Auto Lower Pt	Holding Register	FLOAT	-	W	-	-	-	With in adjustable range	3.4.4
1613	SP trim Manual Upper Pt	Holding Register	FLOAT	-	W	-	-	-	With in adjustable range	3.4.4
1615	SP trim Manual Lower Pt	Holding Register	FLOAT	-	W	-	-	-	With in adjustable range	3.4.4
1617	ET trim Auto Upper Pt	Holding Register	FLOAT	-	W	-	-	-	With in adjustable range	3.4.4
1619	ET trim Auto Lower Pt	Holding Register	FLOAT	-	W	-	-	-	With in adjustable range	3.4.4
1621	ET trim Manual Upper Pt	Holding Register	FLOAT	-	W	-	-	-	With in adjustable range	3.4.4
1623	ET trim Manual Lower Pt	Holding Register	FLOAT	-	W	-	-	-	With in adjustable range	3.4.4
1625	Trim Clear Code	Holding Register	USIGN8	-	W	Table 72	0x0000	-	0 to 5	3.4.4

\*1: This value is factory default of M range measurement span without order specification.

\*2: Upper case character can be used. Lower-case is translated to upper case.



Address	Label used in DTM	Address Type	Access Type	Char/ Date	Read/ Write	Enum list	Default Value*1	Unit	Valid Range	IM Chapter
1626	Trim Date	Holding Register	USIGN32	Date	W	-	0x00010164	-	-	
1628-1635	Trim Desc	Holding Register	USIGN32×4	ASCII*2	W	-	spaces	-	-	
1636-1639	Trim Who	Holding Register	USIGN32×2	ASCII*2	W	-	spaces	-	-	
1640-1643	Trim Loc	Holding Register	USIGN32×2	ASCII*2	W	-	spaces	-	-	
1644	ET Fixed	Holding Register	USIGN8	-	W	Table 73	-	-	0 to 1	3.4.2
1645	Fixed ET Val	Holding Register	FLOAT	-	W	-	20.0	°C	-273 to 1927	3.4.2
1647	Ext SW	Holding Register	USIGN8	-	W	Table 74	0x0000	-	0 to 1	3.4.5
1648	H/L Swap	Holding Register	USIGN8	-	W	Table 75	0x0000	-	0 to 1	3.3.7
1649	Low cut	Holding Register	FLOAT	-	W	-	10.0	%	0 to 20	3.3.6
1651	Low cut mode	Holding Register	USIGN8	-	W	Table 76	0x0000	-	0 to 1	3.3.6
1751	Disp Out 1	Holding Register	USIGN8	-	W	Table 80	0x0000	-	With in enum list	3.4.3
1752	Disp Out 2	Holding Register	USIGN8	-	W	Table 81	0x00FA	-	With in enum list	3.4.3
1753	Disp Out 3	Holding Register	USIGN8	-	W	Table 81	0x00FA	-	With in enum list	3.4.3
1754	Disp Out 4	Holding Register	USIGN8	-	W	Table 81	0x00FA	-	With in enum list	3.4.3
1755	Disp Out 5	Holding Register	USIGN8	-	W	Table 81	0x00FA	-	With in enum list	3.4.3
1756	Disp Out 6	Holding Register	USIGN8	-	W	Table 81	0x00FA	-	With in enum list	3.4.3
1757	Disp Out 7	Holding Register	USIGN8	-	W	Table 81	0x00FA	-	With in enum list	3.4.3
1758	Disp Out 8	Holding Register	USIGN8	-	W	Table 81	0x00FA	-	With in enum list	3.4.3
1759	Disp Out 9	Holding Register	USIGN8	-	W	Table 81	0x00FA	-	With in enum list	3.4.3
1760	Disp Out 10	Holding Register	USIGN8	-	W	Table 81	0x00FA	-	With in enum list	3.4.3
1761	Disp Out 11	Holding Register	USIGN8	-	W	Table 81	0x00FA	-	With in enum list	3.4.3
1762	Disp Out 12	Holding Register	USIGN8	-	W	Table 81	0x00FA	-	With in enum list	3.4.3
1763	Disp Out 13	Holding Register	USIGN8	-	W	Table 81	0x00FA	-	With in enum list	3.4.3
1764	Disp Out 14	Holding Register	USIGN8	-	W	Table 81	0x00FA	-	With in enum list	3.4.3
1765	Disp Out 15	Holding Register	USIGN8	-	W	Table 81	0x00FA	-	With in enum list	3.4.3
1766	Disp Out 16	Holding Register	USIGN8	-	W	Table 81	0x00FA	-	With in enum list	3.4.3
1767	Disp User Value 1	Holding Register	FLOAT	-	W	-	0.0	-	-	3.4.3
1769	Disp User Value 2	Holding Register	FLOAT	-	W	-	0.0	-	-	3.4.3
1771	Disp User Value 3	Holding Register	FLOAT	-	W	-	0.0	-	-	3.4.3
1773	Disp User Value 4	Holding Register	FLOAT	-	W	-	0.0	-	-	3.4.3
1775	Disp User Value 5	Holding Register	FLOAT	-	W	-	0.0	-	-	3.4.3

\*1: This value is factory default of M range measurement span without order specification.

\*2: Upper case character can be used. Lower-case is translated to upper case.

Address	Label used in DTM	Address Type	Access Type	Char/Date	Read/Write	Enum list	Default Value*1	Unit	Valid Range	IM Chapter
1777	Disp User Value 6	Holding Register	FLOAT	-	W	-	0.0	-	-	3.4.3
1779	Disp User Value 7	Holding Register	FLOAT	-	W	-	0.0	-	-	3.4.3
1781	Disp User Value 8	Holding Register	FLOAT	-	W	-	0.0	-	-	3.4.3
1783	Disp User Value 9	Holding Register	FLOAT	-	W	-	0.0	-	-	3.4.3
1785	Disp User Value 10	Holding Register	FLOAT	-	W	-	0.0	-	-	3.4.3
1787	Disp User Value 11	Holding Register	FLOAT	-	W	-	0.0	-	-	3.4.3
1789	Disp User Value 12	Holding Register	FLOAT	-	W	-	0.0	-	-	3.4.3
1791	Disp User Value 13	Holding Register	FLOAT	-	W	-	0.0	-	-	3.4.3
1793	Disp User Value 14	Holding Register	FLOAT	-	W	-	0.0	-	-	3.4.3
1795	Disp User Value 15	Holding Register	FLOAT	-	W	-	0.0	-	-	3.4.3
1797	Disp User Value 16	Holding Register	FLOAT	-	W	-	0.0	-	-	3.4.3
1799-1802	Disp User Info 1_1	Holding Register	USIGN32×2	ASCII	W	-	"INFO 1 "	-	-	3.4.3
1803-1806	Disp User Info 1_2	Holding Register	USIGN32×2	ASCII	W	-	"-----"	-	-	3.4.3
1807-1810	Disp User Info 2_1	Holding Register	USIGN32×2	ASCII	W	-	"INFO 2 "	-	-	3.4.3
1811-1814	Disp User Info 2_2	Holding Register	USIGN32×2	ASCII	W	-	"-----"	-	-	3.4.3
1815-1818	Disp User Info 3_1	Holding Register	USIGN32×2	ASCII	W	-	"INFO 3 "	-	-	3.4.3
1819-1822	Disp User Info 3_2	Holding Register	USIGN32×2	ASCII	W	-	"-----"	-	-	3.4.3
1823-1826	Disp User Info 4_1	Holding Register	USIGN32×2	ASCII	W	-	"INFO 4 "	-	-	3.4.3
1827-1830	Disp User Info 4_2	Holding Register	USIGN32×2	ASCII	W	-	"-----"	-	-	3.4.3
1831-1834	Disp User Info 5_1	Holding Register	USIGN32×2	ASCII	W	-	"INFO 5 "	-	-	3.4.3
1835-1838	Disp User Info 5_2	Holding Register	USIGN32×2	ASCII	W	-	"-----"	-	-	3.4.3
1839-1842	Disp User Info 6_1	Holding Register	USIGN32×2	ASCII	W	-	"INFO 6 "	-	-	3.4.3
1843-1846	Disp User Info 6_2	Holding Register	USIGN32×2	ASCII	W	-	"-----"	-	-	3.4.3
1847-1850	Disp User Info 7_1	Holding Register	USIGN32×2	ASCII	W	-	"INFO 7 "	-	-	3.4.3
1851-1854	Disp User Info 7_2	Holding Register	USIGN32×2	ASCII	W	-	"-----"	-	-	3.4.3
1855-1858	Disp User Info 8_1	Holding Register	USIGN32×2	ASCII	W	-	"INFO 8 "	-	-	3.4.3
1859-1862	Disp User Info 8_2	Holding Register	USIGN32×2	ASCII	W	-	"-----"	-	-	3.4.3
1863-1866	Disp User Info 9_1	Holding Register	USIGN32×2	ASCII	W	-	"INFO 9 "	-	-	3.4.3
1867-1870	Disp User Info 9_2	Holding Register	USIGN32×2	ASCII	W	-	"-----"	-	-	3.4.3
1871-1874	Disp User Info 10_1	Holding Register	USIGN32×2	ASCII	W	-	"INFO10"	-	-	3.4.3
1875-1878	Disp User Info 10_2	Holding Register	USIGN32×2	ASCII	W	-	"-----"	-	-	3.4.3

\*1: This value is factory default of M range measurement span without order specification.

\*2: Upper case character can be used. Lower-case is translated to upper case.

Address	Label used in DTM	Address Type	Access Type	Char/Date	Read/Write	Enum list	Default Value*1	Unit	Valid Range	IM Chapter
1879-1882	Disp User Info 11_1	Holding Register	USIGN32×2	ASCII	W	-	"INFO11"	-	-	3.4.3
1883-1886	Disp User Info 11_2	Holding Register	USIGN32×2	ASCII	W	-	"-----"	-	-	3.4.3
1887-1890	Disp User Info 12_1	Holding Register	USIGN32×2	ASCII	W	-	"INFO12"	-	-	3.4.3
1891-1894	Disp User Info 12_2	Holding Register	USIGN32×2	ASCII	W	-	"-----"	-	-	3.4.3
1895-1898	Disp User Info 13_1	Holding Register	USIGN32×2	ASCII	W	-	"INFO13"	-	-	3.4.3
1899-1902	Disp User Info 13_2	Holding Register	USIGN32×2	ASCII	W	-	"-----"	-	-	3.4.3
1903-1906	Disp User Info 14_1	Holding Register	USIGN32×2	ASCII	W	-	"INFO14"	-	-	3.4.3
1907-1910	Disp User Info 14_2	Holding Register	USIGN32×2	ASCII	W	-	"-----"	-	-	3.4.3
1911-1914	Disp User Info 15_1	Holding Register	USIGN32×2	ASCII	W	-	"INFO15"	-	-	3.4.3
1915-1918	Disp User Info 15_2	Holding Register	USIGN32×2	ASCII	W	-	"-----"	-	-	3.4.3
1919-1922	Disp User Info 16_1	Holding Register	USIGN32×2	ASCII	W	-	"INFO16"	-	-	3.4.3
1923-1926	Disp User Info 16_2	Holding Register	USIGN32×2	ASCII	W	-	"-----"	-	-	3.4.3
1927	Disp % Reso	Holding Register	USIGN8	-	W	Table 82	0x0000	-	0 to 1	3.4.3
1928	Bar Indicator	Holding Register	USIGN8	-	W	Table 83	0x0001	-	0 to 1	
1929	Pres disp point	Holding Register	USIGN8	-	W	Table 84	-	-	0 to 4	3.4.3
1930	SP disp point	Holding Register	USIGN8	-	W	Table 85	-	-	0 to 4	3.4.3
1931	ET disp point	Holding Register	USIGN8	-	W	Table 86	-	-	0 to 4	3.4.3
1932	Chg power on info	Holding Register	USIGN8	-	W	Table 87	0x0001	-	0 to 1	2.2
1933	Disp User Value Point 1	Holding Register	USIGN8	-	W	Table 88	0x0001	-	0 to 4	3.4.3
1934	Disp User Value Point 2	Holding Register	USIGN8	-	W	Table 88	0x0001	-	0 to 4	3.4.3
1935	Disp User Value Point 3	Holding Register	USIGN8	-	W	Table 88	0x0001	-	0 to 4	3.4.3
1936	Disp User Value Point 4	Holding Register	USIGN8	-	W	Table 88	0x0001	-	0 to 4	3.4.3
1937	Disp User Value Point 5	Holding Register	USIGN8	-	W	Table 88	0x0001	-	0 to 4	3.4.3
1938	Disp User Value Point 6	Holding Register	USIGN8	-	W	Table 88	0x0001	-	0 to 4	3.4.3
1939	Disp User Value Point 7	Holding Register	USIGN8	-	W	Table 88	0x0001	-	0 to 4	3.4.3
1940	Disp User Value Point 8	Holding Register	USIGN8	-	W	Table 88	0x0001	-	0 to 4	3.4.3
1941	Disp User Value Point 9	Holding Register	USIGN8	-	W	Table 88	0x0001	-	0 to 4	3.4.3
1942	Disp User Value Point 10	Holding Register	USIGN8	-	W	Table 88	0x0001	-	0 to 4	3.4.3
1943	Disp User Value Point 11	Holding Register	USIGN8	-	W	Table 88	0x0001	-	0 to 4	3.4.3
1944	Disp User Value Point 12	Holding Register	USIGN8	-	W	Table 88	0x0001	-	0 to 4	3.4.3
1945	Disp User Value Point 13	Holding Register	USIGN8	-	W	Table 88	0x0001	-	0 to 4	3.4.3
1946	Disp User Value Point 14	Holding Register	USIGN8	-	W	Table 88	0x0001	-	0 to 4	3.4.3

\*1: This value is factory default of M range measurement span without order specification.

\*2: Upper case character can be used. Lower-case is translated to upper case.

Address	Label used in DTM	Address Type	Access Type	Char/ Date	Read/ Write	Enum list	Default Value*1	Unit	Valid Range	IM Chapter
1947	Disp User Value Point 15	Holding Register	USIGN8	-	W	Table 88	0x0001	-	0 to 4	3.4.3
1948	Disp User Value Point 16	Holding Register	USIGN8	-	W	Table 88	0x0001	-	0 to 4	3.4.3
2001	Engr Select	Holding Register	USIGN8	-	W	Table 89	0x0000	-	0 to 2	3.4.3
2002-2005	Engr Unit	Holding Register	USIGN32×2	ASCII	W	-	spaces	-	-	3.4.3
2006	Engr exp	Holding Register	USIGN8	-	W	Table 90	0x0000	-	0 to 3	3.4.3
2007	Engr URV	Holding Register	FLOAT	-	W	-	100.0	-	-	3.4.3
2009	Engr LRV	Holding Register	FLOAT	-	W	-	0.0	-	-	3.4.3
2011	Engr point	Holding Register	USIGN8	-	W	Table 88	0x0001	-	0 to 4	3.4.3
2012	Set Engr Unit	Holding Register	USIGN8	-	W	Table 91	0x0000	-	0 to 45	3.4.3
2051	Pres Alert Mode	Holding Register	USIGN8	-	W	Table 92	0x0000	-	0 to 3	3.4.7
2052	Pres Hi Alert Val	Holding Register	FLOAT	-	W	-	100.0	kPa	-110 to 110	3.4.7
2054	Pres Lo Alert Val	Holding Register	FLOAT	-	W	-	-100.0	kPa	-110 to 110	3.4.7
2056	SP Alert Mode	Holding Register	USIGN8	-	W	Table 92	0x0000	-	0 to 3	3.4.7
2057	SP Hi Alert Val	Holding Register	FLOAT	-	W	-	25.0	MPa	-2.5 to 27.5	3.4.7
2059	SP Lo Alert Val	Holding Register	FLOAT	-	W	-	0.0	MPa	-2.5 to 27.5	3.4.7
2061	ET Alert Mode	Holding Register	USIGN8	-	W	Table 92	0x0000	-	0 to 3	3.4.7
2062	ET Hi Alert Val	Holding Register	FLOAT	-	W	-	850.0	°C	-200 to 850	3.4.7
2064	ET Lo Alert Val	Holding Register	FLOAT	-	W	-	-200.0	°C	-200 to 850	3.4.7
2101	Flow Simulation Mode	Holding Register	USIGN8	-	W	Table 93	0x0000	-	With in enum list	3.4.8
2102	Flow Sim Pres Unit	Holding Register	USIGN8	-	W	Table 60	0x000C	-	With in enum list	3.4.8
2103	Flow Sim Pres	Holding Register	FLOAT	-	W	-	0.0	kPa	-1600 to 1600	3.4.8
2105	Flow Sim SP Unit	Holding Register	USIGN8	-	W	Table 61	0x000C	-	With in enum list	3.4.8
2106	Flow Sim SP	Holding Register	FLOAT	-	W	-	0.0	kPa	-400000 to 400000	3.4.8
2108	Flow Sim Temp Unit	Holding Register	USIGN8	-	W	Table 62	0x0023	-	With in enum list	3.4.8
2109	Flow Sim Temp	Holding Register	FLOAT	-	W	-	273.15	K	-	3.4.8
2111	Sim Device Variable Code	Holding Register	USIGN8	-	W	Table 94	0x0001	-	1 to 3	3.4.8
2112	Sim Write Device Variable Code	Holding Register	USIGN8	-	W	Table 95	0x0000	-	0 to 1	3.4.8
2113	Sim Unit Code	Holding Register	USIGN8	-	W	Table 60, 61, 62	0x0000	-	With in enum list	3.4.8
2114	Sim Device Variable Value	Holding Register	FLOAT	-	W	-	0.0	-	-	3.4.8
2116	Sim Device Variable Status	Holding Register	USIGN8	-	W	Table 5	0x0000	-	With in enum list	3.4.8
2117	Test Auto Release Time	Holding Register	USIGN8	-	W	Table 96	0x0000	-	0 to 5	3.4.8

\*1: This value is factory default of M range measurement span without order specification.

\*2: Upper case character can be used. Lower-case is translated to upper case.

5.7.3 Enumeration table list

Table 1 Coil

Code	Discription
0x0000	OFF
0xFF00	EXECUTE

Table 2 Status Bytes, Status Bits

Code	Discription
0x80000000 00000000	Calibration Flag
0x40000000 00000000	Critical Alarm *1
0x20000000 00000000	(None)
0x10000000 00000000	P outside limit
0x08000000 00000000	(None)
0x04000000 00000000	P over range
0x02000000 00000000	P over range
0x01000000 00000000	(None)
0x00800000 00000000	P outside limit
0x00400000 00000000	SP outside limit
0x00200000 00000000	(None)
0x00100000 00000000	SP over range
0x00080000 00000000	SP over range
0x00040000 00000000	(None)
0x00020000 00000000	SP outside limit
0x00010000 00000000	(None)
0x00008000 00000000	P sensor error *2
0x00004000 00000000	ET outside limit
0x00002000 00000000	(None)
0x00001000 00000000	ET over range
0x00000800 00000000	ET over range
0x00000400 00000000	(None)
0x00000200 00000000	ET outside limit
0x00000100 00000000	OHM outside limit
0x00000080 00000000	CT outside limit
0x00000040 00000000	CT outside limit
0x00000020 00000000	(None)
0x00000010 00000000	(None)
0x00000008 00000000	(None)
0x00000004 00000000	(None)
0x00000002 00000000	(None)
0x00000001 00000000	(None)
0x00000000 80000000	(None)
0x00000000 40000000	CT sensor error *2
0x00000000 20000000	(None)
0x00000000 10000000	Cap EEPROM error *2
0x00000000 08000000	(None)
0x00000000 04000000	(None)
0x00000000 02000000	(None)
0x00000000 01000000	CPU board error *2
0x00000000 00800000	ET sensor error *2
0x00000000 00400000	(None)
0x00000000 00200000	Amp EEPROM error *2
0x00000000 00100000	(None)
0x00000000 00080000	ET module error *2
0x00000000 00040000	(None)
0x00000000 00020000	Write protected
0x00000000 00010000	ET module com error *2

\*1: The status indicated as "\*\*2" reflects Critical Alarm bit.

Table 5 Data Quality, Limit Status

Code		Discription
bit7-6	00	Bad
	01	Poor Accuracy
	10	Manual / Fixed
	11	Good
bit5-4	00	Not Limited
	01	Low Limited
	10	High Limited
	11	Constant

Table 6 Status group 1

Code	Discription
0x80	P sensor error
0x40	(None)
0x20	CT sensor error
0x10	Cap EEPROM error
0x08	(None)
0x04	(None)
0x02	Amp EEPROM error
0x01	(None)

Table 7 Status group 2

Code	Discription
0x80	CPU board error
0x40	(None)
0x20	(None)
0x10	(None)
0x08	(None)
0x04	(None)
0x02	(None)
0x01	(None)

Table 8 Status group 3

Code	Discription
0x80	P outside limit
0x40	SP outside limit
0x20	CT outside limit
0x10	AT outside limit
0x08	(None)
0x04	(None)
0x02	OHM outside limit
0x01	ET outside limit

Table 9 Status group 4

Code	Discription
0x80	P over range
0x40	SP over range
0x20	(None)
0x10	ET over range
0x08	ET module com error
0x04	(None)
0x02	ET sensor error
0x01	ET module error

**Table 10 Status group 5**

Code	Discription
0x80	P high alarm
0x40	P low alarm
0x20	SP high alarm
0x10	SP low alarm
0x08	(None)
0x04	(None)
0x02	(None)
0x01	Simulate Mode

**Table 14 Status group 9**

Code	Discription
0x80	(None)
0x40	(None)
0x20	(None)
0x10	(None)
0x08	(None)
0x04	(None)
0x02	(None)
0x01	(None)

**Table 11 Status group 6**

Code	Discription
0x80	Illegal P LRV
0x40	Illegal P URV
0x20	Illegal P SPAN
0x10	P SPAN trim err
0x08	P ZERO trim err
0x04	Illegal SP LRV
0x02	Illegal SP URV
0x01	Illegal SP SPAN

**Table 15 Status group 10**

Code	Discription
0x80	(None)
0x40	(None)
0x20	(None)
0x10	(None)
0x08	(None)
0x04	(None)
0x02	(None)
0x01	(None)

**Table 12 Status group 7**

Code	Discription
0x80	SP SPAN trim err
0x40	SP ZERO trim err
0x20	ET SPAN trim err
0x10	ET ZERO trim err
0x08	(None)
0x04	ET Fixed Mode
0x02	(None)
0x01	(None)

**Table 16 Status group 11**

Code	Discription
0x80	P Simulate Mode
0x40	SP Simulate Mode
0x20	(None)
0x10	ET Simulate Mode
0x08	(None)
0x04	(None)
0x02	(None)
0x01	(None)

**Table 13 Status group 8**

Code	Discription
0x80	Illegal ET LRV
0x40	Illegal ET URV
0x20	Illegal ET SPAN
0x10	(None)
0x08	(None)
0x04	(None)
0x02	ET high alarm
0x01	ET low alarm

Table 20 Log1 to 4

Code	Discription
0x80000000 00000000	P sensor error
0x40000000 00000000	(None)
0x20000000 00000000	CT sensor error
0x10000000 00000000	Cap EEPROM error
0x08000000 00000000	(None)
0x04000000 00000000	(None)
0x02000000 00000000	Amp EEPROM error
0x01000000 00000000	(None)
0x00800000 00000000	CPU board error
0x00400000 00000000	(None)
0x00200000 00000000	(None)
0x00100000 00000000	(None)
0x00080000 00000000	(None)
0x00040000 00000000	(None)
0x00020000 00000000	(None)
0x00010000 00000000	(None)
0x00008000 00000000	P outside limit
0x00004000 00000000	SP outside limit
0x00002000 00000000	CT outside limit
0x00001000 00000000	AT outside limit
0x00000800 00000000	(None)
0x00000400 00000000	(None)
0x00000200 00000000	OHM outside limit
0x00000100 00000000	ET outside limit
0x00000080 00000000	P over range
0x00000040 00000000	SP over range
0x00000020 00000000	(None)
0x00000010 00000000	ET over range
0x00000008 00000000	ET module com error
0x00000004 00000000	(None)
0x00000002 00000000	ET sensor error
0x00000001 00000000	ET module error
0x00000000 80000000	P high alarm
0x00000000 40000000	P low alarm
0x00000000 20000000	SP high alarm
0x00000000 10000000	SP low alarm
0x00000000 08000000	CT high alarm
0x00000000 04000000	CT low alarm
0x00000000 02000000	Simulate mode
0x00000000 01000000	Flow Simulation mode
0x00000000 00800000	Illegal P LRV
0x00000000 00400000	Illegal P URV
0x00000000 00200000	Illegal P SPAN
0x00000000 00100000	P SPAN trim err
0x00000000 00080000	P ZERO trim err
0x00000000 00040000	Illegal SP LRV
0x00000000 00020000	Illegal SP URV
0x00000000 00010000	Illegal SP SPAN
0x00000000 00008000	SP SPAN trim err
0x00000000 00004000	SP ZERO trim err
0x00000000 00002000	ET SPAN trim err
0x00000000 00001000	ET ZERO trim err
0x00000000 00000800	(None)

Code	Discription
0x00000000 00000400	ET Fixed Mode
0x00000000 00000200	(None)
0x00000000 00000100	(None)
0x00000000 00000080	Illegal ET LRV
0x00000000 00000040	Illegal ET URV
0x00000000 00000020	Illegal ET SPAN
0x00000000 00000010	(None)
0x00000000 00000008	(None)
0x00000000 00000004	(None)
0x00000000 00000002	ET high alarm
0x00000000 00000001	ET low alarm

Table 31 Write protect

Code	Discription
0	No (Not write protected)
1	Yes (Write protected)

Table 32 Software seal

Code	Discription
0	Break
1	Keep

Table 33 Auto recover

Code	Discription
0	Off
1	On

Table 34 Isoltr matl

Code	Discription
3	Hastelloy C
4	Monel
5	Tantalum
19	Stainless Steel 316L
252	Unknown
253	Special

Table 35 Fill fluid

Code	Discription
0	Si Oil
1	F Oil
252	Unknown
253	Special

Table 36 Gasket matl

Code	Discription
10	PTFE
19	Stainless Steel 316L
252	Unknown
253	Special

**Table 37 Process Conn matl**

Code	Discription
0	Carbon Steel
2	Stainless Steel 316
3	Hastelloy C
4	Monel
19	Stainless Steel 316L
252	Unknown
253	Special

**Table 38 Drain vent matl**

Code	Discription
2	Stainless Steel 316
3	Hastelloy C
4	Monel
19	Stainless Steel 316L
251	None
252	Unknown
253	Special

**Table 39 Process Conn type**

Code	Discription
0	Conventional
1	Remote Seal
2	Level
3	Thread
252	Unknown
253	Special

**Table 40 RS isoltr matl**

Code	Discription
2	Stainless Steel 316
3	Hastelloy C
4	Monel
5	Tantalum
6	Titanium
19	Stainless Steel 316L
251	None
252	Unknown
253	Special

**Table 41 Process Conn size**

Code	Discription
0	ANSI3, C150
1	ANSI3, C300
2	ANSI3, C600
3	ANSI4, C150
4	ANSI4, C300
5	ANSI2, C150
6	ANSI2, C300
7	ANSI2, C600
8	DIN80, PN10/16
9	DIN80, PN25/40
10	DIN80, PN64
11	DIN100, PN10/16
12	DIN100, PN25/40
13	DIN50, PN10/16
14	DIN50, PN25/40
15	DIN50, PN64
16	ANSI 150
17	ANSI 300
18	ANSI 600
19	DIN 10/16
20	DIN 25
21	DIN 40
22	1/2NPT Female
23	1/4NPT Female
24	Rc 1/2 Female
25	1/2NPT Male
26	G 1/2 Male
27	M20 * 1.5 Male
28	R 1/2 Male
251	None
252	Unknown
253	Special

**Table 42 Num of RS**

Code	Discription
1	One Seal
2	Two Seals
251	None
252	Unknown



**Table 43 RS fill fluid**

Code	Discription
0	Silicone
1	SH704
2	SH705
3	Ethy Gly/H2O
4	Prop Gly/H2O
251	None
252	Unknown
253	Special

**Table 44 RS type**

Code	Discription
0	Wafer
1	Extension
2	HTV-W
3	HTV-E
251	None
252	Unknown
253	Special

**Table 55 Stop Bit**

Code	Discription
0	1 bit
1	2 bit

**Table 56 Parity**

Code	Discription
0	None
1	Even
2	Odd

**Table 60 Pres Unit**

Code	Discription
1	inH2O @ 68degF
2	inHg
3	ftH2O @ 68degF
4	mmH2O @ 68degF
5	mmHg
6	psi
7	bar
8	mbar
9	gf/cm2
10	kgf/cm2
11	Pa
12	kPa
13	Torr
14	atm
237	MPa
238	inH2O
239	mmH2O
177	ftH2O
174	hPa

**Table 61 SP Unit**

Code	Discription
1	inH2O @ 68degF
2	inHg
3	ftH2O @ 68degF
4	mmH2O @ 68degF
5	mmHg
6	psi
7	bar
8	mbar
9	gf/cm2
10	kgf/cm2
11	Pa
12	kPa
13	Torr
14	atm
237	MPa
238	inH2O
239	mmH2O
177	ftH2O
174	hPa

**Table 62 ET Unit**

Code	Discription
32	degC
33	degF
35	Kelvin

**Table 70 SP H/L Select**

Code	Discription
0	High
1	Low

**Table 71 A/G Select**

Code	Discription
0	Gauge
1	Absolute

**Table 72 Trim Clear Code**

Code	Discription
0	Off (Not Clear)
1	Pres
2	SP
3	(None)
4	ALL
5	Ext Temp

**Table 73 ET Fixed**

Code	Discription
0	No
1	Yes
2	FALL BACK

**Table 74 Ext SW**

Code	Discription
0	Disabled
1	Enabled

**Table 75 H/L Swap**

Code	Discription
0	Normal
1	Reverse

**Table 76 Low cut mode**

Code	Discription
0	OFF
1	ON

**Table 80 Disp Out 1**

Code	Discription
0	Pres
1	SP
2	ET
3	Pres % Range
4	SP % Range
5	ET % Range
6	Engr Disp
7	Disp User Value 1
8	Disp User Value 2
9	Disp User Value 3
10	Disp User Value 4
11	Disp User Value 5
12	Disp User Value 6
13	Disp User Value 7
14	Disp User Value 8
15	Disp User Value 9
16	Disp User Value 10
17	Disp User Value 11
18	Disp User Value 12
19	Disp User Value 13
20	Disp User Value 14
21	Disp User Value 15
22	Disp User Value 16

**Table 81 Disp Out 2 to 16**

Code	Discription
0	Pres
1	SP
2	ET
3	Pres % Range
4	SP % Range
5	ET % Range
6	Engr Disp
7	Disp User Value 1
8	Disp User Value 2
9	Disp User Value 3
10	Disp User Value 4
11	Disp User Value 5
12	Disp User Value 6
13	Disp User Value 7
14	Disp User Value 8
15	Disp User Value 9
16	Disp User Value 10
17	Disp User Value 11
18	Disp User Value 12
19	Disp User Value 13
20	Disp User Value 14
21	Disp User Value 15
22	Disp User Value 16
250	Not used

**Table 82 Disp % Reso**

Code	Discription
0	Normal
1	High Resolution

**Table 83 Bar Indicator**

Code	Discription
0	Off
1	On

**Table 84 Pres disp point**

Code	Discription
0	Integer
1	Down to 1 place of decimals
2	Down to 2 places of decimals
3	Down to 3 places of decimals
4	Down to 4 places of decimals

**Table 85 SP disp point**

Code	Discription
0	Integer
1	Down to 1 place of decimals
2	Down to 2 places of decimals
3	Down to 3 places of decimals
4	Down to 4 places of decimals

**Table 86 ET disp point**

Code	Discription
0	Integer
1	Down to 1 place of decimals
2	Down to 2 places of decimals
3	Down to 3 places of decimals
4	Down to 4 places of decimals

**Table 87 Chg power on info**

Code	Discription
0	OFF
1	ON

**Table 88 Disp User Value Point/Engr point**

Code	Discription
0	Integer
1	Down to 1 place of decimals
2	Down to 2 places of decimals
3	Down to 3 places of decimals
4	Down to 4 places of decimals

**Table 89 Engr Select**

Code	Discription
0	Pressure
1	Static Pressure
2	External Temperature

**Table 90 Engr exp**

Code	Discription
0	x1
1	x10
2	x100
3	x1000

**Table 91 Set Engr Unit**

Code	Discription
0	(SPACE)
1	kPa
2	MPa
3	mbar
4	bar
5	psi
6	psia
7	mmH2O
8	mmHg
9	mmHgA
10	mmAq
11	mmWG
12	Torr
13	inH2O
14	inHg
15	inHgA
16	ftH2O
17	gf/cm2
18	kgf/cm2
19	kg/cm2G
20	kg/cm2A
21	atm
22	kg/h
23	t/h
24	m3/h
25	m3/min
26	l/h
27	l/min
28	kl/h
29	kl/min
30	NI/h
31	NI/min
32	Nm3/h
33	Nm3/min
34	ACFH
35	ACFM
36	CFH
37	SCFM
38	GPH
39	GPM
40	m
41	mm
42	in
43	ft
44	kg/m3
45	g/cm3

**Table 92 Alert Mode**

Code	Discription
0	Off
1	Hi. AI Detect
2	Lo. AI Detect
3	Hi/Lo. AI Detect

**Table 93 Flow Simulation Mode**

Code	Discription
0	OFF
1	ON:DP=ON,SP=OFF,ET=OFF
2	ON:DP=OFF,SP=ON,ET=OFF
3	ON:DP=ON,SP=ON,ET=OFF
4	ON:DP=OFF,SP=OFF,ET=ON
5	ON:DP=ON,SP=OFF,ET=ON
6	ON:DP=OFF,SP=ON,ET=ON
7	ON:DP=ON,SP=ON,ET=ON
15	Check Flow Calc

**Table 94 Sim Device Variable Code**

Code	Discription
0	(None)
1	Pressure
2	Static Pressure
3	External Temperature

**Table 95 Sim Write Device Variable Code**

Code	Discription
0	Normal
1	Fixed Value

**Table 96 Test Auto Release Time**

Code	Discription
0	10min
1	30min
2	60min
3	3hour
4	6hour
5	12hour

# 6. Modbus Communication Troubleshooting

If any abnormality appears in the Modbus communication, use the troubleshooting lists below to isolate and remedy the problem. Refer to IM01C25R05-01EN “EJX910A and EJX930A Multivariable Transmitters” for the transmitter troubleshooting. Since some problems have complex causes, these lists may not identify all. If you have difficulty isolating or correcting a problem, contact Yokogawa service personnel.

Abnormality phenomenon	Remedy			
	Priority	Item	Explanation	Reference
No response from the device	1	Device power	Confirm if the device power is on.	2.1.2 Wiring
	2	Communication wiring	Confirm if the Modbus communication wiring is correct. Try switching communication wiring A with B.	2.1.2 Wiring
	3	Modbus communication setting	Confirm if the Modbus communication setting (Slave Address, Baud rate, Stop bit, Parity, Data length) is same as the host and terminator is correctly set in the RS485 bus. EJX Multivariable transmitter communication setting (Slave Address, Baud rate, Stop bit, Parity, Data length) is confirmed by integral indicator display when powering on. EJX Multivariable transmitter communication setting (Baud rate and terminator setting) is confirmed by the hardware switch.	2.1.1 The Hardware Switch 2.2 Integral Indicator Display When Powering On
	4	Host timeout setting	Confirm if the timeout setting of host is not shorter than 3 seconds.	3.2 Communication Setup
	5	Host communication period	Confirm if the host communication period between receiving the response from the device and sending the request to the device is set larger than 100 ms under the multi drop connection.	3.2 Communication Setup
	6	Modbus specification	Confirm if the host Modbus communication matches to Modbus specification. E.g. • Sending frame conforms Modbus specification. • Max transmit frame size is not exceeding 200byte. • CRC value is correct.	5. Modbus Communication
	7	Noise	Confirm if the noise is not injected in the signal on RS485 bus. We recommend isolated RS485 USB Adaptor for connecting PC to EJX Multivariable Transmitter.	2.1.2 Wiring
	8	Host is not damaged	Confirm the host or RS-485 USB Adaptor is not damaged by confirming monitor LED. Do not connect MODBUS (RS-485) wiring to Power terminals. It may damage RS-485 adaptor.	2.1.2 Wiring
	9	Device is not damaged	Contact Yokogawa service personnel and confirm the EJX Multivariable transmitter is not damaged. Do not connect power wiring to the MODBUS (RS-485) terminals. It may damage EJX Multivariable Transmitter. The EJX Multivariable Transmitter power supply is not electrically isolated from the RS-485 bus.	2.1.2 Wiring
In the case that Exception code ILLEGAL FUNCTION (0x01) is returned	1		Device received unsupported function code. Confirm if the host Modbus communication matches to Modbus specification or EJX Multivariable transmitter Modbus communication specification. Confirm the host is not sending “Function code 6: Write Single Register” which is not supported by EJX Multivariable transmitter.	5. Modbus Communication
In the case that Exception code ILLEGAL DATA ADDRESS (0x02) is returned	1		Device is under “write protect” status. Confirm “write protect” setting.	2.1.1 The Hardware Switch 3.4.6 Software Write Protection
	2		Device received Read/ Write request on unsupported address. Confirm host setting.	5. Modbus Communication
In the case that Exception code ILLEGAL DATA VALUE (0x03) is returned	1		Received data size and quantity value in the frame is not same. Confirm host setting.	5. Modbus Communication
	2		Received data other than ON (0xFF00) or OFF (0x0000) for writing Coil. Confirm host setting.	5. Modbus Communication

Abnormality phenomenon	Remedy			
	Priority	Item	Explanation	Reference
In the case that Exception code SLAVE DEVICE FAILURE (0x04) is returned	1		EEPROM in the CPU assembly is damaged. Contact Yokogawa service personnel for replacing CPU assembly or device.	IM01C25R05-01EN "EJX910A and EJX930A Multivariable Transmitters" 9. Maintenance
In the case that Exception code SLAVE DEVICE BUSY (0x06) is returned	1		Under write processing to EEPROM in the CPU assembly. Retry after 2 or 3 seconds waiting.	5. Modbus Communication
The writing data is ignored	1		Confirm "write protect" setting.	2.1.1 The Hardware Switch 3.4.6 Software Write Protection
	2		Confirm if the writing data is outside the limit of Modbus specification of the device.	5. Modbus Communication

---

# Revision Information

- Title : EJX910A and EJX930A  
Multivariable Transmitter Modbus Communication Type
- Manual No. : IM 01C25R05-01EN

Edition	Date	Page	Revised Item
1st	Nov. 2013	—	New publication