

**Model EJA210A and EJA220A
Flange Mounted Differential
Pressure Transmitters**

IM 01C21C01-01E

vigilantplant.[®]

Model EJA210A and EJA220A

Flange Mounted Differential Pressure Transmitters

IM 01C21C01-01E 12th Edition

Contents

1.	Introduction.....	1-1
	■ Regarding This Manual.....	1-1
1.1	For Safe Use of Product	1-2
1.2	Warranty.....	1-3
1.3	ATEX Documentation	1-4
2.	Handling Cautions.....	2-1
2.1	Model and Specifications Check.....	2-1
2.2	Unpacking.....	2-1
2.3	Storage	2-1
2.4	Selecting the Installation Location	2-1
2.5	Pressure Connection.....	2-2
2.6	Waterproofing of Cable Conduit Connections	2-2
2.7	Restrictions on Use of Radio Transceiver	2-2
2.8	Insulation Resistance and Dielectric Strength Test.....	2-2
2.9	Installation of Explosion Protected Type	2-3
	2.9.1 FM Approval.....	2-4
	2.9.2 CSA Certification.....	2-5
	2.9.3 IECEx Certification.....	2-7
	2.9.4 ATEX Certification.....	2-8
2.10	EMC Conformity Standards	2-11
2.11	PED (Pressure Equipment Directive)	2-11
2.12	Low Voltage Directive	2-12
3.	Component Names	3-1
4.	Installation.....	4-1
4.1	Precautions	4-1
4.2	Mounting	4-1
4.3	Rotating Transmitter Section.....	4-1
4.4	Changing the Direction of Integral Indicator	4-2
4.5	Affixing the Teflon Film	4-2
5.	Installing Impulse Piping.....	5-1
5.1	Impulse Piping Installation Precautions	5-1
	5.1.1 Connecting Impulse Piping to the Transmitter.....	5-1
	5.1.2 Routing the Impulse Piping.....	5-1

5.2	Impulse Piping Connection Examples	5-2
6.	Wiring.....	6-1
6.1	Wiring Precautions	6-1
6.2	Selecting the Wiring Materials.....	6-1
6.3	Connections of External Wiring to Terminal Box.....	6-1
6.3.1	Power Supply Wiring Connection	6-1
6.3.2	External Indicator Connection.....	6-1
6.3.3	BRAIN TERMINAL BT200 Connection	6-1
6.3.4	Check Meter Connection	6-2
6.4	Wiring	6-2
6.4.1	Loop Configuration	6-2
6.4.2	Wiring Installation.....	6-2
6.5	Grounding.....	6-3
6.6	Power Supply Voltage and Load Resistance	6-3
7.	Operation.....	7-1
7.1	Preparation for Starting Operation	7-1
7.2	Zero Point Adjustment	7-2
7.2.1	When you can obtain Low Range Value from actual measured value of 0% (0 kPa, atmospheric pressure);.....	7-2
7.2.2	When you cannot obtain Low Range Value from actual measured value of 0%;	7-3
7.3	Starting Operation	7-3
7.4	Shutting Down Operation	7-4
7.5	Venting or Draining Transmitter Pressure-detector Section	7-4
7.5.1	Draining Condensate	7-4
7.5.2	Venting Gas.....	7-4
7.6	Setting the Range Using the Range-setting Switch.....	7-4
8.	BRAIN TERMINAL BT200 Operation	8-1
8.1	BT200 Operation Precautions	8-1
8.1.1	Connecting the BT200	8-1
8.1.2	Conditions of Communication Line.....	8-1
8.2	BT200 Operating Procedures	8-2
8.2.1	Key Layout and Screen Display.....	8-2
8.2.2	Operating Key Functions	8-2
8.2.3	Calling Up Menu Addresses Using the Operating Keys.....	8-4
8.3	Setting Parameters Using the BT200.....	8-5
8.3.1	Parameter Summary.....	8-5
8.3.2	Parameter Usage and Selection.....	8-8
8.3.3	Setting Parameters	8-9
	(1) Tag No. Setup	8-9
	(2) Calibration Range Setup.....	8-9
	(3) Damping Time Constant Setup	8-10

	(4) Output Signal Low Cut Mode Setup	8-11
	(5) Change Output Limits	8-11
	(6) Integral Indicator Scale Setup.....	8-11
	(7) Unit Setup for Displayed Temperature	8-13
	(8) Unit Setup for Displayed Static Pressure	8-13
	(9) Operation Mode Setup	8-13
	(10) Output Status Display/Setup when a CPU Failure	8-14
	(11) Output Status Setup when a Hardware Error Occurs	8-14
	(12) Range Change while Applying Actual Inputs	8-14
	(13) Zero Point Adjustment	8-15
	(14) Span Adjustment.....	8-16
	(15) Test Output Setup	8-17
	(16) User Memo Fields.....	8-17
8.4	Displaying Data Using the BT200.....	8-18
	8.4.1 Displaying Measured Data.....	8-18
	8.4.2 Display Transmitter Model and Specifications.....	8-18
8.5	Self-Diagnostics.....	8-18
	8.5.1 Checking for Problems	8-18
	8.5.2 Errors and Countermeasures	8-20
9.	Maintenance.....	9-1
	9.1 Overview	9-1
	9.2 Calibration Instruments Selection	9-1
	9.3 Calibration	9-1
	9.4 Disassembly and Reassembly	9-3
	9.4.1 Replacing the Integral Indicator	9-3
	9.4.2 Replacing the CPU Board Assembly	9-4
	9.4.3 Replacing the Process Connector Gaskets.....	9-5
	9.5 Troubleshooting.....	9-5
	9.5.1 Basic Troubleshooting	9-5
	9.5.2 Troubleshooting Flow Charts.....	9-6
10.	General Specifications	10-1
	10.1 Standard Specifications.....	10-1
	10.2 Model and Suffix Codes	10-3
	10.3 Optional Specifications.....	10-5
	10.4 Dimensions.....	10-8

Customer Maintenance Parts List

DPharp EJA Series Transmitter Section	CMPL 01C21A01-02E
Model EJA210A and EJA220A	
Flange Mounted Differential Pressure Transmitter.....	CMPL 01C21C01-01E

Revision Information

1. Introduction

Thank you for purchasing the DPharp electronic pressure transmitter.

The DPharp Pressure Transmitters are precisely calibrated at the factory before shipment. To ensure correct and efficient use of the instrument, please read this manual thoroughly and fully understand how to operate the instrument before operating it.

■ Regarding This Manual

- This manual should be passed on to the end user.
- The contents of this manual are subject to change without prior notice.
- All rights reserved. No part of this manual may be reproduced in any form without Yokogawa's written permission.
- Yokogawa makes no warranty of any kind with regard to this manual, including, but not limited to, implied warranty of merchantability and fitness for a particular purpose.
- If any question arises or errors are found, or if any information is missing from this manual, please inform the nearest Yokogawa sales office.
- The specifications covered by this manual are limited to those for the standard type under the specified model number break-down and do not cover custom-made instruments.
- Please note that changes in the specifications, construction, or component parts of the instrument may not immediately be reflected in this manual at the time of change, provided that postponement of revisions will not cause difficulty to the user from a functional or performance standpoint.
- Yokogawa assumes no responsibilities for this product except as stated in the warranty.
- If the customer or any third party is harmed by the use of this product, Yokogawa assumes no responsibility for any such harm owing to any defects in the product which were not predictable, or for any indirect damages.



NOTE

For FOUNDATION Fieldbus™, PROFIBUS PA and HART protocol versions, please refer to IM 01C22T02-01E, IM 01C22T03-00E and IM 01C22T01-01E respectively, in addition to this manual.

- The following safety symbol marks are used in this manual:



WARNING

Indicates a potentially hazardous situation which, if not avoided, could result in death or serious injury.



CAUTION

Indicates a potentially hazardous situation which, if not avoided, may result in minor or moderate injury. It may also be used to alert against unsafe practices.



IMPORTANT

Indicates that operating the hardware or software in this manner may damage it or lead to system failure.



NOTE

Draws attention to information essential for understanding the operation and features.

--- Direct current

1.1 For Safe Use of Product

For the protection and safety of the operator and the instrument or the system including the instrument, please be sure to follow the instructions on safety described in this manual when handling this instrument. In case the instrument is handled in contradiction to these instructions, Yokogawa does not guarantee safety. Please give your attention to the followings.

(a) Installation

- The instrument must be installed by an expert engineer or a skilled personnel. The procedures described about INSTALLATION are not permitted for operators.
- In case of high process temperature, care should be taken not to burn yourself because the surface of body and case reaches a high temperature.
- The instrument installed in the process is under pressure. Never loosen the process connector bolts to avoid the dangerous spouting of process fluid.
- During draining condensate from the pressuredetector section, take appropriate care to avoid contact with the skin, eyes or body, or inhalation of vapors, if the accumulated process fluid may be toxic or otherwise harmful.
- When removing the instrument from hazardous processes, avoid contact with the fluid and the interior of the meter.
- All installation shall comply with local installation requirement and local electrical code.

(b) Wiring

- The instrument must be installed by an expert engineer or a skilled personnel. The procedures described about WIRING are not permitted for operators.
- Please confirm that voltages between the power supply and the instrument before connecting the power cables and that the cables are not powered before connecting.

(c) Operation

- Wait 10 min. after power is turned off, before opening the covers.

(d) Maintenance

- Please do not carry out except being written to a maintenance descriptions. When these procedures are needed, please contact nearest YOKOGAWA office.
- Care should be taken to prevent the build up of drift, dust or other material on the display glass and name plate. In case of its maintenance, soft and dry cloth is used.

(e) Explosion Protected Type Instrument

- Users of explosion proof instruments should refer first to section 2.9 (Installation of an Explosion Protected Instrument) of this manual.
- The use of this instrument is restricted to those who have received appropriate training in the device.
- Take care not to create sparks when accessing the instrument or peripheral devices in a hazardous location.

(f) Modification

- Yokogawa will not be liable for malfunctions or damage resulting from any modification made to this instrument by the customer.

1.2 Warranty

- The warranty shall cover the period noted on the quotation presented to the purchaser at the time of purchase. Problems occurred during the warranty period shall basically be repaired free of charge.
- In case of problems, the customer should contact the Yokogawa representative from which the instrument was purchased, or the nearest Yokogawa office.
- If a problem arises with this instrument, please inform us of the nature of the problem and the circumstances under which it developed, including the model specification and serial number. Any diagrams, data and other information you can include in your communication will also be helpful.
- Responsible party for repair cost for the problems shall be determined by Yokogawa based on our investigation.
- The Purchaser shall bear the responsibility for repair costs, even during the warranty period, if the malfunction is due to:
 - Improper and/or inadequate maintenance by the purchaser.
 - Failure or damage due to improper handling, use or storage which is out of design conditions.
 - Use of the product in question in a location not conforming to the standards specified by Yokogawa, or due to improper maintenance of the installation location.
 - Failure or damage due to modification or repair by any party except Yokogawa or an approved representative of Yokogawa.
 - Malfunction or damage from improper relocation of the product in question after delivery.
 - Reason of force majeure such as fires, earthquakes, storms/floods, thunder/lightening, or other natural disasters, or disturbances, riots, warfare, or radioactive contamination.

1.3 ATEX Documentation

This procedure is only applicable to the countries in European Union.

<p>GB All instruction manuals for ATEX Ex related products are available in English, German and French. Should you require Ex related instructions in your local language, you are to contact your nearest Yokogawa office or representative.</p>	<p>SK Všetky návody na obsluhu pre prístroje s ATEX Ex sú k dispozícii v jazyku anglickom, nemeckom a francúzskom. V prípade potreby návodu pre Ex-prístroje vo Vašom národnom jazyku, skontaktujte prosím miestnu kanceláriu firmy Yokogawa.</p>
<p>DK Alle brugervejledninger for produkter relateret til ATEX Ex er tilgængelige på engelsk, tysk og fransk. Skulle De ønske yderligere oplysninger om håndtering af Ex produkter på eget sprog, kan De rette henvendelse herom til den nærmeste Yokogawa afdeling eller forhandler.</p>	<p>CZ Všechny uživatelské příručky pro výrobky, na něž se vztahuje nevybušné schválení ATEX Ex, jsou dostupné v angličtině, němčině a francouzštině. Požadujete-li pokyny týkající se výrobků s nevybušným schválením ve vašem lokálním jazyku, kontaktujte prosím vaši nejbližší reprezentační kancelář Yokogawa.</p>
<p>I Tutti i manuali operativi di prodotti ATEX contrassegnati con Ex sono disponibili in inglese, tedesco e francese. Se si desidera ricevere i manuali operativi di prodotti Ex in lingua locale, mettersi in contatto con l'ufficio Yokogawa più vicino o con un rappresentante.</p>	<p>LT Visos gaminių ATEX Ex kategorijos Eksploatavimo instrukcijos teikiami anglų, vokiečių ir prancūzų kalbomis. Norėdami gauti prietaisų Ex dokumentaciją kitomis kalbomis susisiekite su artimiausiu bendrovės "Yokogawa" biuru arba atstovu.</p>
<p>E Todos los manuales de instrucciones para los productos antiexplosivos de ATEX están disponibles en inglés, alemán y francés. Si desea solicitar las instrucciones de estos artículos antiexplosivos en su idioma local, deberá ponerse en contacto con la oficina o el representante de Yokogawa más cercano.</p>	<p>LV Visas ATEX Ex kategorijas izstrādājumu Lietošanas instrukcijas tiek piegādātas angļu, vācu un franču valodās. Ja vēlaties saņemt Ex ierīšu dokumentāciju citā valodā, Jums ir jāsazinās ar firmas Jokogava (Yokogawa) tuvāko ofisu vai pārstāvi.</p>
<p>NL Alle handleidingen voor producten die te maken hebben met ATEX explosiebeveiliging (Ex) zijn verkrijgbaar in het Engels, Duits en Frans. Neem, indien u aanwijzingen op het gebied van explosiebeveiliging nodig hebt in uw eigen taal, contact op met de dichtstbijzijnde vestiging van Yokogawa of met een vertegenwoordiger.</p>	<p>EST Kõik ATEX Ex toodete kasutamisujuhendid on esitatud inglise, saksa ja prantsuse keeles. Ex seadmete muukeelse dokumentatsiooni saamiseks pöörduge lähima lokagava (Yokogawa) kontori või esindaja poole.</p>
<p>SF Kaikkien ATEX Ex -tyyppisten tuotteiden käyttöohjeet ovat saatavilla englannin-, saksan- ja ranskankielisinä. Mikäli tarvitsette Ex -tyyppisten tuotteiden ohjeita omalla paikallisella kielellänne, ottakaa yhteyttä lähimpään Yokogawa-toimistoon tai -edustajaan.</p>	<p>PL Wszystkie instrukcje obsługi dla urządzeń w wykonaniu przeciwwybuchowym Ex, zgodnych z wymaganiami ATEX, dostępne są w języku angielskim, niemieckim i francuskim. Jeżeli wymagana jest instrukcja obsługi w Państwa lokalnym języku, prosimy o kontakt z najbliższym biurem Yokogawy.</p>
<p>P Todos os manuais de instruções referentes aos produtos Ex da ATEX estão disponíveis em Inglês, Alemão e Francês. Se necessitar de instruções na sua língua relacionadas com produtos Ex, deverá entrar em contacto com a delegação mais próxima ou com um representante da Yokogawa.</p>	<p>SLO Vsi predpisi in navodila za ATEX Ex sorodni pridelki so pri roki v angleščini, nemščini ter francoščini. Če so Ex sorodna navodila potrebna v vašem tujejnem jeziku, kontaktirajte vaš najbližji Yokogawa office ili predstavnika.</p>
<p>F Tous les manuels d'instruction des produits ATEX Ex sont disponibles en langue anglaise, allemande et française. Si vous nécessitez des instructions relatives aux produits Ex dans votre langue, veuillez bien contacter votre représentant Yokogawa le plus proche.</p>	<p>H Az ATEX Ex műszerek gépkönyveit angol, német és francia nyelven adjuk ki. Amennyiben helyi nyelven kérjük az Ex eszközök leírásait, kérjük keressék fel a legközelebbi Yokogawa irodát, vagy képviselőt.</p>
<p>D Alle Betriebsanleitungen für ATEX Ex bezogene Produkte stehen in den Sprachen Englisch, Deutsch und Französisch zur Verfügung. Sollten Sie die Betriebsanleitungen für Ex-Produkte in Ihrer Landessprache benötigen, setzen Sie sich bitte mit Ihrem örtlichen Yokogawa-Vertreter in Verbindung.</p>	<p>BG Всички упътвания за продукти от серията ATEX Ex се предлагат на английски, немски и френски език. Ако се нуждаете от упътвания за продукти от серията Ex на родния ви език, се свържете с най-близкия офис или представителство на фирма Yokogawa.</p>
<p>S Alla instruktionsböcker för ATEX Ex (explosionssäkra) produkter är tillgängliga på engelska, tyska och franska. Om Ni behöver instruktioner för dessa explosionssäkra produkter på annat språk, skall Ni kontakta närmaste Yokogawakontor eller representant.</p>	<p>RO Toate manualele de instructiuni pentru produsele ATEX Ex sunt in limba engleza, germana si franceza. In cazul in care doriti instructiunile in limba locala, trebuie sa contactati cel mai apropiat birou sau reprezentant Yokogawa.</p>
<p>GR Όλα τα εγχειρίδια λειτουργίας των προϊόντων με ATEX Ex διατίθενται στα Αγγλικά, Γερμανικά και Γαλλικά. Σε περίπτωση που χρειάζεστε οδηγίες σχετικά με Ex στην τοπική γλώσσα παρακαλούμε επικοινωνήστε με το πλησιέστερο γραφείο της Yokogawa ή αντιπρόσωπο της.</p>	<p>M Il-manwali kollha ta' l-istruzzjonijiet għal prodotti marbuta ma' ATEX Ex huma disponibbli bi-Ingliż, bi-Ġermaniż u bi-Franċiż. Jekk tkun teħtieġ struzzjonijiet marbuta ma' Ex fil-lingwa lokali tiegħek, għandek tikkuntattja lill-eqreb rappreżentant jew ufficiju ta' Yokogawa.</p>

2. Handling Cautions

This chapter describes important cautions regarding how to handle the transmitter. Read carefully before using the transmitter.

The EJA-A Series pressure transmitters are thoroughly tested at the factory before shipment. When the transmitter is delivered, visually check them to make sure that no damage occurred during shipment.

Also check that all transmitter mounting hardware shown in Figure 2.1 is included. If the transmitter was ordered without the mounting bracket or without the process connector, the transmitter mounting hardware is not included. After checking the transmitter, repack it in the way it was delivered until installation.

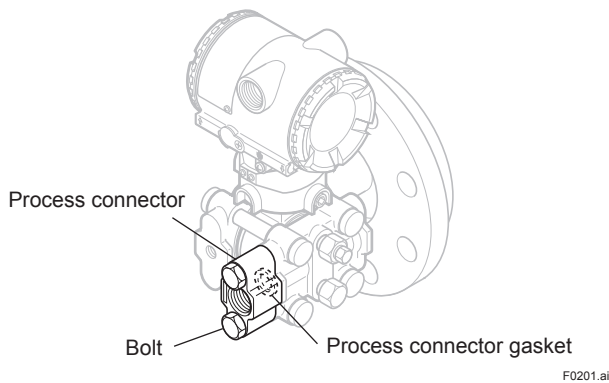

Figure 2.1 Transmitter Mounting Hardware

2.1 Model and Specifications Check

The model name and specifications are indicated on the name plate attached to the case. If the reverse operating mode was ordered (reverse signal), 'REVERSE' will be inscribed in field *1.

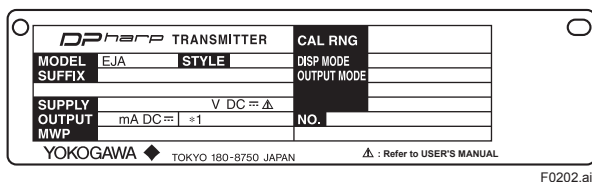

Figure 2.2 Name Plate

2.2 Unpacking

When moving the transmitter to the installation site, keep it in its original packaging. Then, unpack the transmitter there to avoid damage on the way.

2.3 Storage

The following precautions must be observed when storing the instrument, especially for a long period.

- (a) Select a storage area which meets the following conditions:
 - It is not exposed to rain or water.
 - It suffers minimum vibration and shock.
 - It has an ambient temperature and relative humidity within the following ranges.

Ambient temperature:

-40 to 85°C without integral indicator

-30 to 80°C with integral indicator

Relative humidity:

5% to 100% R.H. (at 40°C)

Preferred temperature and humidity:

approx. 25°C and 65% R.H.

- (b) When storing the transmitter, repack it as nearly as possible to the way it was packed when delivered from the factory.
- (c) If storing a transmitter that has been used, thoroughly clean the chambers inside the cover flanges, so that no measured fluid remains in it. Also make sure before storing that the pressure-detector and transmitter section are securely mounted.

2.4 Selecting the Installation Location

The transmitter is designed to withstand severe environmental conditions. However, to ensure stable and accurate operation for years, observe the following precautions when selecting an installation location.

- (a) Ambient Temperature

Avoid locations subject to wide temperature variations or a significant temperature gradient. If the location is exposed to radiant heat from plant equipments, provide adequate thermal insulation and/or ventilation.

- (b) Ambient Atmosphere
Avoid installing the transmitter in a corrosive atmosphere. If the transmitter must be installed in a corrosive atmosphere, there must be adequate ventilation as well as measures to prevent intrusion or stagnation of rain water in conduits.
- (c) Shock and Vibration
Select an installation site suffering minimum shock and vibration (although the transmitter is designed to be relatively resistant to shock and vibration).
- (d) Installation of Explosion-protected Transmitters
Explosion-protected transmitters can be installed in hazardous areas according to the types of gases for which they are certified. See Subsection 2.9 "Installation of Explosion Protected Type Transmitters."

2.5 Pressure Connection



WARNING

- Instrument installed in the process is under pressure. Never loosen the process connector bolts to avoid the dangerous spouting of process fluid.
- During draining condensate from the pressure-detector section, take appropriate care to avoid contact with the skin, eyes or body, or inhalation of vapors, if the accumulated process fluid may be toxic or otherwise harmful.

The following precautions must be observed in order to safely operate the transmitter under pressure.

- (a) Make sure that the two process connector bolts are tightened firmly.
- (b) Make sure that there are no leaks in the impulse piping.
- (c) Never apply a pressure higher than the specified maximum working pressure.

2.6 Waterproofing of Cable Conduit Connections

Apply a non-hardening sealant to the threads to waterproof the transmitter cable conduit connections. (See Figure 6.7, 6.8 and 6.9.)

2.7 Restrictions on Use of Radio Transceiver



IMPORTANT

Although the transmitter has been designed to resist high frequency electrical noise, if a radio transceiver is used near the transmitter or its external wiring, the transmitter may be affected by high frequency noise pickup. To test for such effects, bring the transceiver in use slowly from a distance of several meters from the transmitter, and observe the measurement loop for noise effects. Thereafter, always use the transceiver outside the area affected by noise.

2.8 Insulation Resistance and Dielectric Strength Test

Since the transmitter has undergone insulation resistance and dielectric strength tests at the factory before shipment, normally these tests are not required. However, if required, observe the following precautions in the test procedures.

- (a) Do not perform such tests more frequently than is absolutely necessary. Even test voltages that do not cause visible damage to the insulation may degrade the insulation and reduce safety margins.
- (b) Never apply a voltage exceeding 500 V DC (100 V DC with an internal lightning protector) for the insulation resistance test, nor a voltage exceeding 500 V AC (100 V AC with an internal lightning protector) for the dielectric strength test.
- (c) Before conducting these tests, disconnect all signal lines from the transmitter terminals. Perform the tests in the following procedure:

• Insulation Resistance Test

- 1) Short-circuit the + and – SUPPLY terminals in the terminal box.
- 2) Turn OFF the insulation tester. Then connect the insulation tester plus (+) lead wire to the shorted SUPPLY terminals and the minus (–) leadwire to the grounding terminal.
- 3) Turn ON the insulation tester power and measure the insulation resistance. The voltage should be applied short as possible to verify that the insulation resistance is at least 20 MΩ.
- 4) After completing the test and being very careful not to touch exposed conductors disconnect the insulation tester and connect a 100 kΩ resistor between the grounding terminal and the short-circuiting SUPPLY terminals. Leave this resistor connected at least one second to discharge any static potential. Do not touch the terminals while it is discharging.

• Dielectric Strength Test

- 1) Short-circuit the + and – SUPPLY terminals in the terminal box.
- 2) Turn OFF the dielectric strength tester. Then connect the tester between the shorted SUPPLY terminals and the grounding terminal. Be sure to connect the grounding lead of the dielectric strength tester to the ground terminal.
- 3) Set the current limit on the dielectric strength tester to 10 mA, then turn ON the power and gradually increase the test voltage from '0' to the specified voltage.
- 4) When the specified voltage is reached, hold it for one minute.
- 5) After completing this test, slowly decrease the voltage to avoid any voltage surges.

2.9 Installation of Explosion Protected Type

In this section, further requirements and differences and for explosionproof type instrument are described. For explosionproof type instrument, the description in this chapter is prior to other description in this users manual.

For the intrinsically safe equipment and explosionproof equipment, in case the instrument is not restored to its original condition after any repair or modification undertaken by the customer, intrinsically safe construction or explosionproof construction is damaged and may cause dangerous condition. Please contact Yokogawa for any repair or modification required to the instrument.

**NOTE**

For FOUNDATION Fieldbus and PROFIBUS PA explosion protected type, please refer to IM 01C22T02-01E and IM 01C22T03-00E respectively.

**CAUTION**

This instrument is tested and certified as intrinsically safe type or explosionproof type. Please note that the construction of the instrument, installation, external wiring, maintenance or repair is strictly restricted, and non-observance or negligence of this restriction would result in dangerous condition.

**WARNING**

To preserve the safety of explosionproof equipment requires great care during mounting, wiring, and piping. Safety requirements also place restrictions on maintenance and repair activities. Please read the following sections very carefully.

2.9.1 FM Approval

a. FM Intrinsically Safe Type

Caution for FM intrinsically safe type. (Following contents refer “DOC. No. IFM012-A12 P.1 and 2.”)

Note 1. Model EJA Series pressure transmitters with optional code /FS1 are applicable for use in hazardous locations.

- Applicable Standard: FM3600, FM3610, FM3611, FM3810, ANSI/NEMA250
- Intrinsically Safe for Class I, Division 1, Groups A, B, C & D. Class II, Division 1, Groups E, F & G and Class III, Division 1 Hazardous Locations.
- Nonincendive for Class I, Division 2, Groups A, B, C & D. Class II, Division 2, Groups E, F & G and Class III, Division 1 Hazardous Locations.
- Outdoor hazardous locations, NEMA 4X.
- Temperature Class: T4
- Ambient temperature: -40 to 60°C

Note 2. Entity Parameters

- Intrinsically Safe Apparatus Parameters [Groups A, B, C, D, E, F and G]

$V_{max} = 30\text{ V}$ $C_i = 22.5\text{ nF}$
 $I_{max} = 165\text{ mA}$ $L_i = 730\text{ }\mu\text{H}$
 $P_{max} = 0.9\text{ W}$

- * Associated Apparatus Parameters (FM approved barriers)

$V_{oc} \leq 30\text{ V}$ $C_a > 22.5\text{ nF}$
 $I_{sc} \leq 165\text{ mA}$ $L_a > 730\text{ }\mu\text{H}$
 $P_{max} \leq 0.9\text{ W}$

- Intrinsically Safe Apparatus Parameters [Groups C, D, E, F and G]

$V_{max} = 30\text{ V}$ $C_i = 22.5\text{ nF}$
 $I_{max} = 225\text{ mA}$ $L_i = 730\text{ }\mu\text{H}$
 $P_{max} = 0.9\text{ W}$

- * Associated Apparatus Parameters (FM approved barriers)

$V_{oc} \leq 30\text{ V}$ $C_a > 22.5\text{ nF}$
 $I_{sc} \leq 225\text{ mA}$ $L_a > 730\text{ }\mu\text{H}$
 $P_{max} \leq 0.9\text{ W}$

- Entity Installation Requirements
 $V_{max} \geq V_{oc}$ or V_t , $I_{max} \geq I_{sc}$ or I_t ,
 P_{max} (IS Apparatus) $\geq P_{max}$ (Barrier)
 $C_a \geq C_i + C_{cable}$, $L_a \geq L_i + L_{cable}$

Note 3. Installation

- Barrier must be installed in an enclosure that meets the requirements of ANSI/ISA S82.01.
- Control equipment connected to barrier must not use or generate more than 250 V rms or V dc.
- Installation should be in accordance with ANSI/ISA RP12.6 “Installation of Intrinsically Safe Systems for Hazardous (Classified) Locations” and the National Electric Code (ANSI/NFPA 70).
- The configuration of associated apparatus must be FMRC Approved.
- Dust-tight conduit seal must be used when installed in a Class II, III, Group E, F and G environments.
- Associated apparatus manufacturer’s installation drawing must be followed when installing this apparatus.
- The maximum power delivered from the barrier must not exceed 0.9 W.
- Note a warning label worded “SUBSTITUTION OF COMPONENTS MAY IMPAIR INTRINSIC SAFETY,” and “INSTALL IN ACCORDANCE WITH DOC. No. IFM012-A12 P.1 and 2.”

Note 4. Maintenance and Repair

- The instrument modification or parts replacement by other than authorized representative of Yokogawa Electric Corporation is prohibited and will void Factory Mutual Intrinsically safe and Nonincendive Approval.

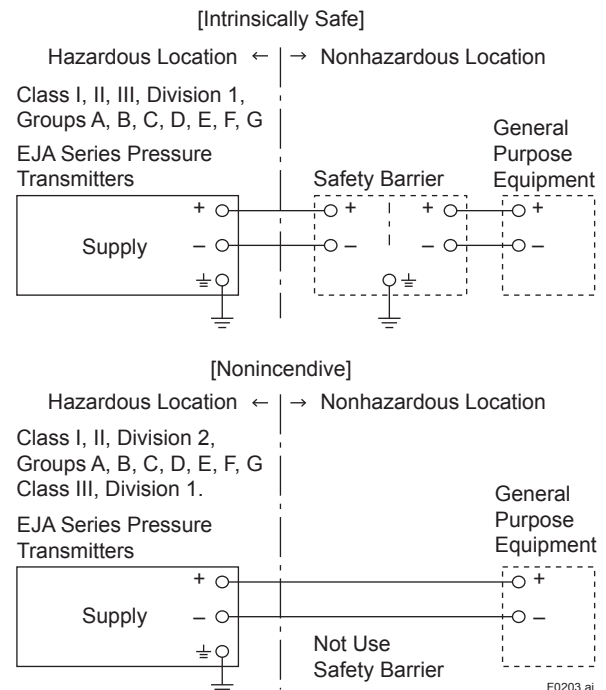

F0203.ai

b. FM Explosionproof Type

Caution for FM explosionproof type.

Note 1. Model EJA Series differential, gauge, and absolute pressure transmitters with optional code /FF1 are applicable for use in hazardous locations.

- Applicable Standard: FM3600, FM3615, FM3810, ANSI/NEMA250
- Explosionproof for Class I, Division 1, Groups B, C and D.
- Dust-ignitionproof for Class II/III, Division 1, Groups E, F and G.
- Outdoor hazardous locations, NEMA 4X.
- Temperature Class: T6
- Ambient Temperature: -40 to 60°C
- Supply Voltage: 42 V dc max.
- Output signal: 4 to 20 mA

Note 2. Wiring

- All wiring shall comply with National Electrical Code ANSI/NEPA70 and Local Electrical Codes.
- When installed in Division 1, "FACTORY SEALED, CONDUIT SEAL NOT REQUIRED."

Note 3. Operation

- Keep the "CAUTION" nameplate attached to the transmitter.
CAUTION: OPEN CIRCUIT BEFORE REMOVING COVER. FACTORY SEALED, CONDUIT SEAL NOT REQUIRED. INSTALL IN ACCORDANCE WITH THE INSTRUCTION MANUAL IM 1C22.
- Take care not to generate mechanical sparking when accessing to the instrument and peripheral devices in a hazardous location.

Note 4. Maintenance and Repair

- The instrument modification or parts replacement by other than authorized representative of Yokogawa Electric Corporation is prohibited and will void Factory Mutual Explosionproof Approval.

c. FM Intrinsically Safe Type/FM Explosionproof Type

Model EJA Series pressure transmitters with optional code /FU1 can be selected the type of protection (FM Intrinsically Safe or FM Explosionproof) for use in hazardous locations.

Note 1. For the installation of this transmitter, once a particular type of protection is selected, any other type of protection cannot be used. The installation must be in accordance with the description about the type of protection in this instruction manual.

Note 2. In order to avoid confusion, unnecessary marking is crossed out on the label other than the selected type of protection when the transmitter is installed.

2.9.2 CSA Certification**a. CSA Intrinsically Safe Type**

Caution for CSA Intrinsically safe type.
(Following contents refer to "DOC No. ICS003-A12 P.1-1 and P.1-2.")

Note 1. Model EJA Series differential, gauge, and absolute pressure transmitters with optional code /CS1 are applicable for use in hazardous locations

Certificate: 1053843

- Applicable Standard: C22.2 No.0, No.0.4, No.25, No.30, No.94, No.142, No.157, No.213
- Intrinsically Safe for Class I, Division 1, Groups A, B, C & D. Class II, Division 1, Groups E, F & G and Class III, Division 1 Hazardous Locations.
- Nonincendive for Class I, Division 2, Groups A, B, C & D, Class II, Division 2, Groups F & G, and Class III, Hazardous Locations. (not use Safety Barrier)
- Encl. "Type 4X"
- Temperature Class: T4
- Ambient temperature: -40* to 60°C
* -15°C when /HE is specified.
- Process Temperature: 120°C max.

Note 2. Entity Parameters

- Intrinsically safe ratings are as follows:
Maximum Input Voltage (Vmax) = 30 V
Maximum Input Current (Imax) = 165 mA
Maximum Input Power (Pmax) = 0.9 W
Maximum Internal Capacitance (Ci) = 22.5nF
Maximum Internal Inductance (Li) = 730 μH
- * Associated apparatus (CSA certified barriers)
Maximum output voltage (Voc) ≤ 30 V
Maximum output current (Isc) ≤ 165 mA
Maximum output power (Pmax) ≤ 0.9 W

Note 3. Installation

- All wiring shall comply with Canadian Electrical Code Part I and Local Electrical Codes.
- The instrument modification or parts replacement by other than authorized representative of Yokogawa Electric Corporation and Yokogawa Corporation of America is prohibited and will void Canadian Standards Intrinsically safe and nonincendive Certification.

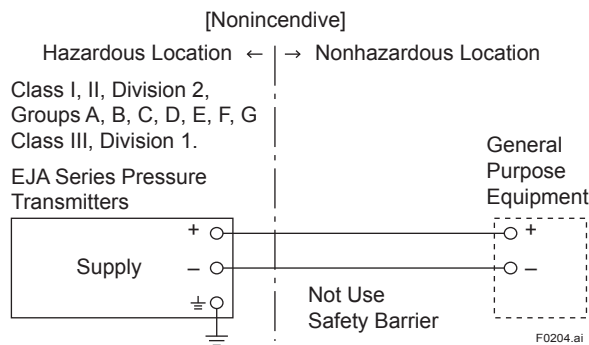
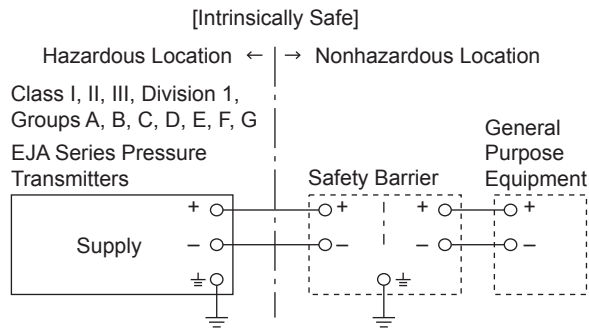

b. CSA Explosionproof Type

Caution for CSA explosionproof type.

Note 1. Model EJA Series differential, gauge, and absolute pressure transmitters with optional code /CF1 are applicable for use in hazardous locations:

Certificate: 1089598

- Applicable Standard: C22.2 No.0, No.0.4, No.25, No.30, No.94, No.142
- Explosionproof for Class I, Division 1, Groups B, C and D.
- Dust-ignitionproof for Class II/III, Division 1, Groups E, F and G.
- Encl "Type 4X"
- Temperature Class: T6, T5, and T4
- Process Temperature: 85°C (T6), 100°C (T5), and 120°C (T4)
- Ambient Temperature: -40* to 80°C
- * -15°C when /HE is specified.
- Supply Voltage: 42 V dc max.
- Output Signal: 4 to 20 mA

Note 2. Wiring

- All wiring shall comply with Canadian Electrical Code Part I and Local Electrical Codes.
- In hazardous location, wiring shall be in conduit as shown in the figure.
CAUTION: SEAL ALL CONDUITS WITHIN 50 cm OF THE ENCLOSURE.
UN SCELLEMENT DOIT ÊTRE INSTALLÉ À MOINS DE 50 cm DU BÂTIER.
- When installed in Division 2, "SEALS NOT REQUIRED."

Note 3. Operation

- Keep the "CAUTION" label attached to the transmitter.
CAUTION: OPEN CIRCUIT BEFORE REMOVING COVER.
OUVRIR LE CIRCUIT AVANT D'NLEVER LE COUVERCLE.
- Take care not to generate mechanical sparking when accessing to the instrument and peripheral devices in a hazardous location.

Note 4. Maintenance and Repair

- The instrument modification or parts replacement by other than authorized representative of Yokogawa Electric Corporation and Yokogawa Corporation of America is prohibited and will void Canadian Standards Explosionproof Certification.

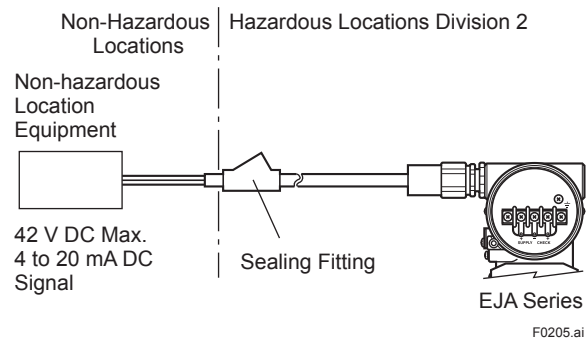
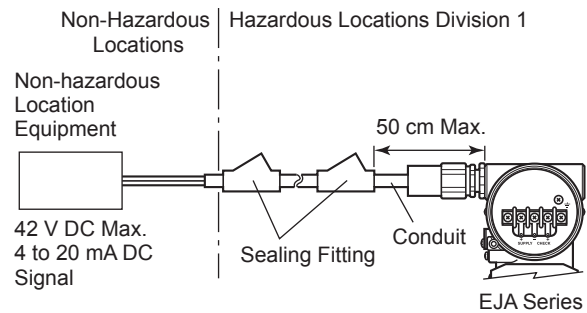

c. CSA Intrinsically Safe Type/CSA Explosionproof Type

Model EJA Series pressure transmitters with optional code /CU1 can be selected the type of protection (CSA Intrinsically Safe or CSA Explosionproof) for use in hazardous locations.

Note 1. For the installation of this transmitter, once a particular type of protection is selected, any other type of protection cannot be used. The installation must be in accordance with the description about the type of protection in this instruction manual.

Note 2. In order to avoid confusion, unnecessary marking is crossed out on the label other than the selected type of protection when the transmitter is installed.

2.9.3 IECEx Certification

Model EJA Series differential, gauge, and absolute pressure transmitters with optional code /SU2 can be selected the type of protection (IECEx Intrinsically Safe/type n or flameproof) for use in hazardous locations.

Note 1. For the installation of this transmitter, once a particular type of protection is selected, any other type of protection cannot be used. The installation must be in accordance with the description about the type of protection in this instruction manual.

Note 2. In order to avoid confusion, unnecessary marking is crossed out on the label other than the selected type of protection when the transmitter is installed.

a. IECEx Intrinsically Safe Type / type n

Caution for IECEx Intrinsically safe and type n.

Note 1. Model EJA Series differential, gauge, and absolute pressure transmitters with optional code /SU2 are applicable for use in hazardous locations.

- No. IECEx KEM 06.0007X
- Applicable Standard: IEC 60079-0:2004, IEC 60079-11:1999, IEC 60079-15:2005, IEC 60079-26:2004
- Type of Protection and Marking Code: Ex ia IIC T4, Ex nL IIC T4
- Ambient Temperature : -40 to 60°C
- Max. Process Temp.: 120°C
- Enclosure: IP67

Note 2. Entity Parameters

- Intrinsically safe ratings are as follows:
 Maximum Input Voltage (Ui) = 30 V
 Maximum Input Current (Ii) = 165 mA
 Maximum Input Power (Pi) = 0.9 W
 Maximum Internal Capacitance (Ci) = 22.5nF
 Maximum Internal Inductance (Li) = 730 μH
- Type “n” ratings are as follows:
 Maximum Input Voltage (Ui) = 30 V
 Maximum Internal Capacitance (Ci) = 22.5nF
 Maximum Internal Inductance (Li) = 730 μH
- Installation Requirements
 $U_o \leq U_i$, $I_o \leq I_i$, $P_o \leq P_i$,
 $C_o \geq C_i + C_{cable}$, $L_o \geq L_i + L_{cable}$
 Uo, Io, Po, Co, and Lo are parameters of barrier.

Note 3. Installation

- In any safety barrier used output current must be limited by a resistor 'R' such that $I_o = U_o/R$.
- The safety barrier must be IECEx certified.
- Input voltage of the safety barrier must be less than 250 Vrms/Vdc.
- The instrument modification or parts replacement by other than authorized representative of Yokogawa Electric Corporation and will void IECEx Intrinsically safe and type n certification.
- The cable entry devices and blanking elements for type n shall be of a certified type providing a level of ingress protection of at least IP54, suitable for the conditions of use and correctly installed.
- Electrical Connection:
 The type of electrical connection is stamped near the electrical connection port according to the following marking.

Screw Size	Marking
ISO M20 × 1.5 female	△ M
ANSI 1/2 NPT female	△ A

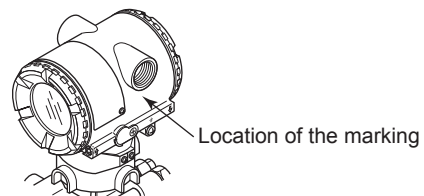

F0206.ai

Note 4. Operation

- WARNING:
WHEN AMBIENT TEMPERATURE $\geq 55^{\circ}\text{C}$,
USE THE HEAT-RESISTING CABLES $\geq 90^{\circ}\text{C}$.

Note 5. Special Conditions for Safe Use

- WARNING:
IN THE CASE WHERE THE ENCLOSURE OF THE PRESSURE TRANSMITTER IS MADE OF ALUMINUM, IF IT IS MOUNTED IN AN AREA WHERE THE USE OF ZONE 0 IS REQUIRED, IT MUST BE INSTALLED SUCH, THAT, EVEN IN THE EVENT OF RARE INCIDENTS, IGNITION SOURCES DUE TO IMPACT AND FRICTION SPARKS ARE EXCLUDED.

- Ambient Temperature: -40 to 75°C (T4), -40 to 80°C (T5), -40 to 75°C (T6)
- Supply Voltage: 42 V dc max.
- Output Signal: 4 to 20 mA dc

Note 2. Wiring

- In hazardous locations, the cable entry devices shall be of a certified flameproof type, suitable for the conditions of use and correctly installed.
- Unused apertures shall be closed with suitable flameproof certified blanking elements. (The plug attached is certificated as the flame proof IP67 as a part of this apparatus.)
- In case of ANSI 1/2 NPT plug, ANSI hexagonal wrench should be applied to screw in.

Note 3. Operation

- WARNING:
AFTER DE-ENERGIZING, DELAY 10 MINUTES BEFORE OPENING.
- WARNING:
WHEN AMBIENT TEMPERATURE $\geq 70^{\circ}\text{C}$,
USE THE HEAT-RESISTING CABLES $\geq 90^{\circ}\text{C}$.
- Take care not to generate mechanical sparking when accessing to the instrument and peripheral devices in a hazardous location.

Note 4. Maintenance and Repair

- The instrument modification or parts replacement by other than authorized representative of Yokogawa Electric Corporation is prohibited and will void IECEx Certification.

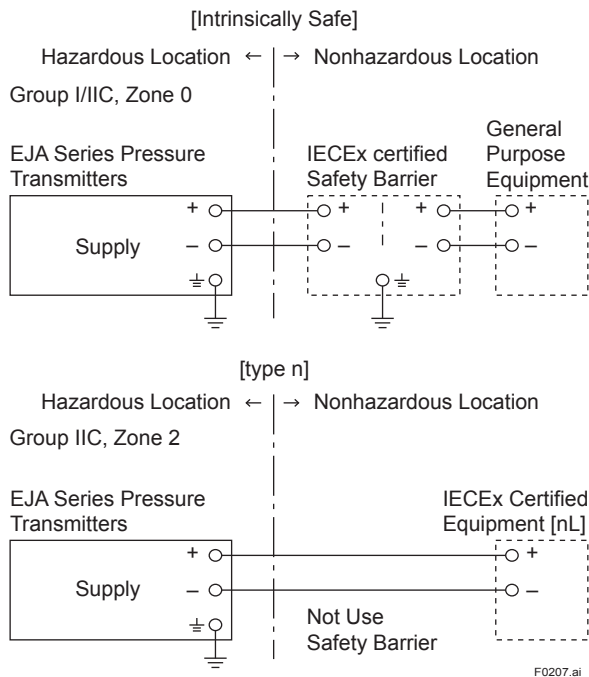

b. IECEx Flameproof Type

Caution for IECEx flameproof type.

Note 1. Model EJA Series differential, gauge, and absolute pressure transmitters with optional code /SU2 are applicable for use in hazardous locations:

- No. IECEx KEM 06.0005
- Applicable Standard: IEC60079-0:2004, IEC60079-1:2003
- Type of Protection and Marking Code: Ex d IIC T6...T4
- Enclosure: IP67
- Maximum Process Temperature: 120°C (T4), 100°C (T5), 85°C (T6)

2.9.4 ATEX Certification

(1) Technical Data

a. ATEX Intrinsically Safe Type

Caution for ATEX Intrinsically safe type.

Note 1. Model EJA Series differential, gauge, and absolute pressure transmitters with optional code /KS2 for potentially explosive atmospheres:

- No. KEMA 02ATEX1030 X
- Applicable Standard: EN 50014:1997, EN 50020:1994, EN 50284:1999

- Type of Protection and Marking code: EEx ia IIC T4
- Temperature Class: T4
- Enclosure: IP67
- Process Temperature: 120°C max.
- Ambient Temperature: -40 to 60°C

Note 2. Electrical Data

- In type of explosion protection intrinsic safety EEx ia IIC only for connection to a certified intrinsically safe circuit with following maximum values:
 $U_i = 30\text{ V}$
 $I_i = 165\text{ mA}$
 $P_i = 0.9\text{ W}$
 Effective internal capacitance; $C_i = 22.5\text{ nF}$
 Effective internal inductance; $L_i = 730\text{ }\mu\text{H}$

Note 3. Installation

- All wiring shall comply with local installation requirements. (Refer to the installation diagram)

Note 4. Maintenance and Repair

- The instrument modification or parts replacement by other than authorized representative of Yokogawa Electric Corporation is prohibited and will void KEMA Intrinsically safe Certification.

Note 5. Special Conditions for Safe Use

- In the case where the enclosure of the Pressure Transmitter is made of aluminium, if it is mounted in an area where the use of category 1 G apparatus is required, it must be installed such, that, even in the event of rare incidents, ignition sources due to impact and friction sparks are excluded.

[Installation Diagram]

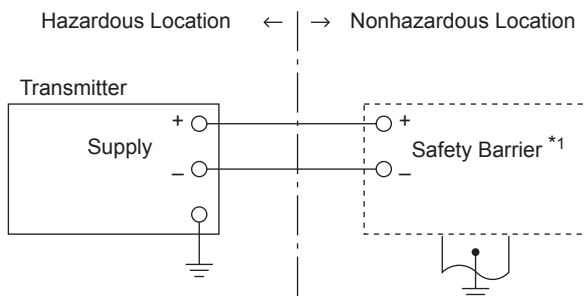

F0208.ai

*1: In any safety barriers used the output current must be limited by a resistor "R" such that $I_{maxout} \leq U_z/R$.

b. ATEX Flameproof Type

Caution for ATEX flameproof type.

Note 1. Model EJA Series differential, gauge, and absolute pressure transmitters with optional code /KF21 for potentially explosive atmospheres:

- No. KEMA 02ATEX2148
- Applicable Standard: EN 60079-0:2006, EN 60079-1:2004
- Type of Protection and Marking Code: Ex d IIC T6...T4
- Temperature Class: T6, T5, and T4
- Enclosure: IP67
- Maximum Process Temperature: 85°C (T6), 100°C (T5), and 120°C (T4)
- Ambient Temperature: T4 and T6; -40* to 75°C, T5; -40* to 80°C
 * -15°C when /HE is specified.

Note 2. Electrical Data

- Supply voltage: 42 V dc max.
- Output signal: 4 to 20 mA

Note 3. Installation

- All wiring shall comply with local installation requirement.
- The cable entry devices shall be of a certified flameproof type, suitable for the conditions of use.

Note 4. Operation

- Keep the "CAUTION" label to the transmitter. CAUTION: AFTER DE-ENERGIZING, DELAY 10 MINUTES BEFORE OPENING. WHEN THE AMBIENT TEMP. $\geq 70^\circ\text{C}$, USE HEAT-RESISTING CABLES $\geq 90^\circ\text{C}$.
- Take care not to generate mechanical sparking when accessing to the instrument and peripheral devices in a hazardous location.

Note 5. Maintenance and Repair

- The instrument modification or parts replacement by other than authorized representative of Yokogawa Electric Corporation is prohibited and will void KEMA Flameproof Certification.

(2) Electrical Connection

The type of electrical connection is stamped near the electrical connection port according to the following marking.

Screw Size	Marking
ISO M20 × 1.5 female	⚠ M
ANSI 1/2 NPT female	⚠ A

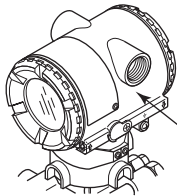

Location of the marking

F0206.ai

(3) Installation



WARNING

- All wiring shall comply with local installation requirement and local electrical code.
- There is no need of the conduit seal for both of Division 1 and Division 2 hazardous locations because this product is sealed at factory.
- In case of ANSI 1/2 NPT plug, ANSI hexagonal wrench should be applied to screw in.

(4) Operation



WARNING

- OPEN CIRCUIT BEFORE REMOVING COVER. INSTALL IN ACCORDANCE WITH THIS USER'S MANUAL
- Take care not to generate mechanical sparking when access to the instrument and peripheral devices in hazardous locations.

(5) Maintenance and Repair



WARNING

The instrument modification or parts replacement by other than authorized Representative of Yokogawa Electric Corporation is prohibited and will void the certification.

(6) Name Plate

- Name plate

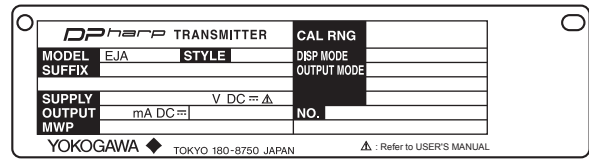

- Tag plate for flameproof type

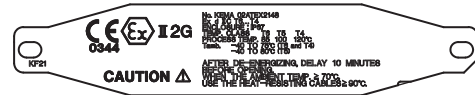

- Tag plate for intrinsically safe type



F0211.ai

MODEL: Specified model code.
 STYLE: Style code.
 SUFFIX: Specified suffix code.
 SUPPLY: Supply voltage.
 OUTPUT: Output signal.
 MWP: Maximum working pressure.
 CAL RNG: Specified calibration range.
 DISP MODE: Specified display mode.
 OUTPUT MODE: Specified output mode.
 NO.: Serial number and year of production*1.
 TOKYO 180-8750 JAPAN:
 The manufacturer name and the address*2.

*1: The third figure from the last shows the last one figure of the year of production. For example, the production year of the product engraved in "NO." column on the name plate as follows is 2001.

12A819857 132
 ↑
 The year 2001

*2: "180-8750" is a zip code which represents the following address.

2-9-32 Nakacho, Musashino-shi, Tokyo Japan

2.10 EMC Conformity Standards

EN 61326-1 Class A, Table 2 (For use in industrial locations)

EN 61326-2-3

EN 61326-2-5 (for Fieldbus)



CAUTION

This instrument is a Class A product, and it is designed for use in the industrial environment. Please use this instrument in the industrial environment only.



NOTE

YOKOGAWA recommends customer to apply the Metal Conduit Wiring or to use the twisted pair Shield Cable for signal wiring to conform the requirement of EMC Regulation, when customer installs the EJA Series Transmitters to the plant.

2.11 PED (Pressure Equipment Directive)

(1) General

- EJA series of pressure transmitters are categorized as pressure accessories under the vessel section of this directive 97/23/EC, which corresponds to Article 3, Paragraph 3 of PED, denoted as Sound Engineering Practice (SEP).
- EJA130A, EJA440A, EJA510A, and EJA530A can be used above 200 bar and therefore considered as a part of a pressure retaining vessel where category III, Module H applies. These models with option code /PE3 conform to that category.

(2) Technical Data

- Models without /PE3
Article 3, Paragraph 3 of PED, denoted as Sound Engineering Practice (SEP) .
- Models with /PE3
Module: H
Type of Equipment: Pressure Accessory-Vessel
Type of Fluid: Liquid and Gas
Group of Fluid: 1 and 2

Model	PS*1 (bar)	V(L)	PS-V (bar-L)	Category*2
EJA110A	160	0.01	1.6	Article 3, paragraph 3 (SEP)
EJA120A	0.5	0.01	0.005	Article 3, paragraph 3 (SEP)
EJA130A	420	0.01	4.2	Article 3, paragraph 3 (SEP)
EJA130A With code /PE3	420	0.01	4.2	III
EJA310A	160	0.01	1.6	Article 3, paragraph 3 (SEP)
EJA430A	160	0.01	1.6	Article 3, paragraph 3 (SEP)
EJA440A	500	0.01	50	Article 3, paragraph 3 (SEP)
EJA440A With code /PE3	500	0.01	50	III
EJA510A	500	0.01	50	Article 3, paragraph 3 (SEP)
EJA510A With code /PE3	500	0.01	50	III
EJA530A	500	0.01	50	Article 3, paragraph 3 (SEP)
EJA530A With code /PE3	500	0.01	50	III

*1: PS is maximum allowable pressure for vessel itself.

*2: Referred to Table 1 covered by ANNEX II of EC Directive on Pressure Equipment Directive 97/23/EC

(3) Operation



CAUTION

- The temperature and pressure of fluid should be applied under the normal operating condition.
- The ambient temperature should be applied under the normal operating condition.
- Please pay attention to prevent the excessive pressure like water hammer, etc. When water hammer is to be occurred, please take measures to prevent the pressure from exceeding PS by setting the safety valve, etc. at the system and the like.
- When external fire is to be occurred, please take safety measures at the device or system not to influence the transmitters.

2.12 Low Voltage Directive

Applicable standard: EN 61010-1

(1) Pollution Degree 2

“Pollution degree” describes the degree to which a solid, liquid, or gas which deteriorates dielectric strength or surface resistivity is adhering. “2” applies to normal indoor atmosphere. Normally, only non-conductive pollution occurs. Occasionally, however, temporary conductivity caused by condensation must be expected.

(2) Installation Category I

“Overvoltage category (Installation category)” describes a number which defines a transient overvoltage condition. It implies the regulation for impulse withstand voltage. “I” applies to electrical equipment which is supplied from the circuit when appropriate transient overvoltage control means (interfaces) are provided.

(3) Altitude of installation site:

Max. 2,000 m above sea level

(4) Indoor/Outdoor use

3. Component Names

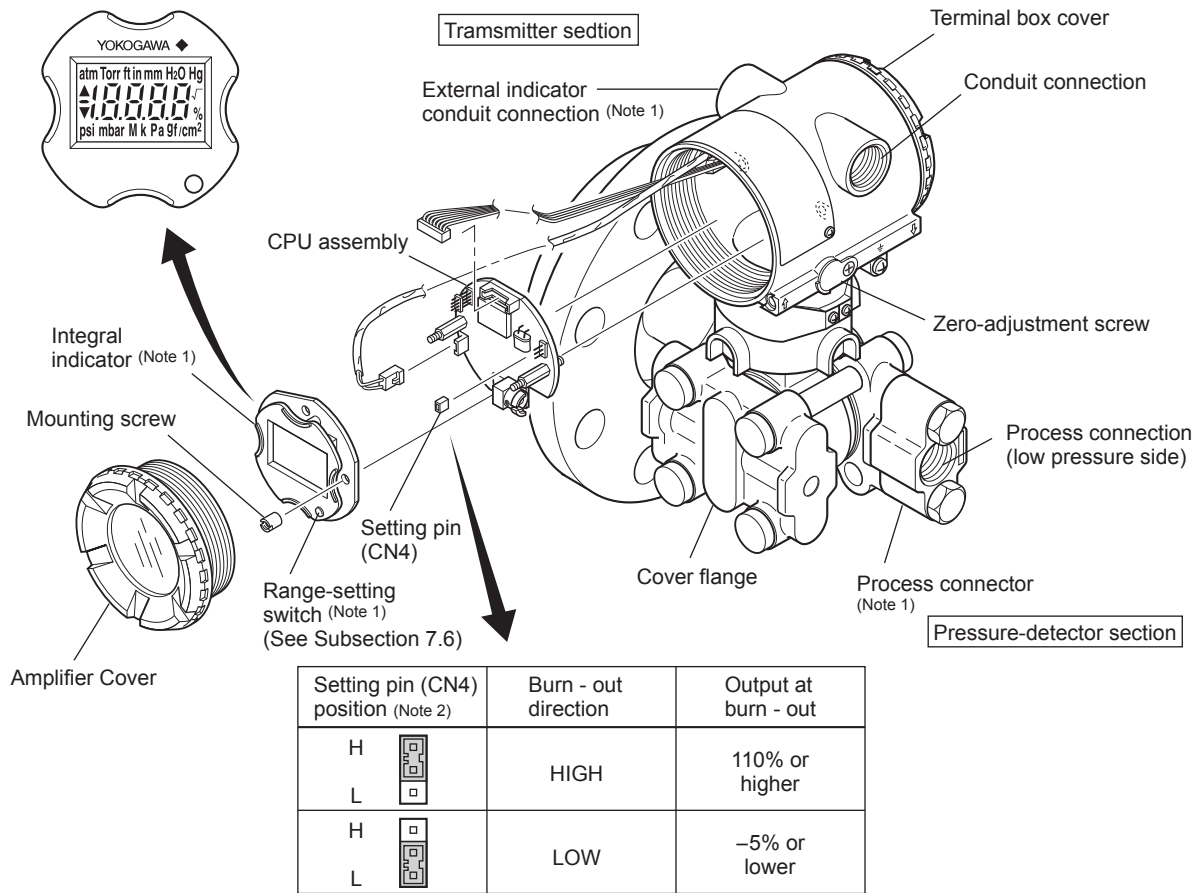

F0301.ai

Note 1: See Subsection 10.2, "Model and Suffix Codes," for details.

Note 2: Insert the pin (CN4) as shown in the figure above to set the burn-out direction. The pin is set to the H side for delivery (unless option code /C1 is specified in the order).

The setting can be confirmed by calling up parameter D52 using the BRAIN TERMINAL. Refer to Subsection 8.3.3 (11).

Figure 3.1 Component Names

Table 3.1 Display Symbol

Display Symbol	Meaning of Display Symbol
▲	The output signal being zero-adjusted is increasing.
▼	The output signal being zero-adjusted is decreasing.
%, kPa, Pa, MPa, kgf/cm ² , gf/cm ² , mbar, bar, atm, mmHg, mmH ₂ O, inH ₂ O, inHg, ftH ₂ O, psi, Torr	Select one of these sixteen available engineering units for the display.

F0302.ai

4. Installation

4.1 Precautions

Before installing the transmitter, read the cautionary notes in Section 2.4, "Selecting the Installation Location." For additional information on the ambient conditions allowed at the installation location, refer to Subsection 10.1 "Standard Specifications."



IMPORTANT

- When welding piping during construction, take care not to allow welding currents to flow through the transmitter.
- Do not step on this instrument after installation.
- Never loosen the four screws securing the cover flanges (if the seal liquid leaks, the transmitter cannot be used).

4.2 Mounting

The transmitter is mounted on a process using its high-pressure side flange as shown in Figure 4.1. The customer should prepare the mating flange, gasket, stud bolts and nuts.

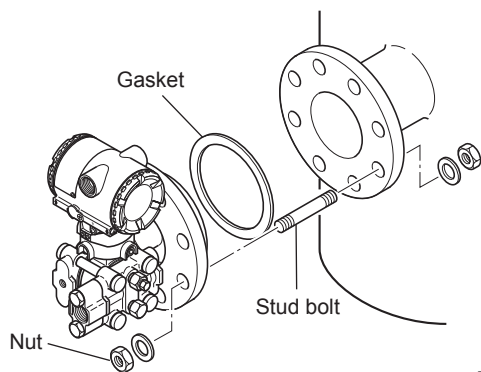

F0401.ai

Figure 4.1 Transmitter Mounting



IMPORTANT

Please use a gasket which has a bigger inside diameter than that of gasket facing ($\varnothing d$) on diaphragm seal. In case a gasket which has a smaller inside diameter than that of gasket facing is used, it may cause an error as the gasket prevents diaphragm from working correctly. (Refer to Subsection 10.4 'Dimensions')

4.3 Rotating Transmitter Section

The DPharp transmitter section can be rotated in 90° segments.

- 1) Remove the two Allen screws that fasten the transmitter section and pressure-detector section, using the Allen wrench supplied with the transmitter.
- 2) Rotate the transmitter section slowly in 90° segments.
- 3) Tighten the two Allen screws.



IMPORTANT

Do not rotate the transmitter section more than 180°.

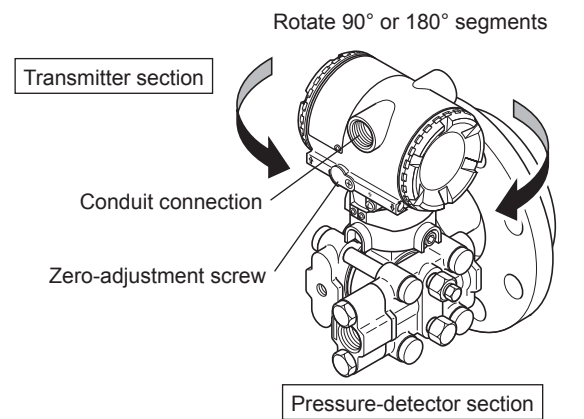

F0402.ai

Figure 4.2 Rotating Transmitter Section

4.4 Changing the Direction of Integral Indicator



IMPORTANT

Always turn OFF power, release pressure and remove a transmitter to non-hazardous area before disassembling and reassembling an indicator.

An integral indicator can be installed in the following three directions. Follow the instructions in section 9.4 for removing and attaching the integral indicator.

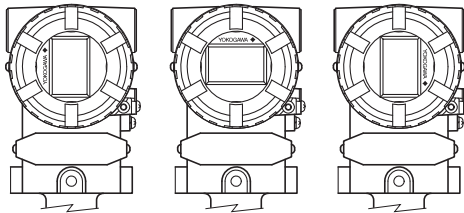

F0403.ai

Figure 4.3 Integral Indicator Direction

4.5 Affixing the Teflon Film



IMPORTANT

The FEP Teflon option includes a teflon film and fluorinated oil. Before mounting the transmitter to the process flange, affix the teflon film as follows:

- 1) Position the diaphragm so that the diaphragm is in an upward position.
- 2) Pour the fluorinated oil on the diaphragm and gasket area covering it completely and evenly.
Be careful not to scratch the diaphragm or change the its shape.
- 3) Affix the teflon film over the diaphragm and gasket area.
- 4) Next, carefully inspect the cover and try to identify any entrapped air between the diaphragm and the teflon film. The air must be removed to ensure accuracy. If air pockets are present, use your fingers to remove the air by starting at the center of the diaphragm and work your way out.
- 5) Place the gasket with the teflon film and affix to the process flange.

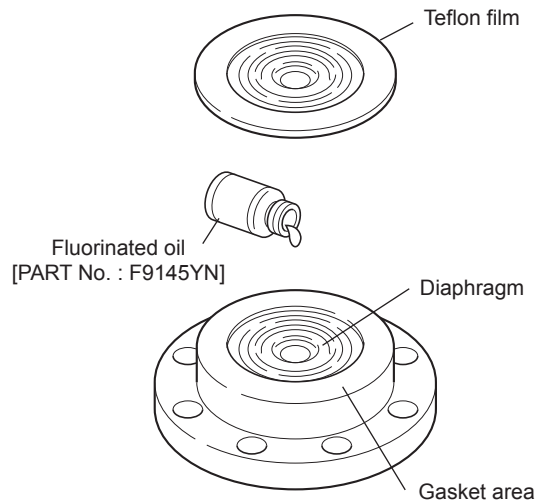

PART No.	Prosess Flange size
F9347XA	3 inch (80mm)
F9347YD	2 inch (50mm)

F0403.ai

Figure 4.4 Affixing the Teflon Film

5. Installing Impulse Piping

5.1 Impulse Piping Installation Precautions

The impulse piping that connects the process outputs to the transmitter must convey the process pressure accurately. If, for example, gas collects in a liquid-filled impulse piping, or the drain of a gas-filled impulse piping becomes plugged, the impulse piping will not convey the pressure accurately. Since this will cause errors in the measurement output, select the proper piping method for the process fluid (gas, liquid, or steam). Pay careful attention to the following points when routing the impulse piping and connecting the impulse piping to the transmitter.

5.1.1 Connecting Impulse Piping to the Transmitter

(1) Check the High and Low Pressure Connections on the Transmitter (Figure 5.1)

Symbols “H” and “L” are shown on a capsule assembly to indicate high and low pressure side. For liquid level measurement in an open tank, the ‘L’ (low pressure) side is used to refer atmosphere. For a closed tank, connect the impulse line to the low pressure side of the transmitter. This will refer the pressure in the tank.

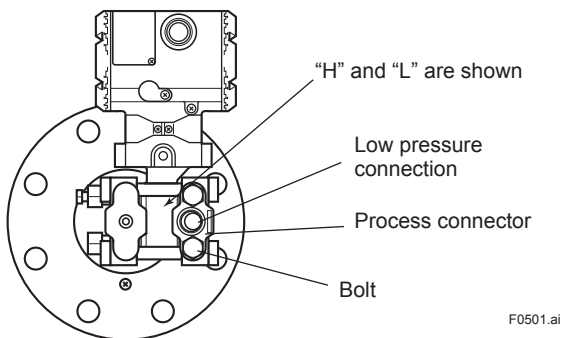

Figure 5.1 “H” and “L” Symbols on a Capsule Assembly

(2) Tightening the Process Connector Mounting Bolts

After connecting the impulse piping, tighten the process connector mounting bolts uniformly.

(3) Removing the Impulse Piping Connecting Port Dustproof Cap

The impulse piping connecting port of the transmitter is covered with a plastic cap to exclude dust. This cap must be removed before connecting the piping. (Be careful not to damage the threads when removing this cap. Never insert a screwdriver or other tool between the cap and port threads to remove the cap.)

5.1.2 Routing the Impulse Piping

(1) Impulse Piping Slope

The impulse piping must be routed with only an upward or downward slope. Even for horizontal routing, the impulse piping should have a slope of at least 1/10 to prevent condensate (or gases) from accumulating in the pipes.

(2) Preventing Freezing

If there is any risk that the process fluid in the impulse piping or transmitter could freeze, use a steam jacket or heater to maintain the temperature of the fluid.



NOTE

After completing the connections, close the valves on the process pressure taps (main valves), the valves at the transmitter (stop valves), and the impulse piping drain valves, so that condensate, sediment, dust and other extraneous material cannot enter the impulse piping.

5.2 Impulse Piping Connection Examples

Figure 5.2 shows examples of typical impulse piping connections. Before connecting the transmitter to the process, study the transmitter installation location, the process piping layout, and the characteristics of the process fluid (corrosiveness, toxicity, flammability, etc.), etc. and make appropriate changes and additions to the connection configurations.

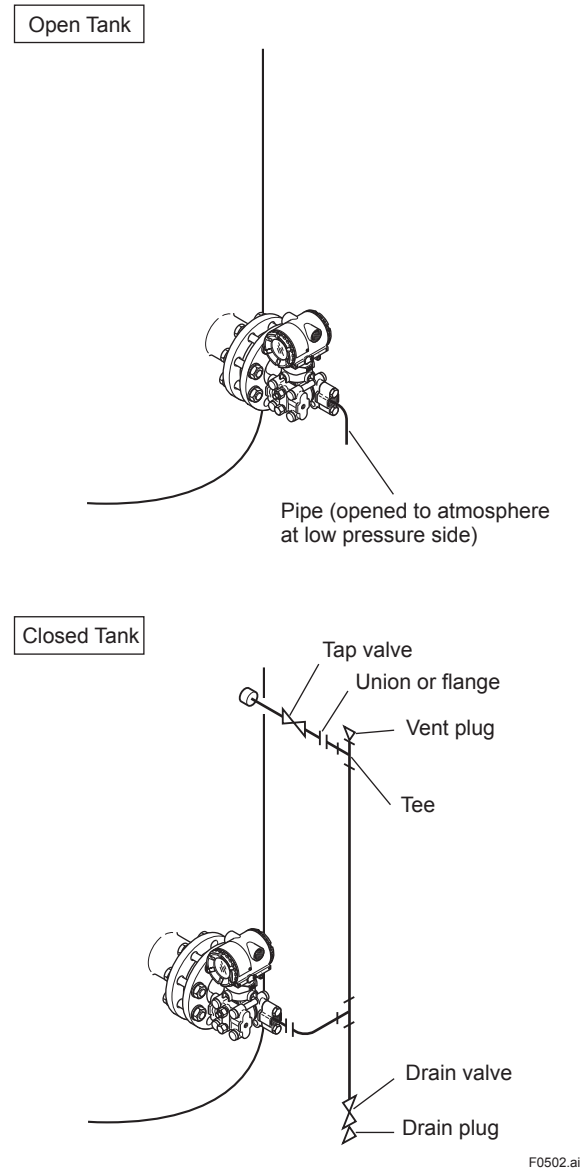

Figure 5.2 Impulse Piping Connection Examples

6. Wiring

6.1 Wiring Precautions



IMPORTANT

- Lay wiring as far as possible from electrical noise sources such as large capacity transformers, motors, and power supplies.
- Remove electrical connection dust cap before wiring.
- All threaded parts must be treated with waterproofing sealant. (A non-hardening silicone group sealant is recommended.)
- To prevent noise pickup, do not pass signal and power cables through the same ducts.
- Explosion-protected instruments must be wired in accordance with specific requirements (and, in certain countries, legal regulations) in order to preserve the effectiveness of their explosion-protected features.
- The terminal box cover is locked by an Allen head bolt (a shrouding bolt) on CENELEC and IECEx flameproof type transmitters. When the shrouding bolt is driven clockwise by an Allen wrench, it is going in and cover lock is released, and then the cover can be opened by hand. See Subsection 9.4 “Disassembly and Reassembly” for details.

6.2 Selecting the Wiring Materials

- Use stranded leadwires or cables which are the same as or better than 600 V grade PVC insulated wire (JIS C3307) or equivalent.
- Use shielded wires in areas that are susceptible to electrical noise.
- In areas with higher or lower ambient temperatures, use appropriate wires or cables.
- In environment where oils, solvents, corrosive gases or liquids may be present, use wires or cables that are resistant to such substances.
- It is recommended that crimp-on solderless terminal lugs (for 4 mm screws) with insulating sleeves be used for leadwire ends.

6.3 Connections of External Wiring to Terminal Box

6.3.1 Power Supply Wiring Connection

Connect the power supply wiring to the SUPPLY + and – terminals.

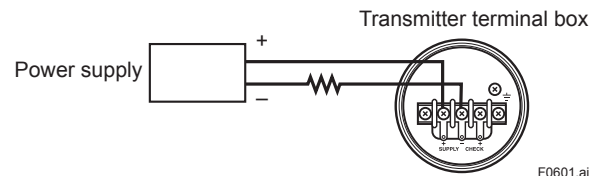

F0601.ai

Figure 6.1 Power Supply Wiring Connection

6.3.2 External Indicator Connection

Connect wiring for external indicators to the CHECK + and – terminals.

(Note) Use a external indicator whose internal resistance is 10Ω or less.

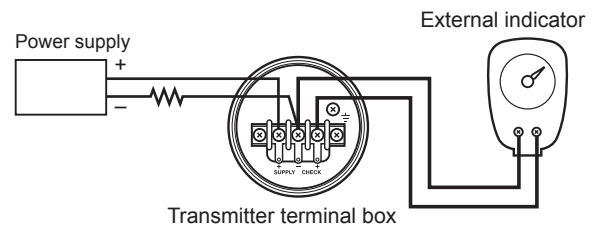

F0602.ai

Figure 6.2 External Indicator Connection

6.3.3 BRAIN TERMINAL BT200 Connection

Connect the BT200 to the SUPPLY + and – terminals (Use hooks). The communication line requires a reception resistor of 250 to 600Ω in series.

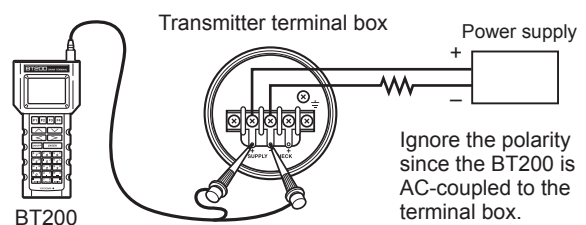

F0603.ai

Figure 6.3 BT200 Connection

6.3.4 Check Meter Connection

Connect the check meter to the CHECK + and – terminals (use hooks).

- A 4 to 20 mA DC output signal from the CHECK + and – terminals.
- (Note) Use a check meter whose internal resistance is 10Ω or less.

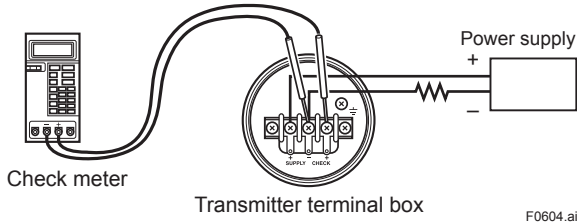

Figure 6.4 Check Meter Connection

(2) Intrinsically Safe Type

For intrinsically safe type, a safety barrier must be included in the loop.

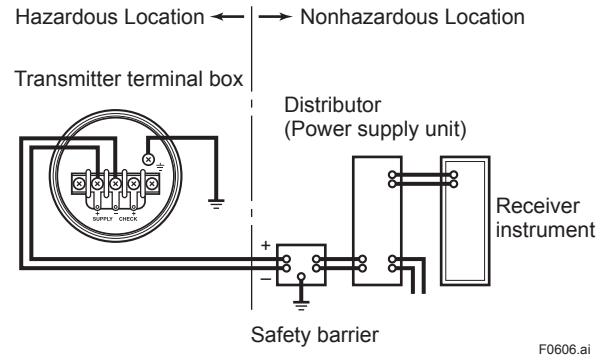

Figure 6.6 Connection between Transmitter and Distributor

6.4 Wiring

6.4.1 Loop Configuration

Since the DPharp uses a two-wire transmission system, signal wiring is also used as power wiring.

DC power is required for the transmitter loop. The transmitter and distributor are connected as shown below.

For details of the power supply voltage and load resistance, see Section 6.6; for communications line requirements, see Subsection 8.1.2.

(1) General-use Type and Flameproof Type

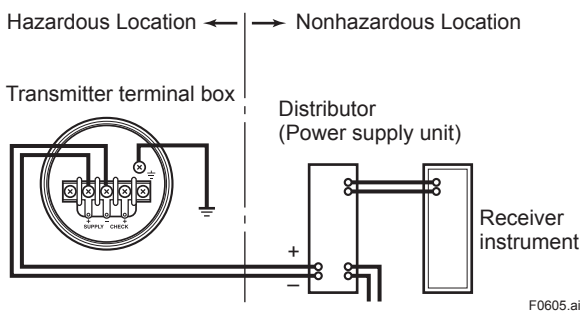

Figure 6.5 Connection between Transmitter and Distributor

6.4.2 Wiring Installation

(1) General-use Type and Intrinsically Safe Type

Make cable wiring using metallic conduit or waterproof glands.

- Apply a non-hardening sealant to the terminal box connection port and to the threads on the flexible metal conduit for waterproofing.

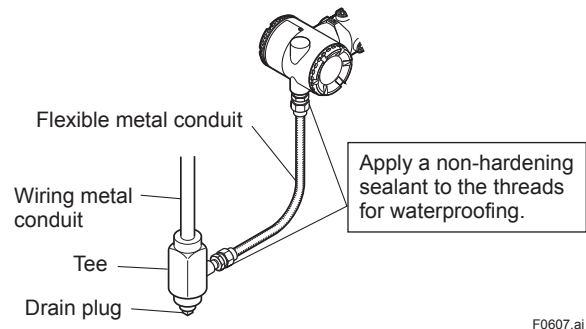

Figure 6.7 Typical Wiring Using Flexible Metal Conduit

(2) Flameproof Type

Wire cables through a flameproof packing adapter, or using a flameproof metal conduit.

- Wiring cable through flameproof packing adapter.
 - Apply a nonhardening sealant to the terminal box connection port and to the threads on the flameproof packing adapter for waterproofing.

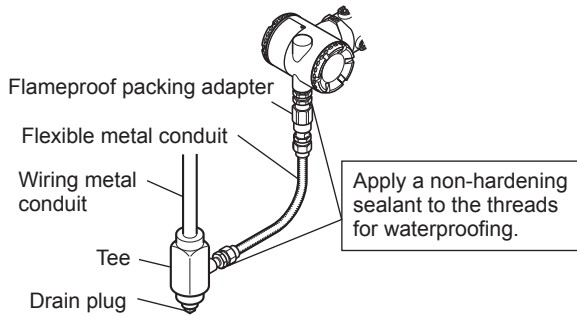

Figure 6.8 Typical Cable Wiring Using Flameproof Packing Adapter

- Flameproof metal conduit wiring
 - A seal fitting must be installed near the terminal box connection port for a sealed construction.
 - Apply a non-hardening sealant to the threads of the terminal box connection port, flexible metal conduit and seal fitting for waterproofing.

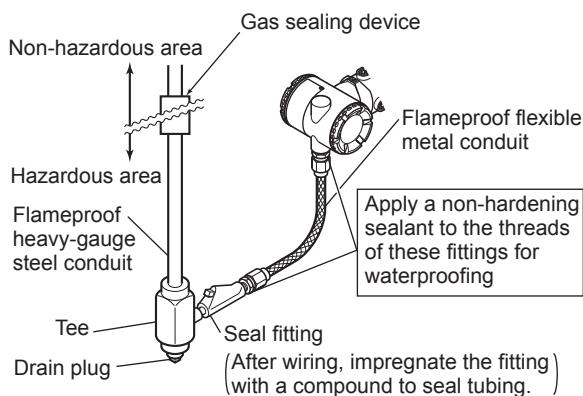

Figure 6.9 Typical Wiring Using Flameproof Metal Conduit

6.5 Grounding

Grounding is always required for the proper operation of transmitters. Follow the domestic electrical requirements as regulated in each country. For a transmitter with built-in lightning protector, grounding should satisfy ground resistance of 10Ω or less.

Ground terminals are located on the inside and outside of the terminal box. Either of these terminals may be used.

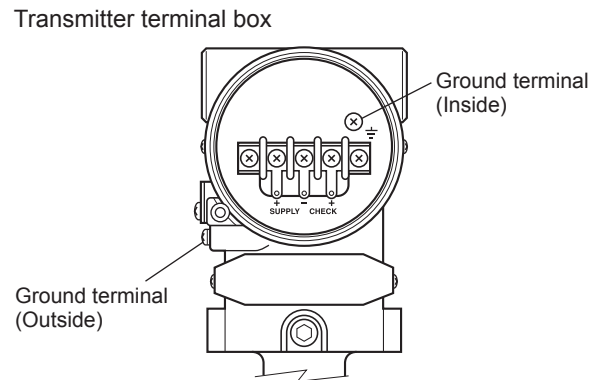

Figure 6.10 Ground Terminals

6.6 Power Supply Voltage and Load Resistance

When configuring the loop, make sure that the external load resistance is within the range in the figure below.

(Note) In case of an intrinsically safe transmitter, external load resistance includes safety barrier resistance.

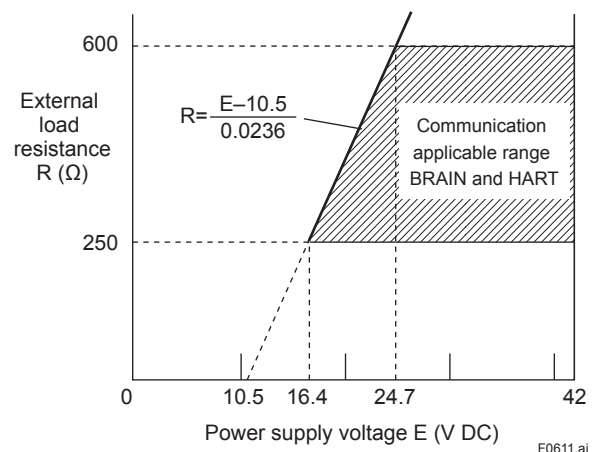

Figure 6.11 Relationship between Power Supply Voltage and External Load Resistance

7. Operation

7.1 Preparation for Starting Operation

The Model EJA210A and EJA220A flange mounted differential pressure transmitter measures the levels or densities of liquids. This section describes the operation procedure for the EJA210A as shown in Figure 7.1 when measuring a liquid level in an open tank.

- (a) Confirm that there is no leak in the connecting part of the transmitter mounting flange. Remove the plastic dust cap placed in the process connector (low pressure side).
- (b) Turn ON power and connect the BT200. Open the terminal box cover and connect the BT200 to the SUPPLY + and – terminals.
- (c) Using the BT200, confirm that the transmitter is operating properly. Check parameter values or change the setpoints as necessary. For BT200 operating procedures, see Chapter 8. If the transmitter is equipped with an integral indicator, its indication can be used to confirm that the transmitter is operating properly.

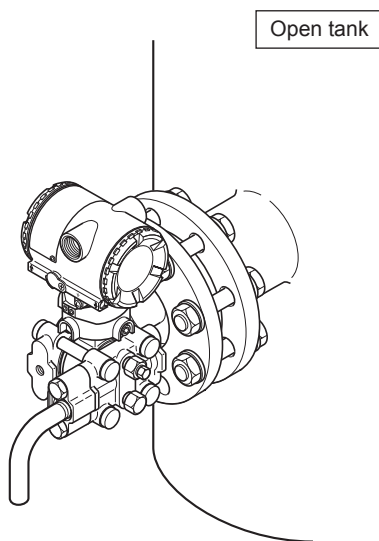

Figure 7.1 Liquid Flow Measurement

F0701.ai

■ Confirming that Transmitter is Operating Properly

Using the BT200

- If the wiring system is faulty, 'communication error' appears on the display.
- If the transmitter is faulty, 'SELF CHECK ERROR' appears on the display.



Communication error (Faulty wiring)

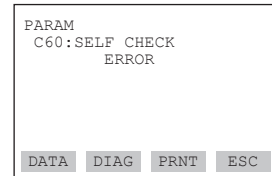

Self-diagnostic error (Faulty transmitter)

F0702.ai

Using the integral indicator

- If the wiring system is faulty, the display stays blank.
- If the transmitter is faulty, an error code will appear on the display according to the nature of the error.

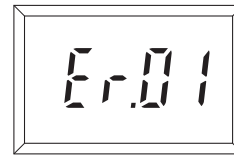

Self-diagnostic error on the integral indicator (Faulty transmitter)

F0703.ai



NOTE

If any of the error indications above appears on the display of the integral indicator or BT200, refer to Subsection 8.5.2 for corrective action.

■ Verify and Change Transmitter Parameter Setting and Values

The following parameters are the minimum settings required for operation. The transmitter has been shipped with these parameters. To confirm or change the values, see Subsection 8.3.3.

- Measuring range ... See Subsection 8.3.3 (2)
- Operation mode ... See Subsection 8.3.3 (8)

7.2 Zero Point Adjustment

Adjust the zero point after operating preparation is completed.



IMPORTANT

Do not turn off the power to the transmitter immediately after a zero adjustment. Powering off within 30 seconds after a zero adjustment will return the adjustment back to the previous settings.

The zero point adjustment can be made in either way: using the zero-adjustment screw of the transmitter or the BT200 operation.

For output signal checking, display the parameter **A10: OUTPUT (%)** in the BT200.

● BT200

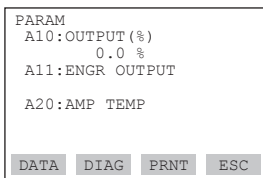

Output signal (%) display

● Zero-adjustment Screw

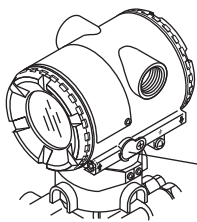

Zero-adjustment screw

F0704.ai

When adjusting the transmitter zero point, the liquid level in a tank does not have to be set to the low limit (0%) of the measuring range. In such case, match the transmitter output signal with the actual measured value using a glass gauge, for example.

7.2.1 When you can obtain Low Range Value from actual measured value of 0% (0 kPa, atmospheric pressure);

■ Using the Transmitter Zero-adjustment Screw

Before adjusting a screw, check that the parameter **J20: EXT ZERO ADJ** displays **ENABLE**. See Subsection 8.3.3 (12) for the setting procedure.

Use a slotted screwdriver to turn the zero-adjustment screw. Turn the screw clockwise to increase the output or counterclockwise to decrease the output. The zero point adjustment can be made with a resolution of 0.01% of the setting range. Since the degree of zero adjustments varies with the screw turning speed, turn the screw slowly for fine adjustment and quickly for coarse adjustment.

■ Using the BT200

Zero point can be adjusted by simple key operation of the BT200.

Select parameter **J10: ZERO ADJ**, and press the ENTER key twice. The zero point will be adjusted automatically to the output signal 0% (4 mA DC). Confirm that the setting value displayed for the parameter is '0.0%' before pressing the ENTER key. See Subsection 8.3.3 (12) for BT200 operating procedures.

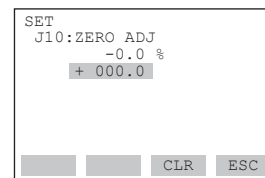

A display when parameter J10 is selected.

Press **ENTER** key twice for 0% output 4 mA DC.

F0705.ai

7.2.2 When you cannot obtain Low Range Value from actual measured value of 0%;

Convert the actual measured value obtained by a glass gauge into %.

[Example]

The measuring range of 0 to 2 m and the actual measured value of 0.8 m.

$$\text{Actual measured value} = \frac{0.8}{2} \times 100 = 40.0\%$$

■ Using the Transmitter Zero-Adjustment Screw

Turn the screw to match the output signal to the actual measured value in %.

■ Using the BT200

Select the parameter **J10: ZERO ADJ.** Change the set point (%) displayed for the parameter to the actual measured value (%), and press the ENTER key twice.

See Subsection 8.3.3 (12) for operation details.

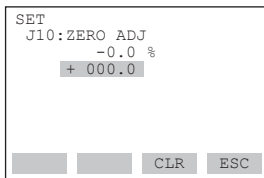

A display at J10

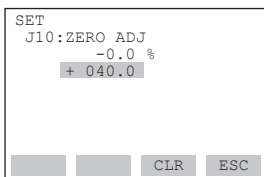

Change setting to the actually measured value (40.0%). Press **ENTER** key twice for 40% output 10.4 mA DC.

F0706.ai

7.3 Starting Operation

After completing the zero point adjustment, follow the procedure below to start operation.

- 1) Confirm the operating status.
The output signal may widely fluctuate (hunting state) due to process pressure periodic variation. In such case, BT200 operation can dampen the transmitter output signal. Confirm the hunting state using a receiving instrument or the integral indicator and set the optimum damping time constant. See Subsection 8.3.3 (3) "Damping time constant setup."
- 2) After confirming the operating status, perform the following:



IMPORTANT

- Remove the BT200 from the terminal box, and confirm that none of the terminal screws are loosened.
- Close the terminal box cover and the amplifier cover. Screw each cover in tightly until it will not turn further.
- Two covers are required to be locked on the CENELEC and IECEx Flameproof type transmitters. An Allen head bolts (shrouding bolts) are provided under edge of the each cover for locking. When a shrouding bolts are driven counterclockwise by an Allen wrench, it is coming out and locks up a cover. (See page 9-3) After locking, the covers should be confirmed not to be opened by hand.
- Tighten the zero-adjustment cover mounting screw to fix the cover in position.

7.4 Shutting Down Operation

Turn off the power.



NOTE

Whenever shutting down the transmitter for a long period, detach the transmitter from the tank.

7.5 Venting or Draining Transmitter Pressure-detector Section

Since this transmitter is designed to be self-draining and self-venting with vertical impulse piping connections, neither draining nor venting will be required if the impulse piping is configured appropriately for self-draining or self-venting operation.

If condensate (or gas) collects in the transmitter pressure-detector section, the measured pressure may be in error. If it is not possible to configure the piping for self-draining (or self-venting) operation, you will need to loosen the drain (vent) screw on the transmitter to completely drain (vent) any stagnated liquid (gas).

However, since draining condensate or bleeding off gas gives the pressure measurement disturbance, this should not be done when the loop is in operation.



WARNING

Since the accumulated liquid (or gas) may be toxic or otherwise harmful, take appropriate care to avoid contact with the body, or inhalation of vapors.

7.5.1 Draining Condensate

- 1) Gradually open the drain plug and drain the transmitter pressure-detector section. (See Figure 7.2)
- 2) When all accumulated liquid is completely removed, close the drain plug.
- 3) Tighten the drain plug to a torque of 34 to 39 N·m.

7.5.2 Venting Gas

- 1) Gradually open the vent screw to vent gas from the transmitter pressure-detector section. (See Figure 7.2)
- 2) When the transmitter is completely vented, close the vent screw.
- 3) Tighten the vent screw to a torque of 10 N·m.

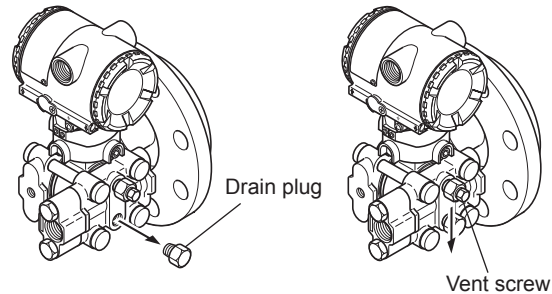

When you loosen the drain plug or the vent screw, the accumulated liquid (or gas) will be expelled in the direction of the arrow.

F0707.ai

Figure 7.2 Draining/Venting the Transmitter

7.6 Setting the Range Using the Range-setting Switch

With actual pressure being applied to the transmitter, the range-setting switch (push-button) located on the optional integral indicator plate and the external zero-adjustment screw allow users to change (re-range) the low- and high-limit values for the measurement range (LRV and HRV) without using BT200. However, other changes in the display settings (scale range and engineering unit) for the integral indicator requires BT200.

Follow the procedure below to change the LRV and HRV settings.

[Example]

Rerange LRV to 0 and HRV to 3 MPa.

- 1) Connect the transmitter and apparatus as shown in Figure 9.1 and warm up for at least five minutes.
- 2) Press the range-setting push-button. The integral indicator then displays “LSET.”
- 3) Apply a pressure of 0 kPa (atmospheric pressure) to the transmitter. (Note 1)

- 4) Turn the external zero-adjustment screw in the desired direction. The integral indicator displays the output signal in %. (Note 2)
- 5) Adjust the output signal to 0% (1 V DC) by rotating the external zero-adjustment screw. Doing so completes the LRV setting.
- 6) Press the range-setting push-button. The integral indicator then displays "HSET."
- 7) Apply a pressure of 3 MPa to the transmitter. (Note 1)
- 8) Turn the external zero-adjustment screw in the desired direction. The integral indicator displays the output signal in %. (Note 2)
- 9) Adjust the output signal to 100% (5 V DC) by rotating the external zero-adjustment screw. Doing so completes the HRV setting.
- 10) Press the range-setting push-button. The transmitter then switches back to the normal operation mode with the measurement range of 0 to 3 MPa.

Note 1: Wait until the pressure inside the pressure-detector section has stabilized before proceeding to the next step.

Note 2: If the pressure applied to the transmitter exceeds the previous LRV (or HRV), the integral indicator may display error number "Er.07" (In this case, the output signal percent and "Er.07" are displayed alternately every two seconds).

Although "Er.07" is displayed, you may proceed to the next step. However, should any other error number be displayed, take the appropriate measure in reference to Subsection 8.5.2, "Errors and Countermeasures."



IMPORTANT

- Do not turn off the power to the transmitter immediately after completion of the change in the LRV and/or HRV setting(s). Note that powering off within thirty seconds after setting will cause a return to the previous settings.
- Changing LRV automatically changes HRV to the following value.

HRV =

$$\text{previous HRV} + (\text{new LRV} - \text{previous LRV})$$

- If the range-setting push-button and external zero-adjustment screw are not touched during a range-change operation, the transmitter automatically switches back to the normal operation mode.

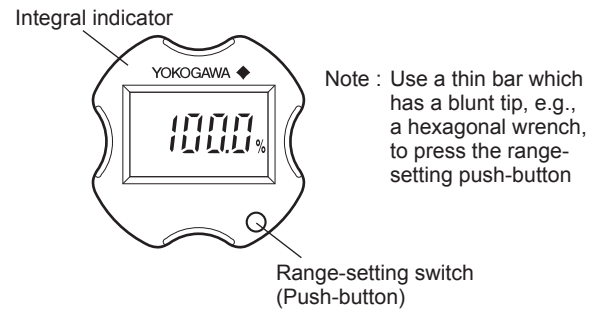

F0708.ai

Figure 7.3 Range-setting Switch

8. BRAIN TERMINAL BT200 Operation

The DPharp is equipped with BRAIN communications capabilities, so that range changes, Tag No. setup, monitoring of self-diagnostic results, and zero point adjustment can be handled by remote control via BT200 BRAIN TERMINAL or CENTUM CS console. This section describes procedures for setting parameters using the BT200. For details concerning the BT200, see IM 01C00A11-01E, "BT200 User's Manual."

8.1 BT200 Operation Precautions

8.1.1 Connecting the BT200

Connection to the transmitter with the BT200 can be made by either connecting to the BT200 connection hooks in the transmitter terminal box or by connecting to a relaying terminal board.

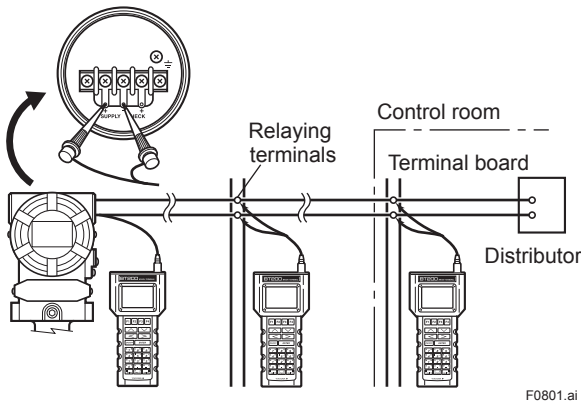

Figure 8.1 Connecting the BT200

F0801.ai

• **Note for Connecting the BT200**



IMPORTANT

- Analog output may change temporally in connecting with BRAIN terminal due to an initial current flowed to it. To prevent communication signal affecting the upper system, it is recommended to install a low-pass filter (approximately 0.1s).
- Communication signal is superimposed on analog output signal. It is recommended to set a low-pass filter (approximately 0.1s) to the receiver in order to reduce the output effect from communication signal. Before online-communication, confirm that communication signal does not give effect on the upper system.

8.1.2 Conditions of Communication Line

• **Communication Line Requirements**

[Protocol specification] Yokogawa original protocol

[Modulation] Burst modulation

0: 2400Hz

1: Signal without carrier

[Baud rate] 1200bps

[Communication signal]

host to device: +/- 0.5V (load resistance 250Ω)

device to host: +/- 2mA

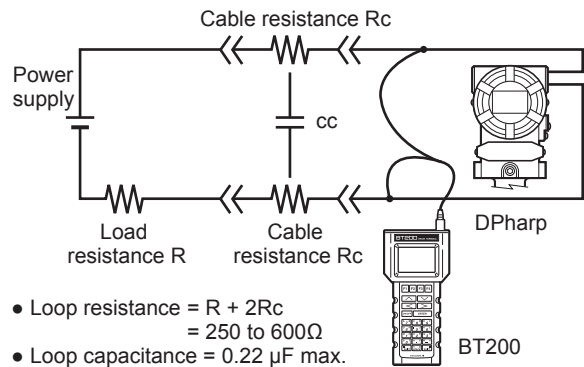

- Loop resistance = $R + 2R_c$
= 250 to 600Ω
- Loop capacitance = 0.22 μF max.

F0802.ai

Figure 8.2 Conditions of Communication Line

8.2 BT200 Operating Procedures

8.2.1 Key Layout and Screen Display

Figure 8.3 shows the arrangement of the operating keys on the BT200 keypad, and Figure 8.4 shows the BT200 screen component.

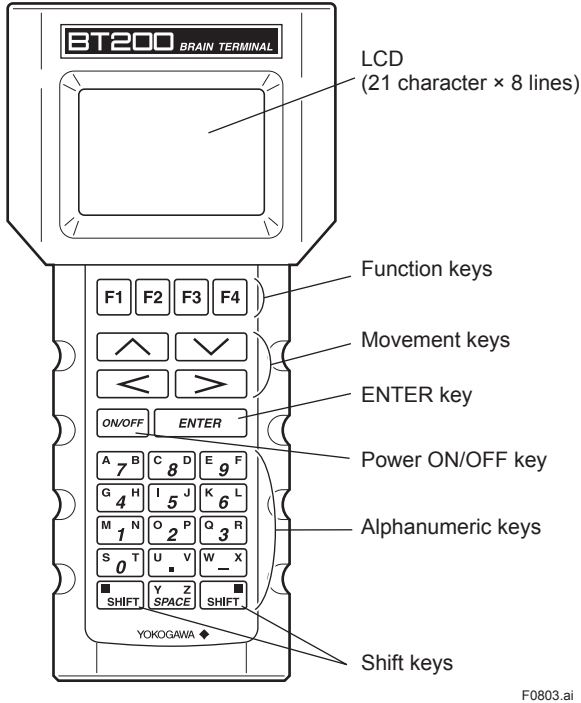
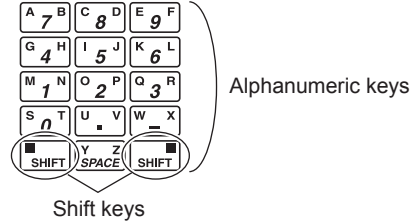

Figure 8.3 BT200 Key Layout

8.2.2 Operating Key Functions

(1) Alphanumeric Keys and Shift Keys

You can use the alphanumeric keys in conjunction with the shift keys to enter symbols, as well as alphanumeric keys.



F0805.ai

a. Entering Digits, Symbols, and Spaces

Simply press the alphanumeric keys.

Entry	Key-in Sequence
-4	[W _ X] [G 4 H]
0.3	[S 0 T] [U . V] [Q 3 R]
1 _ -9	[M 1 N] [Y SPACE] [Z] [W _ X] [E 9 F]

F0806.ai

b. Entering Letters (A through Z)

Press an alphanumeric key following a shift key to enter the letter shown on that side which the shift key represents. You must press the shift key before entering each letter.

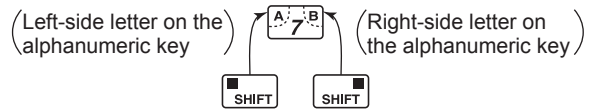

Entry	Key-in Sequence
W	[SHIFT] [W _ X]
IC	[SHIFT] [I 5 J] [SHIFT] [C 8 D]
J. B	[SHIFT] [I 5 J] [U . V] [SHIFT] [A 7 B]

F0807.ai

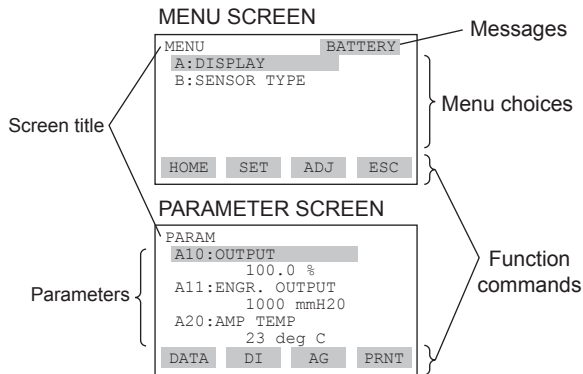

F0804.ai

Figure 8.4 BT200 Screen Component

Use the function key [F2] CAPS to select between uppercase and lowercase (for letters only). The case toggles between uppercase and lowercase each time you press [F2] CAPS.



Entry	Key-in Sequence
Boy	[SHIFT] [A 7 B] [F2] [SHIFT] [O 2 P] [SHIFT] [Y SPACE] (B) (o) (y)

F0808.ai

Use the function key [F1] **CODE** to enter symbols.
 The following symbols will appear in sequence, one at a time, at the cursor each time you press [F1]
 CODE:

/ . - , + *) (' & % \$ # " !

To enter characters next to these symbols, press [>] to move the cursor.

Entry	Key-in Sequence
/m	

F0809.ai

(2) Function Keys

The functions of the function keys depend on the function commands on display.

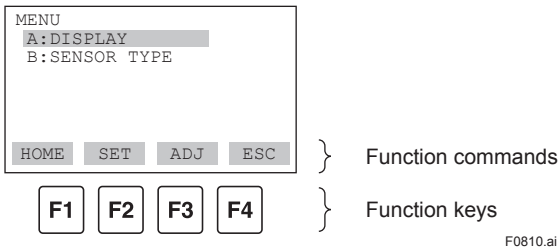

Function Command List

Command	Function
ADJ	Displays the ADJ menu
CAPS/caps	Selects uppercase or lowercase
CODE	Selects symbols
CLR	Erases input data or deletes all data
DATA	Updates parameter data
DEL	Deletes one character
DIAG	Calls the self-check panel
ESC	Returns to the most recent display
HOME	Displays the menu panel
NO	Quits setup and returns to the previous display
OK	Proceeds to the next panel
PARM	Enters the parameter number setup mode
SET	Displays the SET menu
SLOT	Returns to the slot selection panel
UTIL	Calls the utility panel
*COPY	Prints out parameters on display
*FEED	Paper feed
*LIST	Lists all parameters in the menu
*PON/ POFF	Automatic printout mode on or off
*PRNT	Changes to the print mode
*GO	Starts printing
*STOP	Cancels printing

* Available on BT200-P00 (with printer).

8.2.3 Calling Up Menu Addresses Using the Operating Keys

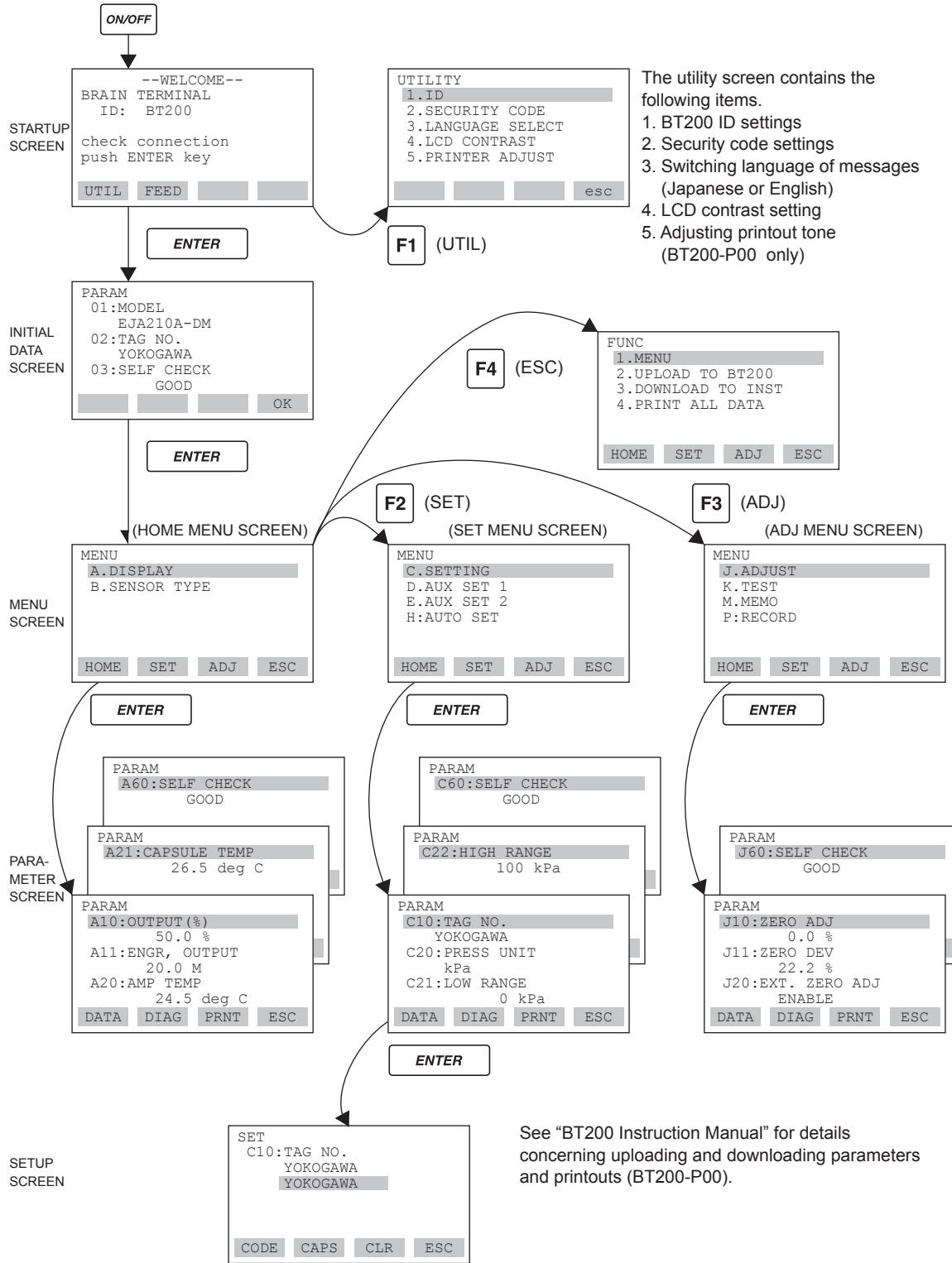

The utility screen contains the following items.

1. BT200 ID settings
2. Security code settings
3. Switching language of messages (Japanese or English)
4. LCD contrast setting
5. Adjusting printout tone (BT200-P00 only)

See "BT200 Instruction Manual" for details concerning uploading and downloading parameters and printouts (BT200-P00).

F0811.ai

8.3 Setting Parameters Using the BT200

8.3.1 Parameter Summary

Instruments to which applicable:

- F: Differential pressure transmitters EJA110A, EJA120A, and EJA130A
- P: Pressure transmitters EJA310A, EJA430A, EJA440A, EJA510A, and EJA530A
- L: Liquid level transmitters EJA210A and EJA220A

No.	Item	Description	Rewritability	Remarks	Default Value	Applicability		
						F	P	L
01	MODEL	Model+capsule type	–			○	○	○
02	TAG NO.	Tag number	–	16 alphanumerics		○	○	○
03	SELF CHECK	Self-diagnostic result	–	GOOD/ERROR		○	○	○
A	DISPLAY	Measured data display	–	Menu name		○	○	○
A10	OUTPUT (%)	Output (in %)	–	–5 to 110%*3		○	○	○
A11	ENGR. OUTPUT	Output (in engineering units)	–	–19999 to 19999		○	○	○
A20	AMP TEMP	Amplifier temperature	–	Unit specified in D30		○	○	○
A21	CAPSULE TEMP	Capsule temperature	–	Unit specified in D30		○	○	○
A30	STATIC PRESS	Static pressure	–	Unit specified in D31*1		○	–	○
A40	INPUT	Input (indicated as the value after zeroing)	–	–32000 to 32000		○	○	○
A60	SELF CHECK	Self-diagnostic messages	–	GOOD/ERROR, CAP MODULE FAULT, AMP MODULE FAULT, OUT OF RANGE, OUT OF SP RANGE*1, OVER TEMP (CAP), OVER TEMP (AMP), OVER OUTPUT, OVER DISPLAY, ILLEGAL LRV, ILLEGAL HRV, ILLEGAL SPAN, and ZERO ADJ OVER		○	○	○
B	SENSOR TYPE	Sensor type	–	Menu name		○	○	○
B10	MODEL	Model+span	–	16 uppercase alphanumerics		○	○	○
B11	STYLE NO.	Style number	–			○	○	○
B20	LRL	Lower range-limit	–	–32000 to 32000		○	○	○
B21	URL	Upper range-limit	–	–32000 to 32000		○	○	○
B30	MIN SPAN	Minimum span	–	–32000 to 32000		○	○	○
B40	MAX STAT.P.	Maximum static pressure*6	–			○	–	○
B60	SELF CHECK	Self-diagnostic messages	–	Same as A60		○	○	○
C	SETTING	Setting data	–	Menu name		○	○	○
C10	TAG NO.	Tag number	○	16 alphanumerics	As specified when ordered.	○	○	○
C20	PRESS UNIT	Measurement range units	○	Selected from mmH ₂ O, mmAq, mmWG, mmHg, Torr, Pa, hPa, kPa, MPa, mbar, bar, gf/cm ² , kgf/cm ² , inH ₂ O, inHg, ftH ₂ O, psi, or atm	As specified when ordered.	○	○	○
C21	LOW RANGE	Measurement range, lower range value	○	–32000 to 32000 (but within measurement range)	As specified when ordered.	○	○	○
C22	HIGH RANGE	Measurement range, higher range value	○	–32000 to 32000 (but within measurement range)	As specified when ordered.	○	○	○
C30	AMP DAMPING	Damping time constant	○	Selected from 0.2*2, 0.5, 1.0, 2.0, 4.0, 8.0, 16.0, 32.0, or 64.0 sec.	2.0 s	○	○	○
C40	OUTPUT MODE	Output mode and integral indicator mode	○	Selected from OUT:LIN; DSP:LIN, OUT:LIN; DSP:SQR, OUT:SQR; DSP:SQR	As specified when ordered. If not specified, OUT:LIN; DSP:LIN.	○	–	–
C60	SELF CHECK	Self-diagnostic messages	–	Same as A60		○	○	○

No.	Item	Description	Rewritability	Remarks	Default Value	Applicability		
						F	P	L
D	AUX SET 1	Auxiliary setting data 1	–	Menu name		○	○	○
D10	LOW CUT	Low cut	○	0.0 to 20.0%	10.0%	○	○	○
D11	LOW CUT MODE	Low cut mode	○	LINEAR/ZERO	LINEAR	○	○	○
D15	OUT LIMIT(L)	Lower output range-limit	○	–5.0 to 110.0%	–5.0%*7	○	○	○
D16	OUT LIMIT(H)	Upper output range-limit	○	–5.0 to 110.0%	110.0%	○	○	○
D20	DISP SELECT	Display selection	○	NORMAL %/USER SET, USER & %/INP PRES, PRES & %	As specified when ordered.	○	○	○
D21	DISP UNIT	Engineering unit for display	○	8 uppercase alphanumerics		○	○	○
D22	DISP LRV	Engineering range, lower range value	○	–19999 to 19999	As specified when ordered.	○	○	○
D23	DISP HRV	Engineering range, higher range value	○	–19999 to 19999	As specified when ordered.	○	○	○
D30	TEMP UNIT	Temperature setting units	○	deg C/deg F	deg C	○	○	○
D31	STAT. P. UNIT	Static pressure setting units	○	Selected from mmH ₂ O, mmAq, mmWG, mmHg, Torr, Pa, hPa, kPa, MPa, mbar, bar, gf/cm ² , kgf/cm ² , inH ₂ O, inHg, ftH ₂ O, psi, or atm	As specified when ordered. If not specified, MPa.	○	–	○
D40	REV OUTPUT	Output reversal	○	NORMAL/REVERSE	If not specified, NORMAL.	○	○	○
D45	H/L SWAP	Impulse piping accessing direction	○	NORMAL/REVERSE*4	NORMAL	○	–	–
D52	BURN OUT	CPU error	–	HIGH/LOW, –5 to 110%*3	HIGH	○	○	○
D53	ERROR OUT	Hardware error	○	HOLD/HIGH/LOW, –5 to 110%*3	HIGH	○	○	○
D60	SELF CHECK	Self-diagnostic messages	–	Same as A60		○	○	○
E	AUX SET 2	Auxiliary setting data 2	–	Menu name		○	○	○
E10	DFS MODE	DFS mode	○	OFF/ON*5	ON	○	○	–
E14	TEMP SELECT	Reference temperature sensor	○	AMP. TEMP/CAP. TEMP*5	CAP. TEMP	○	○	–
E15	TEMP ZERO	Zero shift compensation setup	○	±10.00*5	0.00	○	○	–
E30	BI DIRE MODE	Bidirectional mode	○	OFF/ON	OFF	○	–	–
E50	AUTO RECOVER	Auto-recover from sensor error	○	OFF/ON	ON	○	○	○
E60	SELF CHECK	Self-diagnostic messages	–	Same as A60		○	○	○
H	AUTO SET	Automatic setup	–	Menu name		○	○	○
H10	AUTO LRV	Automatic measurement range lower range value setup	○	–32000 to 32000	Displays the same data as C21.	○	○	○
H11	AUTO HRV	Automatic measurement range higher range value setup	○	–32000 to 32000	Displays the same data as C22.	○	○	○
H60	SELF CHECK	Self-diagnostic messages	–	Same as A60		○	○	○
J	ADJUST	Adjustment data	–	Menu name		○	○	○
J10	ZERO ADJ	Automatic zero adjustment	○	–5 to 110.0%*3		○	○	○
J11	ZERO DEV.	Manual zero adjustment	○			○	○	○
J15	SPAN ADJ	Manual span adjustment	○	–10.00 to 10.00%	0.00%	○	○	○
J20	EXT. ZERO ADJ	External zero-adjustment screw permission	○	ENABLE/INHIBIT		○	○	○
J30	AOUTPUT 4mA	4mA adjustment	○	–10.00 to 10.00%	0.00%	○	○	○
J31	OUTPUT 20mA	20mA adjustment	○	–10.00 to 10.00%	0.00%	○	○	○
J60	ASELF CHECK	Self-diagnostic messages	–	Same as A60		○	○	○
K	TEST	Tests	–	Menu name		○	○	○
K10	OUTPUT in %	Test output % setting	○	–5 to 110.0%*3 Displays 'ACTIVE' while executing		○	○	○
K60	SELF CHECK	Self-diagnostic messages	–	Same as A60		○	○	○

No.	Item	Description	Rewrita- bility	Remarks	Default Value	Applica- bility		
						F	P	L
M	MEMO	Memo	–	Menu name		○	○	○
M10	MEMO 1	Memo	○	8 uppercase alphanumerics		○	○	○
M20	MEMO 2	Memo	○	8 uppercase alphanumerics		○	○	○
M30	MEMO 3	Memo	○	8 uppercase alphanumerics		○	○	○
M40	MEMO 4	Memo	○	8 uppercase alphanumerics		○	○	○
M50	MEMO 5	Memo	○	8 uppercase alphanumerics		○	○	○
M60	SELF CHECK	Self-diagnostic messages	–	Same as A60		○	○	○
P	RECORD	History of the errors	–			○	○	○
P10	ERROR REC 1	Last error	○	Display the error		○	○	○
P11	ERROR REC 2	One time before	○	Display the error		○	○	○
P12	ERROR REC 3	Two time before	○	Display the error		○	○	○
P13	ERROR REC 4	Three time before	○	Display the error		○	○	○
P60	SELF CHECK	Self-diagnostic messages	–	Same as A60		○	○	○

*1: In case of Model EJA120A, static pressure cannot be measured. The display is always 0 MPa, but this is not a measured value.

*2: When Optional code /F1 is specified, substitute the value with 0.1.

*3: When Optional code /F1 is specified, substitute the value –5 with –2.5.

*4: Not applicable for Model EJA115.

*5: Applicable only for Model EJA118W, EJA118N, EJA118Y, EJA438W, and EJA438N.

*6: See MWP(max. working pressure) on the nameplate. B40 shows an approximate value of maximum pressure for the capsule.

*7: Unless otherwise specified by order. When optional code /F1 is specified, substitute the value –5 with –2.5.

8.3.2 Parameter Usage and Selection

Before describing the procedure for setting parameters, we present the following table showing how the parameters are used and in what case.



IMPORTANT

If the transmitter is turned off within 30 seconds after parameters have been set, the set data will not be stored and the terminal returns to previous settings.

Table 8.1 Parameter Usage and Selection

Setup Item	Description
Tag No. setup P. 8-9	Sets the Tag No. (using 16 alphanumeric characters). Note: Up to 8 alphanumerics (upper case letters) can be used in the BT100.
Calibration range setup P. 8-9	Sets the calibration range for 4 to 20 mA DC. Sets three data items: range unit, input value at 4 mA DC (LRV), and input value at 20 mA DC (HRV). Note: LRV and HRV can be specified with range value specifications up to 5 digits (excluding any decimal point) within the range of -32000 to 32000.
Damping time constant setup P. 8-10	Adjusts the output response speed for 4 to 20 mA DC. Can be set in 9 increments from 0.2 to 64 s.
Output signal low cut mode setup P. 8-11	Used mainly to stabilize output near 0% if output signal is the square root mode. Two modes are available: forcing output to 0% for input below a specific value, or changing to proportional output for input below a specific value.
Change the output limits P. 8-11	Change the range of normal output.
Integral indicator scale range and unit setup P. 8-11	Sets the following 5 types of integral indicator scale ranges and units: % scale indicator, user set scale indicator, alternate indication of user set scale and % scale, input pressure display, alternate indication of input pressure and % scale When using the user set scale, 4 types of data can be set: user set scale setting, unit (BT200 only), display value at 4 mA DC (LRV), and display value at 20 mA DC (HRV). Note: LRV and HRV can be specified with range value specifications up to 5 digits (excluding any decimal point) within the range of -19999 to 19999.
Unit setup for displayed temperature P. 8-13	Sets a unit for temperatures displayed on the BT200.
Unit setup for displayed static pressure P. 8-13	Sets a unit for static pressure displayed on the BT200.
Operation mode (normal/reverse signal) setup P. 8-13	Reverses the direction for 4 to 20 mA DC output relative to input. Reverse mode is used for applications in which safety requires that output be driven toward 20 mA if input is lost.
Output status display/setup when a CPU failure P. 8-14	Displays the status of 4 to 20 mA DC output when a CPU failure. The parameter of the standard unit is fixed to the high limit value.
Output status setup when a hardware error occurs P. 8-14	Sets the status of the 4 to 20 mA DC output when an abnormal status is detected with the capsule or the amplifier as the result of self-diagnosis. One of the following statuses; last held, high limit, and low limit values, can be selected.
Range change (while applying actual inputs) P. 8-14	Range for 4 to 20 mA DC signal is set with actual input applied. Sets 20 mA DC output precisely with respect to user's reference instrument output. Note that DPharp is calibrated with high accuracy before shipment, so span should be set using the normal range setup.
Zero point adjustment P. 8-15	Adjusts zero point. This can be done either using the external zero-adjustment screw on the transmitter or using the BT200.
Span adjustment P. 8-16	Adjust the characterization curve. All the transmitters are calibrated at factory and this adjustment is normally not necessary for most cases. Use for specific purposes.
Test output (fixed current output) setup P. 8-17	Used for loop checks. Output can be set freely from -5% to 110% in 1% steps.
User memo fields P. 8-17	Allows user to enter up to 5 items of any desired text in up to 8 uppercase alphanumeric characters per item.

8.3.3 Setting Parameters

Set or change the parameters as necessary. After completing these, do not fail to use the “DIAG” key to confirm that “GOOD” is displayed for the self-diagnostic result at **_60: SELF CHECK**.

(1) Tag No. Setup (C10: TAG NO)

Use the procedure below to change the Tag No. Up to 16 alphanumeric characters can be entered.

- Example: Set a Tag No. to FIC-1a

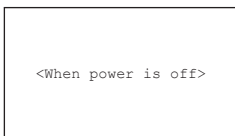

Press the **ON/OFF** key to turn on the BT200.



Connect DPharp and BT200 using a communication cable and press the **ENTER** key.

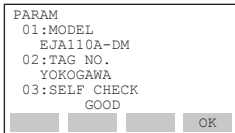

Displays the name of connected DPharp model, TAG NO. and diagnostics information. Press the **F4** (OK) key after confirmation.

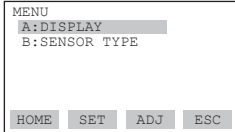

Press the **F2** (SET) key to display the SET menu panel.

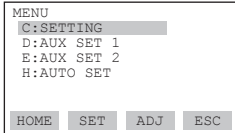

Select **C: SETTING** and press the **ENTER** key.

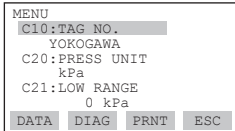

Select **C10: TAG NO.** and press the **ENTER** key.

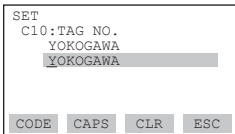

Set the new TAG NO. (FIC-1a).

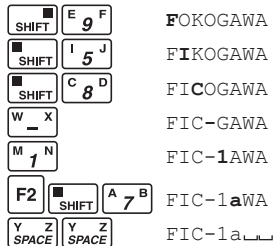

F0812-1.ai

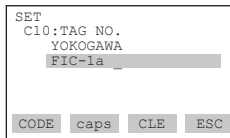

Set TAG NO. and press the **ENTER** key.

(When you have made an entry mistake, return the cursor **<** using the key, then reenter.)

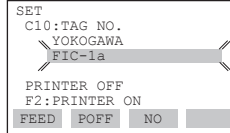

This is the panel for confirming set data. The set data items flash. When all items have been confirmed, press the **ENTER** again. (To go back to the setting panel, press the **F3** (NO) key.

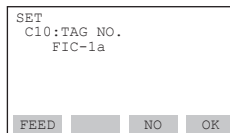

The DPharp TAG NO. was overwritten.

Press the **F4** (OK) key to return to the parameter panel. Press the **F3** (NO) key to return to the setting panel.

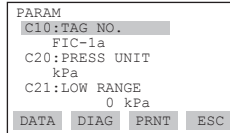

F0812-2.ai

(2) Calibration Range Setup

a. Setting Calibration Range Unit (C20: PRESS UNIT)

The unit is set at the factory before shipment if specified at the time of order. Follow the procedure below to change the unit.

- Example: Change the unit from mmH₂O to kPa.

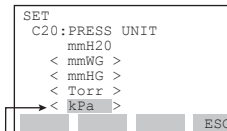

Use the **^** or **v** key to select “kPa.”

Press the **ENTER** key twice to enter the setting.

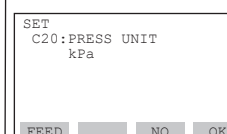

Press the **F4** (OK) key.

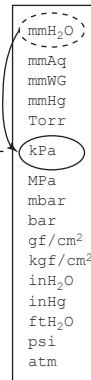

F0813.ai

b. Setting Calibration Range Lower Range Value and Higher Range Value (C21: LOW RANGE, C22: HIGH RANGE)

These range values are set as specified in the order before the instrument is shipped. Follow the procedure below to change the range.

- The measurement span is determined by the high and low range limit values. In this instrument, changing the low range value also automatically changes the high range value, keeping the span constant.

- Example 1: With present settings of 0 to 30 kPa, set the lower range value to 0.5 kPa.

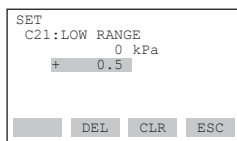

Set **0.5**. Press the **ENTER** key twice to enter the setting.

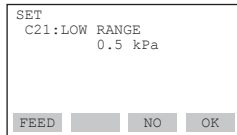

Press the **F4** (OK) key.

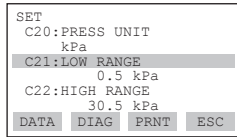

The higher range value is changed while the span remains constant.

(Span = Higher range value – Lower range value)

F0814.ai

- Note, however, that changing the higher range value does not cause the lower range value to change. Thus, changing the higher range value also changes the span.
- Calibration range can be specified with range value specifications up to 5 digits (excluding any decimal point) for low or high range limits within the range of -32000 to 32000.

- Example 2: With present settings of 0 to 30 kPa, set the Higher range value to 10 kPa.

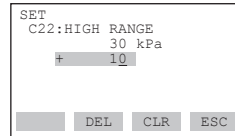

Set **10**. Press the **ENTER** key twice to enter the setting.

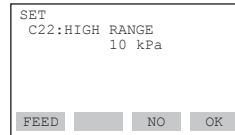

Press the **F4** (OK) key.

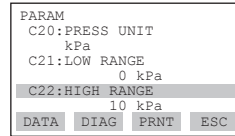

The low range value is not changed, so the span changes.

F0815.ai

(3) Damping Time Constant Setup (C30: AMP DAMPING)

When the instrument is shipped, the damping time constant is set at 2.0 seconds. Follow the procedure below to change the time constant.

- Example: Change from 2.0 sec to 4.0 sec.

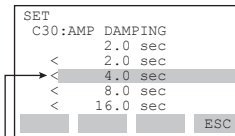

Use the **▲** or **▼** key to select **4.0 sec**. Press the **ENTER** key twice to enter the setting.

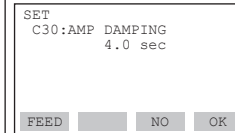

Press the **F4** (OK) key.

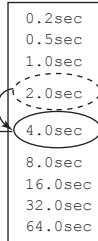

F0816.ai

Note: The damping time constant set here is the damping time constant for the amplifier assembly. The damping time constant for the entire transmitter is the sum of the values for the amplifier assembly and for the capsule assembly. For the capsule assembly damping time constant (fixed), see the "General Specifications" found at the end of this manual. (See Chapter 10.)

**(4) Output Signal Low Cut Mode Setup
(D10: LOW CUT, D11: LOW CUT MODE)**

Low cut mode can be used to stabilize the output signal near the zero point. The low cut point can be set in a range from 0 to 20% of output. (Hysteresis: ±1%)

Either “ZERO” as the low cut mode.

- Low cut mode “ZERO”

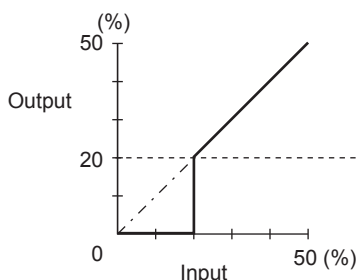

F0817.ai

● Example: Change the low cut setting range from 10% to 20%, and the low cut mode from **LINEAR** to **ZERO**.

SET
D10:LOW CUT
10.0 %
+ 20.0

CLR ESC

Set “20.”
Press the **ENTER** key twice to enter the setting.

SET
D10:LOW CUT
20.0 %

FEED NO OK

Press the **F4** (OK) key.
Next, the [D11: LOW CUT MODE] setting panel is displayed.

SET
D11:LOW CUT MODE
LINEAR
< LINEAR >
< ZERO >

ESC

Use the **↑** or **↓** key to select “ZERO.”
Press the **ENTER** key twice to enter the setting.

SET
D11:LOW CUT MODE
ZERO

FEED NO OK

Press the **F4** (OK) key.

PARAM
D10:LOW CUT
20.0 %
D11:LOW CUT MODE
ZERO
D20:DISP SELECT
NORMAL %
DATA DIAG PRNT ESC

F0818.ai

**(5) Change Output Limits
(D15: OUT LIMIT(L), D16: OUT LIMIT(H))**

The range of normal output is preset at the factory from -5.0% to 110.0% unless otherwise specified, and the output is limited with these upper and lower values. This output range can be changed, for example, to meet the requirements of NAMUR, etc. within the settable range. Set the lower limit with **D15: OUT LIMIT(L)** and upper limit with **D16: OUT LIMIT(H)**.

Settable range: -5.0 to 110.0 (%)

Lower limit < Upper limit

(6) Integral Indicator Scale Setup

The following 5 displays are available for integral indicators.

D20: DISP SELECT and Display	Description and Related parameters
NORMAL % 	Indicates -5 to 110% range depending on the Measurement range (C21, C22). A10:OUTPUT (%) 45.6 %
USER SET 	Indicates values depending on the Engineering range (D22, D23).(Note 1) Units set using Engineering unit (D21) are not indicated. A11:ENGR.OUTPUT 20.0 M
USER & % 	Indicates user set and % alternately in 3 second intervals. A10:OUTPUT (%) 45.6 % A11:ENGR. OUTPUT 20.0 M
INP PRES 	Indicates input pressure.(Note 2) Indication limits -19999 to 19999. A40:INPUT 456 kPa
PRES & % 	Indicates input pressure and % alternately in 3 second intervals. A10:OUTPUT (%) 45.6 % A40:INPUT 456 kPa

F0819.ai

Note 1: Scale range can be specified with range limit specifications up to 5 digits (excluding any decimal point) for low or high range limits within the range of -19999 to 19999.

The range with decimals is available to the third decimal place.

Note 2: It indicates the value after zeroing.

See (a.) through (c.) for each setting procedure.

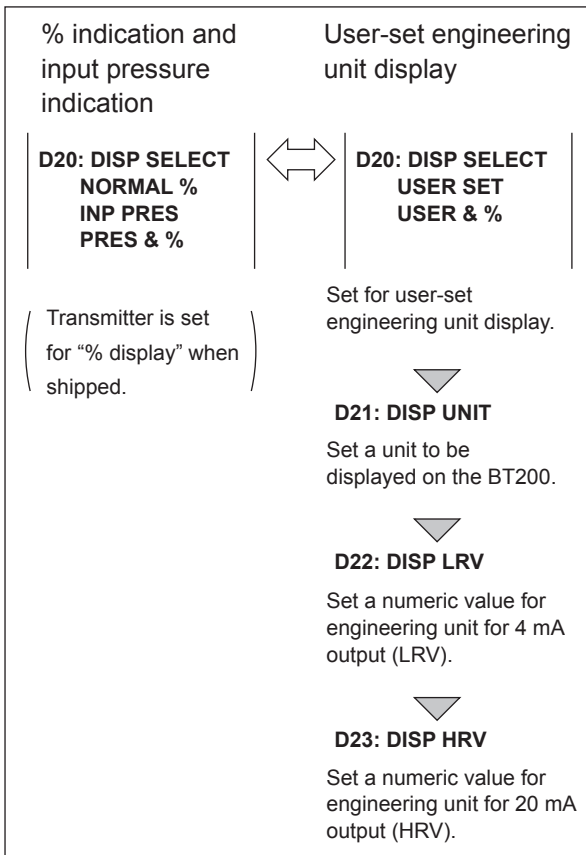

F0820.ai

b. Setting User-set Engineering Unit (D21: DISP UNIT)

This parameter allows entry of the engineering units to be displayed on the BT200. When the instrument is shipped, this is set as specified in the order.

Follow the procedure below to change this setting.

This parameter need not be set for % display.

• Example: Set an engineering unit **M**.

```
SET
D21:DISP UNIT
M
[CODE] [CAPS] [CLR] [ESC]
```

Set “M.”

Press the **ENTER** key twice to enter the setting.

```
SET
D21:DISP UNIT
M
[FEED] [NO] [OK]
```

Press the **F4** (OK) key.

F0822.ai

a. Display Selection (D20: DISP SELECT)

Follow the instructions given to the below to change the range of integral indication scales.

When **USER SET** is selected, the user set values of integral indication and **A11: ENGR. OUTPUT** parameter are indicated.

• Example: Set the integral indicator scale to engineering units display.

```
SET
D20:DISP SELECT
NORMAL %
<NORMAL %>
<USER SET>
<USER & %>
<INP PRES>
[ESC]
```

Use the **^** or **v** key to select “USER SET.”

Press the **ENTER** key twice to enter the setting.

```
SET
D20:DISP SELECT
USER SET
[FEED] [NO] [OK]
```

Press the **F4** (OK) key.

(The “%” disappears from the integral indicator display.)

F0821.ai

c. Lower and Higher Range Value Setup in Engineering Unit (D22: DISP LRV, D23: DISP HRV)

These parameter items are used to set the lower and higher range values for the engineering unit display.

When the instrument is shipped, these are set as specified in the order. Follow the procedure below to change these settings. Note that these parameters need not be set for % display.

• Example: Set lower range value (LRV) to **-50** and higher range value (HRV) to **50**.

Setting LRV

```
SET
D22:DISP LRV
      OM
      50
```

Set **"-50."**
Press the **ENTER** key twice to enter the setting.

DEL CLR ESC

Setting HRV

```
SET
D23:DISP HRV
      100M
      50
```

Set **"50."**
Press the **ENTER** key twice to enter the setting.

DEL CLR ESC

Press the **F4** (OK) key.

```
SET
D23:DISP HRV
      50M
```

FEED NO OK

PARAM

```
D21:DISP UNT
M
D22:DISP LRV
-
50M
D23:DISP HRV
50M
```

DATA DIAG PRNT ESC

F0823.ai

(7) Unit Setup for Displayed Temperature (D30: TEMP UNIT)

When the instrument is shipped, the temperature units are set to **degC**. Follow the procedure below to change this setting. Note that changing the unit here changes the unit for **A20: AMP TEMP** (amplifier temperature) and **A21: CAPSULE TEMP** (capsule temperature).

• Example: Change the unit for the temperature display.

```
SET
D30:TEMP UNIT
deg C
< deg C >
< deg F >
```

Use the **^** or **v** key to select **"deg F."**
Press the **ENTER** key twice to enter the setting.

ESC

F0824.ai

(8) Unit Setup for Displayed Static Pressure (D31: STAT.P.UNIT)

Follow the procedure below to change the static pressure units.

Changing this parameter changes the unit for the **A30: STATIC PRESS** (static pressure) display.

• Example: Change the static pressure unit from **kgf/cm²** to **MPa**.

```
SET
D31:STAT.P.UNIT
kgf/cm^2
< MPa >
< mbar >
< bar >
< gf/cm^2 >
```

Use the **^** or **v** key to select **MPa**.
Press the **ENTER** key twice to enter the setting.

ESC

```
mmH2O
mmAq
mmWG
mmHg
Torr
kPa
MPa
mbar
bar
gf/cm^2
kgf/cm^2
inH2O
inHg
ftH2O
psi
atm
```

F0825.ai

(9) Operation Mode Setup (D40: REV OUTPUT)

This parameter allows the direction of the 4 to 20 mA output to be reversed with respect to input. Follow the procedure below to make this change.

• Example: Change 4 to 20 mA output to 20 to 4 mA output.

```
SET
D40:REV OUTPUT
NORMAL
< NORMAL >
< REVERSE >
```

Use the **^** or **v** key to select **REVERSE**.
Press the **ENTER** key twice to enter the setting.

ESC

F0826.ai

(10) Output Status Display/Setup when a CPU Failure (D52: BURN OUT)

This parameter displays the status of 4 to 20 mA DC output if a CPU failure occurs. In case of a failure, communication is disabled.



Setting of HIGH or LOW is enabled. This is done with the pin (CN4) on the CPU assembly. See Chapter 3 for details.

Standard specifications

The parameter is set to HIGH. If a failure, the transmitter outputs the signal of 110% or higher. The parameter **D53: ERROR OUT** is set to HIGH from the factory.

Optional code/C1

The parameter is set to LOW. If a failure, output which is -5% or lower is generated. The parameter **D53: ERROR OUT** is set to LOW from the factory.

- Example: Standard specifications
 pin (CN4) position: H
- Example: Optional code/C1
 pin (CN4) position: L





F0827.ai

(11) Output Status Setup when a Hardware Error Occurs (D53: ERROR OUT)

This parameter allows the setting of the output status when a hardware error occurs. The following three selections are available.

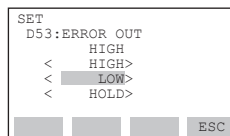
- (a) HOLD; Outputs the last value held before the error occurred.
- (b) HIGH; Outputs an output of 110% when an error has occurred.
- (c) LOW; Outputs an output of -5% when an error has occurred.

Note: A hardware error means CAP MODULE FAULT of Er.01 or AMP MODULE FAULT of Er. 02 which are shown in 8.5.2 "Errors and Countermeasures.")

- Example: Set the output status to LOW when a hardware error occurs.
 Use the  or  key to select "LOW."
 Press the  key twice to enter the setting.





F0828.ai

(12) Range Change while Applying Actual Inputs (H10: AUTO LRV, H11: AUTO HRV)

This feature allows the lower and higher range values to be set up automatically with the actual input applied. If the lower and higher range values are set, **C21: LOW RANGE** and **C22: HIGH RANGE** are changed at this same time.

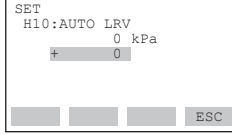
Follow the procedure in the figure below.

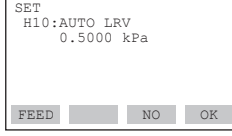
The measurement span is determined by the higher and lower range values. Changing the lower range value results in the higher range value changing auto-matically, keeping the span constant.

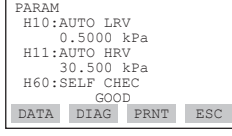
- Example 1: When changing the lower range value to 0.5 kPa for the present setting of 0 to 30 kPa, take the following action with input pressure of 0.5 kPa applied.
 Press the  key twice.
 The lower range value is changed to 0.5 kPa.
 Press the  (OK) key.
 The higher range value is changed keeping the span constant.
 Parameters **C21** and **C22** are changed at the same time.

F0829.ai

Note that changing the higher range value does not cause the lower range value to change but does change the span.

- Example 2: When the higher range value is to be changed to 10 kPa with the present setting of 0 to 30 kPa, take the following action with an input pressure of 10 kPa applied.

```
SET
H11:AUTO HRV
  30 kPa
+ 30
ESC
```

Press the **ENTER** key twice.

The higher range value is changed to 10 kPa.

```
SET
H11:AUTO HRV
 10.000 kPa
FEED NO OK
```

Press the **F4** (OK) key.

```
PARAM
H10:AUTO LRV
  0 kPa
H11:AUTO HRV
 10.000 kPa
H60:SELF CHECK
  GOOD
DATA DIAG PRNT ESC
```

The lower range value is not changed, so the span changes.

Parameter **C22** is changed at the same time.

F0830.ai

(13) Zero Point Adjustment (J10: ZERO ADJ, J11: ZERO DEV, J20: EXT ZERO ADJ)

The DPharp supports several adjustment methods.

Select the method best suited for the conditions of your application.

Note that output signal can be checked by displaying parameter **A10:OUTPUT (%)** on the BT200.

Adjustment Method	Description
Using the BT200	Set the present input to 0%. Adjust for 0% output at input level of 0%.
	Adjust output to the reference value obtained using other means. If the input level cannot easily be made 0% (because of tank level, etc.), adjust output to the reference value obtained using other means, such as a sight glass.
Using the external zero-adjustment screw	Adjust zero point using the zero-adjustment screw on the transmitter. This permits zero adjustment without using the BT200. Accurately adjust the output current to 4 mA DC or other target output value using an ammeter that accurately reads output currents.

- (a) Follow the procedure below when setting the present output to 0% (4 mA).

```
A10:OUTPUT (%)
  0.5 %
```

Output is 0.5%.

```
SET
J10:ZERO ADJ
  0.0 %
+ 000.0
CLR ESC
```

Press the **ENTER** key twice.

```
SET
J10:ZERO ADJ
  0.0 %
FEED NO OK
```

Zero adjustment is completed.

Press the **F4** (OK) key.

```
A10:OUTPUT (%)
  0.0 %
```

Output is 0%.

F0831.ai

- (b) In tank level measurement, if the actual level cannot be brought to zero for zero adjustment, then the output can be adjusted to correspond to the actual level obtained using another measuring instrument such as a glass gauge.

Present level: 45%
Present output: 41%

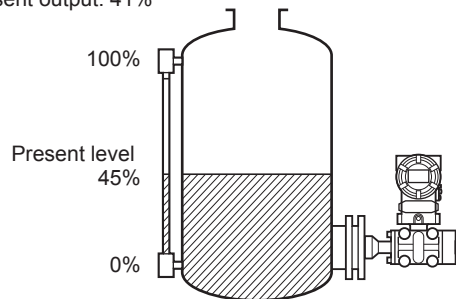

F0832.ai

- (b)-1 Follow the procedure below to use **J10: ZERO ADJ.**

```
A10:OUTPUT (%)
  41.0 %
```

Present output is 41.0%.

```
SET
J10:ZERO ADJ
  0.0 %
+ 045.0
CLR ESC
```

Enter the present actual level, 45%.

Press the **ENTER** key twice.

```
A10:OUTPUT (%)
  45.0 %
```

The output is changed to 45%.

F0833.ai

(b)-2 Follow the procedure below to use **J11: ZERO DEV.**

<pre>A10:OUTPUT (%) 41.0 %</pre>	Present output is 41.0%. Output error = 45.0 – 41.0 = 4.0%.
<pre>SET J11:ZERO DEV. 2.50 % 0</pre>	Since “J11: ZERO DEV.” contains the previous correction, obtain the correction value by adding 4.0% to it. (2.50% + 4.0% = 6.50%)
<pre>SET J11:ZERO DEV. 2.50 % 6.50</pre>	Set the correction value, 6.50. Press the ENTER key twice.
<pre>A10:OUTPUT (%) 45.0 %</pre>	The output is changed to 45%.

F0834.ai

When the zero point is adjusted, the displayed value of A40 is as follows.

[Example]

When the zero point is shifted by 20 kPa for the actual pressure, the parameter of A40 indicates 50 kPa.

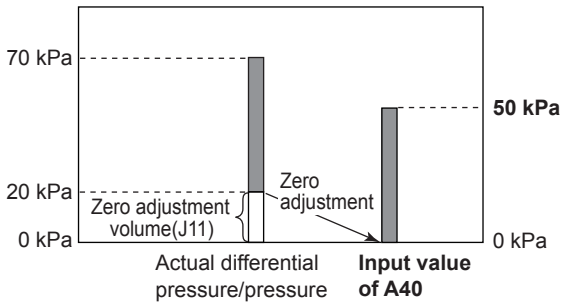

F0835.ai

(c) Zero Point Adjustment Using the External Zero Adjustment Screw

- Enabling/inhibiting of zero point adjustment using the external zero-adjustment screw on the transmitter (J20: EXT ZERO ADJ)

Follow the procedure below to enable or inhibit zero point adjustment from the zero-adjustment screw on the transmitter.

This is set to “ENABLE” when the instrument is shipped.

• Example: Inhibiting zero adjustment by the external zero-adjustment screw

<pre>SET J20:EXIT ZERO ADJ ENABLE < ENABLE > < INHIBIT ></pre>	Use the ▲ or ▼ key to select “INHIBIT.” Press the ENTER key twice to enter the setting.
---	---

F0836.ai

- Zero point adjustment using external zero-adjustment screw on the transmitter

Turn the zero-adjustment screw on the outside of the transmitter case using a slotted screwdriver. Turn the screw to the right to increase the zero point or to the left to decrease the zero output; the zero adjusts in increments of 0.01% of the range setting. Note that the amount of adjustment to the zero point changes according to the speed at which the screw is turned. To make fine adjustments, turn the screw slowly; to make coarse adjustments, turn the screw quickly.

Note: When a zero point adjustment has been made, do not turn off the transmitter less than 30 seconds after adjustment.

(14) Span Adjustment

Each DPharp EJA series transmitter is factory characterized according to the specification. Mounting position effects or zero shifts caused by static pressure are typically compensated by a zero adjustment.

A span adjustment is a function to correct the slope error from a zero point in characterizing 100% point (HRV). This function can be used when span drifts may be caused or characterization to the specific pressure standard is required.

Therefore, the zero point adjustment should always be performed before the upper point adjustment in order to maintain the pitch between zero and 100% points within the calibration range.

You can manually perform the trimming procedure by using J15: SPAN ADJ.

- Span adjustment value
The span adjustment value is calculated as follows.

$$\text{Span adjustment value (\%)} = \frac{P_1 - A40}{P_1} \times 100$$

P_1 : Actual differential pressure/pressure value
A40: Input (indicated as the value after zeroing)

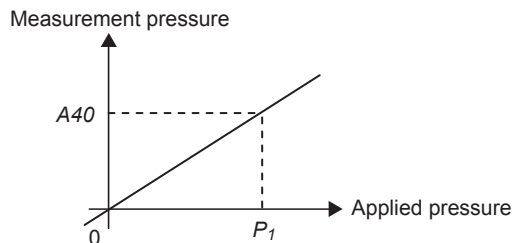

F0837.ai

- Example: For the range of 0 to 30 kPa.
A40: INPUT = 30.15 kPa
J15: SPAN ADJ = 0.15 %

Suppose that a standard pressure of 30 kPa is applied and the value of the parameter of A40:INPUT is 30.15 kPa. Firstly, obtain the slope error for the span as follows;

$$\begin{aligned} \text{Span adjustment value (\%)} &= \frac{P_1 - A40}{P_1} \times 100 \\ &= \frac{30.00 - 30.15}{30.00} \times 100 = -0.5 (\%) \end{aligned}$$

Add -0.5% to 0.15% of the current value to calculate the accumulated span adjustment value.

$$0.15 + (-0.50) = -0.35$$

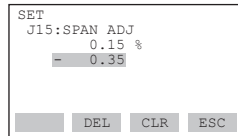

Set **-0.35**.
Press the **ENTER** key twice.



Press the **F4** (OK) key.

Note: Enter 0.00 to J15: SPAN ADJ to reset the span adjustment to the initial value at the shipment.

F0838.ai

(15) Test Output Setup (K10: OUTPUT X%)

This feature can be used to output a fixed current from 3.2 mA (-5%) to 21.6 mA (110%) for loop checks.

- Example: Output 12 mA (50%) fixed current.

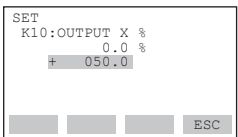

Set **"50.0%."**
Press the **ENTER** key twice to output a fixed current at 50%.

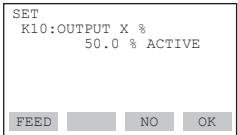

"Active" is displayed while this is being executed.
Press the **F4** (OK) key to cancel the fixed current output.

F0839.ai



IMPORTANT

1. Test output is held for approximately 10 minutes, and then released automatically after the time has elapsed. Even if the BT200 power supply is turned off or the communication cable is disconnected during test output, it is held for approximately 10 minutes.
2. Press the [F4] (OK) key to release test output immediately.

(16) User Memo Fields (M: MEMO)

This feature provides 5 user memo fields, each holding up to 8 alphanumeric characters. Up to 5 items such as inspection date, inspector, and other information can be saved in these fields.

- Example: Save an inspection date of January 30, 1995.

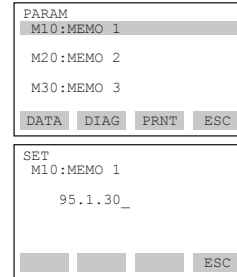

Set **"95.1.30"** in the order of year, month, and day.
Press the **ENTER** key twice to enter the setting.

F0840.ai

8.4 Displaying Data Using the BT200

8.4.1 Displaying Measured Data

The BT200 can be used to display measured data.

The measured data is updated automatically every 7 seconds. In addition, the display can be updated to the present data value at any time by pressing the [F1] (DATA) key. For parameters associated with the display of measured data, see Subsection 8.3.1, "Parameter Summary."

• Example: Display output.

The first screenshot shows the 'MENU' screen with 'A: DISPLAY' selected. The second screenshot shows the 'PARAM' screen with 'A10: OUTPUT (%)' selected, and a callout indicates 'Display "A10: OUTPUT (%)".' The third screenshot shows the same 'PARAM' screen with 'A10: OUTPUT (%)' displaying 'communi', and a callout indicates 'Data is updated automatically at 7-second intervals.'

F0841.ai

8.4.2 Display Transmitter Model and Specifications

The BT200 can be used to display the model and specifications of the transmitter.

• Example: View transmitter model name.

The first screenshot shows the 'MENU' screen with 'B: SENSOR TYPE' selected. A callout says 'Press [ENTER]'. An arrow points down to the second screenshot, which shows the 'PARAM' screen with 'B10: MODEL' selected, displaying 'EJA210A-DM'. A callout says 'For the associated parameters, see Subsection 8.3.1, Parameter Summary.'

F0842.ai

8.5 Self-Diagnostics

8.5.1 Checking for Problems

(1) Identifying Problems with BT200

The following four areas can be checked.

- (a) Whether connections are good.
- (b) Whether BT200 was properly operated.
- (c) Whether settings were properly entered.
- (d) History of the errors.

See examples below.

• Example 1: Connection errors

The first screenshot shows a 'WELCOME' screen with 'BRAIN TERMINAL ID: BT200' and a 'check connection push ENTER key' message. A callout says 'Press the [ON/OFF] key.' The second screenshot shows a 'communication error' message. A callout says 'When the panel shown on the left appears, press the [ENTER] key.' The third screenshot shows the 'communication error' message again. A callout says 'Since communications will be unsuccessful if there is a problem in the connection to the BT200, the display at the left will appear. Recheck the connection. Press the [F4] (OK) key.'

F0843.ai

• Example 2: Setting entry errors

The first screenshot shows the 'PARAM' screen with '01: MODEL' selected, displaying 'EJA210A-DM'. A callout says 'The initial data panel shows the result of current transmitter diagnostics.' The second screenshot shows the 'PARAM' screen with 'C20: PRESS UNIT' selected, displaying 'kPa'. A callout says 'Press the [F2] (DIAG) key in the parameter panel to go to the diagnostics panel (C60: SELF CHECK).' The third screenshot shows the 'DIAG' screen with 'C60: SELF CHECK' selected, displaying 'ERROR' and 'ILLEGAL LRV'. A callout says 'An error message is displayed when an error occurs in the diagnostics panel.'

F0844.ai

• Example 3: Checking the history of the errors

```
MENU
J:ADJUST
K:TEST
M:MEMO
P:RECORD
HOME SET ADJ ESC
```

Connect the BT200 to the transmitter, and call item "P."

```
PARAM
P10:ERROR REC 1
      ERROR
P11:ERROR REC 2
      ERROR
P12:ERROR REC 3
      GOOD
DATA DIAG PRNT ESC
```

- P10: "ERROR REC 1" displays the last error.
- P11: "ERROR REC 2" displays the error one time before the last error occurred.
- P12: "ERROR REC 3" displays the error two times before the last error occurred.
- P13: "ERROR REC 4" displays the error three times before the last error occurred.

The history of up to four errors can be stored. When the 5th error has occurred, it is stored in "P10". The error stored in "P13" will be deleted, and then, the error in "P12" will be copied to "P13". In this sequence, the history of the most previously occurred error will be removed from memory.

"GOOD" will be displayed if there was no previous error.

```
SET
P10:ERROR REC 1
      ERROR
      < ERROR >
      < ILLEGAL LRV >
      < ILLEGAL HRV >
      ESC
```

Select P10: ERROR REC1 and press the **ENTER** key to display the error message.

<(a) SETUP PANEL>

For the details of the messages listed below, see Table 8.5.1 Error Message Summary.

CAP MODULE FAULT	OVER TEMP (CAP)	ILLEGAL LRV
AMP MODULE FAULT	OVER TEMP (AMP)	ILLEGAL HRV
OUT OF RANGE	OVER OUTPUT	ILLEGAL SPAN
OUT OF SP RANGE	OVER DISPLAY	ZERO ADJ OVER

Note 1: Press the **ENTER** key twice in the setting panel (panel 1) to clear all error message (P10 to P13) information.

Note 2: After two hours from when an error occurs, the error message of that error will be recorded. Therefore, if you switch off the transmitter within two hours from when the error occurs, there is no history of that error stored in the transmitter, and this function is meaningless.

F0845.ai

(2) Checking with Integral Indicator



NOTE

If an error is detected in the self-diagnostic, an error number is displayed on the integral indicator. If there is more than one error, the error number changes at two-second intervals. See Table 8.2 regarding the error numbers.



F0846.ai

Figure 8.5 Identifying Problems Using the Integral Indicator

8.5.2 Errors and Countermeasures

The table below shows a summary of error messages.

Table 8.2 Error Message Summary

Integral Indicator Display	BT200 Display	Cause	Output Operation during Error	Countermeasure
None	GOOD			
---	ERROR			
Er.01	CAP MODULE FAULT	Capsule problem.*1	Outputs the signal (Hold, High, or Low) set with parameter D53.	Replace the capsule when error keeps appearing even after restart.*2
Er.02	AMP MODULE FAULT	Amplifier problem.	Outputs the signal (Hold, High, or Low) set with parameter D53.	Replace amplifier.
Er.03	OUT OF RANGE	Input is outside measurement range limit of capsule.	Outputs high range limit value or low range limit value.	Check input.
Er.04	OUT OF SP RANGE	Static pressure exceeds specified range.*3	Displays present output.	Check line pressure (static pressure).
Er.05	OVER TEMP (CAP)	Capsule temperature is outside range (-50 to 130°C).	Displays present output.	Use heat insulation or make lagging to keep temperature within range.
Er.06	OVER TEMP (AMP)	Amplifier temperature is outside range (-50 to 95°C).	Displays present output.	Use heat insulation or make lagging to keep temperature within range.
Er.07	OVER OUTPUT	Output is outside high or low range limit value.	Outputs high or low range limit value.	Check input and range setting, and change them as needed.
Er.08	OVER DISPLAY	Displayed value is outside high or low range limit value.	Displays high or low range limit value.	Check input and display conditions and modify them as needed.
Er.09	ILLEGAL LRV	LRV is outside setting range.	Holds output immediately before error occurrence.	Check LRV and modify as needed.
Er.10	ILLEGAL HRV	HRV is outside setting range.	Holds output immediately before error occurrence.	Check HRV and modify as needed.
Er.11	ILLEGAL SPAN	SPAN is outside setting range.	Holds output immediately before error occurrence.	Check SPAN and change as needed.
Er.12	ZERO ADJ OVER	Zero adjustment is too large.	Displays present output.	Readjust zero point

*1: This error code appears at a capsule problem or when an illegal overpressure is applied to the pressure sensor.

*2: If the normal pressure is regained, the Er.01 will disappear according to the setting of the parameter of **E50: AUTO RECOVER**. When the **E50: AUTO RECOVER** is set to **ON**(default setting), the Er.01 will disappear automatically. When the **E50: AUTO RECOVER** is set to **OFF**, restart the transmitter to cancel Er.01. If no error code appears then, perform necessary adjustment such as zero-adjustment to continue the operation. If the error code still exists, replace the capsule assembly.

*3: For Model EJA120A, static pressure cannot be measured. The display is always 0 MPa, but this is not a measured value.

9. Maintenance

9.1 Overview



WARNING

Since the accumulated process fluid may be toxic or otherwise harmful, take appropriate care to avoid contact with the body, or inhalation of vapors during draining condensate or venting gas in transmitter pressure-detector section and even after dismantling the instrument from the process line for maintenance.

Maintenance of the transmitter is easy due to its modular construction. This chapter describes the procedures for calibration, adjustment, and the disassembly and reassembly procedures required for component replacement.

Since the transmitters are precision instruments, carefully and thoroughly read the following sections for proper handling during maintenance.



IMPORTANT

- As a rule, maintenance of this transmitter should be implemented in a maintenance service shop where the necessary tools are provided.
- The CPU assembly contains sensitive parts that may be damaged by static electricity. Exercise care so as not to directly touch the electronic parts or circuit patterns on the board, for example, by preventing static electrification by using grounded wrist straps when handling the assembly. Also take precautions such as placing a removed CPU assembly into a bag with an antistatic coating.

9.2 Calibration Instruments Selection

Table 9.1 shows the instruments required for calibration. Select instruments that will enable the transmitter to be calibrated or adjusted to the required accuracy.

The calibration instruments should be handled carefully so as to maintain the specified accuracy.

9.3 Calibration

Use the procedure below to check instrument operation and accuracy during periodic maintenance or troubleshooting.

- 1) Connect the instruments as shown in Figure 9.1 and warm up the instruments for at least five minutes.



IMPORTANT

- To adjust the transmitter for highest accuracy, make adjustments with the power supply voltage and load resistance including leadwire resistances set close to the conditions under which the transmitter is installed.
- If the measurement range 0% point is 0 kPa or shifted in the positive direction (suppressed zero), the reference pressure (suppressed zero) should be applied as shown in the figure (low pressure side open to atmosphere). If the measurement range 0% point is shifted in the negative direction (elevated zero), the reference pressure should be applied on the low pressure side (high pressure side open to atmosphere).
- Do not perform the calibration procedures until the transmitter is at room temperature.

- 2) Apply reference pressures of 0%, 50%, and 100% of the measurement range to the transmitter. Calculate the errors (differences between digital voltmeter readings and reference pressures) as the pressure is increased from 0% to 100% and is decreased from 100% to 0%, and confirm that the errors are within the required accuracy.

Table 9.1 Instruments Required for Calibration

Name	Yokogawa-recommended Instrument	Remarks
Power supply	Model SDBT or SDBS distributor	4 to 20 mA DC signal
Load resistor	Model 2792 standard resistor [250 Ω ±0.005%, 3 W] Load adjustment resistor [100 Ω ±1%, 1 W]	
Voltmeter	Model 2501 A digital multimeter Accuracy (10V DC range): ±(0.002% of rdg + 1 dgt)	
Digital manometer	Model MT220 precision digital manometer 1) For 10 kPa class Accuracy: ± (0.015% of rdg + 0.015% of F.S.) ··· for 0 to 10 kPa ± (0.2% of rdg + 0.1% of F.S.) ····· for -10 to 0 kPa 2) For 130 kPa class Accuracy: ± 0.02% of rdg ··········· for 25 to 130 kPa ± 5 digits ··········· for 0 to 25 kPa ± (0.2% of rdg + 0.1% of F.S.) ····· for -80 to 0 kPa 3) For 700 kPa class Accuracy: ± (0.02% of rdg + 3 digits) ········· for 100 to 700 kPa ± 5 digits ··········· for 0 to 100 kPa ± (0.2% of rdg + 0.1% of F.S.) ····· for -80 to 0 kPa 4) For 3000 kPa class Accuracy: ± (0.02% of rdg + 10 digits) ······· for 0 to 3000 kPa ± (0.2% of rdg + 0.1% of F.S.) ····· for -80 to 0 kPa 5) For 130 kPa abs class Accuracy: ± (0.03% of rdg + 6 digits) ······· for 0 to 130 kPa abs	Select a manometer having a pressure range close to that of the transmitter.
Pressure generator	Model 7674 pneumatic pressure standard for 200 kPa {2 kgf/cm ² }, 25 kPa {2500 mmH ₂ O} Accuracy: ± 0.05% of F.S.	Requires air pressure supply.
	Dead weight gauge tester 25 kPa {2500 mmH ₂ O} Accuracy: ±0.03% of setting	Select the one having a pressure range close to that of the transmitter.
Pressure source	Model 6919 pressure regulator (pressure pump) Pressure range: 0 to 133 kPa {1000 mmHg}	Prepare the vacuum pump for negative pressure ranges.

Note: The above table contains the instruments capable of performing calibration to the 0.2% level. Since special maintenance and management procedures involving traceability of each instrument to higher-level standards are required for calibration to the 0.1% level, there are difficulties in calibration to this level in the field. For calibration to the 0.1% level, contact Yokogawa representatives from which the instrument was purchased or the nearest Yokogawa office.

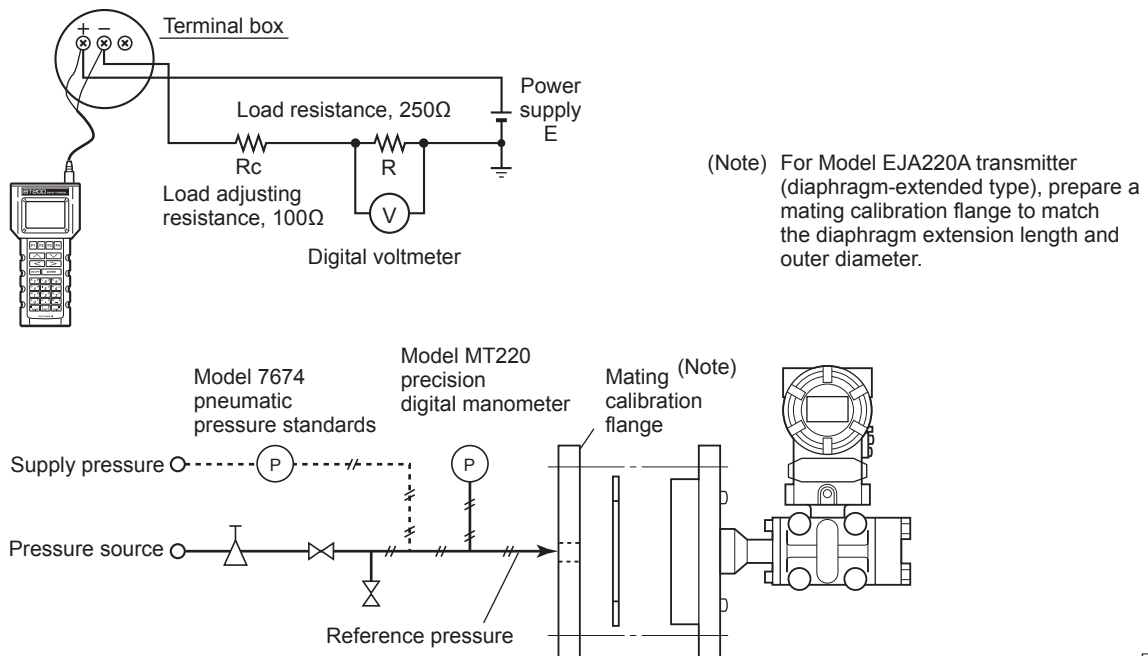

Figure 9.1 Instrument Connections

F0901.ai

9.4 Disassembly and Reassembly

This section describes procedures for disassembly and reassembly for maintenance and component replacement.

Always turn OFF power and shut off and release pressures before disassembly. Use proper tools for all operations. Table 9.2 shows the tools required.

Table 9.2 Tools for Disassembly and Reassembly

Tool	Quantity	Remarks
Phillips screwdriver	1	JIS B4633, No. 2
Slotted screwdriver	1	
Allen wrenches	2	JIS B4648 One each, nominal 3 and 5 mm Allen wrenches
Wrench	1	Width across flats, 17 mm
Torque wrench	1	
Adjustable wrench	1	
Socket wrench	1	Width across flats, 16 mm
Socket driver	1	Width across flats, 5.5 mm
Tweezers	1	

CAUTION

Precautions for CENELEC and IECEx Flameproof Type Transmitters

- Flameproof type transmitters must be, as a rule, removed to a non-hazardous area for maintenance and be disassembled and reassembled to the original state.
- On the flameproof type transmitters the two covers are locked, each by an Allen head bolt (shrouding bolt). When a shrouding bolt is driven clockwise by an Allen wrench, it is going in and cover lock is released, and then the cover can be opened.

When a cover is closed it should be locked by a shrouding bolt without fail. Tighten the shrouding bolt to a torque of 0.7 N·m.

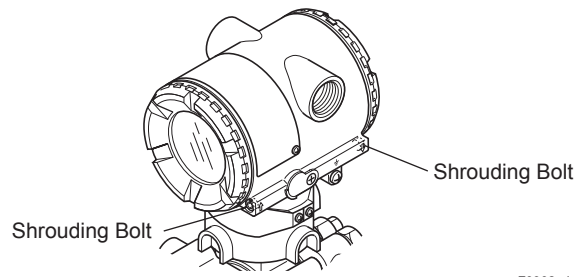

F0902.ai

Figure 9.2 Shrouding Bolts

9.4.1 Replacing the Integral Indicator

CAUTION

Cautions for Flameproof Type Transmitters

Users are prohibited by law from modifying the construction of a flameproof type transmitter.

This would invalidate the agency approval and the transmitter's use in such rated area.

Thus the user is prohibited from using a flameproof type transmitter with its integral indicator removed, or from adding an integral indicator to a transmitter. If such modification is absolutely required, contact Yokogawa.

This subsection describes the procedure for replacing an integral indicator. (See Figure 9.4)

■ Removing the Integral Indicator

- 1) Remove the cover.
- 2) Supporting the integral indicator by hand, loosen its two mounting screws.
- 3) Dismount the LCD board assembly from the CPU assembly.
When doing this, carefully pull the LCD board assembly straight forward so as not to damage the connector pins between it and the CPU assembly.

■ **Attaching the Integral Indicator**

Integral indicator can be installed in the following three directions.

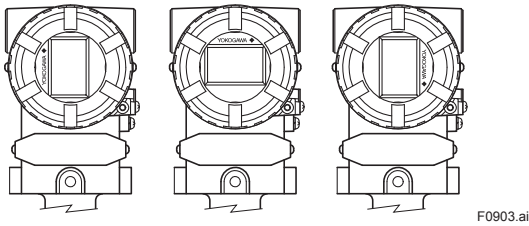

Figure 9.3 Installation Direction of Indicator

- 1) Align both the LCD board assembly and CPU assembly connectors and engage them.
- 2) Insert and tighten the two mounting screws.
- 3) Replace the cover.

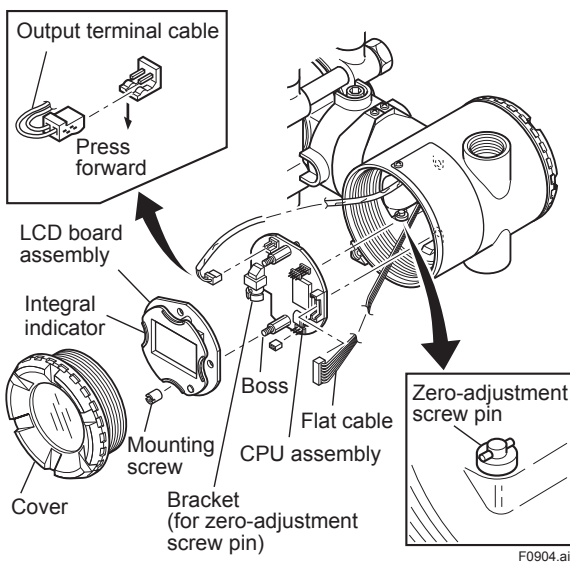

Figure 9.4 Removing and Attaching LCD Board Assembly and CPU Assembly

9.4.2 Replacing the CPU Board Assembly

This subsection describes the procedure for replacing the CPU assembly. (See Figure 9.4)

■ **Removing the CPU Assembly**

- 1) Remove the cover. If an integral indicator is mounted, refer to Subsection 9.4.1 and remove the indicator.
- 2) Turn the zero-adjustment screw to the position (where the screw head slot is horizontal) as shown in Figure 9.4.

- 3) Disconnect the output terminal cable (cable with brown connector at the end). When doing this, lightly press the side of the CPU assembly connector and pull the cable connector to disengage.
- 4) Use a socket driver (width across flats, 5.5mm) to loosen the two bosses.
- 5) Carefully pull the CPU assembly straight forward to remove it.
- 6) Disconnect the flat cable (cable with black connector at the end) that connects the CPU assembly and the capsule.



NOTE

Be careful not to apply excessive force to the CPU assembly when removing it.

■ **Mounting the CPU Assembly**

- 1) Connect the flat cable (with black connector) between the CPU assembly and the capsule.
- 2) Connect the output terminal cable (with brown connector).



NOTE

Make certain that the cables are free of pinching between the case and the CPU assembly edge.

- 3) Align and engage the zero-adjustment screw pin with the groove on the bracket on the CPU assembly. Then insert the CPU board assembly straight onto the post in the amplifier case.
- 4) Tighten the two bosses. If the transmitter is equipped with an integral indicator, refer to Subsection 9.4.1 to mount the indicator.



NOTE

Confirm that the zero-adjustment screw pin is placed properly in the groove on the bracket prior to tightening the two bosses. If it is not, the zero-adjustment mechanism will be damaged.

- 5) Replace the cover.

9.4.3 Replacing the Process Connector Gaskets

This subsection describes the procedure for replacing the process connector gasket. (See Figure 9.5.)

- 1) Loosen the two bolts and remove the process connector.
- 2) Replace the process connector gasket.
- 3) Mount the process connector. Tighten the bolts securely and uniformly to a torque of 39 to 49 N·m{4 to 5 kgf·m}, and verify that there are no pressure leaks.

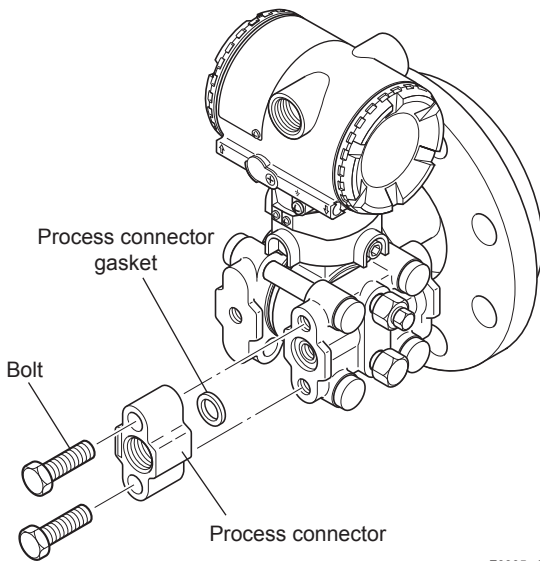

Figure 9.5 Replacing the Process Connector Gasket

9.5 Troubleshooting

If any abnormality appears in the measured values, use the troubleshooting flow chart below to isolate and remedy the problem. Since some problems have complex causes, these flow charts may not identify all. If you have difficulty isolating or correcting a problem, contact Yokogawa service personnel.

9.5.1 Basic Troubleshooting

First determine whether the process variable is actually abnormal or a problem exists in the measurement system.

If the problem is in the measurement system, isolate the problem and decide what corrective action to take.

This transmitter is equipped with a self-diagnostic function which will be useful in troubleshooting; see Section 8.5 for information on using this function.

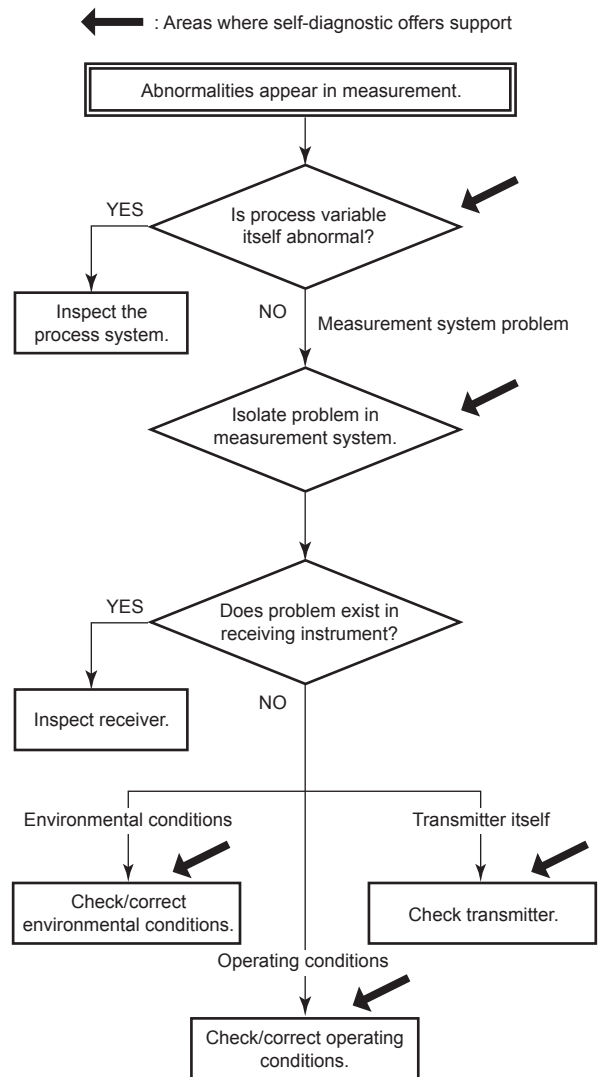
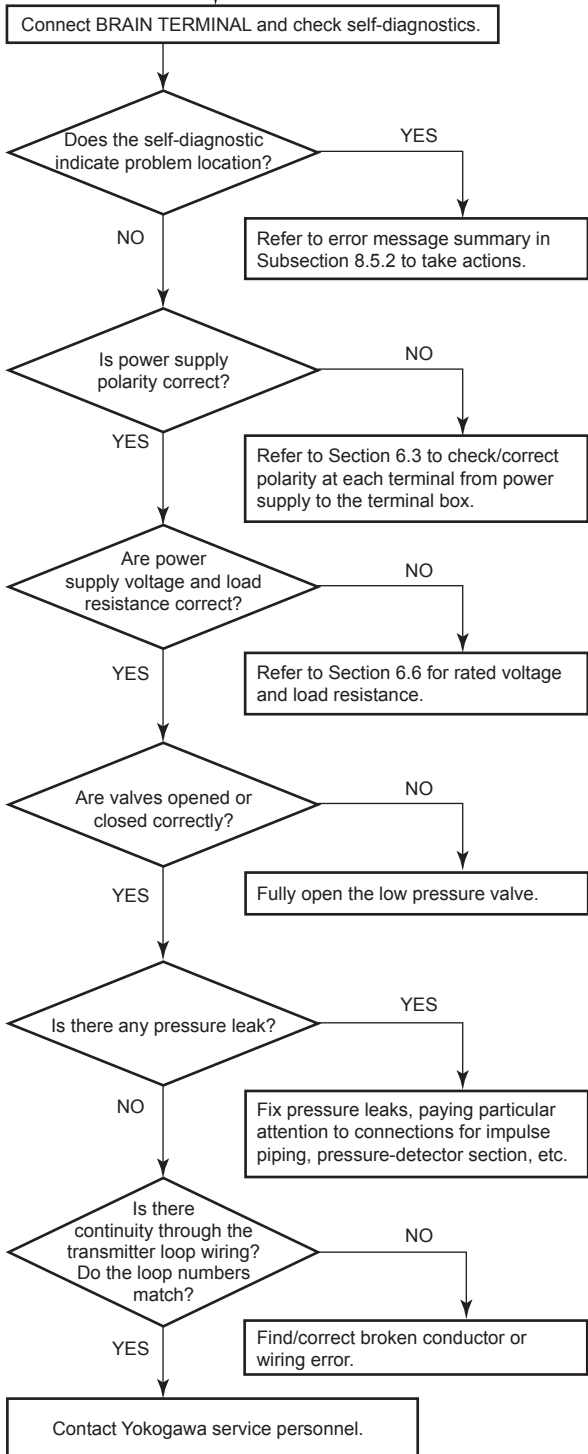

Figure 9.6 Basic Flow and Self-Diagnostics

F0906.ai

9.5.2 Troubleshooting Flow Charts

The following sorts of symptoms indicate that transmitter may not be operating properly.
 Example : • There is no output signal.
 • Output signal does not change even though process variable is known to be varying.
 • Output value is inconsistent with value inferred for process variable.



F0907.ai

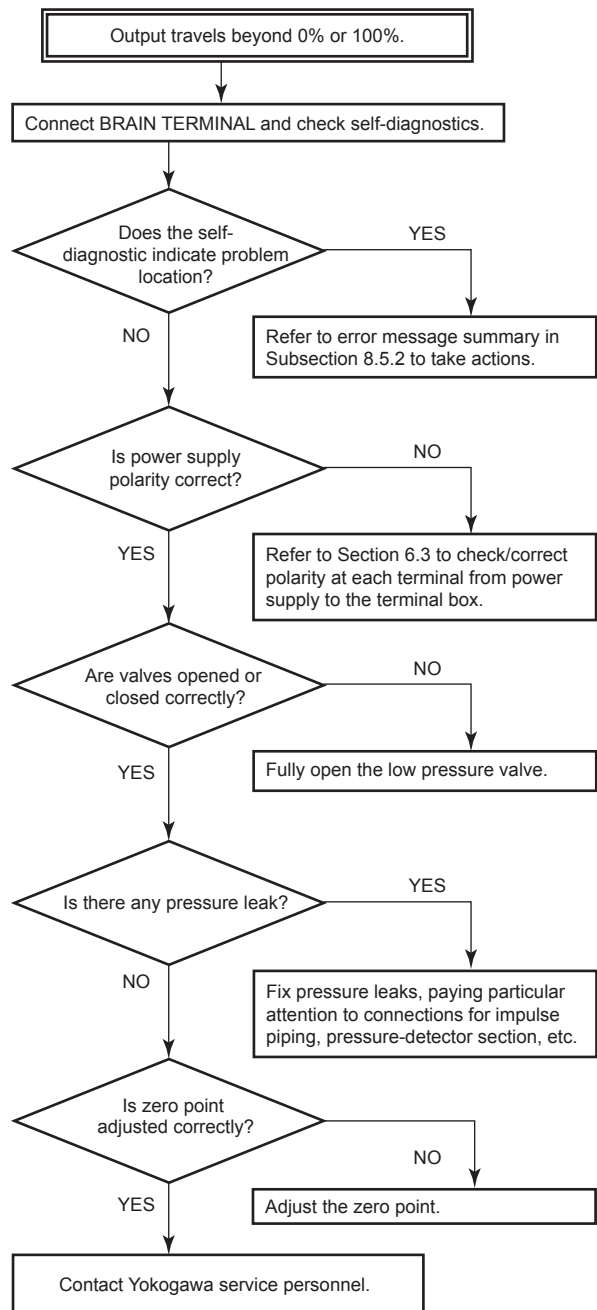

F0908.ai

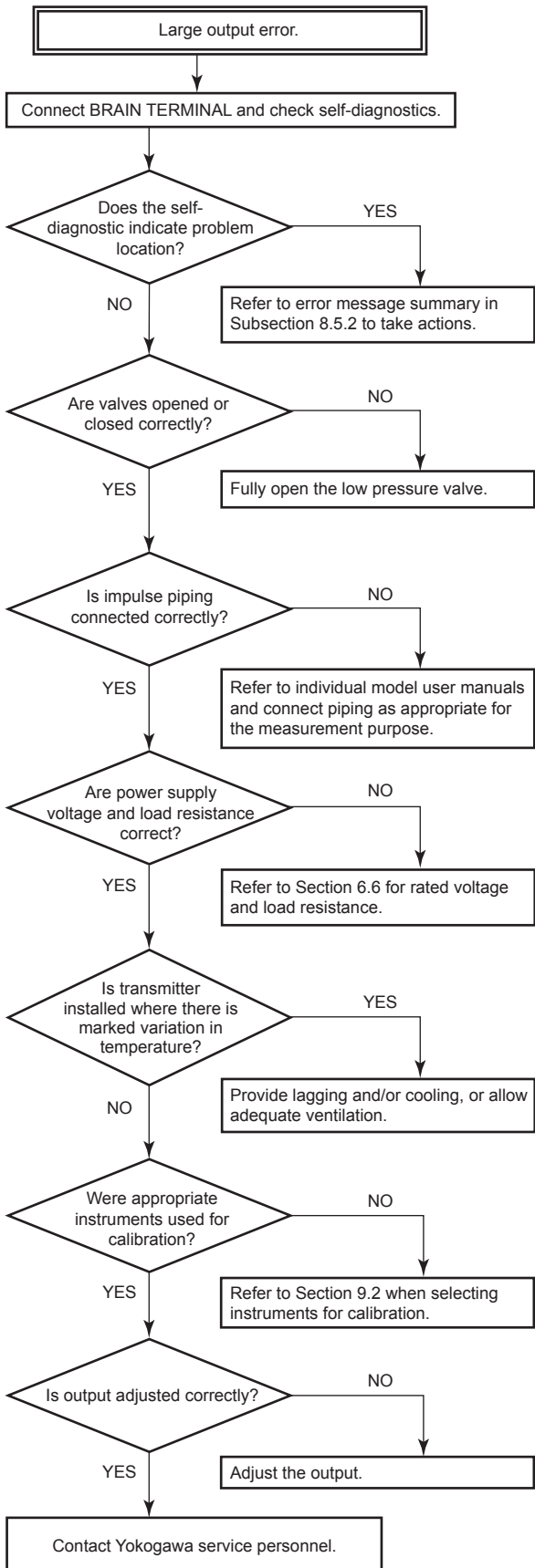

F0909.ai

10. General Specifications

10.1 Standard Specifications

Refer to IM 01C22T02-01E for FOUNDATION Fieldbus communication type and IM 01C22T03-00E for PROFIBUS PA communication type marked with “◇”.

● Performance Specifications

See General Specifications sheet, GS 01C21C01-00E.

● Functional Specifications

Span & Range Limits

Measurement Span and Range		kPa	inH ₂ O (/D1)	mbar (/D3)	mmH ₂ O (/D4)
M	Span	1 to 100	4 to 400	10 to 1000	100 to 10000
	Range	-100 to 100	-400 to 400	-1000 to 1000	-10000 to 10000
H	Span	5 to 500	20 to 2000	50 to 5000	0.05 to 5 kgf/cm ²
	Range	-500 to 500	-2000 to 2000	-5000 to 5000	-50 to 5 kgf/cm ²

URL is define as the Upper Range Limit from the table above.

Zero Adjustment Limits:

Zero can be fully elevated or suppressed, within the Lower and Upper Range Limits of the capsule.

External Zero Adjustment “◇”:

External zero is continuously adjustable with 0.01% incremental resolution of span. Span may be adjusted locally using the digital indicator with range switch.

Output “◇”:

Two wire 4 to 20 mA DC output with digital communications, linear or square root programmable. BRAIN or HART FSK protocol are superimposed on the 4 to 20 mA signal.

Failure Alarm:

Output status at CPU failure and hardware error;

Up-scale:

110%, 21.6 mA DC or more(standard)

Down-scale:

-5%, 3.2 mA DC or less

-2.5%, 3.6 mA DC or less(Optional code /F1)

Note: Applicable for Output signal code D and E

Damping Time Constant (1st order):

The sum of the amplifier and capsule damping time constant must be used for the overall time constant. Amp damping time constant is adjustable from 0.2 to 64 seconds.

	EJA210A		EJA220A	
Capsule (Silicone Oil)	M	H	M	H
Time Constant (approx. sec)	0.4	0.4	0.4	0.4

Ambient Temperature Limits:

* Safety approval codes may affect limits.

-40 to 85°C (-40 to 185°F)

-30 to 80°C (-22 to 176°F) with LCD Display

Process Temperature Limits:

* Safety approval codes may affect limits.

-40 to 120°C (-40 to 248°F)

Working Pressure Limits (Silicone Oil)

2.7 kPa abs (0.38 psia) to flange rating (see Figure 10.1)

● Installation

Supply & Load Requirements “◇”:

* Safety approvals can affect electrical requirements.

See Section 6.6, ‘Power Supply Voltage and Load Resistance.’

Supply Voltage “◇”:

10.5 to 42 V DC for general use and flameproof type

10.5 to 32 V DC for lightning protector (Optional code /A)

10.5 to 30 V DC for intrinsically safe, Type n, nonincendive, or non-sparking type

Minimum voltage limited at 16.4 V DC for digital communications, BRAIN and HART

EMC Conformity Standards:

EN 61326-1 Class A, Table 2 (For use in industrial locations)

EN 61326-2-3

EN 61326-2-5 (for Fieldbus)

Immunity influence during the test

Differential pressure/pressure: Output shift is specified within ±1% of 1/10 Max span.

Communication Requirements “◇”:

BRAIN

Communication Distance;

Up to 2 km (1.25 miles) when using CEV polyethylene-insulated PVC-sheathed cables.

Communication distance varies depending on type of cable used.

Load Capacitance;

0.22 µF or less (see note)

Load Inductance;

3.3 mH or less (see note)

Input Impedance of communicating device;

10 kΩ or more at 2.4 kHz.

Note: For general-use and Flameproof type. For Intrinsically safe type, please refer to 'Optional Specifications.'

HART

Communication Distance;

Up to 1.5 km (1 mile) when using multiple twisted pair cables. Communication distance varies depending on type of cable used.

Use the following formula to determine cable length for specific applications:

$$L = \frac{65 \times 10^6}{(R \times C)} - \frac{(C_f + 10,000)}{C}$$

Where:

L = length in meters or feet

R = resistance in Ω (including barrier resistance)

C = cable capacitance in pF/m or pF/ft

C_f = maximum shunt capacitance of receiving devices in pF/m or pF/ft

● **Physical Specifications**

Wetted Parts Materials:

High side:

See 'Model and Suffix Codes'

Low side:

Diaphragm;

Hastelloy C-276

Cover flange;

SCS14A

Process connector;

SCS14A

Capsule gasket;

Teflon-coated SUS316L

Drain/Vent plug;

SUS316

Process connector gasket;

PTFE Teflon

Non-wetted Parts Materials:

Bolting;

SCM435, SUS630, or SUH660

Housing;

Low copper cast-aluminum alloy with polyurethane paint (Munsell 0.6GY3.1/2.0)

Degrees of Protection

IP67, NEMA4X

Cover O-rings;

Buna-N, Fluoro-rubber (option)

Data plate and tag;

SUS304 or SUS316(optional)

Fill Fluid;

Silicone or Fluorinated oil (optional)

Weight:

EJA210A with 150# flange 11 kg(25 lb)

EJA220A with 150# flange 16 kg(35 lb)

Connections:

Refer to the 'Model and Suffix Codes' to specify the process and electrical connection type.

The high pressure side is a flange connected, and low side is threaded.

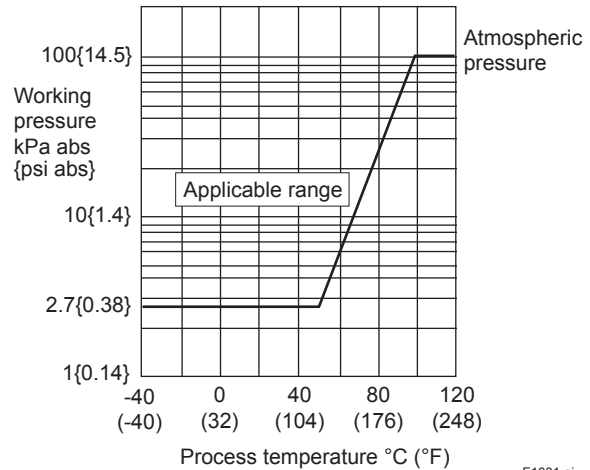

Figure 10.1 Working Pressure and Process Temperature

< **Settings When Shipped** > “◇”

Tag Number	As specified in order *1
Output Mode	'Linear'
Display Mode	'Linear'
Operation Mode	'Normal' unless otherwise specified in order
Damping Time Constant	'2 sec.'
Calibration Range Lower Range Value	As specified in order
Calibration Range Higher Range Value	As specified in order
Calibration Range Units	Selected from mmH ₂ O, mmAq, mmWG, mmHg, Pa, hPa, kPa, MPa, mbar, bar, gf/cm ² , kgf/cm ² , inH ₂ O, inHg, ftH ₂ O, or psi. (Only one unit can be specified)

*1: Up to 16 alphanumeric characters (including - and ·) will be entered in the amplifier memory.

10.2 Model and Suffix Codes

● Model EJA210A

Model	Suffix Codes	Description
EJA210A	Flange-mounted differential pressure transmitter (Flush diaphragm type)
Output Signal	-D -E -F -G	4 to 20 mA DC with digital communication (BRAIN protocol) 4 to 20 mA DC with digital communication (HART protocol, see IM 01C22T01-01E) Digital communication (FOUNDATION Fieldbus protocol, see IM 01C22T02-01E) Digital communication (PROFIBUS PA protocol, see 01C22T03-00E)
Measurement span (capsule)	M H	1 to 100 kPa {100 to 10000 mmH ₂ O} 5 to 500 kPa {0.05 to 5 kgf/cm ² }
High pressure side (Process flange side) Wetted parts material *1	S*2 H*2 T*2 W*3	[Diaphragm] SUS316L Hastelloy C-276 Tantalum Hastelloy C-276 [Others] SUS316 Hastelloy C-276 Tantalum SUS316
Process flange rating	J1 J2 A1 A2 P1 P2 D2 D4	JIS10K JIS20K ANSI Class 150 ANSI Class 300 JPI Class150 JPI Class 300 DIN PN10/16 DIN PN25/40
Process flange size/material	D E F A B C	3-inch (80 mm) /S25C 3-inch (80 mm) /SUS304 3-inch (80 mm) /SUS316 2-inch (50 mm) /SU25C 2-inch (50 mm) /SUS304 2-inch (50 mm) /SUS316
Low pressure side process connection	0 1 2 3 4 5	without process connector (Rc1/4 female on the cover flanges) with Rc1/4 female process connector with Rc1/2 female process connector with 1/4 NPT female process connector with 1/2 NPT female process connector without process connector (1/4 NPT female on the cover flanges)
Bolts and nuts material	A B C	SCM435 SUS630 SUH660
Installation	-9	Horizontal impulse piping type, left side high pressure
Electrical connection	0 2 3 4 5 7 8 9 A C D	G1/2 female, one electrical connection 1/2 NPT female, two electrical connections without blind plug Pg 13.5 female, two electrical connections without blind plug M20 female, two electrical connections without blind plug G1/2 female, two electrical connections and a blind plug 1/2 NPT female, two electrical connections and a blind plug Pg 13.5 female, two electrical connections and a blind plug M20 female, two electrical connections and a blind plug G1/2 female, two electrical connections and a SUS316 blind plug 1/2 NPT female, two electrical connections and a SUS316 blind plug M20 female, two electrical connections and a SUS316 blind plug
Integral indicator	D... E... N...	Digital indicator Digital indicator with the range setting switch (None)
—	N	Always N
Optional codes		<input type="checkbox"/> Optional specification

Example: EJA210A-DMSA1D5A-92NN/□

*1: Low pressure side wetted parts material: Cover flange; SCS14A, Process connector; SCS14A, Capsule; SUS316L (Diaphragm; Hastelloy C-276), Vent plug; SUS316

*2: Applicable only for 3-inch (80 mm) flange size (Process flange size/material codes D and E)

*3: Applicable only for 2-inch (50 mm) flange size (Process flange size/material codes A and B)

● Model EJA220A

Model	Suffix Codes	Description
EJA220A	Flange-mounted differential pressure transmitter (Extended diaphragm type)
Output Signal	-D -E -F -G	4 to 20 mA DC with digital communication (BRAIN protocol) 4 to 20 mA DC with digital communication (HART protocol, see IM 01C22T01-01E) Digital communication (FOUNDATION Fieldbus protocol, see IM 01C22T02-01E) Digital communication (PROFIBUS PA protocol, see 01C22T03-00E)
Measurement span (capsule)	M H	1 to 100 kPa {100 to 10000 mmH ₂ O} 5 to 500 kPa {0.05 to 5 kgf/cm ² }
High pressure side (Process flange side) Wetted parts material *1	S*2 W*3	[Diaphragm] [Pipe] [Others] SUS316L SUS316 SUS316 Hastelloy C-276 SUS316 SUS316
Process flange rating	J1 J2 A1 A2 P1 P2 D2 D4	JIS10K JIS20K ANSI Class 150 ANSI Class 300 JPI Class150 JPI Class 300 DIN PN10/16 DIN PN25/40
Diaphragm extension length (X ₂)	2 4 6	X ₂ =50 mm X ₂ =100 mm X ₂ =150 mm
Process flange size/material	G H J D E F	4-inch (100 mm) / S25C 4-inch (100 mm) / SUS304 4-inch (100 mm) / SUS316 3-inch (80 mm) / S25C 3-inch (80 mm) / SUS304 3-inch (80 mm) / SUS316
Low pressure side process connection	0 1 2 3 4 5	without process connector (Rc1/4 female on the cover flanges) with Rc1/4 female process connector with Rc1/2 female process connector with 1/4 NPT female process connector with 1/2 NPT female process connector without process connector (1/4 NPT female on the cover flanges)
Bolts and nuts material	A B C	SCM435 SUS630 SUH660
Installation	-9	Horizontal impulse piping type, left side high pressure
Electrical connection	0 2 3 4 5 7 8 9 A C D	G1/2 female, one electrical connection 1/2 NPT female, two electrical connections without blind plug Pg 13.5 female, two electrical connections without blind plug M20 female, two electrical connections without blind plug G1/2 female, two electrical connections and a blind plug 1/2 NPT female, two electrical connections and a blind plug Pg 13.5 female, two electrical connections and a blind plug M20 female, two electrical connections and a blind plug G1/2 female, two electrical connections and a SUS316 blind plug 1/2 NPT female, two electrical connections and a SUS316 blind plug M20 female, two electrical connections and a SUS316 blind plug
Integral indicator	D... E... N...	Digital indicator Digital indicator with the range setting switch (None)
—	N..	Always N
Optional codes		/□ Optional specification

Example: EJA220A-DMSA12G5A-92NN/□

- *1: Low pressure side wetted parts material: Cover flange; SCS14A, Process connector; SCS14A, Capsule; SUS316L (Diaphragm, Hastelloy C-276), Vent plug ; SUS316
- *2: Applicable only for 4-inch (100 mm) flange size (Process flange size/material codes G and H).
- *3: Applicable only for 3-inch (80 mm) flange size (Process flange size/material codes D and E).

10.3 Optional Specifications

For FOUNDATION Fieldbus explosion protected type, see IM 01C22T02-01E.

For PROFIBUS PA explosion protected type, see IM 01C22T03-00E.

Item	Description	Code
Factory Mutual (FM)	FM Explosionproof Approval *1 Explosionproof for Class I, Division 1, Groups B, C and D Dust-ignitionproof for Class II/III, Division 1, Groups E, F and G Hazardous (classified) locations, indoors and outdoors (NEMA 4X) Temperature class: T6 Amb. Temp.: -40 to 60°C (-40 to 140°F)	FF1
	FM Intrinsically safe Approval *1 Intrinsically Safe for Class I, Division 1, Groups A, B, C & D, Class II, Division 1, Groups E, F & G and Class III, Division 1 Hazardous Locations. Nonincendive for Class I, Division 2, Groups A, B, C & D, Class II, Division. 2, Groups E, F & G, and Class III, Division 1 Hazardous Locations. Enclosure: "NEMA 4X", Temp. Class: T4, Amb. Temp.: -40 to 60°C (-40 to 140°F) Intrinsically Safe Apparatus Parameters [Groups A, B, C, D, E, F and G] Vmax=30 V, Imax=165 mA, Pmax=0.9 W, Ci=22.5 nF, Li=730 µH [Groups C, D, E, F and G] Vmax=30 V, Imax=225 mA, Pmax=0.9 W, Ci=22.5 nF, Li=730 µH	FS1
	Combined FF1 and FS1 *1	FU1
ATEX	ATEX Flameproof Approval *2 Certificate: KEMA 02ATEX2148 II 2G Exd IIC T4, T5, T6 Amb. Temp.: T5; -40 to 80°C (-40 to 176°F), T4 and T6; -40 to 75°C (-40 to 167°F) Max. process Temp.: T4; 120°C (248°F), T5; 100°C (212°F), T6; 85°C (185°F)	KF21
	ATEX Intrinsically safe Approval *2 Certificate: KEMA 02ATEX1030X II 1G EEx ia IIC T4, Amb. Temp.: -40 to 60°C (-40 to 140°F) Ui=30 V, Ii=165 mA, Pi=0.9 W, Ci=22.5 nF, Li=730 µH	KS2
Canadian Standards Association (CSA)	CSA Explosionproof Approval *1 Certificate: 1089598 Explosionproof for Class I, Division 1, Groups B, C and D Dustignitionproof for Class II/III, Division 1, Groups E, F and G Division2 'SEALS NOT REQUIRED', Temp. Class: T4, T5, T6 Encl Type 4x Max. Process Temp.: T4; 120°C (248°F), T5; 100°C (212°F), T6; 85°C (185°F) Amb. Temp.: -40 to 80°C (-40 to 176°F) Process Sealing Certification Dual seal certified by CSA to the requirement of ANSI/ISA 12.27.01 No additional sealing required. Primary seal failure annunciation : at the zero adjustment screw	CF1
	CSA Intrinsically safe Approval *1 Certificate: 1053843 Intrinsically Safe for Class I, Groups A, B, C and D Class II and III, Groups E, F and G Nonincendive for Class I, Division 2, Groups A, B, C and D Class II, Division 2, Groups F and G and Class III (not use Safety Barrier) Encl Type 4x, Temp. Class: T4, Amb. Temp.: -40 to 60°C (-40 to 140°F) Vmax=30 V, Imax=165 mA, Pmax=0.9 W, Ci=22.5 nF, Li=730 µH Process Sealing Certification Dual seal certified by CSA to the requirement of ANSI/ISA 12.27.01 No additional sealing required. Primary seal failure annunciation : at the zero adjustment screw	CS1
	Combined CF1 and CS1 *1	CU1

Item	Description	Code
IECEX Scheme	IECEX Intrinsically safe, type n and Flameproof Approval *3 Intrinsically safe and type n Certificate: IECEX KEM 06.0007X Ex ia IIC T4, Ex nL IIC T4 Enclosure: IP67 Amb. Temp.: -40 to 60°C (-40 to 140°F), Max. Process Temp.: 120°C (248°F) Electrical Parameters: [Ex ia] $U_i=30$ V, $I_i=165$ mA, $P_i=0.9$ W, $C_i=22.5$ nF, $L_i=730$ μ H [Ex nL] $U_i=30$ V, $C_i=22.5$ nF, $L_i=730$ μ H Flameproof Certificate: IECEX KEM 06.0005 Ex d IIC T6...T4 Enclosure: IP67 Max.Process Temp.: T4;120°C (248°F), T5;100°C (212°F), T6; 85°C (185°F) Amb.Temp.: -40 to 75°C (-40 to 167°F) for T4, -40 to 80°C (-40 to 176°F) for T5, -40 to 75°C (-40 to 167°F) for T6	SU2

*1: Applicable for Electrical connection code 2 and 7 (1/2 NPT female).

*2: Applicable for Electrical connection code 2, 4, 7 and 9 (1/2 NPT and M20 female).

*3: Applicable for Electrical connection code 2, 4 and 7 (1/2 NPT and M20 female).

Item		Description	Code	
Painting	Color change	Amplifier cover only	P□	
		Amplifier cover and terminal cover, Munsell 7.5 R4/14	PR	
	Coating change	Epoxy resin-baked coating	X1	
316 SST exterior parts		Exterior parts on the amplifier housing (name plates, tag plate, zero-adjustment screw, stopper screw) will become 316 or 316L SST.	HC	
Fluoro-rubber O-ring		All O-rings of amplifier housing. Lower limit of ambient temperature : -15 °C (5 °F)	HE	
Lightning protector		Transmitter power supply voltag: 10.5 to 32 V DC (10.5 to 30 V DC for intrinsically safe type, 9 to 32 V DC for FOUNDATION Fieldbus and PROFIBUS PA communication type.) Allowable current: Max. 6000 A (1×40 μs), Repeating 1000 A (1×40 μs), 100 times	A	
Oil-prohibited use	Degrease cleansing treatment		K1	
	Degrease cleansing treatment with fluorinated oil filled capsule. Operating temperature -20 to 80 °C		K2	
Oil-prohibited use with dehydrating treatment	Degrease cleansing and dehydrating treatment		K5	
	Degrease cleansing and dehydrating treatment with fluorinated oil filled capsule. Operating temperature -20 to 80 °C		K6	
Calibration units	P calibration (psi unit)	(See Table for Span and Range Limits.)	D1	
	bar calibration (bar unit)		D3	
	M calibration (kgf/cm ² unit)		D4	
Sealing treatment to SUS630 nuts		Sealant (liquid silicone rubber) is coated on SUS630 cover flange mounting nuts against stress corrosion cracking.	Y	
No serration		No serration work on the flange gasket surface (for ANSI flange only)	Q	
Teflon film		With FEP film and fluorinated oil. Working range: 20 to 120 °C, 0 to 2 MPa {0 to 20 kgf/cm ² } (Not usable under vacuum)	T	
Fast response *2		Update time: 0.125 sec or less, see GS for response time	F1	
Failure alarm down-scale *1		Output status at CPU failure and hardware error is -5%, 3.2 mA or less.	C1	
NAMUR NE43 compliant *1	Output signal limits: 3.8 mA to 20.5 mA	Failure alarm down-scale: output status at CPU failure and hardware error is -5%, 3.2 mA or less.	C2	
		Failure alarm up-scale: output status at CPU failure and hardware error is 110%, 21.6 mA or more.	C3	
Data configuration at factory		Description into "Descriptor" parameter of HART protocol	CA	
Stainless steel amplifier housing		Amplifier housing material: SCS14A stainless steel (equivalent to SUS316 cast stainless steel or ASTM CF-8M)	E1	
Gold-plate		Gold-plated diaphragm for high pressure side (process flange side)	A1	
Stainless steel tag plate		SUS 304 stainless steel tag plate wired onto transmitter	N4	
Mill Certificate	High pressure side: Process flange, Block Low pressure side: Cover flange		For model EJA210A	M03
	High pressure side: Process flange, Block Low pressure side: Cover flange, Process connector			M13
	High pressure side: Process flange, Block, Pipe, Base Low pressure side: Cover flange		For model EJA220A	M04
	High pressure side: Process flange, Block, Pipe, Base Low pressure side: Cover flange, Process connector			M14
Pressure test/Leak test Certificate	(Flange rating)	(Test Pressure)	Nitrogen(N ₂) Gas Retention time: 10 minutes	
	JIS 10K	2 MPa {20 kgf/cm ² }		T31
	JIS 20K	5 MPa {50 kgf/cm ² }		T32
	ANSI/JPI class 150	3 MPa {29.8 kgf/cm ² }		T36
	ANSI/JPI class 300	7.7 MPa {77 kgf/cm ² }		T37
	ANSI/JPI class 300	7 MPa {70 kgf/cm ² }	T38	

*1: Applicable for Output signal code D and E. The hardware error indicates faulty amplifier or capsule. When combining with Optional code F1, output status for down-scale is -2.5%, 3.6 mA DC or less.

*2: Applicable for Output signal code D and E. Write protection switch is attached for Output code E.

10.4 Dimensions

● Model EJA210A

Unit: mm (approx. inch)

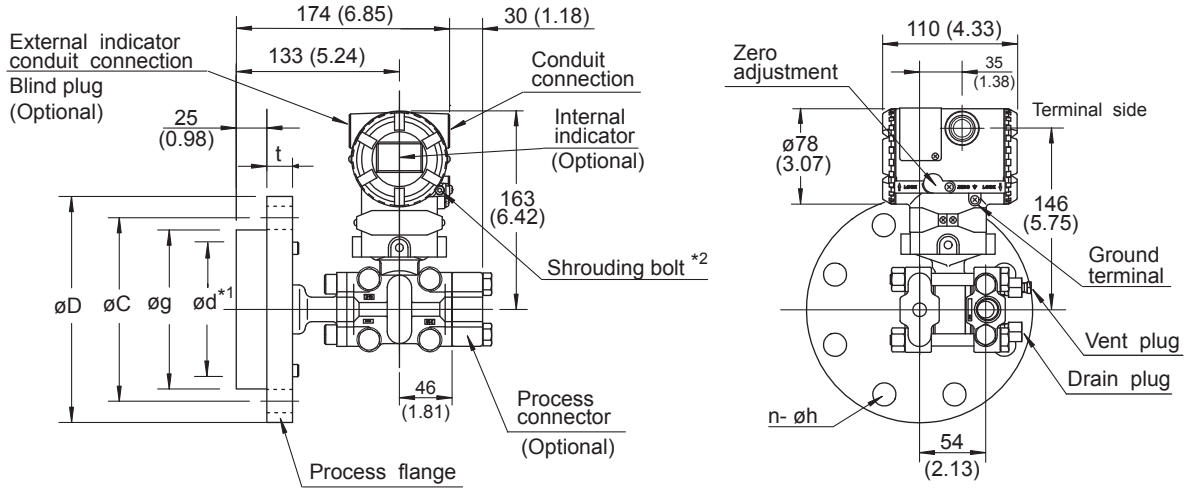

*1 Indicates inside diameter of gasket contact surface.
 *2 Applicable only for ATEX and IECEx Flameproof type.

Flange size: 3-inch (80 mm)

Flange Nominal Diameter and Rating	øD	øC	øg	ød	t	Bolt Holes	
						No. (N)	Dia. (øh)
80 mm JIS 10K	185(7.28)	150(5.91)	130(5.12)	90(3.54)	18(0.71)	8	19(0.75)
80 mm JIS 20K	200(7.87)	160(6.30)	130(5.12)	90(3.54)	22(0.87)	8	23(0.91)
3-inch ANSI Class150	190.5(7.50)	152.4(6.00)	130(5.12)	90(3.54)	23.9(0.94)	4	19.1(0.75)
3-inch ANSI Class300	209.6(8.25)	168.1(6.62)	130(5.12)	90(3.54)	28.5(1.12)	8	22.4(0.88)
3-inch JPI Class150	190(7.48)	152.4(6.00)	130(5.12)	90(3.54)	24(0.44)	4	19(0.75)
3-inch JPI Class300	210(8.27)	168.1(6.62)	130(5.12)	90(3.54)	28.5(1.12)	8	22(0.87)
3-inch DIN PN 10/16	200(7.87)	160(6.30)	130(5.12)	90(3.54)	20(0.79)	8	18(0.71)
3-inch DIN PN 25/40	200(7.87)	160(6.30)	130(5.12)	90(3.54)	24(0.44)	8	18(0.71)

Flange size: 2-inch (50 mm)

Flange Nominal Diameter and Rating	øD	øC	øg	ød	t	Bolt Holes	
						No. (N)	Dia. (øh)
50 mm JIS 10K	155(6.10)	120(4.72)	100(3.94)	61(2.40)	16(0.63)	4	19(0.75)
50 mm JIS 20K	155(6.10)	120(4.72)	100(3.94)	61(2.40)	18(0.71)	8	19(0.75)
2-inch ANSI Class150	152.4(6.00)	120.7(4.75)	100(3.94)	61(2.40)	19.1(0.75)	4	19.1(0.75)
2-inch ANSI Class300	165.1(6.50)	127(5.00)	100(3.94)	61(2.40)	22.4(0.88)	8	19.1(0.75)
2-inch JPI Class150	152(5.98)	120.6(4.75)	100(3.94)	61(2.40)	19.5(0.71)	4	19(0.75)
2-inch JPI Class300	165.1(6.50)	127(5.00)	100(3.94)	61(2.40)	22.5(0.89)	8	19(0.75)
2-inch DIN PN 10/16	165(6.50)	125(4.92)	100(3.94)	61(2.40)	18(0.71)	4	18(0.71)
2-inch DIN PN 25/40	165(6.50)	125(4.92)	100(3.94)	61(2.40)	20(0.79)	4	18(0.71)

F1002.ai

● Model EJA220A

Unit: mm (approx. inch)

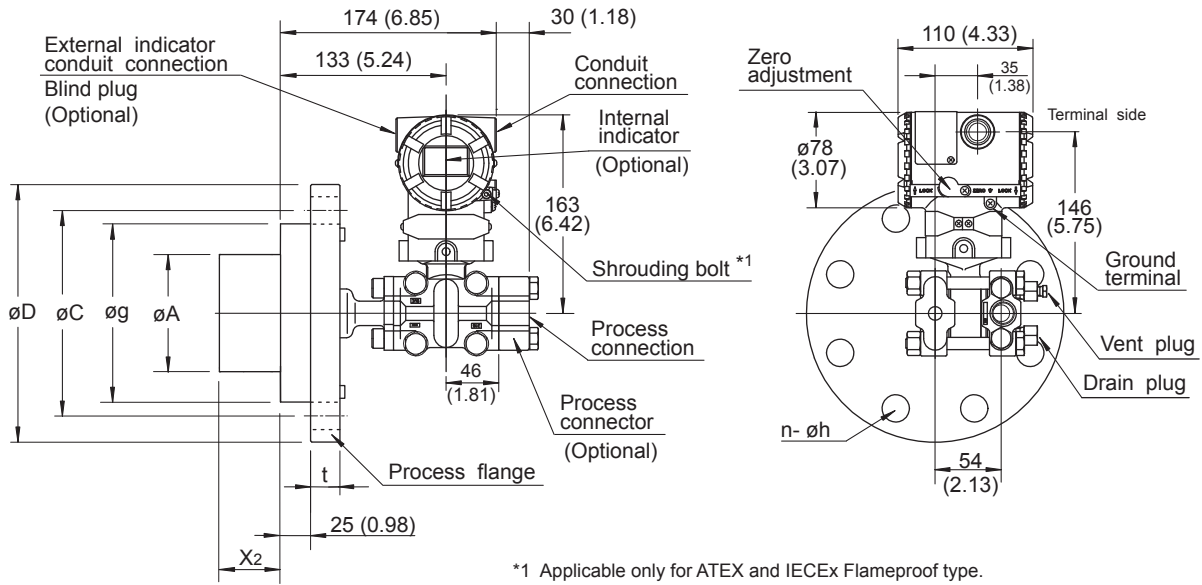

*1 Applicable only for ATEX and IECEx Flameproof type.

Flange size: 4-inch (100 mm)

Flange Nominal Diameter and Rating	øD	øC	øg	øA	t	Bolt Holes	
						No.(N)	Dia.(øh)
100 mm JIS 10K	210(8.27)	175(6.89)	155(6.10)	96(3.78)	18(0.71)	8	19(0.75)
100 mm JIS 20K	225(8.86)	185(7.28)	155(6.10)	96(3.78)	24(0.94)	8	23(0.91)
4-inch ANSI Class150	228.6(9.00)	190.5(7.50)	155(6.10)	96(3.78)	23.9(0.94)	8	19.1(0.75)
4-inch ANSI Class300	254(10.00)	200(7.87)	155(6.10)	96(3.78)	31.8(1.25)	8	22.4(0.88)
4-inch JPI Class150	229(9.02)	190.5(7.50)	155(6.10)	96(3.78)	24(0.94)	8	19(0.75)
4-inch JPI Class300	254(10.00)	200.2(7.88)	155(6.10)	96(3.78)	32(1.26)	8	22(0.87)
4-inch DIN PN 10/16	220(8.66)	180(7.09)	155(6.10)	96(3.78)	20(0.79)	8	18(0.71)
4-inch DIN PN 25/40	235(9.25)	190(7.50)	155(6.10)	96(3.78)	24(0.94)	8	22(0.87)

Flange size: 3-inch (80 mm)

Flange Nominal Diameter and Rating	øD	øC	øg	øA	t	Bolt Holes	
						No.(N)	Dia.(øh)
80 mm JIS 10K	185(7.28)	150(5.91)	130(5.12)	71(2.80)	18(0.71)	8	19(0.75)
80 mm JIS 20K	200(7.87)	160(6.30)	130(5.12)	71(2.80)	22(0.87)	8	23(0.91)
3-inch ANSI Class150	190.5(7.50)	152.4(6.00)	130(5.12)	71(2.80)	23.9(0.94)	4	19.1(0.75)
3-inch ANSI Class300	209.6(8.25)	168.1(6.62)	130(5.12)	71(2.80)	28.5(1.12)	8	22.4(0.88)
3-inch JPI Class150	190(7.48)	152.4(6.00)	130(5.12)	71(2.80)	24(0.94)	4	19(0.75)
3-inch JPI Class300	210(8.27)	168.1(6.62)	130(5.12)	71(2.80)	28.5(1.12)	8	22(0.87)
3-inch DIN PN 10/16	200(7.88)	160(6.30)	130(5.12)	71(2.80)	20(0.79)	8	18(0.71)
3-inch DIN PN 25/40	200(7.87)	160(6.30)	130(5.12)	71(2.80)	24(0.94)	8	18(0.71)

Diaphragm Extension Length Code	X ₂
2	1.97 inch (50 mm)
4	3.94 inch (100 mm)
6	5.91 inch (150 mm)

F1003.ai

Customer Maintenance Parts List

DPharp EJA Series Transmitter Section

DPharp

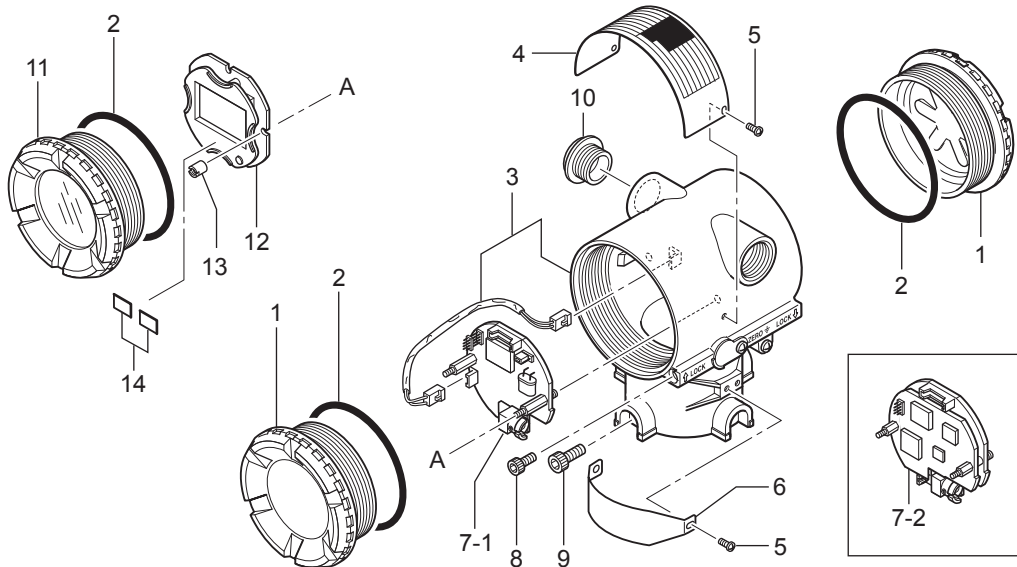

Item	Part No.	Qty	Description
1	Bellow F9341RA F9341RJ F9341JP	2	Cover Cast-aluminum alloy SCS14A stainless steel
2	Bellow	2	O-ring
3	Bellow	1	Case Assembly (Note 1)
	F9341AA		Cast-aluminum alloy for G1/2
	F9341AC		Cast-aluminum alloy for G1/2 (two electrical connections)
	F9341AE		Cast-aluminum alloy for 1/2 NPT (two electrical connections)
	F9341AH		Cast-aluminum alloy for M20 (two electrical connections)
	F9341AJ		Cast-aluminum alloy for Pg13.5 (two electrical connections)
4	F9341AR	1	SCS14A stainless steel for 1/2 NPT (two electrical connections)
5	—	1	Name Plate
	Bellow	4	Screw
	F9900RG		For cast-aluminum alloy case assembly
	F9900RR		For SCS14A stainless steel case assembly
6	F9341KL	1	Tag Plate
7-1	—	1	CPU Assembly
	F9342AB		For BRAIN protocol version
	F9342AL		For HART protocol version
	F9342AF		For BRAIN protocol version(Optional code /F1)
	F9342AM		For HART protocol version with write protection switch (Optional code /F1)
7-2	F9342BF	1	For FOUNDATION Fieldbus protocol version
	F9342BG		For FOUNDATION Fieldbus protocol version with PID/LM function (Optional code /LC1)
8	F9900RP	2	Cap Screw
9	Y9612YU	2	Screw
10	—	1	Plug
	Bellow		For Pg13.5
	F9340NW		For M20
	F9340NX		For G1/2
	G9330DP		For 1/2 NPT
11	—	1	Cover Assembly
	F9341FM		Cast-aluminum alloy
	F9341FJ		SCS14A stainless steel
12	—	1	LCD Board Assembly
	Bellow		Without range-setting switch
	F9342BL		With range-setting switch
13	F9342BM	2	Mounting Screw
14	F9300PB	2	Label

For integral indicator

(Note 1) Applicable for BRAIN and HART protocol versions (Output signal code D and E). For FOUNDATION Fieldbus protocol version (Output signal code F), consult Yokogawa local office.

Customer Maintenance Parts List

Model EJA210A and EJA220A Flange Mounted Differential Pressure Transmitter (Pressure-detector Section)

DPharP

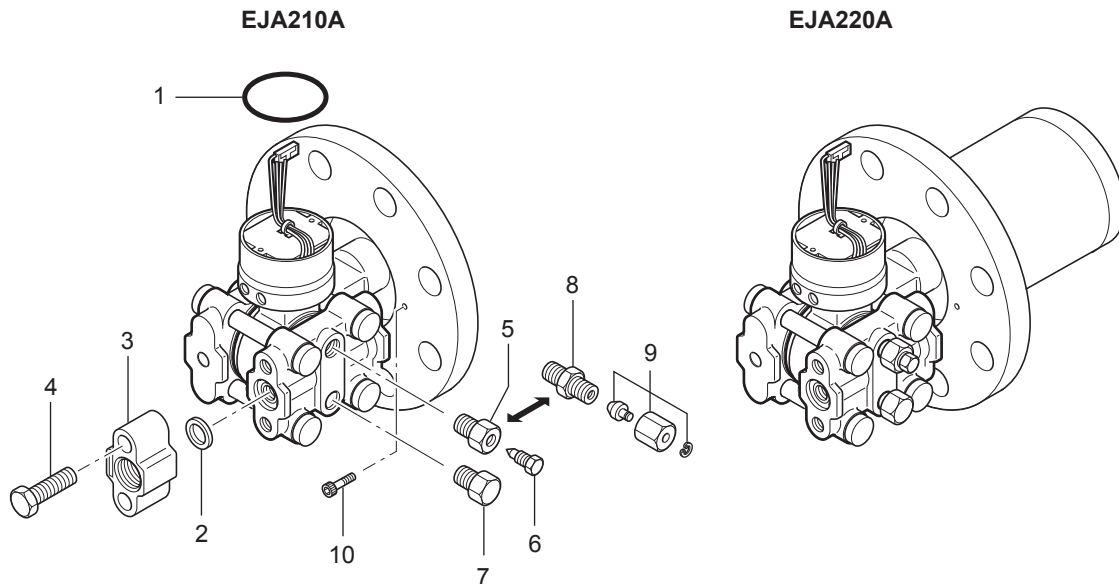

Item	Part No.	Qty	Description
1	F9300AJ	1	O-Ring
2	Below D0114RB U0102XC	1	Gasket PTFE Teflon PTFE Teflon (degreased)
3	Below	1	Process Connector, SCS14A Stainless Steel (Note 1)
4	F9340XY F9340XW F9340XZ F9340XX Below	2	Rc 1/4 Rc 1/2 1/4 NPT 1/2 NPT Bolt
5	X0100MN F9273DZ F9340AZ Below F9340SA	1	SCM435 Chrome Molybdenum Steel SUS630 Stainless Steel SUH660 Stainless Steel Vent Plug, SUS316 Stainless Steel R 1/4
6	F9340SB	1	1/4 NPT Vent Screw, SUS316 Stainless Steel
7	D0114PB Below F9200CS D0114RZ	1	Drain Plug, SUS316 Stainless Steel (Note 1) R 1/4 1/4 NPT
8	Below F9275EC F9275ED	1	Vent Plug (degreased), SUS316 Stainless Steel R 1/4 1/4 NPT
9	F9275EE	1	Needle Assembly (degreased), SUS316 Stainless Steel
10	Y9625YU	2	Bolt

(Note 1) In case of degrease cleansing treatment (Optional Code/K1, K2, K5 and K6), consult YOKOGAWA local office.

Revision Information

- Title : Model EJA210A and EJA220A
Flange Mounted Differential Pressure Transmitter
- Manual No. : IM 01C21C01-01E

Edition	Date	Page	Revised Item
1st	June 1997	—	New publication
2nd	Mar. 1998	CONTENTS 1-1 6-1 11-1 11-3 11-6 2-9+ CMPL	Page 3 Add REVISION RECORD. 1 Add 'NOTE' notice for FOUNDATION Fieldbus and HART protocol versions. 6.1 Add Item to the Wiring Precautions. 11.1 Add FOUNDATION Fieldbus protocol. 11.2 Add Output signal code F. 11.3 Add Optional code A1. Change the figure of terminal configuration. CMPL 1C21A1-02E 1st → 2nd Page 2 Add Item 7-2.
3rd	Sep. 1998	— 2-13 8-17 11-3, 11-4 CMPL	Changed to Electronic File Format. 2.10 Delete EMC Conformity Standards Tables. 8.3.2(9) Correction made in BURN OUT figure. 11.2 Add Process flange size / material code F and C. Add Electrical connection code 7, 8, and 9. Add Process flange size / material code F and J. Add Electrical connection code 7, 8, and 9. CMPL 1C21A1-02E 2nd → 3rd Page 2 Add Part No. to Item 3 (For PG13.5 and M20). Add Part No. to Item 10 (For 1/2NPT, PG13.5, and M20).
4th	Oct. 1999	— 2-8 8-4 CMPL	Revised a book in a new format. (The location of contents and the associated page numbers may not coincide with the one in old editions.) 2.10 Add AS/NZS 2064 1/2 to EMI, EMC Conformity Standards. 8.3.1 Move Parameter Summary table to Chapter 8. CMPL 1C21A1-02E 3rd → 4th Change a format. CMPL 1C21C1-01E 1st → 2nd Change a format.
5th	Sep. 2000	2-8 2-9 8-5 10-2 10-3 10-4 10-5 10-6 CMPL	2.9.4b Change contents of NOTE 1. 2.9.4b Change contents of NOTE 4. 8.3.1 Add footnote 2 and 3. 10.1 Add calibration units of Pa and hPa. 10.2 Add Bolts and nuts material code C. Add Bolts and nuts material code C. 10.3 Add Amb. Temp. for T6: -40 to 75°C Add Optional code /F1 and /N4. CMPL 1C21A1-02E 4th → 5th(Manual Change) Add part numbers to 7-1 CPU Assembly. F9342AF and F9342AM CMPL 1C21A1-02E 5th → 6th Add part numbers to 7-2 CPU Assembly. F9342BG Change part number of 7-1 CPU Assembly. F9342BC → F9342BB Change part number of 10 Plug G9330DK → G9330DP CMPL 1C21C1-01E 2nd → 3rd Add part number to 4 Bolt. F9340AZ

Edition	Date	Page	Revised Item
6th	July 2001	2-10 8-4, 8-5 CMPL	2.10 Change EMC Conformity number. 8.3.1 Add footnote (*4) to B40, Maximum static pressure in Parameter Summary. CMPL 1C21A1-02E 6th → 7th(Manual Change) Change Part No. of 7-1 CPU Assembly for BRAIN protocol. F9342BB → F9342AB CMPL 1C21A1-02E 7th → 8th(Manual Change) Change Part No. of 7-1 CPU Assembly for HART protocol. F9342BH → F9342AL CMPL 1C21A1-02E 8th → CMPL 01C21A01-02E 9th Delete Part No. of 4 Name Plate. Change Part No. of 5 Screw. F9303JU → Y9303JU CMPL 1C21C1-01E 3rd → CMPL 01C21C01-01E 4th
7th	May 2002	1-2 2-7 10-5 10-6	1.1 Add "1.1 For Safety Using." 2.9.4 Add descriptions based on ATEX directive. 10.3 Add Optional code K□2. Add Optional code C2 and C3.
8th	Apr. 2003	2-8 2-10 10-5	2.9.4 Add Option code KU2. 2.11 Add PED (Pressure Equipment Directive). 10.3 Add Option code KU2.
9th	Apr. 2006	1-2 1-3 2-6 2-11 10-5, 10-6 10-6 10-7	1.1 Add (e) Explosion Protected Type Instrument and (f) Modification 1.3 Add "1.3 ATEX Document" 2.9.3 Add "IECEX Certification" and delete "SAA Certification" 2.12 Add Low Voltage Directive 10.3 Add Certificate numbers and Applicable standards Add option code /SU2 and delete option code /SU1 Add option code /PR
10th	Jan. 2008	1-1 1-4 2-3+ 2-10 4-2 8-14 9-3 10-1+ 10-5,10-6 CMPL	Add direct current symbol. Add 11 European languages for ATEX documentation. 2.9.1 Add applicable standard and certificate number for approvals. 2.10 Add EMC caution note. 4.4 Add section of changing the direction of integral indicator. 8.3.3(12) Add figure for A40. 9.4.1 Add figure of integral indicator direction. 10.1, 10.2 Add PROFIBUS PA communication type. 10.3 Delete applicable standard from the table. CMPL 01C21A01-02E 9th → 10th Delete logo from the tag plate.
11th	Oct. 2008	2-9 2-10 8-4, 8-5 8-6 8-9 and later 8-18 9-1 9-5 10-3, 10-4 10-6, 10-7 CMPL	2.9.4 Change explosion protection marking for type n from EEx to Ex. 2.10 Update EMC conformity standards. 8.3.1 Add new parameters. 8.3.2 Add items in table 8.3.1. 8.3.3 Add (5)Change Output Limits and (14)Span Adjustment. Re-number the items. 8.5.2 Modify descriptions and notes for Er.01. 9.3 Add note for calibration. 9.4.3 Add note for cleaning. 10.2 Add new suffix codes. 10.3 Add sealing statement for CSA standards. Add /HC. CMPL 01C21A01-02E 10th → 11th Change Part No. of items 5 and 8.
12th	July 2015	2-5, 2-6 2-9 to 2-10 2-11 2-12 8-1 10-1 10-5 to 10-7	2.9.2 Add temperature limitation for /HE. 2.9.4 b Change /KF2 to /KF21 and modify descriptions. Delete c. Replace tag plate. 2.10 Add standards. 2.12 Add (3) and (4). 8.1.1 Add note. 8.1.2 Add descriptions. 10.1 Add information to "EMC Conformity Standards". 10.3 Delete codes KU2 and KF2. Add KF21. Add Codes HE and CA.