

The contents of this Technical Information are subject to change without notice.

# Contents

Using This Document .....	3
Introduction.....	4
<b>1 Replacing DARWIN with the GX/GP .....</b>	<b>6</b>
1-1 GX/GP Characteristics and Benefits.....	6
1-2 Replacing DARWIN Quick Overview.....	6
1-3 Replacing Standalone Models .....	7
1-4 Replacing Expanded Models .....	7
1-5 GX/GP System Configuration.....	8
1-6 System Configuration Comparison (Maximum Configuration) .....	9
1-7 Example Replacement (Typical) .....	9
1-8 Comparison of Main Specifications.....	11
1-9 Wall Mount Dimensions of Expandable I/O (GX60) .....	12
1-10 Comparison of External Dimensions.....	13
<b>2 Replacing DARWIN with the GM .....</b>	<b>15</b>
2-1 GM Characteristics and Benefits.....	15
2-2 Replacing DARWIN Quick Overview.....	15
2-3 Replacing Standalone Models .....	16
2-4 Replacing Expanded Models .....	16
2-5 GM System Configuration .....	17
2-6 System Configuration Comparison (Maximum Configuration) .....	18
2-7 Example Replacement (Typical) .....	18
2-8 Comparison of Main Specifications.....	20
2-9 Comparison of External Dimensions.....	21
2-10 GM Wall Mounting Dimensions.....	22
<b>3 Other Replacement Suggestions (applicable to GX, GP, and GM) .....</b>	<b>23</b>
3-1 When Using Data Acquisition Software (Sold Separately) .....	23
3-2 DARWIN Compatible Communication Functions .....	23
3-3 Replacing Existing DARWIN Units in Stages.....	26
3-4 Modbus connection with production control systems (CENTUM) .....	27
3-5 Table of Compatible Modules.....	27
<b>Revision Information.....</b>	<b>i</b>

---

# Using This Document

This document describes the replacing DARWIN with SMARTDAC+.

## ■ Notice

- The contents of this manual are subject to change without notice as a result of continuing improvements to the instrument's performance and functions.
- Every effort has been made to ensure accuracy in the preparation of this manual. Should any errors or omissions come to your attention, however, please inform Yokogawa Electric's sales office or sales representative.
- Under no circumstances may the contents of this manual, in part or in whole, be transcribed or copied without our permission.

## ■ Trademarks

- Our product names or brand names mentioned in this manual are the trademarks or registered trademarks of Yokogawa Electric Corporation (hereinafter referred to as YOKOGAWA).
- We do not use the TM or ® mark to indicate these trademarks or registered trademarks in this user's manual.
- All other product names mentioned in this user's manual are trademarks or registered trademarks of their respective companies.

## Introduction





### Replacing DARWIN with the GX/GP/GM

- You can replace your existing DARWIN instruments with a GX/GP/GM model to suit your present and future application
- This guide explains replacement in the following three parts.
  - 1 Replacing DARWIN with the GX/GP
  - 2 Replacing DARWIN with the GM
  - 3 Other Replacement Suggestions (applicable to GX, GP, and GM)



- 2 -

DARWIN Series Linup

Product name	Model	Type	No of measurement	Maximum measurement interval
 Hybrid Recorder	DR241	Standalone	30ch	2s
	DR242	Expandable	300ch	500ms
	DR231	Standalone	30ch	2s
	DR232	Expandable	300ch	500ms
 Portable Recorder	DR130	—	20ch	2s
 Data Acquisition Unit	DA100-1	Standalone	40ch	500ms
	DA100-2	Expandable	300ch	500ms
 Data Collector	DC100-1	Standalone	40ch	500ms
	DC100-2	Expandable	300ch	500ms

**SMARTDAC+**

Papalres recorder **GX/GP**

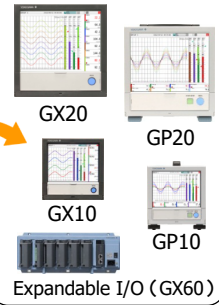

Data Acquisition System **GM**

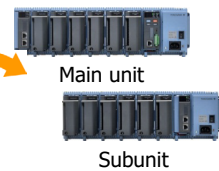

**vigilantplant.**  
The clear path to operational excellence

- 3 -

**YOKOGAWA** ◆

**GX/GP/GM**  
A Full System Configuration Example

**SMARTDAC+**

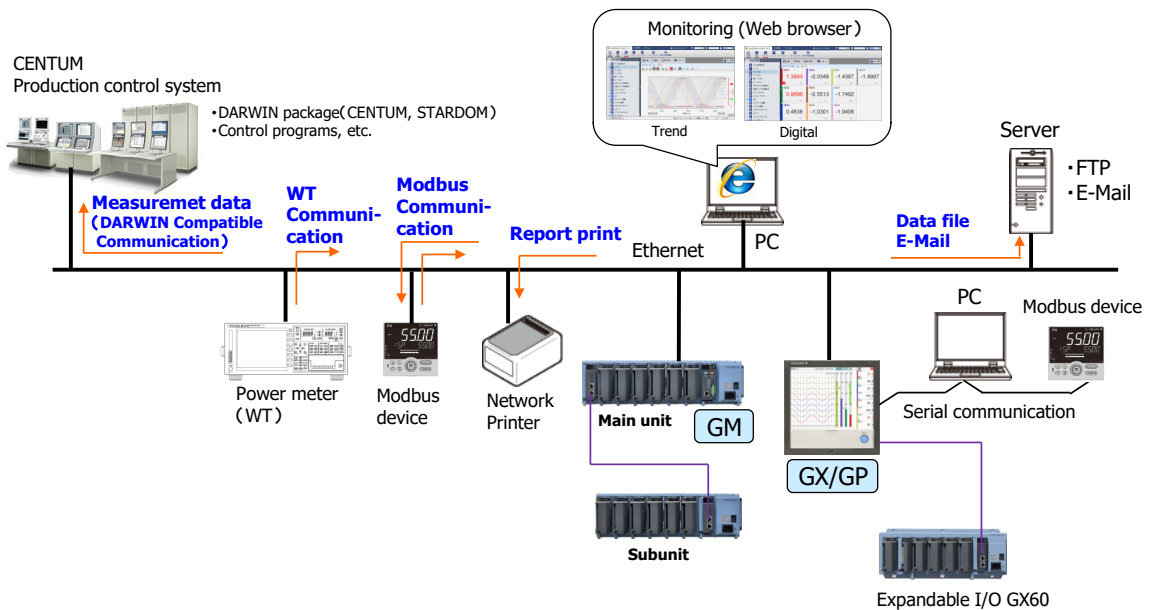

**vigilantplant.**  
The clear path to operational excellence

- 4 -

**YOKOGAWA** ◆

## 1 Replacing DARWIN with the GX/GP

## 1-1 GX/GP Features and Benefits

Feature	Benefit
<b>High speed, multi channel, high accuracy</b>	450 channels can be measured with high accuracy at 100 ms intervals.
<b>DARWIN Compatible Communication</b>	CENTUM and STARDUM that are using the DARWIN communication package can be connected without any modifications.
Paperless (with the DR)	Reduces the running costs of paper, ribbon cassettes, and other items Saves data storage space
Write freehand messages	You can handwrite messages, just like on paper
Modular format	Add or change modules according to your application
Multichannel capability	The standard GX10/GP10 and GX20 are scalable up to 100 channels The GX20/GP20 large memory model can measure on up to 450 channels
Large memory: 500 MB/1.2 GB (with the GX20/GP20 large memory model)	Measured data recorded and saved to internal memory Enables long-duration recording
External memory medium (SD memory card)	Measured data in internal memory can be automatically saved to files at specified intervals (Autosave mode)
PC-independent (with the DA100)	No PC required for recording and saving of measured data Enables monitoring on a variety of displays
Web application (web server)	Enables real time remote monitoring from a browser
Custom displays	You can monitor data using custom screens created on DAQStudio screen builder software

## 1-2 Replacing DARWIN: Quick Overview

Product to consider	GX10/GP10	GX20/GP20 Standard	GX20/GP20 Large memory
Existing			
DA100 standalone MAX 40 ch, 500ms (shortest) DAQ32 (standard software)	<b>MAX 100 ch*</b> <b>100ms (shortest)</b>	<b>MAX 100 ch*</b> <b>100ms (shortest)</b>	<b>MAX 450 ch*</b> <b>100ms (shortest)</b>
DA100 expanded MAX 300 ch, 500ms (shortest) DAQ32 (standard software)	PC-independent	PC-independent	PC-independent
DR241 standalone MAX 30 ch, 2s (shortest)	<b>MAX 100 ch*</b> <b>100ms (shortest)</b>	<b>MAX 100 ch*</b> <b>100ms (shortest)</b>	<b>MAX 450 ch*</b> <b>100ms (shortest)</b>
DR242 expanded MAX 300 ch, 500ms (shortest)			
DR231 standalone MAX 30 ch, 2s (shortest)			
DR232 expanded MAX 300 ch, 500ms (shortest)	Paperless	Paperless	Paperless
DC100 standalone MAX 40 ch, 500ms (shortest)	<b>MAX 100 ch*</b> <b>100ms (shortest)</b>	<b>MAX 100 ch*</b> <b>100ms (shortest)</b>	<b>MAX 450 ch*</b> <b>100ms (shortest)</b>
DC100 expanded MAX 300 ch, 500ms (shortest)	Large memory	Large memory	Large memory
DR130 MAX 20 ch, 2s (shortest)	<b>MAX 100 ch*</b> <b>100ms (shortest)</b>	<b>MAX 100 ch*</b> <b>100ms (shortest)</b>	<b>MAX 450 ch*</b> <b>100ms (shortest)</b>
	Paperless	Paperless	Paperless

## ❖ 1-3 Replacing Standalone Models

❖ Increased channels, PC-independence, long duration data recording, paperless records

You can have more channels, larger memory, longer duration recordings, and PC-free operation (with the DA100).

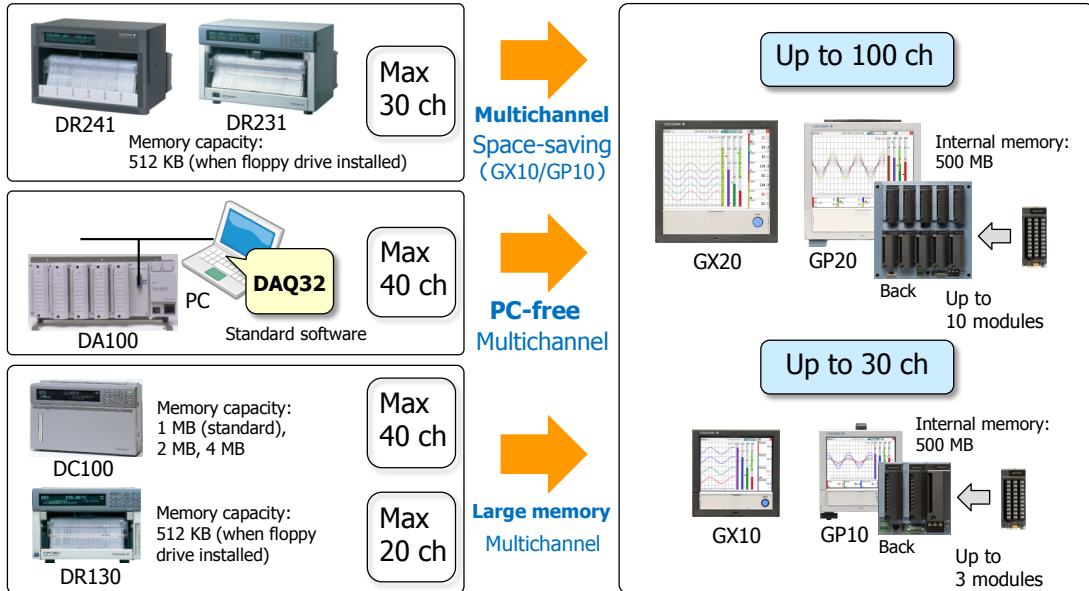

## ❖ 1-4 Replacing Expanded Models

❖ Even more measurements

The GX20/GP20 large memory models can be expanded to measure on up to 450 channels.

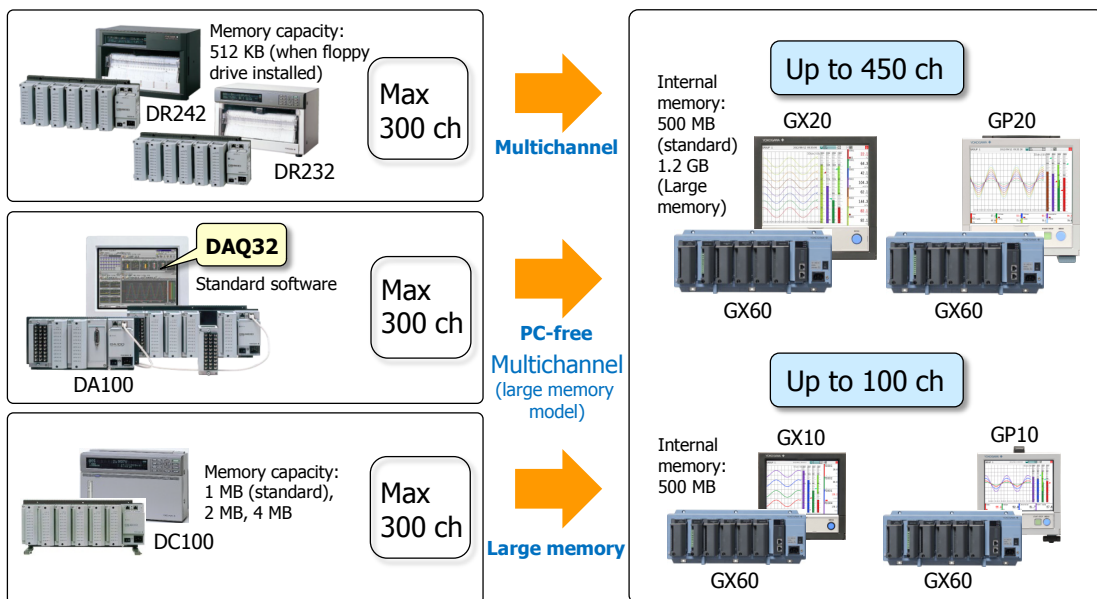

## ❖ 1-5 GX/GP System Configuration 1

### ❖ Standard model configuration

The GX10/GP10 records on up to 30 channels, and the GX20/GP20 records on up to 100 channels. Connecting expansion units (up to 6) lets you spread out your inputs.

Up to 30 ch

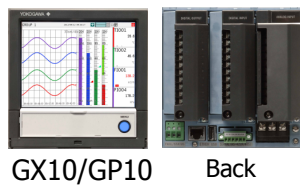

GX10/GP10

Back



Up to 3 modules

Up to 100 ch

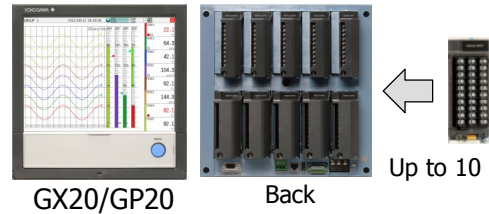

GX20/GP20

Back



Up to 10 modules

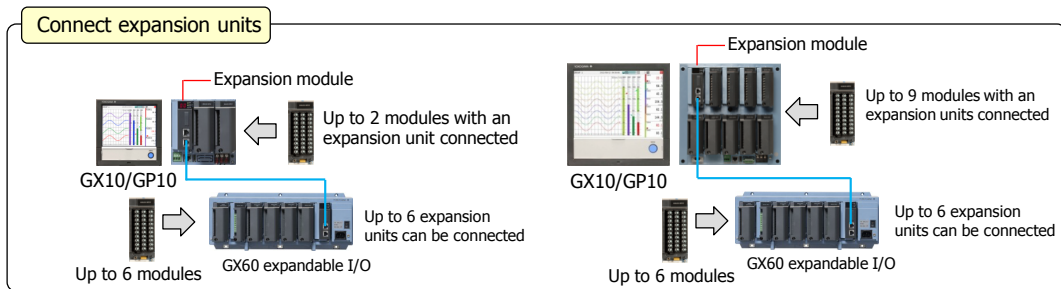

## ❖ 1-5 GX/GP System Configuration 2

### ❖ Large memory model configuration

Connect up to 6 expansion units for up to 450 channels of measurement.

Up to 450 ch

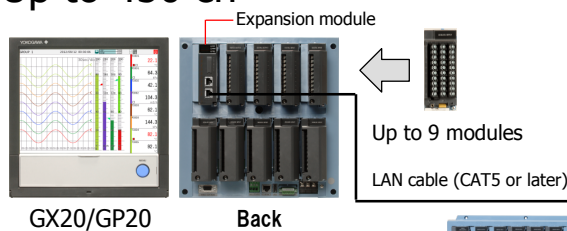

GX20/GP20

Back

#### Chain up to 6 units

Even the standard GX20/GP20 can measure on up to 100 channels. By combining a large memory model with expansion units, you can measure on up to 450 channels.

#### Reduce wiring with distributed installation

When the site (DUT) and recorder are installed in different locations, you can place the expansion unit at the site and monitor without long-distance signal wiring of thermocouples and other sensors.

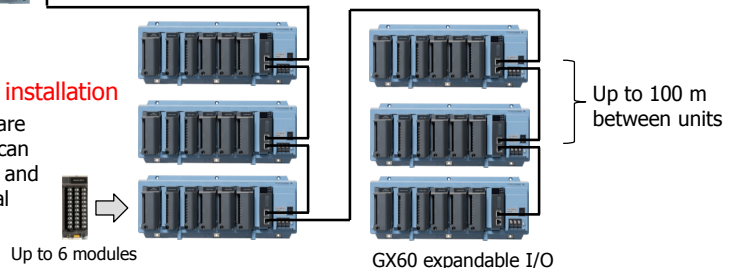



## ❖ 1-6 System Configuration Comparison (Maximum Configuration)

### ❖ Comparison of configurations with GX/GP large memory models

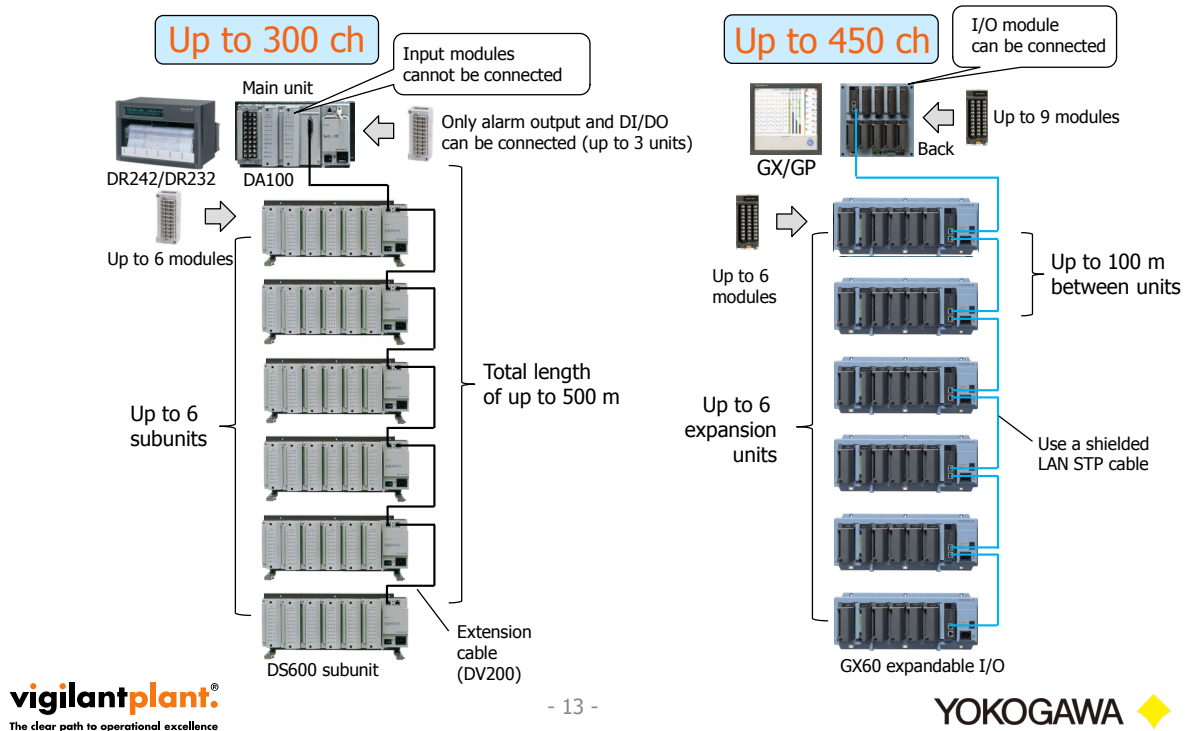

## ❖ 1-7 Example Replacement 1 (Typical)

### ❖ Replacing 300 thermocouples

By installing modules in the GX/GP, you can save space by reducing expansion units. Plus, you get an additional 30 measurements.

Expansion unit/module	Model	Qty	Notes
Subunits	DS600	5	
Universal input module	DU100-11	30	10 ch

Expansion unit/module	Model	Qty	Notes
Expandable I/O	GX60	4	
Analog input module (universal input)	GX90XA (-U2)	30	10 ch
Expansion module	GX90EX	1	

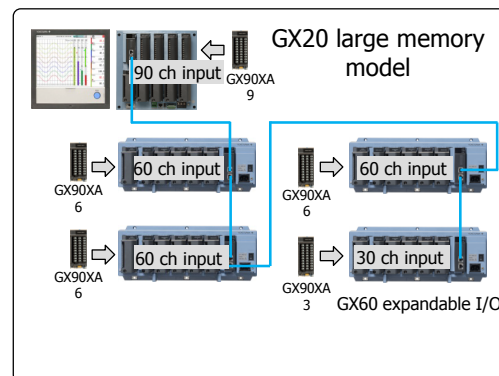
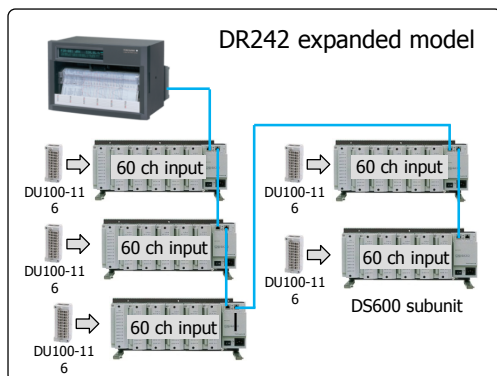

## 1-7 Example Replacement 2 (Typical)

### Replacing 210 thermocouples and 30 alarm outputs

By reducing the number of expansion units you can save space while adding 10 additional channels.

Expansion unit/module	Model	Qty	Notes
Subunit	DS600	4	
Universal input module	DU100-11	21	10 ch
Alarm output module	DU200-21	3	10 A contacts

Expansion unit/module	Model	Qty	Notes
Expandable I/O	GX60	3	
Analog input module (universal input)	GX90XA (-U2)	21	10 ch
Digital output module	GX90YD	5	6 C contacts
Expansion module	GX90EX	1	

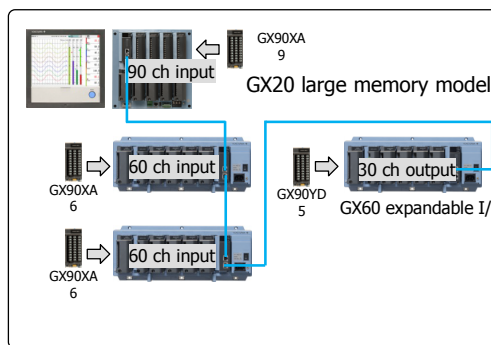
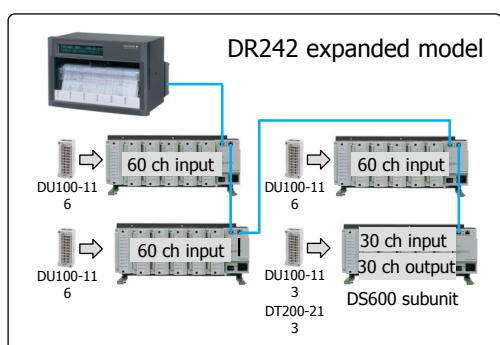

**vigilantplant**<sup>®</sup>  
The clear path to operational excellence

- 15 -

**YOKOGAWA** ◆

## 1-7 Example Replacement 3 (Typical)

### Replacing 240 thermocouples, 2 alarm outputs, 12\* remote inputs, and a Fail output

By reducing the number of expansion units you can save space while adding 20 additional channels.

Expansion unit/module	Model	Qty	Notes
Subunit	DS600	4	
Universal input module	DU100-11	24	10 ch
DI/DO module	DT100-11	1	DI: 12ch DO: 2ch Fail

Expansion unit/module	Model	Qty	Notes
Expandable I/O	GX60	3	
Analog input module (universal input)	GX90XA (-U2)	24	10 ch
DI/DO module	GX90WD	1	DI: 8 ch DO: 6 ch
Expansion module	GX90EX	1	

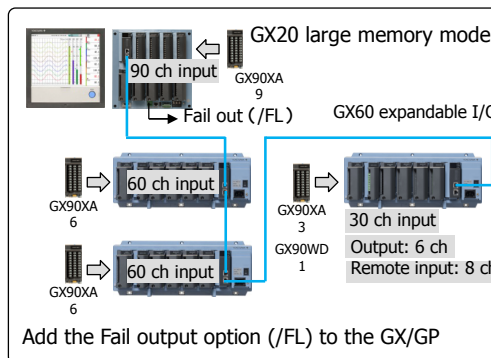
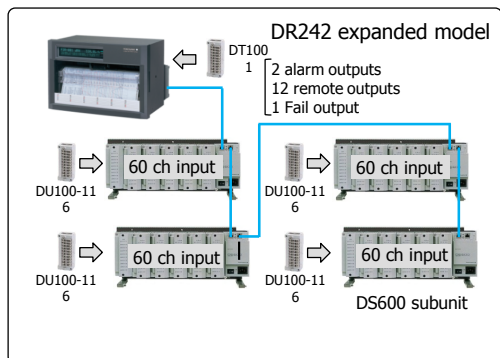

**vigilantplant**<sup>®</sup>  
The clear path to operational excellence

- 16 -

**YOKOGAWA** ◆

\* Remote input is up to eight points.

## 1-7 Example Replacement 4 (Typical)

### Replacing 240 points of DC current (mA)

By reducing the number of expansion units you can save space while adding 30 additional inputs.

Expansion unit/module	Model	Qty	Notes
Subunit	DS600	4	
mA Input Module	DU300-11	24	10 ch

Expansion unit/module	Model	Qty	Notes
Expandable I/O	GX60	3	
Analog input module (DC current, mA)	GX90XA (-C1)	24	10 ch
Expansion module	GX90EX	1	

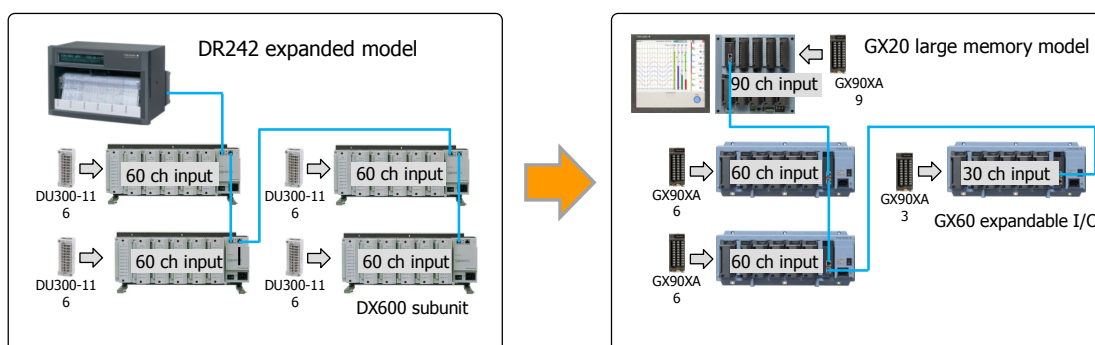

**vigilantplant®**  
The clear path to operational excellence

- 17 -

**YOKOGAWA** ◆

## 1-8 Comparison of Main Specifications (Standalone Models)

Item \ Model	DARWIN			SMARTDAC+		
	DA100-1	DR231/DR241	DC100	GX10/GP10	GX20/GP20 Standard	GX20/GP20 Large mem.
Analog input	Max 40 ch	Max 30 ch	Max 40 ch	Max 100 ch	Max 100 ch	Max 450 ch
Shortest scan interval	500 ms	2 s	500 ms	100 ms	100 ms	100 ms
Internal memory	—	512 KB (with floppy)	1 MB (std)/ 2 MB/4 MB	500 MB	500 MB	1.2 GB
Alarm detection	4 levels/ch	4 levels/ch	4 levels/ch	4 levels/ch	4 levels/ch	4 levels/ch
Ethernet comm.	DT300-41	Ethernet (/C1)	DT300-41	Standard	Standard	Standard
Alarm output	DT200-21 (A contact)	10 (A contacts) (/A4)	DT200-21 (A contacts)	DO output module (GX90YD)×2 (12) (C contacts)		
Alarm output, Remote input, Fail/chart end output	DT100-11	2 alarms, 12 remotes, Fail/chart end (/R1)	DT100-11	DI/DO module (GX90WD)×1 6 alarms, 8 remotes Fail (/FL)		
MATH channels	30 ch (/M1)	30 ch (/M1)	30 ch (/M1)	50 ch (/MT)	100 ch (/MT)	100 ch (/MT)
Report calc.	60 ch (/M3)	60 ch (/M3)	60 ch (/M3)	50 ch (/MT)	60 ch (/MT)	100 ch (/MT)
Comm. channels	—	—	—	100 ch (/MC)	300 ch (/MC)	500 ch (/MC)
Expansion units	None	None	None	Max 6	Max 6	Max 6

**vigilantplant®**  
The clear path to operational excellence

- 18 -

**YOKOGAWA** ◆

## ❖ 1-8 Comparison of Main Specifications (Expandable Models)

Model Item	DARWIN			SMARTDAC+		
	DA100-2	DR232/DR242	DC100	GX10/GP10	GX20/GP20 Standard	GX20/GP20 Large mem.
Analog input	Max 300 ch	Max 300 ch	Max 300 ch	Max 100 ch	Max 100 ch	Max 450 ch
Shortest scan interval	500 ms	500 ms	500 ms	100 ms	100 ms	100 ms
Internal memory	-	512 KB (with floppy)	1 MB (std)/ 2 MB/4 MB	500 MB	500 MB	1.2 GB
Alarm detection	4 levels/ch	4 levels/ch	4 levels/ch	4 levels/ch	4 levels/ch	4 levels/ch
Ethernet comm	DT300-41	DT300-41	DT300-41	Standard	Standard	Standard
Alarm output	DT200-21 (A contacts)	DT200-21 (A contacts)	DT200-21 (A contacts)	DO output module (GX90YD)×2 (12) (C contacts)		
Alarm output, remote input, Fail/chart end output	DT100-11	2 alarms, 12 remotes, Fail/chart end output (/R1)	DT100-11	DI/DO module (GX90WD)×1 6 alarms, 8 remotes Fail (/FL)		
MATH channels	60 ch (/M1)	60 ch (/M1)	60 ch (/M1)	50 ch (/MT)	100 ch (/MT)	100 ch (/MT)
Report calc.	60 ch (/M3)	60 ch (/M3)	60 ch (/M3)	50 ch (/MT)	60 ch (/MT)	100 ch (/MT)
Comm. channels	-	-	-	100 ch (/MC)	300 ch (/MC)	500 ch (/MC)
Expansion units	Max 6	Max 6	Max 6	Max 6	Max 6	Max 6

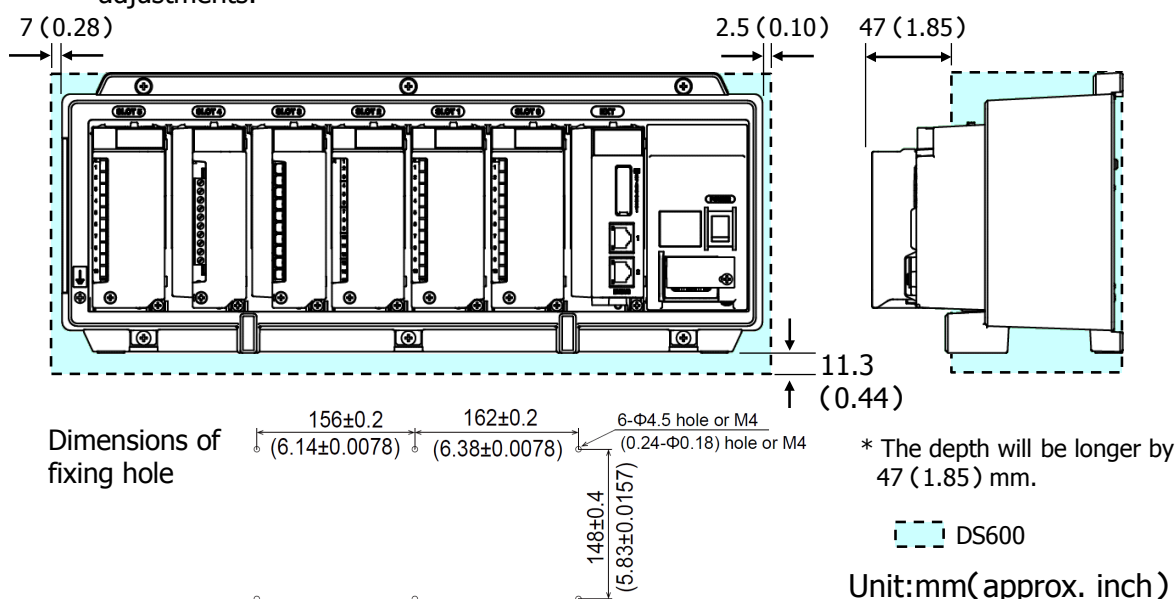

## ❖ 1-9 Wall Mount Dimensions of Expandable I/O (GX60)

- ❖ Can be installed in the sub unit position without any adjustments.  
The attachment hole dimensions of the expandable I/O are the same as those of the DS600. The expandable I/O can be installed in the DS600 position without any adjustments.





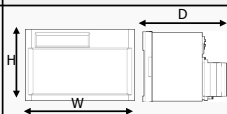
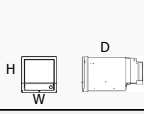
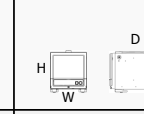
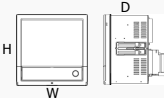
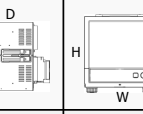
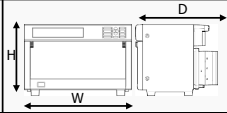
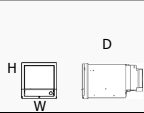

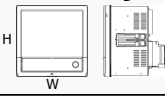
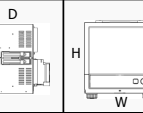
## 1-10 Comparison of External Dimensions(DR240/DR230)

Unit:mm(approx. inch)

DARWIN		GX10	GP10	GX20	GP20	
DR240	W	444 (17.48)	144 (5.67)	144 (5.67)	288 (11.34)	288 (11.34)
	H	288 (11.34)	144 (5.67)	167.9 (6.61)	288 (11.34)	318 (12.52)
	D	343 (13.50)	247.2 (9.73)	247.2 (9.73)	247.4 (9.74)	247.2 (9.73)
						
DR230	W	438 (17.24)	144 (5.67)	144 (5.67)	288 (11.34)	288 (11.34)
	H	291 (11.46)	144 (5.67)	167.9 (6.61)	288 (11.34)	318 (12.52)
	D	335.8 (13.22)	247.2 (9.73)	247.2 (9.73)	247.4 (9.74)	247.2 (9.73)
						

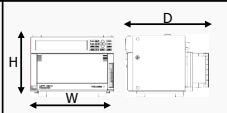
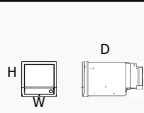

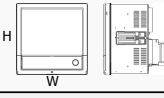
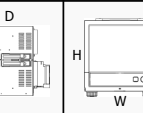
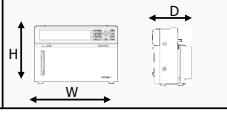
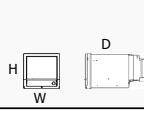
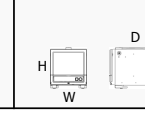

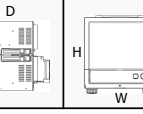
## 1-10 Comparison of External Dimensions(DR130/DC100)

Unit:mm(approx. inch)

DARWIN		GX10	GP10	GX20	GP20	
DR130	W	338 (13.31)	144 (5.67)	144 (5.67)	288 (11.34)	288 (11.34)
	H	252 (9.92)	144 (5.67)	167.9 (6.61)	288 (11.34)	318 (12.52)
	D	335.8 (13.22)	247.2 (9.73)	247.2 (9.73)	247.4 (9.74)	247.2 (9.73)
						
DC100	W	338 (13.31)	144 (5.67)	144 (5.67)	288 (11.34)	288 (11.34)
	H	236 (9.29)	144 (5.67)	167.9 (6.61)	288 (11.34)	318 (12.52)
	D	157 (6.18)	247.2 (9.73)	247.2 (9.73)	247.4 (9.74)	247.2 (9.73)
						

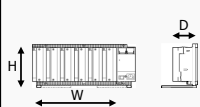
## ❖ 1-10 Comparison of External Dimensions(DA100)

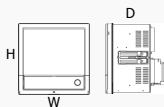
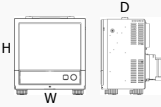
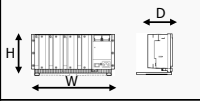
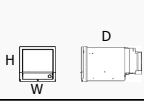
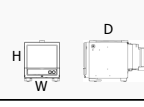
Unit:mm(approx. inch)

DARWIN		GX10	GP10	GX20	GP20	
DA100-1	W	422 (16.61)	144 (5.67)	144 (5.67)	288 (11.34)	288 (11.34)
	H	176 (6.93)	144 (5.67)	167.9 (6.61)	288 (11.34)	318 (12.52)
	D	100 (3.94)	247.2 (9.73)	247.2 (9.73)	247.4 (9.74)	247.2 (9.73)
						
DA100-2	W	336 (13.23)	144 (5.67)	144 (5.67)	288 (11.34)	288 (11.34)
	H	165 (6.50)	144 (5.67)	167.9 (6.61)	288 (11.34)	318 (12.52)
	D	100 (3.94)	247.2 (9.73)	247.2 (9.73)	247.4 (9.74)	247.2 (9.73)
						

## ❖ 1-10 Comparison of External Dimensions(DS600)

Unit:mm(approx. inch)

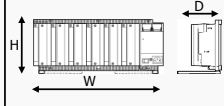
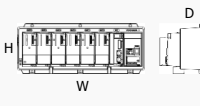
DARWIN		GX60	
DS600	W	422 (16.61)	412.5 (16.24)
	H	176 (6.93)	164.7 (6.48)
	D	100 (3.94)	127.8 (5.03)
			

## 2 Replacing DARWIN with the GM

### 2-1 GM Features and Benefits

Feature	Benefit
High speed, multi channel, high accuracy	420 channels can be measured with high accuracy at 100 ms intervals.
DARWIN Compatible Communication	CENTUM and STARDUM that are using the DARWIN communication package can be connected without any modifications.
Block architecture	Easy addition of modules and modification of configuration according to the measurement application.
Module base system	Incorporates a system in which module bases are linked and modules are installed. Module insertion and removal are easy, improving maintainability.
Multichannel capability	The standard GM10 is scalable up to 100 channels. The GM10 large memory model can measure on up to 420 channels.
Large memory: 500 MB/1.2GB* (*with the GM10 large memory model)	Measured data recorded and saved to internal memory. Enables long-duration recording.
PC-independent (with the DA100)	Measured data is saved in internal memory, so there is no need for a PC for recording and saving data.
External memory medium (SD memory card)	Measured data in internal memory can be automatically saved to files at specified intervals (Autosave mode).
Web application (web server)	Real time monitoring from a Web browser is possible. No need for data acquisition software.
Paperless (with the DR)	Reduces the running costs of paper, ribbon cassettes, and other items Saves data storage space.

### 2-2 Replacing DARWIN: Quick Overview

Product to consider	GM10-1 Standard	GM10-2 Large memory
Existing		
DA100 standalone MAX 40 ch, 500ms (shortest) DAQ32 (standard software)	<b>MAX 100 ch*</b> <b>100ms (shortest)</b>	<b>MAX 420 ch*</b> <b>100ms (shortest)</b>
DA100 expanded MAX 300 ch, 500ms (shortest) DAQ32 (standard software)	PC-independent	PC-independent
DC100 standalone MAX 40 ch, 500ms (shortest)	<b>MAX 100 ch*</b> <b>100ms (shortest)</b>	<b>MAX 420 ch*</b> <b>100ms (shortest)</b>
DC100 expanded MAX 300 ch, 500ms (shortest)	Large memory	Large memory
DR241 standalone MAX 30 ch, 2s (shortest)		
DR242 expanded MAX 300 ch, 500ms (shortest)	<b>MAX 100 ch*</b> <b>100ms (shortest)</b>	<b>MAX 420 ch*</b> <b>100ms (shortest)</b>
DR231 standalone MAX 30 ch, 2s (shortest)		
DR232 expanded MAX 300 ch, 500ms (shortest)	Paperless	Paperless
DR130 MAX 20 ch, 500ms (shortest)	<b>MAX 100 ch*</b> <b>100ms (shortest)</b> Paperless	<b>MAX 420 ch*</b> <b>100ms (shortest)</b> Paperless

## 2-3 Replacing Standalone Models

- Increased channels, long duration data recording, PC-independence
- Increased channels, long-term data recording using large memory, no need for a data acquisition PC.

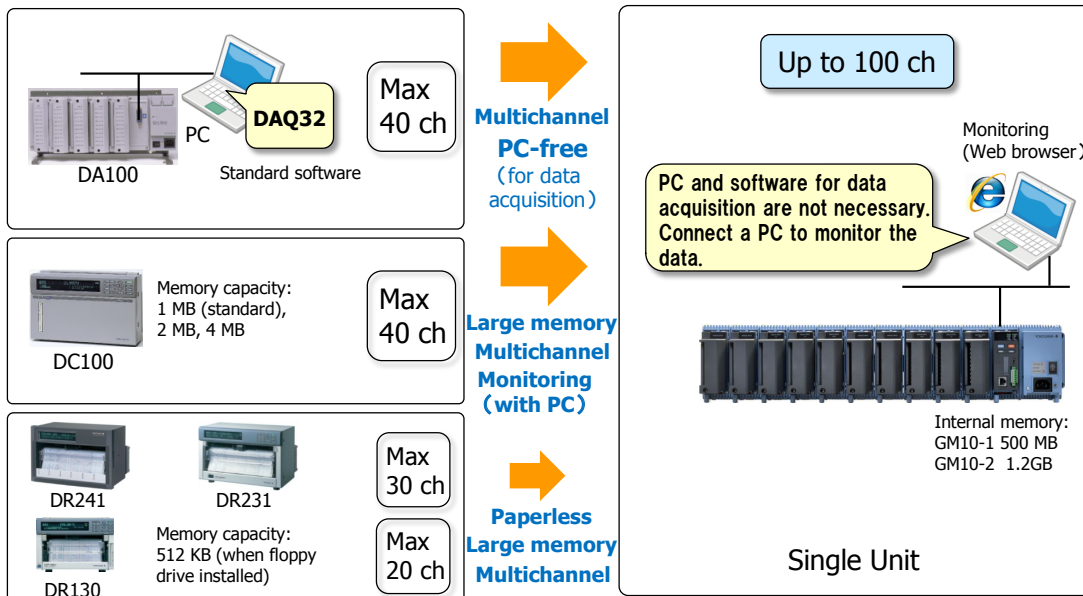

## 2-4 Replacing Expanded Models

- Even more measurements (GM10-2 large memory model)

The GM10-2 large memory models can be expanded to measure on up to 420 channels.

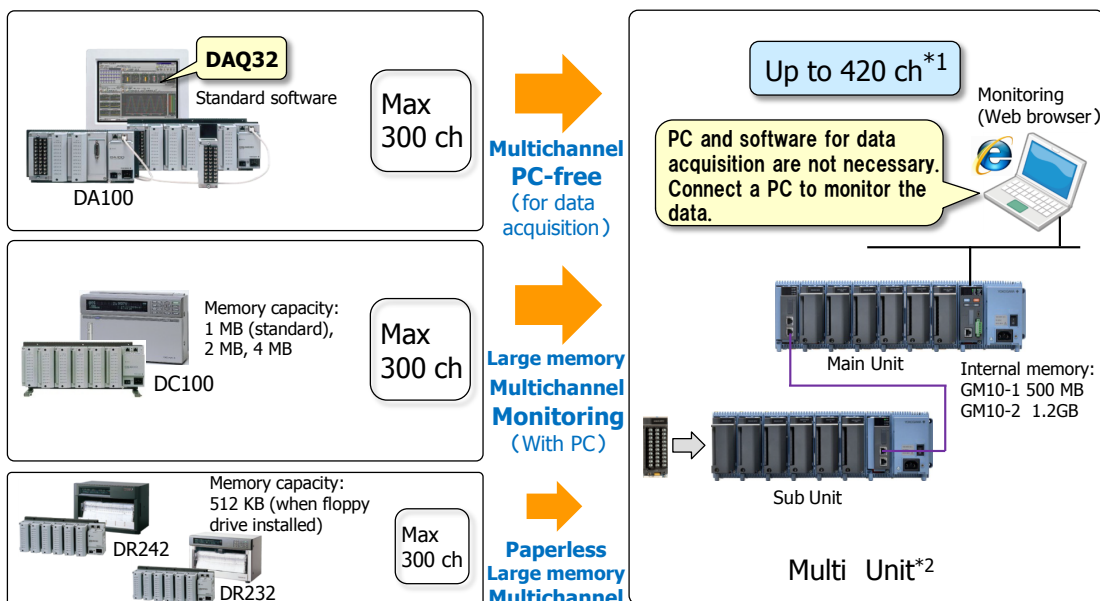

\*1 Up to 100ch (GM10-1)

\*2 A configuration in which sub units are connected to the main unit



## 2-5 GM System Configuration 1

### GM10-1 Standard model configuration

The GM10-1 records on up to 100 channels.

In a multi unit system,\* input sections can be installed in a distributed configuration.

Up to 100 ch



Up to 10 modules

\* A configuration in which sub units are connected to the main unit

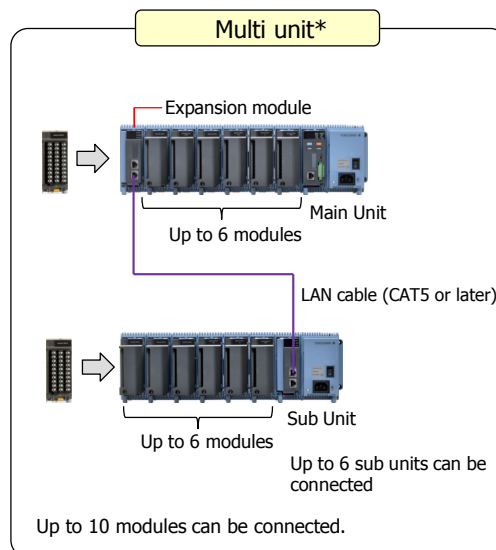

## 2-5 GM System Configuration 2

### GM10-2 Large memory model configuration

Connect up to 6 sub units for up to 420 channels of measurement.

Up to 420 ch

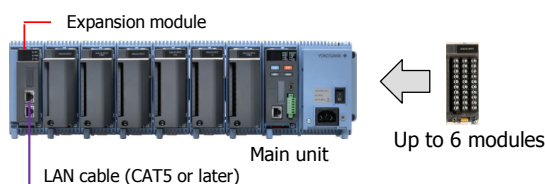

#### Chain up to 6 subunits

By combining a main unit with subunits (Multi unit system), you can measure on up to 420 channels.

#### Reduce wiring with distributed installation

When the site (DUT) and datalogger are installed in different locations, you can place the sub unit at the site and monitor without long-distance signal wiring of thermocouples and other sensors.

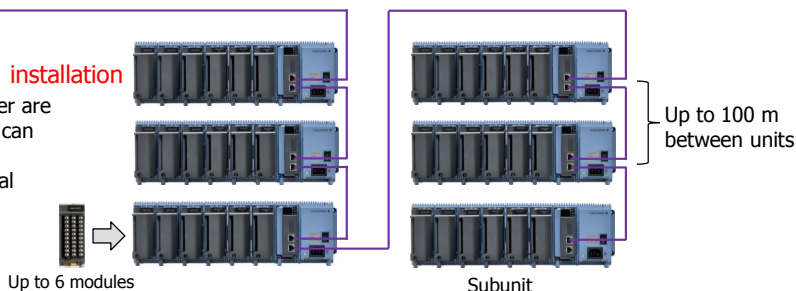

## ❖ 2-6 System Configuration Comparison (Maximum Configuration)

❖ Comparison of configurations with GM10-2 large memory models

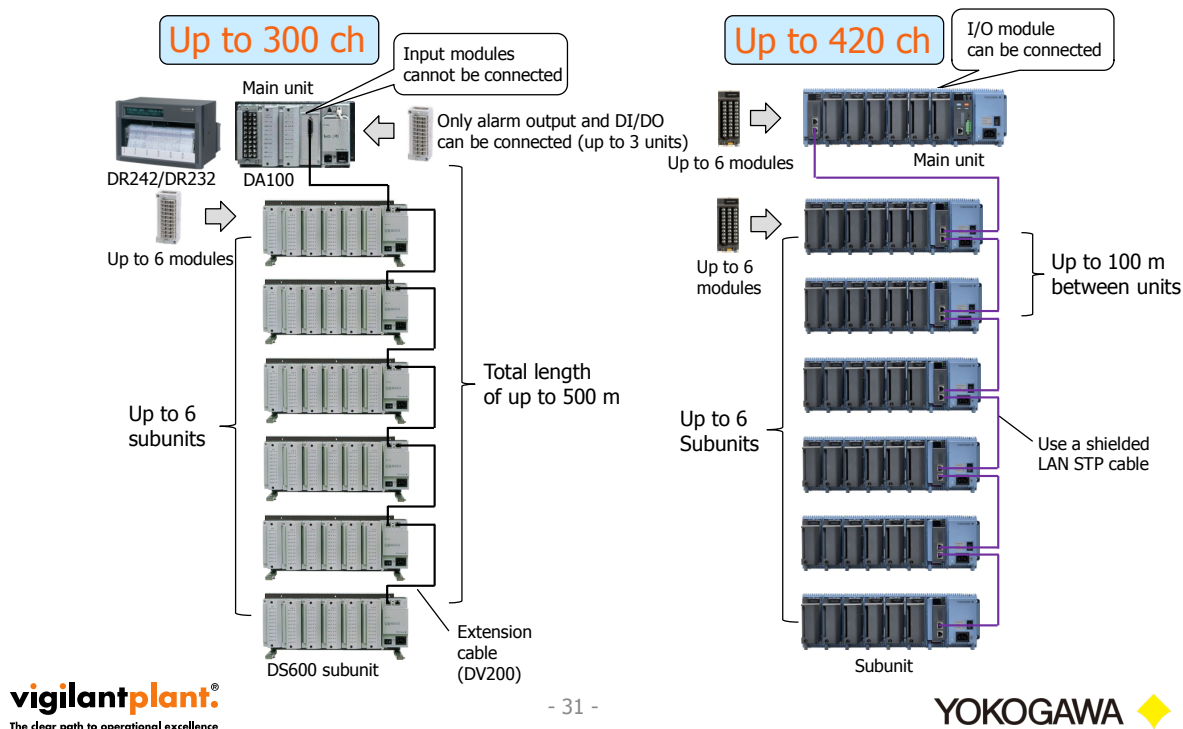

## ❖ 2-7 Example Replacement 1 (Typical)

❖ Replacing 300 thermocouples

By installing modules in the Main unit, you can save space by reducing expansion units.

Expansion unit/module	Model	Qty	Notes
Subunits	DS600	5	
Universal input module	DU100-11	30	10 ch

Expansion unit/module	Model	Qty	Notes
Main unit*1	GM	1	
Subunit*2	GM	4	
Analog input module (universal input)	GX90XA (-U2)	30	10 ch
Expansion module	GX90EX	5	

\*1 Include GM10-2, GM90PS

\*2 Include GM90PS

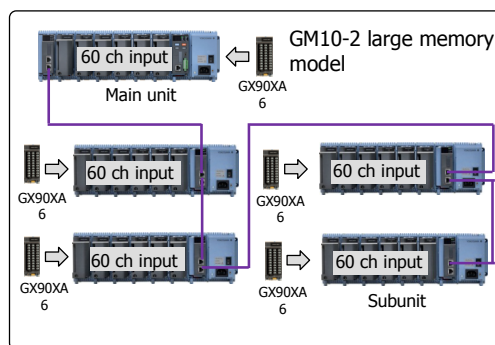
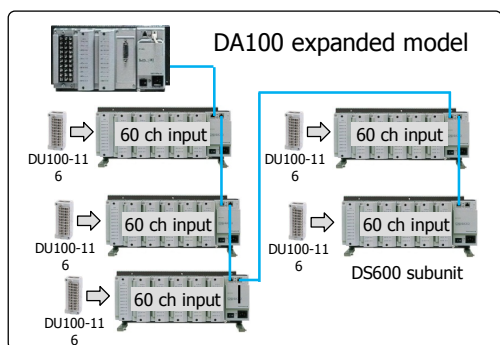

## 2-7 Example Replacement 2 (Typical)

Replacing 210 thermocouples and 30 alarm outputs  
Plus, you get an additional 40 measurements.

Expansion unit/module	Model	Qty	Notes
Subunit	DS600	4	
Universal input module	DU100-11	21	10 ch
Alarm output module	DU200-21	3	10 A contacts

Expansion unit/module	Model	Qty	Notes
Main unit*1	GM	1	
Subunit*2	GM	4	
Analog input module (universal input)	GX90XA (-U2)	21	10 ch
Digital output module	GX90YD	5	6 C contacts
Expansion module	GX90EX	5	

\*1 Include GM10-2, GM90PS

\*2 Include GM90PS

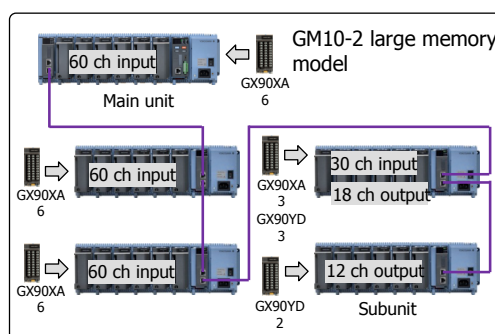
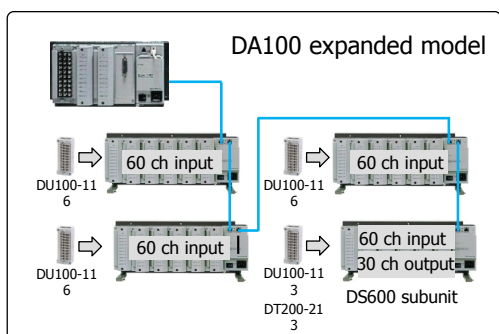

**vigilantplant**<sup>®</sup>  
The clear path to operational excellence

- 33 -

**YOKOGAWA** ◆

## 2-7 Example Replacement 3 (Typical)

Replacing 240 thermocouples, 2 alarm outputs, 12\* remote inputs, and a Fail output  
Plus, you get an additional 50 measurements.

Expansion unit/module	Model	Qty	Notes
Subunit	DS600	4	
Universal input module	DU100-11	24	10 ch
DI/DO module	DT100-11	1	DI: 12ch DO: 2ch Fail

Expansion unit/module	Model	Qty	Notes
Main unit	GM	1	
Subunit	GM	4	
Analog input module (universal input)	GX90XA (-U2)	24	10 ch
DI/DO module	GX90WD	1	DI: 8 ch DO: 6 ch (included Fail)
Expansion module	GX90EX	5	

\*1 Include GM10-2, GM90PS

\*2 Include GM90PS

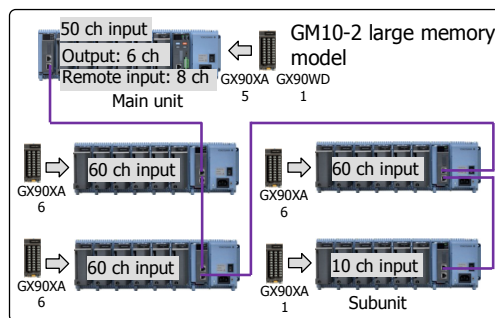
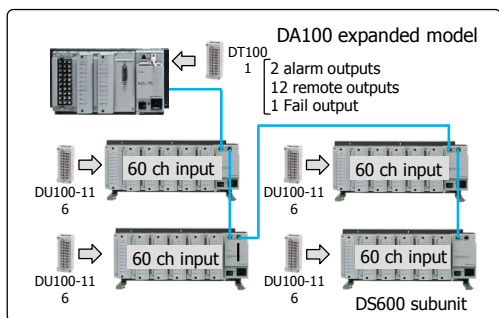

\* Remote input is up to eight points.

**vigilantplant**<sup>®</sup>  
The clear path to operational excellence

- 34 -

**YOKOGAWA** ◆

## 2-7 Example Replacement 4 (Typical)

### Replacing 240 points of DC current (mA)

Space conservation as a result of a reduction in the number of units. If the same number of sub units are used, 60 more channels can be added.

Expansion unit/module	Model	Qty	Notes
Subunit	DS600	4	
mA Input Module	DU300-11	24	10 ch

Expansion unit/module	Model	Qty	Notes
Main unit	GM	1	
Subunit	GM	3	
Analog input module (DC current, mA)	GX90XA (-C1)	24	10 ch
Expansion module	GX90EX	4	

\*1 Include GM10-2, GM90PS

\*2 Include GM90PS

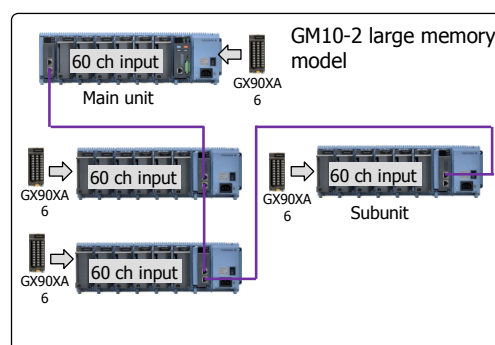
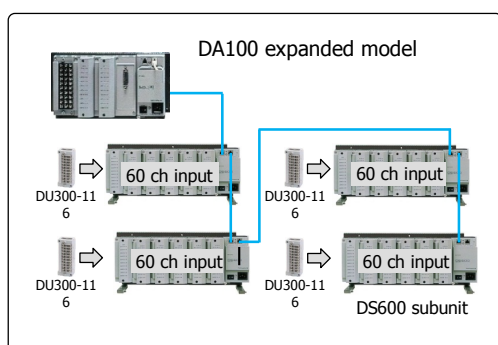

## 2-8 Comparison of Main Specifications (Standalone Models)



Model \ Item	DARWIN			SMARTDAC+	
	DA100-1	DR231/DR241	DC100	GM10-1 Standard	GM10-2 Large mem.
Analog input	Max 40 ch	Max 30 ch	Max 40 ch	Max 100 ch	Max 420 ch
Shortest scan interval	500 ms	2 s	500 ms	100 ms	100 ms
Internal memory	—	512 KB (with floppy)	1 MB (std)/ 2 MB/4 MB	500MB	1.2GB
Alarm detection	4 levels/ch	4 levels/ch	4 levels/ch	4 levels/ch	4 levels/ch
Ethernet comm.	DT300-41	Ethernet(/C1)	DT300-41	Standard	Standard
Alarm output	DT200-21 (A contact)	10 (A contacts) (/A4)	DT200-21 (A contacts)	DO output module (GX90YD)×2 (12) (C contacts)	
Alarm output, Remote input, Fail/chart end output	DT100-11	2 alarms, 12 remotes, Fail/chart end (/R1)	DT100-11	DI/DO module (GX90WD)×1 6 alarms, 8 remotes Fail (/FL)	
MATH channels	30 ch (/M1)	30 ch (/M1)	30 ch (/M1)	100ch (/MT)	100ch (/MT)
Report calc.	60 ch (/M3)	60 ch (/M3)	60 ch (/M3)	60ch (/MT)	60ch (/MT)
Comm. channels	—	—	—	300ch (/MC)	500ch (/MC)
Expansion units	None	None	None	Max 6	Max 6

## 2-8 Comparison of Main Specifications (Expandable Models)

Model Item	DARWIN			SMARTDAC+	
	DA100-2	DR232/DR242	DC100	GM10-1 Standard	GM10-2 Large mem.
Analog input	Max 300 ch	Max 300 ch	Max 300 ch	Max 100 ch	Max 420 ch
Shortest scan interval	500 ms	500 ms	500 ms	100 ms	100 ms
Internal memory	—	512 KB (with floppy)	1 MB (std)/ 2 MB/4 MB	500MB	1.2GB
Alarm detection	4 levels/ch	4 levels/ch	4 levels/ch	4 levels/ch	4 levels/ch
Ethernet comm	DT300-41	DT300-41	DT300-41	Standard	Standard
Alarm output	DT200-21 (A contacts)	DT200-21 (A contacts)	DT200-21 (A contacts)	DO output module (GX90YD)×2 (12) (C contacts)	
Alarm output, remote input, Fail/chart end output	DT100-11	2 alarms, 12 remotes, Fail/chart end output (/R1)	DT100-11	DI/DO module (GX90WD)×1 6 alarms, 8 remotes Fail (/FL)	
MATH channels	60ch (/M1)	60ch (/M1)	60ch (/M1)	100ch (/MT)	100ch (/MT)
Report calc.	60ch (/M3)	60ch (/M3)	60ch (/M3)	60ch (/MT)	60ch (/MT)
Comm. channels	—	—	—	300ch (/MC)	500ch (/MC)
Expansion units	Max 6	Max 6	Max 6	Max 6	Max 6

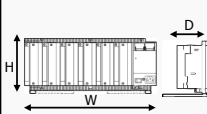
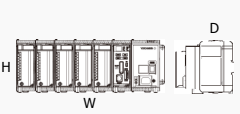
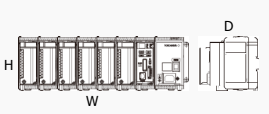
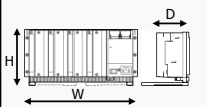

## 2-9 Comparison of External Dimensions (DA100)

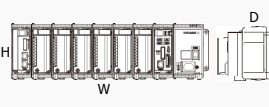
Unit:mm[approx. inch]

DARWIN		GM10 Main unit (3 modules)	GM10 Main unit (5 modules)	GM10 Main unit (6 modules)	
DA100-1	W	422 [16.61]	—	388 [15.28]	438 [17.24]
	H	176 [6.93]	—	137.7 [5.42]	137.7 [5.42]
	D	100 [3.94]	—	146 [5.75]	146 [5.75]
			—		
DA100-2	W	336 [13.23]	338 [13.31]	—	488 [19.21]
	H	165 [6.50]	137.7 [5.42]	—	137.7 [5.42]
	D	100 [3.94]	146 [5.75]	—	146 [5.75]
				—	

## 2-9 Comparison of External Dimensions( DS600)

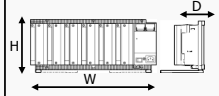
Unit:mm[approx. inch]

DARWIN		GM10 Subunit (6 modules)	
DS600	W	422 [16.61]	438 [17.24]
	H	176 [6.93]	137.7 [5.42]
	D	100 [3.94]	146 [5.75]
			

## 2-10 GM Wall Mounting Dimensions

Unit: mm [approx. inch]

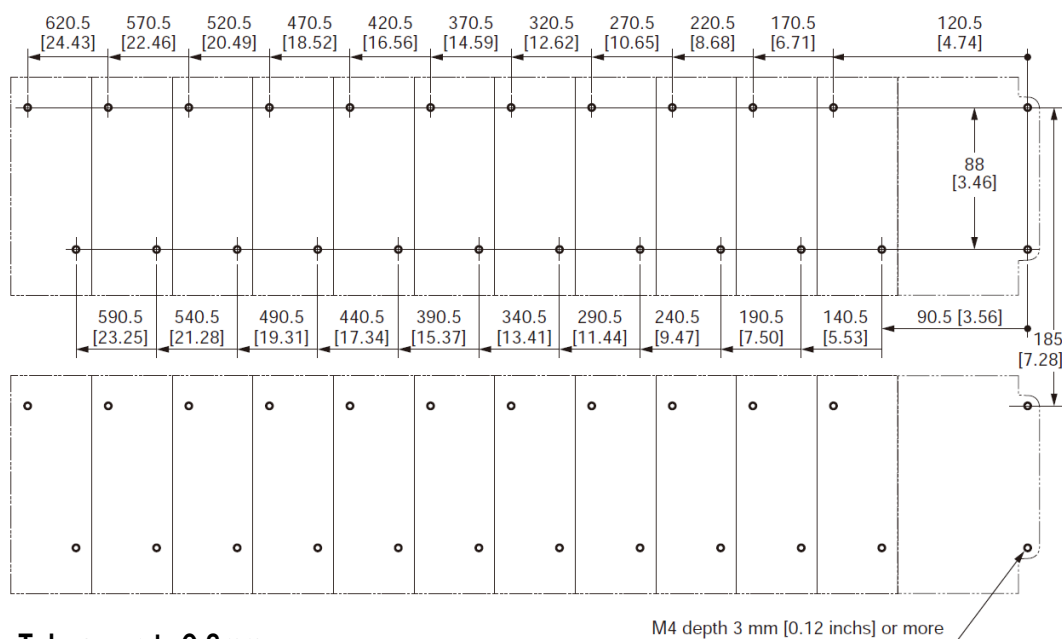

### 3 Other Replacement Suggestions (applicable to GX, GP, and GM)

#### ❖ 3-1 When Using Data Acquisition Software (Sold Separately)

##### ❖ Replace DAQ32Plus and DAQLOGGER with the GA10

Switching over to the GA10 gives you data acquisition of 100 ms, connectivity with up to 100 units, and access to up to 2000 channels. Manage your system with multilogging (multiple asynchronous data acquisitions) and user privileges (4 levels: owner, manager, operator, and monitor).

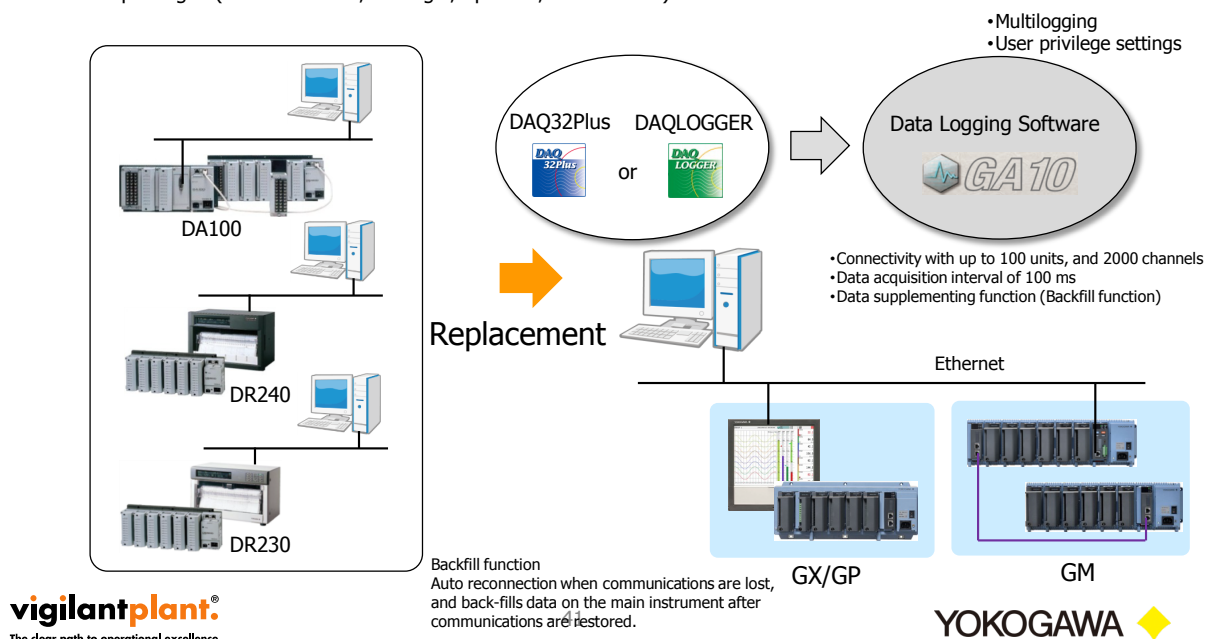

#### ❖ 3-2 DARWIN Compatible Communication Functions 1

##### ❖ Replacing existing programs with the GX/GP/GM

The GX/GP supports DARWIN commands (with a few exceptions). You can use the programs you already created for data acquisition on the GX/GP/GM. Support for Ethernet, RS-232 (GX/GP only), RS-422/485.

**Note)**  
 You must match up your GX/GP/GM system and module configurations with those of the DARWIN system.  
 You cannot use the DARWIN compatible communication functions to connect with DAQ32, DAQ32Plus, or DAQLOGGER.

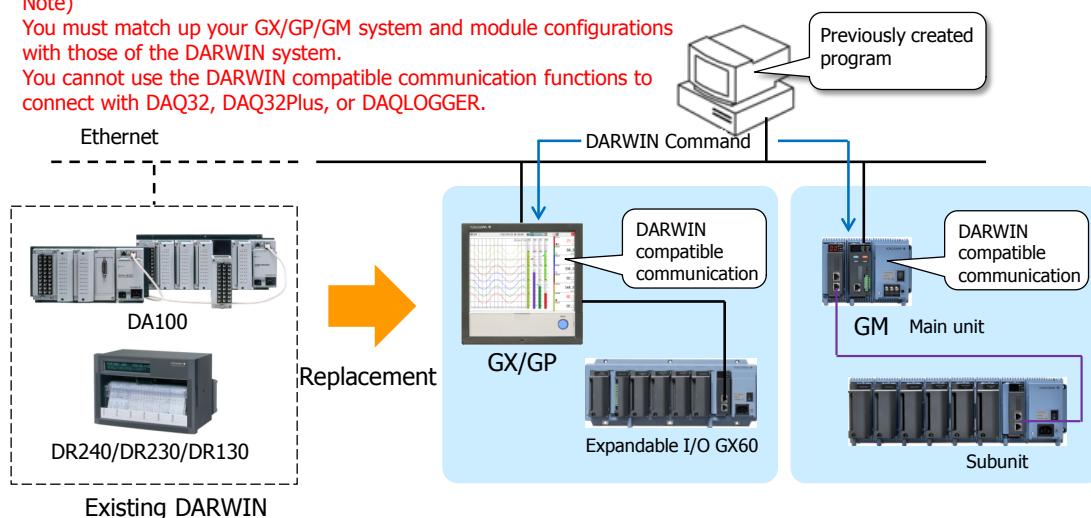

## 3-2 DARWIN Compatible Communication Functions 2

### Supported Commands

#### Instantaneous Data Output Commands

Command	Description
EF	Outputs measured data and math data in binary format.
EL	Outputs unit and decimal point information of a specified channel in ASCII format.
EB	Sets the byte output order.

#### ESC+T Command

Command	Description
Esc+T	Prepares to output the data selected with the TS command.

#### Setting Commands

Command	Description
SR	Sets the range.
SN	Sets the unit (scale unit).
SA	Sets an alarm.
SD	Sets the date and time.
SV	Sets moving average.
CM	Sets math input data (option).

## 3-2 DARWIN Compatible Communication Functions 3

#### Commands Applicable to RS-422/485 Only

Command	Description
Esc+O	Open Command (address a communication destination)
Esc+C	Close Command (close the addressed state of a device)

#### Data Output Request Commands

Command	Parameter	Description
TS	0: Measured data	Selects the talker output data.
	1: Setting parameters	
	2: Unit information	
	5: System configuration information	
	9: Setup mode setting data output	
FM	0: Measured data (ASCII)	Selects the output format of measured/math data.
	1: Math data (binary)	
	2: Math data (ASCII)	
	3: Math channel (binary)	
LF	—	Sets the output channel for the setting data output, unit, and decimal place information.
CF	—	Sets the system configuration data format.
VF	—	Relay status output request.
BO	—	Sets the byte output order.
ESC+S	—	Status byte output command



## ❖ 3-2 DARWIN Compatible Communication Functions 4

### Control Execution Commands

Command	Description
AR	Resets alarms.
IR	Resets timers.
EX	Starts, stops, resets, clears (option) math.
RS	System reconfiguration
RC	Clears RAM (initializes operation mode setting parameters).
VD	Turns on and off relays externally.
CF	System configuration data output request (diagnosis)
PS	Starts or stops recording.
MS	Starts message printing.
IM	Sets the interrupt mask.
SM	Sets the auxiliary mask.

## ❖ 3-2 DARWIN Compatible Communication Functions 5

### ❖ Handling of Commands for Functions Not Available on the GX/GP/GM Commands That the GX/GP/GM Returns Positive Responses For

Command	Description	Response	Operation
DS	Switches the setting mode.	Positive response (E0)	No operation
XE	Confirms setup setting parameters.		
UD	Setting the display mode on the upper part of the display.		
ESC+R	Switch from Local Status to Remote Status.		
ESC+L	Sets the display mode of the top display.		

### Commands That Do Not Affect the Operation (Negative response)

Command	Description	Response	Operation
SX	Sets a math group.	Negative response(E1)	No effect
SI	Sets a timer (option).		
SQ	Sets a match time timer (option).		
SL	Sets event/action (option).		
SO	Sets a calculation expression (option).		
SK	Sets a calculation constant (option).		
AO	Assigns a transmission channel.		
YO	Sets the time constant for transmission output.		
ET	Sets a timeout.		

### 3-3 Replacing Existing DARWIN units in Stages 1

❖ When using data acquisition software (sold separately)

Add the GA10 data logging software and leave the existing DAQ32Plus or DAQLOGGER as-is. Centralize the data in one application, and then replace parts of DARWIN\* with the GX/GP/GM when you are ready.

DAQ32Plus and DAQLOGGER tag settings can be used without any modifications.

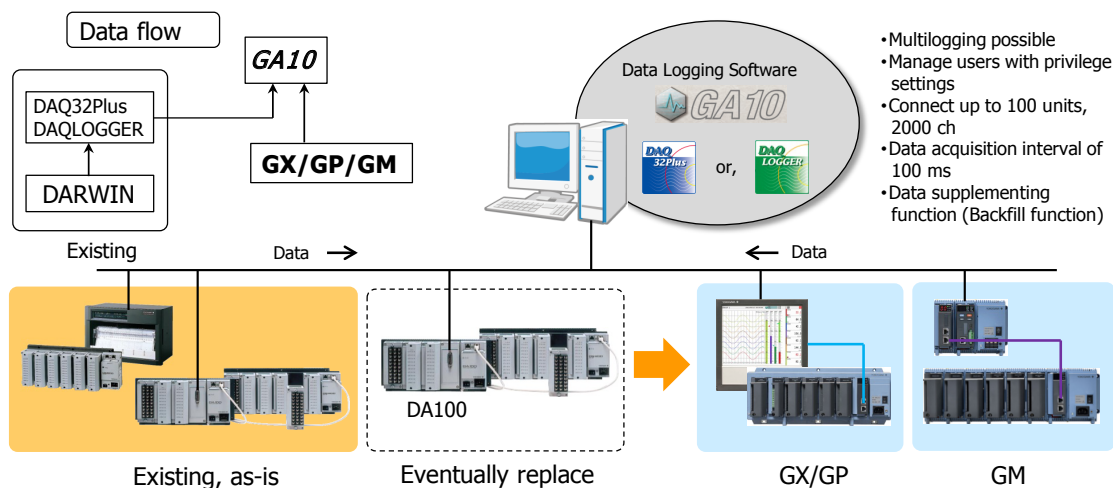

\* Not supported DC100.



### 3-3 Replacing Existing DARWIN units in Stages 2

❖ With the CENTUM Production Control System

With DARWIN compatible communication, you can replace your existing DARWIN in stages. This lets you phase in your replacements and avoid a large up-front investment.

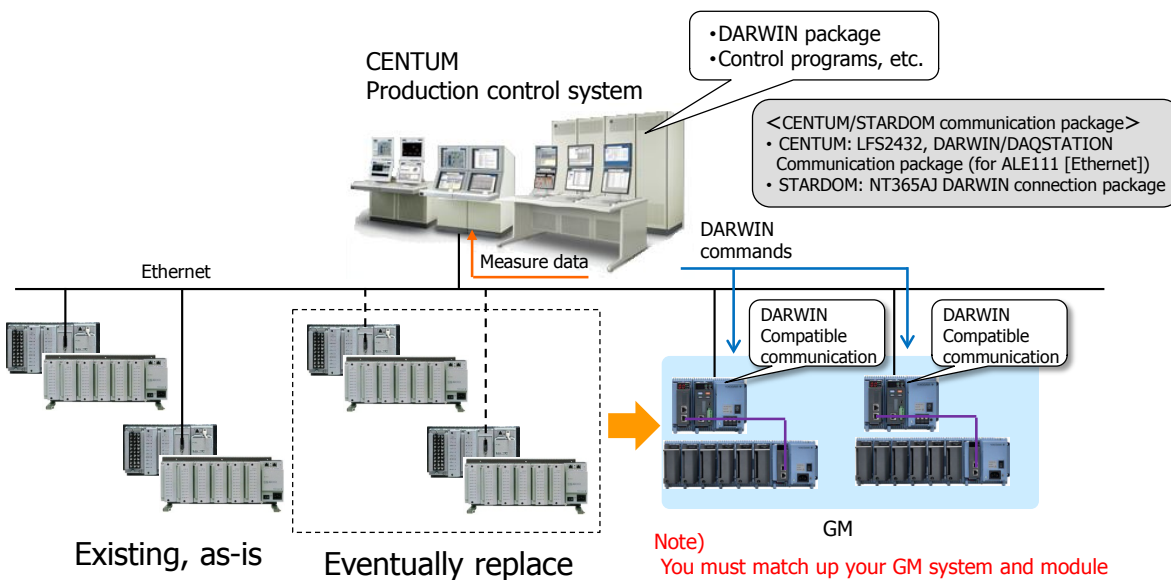

- 48 -



### 3-4 Modbus connection with production control systems (CENTUM)

Measured data can be acquired through Modbus connection.

Measured data can be acquired by reading the GM internal registers from CENTUM. Replacing DARWIN is easy.

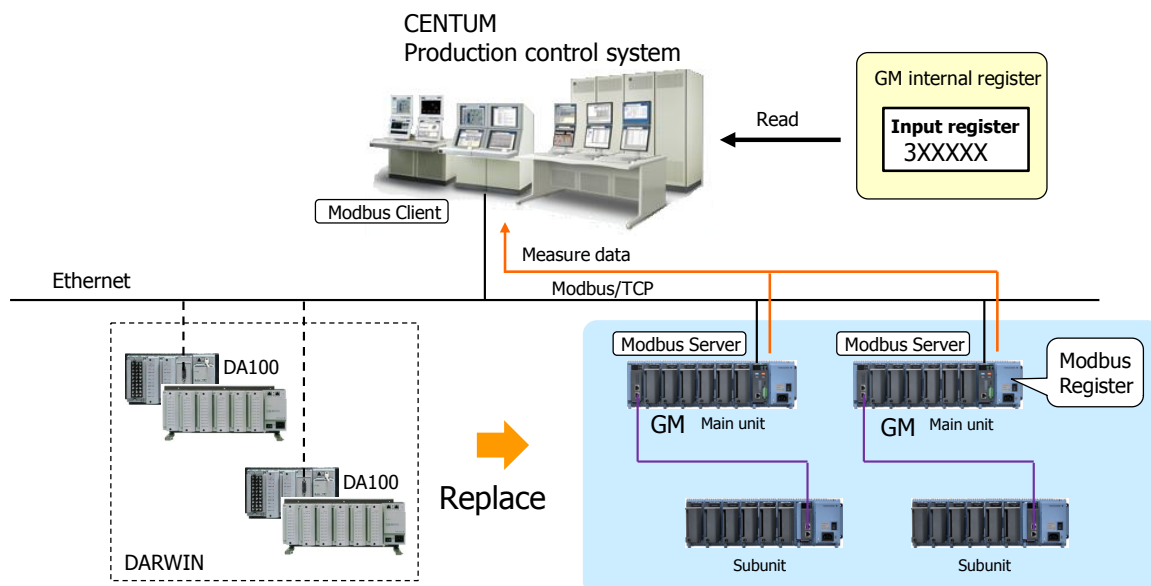

**vigilantplant**  
The clear path to operational excellence

**YOKOGAWA** ◆

### 3-5 Table of Compatible Modules

DARWIN			GX/GP		
Name	Model	No. of channels	Name	Model	No. of channels
Universal	DU100-1□	10	Analog input	GX90XA -10-U2 (-T1*2)	10
	DU100-2□	20		GX90XA-10-U2 (-T1*2) x 2	20
	DU100-3□	30		GX90XA -10-U2(-T1*2) x 3	30
DCV/TC/DI	DU200-1□	10		GX90XA-10-U2	10
	DU200-2□	20		GX90XA -10-U2 x 2	20
	DU200-3□	30		GX90XA -10-U2 x 3	30
mA	DU300-1□	10	mA	GX90XA-10-C1	10
Power monitor	DU400-1□	Voltage: 1, current: 1 Voltage: 3, current: 3	-	-	-
Strain	DU500-1□	10	-	-	-
Pulse	DU600-11	10	Digital input	GX90XD*4, GX90WD*4	10
Digital input	DU700-11	10	Digital input output	GX90XD	16
Alarm contact output	DT200-11	4 C contacts	Digital output	GX90YD	6 C contacts
	DT200-21	10 A contacts		GX90YD x 2	12 C contact
DI/DO	DT100-11	2 alarm outputs 12 remote inputs 1 fail output*1 1 chart end output	DI/DO	GX90WD	DI:8*3 DO:6

\*1 Option (/FL) required for GX/GP fail output.

\*2 Electromagnetic relay scanner type

\*3 Can be used as remote input.

\*4 Pulse: max. 250 Hz

**vigilantplant**  
The clear path to operational excellence

**YOKOGAWA** ◆

---

# Revision Information

Title : DARWIN Replacement Guide

Manual number : TI 04L51B01-02EN

## **December 2014/2nd Edition**

GM have been added.

---

Written by Yokogawa Electric Corporation  
Published by Yokogawa Electric Corporation  
2-9-32 Nakacho, Musashino-shi, Tokyo 180-8750, JAPAN

---



---

**YOKOGAWA ELECTRIC CORPORATION****Headquarters**

2-9-32, Nakacho, Musashino-shi, Tokyo, 180-8750 JAPAN  
Phone : 81-422-52-5555

**Branch Sales Offices**

Osaka, Nagoya, Hiroshima, Kurashiki, Fukuoka, Kitakyusyu

---

**YOKOGAWA CORPORATION OF AMERICA****Head Office**

12530 West Airport Blvd, Sugar Land, Texas 77478, USA  
Phone : 1-281-340-3800 Fax : 1-281-340-3838

**Georgia Office**

2 Dart Road, Newnan, Georgia 30265, USA  
Phone : 1-800-888-6400/ 1-770-253-7000 Fax : 1-770-254-0928

**YOKOGAWA AMERICA DO SUL LTDA.**

Praca Acapulco, 31 - Santo Amaro, São Paulo/SP, BRAZIL, CEP-04675-190  
Phone : 55-11-5681-2400 Fax : 55-11-5681-4434

**YOKOGAWA EUROPE B. V.**

Euroweg 2, 3825 HD Amersfoort, THE NETHERLANDS  
Phone : 31-88-4641000 Fax : 31-88-4641111

**YOKOGAWA ELECTRIC CIS LTD.**

Grokholskiy per 13 Building 2, 4th Floor 129090, Moscow, RUSSIA  
Phone : 7-495-737-7868 Fax : 7-495-737-7869

**YOKOGAWA CHINA CO., LTD.**

3F Tower D Cartelo Crocodile Building, No.568 West Tianshan Road,  
Shanghai 200335, CHINA  
Phone : 86-21-62396262 Fax : 86-21-62387866

**YOKOGAWA ELECTRIC KOREA CO., LTD.**

(Yokogawa B/D, Yangpyeong-dong 4-Ga), 21, Seonyu-ro 45-gil, Yeongdeungpo-gu,  
Seoul, 150-866, KOREA  
Phone : 82-2-2628-6000 Fax : 82-2-2628-6400

**YOKOGAWA ENGINEERING ASIA PTE. LTD.**

5 Bedok South Road, Singapore 469270, SINGAPORE  
Phone : 65-6241-9933 Fax : 65-6241-2606

**YOKOGAWA INDIA LTD.**

Plot No.96, Electronic City Complex, Hosur Road, Bangalore - 560 100, INDIA  
Phone : 91-80-4158-6000 Fax : 91-80-2852-1442

**YOKOGAWA AUSTRALIA PTY. LTD.**

Tower A, 112-118 Talavera Road, Macquarie Park NSW 2113, AUSTRALIA  
Phone : 61-2-8870-1100 Fax : 61-2-8870-1111

**YOKOGAWA MIDDLE EAST & AFRICA B.S.C.(C)**

P.O. Box 10070, Manama, Building 577, Road 2516, Busaiten 225, Muharraq,  
BAHRAIN  
Phone : 973-17-358100 Fax : 973-17-336100

Apr. '14

---

Printed in Japan