

YASKAWA

HV600

NARROW & ENCLOSED BYPASS TECHNICAL REFERENCE

AC DRIVE BYPASS FOR HVAC FAN & PUMP APPLICATIONS

CATALOG CODE:

H6Bxxxxx

CAPACITIES:

208 V: 0.5 to 100 HP

240 V: 0.5 to 100 HP

480 V: 0.5 to 250 HP

PDF

yaskawa.com/SIEPYAIH6B01

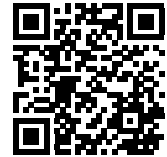

DOCUMENT NUMBER: SIEPYAIH6B01

This Page Intentionally Blank

Table of Contents

i.	Preface and General Precautions	13
i.1	Definitions	14
	Product Description	14
	Glossary	14
	About Registered Trademarks	14
i.2	Using the Product Safely	16
	Explanation of Signal Words	16
	General Safety	16
	Warning Labels	18
	Cybersecurity	19
i.3	Warranty Information	20
	Exclusion of Liability	20
1.	Receiving	21
1.1	Section Safety	22
1.2	Catalog Code and Nameplate Check	23
	Narrow Bypass Nameplate	23
	Enclosed Bypass Nameplate	24
	Drive Nameplate	25
	How to Read Narrow Bypass Catalog Codes	25
	How to Read Enclosed Bypass Catalog Codes	27
	Bypass Enclosures	29
	Features and Advantages of V/f Control Method	29
2.	Mechanical Installation	31
2.1	Section Safety	32
2.2	Installation Environment	34
2.3	Installation Positions and Clearances	35
	Narrow Bypass Installation Position and Clearances	35
	Enclosed Bypass Installation Position and Clearances	36
2.4	Bypass Components	37
2.5	Bypass Component Names	38
	Narrow Bypass Component Names	38
	Enclosed Bypass Component Names	40
2.6	Moving the Bypass	42
	Using the Mounting Rails to Move the Bypass	42
2.7	Removing/Reattaching Covers	44
	Removing/Reattaching the Bypass Cover Using Procedure 1	44
	Removing/Reattaching the Drive Cover Using Procedure A	46

	Opening/Closing the Bypass Cover Using Procedure 2	48
	Removing/Reattaching the Drive Cover Using Procedure A	50
	Removing/Reattaching the Cover Using Procedure B	51
2.8	Exterior and Mounting Dimensions	54
	208 Vac Narrow Models H6BPD002 to D074480 Vac Narrow Models H6BPB1P1, B001 to B077	54
	208 Vac Enclosed Models H6B1D002 to D169240 Vac Enclosed Models H6B1A002 to A154480 Vac Enclosed Models H6B1B1P1, B001 to B156	57
	208 Vac Enclosed Models H6B1D211, D273240 Vac Enclosed Models H6B1A192, A248480 Vac Enclosed Models H6B1B180 to B302	61
2.9	Knock-Out Hole Dimensions	66
	208 Vac Narrow Models H6BPD002 to D074480 Vac Narrow Models H6BPB1P1, B001 to B077	66
3.	Electrical Installation	69
3.1	Section Safety	70
3.2	Wiring Diagrams	72
3.3	Main Circuit Wiring	79
	Narrow Bypass Input and Output Power Wiring Connections	79
	Enclosed Bypass Input and Output Power Wiring Connections	80
	Factory Recommended Branch Circuit Protection	80
	Wire Selection	81
	Main Circuit Terminal and Motor Wiring	87
	Protection of Main Circuit Terminals	89
3.4	Main Circuit Terminal Wiring Procedure	90
	Narrow Bypass Main Circuit Terminal Block Wiring Procedure	90
	Enclosed Bypass Main Circuit Terminal Block Wiring Procedure	91
3.5	Bypass Controller	93
	Wiring the Bypass Control Circuit Terminal	97
3.6	Drive Control Circuit	99
	Wiring the Drive Control Circuit Terminal	104
3.7	Control I/O Connections	107
	Set Input Signals for MFAI Terminals A1 and A2	107
	Set Output Signals for MFAO Terminals FM, AM	107
3.8	Connect the Bypass to a PC	109
3.9	Motor Application Precautions	110
	Precautions for Existing Standard Motors	110
	Precautions for Specialized Motors	110
	Notes on the Power Transmission Mechanism	111
4.	Startup Procedure and Test Run	113
4.1	Section Safety	114
4.2	Keypad: Names and Functions	115
	LCD Display	116
	AUTO LED and HAND LED Indications	117
	Keypad Mode and Menu Displays	119
4.3	Start-up, Test Operation, and Rotation Check	121
	Items to Check before You Energize the Bypass	121
	Bypass Start-Up Procedure	122
	Test Run and Rotation Check	123
4.4	Keypad Operation	127

Home Screen Display Selection	127
Show the Monitors	128
Set Custom Monitors	129
Show Custom Monitors	130
Set the Monitors to Show as a Bar Graph	131
Show Monitors as Bar Graphs	132
Set the Monitors to Show as Analog Gauges.	132
Show Monitors as an Analog Gauge	133
Set Monitor Items to Show as a Trend Plot	134
Show Monitor Items as a Trend Plot.	138
Change Parameter Settings	139
Examine User Custom Parameters	140
Save a Backup of Parameters.	141
Write Backed-up Parameters to the Bypass	142
Verify Keypad Parameters and Bypass Parameters	144
Delete Parameters Backed Up to the Keypad	145
Checking Modified Parameters.	146
Restore Modified Parameters to Defaults.	148
Show Fault History	149
Auto-Tuning	150
Set the Keypad Language Display	152
Set the Date and Time	153
Disable the Initial Setup Screen	155
Start Data Logging	156
Configuring the Data Log Content.	157
Set Backlight to Automatically Turn OFF	159
Show Information about the Bypass	161
Write Automatically Backed-up Parameters to the Bypass.	162
4.5 Automatic Parameter Settings Optimized for Specific Applications (Application Presets)	163
4.6 Auto-Tuning.	165
Auto-Tuning for Induction Motors	165
Precautions before Auto-Tuning	165
4.7 Fine Tuning during Test Runs (Adjust the Control Function)	167
V/f Control.	167
5. Parameter Details.	169
5.1 A: Initialization Parameters.	170
A1: Initialization	170
A2: User Parameters	182
5.2 b: Application.	183
b1: Operation Mode Selection.	183
b2: DC Injection Braking	192
b3: Speed Search	193
b4: Timer Function	201
b5: PID Control.	203
b8: Energy Saving	220
5.3 C: Tuning	222
C1: Accel & Decel Time	222
C2: S-Curve Characteristics	223
C3: Slip Compensation	224
C4: Torque Compensation.	225
C6: Carrier Frequency	226

5.4	d: References	229
	d1: Frequency Reference	229
	d2: Reference Limits	233
	d3: Jump Frequency	234
	d4: Frequency Ref Up/Down & Hold	235
	d6: Field Weakening	236
	d7: Offset Frequency	237
5.5	E: Motor Parameters	238
	E1: V/f Pattern for Motor 1	238
	E2: Motor Parameters	245
5.6	F: Options	248
	F6, F7: Communication Options and Ethernet Options	248
5.7	H: Terminal Functions	257
	H1: Digital Inputs	257
	MFDI Setting Value	261
	H2: Digital Outputs	270
	H2 MFDO Parameters	273
	MFDO Setting Values	276
	H3: Analog Inputs	290
	MFAI Setting Value	294
	H4: Analog Outputs	298
	H5: Serial Communication	301
	H7: Virtual MFIO Selection	307
5.8	L: Protection Functions	311
	L1: Motor Protection	311
	L2: Power Loss Ride Through	314
	L3: Stall Prevention	316
	L4: Speed Detection	322
	L5: Fault Restart	324
	L6: Torque Detection	330
	L8: Drive Protection	335
	L9: Drive Protection 2	340
5.9	n: Special Adjustment	341
	n1: Hunting Prevention	341
	n3: High Slip Braking (HSB) and Overexcitation Braking	342
5.10	o: Keypad-Related Settings	346
	o1: Keypad Display Selection	346
	o2: Keypad Operation	357
	o3: Copy Function	359
	o4: Maintenance Mon Settings	361
	o5: Log Function	364
5.11	S: Special Applications	369
	S1: Dynamic Noise Control	369
	S2: Sequence Run Timers	370
	S3: PI2 Control	379
	S5: Hand/Off/Auto Operation	384
	S6: Protection	392
5.12	Y: Application Features	401
	Y1: Application Basics	401
	Y2: PID Sleep and Protection	406
	Y4: Application Advanced	409
	YA: Preset Setpoint	413
	YC: Foldback Features	415

	YF: PI Auxiliary Control	415
5.13	Z: Bypass Parameters	424
	Z1: Bypass Control System	424
	Z2: Bypass Control Input/Output	439
	Z3: Bypass Control Serial Comm	454
6.	Troubleshooting	457
6.1	Section Safety	458
6.2	Types of Faults, Minor Faults, Alarms, and Errors	460
6.3	Faults, Minor Faults, Alarms, and Error Codes Listed Alphabetically	461
6.4	Faults, Minor Faults, Alarms, and Error Codes Listed by Decimal Value for Use with BACnet/Modbus	468
6.5	Faults	474
6.6	Minor Faults/Alarms	498
6.7	Parameter Setting Errors	511
6.8	Auto-Tuning Errors	514
6.9	Backup Function Operating Mode Display and Errors	517
6.10	Bypass Status Messages	518
6.11	Diagnosing and Resetting Faults	519
	Fault and Power Loss Occur at the Same Time	519
	Fault Occurs Without Power Loss	519
	Fault Reset	519
6.12	Troubleshooting Without Fault Display	520
	Typical Problems	520
	The Parameter Settings Will Not Change	520
	The Motor Does Not Rotate After Entering Run Command	521
	The Motor Rotates in the Opposite Direction from the Run Command in Drive Mode	521
	The Motor Rotates in the Opposite Direction from the Run Command in Bypass Mode	522
	The Motor Rotates in Only One Direction	522
	The Motor Is Too Hot	522
	oPE02 Error Occurs When Decreasing the Motor Rated Current Setting	522
	The Motor Stalls during Acceleration or Accel/Decel Time Is Too Long	522
	The Drive Frequency Reference Is Different than the Controller Frequency Reference Command	523
	There Is Too Much Motor Oscillation and the Rotation Is Irregular	523
	There Is Audible Noise from the Drive or Motor Cables When the Drive Is Energized	524
	The Ground Fault Circuit Interrupter (GFCI) Trips During Run	524
	Motor Rotation Causes Unexpected Audible Noise from Connected Machinery	524
	Motor Rotation Causes Oscillation or Hunting	524
	PID Output Fault	525
	The Motor Rotates after the Drive Output Is Shut Off	525
	The Output Frequency Is Lower Than the Frequency Reference	525
	The Motor Is Making an Audible Noise	525
	The Motor Will Not Restart after a Loss of Power	525
7.	Specifications	527
7.1	Section Safety	528
7.2	208 V Narrow Model Specifications	529
7.3	480 V Narrow Model Specifications	531
7.4	208 V Enclosed Model Specifications	533
7.5	240 V Enclosed Model Specifications	535

7.6	480 V Enclosed Model Specifications	537
7.7	Common Bypass Specifications	539
7.8	Drive Watt Loss	541
7.9	Drive Derating	543
	Carrier Frequency Settings and Rated Current Values	543
	Derating Depending on Ambient Temperature	544
	Altitude Derating	546
7.10	Peripheral Devices and Options	548
	Bypass Options	548
	Option Installation Procedure	549
8.	Periodic Inspection and Maintenance	553
8.1	Section Safety	554
8.2	Inspection	556
	Recommended Daily Inspection	556
	Recommended Periodic Inspection	556
8.3	Maintenance	559
8.4	Replace Drive Cooling Fans and Circulation Fans	561
	Cooling Fans and Circulation Fans	561
	Replace a Fan (Procedure A)	561
	Replace a Fan (Procedure B)	566
	Replace a Fan (Procedure C)	572
	Replace a Fan (Procedure D)	577
	Replace a Fan (Procedure E)	580
8.5	Replace the Keypad Battery	587
8.6	Storage Guidelines	589
9.	Parameter List	591
9.1	Section Safety	592
9.2	How to Read the Parameter List	593
	Terms that Identify Parameters	593
9.3	Parameter Groups	594
9.4	A: Initialization Parameters	595
	A1: Initialization	595
	A2: User Parameters	595
9.5	b: Application	598
	b1: Operation Mode Selection	598
	b2: DC Injection Braking	599
	b3: Speed Search	599
	b4: Timer Function	600
	b5: PID Control	601
	b8: Energy Saving	604
9.6	C: Tuning	605
	C1: Accel & Decel Time	605
	C2: S-Curve Characteristics	605
	C3: Slip Compensation	605
	C4: Torque Compensation	606
	C6: Carrier Frequency	606
9.7	d: Reference Settings	607
	d1: Frequency Reference	607

	d2: Reference Limits	607
	d3: Jump Frequency	607
	d4: Frequency Ref Up/Down & Hold	608
	d6: Field Weakening	608
	d7: Offset Frequency	608
9.8	E: Motor Parameters	609
	E1: V/f Pattern for Motor 1	609
	E2: Motor Parameters	610
9.9	F: Options	611
	F6: Communication Options	611
	F7: Ethernet Options	612
9.10	H: Terminal Functions	616
	H1: Digital Inputs	616
	H2: Digital Outputs	620
	H3: Analog Inputs	627
	H4: Analog Outputs	629
	H5: Serial Communication	630
	H7: Virtual MFIO selection	631
9.11	L: Protection Functions	633
	L1: Motor Protection	633
	L2: Power Loss Ride Through	633
	L3: Stall Prevention	634
	L4: Speed Detection	635
	L5: Fault Restart	635
	L6: Torque Detection	637
	L8: Drive Protection	637
	L9: Drive Protection 2	639
9.12	n: Special Adjustment	640
	n1: Hunting Prevention	640
	n3: High Slip/Overexcite Braking	640
9.13	o: Keypad-Related Settings	641
	o1: Keypad Display	641
	o2: Keypad Operation	644
	o3: Copy Keypad Function	644
	o4: Maintenance Monitors	645
	o5: Log Function	646
9.14	S: Special Applications	647
	S1: Dynamic Noise Control	647
	S2: Sequence Run Timers	647
	S3: PI2 Control	650
	S5: Hand/Off/Auto Operation	652
	S6: Protection	652
9.15	Y: Application Features	656
	Y1: Application Basics	656
	Y2: PID Sleep and Protection	657
	Y4: Application Advanced	658
	YA: Preset Setpoint	660
	YC: Foldback Features	660
	YF: PI Auxiliary Control	660
9.16	Z: Bypass Parameters	664
	Z1: Bypass Control System	664
	Z2: Bypass Control Input/Output	667

	Z3: Bypass Control Serial Comm	671
9.17	U: Monitors	672
	U1: Operation Status Monitors	672
	U2: Fault Trace	673
	U3: Fault History	675
	U4: Maintenance Monitors	677
	U5: PID Monitors	681
	U6: Operation Status Monitors	683
	Ub: Bypass Control Monitors	684
	UC: BACnet Diagnostic Monitors	687
9.18	Defaults by Bypass and Drive Model	689
	208/240 V	689
	480 V	691
10.	Network Communications	695
10.1	Section Safety	696
10.2	Fieldbus Network Support	697
10.3	BACnet Communications	698
	Configure Master/Slave	698
	Communication Specifications	698
	Communication with the Controller	699
	Bypass Operations by Serial Communications	700
	BACnet Objects Supported	701
	Accessing Drive Parameters and the Enter Command	712
	Self-Diagnostics	713
	BACnet Protocol Implementation Conformance Statement	714
10.4	APOGEE FLN (P1) Communications	717
	APOGEE FLN Set-Up	717
	Communication Specifications	717
	Communication with the Controller	717
	Slope and Intercept Conversion	719
	APOGEE FLN Point Database	721
	Cable Loss Configuration and Behavior	724
	Mailbox Functions	725
	Self-Diagnostics	726
	Troubleshooting Checklist	726
10.5	Metasys N2 Communications	728
	Configure Master/Slave	728
	Communication Specifications	728
	Communication with the Controller	728
	Bypass Operations by Serial Communications	730
	Communications Timing	732
	Metasys N2 Point Database	733
	Mailbox Functions	736
	Self-Diagnostics	737
10.6	MEMOBUS/Modbus Communications	738
	Configure Master/Slave	738
	Communication Specifications	738
	Communication with the Controller	738
	Bypass Operations by Serial Communications	740
	Communications Timing	741
	Message Format	742
	Examples of Messages for Commands/Responses	744

Enter Command	748
Self-Diagnostics	749
Communications Data Table	750
Error Codes	767
11. Standards Compliance	769
11.1 Section Safety	770
11.2 UL Standards	772
Area of Use	772
11.3 Seismic Standards	773
IBC/HCAI Seismic Mounting Requirements for HV600 Bypass	773
12. Disposal	777
12.1 Section Safety	778
12.2 Disposal Instructions	779
12.3 WEEE Directive	780
Index	781
Revision History	789

Preface and General Precautions

This chapter gives information about important safety precautions for the use of this product. Failure to obey these precautions can cause serious injury or death, or damage to the product or related devices and systems. Yaskawa must not be held responsible for any injury or equipment damage as a result of the failure to observe these precautions and instructions.

i.1	Definitions	14
i.2	Using the Product Safely	16
i.3	Warranty Information	20

i.1 Definitions

These instructions contain the information necessary to use the product correctly. Read and understand the safety information and precautions before you start to use the product.

◆ Product Description

The HV600 bypass provides a way to bypass the drive and allow the motor to operate directly from the AC line at full speed. It incorporates an AC drive and a two or three-contactor bypass arrangement in a single UL listed enclosure. The two electrically-interlocked IEC-rated contactors isolate the drive from the load when operating in Bypass Mode.

Control logic provides industry standard Hand/Off/Auto functions, BAS Interlock, and safety circuit interlocks in both Drive and Bypass operating modes.

Bypass components include: a fused 120 Vac control circuit transformer, an input disconnect, motor overload, DC link choke, EMC filter, and an HOA keypad with LCD display.

The HV600 drive, a component of the bypass package, is a pulse width modulated drive for three-phase AC induction motors. This type of drive is also known as an adjustable frequency drive, variable frequency drive, AC Drive, AFD, ASD, VFD, and inverter.

The drive is a variable torque AC drive, designed specifically for HVAC applications in building automation, including fans, blowers and pumps.

The bypass has embedded communications for the popular building automation protocols, BACnet (MSTP), N2, P1, and Modbus®.

The LCD keypad is equipped with Hand/Off/Auto functions. Optional DriveWizard software allows upload/download, as well as graphing and monitoring of drive parameters from a PC for ease of drive management.

Built-in PI control eliminates the need for closed loop output signals from a building automation system. It includes feedback display, inverse, square root and differential control functions, and maintains setpoint for closed loop control of fans and pumps for pressure, flow, or temperature regulation. There is also an additional independent PI control for external devices.

◆ Glossary

Phrase	Definition
Bypass	YASKAWA AC Drive Bypass HV600
Drive	YASKAWA AC Drive HV600
MFAI	Multi-Function Analog Input
MFAO	Multi-Function Analog Output
MFDI	Multi-Function Digital Input
MFDO	Multi-Function Digital Output
V/f	V/f Control

◆ About Registered Trademarks

- APOGEE FLN is a registered trademark of Siemens Building Technologies, Inc.
- APOGEE Anywhere is a trademark of Siemens Building Technologies, Inc.
- BACnet is a trademark of the American Society of Heating, Refrigerating, and Air-Conditioning Engineers (ASHRAE).
- EtherNet/IP is a registered trademark of Open DeviceNet Vendor Association, Inc. (ODVA).
- LonWorks and LonTalk are registered trademarks of Echelon Corporation.
- Metasys N2 is a trademark of Johnson Controls, Inc.
- Modbus is a registered trademark of Schneider Electric SA.
- PROFINET is a registered trademark of PROFIBUS International.

- Other company names and product names in this document are trademarks or registered trademarks of the respective companies.

i.2 Using the Product Safely

◆ Explanation of Signal Words

⚠ WARNING

Read and understand this manual before you install, operate, or do maintenance on the drive. Install the drive as specified by this manual and local codes.

The symbols in this section identify safety messages in this manual. If you do not obey these safety messages, the hazards can cause serious injury, death, or damage to the products and related equipment and systems.

These identifier words categorize and emphasize important safety precautions in these instructions.

⚠ DANGER

This signal word identifies a hazard that will cause serious injury or death if you do not prevent it.

⚠ WARNING

This signal word identifies a hazard that can cause death or serious injuries if you do not prevent it.

⚠ CAUTION

Identifies a hazardous situation, which, if not avoided, can cause minor or moderate injury.

NOTICE

This signal word identifies a property damage message that is not related to personal injury.

◆ General Safety

General Precautions

- Some figures in the instructions include options and bypasses without covers or safety shields to more clearly show the inside of the bypass. Replace covers and shields before operation. Use options and bypasses only as specified by the instructions.
- The figures in this manual are examples only. All figures do not apply to all products included in this manual.
- Yaskawa can change the products, specifications, and content of the instructions without notice to make the product and/or the instructions better.
- If you damage or lose these instructions, contact a Yaskawa representative or the nearest Yaskawa sales office on the rear cover of the manual, and tell them the document number to order new copies.

⚠ DANGER

Do not ignore the safety messages in this manual.

If you ignore the safety messages in this manual, it will cause serious injury or death. The manufacturer is not responsible for injuries or damage to equipment.

Electrical Shock Hazard

Do not examine, connect, or disconnect wiring on an energized bypass. Before servicing, disconnect all power to the equipment and wait for the time specified on the warning label at a minimum. The internal capacitor stays charged after the bypass is de-energized. The charge indicator LED extinguishes when the DC bus voltage decreases below 50 Vdc. When all indicators are OFF, remove the covers before measuring for dangerous voltages to make sure that the bypass is safe.

If you do work on the bypass when it is energized, it will cause serious injury or death from electrical shock.

⚠ WARNING**Arc Flash Hazard**

Obey local codes and Arc Flash safety requirements contained in the Standard for Electrical Safety in the Workplace NFPA 70E (2009 Edition or later) and the Workplace Electrical Safety, Canadian Standards Association (CSA) Z462-12. Obey safe work procedures and use applicable personal protective equipment (PPE).

If you do not obey these requirements and procedures, it can cause serious injury or death.

Crush Hazard

Test the system to make sure that the bypass operates safely after you wire the bypass and set parameters.

If you do not test the system, it can cause damage to equipment or serious injury or death.

Sudden Movement Hazard

Before you do a test run, make sure that the setting values for virtual input and output function parameters are correct. Virtual input and output functions can have different default settings and operation than wired input and output functions.

Incorrect function settings can cause serious injury or death.

Remove all personnel and objects from the area around the bypass, motor, and machine and attach covers, couplings, shaft keys, and machine loads before you energize the bypass.

If personnel are too close or if there are missing parts, it can cause serious injury or death.

Electrical Shock Hazard

Do not modify the bypass body, drive body, bypass circuitry, or drive circuitry.

Modifications to bypass and drive body and circuitry can cause serious injury or death, will cause damage to the bypass and drive, and will void the warranty. Yaskawa is not responsible for modifications of the product made by the user.

Only let approved personnel install, wire, maintain, examine, replace parts, and repair the bypass.

If personnel are not approved, it can cause serious injury or death.

Do not remove covers or touch circuit boards while the bypass is energized.

If you touch the internal components of an energized bypass, it can cause serious injury or death.

After the bypass blows a fuse or trips a GFCI, do not immediately energize the bypass or operate peripheral devices. Wait for the time specified on the warning label at a minimum and make sure that all indicators are OFF. Then check the wiring and peripheral device ratings to find the cause of the problem. If you do not know the cause of the problem, contact Yaskawa before you energize the bypass or peripheral devices.

If you do not fix the problem before you operate the bypass or peripheral devices, it can cause serious injury or death.

Damage to Equipment

Do not apply incorrect voltage to the main circuit of the bypass. Operate the bypass in the specified range of the input voltage on the nameplate.

Voltages that are higher than the permitted nameplate tolerance can cause damage to the bypass.

Fire Hazard

Install sufficient branch circuit short circuit protection as specified by applicable codes and this manual. The bypass is suitable for circuits that supply not more than 100,000 RMS symmetrical amperes, 240 Vac maximum (208/240 V), 480 Vac maximum (480 V).

Incorrect branch circuit short circuit protection can cause serious injury or death.

⚠ CAUTION

Crush Hazard

Tighten terminal cover screws and hold the case safely when you move the bypass.
If the bypass or covers fall, it can cause moderate injury.

NOTICE

Use an inverter-duty motor with reinforced insulation and windings applicable for use with an AC drive.

If the motor does not have the correct insulation, it can cause a short circuit or ground fault from insulation deterioration.

Damage to Equipment

When you touch the bypass, drive, and circuit boards, make sure that you observe correct electrostatic discharge (ESD) procedures.

If you do not follow procedures, it can cause ESD damage to the drive and bypass circuitry.

Do not do a withstand voltage test or use a megohmmeter or megger insulation tester on the bypass.

These tests can cause damage to the bypass.

Do not operate a bypass or connected equipment that has damaged or missing parts.

You can cause damage to the bypass and connected equipment.

Do not use steam or other disinfectants to fumigate wood for packaging the bypass. Use alternative methods, for example heat treatment, before you package the components.

Gas from wood packaging fumigated with halogen disinfectants, for example fluorine, chlorine, bromine, iodine or DOP gas (phthalic acid ester), can cause damage to the bypass.

◆ Warning Labels

The drive warning label is in the location shown in [Figure i.1](#). Use the drive as specified by this information.

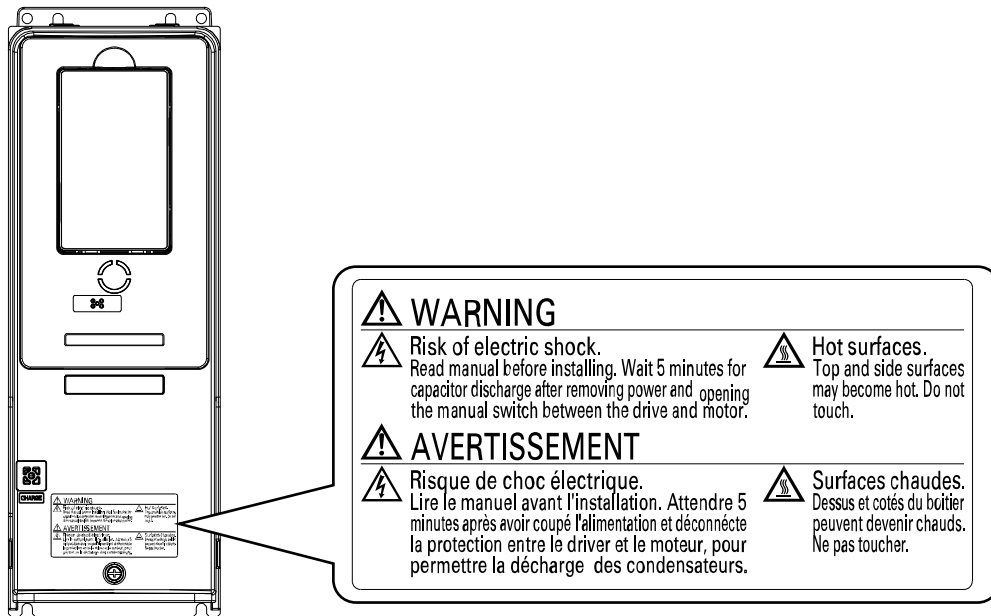

Figure i.1 Drive Warning Label Content and Location

The bypass warning labels are in the locations shown in [Figure i.2](#) and [Figure i.3](#). Use the bypass as specified by this information.

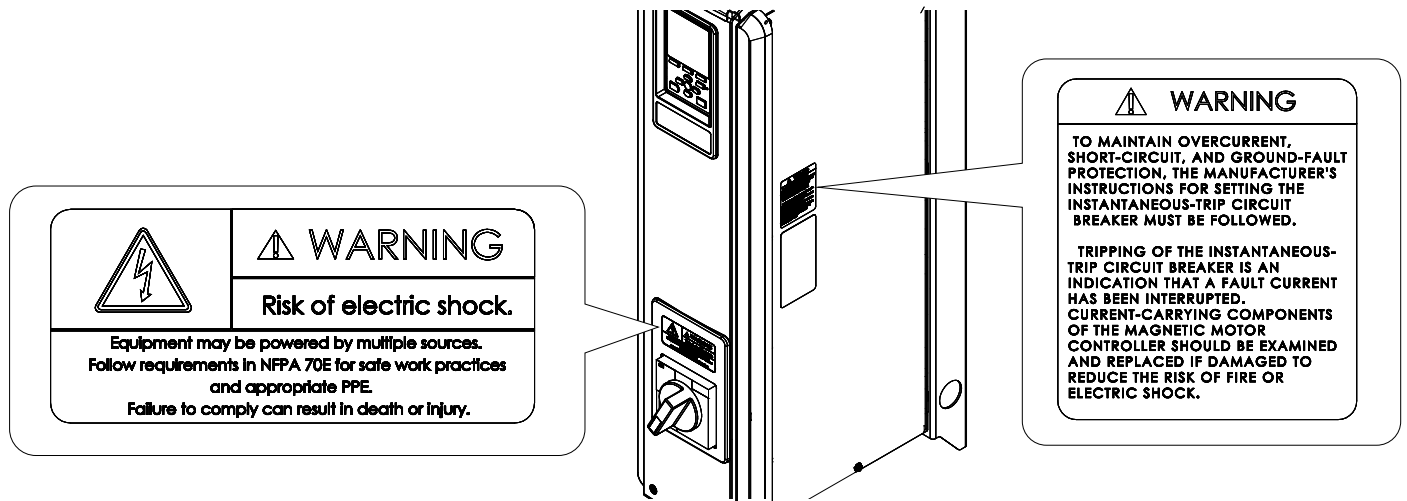

Figure i.2 Narrow Bypass Warning Labels and Locations

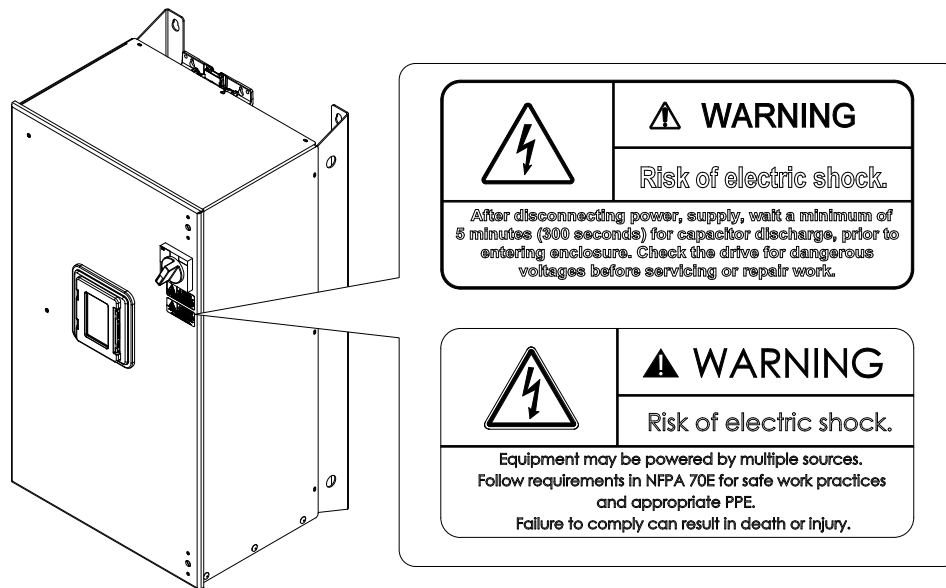

Figure i.3 Enclosed Bypass Warning Labels and Locations

◆ Cybersecurity

This product is designed to connect and communicate information and data through a network interface. It is the sole responsibility of the customer to provide and continuously guarantee a secure connection between the product and the customer's network or if applicable, any other network. The customer must establish and maintain the appropriate measures (such as, but not limited to, the installation of firewalls, the application of authentication measures, the encryption of data, the installation of antivirus programs, etc.) to protect the product, the network, its system and the interface against all types of security breaches, unauthorized access, interference, intrusion, leakage and/or theft of data or information. Yaskawa and its affiliates are not responsible for damages and/or losses related to such security breaches, any unauthorized access, interference, intrusion, leakage and/or theft of data or information.

i.3 Warranty Information

◆ Exclusion of Liability

- This product is not designed and manufactured for use in life-support machines or systems.
- Contact a Yaskawa representative or your Yaskawa sales representative if you are considering the application of this product for special purposes, such as machines or systems used for passenger cars, medicine, airplanes and aerospace, nuclear power, electric power, or undersea relaying.

⚠ WARNING

Injury to Personnel

When you use this product in applications where its failure could cause the loss of human life, a serious accident, or physical injury, you must install applicable safety devices.

If you do not correctly install safety devices, it can cause serious injury or death.

Receiving

This chapter gives information about the different drive models and features, and how to examine the drive when you receive it.

1.1	Section Safety	22
1.2	Catalog Code and Nameplate Check.....	23

1.1 Section Safety

 **DANGER**

Do not ignore the safety messages in this manual.

If you ignore the safety messages in this manual, it will cause serious injury or death. The manufacturer is not responsible for injuries or damage to equipment.

1.2 Catalog Code and Nameplate Check

Please examine these items after you received the bypass:

- Examine the bypass and drive for damage or missing parts. Immediately contact the shipping company if there is damage. The Yaskawa warranty does not cover damage from shipping.
- Examine the model number on the bypass nameplate to make sure that you received the correct model.
- If you received a product different than what you ordered or your product has a defect, contact Yaskawa or your nearest sales representative.

◆ Narrow Bypass Nameplate

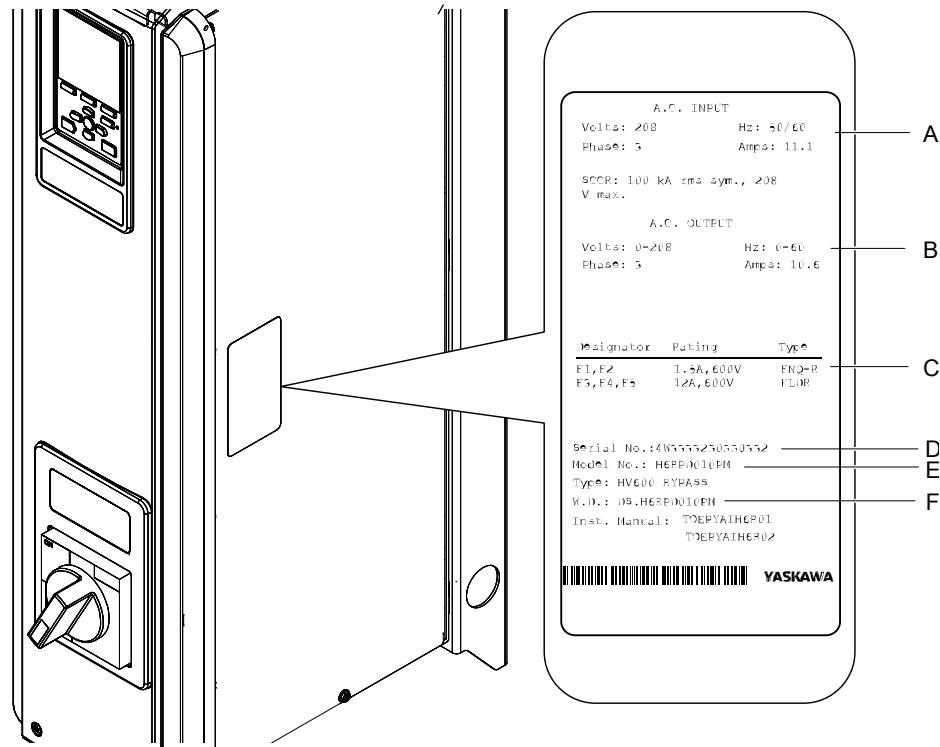

- A - Input specifications** **D - Serial number**
B - Output specifications **E - Bypass model number**
C - Replacement fuse specifications **F - Schematic document number**

Figure 1.1 Narrow Bypass Nameplate Location Example

◆ Enclosed Bypass Nameplate

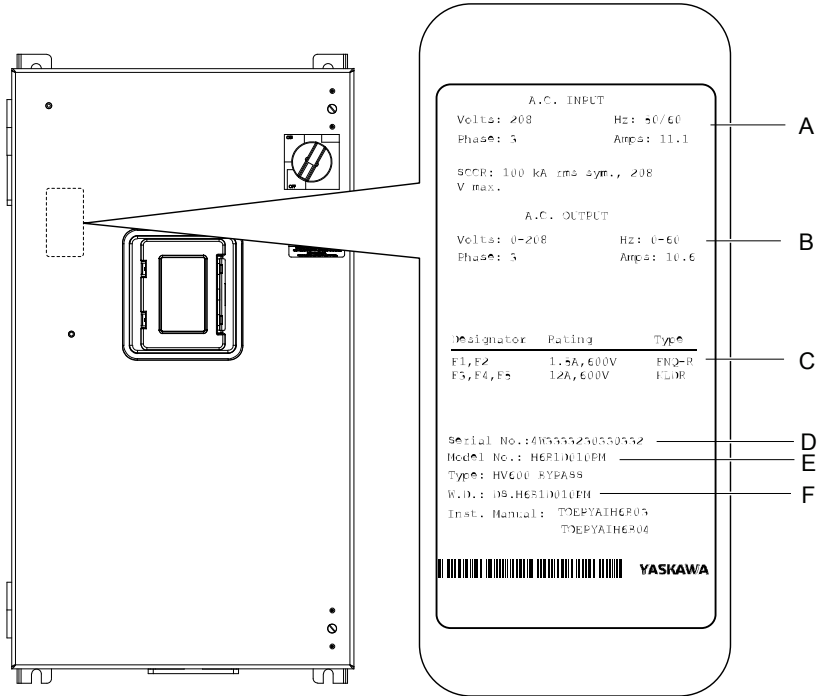
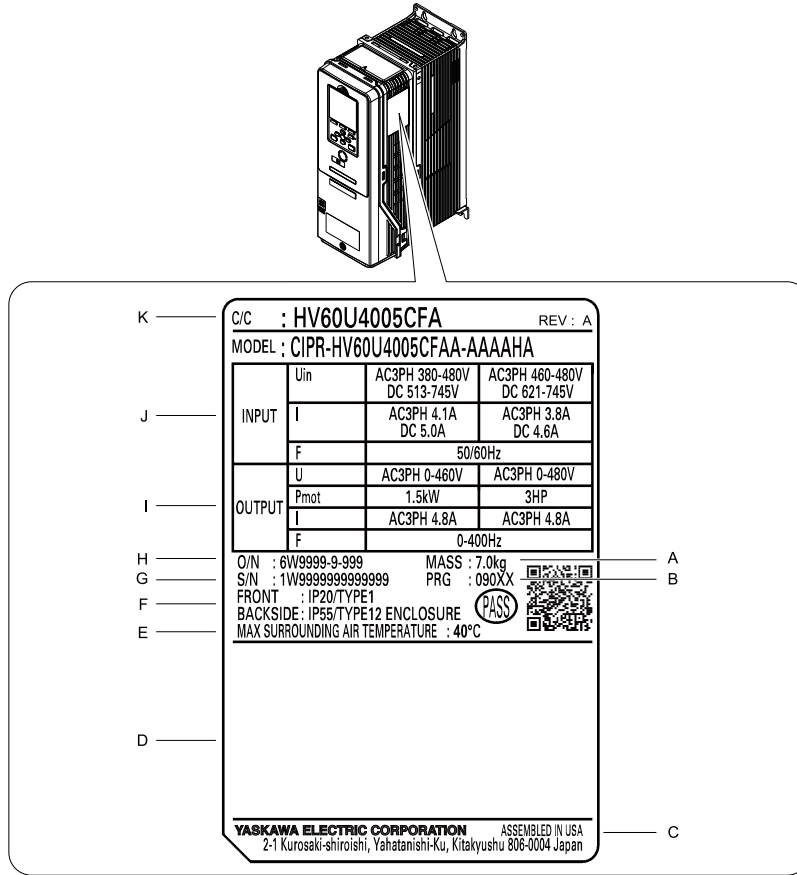

Figure 1.2 Enclosed Bypass Nameplate Location Example

◆ Drive Nameplate



- A - Weight
- B - Drive software version
- C - The address of the head office of Yaskawa Electric Corporation
- D - Accreditation standards
- E - Ambient Temperature Setting
- F - Protection design
- G - Product number
- H - Serial number
- I - Output specifications
- J - Input specifications
- K - Catalog code

Figure 1.3 Drive Nameplate Location

◆ How to Read Narrow Bypass Catalog Codes

Use the information in Figure 1.4 and Table 1.1 to read the bypass catalog codes.

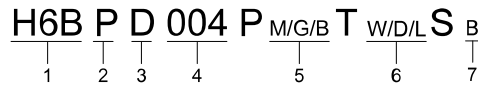

Figure 1.4 Narrow Bypass Catalog Code

Table 1.1 Narrow Bypass Catalog Code Details

No.	Description
1	Product series
2	Bypass type <ul style="list-style-type: none"> • P: IP20/UL Type 1 Narrow • N: IP55/UL Type 12 Narrow
3	Input power supply voltage <ul style="list-style-type: none"> • D: Three-Phase 208 V • B: Three-Phase 480 V

1.2 Catalog Code and Nameplate Check

No.	Description
4	Bypass output amps
5	Power options <ul style="list-style-type: none"> • M: Lockable circuit breaker (100 kA SCCR Panel Rating) • B: 3-contactor bypass • G: Drive input service switch
6	Control options <ul style="list-style-type: none"> • W: Custom nameplate • D: EtherNet/IP • L: LonWorks
7	Special options <ul style="list-style-type: none"> • B: Bluetooth HOA keypad

■ Narrow Bypass Models, Drive Models, and Capacities

Table 1.2 Three-Phase AC 208 V Narrow Models and Capacities (NEMA Rating)

Bypass Model H6BP	Capacity			Drive Catalog Code HV60U	Electrical Schematic	Weight (lb)
	HP	Input (A)	Output (A)			
D002	0.5	2.9	2.4	2011	DS.H6BP.01	55
D003	0.75	4.0	3.5	2011	DS.H6BP.01	55
D004	1	5.1	4.6	2011	DS.H6BP.01	55
D007	2	8.0	7.5	2011	DS.H6BP.01	55
D010	3	11.1	10.6	2011	DS.H6BP.01	55
D016	5	17.2	16.7	2017	DS.H6BP.01	55
D024	7.5	24.7	24.2	2024	DS.H6BP.01	62
D030	10	31.3	30.8	2031	DS.H6BP.01	64
D046	15	46.7	46.2	2046	DS.H6BP.01	87
D059	20	59.9	59.4	2059	DS.H6BP.01	92
D074	25	75.3	74.8	2075	DS.H6BP.01	128

Table 1.3 Three-Phase AC 480 V Narrow Models and Capacities (NEMA Rating)

Bypass Model H6BP	Capacity			Drive Catalog Code HV60U	Electrical Schematic	Weight (lb)
	HP	Input (A)	Output (A)			
B1P1	0.5	1.3	1.1	4005	DS.H6BP.01	56
B001	0.75	1.8	1.6	4005	DS.H6BP.01	56
B002	1	2.3	2.1	4005	DS.H6BP.01	56
B003	2	3.6	3.4	4005	DS.H6BP.01	56
B004	3	5.0	4.8	4005	DS.H6BP.01	56
B007	4	7.8	7.6	4008	DS.H6BP.01	56
B011	7.5	11.2	11.0	4011	DS.H6BP.01	56
B014	10	14.2	14.0	4014	DS.H6BP.01	56
B021	15	21.2	21.0	4021	DS.H6BP.01	62
B027	20	27.2	27.0	4027	DS.H6BP.01	65
B034	25	34.2	34.0	4034	DS.H6BP.01	81
B040	30	40.2	40.0	4040	DS.H6BP.01	90
B052	40	52.2	52.0	4052	DS.H6BP.01	96
B065	50	65.2	65.0	4065	DS.H6BP.01	121
B077	60	77.2	77.0	4077	DS.H6BP.01	135

◆ How to Read Enclosed Bypass Catalog Codes

Use the information in [Figure 1.5](#) and [Table 1.4](#) to read the bypass catalog codes.

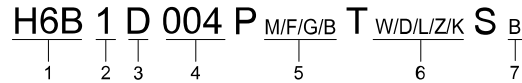

Figure 1.5 Enclosed Bypass Catalog Code

Table 1.4 Enclosed Bypass Catalog Code Details

No.	Description
1	Product series
2	Enclosure type <ul style="list-style-type: none"> • 1: IP20/UL Type 1 Enclosed • 2: IP55/UL Type 12 Enclosed • 3: Type 3R Enclosed
3	Input power supply voltage <ul style="list-style-type: none"> • D: Three-Phase 208 V • A: Three-Phase 240 V • B: Three-Phase 480 V
4	Bypass output amps
5	Power options <ul style="list-style-type: none"> • M: Lockable circuit breaker (100 kA SCCR Panel Rating) • F: Input fuses • G: Drive input service switch • B: 3-contactor bypass
6	Control options <ul style="list-style-type: none"> • W: Custom nameplate • D: EtherNet/IP • L: LonWorks • Z: Speed potentiometer • K: Control transformer - 200 VA additional
7	Special options <ul style="list-style-type: none"> • B: Bluetooth HOA keypad

Receiving

1

■ Enclosed Bypass Models, Drive Models, and Capacities

Table 1.5 Three-Phase AC 208 V Enclosed Models and Capacities (NEMA Rating)

Bypass Model H6B1	Capacity			Drive Catalog Code HV60U	Electrical Schematic	Weight (lb)
	HP	Input (A)	Output (A)			
D002	0.5	3.8	2.4	2011	DS.H6B1.01	93
D003	0.75	4.9	3.5	2011	DS.H6B1.01	93
D004	1	6.0	4.6	2011	DS.H6B1.01	93
D007	2	8.9	7.5	2011	DS.H6B1.01	93
D010	3	12.0	10.6	2011	DS.H6B1.01	93
D016	5	18.1	16.7	2017	DS.H6B1.01	93
D024	7.5	25.6	24.2	2024	DS.H6B1.01	125
D030	10	32.2	30.8	2031	DS.H6B1.01	128
D046	15	48.6	46.2	2046	DS.H6B1.01	159
D059	20	61.8	59.4	2059	DS.H6B1.01	163
D074	25	77.2	74.8	2075	DS.H6B1.01	224
D088	30	90.4	88	2088	DS.H6B1.01	233
D114	40	116.4	114	2114	DS.H6B1.01	248

1.2 Catalog Code and Nameplate Check

Bypass Model H6B1	Capacity			Drive Catalog Code HV60U	Electrical Schematic	Weight (lb)
	HP	Input (A)	Output (A)			
D143	50	145.4	143	2143	DS.H6B1.01	419
D169	60	171.4	169	2169	DS.H6B1.01	434
D211	75	213.4	211	2211	DS.H6B1.01	832
D273	100	275.4	273	2273	DS.H6B1.01	859

Table 1.6 Three-Phase AC 240 V Enclosed Models and Capacities (NEMA Rating)

Bypass Model H6B1	Capacity			Drive Catalog Code HV60U	Electrical Schematic	Weight (lb)
	HP	Input (A)	Output (A)			
A002	0.5	3.5	2.2	2011	DS.H6B1.01	93
A003	0.75	4.5	3.2	2011	DS.H6B1.01	93
A004	1	5.5	4.2	2011	DS.H6B1.01	93
A006	2	8.1	6.8	2011	DS.H6B1.01	93
A009	3	10.9	9.6	2011	DS.H6B1.01	93
A015	5	16.5	15.2	2017	DS.H6B1.01	93
A022	7.5	23.3	22	2024	DS.H6B1.01	125
A028	10	29.3	28	2031	DS.H6B1.01	128
A042	15	44.1	42	2046	DS.H6B1.01	159
A054	20	56.1	54	2059	DS.H6B1.01	163
A068	25	70.1	68	2075	DS.H6B1.01	224
A080	30	82.1	80	2088	DS.H6B1.01	228
A104	40	106.1	104	2114	DS.H6B1.01	243
A130	50	132.1	130	2143	DS.H6B1.01	414
A154	60	156.1	154	2169	DS.H6B1.01	430
A192	75	193.3	192	2211	DS.H6B1.01	803
A248	100	250.1	248	2273	DS.H6B1.01	859

Table 1.7 Three-Phase AC 480 V Enclosed Models and Capacities (NEMA Rating)

Bypass Model H6B1	Capacity			Drive Catalog Code HV60U	Electrical Schematic	Weight (lb)
	HP	Input (A)	Output (A)			
B1P1	0.5	1.7	1.1	4005	DS.H6B1.01	93
B001	0.75	2.2	1.6	4005	DS.H6B1.01	93
B002	1	2.7	2.1	4005	DS.H6B1.01	93
B003	2	4.0	3.4	4005	DS.H6B1.01	93
B004	3	5.4	4.8	4005	DS.H6B1.01	93
B007	5	8.2	7.6	4008	DS.H6B1.01	94
B011	7.5	11.6	11	4011	DS.H6B1.01	94
B014	10	14.6	14	4014	DS.H6B1.01	94
B021	15	21.6	21	4021	DS.H6B1.01	125
B027	20	27.6	27	4027	DS.H6B1.01	129
B034	25	35.0	34	4034	DS.H6B1.01	137
B040	30	41.0	40	4040	DS.H6B1.01	162
B052	40	53.0	52	4052	DS.H6B1.01	168
B065	50	66.0	65	4065	DS.H6B1.01	179
B077	60	78.0	77	4077	DS.H6B1.01	233

Bypass Model H6B1	Capacity			Drive Catalog Code HV60U	Electrical Schematic	Weight (lb)
	HP	Input (A)	Output (A)			
B096	75	97.0	96	4096	DS.H6B1.01	247
B124	100	125.0	124	4124	DS.H6B1.01	263
B156	125	157.0	156	4156	DS.H6B1.01	431
B180	150	180.6	180	4180	DS.H6B1.01	803
B240	200	241.0	240	4240	DS.H6B1.01	857
B302	250	303.0	302	4302	DS.H6B1.01	964

◆ Bypass Enclosures

All bypass units are for installation in non-hazardous locations.

IP20/UL Type 1 Enclosures are for indoor use and provide a degree of protection against incidental contact with enclosed electrical equipment and falling dust or dirt.

IP55/UL Type 12 Enclosures are for indoor use and provide a degree of protection against incidental contact with enclosed electrical equipment and falling dust or dirt, and a degree of protection against harmful effects on the equipment from water.

◆ Features and Advantages of V/f Control Method

Table 1.8 gives information about the features of the V/f control method.

Table 1.8 Features and Advantages of V/f Control Method

Control Method Selection	V/f Control	Notes
Basic Control	V/f	-
Main Applications	General-purpose variable speed control to connect more than one motor to one bypass.	-
Maximum Output Frequency	400 Hz	-
Speed Control Range	1:40	This is the range of variable control. When you connect and operate motors in this mode, think about the increase in motor temperature.
Starting Torque	140%/3 Hz	This is the motor torque that the bypass can supply at low speed during start-up and the related output frequency (rotation speed). You must think about bypass capacity and motor capacity when a large quantity of torque is necessary at low speed.
Auto-Tuning ^{*1}	Rotational and Line-to-Line Resistance (usually not necessary)	Automatically tunes electrical motor parameters.
Torque Limits ^{*1}	No	Controls maximum motor torque to prevent damage to machines and loads.
Speed Search ^{*1}	Yes	Immediately estimates (or detects) motor speed and direction when coasting to a stop to quickly start-up the bypass without stopping the motor.
Automatic Energy-saving Control ^{*1}	Yes	Automatically adjusts the voltage applied to motors to maximize motor efficiency for all load sizes.
High Slip Braking (HSB) ^{*1}	Yes	Increases motor loss to let the motor decelerate faster than usual without a braking resistor. Motor characteristics have an effect on this function.
Overexcitation Deceleration ^{*1}	Yes	Sets the V/f higher than the setting value during deceleration to increase motor loss and decrease deceleration time.
Overvoltage Suppression Function ^{*1}	Yes	Adjusts speed during regeneration to prevent overvoltage.

*1 Note these points when you use this function:

- When you can decouple the motor and machine for a test run, use Rotational Auto-Tuning. You must make adjustments to the control in the range where there is no vibration in the machine after Rotational Auto-Tuning.
- Motor loss increases during overexcitation braking and high-slip braking. Use a maximum braking frequency of 5% ED and a maximum braking time of 90 seconds. After you start high-slip braking, you cannot restart the motor until it stops. Use overexcitation braking to decelerate over a shorter time at a pre-determined speed.

Mechanical Installation

This chapter explains how to properly mount and install the drive.

2.1	Section Safety	32
2.2	Installation Environment	34
2.3	Installation Positions and Clearances	35
2.4	Bypass Components	37
2.5	Bypass Component Names	38
2.6	Moving the Bypass	42
2.7	Removing/Reattaching Covers	44
2.8	Exterior and Mounting Dimensions	54
2.9	Knock-Out Hole Dimensions	66

2.1 Section Safety

WARNING

Electrical Shock Hazard

Only let approved personnel install, wire, maintain, examine, replace parts, and repair the bypass.

If personnel are not approved, it can cause serious injury or death.

Do not modify the bypass body, drive body, bypass circuitry, or drive circuitry.

Modifications to bypass and drive body and circuitry can cause serious injury or death, will cause damage to the bypass and drive, and will void the warranty. Yaskawa is not responsible for modifications of the product made by the user.

Fire Hazard

Do not put flammable or combustible materials on top of the bypass and do not install the bypass near flammable or combustible materials. Attach the bypass to metal or other noncombustible material.

Flammable and combustible materials can start a fire and cause serious injury or death.

Crush Hazard

Only approved personnel can operate a crane or hoist to move the bypass.

If unapproved personnel operate a crane or hoist, it can cause serious injury or death from falling equipment.

Before you hang the bypass vertically, use screws to correctly attach the front cover and other components.

If you do not secure the front cover, it can fall and cause minor injury.

When you use a crane or hoist to lift the bypass during installation or removal, prevent more than 1.96 m/s² (0.2 G) vibration or impact.

Too much vibration or impact can cause serious injury or death from falling equipment.

When you lift the bypass during installation or removal, do not try to turn it over and do not ignore a hanging bypass.

If you move a hanging bypass too much or if you ignore it, it can fall and cause serious injury or death.

Use a crane or hoist to move large bypasses when necessary.

If you try to move a large bypass without a crane or hoist, it can cause serious injury or death.

CAUTION

Crush Hazard

Tighten terminal cover screws and hold the case safely when you move the bypass.

If the bypass or covers fall, it can cause moderate injury.

NOTICE

Do not let unwanted objects, for example metal shavings or wire clippings, fall into the bypass during installation. Put a temporary cover over the bypass during installation. Remove the temporary cover before start-up.

Unwanted objects inside of the bypass can cause damage to the bypass.

Damage to Equipment

When you touch the drive and bypass circuit boards, make sure that you observe correct electrostatic discharge (ESD) procedures.

If you do not follow procedures, it can cause ESD damage to the drive and bypass circuitry.

Install vibration-proof rubber on the base of the motor or use the frequency jump function in the bypass to prevent specific frequencies that vibrate the motor.

Motor or system resonant vibration can occur in fixed speed machines that are converted to variable speed. Too much vibration can cause damage to equipment.

2.2 Installation Environment

The installation environment is important for the lifespan of the product and to make sure that the bypass performance is correct. Make sure that the installation environment agrees with these specifications.

Environment	Conditions
Area of Use	Indoors
Ambient Temperature Setting	IP20/UL Type 1: -10 °C to +40 °C (14 °F to 104 °F) IP55/UL Type 12: -10 °C to +40 °C (14 °F to 104 °F) • Do not let the bypass freeze.
Humidity	98% RH or less Do not let condensation form on the bypass.
Storage Temperature	-20 °C to +70 °C (-4 °F to +158 °F) (short-term temperature during transportation)
Surrounding Area	Pollution degree 2 or less Install the bypass in an area without: <ul style="list-style-type: none"> • Oil mist, corrosive or flammable gas, or dust • Metal powder, oil, water, or other unwanted materials • Radioactive materials or flammable materials, including wood • Harmful gas or fluids • Salt • Direct sunlight Keep wood and other flammable materials away from the bypass.
Altitude	1000 m (3281 ft) maximum Note: Derate the output current by 1% for each 100 m (328 ft) to install the bypass in altitudes between 1000 m to 4000 m (3281 ft to 13123 ft). It is not necessary to derate the rated voltage in these conditions: <ul style="list-style-type: none"> • When you install the bypass at 2000 m (6562 ft) or lower • When you install the bypass between 2000 m to 4000 m (6562 ft to 13123 ft) and ground the neutral point on the power supply.
Vibration	<ul style="list-style-type: none"> • 10 Hz to 20 Hz: 1 G (9.8 m/s², 32.15 ft/s²) • 20 Hz to 55 Hz: H6BPD002 to D030, H6BPP1P1, B001 to B034: 0.6 G (5.9 m/s², 19.36 ft/s²) H6BPD046 to H6BPD074, H6BPP040 to B077: 0.2 G (1.96 m/s², 6.43 ft/s²) • 20 Hz to 55 Hz: H6B1D002 to D030, H6B1A002 to A028, H6B1B1P1, B001 to B034: 0.6 G (5.9 m/s², 19.36 ft/s²) H6B1D046 to D273, H6B1A042 to A248, H6B1B040 to B302: 0.2 G (1.96 m/s², 6.43 ft/s²)
Installation Orientation	Install the bypass vertically for sufficient cooling airflow.

NOTICE: Do not let unwanted objects, for example metal shavings or wire clippings, fall into the bypass during installation. Put a temporary cover over the bypass during installation. Remove the temporary cover before start-up. Unwanted objects inside of the bypass can cause damage to the bypass.

Note:

Do not put peripheral devices, transformers, or other electronics near the bypass. Shield the bypass from electrical interference if components must be near the bypass. The bypass or the devices around the bypass may malfunction due to electrical interference.

2.3 Installation Positions and Clearances

◆ Narrow Bypass Installation Position and Clearances

■ Installation Dimensions

Refer to the Dimension Drawing (DD.HB.x.xx.xx) packaged with the bypass for exterior and mounting dimensions for your model.

■ Installation Position

Install the bypass vertically for sufficient cooling airflow.

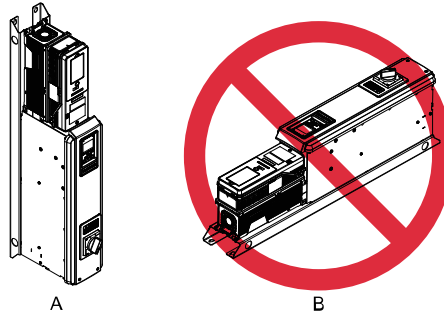

A - Vertical installation

B - Horizontal installation

Figure 2.1 Installation Position

■ Single Narrow Bypass Installation Clearances

Use the clearances specified in Figure 2.2 to install the bypass. Make sure that there is sufficient space for wiring and airflow.

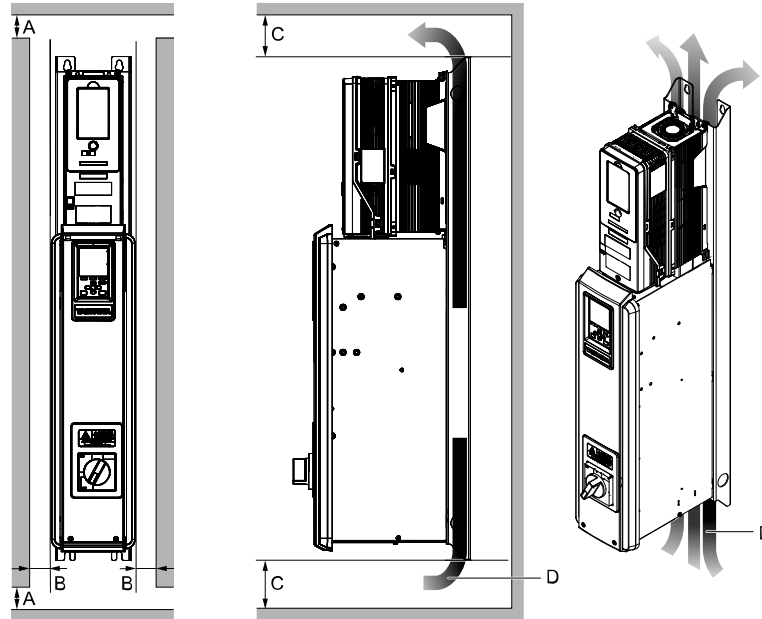

A - 50 mm (2 in) minimum
B - 30 mm (1.2 in) minimum

C - 120 mm (4.7 in) minimum ^{*1}
D - Airflow direction

Figure 2.2 Single Bypass Installation

*1 This is the distance from a component or mounting bracket that has the maximum height. The highest component is different for different models.

◆ Enclosed Bypass Installation Position and Clearances

■ Installation Dimensions

Refer to the Dimension Drawing (DD.HB.x.xx.xx) packaged with the bypass for exterior and mounting dimensions for your model.

■ Installation Position

Install the bypass vertically for sufficient cooling airflow.

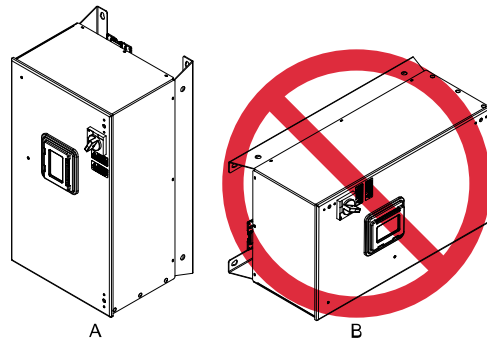

A - Vertical installation

B - Horizontal installation

Figure 2.3 Installation Position

■ Single Enclosed Bypass Installation Clearances

Use the clearances specified in Figure 2.4 to install the bypass. Make sure that there is sufficient space for wiring and airflow.

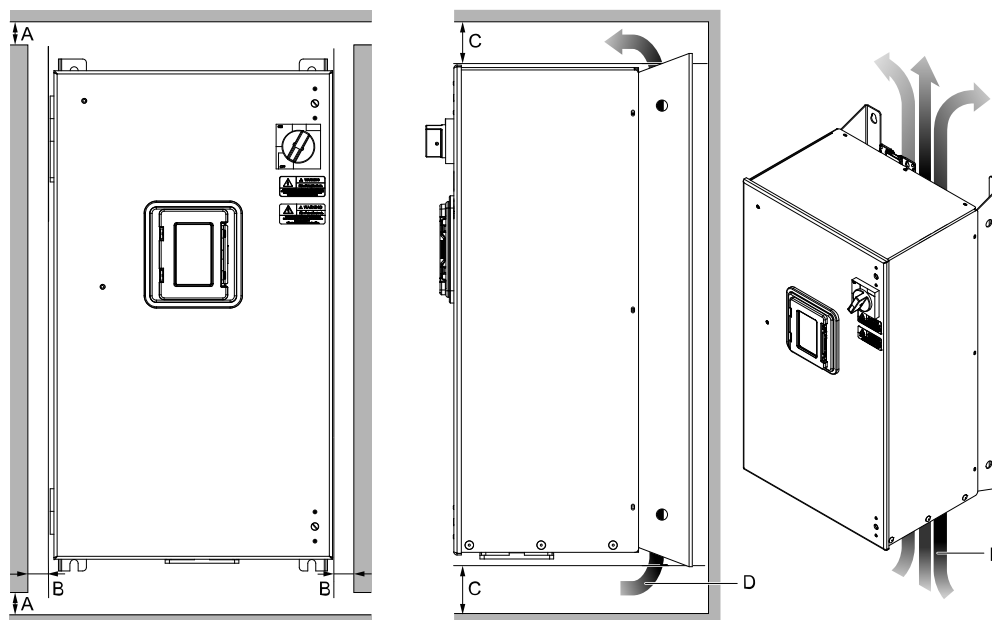

A - 50 mm (2 in) minimum
B - 102 mm (4 in) minimum

C - 152 mm (6 in) minimum ^{*1}
D - Airflow direction

Figure 2.4 Single Bypass Installation

*1 This is the distance from a component or mounting bracket that has the maximum height. The highest component is different for different models.

2.4 Bypass Components

◆ Input Disconnect Switch

Electrically located on the input power side of the bypass, the door mounted rotary input disconnect switch provides a way to disconnect bypass from line power for equipment maintenance. Put the disconnect in the OFF position to open the bypass enclosure door. When open, you can use a padlock to lock the handle in the OFF position. The customer must supply branch short circuit protection for the bypass.

◆ Contactors

The bypass is a 2-contactor or 3-contactor bypass circuit employing IEC rated contactors in an electrically interlocked arrangement to allow mutually exclusive operation in Drive or Bypass modes.

The control logic and “soft start” characteristic of the drive limit the drive input and output contactors to motor FLA current or less. For this reason, the drive output contactor has a lower current rating than the bypass contactor. The bypass contactor is exposed to motor inrush current (LRA) when starting the motor across-the-line and therefore requires a higher current rating.

◆ Overload Relay

Electronic overload relay consists of bypass relay board and two pass-through current transformers. Overload relay functions, settings, adjustments and reset operations are done through the keypad. The bypass three-phase output power connection to the motor is made to terminal block TB3.

◆ Control Power Transformer

A Control Power Transformer (CPT) is provided to power the bypass 120 Vac control circuit. The VA capacity is determined by the control circuit and optional functions specified for the unit. The CPT primary is fused in both legs, the secondary is fused when required by NEC (transformer VA and wire size dependent). One side of the transformer secondary is grounded to the bypass enclosure.

2.5 Bypass Component Names

◆ Narrow Bypass Component Names

This section gives an overview of the Narrow Bypass components described in this manual.

- 208 V Narrow Models: H6BPD002 to D074
- 480 V Narrow Models: H6BPB1P1, B001 to B077

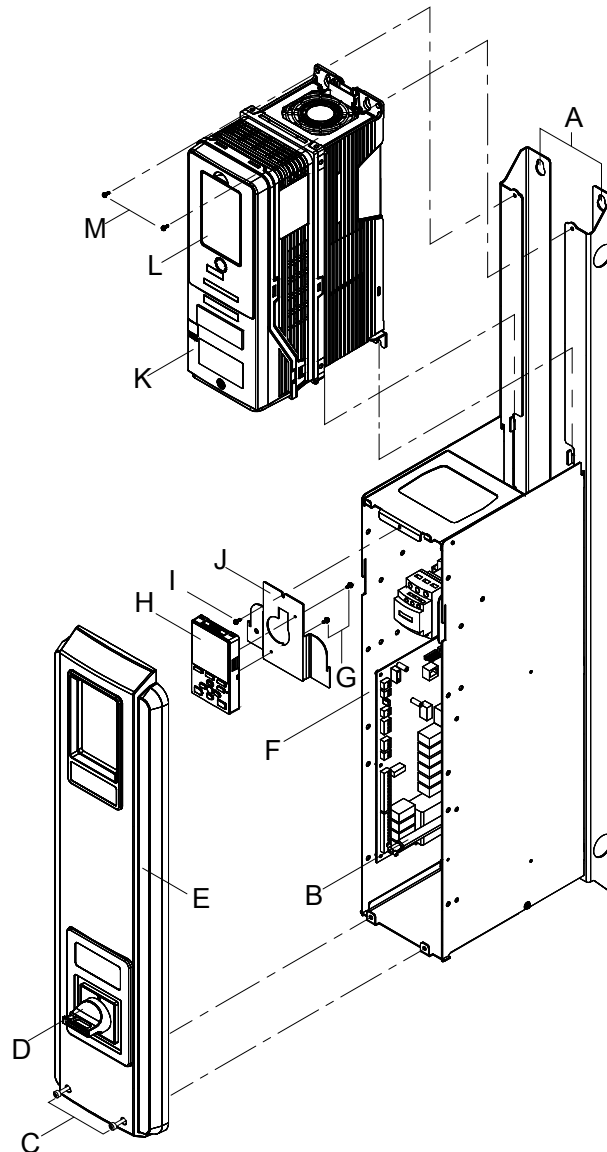

- | | |
|---------------------------------------|-----------------------------------|
| A - Bypass bracket mounting hole | H - Keypad |
| B - Disconnect shaft | I - Keypad mounting bracket screw |
| C - Bypass front cover captive screws | J - Keypad mounting bracket |
| D - Disconnect handle | K - Drive |
| E - Bypass front cover | L - Blank keypad |
| F - Bypass enclosure | M - Drive mounting screw |
| G - Keypad mounting screw | |

Figure 2.5 Exploded View of Components (Example Narrow Model D024)

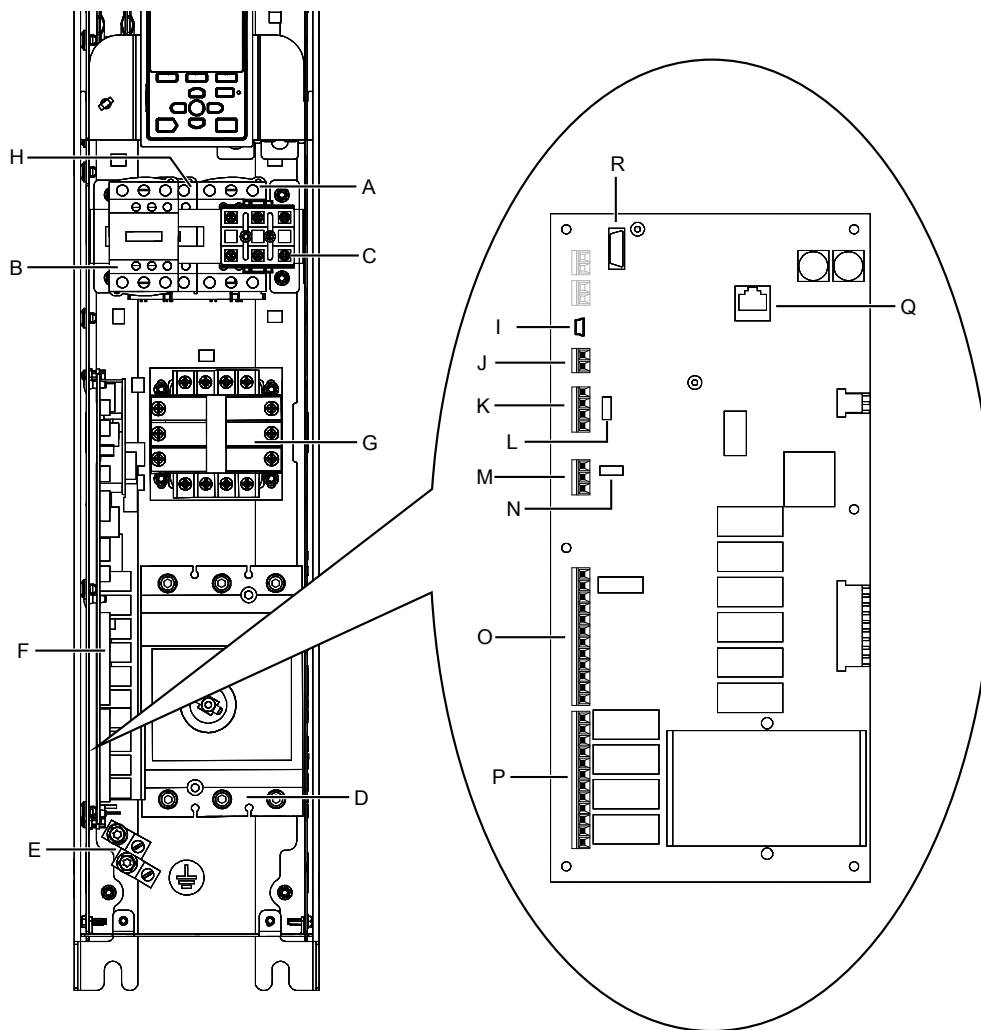

- A - Output contactor K2**
- B - Input contactor K1**
- C - Motor connections**
- D - Input power terminals**
- E - Ground terminals**
- F - A2 bypass control board**
- G - 120 V control transformer**
- H - Bypass contactor K3**
- I - USB port CN1**

- J - Terminal TB6 (Ground)**
- K - Terminal TB3 (Serial Comms)**
- L - RS-485 terminator switch S1**
- M - Terminal TB4 (Analog Input)**
- N - Analog input V or I switch S2**
- O - Terminal TB2 (Digital Inputs)**
- P - Terminal TB1 (Digital Outputs)**
- Q - Digital operator port CN2**
- R - Option card connector CN5**

Figure 2.6 Front View of Narrow Components

◆ Enclosed Bypass Component Names

This section gives an overview of the Enclosed Bypass components described in this manual.

- 208 V Enclosed Models: H6B1D002 to D273
- 240 V Enclosed Models: H6B1A002 to A248
- 480 V Enclosed Models: H6B1B1P1, B001 to B302

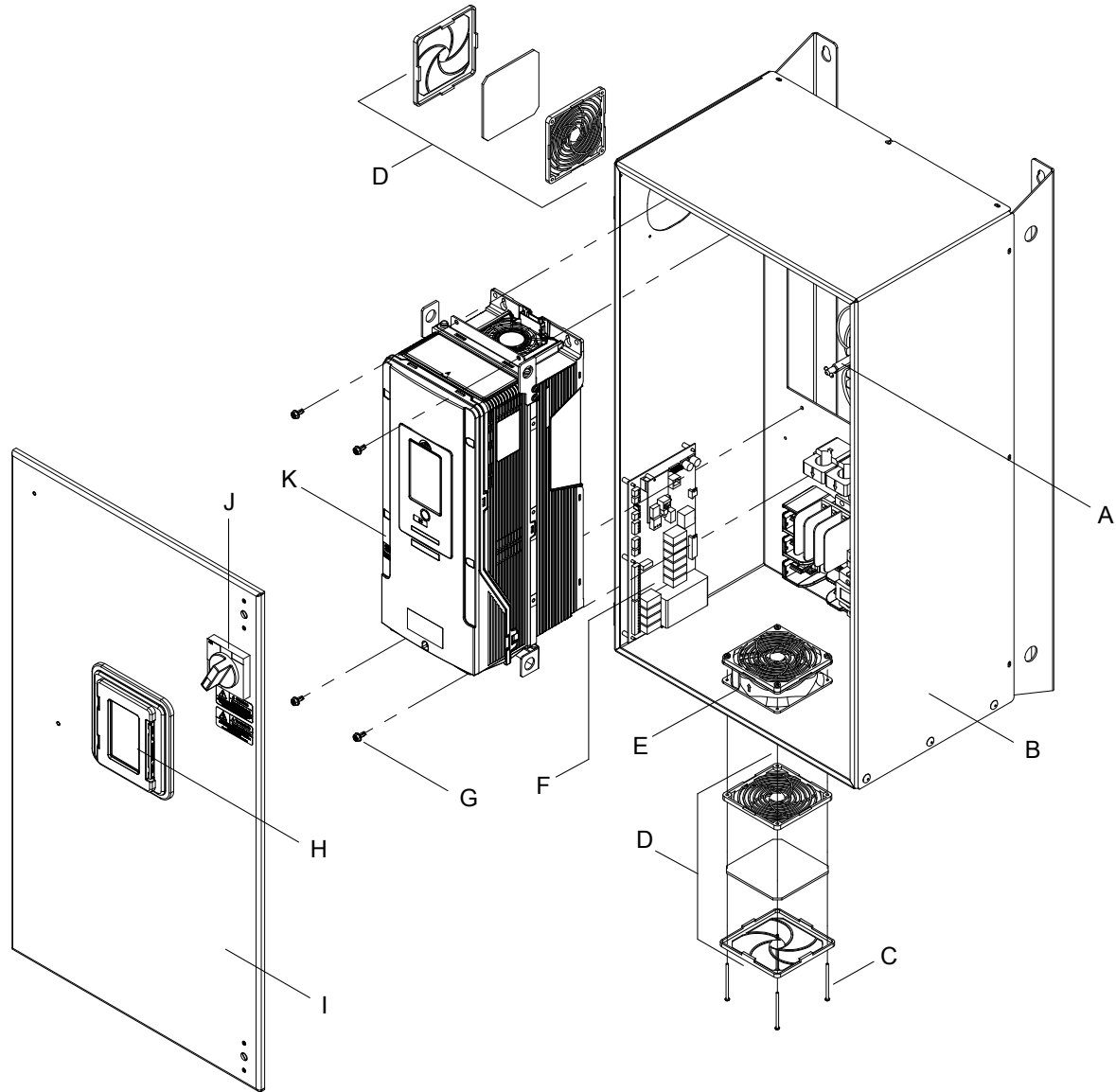

- | | |
|--------------------------|---------------------------------|
| A - Disconnect shaft | G - Drive mounting screws |
| B - Bypass enclosure | H - HOA keypad |
| C - Fan mounting screws | I - Bypass enclosure front door |
| D - Fan cover assembly | J - Disconnect switch |
| E - Bypass enclosure fan | K - HV600 drive |
| F - Bypass PCB A2 | |

Figure 2.7 Exploded View of Components (Enclosed Model D046 Example)

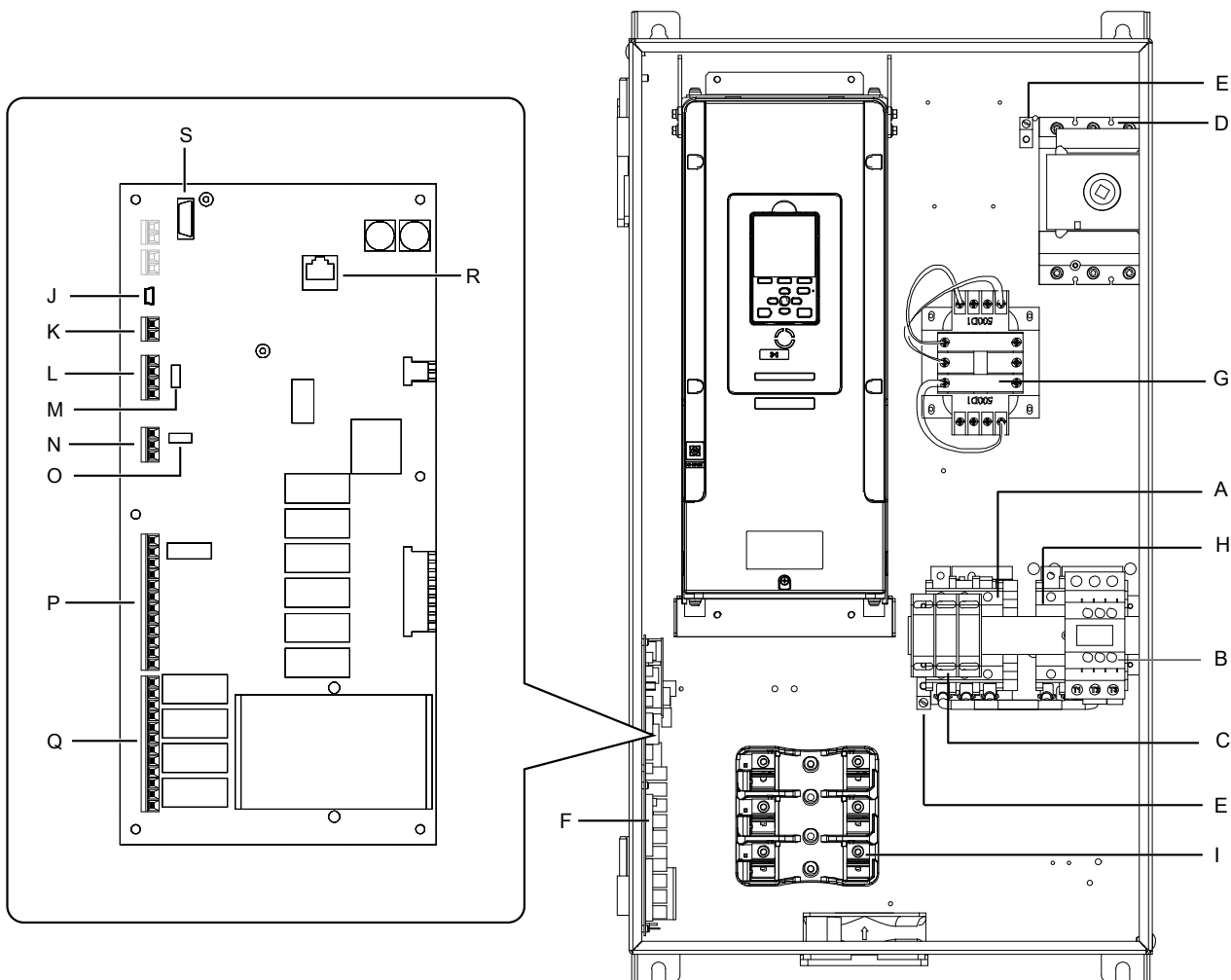

- A - Output contactor K2
- B - Input contactor K1
- C - Motor connections
- D - Input power terminals
- E - Ground terminals
- F - Bypass PCB A2
- G - 120 V control transformer
- H - Bypass contactor K3
- I - Fuse block
- J - USB port CN1

- K - Terminal TB6 (Ground)
- L - Terminal TB3 (Serial Comms)
- M - RS-485 terminator switch S1
- N - Terminal TB4 (Analog Input)
- O - Analog input V or I switch S2
- P - Terminal TB2 (Digital Inputs)
- Q - Terminal TB1 (Digital Outputs)
- R - Digital operator port CN2
- S - Option card connector CN5

Figure 2.8 Front View of Enclosed Components

2.6 Moving the Bypass

Obey local laws and regulations when you move and install this product.

CAUTION! *Crush Hazard. Tighten terminal cover screws and hold the case safely when you move the bypass. If the bypass or covers fall, it can cause moderate injury.*

Bypass Weight	Persons Necessary to Move the Bypass
< 15 kg (33 lbs.)	1
≥ 15 kg (33 lbs.)	2 + using appropriate lifting equipment

Refer to [Using the Mounting Rails to Move the Bypass on page 42](#) for information about how to use suspension systems, wires, or hanging metal brackets to move the bypass.

◆ Using the Mounting Rails to Move the Bypass

Use the holes in the mounting rails attached to the bypass to temporarily lift the bypass when you install it. Do not let the bypass stay vertically or horizontally suspended or move the bypass over a long distance while it is suspended.

Before you install the bypass, make sure that you read these precautions:

WARNING! *Crush Hazard. Before you hang the bypass vertically, use screws to correctly attach the front cover and other components. If you do not secure the front cover, it can fall and cause minor injury.*

WARNING! *Crush Hazard. When you use a crane or hoist to lift the bypass during installation or removal, prevent more than 1.96 m/s² (0.2 G) vibration or impact. Too much vibration or impact can cause serious injury or death from falling equipment.*

WARNING! *Crush Hazard. When you lift the bypass during installation or removal, do not try to turn it over and do not ignore a hanging bypass. If you move a hanging bypass too much or if you ignore it, it can fall and cause serious injury or death.*

■ Vertical Suspension

To use the hanging brackets to vertically suspend the drive, lift the drive with this procedure:

1. Put wire through the two holes in the hanging brackets.

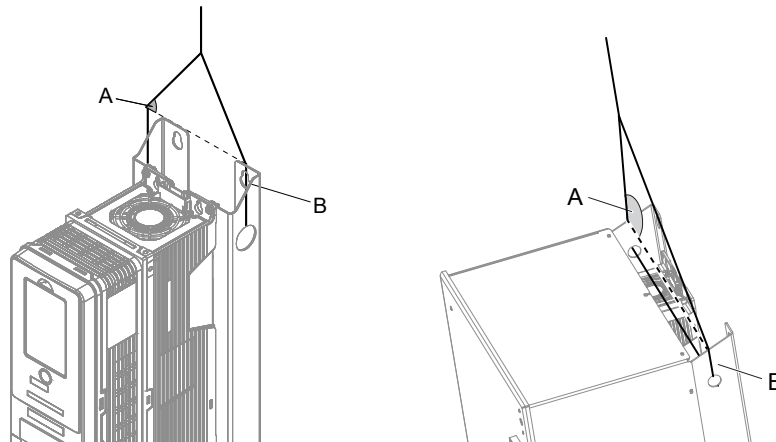

A - Suspension angle of at least 50 degrees

B - Hanging bracket (2)

Figure 2.9 Vertical Suspension

2. Use a crane to gradually wind up the wire. Visually make sure that there is sufficient tension in the wire, then lift the drive to its correct location.
3. Prepare the control panel for installation, then lower the drive.

Note:

When you lower the drive, stop before the drive touches the floor, then slowly lower it the remaining distance.

■ Horizontal Suspension

When horizontal suspension is necessary, use this procedure to hang the bypass:

1. Put the bypass on the ground horizontally.

NOTICE: When you attach a horizontal lifting cable or chain to the bypass, use a jig or pad between the wire and the bypass. The wire can scratch the drive and cause damage to the bypass.

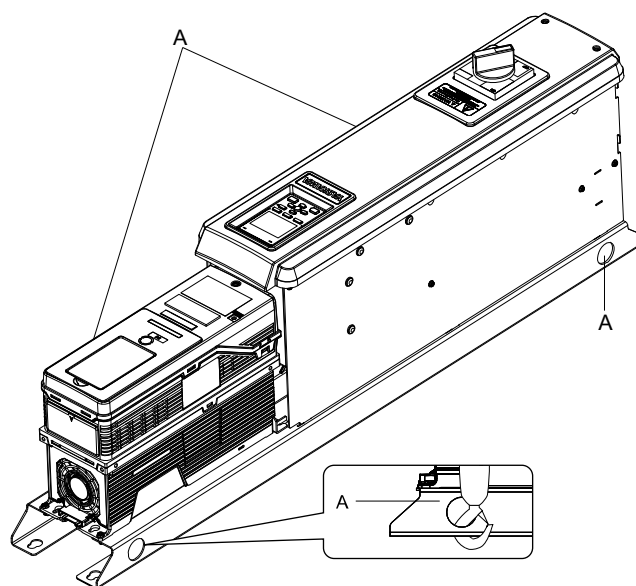

A - Hanging bracket (4)

Figure 2.10 Horizontal Suspension

2. Connect wires to the four hanging brackets.
3. Use a crane to lift the bypass.

2.7 Removing/Reattaching Covers

This section gives information about how to open and close and remove and reattach the bypass front cover and drive front cover and terminal cover for wiring and inspection.

Table 2.1 Procedures to Remove Narrow Covers by Model

Bypass Model H6BP	Removing the Bypass Cover	Removing the Drive Cover
D002 - D074 B1P1, B001 - B077	Procedure 1 44	Procedure A 46

Table 2.2 Procedures to Remove Enclosed Covers by Model

Bypass Model H6B1	Opening the Bypass Cover	Removing the Drive Cover
D002 - D114 A002 - A104 B1P1, B001 - B124	Procedure 2 48	Procedure A 46
D143 - D273 A130 - A248 B156 - B302		Procedure B 46

◆ Removing/Reattaching the Bypass Cover Using Procedure 1

DANGER! Electrical Shock Hazard. Do not examine, connect, or disconnect wiring on an energized bypass. Before servicing, disconnect all power to the equipment and wait for the time specified on the warning label at a minimum. The internal capacitor stays charged after the bypass is de-energized. The charge indicator LED extinguishes when the DC bus voltage decreases below 50 Vdc. When all indicators are OFF, remove the covers before measuring for dangerous voltages to make sure that the bypass is safe. If you do work on the bypass when it is energized, it will cause serious injury or death from electrical shock.

1. Turn the disconnect handle to the "OFF" position.

DANGER! Electrical Shock Hazard. Do not examine, connect, or disconnect wiring on an energized bypass. Before servicing, disconnect all power to the equipment and wait for the time specified on the warning label at a minimum. The internal capacitor stays charged after the bypass is de-energized. The charge indicator LED extinguishes when the DC bus voltage decreases below 50 Vdc. When all indicators are OFF, remove the covers before measuring for dangerous voltages to make sure that the bypass is safe. If you do work on the bypass when it is energized, it will cause serious injury or death from electrical shock.

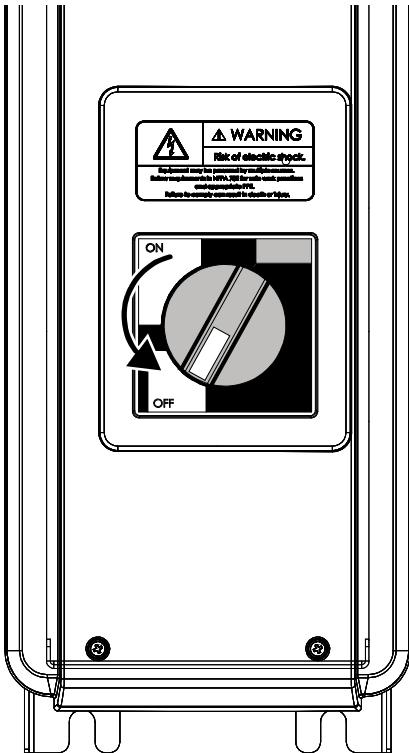

Figure 2.11 Disconnect Power

- 2. Loosen the captive front cover screws.

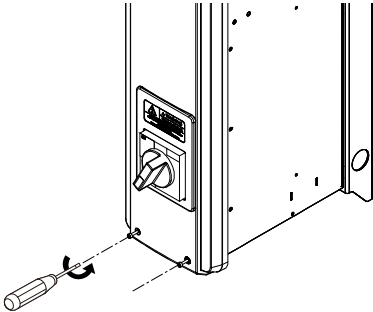

Figure 2.12 Loosen the Front Cover Screws

3. Lift up the cover and gently pull forward to remove the front cover.

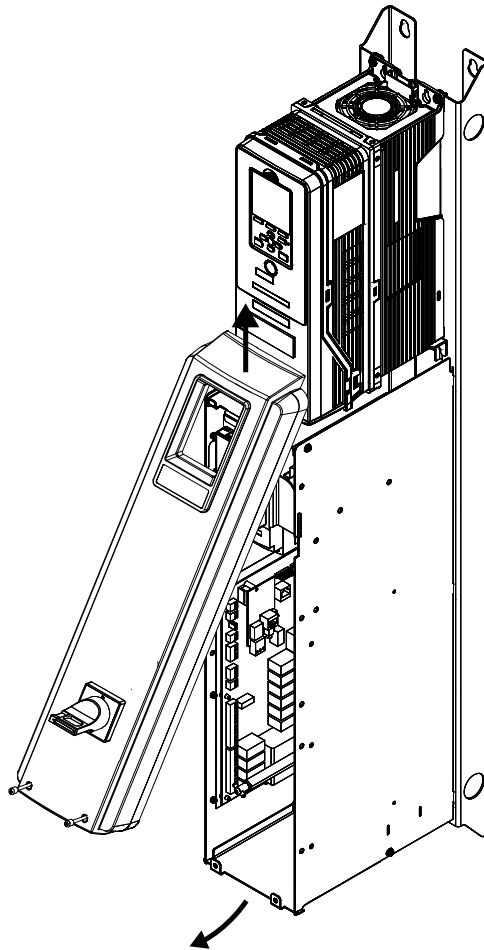

Figure 2.13 Remove the Front Cover

4. Reverse the steps to reattach the cover.

◆ Removing/Reattaching the Drive Cover Using Procedure A

DANGER! *Electrical Shock Hazard. Do not examine, connect, or disconnect wiring on an energized bypass. Before servicing, disconnect all power to the equipment and wait for the time specified on the warning label at a minimum. The internal capacitor stays charged after the bypass is de-energized. The charge indicator LED extinguishes when the DC bus voltage decreases below 50 Vdc. When all indicators are OFF, remove the covers before measuring for dangerous voltages to make sure that the bypass is safe. If you do work on the bypass when it is energized, it will cause serious injury or death from electrical shock.*

■ Remove the Front Cover

1. Remove the bypass front cover in Procedure A

- Loosen the front cover screw.

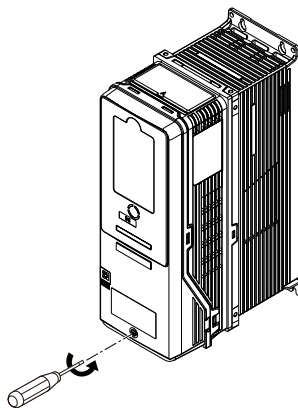

Figure 2.14 Loosen the Front Cover Screw

- Push on the tabs in the sides of the front cover then pull the front cover forward to remove it from the drive.

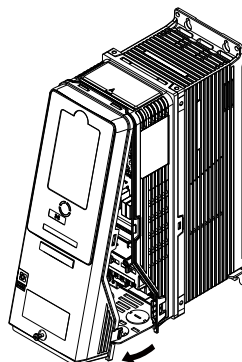

Figure 2.15 Remove the Front Cover

■ Reattach the Front Cover

- Wire the drive and other peripheral devices.
- Reverse the steps to reattach the cover.

Note:

- Make sure that you did not pinch wires or signal lines between the front cover and the drive before you reattach the cover.
- Make sure that the tabs on the sides of the front cover correctly click into the hook.
- Tighten the screws to a tightening torque of 0.98 N·m to 1.33 N·m (8.67 in·lb to 11.77 in·lb).

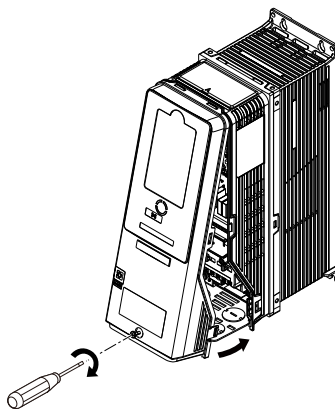

Figure 2.16 Reattach the Front Cover

◆ Opening/Closing the Bypass Cover Using Procedure 2

DANGER! Electrical Shock Hazard. Do not examine, connect, or disconnect wiring on an energized bypass. Before servicing, disconnect all power to the equipment and wait for the time specified on the warning label at a minimum. The internal capacitor stays charged after the bypass is de-energized. The charge indicator LED extinguishes when the DC bus voltage decreases below 50 Vdc. When all indicators are OFF, remove the covers before measuring for dangerous voltages to make sure that the bypass is safe. If you do work on the bypass when it is energized, it will cause serious injury or death from electrical shock.

1. Turn the disconnect handle to the “OFF” position.

DANGER! Electrical Shock Hazard. Do not examine, connect, or disconnect wiring on an energized bypass. Before servicing, disconnect all power to the equipment and wait for the time specified on the warning label at a minimum. The internal capacitor stays charged after the bypass is de-energized. The charge indicator LED extinguishes when the DC bus voltage decreases below 50 Vdc. When all indicators are OFF, remove the covers before measuring for dangerous voltages to make sure that the bypass is safe. If you do work on the bypass when it is energized, it will cause serious injury or death from electrical shock.

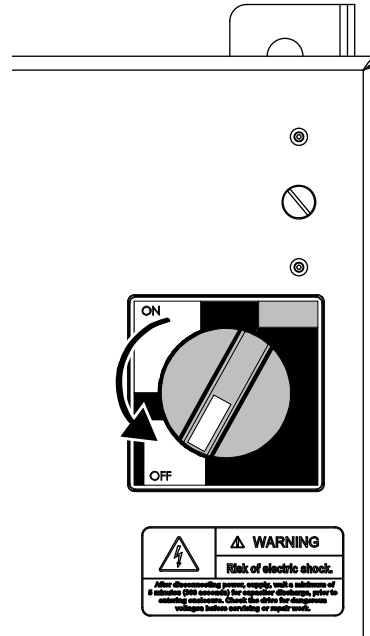

Figure 2.17 Disconnect Power

2. Turn the flat head screw fasteners on the cover 1/2 turn counter-clockwise.

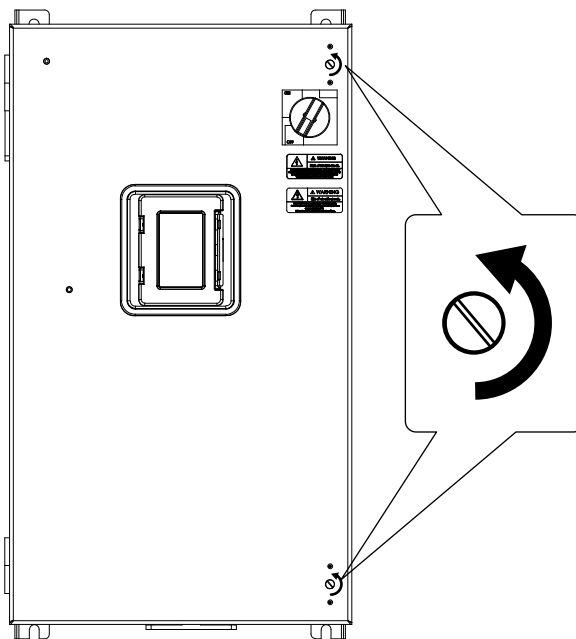

Figure 2.18 Turn the Screw Fasteners

3. The door will now swing open on hinges located on left side of the bypass.

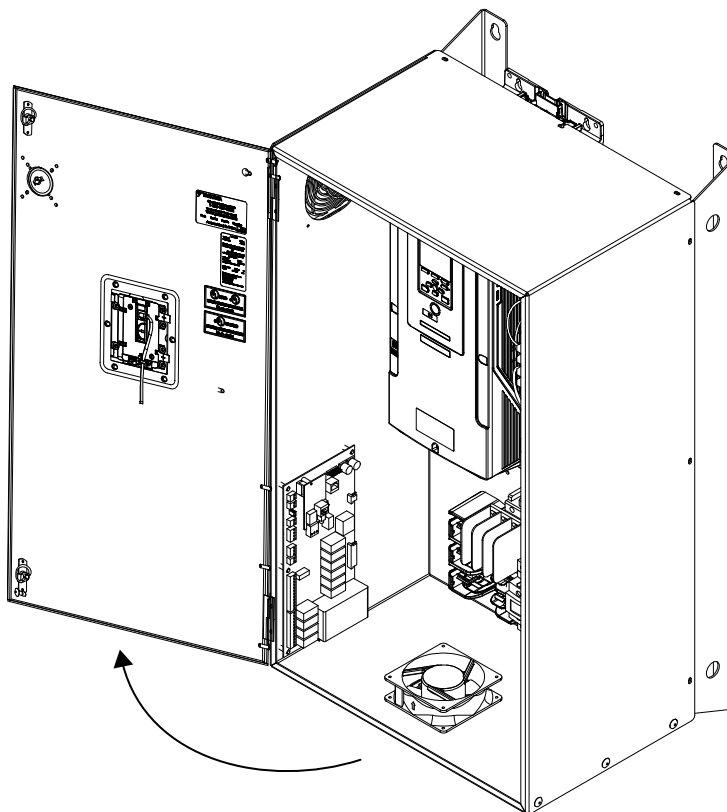

Figure 2.19 Swing Open Door

4. Reverse the steps to close the cover.

◆ Removing/Reattaching the Drive Cover Using Procedure A

DANGER! Electrical Shock Hazard. Do not examine, connect, or disconnect wiring on an energized bypass. Before servicing, disconnect all power to the equipment and wait for the time specified on the warning label at a minimum. The internal capacitor stays charged after the bypass is de-energized. The charge indicator LED extinguishes when the DC bus voltage decreases below 50 Vdc. When all indicators are OFF, remove the covers before measuring for dangerous voltages to make sure that the bypass is safe. If you do work on the bypass when it is energized, it will cause serious injury or death from electrical shock.

■ Remove the Front Cover

1. Remove the bypass front cover in Procedure A
2. Loosen the front cover screw.

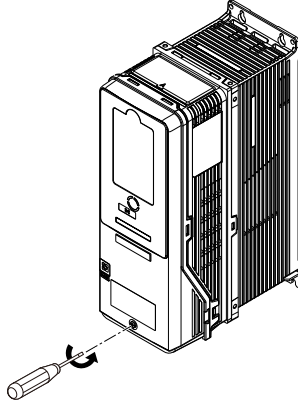

Figure 2.20 Loosen the Front Cover Screw

3. Push on the tabs in the sides of the front cover then pull the front cover forward to remove it from the drive.

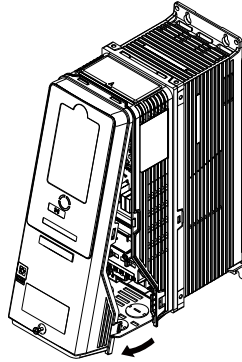

Figure 2.21 Remove the Front Cover

■ Reattach the Front Cover

1. Wire the drive and other peripheral devices.
2. Reverse the steps to reattach the cover.

Note:

- Make sure that you did not pinch wires or signal lines between the front cover and the drive before you reattach the cover.
- Make sure that the tabs on the sides of the front cover correctly click into the hook.
- Tighten the screws to a tightening torque of 0.98 N·m to 1.33 N·m (8.67 in·lb to 11.77 in·lb).

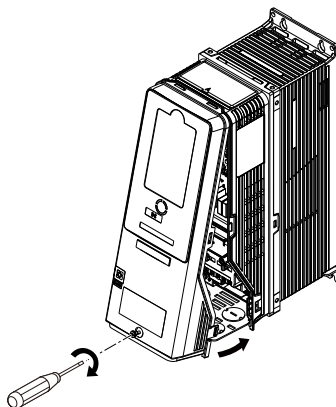

Figure 2.22 Reattach the Front Cover

◆ Removing/Reattaching the Cover Using Procedure B

DANGER! Electrical Shock Hazard. Do not examine, connect, or disconnect wiring on an energized drive. Before servicing, disconnect all power to the equipment and wait for the time specified on the warning label at a minimum. The internal capacitor stays charged after the drive is de-energized. The charge indicator LED extinguishes when the DC bus voltage decreases below 50 Vdc. When all indicators are OFF, remove the covers before measuring for dangerous voltages to make sure that the drive is safe. If you do work on the drive when it is energized, it will cause serious injury or death from electrical shock.

■ Remove the Terminal Cover

1. Loosen the screws on the terminal cover, then pull down on the cover.

CAUTION! Crush Hazard. Loosen the cover screws. Do not fully remove them. If you fully remove the cover screws, the terminal cover can fall and cause moderate injury.

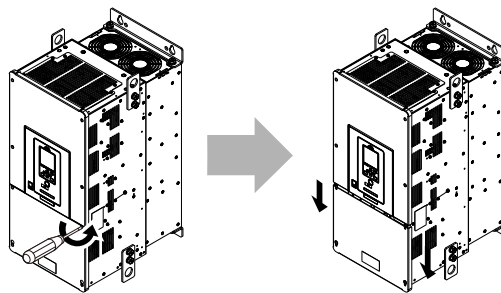

Figure 2.23 Loosen the Terminal Cover Mounting Screws

2. Pull the terminal cover away from the drive.

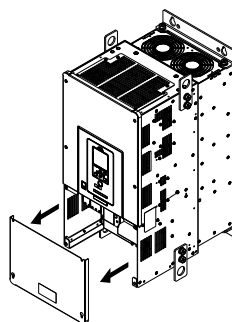
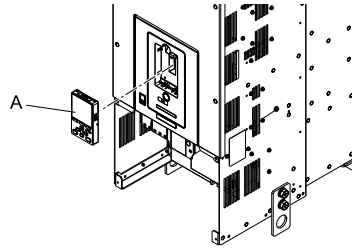

Figure 2.24 Remove the Terminal Cover

■ Remove the Front Cover

1. Remove the keypad from the drive.



A - Keypad

Figure 2.25 Remove the Keypad

2. Loosen the front cover screws.

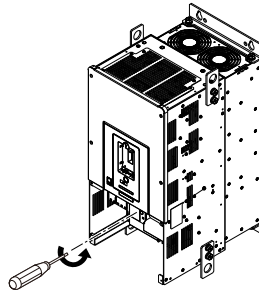
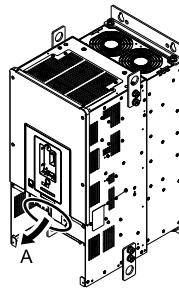

Figure 2.26 Loosen the Front Cover Screws

3. Pull part A of the front cover forward to remove the cover from the drive.



A - Pull forward to remove the front cover.

Figure 2.27 Pull Forward to Remove the Front Cover

4. Remove the front cover from the drive.

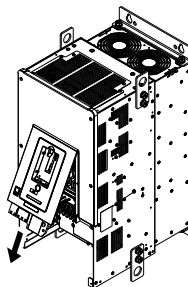
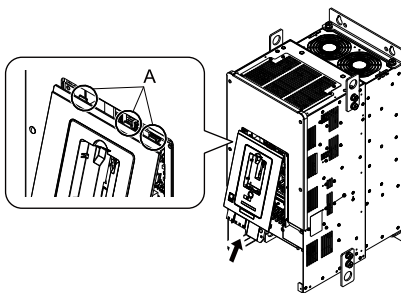

Figure 2.28 Remove the Front Cover

■ Reattach the Front Cover

Wire the drive and other peripheral devices then reattach the front cover.

1. Move the front cover to connect the hooks at the top of the front cover to the drive.



A - Hooks

Figure 2.29 Reattach the Front Cover

2. Move the front cover while pushing on the hooks on the left and right sides of the front cover until it clicks into position.

Note:

Make sure that you did not pinch wires or signal lines between the front cover and the drive before you reattach the cover.

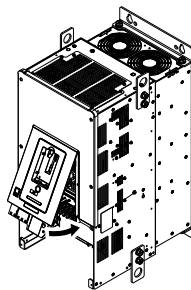

Figure 2.30 Reattach the Front Cover

3. Reattach the keypad to its initial position.

■ Reattach the Terminal Cover

Wire the drive and other peripheral devices then reattach the terminal cover.

Note:

- Make sure that you do not pinch wires or signal lines between the wiring cover and the drive before you reattach the cover.
- Tighten the screws to a tightening torque of 0.98 N·m to 1.33 N·m (8.67 lbf·in to 11.77 lbf·in).

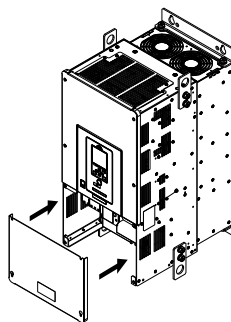
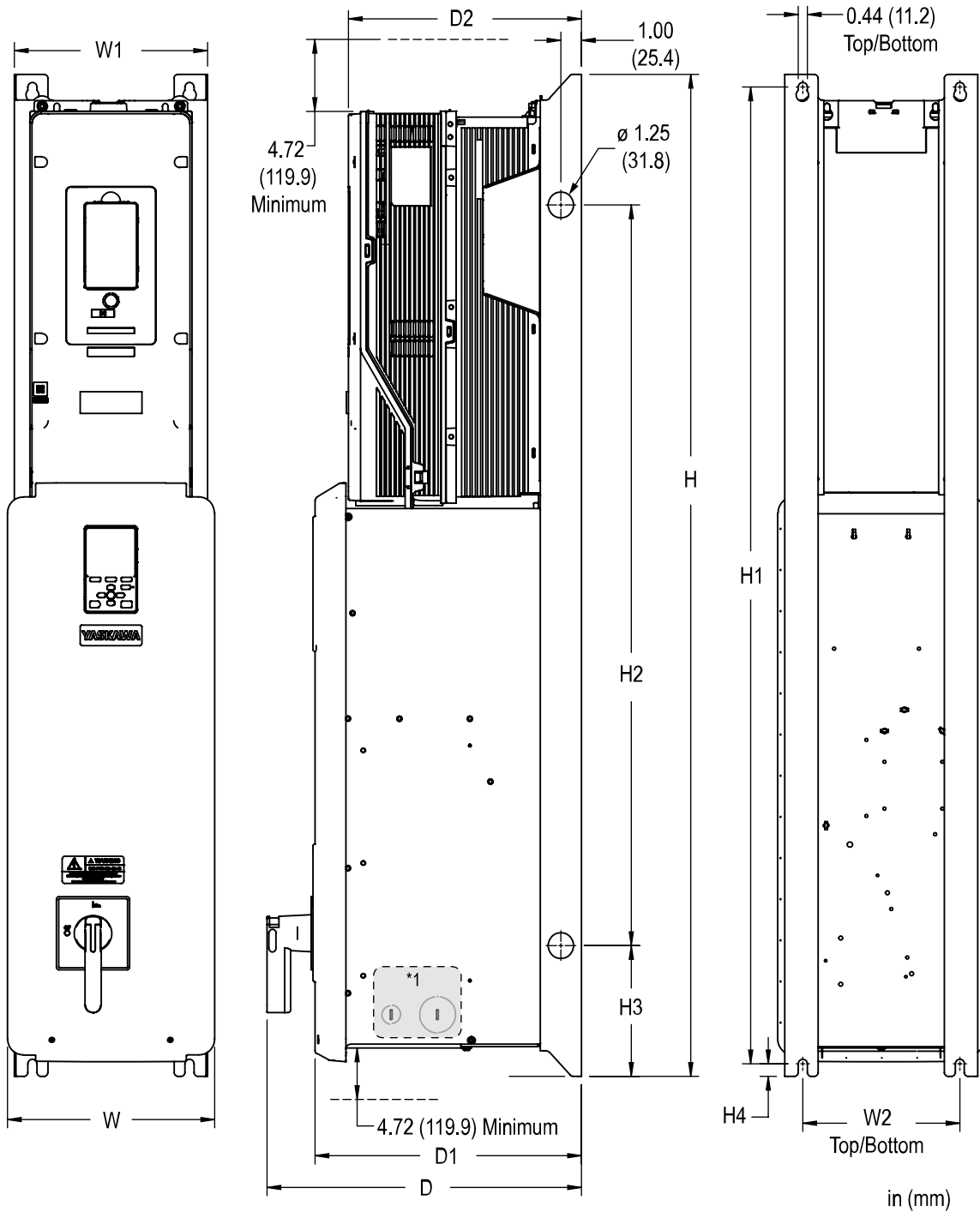

Figure 2.31 Reattach the Terminal Cover

2.8 Exterior and Mounting Dimensions

- ◆ 208 Vac Narrow Models H6BPD002 to D074
- 480 Vac Narrow Models H6BPB1P1, B001 to B077



*1 Refer to "Knock-Out Hole Dimensions" for side and bottom conduit knock-out dimensions.

Figure 2.32 Narrow Exterior and Mounting Dimensions Diagram

Table 2.3 Bypass Narrow Model Enclosure Dimensions: 208 Vac

Bypass Model H6BP	Dimensions in (mm)											Wt. (lb)
	W	H	D	W1	W2	H1	H2	H3	H4	D1	D2	
D002	6.25 (158.8)	41.64 (1057.7)	14.71 (373.6)	6.25 (158.8)	4.29 (108.9)	40.60 (1031.2)	35.64 (905.3)	3.00 (76.2)	0.52 (13.2)	12.97 (329.4)	10.58 (268.8)	55
D003	6.25 (158.8)	41.64 (1057.7)	14.71 (373.6)	6.25 (158.8)	4.29 (108.9)	40.60 (1031.2)	35.64 (905.3)	3.00 (76.2)	0.52 (13.2)	12.97 (329.4)	10.58 (268.8)	55
D004	6.25 (158.8)	41.64 (1057.7)	14.71 (373.6)	6.25 (158.8)	4.29 (108.9)	40.60 (1031.2)	35.64 (905.3)	3.00 (76.2)	0.52 (13.2)	12.97 (329.4)	10.58 (268.8)	55
D007	6.25 (158.8)	41.64 (1057.7)	14.71 (373.6)	6.25 (158.8)	4.29 (108.9)	40.60 (1031.2)	35.64 (905.3)	3.00 (76.2)	0.52 (13.2)	12.97 (329.4)	10.58 (268.8)	55
D010	6.25 (158.8)	41.64 (1057.7)	14.71 (373.6)	6.25 (158.8)	4.29 (108.9)	40.60 (1031.2)	35.64 (905.3)	3.00 (76.2)	0.52 (13.2)	12.97 (329.4)	10.58 (268.8)	55
D016	6.25 (158.8)	41.64 (1057.7)	14.71 (373.6)	6.25 (158.8)	4.29 (108.9)	40.60 (1031.2)	35.64 (905.3)	3.00 (76.2)	0.52 (13.2)	12.97 (329.4)	10.58 (268.8)	55
D024	6.92 (175.7)	45.17 (1147.4)	14.71 (373.6)	6.25 (158.8)	4.29 (108.9)	44.14 (1121.2)	39.17 (995)	3.00 (76.2)	0.52 (13.2)	12.97 (329.4)	11.17 (283.8)	62
D030	6.92 (175.7)	45.17 (1147.4)	14.71 (373.6)	6.25 (158.8)	4.29 (108.9)	44.14 (1121.2)	39.17 (995)	3.00 (76.2)	0.52 (13.2)	12.97 (329.4)	11.17 (283.8)	64
D046	10.07 (255.7)	48.70 (1237)	15.28 (388.2)	9.38 (238.3)	7.63 (193.9)	47.47 (1205.8)	36.00 (914.4)	6.35 (161.3)	0.62 (15.6)	12.94 (328.8)	11.33 (287.8)	87
D059	10.07 (255.7)	48.70 (1237)	15.28 (388.2)	9.38 (238.3)	7.63 (193.9)	47.47 (1205.8)	36.00 (914.4)	6.35 (161.3)	0.62 (15.6)	12.94 (328.8)	11.33 (287.8)	92
D074	12.52 (318.1)	52.06 (1322.3)	16.60 (421.7)	11.86 (301.3)	9.89 (251.2)	51.06 (1296.9)	36.00 (914.4)	8.03 (204)	0.50 (12.7)	14.26 (362.3)	12.35 (313.8)	128

Table 2.4 Bypass Narrow Model Enclosure Dimensions: 480 Vac

Bypass Model H6BP	Dimensions in (mm)											Wt. (lb)
	W	H	D	W1	W2	H1	H2	H3	H4	D1	D2	
B1P1	6.25 (158.8)	41.64 (1057.7)	14.71 (373.6)	6.25 (158.8)	4.29 (108.9)	40.60 (1031.2)	35.64 (905.3)	3.00 (76.2)	0.52 (13.2)	12.97 (329.4)	10.58 (268.8)	56
B001	6.25 (158.8)	41.64 (1057.7)	14.71 (373.6)	6.25 (158.8)	4.29 (108.9)	40.60 (1031.2)	35.64 (905.3)	3.00 (76.2)	0.52 (13.2)	12.97 (329.4)	10.58 (268.8)	56
B002	6.25 (158.8)	41.64 (1057.7)	14.71 (373.6)	6.25 (158.8)	4.29 (108.9)	40.60 (1031.2)	35.64 (905.3)	3.00 (76.2)	0.52 (13.2)	12.97 (329.4)	10.58 (268.8)	56
B003	6.25 (158.8)	41.64 (1057.7)	14.71 (373.6)	6.25 (158.8)	4.29 (108.9)	40.60 (1031.2)	35.64 (905.3)	3.00 (76.2)	0.52 (13.2)	12.97 (329.4)	10.58 (268.8)	56
B004	6.25 (158.8)	41.64 (1057.7)	14.71 (373.6)	6.25 (158.8)	4.29 (108.9)	40.60 (1031.2)	35.64 (905.3)	3.00 (76.2)	0.52 (13.2)	12.97 (329.4)	10.58 (268.8)	56
B007	6.25 (158.8)	41.64 (1057.7)	14.71 (373.6)	6.25 (158.8)	4.29 (108.9)	40.60 (1031.2)	35.64 (905.3)	3.00 (76.2)	0.52 (13.2)	12.97 (329.4)	10.58 (268.8)	56
B011	6.25 (158.8)	41.64 (1057.7)	14.71 (373.6)	6.25 (158.8)	4.29 (108.9)	40.60 (1031.2)	35.64 (905.3)	3.00 (76.2)	0.52 (13.2)	12.97 (329.4)	10.58 (268.8)	56
B014	6.25 (158.8)	41.64 (1057.7)	14.71 (373.6)	6.25 (158.8)	4.29 (108.9)	40.60 (1031.2)	35.64 (905.3)	3.00 (76.2)	0.52 (13.2)	12.97 (329.4)	10.58 (268.8)	56
B021	6.92 (175.7)	45.17 (1147.4)	14.71 (373.6)	6.25 (158.8)	4.29 (108.9)	44.14 (1121.2)	39.17 (995)	3.00 (76.2)	0.52 (13.2)	12.97 (329.4)	11.17 (283.8)	62
B027	6.92 (175.7)	45.17 (1147.4)	14.71 (373.6)	6.25 (158.8)	4.29 (108.9)	44.14 (1121.2)	39.17 (995)	3.00 (76.2)	0.52 (13.2)	12.97 (329.4)	11.17 (283.8)	65
B034	10.07 (255.7)	48.70 (1237)	15.28 (388.2)	9.38 (238.3)	7.63 (193.9)	47.47 (1205.8)	36.00 (914.4)	6.35 (161.3)	0.62 (15.6)	12.94 (328.8)	11.33 (287.8)	81
B040	10.07 (255.7)	48.70 (1237)	15.28 (388.2)	9.38 (238.3)	7.63 (193.9)	47.47 (1205.8)	36.00 (914.4)	6.35 (161.3)	0.62 (15.6)	12.94 (328.8)	11.33 (287.8)	90

2.8 Exterior and Mounting Dimensions

Bypass Model H6BP	Dimensions in (mm)											Wt. (lb)
	W	H	D	W1	W2	H1	H2	H3	H4	D1	D2	
B052	10.07 (255.7)	48.70 (1237)	15.28 (388.2)	9.38 (238.3)	7.63 (193.9)	47.47 (1205.8)	36.00 (914.4)	6.35 (161.3)	0.62 (15.6)	12.94 (328.8)	11.33 (287.8)	96
B065	12.52 (318.1)	52.06 (1322.3)	16.60 (421.7)	11.86 (301.3)	9.89 (251.2)	51.06 (1296.9)	36.00 (914.4)	8.03 (204)	0.50 (12.7)	14.26 (362.3)	12.35 (313.8)	121
B077	12.52 (318.1)	52.06 (1322.3)	16.60 (421.7)	11.86 (301.3)	9.89 (251.2)	51.06 (1296.9)	36.00 (914.4)	8.03 (204)	0.50 (12.7)	14.26 (362.3)	12.35 (313.8)	135

- ◆ 208 Vac Enclosed Models H6B1D002 to D169
- 240 Vac Enclosed Models H6B1A002 to A154
- 480 Vac Enclosed Models H6B1B1P1, B001 to B156

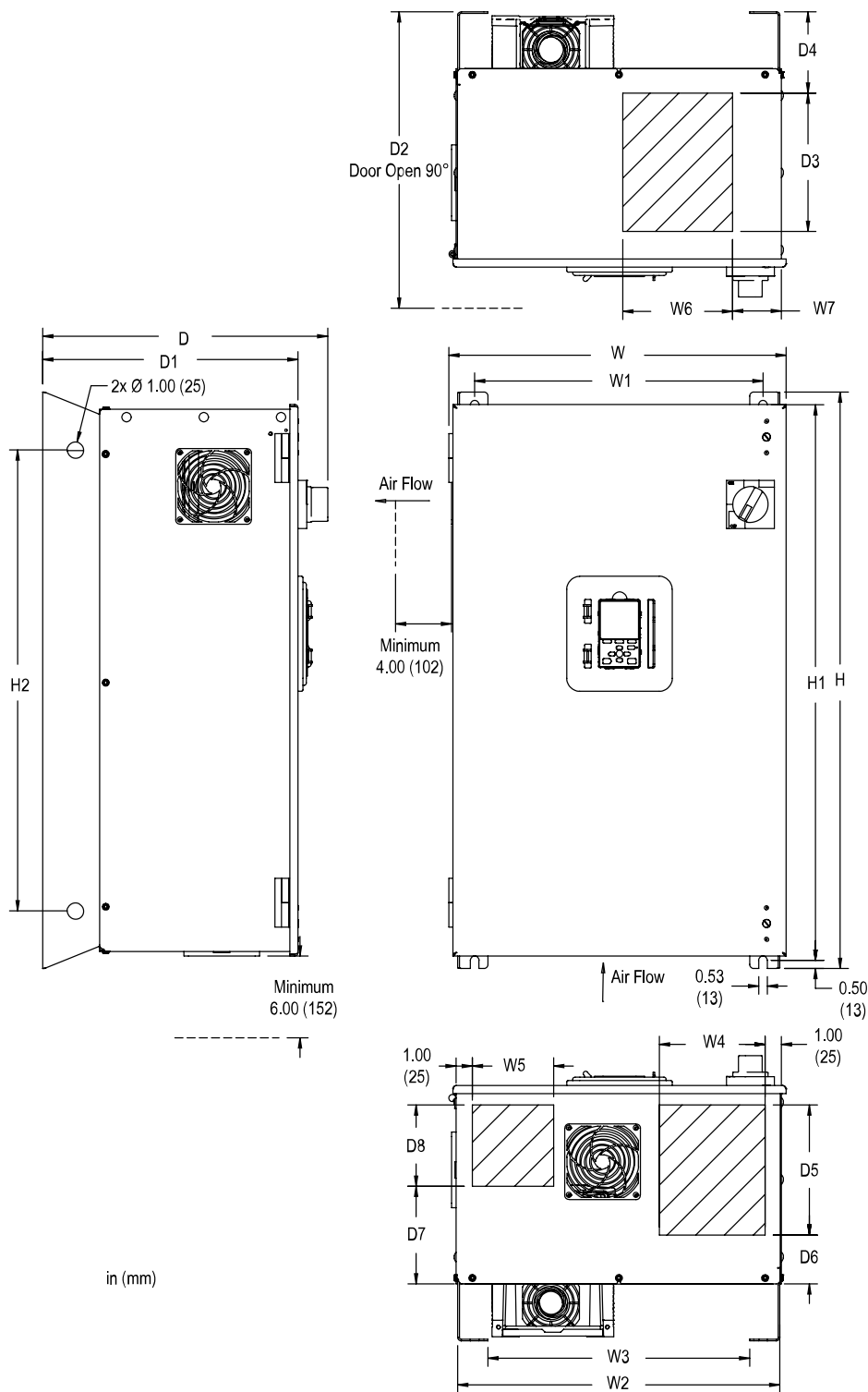

Figure 2.33 Enclosed Exterior and Mounting Dimensions Diagram

2.8 Exterior and Mounting Dimensions

Table 2.5 Bypass Enclosed Model Enclosure Dimensions: 208 Vac

Bypass Model H6B1	Dimensions in (mm)														
	D002	D003	D004	D007	D010	D016	D024	D030	D046	D059	D074	D088	D114	D143	D169
W	15.69 (398)					18.69 (475)		20.73 (526)		25.63 (651)			33.73 (857)		
H	25.88 (657)					33.88 (860)		37.09 (942)		42.09 (1069)			53.09 (1349)		
D	15.57 (396)					17.58 (447)		18.54 (471)		18.84 (479)			20.54 (522)		
W1	12.73 (323)					15.73 (400)		17.73 (450)		22.73 (577)			30.73 (781)		
W2	14.81 (376)					17.81 (452)		19.81 (503)		24.81 (630)			32.81 (833)		
W3	11.09 (282)					14.09 (358)		16.09 (409)		21.09 (536)			29.09 (739)		
W4	3.75 (95)					4.50 (114)		6.50 (165)		4.00 (102)			9.00 (229)		
W5	3.50 (89)					5.00 (127)		5.00 (127)		8.00 (203)			9.00 (229)		
W6	6.75 (171)					6.75 (171)		6.75 (171)		8.00 (203)			10.00 (254)		
W7	1.25 (32)					3.00 (76)		3.00 (76)		3.00 (76)			3.00 (76)		
H1	24.61 (625)					32.61 (828)		35.82 (910)		40.82 (1037)			51.82 (1316)		
H2	20.00 (508)					27.00 (686)		30.00 (762)		30.00 (762)			44.00 (1118)		
D1	13.73 (349)					15.74 (400)		16.70 (424)		17.00 (432)			18.70 (475)		
D2	28.415 (722)					33.420 (849)		36.42 (925)		41.720 (1060)			51.417 (1306)		
D3	7.00 (178)					8.50 (216)		9.50 (241)		8.50 (216)			8.50 (216)		
D4	5.00 (127)					5.00 (127)		5.00 (127)		5.00 (127)			8.00 (203)		
D5	7.00 (178)					8.00 (203)		9.00 (229)		8.00 (203)			8.50 (216)		
D6	1.50 (25)					3.00 (76)		3.00 (76)		3.00 (76)			8.00 (203)		
D7	5.00 (127)					6.00 (152)		6.00 (152)		5.00 (127)			8.00 (203)		
D8	4.00 (102)					5.00 (127)		6.00 (152)		7.00 (178)			8.50 (216)		
Wt. (lb)	93					125	128	159	163	224	233	248	419	434	

Table 2.6 Bypass Enclosed Model Enclosure Dimensions: 240 Vac

Bypass Model H6B1	Dimensions in (mm)														
	A002	A003	A004	A006	A009	A015	A022	A028	A042	A054	A068	A080	A104	A130	A154
W	15.69 (398)					18.69 (475)		20.73 (526)		25.63 (651)			33.73 (857)		
H	25.88 (657)					33.88 (860)		37.09 (942)		42.09 (1069)			53.09 (1349)		

Bypass Model H6B1	Dimensions in (mm)															
	A002	A003	A004	A006	A009	A015	A022	A028	A042	A054	A068	A080	A104	A130	A154	
D	15.57 (396)						17.58 (447)		18.54 (471)		18.84 (479)			20.54 (522)		
W1	12.73 (323)						15.73 (400)		17.73 (450)		22.73 (577)			30.73 (781)		
W2	14.81 (376)						17.81 (452)		19.81 (503)		24.81 (630)			32.81 (833)		
W3	11.09 (282)						14.09 (358)		16.09 (409)		21.09 (536)			29.09 (739)		
W4	3.75 (95)						4.50 (114)		6.50 (165)		4.00 (102)			9.00 (229)		
W5	3.50 (89)						5.00 (127)		5.00 (127)		8.00 (203)			9.00 (229)		
W6	6.75 (171)						6.75 (171)		6.75 (171)		8.00 (203)			10.00 (254)		
W7	1.25 (32)						3.00 (76)		3.00 (76)		3.00 (76)			3.00 (76)		
H1	24.61 (625)						32.61 (828)		35.82 (910)		40.82 (1037)			51.82 (1316)		
H2	20.00 (508)						27.00 (686)		30.00 (762)		30.00 (762)			44.00 (1118)		
D1	13.73 (349)						15.74 (400)		16.70 (424)		17.00 (432)			18.70 (475)		
D2	28.415 (722)						33.420 (849)		36.42 (925)		41.720 (1060)			51.417 (1306)		
D3	7.00 (178)						8.50 (216)		9.50 (241)		8.50 (216)			8.50 (216)		
D4	5.00 (127)						5.00 (127)		5.00 (127)		5.00 (127)			8.00 (203)		
D5	7.00 (178)						8.00 (203)		9.00 (229)		8.00 (203)			8.50 (216)		
D6	1.50 (25)						3.00 (76)		3.00 (76)		3.00 (76)			8.00 (203)		
D7	5.00 (127)						6.00 (152)		6.00 (152)		5.00 (127)			8.00 (203)		
D8	4.00 (102)						5.00 (127)		6.00 (152)		7.00 (178)			8.50 (216)		
Wt. (lb)	93						125	128	159	163	224	233	248	419	434	

Mechanical Installation

Table 2.7 Bypass Enclosed Model Enclosure Dimensions: 480 Vac

Bypass Model H6B1	Dimensions in (mm)																		
	B1P1	B001	B002	B003	B004	B007	B011	B014	B021	B027	B034	B040	B052	B065	B077	B096	B124	B156	
W	15.69 (398)								18.69 (475)			20.73 (526)			25.63 (651)			33.73 (857)	
H	25.88 (657)								33.88 (860)			37.09 (942)			42.09 (1069)			53.09 (1349)	
D	15.57 (396)								17.58 (447)			18.54 (471)			18.84 (479)			20.54 (522)	
W1	12.73 (323)								15.73 (400)			17.73 (450)			22.73 (577)			30.73 (781)	
W2	14.81 (376)								17.81 (452)			19.81 (503)			24.81 (630)			32.81 (833)	

2.8 Exterior and Mounting Dimensions

Bypass Model H6B1	Dimensions in (mm)																	
	B1P1	B001	B002	B003	B004	B007	B011	B014	B021	B027	B034	B040	B052	B065	B077	B096	B124	B156
W3	11.09 (282)							14.09 (358)			16.09 (409)			21.09 (536)			29.09 (739)	
W4	3.75 (95)							4.50 (114)			6.50 (165)			4.00 (102)			9.00 (229)	
W5	3.50 (89)							5.00 (127)			5.00 (127)			8.00 (203)			9.00 (229)	
W6	6.75 (171)							6.75 (171)			6.75 (171)			8.00 (203)			10.00 (254)	
W7	1.25 (32)							3.00 (76)			3.00 (76)			3.00 (76)			3.00 (76)	
H1	24.61 (625)							32.61 (828)			35.82 (910)			40.82 (1037)			51.82 (1316)	
H2	20.00 (508)							27.00 (686)			30.00 (762)			30.00 (762)			44.00 (1118)	
D1	13.73 (349)							15.74 (400)			16.70 (424)			17.00 (432)			18.70 (475)	
D2	28.415 (722)							33.420 (849)			36.42 (925)			41.720 (1060)			51.417 (1306)	
D3	7.00 (178)							8.50 (216)			9.50 (241)			8.50 (216)			8.50 (216)	
D4	5.00 (127)							5.00 (127)			5.00 (127)			5.00 (127)			8.00 (203)	
D5	7.00 (178)							8.00 (203)			9.00 (229)			8.00 (203)			8.50 (216)	
D6	1.50 (25)							3.00 (76)			3.00 (76)			3.00 (76)			8.00 (203)	
D7	5.00 (127)							6.00 (152)			6.00 (152)			5.00 (127)			8.00 (203)	
D8	4.00 (102)							5.00 (127)			6.00 (152)			7.00 (178)			8.50 (216)	
Wt. (lb)	93	93	93	93	93	94	94	94	125	129	137	162	168	179	233	247	263	431

- ◆ 208 Vac Enclosed Models H6B1D211, D273
- 240 Vac Enclosed Models H6B1A192, A248
- 480 Vac Enclosed Models H6B1B180 to B302

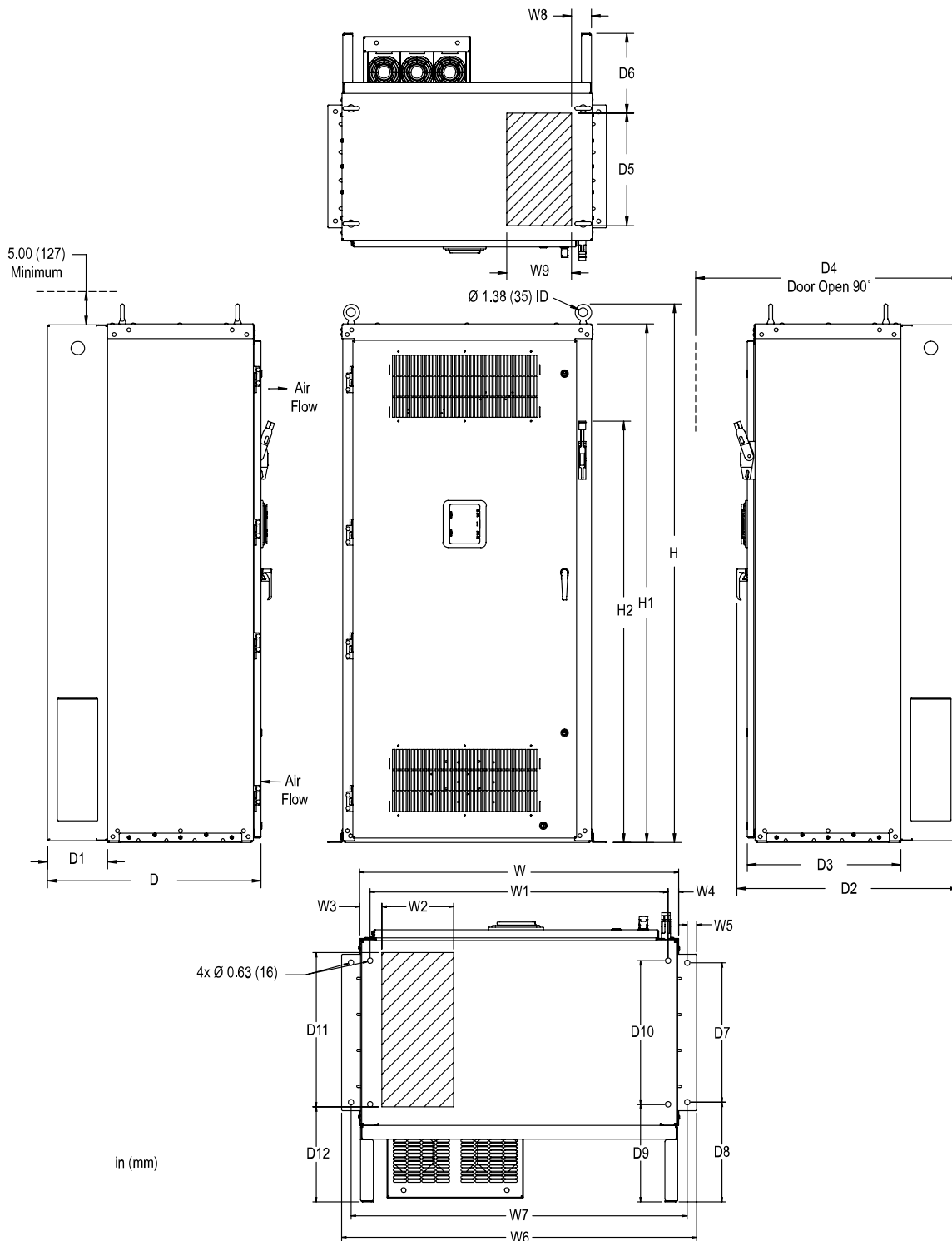

Figure 2.34 Enclosed Exterior and Mounting Dimensions Diagram

2.8 Exterior and Mounting Dimensions

Table 2.8 Bypass Enclosed Model Enclosure Dimensions: 208 Vac

Bypass Model H6B1	Dimensions in (mm)	
	D211	D273
W	37.75 (959)	
H	87.01 (2210)	
D	32.19 (818)	
W1	35.25 (895)	
W2	8.50 (216)	
W3	2.62 (67)	
W4	1.25 (32)	
W5	1.12 (28)	
W6	41.99 (1067)	
W7	39.75 (1010)	
W8	3.00 (76)	
W9	9.75 (248)	
H1	84.01 (2134)	
H2	69.34 (1761)	
D1	9.05 (230)	
D2	33.53 (852)	
D3	23.14 (588)	
D4	65.23 (1657)	
D5	17.00 (432)	
D6	12.00 (305)	
D7	16.50 (419)	
D8	11.80 (300)	
D9	11.54 (293)	
D10	17.00 (432)	
D11	18.25 (464)	

Bypass Model H6B1	Dimensions in (mm)	
	D211	D273
D12	11.25 (286)	
Wt. (lb)	832	859

Table 2.9 Bypass Enclosed Model Enclosure Dimensions: 240 Vac

Bypass Model H6B1	Dimensions in (mm)	
	A192	A248
W	37.75 (959)	
H	87.01 (2210)	
D	32.19 (818)	
W1	35.25 (895)	
W2	8.50 (216)	
W3	2.62 (67)	
W4	1.25 (32)	
W5	1.12 (28)	
W6	41.99 (1067)	
W7	39.75 (1010)	
W8	3.00 (76)	
W9	9.75 (248)	
H1	84.01 (2134)	
H2	69.34 (1761)	
D1	9.05 (230)	
D2	33.53 (852)	
D3	23.14 (588)	
D4	65.23 (1657)	
D5	17.00 (432)	
D6	12.00 (305)	
D7	16.50 (419)	
D8	11.80 (300)	

2.8 Exterior and Mounting Dimensions

Bypass Model H6B1	Dimensions in (mm)	
	A192	A248
D9	11.54 (293)	
D10	17.00 (432)	
D11	18.25 (464)	
D12	11.25 (286)	
Wt. (lb)	803	859

Table 2.10 Bypass Enclosed Model Enclosure Dimensions: 480 Vac

Bypass Model H6B1	Dimensions in (mm)		
	B180	B240	B302
W	37.75 (959)		
H	87.01 (2210)		
D	32.19 (818)		
W1	35.25 (895)		
W2	8.50 (216)		
W3	2.62 (67)		
W4	1.25 (32)		
W5	1.12 (28)		
W6	41.99 (1067)		
W7	39.75 (1010)		
W8	3.00 (76)		
W9	9.75 (248)		
H1	84.01 (2134)		
H2	69.34 (1761)		
D1	9.05 (230)		
D2	33.53 (852)		
D3	23.14 (588)		
D4	65.23 (1657)		
D5	17.00 (432)		

Bypass Model H6B1	Dimensions in (mm)		
	B180	B240	B302
D6	12.00 (305)		
D7	16.50 (419)		
D8	11.80 (300)		
D9	11.54 (293)		
D10	17.00 (432)		
D11	18.25 (464)		
D12	11.25 (286)		
Wt. (lb)	803	857	964

2.9 Knock-Out Hole Dimensions

- ◆ 208 Vac Narrow Models H6BPD002 to D074
- 480 Vac Narrow Models H6BPB1P1, B001 to B077

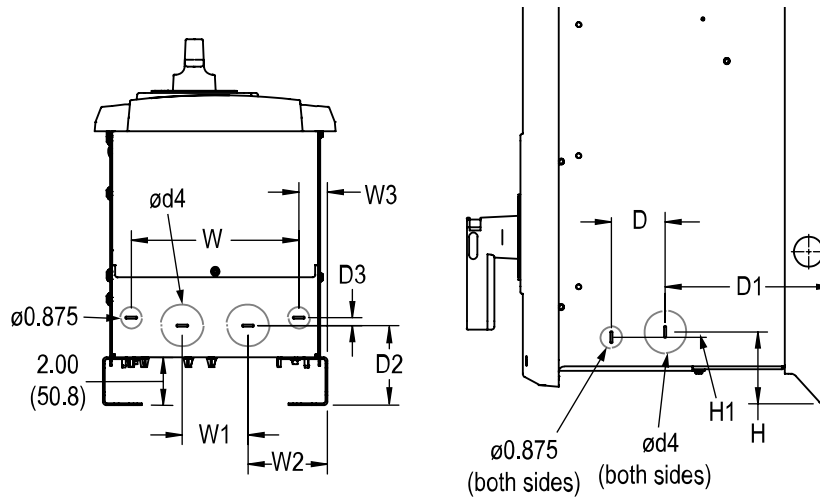

Figure 2.35 Knock-out Dimensions Diagram

Table 2.11 Narrow Bypass Knock-out Hole Dimensions: 208 Vac

Bypass Model H6BP	Dimensions in (mm)										
	W	H	D	W1	W2	W3	H1	D1	D2	D3	ød4
D002	4.18 (106.2)	3.01 (76.5)	2.00 (50.8)	2.25 (57.2)	2.00 (50.8)	1.04 (26.3)	no offset	4.08 (103.5)	3.08 (78.1)	1.51 (38.4)	1.375
D003	4.18 (106.2)	3.01 (76.5)	2.00 (50.8)	2.25 (57.2)	2.00 (50.8)	1.04 (26.3)	no offset	4.08 (103.5)	3.08 (78.1)	1.51 (38.4)	1.375
D004	4.18 (106.2)	3.01 (76.5)	2.00 (50.8)	2.25 (57.2)	2.00 (50.8)	1.04 (26.3)	no offset	4.08 (103.5)	3.08 (78.1)	1.51 (38.4)	1.375
D007	4.18 (106.2)	3.01 (76.5)	2.00 (50.8)	2.25 (57.2)	2.00 (50.8)	1.04 (26.3)	no offset	4.08 (103.5)	3.08 (78.1)	1.51 (38.4)	1.375
D010	4.18 (106.2)	3.01 (76.5)	2.00 (50.8)	2.25 (57.2)	2.00 (50.8)	1.04 (26.3)	no offset	4.08 (103.5)	3.08 (78.1)	1.51 (38.4)	1.375
D016	4.18 (106.2)	3.01 (76.5)	2.00 (50.8)	2.25 (57.2)	2.00 (50.8)	1.04 (26.3)	no offset	4.08 (103.5)	3.08 (78.1)	1.51 (38.4)	1.375
D024	4.18 (106.2)	3.01 (76.5)	2.00 (50.8)	2.25 (57.2)	2.00 (50.8)	1.04 (26.3)	no offset	4.08 (103.5)	3.08 (78.1)	1.51 (38.4)	1.375
D030	4.18 (106.2)	3.01 (76.5)	2.00 (50.8)	2.25 (57.2)	2.00 (50.8)	1.04 (26.3)	no offset	4.08 (103.5)	3.08 (78.1)	1.51 (38.4)	1.375
D046	7.00 (177.8)	3.00 (76.2)	2.25 (57.2)	2.75 (69.9)	3.32 (84.2)	1.19 (30.3)	no offset	7.00 (177.8)	3.33 (84.5)	0.33 (8.3)	1.750
D059	7.00 (177.8)	3.00 (76.2)	2.25 (57.2)	2.75 (69.9)	3.32 (84.2)	1.19 (30.3)	no offset	7.00 (177.8)	3.33 (84.5)	0.33 (8.3)	1.750
D074	9.75 (247.7)	3.75 (95.3)	2.75 (69.9)	4.00 (101.6)	3.93 (99.9)	1.06 (26.8)	0.50 (12.7)	14.26 (362.3)	3.88 (98.4)	0.38 (9.5)	2.469

Table 2.12 Bypass Knock-out Hole Dimensions: 480 Vac

Bypass Model H6BP	Dimensions in (mm)										
	W	H	D	W1	W2	W3	H1	D1	D2	D3	Ød4
B1P1	4.18 (106.2)	3.01 (76.5)	2.00 (50.8)	2.25 (57.2)	2.00 (50.8)	1.04 (26.3)	no offset	4.08 (103.5)	3.08 (78.1)	1.51 (38.4)	1.375
B001	4.18 (106.2)	3.01 (76.5)	2.00 (50.8)	2.25 (57.2)	2.00 (50.8)	1.04 (26.3)	no offset	4.08 (103.5)	3.08 (78.1)	1.51 (38.4)	1.375
B002	4.18 (106.2)	3.01 (76.5)	2.00 (50.8)	2.25 (57.2)	2.00 (50.8)	1.04 (26.3)	no offset	4.08 (103.5)	3.08 (78.1)	1.51 (38.4)	1.375
B003	4.18 (106.2)	3.01 (76.5)	2.00 (50.8)	2.25 (57.2)	2.00 (50.8)	1.04 (26.3)	no offset	4.08 (103.5)	3.08 (78.1)	1.51 (38.4)	1.375
B004	4.18 (106.2)	3.01 (76.5)	2.00 (50.8)	2.25 (57.2)	2.00 (50.8)	1.04 (26.3)	no offset	4.08 (103.5)	3.08 (78.1)	1.51 (38.4)	1.375
B007	4.18 (106.2)	3.01 (76.5)	2.00 (50.8)	2.25 (57.2)	2.00 (50.8)	1.04 (26.3)	no offset	4.08 (103.5)	3.08 (78.1)	1.51 (38.4)	1.375
B011	4.18 (106.2)	3.01 (76.5)	2.00 (50.8)	2.25 (57.2)	2.00 (50.8)	1.04 (26.3)	no offset	4.08 (103.5)	3.08 (78.1)	1.51 (38.4)	1.375
B014	4.18 (106.2)	3.01 (76.5)	2.00 (50.8)	2.25 (57.2)	2.00 (50.8)	1.04 (26.3)	no offset	4.08 (103.5)	3.08 (78.1)	1.51 (38.4)	1.375
B021	4.18 (106.2)	3.01 (76.5)	2.00 (50.8)	2.25 (57.2)	2.00 (50.8)	1.04 (26.3)	no offset	4.08 (103.5)	3.08 (78.1)	1.51 (38.4)	1.375
B027	4.18 (106.2)	3.01 (76.5)	2.00 (50.8)	2.25 (57.2)	2.00 (50.8)	1.04 (26.3)	no offset	4.08 (103.5)	3.08 (78.1)	1.51 (38.4)	1.375
B034	7.00 (177.8)	3.00 (76.2)	2.25 (57.2)	2.75 (69.9)	3.32 (84.2)	1.19 (30.3)	no offset	7.00 (177.8)	3.33 (84.5)	0.33 (8.3)	1.750
B040	7.00 (177.8)	3.00 (76.2)	2.25 (57.2)	2.75 (69.9)	3.32 (84.2)	1.19 (30.3)	no offset	7.00 (177.8)	3.33 (84.5)	0.33 (8.3)	1.750
B052	7.00 (177.8)	3.00 (76.2)	2.25 (57.2)	2.75 (69.9)	3.32 (84.2)	1.19 (30.3)	no offset	7.00 (177.8)	3.33 (84.5)	0.33 (8.3)	1.750
B065	9.75 (247.7)	3.75 (95.3)	2.75 (69.9)	4.00 (101.6)	3.93 (99.9)	1.06 (26.8)	0.50 (12.7)	14.26 (362.3)	3.88 (98.4)	0.38 (9.5)	2.469
B077	9.75 (247.7)	3.75 (95.3)	2.75 (69.9)	4.00 (101.6)	3.93 (99.9)	1.06 (26.8)	0.50 (12.7)	14.26 (362.3)	3.88 (98.4)	0.38 (9.5)	2.469

Electrical Installation

This chapter explains how to wire the control circuit terminals, motor, and power supply.

3.1	Section Safety	70
3.2	Wiring Diagrams	72
3.3	Main Circuit Wiring	79
3.4	Main Circuit Terminal Wiring Procedure	90
3.5	Bypass Controller	93
3.6	Drive Control Circuit.....	99
3.7	Control I/O Connections	107
3.8	Connect the Bypass to a PC	109
3.9	Motor Application Precautions	110

3.1 Section Safety

DANGER

Electrical Shock Hazard

Do not examine, connect, or disconnect wiring on an energized bypass. Before servicing, disconnect all power to the equipment and wait for the time specified on the warning label at a minimum. The internal capacitor stays charged after the bypass is de-energized. The charge indicator LED extinguishes when the DC bus voltage decreases below 50 Vdc. When all indicators are OFF, remove the covers before measuring for dangerous voltages to make sure that the bypass is safe.

If you do work on the bypass when it is energized, it will cause serious injury or death from electrical shock.

WARNING

Electrical Shock Hazard

Do not operate the bypass when covers are missing. Replace covers and shields before you operate the bypass. Use the bypass only as specified by the instructions.

Some figures in this section include bypasses without covers or safety shields to more clearly show the inside of the bypass. If covers or safety shields are missing from the bypass, it can cause serious injury or death.

Ground the neutral point on the power supply of the bypass to comply with the EMC Directive before you turn on the EMC filter.

If you turn ON the EMC filter, but you do not ground the neutral point, it can cause serious injury or death.

Make sure that the protective ground wire conforms to technical standards and local safety regulations. The IEC/EN 61800-5-1:2007 standard specifies that you must wire the power supply to automatically de-energize when the protective ground wire disconnects. You can also connect a protective ground wire that has a minimum cross-sectional area of 10 mm² (copper wire) or 16 mm² (aluminum wire).

If you do not obey the standards and regulations, it can cause serious injury or death. The leakage current of the bypass will be more than 3.5 mA.

The bypass can cause a residual current with a DC component in the protective earthing conductor. When a residual current operated protective or monitoring device prevents direct or indirect contact, always use a type B Ground Fault Circuit Interrupter (GFCI) as specified by IEC/EN 60755.

If you do not use the correct GFCI, it can cause serious injury or death.

Do not wear loose clothing or jewelry when you do work on the bypass. Tighten loose clothing and remove all metal objects, for example watches or rings.

Loose clothing can catch on the bypass and jewelry can conduct electricity and cause serious injury or death.

Do not remove covers or touch circuit boards while the bypass is energized.

If you touch the internal components of an energized bypass, it can cause serious injury or death.

Only let approved personnel install, wire, maintain, examine, replace parts, and repair the bypass.

If personnel are not approved, it can cause serious injury or death.

Do not modify the bypass body, drive body, bypass circuitry, or drive circuitry.

Modifications to bypass and drive body and circuitry can cause serious injury or death, will cause damage to the bypass and drive, and will void the warranty. Yaskawa is not responsible for modifications of the product made by the user.

Fire Hazard

Tighten all terminal screws to the correct tightening torque.

Connections that are too loose or too tight can cause incorrect operation and damage to the bypass. Incorrect connections can also cause death or serious injury from fire.

⚠ WARNING

Tighten screws at an angle in the specified range shown in this manual.

If you tighten the screws at an angle not in the specified range, you can have loose connections that can cause damage to the terminal block or start a fire and cause serious injury or death.

Damage to Equipment

Do not apply incorrect voltage to the main circuit of the bypass. Operate the bypass in the specified range of the input voltage on the nameplate.

Voltages that are higher than the permitted nameplate tolerance can cause damage to the bypass.

NOTICE

Do not let unwanted objects, for example metal shavings or wire clippings, fall into the bypass during installation. Put a temporary cover over the bypass during installation. Remove the temporary cover before start-up.

Unwanted objects inside of the bypass can cause damage to the bypass.

Damage to Equipment

When you touch the bypass, drive, and circuit boards, make sure that you observe correct electrostatic discharge (ESD) procedures.

If you do not follow procedures, it can cause ESD damage to the drive and bypass circuitry.

Select a motor that is compatible with the load torque and speed range. When 100% continuous torque is necessary at low speed, use an inverter-duty motor. When you use a standard fan-cooled motor, decrease the motor torque in the low-speed range.

If you operate a standard fan-cooled motor at low speed and high torque, it will decrease the cooling effects and can cause heat damage.

Obey the speed range specification of the motor as specified by the manufacturer. When you must operate the motor outside of its specifications, contact the motor manufacturer.

If you continuously operate oil-lubricated motors outside of the manufacturer specifications, it can cause damage to the motor bearings.

When the input voltage is 440 V or higher or the wiring distance is longer than 100 m (328 ft), make sure that the motor insulation voltage is sufficient or use an inverter-duty motor with reinforced insulation.

Motor winding and insulation failure can occur.

Make sure that all connections are correct after you install the bypass and connect peripheral devices.

Incorrect connections can cause damage to the bypass.

Note:

- Torque characteristics are different than when you operate the motor directly from line power. Make sure that you understand the load torque characteristics for the application.
- The current rating of submersible motors is usually higher than the current rating of standard motors for a given motor power. Make sure that the rated output current of the bypass is equal to or more than the current rating of the motor. If the motor wire length is longer than 100 m (328 ft), select the correct wire gauge to adjust for a loss in voltage and prevent a loss of motor torque.
- Do not use unshielded wire for control wiring. Use shielded, twisted-pair wires and ground the shield to the ground terminal of the bypass. Unshielded wire can cause electrical interference and unsatisfactory system performance.

3.2 Wiring Diagrams

DANGER! *Electrical Shock Hazard. Do not examine, connect, or disconnect wiring on an energized bypass. Before servicing, disconnect all power to the equipment and wait for the time specified on the warning label at a minimum. The internal capacitor stays charged after the bypass is de-energized. The charge indicator LED extinguishes when the DC bus voltage decreases below 50 Vdc. When all indicators are OFF, remove the covers before measuring for dangerous voltages to make sure that the bypass is safe. If you do work on the bypass when it is energized, it will cause serious injury or death from electrical shock.*

WARNING! *Electrical Shock Hazard. De-energize the bypass and wait 5 minutes minimum until the Charge LED turns off. Remove the front cover and terminal cover to do work on wiring, circuit boards, and other parts. Use terminals for their correct function only. Incorrect wiring, incorrect ground connections, and incorrect repair of protective covers can cause death or serious injury.*

WARNING! *Electrical Shock Hazard. Correctly ground the drive before you turn on the EMC filter switch. If you touch electrical equipment that is not grounded, it can cause serious injury or death.*

WARNING! *Electrical Shock Hazard. Use the terminals for the drive only for their intended purpose. Refer to the technical manual for more information about the I/O terminals. Wiring and grounding incorrectly or modifying the cover may damage the equipment or cause injury.*

◆ Standard Narrow Connection Diagram

Wire the bypass as specified by [Figure 3.1](#).

WARNING! *Sudden Movement Hazard. Set the MFDI parameters before you close control circuit switches. Incorrect Run/Stop circuit sequence settings can cause serious injury or death from moving equipment.*

WARNING! *Sudden Movement Hazard. Check the I/O signals and the external sequences for the drive before you set the Application Preset function. When you set the Application Preset function (A1-06 ≠ 0), it changes the I/O terminal functions for the drive and it can cause equipment to operate unusually. This can cause serious injury or death.*

WARNING! *Fire Hazard. Install sufficient branch circuit short circuit protection as specified by applicable codes and this manual. The bypass is suitable for circuits that supply not more than 100,000 RMS symmetrical amperes, 240 Vac maximum (208/240 V), 480 Vac maximum (480 V). Incorrect branch circuit short circuit protection can cause serious injury or death.*

NOTICE: *When the input voltage is 440 V or higher or the wiring distance is longer than 100 m (328 ft), make sure that the motor insulation voltage is sufficient or use an inverter-duty motor with reinforced insulation. Motor winding and insulation failure can occur.*

Note:

Do not connect the AC control circuit ground to the drive enclosure. Incorrect ground wiring can cause the control circuit to operate incorrectly.

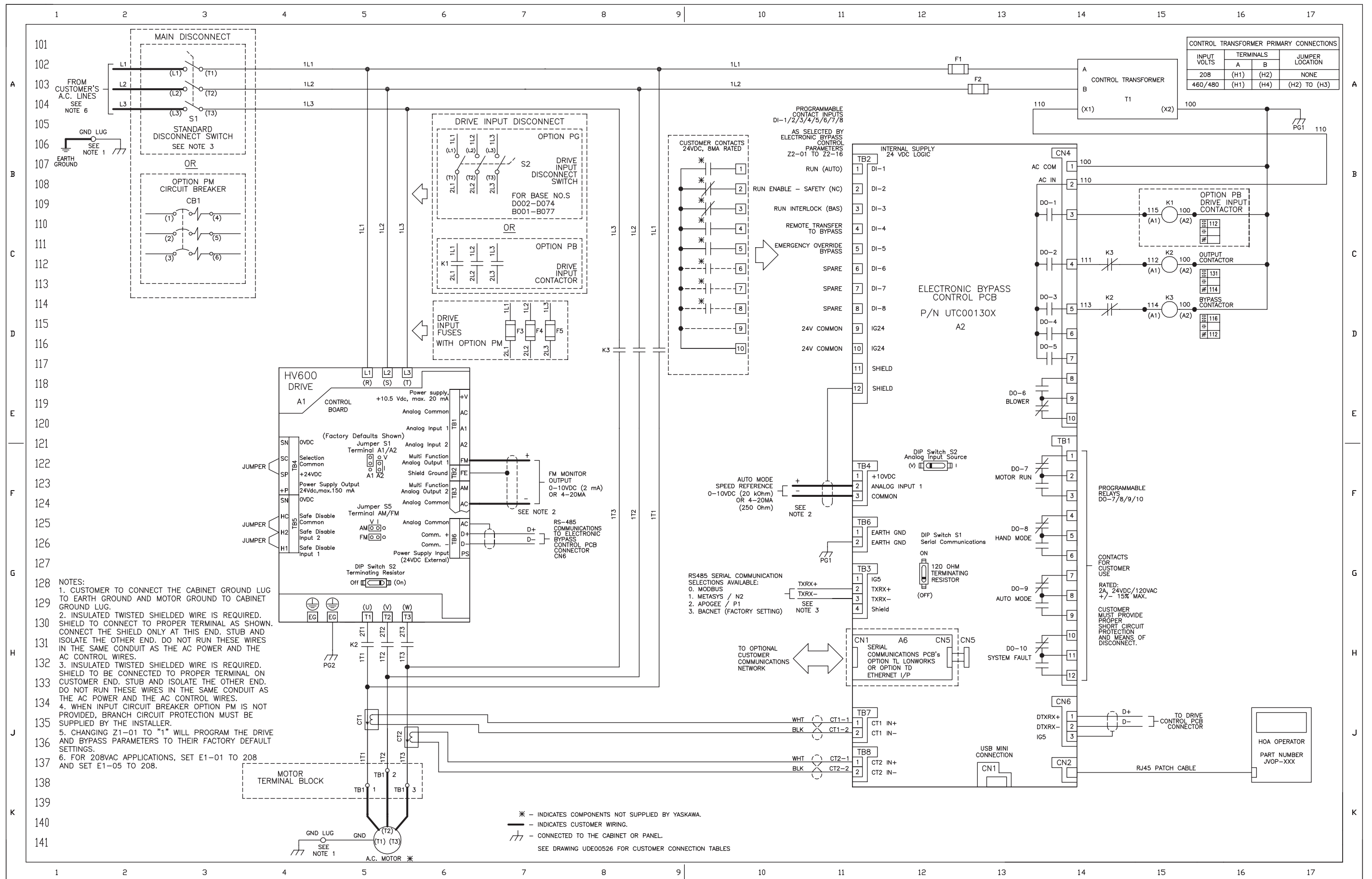

Figure 3.1 Standard Narrow Bypass Connection Diagram

Page Intentionally Blank

◆ Standard Enclosed Connection Diagram

Wire the bypass as specified by [Figure 3.2](#).

WARNING! Sudden Movement Hazard. Set the MFDI parameters before you close control circuit switches. Incorrect Run/Stop circuit sequence settings can cause serious injury or death from moving equipment.

WARNING! Sudden Movement Hazard. Check the I/O signals and the external sequences for the drive before you set the Application Preset function. When you set the Application Preset function ($A1-06 \neq 0$), it changes the I/O terminal functions for the drive and it can cause equipment to operate unusually. This can cause serious injury or death.

WARNING! Fire Hazard. Install sufficient branch circuit short circuit protection as specified by applicable codes and this manual. The bypass is suitable for circuits that supply not more than 100,000 RMS symmetrical amperes, 240 Vac maximum (208/240 V), 480 Vac maximum (480 V). Incorrect branch circuit short circuit protection can cause serious injury or death.

NOTICE: When the input voltage is 440 V or higher or the wiring distance is longer than 100 m (328 ft), make sure that the motor insulation voltage is sufficient or use an inverter-duty motor with reinforced insulation. Motor winding and insulation failure can occur.

Note:

Do not connect the AC control circuit ground to the drive enclosure. Incorrect ground wiring can cause the control circuit to operate incorrectly.

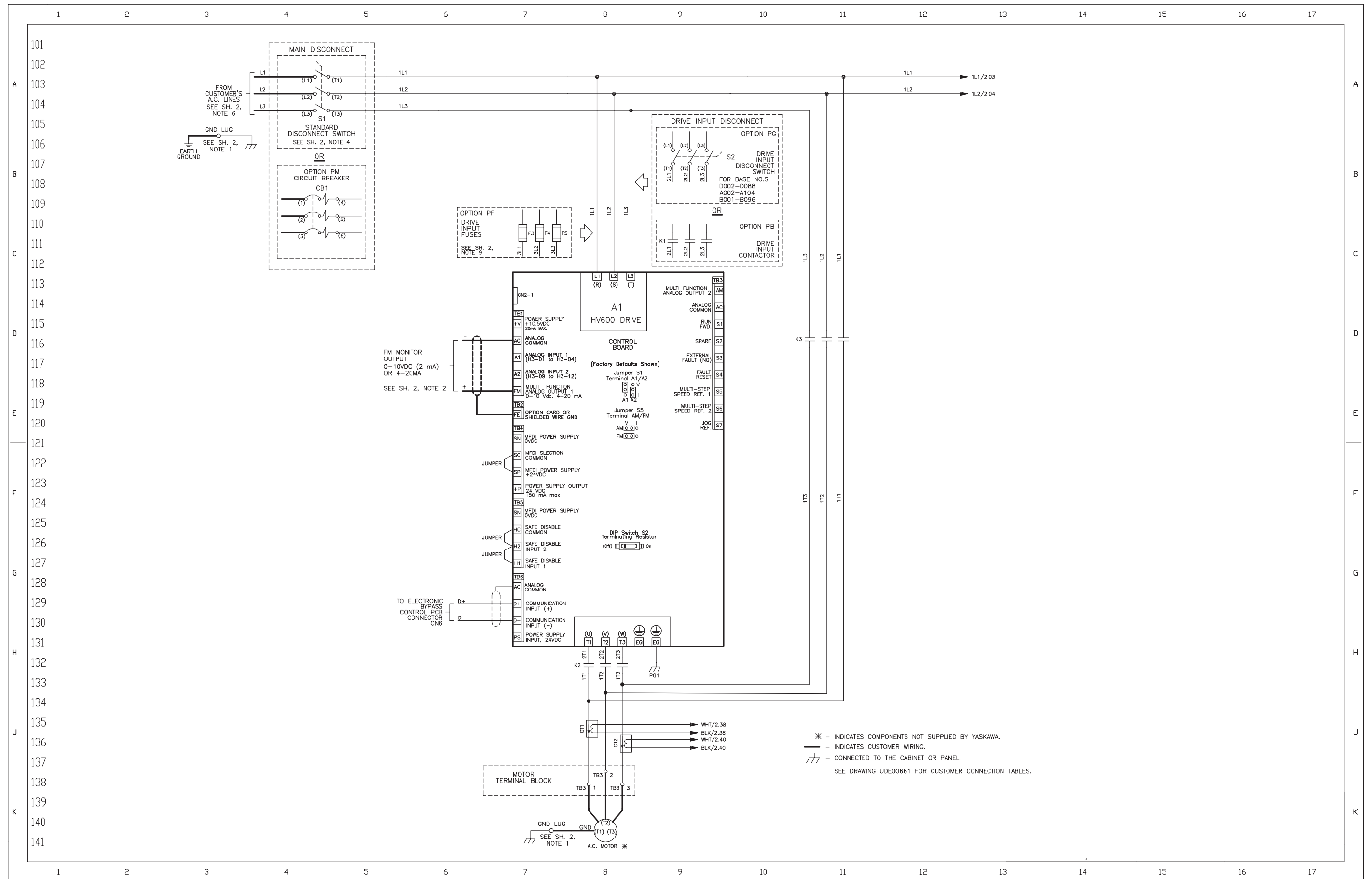

Figure 3.2 Standard Enclosed Bypass Connection Diagram

3.2 Wiring Diagrams

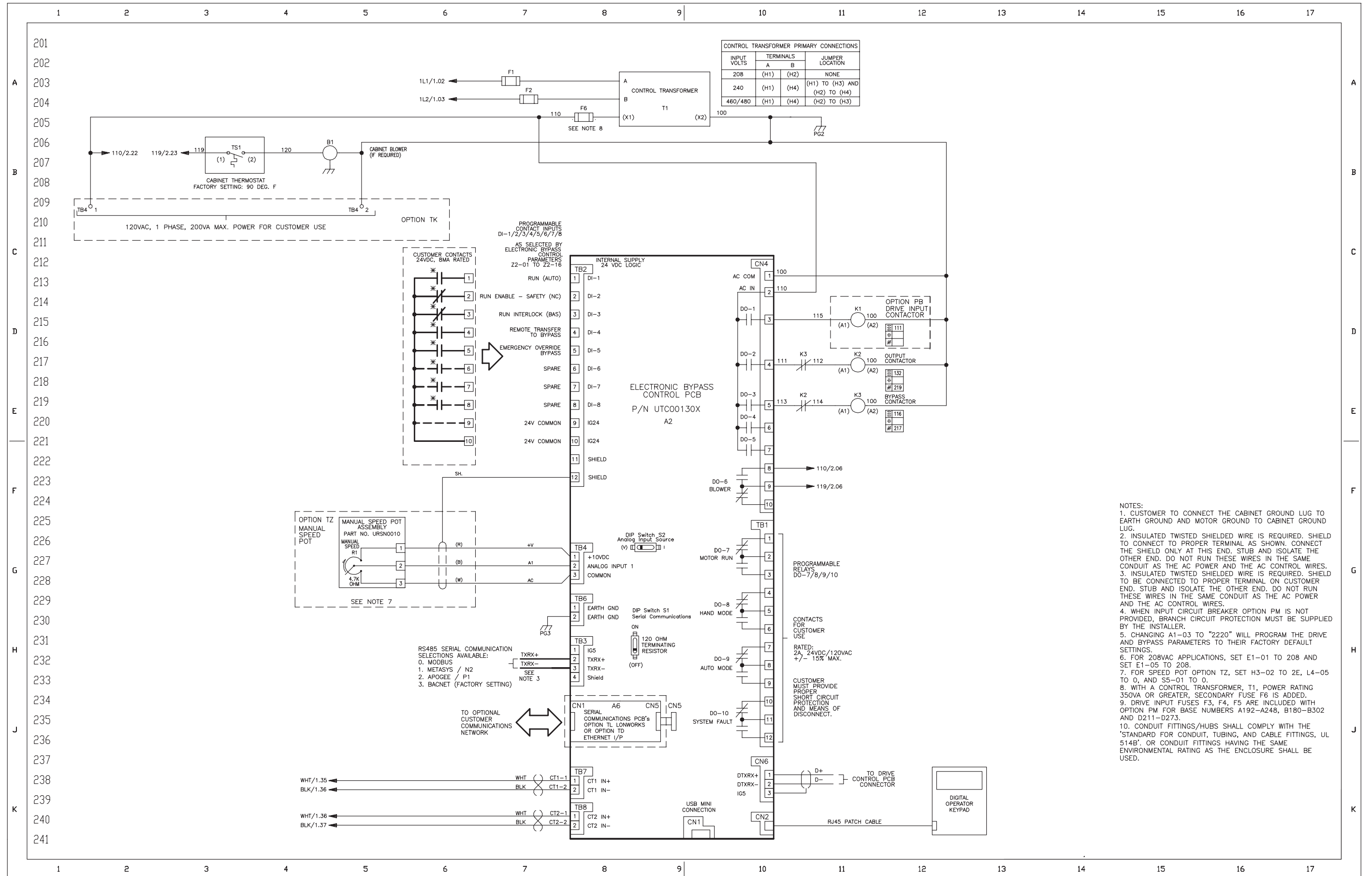

Figure 3.2 Standard Enclosed Bypass Connection Diagram (Continued)

3.3 Main Circuit Wiring

This section gives information about the functions, specifications, and procedures necessary to safely and correctly wire the main circuit in the bypass.

NOTICE: Damage to Equipment. Do not energize and de-energize the bypass more frequently than one time each 30 minutes. If you frequently energize and de-energize the bypass, it can cause failure.

Note:

Soldered wire connections can become loose over time and cause unsatisfactory performance.

◆ Narrow Bypass Input and Output Power Wiring Connections

The input disconnect switch is located in the upper right hand side of the bypass. The three-phase input power connection is made to the input terminals of the disconnect. Refer to [Figure 3.3](#) for a representative example. Motor Terminal Block TB1 is mounted to the contactor assembly or back panel (depending on rating), just above the bypass contactor. The bypass three-phase output power connection to the motor is made to Terminal Block TB1.

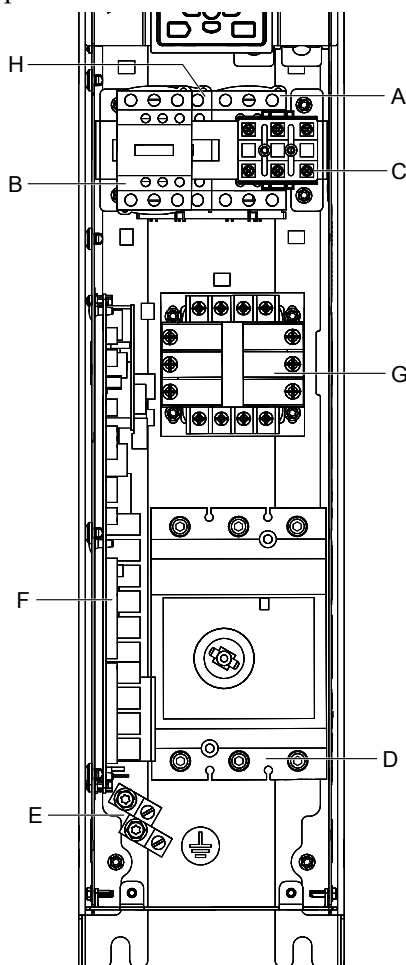

Note:

The location of components are different for different bypass models.

- | | |
|--------------------------------------|--------------------------------------|
| A - Drive output contactor K2 | E - Ground screw |
| B - Input contactor K1 | F - Bypass PCB A2 |
| C - Motor connections | G - 120 V control transformer |
| D - Input power terminals | H - Bypass contactor K3 |

Figure 3.3 Narrow Bypass Circuit Components Example

◆ Enclosed Bypass Input and Output Power Wiring Connections

The input disconnect switch is located in the upper right hand side of the bypass. The three-phase input power connection is made to the input terminals of the disconnect. Refer to [Figure 3.4](#) for a representative example. Motor Terminal Block TB3 is mounted to the contactor assembly or back panel (depending on rating), just above the bypass contactor. The bypass three-phase output power connection to the motor is made to Terminal Block TB3.

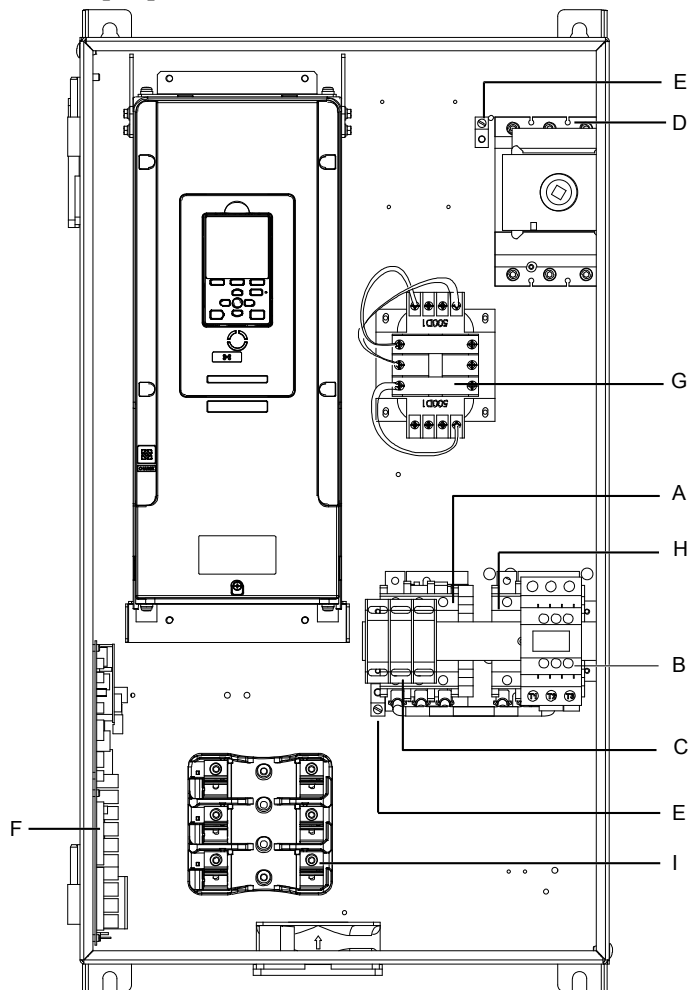

Note:

The location of components are different for different bypass models.

- | | |
|--------------------------------------|--------------------------------------|
| A - Drive output contactor K2 | F - Bypass PCB A2 |
| B - Input contactor K1 | G - 120 V control transformer |
| C - Motor connections | H - Bypass contactor K3 |
| D - Input power terminals | I - Fuse block |
| E - Ground screw | |

Figure 3.4 Enclosed Bypass Circuit Components Example

◆ Factory Recommended Branch Circuit Protection

WARNING! Fire Hazard. Branch Circuit protection is required to be installed according to applicable local codes and the requirements listed on the bypass nameplate. The bypass is suitable for use on a circuit capable of delivering not more than 100,000 RMS symmetrical amperes, 208/240 Vac and 480 Vac with the circuit breaker option or when protected by class J or class L fuses as specified on the bypass nameplate. Failure to obey can cause fire and damage to the bypass and drive or injury to personnel.

Yaskawa recommends installing branch circuit protection according to maintain compliance with UL508C. Semiconductor protective type fuses are preferred. Alternate branch circuit protection devices are also listed in this manual.

◆ Wire Selection

Select the correct wires for main circuit wiring.

■ Wire Selection Precautions

WARNING! Electrical Shock Hazard. Make sure that the protective ground wire conforms to technical standards and local safety regulations. The IEC/EN 61800-5-1:2007 standard specifies that you must wire the power supply to automatically de-energize when the protective ground wire disconnects. You can also connect a protective ground wire that has a minimum cross-sectional area of 10 mm² (copper wire) or 16 mm² (aluminum wire). If you do not obey the standards and regulations, it can cause serious injury or death. The leakage current of the bypass will be more than 3.5 mA.

Think about line voltage drop before you select wire gauges. Select wire gauges that drop the voltage by 2% or less of the rated voltage. Increase the wire gauge and the cable length when the risk of voltage drop increases. Calculate line voltage drop with this formula:

Line voltage drop (V) = $\sqrt{3} \times$ wire resistance (Ω/km) \times wiring distance (m) \times motor rated current (A) $\times 10^{-3}$.

■ Wire Gauge and Torque Specifications for UL Listing

WARNING! Electrical Shock Hazard. Make sure that the protective ground wire conforms to technical standards and local safety regulations. The IEC/EN 61800-5-1:2007 standard specifies that you must wire the power supply to automatically de-energize when the protective ground wire disconnects. You can also connect a protective ground wire that has a minimum cross-sectional area of 10 mm² (copper wire) or 16 mm² (aluminum wire). If you do not obey the standards and regulations, it can cause serious injury or death. The leakage current of the bypass will be more than 3.5 mA.

Refer to the following tables for the recommended wire gauges and tightening torques of the main circuit terminals.

Note:

The recommended wire gauges are based on drive continuous current ratings with 75 °C (167 °F) 600 V class copper wire. Assume these conditions:

- Ambient temperature: 40 °C (104 °F) or lower
- Wiring distance: 100 m (3281 ft) or shorter
- Normal Duty Rated current value

■ 208 V Narrow Wire Gauges and Torques

Table 3.1 Input Wiring

Model H6BP	Standard Non-Fused Input Disconnect Switch S1			With Option PM Circuit Breaker CB1		
	Current Rating Amps	AWG, kcmil	Tightening Torque (in lb)	Current Rating Amps	AWG, kcmil	Tightening Torque (in lb)
D002	20	14-8	20	15	14-10 or 8-3/0	50 or 120
D003	20	14-8	20	15	14-10 or 8-3/0	50 or 120
D004	20	14-8	20	15	14-10 or 8-3/0	50 or 120
D007	20	14-8	20	20	14-10 or 8-3/0	50 or 120
D010	20	14-8	20	25	14-10 or 8-3/0	50 or 120
D016	20	14-8	20	40	14-10 or 8-3/0	50 or 120
D024	45	10, 8, or 6-2	35, 40, or 50	60	14-10 or 8-3/0	50 or 120
D030	63	10, 8, or 6-2	35, 40, or 50	70	14-10 or 8-3/0	50 or 120
D046	100	8-2/0	200	110	14-10 or 8-3/0	50 or 120
D059	100	8-2/0	200	125	14-10 or 8-3/0	50 or 120
D074	115	8-2/0	200	150	14-10 or 8-3/0	50 or 120

Table 3.2 Output and Control Wiring

Model H6BP	Motor Wiring Standard Motor Terminal Block TB1		Ground Wiring		Control Wiring					
	AWG, kcmil	Tightening Torque (in lb)	AWG, kcmil	Tightening Torque (in lb)	A1 Terminal Blocks TB1, TB3-TB6		A1 Terminal Block TB2 (FE)		A2 Terminal Blocks TB1-TB4 and TB6	
					AWG, kcmil	Tightening Torque (in lb)	AWG, kcmil	Tightening Torque (in lb)	AWG, kcmil	Tightening Torque (in lb)
D002	14-2	32	14-10, 8, 6-4, or 2	35, 40, 45, or 50	24-16	4.4 to 5.3	24-18 <i>*1</i>	8.85 to 10.62	26-14	4
D003	14-2	32	14-10, 8, 6-4, or 2	35, 40, 45, or 50	24-16	4.4 to 5.3	24-18 <i>*1</i>	8.85 to 10.62	26-14	4
D004	14-2	32	14-10, 8, 6-4, or 2	35, 40, 45, or 50	24-16	4.4 to 5.3	24-18 <i>*1</i>	8.85 to 10.62	26-14	4
D007	14-2	32	14-10, 8, 6-4, or 2	35, 40, 45, or 50	24-16	4.4 to 5.3	24-18 <i>*1</i>	8.85 to 10.62	26-14	4
D010	14-2	32	14-10, 8, 6-4, or 2	35, 40, 45, or 50	24-16	4.4 to 5.3	24-18 <i>*1</i>	8.85 to 10.62	26-14	4
D016	14-2	32	14-10, 8, 6-4, or 2	35, 40, 45, or 50	24-16	4.4 to 5.3	24-18 <i>*1</i>	8.85 to 10.62	26-14	4
D024	14-2	32	14-10, 8, 6-4, or 2	35, 40, 45, or 50	24-16	4.4 to 5.3	24-18 <i>*1</i>	8.85 to 10.62	26-14	4
D030	14-2	32	14-10, 8, 6-4, or 2	35, 40, 45, or 50	24-16	4.4 to 5.3	24-18 <i>*1</i>	8.85 to 10.62	26-14	4
D046	14-2	32	14-10, 8, 6-4, or 2-1/0	35, 40, 45, or 50	24-16	4.4 to 5.3	24-18 <i>*1</i>	8.85 to 10.62	26-14	4
D059	14-2	32	14-10, 8, 6-4, or 2-1/0	35, 40, 45, or 50	24-16	4.4 to 5.3	24-18 <i>*1</i>	8.85 to 10.62	26-14	4
D074	6-2/0	120	14-10, 8, 6-4, or 2-1/0	35, 40, 45, or 50	24-16	4.4 to 5.3	24-18 <i>*1</i>	8.85 to 10.62	26-14	4

*1 24-16 is acceptable for solid wire or ferrule use only.

■ 480 V Narrow Wire Gauges and Torques

Table 3.3 Input Wiring

Model H6BP	Standard Non-Fused Input Disconnect Switch S1			With Option PM Circuit Breaker CB1		
	Current Rating Amps	AWG, kcmil	Tightening Torque (in lb)	Current Rating Amps	AWG, kcmil	Tightening Torque (in lb)
B1P1	20	14-8	20	15	(14-10) or (8-3/0)	50 or 120
B001	20	14-8	20	15	(14-10) or (8-3/0)	50 or 120
B002	20	14-8	20	15	(14-10) or (8-3/0)	50 or 120
B003	20	14-8	20	15	(14-10) or (8-3/0)	50 or 120
B004	20	14-8	20	15	(14-10) or (8-3/0)	50 or 120
B007	20	14-8	20	20	(14-10) or (8-3/0)	50 or 120
B011	20	14-8	20	25	(14-10) or (8-3/0)	50 or 120
B014	20	14-8	20	35	(14-10) or (8-3/0)	50 or 120
B021	45	10, 8 or (6-2)	35, 40, or 50	50	(14-10) or (8-3/0)	50 or 120
B027	45	10, 8 or (6-2)	35, 40, or 50	60	(14-10) or (8-3/0)	50 or 120
B034	63	10, 8 or (6-2)	35, 40, or 50	70	(14-10) or (8-3/0)	50 or 120
B040	63	10, 8 or (6-2)	35, 40, or 50	80	(14-10) or (8-3/0)	50 or 120
B052	100	8-2/0	200	110	(14-10) or (8-3/0)	50 or 120
B065	100	8-2/0	200	150	(14-10) or (8-3/0)	50 or 120
B077	150	8-3/0	120	150	(14-10) or (8-3/0)	50 or 120

Table 3.4 Output and Control Wiring

Model H6BP	Motor Wiring Standard Motor Terminal Block TB1		Ground Wiring		Control Wiring					
	AWG, kcmil	Tightening Torque (in lb)	AWG, kcmil	Tightening Torque (in lb)	A1 Terminal Blocks TB1, TB3-TB6		A1 Terminal Block TB2 (FE)		A2 Terminal Blocks TB1-TB4 and TB6	
					AWG, kcmil	Tightening Torque (in lb)	AWG, kcmil	Tightening Torque (in lb)	AWG, kcmil	Tightening Torque (in lb)
B1P1	14-2	32	14-10, 8, 6-4, or 2	35, 40, 45, or 50	24-16	4.4 to 5.3	24-18 *1	8.85 to 10.62	26-14	4
B001	14-2	32	14-10, 8, 6-4, or 2	35, 40, 45, or 50	24-16	4.4 to 5.3	24-18 *1	8.85 to 10.62	26-14	4
B002	14-2	32	14-10, 8, 6-4, or 2	35, 40, 45, or 50	24-16	4.4 to 5.3	24-18 *1	8.85 to 10.62	26-14	4
B003	14-2	32	14-10, 8, 6-4, or 2	35, 40, 45, or 50	24-16	4.4 to 5.3	24-18 *1	8.85 to 10.62	26-14	4
B004	14-2	32	14-10, 8, 6-4, or 2	35, 40, 45, or 50	24-16	4.4 to 5.3	24-18 *1	8.85 to 10.62	26-14	4
B007	14-2	32	14-10, 8, 6-4, or 2	35, 40, 45, or 50	24-16	4.4 to 5.3	24-18 *1	8.85 to 10.62	26-14	4
B011	14-2	32	14-10, 8, 6-4, or 2	35, 40, 45, or 50	24-16	4.4 to 5.3	24-18 *1	8.85 to 10.62	26-14	4
B014	14-2	32	14-10, 8, 6-4, or 2	35, 40, 45, or 50	24-16	4.4 to 5.3	24-18 *1	8.85 to 10.62	26-14	4
B021	14-2	32	14-10, 8, 6-4, or 2	35, 40, 45, or 50	24-16	4.4 to 5.3	24-18 *1	8.85 to 10.62	26-14	4
B027	14-2	32	14-10, 8, 6-4, or 2	35, 40, 45, or 50	24-16	4.4 to 5.3	24-18 *1	8.85 to 10.62	26-14	4
B034	14-2	32	14-10, 8, 6-4, or 2-1/0	35, 40, 45, or 50	24-16	4.4 to 5.3	24-18 *1	8.85 to 10.62	26-14	4
B040	14-2	32	14-10, 8, 6-4, or 2-1/0	35, 40, 45, or 50	24-16	4.4 to 5.3	24-18 *1	8.85 to 10.62	26-14	4
B052	14-2	32	14-10, 8, 6-4, or 2-1/0	35, 40, 45, or 50	24-16	4.4 to 5.3	24-18 *1	8.85 to 10.62	26-14	4
B065	14-2	32	14-10, 8, 6-4, or 2-1/0	35, 40, 45, or 50	24-16	4.4 to 5.3	24-18 *1	8.85 to 10.62	26-14	4
B077	6-2/0	120	14-10, 8, 6-4, or 2-1/0	35, 40, 45, or 50	24-16	4.4 to 5.3	24-18 *1	8.85 to 10.62	26-14	4

*1 24-16 is acceptable for solid wire or ferrule use only.

208 V Enclosed Wire Gauges and Torques

Table 3.5 Input Wiring

Model H6B1	Standard Non-Fused Input Disconnect Switch S1			With Option PM Circuit Breaker CB1		
	Current Rating Amps	AWG, kcmil	Tightening Torque (in lb)	Current Rating Amps	AWG, kcmil	Tightening Torque (in lb)
D002	20	14-8	19	15	14-10 or 8-3/0	50 or 120
D003	20	14-8	19	15	14-10 or 8-3/0	50 or 120
D004	20	14-8	19	15	14-10 or 8-3/0	50 or 120
D007	20	14-8	19	20	14-10 or 8-3/0	50 or 120
D010	20	14-8	19	25	14-10 or 8-3/0	50 or 120
D016	20	14-8	19	40	14-10 or 8-3/0	50 or 120
D024	45	10, 8, or (6-2)	35, 40, or 50	60	14-10 or 8-3/0	50 or 120
D030	63	10, 8, or (6-2)	35, 40, or 50	70	14-10 or 8-3/0	50 or 120
D046	100	8-2/0	200	110	14-10 or 8-3/0	50 or 120

3.3 Main Circuit Wiring

Model H6B1	Standard Non-Fused Input Disconnect Switch S1			With Option PM Circuit Breaker CB1		
	Current Rating Amps	AWG, kcmil	Tightening Torque (in lb)	Current Rating Amps	AWG, kcmil	Tightening Torque (in lb)
D059	100	8-2/0	200	125	14-10 or 8-3/0	50 or 120
D074	115	8-2/0	200	150	14-10 or 8-3/0	50 or 120
D088	150	14 - 10 or 8 - 3/0	50 or 120	150	14 - 10 or 8 - 3/0	50 or 120
D114	175	4 - 4/0	225	150	14 - 10 or 8 - 3/0	50 or 120
D143	250	3/0-350 kcmil	225	250	3/0 - 350 kcmil	225
D169	250	3/0-350 kcmil	225	250	3/0 - 350 kcmil	225
D211	400	(1-2) x (2/0-500 kcmil)	(1-2) x 442	400	(1-2) x (2/0-500 kcmil)	(1-2) x 442
D273	400	(1-2) x (2/0-500 kcmil)	(1-2) x 442	600	(1-2) x (2/0-500 kcmil)	(1-2) x 442

Table 3.6 Output and Control Wiring

Model H6B1	Motor Wiring Standard Motor Terminal Block TB1		Ground Wiring		Control Wiring							
	AWG, kcmil	Tightening Torque (in lb)	AWG, kcmil	Tightening Torque (in lb)	A1 Terminal Blocks TB1, TB3-TB6		A1 Terminal Block TB2 (FE)		A2 Terminal Blocks TB1-TB4 and TB6		Panel Terminal Block TB4	
					AWG, kcmil	Tightening Torque (in lb)	AWG, kcmil	Tightening Torque (in lb)	AWG, kcmil	Tightening Torque (in lb)	AWG, kcmil	Tightening Torque (in lb)
D002	14-2	32	14-10, 8, 6-4, or 2	35, 40, 45, or 50	24-16	4.4 to 5.3	24-18 *1	8.85 to 10.62	26-14	4	26-10	5.3 to 7.1
D003	14-2	32	14-10, 8, 6-4, or 2	35, 40, 45, or 50	24-16	4.4 to 5.3	24-18 *1	8.85 to 10.62	26-14	4	26-10	5.3 to 7.1
D004	14-2	32	14-10, 8, 6-4, or 2	35, 40, 45, or 50	24-16	4.4 to 5.3	24-18 *1	8.85 to 10.62	26-14	4	26-10	5.3 to 7.1
D007	14-2	32	14-10, 8, 6-4, or 2	35, 40, 45, or 50	24-16	4.4 to 5.3	24-18 *1	8.85 to 10.62	26-14	4	26-10	5.3 to 7.1
D010	14-2	32	14-10, 8, 6-4, or 2	35, 40, 45, or 50	24-16	4.4 to 5.3	24-18 *1	8.85 to 10.62	26-14	4	26-10	5.3 to 7.1
D016	14-2	32	14-10, 8, 6-4, or 2	35, 40, 45, or 50	24-16	4.4 to 5.3	24-18 *1	8.85 to 10.62	26-14	4	26-10	5.3 to 7.1
D024	14-2	32	14-10, 8, 6-4, or 2	35, 40, 45, or 50	24-16	4.4 to 5.3	24-18 *1	8.85 to 10.62	26-14	4	26-10	5.3 to 7.1
D030	14-2	32	14-10, 8, 6-4, or 2	35, 40, 45, or 50	24-16	4.4 to 5.3	24-18 *1	8.85 to 10.62	26-14	4	26-10	5.3 to 7.1
D046	14-2	32	14-10, 8, 6-4, or 2-1/0	35, 40, 45, or 50	24-16	4.4 to 5.3	24-18 *1	8.85 to 10.62	26-14	4	26-10	5.3 to 7.1
D059	14-2	32	14-10, 8, 6-4, or 2-1/0	35, 40, 45, or 50	24-16	4.4 to 5.3	24-18 *1	8.85 to 10.62	26-14	4	26-10	5.3 to 7.1
D074	6-2/0	120	14-10, 8, 6-4, or 2-1/0	35, 40, 45, or 50	24-16	4.4 to 5.3	24-18 *1	8.85 to 10.62	26-14	4	26-10	5.3 to 7.1
D088	14 - 8 or 6 - 2/0	50 or 120	14-10, 8, 6-4, or 2	35, 40, 45, or 50	24 - 16	4.4 to 5.3	24-18 *1	8.85 to 10.62	26 - 14	4	26-10	5.3 to 7.1
D114	14 - 10 or 8 or 6 - 2/0	35 or 40 or 120	14-10, 8, 6-4, or 2	35, 40, 45, or 50	24 - 16	4.4 to 5.3	24-18 *1	8.85 to 10.62	26 - 14	4	26-10	5.3 to 7.1
D143	6 - 350 kcmil	275	14-10, 8, 6-4, or 2	35, 40, 45, or 50	24 - 16	4.4 to 5.3	24-18 *1	8.85 to 10.62	26 - 14	4	26-10	5.3 to 7.1
D169	6 - 350 kcmil	275	14-10, 8, 6-4, or 2	35, 40, 45, or 50	24 - 16	4.4 to 5.3	24-18 *1	8.85 to 10.62	26 - 14	4	26-10	5.3 to 7.1
D211	(1-2) x (4 - 500 kcmil)	(1-2) x 500	14 - 2/0	120	24 - 16	4.4 to 5.3	24-18 *1	8.85 to 10.62	26 - 14	4	26-10	5.3 to 7.1
D273	(1-2) x (4 - 500 kcmil)	(1-2) x 500	14 - 2/0	120	24 - 16	4.4 to 5.3	24-18 *1	8.85 to 10.62	26 - 14	4	26-10	5.3 to 7.1

*1 24-16 is acceptable for solid wire or ferrule use only.

■ 240 V Enclosed Wire Gauges and Torques

Table 3.7 Input Wiring

Model H6B1	Standard Non-Fused Input Disconnect Switch S1			With Option PM Circuit Breaker CB1		
	Current Rating Amps	AWG, kcmil	Tightening Torque (in lb)	Current Rating Amps	AWG, kcmil	Tightening Torque (in lb)
A002	20	14-8	20	15	14-10 or 8-3/0	50 or 120
A003	20	14-8	20	15	14-10 or 8-3/0	50 or 120
A004	20	14-8	20	15	14-10 or 8-3/0	50 or 120
A006	20	14-8	20	20	14-10 or 8-3/0	50 or 120
A009	20	14-8	20	25	14-10 or 8-3/0	50 or 120
A015	20	14-8	20	35	14-10 or 8-3/0	50 or 120
A022	45	10, 8, or (6-2)	35, 40, or 50	50	14-10 or 8-3/0	50 or 120
A028	63	10, 8, or (6-2)	35, 40, or 50	70	14-10 or 8-3/0	50 or 120
A042	100	8-2/0	200	100	14-10 or 8-3/0	50 or 120
A054	100	8-2/0	200	125	14-10 or 8-3/0	50 or 120
A068	100	8-2/0	200	150	14-10 or 8-3/0	50 or 120
A080	115	8-2/0	200	150	14-10 or 8-3/0	50 or 120
A104	175	4-4/0	225	150	14-10 or 8-3/0	50 or 120
A130	250	3/0-350 kcmil	225	250	4-4/0	225
A154	250	3/0-350 kcmil	225	250	3/0-350	225
A192	250	3/0-350 kcmil	225	400	(1-2) x (2/0-500 kcmil)	(1-2) x 442
A248	400	(1-2) x (2/0-500 kcmil)	(1-2) x 442	600	(1-2) x (2/0-500 kcmil)	(1-2) x 442

Table 3.8 Output and Control Wiring

Model H6B1	Motor Wiring Standard Motor Terminal Block TB1		Ground Wiring		Control Wiring							
	AWG, kcmil	Tightening Torque (in lb)	AWG, kcmil	Tightening Torque (in lb)	A1 Terminal Blocks TB1, TB3-TB6		A1 Terminal Block TB2 (FE)		A2 Terminal Blocks TB1-TB4 and TB6		Panel Terminal Block TB4	
					AWG, kcmil	Tightening Torque (in lb)	AWG, kcmil	Tightening Torque (in lb)	AWG, kcmil	Tightening Torque (in lb)	AWG, kcmil	Tightening Torque (in lb)
A002	14-2	32	14-10, 8, 6-4, or 2	35, 40, 45, or 50	24-16	4.4 to 5.3	24-18 *I	8.85 to 10.62	26-14	4	26-10	5.3 to 7.1
A003	14-2	32	14-10, 8, 6-4, or 2	35, 40, 45, or 50	24-16	4.4 to 5.3	24-18 *I	8.85 to 10.62	26-14	4	26-10	5.3 to 7.1
A004	14-2	32	14-10, 8, 6-4, or 2	35, 40, 45, or 50	24-16	4.4 to 5.3	24-18 *I	8.85 to 10.62	26-14	4	26-10	5.3 to 7.1
A006	14-2	32	14-10, 8, 6-4, or 2	35, 40, 45, or 50	24-16	4.4 to 5.3	24-18 *I	8.85 to 10.62	26-14	4	26-10	5.3 to 7.1
A009	14-2	32	14-10, 8, 6-4, or 2	35, 40, 45, or 50	24-16	4.4 to 5.3	24-18 *I	8.85 to 10.62	26-14	4	26-10	5.3 to 7.1
A015	14-2	32	14-10, 8, 6-4, or 2	35, 40, 45, or 50	24-16	4.4 to 5.3	24-18 *I	8.85 to 10.62	26-14	4	26-10	5.3 to 7.1
A022	14-2	32	14-10, 8, 6-4, or 2	35, 40, 45, or 50	24-16	4.4 to 5.3	24-18 *I	8.85 to 10.62	26-14	4	26-10	5.3 to 7.1
A028	14-2	32	14-10, 8, 6-4, or 2	35, 40, 45, or 50	24-16	4.4 to 5.3	24-18 *I	8.85 to 10.62	26-14	4	26-10	5.3 to 7.1
A042	14-2	32	14-10, 8, 6-4, or 2	35, 40, 45, or 50	24-16	4.4 to 5.3	24-18 *I	8.85 to 10.62	26-14	4	26-10	5.3 to 7.1
A054	14-2	32	14-10, 8, 6-4, or 2	35, 40, 45, or 50	24-16	4.4 to 5.3	24-18 *I	8.85 to 10.62	26-14	4	26-10	5.3 to 7.1

3.3 Main Circuit Wiring

Model H6B1	Motor Wiring Standard Motor Terminal Block TB1		Ground Wiring		Control Wiring							
	AWG, kcmil	Tightening Torque (in lb)	AWG, kcmil	Tightening Torque (in lb)	A1 Terminal Blocks TB1, TB3-TB6		A1 Terminal Block TB2 (FE)		A2 Terminal Blocks TB1-TB4 and TB6		Panel Terminal Block TB4	
					AWG, kcmil	Tightening Torque (in lb)	AWG, kcmil	Tightening Torque (in lb)	AWG, kcmil	Tightening Torque (in lb)	AWG, kcmil	Tightening Torque (in lb)
A068	14-2	32	14-10, 8, 6-4, or 2	35, 40, 45, or 50	24-16	4.4 to 5.3	24-18 <i>*1</i>	8.85 to 10.62	26-14	4	26-10	5.3 to 7.1
A080	14-8 or 6-2/0	50 or 120	14-10, 8, 6-4, or 2	35, 40, 45, or 50	24-16	4.4 to 5.3	24-18 <i>*1</i>	8.85 to 10.62	26-14	4	26-10	5.3 to 7.1
A104	14-8 or 6-2/0	50 or 120	14-10, 8, 6-4, or 2	35, 40, 45, or 50	24-16	4.4 to 5.3	24-18 <i>*1</i>	8.85 to 10.62	26-14	4	26-10	5.3 to 7.1
A130	(1-2) x (6) or (4) or (3-4/0)	(1-2) x 80 or 100 or 150	14-10, 8, 6-4, or 2	35, 40, 45, or 50	24-16	4.4 to 5.3	24-18 <i>*1</i>	8.85 to 10.62	26-14	4	26-10	5.3 to 7.1
A154	6 - 350 kcmil	275	14-10, 8, 6-4, or 2	35, 40, 45, or 50	24-16	4.4 to 5.3	24-18 <i>*1</i>	8.85 to 10.62	26-14	4	26-10	5.3 to 7.1
A192	6-350 kcmil	275	14 - 2/0	120	24-16	4.4 to 5.3	24-18 <i>*1</i>	8.85 to 10.62	26-14	4	26-10	5.3 to 7.1
A248	(1-2) x (4-500 kcmil)	(1-2) x 500	14 - 2/0	120	24-16	4.4 to 5.3	24-18 <i>*1</i>	8.85 to 10.62	26-14	4	26-10	5.3 to 7.1

*1 24-16 is acceptable for solid wire or ferrule use only.

■ 480 V Enclosed Wire Gauges and Torques

Table 3.9 Input Wiring

Model H6B1	Standard Non-Fused Input Disconnect Switch S1			With Option PM Circuit Breaker CB1		
	Current Rating Amps	AWG, kcmil	Tightening Torque (in lb)	Current Rating Amps	AWG, kcmil	Tightening Torque (in lb)
B1P1	20	14-8	20	15	(14-10) or (8-3/0)	50 or 120
B001	20	14-8	20	15	(14-10) or (8-3/0)	50 or 120
B002	20	14-8	20	15	(14-10) or (8-3/0)	50 or 120
B003	20	14-8	20	15	(14-10) or (8-3/0)	50 or 120
B004	20	14-8	20	15	(14-10) or (8-3/0)	50 or 120
B007	20	14-8	20	20	(14-10) or (8-3/0)	50 or 120
B011	20	14-8	20	25	(14-10) or (8-3/0)	50 or 120
B014	20	14-8	20	35	(14-10) or (8-3/0)	50 or 120
B021	45	10, 8 or (6-2)	35, 40, or 50	50	(14-10) or (8-3/0)	50 or 120
B027	45	10, 8 or (6-2)	35, 40, or 50	60	(14-10) or (8-3/0)	50 or 120
B034	63	10, 8 or (6-2)	35, 40, or 50	70	(14-10) or (8-3/0)	50 or 120
B040	63	10, 8 or (6-2)	35, 40, or 50	80	(14-10) or (8-3/0)	50 or 120
B052	100	8-2/0	200	110	(14-10) or (8-3/0)	50 or 120
B065	100	8-2/0	200	115	(14-10) or (8-3/0)	50 or 120
B077	150	8-3/0	120	150	(14-10) or (8-3/0)	50 or 120
B096	150	14-10 or 8-3/0	50 or 120	150	(14-10) or (8-3/0)	50 or 120
B124	175	4 - 4/0	225	250	4-4/0	225
B156	250	3/0-350 kcmil	225	250	3/0-350 kcmil	225
B180	250	3/0-350 kcmil	225	250	3/0-350 kcmil	225
B240	400	(1-2) x (2/0-500 kcmil)	(1-2) x 442	500	(1-2) x (2/0-500 kcmil)	(1-2) x 442
B302	600	(1-2) x (2/0-500 kcmil)	(1-2) x 442	600	(1-2) x (2/0-500 kcmil)	(1-2) x 442

Table 3.10 Output and Control Wiring

Model H6B1	Motor Wiring Standard Motor Terminal Block TB1		Ground Wiring		Control Wiring							
	AWG, kcmil	Tightening Torque (in lb)	AWG, kcmil	Tightening Torque (in lb)	A1 Terminal Blocks TB1, TB3-TB6		A1 Terminal Block TB2 (FE)		A2 Terminal Blocks TB1-TB4 and TB6		Panel Terminal Block TB4	
					AWG, kcmil	Tightening Torque (in lb)	AWG, kcmil	Tightening Torque (in lb)	AWG, kcmil	Tightening Torque (in lb)	AWG, kcmil	Tightening Torque (in lb)
B1P1	14-2	32	14-10, 8, 6-4, or 2	35, 40, 45, or 50	24-16	4.4 to 5.3	24-18 ^{*1}	8.85 to 10.62	26-14	4	26-10	5.3 to 7.1
B001	14-2	32	14-10, 8, 6-4, or 2	35, 40, 45, or 50	24-16	4.4 to 5.3	24-18 ^{*1}	8.85 to 10.62	26-14	4	26-10	5.3 to 7.1
B002	14-2	32	14-10, 8, 6-4, or 2	35, 40, 45, or 50	24-16	4.4 to 5.3	24-18 ^{*1}	8.85 to 10.62	26-14	4	26-10	5.3 to 7.1
B003	14-2	32	14-10, 8, 6-4, or 2	35, 40, 45, or 50	24-16	4.4 to 5.3	24-18 ^{*1}	8.85 to 10.62	26-14	4	26-10	5.3 to 7.1
B004	14-2	32	14-10, 8, 6-4, or 2	35, 40, 45, or 50	24-16	4.4 to 5.3	24-18 ^{*1}	8.85 to 10.62	26-14	4	26-10	5.3 to 7.1
B007	14-2	32	14-10, 8, 6-4, or 2	35, 40, 45, or 50	24-16	4.4 to 5.3	24-18 ^{*1}	8.85 to 10.62	26-14	4	26-10	5.3 to 7.1
B011	14-2	32	14-10, 8, 6-4, or 2	35, 40, 45, or 50	24-16	4.4 to 5.3	24-18 ^{*1}	8.85 to 10.62	26-14	4	26-10	5.3 to 7.1
B014	14-2	32	14-10, 8, 6-4, or 2	35, 40, 45, or 50	24-16	4.4 to 5.3	24-18 ^{*1}	8.85 to 10.62	26-14	4	26-10	5.3 to 7.1
B021	14-2	32	14-10, 8, 6-4, or 2	35, 40, 45, or 50	24-16	4.4 to 5.3	24-18 ^{*1}	8.85 to 10.62	26-14	4	26-10	5.3 to 7.1
B027	14-2	32	14-10, 8, 6-4, or 2	35, 40, 45, or 50	24-16	4.4 to 5.3	24-18 ^{*1}	8.85 to 10.62	26-14	4	26-10	5.3 to 7.1
B034	14-2	32	14-10, 8, 6-4, or 2-1/0	35, 40, 45, or 50	24-16	4.4 to 5.3	24-18 ^{*1}	8.85 to 10.62	26-14	4	26-10	5.3 to 7.1
B040	14-2	32	14-10, 8, 6-4, or 2-1/0	35, 40, 45, or 50	24-16	4.4 to 5.3	24-18 ^{*1}	8.85 to 10.62	26-14	4	26-10	5.3 to 7.1
B052	14-2	32	14-10, 8, 6-4, or 2-1/0	35, 40, 45, or 50	24-16	4.4 to 5.3	24-18 ^{*1}	8.85 to 10.62	26-14	4	26-10	5.3 to 7.1
B065	14-2	32	14-10, 8, 6-4, or 2-1/0	35, 40, 45, or 50	24-16	4.4 to 5.3	24-18 ^{*1}	8.85 to 10.62	26-14	4	26-10	5.3 to 7.1
B077	6-2/0	120	14-10, 8, 6-4, or 2-1/0	35, 40, 45, or 50	24-16	4.4 to 5.3	24-18 ^{*1}	8.85 to 10.62	26-14	4	26-10	5.3 to 7.1
B096	14 - 8 or 6 - 2/0	50 or 120	14-10, 8, 6-4, or 2	35, 40, 45, or 50	24-16	4.4 to 5.3	24-18 ^{*1}	8.85 to 10.62	26 - 14	4	26-10	5.3 to 7.1
B124	(1-2) x (6) or (4) or (3 - 4/ 0)	(1-2) x 80 or 100 or 150	14-10, 8, 6-4, or 2	35, 40, 45, or 50	24-16	4.4 to 5.3	24-18 ^{*1}	8.85 to 10.62	26 - 14	4	26-10	5.3 to 7.1
B156	6 - 350 kcmil	275	14-10, 8, 6-4, or 2	35, 40, 45, or 50	24-16	4.4 to 5.3	24-18 ^{*1}	8.85 to 10.62	26 - 14	4	26-10	5.3 to 7.1
B180	6 - 350 kcmil	275	14 - 2/0	120	24-16	4.4 to 5.3	24-18 ^{*1}	8.85 to 10.62	26 - 14	4	26-10	5.3 to 7.1
B240	(1-2) x (4 - 500 kcmil)	(1-2) x 500	14 - 2/0	120	24-16	4.4 to 5.3	24-18 ^{*1}	8.85 to 10.62	26 - 14	4	26-10	5.3 to 7.1
B302	(1-2) x (4 - 500 kcmil)	(1-2) x 500	14 - 2/0	120	24-16	4.4 to 5.3	24-18 ^{*1}	8.85 to 10.62	26 - 14	4	26-10	5.3 to 7.1

*1 24-16 is acceptable for solid wire or ferrule use only.

◆ Main Circuit Terminal and Motor Wiring

This section outlines the various steps, precautions, and checkpoints to wire the main circuit terminals and motor terminals.

3.3 Main Circuit Wiring

WARNING! Sudden Movement Hazard. Make sure that you align the phase order for the bypass and motor when you connect the motor to output terminals U/T1, V/T2, and W/T3. If the phase order is incorrect, it can cause the motor to run in reverse. If the motor accidentally runs in reverse, it can cause serious injury or death.

NOTICE: Do not connect phase-advancing capacitors, LC/RC noise filters, or leakage breakers (GFCI) to the motor circuit. If you connect these devices to the output circuits, it can cause damage to the bypass and connected equipment.

■ Cable Length Between Bypass and Motor

When the wiring between the bypass and the motor is too long, voltage drop along the motor cable can decrease motor torque, usually at low frequency output. If you use a long motor cable to connect motors in parallel, this is also a problem. Output current increases when the leakage current from the cable increases. An increase in leakage current can cause overcurrent and decrease the precision of current detection.

If the system configuration makes the motor wiring distance more than 100 m (328 ft), do not use metal conduits or use isolated cables for each phase to decrease stray capacitance.

Table 3.11 Carrier Frequency against Cable Length Between Drive and Motor

Wiring Distance between the Bypass and Motor	100 m (328 ft) Maximum
Carrier Frequency	2 kHz or less

Note:

- For bypass models D004 to D016, A002 to A015, and B1P1, B001 to B014:
 - Shorter than 10 m: No carrier frequency derating from default setting (5 kHz) is necessary.
 - 10 m to 50 m: 5 kHz to 2 kHz is necessary.
 - 50 m and longer: 2 kHz
- To set the carrier frequency in a bypass that is operating more than one motor, calculate the cable length as the total distance of wiring to all connected motors.

■ Ground Wiring

Follow these precautions to wire the ground for one bypass or a series of bypasses.

WARNING! Electrical Shock Hazard. Make sure that the protective ground wire conforms to technical standards and local safety regulations. The IEC/EN 61800-5-1:2007 standard specifies that you must wire the power supply to automatically de-energize when the protective ground wire disconnects. You can also connect a protective ground wire that has a minimum cross-sectional area of 10 mm² (copper wire) or 16 mm² (aluminum wire). If you do not obey the standards and regulations, it can cause serious injury or death. The leakage current of the bypass will be more than 3.5 mA.

WARNING! Electrical Shock Hazard. Ground the neutral point on the power supply of the bypass to comply with the EMC Directive before you turn on the EMC filter. If you turn ON the EMC filter, but you do not ground the neutral point, it can cause serious injury or death.

WARNING! Electrical Shock Hazard. Use a ground wire that complies with technical standards on electrical equipment and use the minimum length of ground wire. Incorrect equipment grounding can cause serious injury or death from dangerous electrical potentials on the equipment chassis.

Note:

- Only use the bypass grounding wire to ground the bypass. Do not share the ground wire with other devices, for example, welding machines or large-current electrical equipment. Incorrect equipment grounding can cause incorrect operation of equipment.
- To connect more than one bypass to the same grounding circuit, use the instructions in the manual. Incorrect equipment grounding can cause incorrect operation of equipment.

When you install more than one bypass, refer to [Figure 3.5](#). Do not loop the grounding wire.

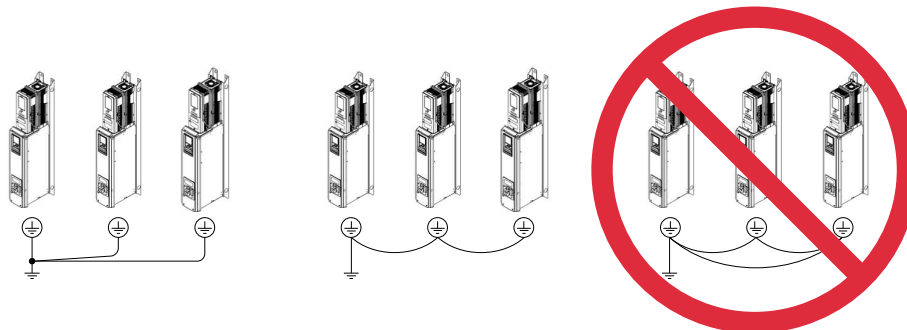

Figure 3.5 Wiring More than One Bypass

■ Wiring the Main Circuit Terminal Block

WARNING! *Electrical Shock Hazard. Before you wire the main circuit terminals, make sure that MCCB and MC are OFF. If you touch electrical equipment when MCCB and MC are ON, it can cause serious injury or death.*

◆ Protection of Main Circuit Terminals

When you wire the main circuit terminals, do not let cable ends go near terminals or the drive. If you use crimped terminals, make sure that you also use insulation caps.

3.4 Main Circuit Terminal Wiring Procedure

DANGER! Electrical Shock Hazard. Do not examine, connect, or disconnect wiring on an energized bypass. Before servicing, disconnect all power to the equipment and wait for the time specified on the warning label at a minimum. The internal capacitor stays charged after the bypass is de-energized. The charge indicator LED extinguishes when the DC bus voltage decreases below 50 Vdc. When all indicators are OFF, remove the covers before measuring for dangerous voltages to make sure that the bypass is safe. If you do work on the bypass when it is energized, it will cause serious injury or death from electrical shock.

◆ Notes on Wiring the Main Circuit Terminal

Read these safety messages and notes before you wire the main circuit terminal.

WARNING! Fire Hazard. Do not use bent or crushed wires. Remove the damaged end of the wire before you use it. Incorrect connections can cause death or serious injury from fire.

WARNING! Fire Hazard. If you use stranded wire, make sure that all of the wire strands are in the connection. Also, do not twist the stranded wire too much. Incorrect connections can cause death or serious injury from fire.

NOTICE: Do not solder stranded wire. Soldered wire connections can become loose over time and cause unsatisfactory drive performance.

NOTICE: If you use power tools to tighten the terminal screws, use a low speed setting (300 min⁻¹ (r/min) to 400 min⁻¹ (r/min)). High speeds can cause damage to the terminal screws.

Note:

- Use UL Listed vinyl-coated insulated copper wires for operation with a continuous maximum permitted temperature of 75 °C at 600 V.
- Remove all unwanted objects that are near the terminal block connections.
- Remove the insulation from the connection wires to the wire stripping lengths shown in the manual.
- Put the wire all the way into the terminal block. Remove the insulation from the wire to the recommended wire stripping length to fit the wire with insulation in the plastic housing.
- Use a torque driver, torque ratchet, or torque wrench for the screws. A slotted driver or a hex tool will be necessary to wire the screw clamp terminal. Use applicable tools as specified by the recommended conditions in the product manual.
- Put the bit all the way into the hex socket to tighten the hex socket cap screw.
- When tightening slotted screws, hold the straight-edge screwdriver perpendicularly to the screw. Take care to ensure that the tip of the straight-edge screwdriver is aligned with the screw groove.

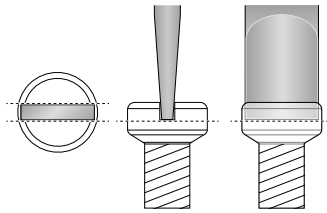
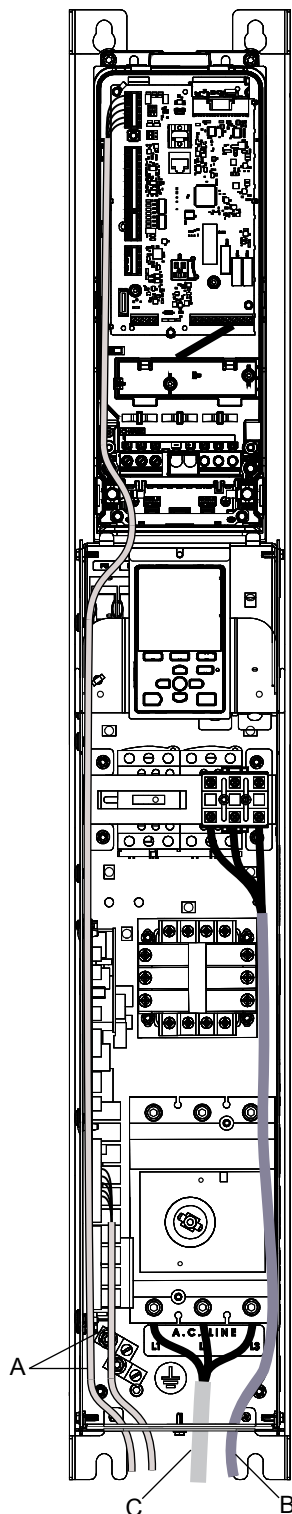

Figure 3.6 Tightening Slotted Screws

- After connecting the wires to the terminal block, lightly pull on the wires to make sure that they do not come out of the terminals.

◆ Narrow Bypass Main Circuit Terminal Block Wiring Procedure

1. Correctly ground the bypass terminal board.
2. Route the main circuit wiring. [Figure 3.7](#) shows suggested wire entry and bending areas for the enclosure.



A - Optional drive control wiring
B - Motor output circuit

C - Main input circuit

Figure 3.7 Narrow Bypass Wire Routing Example (Models H6BPD002 to D074 and B1P1, B001 to B077)

◆ Enclosed Bypass Main Circuit Terminal Block Wiring Procedure

1. Correctly ground the bypass terminal board.
2. Route the main circuit wiring. [Figure 3.8](#) shows suggested wire entry and bending areas for the enclosure.

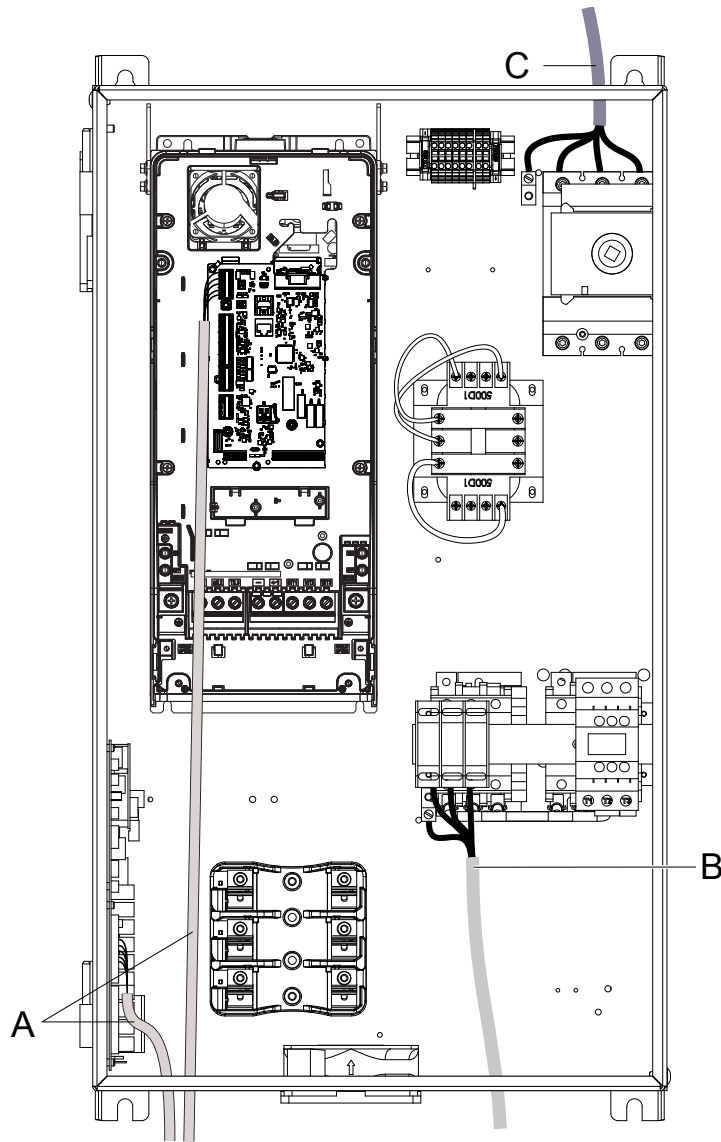

A - Optional drive control wiring
B - Motor output circuit

C - Main input circuit

Figure 3.8 Enclosed Bypass Wire Routing Example (Models H6B1D002 to D273, A002 to A248, B1P1, B001 to B302)

3.5 Bypass Controller

Note:

When possible, use these control terminal connections on the bypass controller. There are additional control I/O terminals available on the drive, however those terminals are active in Drive Mode ONLY and may not report correctly in Bypass Mode.

◆ Control Circuit Terminal Arrangement

The bypass control circuit terminals are in the positions shown in [Figure 3.9](#).

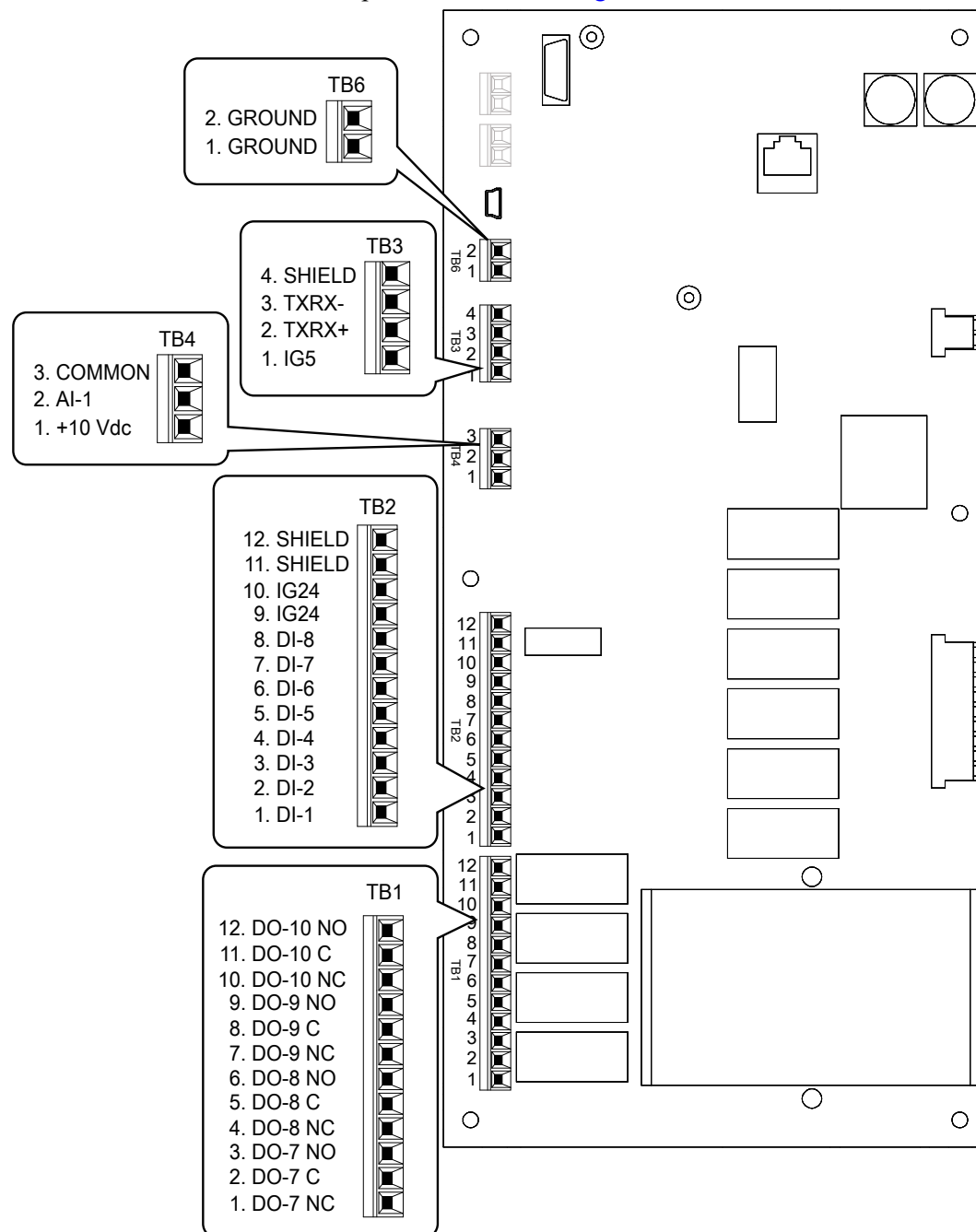

Figure 3.9 Bypass Control Circuit Terminal Arrangement

◆ Bypass Control Circuit Wire Gauges and Tightening Torques

Use the tables in this section to select the correct wires. Use shielded wire to wire the control circuit terminal block. Use crimp ferrules on the wire ends to make the wiring procedure easier and more reliable.

Table 3.12 Bypass Control Circuit Wire Gauges and Tightening Torques

Bypass Terminal Block	Terminal	Tightening Torque in-lb	Recommended Gauge AWG	Applicable Gauge AWG
TB1	DO-7 - DO-10	4	18	26-14
TB2	DI-1 - DI-8, IG24, SHIELD			
TB3	SHEILD, TXRX-, TXRX+, IG5			
TB4	+10 Vdc, AI-1, COMMON			
TB6	GROUND, GROUND			

◆ Crimp Ferrules

Attach an insulated sleeve when you use crimp ferrules. Refer to [Table 3.13](#) for the recommended external dimensions and model numbers of the crimp ferrules.

Use the CRIMPFOX 6, a crimping tool made by PHOENIX CONTACT.

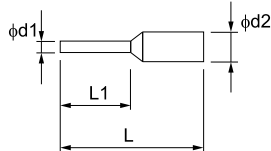

Figure 3.10 External Dimensions of Crimp Ferrules

Table 3.13 Crimp Ferrule Models and Sizes

Wire Gauge mm ² (AWG)	Model	L (mm)	L1 (mm)	φd1 (mm)	φd2 (mm)
0.25 (24)	AI 0.25-8YE	12.5	8	0.8	2.0
0.34 (22)	AI 0.34-8TQ	12.5	8	0.8	2.0
0.5 (20)	AI 0.5-8WH AI 0.5-8OG	14	8	1.1	2.5
0.75 (18)	AI 0.75-8 GY	14	8	1.3	2.8

◆ Bypass Control Circuit Terminal Block Input Functions

WARNING! Sudden Movement Hazard. Correctly wire and test all control circuits to make sure that the control circuits operate correctly. If you use a drive that has incorrect control circuit wiring or operation, it can cause death or serious injury.

WARNING! Sudden Movement Hazard. Check the I/O signals and the external sequences for the drive before you set the Application Preset function. When you set the Application Preset function (A1-06 ≠ 0), it changes the I/O terminal functions for the drive and it can cause equipment to operate unusually. This can cause serious injury or death.

NOTICE: Damage to Equipment. Do not energize and de-energize the bypass more frequently than one time each 30 minutes. If you frequently energize and de-energize the bypass, it can cause failure.

Table 3.14 Bypass Digital Input Terminals (TB2)

Type	Terminal	Name (Default)	Function (Signal Level)
Digital Inputs	TB2-1 DI-1	Digital Input 1 (Run (AUTO))	Dry contact rated, photocoupler sinking input to IG24, 24 Vdc 8 mA, Ground fault protected
	TB2-2 DI-2	Digital Input 2 (Run Enable - Safety (NC))	
	TB2-3 DI-3	Digital Input 3 (Run Interlock (BAS))	
	TB2-4 DI-4	Digital Input 4 (Remote Transfer to Bypass)	
	TB2-5 DI-5	Digital Input 5 (Emergency Override Bypass)	
	TB2-6 DI-6	Digital Input 6 (Not used)	
	TB2-7 DI-7	Digital Input 7 (Not used)	
	TB2-8 DI-8	Digital Input 8 (Not used)	
	TB2-9/10 IG24	Isolated Ground	Digital input common

Table 3.15 Bypass Analog Input Terminals (TB4)

Type	Terminal	Name (Default)	Function (Signal Level)
Analog Input	TB4-1 +10 Vdc	Analog Input Power Supply	AUTO Mode Speed Reference 0 to 10 Vdc (20 k Ω) or 4 to 20 mA (250 Ω)
	TB4-2 AI	Analog Input Speed Reference	
	TB4-3 COMMON	Analog Input Common	

◆ Bypass Control Circuit Terminal Block Output Functions

Table 3.16 Bypass Digital Output Terminals (TB1)

Type	Terminal	Name (Default)	Function (Signal Level)
Digital Outputs	TB1-1/2/3 DO-7	Digital Output 7 (Run Active)	Relay, dry contact form C, 30 Vdc or 120 Vac, DO-7 to DO-10 for customer use, 2 Amp
	TB1-4/5/6 DO-8	Digital Output 8 (HAND mode Active)	
	TB1-7/8/9 DO-9	Digital Output 9 (AUTO mode Active)	
	TB1-10/11/ 12 DO-10	Digital Output 10 (Fault Active)	

Table 3.17 Control Circuit Ground Terminals (TB6)

Type	Terminal	Name (Default)	Function (Signal Level)
Ground	TB6-1/2 GROUND	Chassis Ground	-

◆ Bypass Serial Communication Terminals

Table 3.18 Bypass Serial Communication Terminals (TB3)

Type	Terminal	Terminal Name	Function (Signal Level)
Serial Communication	TB3-1 IG5	Isolated ground	Ground reference for RS-485 signals. This is an isolated ground used only for communications and may be used in certain circumstances to connect the floating ground references of other communication devices.
	TB3-2 TXRX+	(+) Differential communication signal	<ul style="list-style-type: none"> • BACnet communications • APOGEE FLN communications • MEMOBUS/ Modbus communications • Metasys N2 communications Use an RS-485 cable to connect the drive. Note: Make sure that DIP switch S1 is ON to enable the termination resistor in the last drive in a BACnet, APOGEE FLN, MEMOBUS/ Modbus, or Metasys N2 network.
	TB3-3 TXRX-	(-) Differential communication signal	
	TB3-4 SHIELD	Shield tie point	Capacitively coupled to chassis ground.

◆ Switches on the Bypass Controller

The bypass controller has switches to adapt the bypass I/Os to the external control signals as shown in [Figure 3.11](#). Set the switches to select the functions for each terminal.

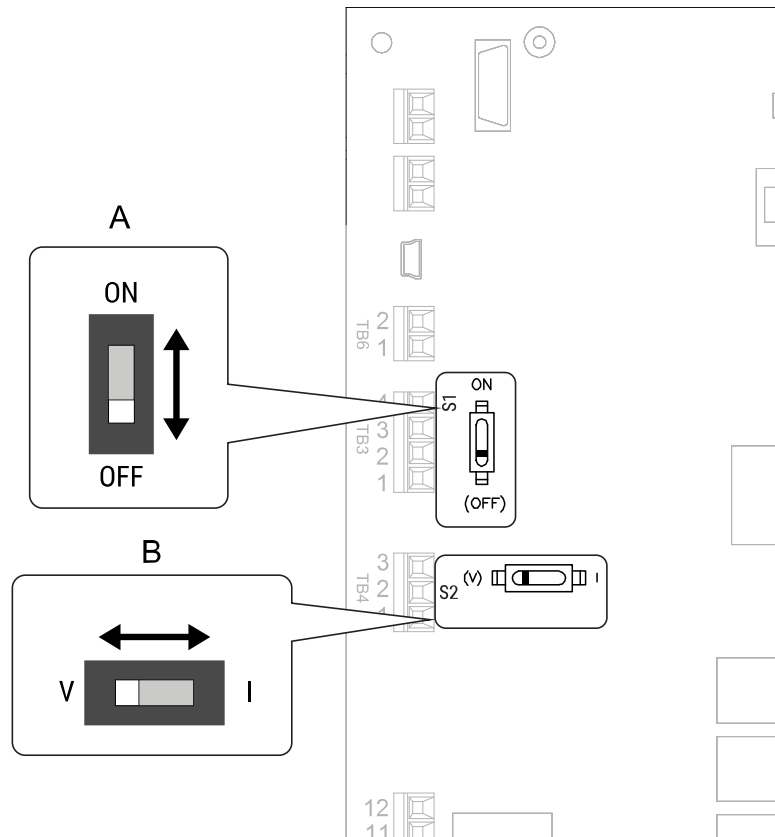

Figure 3.11 Locations of Switches

Table 3.19 I/O Switch Functions

Position	Switch	Function	Default Setting
A	DIP switch S1	RS-485 Terminating Resistor (120 Ω) enables and disables the termination resistor of these communications: <ul style="list-style-type: none"> • BACnet (MSTP) • APOGEE FLN • MEMOBUS/Modbus • Metasys N2 	OFF
B	DIP switch S2	V/I switch for analog input.	V (voltage input) I (current input)

◆ Wiring the Bypass Control Circuit Terminal

WARNING! Electrical Shock Hazard. Do not remove covers or touch circuit boards while the bypass is energized. If you touch the internal components of an energized bypass, it can cause serious injury or death.

NOTICE: Do not let wire shields touch other signal lines or equipment. Insulate the wire shields with electrical tape or shrink tubing. If you do not insulate the wire shields, it can cause a short circuit and damage the drive.

Note:

- Isolate control circuit wiring from main circuit wiring and other high-power wiring. If the control circuit wires are adjacent to the main circuit wires, electrical interference can cause the bypass or the devices around the bypass to malfunction.
- Isolate TB1 contact output terminals from other control circuit wiring. If the output terminal wires are adjacent to other control circuit wires, electrical interference can cause the bypass or devices around the bypass to malfunction.
- Use a UL Listed Class 2 Power Supply to connect external power to the TB1 contact output control terminals. If the power supply for peripheral devices is incorrect, it can cause a decrease in bypass performance.
- Connect the shield of shielded cable to the applicable ground or shield terminal. If the shield connections are not correct, electrical interference can cause the bypass or devices around the bypass to malfunction.

Correctly ground the bypass terminals and complete main circuit wiring before you wire the control circuit. Remove the front cover.

1. Refer to [Figure 3.12](#) and wire the control circuit.

WARNING! Fire Hazard. Tighten all terminal screws to the correct tightening torque. Connections that are too loose or too tight can cause incorrect operation and damage to the bypass. Incorrect connections can also cause death or serious injury from fire.

Note:

- Use shielded wires and shielded twisted-pair wires for the control circuit terminal wiring. If the grounding is not correct, electrical interference can cause the drive or devices around it to malfunction.
- Do not use control circuit wiring that is longer than 50 m (164 ft) to supply the frequency reference with an analog signal from a remote source. Wiring that is too long can cause unsatisfactory system performance.

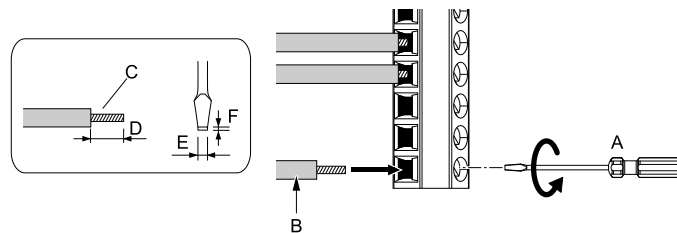

- A - Loosen the screws and put the wire into the opening on the terminal block.**
- B - Wire with a crimp ferrule attached, or use wire that is not soldered with the core wires lightly twisted.**
- C - Pull back the shielding and lightly twist the end with your fingers to keep the ends from fraying.**
- D - If you do not use crimp ferrules, remove approximately 5.5 mm (0.21 in) of the covering at the end of the wire.**
- E - Blade width of 2.5 mm (0.1 in) or less**
- F - Blade depth of 0.4 mm (0.01 in) or less**

Figure 3.12 Wiring Procedure for the Control Circuit

WARNING! Fire Hazard. Tighten all terminal screws to the correct tightening torque. Connections that are too loose or too tight can cause incorrect operation and damage to the bypass. Incorrect connections can also cause death or serious injury from fire.

3.5 Bypass Controller

NOTICE: Do not tin stranded wire with solder. Soldered wire connections can become loose over time and cause unsatisfactory system performance.

Note:

- Refer to [Figure 3.13](#) for information to prepare terminal ends of the shielded wire.
- Prepare the wire ends of shielded twisted-pair wires as shown in [Figure 3.13](#) to use an analog reference from an external frequency setting potentiometer to set the frequency. Connect the shield to TB2-11 or TB2-12 on the bypass control board or terminal FE on the drive.

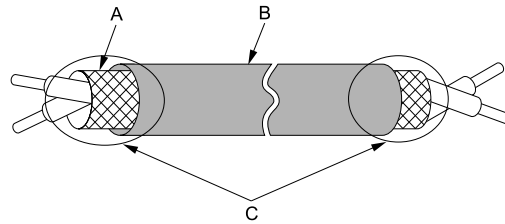

A - Connect the shield to TB2-11 or TB2-12.
B - Sheath

C - Insulate with electrical tape or shrink tubing.

Figure 3.13 Prepare the Ends of Shielded Wire

2. Install the front cover to its initial position.

3.6 Drive Control Circuit

Note:

When possible, use the control terminal connections on the Bypass PCB A2. The additional control I/O terminals available on the Drive Control circuit, are active in Drive Mode ONLY and may not report correctly in Bypass Mode. Typically, the Drive Control circuit wiring is used with a PID feedback signal or an analog monitor (output). In most applications, you should not connect to the drive control circuit digital inputs (S1 to S7) because it can cause unintended operation.

◆ Drive Control Circuit Terminal Arrangement

The drive control circuit terminals are in the positions shown in [Figure 3.14](#).

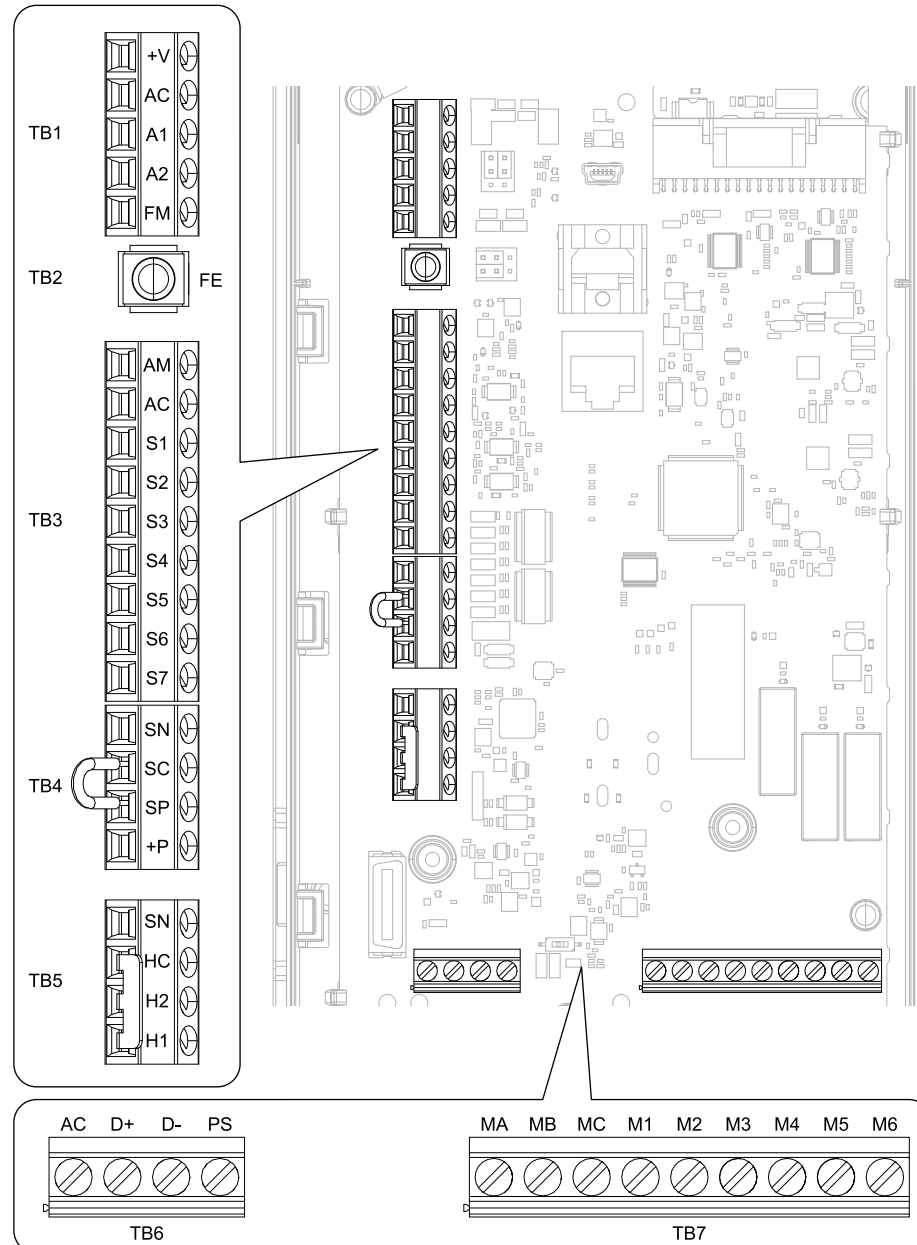

Figure 3.14 Drive Control Circuit Terminal Arrangement

The tightening torque for the drive terminal screws is shown on the reverse side or the lower front side of the drive front cover.

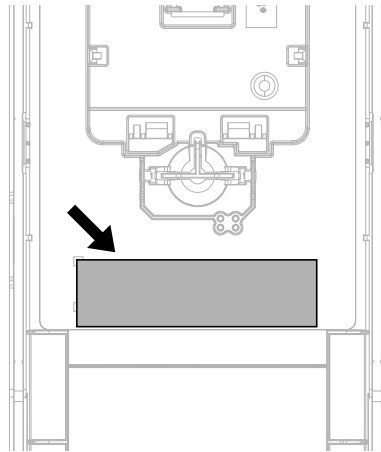

Figure 3.15 Tightening Torque Display Location (Reverse Side of Drive Front Cover)

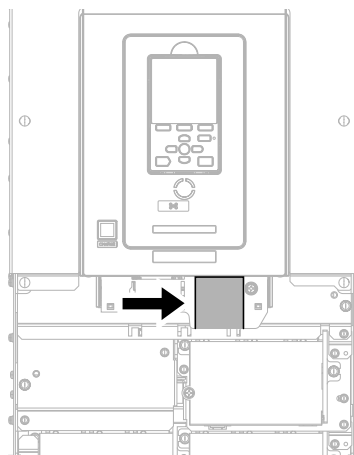

Figure 3.16 Tightening Torque Display Location (Lower Front Side of Drive Front Cover)

◆ Drive Control Circuit Wire Gauges and Tightening Torques

Use the tables in this section to select the correct wires. Use shielded wire to wire the control circuit terminal block. Use crimp ferrules on the wire ends to make the wiring procedure easier and more reliable.

Table 3.20 Drive Control Circuit Wire Gauges and Tightening Torques

Drive Terminal Block	Terminal	Screw Size	Tightening Torque N·m (in·lb)	Bare Wire		Crimp Ferrule	
				Recommended Gauge mm ² (AWG)	Applicable Gauge mm ² (AWG)	Recommended Gauge mm ² (AWG)	Applicable Gauge mm ² (AWG)
TB1	+V, AC, A1, A2, FM	M3	0.5 - 0.6 (4.4 - 5.3)	0.75 (18)	Stranded wire: 0.25 - 1.5 (24 - 16) Solid wire: 0.25 - 1.5 (24 - 16)	0.75 (18)	0.25 - 1.5 (24 - 16)
TB3	AM, AC, S1 - S7						
TB4	SN, SC, SP, +P						
TB5	SN, HC, H1, H2						
TB6	AC, D+, D-, PS						
TB7	MA, MB, MC, M1 - M6						
TB2	FE		1.0 - 1.2 (8.85 - 10.62)	0.75 (18)	Stranded wire: 0.12 - 0.75 (26 - 18) Solid wire: 0.2 - 1.5 (26 - 16)	0.75 (18)	0.25 - 1.5 (24 - 16)

◆ Crimp Ferrules

Attach an insulated sleeve when you use crimp ferrules. Refer to [Table 3.21](#) for the recommended external dimensions and model numbers of the crimp ferrules.

Use the CRIMPFOX 6, a crimping tool made by PHOENIX CONTACT.

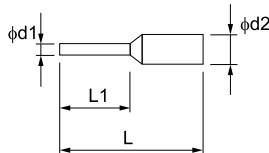

Figure 3.17 External Dimensions of Crimp Ferrules

Table 3.21 Crimp Ferrule Models and Sizes

Wire Gauge mm ² (AWG)	Model	L (mm)	L1 (mm)	φd1 (mm)	φd2 (mm)
0.25 (24)	AI 0.25-8YE	12.5	8	0.8	2.0
0.34 (22)	AI 0.34-8TQ	12.5	8	0.8	2.0
0.5 (20)	AI 0.5-8WH AI 0.5-8OG	14	8	1.1	2.5
0.75 (18)	AI 0.75-8 GY	14	8	1.3	2.8

◆ Drive Control Circuit Terminal Block Input Functions

Hx-xx parameters set functions for the multi-function input and output terminals.

WARNING! Sudden Movement Hazard. Correctly wire and test all control circuits to make sure that the control circuits operate correctly. If you use a drive that has incorrect control circuit wiring or operation, it can cause death or serious injury.

WARNING! Sudden Movement Hazard. Check the I/O signals and the external sequences for the drive before you set the Application Preset function. When you set the Application Preset function (A1-06 ≠ 0), it changes the I/O terminal functions for the drive and it can cause equipment to operate unusually. This can cause serious injury or death.

NOTICE: Damage to Equipment. Do not energize and de-energize the bypass more frequently than one time each 30 minutes. If you frequently energize and de-energize the bypass, it can cause failure.

Refer to [Table 3.22](#) for a list of input terminals and functions on the drive.

Table 3.22 Drive Multi-function Input Terminals

Type	Terminal	Name (Default)	Function (Signal Level)
MFDI	S1	MFDI selection 1 (Not used)	<p>Note: Connections to these inputs can cause unintended operation. Use the Bypass PCB digital inputs. Multi-Function Digital Input</p> <ul style="list-style-type: none"> • Photocoupler • 24 V, 6 mA <p>Note: Install the wire jumpers between terminals SC-SP and SC-SN to set the MFDI power supply (sinking/sourcing mode or internal/external power supply). • Sinking Mode: Install a jumper between terminals SC and SP.</p> <p>NOTICE: Damage to Equipment. Do not close the circuit between terminals SC-SN. If you close the circuits between terminals SC-SP and terminals SC-SN at the same time, it will cause damage to the drive.</p> <ul style="list-style-type: none"> • Sourcing Mode: Install a jumper between terminals SC and SN. <p>NOTICE: Damage to Equipment. Do not close the circuit between terminals SC-SP. If you close the circuits between terminals SC-SP and terminals SC-SN at the same time, it will cause damage to the drive.</p> <ul style="list-style-type: none"> • External power supply: No jumper necessary between terminals SC-SN and terminals SC-SP.
	S2	MFDI selection 2 (Not Used)	
	S3	MFDI selection 3 (External Fault (NO-Always-Coast))	
	S4	MFDI selection 4 (Not used)	
	S5	MFDI selection 5 (Multi-Step Speed Reference 1)	
	S6	MFDI selection 6 (Multi-Step Speed Reference 2)	
	S7	MFDI selection 7 (Jog Reference Selection)	
	SN	MFDI power supply 0 V	
	SC	MFDI selection common	
SP	MFDI power supply +24 Vdc		
Safe Disable Input	H1	Safe Disable input 1	<p>Note: Active during Drive Mode only. Safe Disable Input Remove the jumper between terminals H1-HC and H2-HC to use the Safe Disable input.</p> <ul style="list-style-type: none"> • 24 V, 6 mA • ON: Normal operation • OFF: Coasting motor • Internal impedance 4.7 kΩ • OFF Minimum OFF time of 2 ms. <p>Note: Safe disable inputs are only effective in Drive Mode. They will not function in Bypass Mode.</p>
	H2	Safe Disable input 2	
	HC	Safe Disable function common	
Analog Inputs (Drive Mode only)	+V	Power supply for frequency setting	Power Supply for Multi-Function Analog Input <ul style="list-style-type: none"> • 10.5 V (allowable current 20 mA maximum)
	A1	MFAI 1 (Not used)	Voltage input or current input Select terminal A1 with Jumper switch S1 and H3-01 [Terminal A1 Signal Level Select]. <ul style="list-style-type: none"> • 0 V to 10 V/100% (input impedance: 20 kΩ) • 4 mA to 20 mA/100%, 0 mA to 20 mA/100% (input impedance: 250 Ω)
	A2	MFAI 2 (Not used)	Voltage input or current input Select terminal A2 with Jumper switch S1 and H3-09 [Terminal A2 Signal Level Select] <ul style="list-style-type: none"> • 0 V to 10 V/100% (input impedance: 20 kΩ) • 4 mA to 20 mA/100%, 0 mA to 20 mA/100% (input impedance: 250 Ω)
	AC	Analog input common	Signal Ground for Multi-Function Analog Input <ul style="list-style-type: none"> • 0 V
	FE	Connecting shielded cable	Frame Earth

◆ Drive Control Circuit Terminal Block Output Functions

Refer to [Table 3.23](#) and [Table 3.24](#) for a list of output terminals and functions.

Table 3.23 Drive Control Circuit Output Terminals

Type	Terminal	Name (Default)	Function (Signal Level)
Fault Relay Output	MA	N.O. output (Fault)	Drive Fault Signal Output <ul style="list-style-type: none"> Relay output 30 Vdc, 10 mA to 2 A 250 Vac, 10 mA to 2 A Minimum load: 5 V, 10 mA (Reference value) Note: <ul style="list-style-type: none"> Active during Drive Mode only. This will signal drive-based faults only. Note:
	MB	N.C. output (Fault)	
	MC	Digital output common	
MFDO	M1	MFDO (During Run)	Multi Function Digital Output <ul style="list-style-type: none"> Relay output 30 Vdc, 10 mA to 2 A 250 Vac, 10 mA to 2 A Minimum load: 5 V, 10 mA (Reference value) Note: <ul style="list-style-type: none"> Active during Drive Mode only. These are active for drive-based conditions only. Do not set functions that frequently switch ON/OFF to MFDO (M1 to M6) because this will decrease the performance life of the relay contacts. Yaskawa estimates switching life at 200,000 times (assumes 1 A, resistive load).
	M2		
	M3	MFDO (Zero Speed)	
	M4		
	M5	MFDO (Speed Agree 1)	
	M6		

Table 3.24 Drive Control Circuit Monitor Output Terminals

Type	Terminal	Name (Default)	Function (Signal Level)
Monitor Output	FM	MFAO 1 (Output frequency)	Multi Function Analog Output Select voltage or current output. <ul style="list-style-type: none"> 0 V to 10 V/0% to 100% 4 mA to 20 mA (receiver recommended impedance: 250 Ω) Note: <ul style="list-style-type: none"> This functions in Drive Mode only. Select with jumper switch S5 and H4-07 [Terminal FM Signal Level Select] or H4-08 [Terminal AM Signal Level Select].
	AM	MFAO 2 (Output current)	
	AC	Monitor common	
External Power Supply Output (Not used)	+P	External power supply	Power supply for external devices. <ul style="list-style-type: none"> 24 V (150 mA maximum)

◆ Switches and Jumpers on the Drive Control Circuit

The terminal board has switches to adapt the drive I/Os to the external control signals as shown in [Figure 3.18](#). Set the switches to select the functions for each terminal.

Note:

Active during Drive Mode only.

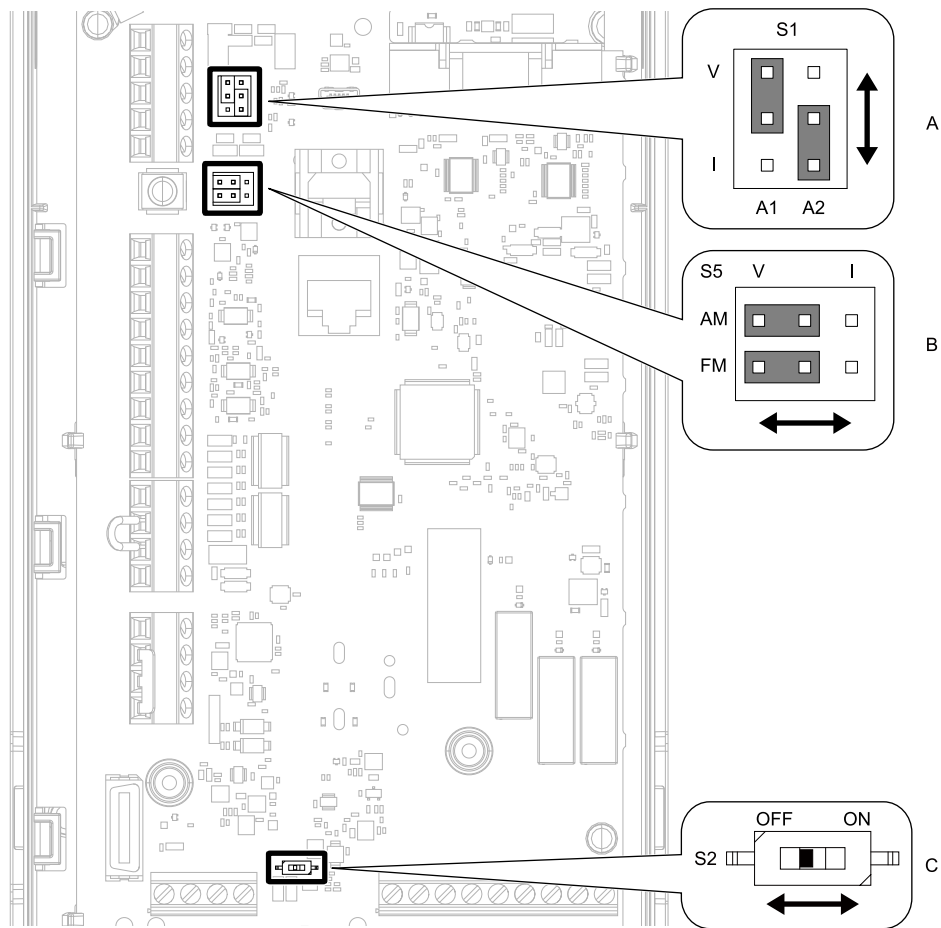

Figure 3.18 Locations of Switches

Table 3.25 I/O Terminals and Switches Functions

Position	Switch	Terminal	Function	Default Setting
A	Jumper switch S1	A1, A2	Sets terminals A1 and A2 to voltage or current output.	A1: V (voltage input) A2: I (current input)
B	Jumper switch S5	FM, AM	Sets terminals FM and AM to voltage or current output.	FM: V (voltage output) AM: V (voltage output)
C	DIP switch S2	-	Enables and disables the termination resistor of embedded communications protocols. This switch should always be in the ON position.	ON Note: This switch should always be ON when the drive is part of a bypass package.

◆ Wiring the Drive Control Circuit Terminal

WARNING! *Electrical Shock Hazard. Do not remove covers or touch circuit boards while the bypass is energized. If you touch the internal components of an energized bypass, it can cause serious injury or death.*

NOTICE: *Do not let wire shields touch other signal lines or equipment. Insulate the wire shields with electrical tape or shrink tubing. If you do not insulate the wire shields, it can cause a short circuit and damage the drive.*

Note:

- Isolate control circuit wiring from main circuit wiring (terminals R/L1, S/L2, T/L3, U/T1, V/T2, W/T3, -, +1) and other high-power wiring. If the control circuit wires are adjacent to the main circuit wires, electrical interference can cause the drive or the devices around the drive to malfunction.
- Isolate contact output terminals MA, MB, MC and M1-M6 from other control circuit wiring. If the output terminal wires are adjacent to other control circuit wires, electrical interference can cause the drive or devices around the drive to malfunction.
- Use a UL Listed Class 2 Power Supply to connect external power to the contact output control terminals. If the power supply for peripheral devices is incorrect, it can cause a decrease in drive performance.
- Connect the shield of shielded cable to the applicable ground terminal. If the grounding is not correct, electrical interference can cause the drive or devices around the drive to malfunction.

Correctly ground the drive terminals and complete main circuit wiring before you wire the control circuit. Remove the keypad and front cover.

1. Refer to [Figure 3.19](#) and wire the control circuit.

WARNING! Fire Hazard. Tighten all terminal screws to the correct tightening torque. Connections that are too loose or too tight can cause incorrect operation and damage to the bypass. Incorrect connections can also cause death or serious injury from fire.

Note:

- Use shielded wires and shielded twisted-pair wires for the control circuit terminal wiring. If the grounding is not correct, electrical interference can cause the drive or devices around it to malfunction.
- Do not use control circuit wiring that is longer than 50 m (164 ft) to supply the frequency reference with an analog signal from a remote source. Wiring that is too long can cause unsatisfactory system performance.

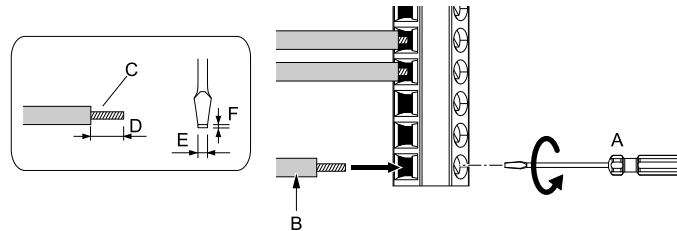

- A** - Loosen the screws and put the wire into the opening on the terminal block.
- B** - Wire with a crimp ferrule attached, or use wire that is not soldered with the core wires lightly twisted.
- C** - Pull back the shielding and lightly twist the end with your fingers to keep the ends from fraying.

- D** - If you do not use crimp ferrules, remove approximately 5.5 mm (0.21 in) of the covering at the end of the wire.
- E** - Blade width of 2.5 mm (0.1 in) or less
- F** - Blade depth of 0.4 mm (0.01 in) or less

Figure 3.19 Wiring Procedure for the Control Circuit

WARNING! Fire Hazard. Tighten all terminal screws to the correct tightening torque. Connections that are too loose or too tight can cause incorrect operation and damage to the bypass. Incorrect connections can also cause death or serious injury from fire.

NOTICE: Do not tin stranded wire with solder. Soldered wire connections can become loose over time and cause unsatisfactory system performance.

Note:

- Refer to [Figure 3.20](#) for information to prepare terminal ends of the shielded wire.
- Prepare the wire ends of shielded twisted-pair wires as shown in [Figure 3.20](#) to use an analog reference from an external frequency setting potentiometer to set the frequency. Connect the shield to terminal FE of the drive.

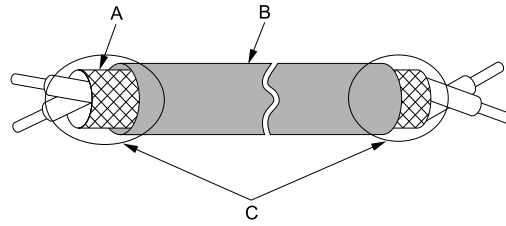

**A - Connect the shield to terminal
FE of the drive.
B - Sheath**

**C - Insulate with electrical tape or
shrink tubing.**

Figure 3.20 Prepare the Ends of Shielded Wire

2. Install the front cover to its initial position.

3.7 Control I/O Connections

This section gives information about the settings for the listed control circuit I/O signals.

- MFDI (terminals S1 to S7)
- MFDO (terminals M1 to M6)
- MFAI (terminals A1, A2)
- MFAO (terminals FM, AM)
- RS-485 communications (terminals D+, D-, AC)

◆ Set Input Signals for MFAI Terminals A1 and A2

Use terminals A1 and A2 to input a voltage or a current signal. Set the signal type as shown in [Table 3.26](#).

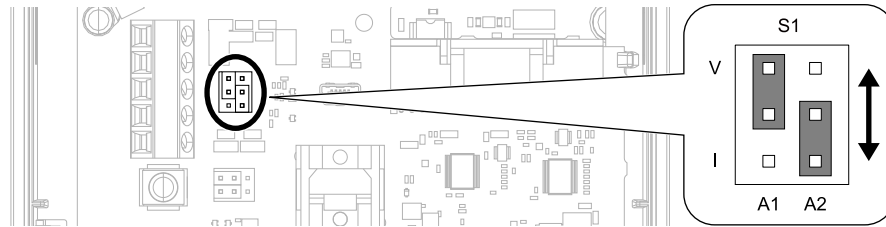
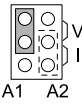
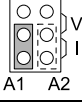
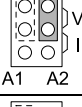



Figure 3.21 Location of Jumper Switch S1

Table 3.26 MFAI Terminals A1 and A2 Signal Settings

Terminal	Types of Input Signals	Jumper Switch S1	Parameter	
			No.	Signal Level
A1	Voltage input (Default)		H3-01	0: 0 V to 10 V/0% to 100% (input impedance: 20 kΩ)
	Current input			2: 4 mA to 20 mA/0% to 100% (input impedance: 250 Ω) 3: 0 mA to 20 mA/0% to 100% (input impedance: 250 Ω)
A2	Voltage input		H3-09	0: 0 V to 10 V/0% to 100% (input impedance: 20 kΩ)
	Current input (Default)			2: 4 mA to 20 mA/0% to 100% (input impedance: 250 Ω) 3: 0 mA to 20 mA/0% to 100% (input impedance: 250 Ω)

Note:

Set H3-02, H3-10 = 0 [Terminal A1 Function Selection, Terminal A2 Function Selection = Frequency Reference] to set A1 and A2 to frequency reference. The drive will add the analog input values together to make the frequency reference.

◆ Set Output Signals for MFAO Terminals FM, AM

Set the signal type for terminals AM and FM to voltage or current output. Use jumper switch S5 and H4-07, H4-08 [Terminal FM Signal Level Select, Terminal AM Signal Level Select] to set the signal type.

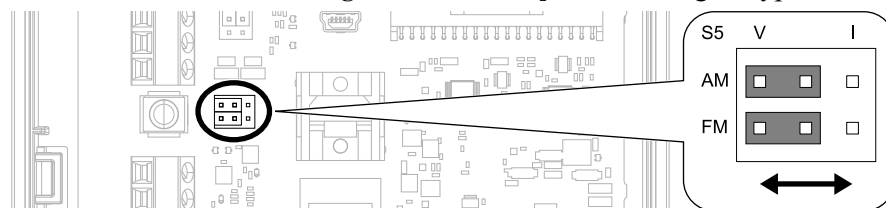





Figure 3.22 Location of Jumper Switch S5

3.7 Control I/O Connections

Terminal	Types of Output Signals	Jumper Switch S5	Parameter	
			No.	Signal Level
FM	Voltage output (Default)		H4-07	0: 0 V to 10 V
	Current output			2: 4 mA to 20 mA
AM	Voltage output (Default)		H4-08	0: 0 V to 10 V
	Current output			2: 4 mA to 20 mA

3.8 Connect the Bypass to a PC

The bypass control board has a mini-B type USB port.

You can use a USB cable (USB 2.0, type: A - mini-B) to connect the bypass to a type-A USB port on a PC. Open the front door of the bypass cabinet to connect the USB cable to the CN1 port on the bypass PCB. After you connect the bypass PCB to the PC, you can use Yaskawa DriveWizard HVAC software to monitor drive performance and manage parameter settings. Visit the Yaskawa website to download the DriveWizard HVAC software:

<https://www.yaskawa.com/products/drives/hvac-drives/software-tools/drivewizard-hvac>

Note:

Do not connect to the USB port on the drive. Always use the CN1 port on the bypass PCB to communicate with a bypass.

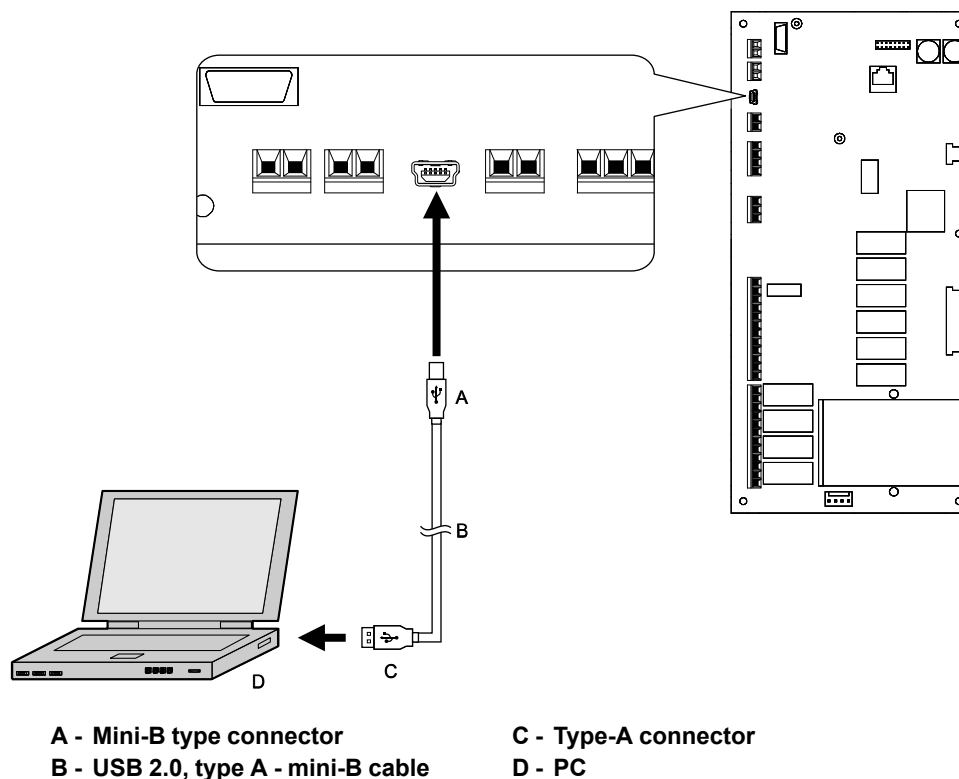

Figure 3.23 Connect to a PC (USB)

Yaskawa recommends that you use a USB cable with connectors connected with shielded wires.

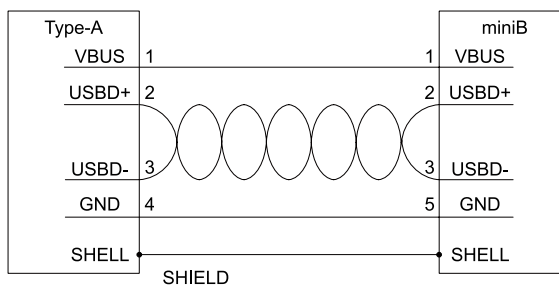

Figure 3.24 Recommended USB Cable

3.9 Motor Application Precautions

◆ Precautions for Existing Standard Motors

■ Insulation Withstand Voltage

Consider motor voltage tolerance levels and motor insulation in applications with an input voltage of over 440 V or particularly long wiring distances. Use an insulated drive motor.

NOTICE: Use an inverter-duty motor with reinforced insulation and windings applicable for use with an AC drive. If the motor does not have the correct insulation, it can cause a short circuit or ground fault from insulation deterioration.

■ Vibration

Vibrations can occur in the these conditions:

- Resonance with the natural frequency of machinery
Use caution if you add a variable-speed drive to applications that operate the motor from line power at a constant speed. If resonance occurs, install shock-absorbing rubber around the base of the motor and enable the Jump frequency control.
- The motor is not balanced
Use caution if the motor speed is higher than the rated motor speed.
- Subsynchronous resonance
Subsynchronous resonance can occur with long motor shafts and in applications such as turbines, blowers, and fans with high inertia loads.

■ Audible Noise

The audible noise of the motor changes when the carrier frequency setting changes. When you use a high carrier frequency, audible noise from the motor is equivalent to the motor noise generated when you operate from line power. If you operate at speeds that are more than the rated rotation speed, the unwanted motor noise increases.

◆ Precautions for Specialized Motors

■ Pole Change Motors

The rated current of pole change motors is different than standard motors. Check the maximum current of the motor before you select a drive. Always stop the motor before you switch between the number of motor poles. If you change the number of poles while the motor is rotating, the overvoltage from regeneration or the overcurrent protection circuitry will make the motor coast to stop.

■ Submersible Motors

The rated current of a submersible motor is more than the rated current of a standard motor. Use a sufficiently large motor cable that will not let voltage drop decrease the maximum torque level.

■ Explosion-Proof Motors

You must test the motor and the drive together for explosion-proof certification. You must also test existing installations of explosion-proof motors. The drive is not designed for explosion-proof areas. Install the drive in a safe location.

The encoder used with pressure-resistant explosion-proof motors is intrinsically safe. When wiring between the drive and encoder, always connect through a specialized pulse coupler.

■ Geared Motors

The continuous speed range is different for different lubricating methods and manufacturers. For oil lubrication, continuous operation in the low-speed range can cause burnout. Contact the manufacturer for more information about applications where operating at more than the rated frequency is necessary.

■ Single-Phase Motors

Variable speed drives are not designed to operate with single-phase motors. The drive is for use with three-phase motors only. If you use capacitors to start the motor, it can cause a high frequency current to flow to the capacitors and can damage the capacitors. A split-phase start or a repulsion start can burn out the starter coils because the internal centrifugal switch is not activated.

◆ Notes on the Power Transmission Mechanism

For power transmission machinery that uses oil to lubricate gearboxes, transmissions, or reduction gears, make sure that you use precaution if you operate the machinery continuously at low speed. Oil does not lubricate the system as well at low speeds. If you operate at frequencies higher than the rated frequency, it can cause problems with the power transmission mechanism. These problems include audible noise, decreased service life, and decreased durability.

Startup Procedure and Test Run

4.1	Section Safety	114
4.2	Keypad: Names and Functions.....	115
4.3	Start-up, Test Operation, and Rotation Check.....	121
4.4	Keypad Operation	127
4.5	Automatic Parameter Settings Optimized for Specific Applications (Application Presets).....	163
4.6	Auto-Tuning	165
4.7	Fine Tuning during Test Runs (Adjust the Control Function).....	167

4.1 Section Safety

DANGER

Electrical Shock Hazard

Do not examine, connect, or disconnect wiring on an energized bypass. Before servicing, disconnect all power to the equipment and wait for the time specified on the warning label at a minimum. The internal capacitor stays charged after the bypass is de-energized. The charge indicator LED extinguishes when the DC bus voltage decreases below 50 Vdc. When all indicators are OFF, remove the covers before measuring for dangerous voltages to make sure that the bypass is safe.

If you do work on the bypass when it is energized, it will cause serious injury or death from electrical shock.

WARNING

Electrical Shock Hazard

Do not operate the bypass when covers are missing. Replace covers and shields before you operate the bypass. Use the bypass only as specified by the instructions.

Some figures in this section include bypasses without covers or safety shields to more clearly show the inside of the bypass. If covers or safety shields are missing from the bypass, it can cause serious injury or death.

Do not remove covers or touch circuit boards while the bypass is energized.

If you touch the internal components of an energized bypass, it can cause serious injury or death.

NOTICE

Sudden Movement Hazard

Deactivate the Run command before you switch from Programming Mode to Drive Mode.

If you switch from Programming Mode to Drive Mode and there is an active Run command, the motor will rotate and the equipment can suddenly start.

4.2 Keypad: Names and Functions

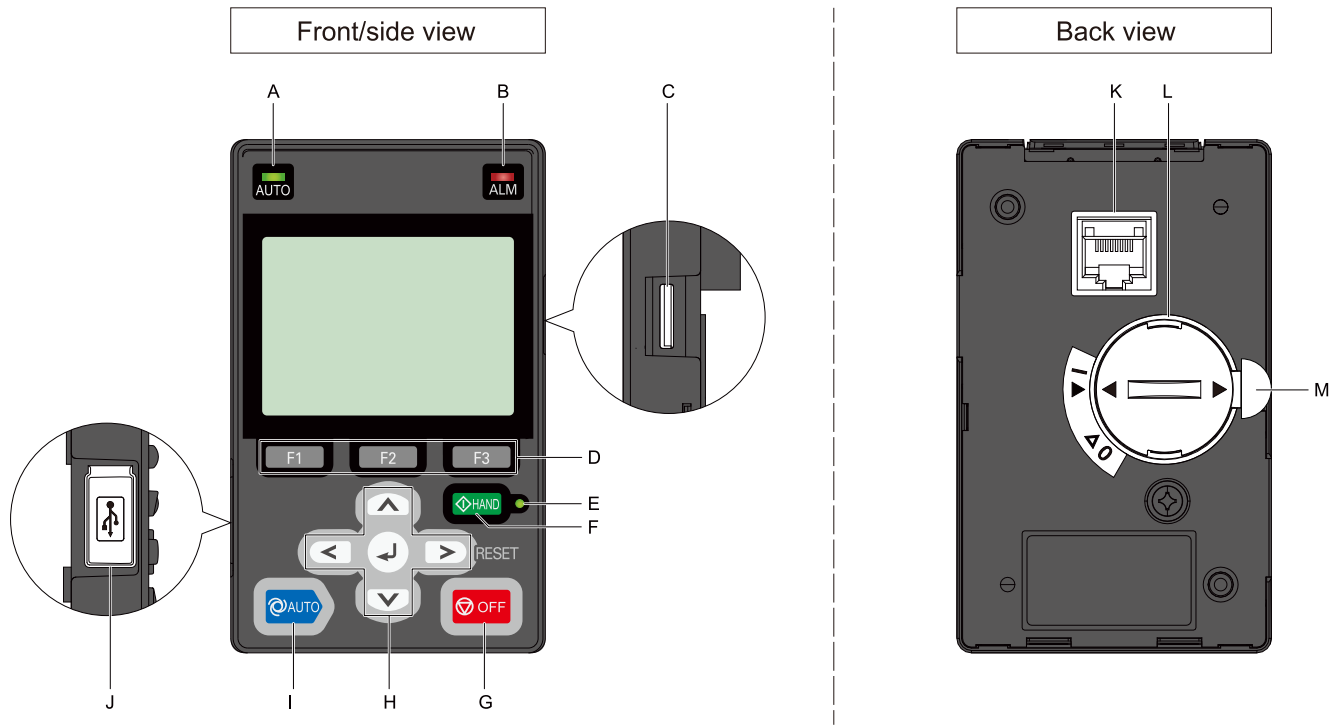







Figure 4.1 Keypad

Table 4.1 Keypad: Names and Functions

No.	Name	Function
A	AUTO LED ^{*/} 	Illuminates to show that the drive is in AUTO Mode.
B	ALM LED 	Illuminates when the drive detects a fault. Flashes when the drive detects: <ul style="list-style-type: none"> • An alarm • An oPE parameter setting error • A fault or alarm during Auto-Tuning The LED turns off when there are no drive faults or alarms.
C	microSD Card Insertion Slot	The insertion point for a microSD card.
D	Function Keys (F1, F2, F3) 	The menu shown on the keypad sets the functions for function keys. The name of each function is in the lower half of the display window.
E	HAND LED ^{*/} 	Illuminates to show that the drive is in HAND Mode.
F	HAND Key 	Sets drive operation to HAND Mode. The drive uses the S5-01 [HAND Frequency Reference Selection] setting.
G	OFF Key 	Stops drive operation. Note: The OFF key has highest priority. Push to stop the motor even when a Run command is active at an external Run command source. Set o2-02 = 0 [STOP Key Function Selection = Disabled] to disable priority.

Startup Procedure and Test Run

4.2 Keypad: Names and Functions

No.	Name	Function
H	Left Arrow Key 	Moves the cursor to the left.
	Up Arrow Key/Down Arrow Key 	<ul style="list-style-type: none"> Scrolls up or down to display the next item or the previous item. Selects parameter numbers, and increments or decrements setting values.
	Right Arrow Key (RESET) 	<ul style="list-style-type: none"> Moves the cursor to the right. Continues to the next screen. Clears drive faults.
	ENTER Key 	<ul style="list-style-type: none"> Enters parameter values and settings. Selects menu items to move the user between keypad displays. Selects each mode, parameter, and set value.
I	AUTO Key 	<p>Sets drive operation to AUTO Mode. The drive uses the <i>b1-01 [Frequency Reference Selection 1]</i> and <i>b1-02 [Run Command Selection 1]</i> settings.</p> <p>Note: Push  on the keypad to set the drive to HAND Mode before you use the keypad to operate the motor.</p>
J	USB Terminal	Insertion point for a mini USB cable. Uses a USB cable (USB standard 2.0, type A - mini-B) to connect the keypad to a PC.
K	RJ-45 Connector	Uses an RJ-45 8-pin straight through UTP CAT5e extension cable or keypad connector to connect to the drive.
L	Clock Battery Cover	<p>Cover for the clock battery.</p> <p>Note:</p> <ul style="list-style-type: none"> The battery included with the keypad is for operation check. It may be exhausted earlier than the expected battery life described in the manual. Refer to "Maintenance & Troubleshooting Manual (TOEPYAIHV6001)" for more information about replacement procedure. <p>To replace the battery, use a Hitachi Maxell "CR2016 Lithium Manganese Dioxide Lithium Battery" or an equivalent battery with these properties:</p> <ul style="list-style-type: none"> Nominal voltage: 3 V Operating temperature range: -20 °C to +85 °C (-4 °F to +185 °F)
M	Insulation Sheet	An insulating sheet is attached to the keypad battery to prevent battery drain. Remove the insulation sheet before you use the keypad for the first time.

*1 Refer to [AUTO LED and HAND LED Indications on page 117](#) for more information about AUTO LED and HAND LED indications.

◆ LCD Display

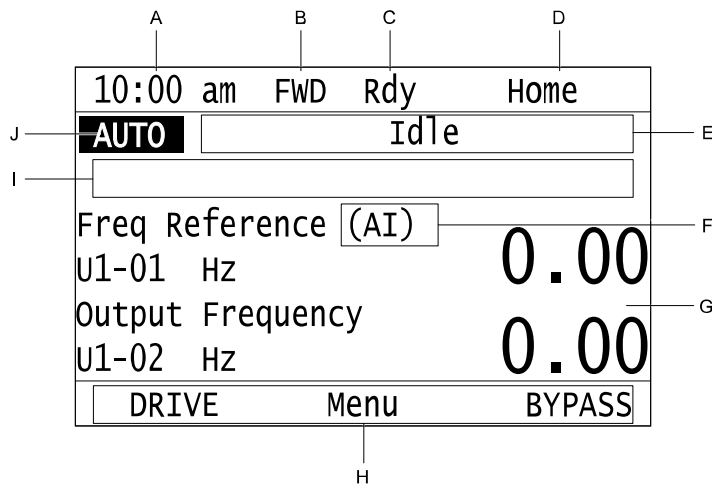

Figure 4.2 LCD Display Indications



Table 4.2 LCD Display Indications and Meanings

Symbol	Name	Description
A	Time display area	Shows the current time. Set the time on the default settings screen.
B	Forward/Reverse run indication	Shows direction of motor rotation. <ul style="list-style-type: none"> FWD: Shown when set to Forward run. REV: Shown when set to Reverse run.
C	Ready	The screen will show Rdy when the drive is ready for operation or when the drive is running.

Symbol	Name	Description
D	Mode display area	Shows the name of the current mode or screen.
E	Alarm codes and status messages display area	Shows an alarm code or message about bypass status. Refer to page 518 for more information about status messages.
F	Frequency reference source indication	Shows the current frequency reference source. <ul style="list-style-type: none"> • KPD: keypad • AI: analog input terminal (Bypass PCB Terminal TB4-2) • COM: serial communications • OPT: option card
G	Data display area	Shows parameter values, monitor values, and details of the results of operations.
H	Function keys 1 to 3 (F1 to F3)	The function names shown in this area will change when the selected screen changes. Push one of the function keys F1 to F3 on the keypad to do the function.
I	Alarm and message texts display area	Shows a fault, minor fault, alarm, or error name and message text. Note: When the drive must show an alarm and a message on the keypad at the same time, the keypad will switch between the alarm code and message text in 2-second intervals.
J	HOA mode or alternative Run command source indication	<ul style="list-style-type: none"> • OFF: The bypass is operating in OFF Mode. • AUTO: The bypass is operating in AUTO Mode. • HAND: The bypass is operating in HAND Mode. • EMOV: The bypass is operating in Emergency Override Mode.

◆ AUTO LED and HAND LED Indications

Table 4.3 AUTO LED and HAND LED Indications

		Status
OFF	OFF	OFF Mode
OFF	ON	HAND Mode
OFF	Long blink (50% duty)	HAND Mode <ul style="list-style-type: none"> • When the Frequency Reference is 0 or during deceleration • During PI Sleep
OFF	Double blink	HAND Mode When you clear the Run command and enter the Run command again during the time set in C1-02 [Deceleration Time 1]
ON	OFF	AUTO Mode
Long blink (50% duty)	OFF	AUTO Mode <ul style="list-style-type: none"> • When the Frequency Reference is 0 or during deceleration • During PI Sleep
Double blink	OFF	AUTO Mode When an MFDI sends a Fast Stop signal to stop the drive

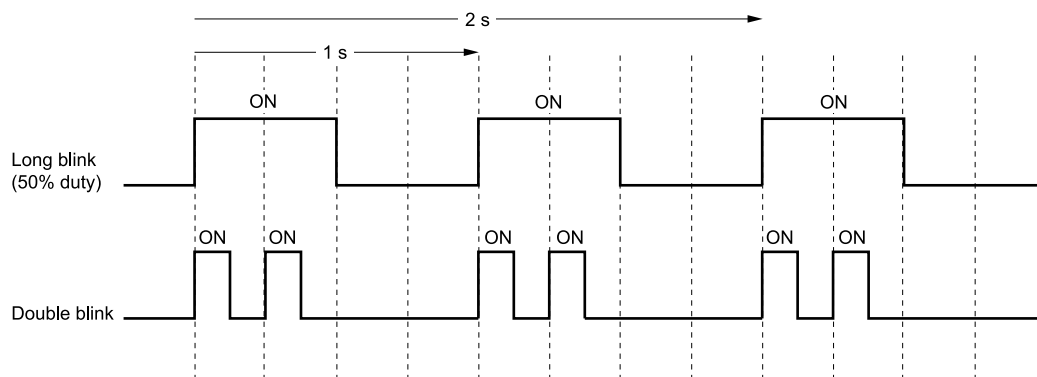

Figure 4.3 AUTO LED and HAND LED Timing Status

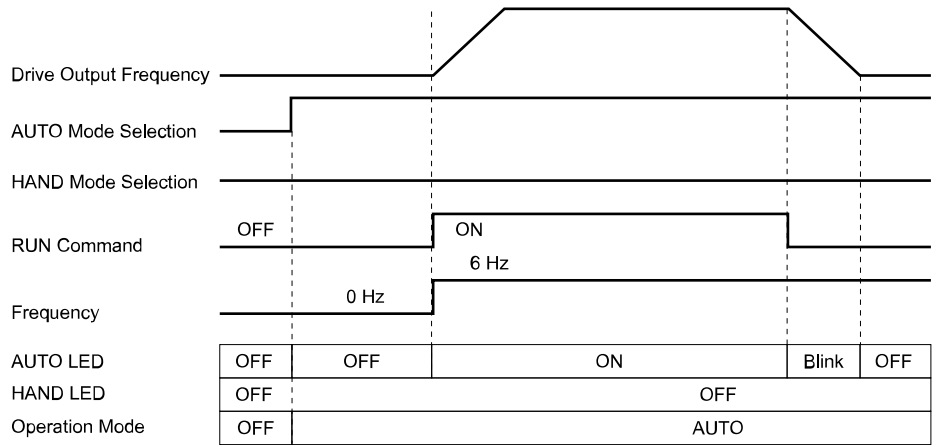

Figure 4.4 LEDs and Drive Operation in AUTO and HAND Modes

◆ Keypad Mode and Menu Displays

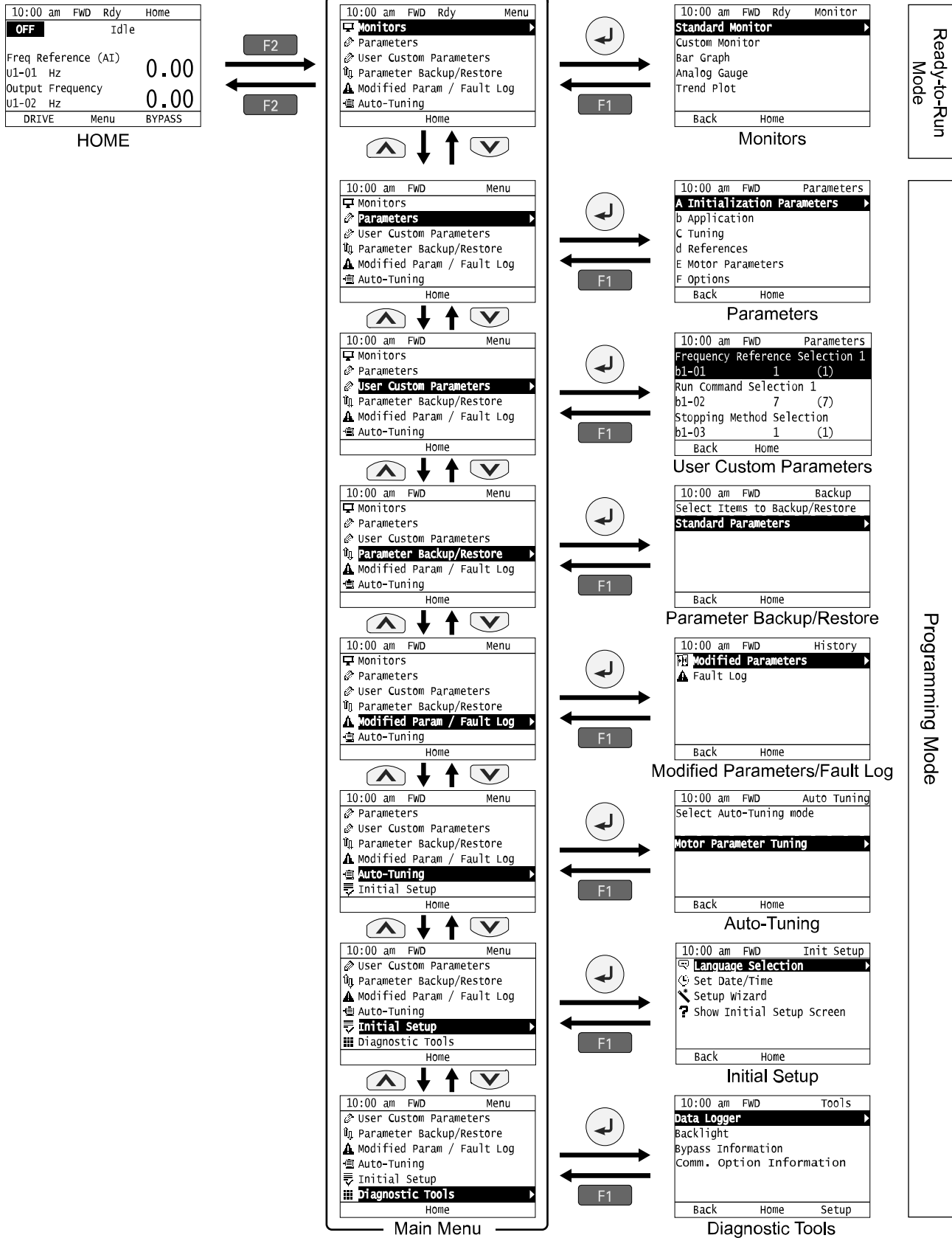

Figure 4.5 Keypad Functions and Display Levels

4.2 Keypad: Names and Functions

Note:



- Push  from the Home screen to show monitors.
- Push  to set *d1-01 [Reference 1]* when you set *b1-01 = 0 [Frequency Reference Selection 1 = Keypad]* and the Home screen shows *U1-01 [Frequency Reference]*.
- The keypad will show [Rdy] when the drive is in Ready-to-Run Mode. The drive is prepared to accept a Run command.
- The bypass will not accept a Run command in Programming Mode in the default setting. Set *b1-08 [Run Command Select in PRG Mode]* to accept or reject a Run command from an external source while in Programming Mode.
 - Set *b1-08 = 0 [Disregard RUN while Programming]* to reject the Run command from an external source while in Programming Mode (default).
 - Set *b1-08 = 1 [Accept RUN while Programming]* to accept the Run command from an external source while in Programming Mode.
 - Set *b1-08 = 2 [Allow Programming Only at Stop]* to prevent changes from Drive Mode to Programming Mode while the drive is operating.

Table 4.4 Drive Mode Screens and Functions

Mode	Keypad Screen	Function
Ready-to-Run Mode	Monitors	Sets monitor items to display.
Programming Mode	Parameters	Changes parameter settings.
	User Custom Parameters	Shows the User Parameters.
	Parameter Backup/Restore	Saves parameters to the keypad as backup.
	Modified Parameters/Fault Log	Shows modified parameters and fault history.
	Auto-Tuning	Auto-Tunes the drive.
	Initial Setup	Changes initial settings.
	Diagnostic Tools	Sets data logs and backlight. Will also show bypass and communications option information (if installed).

4.3 Start-up, Test Operation, and Rotation Check

This section gives the basic steps necessary to get the bypass started and make sure the motor spins in the correct direction. This section gives information about only the most basic settings.

◆ Items to Check before You Energize the Bypass

1. Make sure there is no power to the bypass. Use a properly rated and functioning multimeter to make sure that it is safe and do all appropriate lockout/tagout procedures.

WARNING! Electrical Shock Hazard. Do not operate the bypass when covers are missing. Replace covers and shields before you operate the bypass. Use the bypass only as specified by the instructions. Some figures in this section include bypasses without covers or safety shields to more clearly show the inside of the bypass. If covers or safety shields are missing from the bypass, it can cause serious injury or death.

2. Record the motor nameplate information and make sure that the input voltage aligns with the bypass rating. Make sure that the motor rated FLA is not more than the output current rating of the bypass as shown on the bypass nameplate. Make sure that the motor rated FLA is in range of the specifications.
3. The bypass will have one of two types of main input disconnect:

A non-fusible disconnect switch

The standard bypass includes a non-fusible disconnect switch that does not provide branch circuit protection. If you will be installing the bypass according to applicable local codes and the requirements shown on the bypass nameplate, you must install appropriate branch circuit protection. Yaskawa recommends semiconductor fusing to ensure 100 kAIC SCCR panel rating. This fusing is specified on the bypass nameplate.

WARNING! Fire Hazard. You must install branch circuit protection according to applicable local codes and the requirements listed on the bypass nameplate. The bypass is suitable for use on a circuit capable of delivering not more than 100,000 RMS symmetrical amperes, 208 Vac and 480 Vac with the circuit breaker option or when protected by class J or class L fuses as specified on the bypass nameplate. Consult factory with questions. Failure to comply could result in fire and damage to the bypass unit or injury to personnel

An input circuit breaker

Bypass Option M includes an input circuit breaker. You must use the two dials on the circuit breaker to set the adjustable trip level. The dial marked "FLA" sets the breaker to match the motor FLA. Use a small straight-edge screwdriver and adjust to the appropriate current level. The other dial sets the inrush level. Make sure this dial is set to "Auto 1" (factory setting).

4. Make sure that the available three-phase line power is the correct voltage. Connect line power to the input disconnect device.
5. Connect the bypass grounding terminal to the appropriate building ground circuit.
6. If you are using a dual voltage motor, make sure that the motor is wired for the application voltage.
7. Connect the motor to the output terminal block in the bypass or to the motor overload (if provided).
8. Connect the motor ground to the bypass drive ground terminal.
9. If you have an external motor overload, set the correct FLA from Step 2 there.
10. Use the connection diagram or the schematic packaged with the bypass to make sure that you correctly terminate wiring connections and connected to appropriate circuits at Bypass PCB A2. Please note the following with respect to the safety circuit (DI-2, terminal TB2-2) and the BAS interlock circuit (DI-3, terminal TB2-3):

Safety Interlock Circuit

DI-2 (terminal TB2-2) is provided to connect safety devices in a normally-closed series circuit, such as: freeze up thermostats, smoke/fire sensors, high pressure limits, temperature limits, or vibration detectors.

The keypad will display the status "Safety Open" if a N.C. safety circuit is not closed between DI-2 and IG24 (TB2-10) on Bypass PCB A2. An open circuit between DI-2 and IG24 will prevent drive or bypass operation.

Take ONE of these steps to ensure proper operation prior to startup:

- Install normally-closed (N.C.) safety circuit between DI-2 and IG24 on Bypass PCB A2.
- Install a jumper between DI-2 and IG24 on Bypass PCB A2.

Building Automation System Interlock Circuit (Drive and Bypass Enable Input)

The keypad will display an AL02 - Interlock Open alarm or FB-02 - Wait For Interlock Timeout fault if a N.C. safety circuit is not closed between DI-3 (TB2-3 by default setting of Z2-03) and IG24 on Bypass PCB A2 when there is an active Run command in either HAND or AUTO Mode. An open circuit between TB2-3 and IG24 (TB2-10) will prevent drive or bypass operation.

Take ONE of these steps to ensure proper operation prior to startup:

- Install a normally-closed (N.C.) BAS Interlock Circuit/Damper Interlock between DI-3 and IG24 on Bypass PCB A2.
 - Install a jumper between DI-3 and IG24 on Bypass PCB A2.
11. Record all other connections to the bypass by terminal number to determine if special programming of any of the following is required:
 - Multi-function Digital Inputs – Bypass control board TB2 (A2)
 - Multi-function Digital Outputs – Bypass control board TB1 (A2)
 - Analog Speed Reference - Bypass control board TB4 (A2)
 - Other Analog Inputs – Drive control board (A1)
 - Analog Outputs – Drive control board (A1)
 - Differential PI control – Drive control board (A1)
 - Serial Communications – Bypass control board TB3 (A2)
 12. Run all control wiring in separate conduit from motor or line power. Route digital output wiring exceeding 24 V in conduit separate from other control wiring.
 13. Make sure that the building automation system logic is ready for the start, stop, and speed command functions.

◆ **Bypass Start-Up Procedure**

1. Replace all bypass and drive covers.
2. Before you apply power to the bypass, use a properly rated multimeter to check all three-phases of input power for proper levels and balance. Record these levels for future reference.
3. Turn the main input disconnect handle (if equipped) clockwise to energize the bypass.
4. When you energize the bypass for the first time, the keypad will show the Setup Wizard prompt screen.

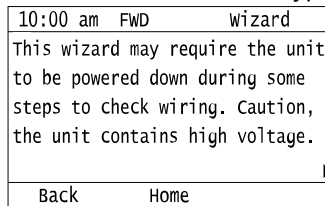
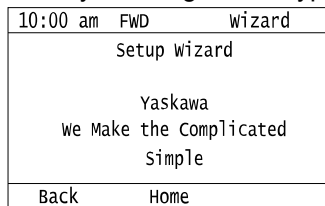

The Setup Wizard will quickly configure and adjust commonly used parameters related to:

- Clock
- Motor FLA
- Frequency Reference
- Run Command
- Accel/Decel Times
- Safety Interlocks
- Speed Search

5. Select [Yes] to run the Setup Wizard. After you complete the Setup Wizard, the bypass will not show the Setup Wizard prompt again.

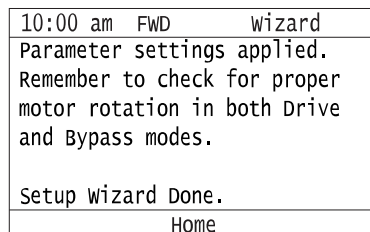
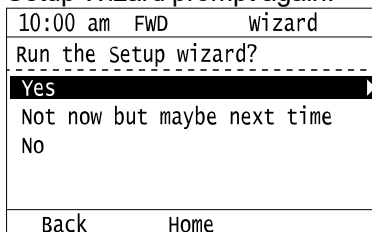

Note:

If you select [Not now but maybe next time] from the Setup Wizard prompt, the keypad will show the Setup Wizard prompt each time you energize the bypass.

If you select [No], the keypad will not show the Setup Wizard prompt nor the Initial Setup screen when you energize the bypass. You can set the date and time or run the Setup Wizard from the Initial Setup screen.

6. Check for correct motor rotation in Drive Mode and Bypass Mode. Refer to [Test Run and Rotation Check on page 123](#) for more information about checking and changing motor rotation.

◆ Test Run and Rotation Check

■ Test Run (No Load)

When possible, Yaskawa recommends that you do a test run in Drive Mode and Bypass Mode to check rotation in both modes before you mechanically connect the motor to the rest of the machine. This is critically important if running the machine at full speed and/or running the machine in the wrong direction could cause damage or injury.

■ Rotation Check in Drive Mode and Bypass Mode

You must check the rotation in both Drive Mode and Bypass Mode. If the rotation direction is incorrect in Drive Mode, you must change the output (motor) wiring. If the rotation direction is incorrect in Bypass Mode, you must change the input power wiring.

Note:

Do the Drive Mode rotation check first. If there are any problems, make sure that you correct them before you do the Bypass Mode rotation check.

■ Precautions before You Do a Test Run



Before you rotate the motor, check these items:

- Check for safety issues near the bypass system, motor, and machine.
- Make sure that all safety, interlock, emergency stop circuits and safety mechanisms are operating correctly.

■ Test Run and Rotation Check - Drive Mode (HAND)



Note:

Yaskawa strongly recommends that you do the items in [Start-up, Test Operation, and Rotation Check on page 121](#), including completing the Setup Wizard before you do this procedure.

1. Energize the bypass. If the HOME screen is not shown, push .
2. Push  to make sure that the bypass does not respond to an Auto-Run command.
3. Check the lower-left corner of the keypad screen to make sure that the bypass is in Drive Mode. "DRIVE" will flash when the bypass is in Drive Mode.

10:00 am	FWD	Rdy	Home
OFF			
Freq Reference (AI)		0.00	
U1-01 Hz		0.00	
Output Frequency		0.00	
U1-02 Hz		0.00	
	Menu	BYPASS	



WARNING! Sudden Movement Hazard. Before you do the next step, remove all personnel and objects from the area around the bypass and motor. The motor will rotate in the next step and can cause serious injury or death.

4. Push  to give the bypass a Run command from HAND Mode.
5. Push  to show S5-05 [HAND Frequency Reference], and set it to 6.00 Hz.

6. Push  to save the value and the motor will start to run.

10:00 am	FWD Rdy	Parameters
HAND Frequency Reference		
S5-05		
006.00 Hz		
Default : 0.00Hz		
Range : 0.00~400.00		
Home		Min/Max

If the system does not run, check the keypad for a “Safety Open” message or an “AL02 – Interlock Open” alarm.

- If there is a “Safety Open” message, check the safety circuit (or jumper) connected at TB2-2.
 - If there is an “AL02 – Interlock Open” alarm, check the BAS Interlock circuit (or jumper) connected at TB2-3.
7. Push  to return to the HOME screen, then push  until you can see the Output Current display on the keypad screen.

10:00 am	FWD Rdy	Monitor
Freq Reference (AI)		
U1-01 Hz	6.00	

Output Frequency		
U1-02 Hz	6.00	

Output Current		
U1-03 A	12.34	
DRIVE	Menu	BYPASS

Output current should typically be between 20% and 100% of motor full load amps (FLA).

If the output current is **not** in this range:

- Make sure that there are no mechanical issues or binding in the machinery.
 - Make sure that the motor is correctly wired to the motor terminal block (or motor overload, if equipped).
 - Make sure that a multi-voltage motor is correctly wired in the motor junction box.
8. Look at the motor (or load) to make sure that the rotation direction is correct (Drive Mode).

If the motor direction in Drive Mode is **CORRECT**, do steps 15 to 18.

If the motor direction in Drive Mode is **INCORRECT**, do steps 9 to 14.

9. Push  to stop the motor.
10. De-energize the system at the power source. Observe correct lockout/tagout safety procedures and wait for the CHARGE light to completely go out on the HV600. The CHARGE light will be visible after you open the cabinet door.
11. Remove lower cover (or open cabinet door) to access motor wiring.
12. Switch any two phases on the **customer wiring side of the motor terminal block or motor overload**.

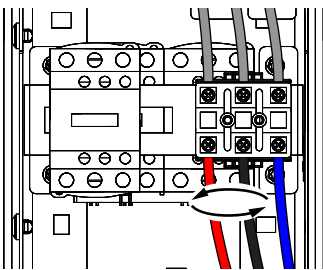



Note:

DO NOT change the wiring connected directly to the HV600 drive unit.

13. Replace lower cover (or close cabinet door).
14. Repeat Steps 1 to 8 of this procedure to confirm correct rotation in Drive Mode.

WARNING! Sudden Movement Hazard. Before you do this step, remove all personnel and objects from the area around the bypass and motor. The motor will rotate at full speed in this step and can cause serious injury or death.

15. Push  to give the bypass a Run command from HAND Mode.
16. Push  to show S5-05 [HAND Frequency Reference].

17. Push  to increase the frequency reference value.

Change the setting value in increments of 10 Hz if necessary and examine the response.

Each time you increase the setting value, use *U1-03 [Output Current]* to check the drive output current. Watch and listen for unusual conditions or noises.

When the output current of the drive is not more than the motor rated current, the status is correct.



Example: 6 Hz → 20 Hz → 30 Hz → 40 Hz → 50 Hz → 60 Hz



10:00 am	FWD	Rdy	Home
Freq Reference (AI)		60.00	
U1-01	Hz	60.00	
Output Frequency		60.00	
U1-02	Hz	60.00	
Output Current		29.48	
U1-03	A	29.48	
DRIVE	Menu	BYPASS	

18. Set the HAND frequency reference back to the desired value, then push . The Drive Mode test run and rotation check is complete.

■ Test Run and Rotation Check - Bypass Mode (HAND)

Before you do this procedure, Yaskawa strongly recommends that you do the items in *Start-up, Test Operation, and Rotation Check on page 121* (including the Setup Wizard), and do the steps in *Test Run and Rotation Check - Drive Mode (HAND) on page 123*.



- Energize the bypass. If the HOME screen is not shown, push .
- Push  to make sure that the bypass does not respond to an Auto-Run command.
- Check the lower-right corner of the keypad screen to make sure that the bypass is in Bypass Mode. "BYPASS" will flash when the bypass is in Bypass Mode. If it is NOT in Bypass Mode, push  to put the system into Bypass Mode

10:00 am	FWD	Rdy	Home
		Idle	
Motor Current		0.00A	
Ub-01		0.00A	
DRIVE	Menu		

WARNING! Sudden Movement Hazard. Before you do the next step, remove all personnel and objects from the area around the bypass and motor. The motor will immediately rotate at full speed in the next step and can cause serious injury or death.

- Push  to give the bypass a Run command from HAND Mode. Make sure that *Ub-01 [Motor Current]* is not more than the nameplate FLA. It is normal for the current be more than full load amps temporarily at start. Watch and listen for unusual conditions or noises.

10:00 am	FWD	Rdy	Home
		Running in Bypass	
Motor Current		29.48A	
Ub-01		29.48A	
DRIVE	Menu	BYPASS	

- Look at the motor (or load) to make sure that the rotation direction is correct (Bypass Mode). If you cannot determine the rotation direction, push  and watch the motor as it coasts to stop. If the motor direction in Bypass Mode is **CORRECT**, the test is complete. If the motor direction in Bypass Mode is **INCORRECT**, do steps 6 to 11.
- Push  to stop the motor.
- De-energize the system at the power source. Observe correct lockout/tagout safety procedures and wait for the CHARGE light to completely go out on the HV600. The CHARGE light will be visible after you open the cabinet door.

4.3 Start-up, Test Operation, and Rotation Check

8. Remove lower cover (or open cabinet door) to access motor wiring.
9. Switch any two phases on the **customer connection side of incoming power**.

Note:

- DO NOT change the motor (output) wiring.
- DO NOT change the wiring connected directly to the HV600 drive unit.

10. Replace lower cover (or close cabinet door).
11. Repeat Steps 1 to 5 of this procedure to confirm correct rotation in Bypass Mode.

4.4 Keypad Operation

Note:

Make sure that you use a keypad with FLASH number 1004 or later. Keypads with FLASH numbers 1003 and earlier will not show characters correctly. To display the keypad FLASH version, hold down the F1 and F3 keys on the keypad when you first apply power to the bypass.

◆ Home Screen Display Selection

This section gives information about the functions that you can control from the HOME screen and the content shown on the HOME screen.

10:00 am	FWD	Rdy	Home
OFF			

Freq Reference (AI)			
U1-01 Hz		0.00	
Output Frequency			
U1-02 Hz		0.00	
Menu			



■ View Monitors Shown in Home Screen

This figure shows monitor data in the data display area of the HOME screen.

10:00 am	FWD	Rdy	Home
OFF			

Freq Reference (AI)			
U1-01 Hz		0.00	
Output Frequency			
U1-02 Hz		0.00	
Menu			



Monitor

- To change what the screen shows, change the setting for *o1-40 [Home display selection]*.
- When *o1-40 [Home display selection]* is set to "Custom Monitor", and there is more than one screen, use  or  to switch between screens.







■ Show the Standard Monitor

Push  to show the standard monitor (*Ux-xx*). Push  (HOME) to go back to the HOME screen.

Note:

When a fault, minor fault, or an error occurs, push  to show the content of the fault. Push  again to show the standard monitor (*Ux-xx*).

■ Change the Frequency Reference Value

1. Push  to access the screen to change the frequency.
2. Push  or  to select the digit, then push  or  to change the value.
3. Push  to keep the changes.

Note:

The HOME screen must show *U1-01 [Frequency Reference]* or you must set *b1-01 = 0 [Frequency Reference Selection 1 = Keypad]* to use this function.

■ Show the Main Menu

Push  to show the main menu. Push  (HOME) to go back to the HOME screen.

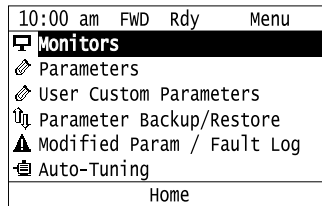

◆ Show the Monitors

This section shows how to show the standard monitors (*Ux-xx*).

1. Push **F2** (Home) to show the HOME screen.

Note:

- When the drive is in HOME Mode, the screen shows [Home] in the upper right-hand corner of the screen.
- If the screen does not show [Home] for **F2**, push **F1** (Back), and then push **F2** to show [Home].

2. Push **F2** (Menu).

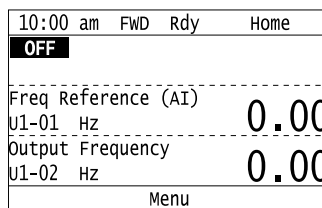

3. Push **▲** or **▼** to select [Monitors], then push **↵**.

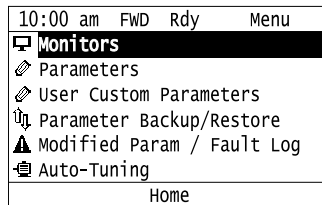

4. Push **▲** or **▼** to select [Standard Monitor], then push **↵**.

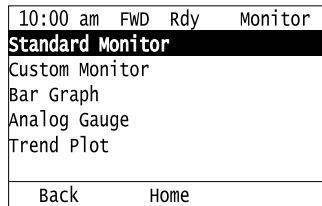

5. Push **▲** or **▼** to select the monitor group, then push **↵**.

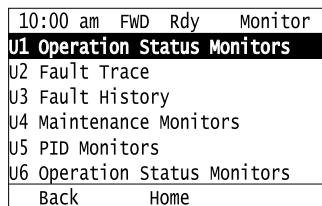

6. Push **▲** or **▼** to change the monitor number to show the monitor item.

Note:

Push **◀** to return to the previous page.

10:00 am FWD Rdy Monitor	
Terminal A1 Level	0.00
U1-16 %	
Terminal A2 Level	0.00
U1-14 %	
SFS Output Frequency	0.00
U1-16 %	
Home	

◆ Set Custom Monitors

You can select and register a maximum of 12 monitoring items to regularly show on the keypad. This procedure shows how to set the motor speed to [Custom Monitor 1].

1. Push **F2** (Home) to show the HOME screen.

Note:

- The keypad will show [Home] in the top right corner when the HOME screen is active.
- If the keypad does not show [Home] on **F2**, push **F1** (Back) to show [Home] on **F2**.

2. Push **F2** (Menu).

10:00 am FWD Rdy Home	
OFF	



Freq Reference (AI)	0.00
U1-01 Hz	
Output Frequency	0.00
U1-02 Hz	
Menu	

3. Push  or  to select [Monitors], then push .

10:00 am FWD Rdy Menu
Monitors
Parameters
User Custom Parameters
Parameter Backup/Restore
Modified Param / Fault Log
Auto-Tuning
Home

4. Push  or  to select [Custom Monitor], then push **F3** (Setup).

10:00 am FWD Rdy Monitor
Standard Monitor
Custom Monitor
Bar Graph
Analog Gauge
Trend Plot
Back Home Setup

5. Push  or  to select [Custom Monitor 1], then push .

10:00 am FWD Setup
Custom Monitor 1
Custom Monitor 2
Custom Monitor 3
Custom Monitor 4
Custom Monitor 5
Custom Monitor 6
Back Home

6. Push  or  to select the monitor number to register, then push .

Set the x-xx part of monitor Ux-xx. For example, to show monitor U1-05, set it to "105" as shown in this figure.

10:00 am FWD	Parameters
Custom Monitor 1	
U1-24	105
Motor Speed	
Default : 101	
Back	Default

The configuration procedure is complete.

◆ Show Custom Monitors

The procedure in this section shows how to show the registered custom monitors.

1. Push **F2** (Home) to show the HOME screen.

Note:

- The keypad will show [Home] in the top right corner when the HOME screen is active.
- If [Home] is not shown on **F2**, push **F1** (Back) to show [Home] on **F2**.

2. Push **F2** (Menu).

10:00 am FWD Rdy	Home
OFF	

Freq Reference (AI)	0.00
U1-01 Hz	
Output Frequency	0.00
U1-02 Hz	

Menu	

3. Push **▲** or **▼** to select [Monitors], then push **↵**.

10:00 am FWD Rdy	Menu
Monitors	
Parameters	
User Custom Parameters	
Parameter Backup/Restore	
Modified Param / Fault Log	
Auto-Tuning	

Home	

4. Push **▲** or **▼** to select [Custom Monitor], then push **↵**.

10:00 am FWD Rdy	Monitor
Standard Monitor	
Custom Monitor	
Bar Graph	
Analog Gauge	
Trend Plot	

Back	Home Setup

The keypad shows the selected monitor as shown in this figure.

10:00 am FWD Rdy	Monitor
Motor Speed	
U1-05 Hz	20.00
Output Power	
U1-08 kw	15.0
Terminal A1 Level	
U1-13 %	30.0

Home	

- When there are a minimum of two screens, push **▲** or **▼** to switch between screens.
- If you registered only one custom monitor to [Custom Monitor 1], the screen will show only one monitor. If you registered custom monitors only to [Custom Monitor 1] and [Custom Monitor 2], the screen will show only two monitors.

◆ Set the Monitors to Show as a Bar Graph

The procedure in this section shows how to show the frequency reference monitor as a bar graph.

1. Push **F2** (Home) to show the HOME screen.

Note:

- The keypad will show [Home] in the top right corner when the HOME screen is active.
- If [Home] is not shown on **F2**, push **F1** (Back) to show [Home] on **F2**.

2. Push **F2** (Menu).

10:00 am	FWD	Rdy	Home
OFF			

Freq Reference (AI)			0.00
U1-01 Hz			0.00
Output Frequency			0.00
U1-02 Hz			0.00
Menu			

3. Push **▲** or **▼** to select [Monitors], then push **↵**.

10:00 am	FWD	Rdy	Menu
Monitors ▶			
Parameters			
User Custom Parameters			
Parameter Backup/Restore			
Modified Param / Fault Log			
Auto-Tuning			
Home			

4. Push **▲** or **▼** to select [Bar Graph], then push **F3** (Setup).

10:00 am	FWD	Rdy	Monitor
Standard Monitor			
Custom Monitor			
Bar Graph ▶			
Analog Gauge			
Trend Plot			
Back Home Setup			

5. Push **▲** or **▼** to select the location to store the monitor, then push **↵**.

10:00 am	FWD		Setup
Custom Monitor 1 ▶			
Custom Monitor 2			
Custom Monitor 3			
Back Home			

6. Push **↵**.

10:00 am	FWD		Setup
Custom Monitor 1			
Custom Monitor 1			
o1-24	101	(101)	
1st Monitor Area Selection			
o1-41	0	(0)	
Back Home			

7. Push **▲** or **▼** to select the monitor number to register, then push **↵**.

Enter the three digits in "x-xx" part of monitor $U_x\text{-xx}$ to identify which monitor to output. For example, to show monitor U1-01 [Frequency Reference], set it to "101" as shown in this figure.

10:00 am FWD	Parameters
Custom Monitor 1	
U1-24	101
Frequency Reference	
Default : 101	
Back	Default

The configuration procedure is complete.

◆ Show Monitors as Bar Graphs

The procedure in this section shows how to show a specific monitor as a bar graph. You can show a maximum of three.

1. Push **F2** (Home) to show the HOME screen.

Note:

- When the drive is in HOME Mode, the screen shows [Home] in the upper right-hand corner of the screen.
- If the screen does not show [Home] for **F2**, push **F1** (Back), and then push **F2** to show [Home].

2. Push **F2** (Menu).

10:00 am FWD Rdy	Home
OFF	

Freq Reference (AI)	0.00
U1-01 Hz	
Output Frequency	0.00
U1-02 Hz	
Menu	

3. Push **▲** or **▼** to select [Monitors], then push **↵**.

10:00 am FWD Rdy	Menu
Monitors	
Parameters	
User Custom Parameters	
Parameter Backup/Restore	
Modified Param / Fault Log	
Auto-Tuning	
Home	

4. Push **▲** or **▼** to select [Display Bar Graph], then push **↵**.

10:00 am FWD Rdy	Monitor
Standard Monitor	
Custom Monitor	
Bar Graph	
Analog Gauge	
Trend Plot	
Back	Home Setup

The screen will show the monitors as shown in this figure.

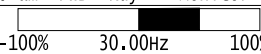
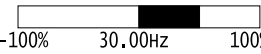
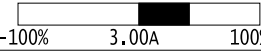
10:00 am FWD Rdy	Monitor
U1-01	
-100%	30.00Hz 100%
U1-02	
-100%	30.00Hz 100%
U1-03	
-100%	3.00A 100%
Home	

◆ Set the Monitors to Show as Analog Gauges

The procedure in this section shows how to show the frequency reference monitor as an analog gauge.

1. Push **F2** (Home) to show the HOME screen.

Note:

- The keypad will show [Home] in the top right corner when the HOME screen is active.
- If [Home] is not shown on **F2**, push **F1** (Back) to show [Home] on **F2**.

2. Push **F2** (Menu).

10:00 am	FWD	Rdy	Home
OFF			

Freq Reference (AI)			0.00
U1-01	Hz		
Output Frequency			0.00
U1-02	Hz		
Menu			

3. Push **▲** or **▼** to select [Monitors], then push **↵**.

10:00 am	FWD	Rdy	Menu
Monitors			
Parameters			
User Custom Parameters			
Parameter Backup/Restore			
Modified Param / Fault Log			
Auto-Tuning			
Home			

4. Push **▲** or **▼** to select [Analog Gauge], then push **F3** (Setup).

10:00 am	FWD	Rdy	Monitor
Standard Monitor			
Custom Monitor			
Bar Graph			
Analog Gauge			
Trend Plot			

Back	Home	Setup	

5. Push **↵**.

10:00 am	FWD		Setup
Analog Gauge			
Custom Monitor 1			
o1-24	101	(101)	
Analog Gauge Area Selection			
o1-55	1	(1)	

Back	Home		

6. Push **▲** or **▼** to select the monitor number to register, then push **↵**.

Enter the three digits in "x-xx" part of monitor U_x-xx to identify which monitor to output. For example, to show monitor U1-01 [Frequency Reference], set it to "101" as shown in this figure.

10:00 am	FWD		Parameters
Custom Monitor 1			
o1-24	101		
Frequency Reference			
Default : 101			

Back	Default		

The configuration procedure is complete.

◆ Show Monitors as an Analog Gauge

The following explains how to display the contents selected for a monitor as an analog gauge.

4.4 Keypad Operation

1. Push **F2** (Home) to show the HOME screen.

Note:

- The keypad will show [Home] in the top right corner when the HOME screen is active.
- If [Home] is not on **F2**, push **F1** (Back) to show [Home] on **F2**.

2. Push **F2** (Menu).

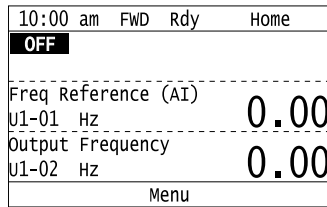

3. Push **▲** or **▼** to select [Monitors], then push **↵**.

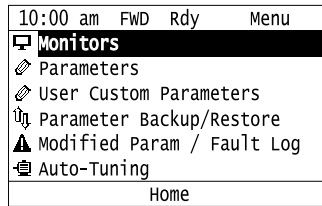

4. Push **▲** or **▼** to select [Analog Gauge], then push **↵**.

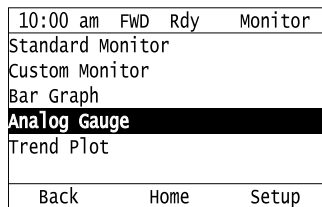

It will be displayed as follows.

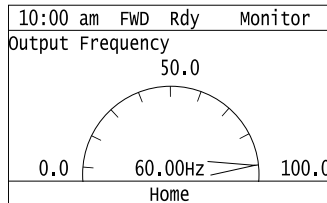

◆ Set Monitor Items to Show as a Trend Plot

You must set the items in this figure to display as a trend plot.

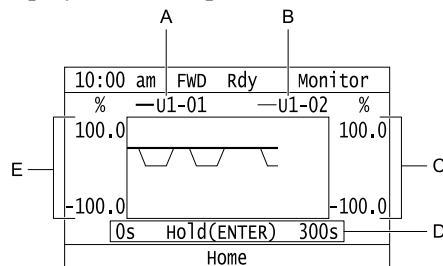

A - Monitor Parameter 1 (set with [Custom Monitor 1])

B - Monitor Parameter 2 (set with [Custom Monitor 2])

C - Trend Plot 2 Scale Maximum/Minimum Value

D - Trend Plot Time Scale

E - Trend Plot 1 Scale Maximum/Minimum Value

■ Select Monitor Items to Show as a Trend Plot

The procedure in this section shows how to show the frequency reference monitor as a trend plot.

1. Push **F2** (Home) to show the HOME screen.

Note:

- The keypad will show [Home] in the top right corner when the HOME screen is active.
- If [Home] is not shown on **F2**, push **F1** (Back) to show [Home] on **F2**.

2. Push **F2** (Menu).

10:00 am	FWD	Rdy	Home
OFF			

Freq Reference (AI)			0.00
U1-01 Hz			
Output Frequency			0.00
U1-02 Hz			
Menu			

3. Push  or  to select [Monitors], then push .

10:00 am	FWD	Rdy	Menu
Monitors			
Parameters			
User Custom Parameters			
Parameter Backup/Restore			
Modified Param / Fault Log			
Auto-Tuning			
Home			

4. Push  or  to select [Trend Plot], then push **F3** (Setup).

10:00 am	FWD	Rdy	Monitor
Standard Monitor			
Custom Monitor			
Bar Graph			
Analog Gauge			
Trend Plot			
Back Home Setup			

5. Push  or  to select [Custom Monitor 1], then push .

10:00 am	FWD	Setup
Custom Monitor 1		
Custom Monitor 2		
Trend Plot Time Scale Setting		
Back Home		



6. Push .

10:00 am	FWD	Setup
Custom Monitor 1		
Custom Monitor 1		
o1-24	101	(101)
Trend Plot 1 Scale Minimum Value		
o1-47	-100.0	(-100.0)%
Back Home		





7. Push  or  to select the monitor number to register, then push .

When the *U* parameters are on the display as “Ux-xx”, the three digits in “x-xx” identify which monitor to output. For example, to show monitor U1-01 [Frequency Reference], set it to “101” as shown in this figure.



10:00 am FWD	Parameters
Custom Monitor 1	
o1-24	101
Frequency Reference	
Default : 101	
Back	Default

8. Push  or  to select [Trend Plot 1 Scale Minimum Value], then push .

10:00 am FWD	Setup
Custom Monitor 1	
Trend Plot 1 Scale Minimum Value	
o1-47	-100.0 (-100.0)%
Trend Plot 1 Scale Maximum Value	
o1-48	100.0 (100.0)%
Back	Home



9. Push  or  to select the specified digit, then push  or  to select the correct number.

10:00 am FWD	Parameters
Trend Plot 1 Scale Minimum Value	
o1-47	-100.0 %
Default : -100.0%	
Range : -300.0~ 99.9	
Back	Default Min/Max





- Push  (Default) to set the parameters to the factory default.
- Push  (Min/Max) to move between the minimum value and maximum value.

10. Push  to keep the changes.



10:00 am FWD	Parameters
Trend Plot 1 Scale Minimum Value	
o1-47	0020.0 %
Default : -100.0%	
Range : -300.0~ 99.9	
Back	Default Min/Max

11. Push  or  to select [Trend Plot 1 Scale Maximum Value], then push .

10:00 am FWD	Setup
Custom Monitor 1	
Trend Plot 1 Scale Minimum Value	
o1-47	20.0 (-100.0)%
Trend Plot 1 Scale Maximum Value	
o1-48	100.0 (100.0)%
Back	Home

12. Push  or  to select the specified digit, then push  or  to select the correct number.

10:00 am FWD	Parameters
Trend Plot 1 Scale Maximum Value	
o1-48	0100.0 %
Default : 100.0%	
Range : 20.1~ 300.0	
Back	Default Min/Max

- Push  (Default) to set the parameters to the factory default.
- Push  (Min/Max) to move between the minimum value and maximum value.

13. Push  to keep the changes.

10:00 am	FWD	Parameters
Trend Plot 1 Scale Maximum Value		
01-48	0080.0	%
Default : 100.0%		
Range : 20.1~ 300.0		
Back	Default	Min/Max

14. Push  (Back).



If necessary, use the same procedure to set [Custom Monitor 2].

■ Set the Time Scale for the Trend Plot Monitor

The procedure in this section shows how to set the time scale for the trend plot monitor.

1. Push  (Home) to show the HOME screen.

Note:

- The keypad will show [Home] in the top right corner when the HOME screen is active.
- If [Home] is not shown on , push  (Back) to show [Home] on .

2. Push  (Menu).







10:00 am	FWD	Rdy	Home
OFF			

Freq Reference (AI)			
U1-01 Hz	0.00		

Output Frequency			
U1-02 Hz	0.00		

Menu			

3. Push  or  to select [Monitors], then push .



10:00 am	FWD	Rdy	Menu
 Monitors ▶			
 Parameters			
 User Custom Parameters			
 Parameter Backup/Restore			
 Modified Param / Fault Log			
 Auto-Tuning			

Home			

4. Push  or  to select [Trend Plot], then push  (Setup).

10:00 am	FWD	Rdy	Monitor
Standard Monitor			
Custom Monitor			
Bar Graph			
Analog Gauge			
Trend Plot ▶			

Back	Home	Setup	

5. Push  or  to select [Trend Plot Time Scale Setting], then push .

10:00 am	FWD	Setup
1st Monitor Setting		
2nd Monitor Setting		
Trend Plot Time Scale Setting ▶		

Back	Home	

6. Push or to select the specified digit, then push or to select the correct number.

10:00 am	FWD	Parameters
Trend Plot Time Scale Setting		
01-51	0300	sec
Default : 300sec		
Range : 1~3600		
Back	Default	Min/Max

- Push (Default) to set the parameters to the factory default.
- Push (Min/Max) to move between the minimum value and maximum value.

7. Push to keep the changes.

10:00 am	FWD	Parameters
Trend Plot Time Scale Setting		
01-51	1300	sec
Default : 300sec		
Range : 1~3600		
Back	Default	Min/Max

The configuration procedure is complete.

◆ Show Monitor Items as a Trend Plot

The procedure in this section shows how to show the selected monitor data as a trend plot.

1. Push (Home) to show the HOME screen.

Note:

- The keypad will show [Home] in the top right corner when the HOME screen is active.
- If [Home] is not shown on , push (Back) to show [Home] on .

2. Push (Menu).

10:00 am	FWD	Rdy	Home
OFF			

Freq Reference (AI)		0.00	
U1-01	Hz		
Output Frequency		0.00	
U1-02	Hz		

Menu			

3. Push or to select [Monitors], then push .

10:00 am	FWD	Rdy	Menu
Monitors			
Parameters			
User Custom Parameters			
Parameter Backup/Restore			
Modified Param / Fault Log			
Auto-Tuning			

Home			

4. Push or to select [Trend Plot], then push .

10:00 am	FWD	Rdy	Monitor
Standard Monitor			
Custom Monitor			
Bar Graph			
Analog Gauge			
Trend Plot			

Back	Home	Setup	

The screen will show the monitors as shown in this figure.

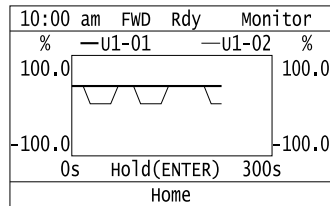
**Note:**

Push (Hold) to switch between Pause and Restart for the monitor display. The “Hold (ENTER)” message flashes while you pause monitoring.

◆ Change Parameter Settings

This example shows how to change the setting value for *C1-01 [Acceleration Time 1]*. Do the steps in this procedure to set parameters for the application.

1. Push (Home) to show the HOME screen.

Note:

- When the drive is in HOME Mode, the screen shows [Home] in the upper right-hand corner of the screen.
- If [Home] is not shown above the , push (Back).

2. Push (Menu).

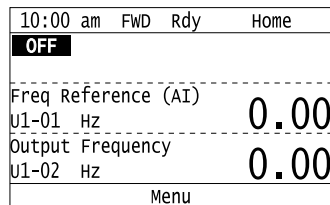

3. Push or to select [Parameters], then push .

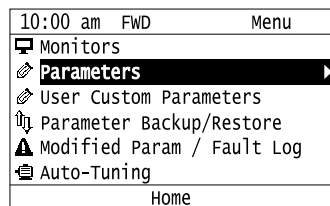

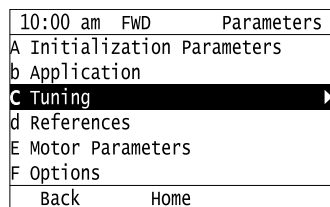

4. Push or to select [C Tuning], then push .



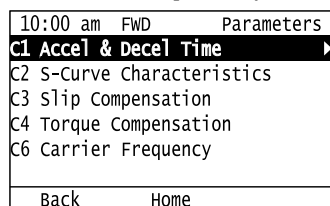



5. Push or to select [C1 Accel & Decel Time], then push .





6. Push  or  to select C1-01, then push .

10:00 am	FWD	Parameters
Acceleration Time 1		
C1-01	30.0	(30.0)sec
Deceleration Time 1		
C1-02	30.0	(30.0)sec
Acceleration Time 2		
C1-03	30.0	(30.0)sec
Back	Home	



7. Push  or  to select the specified digit, then push  or  to select the correct number.

10:00 am	FWD	Parameters
Acceleration Time 1		
C1-01		
	00	30.0 sec
Default : 30.0sec		
Range : 0.1~6000.0		
Back	Default	Min/Max

- Push  [Default] to set the parameters to factory defaults.
- Push  [Min/Max] to show the minimum value or the maximum value on the display.

8. Push  to keep the changes.

10:00 am	FWD	Parameters
Acceleration Time 1		
C1-01		
	00	20.0 sec
Default : 30.0sec		
Range : 0.1~6000.0		
Back	Default	Min/Max

9. Continue to change parameters, then push  [Back],  [Home] to go back to the home screen after you change all the applicable parameters.

◆ Examine User Custom Parameters



The User Custom Parameters show the parameters set in A2-01 to A2-32 [User Parameter 1 to User Parameter 32] to let you quickly access and change settings to these parameters.

Note:

The User Custom Parameters always show A1-06 [Application Selection] at the top of the list. The A2-01 to A2-32 settings change when the A1-06 setting changes, which makes it easier to set and reference the necessary parameter settings.

1. Push  (Home) to show the HOME screen.

Note:







- The keypad will show [Home] in the top right corner when the HOME screen is active.
- If [Home] is not shown on , push  (Back) to show [Home] on .



2. Push  (Menu).

10:00 am	FWD	Rdy	Home
OFF			

Freq Reference (AI)			
U1-01	Hz	0.00	
Output Frequency			
U1-02	Hz	0.00	
Menu			

3. Push  or  to select [User Custom Parameters], then push .





10:00 am	FWD	Menu
	Monitors	
	Parameters	
	User Custom Parameters	
	Parameter Backup/Restore	
	Modified Param / Fault Log	
	Auto-Tuning	
	Home	

4. Push  or  to show the parameter to examine.

10:00 am	FWD	Parameters
	Application Preset	
A1-06	0	(0)
	Control Method Selection	
A1-02	0	(0)
	Frequency Reference Selection 1	
b1-01	1	(1)
Back	Home	

5. To change the parameter settings, push  or  to select the parameter, then push .

10:00 am	FWD	Parameters
	Application Preset	
A1-06	0	(0)
	Control Method Selection	
A1-02	0	(0)
	Frequency Reference Selection 1	
b1-01	1	(1)
Back	Home	

6. Push  or  to select the digit, then push  or  to change the value.

10:00 am	FWD	Parameters
	Control Method Selection	
A1-02	0	
	V/f Control	
	Default : 0	
Back	Default	

7. Change the value, push .

10:00 am	FWD	Parameters
	Control Method Selection	
A1-02	5	
	PM Open Loop Vector	
	Default : 0	
Back	Default	

The parameter setting procedure is complete.

◆ Save a Backup of Parameters

You can save a backup of the drive parameters to the keypad. The keypad can store parameter setting values for a maximum of four drives in different storage areas. Backups of the parameter settings can save time when you set parameters after you replace a drive. When you set up more than one drive, you can copy the parameter settings from a drive that completed a test run to the other drives.

Note:

- Stop the motor before you back up parameters.
- The drive will not accept a Run command while it makes a backup.

4.4 Keypad Operation

1. Push **F2** (Home) to show the HOME screen.

Note:

- When the drive is in HOME Mode, the screen shows [Home] in the upper right-hand corner of the screen.
- If the screen does not show [Home] for **F2**, push **F1** (Back), and then push **F2** to show [Home].

2. Push **F2** (Menu).

10:00 am FWD Rdy Home	
OFF	

Freq Reference (AI)	
U1-01 Hz	0.00
Output Frequency	
U1-02 Hz	0.00

Menu	

3. Push **▲** or **▼** to select [Parameter Backup/Restore], then push **↵**.

10:00 am FWD Menu
Monitors
Parameters
User Custom Parameters
Parameter Backup/Restore
Modified Param / Fault Log
Auto-Tuning
Home

4. Push **▲** or **▼** to select the items to back up, then push **↵**.

10:00 am FWD Backup
Select Items to Backup/Restore
Standard Parameters
Back Home

5. Push **▲** or **▼** to select [Backup (drive → keypad)], then push **↵**.

10:00 am FWD Backup
Select Desired Action
Backup (drive → keypad)
Restore (keypad → drive)
Verify (check for mismatch)
Erase (backup data of keypad)
Back Home

6. Push **▲** or **▼** to select a memory location, then push **↵**.

10:00 am FWD Backup
Select Backup/Restore Location
#1 No Data
#2 No Data
#3 No Data
#4 No Data
Back Home

The keypad shows “End” when the backup procedure completes successfully.

◆ Write Backed-up Parameters to the Bypass

You can back up parameters on the keypad and write them to different bypasses.

Note:

- Always stop the bypass before you start to restore the parameter backups.
- The bypass will not accept a Run command while it restores parameters.

1. Push **F2** (Home) to show the HOME screen.

Note:

- When the bypass is in HOME Mode, the screen shows [Home] in the upper right-hand corner of the screen.
- If the screen does not show [Home] for **F2**, push **F1** (Back), and then push **F2** to show [Home].

2. Push **F2** (Menu).

10:00 am	FWD	Rdy	Home
OFF			

Freq Reference (AI)			0.00
U1-01	Hz		
Output Frequency			0.00
U1-02	Hz		

Menu			

3. Push **▲** or **▼** to select [Parameter Backup/Restore], then push **↵**.

10:00 am	FWD		Menu
Monitors			
Parameters			
User Custom Parameters			
Parameter Backup/Restore			▶
Modified Param / Fault Log			
Auto-Tuning			

Home			

4. Push **▲** or **▼** to select the item to restore, then push **↵**.

10:00 am	FWD		Backup
Select Items to Backup/Restore			
Standard Parameters			▶

Back Home			

5. Push **▲** or **▼** to select [Restore (keypad → drive)], then push **↵**.

10:00 am	FWD		Backup
Select Desired Action			

Backup (drive → keypad)			
Restore (keypad → drive)			▶
Verify (check for mismatch)			
Erase (backup data of keypad)			

Back Home			

6. Push **▲** or **▼** to select the backed-up parameter data, then push **↵**.

10:00 am	FWD		Backup
Select Backup/Restore Location			
#1 2020/01/01 13:00 0-65			▶
#2	No Data		
#3	No Data		
#4	No Data		

Back Home			

The keypad will show the “End” message when the write process is complete.

4.4 Keypad Operation

Note:

Different settings and conditions will change the keypad display.

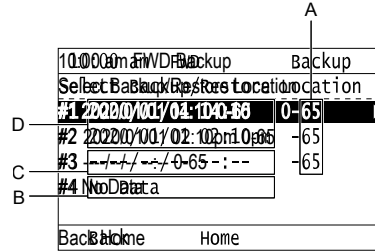

A - o2-04 [Drive Model (KVA Selection) settings (2 or 3 digits)
B - Parameter backup data is not registered

C - Backup data does not contain the date Information
D - Backup date

◆ Verify Keypad Parameters and Bypass Parameters

This procedure verifies that the parameter setting values that were backed up in the keypad agree with the parameter setting values in the bypass.

Note:

- Always stop the bypass before you start to verify the parameters.
- The bypass will not accept a Run command while it verifies parameters.

1. Push **F2** (Home) to show the HOME screen.

Note:

- When the bypass is in HOME Mode, the screen shows [Home] in the upper right-hand corner of the screen.
- If the screen does not show [Home] for **F2**, push **F1** (Back), and then push **F2** to show [Home].

2. Push **F2** (Menu).

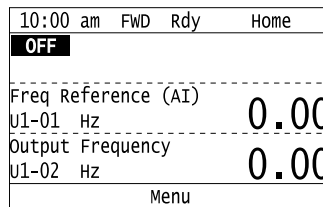

3. Push **▲** or **▼** to select [Parameter Backup/Restore], then push **↵**.

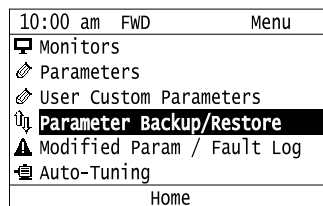

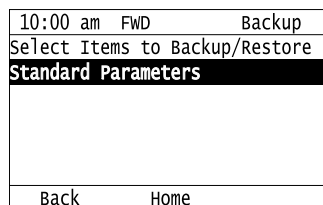

4. Push **▲** or **▼** to select the item to verify, then push **↵**.



5. Push  or  to select [Verify (drive → keypad)], then push .

10:00 am	FWD	Backup
Select desired action.		
Backup (drive → keypad)		
Restore (keypad → drive)		
Verify (check for mismatch) ▶		
Erase (backup data of keypad)		
Back	Home	

6. Push  or  to select the data to verify, then push .

10:00 am	FWD	Backup
Select Backup/Restore Location		
#1 2020/01/01 13:00 0-65 ▶		
#2 No Data		
#3 No Data		
#4 No Data		
Back	Home	

The keypad shows “End” when the parameter settings backed up in the keypad agree with the parameter settings copied to the bypass.

Note:



The keypad shows *vFyE [Parameters do not Match]* when the parameter settings backed up in the keypad do not agree with the parameter settings copied to the drive. Push one of the keys to return to the screen in Step 6.

◆ Delete Parameters Backed Up to the Keypad

This procedure deletes the parameters that were backed up to the keypad.

1. Push  (Home) to show the HOME screen.

Note:

- When the drive is in HOME Mode, the screen shows [Home] in the upper right-hand corner of the screen.
- If the screen does not show [Home] for , push  (Back), and then push  to show [Home].



2. Push  (Menu).

10:00 am	FWD	Rdy	Home
OFF			

Freq Reference (AI)		0.00	
U1-01	Hz		
Output Frequency		0.00	
U1-02	Hz		
Menu			

3. Push  or  to select [Parameter Backup/Restore], then push .

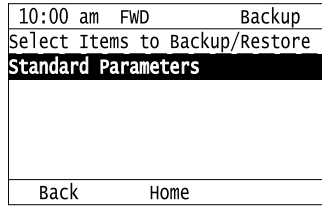

10:00 am	FWD	Menu
Monitors		
Parameters		
User Custom Parameters		
Parameter Backup/Restore ▶		
Modified Param / Fault Log		
Auto-Tuning		
Home		

4. Push  or  to select the item to verify, then push .

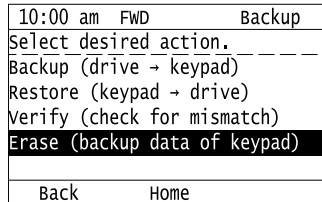

5. Push  or  to select [Delete (keypad)], then push .



6. Push  or  to select the data to delete, then push .

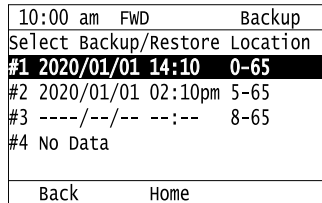

The keypad will show the “End” message when the write process is complete.

◆ Checking Modified Parameters

■ Modified Parameters Screen Displays

The keypad display for Modified Parameters screen changes when *A1-06 [Application Preset]* changes:

A1-06 Settings	Keypad Display	Description
0	<p>10:00 am FWD Modified User Modified Parameters Standard: 2 Parameters Modified Back Home</p>	When you set <i>A1-06 = 0 [No Preset Selected]</i> , the Modified Parameters screen will only show [Standard].
1 - 8	<p>10:00 am FWD Modified User Modified Parameters Standard: 8 Parameters Modified Application Presets: 2 Parameters Modified Back Home</p>	When you set an application macro (<i>A1-06 ≠ 0</i>), the Modified Parameters screen will show the Standard menu and Application Presets menu. <ul style="list-style-type: none"> Standard: This menu shows all parameters modified by the <i>A1-06</i> setting and any standard drive parameters modified after you changed the <i>A1-06</i> setting. Application Presets: This menu only shows parameters not set by <i>A1-06</i>.

■ Check Modified Parameters

This procedure will show all parameters that are not at their default values. This helps find settings have been changed, and is very useful when you replace a drive. This lets you quickly access and re-edit changed parameters. The keypad will show “0 Parameters” when all parameters are at their default values.

1. Push **F2** (Home) to show the HOME screen.

Note:

- The keypad will show [Home] in the top right corner when the HOME screen is active.
- If [Home] is not shown on **F2**, push **F1** (Back) to show [Home] on **F2**.

2. Push **F2** (Menu).

10:00 am	FWD	Rdy	Home
OFF			

Freq Reference (AI)			
U1-01	Hz		0.00

Output Frequency			
U1-02	Hz		0.00

Menu			

3. Push **▲** or **▼** to select [Modified Param / Fault Log], then push **↵**.

10:00 am	FWD		Menu
Monitors			
Parameters			
User Custom Parameters			
Parameter Backup/Restore			
Modified Param / Fault Log			▶
Auto-Tuning			

Home			

4. Push **▲** or **▼** to select [Modified Parameters], then push **↵**.

10:00 am	FWD		History
Modified Parameters			▶
Fault Log			

Back			Home

5. Push **↵**.

10:00 am	FWD		Modified
User Modified Parameters			
Standard:			▶
2 Parameters Modified			

Back			Home

6. Push **▲** or **▼** to show the parameter to check.

10:00 am	FWD		Modified
Acceleration Time 1			
C1-01	20.0	(30.0)sec	

Motor Rated Current (FLA)			
E2-01	97.2	(77.0)A	

Back			Home

7. To re-edit a parameter, push **▲** or **▼**, select the parameter to edit, then push **↵**.

10:00 am	FWD		Modified
Acceleration Time 1			
C1-01	20.0	(30.0)sec	

Motor Rated Current (FLA)			
E2-01	97.2	(77.0)A	

Back			Home

8. Push or to select the digit, then push or to change the value.

10:00 am	FWD	Parameters
Acceleration Time 1		
C1-01	0020.0	sec
Default : 30.0sec		
Range : 0.1~6000.0		
Back	Default	Min/Max

9. When you are done changing the value, push .

10:00 am	FWD	Parameters
Acceleration Time 1		
C1-01	0010.0	sec
Default : 30.0sec		
Range : 0.1~6000.0		
Back	Default	Min/Max

The parameter revision procedure is complete.

◆ Restore Modified Parameters to Defaults

This procedure will set all parameters with changed values to their default settings.

1. Push (Home) to show the HOME screen.

Note:

- The keypad will show [Home] in the top right corner when the HOME screen is active.
- If [Home] is not shown on , push (Back) to show [Home] on .

2. Push (Menu).

10:00 am	FWD	Rdy	Home
OFF			

Freq Reference (AI)			
U1-01	Hz	0.00	

Output Frequency			
U1-02	Hz	0.00	

Menu			

3. Push or to select [Modified Param / Fault Log], then push .

10:00 am	FWD	Menu
☐ Monitors		
✎ Parameters		
✎ User Custom Parameters		
📁 Parameter Backup/Restore		
⚠ Modified Param / Fault Log ▶		
🔧 Auto-Tuning		

Home		



4. Push or to select [Modified Parameters], then push .

10:00 am	FWD	History
📁 Modified Parameters ▶		
⚠ Fault Log		

Back	Home	

5. Push .

10:00 am	FWD	Modified
User Modified Parameters		
Standard:		
2 Parameters Modified		
Back	Home	

6. Push  or  to select the parameters to return to their default settings, then push .

10:00 am	FWD	Modified
Acceleration Time 1		
C1-01	20.0	(30.0)sec
Motor Rated Current (FLA)		
E2-01	97.2	(77.0)A
Back	Home	

7. Push  (Default).

10:00 am	FWD	Parameters
Acceleration Time 1		
C1-01	0020.0 sec	
Default : 30.0sec		
Range : 0.1~6000.0		
Back	Default	Min/Max

8. Push .

10:00 am	FWD	Parameters
Acceleration Time 1		
C1-01	0030.0 sec	
Default : 30.0sec		
Range : 0.1~6000.0		
Back	Default	Min/Max

The modified parameters are now set to default values.

◆ Show Fault History



You can examine a maximum of 10 fault codes and dates and times that the faults occurred.

Note:

- To monitor the date and time of faults, you must first set the date and time on the keypad.
- If the keypad does not have a clock battery, you must set the date and time each time you energize the drive.

1. Push  (Home) to show the HOME screen.

Note:

- The keypad will show [Home] in the top right corner when the HOME screen is active.
- If [Home] is not shown on , push  (Back) to show [Home] on .

2. Push  (Menu).

10:00 am	FWD	Rdy	Home
OFF			

Freq Reference (AI)			
U1-01	Hz	0.00	

Output Frequency			
U1-02	Hz	0.00	

Menu			

3. Push or to select [Modified Parameters/Fault History], then push .

10:00 am FWD	Menu
Monitors	
Parameters	
User Custom Parameters	
Parameter Backup/Restore	
Modified Param / Fault Log	
Auto-Tuning	
Home	

4. Push or to select [Fault History], then push .

10:00 am FWD	History
Modified Parameters	
Fault Log	
Back Home	

5. Push or to show the fault history you will examine.

10:00 am FWD	History
Fault History Log	
01 ov	2020/01/01 14:00 Overvoltage
02 oc	2020/01/01 13:00 Overcurrent
Back Home	

◆ Auto-Tuning

Auto-Tuning uses motor characteristics to automatically set parameters.

Refer to the motor nameplate or the motor test report for the necessary information for Auto-Tuning.

VARTSPEED									
3-PHASE PERMANENT MAGNET MOTOR									
TYPE SST4-					POLES E5-04				
PROTECTION					COOLING				
kW	V	Hz	RATING	A	r/min	r ₁	E5-05		
E5-02	E1-05			E5-03	E1-04,06	Ld	E5-06		
						Lq	E5-07		
						Ke	E5-09		
TNS		COOLANT TEMP.		°C		ALTITUDE		m	
STD				MASS		kg		Δθ'	
BRG NO	DRIVE	OPP					Ki		
END	END	END					Kt		
SER NO	YEAR						Si		
YASKAWA ELECTRIC CORPORATION JAPAN									

Figure 4.6 Motor Nameplate (Example)

WARNING! Sudden Movement Hazard. Before you do Auto-Tuning, remove all personnel and objects from the area around the bypass, motor, and load. The bypass and motor can start suddenly during Auto-Tuning and cause serious injury or death.

WARNING! Electrical Shock Hazard. During Auto-Tuning, the motor will receive high voltage when the motor is stopped. Do not touch the motor until Auto-Tuning is complete. If you touch a motor that is energized, it can cause serious injury or death.

WARNING! Sudden Movement Hazard. Before you do Rotational Auto-Tuning, disconnect the load from the motor. The load can move suddenly and cause serious injury or death.

This procedure shows how to do Rotational Auto-Tuning.

1. Push (Home) to show the HOME screen.

Note:







- When the bypass is in HOME Mode, the screen shows [Home] in the upper right-hand corner of the screen.
- If the screen does not show [Home] for , push (Back), and then push to show [Home].

2. Push **F2** (Menu).

10:00 am	FWD	Rdy	Home
OFF			

Freq Reference (AI)			0.00
U1-01	Hz		
Output Frequency			0.00
U1-02	Hz		
Menu			

3. Push  or  to select [Auto-Tuning], then push .

10:00 am	FWD		Menu
	Parameters		
	User Custom Parameters		
	Parameter Backup/Restore		
	Modified Param / Fault Log		
	Auto-Tuning 		
	Initial Setup		
Home			





4. Push .

10:00 am	FWD		Auto Tuning
Select Auto-Tuning mode			
Motor Parameter Tuning 			
Back	Home		

5. Push  or  to select [Rotational Auto-Tuning], then push .

10:00 am	FWD		Auto Tuning
Select the Auto-Tuning mode.			
Rotational Auto-Tuning 			
Stationary Line-Line Resistance			
Back	Home		

6. Follow the messages shown on the keypad to input the necessary Auto-Tuning data.

Example: Push  or  to select the specified digit, then push  or  to change the number. Push  to save the change and move to the next entry field.

10:00 am	FWD		Auto Tuning
Enter motor rated power.			

007.50 HP			
Range : 0.00~650.00			
Back	Home		

7. Follow the messages shown on the keypad to do the next steps.



8. When the keypad shows the Auto-Tuning start screen, push .

10:00 am	FWD		Auto Tuning
AUTO key : Tuning Start			
Home key : Cancel			
The motor turns.			
Please be careful.			
Back	Home		

Auto-Tuning starts.



4.4 Keypad Operation

When doing Rotational Auto-Tuning, the motor will stay stopped for approximately one minute with power energized and then the motor will start to rotate.

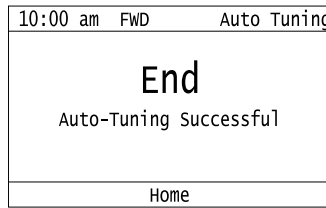

9. When the keypad shows this screen after Auto-Tuning is complete for 1 or 2 minutes, push  or .

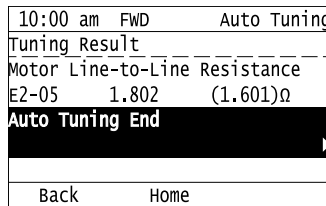

The keypad will show a list of the changed parameters as the result of Auto-Tuning.

10. Push  or  in the parameter change confirmation screen to check the changed parameters, then select [Auto-Tuning Successful] at the bottom of the screen and push .



To change a parameter again, push  or  to select the parameter to change, then push  to show the parameter setting screen.

Auto-Tuning is complete.

Note:

If the bypass detects an error or you push  before Auto-Tuning is complete, Auto-Tuning will stop and the keypad will show an error code. *Endx* identifies that Auto-Tuning was successful with calculation errors. Find and repair the cause of the error and do Auto-Tuning again, or set the motor parameters manually. You can use the bypass in the application if you cannot find the cause of the *Endx* error. *Er-xx* identifies that Auto-Tuning was not successful. Find and repair the cause of the error and do Auto-Tuning again.

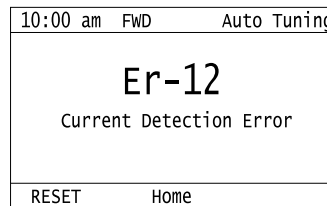
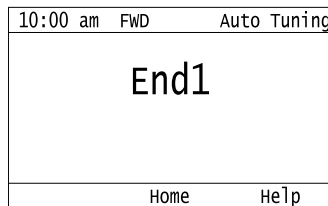



◆ Set the Keypad Language Display

The procedure in this section shows how to set the language shown on the keypad.



1. Push  (Home) to show the HOME screen.





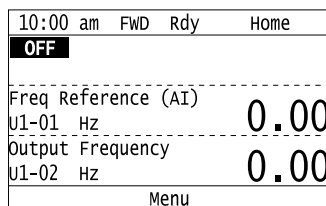

Note:

- The keypad will show [Home] in the top right corner when the HOME screen is active.
- If [Home] is not shown on , push  (Back), to show [Home] on .





2. Push  (Menu).





3. Push  or  to select [Initial Settings], then push .

10:00 am FWD	Menu
 User Custom Parameters	
 Parameter Backup/Restore	
 Modified Param / Fault Log	
 Auto-Tuning	
 Initial Setup	
 Diagnostic Tools	
Home	

4. Push  or  to select [Language Selection], then push .

10:00 am FWD	Init Setup
 Language Selection	
 Set Date/Time	
 Show Initial Setup Screen	
Back Home	

5. Push  or  to select the language, then push .

10:00 am FWD	Init Setup
Language Selection	
English	
Spanish	
Back Home	

The procedure to set the keypad language is complete.

◆ Set the Date and Time



The procedure in this section shows how to set the date and time.

Note:

- Refer to [Replace the Keypad Battery on page 587](#) for information about the battery installation procedure.
- The drive can detect an alarm when the battery dies or when you do not set the clock. Set *o4-24 = 1 [bAT Detection selection = Enable (Alarm Detected)]* to enable this alarm.
- If the keypad does not have a clock battery, you must set the date and time each time you energize the drive.

1. Push  (Home) to show the HOME screen.

Note:

- The keypad will show [Home] in the top right corner when the HOME screen is active.
- If [Home] is not shown on , push  (Back) to show [Home] on .



2. Push  (Menu).

10:00 am FWD	Rdy	Home
OFF		

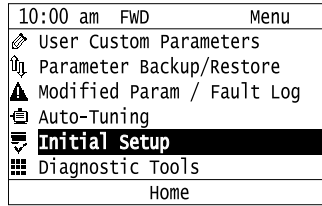

Freq Reference (AI)		
U1-01 Hz		0.00
Output Frequency		
U1-02 Hz		0.00
Menu		

3. Push  or  to select [Initial Setup], then push .



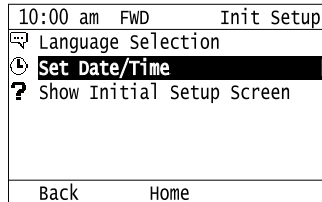

4. Push  or  to select [Set Date/Time], and push .

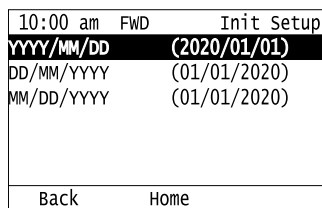

5. Push  or  to select the format of date display, then push .



6. Push  or  to select the format of time display, then push .

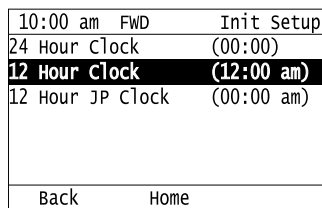



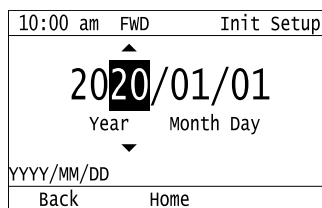

7. Push  or  to select a number from Year/Month/Day, then push  or  to change the value.

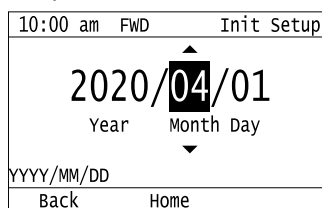

8. When you are done changing the value, push .



9. Push  or  to select the hour or minute, then push  or  to change the value.

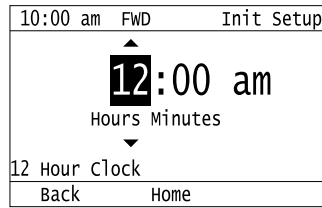

10. When you are done setting the time, push .

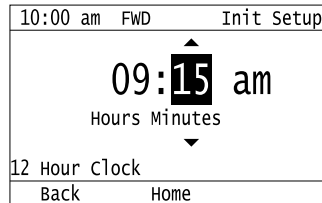



The procedure for setting the date and time is complete.

◆ Disable the Initial Setup Screen

Do the steps in this procedure to not show the initial start-up screen when the drive is energized.

1. Push  (Home) to show the HOME screen.

Note:

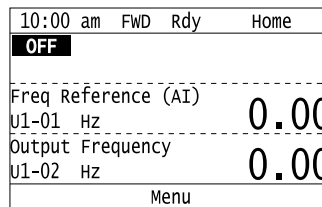

- When the drive is in HOME Mode, the screen shows [Home] in the upper right-hand corner of the screen.
- If the screen does not show [Home] for , push  (Back), and then push  to show [Home].

2. Push  (Menu).



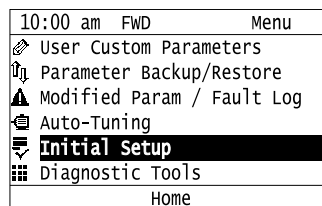

3. Push  /  to select [Initial Setup], then push .

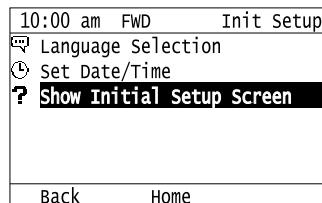

4. Push  /  to select [Show Initial Setup Screen], then push .



5. Push  /  to select [No], then push .

10:00 am	FWD	Init Setup
Show Initial Setup Screen		
No		
Yes		
Back	Home	

- [No]: The keypad will not show the Initial Setup Screen when the drive is energized.
- [Yes]: The keypad will show the Initial Setup Screen when the drive is energized.



◆ Start Data Logging

The data log function saves drive status information. Monitors *Ux-xx* are the source of log information. The procedure in this section shows how to start logging data.

You can record a maximum of 10 monitors.

1. Insert a microSD card in the keypad.
2. Push  (Home) to show the HOME screen.

Note:

- When the drive is in HOME Mode, the screen shows [Home] in the upper right-hand corner of the screen.
- If the screen does not show [Home] for , push  (Back), and then push  to show [Home].

3. Push  (Menu).

10:00 am	FWD	Rdy	Home
OFF			



Freq Reference (AI)			
U1-01	Hz	0.00	

Output Frequency			
U1-02	Hz	0.00	



Menu			

4. Push  or  to select [Diagnostic Tools], then push .

10:00 am	FWD	Menu
◆ User Custom Parameters		
⌚ Parameter Backup/Restore		
⚠ Modified Param / Fault Log		
🔧 Auto-Tuning		
⌄ Initial Setup		
🔧 Diagnostic Tools		
Home		

5. Push  or  to select [Data Logger], then push .

10:00 am	FWD	Tools
Data Logger		
Backlight		
Drive Information		
Back	Home	Setup

6. Push  or  to select [Yes] or [No], then push .

10:00 am	FWD	Tools
Begin Data Logging?		
No		
Yes		
Back	Home	

- [Yes]: Data logging starts.
- [No]: Data logging will not start.

If the drive was logging data when you entered the command, the keypad looks like this:

10:00 am	FWD	Tools
End Data Logging?		
No		
Yes		
Start Time	:2020/01/01 00:00	
Period	:00:10:00	
Back	Home	



◆ Configuring the Data Log Content

■ Set Monitor to Log

The procedure in this section shows how to set the monitor for which to log data.

1. Push  (Home) to show the HOME screen.

Note:

- When the drive is in HOME Mode, the screen shows [Home] in the upper right-hand corner of the screen.
- If the screen does not show [Home] for , push  (Back), and then push  to show [Home].



2. Push  (Menu).

10:00 am	FWD	Rdy	Home
OFF			

Freq Reference (AI)			
U1-01	Hz	0.00	

Output Frequency			
U1-02	Hz	0.00	

Menu			

3. Push  or  to select [Diagnostic Tools], then push .

10:00 am	FWD	Menu
User Custom Parameters		
Parameter Backup/Restore		
Modified Param / Fault Log		
Auto-Tuning		
Initial Setup		
Diagnostic Tools		
Home		

4. Push  or  to select [Data Logger], then push  (Setup).

10:00 am	FWD	Tools
Data Logger		
Backlight		
Drive Information		
Back	Home	Setup

5. Push  or  to select [Log Monitor], then push .

10:00 am	FWD	Setup
Log Monitor		
Log Sampling Interval		
Back	Home	

6. Push  or  to select the save-destination monitor parameter, then push .

10:00 am	FWD	Setup
Log Monitor		
Log Monitor Data 1		
o5-03	101	(101)
Log Monitor Data 2		
o5-04	102	(102)
Back	Home	

7. Push  or  to select the monitor number to be logged, then push .

10:00 am	FWD	Parameters
Log Monitor Data 1		
o5-03	101	
Frequency Reference		
Default : 101		
Back	Default	



The configuration procedure is complete.

■ Set the Sampling Time

The procedure in this section shows how to set the sampling time for data logging.

1. Push  (Home) to show the HOME screen.

Note:

- When the drive is in HOME Mode, the screen shows [Home] in the upper right-hand corner of the screen.
- If the screen does not show [Home] for , push  (Back), and then push  to show [Home].

2. Push  (Menu).

10:00 am	FWD	Rdy	Home
OFF			

Freq Reference (AI)			
U1-01	Hz	0.00	

Output Frequency			
U1-02	Hz	0.00	

Menu			

3. Push  or  to select [Diagnostic Tools], then push .





10:00 am	FWD	Menu
⚙ User Custom Parameters		
🔄 Parameter Backup/Restore		
⚠ Modified Param / Fault Log		
🔧 Auto-Tuning		
📄 Initial Setup		
🔧 Diagnostic Tools		
Home		

4. Push  or  to select [Data Logger], then push  (Setup).

10:00 am	FWD	Tools
Data Logger		
Backlight		
Drive Information		
Back	Home	Setup

5. Push  or  to select [Log Sampling Interval], then push .

10:00 am	FWD	Setup
Log Monitor		
Log Sampling Interval		
Back	Home	

6. Push  or  to select the digit, then push  or  to change the value.

10:00 am	FWD	Parameters
Log Sampling Interval		
05-02		
00100 ms		
Default : 100ms		
Range : 100~60000		
Back	Default	Min/Max

7. When you complete changing the value, push .

10:00 am	FWD	Parameters
Log Sampling Interval		
05-02		
20000 ms		
Default : 100ms		
Range : 100~60000		
Back	Default	Min/Max



The procedure to set the sampling time is complete.

◆ Set Backlight to Automatically Turn OFF

You can set the backlight of the keypad screen to automatically turn OFF after a set length of time since the last key operation on the keypad. The procedure in this section shows how to turn ON and turn OFF the backlight.

1. Push  (Home) to show the HOME screen.

Note:

- The keypad will show [Home] in the top right corner when the HOME screen is active.
- If [Home] is not shown on , push  (Back) to show [Home] on .

2. Push  (Menu).

10:00 am	FWD	Rdy	Home
OFF			

Freq Reference (AI)			
U1-01	Hz	0.00	

Output Frequency			
U1-02	Hz	0.00	



Menu			

3. Push  or  to select [Diagnostic Tools], then push .

10:00 am	FWD	Menu
User Custom Parameters		
Parameter Backup/Restore		
Modified Param / Fault Log		
Auto-Tuning		
Initial Setup		
Diagnostic Tools		
Home		

4. Push  or  to select [Backlight], then push .

10:00 am	FWD	Tools
Data Logger		
Backlight		
Drive Information		
Back	Home	Setup

5. Push  or  to select [ON] or [OFF], then push .

10:00 am	FWD	Tools
LCD backlight ON/OFF Selection		
OFF		
ON		
Back	Home	





- [ON]: Backlight is always ON
- [OFF]: Backlight turns OFF after set length of time.

6. Push  (Setup).

10:00 am	FWD	Tools
Data Logger		
Backlight		
Drive Information		
Back	Home	Setup

7. Push .

10:00 am	FWD	Setup
Energy Saving		
LCD Backlight Off-Delay		
01-38	60	(60)sec
Back	Home	

8. Push  or  to select the digit, then push  or  to change the value.

10:00 am	FWD	Parameters
LCD Backlight Off-Delay		
01-38		
	0	60 sec
Default : 60sec		
Range : 10~300		
Back	Default	Min/Max

9. When you are done changing the value, push .

10:00 am	FWD	Parameters
LCD Backlight Off-Delay		
01-38		
030 sec		
Default : 60sec		
Range : 10~300		
Back	Default	Min/Max



The procedure to set the backlight to turn OFF automatically is complete.

◆ Show Information about the Bypass

The procedure in this section shows how to show the bypass model, maximum applicable motor output, rated output current, software version, and the serial number on the keypad.

1. Push  (Home) to show the HOME screen.

Note:

- The keypad will show [Home] in the top right corner when the HOME screen is active.
- If [Home] is not shown on , push  (Back) to show [Home] on .







2. Push  (Menu).

10:00 am	FWD	Rdy	Home
OFF			

Freq Reference (AI)		0.00	
U1-01 Hz		0.00	

Output Frequency		0.00	
U1-02 Hz		0.00	
Menu			

3. Push  or  to select [Diagnostic Tools], then push .

10:00 am	FWD	Menu
 User Custom Parameters  Parameter Backup/Restore  Modified Param / Fault Log  Auto-Tuning  Initial Setup  Diagnostic Tools ▶		
Home		

4. Push  or  to select [Bypass Information], then push .

10:00 am	FWD	Tools
Data Logger		
Backlight		
Bypass Information ▶		
Back	Home	

The keypad will show the bypass information.

10:00 am	FWD	Tools
HV600 Bypass		
200V, 3.0HP		
10, 60A		
<Software: 00441>		
S/N: Y0065F575310100		
Back	Home	

A - Drive Series
B - Model Information
C - Rated Output Current



D - Software Version
E - Serial Number

◆ Write Automatically Backed-up Parameters to the Bypass

You can automatically back up parameters to the keypad connected to the bypass and write those parameters to a different drive as specified by the settings of *o3-06 [Auto Parameter Backup Selection]* and *o3-07 [Auto Parameter Backup Interval]*.

Note:

- Set *o3-06 = 1 [Auto Parameter Backup Selection = Enabled]* in each bypass to which you will write the parameters.
- This operation is not available when the parameters in the keypad and the parameters on the other bypasses are set to the same values.

1. Connect the keypad to the bypass.
2. Push  or  to select [Yes] and then push .

10:00 am	FWD	Backup
Drive and keypad mismatch. Should the parameters be restored?		

No		
Yes		

3. Push  or  to select [Yes] and then push .

10:00 am	FWD	Backup
Starting restore. Are you sure you want to start?		

No		
Yes		

The keypad will show the “End” message when the write process is complete.

4.5 Automatic Parameter Settings Optimized for Specific Applications (Application Presets)

The bypass has application presets to set the necessary parameters for different applications to their best values. To examine the parameters that *A1-06 [Application Preset]* automatically changed, use [User Custom Parameters] on the Main menu.

Note:

Make sure that you set *A1-03 = 2220 [Initialize Parameters = 2-Wire Initialization]* to initialize parameters before you set *A1-06*.

This section shows the procedure to set an application preset.

1. Push **F2** (Home) to show the HOME screen.

Note:







- The keypad will show [Home] in the top right corner when the HOME screen is active.
- If [Home] is not shown on **F2**, push **F1** (Back) to show [Home] on **F2**.

2. Push **F2** (Menu).

10:00 am	FWD	Rdy	Home
OFF			



Freq Reference (AI)		0.00	
U1-01 Hz		-----	
Output Frequency		0.00	
U1-02 Hz		-----	
Menu			

3. Push  or  to select [Parameters], then push .



10:00 am	FWD	Menu
	Monitors	
	Parameters	
	User Custom Parameters	
	Parameter Backup/Restore	
	Modified Param / Fault Log	
	Auto-Tuning	
Home		

4. Push  or  to select [A Initialization Parameters], then push .



10:00 am	FWD	Parameters
A	Initialization Parameters	
b	Application	
C	Tuning	
d	References	
E	Motor Parameters	
F	Options	
Back	Home	

5. Push  or  to select [A1 Initialization], then push .

10:00 am	FWD	Parameters
A1	Initialization	
A2	User Parameters	
Back	Home	

6. Push  or  to select A1-06, then push .

10:00 am	FWD	Parameters
Password		
A1-04	0	(0)
Application Preset		
A1-06	0	(0)
Bluetooth ID		
A1-12	0	(0)
Back	Home	

7. Push  or  to change the value, then push .

10:00 am	FWD	Parameters
Application Preset		
A1-06	3	
Return Fan w/ PID Control		
Default : 0		
Back	Default	

The parameter setting procedure is complete.

Note:

- You cannot change the value set in A1-06. To select an application preset, first set A1-03 = 2220 to initialize parameters and then make a selection to A1-06. If initializing all parameters will cause a problem, it is not necessary to change settings.
- When the drive changes to the A1-06 setting, it will also reset the parameters automatically registered to A2-17 to A2-32 [User Parameters 17 to 32] when A2-33 = 1 [User Parameter Auto Selection = Enabled: Auto Save Recent Params].

4.6 Auto-Tuning

Auto-Tuning uses motor characteristics to automatically set parameters. Think about the type of motor and the motor installation environment and select the best Auto-Tuning method.

The keypad will show the messages with prompts to input the necessary parameter information.

◆ Auto-Tuning for Induction Motors

This section gives information about Auto-Tuning for induction motors. Auto-Tuning sets motor parameters $E1-xx$, $E2-xx$.

Note:

Do Stationary Auto-Tuning if you cannot do Rotational Auto-Tuning. There can be large differences between the measured results and the motor characteristics when Auto-Tuning is complete. Examine the parameters for the measured motor characteristics after you do Stationary Auto-Tuning.

Table 4.5 Types of Auto-Tuning for Induction Motors

Mode	Application Conditions and Benefits
Rotational Auto-Tuning	<ul style="list-style-type: none"> When you can decouple the motor and load the motor can rotate freely while Auto-Tuning. When operating motors that have fixed output characteristics. When it is necessary to use motors that have high-precision control. When you cannot decouple the motor and load, but the motor load is less than 30%.
Line-to-Line Resistance	<ul style="list-style-type: none"> After Auto-Tuning, the wiring distance between the drive and motor changed by 50 m or more. When the wiring distance is 50 m or more in the V/f Control mode. When the motor output and drive capacity are different.

■ Input Data for Induction Motor Auto-Tuning

To do Auto-Tuning, input data for the items in [Table 4.6](#) that have an "x". Before starting Auto-Tuning, prepare the motor test report or record the information on the motor nameplate as a reference.

Table 4.6 Input Data for Induction Motor Auto-Tuning

Input Data	Unit	Auto-Tuning Mode	
		Rotational Auto-Tuning	Line-to-Line Resistance
Motor Rated Power	HP	x	x
Motor Rated Voltage	V	x	-
Motor Rated Current	A	x	x
Motor Base Frequency	Hz	x	-
Number of Motor Poles	-	x	-
Motor Base Speed	RPM (min ⁻¹)	x	-
Motor Iron Loss	W	x	-

◆ Precautions before Auto-Tuning

Examine the topics in this section before you start Auto-Tuning.

■ Prepare for Basic Auto-Tuning

- You must input data from the motor nameplate or motor test report to do Auto-Tuning. Make sure that this data is available before Auto-Tuning.
- For best performance, make sure that the input supply voltage is equal to or more than the motor rated voltage.
- Push  on the keypad to cancel Auto-Tuning.
- [Table 4.7](#) shows the status of input/output terminals during Auto-Tuning.

Table 4.7 Status of Drive Unit Input/Output Terminals during Auto-Tuning

Auto-Tuning Type	Mode		Multi-Function Inputs	Multi-Function Outputs ^{*1}
Induction Motor Auto-Tuning	Rotational	Rotational Auto-Tuning	Disabled	Functions the same as during usual operation.
	Stationary	Line-to-Line Resistance	Disabled	Keeps the status at the start of Auto-Tuning.

*1 A terminal to which H2-xx = E [MFDO Function Selection = Fault] is assigned functions the same as during usual operation.

WARNING! Sudden Movement Hazard. Before you do Rotational Auto-Tuning, disconnect the load from the motor. The load can move suddenly and cause serious injury or death.

WARNING! Injury to Personnel. Rotational Auto-Tuning rotates the motor at 50% or more of the motor rated frequency. Make sure that there are no issues related to safety in the area around the drive and motor. Increased motor frequency can cause serious injury or death.

WARNING! Electrical Shock Hazard. During Auto-Tuning, the motor will receive high voltage when the motor is stopped. Do not touch the motor until Auto-Tuning is complete. If you touch a motor that is energized, it can cause serious injury or death.

■ Precautions before Rotational Auto-Tuning

WARNING! Electrical Shock Hazard. During Auto-Tuning, the motor will receive high voltage when the motor is stopped. Do not touch the motor until Auto-Tuning is complete. If you touch a motor that is energized, it can cause serious injury or death.

- Before you do Rotational Auto-Tuning, to prevent drive malfunction, uncouple the motor from the load. If you do Rotational Auto-Tuning with the motor connected to a load that is more than 30% of the motor duty rating, the bypass will not correctly calculate the motor parameters and the motor can operate incorrectly.
- When the load is 30% or less of the motor duty rating, you can do Auto-Tuning with the motor connected to a load.
- Make sure that external force from the machine will not cause the motor to rotate.

■ Precautions before Stationary Auto-Tuning

- Make sure that external force from the machine will not cause the motor to rotate.

WARNING! Electrical Shock Hazard. During Auto-Tuning, the motor will receive high voltage when the motor is stopped. Do not touch the motor until Auto-Tuning is complete. If you touch a motor that is energized, it can cause serious injury or death.

■ Precautions before Stationary Auto-Tuning for Line-to-Line Resistance and Stator Resistance Auto-Tuning

In V/f control, when the motor cable is 50 meters (164 feet) or longer, do Stationary Auto-Tuning for Line-to-Line Resistance.

WARNING! Electrical Shock Hazard. During Auto-Tuning, the motor will receive high voltage when the motor is stopped. Do not touch the motor until Auto-Tuning is complete. If you touch a motor that is energized, it can cause serious injury or death.

4.7 Fine Tuning during Test Runs (Adjust the Control Function)

This section gives information about the adjustment procedures to stop hunting or oscillation errors caused by control function during a test run. Adjust the applicable parameters as specified by your status.

Note:

This section only lists frequently adjusted parameters. If you must adjust parameters that have a higher degree of precision, contact Yaskawa.

◆ V/f Control

Table 4.8 Parameters for Fine Tuning the Drive (V/f)

Issue	Parameter Number	Possible Solutions	Default	Recommended Setting
Hunting or oscillation at mid-range speeds (10 Hz to 40 Hz)	n1-02 [Hunting Prevention Gain Setting]	<ul style="list-style-type: none"> If torque is not sufficient with heavy loads, decrease the setting value. If hunting or oscillation occur with light loads, increase the setting value. If hunting occurs with a low-inductance motor, for example a motor with a larger frame size or a high-frequency motor, lower the setting value. 	1.00	0.10 - 2.00
<ul style="list-style-type: none"> The volume of the motor excitation sound is too high. Hunting or oscillation at low speeds (10 Hz or lower), or at mid-range speeds (10 Hz to 40 Hz) 	C6-02 [Carrier Frequency Selection]	<ul style="list-style-type: none"> If the volume of the motor excitation sound is too high, increase the carrier frequency. If hunting or oscillation occur at low or mid-range speeds, decrease the carrier frequency. 	1 (2 kHz) *1	1 to upper limit value
<ul style="list-style-type: none"> Unsatisfactory motor torque and speed response Hunting or oscillation 	C4-02 [Torque Compensation Delay Time]	<ul style="list-style-type: none"> If torque or speed response are slow, decrease the setting value. If hunting or oscillation occur, increase the setting value. 	200 ms *1	100 - 1000 ms
<ul style="list-style-type: none"> Torque at low speeds (10 Hz or lower) is not sufficient. Hunting or oscillation 	C4-01 [Torque Compensation Gain]	<ul style="list-style-type: none"> If torque at low speeds (10 Hz or lower) is not sufficient, increase the setting value. If hunting or oscillation occur with light loads, decrease the setting value. 	1.00	0.50 - 1.50
<ul style="list-style-type: none"> Torque at low speeds (10 Hz or lower) is not sufficient. Large initial vibration at start up. 	<ul style="list-style-type: none"> E1-08 [Mid Point A Voltage] E1-10 [Minimum Output Voltage] 	<ul style="list-style-type: none"> If torque at low speeds (10 Hz or lower) is not sufficient, increase the setting value. If there is large initial vibration at start up, decrease the setting value 	<ul style="list-style-type: none"> E1-08: 15.0 V *2 E1-10: 9.0 V *2 	Default setting +/- 5 V *3
Speed precision is unsatisfactory. (V/f Control)	C3-01 [Slip Compensation Gain]	Set E2-01 [Motor Rated Current], E2-02 [Motor Rated Slip], and E2-03 [Motor No-Load Current], then adjust C3-01.	0.0 (no slip compensation)	0.5 - 1.5

*1 The default setting changes when the setting for o2-04 [Drive Model (KVA) Selection] changes.

*2 The default setting changes when the setting for E1-03 [V/f Pattern Selection] changes.

*3 Recommended settings are for 208/240 V. Multiply the voltage by 2 for 480 V.

Parameter Details

5.1	A: Initialization Parameters.....	170
5.2	b: Application	183
5.3	C: Tuning	222
5.4	d: References	229
5.5	E: Motor Parameters.....	238
5.6	F: Options.....	248
5.7	H: Terminal Functions	257
5.8	L: Protection Functions	311
5.9	n: Special Adjustment.....	341
5.10	o: Keypad-Related Settings	346
5.11	S: Special Applications.....	369
5.12	Y: Application Features.....	401
5.13	Z: Bypass Parameters	424

5.1 A: Initialization Parameters

A parameters [Initialization Parameters] set the operating environment and operating conditions for the drive.

◆ A1: Initialization

A1 parameters set the operating environment and operating conditions. For example, these parameters set the keypad language and the parameter access level.

■ A1-00: Language Selection

No. (Hex.)	Name	Description	Default (Range)
A1-00 (0100) RUN	Language Selection	Sets the language for the HOA keypad.	0 (0, 5)

Note:

When you initialize the drive with parameter *A1-03 [Initialize Parameters]*, the drive will not reset this parameter.

0 : English

5 : Spanish

■ A1-01: Access Level Selection

No. (Hex.)	Name	Description	Default (Range)
A1-01 (0101) RUN	Access Level Selection	Sets user access to parameters. The access level controls which parameters the keypad will display and which parameters you can set.	2 (0 - 4)

0 : Operation Only

Access to *A1-00 [Language Selection]*, *A1-01*, *A1-04 [Password]*, and the *U Monitors*.

1 : User Parameters

Access to *A1-00*, *A1-01*, *A1-04*, and parameters registered to *A2-01 to A2-32 [User Parameters 1 to 32]*.

2 : Advanced Level

Access to all parameters, but not Expert Mode parameters.

3 : Expert Level

Access to all parameters including Expert Mode parameters.

4 : Lock Parameters

Parameters that you can see are the same as *Advanced Level*, but parameters that you can change are only *A1-01* and *A1-04*.

The keypad will show the message *[Parameters Locked]*:

- In the HOME screen, the keypad will show the message *[Parameters Locked]* on the second line.

10:00 am FWD Rdy Home	
OFF Parameters Locked	

Freq Reference (KPD)	
U1-01 Hz	40.00
Output Frequency	
U1-02 Hz	40.00

Menu	

- If you try to change a parameter setting, the keypad will show the warning *[LOCK] [Parameters Locked]* for 2 s. To clear this warning, push one of the keys on the keypad.

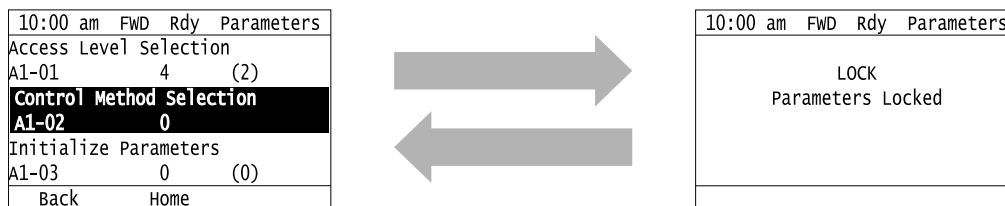

Table 5.1 shows which keypad screens are available for each *A1-01* settings.

Table 5.1 Access Level and Available Keypad Screens

Mode	Keypad Screen	A1-01 Setting				
		0	1	2	3	4
Drive Mode	Monitors	Yes	Yes	Yes	Yes	Yes
Programming Mode	Parameters	Yes	Yes	Yes	Yes	Yes
	User Custom Parameters	No	Yes	Yes	Yes	No
	Parameter Backup/ Restore	No	No	Yes	Yes	No
	Modified Parameters/ Fault Log	No	No	Yes	Yes	Yes
	Auto-Tuning	No	No	Yes	Yes	No
	Initial Setup Screen	No	No	Yes	Yes	No
	Diagnostic Tools	No	No	Yes	Yes	No

Note:

- When you use *A1-04* and *A1-05* [*Password Setting*] to set a password, you cannot change these parameters:
 - A1-01*
 - A1-03* [*Initialize Parameters*]
 - A1-06* [*Application Preset*]
 - A2-01* to *A2-32*
- When *H1-xx = 1B* [*MFDI Function Selection = Program Lockout*], you must activate the terminal to change parameter settings.
- When you use serial communications, you must send the Enter command from the controller to the drive and complete the serial communication write process before you can use the keypad to change parameter settings.

■ A1-03: Initialize Parameters

No. (Hex.)	Name	Description	Default (Range)
A1-03 (0103)	Initialize Parameters	Sets parameters to default values.	0 (0, 1110, 2220)

Note:

- After you initialize the drive, the drive automatically sets *A1-03 = 0*.
- User Parameters can save the parameter values for your application and use these values as default values for drive initialization.

0 : No Initialization

1110 : User Initialization

Sets parameters to the values set by the user as user settings. Set *o2-03 = 1* [*User Parameter Default Value = Set defaults*] to save the user settings.

You can save the adjusted parameter settings from the test run as user-set default values to the drive. When you make changes to the parameter values after you save the settings as User Parameter Settings, initialize with *A1-03 = 1110* for the drive to set the parameters to the User Parameter Setting value.

Follow this procedure to save User Parameter setting values and to do a User Initialization:

1. Set parameters correctly for the application.
2. Set *o2-03 = 1* [*User Parameter Default Value = Set defaults*]. This saves 1 parameter settings for a User Initialization. The drive will automatically set *o2-03 = 0*.

5.1 A: Initialization Parameters

- Set *A1-03* = *1110* to reset to the saved parameter settings.
When you initialize the drive, the drive sets the parameter values to the User Parameter setting values.

2220 : 2-Wire Initialization

Resets all parameters to default settings.

The drive will not initialize the parameters in [Table 5.2](#) when *A1-03* = *2220*.

Table 5.2 Parameters that are not Initialized Using a 2-Wire Sequence (2220)

No.	Name
A1-00	Language Selection
E1-03	V/f Pattern Selection
F6-08	Comm Parameter Reset @Initialize
F6-xx/F7-xx	Communication Option Parameters Set <i>F6-08</i> = <i>1</i> [<i>Comm Parameter Reset @Initialize</i> = <i>Reset Back to Factory Default</i>] to initialize communication option card parameters.
L8-35	Installation Method Selection
o2-04	Drive Model (KVA) Selection
o2-24	LED Light Function Selection

Note:

- Set *A1-06* [*Application Preset*] to let the drive automatically set the best parameter settings for the selected application.
- When *A1-03* = *2220*, the drive automatically sets *A1-05* [*Password Setting*] = *0000*. Make sure that you set the password again for applications where a password is necessary.

■ A1-04: Password

No. (Hex.)	Name	Description	Default (Range)
A1-04 (0104)	Password	Entry point for the password set in <i>A1-05</i> [<i>Password Setting</i>]. The user can view the settings of parameters that are locked without entering the password. Enter the correct password in this parameter to change parameter settings.	0000 (0000 - 9999)

If the password entered in *A1-04* does not agree with the password setting in *A1-05*, you cannot change these parameters:

- A1-01* [*Access Level Selection*]
- A1-03* [*Initialize Parameters*]
- A1-06* [*Application Preset*]
- A2-01* to *A2-32* [*User Parameter 1 to 32*]













To lock parameter settings after making changes without changing the password, enter the incorrect password in *A1-04* and push .



Enter the Password to Unlock Parameters

Use this procedure to unlock parameter settings.

Set the password in *A1-05* [*Password Setting*], and show the Parameter Setting Mode screen on the keypad.

This procedure verifies the password, and makes sure that the parameter settings are unlocked.

- Push  or  to select "A: Initialization Parameters", then push .
- Push  or  to select [*A1-04*], then push .
You can now change parameter settings.
- Push  or  to move the digit and enter the password.
- Push  to confirm the password.
The drive unlocks the parameters and automatically shows the Parameters Screen.
- Push  or  to show [*A1-06*], then push .
The keypad shows the setting value for [*A1-06*].

6. Push  or  to make sure that you can change the setting value.

Push  (Back) until the keypad shows the Parameter Setup Mode screen.



■ A1-05: Password Setting

No. (Hex.)	Name	Description	Default (Range)
A1-05 (0105)	Password Setting	Sets a password to lock parameters and prevent changes to parameter settings. Enter the correct password in <i>A1-04 [Password]</i> to unlock parameters and accept changes.	0000 (0000 - 9999)

This parameter locks these parameters:

- *A1-01 [Access Level Selection]*
- *A1-03 [Initialize Parameters]*
- *A1-06 [Application Preset]*
- *A2-01 to A2-32 [User Parameter 1 to 32]*

Note:

- Usually, the keypad will not show *A1-05*. To show and set *A1-05*, show *A1-04 [Password]* and then push  and  on the keypad at the same time.
- After you set *A1-05*, the keypad will not show it again until you enter the correct password in *A1-04*. Make sure that you remember the *A1-05* setting value. If you do not know the *A1-05* setting value, contact Yaskawa or your nearest sales representative.
- When *A1-03 = 2220 [2-Wire Initialization]*, the drive is initialized to *A1-05 = 0000*. Be sure to set the password again when a password is necessary for the application.
- Change the setting value in *A1-05* to change the password. The new setting value becomes the new password.
- When you use the password to unlock and change a parameter, enter a value other than the password in *A1-04* to lock the parameter again with the same password.
- If $A1-04 \neq A1-05$, MEMOBUS Communication cannot read or write *A1-05*.

■ A1-06: Application Preset

WARNING

Sudden Movement Hazard

Check the I/O signals and the external sequences for the drive before you set the Application Preset function.

When you set the Application Preset function ($A1-06 \neq 0$), it changes the I/O terminal functions for the drive and it can cause equipment to operate unusually. This can cause serious injury or death.

No. (Hex.)	Name	Description	Default (Range)
A1-06 (0127)	Application Preset	Sets the drive to operate in selected application conditions.	0 (0 - 7)

The drive software contains the application presets shown below. Set *A1-06* to align with the application to let the drive automatically set the best parameter settings for the selected application. The drive saves parameters frequently used for the application in parameters *A2-01 to A2-16 [User Parameters 1 to 16]* for easy configuration and reference in [User Custom Parameters] in the main menu.

- General purpose fan
- Fan with PID Control function
- Return fan
- Cooling tower fan
- Secondary pump
- Pump with PID control function

5.1 A: Initialization Parameters

Note:

- Before you set *A1-06*, make sure that you set *A1-03* = 2220 [*Initialize Parameters* = 2-Wire Initialization] to initialize parameters.
- It is not possible to change the *A1-06* value. To set an application preset, first set *A1-03* = 2220 to initialize parameters, then set this parameter. If initializing all parameters will cause a problem, do not change the settings.
- If you set *A2-33* = 1 [*User Parameter Auto Selection* = Enabled: Auto Save Recent Parm] to set parameters to *A2-17* to *A2-32* [*User Parameters 17 to 32*] automatically, the drive will reset these parameters when you change the *A1-06* setting.

0 : No Preset Selected

The drive saves the parameters in [Table 5.3](#) as user parameters.

Table 5.3 Parameters Saved as User Parameters with the No Preset Selected

User Parameter No.	Parameter No. Saved	Name
A2-01	b1-01	Frequency Reference Selection 1
A2-02	b1-02	Run Command Selection 1
A2-03	b1-03	Stopping Method Selection
A2-04	C1-01	Acceleration Time 1
A2-05	C1-02	Deceleration Time 1
A2-06	C6-02	Carrier Frequency Selection
A2-07	d1-01	Reference 1
A2-08	d1-02	Reference 2
A2-09	d1-03	Reference 3
A2-10	d1-04	Reference 4
A2-11	d1-17	Jog Reference
A2-12	E1-01	Input AC Supply Voltage
A2-13	E1-03	V/f Pattern Selection
A2-14	E1-04	Maximum Output Frequency
A2-15	E1-05	Maximum Output Voltage
A2-16	E1-06	Base Frequency
A2-17	E1-09	Minimum Output Frequency
A2-18	E1-13	Base Voltage
A2-19	E2-01	Motor Rated Current (FLA)
A2-20	E2-04	Motor Pole Count
A2-21	E2-11	Motor Rated Power
A2-22	H4-02	Terminal FM Analog Output Gain
A2-23	L1-01	Motor Overload (oL1) Protection
A2-24	L3-04	Stall Prevention during Decel
A2-25	-	-

1 : General Purpose Fan

The drive automatically sets the parameters in [Table 5.4](#) for a general purpose fan application.

Table 5.4 Best Parameter Settings for General Purpose Fan Applications

No.	Name	Optimal Value
A1-02	Control Method Selection	0: V/f Control
b1-03	Stopping Method Selection	1: Coast to Stop
b1-04	Reverse Operation Selection	1: Reverse Disabled
C1-01	Acceleration Time 1	60.0 s
L5-01	Number of Auto-Restart Attempts	10

The drive saves the parameters in [Table 5.5](#) as user parameters.

Table 5.5 Parameters Saved as User Parameters with the General Purpose Fan Preset

User Parameter No.	Parameter No. Saved	Name
A2-01	b1-03	Stopping Method Selection
A2-02	b1-04	Reverse Operation Selection
A2-03	b2-09	Pre-heat Current 2
A2-04	b5-01	PID Mode Setting
A2-05	b5-03	Integral Time (I)
A2-06	b5-08	PID Primary Delay Time Constant
A2-07	b5-09	PID Output Level Selection
A2-08	C1-01	Acceleration Time 1
A2-09	d2-03	Analog Frequency Ref Lower Limit
A2-10	H1-07	Terminal S7 Function Selection
A2-11	H3-01	Terminal A1 Signal Level Select
A2-12	H3-02	Terminal A1 Function Selection
A2-13	H3-10	Terminal A2 Function Selection
A2-14	L5-01	Number of Auto-Restart Attempts
A2-15	o1-24	Custom Monitor 1
A2-16	o1-25	Custom Monitor 2
A2-17	o1-26	Custom Monitor 3
A2-18	Y1-04	Sleep Wake-up Level
A2-19	Y1-05	Sleep Wake-up Level Delay Time
A2-20	Y1-08	Low Feedback Level
A2-21	Y1-09	Low Feedback Lvl Fault Dly Time
A2-22	Y2-01	Sleep Level Type
A2-23	Y2-02	Sleep Level
A2-24	Y2-03	Sleep Delay Time
A2-25	Y2-04	Sleep Activation Level

2 : Fan w/ PID Control

The drive automatically sets the parameters in [Table 5.6](#) for a fan with PID control application.

Table 5.6 Best Parameter Settings for Fan with PID Control Applications

No.	Name	Optimal Value
A1-02	Control Method Selection	0: V/f Control
b1-03	Stopping Method Selection	1: Coast to Stop
b1-04	Reverse Operation Selection	1: Reverse Disabled
b5-01	PID Mode Setting	1: Standard
b5-03	Integral Time (I)	30.0 s
b5-08	PID Primary Delay Time Constant	2.00 s
C1-01	Acceleration Time 1	60.0 s
H3-10	Terminal A2 Function Selection	B: PID Feedback
L5-01	Number of Auto-Restart Attempts	10
Y1-08	Low Feedback Level	2.00%
Y1-09	Low Feedback Lvl Fault Dly Time	25 s

The drive saves the parameters in [Table 5.7](#) as user parameters.

Table 5.7 Parameters Saved as User Parameters with the Fan with PID Control Preset

User Parameter No.	Parameter No. Saved	Name
A2-01	b1-03	Stopping Method Selection
A2-02	b1-04	Reverse Operation Selection
A2-03	b2-09	Pre-heat Current 2
A2-04	b5-01	PID Mode Setting
A2-05	b5-03	Integral Time (I)
A2-06	b5-08	PID Primary Delay Time Constant
A2-07	b5-09	PID Output Level Selection
A2-08	C1-01	Acceleration Time 1
A2-09	d2-03	Analog Frequency Ref Lower Limit
A2-10	H1-07	Terminal S7 Function Selection
A2-11	H3-01	Terminal A1 Signal Level Select
A2-12	H3-02	Terminal A1 Function Selection
A2-13	H3-10	Terminal A2 Function Selection
A2-14	L5-01	Number of Auto-Restart Attempts
A2-15	o1-24	Custom Monitor 1
A2-16	o1-25	Custom Monitor 2
A2-17	o1-26	Custom Monitor 3
A2-18	Y1-04	Sleep Wake-up Level
A2-19	Y1-05	Sleep Wake-up Level Delay Time
A2-20	Y1-08	Low Feedback Level
A2-21	Y1-09	Low Feedback Lvl Fault Dly Time
A2-22	Y2-01	Sleep Level Type
A2-23	Y2-02	Sleep Level
A2-24	Y2-03	Sleep Delay Time
A2-25	Y2-04	Sleep Activation Level

3 : Return Fan w/ PID Control

The drive automatically sets the parameters in [Table 5.8](#) for a return fan with PID control application.

Table 5.8 Best Parameter Settings for Return Fan with PID Control Applications

No.	Name	Optimal Value
A1-02	Control Method Selection	0: V/f Control
b1-03	Stopping Method Selection	1: Coast to Stop
b1-04	Reverse Operation Selection	1: Reverse Disabled
b5-01	PID Mode Setting	1: Standard
b5-03	Integral Time (I)	30.0 s
b5-08	PID Primary Delay Time Constant	2.00 s
C1-01	Acceleration Time 1	60.0 s
H3-01	Terminal A1 Signal Level Select	2: 4 to 20 mA
H3-02	Terminal A1 Function Selection	B: PID Feedback
H3-10	Terminal A2 Function Selection	16: Differential PID Feedback
L5-01	Number of Auto-Restart Attempts	10
o1-27	Custom Monitor 4	505: PID DifferentialFdbk

No.	Name	Optimal Value
Y1-08	Low Feedback Level	2.00%
Y1-09	Low Feedback Lvl Fault Dly Time	25 s

The drive saves the parameters in [Table 5.9](#) as user parameters.

Table 5.9 Parameters Saved as User Parameters with the Return Fan with PID Control Preset

User Parameter No.	Parameter No. Saved	Name
A2-01	b1-03	Stopping Method Selection
A2-02	b1-04	Reverse Operation Selection
A2-03	b2-09	Pre-heat Current 2
A2-04	b5-01	PID Mode Setting
A2-05	b5-03	Integral Time (I)
A2-06	b5-08	PID Primary Delay Time Constant
A2-07	b5-09	PID Output Level Selection
A2-08	C1-01	Acceleration Time 1
A2-09	d2-03	Analog Frequency Ref Lower Limit
A2-10	H1-07	Terminal S7 Function Selection
A2-11	H3-01	Terminal A1 Signal Level Select
A2-12	H3-02	Terminal A1 Function Selection
A2-13	H3-10	Terminal A2 Function Selection
A2-14	L5-01	Number of Auto-Restart Attempts
A2-15	o1-24	Custom Monitor 1
A2-16	o1-25	Custom Monitor 2
A2-17	o1-26	Custom Monitor 3
A2-18	Y1-04	Sleep Wake-up Level
A2-19	Y1-05	Sleep Wake-up Level Delay Time
A2-20	Y1-08	Low Feedback Level
A2-21	Y1-09	Low Feedback Lvl Fault Dly Time
A2-22	Y2-01	Sleep Level Type
A2-23	Y2-02	Sleep Level
A2-24	Y2-03	Sleep Delay Time
A2-25	Y2-04	Sleep Activation Level

4 : Cooling Tower Fan

The drive automatically sets the parameters in [Table 5.10](#) for a cooling tower fan application.

Table 5.10 Best Parameter Settings for Cooling Tower Fan Applications

No.	Name	Optimal Value
A1-02	Control Method Selection	0: V/f Control
b1-03	Stopping Method Selection	1: Coast to Stop
b1-04	Reverse Operation Selection	0: Reverse Enabled
C1-01	Acceleration Time 1	60.0 s
L5-01	Number of Auto-Restart Attempts	10

The drive saves the parameters in [Table 5.11](#) as user parameters.

Table 5.11 Parameters Saved as User Parameters with the Cooling Tower Fan Preset

User Parameter No.	Parameter No. Saved	Name
A2-01	b1-03	Stopping Method Selection
A2-02	b1-04	Reverse Operation Selection
A2-03	b2-09	Pre-heat Current 2
A2-04	b5-01	PID Mode Setting
A2-05	b5-03	Integral Time (I)
A2-06	b5-08	PID Primary Delay Time Constant
A2-07	b5-09	PID Output Level Selection
A2-08	C1-01	Acceleration Time 1
A2-09	d2-03	Analog Frequency Ref Lower Limit
A2-10	H1-07	Terminal S7 Function Selection
A2-11	H3-01	Terminal A1 Signal Level Select
A2-12	H3-02	Terminal A1 Function Selection
A2-13	H3-10	Terminal A2 Function Selection
A2-14	L5-01	Number of Auto-Restart Attempts
A2-15	o1-24	Custom Monitor 1
A2-16	o1-25	Custom Monitor 2
A2-17	o1-26	Custom Monitor 3
A2-18	Y1-04	Sleep Wake-up Level
A2-19	Y1-05	Sleep Wake-up Level Delay Time
A2-20	Y1-08	Low Feedback Level
A2-21	Y1-09	Low Feedback Lvl Fault Dly Time
A2-22	Y2-01	Sleep Level Type
A2-23	Y2-02	Sleep Level
A2-24	Y2-03	Sleep Delay Time
A2-25	Y2-04	Sleep Activation Level

5 : Cooling Tower Fan w/ PID

The drive automatically sets the parameters in [Table 5.12](#) for a cooling tower fan with PID control application.

Table 5.12 Best Parameter Settings for Cooling Tower Fan with PID Control Applications

No.	Name	Optimal Value
A1-02	Control Method Selection	0: V/f Control
b1-03	Stopping Method Selection	1: Coast to Stop
b1-04	Reverse Operation Selection	0: Reverse Enabled
b5-01	PID Mode Setting	1: Standard
b5-03	Integral Time (I)	30.0 s
b5-08	PID Primary Delay Time Constant	2.00 s
b5-09	PID Output Level Selection	1: Reverse Output (Reverse Acting)
C1-01	Acceleration Time 1	60.0 s
H3-10	Terminal A2 Function Selection	B: PID Feedback
L5-01	Number of Auto-Restart Attempts	10
Y1-04	Sleep Wake-up Level	-5.00
Y1-05	Sleep Wake-up Level Delay Time	30 s
Y1-08	Low Feedback Level	2.00%

No.	Name	Optimal Value
Y1-09	Low Feedback Lvl Fault Dly Time	25 s
Y2-01	Sleep Level Type	0: Output Frequency
Y2-02	Sleep Level	10.8
Y2-03	Sleep Delay Time	30 s

The drive saves the parameters in [Table 5.13](#) as user parameters.

Table 5.13 Parameters Saved as User Parameters with the Cooling Tower Fan with PID Control Preset

User Parameter No.	Parameter No. Saved	Name
A2-01	b1-03	Stopping Method Selection
A2-02	b1-04	Reverse Operation Selection
A2-03	b2-09	Pre-heat Current 2
A2-04	b5-01	PID Mode Setting
A2-05	b5-03	Integral Time (I)
A2-06	b5-08	PID Primary Delay Time Constant
A2-07	b5-09	PID Output Level Selection
A2-08	C1-01	Acceleration Time 1
A2-09	d2-03	Analog Frequency Ref Lower Limit
A2-10	H1-07	Terminal S7 Function Selection
A2-11	H3-01	Terminal A1 Signal Level Select
A2-12	H3-02	Terminal A1 Function Selection
A2-13	H3-10	Terminal A2 Function Selection
A2-14	L5-01	Number of Auto-Restart Attempts
A2-15	o1-24	Custom Monitor 1
A2-16	o1-25	Custom Monitor 2
A2-17	o1-26	Custom Monitor 3
A2-18	Y1-04	Sleep Wake-up Level
A2-19	Y1-05	Sleep Wake-up Level Delay Time
A2-20	Y1-08	Low Feedback Level
A2-21	Y1-09	Low Feedback Lvl Fault Dly Time
A2-22	Y2-01	Sleep Level Type
A2-23	Y2-02	Sleep Level
A2-24	Y2-03	Sleep Delay Time
A2-25	Y2-04	Sleep Activation Level

6 : Secondary Pump

The drive automatically sets the parameters in [Table 5.14](#) for a secondary pump application.

Table 5.14 Best Parameter Settings for Secondary Pump Applications

No.	Name	Optimal Value
A1-02	Control Method Selection	0: V/f Control
b1-04	Reverse Operation Selection	1: Reverse Disabled
C1-01	Acceleration Time 1	20.0 s
d2-03	Analog Frequency Ref Lower Limit	20.0%
L5-01	Number of Auto-Restart Attempts	10

The drive saves the parameters in [Table 5.15](#) as user parameters.

Table 5.15 Parameters Saved as User Parameters with the Secondary Pump Preset

User Parameter No.	Parameter No. Saved	Name
A2-01	b1-03	Stopping Method Selection
A2-02	b1-04	Reverse Operation Selection
A2-03	b2-09	Pre-heat Current 2
A2-04	b5-01	PID Mode Setting
A2-05	b5-03	Integral Time (I)
A2-06	b5-08	PID Primary Delay Time Constant
A2-07	b5-09	PID Output Level Selection
A2-08	C1-01	Acceleration Time 1
A2-09	d2-03	Analog Frequency Ref Lower Limit
A2-10	H1-07	Terminal S7 Function Selection
A2-11	H3-01	Terminal A1 Signal Level Select
A2-12	H3-02	Terminal A1 Function Selection
A2-13	H3-10	Terminal A2 Function Selection
A2-14	L5-01	Number of Auto-Restart Attempts
A2-15	o1-24	Custom Monitor 1
A2-16	o1-25	Custom Monitor 2
A2-17	o1-26	Custom Monitor 3
A2-18	Y1-04	Sleep Wake-up Level
A2-19	Y1-05	Sleep Wake-up Level Delay Time
A2-20	Y1-08	Low Feedback Level
A2-21	Y1-09	Low Feedback Lvl Fault Dly Time
A2-22	Y2-01	Sleep Level Type
A2-23	Y2-02	Sleep Level
A2-24	Y2-03	Sleep Delay Time
A2-25	Y2-04	Sleep Activation Level

7 : Pump w/ PID Control

The drive automatically sets the parameters in [Table 5.16](#) for a pump with PID control application.

Table 5.16 Optimal Settings for Pump with PID Control Applications

No.	Name	Optimal Value
A1-02	Control Method Selection	0: V/f Control
b1-04	Reverse Operation Selection	1: Reverse Disabled
b5-01	PID Mode Setting	1: Standard
b5-03	Integral Time (I)	15.0 s
b5-08	PID Primary Delay Time Constant	1.00 s
C1-01	Acceleration Time 1	20.0 s
d2-03	Analog Frequency Ref Lower Limit	20.0%
H3-10	Terminal A2 Function Selection	B: PID Feedback
L5-01	Number of Auto-Restart Attempts	10
L5-49	Fault Retry Speed Search Select	0: Disabled
Y1-04	Sleep Wake-up Level	-5.00
Y1-05	Sleep Wake-up Level Delay Time	30 s
Y1-08	Low Feedback Level	2.00%

No.	Name	Optimal Value
Y1-09	Low Feedback Lvl Fault Dly Time	25 s
Y2-01	Sleep Level Type	0: Output Frequency
Y2-02	Sleep Level	20.0
Y2-03	Sleep Delay Time	30 s

The drive saves the parameters in [Table 5.17](#) as user parameters.

Table 5.17 Parameters Saved as User Parameters with the Pump with PID Control Preset

User Parameter No.	Parameter No. Saved	Name
A2-01	b1-03	Stopping Method Selection
A2-02	b1-04	Reverse Operation Selection
A2-03	b2-09	Pre-heat Current 2
A2-04	b5-01	PID Mode Setting
A2-05	b5-03	Integral Time (I)
A2-06	b5-08	PID Primary Delay Time Constant
A2-07	b5-09	PID Output Level Selection
A2-08	C1-01	Acceleration Time 1
A2-09	d2-03	Analog Frequency Ref Lower Limit
A2-10	H1-07	Terminal S7 Function Selection
A2-11	H3-01	Terminal A1 Signal Level Select
A2-12	H3-02	Terminal A1 Function Selection
A2-13	H3-10	Terminal A2 Function Selection
A2-14	L5-01	Number of Auto-Restart Attempts
A2-15	o1-24	Custom Monitor 1
A2-16	o1-25	Custom Monitor 2
A2-17	o1-26	Custom Monitor 3
A2-18	Y1-04	Sleep Wake-up Level
A2-19	Y1-05	Sleep Wake-up Level Delay Time
A2-20	Y1-08	Low Feedback Level
A2-21	Y1-09	Low Feedback Lvl Fault Dly Time
A2-22	Y2-01	Sleep Level Type
A2-23	Y2-02	Sleep Level
A2-24	Y2-03	Sleep Delay Time
A2-25	Y2-04	Sleep Activation Level

■ A1-11: Firmware Update Lock

No. (Hex.)	Name	Description	Default (Range)
A1-11 (111D) Expert	Firmware Update Lock	Protects the drive firmware. When you enable the protection, you cannot update the bypass controller firmware.	0 (0, 1)

0 : Disabled

Lock is disabled.

1 : Enabled

Lock is enabled.

■ A1-12: Bluetooth ID

No. (Hex.)	Name	Description	Default (Range)
A1-12 (1564)	Bluetooth ID	Sets the password necessary to use Bluetooth to control the drive with a smartphone or tablet.	- (0000 - 9999)

◆ A2: User Parameters

You can register frequently used parameters and recently changed parameters here to access them quickly. You can show the registered parameters in [User Custom Parameters] in the main menu.

■ A2-01 to A2-32: User Parameters 1 to 32

No. (Hex.)	Name	Description	Default (Range)
A2-01 to A2-32 (0106 - 0125)	User Parameters 1 to 32	You can select a maximum of 32 parameters for the drive and set them to parameters <i>A2-01 to A2-32</i> . The [User Parameters] section of the keypad main menu shows the set parameters. You can immediately access these set parameters.	Parameters in General-Purpose Setup Mode (A1-00 - Z3-16)

Note:

- Settings for *A2-01 to A2-32* change when the *A1-06 [Application Preset]* value changes.
- You must set *A1-01 = 1 [Access Level Selection = User Parameters]* to access parameters *A2-01 to A2-32*.

The drive saves these parameters to *A2-01 to A2-32*.

- The drive saves a maximum of 32 parameters.

Note:

Set *A1-01 = 2 [Advanced Level]* or *A1-01 = 3 [Expert Level]* to register the necessary parameters.

- The drive automatically saves changed parameters to *A2-17 to A2-32*.

Note:

Set *A2-33 = 1 [User Parameter Auto Selection = Enabled]*.

■ A2-33: User Parameter Auto Selection

No. (Hex.)	Name	Description	Default (Range)
A2-33 (0126)	User Parameter Auto Selection	Sets the automatic save feature for changes to parameters <i>A2-17 to A2-32 [User Parameters 17 to 32]</i> .	Determined by A1-06 (0, 1)

0 : Disabled: Manual Entry Required

Set User Parameters manually.

1 : Enabled: Auto Save Recent Parm

The drive automatically registers changed parameter *A2-17 to A2-32*. The drive automatically saves the most recently changed parameter to *A2-17*, and saves a maximum of 16 parameters. After the drive registers 16 parameters, when you save a new parameter, the drive will remove a parameter from the User Parameter list to make space for the new parameter. The drive removes parameters with First In, First Out.

You can show the registered parameters in [User Custom Parameters] in the main menu.

Note:

In General-Purpose Setup Mode, the drive registers parameters starting with *A2-27* because the drive registers parameters *A2-26* and lower by default.

5.2 b: Application

b parameters set these functions:

- Frequency reference source/Run command source
- Stopping method settings
- DC Injection Braking
- Speed Search
- Timer Function
- PID control
- Energy Savings Control

◆ b1: Operation Mode Selection

b1 parameters set the operation mode for the drive.

■ b1-01: Frequency Reference Selection 1

No. (Hex.)	Name	Description	Default (Range)
b1-01 (0180)	Frequency Reference Selection 1	Sets the input method for the frequency reference.	1 (0 - 3)

Note:



When the drive receives a Run command when the frequency reference is 0 Hz or less than the *E1-09* [Minimum Output Frequency] value,



on the keypad will flash. Examine the setting for the frequency reference input and enter a value $\geq E1-09$.

0 : Keypad

The bypass uses the keypad to enter the frequency reference and also switches the PID setpoint to *YA-01* [Setpoint 1].

Use  and  on the keypad to change the frequency reference.

1 : Analog Input

The bypass uses MFAI on the bypass board to input an analog frequency reference with a voltage or current input signal.

• Voltage Input

Refer to [Table 5.18](#) to use a voltage signal input to one of the MFAI terminals.

Table 5.18 Frequency Reference Voltage Input

Terminal	Terminal Signal Level	Parameter Settings			Note
		Signal Level Selection	Gain	Bias	
Bypass MFAI	0 - 10 V	Z2-30 = 0	Z2-32	Z2-33	Set Jumper Switch S2 to "V" for voltage input.

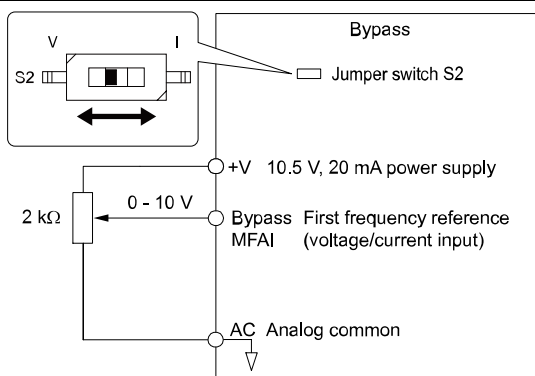

Figure 5.1 Example of Setting the Frequency Reference with a Voltage Signal to the Bypass MFAI

• Current Input

Refer to [Table 5.19](#) to use a current signal input to one of the MFAI terminals.

Table 5.19 Frequency Reference Current Input

Terminal	Signal Level	Parameter Settings			Note
		Signal Level Selection	Gain	Bias	
Bypass MFAI	4 - 20 mA	Z2-30 = 2	Z2-32	Z2-33	Set Jumper Switch S2 to "I" for current input.
	0 - 20 mA	Z2-30 = 3			

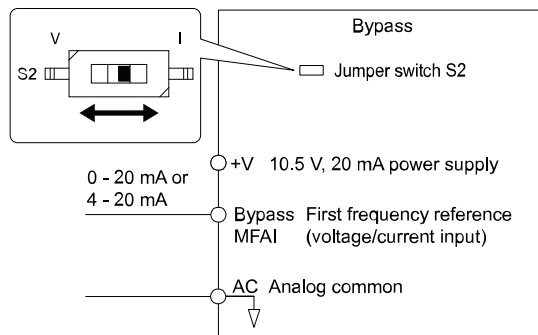

Figure 5.2 Example of Setting the Frequency Reference with a Current Signal to the Bypass MFAI

Changing between Master and Auxiliary Frequency References

2 : Serial Communications

The bypass uses serial communications to enter the frequency reference.

3 : Option PCB

The bypass uses a communications option card or input option card connected to the bypass control board to enter the Run command.

Note:

If $b1-01 = 3$, but you did not connect a communications option card, $oPE05$ [Run Cmd/Freq Ref Source Sel Err] will flash on the keypad.

■ b1-02: Run Command Selection 1

No. (Hex.)	Name	Description	Default (Range)
b1-02 (0181)	Run Command Selection 1	Sets the input method for the Run command.	7 (0 - 9)

0 : Keypad

The bypass uses the keypad to enter the Run command. Use the AUTO and the OFF keys to start and stop the bypass.

1 : Digital Input

The bypass uses the control circuit terminals to enter the Run command. Select the input method for the Run command with an $Z2-xx$ parameter.

Set $Z2-xx = 21, 37$ [Run (AUTO), Run Reverse (AUTO)].

- 2-wire Sequence

When you set $A1-03 = 2220$ [Initialize Parameters = 2-Wire Initialization], it will initialize the bypass and set $Z2-01 = 21$ [Run FWD]. Run Reverse is not set by default.

2 : Serial Communications

The bypass uses serial communications to enter the Run command.

3 : Option PCB

The bypass uses a communications option card or input option card connected to the bypass control board to enter the Run command.

Refer to the instruction manual included with the option card to install and set the option card.

Note:

If $b1-02 = 3$, but you did not connect a communications option card, *oPE05 [Run Cmd/Freq Ref Source Sel Err]* will flash on the keypad.

7 : AUTO Command + Term Run

The bypass uses the AUTO Command to put the bypass into AUTO Mode, and uses the terminal set for Run [$Z2-xx = 21, 37$] to enter the Run command.

8 : AUTO Command + Serial Run

The bypass uses the AUTO Command to put the bypass into AUTO Mode, and uses the Serial Run command (register 0001) to enter the Run command.

9 : AUTO Command + Option Run

The bypass uses the AUTO Command to put the bypass into AUTO Mode, and uses a communications option card connected to the bypass control board to enter the Run command.

■ b1-03: Stopping Method Selection

No. (Hex.)	Name	Description	Default (Range)
b1-03 (0182)	Stopping Method Selection	Sets the method to stop the motor after removing a Run command or entering a Stop command.	1 (0 - 3)

Select the applicable stopping method for the application from these four options:

0 : Ramp to Stop

When you enter the Stop command or turn OFF the Run command, the drive ramps the motor to stop.

The drive ramps the motor to stop as specified by the deceleration time. The default setting for the deceleration time is *C1-02 [Deceleration Time 1]*. The actual deceleration time changes as the load conditions change (for example, mechanical loss and inertia).

If the output frequency is less than or equal to the value set in *b2-01 [DC Injection/Zero SpeedThreshold]* during deceleration, the drive will do DC Injection Braking.

• Ramp to Stop

Parameter *b2-01* sets the frequency to start DC Injection Braking at stop. If the output frequency is less than or equal to the value set in *b2-01* during deceleration, the drive will do DC Injection Braking for the time set in *b2-04 [DC Inject Braking Time at Stop]*.

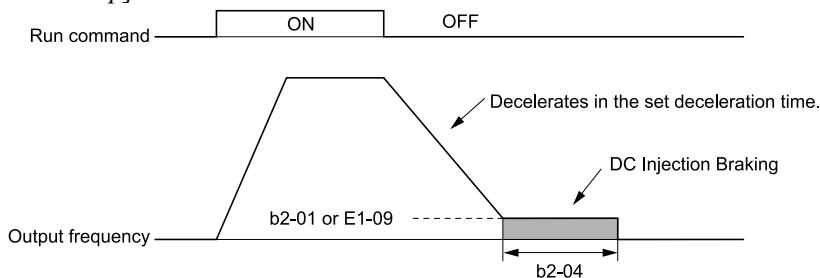

b2-01: DC Injection/Zero SpeedThreshold
b2-04: DC Inject Braking Time at Stop

E1-09: Minimum Output Frequency

Figure 5.3 Ramp to Stop

Note:

When $b2-01 \leq E1-09$ [*Minimum Output Frequency*], the drive will start DC Injection Braking from the frequency set in *E1-09*.

1 : Coast to Stop

When you enter the Stop command or turn OFF the Run command, the drive turns OFF the output and coasts the motor to stop.

Load conditions will have an effect on the deceleration rate as the motor coasts to stop (for example, mechanical loss and inertia).

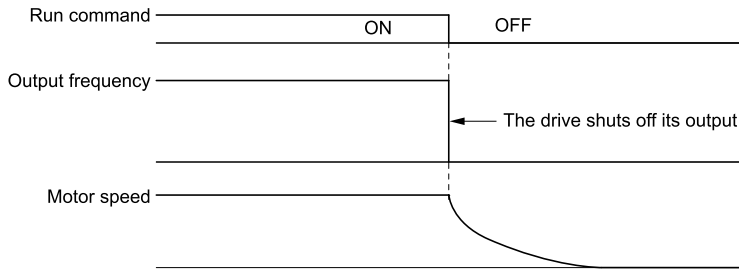

Figure 5.4 Coast to Stop

Note:

The drive ignores the Run command for the time set in *L2-03 [Minimum Baseblock Time]* when you enter a Stop command or switch OFF the Run command. Make sure that the motor stops completely before you enter a Run command. Use DC Injection or Speed Search to restart the motor before it stops.

2 : DC Injection Braking to Stop

When you enter the Stop command or turn OFF the Run command, the drive turns OFF the output for the time set in *L2-03*. The drive waits for the minimum baseblock time and then injects the amount of DC current into the motor set in *b2-02 [DC Injection Braking Current]* to stop the motor with DC current.

DC Injection Braking stops the motor more quickly than coast to stop.

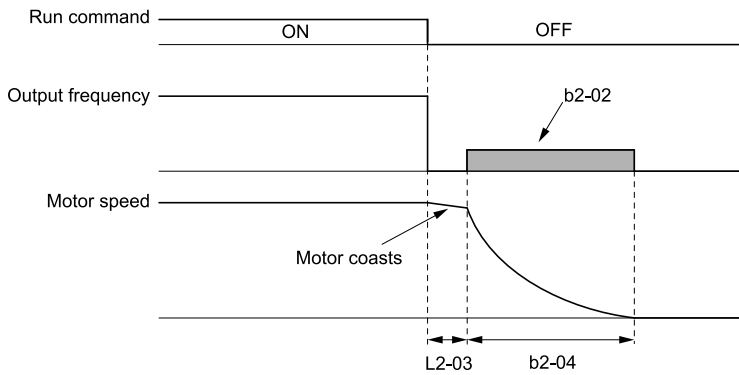

b2-02: DC Injection Braking Current
b2-04: DC Inject Braking Time at Stop

L2-03: Minimum Baseblock Time

Figure 5.5 DC Injection Braking to Stop

The value set in *b2-04* and the output frequency when the drive receives the Stop command determine the DC Injection Braking time. The drive calculates the DC Injection Braking time as in [Figure 5.6](#).

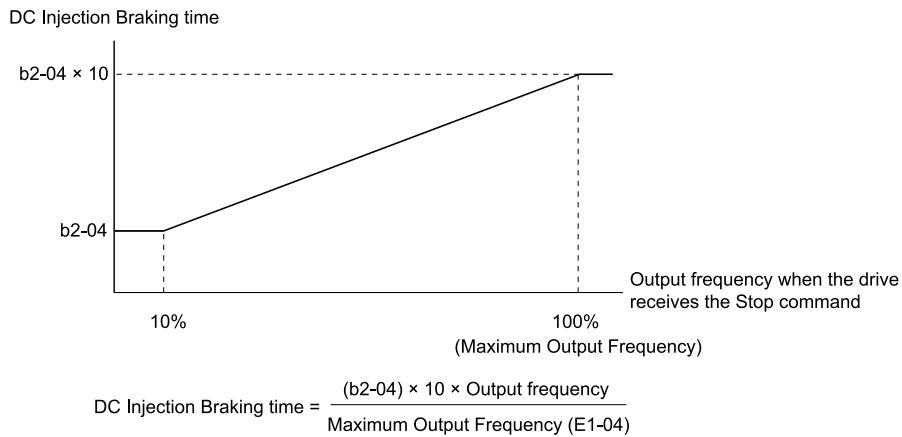

b2-04: DC Inject Braking Time at Stop

E1-04: Maximum Output Frequency

Figure 5.6 DC Injection Braking Time and Output Frequency

Note:

If the drive detects *oC* [Overcurrent] when it uses DC Injection Braking to stop the motor, set L2-03 to a high value that will not trigger *oC*.

3 : Coast to Stop with Timer

When you enter the Stop command or turn OFF the Run command, the drive turns OFF the output and coasts the motor to stop. The drive ignores the Run command until the “Run wait time t ” is expired.

To start the drive again, enter the Run command after the “Run wait time t ” is expired.

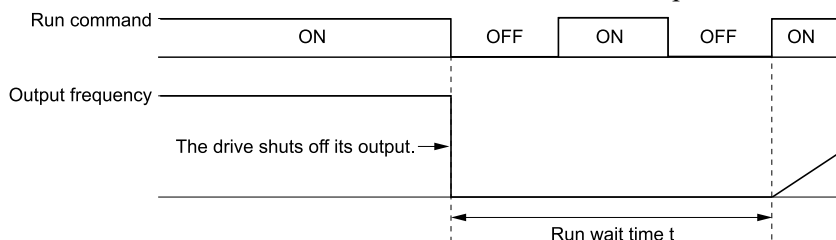

Figure 5.7 Coast to Stop with Timer

The active deceleration time and the output frequency when drive receives the Stop command determine the length of “Run wait time t ”.

**L2-03: Minimum Baseblock Time**

Figure 5.8 Run Wait Time and Output Frequency

■ b1-04: Reverse Operation Selection

No. (Hex.)	Name	Description	Default (Range)
b1-04 (0183)	Reverse Operation Selection	Sets the reverse operation function. Disable reverse operation in fan or pump applications where reverse rotation is dangerous.	1 (0, 1)

When reverse operation is prohibited, the drive will not accept a Reverse operation command.

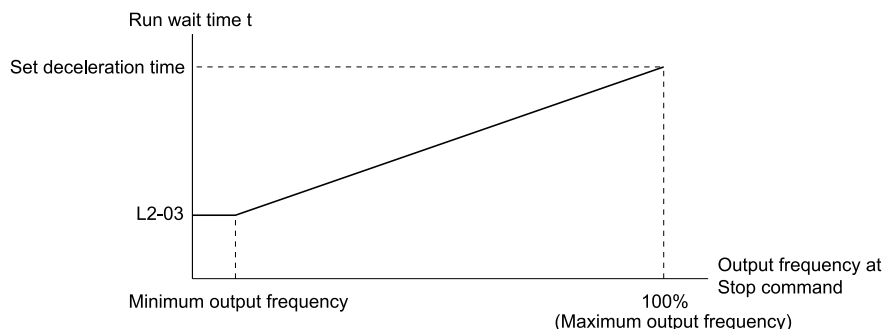
0 : Reverse Enabled

The drive will accept a Reverse operation command.

1 : Reverse Disabled

The drive will not accept a Reverse operation command.

■ b1-08: Run Command Select in PRG Mode

No. (Hex.)	Name	Description	Default (Range)
b1-08 (0187)	Run Command Select in PRG Mode	Sets the conditions for the drive to accept a Run command entered from an external source when using the keypad to set parameters.	0 (0 - 2)

As a safety precaution, when the drive is in Programming Mode, it will not respond to a Run command.

This parameter helps prevent accidents that can occur if the motor starts to rotate because the drive received a Run command from an external source while the user is programming the drive. You can also set the drive to not show the Programming Mode when a Run command is active.

Note:

Refer to this table for Drive Mode and Programming Mode functions.

Mode	Keypad Screen	Function
Drive Mode	Monitors	Sets monitor display.
Programming Mode	Parameters	Changes parameter settings.
	User Custom Parameters	Shows the User Parameters.
	Parameter Backup/Restore	Saves parameters to the keypad as backup.
	Modified Parameters/Fault Log	Shows modified parameters and fault history.
	Auto-Tuning	Auto-Tunes the drive.
	Initial Setup	Changes initial settings.
	Diagnostic Tools	Sets data logs and backlight.

0 : Disregard RUN while Programming

The drive rejects the Run command while in Programming Mode.

1 : Accept RUN while Programming

The drive accepts a Run command entered from an external source while in Programming Mode.

2 : Allow Programming Only at Stop

The drive does not let the user enter Programming Mode when the drive is operating. The drive does not show the Programming Mode when a Run command is active.

■ b1-11: Run Delay @ Stop

No. (Hex.)	Name	Description	Default (Range)
b1-11 (01DF)	Run Delay @ Stop	Sets the amount of time that the drive will not accept the Run command again after the Run command is lost.	0.0 s (0.0 - 6000.0 s)

Note:

- This parameter will operate for both AUTO Mode and HAND Mode.
- This parameter will operate when the drive goes to sleep then wakes up.
- The time set in this parameter does not apply for faults or Auto-Restarts.
- When there is an active Run command while the time set in *b1-11* is active, the keypad will show a *[Start Delay]* message as specified by the *o1-82 [Message Screen Display]* display format.

Coast to Stop with Timer Function

When *b1-03 = 3 [Stopping Method Selection = Coast to Stop with Timer]*, the drive operates as:

1. The drive operates at an output frequency > 0.
2. The Run command is removed and the drive coasts to stop.
3. The drive will set the coast-timer based on *b1-11*:
 - When *b1-11 = 0.0 s*, *C1-02 [Deceleration Time 1]* and the output frequency set the coast-timer.
 - When *b1-11 > 0.0 s*, *b1-11* is the coast-timer.
4. When the drive receives the Run command again during the time set in *b1-11*, the drive will restart when the timer expires and it is not necessary to cycle the Run command.

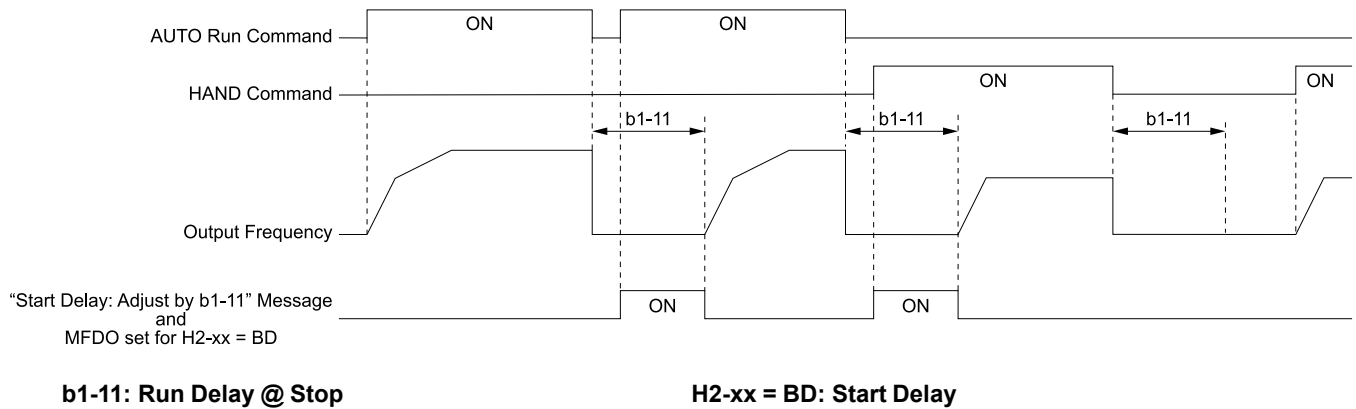
Figure 5.9 Coast To Stop With Timer when $b1-11 > 0$

Ramp to Stop, Coast to Stop or DC Injection to Stop Functions when $b1-03 \neq 3$

When $b1-03 = 0$ or 2 [Ramp to Stop or DC Injection Braking to Stop], the drive operates as:

1. The drive operates at an output frequency > 0 .
2. When you remove the Run command or the drive goes to sleep, the $b1-11$ timer immediately starts while ramping or coasting.
3. When the drive receives the Run command again during the time set in $b1-11$, the drive will restart when the timer expires and it is not necessary to cycle the Run command.

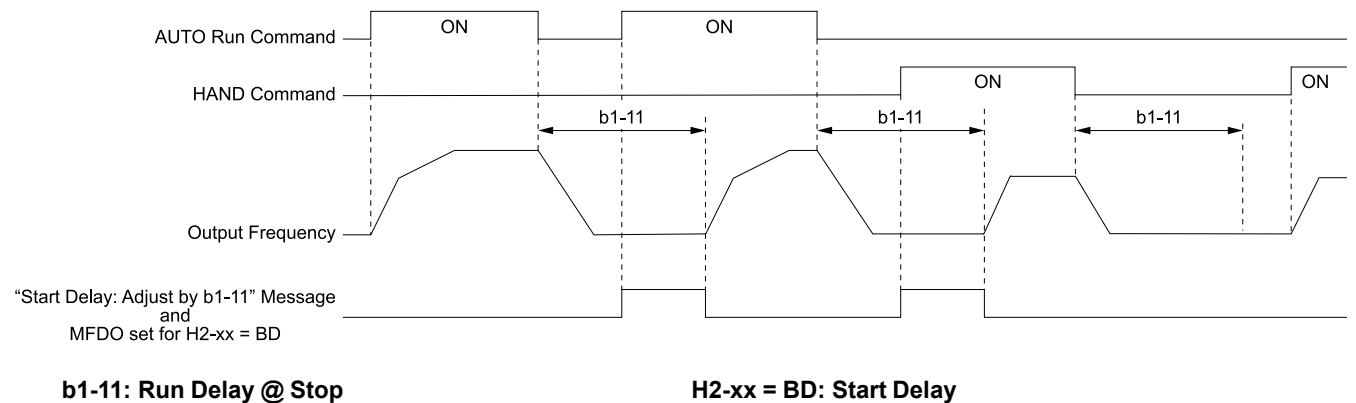
Figure 5.10 Ramp To Stop when $b1-11 > 0$

■ b1-12: Run Delay Memory Selection

No. (Hex.)	Name	Description	Default (Range)
b1-12 (01E0)	Run Delay Memory Selection	Sets how the drive saves the Run Delay Timer to the EEPROM during power loss.	2 (0 - 2)

0 : Disabled

The drive does not save the Run Delay timer during power loss.

When the drive power is restored, the drive will not apply the delay time set in $b1-11$ [Run Delay @ Stop].

Figure 5.11 shows the example of drive operation when:

- $b1-03 = 3$ [Stopping Method Selection = Coast to Stop with Timer]
- $b1-11 = 60.0$ s
- $b1-12 = 0$

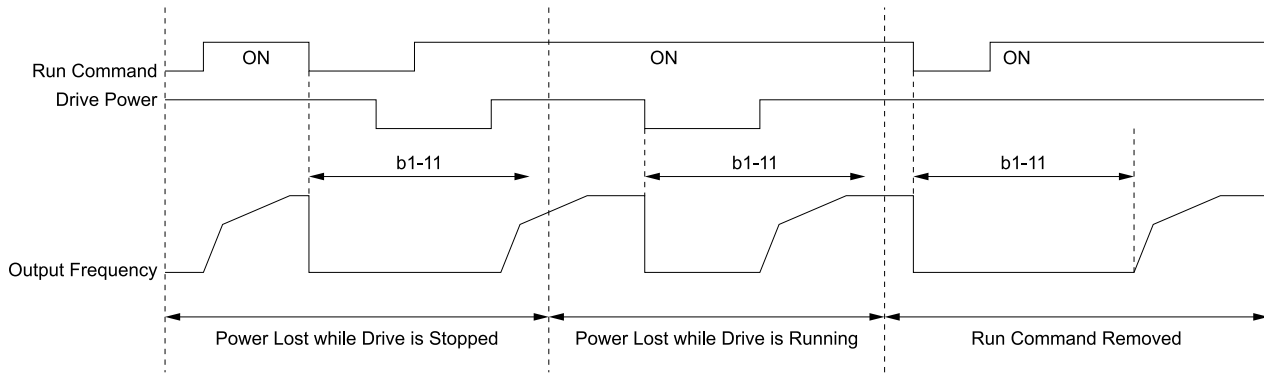

b1-11: Run Delay @ Stop

Figure 5.11 Run Delay Memory Disabled

1 : Only at Stop

The drive saves Run Delay timer only when the drive is stopped.

When the drive is running and it loses power, the drive will not apply the delay time set in *b1-11* when power is restored. When the drive is stopped with *b1-11* counting down and it loses power, the drive will apply the delay time set in *b1-11* based on the time elapsed during the power outage.

Figure 5.12 shows the example of drive operation when:

- *b1-03* = 3
- *b1-11* = 60.0 s
- *b1-12* = 1

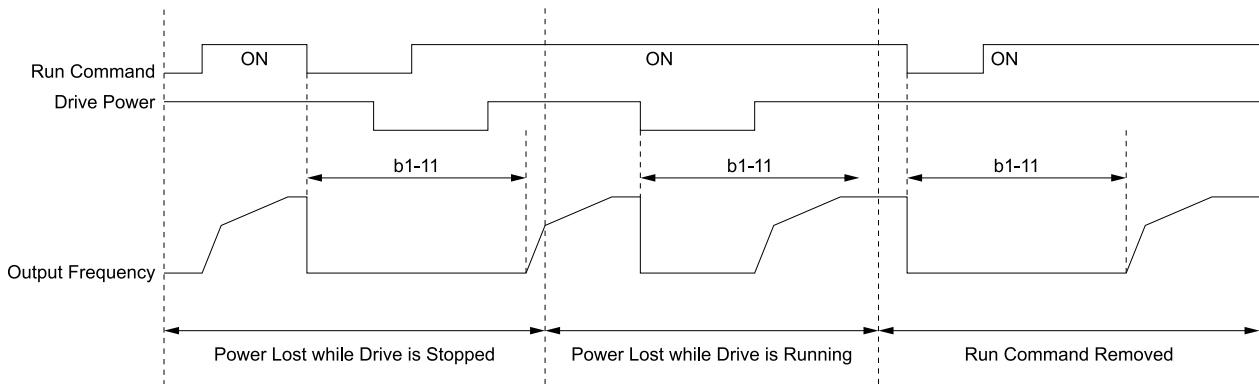

b1-11: Run Delay @ Stop

Figure 5.12 Run Delay Memory Only at Stop

2 : Running & Stop

The drive always saves the Run Delay timer.

When the drive is running and it loses power, the drive will save-off the maximum delay time set in *b1-11*. When power is restored, the drive will apply that time minus the time elapsed during the power outage. When the drive is stopped with *b1-11* counting down and it loses power, the drive will apply the delay time set in *b1-11* based on the time elapsed during the power outage.

Figure 5.13 shows the example of drive operation when:

- *b1-03* = 3
- *b1-11* = 60.0 s
- *b1-12* = 2

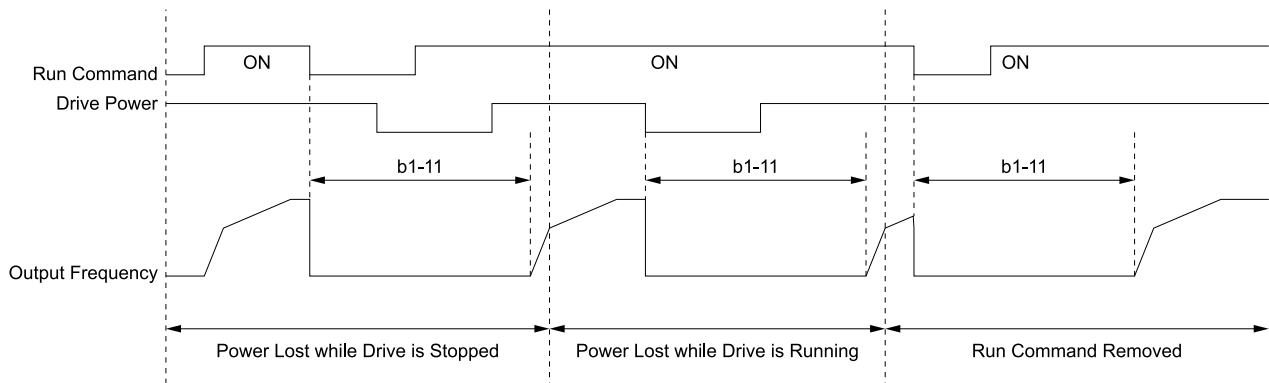

b1-11: Run Delay @ Stop

Figure 5.13 Run Delay Memory Running & Stop

■ b1-17: Run Command at Power Up

No. (Hex.)	Name	Description	Default (Range)
b1-17 (01C6)	Run Command at Power Up	Sets drive response when you apply power to drive that has an external Run command. Set this parameter in applications where energizing or de-energizing the drive enables the Run command.	1 (0, 1)

0 : Disregard Existing RUN Command

The drive does not start to operate the application when you apply power, even when there is an existing Run command.

Enter the Run command again to operate the application.

Note:

When you energize the drive, if there is an existing Run command enabled from an external source,  on the keypad will flash quickly.

1 : Accept Existing RUN Command

When there is an existing Run command, the drive starts to operate the application when you apply power.

■ b1-40: Deceleration Abort Time

No. (Hex.)	Name	Description	Default (Range)
b1-40 (3BCF)	Deceleration Abort Time	Sets the maximum time until the drive shuts off the output to decelerate to stop.	0.0 s (0.0 - 6000.0 s)

Note:

Set this parameter to 0.0 s to disable this function.

When $b1-40 > 0.0$ s, the drive will coast-to-stop when you remove the Run command and decelerate for the time set in $b1-40$. Refer to [Figure 5.14](#) for the timing chart.

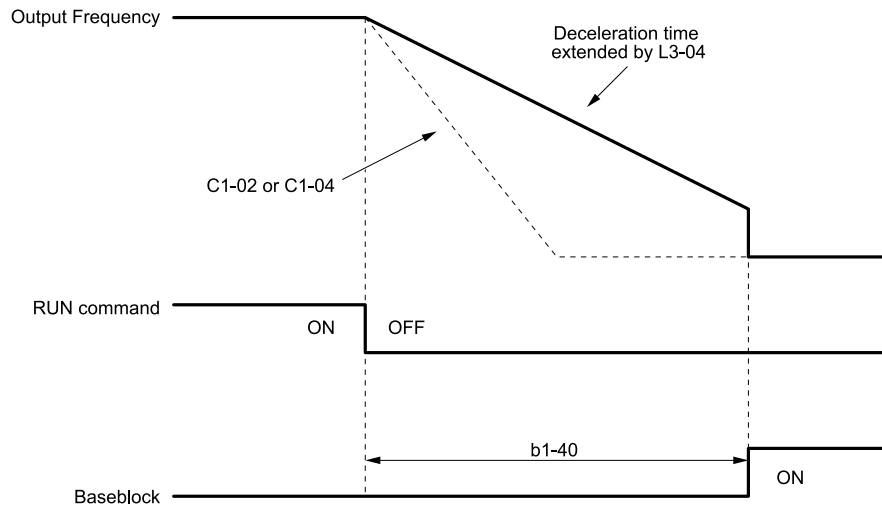

b1-40: Deceleration Abort Time
C1-02: Deceleration Time 1

C1-04: Deceleration Time 2
L3-04: Stall Prevention during Decel

Figure 5.14 Deceleration Abort Time Chart

◆ b2: DC Injection Braking

b2 parameters set the DC Injection Braking functions.

- DC Injection Braking: A braking method that injects DC current into the motor windings. This function should not be used too frequently, because it generates a fair amount of heat in the motor.

■ b2-01: DC Injection/Zero SpeedThreshold

No. (Hex.)	Name	Description	Default (Range)
b2-01 (0189)	DC Injection/Zero SpeedThreshold	Sets the frequency to start DC Injection Braking.	0.5 Hz (0.0 - 10.0 Hz)

Note:

This parameter is available when *b1-03* = 0 [Stopping Method Selection = Ramp to Stop].

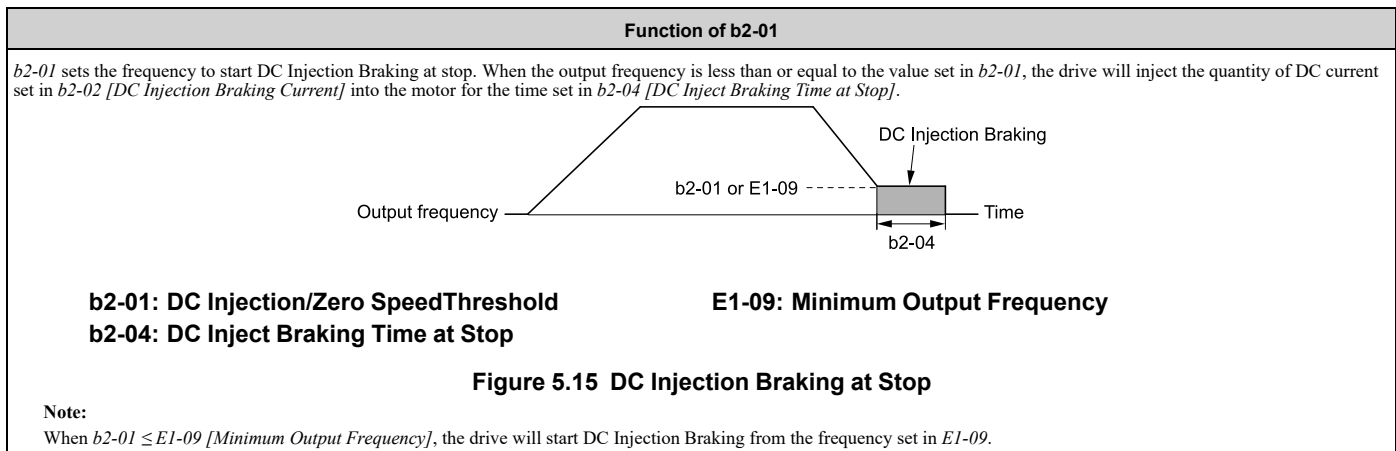

■ b2-02: DC Injection Braking Current

No. (Hex.)	Name	Description	Default (Range)
b2-02 (018A)	DC Injection Braking Current	Sets the DC Injection Braking current as a percentage of the drive rated current.	50% (0 - 100%)

When the DC Injection Braking current is more than 50%, the drive decreases the carrier frequency to 1 kHz. The motor rated current determines the quantity of DC Injection Braking current that the drive can use.

The DC Injection Braking current level has an effect on the strength of the magnetic field that locks the motor shaft. As the current level increases, the motor windings will supply more heat. Do not set this parameter higher than the level that is necessary to hold the motor shaft.

■ b2-03: DC Inject Braking Time at Start

No. (Hex.)	Name	Description	Default (Range)
b2-03 (018B)	DC Inject Braking Time at Start	Sets the DC Injection Braking Time at stop.	0.00 s (0.00 - 10.00 s)

This function stops then restarts a coasting motor and increases motor flux to make high starting torque (a process called initial excitation). Set this parameter to 0.00 to disable the function.

Note:

To restart a coasting motor, use DC Injection Braking to stop and then restart the motor, or enable Speed Search. Enable DC Injection Braking or Speed Search to prevent *ov* [Overvoltage] and *oC* [Overcurrent] faults.

■ b2-04: DC Inject Braking Time at Stop

No. (Hex.)	Name	Description	Default (Range)
b2-04 (018C)	DC Inject Braking Time at Stop	Sets the DC Injection Braking Time at stop.	0.00 s (0.00 - 10.00 s)

This function fully stops a motor with a large inertia during deceleration and will not let the inertia continue to rotate the motor.

Set this parameter to 0.00 to disable the function.

When a longer time is necessary to stop the motor, increase the value.

■ b2-09: Pre-heat Current 2

No. (Hex.)	Name	Description	Default (Range)
b2-09 (01E1)	Pre-heat Current 2	Sets the percentage of motor rated output current used for the motor pre-heat function.	5% (0 - 100%)

◆ b3: Speed Search

The Speed Search function detects the actual speed of a coasting motor, then restarts the motor before the motor stops. Use Speed Search in these conditions:

- To continue operation after momentary power loss
- To switch from commercial power supply to drive power
- To restart a coasting fan

For example, the drive output turns off and the motor coasts when there is a momentary loss of power. After you return power, the drive does Speed Search on the coasting motor, and restarts the motor from the detected speed.

There are two types of Speed Search for induction motors: Current Detection and Speed Estimation. Use parameter *b3-24* [Speed Search Method Selection] to select the type of Speed Search.

Parameter settings are different for different types of Speed Search. Refer to [Table 5.20](#) for more information.

Table 5.20 Speed Search and Related Parameters

Parameters	Speed Estimation	Current Detection 2
	b3-24 = 1	b3-24 = 2
b3-01 [Speed Search at Start Selection]	x	x
b3-03 [Speed Search Deceleration Time]	-	x

Parameters	Speed Estimation	Current Detection 2
	b3-24 = 1	b3-24 = 2
b3-05 [Speed Search Delay Time]	x	x
b3-06 [Speed Estimation Current Level 1]	x	-
b3-07 [Speed Estimation Current Level 2]	x	-
b3-08 [Speed Estimation ACR P Gain]	x	-
b3-09 [Speed Estimation ACR I Time]	x	-
b3-10 [Speed Estimation Detection Gain]	x	-
b3-14 [Bi-directional Speed Search]	x	x
b3-17 [Speed Est Retry Current Level]	x	x
b3-18 [Speed Est Retry Detection Time]	x	x
b3-19 [Speed Search Restart Attempts]	x	x
b3-24 [Speed Search Method Selection]	x (1)	x (2)
b3-25 [Speed Search Wait Time]	x	x
b3-26 [Direction Determination Level]	x	-
b3-27 [Speed Search RUN/BB Priority]	x	x
b3-31 [Spd Search Current Reference Lvl]	-	x
b3-32 [Spd Search Current Complete Lvl]	-	x
b3-56 [InverseRotationSearch WaitTime]	-	x

Note:

- To use Speed Estimation Speed Search with V/f Control, do Rotational Auto-Tuning before you set the Speed Search function. If the wire length between the drive and motor changed since the last time you did Auto-Tuning, do Stationary Auto-Tuning for Line-to-Line Resistance process again.

■ **Current Detection 2**

Use this Speed Search function with induction motors. Set *b3-24 = 2* [Speed Search Method Selection = Current Detection 2]. Current Detection Speed Search injects current into the motor to detect the speed of an induction motor. Speed Search increases the output voltage for the time set in *L2-04* [Powerloss V/f Recovery Ramp Time], starting from the maximum output frequency or the frequency reference.

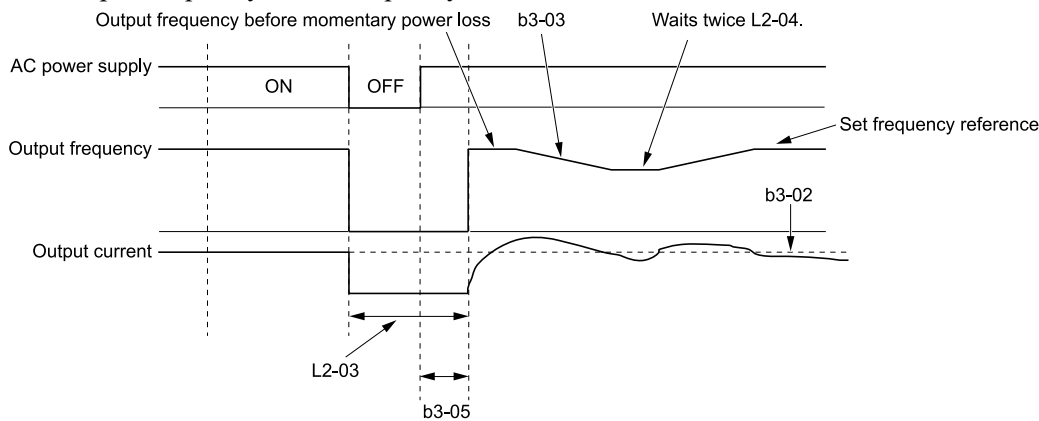

- b3-02: SpeedSearch Deactivation Current**
- b3-03: Speed Search Deceleration Time**
- b3-05: Speed Search Delay Time**

- L2-03: Minimum Baseblock Time**
- L2-04: Powerloss V/f Recovery Ramp Time**

Figure 5.16 Current Detection 2 after a Momentary Power Loss

Note:

After you restore power, the drive will not do Speed Search until the time set in *b3-05* [Speed Search Delay Time] expires. This means that the drive will not always start Speed Search when time set in *L2-03* [Minimum Baseblock Time] expires.

If you enter the Run command at the same time as Speed Search, the drive will not do Speed Search until the time set in $L2-03$ expires. When $L2-03 < b3-05$, the drive will use the wait time set in $b3-05$.

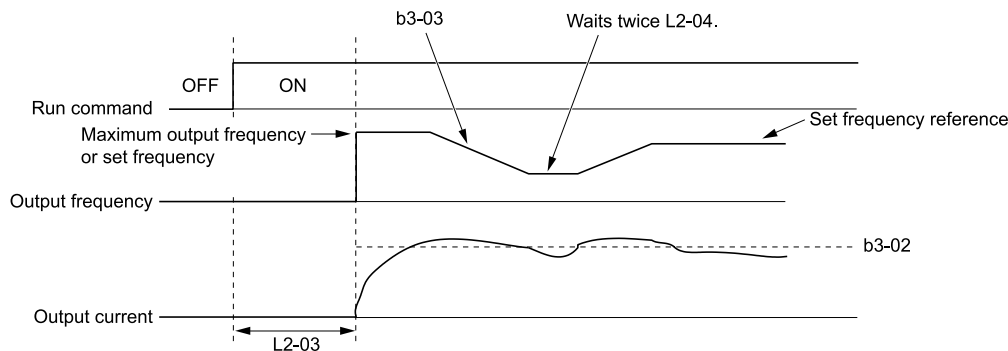

b3-02: SpeedSearch Deactivation Current
b3-03: Speed Search Deceleration Time

L2-03: Minimum Baseblock Time
L2-04: Powerloss V/f Recovery Ramp Time

Figure 5.17 Speed Search Selection at Start (Current Detection Type)

WARNING! Sudden Movement Hazard. Do not do Current Detection Speed Search with light loads or a stopped motor. If you do Auto-Tuning in these conditions, the motor can suddenly accelerate and cause serious injury or death.

Note:

- If the drive detects $oL1$ [Motor Overload] during Current Detection Speed Search, decrease $b3-03$.
- If the drive detects oC [Overcurrent] or ov [Overvoltage] during Current Detection Speed Search after the drive recovers from a momentary power loss, increase $L2-03$.

■ Speed Estimation

Use this Speed Search function with induction motors. Set $b3-24 = 1$ [Speed Search Method Selection = Speed Estimation]. This function uses less current and has a shorter search time than other functions. This function lets you do Speed Search when the motor is rotating in reverse. When you return power after a power loss, the motor will not suddenly accelerate.

Note:

You cannot do Speed Estimation Speed Search in these conditions:

- When you operate more than one motor with one drive
- When you use a high-speed motor (200 Hz or higher)
- When you use a 1.5 kW or smaller motor.
- When the motor output is more than 1 frame size smaller than the drive capacity
- When there is a long wiring distance between the drive and motor

For these conditions, use Current Detection Speed Search.

Speed Estimation Speed Search uses these two steps to estimate the motor speed:

1. Residual Voltage Search

When there is a short baseblock time, the drive searches for residual voltage. The drive uses the residual voltage in the motor to estimate the motor speed and direction of rotation. The drive outputs the estimated motor speed as frequency, then uses the deceleration rate set in $L2-04$ to increase the voltage. When the output voltage aligns with the V/f pattern, the drive accelerates or decelerates the motor to the frequency reference. If the drive cannot estimate the motor speed because of low residual voltage, it will automatically do Current Injection.

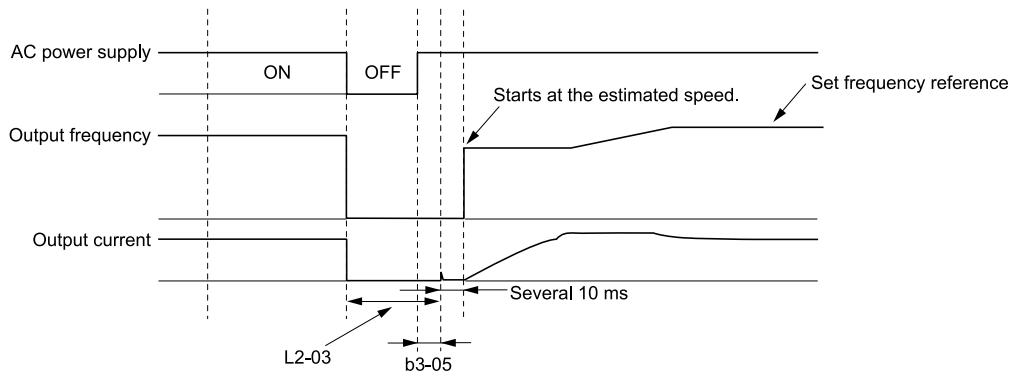

b3-05: Speed Search Delay Time

L2-03: Minimum Baseblock Time

Figure 5.18 Speed Search after Baseblock

Note:

After you return power, the drive waits for the time set in *b3-05*. When power loss is longer than the time set in *L2-03*, the drive will start Speed Search when the time set in *b3-05* is expired after the power recovery.

2. Current Injection

If there is not sufficient residual voltage in the motor, the drive does Current Injection. The drive injects the quantity of DC current set in *b3-06* [*Speed Estimation Current Level 1*] into the motor windings to estimate the motor speed and direction of rotation. The drive outputs the estimated motor speed as frequency, then uses the deceleration rate set in *L2-04* to increase the voltage. When the output voltage aligns with the V/f pattern, the drive accelerates or decelerates the motor to the frequency reference.

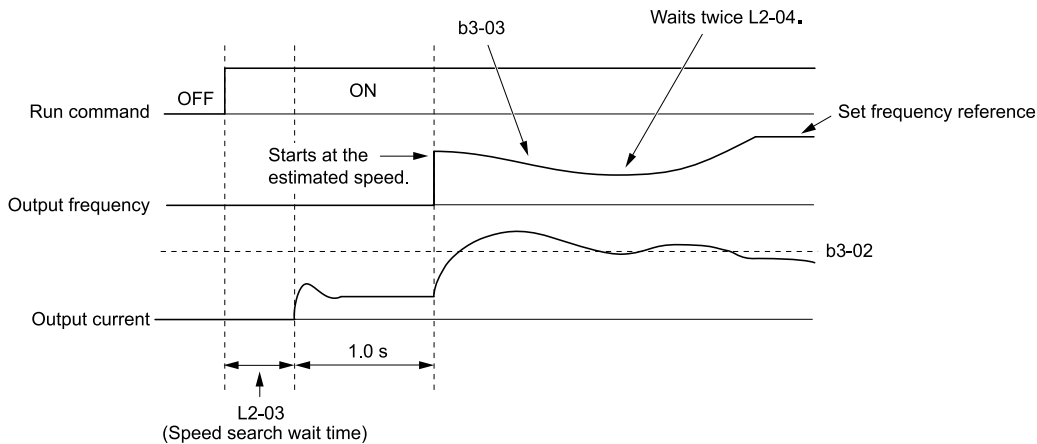

b3-02: SpeedSearch Deactivation Current

L2-03: Minimum Baseblock Time

b3-03: Speed Search Deceleration Time

L2-04: Powerloss V/f Recovery Ramp Time

Figure 5.19 Speed Search Selection at Start

Note:

Set the lower limit of the delay time to *b3-05* for when Speed Search starts.

■ Speed Search and Operation Conditions

These conditions apply to Speed Search operation. Set *b3-24* [*Speed Search Method Selection*] before you do Speed Search.

- Do Speed Search with each Run Command
The drive ignores a Speed Search command from the external terminals.
- Use an MFDI to do an External Speed Search Command
To use an MFDI to do Speed Search, input the Run command at the same time that terminal Sx set for Speed Search activates, or after Speed Search activates.
Set Speed Search to *H1-xx* to do the function externally. You cannot set external Speed Search 1 and 2 at the same time.

Table 5.21 Execute Speed Search via the Digital Input Terminals

H1-xx Setting	Name	Current Detection 2	Speed Estimation
61	Speed Search from Fmax	ON: Speed Search starts from <i>E1-04 [Maximum Output Frequency]</i> .	External Speed Search commands 1 and 2 work the same.
62	Speed Search from Fref	ON: Speed Search starts from the frequency reference immediately before you input the Speed Search command.	The drive estimates the motor speed, then starts Speed Search from the estimated speed.

- Do Speed Search with Each Auto Restart
Set *L5-01 [Number of Auto-Restart Attempts]* = 1 or more. After an Auto Restart fault, the drive automatically does Speed Search.
- Do Speed Search after Momentary Power Loss
Set *L2-01* = 1, 2 [*Power Loss Ride Through Select = Enabled for L2-02 Time, Enabled while CPU Power Active*].
- Do Speed Search after You Clear the External Baseblock Command
When there is an active Run command and the output frequency is higher than the minimum frequency, you must clear the external baseblock command to do Speed Search.

■ b3-01: Speed Search at Start Selection

No. (Hex.)	Name	Description	Default (Range)
b3-01 (0191)	Speed Search at Start Selection	Sets the Speed Search at Start function where the drive will perform Speed Search with each Run command.	0 (0, 1)

0 : Disable

Enter a Run command to start to operate the drive at the minimum output frequency.

When you enable the Run command and input the *Speed Search from Fmax or Fref [H1-xx = 61, 62]* from a drive unit multi-function input terminal, the drive will do Speed Search and start to operate the motor.

Note:

The bypass will do a speed search automatically under certain conditions.

1 : Enabled

Enter the Run command to do Speed Search. The drive completes Speed Search then starts to operate the motor.

■ b3-02: SpeedSearch Deactivation Current

No. (Hex.)	Name	Description	Default (Range)
b3-02 (0192)	SpeedSearch Deactivation Current	Sets the current level that stops Speed Search as a percentage of the drive rated output current. Usually it is not necessary to change this setting.	120% (0 - 200%)

If the drive cannot restart the motor, decrease this setting.

■ b3-03: Speed Search Deceleration Time

No. (Hex.)	Name	Description	Default (Range)
b3-03 (0193)	Speed Search Deceleration Time	Sets the deceleration time during Speed Search operation. Set the length of time to decelerate from the maximum output frequency to the minimum output frequency.	2.0 s (0.1 - 10.0 s)

This is the output frequency deceleration time used by Current Detection Speed Search and by the Current Injection Method of Speed Estimation Speed Search.

Note:

If the drive detects *oL1 [Motor Overload]* during Current Detection Speed Search, decrease the value set in *b3-03*.

■ b3-04: V/f Gain during Speed Search

No. (Hex.)	Name	Description	Default (Range)
b3-04 (0194)	V/f Gain during Speed Search	Sets the ratio used to reduce the V/f during searches to reduce the output current during speed searches.	Determined by o2-04 (10 - 100)

5.2 b: Application

Use the this formula to calculate the output voltage during Speed Search:

Output voltage during Speed Search = Configured V/f × b3-04

When the current detection search operates correctly, this configuration is not necessary.

■ b3-05: Speed Search Delay Time

No. (Hex.)	Name	Description	Default (Range)
b3-05 (0195)	Speed Search Delay Time	Sets the Speed Search delay time to activate a magnetic contactor installed between the drive and motor.	0.2 s (0.0 - 100.0 s)

This parameter will delay the start of the Speed Search operation. Use a magnetic contactor between the drive and the motor to allow time for the contactor to close before Speed Search.

■ b3-06: Speed Estimation Current Level 1

No. (Hex.)	Name	Description	Default (Range)
b3-06 (0196) Expert	Speed Estimation Current Level 1	Sets the level of current that flows to the motor during Speed Estimation Speed Search as a coefficient of the motor rated current. Usually it is not necessary to change this setting.	Determined by o2-04 (0.0 - 2.0)

When the speed estimation value is the minimum output frequency, increase this setting. You can do this when the motor coasts at a high speed while the drive estimates the speed during Speed Estimation Speed Search. The limit of the output current during speed search is automatically the drive rated current.

Note:

When the drive cannot accurately estimate the speed after you adjust this parameter, use Current Detection Speed Search.

■ b3-07: Speed Estimation Current Level 2

No. (Hex.)	Name	Description	Default (Range)
b3-07 (0197) Expert	Speed Estimation Current Level 2	Sets the level of current that flows to the motor during Speed Estimation Speed Search as a coefficient of <i>E2-03 [Motor No-Load Current]</i> . Usually it is not necessary to change this setting.	1.0 (0.0 - 3.0)

During Speed Estimation Speed Searches, when the speed estimation value aligns with the minimum output frequency, increase the setting value in 0.1-unit increments. The limit of the output current during speed search is automatically the drive rated current.

■ b3-08: Speed Estimation ACR P Gain

No. (Hex.)	Name	Description	Default (Range)
b3-08 (0198)	Speed Estimation ACR P Gain	Sets the proportional gain for the automatic current regulator during Speed Estimation Speed Search. Also adjusts speed search responsiveness. Usually it is not necessary to change this setting.	Determined by o2-04 (0.00 - 6.00)

■ b3-09: Speed Estimation ACR I Time

No. (Hex.)	Name	Description	Default (Range)
b3-09 (0199)	Speed Estimation ACR I Time	Sets the integral time for the automatic current regulator during Speed Estimation Speed Search. Also adjusts speed search responsiveness. Usually it is not necessary to change this setting.	2.0 ms (0.0 - 1000.0 ms)

■ b3-10: Speed Estimation Detection Gain

No. (Hex.)	Name	Description	Default (Range)
b3-10 (019A) Expert	Speed Estimation Detection Gain	Sets the gain to correct estimated frequencies from Speed Estimation Speed Search.	1.05 (1.00 - 1.20)

If the drive detects *ov* [*DC Bus Overvoltage*] when you restart the motor, increase the setting value.

■ b3-11: Spd Est Method Switch-over Level

No. (Hex.)	Name	Description	Default (Range)
b3-11 (019B) Expert	Spd Est Method Switch-over Level	Uses the quantity of voltage in the motor to automatically switch the search method within the type of speed measurement.	5.0% (0.5 - 100.0%)

Note:

- 208/240 V at 100% = 200 V
- 480 V at 100% = 400 V

■ b3-12: Speed Search Current Deadband

No. (Hex.)	Name	Description	Default (Range)
b3-12 (019C) Expert	Speed Search Current Deadband	Sets the minimum current detection level during Speed Search. If the drive does not do Speed Estimation, increase this setting in 0.1-unit increments.	determined by o2-04 (2.0 - 10.0)

■ b3-14: Bi-directional Speed Search

No. (Hex.)	Name	Description	Default (Range)
b3-14 (019E)	Bi-directional Speed Search	Sets the direction of Speed Search to the direction of the frequency reference or in the motor rotation direction as detected by the drive.	0 (0, 1)

0 : Disabled

The drive uses the frequency reference to detect the direction of motor rotation.

1 : Enabled

The drive detects the direction of motor rotation during Speed Search.

■ b3-17: Speed Est Retry Current Level

No. (Hex.)	Name	Description	Default (Range)
b3-17 (01F0) Expert	Speed Est Retry Current Level	Sets the current level for the search retry function in Speed Estimation Speed Search as a percentage where drive rated current is a setting value of 100%.	110% (0 - 200%)

When a large quantity of current flows during Speed Estimation Speed Search, the drive temporarily stops operation to prevent overvoltage and overcurrent. When the current is at the level set in *b3-17*, the drive tries speed search again.

■ b3-18: Speed Est Retry Detection Time

No. (Hex.)	Name	Description	Default (Range)
b3-18 (01F1) Expert	Speed Est Retry Detection Time	Sets the length of time that the drive will wait to retry Speed Estimation Speed Search when too much current flow stopped the Speed Search.	0.10 s (0.00 - 1.00 s)

When the current is more than the level set in *b3-17* [*Speed Est Retry Current Level*] during the time set in *b3-18*, the drive tries speed search again.

■ b3-19: Speed Search Restart Attempts

No. (Hex.)	Name	Description	Default (Range)
b3-19 (01F2)	Speed Search Restart Attempts	Sets the number of times to restart Speed Search if Speed Search does not complete.	3 times (0 - 10 times)

If the drive does the number of Speed Search restarts set in this parameter, it will trigger an *SEr* [*Speed Search Retries Exceeded*] error.

■ b3-24: Speed Search Method Selection

No. (Hex.)	Name	Description	Default (Range)
b3-24 (01C0)	Speed Search Method Selection	Sets the Speed Search method when you start the motor or when you return power after a momentary power loss.	2 (1, 2)

Note:

Set *b3-24* = 1. If *b3-24* = 2, the drive will detect *oPE08* [*Parameter Selection Error*].

Set *b3-01* = 1 [*Speed Search at Start Selection = Enabled*] to do Speed Search at start. Set *L2-01* = 1 [*Power Loss Ride Through Select = Enabled for L2-02 Time*] to do Speed Search after you restore power after a momentary power loss.

1 : Speed Estimation

The drive uses the residual voltage from a short baseblock time to estimate the motor speed.

If there is not sufficient residual voltage, then the drive will inject DC current into the motor to estimate the motor speed.

2 : Current Detection 2

The drive will inject DC current into the motor to estimate motor speed.

■ b3-25: Speed Search Wait Time

No. (Hex.)	Name	Description	Default (Range)
b3-25 (01C8) Expert	Speed Search Wait Time	Sets the length of time the drive will wait to start the Speed Search Retry function.	0.5 s (0.0 - 30.0 s)

If the drive detects these faults during speed search, increase the setting value:

- *oC* [*Overcurrent*]
- *ov* [*Overvoltage*]
- *SEr* [*Speed Search Retries Exceeded*]

■ b3-26: Direction Determination Level

No. (Hex.)	Name	Description	Default (Range)
b3-26 (01C7) Expert	Direction Determination Level	Sets the level to find the motor rotation direction. Increase the value if the drive cannot find the direction.	1000 (40 to 60000)

■ b3-27: Speed Search RUN/BB Priority

No. (Hex.)	Name	Description	Default (Range)
b3-27 (01C9) Expert	Speed Search RUN/BB Priority	Sets the conditions necessary to start Speed Search.	0 (0, 1)

Executes *Speed Search from Fmax or Fref* [*H1-xx = 61/62*] for initial speed searches or from the MFDI terminal.

0 : SS Only if RUN Applied Before BB

1 : SS Regardless of RUN/BB Sequence

■ b3-31: Spd Search Current Reference Lvl

No. (Hex.)	Name	Description	Default (Range)
b3-31 (0BC0) Expert	Spd Search Current Reference Lvl	Sets the current level that decreases the output current during Current Detection Speed Search.	1.50 (1.50 - 3.50)

Set this parameter as a ratio of $E2-03$ [Motor No-Load Current]. The setting is a ratio with respect to 30% of the motor rated current when $E2-03 \leq E2-01$ [Motor Rated Current] $\times 0.3$.

■ b3-32: Spd Search Current Complete Lvl

No. (Hex.)	Name	Description	Default (Range)
b3-32 (0BC1) Expert	Spd Search Current Complete Lvl	Sets the current level that completes Speed Search.	1.20 (0.00 - 1.49)

The Current Detection Speed Search gradually decreases the output frequency to search for the motor speed when the output current is equal to or less than Speed Search Current Complete Level.

Set this parameter as a ratio of $E2-03$ [Motor No-Load Current]. The setting is a ratio with respect to 30% of the motor rated current when $E2-03 \leq E2-01$ [Motor Rated Current] $\times 0.3$.

■ b3-39: Regen Judgment Lv of Spd Search

No. (Hex.)	Name	Description	Default (Range)
b3-39 (1B8F) Expert	Regen Judgment Lv of Spd Search	Sets the level to determine the regenerative state during speed search. Usually it is not necessary to change this setting.	15% (0 - 50%)

If the speed search is not completed after starting the speed search, increase the setting value in 5% increments after the drive stops.

If the drive detects *ov* [Overvoltage] during speed search, decrease the setting value in 5% increments after the drive stops.

■ b3-56: InverseRotationSearch WaitTime

No. (Hex.)	Name	Description	Default (Range)
b3-56 (3126)	InverseRotationSearch WaitTime	Sets the wait time until the drive starts inverse rotation search after it completes forward search when you do inverse rotation search during Current Detection Speed Search.	Determined by o2-04 (0.1 - 5.0 s)

◆ b4: Timer Function

The drive uses timers to delay activating and deactivating MFDO terminals.

Timers prevent sensors and switches from making chattering noise.

There are two types of timers:

- Timers that set a delay for timer inputs and timer outputs.
These timers delay activating and deactivating of the MFDI and MFDOs.
To enable this function, set $H1-xx = 18$ [MFDI Function Select = Timer Function], and set $H2-01$ to $H2-03 = 12$ [MFDO Function Select = Timer Output].
- Timers that set a delay to activate and deactivate MFDO terminals.
These timers delay activating and deactivating MFDO terminals.
To enable this function, set delay times in parameters $b4-03$ to $b4-08$.

■ Timer Function Operation

- Timers that Set a Delay for Timer Inputs and Timer Outputs

Triggers timer output if the timer input is active for longer than the time set in *b4-01* [Timer Function ON-Delay Time]. Triggers timer output late for the time set in *b4-02* [Timer Function OFF-Delay Time]. Figure 5.20 shows an example of how the timer function works.

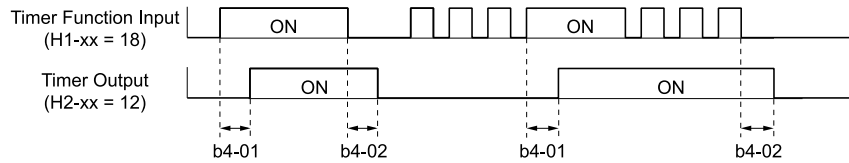

Figure 5.20 Example of Timer Function Operation

• Setting On/Off-delay Time for MFDO

Figure 5.21 uses H2-01 terminals to show an example of how the timer function works. Use *b4-03* [Terminal M1-M2 ON-Delay Time] and *b4-04* [Terminal M1-M2 OFF-Delay Time] to set this function.

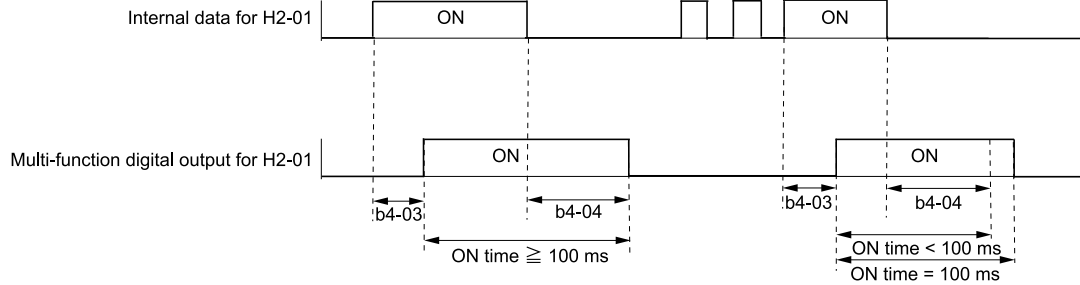

Figure 5.21 Example of How the Timer Function Works with H2-01 Terminals

Note:

When the terminal is triggered, it continues for a minimum of 100 ms. The on/off-delay time of MFDO terminal does not have an effect.

■ **b4-01: Timer Function ON-Delay Time**

No. (Hex.)	Name	Description	Default (Range)
b4-01 (01A3)	Timer Function ON-Delay Time	Sets the ON-delay time for the timer input.	0.0 s (0.0 - 3000.0 s)

■ **b4-02: Timer Function OFF-Delay Time**

No. (Hex.)	Name	Description	Default (Range)
b4-02 (01A4)	Timer Function OFF-Delay Time	Sets the OFF-delay time for the timer input.	0.0 s (0.0 - 3000.0 s)

■ **b4-03: Terminal M1-M2 ON-Delay Time**

No. (Hex.)	Name	Description	Default (Range)
b4-03 (0B30) Expert	Terminal M1-M2 ON-Delay Time	Sets the delay time to activate the contact after the function set in <i>H2-01</i> activates.	0 ms (0 - 65000 ms)

■ **b4-04: Terminal M1-M2 OFF-Delay Time**

No. (Hex.)	Name	Description	Default (Range)
b4-04 (0B31) Expert	Terminal M1-M2 OFF-Delay Time	Sets the delay time to deactivate the contact after the function set in <i>H2-01</i> deactivates.	0 ms (0 - 65000 ms)

■ b4-05: Terminal M3-M4 ON-Delay Time

No. (Hex.)	Name	Description	Default (Range)
b4-05 (0B32) Expert	Terminal M3-M4 ON-Delay Time	Sets the delay time to activate the contact after the function set in <i>H2-02</i> activates.	0 ms (0 - 65000 ms)

■ b4-06: Terminal M3-M4 OFF-Delay Time

No. (Hex.)	Name	Description	Default (Range)
b4-06 (0B33) Expert	Terminal M3-M4 OFF-Delay Time	Sets the delay time to deactivate the contact after the function set in <i>H2-02</i> deactivates.	0 ms (0 - 65000 ms)

■ b4-07: Terminal M5-M6 ON-Delay Time

No. (Hex.)	Name	Description	Default (Range)
b4-07 (0B34) Expert	Terminal M5-M6 ON-Delay Time	Sets the delay time to activate the contact after the function set in <i>H2-03</i> activates.	0 ms (0 - 65000 ms)

■ b4-08: Terminal M5-M6 OFF-Delay Time

No. (Hex.)	Name	Description	Default (Range)
b4-08 (0B35) Expert	Terminal M5-M6 OFF-Delay Time	Sets the delay time to deactivate the contact after the function set in <i>H2-03</i> deactivates.	0 ms (0 - 65000 ms)

◆ b5: PID Control

The drive has a PID control function. You can control drive output to adjust the proportional gain, integral time, and derivative time that has an effect on the bias between the target value and the feedback value to align the target value with the detected value. Use this function to adjust the drive output to accurately match the flow, pressure, and temperature in the application match the target value.

Use a combination of these controls to increase the performance:

- P control
P control has a proportional effect on the deviation. It outputs the product (the controlled output) proportional to the deviation. You cannot use only the offset from P control to get to zero deviation.
- I control
I control is the integral of the deviation. It uses an integral value of the deviation to output the product (the controlled output). I control helps align the feedback value and the target value. If you use the proportional effect (P Control) only, it will cause offset. If you use the proportional effect with the integral operation, it will gradually remove the offset over time.
- D control
D control is the derivative of the deviation. If there are sudden, large changes in the deviation or feedback value, it will have an effect on drive output. It quickly returns drive output to the value before the sudden change. It multiplies a time constant by a derivative value of the deviation (slope of the deviation), and adds that result to PID input to calculate the deviation of the signal, then it corrects the deviation.

Note:

D control causes less stable operation because the noise changes the deviation signal. Use D control only when necessary.

■ PID Control Operation

Figure 5.22 shows PID control operation. The modified output (output frequency) changes when the drive uses PID control to keep the deviation (the difference between the target value and the feedback value) constant.

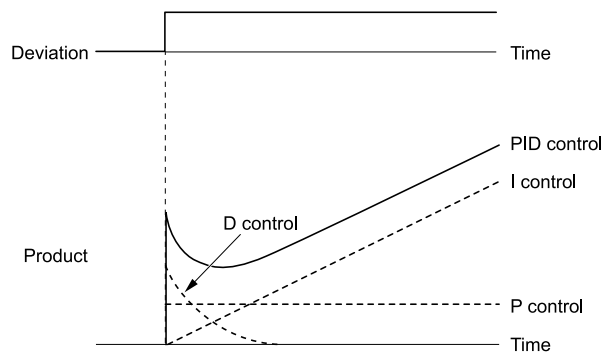

Figure 5.22 PID Control Operation

■ PID Control Applications

Table 5.22 shows applications for PID control.

Table 5.22 PID Control Applications

Application	Control Content	Sensors Used
Pressure control	The drive uses feedback from the actual pressure to hold constant pressure.	Pressure sensor
Flow control	The drive uses feedback from the actual flow to hold constant flow.	Flow rate sensor
Temperature control	The drive uses feedback from the actual temperature to control a fan and hold constant temperature.	Thermocoupler, thermistor

■ Input Methods for the PID Setpoint

Use *b5-01 [PID Mode Setting]* to select how the PID setpoint is input to the drive.

When *b5-01 = 1 [Standard]*, the frequency reference set in *b1-01 [Frequency Reference Selection 1]* will be the PID setpoint, or the one of the values shown in Table 5.23 will be the PID setpoint.

When *b5-01 = 3 [Fref + PID Trim]*, one of the inputs in Table 5.23 will be the PID setpoint.

Table 5.23 Input Methods for the PID Setpoint

Input Methods for the PID Setpoint	Setting Value
MFAI terminal A1	Set <i>H3-02 = C [Terminal A1 Function Selection = PID Setpoint]</i> .
MFAI terminal A2	Set <i>H3-10 = C [Terminal A2 Function Selection = PID Setpoint]</i> .
MEMOBUS/Modbus register 0006H	Sets MEMOBUS/Modbus register 000FH (Control Selection Setting) bit 1 to 1 (PID setpoint input). Enters the PID setpoint to MEMOBUS/Modbus register 0006H (PID setpoint, 0.01% units, signed).

Note:

If you set two inputs for the PID setpoint, it will trigger operation error *oPE07 [Analog Input Selection Error]*.

■ Entering the PID Feedback Value

You can use two methods to input the PID feedback value to the drive. One method uses a single feedback signal for usual PID control. The other method uses two signals. The difference between those signals sets the deviation.

• **Use One Feedback Signal**

Use Table 5.24 to select how the feedback signal is input to the drive for PID control.

Table 5.24 PID Feedback Input Method

PID Feedback Input Method	Setting Value
MFAI terminal A1	Set <i>H3-02 = B [PID Feedback]</i> .
MFAI terminal A2	Set <i>H3-10 = B</i> . Set automatically when <i>b5-01 = 1</i> .
MEMOBUS/Modbus register 15FFH	Enters the PID setpoint to MEMOBUS/Modbus register 15FFH (PID setpoint, 0.01% units, signed).

• **Use Two Feedback Signals and Calculate the Deviation from the Difference Between Those Signals**

Use [Table 5.25](#) to select how the second feedback value is input to the drive. The drive calculates the deviation of the second feedback value. Set *H3-02* or *H3-10* = 16 [*Terminal A1/A2 Function Selection = Differential PID Feedback*] to enable the second feedback signal used to calculate the deviation.

Table 5.25 PID Differential Feedback Input Method

PID Differential Feedback Input Method	Setting Value
MFAI terminal A1	Set <i>H3-02</i> = 16.
MFAI terminal A2	Set <i>H3-10</i> = 16.

Note:

If you set more than one of *H3-02* and *H3-10* to 16, the drive will detect *oPE07* [*Analog Input Selection Error*].

■ PID Control Block Diagram

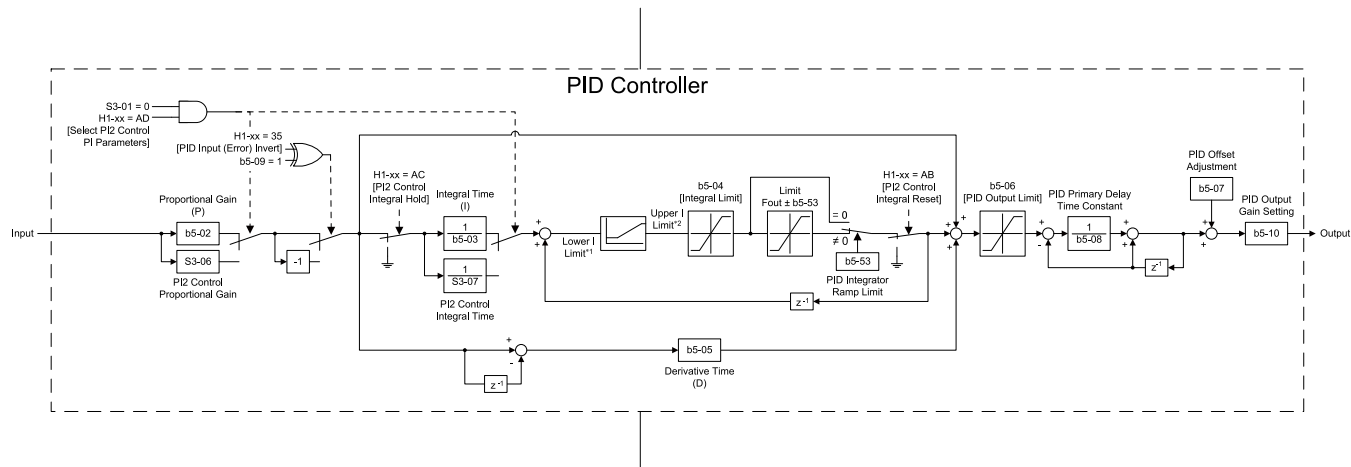

Figure 5.23 PID Block Diagram

- *1 The drive uses the largest value of *Y1-06* [*Minimum Speed*], *Y4-12* [*Thrust Frequency*], or *d2-02* [*Frequency Reference Lower Limit*] for Lower I Limit. When the drive is in Emergency Override Mode, it uses the largest value of *Y1-06*, *Y4-12*, *d2-02*, or *S6-09* [*Emergency Override Min Speed*].
- *2 The drive uses the smallest value of *Y1-40* [*Maximum Speed*], *E1-04* [*Maximum Output Frequency*], or *d2-01* [*Frequency Reference Upper Limit*] for Upper I Limit. When the drive is in Emergency Override Mode, it uses the smallest value of *Y1-40*, *E1-04*, *d2-01*, or *S6-10* [*Emergency Override Max Speed*].

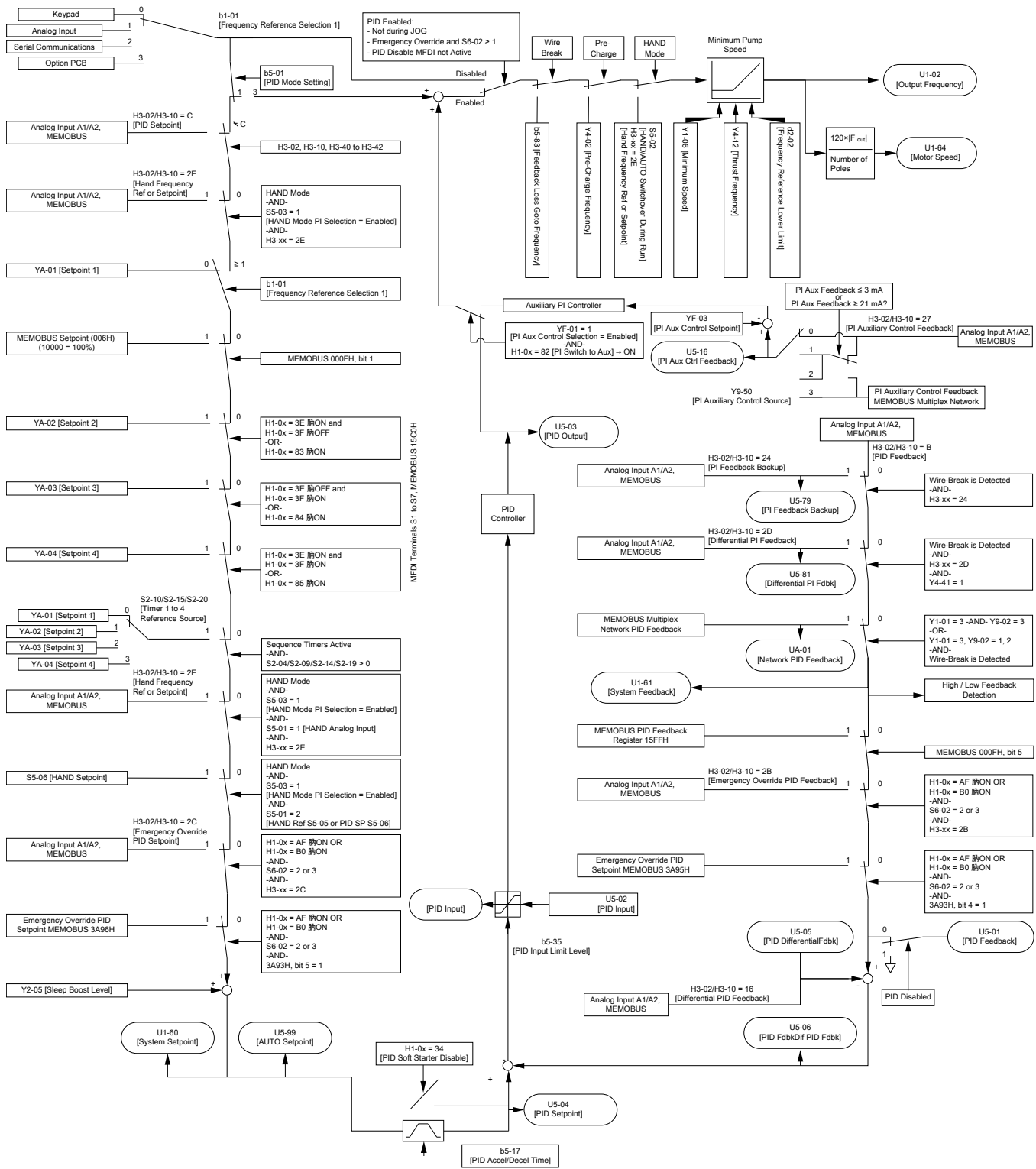

Figure 5.24 Sequence of Speed References to the PID Controller

Fine-Tuning PID

Fine-tune the following parameter settings to have PID control eliminate problems with overshoot and oscillation.

- *b5-02 [Proportional Gain (P)]*
- *b5-03 [Integral Time (I)]*
- *b5-05 [Derivative Time (D)]*

• *b5-08 [PID Primary Delay Time Constant]*

Purpose	Procedure	Results
Prevent overshoot.	<ul style="list-style-type: none"> Set <i>b5-05 [Derivative Time (D)]</i> to a smaller value. Set <i>b5-03 [Integral Time (I)]</i> to a larger value. 	<p>Response</p> <p>Before adjustment</p> <p>After adjustment</p> <p>Time</p>
Quickly stabilize control.	<ul style="list-style-type: none"> Set <i>b5-05 [Derivative Time (D)]</i> to a larger value. Set <i>b5-03 [Integral Time (I)]</i> to a smaller value. 	<p>Response</p> <p>After adjustment</p> <p>Before adjustment</p> <p>Time</p>
Prevent long-cycle oscillations.	Set <i>b5-03 [Integral Time (I)]</i> to a larger value.	<p>Response</p> <p>Before adjustment</p> <p>After adjustment</p> <p>Time</p>
Prevent short-cycle oscillations.	<ul style="list-style-type: none"> Set <i>b5-05 [Derivative Time (D)]</i> to a smaller value. If you set <i>b5-05 = 0.00 [Derivative Time (D) = disabling D control]</i> and it does not stop oscillation, then set <i>b5-02 [Proportional Gain (P)]</i> to a smaller value or set <i>b5-08 [PID Primary Delay Time Constant]</i> to a larger value. 	<p>Response</p> <p>Before adjustment</p> <p>After adjustment</p> <p>Time</p>

■ System Units

The drive uses *b5-38 [PID User Unit Display Scaling]*, *b5-39 [PID Setpoint Display Digits]*, and *b5-46 [PID Unit Display Selection]* together to apply the user-set PID setpoint and display units at any time.

Parameter *b5-38* sets the scaling and *b5-46* sets the units-text to the parameters and monitors shown in [Table 5.26](#) and [Table 5.27](#).

5.2 b: Application

Note:

When you change *b5-38* and *b5-46*, the drive will not automatically convert the parameters in [Table 5.26](#).

For example, when you set *YA-01* = 70.0 [PSI] and change these parameters:

- *b5-46* from 1 [PSI] to 8 [Bar]
- *b5-38* from 145.0 to 10.0

The drive changes only the unit setting and *YA-01* will be 70.0 [Bar]. When the setpoint value after you change *b5-38* and *b5-46* is more than *b5-38*, the drive internally limits the setpoint value to 200% of *b5-38*. The drive regards the *YA-01* setting as 20.0 [Bar].

Table 5.26 Parameters Set by b5-38 and b5-46

Parameter Groups	No.
b5	b5-71 [Min PID Transducer Scaling]
S5	<ul style="list-style-type: none"> • S5-06 [HAND Setpoint] • S5-12 [HAND Setpoint 2]
Y1	<ul style="list-style-type: none"> • Y1-04 [Sleep Wake-up Level] • Y1-08 [Low Feedback Level] • Y1-11 [High Feedback Level] • Y1-14 [High Feedback Hysteresis Level] • Y1-15 [Maximum Setpoint Difference]
Y2	<ul style="list-style-type: none"> • Y2-05 [Sleep Boost Level] • Y2-08 [Delta Feedback Drop Level] • Y2-25 [Anti-No-Flow Release Level]
Y4	<ul style="list-style-type: none"> • Y4-01 [Pre-Charge Level] • Y4-18 [Differential Level] • Y4-37 [Pressure Reached Hysteresis Lvl]
YA	<ul style="list-style-type: none"> • YA-01 [Setpoint 1] • YA-02 [Setpoint 2] • YA-03 [Setpoint 3] • YA-04 [Setpoint 4]

Table 5.27 Monitors Set by b5-38 and b5-46

Monitor Groups	No.
U1	<ul style="list-style-type: none"> • U1-60 [System Setpoint] • U1-61 [System Feedback]
U5	<ul style="list-style-type: none"> • U5-01 [PID Feedback] • U5-04 [PID Setpoint] • U5-79 [PI Feedback Backup] • U5-81 [Differential PI Fdbk] • U5-99 [PID Setpoint Command]

Full-Scale of the PID Analog Input Signals

The full-scale of the analog signals listed in this table go from *b5-71* [Min PID Transducer Scaling] to *b5-38* [PID User Unit Display Scaling].

H3-xx Setting	MFAI	H3-xx Setting	MFAI
B	PID Feedback	2B	Emergency Override PID Feedback
C	PID Setpoint	2D	Differential Level Source
24	PID Feedback Backup	2E	HAND Frequency Ref or Setpoint ^{*1}

*1 Only when *b5-01* = 1 [PID Mode Setting = Standard] and *S5-03* = 1 [HAND Mode PID Selection = Enabled]

Note:

When you set *b5-71* < 0, the drive appropriately scales the setpoint and feedback values of the drive, but internally limits to 0 when the reported value from the transducer is negative.

Custom Units

These selections are available for custom system units:

Table 5.28 Settings and Characters

Settings	Characters	Settings	Characters
20	SPACE	4E	N
21	!	4F	O
22	"	50	P
23	#	51	Q
24	\$	52	R
25	%	53	S
26	&	54	T
27	'	55	U
28	(56	V
29)	57	W
2A	*	58	X
2B	+	59	Y
2C	,	5A	Z
2D	-	61	a
2E	.	62	b
2F	/	63	c
30	0	64	d
31	1	65	e
32	2	66	f
33	3	67	g
34	4	68	h
35	5	69	i
36	6	6A	j
37	7	6B	k
38	8	6C	l
39	9	6D	m
41	A	6E	n
42	B	6F	o
43	C	70	p
44	D	71	q
45	E	72	r
46	F	73	s
47	G	74	t
48	H	75	u
49	I	76	v
4A	J	77	w
4B	K	78	x
4C	L	79	y
4D	M	7A	z

■ b5-01: PID Mode Setting

No. (Hex.)	Name	Description	Default (Range)
b5-01 (01A5)	PID Mode Setting	Sets the type of PID control.	0 (0 - 3)

0 : Disabled

1 : Standard

The drive does D control on the difference between the feedback value and the PID setpoint output through *U5-02* [PID Input].

3 : Fref + PID Trim

The drive adds the frequency reference to the PID output. The drive does D control on the difference between the feedback value and the PID setpoint output through *U5-02*.

Note:

- When you set *b5-01* = 1 or 3 from the keypad, the drive will automatically set *H3-10* = B [Terminal A2 Function Selection = PID Feedback] and *o1-26* = 501 [Custom Monitor 3 = PID Feedback]. The drive will also update the defaults for *H3-10* and *o1-26* when you change *b5-01*.
- When you set *b5-01* = 0 from the keypad, the drive will automatically set *H3-10* = 0 [Frequency Reference] and *o1-26* = 103 [Output Current].
- When you set *b5-01* from a different method, for example MEMOBUS, the drive will automatically update the defaults for *H3-10* and *o1-26*, but it will not update the parameters.

■ b5-02: Proportional Gain (P)

No. (Hex.)	Name	Description	Default (Range)
b5-02 (01A6) RUN	Proportional Gain (P)	Sets the proportional gain (P) that is applied to PID input.	2.00 (0.00 - 25.00)

Larger values decrease errors, but can cause oscillations. Smaller values let too much offset between the setpoint and feedback.

Set *b5-02* = 0.00 to disable P control.

■ b5-03: Integral Time (I)

No. (Hex.)	Name	Description	Default (Range)
b5-03 (01A7) RUN	Integral Time (I)	Sets the integral time (I) that is applied to PID input.	0.5 s (0.0 - 360.0 s)

Set a short integral time in *b5-03* to remove the offset faster. If the integral time is too short, it can cause overshoot or oscillation.

Set *b5-03* = 0.0 to disable I control.

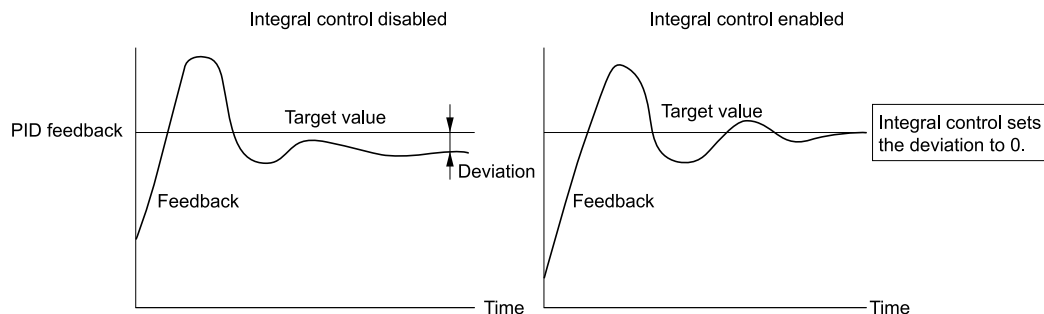

Figure 5.25 Integral Time and Deviation

■ b5-04: Integral Limit

No. (Hex.)	Name	Description	Default (Range)
b5-04 (01A8) RUN	Integral Limit	Sets the upper limit for integral control (I) as a percentage of the Maximum Output Frequency.	100.0% (0.0 - 100.0%)

Applications with loads that quickly change will cause the output of the PID function to oscillate. Set this parameter to a low value to prevent oscillation, mechanical loss, and motor speed loss.

■ b5-05: Derivative Time (D)

No. (Hex.)	Name	Description	Default (Range)
b5-05 (01A9) RUN	Derivative Time (D)	Sets the derivative time (D) for PID control. This parameter adjusts system responsiveness.	0.00 s (0.00 - 10.00 s)

When you increase the time setting, it will increase controller responsiveness, but it can also cause vibration. When you decrease the time setting, it will suppress overshoot and decrease controller responsiveness.

Set *b5-05* = 0.00 to disable D control.

■ b5-06: PID Output Limit

No. (Hex.)	Name	Description	Default (Range)
b5-06 (01AA) RUN	PID Output Limit	Sets the maximum possible output from the PID controller as a percentage of the Maximum Output Frequency.	100.0% (0.0 - 100.0%)

■ b5-07: PID Offset Adjustment

No. (Hex.)	Name	Description	Default (Range)
b5-07 (01AB) RUN	PID Offset Adjustment	Sets the offset for the PID control output as a percentage of the Maximum Output Frequency.	0.0% (-100.0 - +100.0%)

■ b5-08: PID Primary Delay Time Constant

No. (Hex.)	Name	Description	Default (Range)
b5-08 (01AC) RUN Expert	PID Primary Delay Time Constant	Sets the primary delay time constant for the PID control output. Usually it is not necessary to change this setting.	0.00 s (0.00 - 10.00 s)

Prevents resonance if there is a large quantity of mechanical friction or if rigidity is unsatisfactory. Set the value larger than the resonant frequency cycle. A value that is too large will decrease drive responsiveness.

■ b5-09: PID Output Level Selection

No. (Hex.)	Name	Description	Default (Range)
b5-09 (01AD)	PID Output Level Selection	Sets the polarity of the PID output.	0 (0, 1)

Use this parameter in applications that decrease the drive output frequency when you increase the PID setpoint.

0 : Normal Output (Direct Acting)

A positive PID input increases the PID output (direct acting).

1 : Reverse Output (Reverse Acting)

A positive PID input decreases the PID output (reverse acting).

■ b5-10: PID Output Gain Setting

No. (Hex.)	Name	Description	Default (Range)
b5-10 (01AE) RUN	PID Output Gain Setting	Sets the amount of gain to apply to the PID output.	1.00 (0.00 - 25.00)

Applies a gain to the PID output and can help when $b5-01 = 3$ [$PID\ Mode\ Setting = Fref + PID\ Trim$].

■ b5-11: PID Output Reverse Selection

No. (Hex.)	Name	Description	Default (Range)
b5-11 (01AF)	PID Output Reverse Selection	Sets the function that enables and disables reverse motor rotation for negative PID control output.	0 (0, 1)

When $b5-01 = 3$ [$PID\ Mode\ Setting = Fref + PID\ Trim$], this parameter is disabled. There is no limit for PID output. The drive will operate the same as setting 1 [$Negative\ Output\ Accepted$].

0 : Lower Limit is Zero

When PID output is negative, PID output is limited to 0 and drive output is shut off.

1 : Negative Output Accepted

When the PID output is negative, the motor will rotate in reverse. When $b1-04 = 1$ [$Reverse\ Operation\ Selection = Reverse\ Disabled$], the lower limit is 0.

■ b5-17: PID Accel/Decel Time

No. (Hex.)	Name	Description	Default (Range)
b5-17 (01B5) RUN	PID Accel/Decel Time	Raises or lowers the PID setpoint using the acceleration and deceleration times set to the drive. This is a soft-starter for the PID setpoint.	0.0 s (0.0 - 6000.0 s)

The drive usually uses the acceleration and deceleration times set in $C1-xx$ [$Accel\ and\ Decel\ Times$], but when PID control is enabled, the drive applies $C1-xx$ after PID output. If you frequently change the PID setpoint, the drive responsiveness decreases. When resonance with PID control causes hunting, overshoot, or undershoot, set $b5-17$ for longer acceleration and deceleration times.

Decrease $C1-xx$ until hunting stops, then use $b5-17$ to check the acceleration and deceleration. To enable and disable the setting in $b5-17$ through an MFDI terminal, set $PID\ Soft\ Starter\ Disable$ [$H1-xx = 34$].

■ b5-28: PID Feedback Square Root Sel

No. (Hex.)	Name	Description	Default (Range)
b5-28 (01EA)	PID Feedback Square Root Sel	Enables and disables the square root of the PID Feedback compared to the PID Setpoint to set an appropriate drive output for the correct system regulation.	0 (0, 1)

0 : Disabled

1 : Enabled

■ b5-29: PID Feedback Square Root Gain

No. (Hex.)	Name	Description	Default (Range)
b5-29 (01EB)	PID Feedback Square Root Gain	Sets the multiplier applied to the square root of the feedback.	0.00 (0.00 - 2.00)

■ b5-30: PID Feedback Offset

No. (Hex.)	Name	Description	Default (Range)
b5-30 (01EC)	PID Feedback Offset	Sets PID feedback Offset as a percentage of maximum frequency.	0.00% (0.00 - 100.00%)

■ b5-34: PID Output Lower Limit Level

No. (Hex.)	Name	Description	Default (Range)
b5-34 (019F) RUN	PID Output Lower Limit Level	Sets the output lower limit for the PID control as a percentage of the Maximum Output Frequency.	0.0% (-100.0 - +100.0%)

Use a lower limit to keep PID control output from dropping below a fixed level.

Set this parameter to 0.0% to disable this function.

■ b5-35: PID Input Limit Level

No. (Hex.)	Name	Description	Default (Range)
b5-35 (01A0) RUN	PID Input Limit Level	Sets the output upper limit for the PID control as a percentage of the Maximum Output Frequency.	1000.0% (0.0 - 1000.0%)

A large input value for PID control makes a high output. The drive applies this limit to the negative and positive domains.

■ b5-38: PID User Unit Display Scaling

No. (Hex.)	Name	Description	Default (Range)
b5-38 (01FE)	PID User Unit Display Scaling	Sets the value that the drive sets or shows as the PID setpoint when at the maximum output frequency.	100.00% (0.01 - 600.00%)

Refer to [System Units on page 207](#) for more information.

■ b5-39: PID User Unit Display Digits

No. (Hex.)	Name	Description	Default (Range)
b5-39 (01FF)	PID User Unit Display Digits	Sets the number of digits to set and show the PID setpoint.	2 (0 - 3)

Refer to [System Units on page 207](#) for more information.

0 : No Decimal Places (XXXXX)

1 : One Decimal Places (XXXX.X)

2 : Two Decimal Places (XXX.XX)

3 : Three Decimal Places (XX.XXX)

■ b5-41: PID Output 2 Unit

No. (Hex.)	Name	Description	Default (Range)
b5-41 (0160)	PID Output 2 Unit	Sets the display units in U5-14 [PID Out2 Upr4 Digits] and U5-15 [PID Out2 Lwr4 Digits].	0 (0 - 50)

0 : "WC: inches of water column

1 : PSI: pounds per square inch

2 : GPM: gallons/min

3 : °F: Fahrenheit**4 : ft³/min: cubic feet/min****5 : m³/h: cubic meters/hour****6 : L/h: liters/hour****7 : L/s: liters/sec****8 : bar: bar****9 : Pa: Pascal****10 : °C: Celsius****11 : m: meters****12 : ft: feet****13 : L/min: liters/min****14 : m³/min: cubic meters/min****15 : "Hg: Inch Mercury****16 : kPa: kilopascal****48 : %: Percent****49 : Custom(b5-68~70)****50 : None****■ b5-42: PID Output 2 Calc Mode**

No. (Hex.)	Name	Description	Default (Range)
b5-42 (0161) RUN	PID Output 2 Calc Mode	Sets how to calculate the original PID output.	0 (0 - 3)

0 : Linear

The monitor displays PID output

Note:

When the PID output is 0, *b5-45 [PID Out2 Monitor MIN for Linear]* will set the minimum value. If the minimum value is set to be more than or equal to the maximum value, *U5-14 [PID Out2 Upr4 Digits]* and *U5-15 [PID Out2 Lwr4 Digits]* will be limited to 0.

1 : Square Root

The monitor displays square root PID output

2 : Quadratic

The monitor displays $1/(\text{PID output})^2$

3 : Cubic

The monitor displays $1/(\text{PID output})^3$

Note:

Used for *U5-14* and *U5-15* only.

■ b5-43: PID Out2 Monitor MAX Upper4 Dig

No. (Hex.)	Name	Description	Default (Range)
b5-43 (0162) RUN	PID Out2 Monitor MAX Upper4 Dig	Sets the upper 4 digits of the maximum monitor value. Used with <i>b5-44 [PID Out2 Monitor MAX Lower4 Dig]</i> to set maximum monitor value of <i>U5-14 [PID Out2 Upr4 Digits]</i> and <i>U5-15 [PID Out2 Lwr4 Digits]</i> at maximum frequency.	0 (0 - 9999)

Note:

Used for *U5-14 [PID Out2 Upr4 Digits]* and *U5-15 [PID Out2 Lwr4 Digits]* only.

■ b5-44: PID Out2 Monitor MAX Lower4 Dig

No. (Hex.)	Name	Description	Default (Range)
b5-44 (0163) RUN	PID Out2 Monitor MAX Lower4 Dig	Sets the lower 4 digits of the maximum monitor value. Used with b5-43 [PID Out2 Monitor MAX Upper4 Dig] to set maximum monitor value of U5-14 [PID Out2 Upr4 Digits] and U5-15 [PID Out2 Lwr4 Digits] at maximum frequency.	0.00 (0.00 - 99.99)

Note:

Used for U5-14 [PID Out2 Upr4 Digits] and U5-15 [PID Out2 Lwr4 Digits] only.

■ b5-45: PID Out2 Monitor MIN for Linear

No. (Hex.)	Name	Description	Default (Range)
b5-45 (0164) RUN	PID Out2 Monitor MIN for Linear	Sets the minimum display value to show when at zero speed. Only effective when b5-42 = 0 [PID Output 2 Calc Mode = Linear].	0.0 (0.0 - 999.9)

Note:

Used for U5-14 [PID Out2 Upr4 Digits] and U5-15 [PID Out2 Lwr4 Digits] only.

■ b5-46: PID Unit Display Selection

No. (Hex.)	Name	Description	Default (Range)
b5-46 (0165)	PID Unit Display Selection	Sets the units-text for the PID Display.	48 (0 - 50)

Refer to [System Units on page 207](#) for more information.

0 : "WC: inches of water column

1 : PSI: pounds per square inch

2 : GPM: gallons/min

3 : °F: Fahrenheit

4 : ft³/min: cubic feet/min

5 : m³/h: cubic meters/hour

6 : L/h: liters/hour

7 : L/s: liters/sec

8 : bar: bar

9 : Pa: Pascal

10 : °C: Celsius

11 : m: meters

12 : ft: feet

13 : L/min: liters/min

14 : m³/min: cubic meters/min

15 : "Hg: Inch Mercury

16 : kPa: kilopascal

48 : %: Percent

49 : Custom(b5-68~70)

50 : None

■ b5-53: PID Integrator Ramp Limit

No. (Hex.)	Name	Description	Default (Range)
b5-53 (0B8F) RUN	PID Integrator Ramp Limit	Sets the responsiveness of PID control when the PID feedback changes quickly.	0.0 Hz (0.0 - 10.0 Hz)

Note:

- This parameter is disabled when set to 0.0 Hz.
- When $b5-53 > 0.0 \text{ Hz}$ and the drive enables the integrator ramp limit, the PID integrator value limit is the range set by the output frequency $\pm b5-53$.
- When the PID feedback changes quickly, gradually decrease this parameter in 0.1 Hz increments to decrease the speed of the response of PID control.

■ b5-61: PID Trim Mode Lower Limit Sel

No. (Hex.)	Name	Description	Default (Range)
b5-61 (119A)	PID Trim Mode Lower Limit Sel	Sets the function that adjusts the PID output in relation to the frequency reference.	0 (0, 1)

0 : Disabled

Does not adjust the PID output with the frequency reference.

1 : Enabled

Adjusts the PID output in relation to the frequency reference. The setting value of $b5-62$ [PID Trim Mode Lower Limit Value] sets the lower limit of the post-adjustment value. The maximum output frequency sets the upper limit.

Note:

- Set $b5-01 = 3$ [PID Mode Setting = Fref + PID Trim] to enable this parameter.
- When $b5-61 = 1$, you can use this formula to adjust PID output proportional to the frequency reference:

$$U5-03 = U5-03 \times \left| \frac{Fref}{Fmax} \right|^{*1}$$

$U5-03$ [PID Output], $Fref$ [Frequency Reference], and $Fmax$ [Maximum Output Frequency]

*1 Lower limit = $b5-62$, Upper limit = Maximum output frequency

■ b5-62: PID Trim Mode Lower Limit Value

No. (Hex.)	Name	Description	Default (Range)
b5-62 (119B)	PID Trim Mode Lower Limit Value	Sets the PID Trim Mode Lower Limit Value as a percentage of the maximum output frequency.	0.00% (0.00 - 100.00%)

Note:

Set $b5-01 = 3$ [PID Mode Setting = Fref + PID Trim] to enable this parameter.

■ b5-68: System Unit Custom Character 1

No. (Hex.)	Name	Description	Default (Range)
b5-68 (3C1F)	System Unit Custom Character 1	Sets the first character of the custom unit display when $b5-46 = 49$ [PID Unit Display Selection = Custom (B5-68~70)].	41 (20 - 7A)

Refer to [Custom Units on page 208](#) for more information about available selections.

■ b5-69: System Unit Custom Character 2

No. (Hex.)	Name	Description	Default (Range)
b5-69 (3C20)	System Unit Custom Character 2	Sets the second character of the custom unit display when $b5-46 = 49$ [PID Unit Display Selection = Custom (B5-68~70)].	41 (20 - 7A)

Refer to [Custom Units on page 208](#) for more information about available selections.

■ b5-70: System Unit Custom Character 3

No. (Hex.)	Name	Description	Default (Range)
b5-70 (3C21)	System Unit Custom Character 3	Sets the third character of the custom unit display when $b5-46 = 49$ [PID Unit Display Selection = Custom (B5-68~70)].	41 (20 - 7A)

Refer to [Custom Units on page 208](#) for more information about available selections.

■ b5-71: Min PID Transducer Scaling

No. (Hex.)	Name	Description	Default (Range)
b5-71 (3C22)	Min PID Transducer Scaling	Sets the minimum PID level corresponding to the lowest analog input signal level.	0.00 (-99.99 - +99.99)

Note:

- To enable this parameter, you must set $b5-71 < b5-38$ [PID User Unit Display Scaling]. If you set $b5-71 > b5-38$, the drive will disable all PID analog inputs.
- Parameters $b5-46$ [PID Unit Display Selection], $b5-38$, and $b5-39$ [PID User Unit Display Digits] set the unit, range, and resolution.

When you set $b5-71 < 0$, the drive appropriately scales the setpoint and feedback values of the drive, but internally limits to 0 when the reported value from the transducer is negative.

Figure 5.26 shows an example of the transducer scaling lower limit when:

- $b5-01 = 1$ [PID Mode Setting = Standard]
- $b5-46 = 3$ [°F: Fahrenheit]
- $b5-71 < 0.00$
- $H3-09 = 0$ [Terminal A2 Signal Level Select = 0-10V (LowLim=0)]
- $H3-10 = B$ [Terminal A2 Function Selection = PID Feedback]

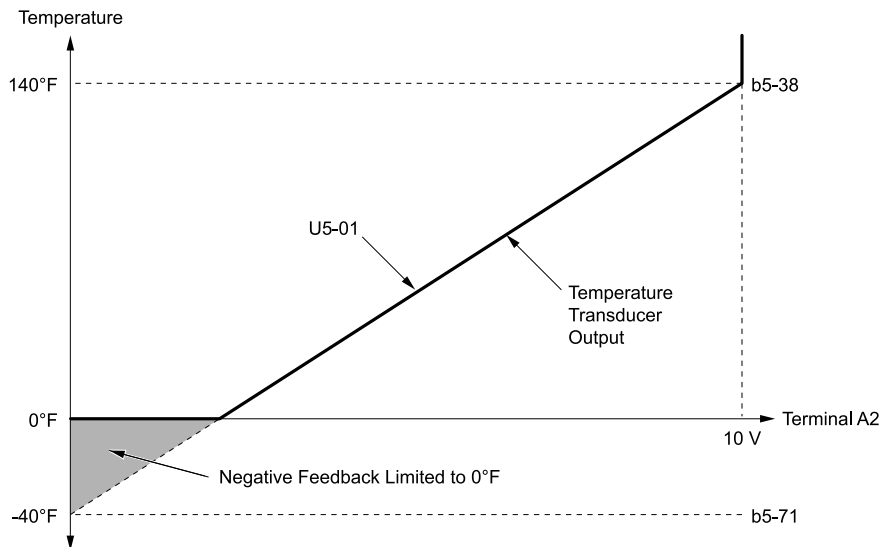

b5-38: PID User Unit Display Scaling
b5-71: Min PID Transducer Scaling

U5-01: PID Feedback

Figure 5.26 Transducer Scaling Lower Limit

■ b5-82: Feedback Loss 4 ~ 20mA Detect Sel

No. (Hex.)	Name	Description	Default (Range)
b5-82 (31B0)	Feedback Loss 4 ~ 20mA Detect Sel	Sets the drive to do a 4 to 20 mA wire-break detection on the analog input set for PID feedback.	2 (0 - 3)

0 : Disabled

1 : Alarm Only

2 : Fault

Note:

When $b5-82 = 2$, PID feedback detection will trigger an alarm if one of these conditions is true:

- The drive is in HAND Mode
- The drive is not in AUTO Mode

3 : Run At $b5-83$

If the drive detects a Wire-Break, the drive will respond as specified by $b5-82$.

Note:

- A: The keypad shows an *FDBKL [Feedback Loss Wire Break]* alarm.
- F: The drive detects an *FDBKL [WIRE Break]* fault.
- R: The drive operates at $b5-83$ [*Feedback Loss GoTo Frequency*] and shows an *FDBKL* alarm.

b5-82 Setting	Drive Mode							
	OFF	Pre-Charge	AUTO (Simplex)	HAND Mode PID	Sleep Boost	Y2-08 [Delta Feedback Drop Level]	Sleep	HAND Mode
0	-	-	-	-	-	-	-	-
1	A	A	A	A	A	A	A	A
2	A	F	F	F	F	F	F	A
3	A	R *1	R	R	R	R	R	A

*1 The drive will operate at $Y4-02$ [*Pre-Charge Frequency*] while Pre-Charge is active.

Note:

- If the drive is set in a mode where the fault will occur, the drive will detect the fault only when the drive is in operation. If the drive is not in operation, the drive will detect an alarm. Refer to [Figure 5.27](#) for an example where $b5-82 = 2$ [*Fault*] and the drive is OFF.
- If the Feedback Loss fault is set to $L5-42 = 1$ [*Feedback Loss Fault Retry Select = Retry*], the drive will use the $L5-04$ [*Interval Method Restart Time*] timer when it Auto-Restarts.

PID Feedback Loss Detection Start Delay

You can use $b5-86$ [*Feedback Loss Start Delay*] to delay the PID Feedback Loss Detection at start. Feedback Loss detection will still be active when $b5-86$ timer has started, but the drive will only detect an alarm. When $b5-86$ expires, the drive will use the $b5-82$ setting to start the appropriate action. Refer to [Figure 5.27](#) for more information.

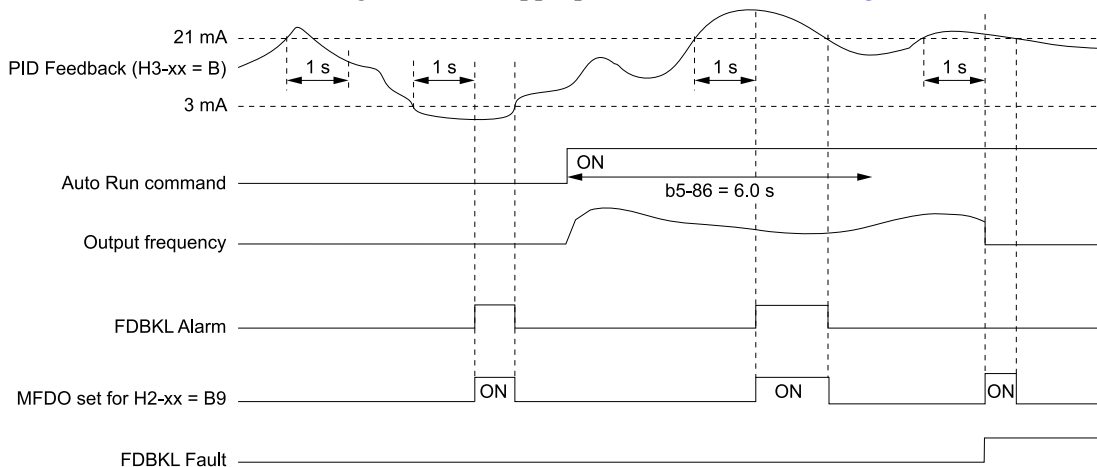

b5-86: Feedback Loss Start Delay
H2-xx = B9: Transducer Loss
H3-xx = B: PID Feedback

FDBKL Alarm: Feedback Loss Wire Break
FDBKL Fault: WIRE Break

Figure 5.27 Time Chart for the Wire Break Detection when $b5-82 = 2$ [Fault]

PID Feedback Loss Go To Frequency Timeout

The drive will apply this feature only when $b5-82 = 3$ [Run At $b5-83$] and it detects a Feedback Loss. Parameter $b5-85$ [Feedback Loss GoTo Freq Timeout] sets the length of time that the drive will run at the frequency set in $b5-83$ [Feedback Loss GoTo Frequency].

- When $b5-85 = 0$ sec, the drive will operate at the $b5-83$ speed indefinitely.
- When $b5-85 > 0$ sec, the drive will only operate at the $b5-83$ speed for the time specified in $b5-85$, after which the drive will fault on an *FDBKL* [WIRE Break] fault.

Refer to [Figure 5.28](#) for more information.

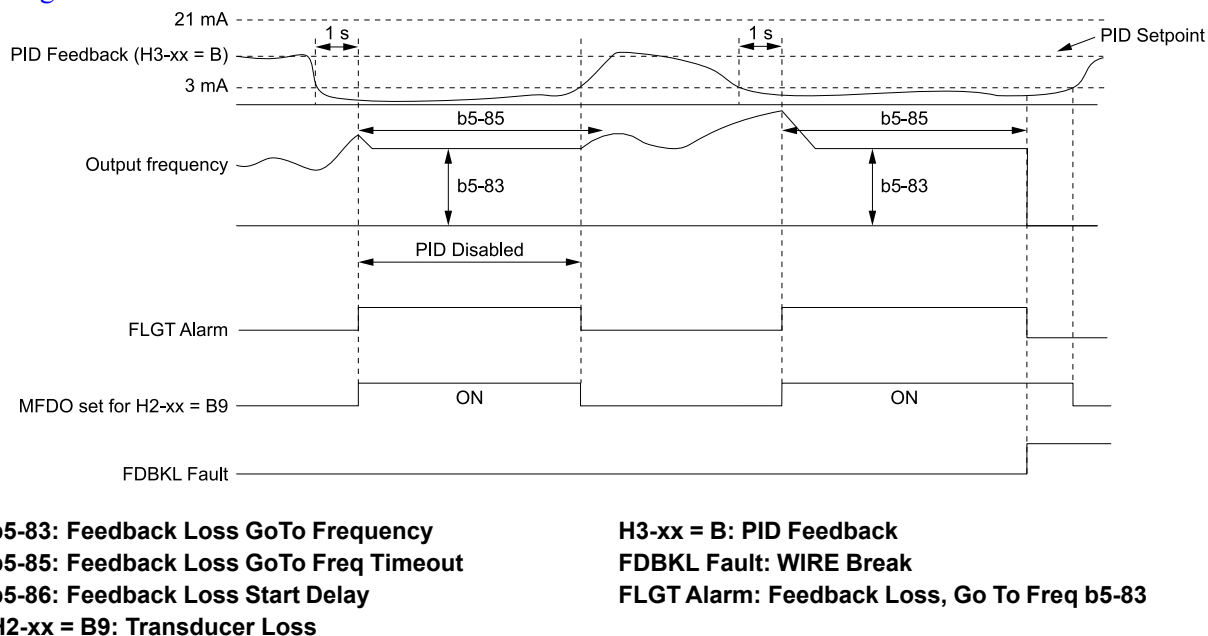

Figure 5.28 Time Chart for the Wire Break Detection when $b5-82 = 3$

Backup PID Feedback Transducer Input

When you set $H3-xx = 24$ [MFAI Function Selection = PID Feedback Backup], the drive will activate the PID Feedback Backup signal.

- If the primary PID Feedback ($H3-xx = B$ [PID Feedback]) is lost, the system will automatically use the backup PID Feedback from the MFAI terminal set for $H3-xx = 24$ and flash a *Bu-Fb* [Main Fdbk Lost Using Backup Fdbk] alarm.
- If the main PID Feedback is operational, but the backup PID Feedback is lost, the drive will show a *BuFbl* [Backup Fdbk Lost Chk/Repl Xducer] alarm. If the main and backup PID Feedback devices are lost, the drive will use the $b5-82$ [Feedback Loss 4 ~ 20mA Detect Sel] setting.

Note:

To enable the *FDBKL* [WIRE Break] detection correctly, use a 4 to 20 mA operation in these conditions:

- Use a 4 to 20 mA signal for transducers.
 - Program the drive analog inputs and set Jumper Switch S1 to "I" for current input.
- If you set the analog input for voltage, the drive will disable the detection mechanism.

■ b5-83: Feedback Loss GoTo Frequency

No. (Hex.)	Name	Description	Default (Range)
b5-83 (31B1) RUN	Feedback Loss GoTo Frequency	Sets the speed at which the drive will run if the drive detects a 4 to 20 mA wire-break on the PID Feedback and $b5-82 = 3$ [Feedback Loss 4 ~ 20mA Detect Sel = Run At $b5-83$].	0.0 Hz (0.0 - 400.0 Hz)

■ b5-84: Feedback Loss Loss Of Prime Lvl

No. (Hex.)	Name	Description	Default (Range)
b5-84 (31B2) RUN	Feedback Loss Loss Of Prime Lvl	Sets the level at which the drive will detect Loss of Prime in the pump.	0.0 A (0.0 - 1000.0 A)

Note:

- Loss of Prime condition occurs when the measured quantity set by Y1-18 [Prime Loss Detection Method] decreases to this level for the time set in Y1-20 [Loss of Prime Time] and the output frequency is at the Y4-02 [Pre-Charge Frequency] level. The drive will respond to the Loss of Prime condition as specified by Y1-22 [Loss of Prime Selection].
- Display unit and scaling are dependent on System Units.

■ b5-85: Feedback Loss GoTo Freq Timeout

No. (Hex.)	Name	Description	Default (Range)
b5-85 (31B3) RUN	Feedback Loss GoTo Freq Timeout	When b5-82 = 3 [Feedback Loss 4 ~ 20mA Detect Sel = Run At b5-83] and the Feedback signal is lost, the drive will run at the b5-83 [Feedback Loss Goto Frequency] speed for this length of time, after which the drive will fault on FDBKL [WIRE Break].	0 s (0 - 6000 s)

Note:

Set this parameter to 0.0 s to disable the function.

■ b5-86: Feedback Loss Start Delay

No. (Hex.)	Name	Description	Default (Range)
b5-86 (31B4) RUN	Feedback Loss Start Delay	When you initiate an AUTO Run command, the drive will wait for this length of time before it will fault on FDBKL [WIRE Break] or use parameter b5-83 [Feedback Loss Goto Frequency].	0.0 s (0.0 - 120.0 s)

◆ b8: Energy Saving

Energy-saving control operates the motor at its most efficient level to improve overall system operating efficiency.

When you use V/f Control, set these parameters:

- b8-01 [Energy Saving Control Selection]
- b8-04 [Energy Saving Coefficient Value]
- b8-05 [Power Detection Filter Time]
- b8-06 [Search Operation Voltage Limit]

Note:

- Energy-saving control is not appropriate for applications with sudden changes in the load or applications driving heavy loads.
- Energy-saving control maximizes operation based on precise motor data set to the drive. Do Auto-Tuning and enter the correct information about the motor before you use Energy-saving control.

■ b8-01: Energy Saving Control Selection

No. (Hex.)	Name	Description	Default (Range)
b8-01 (01CC)	Energy Saving Control Selection	Sets the Energy-saving control function.	0 (0, 1)

0 : Disabled

1 : Enabled

■ b8-04: Energy Saving Coefficient Value

No. (Hex.)	Name	Description	Default (Range)
b8-04 (01CF) Expert	Energy Saving Coefficient Value	Sets the Energy-saving control coefficient to maintain maximum motor efficiency. The default setting is for Yaskawa motors.	Determined by E2-11 and o2-04 (0.00 - 655.00)

When you use a motor from a different manufacturer, increase the setting value in 5% increments to find the minimum value for *U1-08 [Output Power]* at light loads.

When you decrease the setting value, it decreases the output voltage and decreases power consumption. If the setting value is too low, the motor will stall.

Note:

- When you do Rotational Auto-Tuning, the drive will automatically set the energy-saving coefficient.
- The minimum values and the maximum values are different for different drive models:
- 2011 to 2024, 4005 to 4008: 0.0 - 2000.0
- 2031 to 2273, 4011 to 4302: 0.00 - 655.00

■ b8-05: Power Detection Filter Time

No. (Hex.)	Name	Description	Default (Range)
b8-05 (01D0) Expert	Power Detection Filter Time	Sets the time constant to measure output power.	20 ms (0 - 2000 ms)

Decrease the setting value to increase responsiveness to load changes. If you set the value too low during operation at light loads, motor speed is not stable.

■ b8-06: Search Operation Voltage Limit

No. (Hex.)	Name	Description	Default (Range)
b8-06 (01D1) Expert	Search Operation Voltage Limit	Sets the voltage limit for Search Operation as a percentage of the motor rated voltage.	0% (0 - 100%)

The Search Operation changes the output voltage in small increments to find a setpoint at which the drive can use minimum power to operate.

Set this parameter to 0 to disable Search Operation. This will not disable Energy-saving control.

If the setting value is too low, the motor will stall when loads suddenly increase.

5.3 C: Tuning

C parameters adjust drive operation, including:

- Acceleration Time
- Deceleration Time
- Slip Compensation
- Torque Compensation
- Carrier Frequency

◆ C1: Accel & Decel Time

You can set two different acceleration and deceleration time pairs in the drive. When you activate and deactivate *H1-xx = 7* [*MFDI Function Selection = Accel/Decel Time Selection*], you can switch acceleration and deceleration times during run.

Acceleration time parameters always set the time to accelerate from 0 Hz to *E1-04* [*Maximum Output Frequency*]. Deceleration time parameters always set the time to decelerate from *E1-04* to 0 Hz.

C1-01 [*Acceleration Time 1*] and *C1-02* [*Deceleration Time 1*] are the default active accel/decel settings.

Parameter	Range
<i>C1-01</i> [Acceleration Time 1]	0.1 to 6000.0 s
<i>C1-02</i> [Deceleration Time 1]	
<i>C1-03</i> [Acceleration Time 2]	
<i>C1-04</i> [Deceleration Time 2]	

■ Use MFDIs to Switch Acceleration Times

Table 5.29 shows the different acceleration and deceleration times.

Table 5.29 Accel/Decel Times and Active Parameters

<i>H1-xx = 7</i> [Accel/Decel Time Selection 1]	Active Parameter	
	Acceleration Time	Deceleration Time
OFF	<i>C1-01</i> [Acceleration Time 1]	<i>C1-02</i> [Deceleration Time 1]
ON	<i>C1-03</i> [Acceleration Time 2]	<i>C1-04</i> [Deceleration Time 2]

Figure 5.29 shows an operation example to change acceleration and deceleration times. It is necessary to set *b1-03 = 0* [*Stopping Method Selection = Ramp to Stop*] for this example.

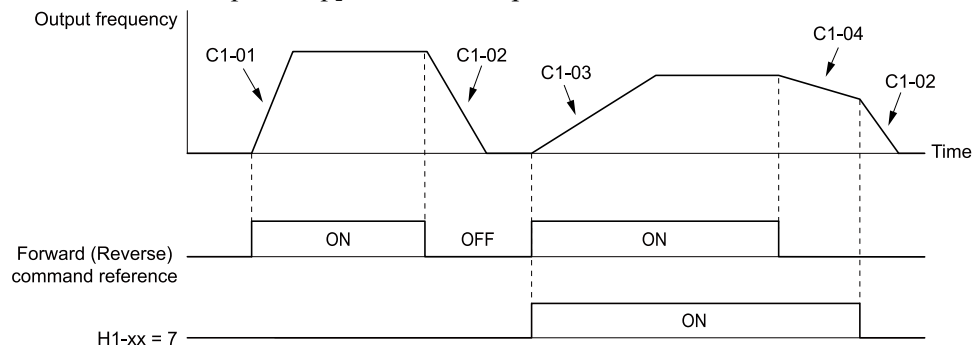

C1-01: Acceleration Time 1
C1-02: Deceleration Time 1
C1-03: Acceleration Time 2

C1-04: Deceleration Time 2
H1-xx = 7: Accel/Decel Time Selection 1

Figure 5.29 Timing Diagram of Acceleration and Deceleration Times

■ C1-01: Acceleration Time 1

No. (Hex.)	Name	Description	Default (Range)
C1-01 (0200) RUN	Acceleration Time 1	Sets the length of time to accelerate from zero to maximum output frequency.	30.0 s (0.1 - 6000.0 s)

■ C1-02: Deceleration Time 1

No. (Hex.)	Name	Description	Default (Range)
C1-02 (0201) RUN	Deceleration Time 1	Sets the length of time to decelerate from maximum output frequency to zero.	30.0 s (0.1 - 6000.0 s)

■ C1-03: Acceleration Time 2

No. (Hex.)	Name	Description	Default (Range)
C1-03 (0202) RUN	Acceleration Time 2	Sets the length of time to accelerate from zero to maximum output frequency.	30.0 s (0.1 - 6000.0 s)

■ C1-04: Deceleration Time 2

No. (Hex.)	Name	Description	Default (Range)
C1-04 (0203) RUN	Deceleration Time 2	Sets the length of time to decelerate from maximum output frequency to zero.	30.0 s (0.1 - 6000.0 s)

■ C1-09: Fast Stop Time

No. (Hex.)	Name	Description	Default (Range)
C1-09 (0208) RUN	Fast Stop Time	Sets the length of time that the drive will decelerate to zero for a Fast Stop.	10.0 s (0.1 - 6000.0 s)

These conditions will start the Fast Stop function:

- When the drive received the Fast Stop command from the MFDI terminal
 - When you set *Fast Stop (Use C1-09)* for a parameter to set a stopping method when the drive detected a fault
- Set $H1-xx = 15, 17$ [*MFDI Function Selection = Fast Stop (N.O.), Fast Stop (N.C.)*].

When the drive receives the Fast Stop command, the motor ramps to stop in the deceleration time set in *C1-09*. After the drive receives the Fast Stop command, you cannot start the drive operation again until deceleration is complete. To clear the Fast Stop condition, deactivate the Fast Stop command, deactivate the Run command, then activate the Run command again.

The terminal set for $H2-xx = 4C$ [*MFDO Function Selection = During Fast Stop*] will activate during Fast Stop.

Note:

If you decelerate the drive too quickly, the drive will detect an *ov [Overvoltage]* fault and shut off the output, and the motor will coast to stop. To prevent motor coasting and stop the motor quickly and safely, make sure to set a Fast Stop time in *C1-09*.

◆ C2: S-Curve Characteristics

Use S-curve characteristics to smooth acceleration and deceleration and to minimize abrupt shock to the load.

Set S-curve characteristic time during acceleration/deceleration at start and acceleration/deceleration at stop.

The following figure explains how S-curves are applied.

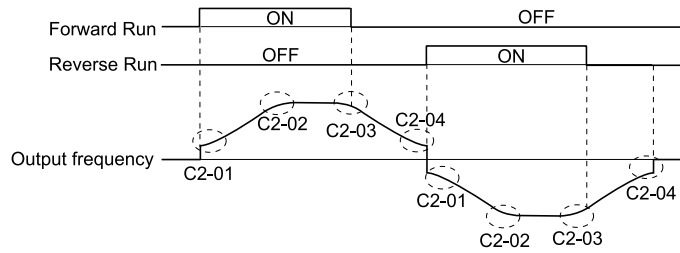

Figure 5.30 S-Curve Timing Diagram - Forward/Reverse Operation

Note:

- Setting the S-curve will increase the acceleration and deceleration times.

$$\text{Acceleration time} = \text{Selected acceleration time} + \frac{C2-01 + C2-02}{2}$$

$$\text{Deceleration time} = \text{Selected deceleration time} + \frac{C2-03 + C2-04}{2}$$

■ **C2-01: S-Curve Time @ Start of Accel**

No. (Hex.)	Name	Description	Default (Range)
C2-01 (020B)	S-Curve Time @ Start of Accel	Sets the S-curve acceleration time at start.	0.20 s (0.00 - 10.00 s)

■ **C2-02: S-Curve Time @ End of Accel**

No. (Hex.)	Name	Description	Default (Range)
C2-02 (020C)	S-Curve Time @ End of Accel	Sets the S-curve acceleration time at completion.	0.20 s (0.00 - 10.00 s)

■ **C2-03: S-Curve Time @ Start of Decel**

No. (Hex.)	Name	Description	Default (Range)
C2-03 (020D)	S-Curve Time @ Start of Decel	Sets the S-curve deceleration time at start.	0.20 s (0.00 - 10.00 s)

■ **C2-04: S-Curve Time @ End of Decel**

No. (Hex.)	Name	Description	Default (Range)
C2-04 (020E)	S-Curve Time @ End of Decel	Sets the S-curve deceleration time at completion.	0.00 s (0.00 - 10.00 s)

◆ **C3: Slip Compensation**

The Slip Compensation function improves the speed accuracy of an induction motor. As loads on induction motors increase, motor slip increases and motor speed decreases. By adjusting the output frequency in accordance with the motor load, it compensates the slip and makes the motor speed equal to the frequency reference.

■ **C3-01: Slip Compensation Gain**

No. (Hex.)	Name	Description	Default (Range)
C3-01 (020F) RUN	Slip Compensation Gain	Sets the gain for the slip compensation function. Usually it is not necessary to change this setting.	0.0 (0.0 - 2.5)

Note:

Correctly set these parameters before you change the slip compensation gain:

- E2-01 [Motor Rated Current (FLA)]
- E2-02 [Motor Rated Slip]
- E2-03 [Motor No-Load Current]

Use these settings to adjust this parameter as necessary:

- If the motor speed is slower than the frequency reference, increase the setting of this parameter in 0.1-unit increments.
- If the motor speed is higher than the frequency reference, decrease the setting of this parameter in 0.1-unit increments.

■ C3-02: Slip Compensation Delay Time

No. (Hex.)	Name	Description	Default (Range)
C3-02 (0210) RUN	Slip Compensation Delay Time	Sets the slip compensation delay time when speed is unstable or when the slip compensation response is too slow. Usually it is not necessary to change this setting.	2000 ms (0 - 10000 ms)

Use these settings to adjust this parameter as necessary:

- When the speed is not stable, increase the setting.
- When the slip compensation response is too slow, decrease the setting.

◆ C4: Torque Compensation

Torque compensation is a function that increases voltage to increase output torque as compensation for insufficient torque production at start-up or low-speed operation.

Voltage drops due to motor winding resistance cause torque generating voltage to decrease, which causes insufficient torque. If the main circuit cable connecting the drive and motor is long, this can also cause insufficient torque due to voltage drops.

Note:

Set the motor parameters and V/f pattern properly before setting C4 parameters.

■ C4-01: Torque Compensation Gain

No. (Hex.)	Name	Description	Default (Range)
C4-01 (0215) RUN	Torque Compensation Gain	Sets the gain for the torque compensation function. Use this parameter value for motor 1 when you operate multiple motors.	1.00 (0.00 - 2.50)

Adjust the setting in these conditions:

Status	Adjustment
Torque is not sufficient during low-speed operation of 10 Hz or less.	Increase the setting in 0.05-unit increments.
There is vibration in the motor when you operate the drive with a light load.	Decrease the setting in 0.05-unit decrements.
The cable between the drive and motor is too long.	Increase the setting in 0.05-unit increments.

Note:

Adjust C4-01 to make sure that the output current is not more than the drive rated current during low-speed operation.

■ C4-02: Torque Compensation Delay Time

No. (Hex.)	Name	Description	Default (Range)
C4-02 (0216) RUN	Torque Compensation Delay Time	Sets the torque compensation delay time. Usually it is not necessary to change this setting.	200 ms (0 - 60000 ms)

Set this parameter in these conditions:

- If there is vibration in the motor, increase the setting.
- If the motor speed or motor torque response is too slow, decrease the setting.

◆ C6: Carrier Frequency

C6 parameters select the carrier frequency and set the upper and lower limits of carrier frequencies.

■ C6-02: Carrier Frequency Selection

No. (Hex.)	Name	Description	Default (Range)
C6-02 (0224)	Carrier Frequency Selection	Sets the carrier frequency for the transistors in the drive.	Determined by o2-04 (1 - F)

Changes to the switching frequency will decrease audible noise and decrease leakage current.

Note:

When you increase the carrier frequency to more than the default setting, it will automatically decrease the drive current rating.

1 : 2.0 kHz

2 : 5.0 kHz

3 : 8.0 kHz

4 : 10.0 kHz

5 : 12.5 kHz

7 : Swing PWM1 (Audible Sound 1)

8 : Swing PWM2 (Audible Sound 2)

9 : Swing PWM3 (Audible Sound 3)

A : Swing PWM4 (Audible Sound 4)

B : Leakage Current Rejection PWM

F : User Defined (C6-03 to C6-05)

Use *C6-03 to C6-05* to set detailed setting values.

Note:

- The carrier frequency for Swing PWM 1 to 4 is equivalent to 2.0 kHz. Swing PWM applies a special PWM pattern to decrease the audible noise.
- Setting *B* uses a PWM pattern that decreases the leakage current that the drive detects over long wiring distances. This can help decrease alarm detection and decrease problems with the current monitor from leakage current over long wiring distances.

Table 5.30 Guidelines for Carrier Frequency Parameter Setup

Symptom	Remedy
Speed and torque are not stable at low speed.	Decrease the carrier frequency.
Speed and torque are not stable at low speed.	Decrease the carrier frequency.
Too much leakage current from the drive.	Decrease the carrier frequency.
Wiring between the drive and motor is too long.	Decrease the carrier frequency. Note: If the motor cable is too long, it can be necessary to decrease the carrier frequency. Refer to Table 5.31 for the wiring distance and decrease the carrier frequency.
Audible motor noise is too loud.	Increase the carrier frequency. Use Swing PWM. Note: The default carrier frequency is Swing PWM 1 (<i>C6-02</i> = 7), with a 2 kHz base. You can increase the carrier frequency, but this will also decrease the drive rated current.

Table 5.31 Wiring Distance

Wiring Distance	50 m (164 ft) Maximum	100 m (328 ft) Maximum	More than 100 m (328 ft)
C6-02 [Carrier Frequency Selection]	1 to F (12.5 kHz maximum)	1 to 2 (5 kHz maximum), 7	1 (2 kHz maximum), 7

Note:

When the wiring length for bypass models B1P1 and B001 to B007 is more than 10 m, you must decrease the carrier frequency or output current.

■ C6-03: Carrier Frequency Upper Limit

No. (Hex.)	Name	Description	Default (Range)
C6-03 (0225)	Carrier Frequency Upper Limit	Sets the upper limit of the carrier frequency. Set $C6-02 = F$ [Carrier Frequency Selection = User Defined (C6-03 to C6-05)] to set this parameter.	Determined by C6-02 (1.0 - 12.5 kHz)

Setting a Fixed User-Defined Carrier Frequency

When you cannot use $C6-02$ to set a carrier frequency between set selectable values, you can set the value in $C6-03$. The carrier frequency will be fixed to the value set to $C6-03$.

Set $C6-03 = C6-04$ [Carrier Frequency Lower Limit] to fix the carrier frequency.

Setting a Variable Carrier Frequency to Agree with the Output Frequency

Set $C6-03$, $C6-04$, and $C6-05$ [Carrier Freq Proportional Gain] as shown in Figure 5.31 to make the carrier frequency change linearly with the output frequency.

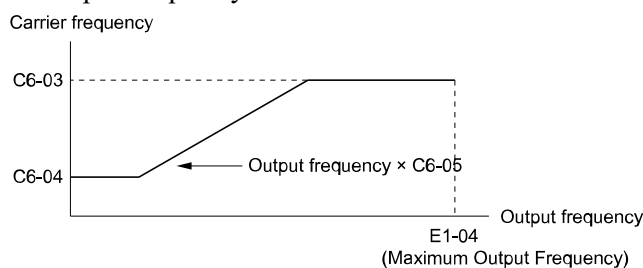

C6-03: Carrier Frequency Upper Limit

C6-04: Carrier Frequency Lower Limit

C6-05: Carrier Freq Proportional Gain

E1-04: Maximum Output Frequency

Figure 5.31 Setting a Variable Carrier Frequency to Agree with the Output Frequency

Note:

- When $C6-05 \leq 7$, the drive disables $C6-04$. The carrier frequency is fixed to the value set to $C6-03$.
- If these conditions are true at the same time, the drive will detect $oPE11$ [Carrier Frequency Setting Error]:
 - $C6-05 \geq 6$
 - $C6-04 \geq C6-03$

■ C6-04: Carrier Frequency Lower Limit

No. (Hex.)	Name	Description	Default (Range)
C6-04 (0226)	Carrier Frequency Lower Limit	Sets the lower limit of the carrier frequency. Set $C6-02 = F$ [Carrier Frequency Selection = User Defined (C6-03 to C6-05)] to set this parameter.	Determined by C6-02 (1.0 - 12.5 kHz)

Set $C6-03$ [Carrier Frequency Upper Limit], $C6-04$, and $C6-05$ [Carrier Freq Proportional Gain] to make the carrier frequency change linearly with the output frequency.

Note:

If these conditions are true at the same time, the drive will detect $oPE11$ [Carrier Frequency Setting Error]:

- $C6-04 \geq C6-03$
- $C6-05 \geq 6$

■ C6-05: Carrier Freq Proportional Gain

No. (Hex.)	Name	Description	Default (Range)
C6-05 (0227)	Carrier Freq Proportional Gain	Sets the proportional gain for the carrier frequency. Set $C6-02 = F$ [Carrier Frequency Selection = User Defined (C6-03 to C6-05)] to set this parameter.	Determined by C6-02 (0 - 99)

5.3 C: Tuning

Set *C6-03 [Carrier Frequency Upper Limit]*, *C6-04 [Carrier Frequency Lower Limit]*, and *C6-05* to make the carrier frequency change linearly with the output frequency.

5.4 d: References

d parameters [References] set the frequency reference input method and dead band range. They also set the field weakening function.

WARNING! Sudden Movement Hazard. Use fast stop circuits to safely and quickly stop the drive. After you wire the fast stop circuits, you must check their operation. Test the operation of the fast stop function before you use the drive. If you do not test the fast stop circuit before you operate the drive, it can cause serious injury or death.

◆ d1: Frequency Reference

Figure 5.32 shows the frequency reference input method, command source selection method and priority descriptions.

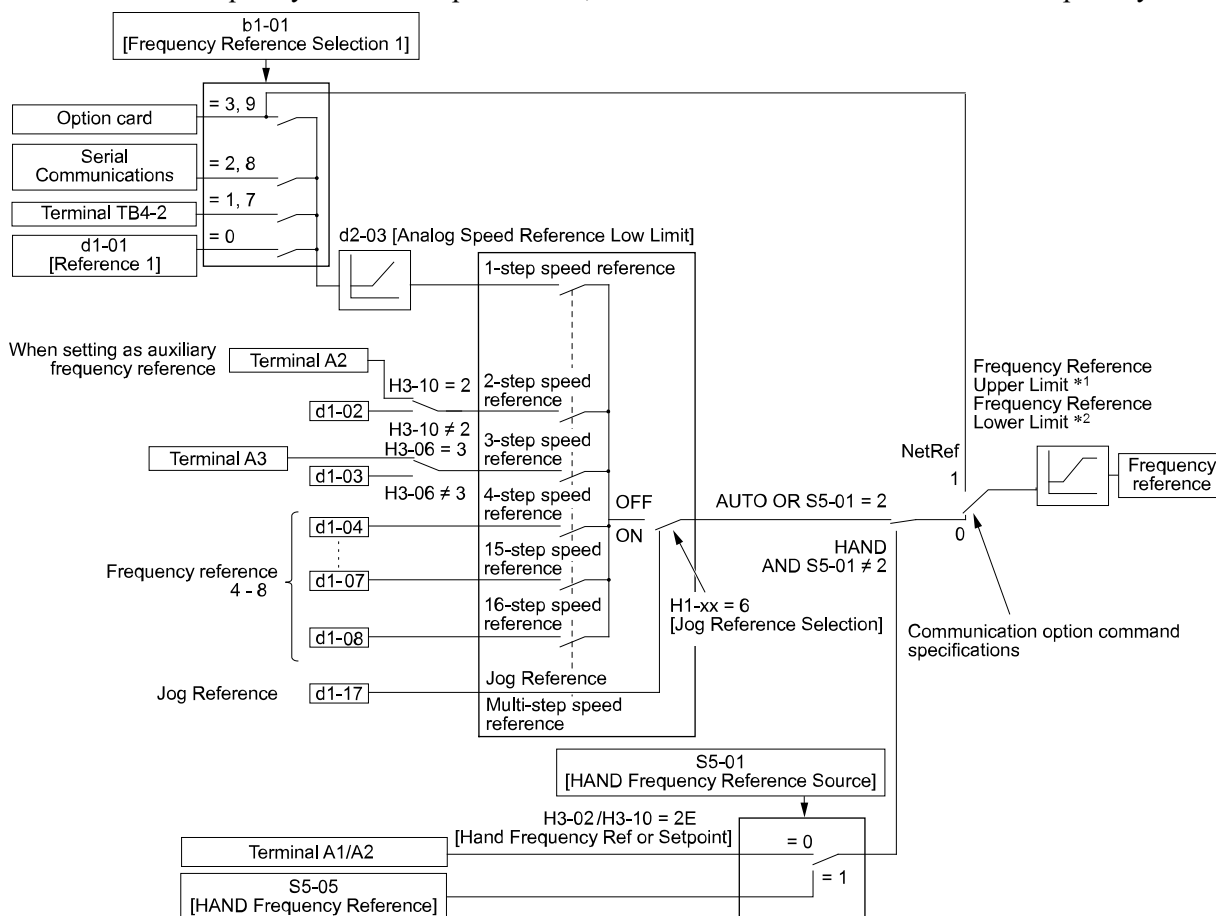

Figure 5.32 Frequency Reference Setting Hierarchy

- *1 The drive uses the smallest value of *Y1-40* [Maximum Speed], *E1-04* [Maximum Output Frequency], or *d2-01* [Frequency Reference Upper Limit] for Frequency Reference Upper Limit. When the drive is in Emergency Override Mode, it uses the smallest value of *Y1-40*, *E1-04*, *d2-01*, or *S6-10* [Emergency Override Max Speed].
- *2 The drive uses the largest value of *Y1-06* [Minimum Speed], *Y4-12* [Thrust Frequency], or *d2-02* [Frequency Reference Lower Limit] for Frequency Reference Lower Limit. When the drive is in Emergency Override Mode, it uses the largest value of *Y1-06*, *Y4-12*, *d2-02*, or *S6-09* [Emergency Override Min Speed].

■ Multi-Step Speed Operation

The drive has a multi-step speed operation function that can set many frequency references in advance. Set frequency references in *d1-xx* parameters. You can select the set frequency references with MFDI signals from an external source. Activate and deactivate the digital input to select the frequency reference to change the motor speed in steps. You can use the 8-step frequency reference and one Jog Frequency Reference (JOG command) to switch the speed to the maximum 9-step speeds.

Note:

- The Jog Frequency Reference (JOG command) overrides all other frequency references.
- You can use the MFDI to switch the frequency reference when the motor is running. The drive will apply the enabled acceleration and deceleration times.

■ Setting Procedures for Multi-step Speed Operation

Use an Analog Input as Reference 1 and 2

This section gives information about the procedures to set these examples:

- Multi-Step Speed 6 (6 types of frequency references)
- Use Terminal TB4-2 on Bypass Control PCB A2 as a 0 to 10 VDC analog frequency reference.
- Use drive terminal A2 as an alternate 0 to 10 VDC analog frequency reference.

Procedure	Configuration Parameter	Task Contents
1	Reference 1	1. Set $b1-01 = 1$ [Frequency Reference Selection 1 = Analog Input]. 2. Set $Z2-30 = 0$ [Analog Input Signal Level Select = 0 to 10 V (Lower Limit at 0)].
2	Reference 2	1. Set $H3-10 = 2$ [Terminal A2 Function Selection = Auxiliary Frequency Reference 1]. 2. Set $H3-09 = 0$ [Terminal A2 Signal Level Select = 0 to 10 V (Lower Limit at 0)].
3	Signal type of analog input	Make sure that the S2 switch on Bypass Control PCB A2 is set to the V-side (voltage). Set Jumper switch S1 on the control circuit board to the V-side (voltage) to set terminal A2 for voltage input. Note: Set this before you energize the drive.
4	Reference 3	Set the value of $d1-03$ [Reference 3].
5	Reference 4	Set the value of $d1-04$ [Reference 4].
6	Reference 5	Set the value of $d1-05$ [Reference 5].
7	Jog Reference	Set $d1-17$ [Jog Reference] to the jog speed.
8	External digital input (3 inputs)	Set the Multi-Step Speed Reference 1 to 3 [$H1-xx = 3, 4, 5$] to one of the MFDI terminals S1 to S7.
9	JOG command	Set the Jog Reference Selection [$H1-xx = 6$] to one of the MFDI terminals S1 to S7.

Use the Maximum 9-Step Speed with All Digital Inputs

This section is the procedure to set the 9-step speeds (9 types of frequency references) without an analog input.

Procedure	Configuration Parameter	Task Contents
1	Reference 1	1. Set $b1-01 = 0$ [Frequency Reference Selection 1 = Keypad]. 2. Set the value of $d1-01$ [Reference 1].
2	Reference 2	Set the value of $d1-02$ [Reference 2].
3	Reference 3	1. Set $H3-10 = F$ [Terminal A2 Function Selection = Not Used], and disables the analog reference. 2. Set the value of $d1-03$ [Reference 3].
4	Reference 4 to 8	Set the values of $d1-04$ to $d1-08$ [Reference 4 to 8].
5	Jog Reference	Set $d1-17$ [Jog Reference] to the jog speed.
6	External digital input (4 inputs)	Set Multi-Step Speed Reference 1 to 4 [$H1-xx = 3, 4, 5, 32$] to one of the MFDI terminals S1 to S7.
7	JOG command	Set the Jog Reference Selection [$H1-xx = 6$] to one of the MFDI terminals S1 to S7.

Multi-step Speed Operation Combinations

Refer to [Table 5.32](#) and [Figure 5.33](#) for information about multi-step speed reference combinations. The selected frequency reference changes when the combination of digital input signals from an external source changes.

Table 5.32 Multi-step Speed Reference and MFDI Terminal Combinations

Related Parameters	Multi-Step Speed Reference 1 $H1-xx = 3$	Multi-Step Speed Reference 2 $H1-xx = 4$	Multi-Step Speed Reference 3 $H1-xx = 5$	Jog Reference $H1-xx = 6$
Reference 1 (set in $b1-01$)	OFF	OFF	OFF	OFF
Reference 2 ($d1-02$ or terminals A1, A2)	ON	OFF	OFF	OFF
Reference 3 ($d1-03$ or terminals A1, A2)	OFF	ON	OFF	OFF

Related Parameters	Multi-Step Speed Reference 1 H1-xx = 3	Multi-Step Speed Reference 2 H1-xx = 4	Multi-Step Speed Reference 3 H1-xx = 5	Jog Reference H1-xx = 6
Reference 4 (d1-04)	ON	ON	OFF	OFF
Reference 5 (d1-05)	OFF	OFF	ON	OFF
Reference 6 (d1-06)	ON	OFF	ON	OFF
Reference 7 (d1-07)	OFF	ON	ON	OFF
Reference 8 (d1-08)	ON	ON	ON	OFF
Jog Reference (d1-17) *1	-	-	-	ON

*1 The Jog Frequency Reference (JOG command) overrides all other frequency references.

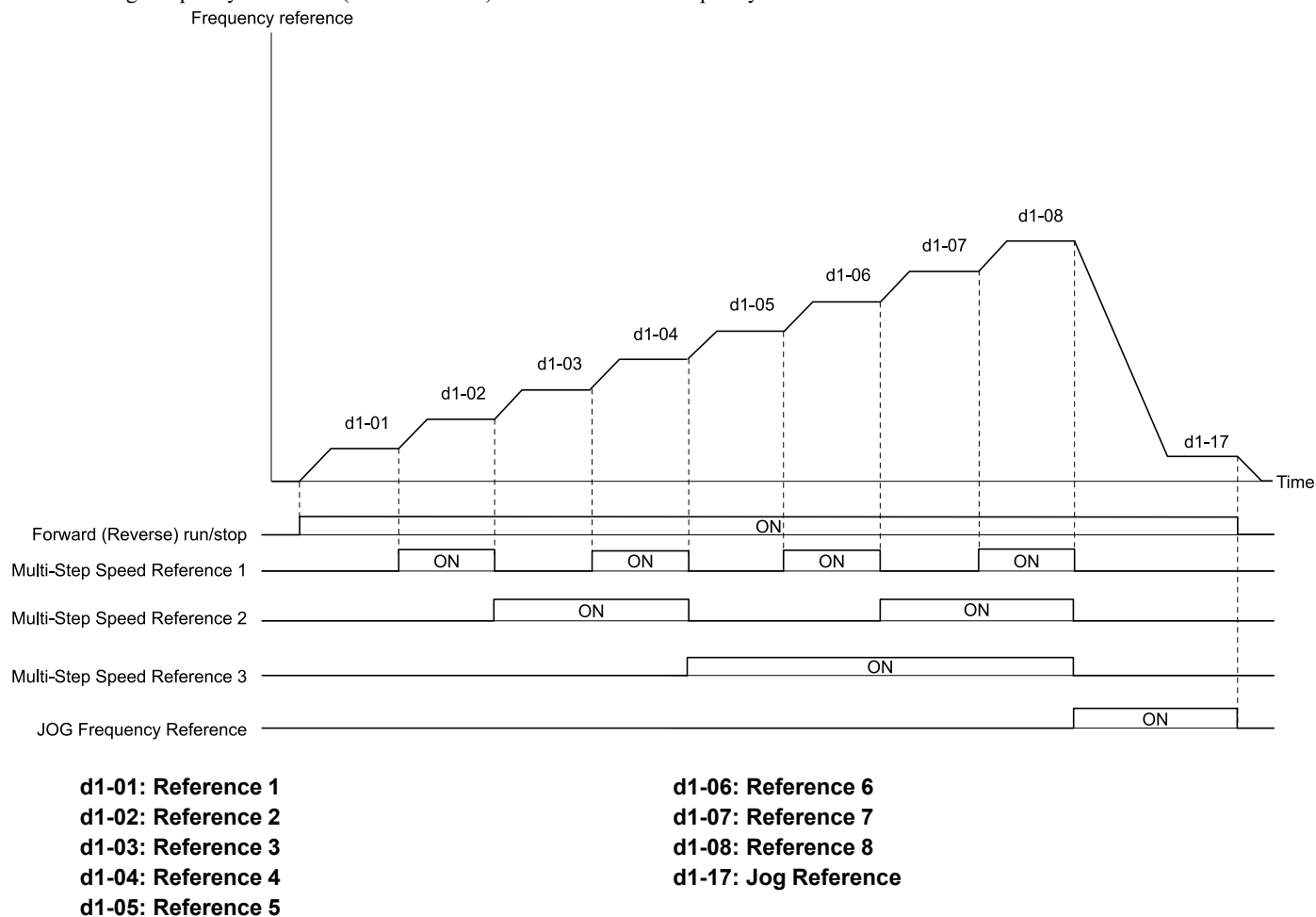

Figure 5.33 Time Chart for Multi-step Speed Reference/JOG Reference

■ d1-01: Reference 1

No. (Hex.)	Name	Description	Default (Range)
d1-01 (0280) RUN	Reference 1	Sets the frequency reference in the units from <i>o1-03</i> [Frequency Display Unit Selection].	0.00 Hz (0.00 - 400.00 Hz)

Note:

- The upper limit value changes when the *E1-04* [Maximum Output Frequency] and *d2-01* [Frequency Reference Upper Limit] values change. Calculate the upper limit value with this formula:
Upper limit value = $(E1-04) \times (d2-01) / 100$
- To set *d1-01* to 1-step speed parameter in a multi-step speed operation, set *b1-01* = 0 [Frequency Reference Selection 1 = Keypad].

■ d1-02: Reference 2

No. (Hex.)	Name	Description	Default (Range)
d1-02 (0281) RUN	Reference 2	Sets the frequency reference in the units from o1-03 [Frequency Display Unit Selection].	0.00 Hz (0.00 - 400.00 Hz)

Note:

- The upper limit value changes when the E1-04 [Maximum Output Frequency] and d2-01 [Frequency Reference Upper Limit] values change.
- To set d1-02 to Multi-Step Speed 2, set H3-02 and H3-10 ≠ 2 [MFAI Function Select ≠ Auxiliary Frequency Reference 1].

■ d1-03: Reference 3

No. (Hex.)	Name	Description	Default (Range)
d1-03 (0282) RUN	Reference 3	Sets the frequency reference in the units from o1-03 [Frequency Display Unit Selection].	0.00 Hz (0.00 - 400.00 Hz)

Note:

- The upper limit value changes when the E1-04 [Maximum Output Frequency] and d2-01 [Frequency Reference Upper Limit] values change.
- To set d1-03 to Multi-Step Speed 3, set H3-02 and H3-10 ≠ 3 [MFAI Function Select ≠ Auxiliary Frequency Reference 2].

■ d1-04: Reference 4

No. (Hex.)	Name	Description	Default (Range)
d1-04 (0283) RUN	Reference 4	Sets the frequency reference in the units from o1-03 [Frequency Display Unit Selection].	0.00 Hz (0.00 - 400.00 Hz)

Note:

- The upper limit value changes when the E1-04 [Maximum Output Frequency] and d2-01 [Frequency Reference Upper Limit] values change.
- This parameter sets the frequency reference of Multi-Step Speed 4.

■ d1-05: Reference 5

No. (Hex.)	Name	Description	Default (Range)
d1-05 (0284) RUN	Reference 5	Sets the frequency reference in the units from o1-03 [Frequency Display Unit Selection].	0.00 Hz (0.00 - 400.00 Hz)

Note:

- The upper limit value changes when the E1-04 [Maximum Output Frequency] and d2-01 [Frequency Reference Upper Limit] values change.
- This parameter sets the frequency reference of Multi-Step Speed 5.

■ d1-06: Reference 6

No. (Hex.)	Name	Description	Default (Range)
d1-06 (0285) RUN	Reference 6	Sets the frequency reference in the units from o1-03 [Frequency Display Unit Selection].	0.00 Hz (0.00 - 400.00 Hz)

Note:

- The upper limit value changes when the E1-04 [Maximum Output Frequency] and d2-01 [Frequency Reference Upper Limit] values change.
- This parameter sets the frequency reference of Multi-Step Speed 6.

■ d1-07: Reference 7

No. (Hex.)	Name	Description	Default (Range)
d1-07 (0286) RUN	Reference 7	Sets the frequency reference in the units from <i>o1-03</i> [<i>Frequency Display Unit Selection</i>].	0.00 Hz (0.00 - 400.00 Hz)

Note:

- The upper limit value changes when the *E1-04* [*Maximum Output Frequency*] and *d2-01* [*Frequency Reference Upper Limit*] values change.
- This parameter sets the frequency reference of Multi-Step Speed 7.

■ d1-08: Reference 8

No. (Hex.)	Name	Description	Default (Range)
d1-08 (0287) RUN	Reference 8	Sets the frequency reference in the units from <i>o1-03</i> [<i>Frequency Display Unit Selection</i>].	0.00 Hz (0.00 - 400.00 Hz)

Note:

- The upper limit value changes when the *E1-04* [*Maximum Output Frequency*] and *d2-01* [*Frequency Reference Upper Limit*] values change.
- This parameter sets the frequency reference of Multi-Step Speed 8.

■ d1-17: Jog Reference

No. (Hex.)	Name	Description	Default (Range)
d1-17 (0292) RUN	Jog Reference	Sets the Jog frequency reference in the units from <i>o1-03</i> [<i>Frequency Display Unit Selection</i>]. Set <i>H1-xx = 6</i> [<i>MFDI Function Selection = Jog Reference Selection</i>] to use the Jog frequency reference.	6.00 Hz (0.00 - 400.00 Hz)

Note:

The upper limit value changes when the *E1-04* [*Maximum Output Frequency*] and *d2-01* [*Frequency Reference Upper Limit*] values change.

◆ d2: Reference Limits

d2 parameters set the upper and lower frequency limits to control the motor speed. Apply these parameters to for example, run the motor at low-speed due to mechanical strength concerns, or if the motor should not be run at low speed because of lubrication issues with the gears and bearings.

The upper frequency limit is set in *d2-01* [*Frequency Reference Upper Limit*] and the lower limit is set in *d2-02* [*Frequency Reference Lower Limit*].

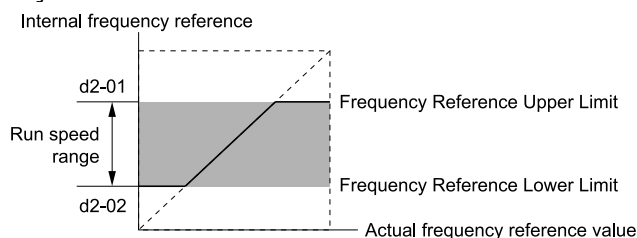

Figure 5.34 Upper and Lower Frequency Limits

■ d2-01: Frequency Reference Upper Limit

No. (Hex.)	Name	Description	Default (Range)
d2-01 (0289)	Frequency Reference Upper Limit	Sets maximum limit for all frequency references. The maximum output frequency is 100%.	100.0% (0.0 - 110.0%)

When the frequency reference is more than the value set in *d2-01* the drive will continue to operate at the value set in *d2-01*.

■ d2-02: Frequency Reference Lower Limit

No. (Hex.)	Name	Description	Default (Range)
d2-02 (028A)	Frequency Reference Lower Limit	Sets minimum limit for all frequency references. The maximum output frequency is 100%.	0.0% (0.0 - 110.0%)

When the frequency reference is less than the value set in *d2-02*, the drive will continue to operate at the value set in *d2-02*. The motor will accelerate to the *d2-02* value after the drive receives a Run command and a lower frequency reference than *d2-02* has been entered.

■ d2-03: Analog Frequency Ref Lower Limit

No. (Hex.)	Name	Description	Default (Range)
d2-03 (0293)	Analog Frequency Ref Lower Limit	Sets the lower limit for the master frequency reference (the first frequency of the multi-step speed reference) as a percentage. The maximum output frequency is 100%.	0.0% (0.0 - 110.0%)

This parameter does not change the lower limit of Jog reference, frequency reference for multi-step speed operation, or the auxiliary frequency reference.

The drive operates at the value set in *d2-03* when the frequency reference decreases to less than the value set in *d2-03*.

Note:

When lower limits are set to parameters *d2-02* [*Frequency Reference Lower Limit*] and *d2-03*, the drive uses the larger value as the lower limit.

◆ d3: Jump Frequency

The Jump frequency is a function that sets the dead band to a specified frequency band. If a machine that operated at constant speed is operated with variable speed, it can make resonance. To operate the machine without resonance from the natural frequency of the machinery mechanical system, use a frequency band jump.

You can program the drive to have three different Jump frequencies. Set *d3-01* to *d3-03* [*Jump Frequencies*] to the median value for the jumped frequency and set *d3-04* [*Jump Frequency Width*] to the Jump frequency width.

When you input a frequency reference that is the same as or near the Jump frequency width, the frequency reference changes automatically.

The drive accelerates or decelerates the motor smoothly until the frequency reference is not in the range of the Jump frequency band. The drive will use the active accel/decel time to go through the specified dead band range. If the frequency reference is not in the range of the Jump frequency band, switch to constant speed operation.

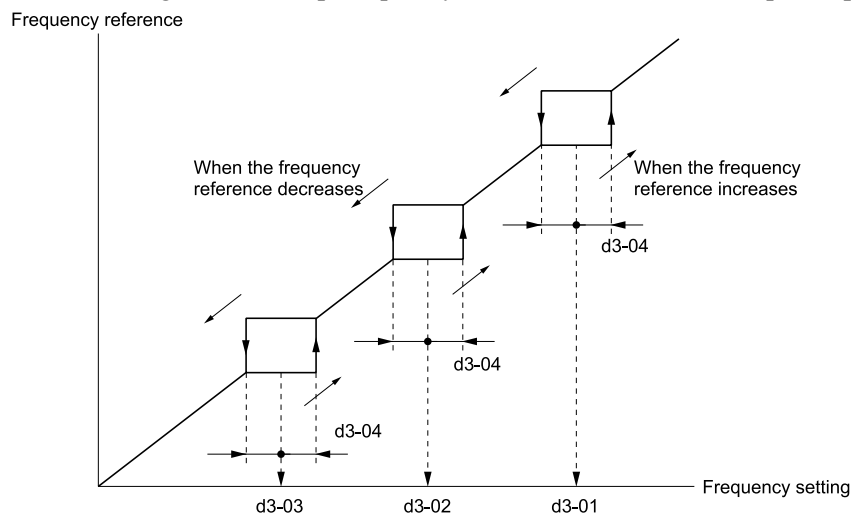

Figure 5.35 Jump Frequency

Note:

- When you set Jump Frequencies 1 to 3, make sure that the parameters do not overlap.
- When the drive is in the range of the Jump frequency, the frequency reference changes automatically. When Jump is executed, the output frequency changes smoothly as specified by the values set in *C1-01 [Acceleration Time 1]* and *C1-02 [Deceleration Time 1]*.

■ d3-01: Jump Frequency 1

No. (Hex.)	Name	Description	Default (Range)
d3-01 (0294)	Jump Frequency 1	Sets the median value of the frequency band that the drive will avoid.	0.0 Hz (0.0 - 400.0 Hz)

Note:

Set this parameter to 0.0 Hz to disable the Jump frequency.

■ d3-02: Jump Frequency 2

No. (Hex.)	Name	Description	Default (Range)
d3-02 (0295)	Jump Frequency 2	Sets the median value of the frequency band that the drive will avoid.	0.0 Hz (0.0 - 400.0 Hz)

Note:

Set this parameter to 0.0 Hz to disable the Jump frequency.

■ d3-03: Jump Frequency 3

No. (Hex.)	Name	Description	Default (Range)
d3-03 (0296)	Jump Frequency 3	Sets the median value of the frequency band that the drive will avoid.	0.0 Hz (0.0 - 400.0 Hz)

Note:

Set this parameter to 0.0 Hz to disable the Jump frequency.

■ d3-04: Jump Frequency Width

No. (Hex.)	Name	Description	Default (Range)
d3-04 (0297)	Jump Frequency Width	Sets the width of the frequency band that the drive will avoid.	1.0 Hz (0.0 - 20.0 Hz)

◆ d4: Frequency Ref Up/Down & Hold

The *d4 parameters* set the Frequency Reference Hold function and Up/Down commands.

Frequency Reference Hold Function Command: This acceleration/deceleration ramp hold command uses an MFDI to momentarily stop the acceleration/deceleration of the motor, and continues to operate the motor at the output frequency at which the command reference was input. Turn OFF the acceleration/deceleration ramp hold command to continue acceleration/deceleration.

■ d4-01: Freq Reference Hold Selection

No. (Hex.)	Name	Description	Default (Range)
d4-01 (0298)	Freq Reference Hold Selection	Sets the function that saves the frequency reference after a Stop command or when de-energizing the drive.	0 (0, 1)

Set *H1-xx = A [MFDI Function Selection = Accel/Decel Ramp Hold]* to enable this parameter:

0 : Disabled

- Acceleration/Deceleration Ramp Hold
When you enter a Stop command or de-energize the drive, the hold value is reset to 0 Hz. The drive will use the active frequency reference when it restarts.

1 : Enabled

• Acceleration/Deceleration Ramp Hold

When you clear the Run command or de-energize the drive, it will save the last hold value. The drive will use the saved value as the frequency reference when it restarts.

Note:

When you energize the drive, continuously enable the MFDI terminal set for *Accel/Decel Ramp Hold* [$H1-xx = A$]. If the digital input does not activate, the drive will clear the hold value and set it to 0 Hz.

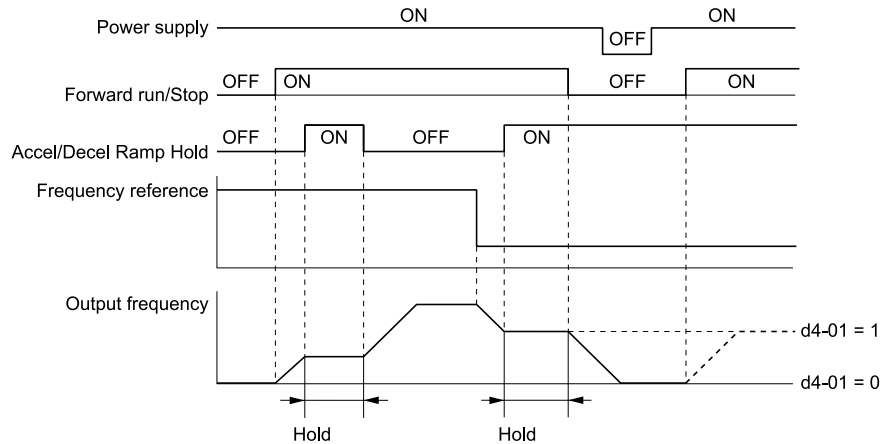

Figure 5.36 Frequency Reference Hold with Accel/Decel Hold Function

Remove the Saved Frequency Reference Value

The procedure to remove the saved frequency reference value is different for different functions. Use these methods to remove the value:

- Release the input programmed for *Accel/Decel Ramp Hold* [$H1-xx = A$].

◆ d6: Field Weakening

d6 parameters set the field weakening function.

The field weakening function decreases the energy consumption of the motor. It decreases the output voltage of the drive to a set level. The function decreases the motor excitation current inversely proportional to speed in a constant output range, and does not let the induced voltage of the motor become more than the power supply voltage. To enable this function, set *Field Weakening* [$H1-xx = 63$] ON.

Note:

Use the Field Weakening function in constant light-load applications. To control the energy consumption of the motor for other load conditions, use the *b8 parameters* [*Energy Saving*].

■ d6-01: Field Weakening Level

No. (Hex.)	Name	Description	Default (Range)
d6-01 (02A0)	Field Weakening Level	Sets the drive output voltage as a percentage of $E1-05$ [<i>Maximum Output Voltage</i>] when $H1-xx = 63$ [<i>Field Weakening</i>] is activated.	80% (0 - 100%)

■ d6-02: Field Weakening Frequency Limit

No. (Hex.)	Name	Description	Default (Range)
d6-02 (02A1)	Field Weakening Frequency Limit	Sets the minimum output frequency to start field weakening.	0.0 Hz (0.0 - 400.0 Hz)

To enable the Field Weakening command, make sure that these two conditions are true:

- The output frequency $\geq d6-02$.
- There is a speed agreement status.

◆ d7: Offset Frequency

The drive will use 3 digital signal inputs, to add or subtract the set frequency (Offset frequency) to/from the frequency reference and correct the speed. The drive uses the terminal set in $H1-xx = 44$ to 46 [*MFDI Function Select = Add Offset Frequency 1 to 3*] to set the Offset frequency. When you close more than one input at the same time, the drive adds the selected offset values together.

Figure 5.37 shows the Offset frequency function:

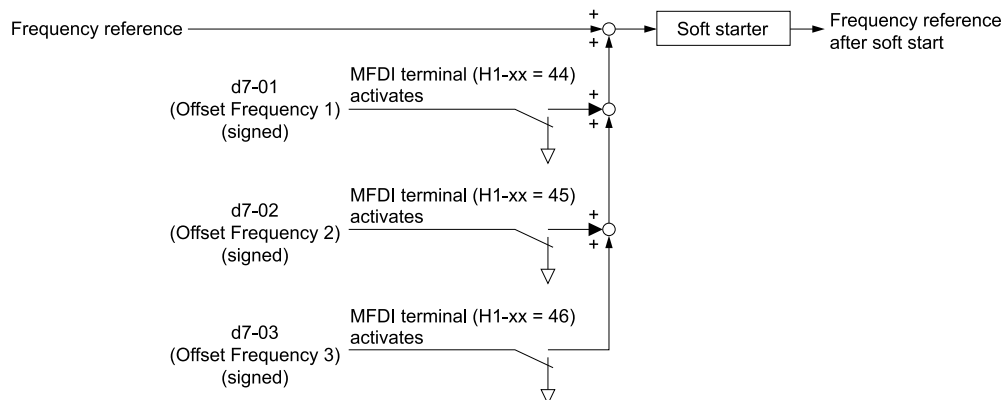

Figure 5.37 Offset Frequency Operation

■ d7-01: Offset Frequency 1

No. (Hex.)	Name	Description	Default (Range)
d7-01 (02B2) RUN	Offset Frequency 1	Uses $H1-xx = 44$ [<i>MFDI Function Select = Add Offset Frequency 1 (d7-01)</i>] as a percentage of the Maximum Output Frequency to add or subtract the set frequency to/from the frequency reference.	0.0% (-100.0 - +100.0%)

■ d7-02: Offset Frequency 2

No. (Hex.)	Name	Description	Default (Range)
d7-02 (02B3) RUN	Offset Frequency 2	Uses $H1-xx = 45$ [<i>MFDI Function Select = Add Offset Frequency 2 (d7-02)</i>] as a percentage of the Maximum Output Frequency to add or subtract the set frequency to/from the frequency reference.	0.0% (-100.0 - +100.0%)

■ d7-03: Offset Frequency 3

No. (Hex.)	Name	Description	Default (Range)
d7-03 (02B4) RUN	Offset Frequency 3	Uses $H1-xx = 46$ [<i>MFDI Function Select = Add Offset Frequency 3 (d7-03)</i>] as a percentage of the Maximum Output Frequency to add or subtract the set frequency to/from the frequency reference.	0.0% (-100.0 - +100.0%)

5.5 E: Motor Parameters

E parameters cover drive input voltage, V/f pattern, and motor parameters.

◆ E1: V/f Pattern for Motor 1

E1 parameters set the drive input voltage and motor V/f characteristics. To switch drive operation from one motor to another motor, set the V/f characteristics for motor 1.

■ V/f Pattern Settings

The drive uses a V/f pattern to adjust the output voltage relative to the frequency reference.

This product has been preconfigured with 15 voltage/frequency (V/f) patterns. Use *E1-03 [V/f Pattern Selection]* to select the V/f pattern that is appropriate for the application.

Additionally, one custom V/f pattern is available. Set *E1-03 = F [Custom]* and then manually set parameters *E1-04* to *E1-10*.

Table 5.33 Predefined V/f Patterns

Setting Value	Specification	Characteristic	Application
0	Const Trq, 50Hz base, 50Hz max	Constant torque	For general purpose applications. This pattern is used when the load torque is constant without any rotation speed such as that used for linear conveyor systems.
1	Const Trq, 60Hz base, 60Hz max		
2	Const Trq, 50Hz base, 60Hz max		
3	Const Trq, 60 Hz base, 72 Hz max		
4	VT, 50 Hz, 65% Vmid reduction	Derated Torque Characteristics	This pattern is used for torque loads proportional to 2 or 3 times the rotation speed, such as is the case with fans and pumps.
5	VT, 50 Hz, 50% Vmid reduction		
6	VT, 60 Hz, 65% Vmid reduction		
7	VT, 60 Hz, 50% Vmid reduction		
8	High Trq, 50 Hz, 25% Vmin Boost	High starting torque	This pattern is used when strong torque is required during startup.
9	High Trq, 50 Hz, 65% Vmin Boost		
A	High Trq, 60 Hz, 25% Vmin Boost		
B	High Trq, 60 Hz, 65% Vmin Boost		
C	Const Trq, 60 Hz base, 90 Hz max	Constant output	This pattern is used to rotate motors at greater than 60 Hz. Output voltage is constant when operating at greater than 60 Hz.
D	Const Trq, 60 Hz base, 120 Hz max		
E	Const Trq, 60 Hz base, 180 Hz max		
F	V/f Pattern Selection	Constant torque	Enables a custom V/f pattern by changing <i>E1-04</i> to <i>E1-13 [V/f Pattern for Motor 1]</i> . The default settings for <i>E1-04</i> to <i>E1-13</i> are the same as <i>Setting Value 1 [Const Trq, 60Hz base, 60Hz max]</i> .

Note:

Be aware of the following points when manually setting V/f patterns.

- To set linear V/f characteristics at frequencies lower than $E1-06$ [Base Frequency], set $E1-07 = E1-09$ [Mid Point A Frequency = Minimum Output Frequency]. In this application, the drive ignores $E1-08$ [Mid Point A Voltage].
- Set the five frequencies as specified by these rules: Incorrect settings will cause $oPE10$ [V/f Data Setting Error].
 $E1-09 \leq E1-07 < E1-06 \leq E1-11 \leq E1-04$ [Minimum Output Frequency \leq Mid Point A Frequency $<$ Base Frequency \leq Mid Point B Frequency \leq Maximum Output Frequency]
- Setting $E1-11 = 0$ [Mid Point B Frequency = 0 Hz] disables $E1-12$ [Mid Point B Voltage]. Ensure that the four frequencies are set according to the following rules;
 $E1-09 \leq E1-07 < E1-06 \leq E1-04$
- When you use $A1-03$ [Initialize] to initialize the drive, it will not reset $E1-03$.

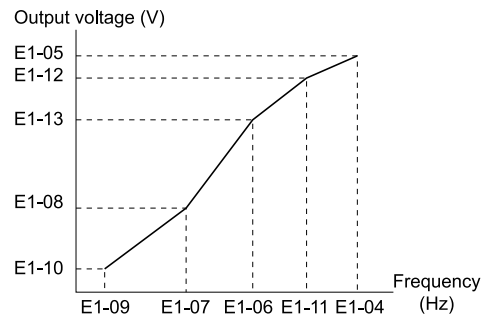

Figure 5.38 V/f Pattern

■ E1-01: Input AC Supply Voltage

No. (Hex.)	Name	Description	Default (Range)
E1-01 (0300)	Input AC Supply Voltage	Sets the drive input voltage.	208/240 V: 240 V, 480 V: 480 V (208/240 V: 155 - 255 V, 480 V: 310 - 510 V)

NOTICE: Set parameter $E1-01$ to align with the drive input voltage (not motor voltage). If this parameter is incorrect, the protective functions of the drive will not operate correctly and it can cause damage to the drive.

Values Related to the Drive Input Voltage

The value set in $E1-01$ is the base value that the drive uses for the motor protective functions in Table 5.34. With a 480 V drive, the detection level changes for some motor protective functions.

Table 5.34 Values Related to the Drive Input Voltage

Voltage	E1-01 Setting	Approximate Values		
		ov Detection Level	L2-05 [Undervoltage Detection Lvl (Uv1)]	L3-17 [DC Bus Regulation Level]
208/240 V	All settings	410 V	190 V	375 V
480 V	Setting value \geq 400 V	820 V	380 V	750 V
	Setting value $<$ 400 V	820 V	350 V	750 V

■ E1-03: V/f Pattern Selection

No. (Hex.)	Name	Description	Default (Range)
E1-03 (0302)	V/f Pattern Selection	Sets the V/f pattern for the drive and motor. You can use one of the preset patterns or you can make a custom pattern.	F (0 - F)

Note:

- Set the correct V/f pattern for the application and operation area. An incorrect V/f pattern can decrease motor torque and increase current from overexcitation.
- Parameter $A1-03$ [Initialize Parameters] will not initialize the value of $E1-03$.

0 : Const Trq, 50Hz base, 50Hz max

5.5 E: Motor Parameters

Use this constant torque pattern for general applications. Use this pattern when the load torque is constant without any rotation speed, for example with linear conveyor systems.

Note:

The voltage values in the figures are for 208/240 V. Multiply the values by 2 for 480 V.

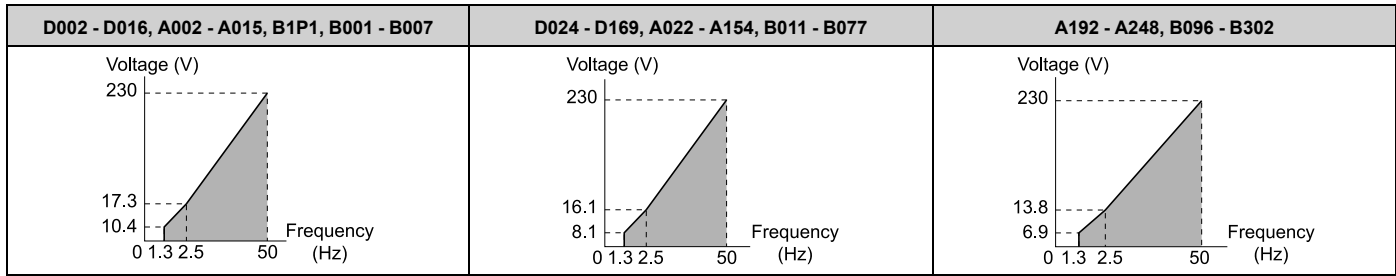

1 : Const Trq, 60Hz base, 60Hz max

Use this constant torque pattern for general applications. Use this pattern when the load torque is constant without any rotation speed, for example with linear conveyor systems.

Note:

The voltage values in the figures are for 208/240 V. Multiply the values by 2 for 480 V.

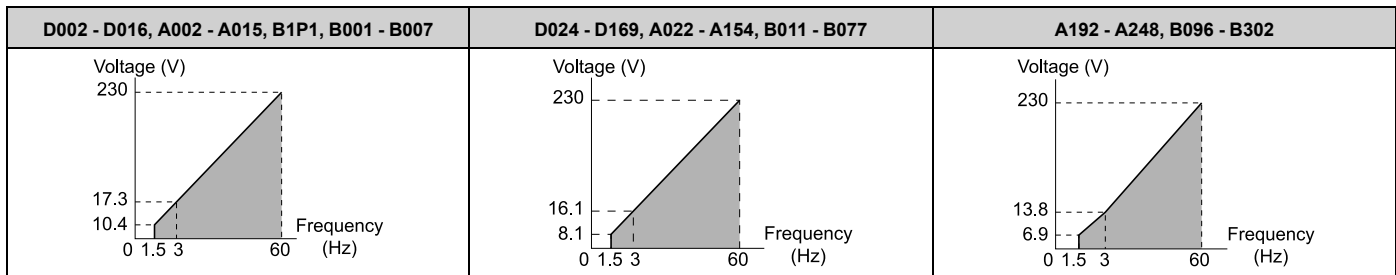

2 : Const Trq, 50Hz base, 60Hz max

Use this constant torque pattern for general applications. Use this pattern when the load torque is constant without any rotation speed, for example with linear conveyor systems.

Note:

The voltage values in the figures are for 208/240 V. Multiply the values by 2 for 480 V.

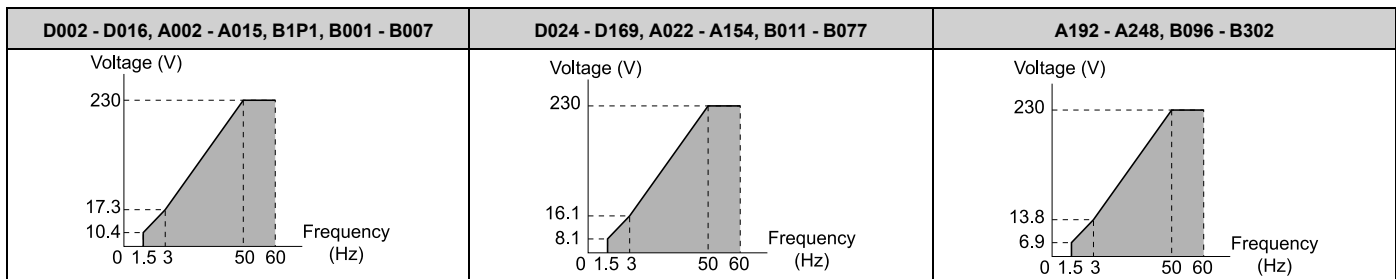

3 : Const Trq, 60 Hz base, 72 Hz max

Use this constant torque pattern for general applications. Use this pattern when the load torque is constant without any rotation speed, for example with linear conveyor systems.

Note:

The voltage values in the figures are for 208/240 V. Multiply the values by 2 for 480 V.

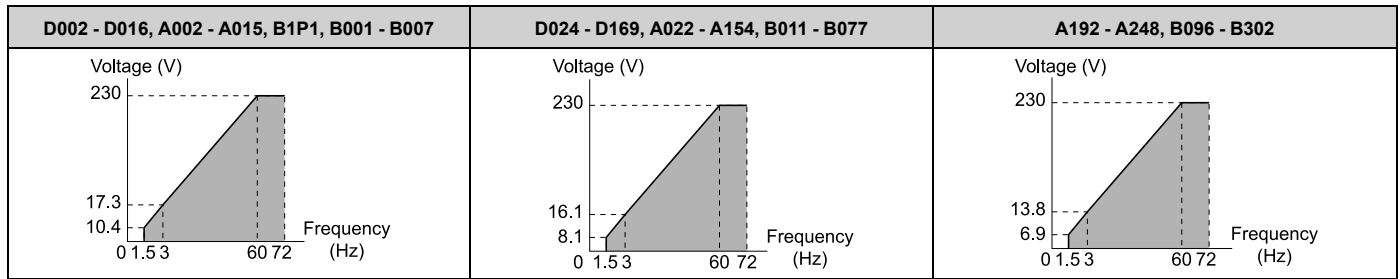

4 : VT, 50Hz, 65% Vmid reduction

Use this derated torque pattern for torque loads proportional to three times the rotation speed. For example, fans and pumps.

Note:

The voltage values in the figures are for 208/240 V. Multiply the values by 2 for 480 V.

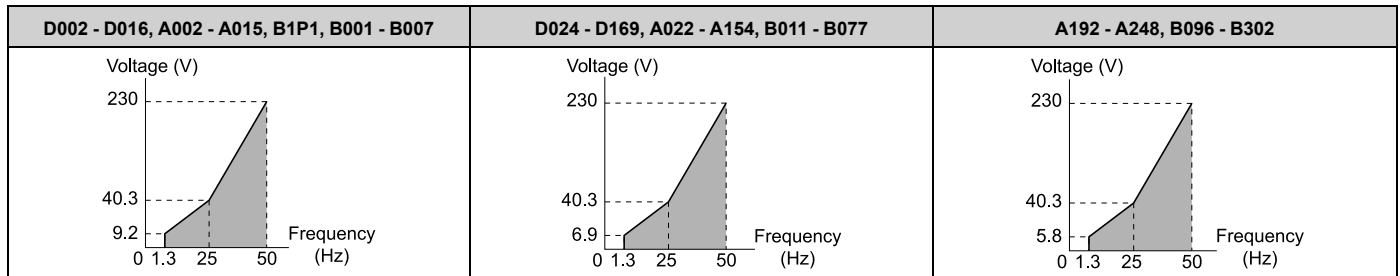

5 : VT, 50Hz, 50% Vmid reduction

Use this derated torque pattern for torque loads proportional to two times the rotation speed. For example, fans and pumps.

Note:

The voltage values in the figures are for 208/240 V. Multiply the values by 2 for 480 V.

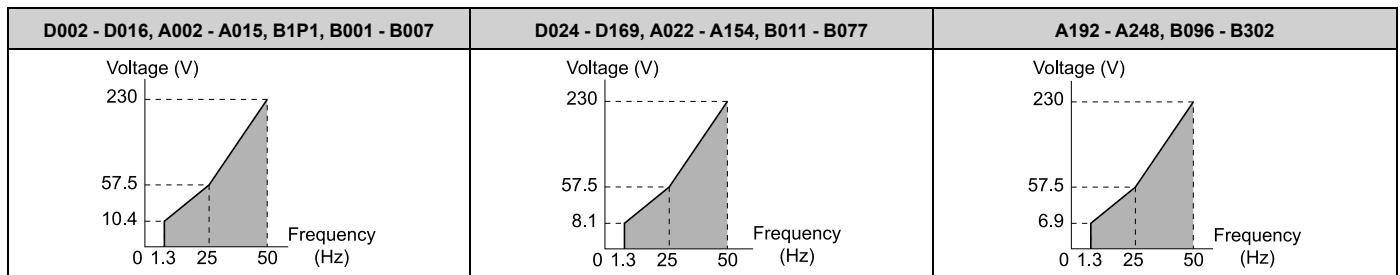

6 : VT, 60 Hz, 65% Vmid reduction

Use this derated torque pattern for torque loads proportional to three times the rotation speed. For example, fans and pumps.

Note:

The voltage values in the figures are for 208/240 V. Multiply the values by 2 for 480 V.

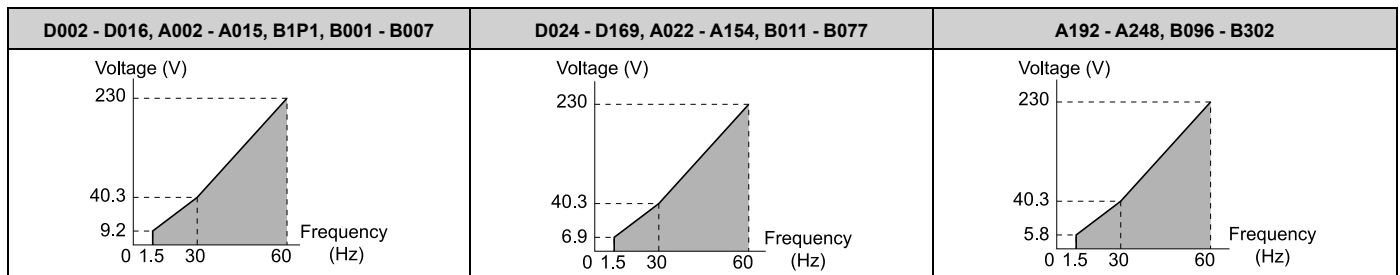

7 : VT, 60Hz, 50% Vmid reduction

Parameter Details

5

5.5 E: Motor Parameters

Use this derated torque pattern for torque loads proportional to two times the rotation speed. For example, fans and pumps.

Note:

The voltage values in the figures are for 208/240 V. Multiply the values by 2 for 480 V.

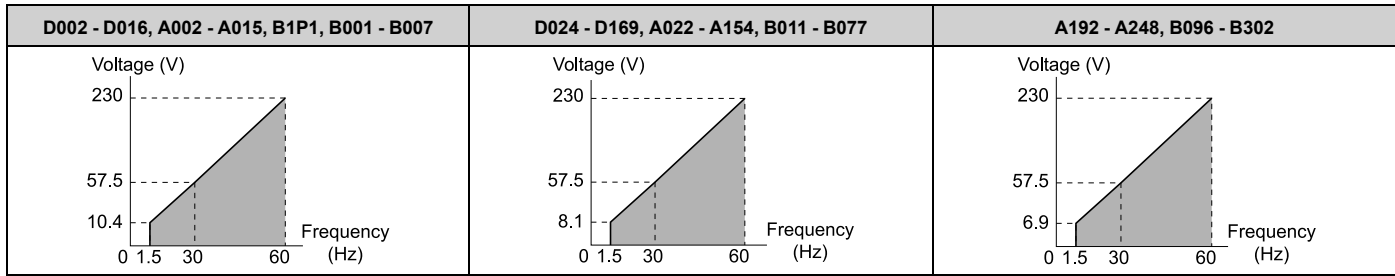

8 : High Trq, 50Hz, 25% Vmin boost

Use this pattern when moderate torque is necessary during start up.

Select this pattern only in these conditions:

- The wiring distance between the drive and motor is 150 m (492.1 ft) minimum.
- There is an AC reactor connected to the drive output.

Note:

The voltage values in the figures are for 208/240 V. Multiply the values by 2 for 480 V.

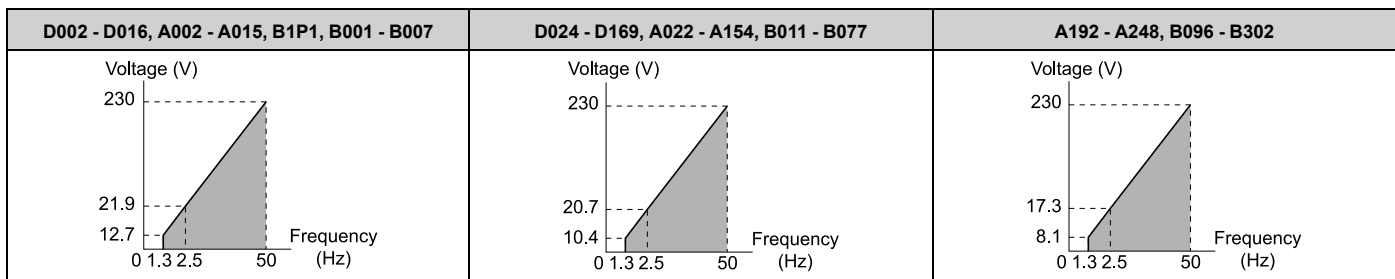

9 : High Trq, 50Hz, 65% Vmin boost

Use this pattern when high torque is necessary during start up.

Select this pattern only in these conditions:

- The wiring distance between the drive and motor is 150 m (492.1 ft) minimum.
- There is an AC reactor connected to the drive output.

Note:

The voltage values in the figures are for 208/240 V. Multiply the values by 2 for 480 V.

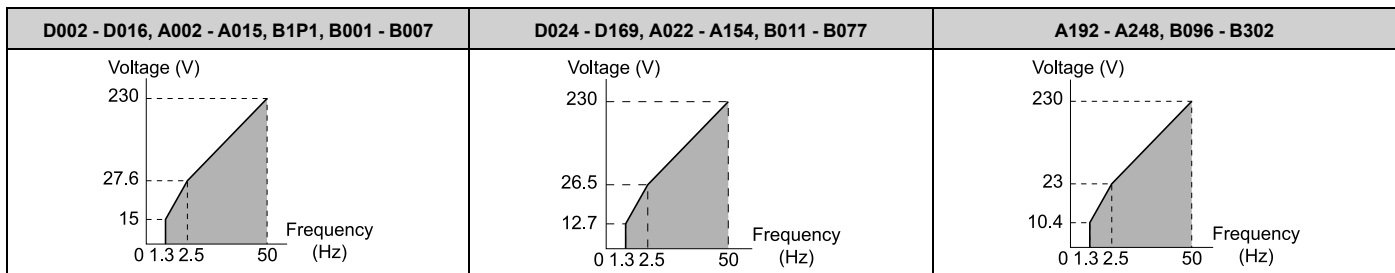

A : High Trq, 60Hz, 25% Vmin boost

Use this pattern when moderate torque is necessary during start up.

Select this pattern only in these conditions:

- The wiring distance between the drive and motor is 150 m (492.1 ft) minimum.
- There is an AC reactor connected to the drive output.

Note:

The voltage values in the figures are for 208/240 V. Multiply the values by 2 for 480 V.

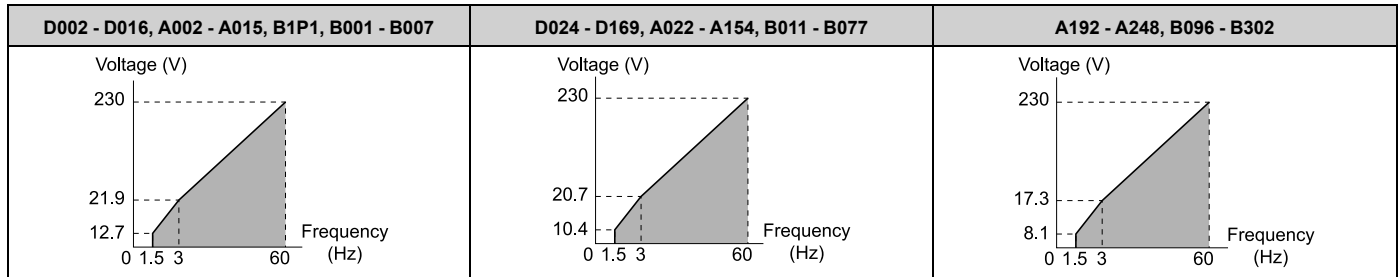

B : High Trq, 60Hz, 65% Vmin boost

Use this pattern when high torque is necessary during start up.

Select this pattern only in these conditions:

- The wiring distance between the drive and motor is 150 m (492.1 ft) minimum.
- There is an AC reactor connected to the drive output.

Note:

The voltage values in the figures are for 208/240 V. Multiply the values by 2 for 480 V.

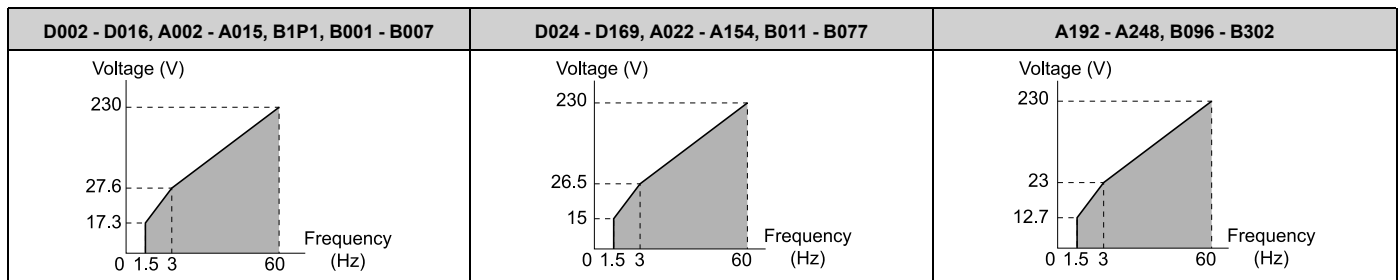

C : High Freq, 60Hz base, 90Hz max

Use this constant output pattern to rotate motors at more than 60 Hz. Output voltage is constant when you operate at more than 60 Hz.

Note:

The voltage values in the figures are for 208/240 V. Multiply the values by 2 for 480 V.

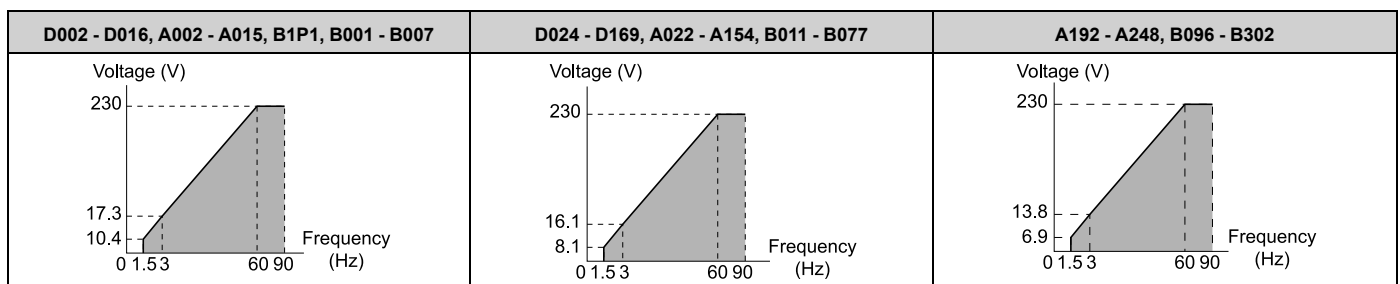

D : Const Trq, 60 Hz base, 120 Hz max

Use this constant output pattern to rotate motors at more than 60 Hz. Output voltage is constant when you operate at more than 60 Hz.

Note:

The voltage values in the figures are for 208/240 V. Multiply the values by 2 for 480 V.

5.5 E: Motor Parameters

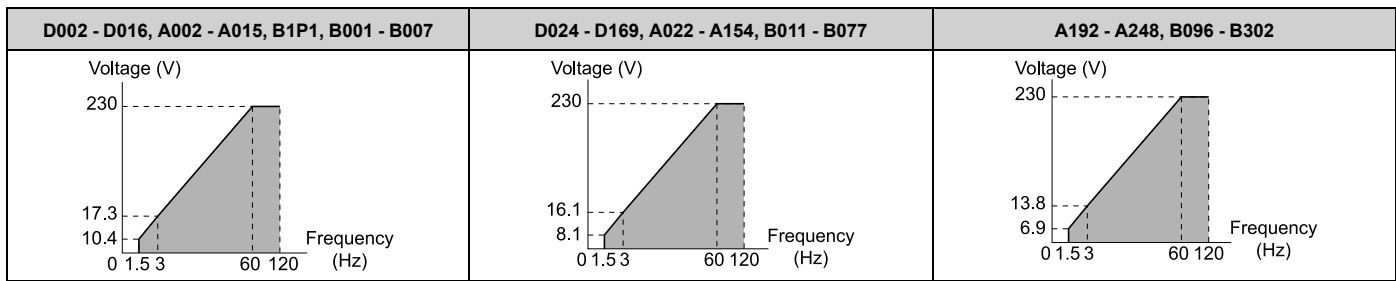

E : Const Trq, 60 Hz base, 180 Hz max

Use this constant output pattern to rotate motors at more than 60 Hz. Output voltage is constant when you operate at more than 60 Hz.

Note:

The voltage values in the figures are for 208/240 V. Multiply the values by 2 for 480 V.

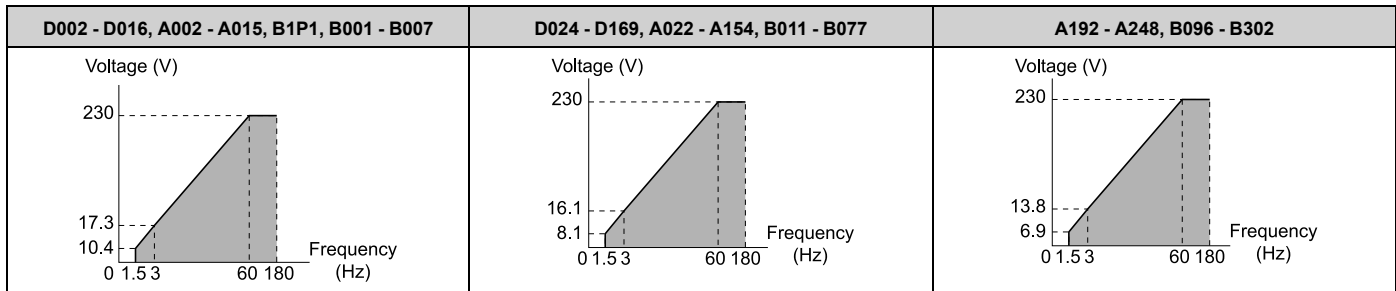

F : Custom

Set E1-04 to E1-13 [V/f Pattern for Motor 1] to set the values for this custom pattern.

The default settings are the same as setting value 1 [Const Trq, 60Hz base, 60Hz max].

■ E1-04: Maximum Output Frequency

No. (Hex.)	Name	Description	Default (Range)
E1-04 (0303)	Maximum Output Frequency	Sets the maximum output frequency for the V/f pattern.	60.0 Hz (40.0 to 400.0 Hz)

■ E1-05: Maximum Output Voltage

No. (Hex.)	Name	Description	Default (Range)
E1-05 (0304)	Maximum Output Voltage	Sets the maximum output voltage for the V/f pattern.	208/240 V: 230.0 V, 480 V: 460.0 V (208/240 V: 0.0 - 255.0 V, 480 V: 0.0 - 510.0 V)

■ E1-06: Base Frequency

No. (Hex.)	Name	Description	Default (Range)
E1-06 (0305)	Base Frequency	Sets the base frequency for the V/f pattern.	60.0 Hz (0.0 - E1-04)

■ E1-07: Mid Point A Frequency

No. (Hex.)	Name	Description	Default (Range)
E1-07 (0306)	Mid Point A Frequency	Sets a middle output frequency for the V/f pattern.	30.0 Hz (0.0 - E1-04)

■ E1-08: Mid Point A Voltage

No. (Hex.)	Name	Description	Default (Range)
E1-08 (0307)	Mid Point A Voltage	Sets a middle output voltage for the V/f pattern.	Determined by o2-04 (208/240 V: 0.0 - 255.0 V, 480 V: 0.0 - 510.0 V)

Note:

Default setting is determined by o2-04 [Drive Model Selection].

■ E1-09: Minimum Output Frequency

No. (Hex.)	Name	Description	Default (Range)
E1-09 (0308)	Minimum Output Frequency	Sets the minimum output frequency for the V/f pattern.	1.5 Hz (Determined by E1-04)

■ E1-10: Minimum Output Voltage

No. (Hex.)	Name	Description	Default (Range)
E1-10 (0309)	Minimum Output Voltage	Sets the minimum output voltage for the V/f pattern.	10.2 V (208/240 V: 0.0 - 255.0 V, 480 V: 0.0 - 510.0 V)

■ E1-11: Mid Point B Frequency

No. (Hex.)	Name	Description	Default (Range)
E1-11 (030A) Expert	Mid Point B Frequency	Sets a middle output frequency for the V/f pattern.	0.0 Hz (0.0 - E1-04)

Note:

Set this parameter to 0.0 to disable the function.

■ E1-12: Mid Point B Voltage

No. (Hex.)	Name	Description	Default (Range)
E1-12 (030B) Expert	Mid Point B Voltage	Sets a middle point voltage for the V/f pattern.	0.0 V (208/240 V: 0.0 - 255.0 V, 480 V: 0.0 - 510.0 V)

Note:

Set this parameter to 0.0 to disable the function.

■ E1-13: Base Voltage

No. (Hex.)	Name	Description	Default (Range)
E1-13 (030C) Expert	Base Voltage	Sets the base voltage for the V/f pattern.	0.0 V (208/240 V: 0.0 - 255.0 V, 480 V: 0.0 - 510.0 V)

Note:

- After Auto-Tuning, the value of E1-13 = E1-05 [Maximum Output Voltage].
- When E1-13 = 0.0, use the value of E1-05 to control the voltage.

◆ E2: Motor Parameters

E2 parameters [Motor Parameters] set induction motor data. To switch drive operation from one motor to another motor, configure the first motor (motor 1).

5.5 E: Motor Parameters

Doing Auto-Tuning automatically sets the *E2 parameters* to the optimal values. If you cannot do Auto-Tuning, set the *E2 parameters* manually.

■ E2-01: Motor Rated Current (FLA)

No. (Hex.)	Name	Description	Default (Range)
E2-01 (030E)	Motor Rated Current (FLA)	Sets the motor rated current in amps.	Determined by o2-04 (10% to 200% of the drive rated current)

Note:

- If $E2-01 < E2-03$ [Motor No-Load Current] the drive will detect *oPE02* [Parameter Range Setting Error].
- The default settings and setting ranges are in these units:
 - 0.01 A: D002 to D046, A002 to A042, B1P1, B001 to B014
 - 0.1 A: D059 to D273, A054 to A248, B021 to B302

The value set for *E2-01* becomes the reference value for motor protection and the torque limit. Enter the motor rated current as written on the motor nameplate. The value of *E2-01* is automatically set to the value input for “Motor Rated Current” by the Auto-Tuning process.

■ E2-02: Motor Rated Slip

No. (Hex.)	Name	Description	Default (Range)
E2-02 (030F)	Motor Rated Slip	Sets motor rated slip.	Determined by o2-04 (0.000 - 20.000 Hz)

This parameter value becomes the base slip compensation value. The drive automatically sets this parameter during Auto-Tuning. When you cannot do Auto-Tuning, calculate the motor rated slip with the information on the motor nameplate and this formula:

$$E2-02 = f - [(n \times p) / 120]$$

- *f*: Motor rated frequency (Hz)
- *n*: Rated motor speed (min^{-1} (r/min))
- *p*: Number of motor poles

■ E2-03: Motor No-Load Current

No. (Hex.)	Name	Description	Default (Range)
E2-03 (0310)	Motor No-Load Current	Sets the no-load current for the motor in amps when operating at the rated frequency and the no-load voltage.	Determined by o2-04 (0 to E2-01)

Note:

- The default settings and setting ranges are in these units:
- 0.01 A: D002 to D046, A002 to A042, B1P1, B001 to B014
 - 0.1 A: D059 to D273, A054 to A248, B021 to B302

The drive automatically sets this parameter during Auto-Tuning. When you cannot do Auto-Tuning, you can also use the motor no-load current on the motor test report to enter this value manually. Contact the motor manufacturer to receive a copy of the motor test report.

Note:

The default setting of the no-load current is for operation with a 4-pole motor recommended by Yaskawa.

■ E2-04: Motor Pole Count

No. (Hex.)	Name	Description	Default (Range)
E2-04 (0311)	Motor Pole Count	Sets the number of motor poles.	4 (2 - 120)

Auto-Tuning automatically sets this parameter to the value of [Number of Motor Poles].

■ E2-05: Motor Line-to-Line Resistance

No. (Hex.)	Name	Description	Default (Range)
E2-05 (0312)	Motor Line-to-Line Resistance	Sets the line-to-line resistance for the motor stator windings.	Determined by o2-04 (0.000 - 65.000 Ω)

Note:

This value is the motor line-to-line resistance. Do not set this parameter with the resistance per phase.

Auto-Tuning automatically sets this parameter. If you cannot do Auto-Tuning, use the test report from the motor manufacturer to configure the settings. You can calculate the motor line-to-line resistance with one of these formulas:

- E-type insulation: [the resistance value (Ω) shown on the test report at 75 °C] × 0.92
- B-type insulation: [the resistance value (Ω) shown on the test report at 75 °C] × 0.92
- F-type insulation: [the resistance value (Ω) shown on the test report at 115 °C] × 0.87

■ E2-06: Motor Leakage Inductance

No. (Hex.)	Name	Description	Default (Range)
E2-06 (0313)	Motor Leakage Inductance	Sets the voltage drop from motor leakage inductance when the motor is operating at the rated frequency and rated current. This value is a percentage of Motor Rated Voltage.	Determined by o2-04 (0.0 - 60.0%)

The drive automatically sets this parameter during Auto-Tuning.

Note:

The motor nameplate does not usually show the quantity of voltage drop. If you do not know the value of the motor leakage inductance, contact the motor manufacturer to receive a copy of the motor test report.

■ E2-10: Motor Iron Loss

No. (Hex.)	Name	Description	Default (Range)
E2-10 (0317)	Motor Iron Loss	Sets the motor iron loss.	Determined by o2-04 (0 - 65535 W)

■ E2-11: Motor Rated Power

No. (Hex.)	Name	Description	Default (Range)
E2-11 (0318)	Motor Rated Power	Sets the motor rated output in the units from o1-58 [Motor Power Unit Selection].	Determined by o2-04 (0.00 - 650.00 HP)

The drive automatically sets this parameter to the value input for “Motor Rated Power” during Auto-Tuning.

5.6 F: Options

F parameters set communication option card parameters, which function as interfaces for fieldbus communication.

◆ F6, F7: Communication Options and Ethernet Options

F6 and *F7* parameters set the basic communication settings and method of fault detection for the communication option card. The communication option card parameters include common option card parameters and communication protocol-specific parameters.

The following table lists the parameters that you must set for each communication option card.

Refer to the manual for each communication option card for more information about how to install, wire, and configure the option card before you start communication.

WARNING! Sudden Movement Hazard. Do test runs and examine the drive to make sure that the command references are correct. If you set the command reference incorrectly, it can cause damage to the drive or serious injury or death.

■ F6-01: Communication Error Selection

No. (Hex.)	Name	Description	Default (Range)
F6-01 (03A2)	Communication Error Selection	Sets the method to stop the motor or let the motor continue operating when the drive detects <i>bUS</i> [Option Communication Error].	1 (0 - 5)

0 : Ramp to Stop

The drive ramps the motor to stop in the deceleration time. Fault relay output terminal MA-MC turns ON, and MB-MC turns OFF.

1 : Coast to Stop

The output turns off and the motor coasts to stop. Fault relay output terminal MA-MC turns ON, and MB-MC turns OFF.

2 : Fast Stop (Use C1-09)

The drive stops the motor in the deceleration time set in *C1-09* [Fast Stop Time]. Fault relay output terminal MA-MC turns ON, and MB-MC turns OFF.

3 : Alarm Only

The keypad shows *bUS* and the drive continues operation at the current frequency reference.

Note:

Separately prepare safety protection equipment and systems, for example fast stop switches.

The output terminal set for *Alarm* [*H2-01* to *H2-03* = 10] activates.

4 : Alarm (Run at d1-04)

The keypad shows *bUS* and the drive continues operation at the speed set in *d1-04* [Reference 4].

Note:

Separately prepare safety protection equipment and systems, for example fast stop switches.

5 : Alarm - Ramp Stop

The drive stops the motor in the deceleration time set in *C1-02* [Deceleration Time 1].

After you remove the *bUS* alarm, the motor will accelerate to the frequency reference you set before.

■ F6-02: Comm External Fault (EF0) Detect

No. (Hex.)	Name	Description	Default (Range)
F6-02 (03A3)	Comm External Fault (EF0) Detect	Sets the conditions at which <i>EF0</i> [Option Card External Fault] is detected.	0 (0, 1)

0 : Always Detected

1 : Detected during RUN Only

■ F6-03: Comm External Fault (EF0) Select

No. (Hex.)	Name	Description	Default (Range)
F6-03 (03A4)	Comm External Fault (EF0) Select	Sets the method to stop the motor or let the motor continue operating when the drive detects an <i>EF0</i> [Option Card External Fault].	1 (0 - 3)

0 : Ramp to Stop

The drive ramps the motor to stop in the deceleration time. Fault relay output terminal MA-MC turns ON, and MB-MC turns OFF.

1 : Coast to Stop

The output turns off and the motor coasts to stop. Fault relay output terminal MA-MC turns ON, and MB-MC turns OFF.

2 : Fast Stop (Use C1-09)

The drive stops the motor in the deceleration time set in *C1-09* [Fast Stop Time]. Fault relay output terminal MA-MC turns ON, and MB-MC turns OFF.

3 : Alarm Only

The keypad shows *EF0* and the drive continues operation.

Note:

Separately prepare safety protection equipment and systems, for example fast stop switches.

The output terminal set for *Alarm* [H2-01 to H2-03 = 10] activates.

■ F6-04: bUS Error Detection Time

No. (Hex.)	Name	Description	Default (Range)
F6-04 (03A5)	bUS Error Detection Time	Sets the delay time for the drive to detect <i>bUS</i> [Option Communication Error].	2.0 s (0.0 - 5.0 s)

■ F6-07: Multi-Step Ref @ NetRef/ComRef

No. (Hex.)	Name	Description	Default (Range)
F6-07 (03A8)	Multi-Step Ref @ NetRef/ComRef	Sets the function that enables and disables the multi-step speed reference when the frequency reference source is NetRef or ComRef (communication option card or MEMOBUS/Modbus communications).	0 (0, 1)

0 : Disable Multi-Step References

When NetRef or ComRef are the frequency reference source, the multi-step speed reference (2-step speed to 16-step speed references) and the Jog Frequency Reference (JOG command) are disabled.

1 : Enable Multi-Step References

When NetRef or ComRef are the frequency reference source, the multi-step speed reference (2-step speed through 16-step speed references) and the Jog Frequency Reference (JOG command) are enabled, and you can change the frequency reference.

■ F6-08: Comm Parameter Reset @Initialize

No. (Hex.)	Name	Description	Default (Range)
F6-08 (036A)	Comm Parameter Reset @Initialize	Sets the function to initialize <i>F6-xx</i> and <i>F7-xx</i> parameters when the drive is initialized with <i>A1-03</i> [Initialize Parameters].	0 (0, 1)

0 : No Reset - Parameters Retained

1 : Reset Back to Factory Default

Note:

When you use *A1-03* to initialize the drive, this setting will not change.

■ F6-14: BUS Error Auto Reset

No. (Hex.)	Name	Description	Default (Range)
F6-14 (03BB)	BUS Error Auto Reset	Sets the automatic reset function for <i>bUS</i> [Option Communication Errors].	0 (0, 1)

0 : Disabled

1 : Enabled

■ F6-15: Comm. Option Parameters Reload

No. (Hex.)	Name	Description	Default (Range)
F6-15 (0B5B)	Comm. Option Parameters Reload	Sets the update method when you change <i>F6-xx, F7-xx</i> [Communication Options].	0 (0 - 2)

Note:

- Set *F6-15* = 0, 1 to reload *F6-xx, F7-xx*.
- Set *F6-15* = 0, 1 to reset the display on the keypad to 0.

0 : Reload at Next Power Cycle

Restart the drive to update parameters.

1 : Reload Now

The changed parameters are updated without restarting the drive.

2 : Cancel Reload Request

Cancels *CyPo* [Cycle Power to Accept Changes].

■ F6-48: BACnet Device Object Identifier 0

No. (Hex.)	Name	Description	Default (Range)
F6-48 (02FE)	BACnet Device Object Identifier 0	Sets the Instance Identifier of the BACnet Device Object, where the <i>F6-48</i> value is the least significant word. Available in bypass software versions 00446 and later.	1 (0 - FFFFH)

Note:

This parameter and *F6-49* set the Instance Identifier of the BACnet Device Object.

Example 1: Set the Device Object Instance Identifier to 1234. 1234 decimal is equal to 4D2H (hexadecimal). Set *F6-48* = 4D2H and *F6-49* = 0.

Example 2: Set the Device Object Instance Identifier to 1234567. 1234567 decimal is equal to 12D687H. Set *F6-48* = D687H and *F6-49* = 12H.

■ F6-49: BACnet Device Object Identifier 1

No. (Hex.)	Name	Description	Default (Range)
F6-49 (02FF)	BACnet Device Object Identifier 1	Sets the Instance Identifier of the BACnet Device Object, where the <i>F6-49</i> value is the most significant word. Available in bypass software versions 00446 and later.	0 (0 - 3FH)

Note:

This parameter and *F6-48* set the Instance Identifier of the BACnet Device Object.

Example 1: Set the Device Object Instance Identifier to 1234. 1234 decimal is equal to 4D2H (hexadecimal). Set *F6-48* = 4D2H and *F6-49* = 0.

Example 2: Set the Device Object Instance Identifier to 1234567. 1234567 decimal is equal to 12D687H. Set *F6-48* = D687H and *F6-49* = 12H.

■ F6-54: DeviceNet Idle Fault Detection

No. (Hex.)	Name	Description	Default (Range)
F6-54 (03C5)	DeviceNet Idle Fault Detection	V/f OLV/PM EZOLV Sets the function to detect <i>EF0</i> [Option Card External Fault] when the drive does not receive data from the DeviceNet master.	0 (0 - 4)

0 : Enabled

1 : Disabled, No Fault Detection

Does not detect *EF0* issues.

2 : Vendor Specific

3 : RUN Forward

4 : RUN Reverse

■ F7-01: IP Address 1

No. (Hex.)	Name	Description	Default (Range)
F7-01 (03E5)	IP Address 1	Sets the first octet of the IP Address for the device that is connecting to the network. Restart the drive after you change this parameter.	192 (0 - 255)

Note:

When *F7-13 = 0* [Address Mode at Startup = Static]:

- Use parameters *F7-01 to F7-04* [IP Address 4] to set the IP Address. Be sure to set a different IP address for each drive on the network.
- Also set parameters *F7-01 to F7-12*.

■ F7-02: IP Address 2

No. (Hex.)	Name	Description	Default (Range)
F7-02 (03E6)	IP Address 2	Sets the second octet of the IP Address for the device that is connecting to the network. Restart the drive after you change this parameter.	168 (0 - 255)

Note:

When *F7-13 = 0* [Address Mode at Startup = Static]:

- Use parameters *F7-01 to F7-04* [IP Address 4] to set the IP Address. Be sure to set a different IP address for each drive on the network.
- Also set parameters *F7-01 to F7-12*.

■ F7-03: IP Address 3

No. (Hex.)	Name	Description	Default (Range)
F7-03 (03E7)	IP Address 3	Sets the third octet of the IP Address for the device that is connecting to the network. Restart the drive after you change this parameter.	1 (0 - 255)

Note:

When *F7-13 = 0* [Address Mode at Startup = Static]:

- Use parameters *F7-01 to F7-04* [IP Address 4] to set the IP Address. Be sure to set a different IP address for each drive on the network.
- Also set parameters *F7-01 to F7-12*.

■ F7-04: IP Address 4

No. (Hex.)	Name	Description	Default (Range)
F7-04 (03E8)	IP Address 4	Sets the fourth octet of the IP Address for the device that is connecting to the network. Restart the drive after you change this parameter.	20 (0 - 255)

Note:

When *F7-13 = 0* [Address Mode at Startup = Static]:

- Use parameters *F7-01 to F7-04* [IP Address 4] to set the IP Address. Be sure to set a different IP address for each drive on the network.
- Also set parameters *F7-01 to F7-12*.

■ F7-05: Subnet Mask 1

No. (Hex.)	Name	Description	Default (Range)
F7-05 (03E9)	Subnet Mask 1	Sets the first octet of the subnet mask of the connected network.	255 (0 - 255)

Note:

Set this parameter when $F7-13 = 0$ [Address Mode at Startup = Static].

■ F7-06: Subnet Mask 2

No. (Hex.)	Name	Description	Default (Range)
F7-06 (03EA)	Subnet Mask 2	Sets the second octet of the subnet mask of the connected network.	255 (0 - 255)

Note:

Set this parameter when $F7-13 = 0$ [Address Mode at Startup = Static].

■ F7-07: Subnet Mask 3

No. (Hex.)	Name	Description	Default (Range)
F7-07 (03EB)	Subnet Mask 3	Sets the third octet of the subnet mask of the connected network.	255 (0 - 255)

Note:

Set this parameter when $F7-13 = 0$ [Address Mode at Startup = Static].

■ F7-08: Subnet Mask 4

No. (Hex.)	Name	Description	Default (Range)
F7-08 (03EC)	Subnet Mask 4	Sets the fourth octet of the subnet mask of the connected network.	0 (0 - 255)

Note:

Set this parameter when $F7-13 = 0$ [Address Mode at Startup = Static].

■ F7-09: Gateway Address 1

No. (Hex.)	Name	Description	Default (Range)
F7-09 (03ED)	Gateway Address 1	Sets the first octet of the gateway address of the connected network.	192 (0 - 255)

Note:

Set this parameter when $F7-13 = 0$ [Address Mode at Startup = Static].

■ F7-10: Gateway Address 2

No. (Hex.)	Name	Description	Default (Range)
F7-10 (03EE)	Gateway Address 2	Sets the second octet of the gateway address of the connected network.	168 (0 - 255)

Note:

Set this parameter when $F7-13 = 0$ [Address Mode at Startup = Static].

■ F7-11: Gateway Address 3

No. (Hex.)	Name	Description	Default (Range)
F7-11 (03EF)	Gateway Address 3	Sets the third octet of the gateway address of the connected network.	1 (0 - 255)

Note:

Set this parameter when $F7-13 = 0$ [Address Mode at Startup = Static].

■ F7-12: Gateway Address 4

No. (Hex.)	Name	Description	Default (Range)
F7-12 (03F0)	Gateway Address 4	Sets the fourth octet of the gateway address of the connected network.	1 (0 - 255)

Note:

Set this parameter when $F7-13 = 0$ [Address Mode at Startup = Static].

■ F7-13: Address Mode at Startup

No. (Hex.)	Name	Description	Default (Range)
F7-13 (03F1)	Address Mode at Startup	Sets the method to set option card IP addresses.	2 (0 - 2)

0 : Static

1 : BOOTP

2 : DHCP

Note:

- The following setting values are available when using the PROFINET communication option card (SI-EP3).
 - 0: Static
 - 2: DCP
- When $F7-13 = 0$, set parameters $F7-01$ to $F7-12$ [IP Address 1 to Gateway Address 4] to set the IP Address. Be sure to set a different IP address for each drive on the network.

■ F7-14: Duplex Mode Selection

No. (Hex.)	Name	Description	Default (Range)
F7-14 (03F2)	Duplex Mode Selection	Sets the duplex mode setting method.	1 (0 - 8)

0 : Half/Half

1 : Auto/Auto

2 : Full/Full

3 : Half/Auto

Port 1 is set to "Half" and port 2 is set to "Auto".

4 : Half/Full

Port 1 is set to "Half" and port 2 is set to "Full".

5 : Auto/Half

Port 1 is set to "Auto" and port 2 is set to "Half".

6 : Auto/Full

Port 1 is set to "Auto" and port 2 is set to "Full".

7 : Full/Half

Port 1 is set to "Full" and port 2 is set to "Half".

8 : Full/Auto

Port 1 is set to “Full” and port 2 is set to “Auto”.

■ F7-15: Communication Speed Selection

No. (Hex.)	Name	Description	Default (Range)
F7-15 (03F3)	Communication Speed Selection	Sets the communications speed.	10 (10, 100 - 102)

10 : 10/10 Mbps

100 : 100/100 Mbps

101 : 10/100 Mbps

102 : 100/10 Mbps

Note:

Set this parameter when $F7-14 = 0$ or 2 [*Duplex Mode Selection = Half/Half or Full/Full*].

■ F7-16: Timeout Value

No. (Hex.)	Name	Description	Default (Range)
F7-16 (03F4)	Timeout Value	Sets the detection time for a communications timeout.	0.0 s (0.0 - 30.0 s)

Note:

Set this parameter to 0.0 to disable the connection timeout function.

■ F7-17: EtherNet/IP Speed Scaling Factor

No. (Hex.)	Name	Description	Default (Range)
F7-17 (03F5)	EtherNet/IP Speed Scaling Factor	Sets the scaling factor for the speed monitor in the EtherNet/IP Class ID 2AH Object.	0 (-15 - +15)

■ F7-18: EtherNet/IP Current Scale Factor

No. (Hex.)	Name	Description	Default (Range)
F7-18 (03F6)	EtherNet/IP Current Scale Factor	Sets the scaling factor for the output current monitor in the EtherNet/IP Class ID 2AH Object.	0 (-15 - +15)

■ F7-19: EtherNet/IP Torque Scale Factor

No. (Hex.)	Name	Description	Default (Range)
F7-19 (03F7)	EtherNet/IP Torque Scale Factor	Sets the scaling factor for the torque monitor in the EtherNet/IP Class ID 2AH Object.	0 (-15 - +15)

■ F7-20: EtherNet/IP Power Scaling Factor

No. (Hex.)	Name	Description	Default (Range)
F7-20 (03F8)	EtherNet/IP Power Scaling Factor	Sets the scaling factor for the power monitor in the EtherNet/IP Class ID 2AH Object.	0 (-15 - +15)

■ F7-21: EtherNet/IP Voltage Scale Factor

No. (Hex.)	Name	Description	Default (Range)
F7-21 (03F9)	EtherNet/IP Voltage Scale Factor	Sets the scaling factor for the voltage monitor in the EtherNet/IP Class ID 2AH Object.	0 (-15 - +15)

■ F7-22: EtherNet/IP Time Scaling

No. (Hex.)	Name	Description	Default (Range)
F7-22 (03FA)	EtherNet/IP Time Scaling	Sets the scaling factor for the time monitor in the EtherNet/IP Class ID 2AH Object.	0 (-15 - +15)

■ F7-23 to F7-32: Dynamic Out Param 1 to 10 for CommCard

No. (Hex.)	Name	Description	Default (Range)
F7-23 to F7-27 (03FB - 03FF) F7-28 to F7-32 (0370 - 0374)	Dynamic Out Param 1 to 10 for CommCard	When you use an Ethernet/IP option, sets Output Assembly 116. The drive writes the values from Output Assembly 116 to the MEMOBUS/Modbus address register that is stored for each parameter. The drive will not write the values from Output Assembly 116 to the registers when the MEMOBUS/Modbus address is 0. When you use a ProfiNet option, set <i>F7-23</i> to <i>F7-27</i> to configurable Output 1-5.	0

■ F7-33 to F7-42: Dynamic In Param 1 to 10 for CommCard

No. (Hex.)	Name	Description	Default (Range)
F7-33 to F7-42 (0375 - 037E)	Dynamic In Param 1 to 10 for CommCard	When you use an Ethernet/IP option, sets Input Assembly 166. The drive sends the values from the MEMOBUS/Modbus address registers stored for each parameter to Input Assembly 166. The drive returns the default register value for the option card when the MEMOBUS/Modbus address is 0 and the value sent to Input Assembly 166 is not defined. When you use a ProfiNet option, set <i>F7-33</i> to <i>F7-37</i> to configurable inputs 1-5.	0

■ F7-43: PLC Connection Close Behavior at Run

No. (Hex.)	Name	Description	Default (Range)
F7-43 (1BCE)	PLC Cnxn Close Behavior@Run	Sets the drive response when a PLC closes a connection while the drive has an active Run command from the network.	0 (0 - 2)

0 : Continue

If the PLC is commanding a run when the connection closes, the drive will continue to run.

1 : Clear Run Command

If the PLC is commanding a run when the connection closes, the Run command is cleared and the drive stops running. This lets the PLC reopen a connection to the drive and initiate the run. A fault reset is not necessary.

2 : Fault

If the PLC is commanding a run when the connection closes, the drive will go into a bUS condition and react according to *F6-01*.

bUS Fault Delay in *F7-16* and BUS Fault Auto–Restart in *F6-14* work the same as other faults that declare bUS.

The initial Run command and all other Run commands from the network, will stay cleared until the PLC reconnects and initiates a run.

■ F7-50: BACnet/IP Port

No. (Hex.)	Name	Description	Default (Range)
F7-50 (1BC1)	BACnet/IP Port	Sets the UDP port on which the drive will receive incoming BACnet messages. Available in bypass software versions 00446 and later.	47808 (1024 - 65535)

■ F7-51 to F7-54: DBBMD Foreign Register Addr 1 to 4

No. (Hex.)	Name	Description	Default (Range)
F7-51 to F7-54 (1BE9 - 1BEC)	BBMD Foreign Register Addr 1 to 4	Sets the first through fourth octets of the IP Address of the BACnet Broadcast Management Device (BBMD) to which the drive will register as a foreign device. Available in bypass software versions 00446 and later.	0 (0 - 255)

■ F7-55: BBMD Foreign Register Port

No. (Hex.)	Name	Description	Default (Range)
F7-55 (1BED)	BBMD Foreign Register Port	Sets the UDP port of the BBMD device to which the drive will register. Available in bypass software versions 00446 and later.	47808 (1024 - 65535)

■ F7-56: BBMD Foreign Register Time

No. (Hex.)	Name	Description	Default (Range)
F7-56 (1BEE)	BBMD Foreign Register Time	Sets the time interval in which the drive will repeat BBMD foreign registration. Available in bypass software versions 00446 and later.	3600 s (0 - 65535 s)

■ F7-57: BACnet/IP BUS Timeout Value

No. (Hex.)	Name	Description	Default (Range)
F7-57 (1BEF)	BACnet/IP BUS Timeout Value	Sets the length of time that the drive will wait after it receives a Run command or frequency reference command before it detects a <i>bUS</i> fault. Available in bypass software versions 00446 and later.	3600 s (0 - 65535 s)

5.7 H: Terminal Functions

H parameters are used to assign functions to external input and output terminals.

◆ H1: Digital Inputs

H1 Parameters set the MFDI terminal functions.

■ H1-01 to H1-07 Terminal S1 to S7 Function Selection

The drive has 7 MFDI terminals. Refer to [Table 5.35](#) for drive default settings and functions.

Table 5.35 MFDI Default Settings and Functions

No.	Name	Default	Function
H1-01	Terminal S1 Function Selection	40	Forward RUN (2-Wire) ^{*1}
H1-02	Terminal S2 Function Selection	F	Not Used
H1-03	Terminal S3 Function Selection	24	External Fault (NO-Always-Coast)
H1-04	Terminal S4 Function Selection	14	Fault Reset
H1-05	Terminal S5 Function Selection	3	Multi-Step Speed Reference 1
H1-06	Terminal S6 Function Selection	4	Multi-Step Speed Reference 2
H1-07	Terminal S7 Function Selection	6	Jog Reference Selection

*1 This terminal does not control bypass Run/Stop. Use terminal TB2 on the Bypass PCB A2 instead.

Table 5.36 MFDI Setting Values

Setting Value	Function	Reference	Setting Value	Function	Reference
3	Multi-Step Speed Reference 1	261	3F	PID Setpoint Selections 2	267
4	Multi-Step Speed Reference 2	261	40	Forward RUN (2-Wire)	267
5	Multi-Step Speed Reference 3	262	44	Add Offset Frequency 1 (d7-01)	267
6	Jog Reference Selection	262	45	Add Offset Frequency 2 (d7-02)	267
7	Accel/Decel Time Selection 1	262	46	Add Offset Frequency 3 (d7-03)	267
8	Baseblock Command (N.O.)	262	51	Sequence Timer Disable	267
9	Baseblock Command (N.C.)	262	52	Sequence Timer Cancel	268
A	Accel/Decel Ramp Hold	263	61	Speed Search from Fmax	268
B	Overheat Alarm (oH2)	263	62	Speed Search from Fref	268
C	Analog Terminal Enable Selection	263	63	Field Weakening	268
F	Not Used	263	68	High Slip Braking (HSB) Activate	268
14	Fault Reset Procedure	263	6A	Drive Enable	268
15	Fast Stop (N.O.)	263	70	Drive Enable 2	269
17	Fast Stop (N.C.)	264	82	PI Switch to Aux	269
18	Timer Function	264	83	Dedicated Multi-Setpoint YA-02	269
19	PID Disable	264	84	Dedicated Multi-Setpoint YA-03	269
1E	Reference Sample Hold	264	85	Dedicated Multi-Setpoint YA-04	269
20 to 2F	External Fault	265	88	Thermostat Fault	270
30	PID Integrator Reset	266	A8	PI2 Control Disable	270
31	PID Integrator Hold	266	AA	PI2 Control Inverse Operation	270
34	PID Soft Starter Disable	266	AB	PI2 Control Integral Reset	270
35	PID Input (Error) Invert	266	AC	PI2 Control Integral Hold	270
3E	PID Setpoint Selection 1	266	AD	Select PI2 Control PI Parameters	270

5.7 H: Terminal Functions

Setting Value	Function	Reference
B9	Disable Pre-charge	270

Setting Value	Function	Reference
188 and 1A8	Inverse Inputs of 88 and A8 Sets the function of the selected MFDI to operate inversely. To select the function for inverse input, enter two digits of 88 or A8 for the "xx" in "1xx".	270

■ H1-01: Terminal S1 Function Selection

No. (Hex.)	Name	Description	Default (Range)
H1-01 (0438)	Terminal S1 Function Selection	Sets the function for MFDI terminal S1.	40 (3 to 1A8)

■ H1-02: Terminal S2 Function Selection

No. (Hex.)	Name	Description	Default (Range)
H1-02 (0439)	Terminal S2 Function Selection	Sets the function for MFDI terminal S2.	F (3 to 1A8)

■ H1-03: Terminal S3 Function Selection

No. (Hex.)	Name	Description	Default (Range)
H1-03 (0400)	Terminal S3 Function Selection	Sets the function for MFDI terminal S3.	24 (3 to 1A8)

■ H1-04: Terminal S4 Function Selection

No. (Hex.)	Name	Description	Default (Range)
H1-04 (0401)	Terminal S4 Function Selection	Sets the function for MFDI terminal S4.	14 (3 to 1A8)

■ H1-05: Terminal S5 Function Selection

No. (Hex.)	Name	Description	Default (Range)
H1-05 (0402)	Terminal S5 Function Selection	Sets the function for MFDI terminal S5.	3 (3 to 1A8)

■ H1-06: Terminal S6 Function Selection

No. (Hex.)	Name	Description	Default (Range)
H1-06 (0403)	Terminal S6 Function Selection	Sets the function for MFDI terminal S6.	4 (3 to 1A8)

■ H1-07: Terminal S7 Function Selection

No. (Hex.)	Name	Description	Default (Range)
H1-07 (0404)	Terminal S7 Function Selection	Sets the function for MFDI terminal S7.	6 (3 to 1A8)

■ MFDI ON/OFF Time Delay

This function supplies an ON/OFF Delay to all MFDIs. To use this function, set parameters *H1-61 to H1-67* [Terminal Sx On-Delay Time] and *H1-71 to H1-77* [Terminal Sx Off-Delay Time].

WARNING! Crush Hazard. Make sure that the settings for H1-61 to H1-67 [Terminal Sx On-Delay Time] and H1-71 to H1-77 [Terminal Sx Off-Delay Time] are correct when you interface the drive with a safety process. The drive also applies the time delay settings to the safety functions such as Baseblock. Incorrect time delay settings can cause serious injury or death from malfunction of the safety functions.

When the terminal is ON, the function set to that terminal activates after the ON-delay timer for the terminal is expired. The terminal will reset the ON-delay timer when the terminal is OFF.

When the terminal is OFF and the function is active, the function will run until the OFF-delay timer is expired. The terminal will reset the OFF-delay timer when the terminal is ON again.

The ON-delay and OFF-delay timers also have an effect on U1-10 [Input Terminal Status]. When the ON-delay is expired and the function is active, the drive sets the applicable bits. When the OFF-delay is expired and the function deactivates, the drive resets the bits.

Note:

The ON-delay timer does not apply when the inputs are ON at power-up.

Figure 5.39 shows drive operation when you apply ON/OFF-Delay Timers to the MFDI set for $H1-xx = 6E$ [HAND Command] when $S5-02 = 1$ [HAND/AUTO Switchover During Run = Enabled].

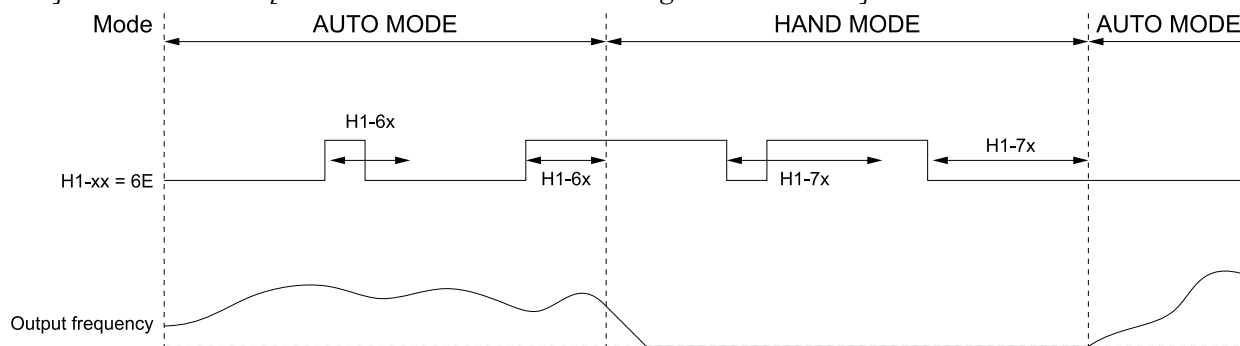

Figure 5.39 Example of ON-Delay and OFF-Delay Timers

Inverse Multi-Function Digital Inputs

For inverse MFDI (H1-xx > 100), the delay timers use the inverse condition of the digital input.

When a terminal is OFF, the function set to that terminal activates after the ON-delay timer for the terminal is expired. The terminal will reset the ON-delay timer when the terminal is ON.

When the terminal is ON and the function is active, the function will run until the OFF-delay timer is expired. The terminal will reset the OFF-delay timer when the terminal is OFF again.

Note:

If you change a terminal function selection between an inverse and a non-inverse digital input selection while an ON-delay or OFF-delay timer is active, the new delay timer will not go into effect until the current ON-delay or OFF-delay timer is expired, and the digital input changes to ON or OFF.

■ H1-61: Terminal S1 On-Delay Time

No. (Hex.)	Name	Description	Default (Range)
H1-61 (39E1) RUN	Terminal S1 On-Delay Time	Sets the length of time necessary for Terminal S1 to be closed before the drive does the programmed function.	0.00 s (0.00 - 300.00 s)

■ H1-62: Terminal S2 On-Delay Time

No. (Hex.)	Name	Description	Default (Range)
H1-62 (39E2) RUN	Terminal S2 On-Delay Time	Sets the length of time necessary for Terminal S2 to be closed before the drive does the programmed function.	0.00 s (0.00 - 300.00 s)

■ H1-63: Terminal S3 On-Delay Time

No. (Hex.)	Name	Description	Default (Range)
H1-63 (39E3) RUN	Terminal S3 On-Delay Time	Sets the length of time necessary for Terminal S3 to be closed before the drive does the programmed function.	0.00 s (0.00 - 300.00 s)

■ H1-64: Terminal S4 On-Delay Time

No. (Hex.)	Name	Description	Default (Range)
H1-64 (39E4) RUN	Terminal S4 On-Delay Time	Sets the length of time necessary for Terminal S4 to be closed before the drive does the programmed function.	0.00 s (0.00 - 300.00 s)

■ H1-65: Terminal S5 On-Delay Time

No. (Hex.)	Name	Description	Default (Range)
H1-65 (39E5) RUN	Terminal S5 On-Delay Time	Sets the length of time necessary for Terminal S5 to be closed before the drive does the programmed function.	0.00 s (0.00 - 300.00 s)

■ H1-66: Terminal S6 On-Delay Time

No. (Hex.)	Name	Description	Default (Range)
H1-66 (39E6) RUN	Terminal S6 On-Delay Time	Sets the length of time necessary for Terminal S6 to be closed before the drive does the programmed function.	0.00 s (0.00 - 300.00 s)

■ H1-67: Terminal S7 On-Delay Time

No. (Hex.)	Name	Description	Default (Range)
H1-67 (39E7) RUN	Terminal S7 On-Delay Time	Sets the length of time necessary for Terminal S7 to be closed before the drive does the programmed function.	0.00 s (0.00 - 300.00 s)

■ H1-71: Terminal S1 Off-Delay Time

No. (Hex.)	Name	Description	Default (Range)
H1-71 (39EB) RUN	Terminal S1 Off-Delay Time	Sets the length of time necessary for Terminal S1 to be open before the drive removes the programmed function.	0.00 s (0.00 - 300.00 s)

■ H1-72: Terminal S2 Off-Delay Time

No. (Hex.)	Name	Description	Default (Range)
H1-72 (39EC) RUN	Terminal S2 Off-Delay Time	Sets the length of time necessary for Terminal S2 to be open before the drive removes the programmed function.	0.00 s (0.00 - 300.00 s)

■ H1-73: Terminal S3 Off-Delay Time

No. (Hex.)	Name	Description	Default (Range)
H1-73 (39ED) RUN	Terminal S3 Off-Delay Time	Sets the length of time necessary for Terminal S3 to be open before the drive removes the programmed function.	0.00 s (0.00 - 300.00 s)

■ H1-74: Terminal S4 Off-Delay Time

No. (Hex.)	Name	Description	Default (Range)
H1-74 (39EE) RUN	Terminal S4 Off-Delay Time	Sets the length of time necessary for Terminal S4 to be open before the drive removes the programmed function.	0.00 s (0.00 - 300.00 s)

■ H1-75: Terminal S5 Off-Delay Time

No. (Hex.)	Name	Description	Default (Range)
H1-75 (39EF) RUN	Terminal S5 Off-Delay Time	Sets the length of time necessary for Terminal S5 to be open before the drive removes the programmed function.	0.00 s (0.00 - 300.00 s)

■ H1-76: Terminal S6 Off-Delay Time

No. (Hex.)	Name	Description	Default (Range)
H1-76 (39F0) RUN	Terminal S6 Off-Delay Time	Sets the length of time necessary for Terminal S6 to be open before the drive removes the programmed function.	0.00 s (0.00 - 300.00 s)

■ H1-77: Terminal S7 Off-Delay Time

No. (Hex.)	Name	Description	Default (Range)
H1-77 (39F1) RUN	Terminal S7 Off-Delay Time	Sets the length of time necessary for Terminal S7 to be open before the drive removes the programmed function.	0.00 s (0.00 - 300.00 s)

◆ MFDI Setting Value

Selects a function set with *H1-01 to H1-07*.

■ 3: Multi-Step Speed Reference 1

Setting Value	Function	Description
3	Multi-Step Speed Reference 1	Uses speed references <i>d1-01 to d1-08</i> to set a multi-step speed reference.

Note:

Refer to “Setting Procedures for Multi-step Speed Operation” in “d: Reference Settings” for more information.

■ 4: Multi-Step Speed Reference 2

Setting Value	Function	Description
4	Multi-Step Speed Reference 2	Uses speed references <i>d1-01 to d1-08</i> to set a multi-step speed reference.

Note:

Refer to “Setting Procedures for Multi-step Speed Operation” in “d: Reference Settings” for more information.

■ 5: Multi-Step Speed Reference 3

Setting Value	Function	Description
5	Multi-Step Speed Reference 3	Uses speed references <i>d1-01</i> to <i>d1-08</i> to set a multi-step speed reference.

Note:

Refer to “Setting Procedures for Multi-step Speed Operation” in “d: Reference Settings” for more information.

■ 6: Jog Reference Selection

Setting Value	Function	Description
6	Jog Reference Selection	Sets the drive to use the JOG Frequency Reference (JOG command) set in <i>d1-17</i> [<i>Jog Reference</i>]. The JOG Frequency Reference (JOG command) overrides the <i>d1-01</i> to <i>d1-08</i> [<i>References 1 to 8</i>] settings.

■ 7: Accel/Decel Time Selection 1

Setting Value	Function	Description
7	Accel/Decel Time Selection 1	Sets the drive to use <i>Acceleration/Deceleration Time 1</i> [<i>C1-01, C1-02</i>] or <i>Acceleration/Deceleration Time 2</i> [<i>C1-03, C1-04</i>].

Note:

Refer to *C1: Accel & Decel Time on page 222* for more information.

■ 8: Baseblock Command (N.O.)

Setting Value	Function	Description
8	Baseblock Command (N.O.)	Sets the command that stops drive output and coasts the motor to stop when the input is ON.

The keypad flashes *bb* [*Baseblock*]. If you cancel the baseblock command when the Run command is active, the drive will restart the motor and use the speed search function.

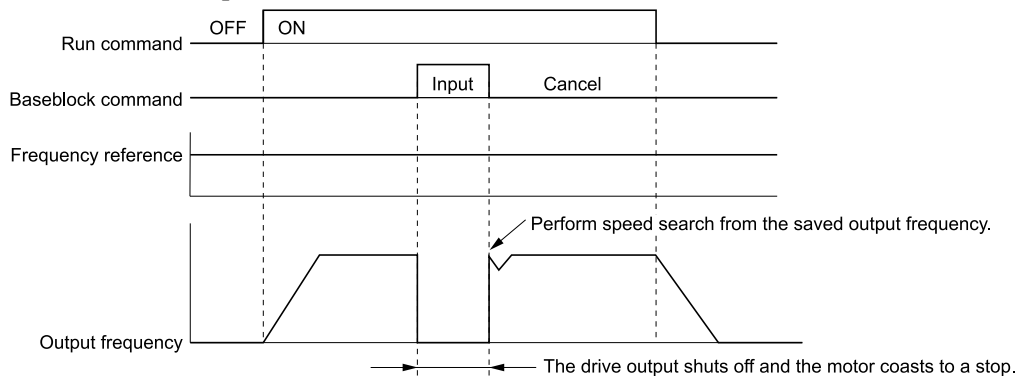

Figure 5.40 Baseblock Command Time Chart

ON : Baseblock (drive output stop)

OFF : Normal operation

■ 9: Baseblock Command (N.C.)

Setting Value	Function	Description
9	Baseblock Command (N.C.)	Sets the command that stops drive output and coasts the motor to stop when the input terminal is OFF.

The keypad flashes *bb* [*Baseblock*]. If you cancel the baseblock command when the Run command is active, the drive will restart the motor and use the speed search function.

ON : Normal operation

OFF : Baseblock (drive output stop)

■ A: Accel/Decel Ramp Hold

Setting Value	Function	Description
A	Accel/Decel Ramp Hold	Momentarily pauses motor acceleration and deceleration when the terminal is turned ON, retains the output frequency that was stored in the drive at the time of the pause, and restarts motor operation.

If the terminal is deactivated, the drive restarts acceleration and deceleration.

When the acceleration/deceleration ramp hold terminal is activated and $d4-01 = 1$ [*Freq Reference Retention Select = Enabled*], the drive will store the output frequency in memory. While the acceleration/deceleration ramp hold command is activated, the drive will always restart the motor at this output frequency.

Note:

Refer to [d4-01: Freq Reference Hold Selection on page 235](#) for more information.

■ B: Overheat Alarm (oH2)

Setting Value	Function	Description
B	Overheat Alarm (oH2)	Sets the drive to display an oH2 [<i>Drive Overheat Warning</i>] alarm when the input terminal is ON. The alarm does not have an effect on drive operation.

■ C: Analog Terminal Enable Selection

Setting Value	Function	Description
C	Analog Terminal Enable Selection	Sets the command that enables or disables the terminals selected in H3-14 [<i>Analog Input Terminal Enable Sel</i>].

ON : Terminal selected with H3-14 is enabled

OFF : Terminal selected with H3-14 is disabled

■ F: Not Used

Setting Value	Function	Description
F	Not Used	Use this setting for unused terminals or to use terminals in through mode.

Through Mode uses the signal input to the terminal as a digital input for the upper sequence through a communication option or MEMOBUS/Modbus communications. This input signal does not have an effect on drive operation.

■ 14: Fault Reset

Setting Value	Function	Description
14	Fault Reset	Sets the command to reset the current fault when the Run command is inactive.

If the drive detects a fault, the drive will activate the fault relay output, turn off the output, and the motor will coast to stop.

If the drive detects a fault for which you can set the stopping method, apply the appropriate Stopping Method. Then push  (RESET) on the keypad to turn the Run command OFF, or activate the fault reset terminal to reset the fault.

Note:

- The drive ignores the fault reset command when the Run command is active. Remove the Run command before trying to reset a fault.
- This will only reset drive-specific faults. It will not reset bypass (*FBxx*) faults. Set $Z2-0x = 34$ and a bypass digital input to reset ALL faults.

■ 15: Fast Stop (N.O.)

Setting Value	Function	Description
15	Fast Stop (N.O.)	Sets the command to ramp to stop in the deceleration time set in C1-09 [<i>Fast Stop Time</i>] when the input terminal is activated while the drive is operating.

If you cancel the fast stop input, the drive will not restart the motor until you meet these conditions:

- Fully stop the motor
- Cancel the Run command
- Cancel the fast stop command

Note:

- To use the N.C. switch to input the fast stop command, set 17 (Fast Stop (N.C.)).
- Refer to [C1-09: Fast Stop Time on page 223](#) for more information.
- Set *C1-09 [Fast Stop Time]* to a correct deceleration time. If the deceleration time is too short, it can cause an overvoltage fault and failure to stop the motor from coasting.

■ 17: Fast Stop (N.C.)

Setting Value	Function	Description
17	Fast Stop (N.C.)	Sets the command to ramp to stop in the deceleration time set in <i>C1-09 [Fast Stop Time]</i> when the input terminal is activated while the drive is operating.

If you cancel the fast stop input, the drive will not restart the motor until you meet these conditions:

- Fully stop the motor
- Cancel the Run command
- Cancel the fast stop command

Note:

- To use the N.O. switch to input the fast stop command, set 15 (Fast Stop (N.O.)).
- Refer to [C1-09: Fast Stop Time on page 223](#) for more information.
- Set *C1-09 [Fast Stop Time]* to a correct deceleration time. If the deceleration time is too short, it can cause an overvoltage fault and failure to stop the motor from coasting.

[Figure 5.41](#) shows an example of how fast stop operates.

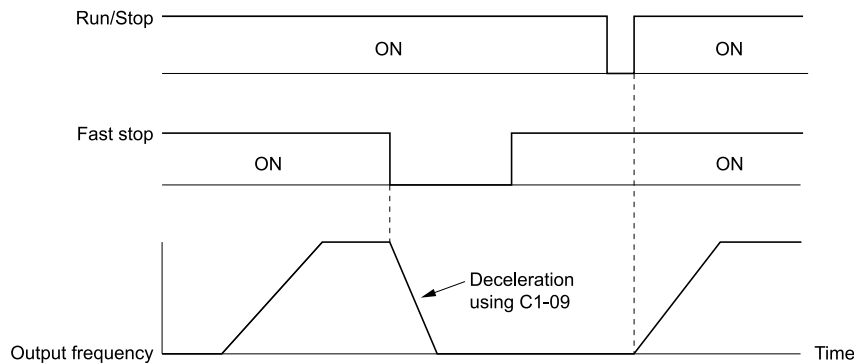

C1-09: Fast Stop Time

Figure 5.41 Fast Stop Time Chart

■ 18: Timer Function

Setting Value	Function	Description
18	Timer Function	Sets the command to start the timer function. Use this setting with <i>Timer Output [H2-xx = 12]</i> .

Note:

Refer to “b4: Timer Function” for more information.

■ 19: PID Disable

Setting Value	Function	Description
19	PID Disable	Sets the command to disable PID control when <i>b5-01 = 1 or 3 [PID Mode Setting = Standard or Fref + PID Trim]</i> .

ON : PID control disabled

OFF : PID control enabled

■ 1E: Reference Sample Hold

Setting Value	Function	Description
1E	Reference Sample Hold	Sets the command to sample the frequency reference at terminals A1 or A2 and hold the frequency reference at that frequency.

When the terminal is active for 100 ms, this function reads a sample of the analog frequency reference and holds that sample. When you input the sample/hold command again, the function reads a sample of the analog frequency reference again and holds that sample. When you turn off the power, the drive erases the saved analog frequency and resets the frequency reference to 0.

Figure 5.42 shows an example of how the function operates.

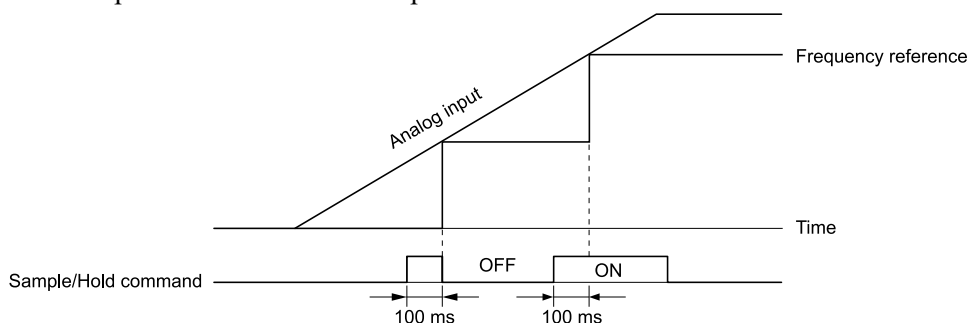

Figure 5.42 Reference Sample Hold

You cannot set the Reference Sample Hold function at the same time as these functions:

- $H1-xx = A$ [Accel/Decel Ramp Hold]
- $H1-xx = 10, 11$ [Up Command, Down Command]
- $H1-xx = 44$ to 46 [Offset Frequency 1 to 3]

If you set them at the same time, the drive will detect $oPE03$ [Multi-Function Input Setting Err].

■ 20 to 2F: External Fault

Setting Value	Function	Description
20 to 2F	External fault	Sets a command to stop the drive when a failure or fault occurs on an external device.

If an external fault is input to the drive, the keypad will show EFx [External Fault (Terminal Sx)], where x is the number of the terminal (terminal Sx) to which the external fault signal is assigned. For example, when an external fault signal is input to terminal $S3$, the keypad will show $EF3$.

Use these conditions to select the value to set in $H1-xx$:

- Signal input method from peripheral devices
- External fault detection method
- Motor stopping method (operation after external fault detection)

Table 5.37 shows the relation between the conditions and the value set to $H1-xx$.

Table 5.37 Stopping Methods for External Fault

Setting	Signal Input Method from Peripheral Devices ^{*1}		External Fault Detection Method ^{*2}		Stopping Method			
	N.O.	N.C.	Always Detected	Detected during RUN Only	Ramp to Stop (Fault)	Coast to Stop (Fault)	Fast Stop (Fault)	Continuous Operation (Alarm Only)
20	x	-	x	-	x	-	-	-
21	-	x	x	-	x	-	-	-
22	x	-	-	x	x	-	-	-
23	-	x	-	x	x	-	-	-
24	x	-	x	-	-	x	-	-
25	-	x	x	-	-	x	-	-
26	x	-	-	x	-	x	-	-
27	-	x	-	x	-	x	-	-
28	x	-	x	-	-	-	x	-
29	-	x	x	-	-	-	x	-

5.7 H: Terminal Functions

Setting	Signal Input Method from Peripheral Devices *1		External Fault Detection Method *2		Stopping Method			
	N.O.	N.C.	Always Detected	Detected during RUN Only	Ramp to Stop (Fault)	Coast to Stop (Fault)	Fast Stop (Fault)	Continuous Operation (Alarm Only)
2A	x	-	-	x	-	-	x	-
2B	-	x	-	x	-	-	x	-
2C	x	-	x	-	-	-	-	x
2D	-	x	x	-	-	-	-	x
2E	x	-	-	x	-	-	-	x
2F	-	x	-	x	-	-	-	x

*1 Set the terminal to N.O. (detects external fault when switched ON) or N.C. (detects external fault when switched OFF).

*2 Set the drive to always detect each fault or to detect only during run.

■ 30: PID Integrator Reset

Setting Value	Function	Description
30	PID Integrator Reset	Sets the command to reset and hold the PID control integral to 0 when the terminal is ON.

Note:

Refer to "PID control block diagram" for more information.

■ 31: PID Integrator Hold

Setting Value	Function	Description
31	PID Integrator Hold	Sets the command to hold the integral value of the PID control while the terminal is activated.

When you turn off the input terminal, PID control restarts the integral.

Note:

Refer to "PID control block diagram" for more information.

■ 34: PID Soft Starter Disable

Setting Value	Function	Description
34	PID Soft Starter Disable	Sets the PID soft starter function.

ON : Disabled

Disables *b5-17 [PID Accel/Decel Time]*.

OFF : Enabled

Enables *b5-17 [PID Accel/Decel Time]*.

Note:

Refer to "PID control block diagram" for more information.

■ 35: PID Input (Error) Invert

Setting Value	Function	Description
35	PID Input (Error) Invert	Sets the command to turn the terminal ON and OFF to switch the PID input level (polarity).

Note:

Refer to "PID control block diagram" for more information.

■ 3E: PID Setpoint Selection 1

Setting Value	Function	Description
3E	PID Setpoint Selection 1	Sets the function to switch the PID setpoint to <i>YA-02 [Setpoint 2]</i> or <i>YA-04 [Setpoint 4]</i> . Set this function and <i>H1-xx = 3F [PID Setpoint Selection 2]</i> at the same time.

Note:

If you use this function and one of $H1-xx = 83$ to 85 [*Dedicated Multi-Setpoint YA-02 to YA-04*] at the same time, the drive will detect an *oPE03* [*Multi-Function Input Setting Err*].

ON : YA-02 or YA-04 is PID setpoint.

OFF : The frequency reference, YA-01 [Setpoint 1], or YA-03 [Setpoint 3] is PID setpoint.

■ 3F: PID Setpoint Selection 2

Setting Value	Function	Description
3F	PID Setpoint Selection 2	Sets the function to switch the PID setpoint to YA-03 [Setpoint 3] or YA-04 [Setpoint 4]. Set this function and $H1-xx = 3E$ [PID Setpoint Selection 1] at the same time.

Note:

If you use this function and one of $H1-xx = 83$ to 85 [*Dedicated Multi-Setpoint YA-02 to YA-04*] at the same time, the drive will detect an *oPE03* [*Multi-Function Input Setting Err*].

ON : YA-03 or YA-04 is PID setpoint.

OFF : The frequency reference, YA-01 [Setpoint 1], or YA-02 [Setpoint 2] is PID setpoint.

■ 40: Forward RUN (2-Wire)

Setting Value	Function	Description
40	Forward RUN (2-Wire)	Terminals assigned to this value will have no effect. Set $Z2-0x = 2I$ and use a bypass digital input instead.

ON : Forward Run

OFF : Run Stop

■ 44: Add Offset Frequency 1 (d7-01)

Setting Value	Function	Description
44	Add Offset Frequency 1 (d7-01)	Sets the function to add the offset frequency set in $d7-01$ [<i>Offset Frequency 1</i>] to the frequency reference when the terminal activates.

Note:

Refer to [d7: Offset Frequency on page 237](#) for more information.

■ 45: Add Offset Frequency 2 (d7-02)

Setting Value	Function	Description
45	Add Offset Frequency 2 (d7-02)	Sets the function to add the offset frequency set in $d7-02$ [<i>Offset Frequency 2</i>] to the frequency reference when the terminal activates.

Note:

Refer to [d7: Offset Frequency on page 237](#) for more information.

■ 46: Add Offset Frequency 3 (d7-03)

Setting Value	Function	Description
46	Add Offset Frequency 3 (d7-03)	Sets the function to add the offset frequency set in $d7-03$ [<i>Offset Frequency 3</i>] to the frequency reference when the terminal activates.

Note:

Refer to [d7: Offset Frequency on page 237](#) for more information.

■ 51: Sequence Timer Disable

Setting Value	Function	Description
51	Sequence Timer Disable	Sets the command to disable Sequence Timers.

ON : Sequence Timer is Disabled

The drive ignores Sequence Timers and operates as usual as specified by $b1-02$ [*Run Command Selection 1*].

■ 52: Sequence Timer Cancel

Setting Value	Function	Description
52	Sequence Timer Cancel	Sets the command to cancel the currently active Sequence Timer.

ON : Cancel Active Sequence Timer

Operation will continue with the next scheduled sequence timer. When you cancel the sequence timer before you cycle the Run command, it will enable the sequence timer again.

■ 61: Speed Search from Fmax

Setting Value	Function	Description
61	Speed Search from Fmax	Sets the function to start speed search using an external reference although $b3-01 = 0$ [Speed Search Selection at Start = Disabled].

When the terminal is turned ON for $b3-24 = 2$ [Speed Search Method Selection = Current Detection 2], the drive starts speed search from the maximum output frequency.

Note:

- The drive will detect *oPE03* [Multi-Function Input Setting Err] when $H1-xx = 61$ and 62 are set at the same time.
- Refer to “b3: Speed Search” for more information.

■ 62: Speed Search from Fref

Setting Value	Function	Description
62	Speed Search from Fref	Sets the function to use an external reference to start speed search although $b3-01 = 0$ [Speed Search Selection at Start = Disabled].

When the terminal is turned ON for $b3-24 = 2$ [Speed Search Method Selection = Current Detection 2], the drive starts speed search from the frequency reference.

Note:

- The drive will detect *oPE03* [Multi-Function Input Setting Err] when $H1-xx = 61$ and 62 are set at the same time.
- Refer to “b3: Speed Search” for more information.

■ 63: Field Weakening

Setting Value	Function	Description
63	Field Weakening	Sets the function to send the Field Weakening Level and Field Weakening Frequency Limit commands set in $d6-01$ [Field Weakening Level] and $d6-02$ [Field Weakening Frequency Limit] when the input terminal is activated.

Note:

Refer to [d6: Field Weakening on page 236](#) for more information.

■ 68: High Slip Braking (HSB) Activate

Setting Value	Function	Description
68	High Slip Braking (HSB) Activate	Sets the command to use high-slip braking to stop the motor.

Note:

- When you restart the drive after you use high-slip braking, make sure that the drive fully stops the motor then clear the high-slip braking input.
- Refer to “n3: High Slip/Overex Braking” for more information.

■ 6A: Drive Enable

Setting Value	Function	Description
6A	Drive Enable	This will only function in Drive Mode. Sets the function to show <i>dnE</i> [Drive Enabled] on the keypad and ignore Run commands when the terminal is OFF.

If you input the Run command before you turn ON the Drive Enable terminal, you must input the Run command again to operate the drive. When you deactivate the terminal set for Drive Enable while the drive is operating, the drive will use the stopping method set in $b1-03$ [Stopping Method Selection] to stop the motor.

ON : Run command is accepted.

OFF : Run command is disabled. When the drive is running, it stops according to *b1-03* setting.

■ 70: Drive Enable 2

Setting Value	Function	Description
70	Drive Enable 2	This will only function in Drive Mode. Sets the function to show <i>dnE [Drive Enabled]</i> on the keypad and ignore Run commands when the terminal is OFF.

When you input the Run command before you turn ON the Drive Enable 2 terminal, it is not necessary to remove and apply the Run command again. The drive will start to operate when the Run command and Drive Enable 2 are both ON. If you turn OFF the terminal set for Drive Enable while the drive is operating, the drive will use the stopping method set in *b1-03 [Stopping Method Selection]* to stop the motor.

ON : Run command is accepted.

OFF : Run command is disabled. When the drive is running, it stops according to *b1-03* setting.

■ 82: PI Switch to Aux

Setting Value	Function	Description
82	PI Switch to Aux	Sets <i>YF-xx [PI Auxiliary Control]</i> parameters as primary PI loop parameters and disables <i>b5-xx [PID Control]</i> .

Note:

When this input is active, *YF-xx [PI Auxiliary Control]* parameters will always be the primary PI loop parameters. Parameter *YF-20 [PI Aux Main PI Speed Control]* does not have an effect.

■ 83: Dedicated Multi-Setpoint YA-02

Setting Value	Function	Description
83	Dedicated Multi-Setpoint YA-02	Sets the function to set the PID setpoint to <i>YA-02 [Setpoint 2]</i> .

Note:

If you use this function and one of *H1-xx = 3E or 3F [PID Setpoint Selection 1 or 2]* at the same time, the drive will detect an *oPE03 [Multi-Function Input Setting Err]*.

ON : YA-02 is PID setpoint.

OFF : YA-01 [Setpoint 1], YA-03 [Setpoint 3], or YA-04 [Setpoint 4] is PID setpoint.

■ 84: Dedicated Multi-Setpoint YA-03

Setting Value	Function	Description
84	Dedicated Multi-Setpoint YA-03	Sets the function to set the PID setpoint to <i>YA-03 [Setpoint 3]</i> . Set this function and <i>H1-xx = 83 [Dedicated Multi-Setpoint YA-02]</i> at the same time.

Note:

If you use this function and one of *H1-xx = 3E or 3F [PID Setpoint Selection 1 or 2]* at the same time, the drive will detect an *oPE03 [Multi-Function Input Setting Err]*.

ON : YA-03 is PID setpoint.

OFF : YA-01 [Setpoint 1], YA-02 [Setpoint 2], or YA-04 [Setpoint 4] is PID setpoint.

■ 85: Dedicated Multi-Setpoint YA-04

Setting Value	Function	Description
85	Dedicated Multi-Setpoint YA-04	Sets the function to set the PID setpoint to <i>YA-04 [Setpoint 4]</i> . Set this function, <i>H1-xx = 83 [Dedicated Multi-Setpoint YA-02]</i> , and <i>H1-xx = 84 [Dedicated Multi-Setpoint YA-03]</i> at the same time.

Note:

If you use this function and one of *H1-xx = 3E or 3F [PID Setpoint Selection 1 or 2]* at the same time, the drive will detect an *oPE03 [Multi-Function Input Setting Err]*.

ON : YA-04 is PID setpoint.

OFF : YA-01 [Setpoint 1], YA-02 [Setpoint 2], or YA-03 [Setpoint 3] is PID setpoint.

■ 88: Thermostat Fault

Setting Value	Function	Description
88	Thermostat Fault	Sets the drive to show the <i>VLTS [Thermostat Fault]</i> when the input terminal is ON.

Note:

This function is active when the drive is running.

If the drive is running in AUTO Mode or HAND Mode and if the terminal set for $H1-xx = 88$ [*MFDI Function Selection = Thermostat Fault*] is ON or if the terminal set for $H1-xx = 188$ [*!Thermostat Fault*] is OFF, the drive will detect *VLTS*.

■ A8: PI2 Control Disable

Setting Value	Function	Description
A8	PI2 Control Disable	Sets the command to disable the PI2 Control function. Parameter <i>S3-12 [PI2 Control Disable Mode Sel]</i> sets the output performance.

ON : Enabled

OFF : Disabled

■ AA: PI2 Control Inverse Operation

Setting Value	Function	Description
AA	PI2 Control Inverse Operation	Sets the command to change the sign of the PI2 Control input.

■ AB: PI2 Control Integral Reset

Setting Value	Function	Description
AB	PI2 Control Integral Reset	Sets the command to reset the PI2 Control integral value.

■ AC: PI2 Control Integral Hold

Setting Value	Function	Description
AC	PI2 Control Integral Hold	Sets the command to lock the PI2 Control integral value.

■ AD: Select PI2 Control PI Parameters

Setting Value	Function	Description
AD	Select PI2 Control PI Parameters	Sets the command to use the <i>S3-06 [PI2 Control Proportional Gain]</i> and <i>S3-07 [PI2 Control Integral Time]</i> values instead of the <i>b5-02 [Proportional Gain (P)]</i> and <i>b5-03 [Integral Time (I)]</i> values. Set <i>S3-01 = 0 [PI2 Control Enable Selection = Disabled]</i> to enable this function.

■ B9: Disable Pre-charge

Setting Value	Function	Description
B9	Disable Pre-charge	Sets the command to disable the Pre-charge function.

ON : Pre-charge function is disabled

■ 188 and 1A8: Inverse Inputs of 88 and A8

Setting Value	Function	Description
188 and 1A8	Inverse Inputs of 88 and A8	Sets the function of the selected MFDI to operate inversely. To select the function for inverse input, enter two digits of 88 or A8 for the "xx" in "1xx".

For example, to use the inverse input of *88 [Thermostat Fault]*, set $H1-xx = 188$.

◆ H2: Digital Outputs

H2 parameters set the MFDO terminal functions.

■ H2-01 to H2-03 Terminal M1-M2, M3-M4, M5-M6 Function Selection

The drive has three MFDO terminals. [Table 5.38](#) shows the default function settings for the terminals.

Table 5.38 MFDO Terminals Default Function Settings

No.	Name	Default	Function
H2-01	Term M1-M2 Function Selection	0	During Run
H2-02	Term M3-M4 Function Selection	1	Zero Speed
H2-03	Term M5-M6 Function Selection	2	Speed Agree 1

Refer to [Table 5.39](#) to set *H2-xx* [MFDO Function Selection].

Table 5.39 MFDO Setting Value

Setting Value	Function	Reference	Setting Value	Function	Reference
0	During Run	276	39	Watt Hour Pulse Output	285
1	Zero Speed	277	3A	Drive Overheat Alarm	285
2	Speed Agree 1	277	3D	During Speed Search	285
3	User-Set Speed Agree 1	278	42	Pressure Reached	285
4	Frequency Detection 1	278	4C	During Fast Stop	286
5	Frequency Detection 2	279	4D	oH Pre-Alarm Reduction Limit	286
6	Drive ready	279	51	Sequence Timer 1	286
7	DC Bus Undervoltage	279	52	Sequence Timer 2	286
8	During Baseblock (N.O.)	279	53	Sequence Timer 3	286
9	Frequency Reference from Keypad	280	54	Sequence Timer 4	286
B	Torque Detection 1 (N.O.)	280	58	UL6 Underload Detected	286
C	Frequency Reference Loss	280	60	Internal Cooling Fan Failure	286
E	Fault	280	62	Modbus Reg 1 Status Satisfied	287
F */	Not Used	280	63	Modbus Reg 2 Status Satisfied	287
10	Alarm	280	69	External Power 24V Supply	287
11	Fault Reset Command Active	280	6A	Data Logger Error	287
12	Timer Output	280	71	Low PI2 Control Feedback Level	287
13	Speed Agree 2	281	72	High PI2 Control Feedback Level	287
14	User-Set Speed Agree 2	281	89	Output Current Lim	287
15	Frequency Detection 3	282	94	Loss of Prime	287
16	Frequency Detection 4	282	95	Thermostat Fault	287
17	Torque Detection 1 (N.C.)	282	96	High Feedback	287
18	Torque Detection 2 (N.O.)	283	97	Low Feedback	288
19	Torque Detection 2 (N.C.)	283	9E	Low PI Auxiliary Control Level	288
1A	During reverse	283	9F	High PI Auxiliary Control Level	288
1B	During Baseblock (N.C.)	283	A9	RELAY Operator Control	288
1E	Executing Auto-Restart	284	AB	Thrust Mode	288
1F	Motor Overload Alarm (oL1)	284	AC	Setpoint Not Maintained	288
20	Drive Overheat Pre-Alarm (oH)	284	B2	BAS Interlock	288
21	Safe Torque OFF	284	B8	Pump Fault	288
2F	Maintenance Notification	284	B9	Transducer Loss	288
37	During Frequency Output	285	BA	PI Auxiliary Control Active	288
38	Drive Enabled	285	BB	Differential Feedback Exceeded	289

5.7 H: Terminal Functions

Setting Value	Function	Reference
BC	Sleep Active	289
BD	Start Delay	289
BE	Pre-Charge	289
C0	HAND Mode	289
C1	AUTO Mode	289
C2	OFF Mode	289

Setting Value	Function	Reference
C3	Main Feedback Lost	289
C4	Backup Feedback Lost	289
100 to 1C4	Inverse Outputs of 0 to C4 Sets an inverse output of the function for the MFDO. Put a 1 at the front of the function setting to set inverse output. For example, set 138 for inverse output of 38 [Drive Enabled].	289

*1 Inverse output is not available.

*2 You cannot set this parameter on models D169 to D273, A154 to A248, and B065 to B302.

Extended MFDO1 to MFDO3 Function Selection

You can set MFDO functions to *bit 0 to bit 2* [MEMOBUS MFDO1 to 3] of MEMOBUS register 15E0 (Hex.). Use *H2-40 to H2-42* [Mbus Reg 15E0h bit0 to bit2 Output Func] to select the function.

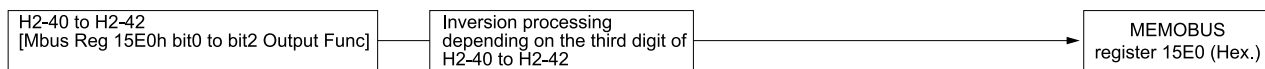

Figure 5.43 Functional Block Diagram of MEMOBUS Multi-function Output

Table 5.40 MEMOBUS MFDO Registers

Register number (Hex.)	Name	
15E0	bit0	MEMOBUS MFDO 1
	bit1	MEMOBUS MFDO 2
	bit2	MEMOBUS MFDO 3

Note:

- Refer to *MFDO Setting Values on page 276* for more information about MFDO setting values.
- When you do not set functions to *H2-40 to H2-42*, set them to *F*.

Output of Logical Operation Results of MFDO

This enables the logical operation results of two MFDOs to be output to one MFDO terminal.

Use *H2-60, H2-63, and H2-66* [Term M1-M2 Secondary Function to Term M5-M6 Secondary Function] to set the function of the output signal for which logical operations are performed.

Use *H2-61, H2-64, H2-67* [Term M1-M2 Logical Operation to Term M5-M6 Logical Operation] to set the logical operation.

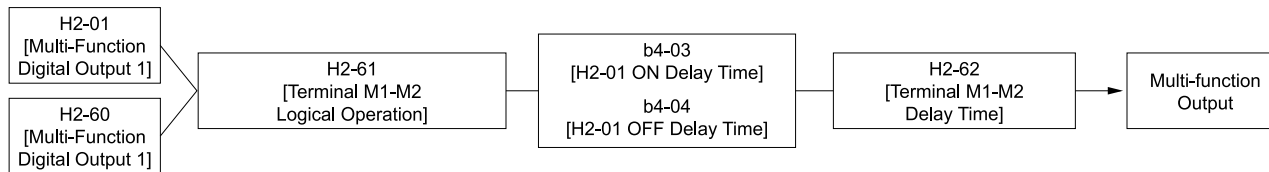
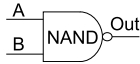

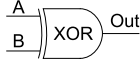
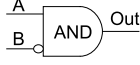
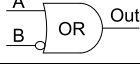

Figure 5.44 Functional Block Diagram of Logical Operation Output for MFDO 1

Table 5.41 MFDO Logical Operation Table

Logical Operation Selection	Logical Operation Expression	Logical Operation Notation
H2-61, H2-64, H2-67		
0	$A=B=1$	
1	$A=1 \text{ or } B=1$	

Logical Operation Selection	Logical Operation Expression	Logical Operation Notation
H2-61, H2-64, H2-67		
2	$A=0$ or $B=0$	
3	$A=B=0$	
4	$A=B$	$A=B$
5	$A \neq B$	
6	$AND(A, \bar{B})$	
7	$OR(A, \bar{B})$	
8	-	On

Note:

- When you use the function to output logical calculation results, you cannot set H2-01 to H2-03 = 1xx [Inverse Output of xx]. If you do, the drive will detect oPE33 [Digital Output Selection Error].
- When you do not use H2-60, H2-63, and H2-66, set them to F. The through mode function is not supported.

◆ H2 MFDO Parameters

■ H2-01: Term M1-M2 Function Selection

No. (Hex.)	Name	Description	Default (Range)
H2-01 (040B)	Term M1-M2 Function Selection	Sets the function for MFDO terminal M1-M2.	0 (0 - 1FF)

Note:

When you do not use the terminal or when you use the terminal in through mode, set this parameter to F.

■ H2-02: Term M3-M4 Function Selection

No. (Hex.)	Name	Description	Default (Range)
H2-02 (040C)	Term M3-M4 Function Selection	Sets the function for MFDO terminal M3-M4.	1 (0 - 1FF)

Note:

When you do not use the terminal or when you use the terminal in through mode, set this parameter to F.

■ H2-03: Term M5-M6 Function Selection

No. (Hex.)	Name	Description	Default (Range)
H2-03 (040D)	Term M5-M6 Function Selection	Sets the function for MFDO terminal M5-M6.	2 (0 - 1FF)

Note:

When you do not use this terminal, or when you will use the terminal in through mode, set this parameter to F.

■ H2-06: Watt Hour Output Unit Selection

No. (Hex.)	Name	Description	Default (Range)
H2-06 (0437)	Watt Hour Output Unit Selection	Sets the unit for the output signal when H2-01 to H2-03 = 39 [MFDO Function Selection = Watt Hour Pulse Output].	0 (0 - 4)

This output is input to the Watt hour meter or PLC through a 200 ms pulse signal. This parameter sets the kWh unit for each pulse output.

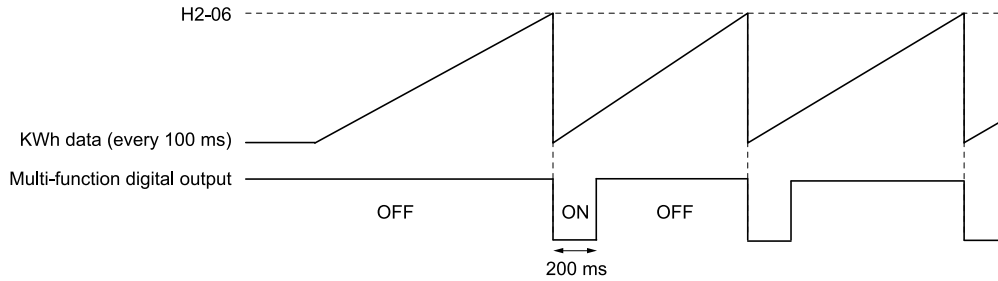

Figure 5.45 Example MFDO when Configured for Watt Hours

Note:

- When in Bypass Mode, the drive does not count Watt hours.
- When the power value is a negative value (regenerative state), the drive does not count Watt hours.
- When the control power supply to the drive is operating, the drive will keep the Watt hours. If a momentary power loss causes the drive to lose control power, the Watt hour count will reset.

- 0 : 0.1 kWh units**
- 1 : 1 kWh units**
- 2 : 10 kWh units**
- 3 : 100 kWh units**
- 4 : 1000 kWh units**

■ **H2-07: Modbus Register 1 Address Select**

No. (Hex.)	Name	Description	Default (Range)
H2-07 (0B3A)	Modbus Register 1 Address Select	Sets the address of the MEMOBUS/Modbus register output to the MFDO terminal.	0001 (0001 - 1FFF)

Sets the address of the register that is output to *Modbus Reg 1 Status Satisfied* [H2-01 to H2-03 = 62] and uses the bit in H2-08 [Modbus Register 1 Bit Select].

■ **H2-08: Modbus Register 1 Bit Select**

No. (Hex.)	Name	Description	Default (Range)
H2-08 (0B3B)	Modbus Register 1 Bit Select	Sets the bit of the MEMOBUS/Modbus register output to the MFDO terminal.	0000 (0000 - FFFF)

Sets the bit of the register that is output to *Modbus Reg 1 Status Satisfied* [H2-01 to H2-03 = 62] and uses the address in H2-07 [Modbus Register 1 Address Select].

■ **H2-09: Modbus Register 2 Address Select**

No. (Hex.)	Name	Description	Default (Range)
H2-09 (0B3C)	Modbus Register 2 Address Select	Sets the address of the MEMOBUS/Modbus register output to the MFDO terminal.	0001 (0001 - 1FFF)

Sets H2-09 with the address of the register that is output to *Modbus Reg 2 Status Satisfied* [H2-01 to H2-03 = 63] and uses the bit in H2-10 [Modbus Register 2 Bit Select].

■ **H2-10: Modbus Register 2 Bit Select**

No. (Hex.)	Name	Description	Default (Range)
H2-10 (0B3D)	Modbus Register 2 Bit Select	Sets the bit of the MEMOBUS/Modbus register output to the MFDO terminal.	0000 (0000 - FFFF)

Sets the bit of the register that is output to *Modbus Reg 2 Status Satisfied* [H2-01 to H2-03 = 63] and uses the address in H2-09.

■ H2-40: Mbus Reg 15E0h bit0 Output Func

No. (Hex.)	Name	Description	Default (Range)
H2-40 (0B58)	Mbus Reg 15E0h bit0 Output Func	Sets the MFDO for bit 0 of MEMOBUS register 15E0 (Hex.).	F (0 - 1FF)

■ H2-41: Mbus Reg 15E0h bit1 Output Func

No. (Hex.)	Name	Description	Default (Range)
H2-41 (0B59)	Mbus Reg 15E0h bit1 Output Func	Sets the MFDO for bit 1 of MEMOBUS register 15E0 (Hex.).	F (0 - 1FF)

■ H2-42: Mbus Reg 15E0h bit2 Output Func

No. (Hex.)	Name	Description	Default (Range)
H2-42 (0B5A)	Mbus Reg 15E0h bit2 Output Func	Sets the MFDO for bit 2 of MEMOBUS register 15E0 (Hex.).	F (0 - 1FF)

■ H2-60: Term M1-M2 Secondary Function

No. (Hex.)	Name	Description	Default (Range)
H2-60 (1B46) Expert	Term M1-M2 Secondary Function	Sets the second function for terminal M1-M2. Outputs the logical calculation results of the terminals assigned to functions by H2-01 [Term M1-M2 Function Selection].	F (0 - FF)

■ H2-61: Terminal M1-M2 Logical Operation

No. (Hex.)	Name	Description	Default (Range)
H2-61 (1B47) Expert	Terminal M1-M2 Logical Operation	Sets the logical operation for the functions set in H2-01 [Term M1-M2 Function Selection] and H2-60 [Term M1-M2 Secondary Function].	0 (0 - 8)

Note:

Refer to [Output of Logical Operation Results of MFDO on page 272](#) for more information about the relation between parameter settings and logical operations.

■ H2-62: Terminal M1-M2 Delay Time

No. (Hex.)	Name	Description	Default (Range)
H2-62 (1B48) Expert	Terminal M1-M2 Delay Time	Sets the minimum on time used to output the logical calculation results from terminal M1-M2.	0.1 s (0.0 - 25.0 s)

■ H2-63: Term M3-M4 Secondary Function

No. (Hex.)	Name	Description	Default (Range)
H2-63 (1B49) Expert	Term M3-M4 Secondary Function	Sets the second function for terminal M3-M4. Outputs the logical calculation results of the terminals assigned to functions by H2-02 [Term M3-M4 Function Selection].	F (0 - FF)

■ H2-64: Terminal M3-M4 Logical Operation

No. (Hex.)	Name	Description	Default (Range)
H2-64 (1B4A) Expert	Terminal M3-M4 Logical Operation	Sets the logical operation for the functions set in <i>H2-02 [Term M3-M4 Function Selection]</i> and <i>H2-63 [Term M3-M4 Secondary Function]</i> .	0 (0 - 8)

Note:

Refer to [Output of Logical Operation Results of MFDO on page 272](#) for more information about the relation between parameter settings and logical operations.

■ H2-65: Terminal M3-M4 Delay Time

No. (Hex.)	Name	Description	Default (Range)
H2-65 (1B4B) Expert	Terminal M3-M4 Delay Time	Sets the minimum on time used to output the logical calculation results from terminal M3-M4.	0.1 s (0.0 - 25.0 s)

■ H2-66: Term M5-M6 Secondary Function

No. (Hex.)	Name	Description	Default (Range)
H2-66 (1B4C) Expert	Term M5-M6 Secondary Function	Sets the second function for terminal M5-M6. Outputs the logical calculation results of the terminals assigned to functions by <i>H2-03 [Terminal M5-M6 Function Select]</i> .	F (0 - FF)

■ H2-67: Terminal M5-M6 Logical Operation

No. (Hex.)	Name	Description	Default (Range)
H2-67 (1B4D) Expert	Terminal M5-M6 Logical Operation	Sets the logical operation for the functions set in <i>H2-03 [Term M5-M6 Function Selection]</i> and <i>H2-66 [Term M5-M6 Secondary Function]</i> .	0 (0 - 8)

Note:

Refer to [Output of Logical Operation Results of MFDO on page 272](#) for more information about the relation between parameter settings and logical operations.

■ H2-68: Terminal M5-M6 Delay Time

No. (Hex.)	Name	Description	Default (Range)
H2-68 (1B4E) Expert	Terminal M5-M6 Delay Time	Sets the minimum on time used to output the logical calculation results from terminal M5-M6.	0.1 s (0.0 - 25.0 s)

◆ MFDO Setting Values

Selects the function configured to MFDO.

■ 0: During Run

Setting Value	Function	Description
0	During Run	The terminal activates when you input a Run command and when the drive is outputting voltage.

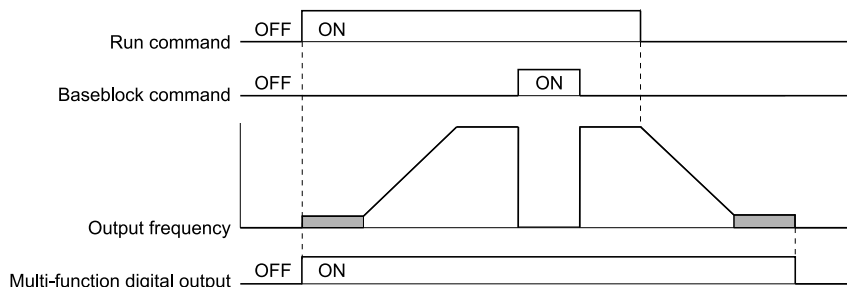

Figure 5.46 Drive Running Time Chart

ON : Drive is running

The drive is receiving a Run command or outputting voltage.

OFF : Drive is stopping

■ 1: Zero Speed

Setting Value	Function	Description
1	Zero Speed	The terminal activates when the output frequency < <i>E1-09</i> [<i>Minimum Output Frequency</i>].

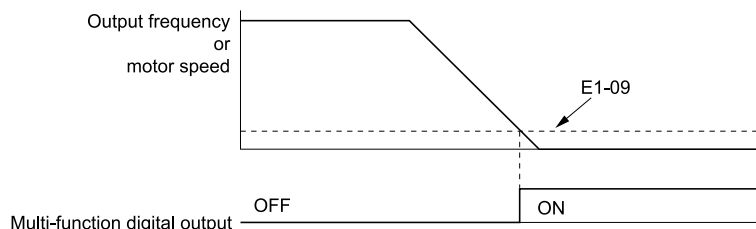

E1-09: Minimum Output Frequency

Figure 5.47 Zero Speed Time Chart

ON : Output frequency < *E1-09*.

OFF : Output frequency ≥ *E1-09*.

■ 2: Speed Agree 1

Setting Value	Function	Description
2	Speed Agree 1	The terminal activates when the output frequency is in the range of the frequency reference ± <i>L4-02</i> [<i>Speed Agree Detection Width</i>].

Note:

The detection function operates in the two motor rotation directions.

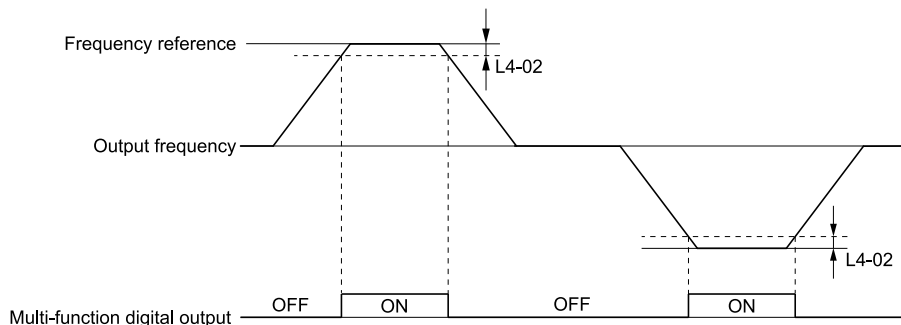

L4-02: Speed Agree Detection Width

Figure 5.48 Speed Agree 1 Time Chart

ON : The output frequency is in the range of “frequency reference ± *L4-02*”.

OFF : The output frequency does not align with the frequency reference although the drive is running.

3: User-Set Speed Agree 1

Setting Value	Function	Description
3	User-Set Speed Agree 1	The terminal activates when the output frequency is in the range of $L4-01$ [Speed Agree Detection Level] \pm $L4-02$ [Speed Agree Detection Width] and in the range of the frequency reference \pm $L4-02$.

Note:

The detection function operates in the two motor rotation directions. The drive uses the $L4-01$ value as the forward/reverse detection level.

ON : The output frequency is in the range of “ $L4-01 \pm L4-02$ ” and the range of frequency reference \pm $L4-02$.

OFF : The output frequency is not in the range of “ $L4-01 \pm L4-02$ ” or the range of frequency reference \pm $L4-02$.

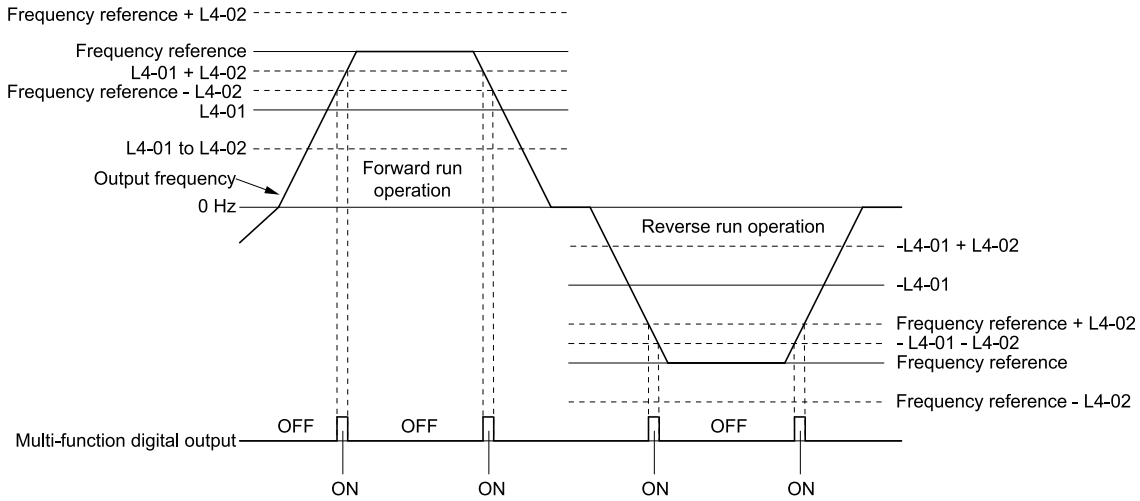

L4-01: Speed Agree Detection Level

L4-02: Speed Agree Detection Width

Figure 5.49 User-Defined Speed Agree 1 Time Chart

4: Frequency Detection 1

Setting Value	Function	Description
4	Frequency Detection 1	The terminal deactivates when the output frequency $>$ “ $L4-01$ [Speed Agree Detection Level] $+$ $L4-02$ [Speed Agree Detection Width]”. After the terminal deactivates, the terminal stays deactivated until the output frequency is at the value of $L4-01$.

Note:

The detection function operates in the two motor rotation directions. The drive uses the $L4-01$ value as the forward/reverse detection level.

ON : The output frequency $<$ $L4-01$, or the output frequency \leq “ $L4-01 + L4-02$ ”

OFF : The output frequency $>$ “ $L4-01 + L4-02$ ”

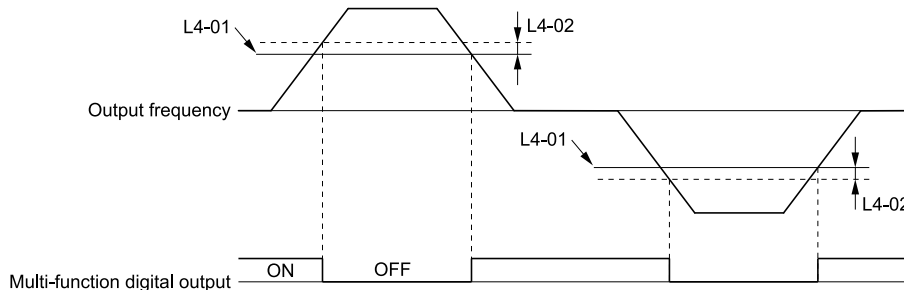

L4-01: Speed Agree Detection Level

L4-02: Speed Agree Detection Width

Figure 5.50 Frequency Detection 1 Time Chart

Note:

Figure 5.50 shows the result of the configuration when $L4-07 = 1$ [Speed Agree Detection Selection = Detection Always Enabled]. The default setting of $L4-07$ is 0 [No Detection during Baseblock]. When the speed agreement detection selection is “No Detection during Baseblock”, the terminal is deactivated when the drive output stops.

■ 5: Frequency Detection 2

Setting Value	Function	Description
5	Frequency Detection 2	The terminal activates when the output frequency > $L4-01$ [Speed Agree Detection Level]. After the terminal activates, the terminal stays activated until the output frequency is at the value of “ $L4-01 - L4-02$ [Speed Agree Detection Width]”.

Note:

The detection function operates in the two motor rotation directions. The drive uses the $L4-01$ value as the forward/reverse detection level.

ON : The output frequency > $L4-01$

OFF : The output frequency < “ $L4-01 - L4-02$ ”, or the output frequency $\leq L4-01$

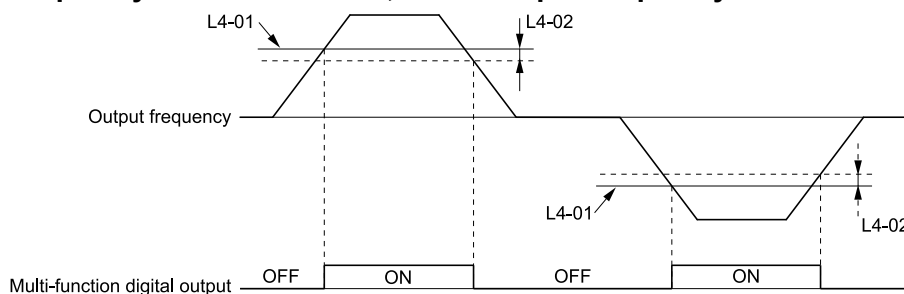

L4-01: Speed Agree Detection Level

L4-02: Speed Agree Detection Width

Figure 5.51 Frequency Detection 2 Time Chart

■ 6: Drive Ready

Setting Value	Function	Description
6	Drive Ready	The terminal activates when the drive is ready and running.

The terminal deactivates in these conditions:

- When the power supply is OFF
- During a fault
- When there is problem with the control power supply
- When there is a parameter setting error and the drive cannot operate although there is a Run command
- When you enter a Run command and it immediately triggers an overvoltage or undervoltage fault because the drive has an overvoltage or undervoltage fault during stop
- When the drive is in Programming Mode and will not accept a Run command
- When the Safe Disable function is active

■ 7: DC Bus Undervoltage

Setting Value	Function	Description
7	DC Bus Undervoltage	The terminal activates when the DC bus voltage or control circuit power supply is at the voltage set in $L2-05$ [Undervoltage Detection Lvl (Uv1)] or less. The terminal also activates when there is a fault with the DC bus voltage.

ON : The DC bus voltage $\leq L2-05$

OFF : The DC bus voltage > $L2-05$

■ 8: During Baseblock (N.O.)

Setting Value	Function	Description
8	During Baseblock (N.O.)	The terminal activates during baseblock. When the drive is in baseblock, the drive output transistor stops switching and does not make DC bus voltage.

ON : During baseblock

OFF : The drive is not in baseblock.

■ 9: Frequency Reference from Keypad

Setting Value	Function	Description
9	Frequency Reference from Keypad	Shows the selected frequency reference source. This terminal has no function when part of a bypass configuration.

■ B: Torque Detection 1 (N.O.)

Setting Value	Function	Description
B	Torque Detection 1 (N.O.)	The terminal activates when the drive detects overtorque or undertorque.

ON : The output current/torque > L6-02 [Torque Detection Level 1], or the output current/torque < L6-02 for longer than the time set in L6-03 [Torque Detection Time 1].

Note:

- When $L6-01 \geq 5$, the drive will detect when the output current/torque is less than L6-02 for longer than L6-03.
- Refer to [L6: Torque Detection on page 330](#) for more information.

■ C: Frequency Reference Loss

Setting Value	Function	Description
C	Frequency Reference Loss	The terminal activates when the drive detects a loss of frequency reference. This terminal has no function when part of a bypass configuration.

■ E: Fault

Setting Value	Function	Description
E	Fault	The terminal activates when the drive detects a fault.

Note:

The terminal will not activate for bypass-specific faults, CPF00 and CPF01 [Control Circuit Error] faults.

■ F: Not Used

Setting Value	Function	Description
F	Not Used	Use this setting for unused terminals or to use terminals in through mode. Also use this setting as the PLC contact output via serial communication or the communication option. This signal does not function if signals from the PLC are not configured.

■ 10: Alarm

Setting Value	Function	Description
10	Alarm	The terminal activates when the drive detects a minor fault. The terminal will not activate for bypass-specific alarms.

■ 11: Fault Reset Command Active

Setting Value	Function	Description
11	Fault Reset Command Active	The terminal activates when the drive receives the Reset command from the control circuit terminal, serial communications, or the communication option.

■ 12: Timer Output

Setting Value	Function	Description
12	Timer Output	Use this setting when the drive uses the timer function as an output terminal.

Note:

Refer to [Timer Function Operation on page 201](#) for more information.

13: Speed Agree 2

Setting Value	Function	Description
13	Speed Agree 2	The terminal activates when the output frequency is in the range of the frequency reference $\pm L4-04$ [Speed Agree Detection Width (+/-)].

Note:

The detection function operates in the two motor rotation directions.

ON : The output frequency is in the range of “frequency reference $\pm L4-04$ ”.

OFF : The output frequency is not in the range of “frequency reference $\pm L4-04$ ”.

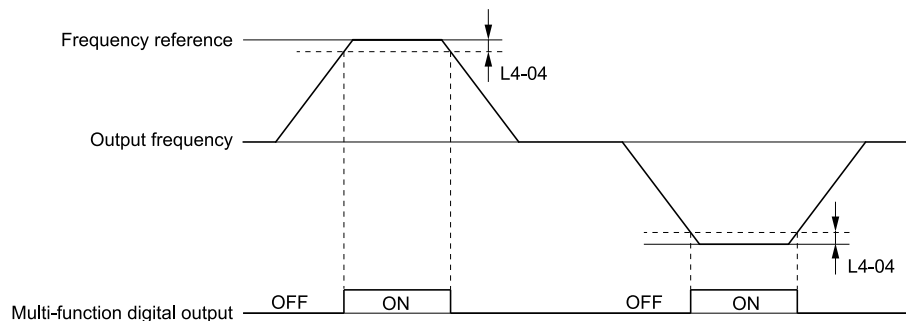

L4-04: Speed Agree Detection Width(+/-)

Figure 5.52 Speed Agree 2 Time Chart

14: User-Set Speed Agree 2

Setting Value	Function	Description
14	User-Set Speed Agree 2	The terminal activates when the output frequency is in the range of $L4-03$ [Speed Agree Detection Level (+/-)] $\pm L4-04$ [Speed Agree Detection Width (+/-)] and in the range of the frequency reference $\pm L4-04$.

Note:

The detection level set in $L4-03$ is a signed value. The drive will only detect in one direction.

ON : The output frequency is in the range of “ $L4-03 \pm L4-04$ ” and the range of frequency reference $\pm L4-04$.

OFF : The output frequency is not in the range of “ $L4-03 \pm L4-04$ ” or the range of frequency reference $\pm L4-04$.

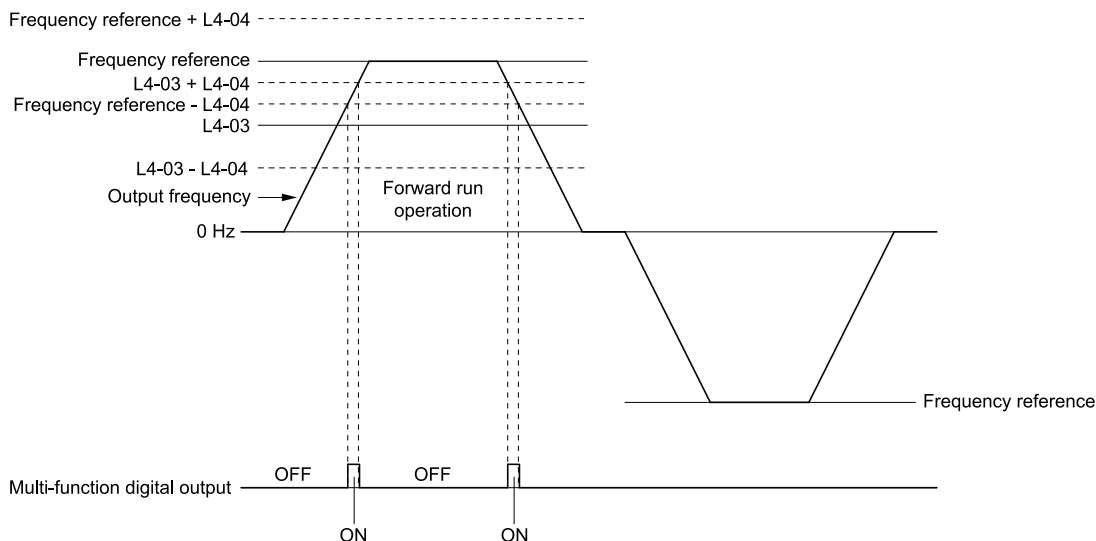

L4-03: Speed Agree Detection Level(+/-)

L4-04: Speed Agree Detection Width(+/-)

Figure 5.53 Example of User-set Speed Agree 2 (L4-03 Is Positive)

■ 15: Frequency Detection 3

Setting Value	Function	Description
15	Frequency Detection 3	The terminal deactivates when the output frequency > " $L4-03$ [Speed Agree Detection Level (+/-)] + $L4-04$ [Speed Agree Detection Width (+/-)]". After the terminal deactivates, the terminal stays deactivated until the output frequency is at the value of $L4-03$.

Note:

The detection level set in $L4-03$ is a signed value. The drive will only detect in one direction.

ON : The output frequency < $L4-03$, or the output frequency $\leq L4-03 + L4-04$.

OFF : The output frequency > " $L4-03 + L4-04$ ".

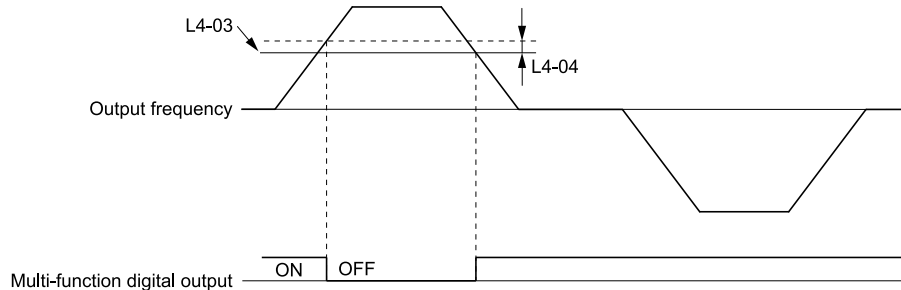

L4-03: Speed Agree Detection Level(+/-)

L4-04: Speed Agree Detection Width(+/-)

Figure 5.54 Example of Frequency Detection 3 (Value of $L4-03$ is Positive)

Note:

Figure 5.54 shows the time chart when $L4-07 = 1$ [Speed Agree Detection Selection = Detection Always Enabled]. The default setting of $L4-07$ is 0 [No Detection during Baseblock]. When the speed agreement detection selection is "No Detection during Baseblock", the terminal deactivates when the drive output stops.

■ 16: Frequency Detection 4

Setting Value	Function	Description
16	Frequency Detection 4	The terminal activates when the output frequency > $L4-03$ [Speed Agree Detection Level (+/-)]. After the terminal activates, the terminal stays activated until the output frequency is at the value of " $L4-03 - L4-04$ ".

Note:

The detection level set in $L4-03$ is a signed value. The drive will only detect in one direction.

ON : The output frequency > $L4-03$.

OFF : The output frequency < " $L4-03 - L4-04$ ", or the output frequency $\leq L4-03$.

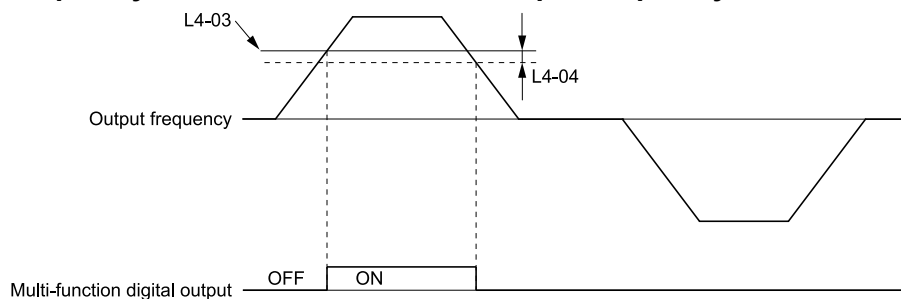

L4-03: Speed Agree Detection Level(+/-)

L4-04: Speed Agree Detection Width(+/-)

Figure 5.55 Example of Frequency Detection 4 (Value of $L4-03$ is Positive)

■ 17: Torque Detection 1 (N.C.)

Setting Value	Function	Description
17	Torque Detection 1 (N.C.)	The terminal deactivates when the drive detects overtorque or undertorque.

Use the $L6$ [Torque Detection] parameters to set torque detection.

OFF : The output current/torque > L6-02 [Torque Detection Level 1], or the output current/torque < L6-02 for longer than the time set in L6-03 [Torque Detection Time 1].

Note:

- When $L6-01 \geq 5$, the drive will detect when the output current/torque is less than $L6-02$ for longer than $L6-03$.
- Refer to [L6: Torque Detection on page 330](#) for more information.

■ 18: Torque Detection 2 (N.O.)

Setting Value	Function	Description
18	Torque Detection 2 (N.O.)	The terminal activates when the drive detects overtorque or undertorque.

Use the *L6 [Torque Detection]* parameters to set torque detection.

ON : The output current/torque > L6-05 [Torque Detection Level 2], or the output current/torque < L6-05 for longer than the time set in L6-06 [Torque Detection Time 2].

Note:

- When $L6-04 \geq 5$, the drive will detect when the output current/torque is less than $L6-05$ for longer than $L6-06$.
- Refer to [L6: Torque Detection on page 330](#) for more information.

■ 19: Torque Detection 2 (N.C.)

Setting Value	Function	Description
19	Torque Detection 2 (N.C.)	The terminal deactivates when the drive detects overtorque or undertorque.

Use the *L6 [Torque Detection]* parameters to set torque detection.

OFF : The output current/torque > L6-05 [Torque Detection Level 2], or the output current/torque < L6-05 for longer than the time set in L6-06 [Torque Detection Time 2].

Note:

- When $L6-04 \geq 5$, the drive will detect when the output current/torque is less than $L6-05$ for longer than $L6-06$.
- Refer to [L6: Torque Detection on page 330](#) for more information.

■ 1A: During Reverse

Setting Value	Function	Description
1A	During Reverse	The terminal activates when the motor operates in the reverse direction.

ON : The motor is operating in the reverse direction.

OFF : The motor is operating in the forward direction or the motor stopped.

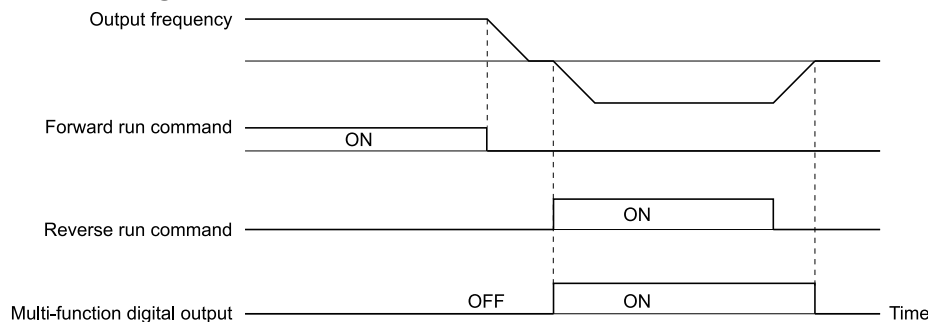

Figure 5.56 Reverse Operation Output Time Chart

■ 1B: During Baseblock (N.C.)

Setting Value	Function	Description
1B	During Baseblock (N.C.)	The terminal deactivates during baseblock. When the drive is in baseblock, the drive output transistor stops switching and does not make DC bus voltage.

ON : The drive is not in baseblock.

OFF : During baseblock

■ 1E: Executing Auto-Restart

Setting Value	Function	Description
1E	Executing Auto-Restart	The terminal activates when the Auto Restart function is trying to restart after a fault.

The terminal deactivates when the Auto Restart function automatically resets a fault. The terminal deactivates when the Auto Restart function detects the fault again because there were too many restart attempts as specified by *L5-01 [Number of Auto Restart Attempts]*.

Note:

Refer to *L5: Fault Restart on page 324* for more information.

■ 1F: Motor Overload Alarm (oL1)

Setting Value	Function	Description
1F	Motor Overload Alarm (oL1)	The terminal activates when the electronic thermal protection value of the motor overload protective function is a minimum of 90% of the detection level.

Note:

- Refer to “L1-01: Motor Overload (oL1) Protection” for more information.
- This terminal will not activate if the Motor Overload occurs during Bypass Mode.

■ 20: Drive Overheat Pre-Alarm (oH)

Setting Value	Function	Description
20	Drive Overheat Pre-Alarm (oH)	The terminal activates when the drive heatsink temperature is at the level set with <i>L8-02 [Overheat Alarm Level]</i> .

Note:

Refer to “L8-02: Overheat Alarm Level” for more information.

■ 21: Safe Torque OFF

Setting Value	Function	Description
21	Safe Torque OFF	The terminal activates (safety stop state) when the safety circuit and safety diagnosis circuit are operating correctly and when terminals H1-HC and H2-HC are OFF (Open).

Note:

EDM = External Device Monitor

ON : Safety stop state

Terminals H1-HC and H2-HC are OFF (Open) (safety stop state).

OFF : Safety circuit fault or RUN/READY

Terminal H1-HC or terminal H2-HC is OFF (Open) (safety circuit fault), or the two terminals are ON or have short circuited (RUN/READY).

■ 2F: Maintenance Notification

Setting Value	Function	Description
2F	Maintenance Notification	The terminal activates when drive components are at their estimated maintenance period.

Tells the user about the maintenance period for these items:

- IGBT
- Cooling fan
- Capacitor
- Soft charge bypass relay

Note:

Refer to “Alarm Outputs for Maintenance Monitors” for more information.

■ 37: During Frequency Output

Setting Value	Function	Description
37	During Frequency Output	The terminal activates when the drive outputs frequency.

ON : The drive outputs frequency.

OFF : The drive does not output frequency.

Note:

The terminal deactivates in these conditions:

- During Stop
- During baseblock
- During DC Injection Braking (initial excitation)

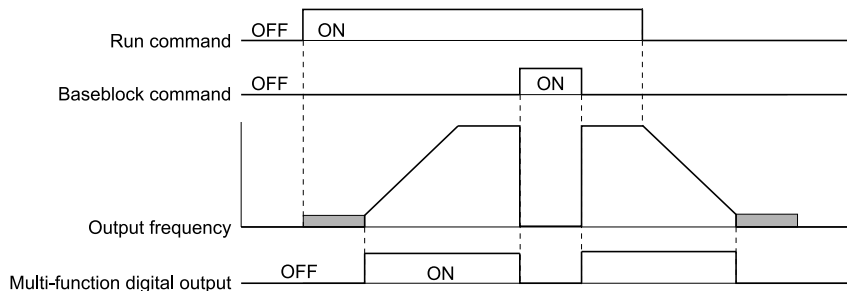

Figure 5.57 Active Frequency Output Time Chart

■ 38: Drive Enabled

Setting Value	Function	Description
38	Drive Enabled	This terminal activates when the $H1-xx = 6A$ [Drive Enable] terminal activates.

■ 39: Watt Hour Pulse Output

Setting Value	Function	Description
39	Watt Hour Pulse Output	Outputs the pulse that shows the watt hours.

Note:

Refer to “H2-06: Watt Hour Output Unit Selection” for more information.

■ 3A: Drive Overheat Alarm

Setting Value	Function	Description
3A	Drive Overheat Alarm	The terminal activates when the drive heatsink temperature is at the $L8-02$ [Overheat Alarm Level] setting while $L8-03 = 4$ [Overheat Pre-Alarm Selection = Operate at Reduced Speed (L8-19)] and the drive is running.

The drive will decrease the frequency reference as specified by $L8-19$ [Freq Reduction @ oH Pre-Alarm]. Carrier frequency reduction is active when $L8-97 = 1$ [Carrier Freq Reduce during OH = Enabled].

■ 3D: During Speed Search

Setting Value	Function	Description
3D	During Speed Search	The terminal activates when the drive is doing speed search.

Note:

Refer to “b3: Speed Search” for more information.

■ 42: Pressure Reached

Setting Value	Function	Description
42	Pressure Reached	The terminal activates when the drive is at the Pressure Setpoint.

5.7 H: Terminal Functions

The drive uses the Pressure Feedback and Y4-36 [Pressure Reached Exit Conditions] to Y4-40 [Pressure Reached Detection Sel] for the activation and deactivation conditions.

When the b5-09 [PID Output Level Selection] setting changes, the MFDO terminal operation also changes.

- When b5-09 = 0 [Normal Output (Direct Acting)]
The function activates when the feedback is at or above the setpoint for the time set in Y4-38 [Pressure Reached On Delay Time].
- When b5-09 = 1 [Reverse Output (Reverse Acting)]
The function activates when the feedback is at or below the setpoint for the time set in Y4-38.

When this function activates, it will use Y4-36, Y4-37 [Pressure Reached Hysteresis Lvl], and Y4-39 [Pressure Reached Off Delay Time] to deactivate.

■ 4C: During Fast Stop

Setting Value	Function	Description
4C	During Fast Stop	The terminal activates when the fast stop is in operation.

■ 4D: oH Pre-Alarm Reduction Limit

Setting Value	Function	Description
4D	oH Pre-Alarm Reduction Limit	The terminal activates when L8-03 = 4 [Overheat Pre-Alarm Selection = Operate at Reduced Speed (L8-19)] and oH [Heatsink Overheat] does not clear after the drive decreases the frequency for 10 cycles.

Note:

Refer to “L8-03: Overheat Pre-Alarm Selection” for more information.

■ 51: Sequence Timer 1

Setting Value	Function	Description
51	Sequence Timer 1	The terminal activates when Sequence Timer 1 is active.

■ 52: Sequence Timer 2

Setting Value	Function	Description
52	Sequence Timer 2	The terminal activates when Sequence Timer 2 is active.

■ 53: Sequence Timer 3

Setting Value	Function	Description
53	Sequence Timer 3	The terminal activates when Sequence Timer 3 is active.

■ 54: Sequence Timer 4

Setting Value	Function	Description
54	Sequence Timer 4	The terminal activates when Sequence Timer 4 is active.

■ 58: UL6 Underload Detected

Setting Value	Function	Description
58	UL6 Underload Detected	The terminal activates when the drive detected UL6 [Underload or Belt Break Detected].

■ 60: Internal Cooling Fan Failure

Setting Value	Function	Description
60	Internal Cooling Fan Failure	The terminal activates when the drive detects a cooling fan failure in the drive.

■ 62: Modbus Reg 1 Status Satisfied

Setting Value	Function	Description
62	Modbus Reg 1 Status Satisfied	The terminal activates when the bit specified by H2-08 [Modbus Register 1 Bit Select] for the MEMOBUS register address set with H2-07 [Modbus Register 1 Address Select] activates.

■ 63: Modbus Reg 2 Status Satisfied

Setting Value	Function	Description
63	Modbus Reg 2 Status Satisfied	The terminal activates when the bit specified by H2-10 [Modbus Register 2 Bit Select] for the MEMOBUS register address set with H2-09 [Modbus Register 2 Address Select] activates.

■ 69: External Power 24V Supply

Setting Value	Function	Description
69	External Power 24V Supply	The terminal activates when there is an external 24V power supply between terminals PS-AC.

ON : An external 24V power supply supplies power.

OFF : An external 24V power supply does not supply power.

■ 6A: Data Logger Error

Setting Value	Function	Description
6A	Data Logger Error	The terminal activates when the drive detects LoG [Com Error / Abnormal SD card].

■ 71: Low PI2 Control Feedback Level

Setting Value	Function	Description
71	Low PI2 Control Feedback Level	The terminal activates when the PI2 Control Feedback Level is less than S3-13 [PI2 Control Low Feedback Lvl].

■ 72: High PI2 Control Feedback Level

Setting Value	Function	Description
72	High PI2 Control Feedback Level	The terminal activates when the PI2 Control Feedback Level is more than S3-15 [PI2 Control High Feedback Lvl].

■ 89: Output Current Lim

Setting Value	Function	Description
89	Output Current Lim	The terminal activates when the output current limit is limiting the drive output speed.

■ 94: Loss of Prime

Setting Value	Function	Description
94	Loss of Prime	The terminal activates when the drive is in an LOP [Loss of Prime] condition.

■ 95: Thermostat Fault

Setting Value	Function	Description
95	Thermostat Fault	The terminal activates when the terminal set for H1-xx = 88 [MFDI Function Selection = Thermostat Fault] is active.

■ 96: High Feedback

Setting Value	Function	Description
96	High Feedback	The terminal activates when the drive is in a High Feedback Condition as specified by Y1-11 [High Feedback Level] and Y1-12 [High Feedback Lvl Fault Dly Time] and when the drive detects an HFB [High Feedback Sensed] fault or an HIFB [High Feedback Sensed] alarm.

■ 97: Low Feedback

Setting Value	Function	Description
97	Low Feedback	The terminal activates when the drive is in a Low Feedback Condition as specified by <i>Y1-08 [Low Feedback Level]</i> and <i>Y1-09 [Low Feedback Lvl Fault Dly Time]</i> and when the drive detects an <i>LFB [Low Feedback Sensed]</i> fault or an <i>LOFB [High Feedback Sensed]</i> alarm.

■ 9E: Low PI Auxiliary Control Level

Setting Value	Function	Description
9E	Low PI Auxiliary Control Level	The terminal activates when the PI Aux Feedback Level is less than <i>YF-09 [PI Aux Control Low Level Detect]</i> or if the drive detects an <i>LOAUX [Low PI Aux Feedback Level]</i> fault.

■ 9F: High PI Auxiliary Control Level

Setting Value	Function	Description
9F	High PI Auxiliary Control Level	The terminal activates when the PI Aux Feedback Level is more than <i>YF-12 [PI Aux Control High Level Detect]</i> or if the drive detects an <i>HIAUX [High PI Aux Feedback Level]</i> fault.

■ A9: RELAY Operator Control

Setting Value	Function	Description
A9	RELAY Operator Control	The terminal changes to OFF or ON when you push the RELAY (F3) button. When the terminal is ON, push F3 to turn it OFF. When the terminal is OFF, push F3 to turn in ON.

■ AB: Thrust Mode

Setting Value	Function	Description
AB	Thrust Mode	The terminal activates when the output frequency is between 0.0 Hz and the value set in <i>Y4-12 [Thrust Frequency]</i> and the Thrust Bearing function is active.

■ AC: Setpoint Not Maintained

Setting Value	Function	Description
AC	Setpoint Not Maintained	The terminal activates when the drive detects <i>NMS [Setpoint Not Met]</i> condition.

■ B2: BAS Interlock

Setting Value	Function	Description
B2	BAS Interlock	The terminal activates when the Run command is active or the drive is outputting the voltage. The drive will use this as an actuation signal for an external damper.

■ B8: Pump Fault

Setting Value	Function	Description
B8	Pump Fault	The terminal activates when one of these faults is active: <i>LFB [Low Feedback Sensed]</i> , <i>HFB [High Feedback Sensed]</i> , <i>NMS [Setpoint Not Met]</i> , or <i>EFx [External Fault (Terminal Sx)]</i> .

■ B9: Transducer Loss

Setting Value	Function	Description
B9	Transducer Loss	The terminal activates when the current into the analog input associated with PID feedback is more than 21 mA or less than 3 mA, or an <i>FDBKL [WIRE Break]</i> Fault or an <i>FDBKL [Feedback Loss Wire Break]</i> Alarm is active.

■ BA: PI Auxiliary Control Active

Setting Value	Function	Description
BA	PI Auxiliary Control Active	The terminal activates when the PI Auxiliary Controller has an effect on the output speed.

■ BB: Differential Feedback Exceeded

Setting Value	Function	Description
BB	Differential Feedback Exceeded	The terminal activates when the difference between the PID Feedback and the value from the terminal set for $H3-xx = 2D$ [Differential Feedback] is more than $Y4-18$ [Differential Level] for the time set in $Y4-19$ [Differential Lvl Detection Time].

■ BC: Sleep Active

Setting Value	Function	Description
BC	Sleep Active	The terminal activates when the Sleep function is active and the drive is not operating.

Note:

The terminal will not activate for Sleep Boost function.

■ BD: Start Delay

Setting Value	Function	Description
BD	Start Delay	The terminal activates when the Feedback is more than the start level or the Feedback is less than the Inverse PID and the start timer is timing.

Note:

You must set $Y1-04$ [Sleep Wake-up Level] $\neq 0$ and $Y1-05$ [Sleep Wake-up Level Delay Time] $\neq 0$ to use this function.

The terminal also activates when $b1-11$ [Run Delay @ Stop] $\neq 0.0$ s and $b1-03$ [Stopping Method Selection = Coast to Stop with Timer] delayed the start of the drive.

■ BE: Pre-Charge

Setting Value	Function	Description
BE	Pre-Charge	The terminal activates when the drive is in Pre-Charge Mode.

■ C0: HAND Mode

Setting Value	Function	Description
C0	HAND Mode	The terminal activates when the drive is in HAND Mode operation.

■ C1: AUTO Mode

Setting Value	Function	Description
C1	AUTO Mode	The terminal activates when the drive is in AUTO Mode operation.

■ C2: OFF Mode

Setting Value	Function	Description
C2	OFF Mode	The terminal activates when the drive is in OFF Mode operation.

■ C3: Main Feedback Lost

Setting Value	Function	Description
C3	Main Feedback Lost	The terminal activates when the drive loses the main PID feedback.

■ C4: Backup Feedback Lost

Setting Value	Function	Description
C4	Backup Feedback Lost	The terminal activates when the drive loses the backup PID feedback.

■ 100 to 1C4: Inverse Outputs of 0 to C4

Setting Value	Function	Description
100 to 1C4	Inverse Outputs of 0 to C4	Causes inverse output of the function for the selected MFDO. Uses the last two digits of 1xx to select which function to inversely output.

For example, set $H2-xx = 10E$ for the inverse output of E [Fault].

◆ H3: Analog Inputs

WARNING! Sudden Movement Hazard. Do test runs and examine the drive to make sure that the command references are correct. If you set the command reference incorrectly, it can cause damage to the drive or serious injury or death.

Drives have two analog input terminals, terminals A1 and A2. *H3 parameters* select the functions set to these analog input terminals and adjust signal levels.

Table 5.42 shows the functions that you can set to analog input terminals. Use *H3-02 and H3-10 [MFAI Function Selection]* to set functions.

Table 5.42 MFAI Setting Values

Setting Value	Function	Ref.	Setting Value	Function	Ref.
0	Frequency Reference (Not used)	294	E	Motor Temperature (PTC Input)	296
1	Frequency Gain	294	F	Not Used	296
2	Auxiliary Frequency Reference 1	294	16	Differential PID Feedback	297
3	Auxiliary Frequency Reference 2	294	1F	Not Used	297
4	Output Voltage Bias	294	24	PID Feedback Backup	297
5	Accel/Decel Time Gain	295	25	PI2 Control Setpoint	297
6	DC Injection Braking Current	295	26	PI2 Control Feedback	297
7	Torque Detection Level	295	27	PI Auxiliary Control Feedback	297
8	Stall Prevent Level During Run	295	2B	Emergency Override PID Feedback	297
9	Output Frequency Lower Limit	296	2C	Emergency Override PID Setpoint	297
B	PID Feedback	296	2D	Differential Level Source	297
C	PID Setpoint	296	2E	Hand Frequency Ref or Setpoint	298
D	Frequency Bias	296			

Note:

All analog input scaling uses gain and bias for adjustment. Set the gain and bias values correctly.

■ H3-01: Terminal A1 Signal Level Select

No. (Hex.)	Name	Description	Default (Range)
H3-01 (0410)	Terminal A1 Signal Level Select	Sets the input signal level for MFAI terminal A1.	0 (0 - 3)

0 : 0 to 10V (Lower Limit at 0)

The voltage signal is 0 Vdc to 10 Vdc. The minimum input level limit is 0%. The drive will read a negative input signal caused by gain and bias settings as 0%.

2 : 4 to 20 mA

The current signal is 4 mA to 20 mA. The minimum input level limit is 0%. The drive will read a negative input signal caused by gain and bias settings as 0%.

3 : 0 to 20 mA

The current signal is 0 mA to 20 mA. The minimum input level limit is 0%. The drive will read a negative input signal caused by gain and bias settings as 0%.

Note:

When $H3-01 = 0$, set Jumper switch S1 to the V side (voltage). When $H3-01 = 2, 3$, set Jumper switch S1 to the I side (current). The default setting is the V side (voltage).

■ H3-02: Terminal A1 Function Selection

No. (Hex.)	Name	Description	Default (Range)
H3-02 (0434)	Terminal A1 Function Selection	Sets the function for MFAI terminal A1.	0 (0 - 31)

■ H3-03: Terminal A1 Gain Setting

No. (Hex.)	Name	Description	Default (Range)
H3-03 (0411) RUN	Terminal A1 Gain Setting	Sets the gain of the analog signal input to MFAI terminal A1.	100.0% (-999.9 - +999.9%)

This parameter sets the quantity of reference for the function set for terminal A1 as a percentage when 10 V (or 20 mA) is input.

Use this parameter and *H3-04 [Terminal A1 Bias Setting]* to adjust the characteristics of the analog input signal to terminal A1.

■ H3-04: Terminal A1 Bias Setting

No. (Hex.)	Name	Description	Default (Range)
H3-04 (0412) RUN	Terminal A1 Bias Setting	Sets the bias of the analog signal input to MFAI terminal A1.	0.0% (-999.9 - +999.9%)

This parameter sets the bias for the function set for terminal A1 as a percentage when 0 V (4 mA or 0 mA) is input.

Use this parameter and *H3-03 [Terminal A1 Gain Setting]* to adjust the characteristics of the analog input signal to terminal A1.

■ H3-09: Terminal A2 Signal Level Select

No. (Hex.)	Name	Description	Default (Range)
H3-09 (0417)	Terminal A2 Signal Level Select	Sets the input signal level for MFAI terminal A2.	2 (0 - 3)

0 : 0-10V (LowLim=0)

The voltage signal is 0 Vdc to 10 Vdc. The minimum input level is limited to 0%, so that a negative input signal due to gain and bias settings will be read as 0%.

2 : 4 to 20 mA

The current signal is 4 mA to 20 mA. The minimum input level is limited to 0%, so that a negative input signal due to gain and bias settings will be read as 0%.

3 : 0 to 20 mA

The current signal is 0 mA to 20 mA. The minimum input level is limited to 0%, so that a negative input signal due to gain and bias settings will be read as 0%.

Note:

When *H3-09 = 0*, set Jumper switch S1 to the V side (voltage). When *H3-09 = 2, 3*, set Jumper switch S1 to the I side (current). The default setting is the I side (current).

■ H3-10: Terminal A2 Function Selection

No. (Hex.)	Name	Description	Default (Range)
H3-10 (0418)	Terminal A2 Function Selection	Sets the function for MFAI terminal A2.	Determined by b5-01 (0 - 31)

Note:

The default setting for *H3-10* changes when *b5-01* [*PID Mode Setting*] changes:

- *b5-01* = 0 [*Disabled*]: 0
- *b5-01* ≠ 0: B

■ H3-11: Terminal A2 Gain Setting

No. (Hex.)	Name	Description	Default (Range)
H3-11 (0419) RUN	Terminal A2 Gain Setting	Sets the gain of the analog signal input to MFAI terminal A2.	100.0% (-999.9 - +999.9%)

When 10 V (or 20 mA) is input, this parameter sets the reference quantity for the function set for terminal A2 as a percentage.

Use this parameter and *H3-12* [*Terminal A2 Bias Setting*] to adjust the characteristics of the analog input signal to terminal A2.

■ H3-12: Terminal A2 Bias Setting

No. (Hex.)	Name	Description	Default (Range)
H3-12 (041A) RUN	Terminal A2 Bias Setting	Sets the bias of the analog signal input to MFAI terminal A2.	0.0% (-999.9 - +999.9%)

When 0 V (4 mA or 0 mA) is input, this parameter sets the bias for the function set for terminal A2 as a percentage.

Use this parameter and *H3-11* [*Terminal A2 Gain Setting*] to adjust the characteristics of the analog input signal to terminal A2.

■ H3-13: Analog Input FilterTime Constant

No. (Hex.)	Name	Description	Default (Range)
H3-13 (041B)	Analog Input FilterTime Constant	Sets the time constant for primary delay filters on MFAI terminals.	0.03 s (0.00 - 2.00 s)

Apply the primary delay filter to the analog input to enable an analog input signal without the use of high-frequency noise components. An analog input filter prevents irregular drive control. Drive operation becomes more stable as the programmed time becomes longer, but it also becomes less responsive to quickly changing analog signals.

■ H3-14: Analog Input Terminal Enable Sel

No. (Hex.)	Name	Description	Default (Range)
H3-14 (041C)	Analog Input Terminal Enable Sel	Sets which terminal or terminals to enable when <i>H1-xx</i> = <i>C</i> [<i>MFDI Function Selection</i> = <i>Analog Terminal Enable Selection</i>] is activated.	2 (1 - 3)

Input signals do not have an effect on terminals not set as targets.

1 : Terminal A1 only

2 : Terminal A2 only

3 : Terminals A1 and A2

Note:

- The ON/OFF operation of terminal *Sx* set in *Analog Terminal Input Selection* [*H1-xx* = *C*] has an effect on only the analog input terminal selected with *H3-14*.
- When *H1-xx* ≠ *C*, the functions set to terminals A1 and A2 are always enabled.

■ H3-16: Terminal A1 Offset

No. (Hex.)	Name	Description	Default (Range)
H3-16 (02F0)	Terminal A1 Offset	Sets the offset level for analog signals input to terminal A1. Usually it is not necessary to change this setting.	0 (-500 - +500)

Adds the offset value for the analog input value. For voltage input, this parameter will set the offset when a signal of 0 V is input. For current input, this parameter will set the offset when a signal of 4 mA [H3-01 = 2] or 0 mA [H3-01 = 3] is input.

■ H3-17: Terminal A2 Offset

No. (Hex.)	Name	Description	Default (Range)
H3-17 (02F1)	Terminal A2 Offset	Sets the offset level for analog signals input to terminal A2. Usually it is not necessary to change this setting.	0 (-500 - +500)

Adds the offset value for the analog input value. For voltage input, this parameter will set the offset when a signal of 0 V is input. For current input, this parameter will set the offset when a signal of 4 mA [H3-09 = 2] or 0 mA [H3-09 = 3] is input.

■ H3-40: Mbus Reg 15C1h Input Function

No. (Hex.)	Name	Description	Default (Range)
H3-40 (0B5C)	Mbus Reg 15C1h Input Function	Sets the MEMOBUS AI1 function.	F (4 - 2E)

Uses the MFAI function from MEMOBUS/Modbus communications to set the input for the function in MEMOBUS/Modbus register 15C1.

Refer to H3-xx "MFAI Setting Values" for the setting values.

■ H3-41: Mbus Reg 15C2h Input Function

No. (Hex.)	Name	Description	Default (Range)
H3-41 (0B5F)	Mbus Reg 15C2h Input Function	Sets the MEMOBUS AI2 function.	F (4 - 2E)

Uses the MFAI function from MEMOBUS/Modbus communications to set the input for the function in MEMOBUS/Modbus register 15C2.

Refer to H3-xx "MFAI Setting Values" for the setting values.

■ H3-42: Mbus Reg 15C3h Input Function

No. (Hex.)	Name	Description	Default (Range)
H3-42 (0B62)	Mbus Reg 15C3h Input Function	Sets the MEMOBUS AI3 function.	F (4 - 2E)

Uses the MFAI function from MEMOBUS/Modbus communications to set the input for the function in MEMOBUS/Modbus register 15C3.

Refer to H3-xx "MFAI Setting Values" for the setting values.

■ H3-43: Mbus Reg Inputs FilterTime Const

No. (Hex.)	Name	Description	Default (Range)
H3-43 (117F)	Mbus Reg Inputs FilterTime Const	Sets the time constant to apply a primary delay filter to the MEMOBUS analog input register values.	0.00 s (0.00 - 2.00 s)

◆ MFAI Setting Value

This section gives information about the functions set with *H3-02* and *H3-10*.

■ 0: Frequency Reference

Setting Value	Function	Description
0	Frequency Reference	This selection has no effect. Use bypass analog input (TB4-2) as the frequency reference. Refer to the Bypass Controller section on page 93 for more information.

■ 1: Frequency Gain

Setting Value	Function	Description
1	Frequency Gain	The drive multiplies the analog frequency reference with the input value from the MFAI set with this function.

Example: When you set frequency gain for terminal A2

- $H3-10 = 1$ [Terminal A2 Function Selection = Frequency Gain]
- A 50% frequency gain is input to terminal A2
- A frequency reference of 80% is input from bypass analog input (TB4-2)

The calculated frequency reference is 40% of the maximum output frequency.

■ 2: Auxiliary Frequency Reference 1

Setting Value	Function	Description
2	Auxiliary Frequency Reference 1	Sets Reference 2 through multi-step speed reference to enable the command reference (Auxiliary Frequency Reference 1) from the analog input terminal set here. This value is a percentage where the Maximum Output Frequency setting is a setting value of 100%.

■ 3: Auxiliary Frequency Reference 2

Setting Value	Function	Description
3	Auxiliary Frequency Reference 2	Sets Reference 3 through multi-step speed reference to enable the command reference (Auxiliary Frequency Reference 2) from the analog input terminal set here. This value is a percentage where the Maximum Output Frequency setting is a setting value of 100%.

■ 4: Output Voltage Bias

Setting Value	Function	Description
4	Output Voltage Bias	Set this parameter to input a bias signal and amplify the output voltage.

The gain (%) for the MFAI terminals A1 and A2 is 100% of the voltage class standard, which is 208 V for 208/240 V and 480 V for 480 V. The bias (%) for MFAI terminals A1 and A2 is 100% of the voltage configured for *E1-05* [Maximum Output Voltage].

Note:

Parameters *H3-03* [Terminal A1 Gain Setting] and *H3-11* [Terminal A2 Gain Setting] independently set the gain for each terminal A1 and A2. Parameters *H3-04* [Terminal A1 Bias Setting] and *H3-12* [Terminal A2 Bias Setting] independently set the bias for each terminal A1 and A2.

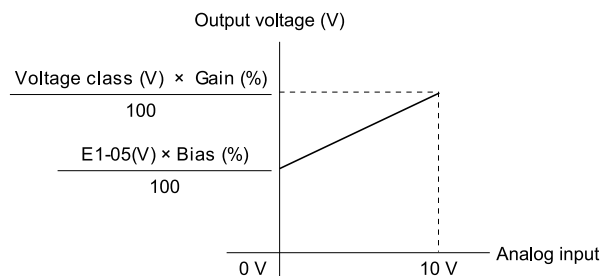

Figure 5.58 Output Voltage Bias through Analog Input

■ 5: Accel/Decel Time Gain

Setting Value	Function	Description
5	Accel/Decel Time Gain	Enters a signal to adjust the gain used for <i>C1-01 to C1-04 [Acceleration/Deceleration Times 1 and 2]</i> and <i>C1-09 [Fast Stop Time]</i> when the full scale analog signal (10 V or 20 mA) is 100%.

When you enable *C1-01 [Acceleration Time 1]*, the acceleration time is:

Acceleration Time 1 = Setting value of *C1-01* × acceleration and deceleration time gain / 100

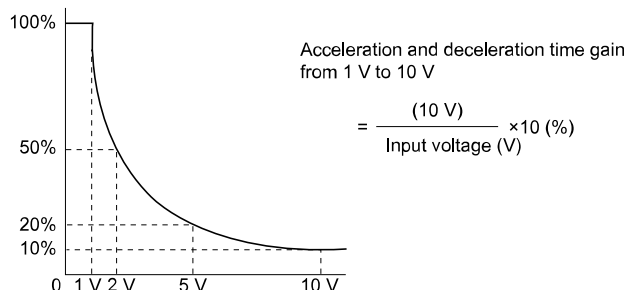

Figure 5.59 Acceleration/Deceleration Time Gain through Analog Input

■ 6: DC Injection Braking Current

Setting Value	Function	Description
6	DC Injection Braking Current	Enters a signal to adjust the current level used for DC Injection Braking when the drive rated output current is 100%.

Note:

When you set this function, it will disable the setting value of *b2-02 [DC Injection Braking Current]*.

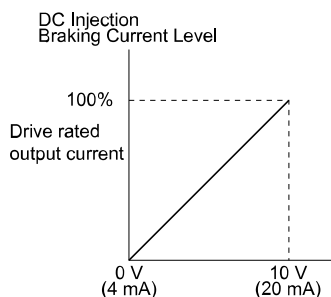

Figure 5.60 DC Injection Braking Current through Analog Input

■ 7: Torque Detection Level

Setting Value	Function	Description
7	Torque Detection Level	Enters a signal to adjust the overtorque/undertorque detection level.

Note:

Use this function with *L6-01 [Torque Detection Selection 1]*. This parameter functions as an alternative to *L6-02 [Torque Detection Level 1]*.

■ 8: Stall Prevent Level During Run

Setting Value	Function	Description
8	Stall Prevent Level During Run	Enters a signal to adjust the stall prevention level during run if the drive rated current is 100%.

Note:

The Stall Prevent Level During Run is based on the smaller of these two values:

- Analog input value of MFAI terminal
- *L3-06 [Stall Prevent Level during Run]*

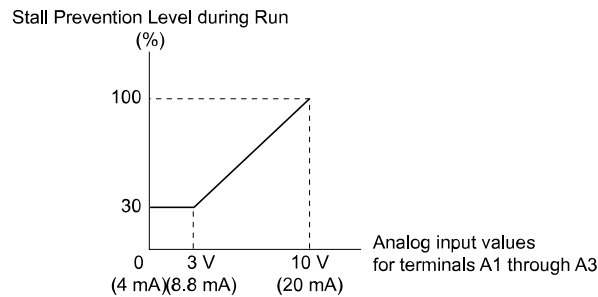

Figure 5.61 Stall Prevention Level during Run with Analog Input

■ 9: Output Frequency Lower Limit

Setting Value	Function	Description
9	Output Frequency Lower Limit	Enters a signal to adjust the output frequency lower limit level as a percentage of the maximum output frequency.

■ B: PID Feedback

Setting Value	Function	Description
B	PID Feedback	Enter the PID feedback value as a percentage of the maximum output frequency.

When you use this function, set $b5-01 \neq 0$ [PID Mode Setting \neq Disabled].

■ C: PID Setpoint

Setting Value	Function	Description
C	PID Setpoint	Enters the PID setpoint as a percentage of the maximum output frequency.

When you use this function, set $b5-01 \neq 0$ [PID Mode Setting \neq Disabled].

Note:

Configuring this function disables the frequency reference set with $b1-01$ [Frequency Reference Selection 1].

■ D: Frequency Bias

Setting Value	Function	Description
D	Frequency Bias	Enters the bias value added to the frequency reference as a percentage of the maximum output frequency.

The drive adds the input value from the MFAI terminal set with this function to the frequency reference as the bias value.

Note:

When you select $d1-01$ to $d1-17$ [Reference 1 to 8 or JOG Frequency Reference] as the frequency reference, it will disable this function.

■ E: Motor Temperature (PTC Input)

Setting Value	Function	Description
E	Motor Temperature (PTC Input)	Uses the motor Positive Temperature Coefficient (PTC) thermistor to prevent heat damage to the motor as a percentage of the current value when the 10 V analog signal is input.

- You can use the Positive Temperature Coefficient (PTC) thermistor as an auxiliary or alternative detection function for $oL1$ [Motor Overload] problems to help prevent heat damage to motors. If the PTC input signal is more than the overload alarm level, $oH3$ [Motor Overheat (PTC Input)] will flash on the keypad.
- When the drive detects $oH3$, the motor stops with the setting in $L1-03$. When the drive detects $oH4$, the motor stops with the setting in $L1-04$. When the drive incorrectly detects motor overheating problems, set $L1-05$.

■ F: Not Used

Setting Value	Function	Description
F	Not Used	Use this setting for unused terminals or to use terminals in through mode.

When you set a terminal that is not in use to F, you can use the signal input to the terminal as PLC analog signal input through serial communications or the communication option. This input signal does not have an effect on drive operation. This functions the same as setting 1F (Through Mode).

■ 16: Differential PID Feedback

Setting Value	Function	Description
16	Differential PID Feedback	Enters the PID differential feedback value if the full scale analog signal (10 V or 20 mA) is 100%.

The drive uses the deviation between the PID feedback and the differential feedback value signals to calculate the PID input.

■ 1F: Not Used

Setting Value	Function	Description
1F	Not Used	Use this setting for unused terminals or to use terminals in through mode.

When you set a terminal that you do not use to 1F, you can use the signal that is input to that terminal as the PLC analog signal input from MEMOBUS/Modbus communications or the communication option. This input signal does not have an effect on drive operation. This signal functions the same as F (Through Mode).

■ 24: PID Feedback Backup

Setting Value	Function	Description
24	PID Feedback Backup	Enters the PID Feedback Backup signal for the drive to use when it loses the primary PID feedback set for $H3-xx = B$ [PID Feedback].

■ 25: PI2 Control Setpoint

Setting Value	Function	Description
25	PI2 Control Setpoint	Enters the PI2 Control setpoint level as a percentage of the $S3-02$ [PI2 Control Transducer Scale] value.

■ 26: PI2 Control Feedback

Setting Value	Function	Description
26	PI2 Control Feedback	Enters the PI2 Control feedback level as a percentage of the $S3-02$ [PI2 Control Transducer Scale] value.

■ 27: PI Auxiliary Control Feedback

Setting Value	Function	Description
27	PI Auxiliary Control Feedback	Enters the PI Auxiliary Control feedback value when $YF-01 = 1$ [PI Aux Control Selection = Enabled].

■ 2B: Emergency Override PID Feedback

Setting Value	Function	Description
2B	Emergency Override PID Feedback	This input is the PID Feedback source when Emergency Override is running in PID mode ($S6-02 = 2$ or 3 [Emergency Override Ref Selection = System PID Mode or Independent PID Mode]).

■ 2C: Emergency Override PID Setpoint

Setting Value	Function	Description
2C	Emergency Override PID Setpoint	This input is the PID Setpoint source when Emergency Override is running in PID mode ($S6-02 = 2$ or 3 [Emergency Override Ref Selection = System PID Mode or Independent PID Mode]).

■ 2D: Differential Level Source

Setting Value	Function	Description
2D	Differential Level Source	Enters a feedback value to calculate the Differential Level between the <i>Differential Level Source</i> feedback and the primary <i>PID Feedback</i> [$H3-xx = B$].

■ 2E: HAND Frequency Ref or Setpoint

Setting Value	Function	Description
2E	HAND Frequency Ref or Setpoint	Enters the S5-05 [HAND Frequency Reference] value or the S5-06 [HAND Setpoint] value. When S5-01 = 0 [HAND Frequency Reference Source = HAND Analog Input] and S5-03 = 0 [HAND Mode PI Selection = Disabled], the drive enters HAND Frequency Reference. When b5-01 ≠ 0, S5-01 = 0, and S5-03 = 1 [Enabled], the drive enters HAND Setpoint.

◆ H4: Analog Outputs

H4 parameters set the drive analog monitors. These parameters select monitor parameters, adjust gain and bias, and select output signal levels.

■ Calibrate Meters Connected to MFAO Terminals FM and AM

To calibrate the meters connected to terminals FM and AM, use these parameters:

- H4-02 [Terminal FM Analog Output Gain]
- H4-03 [Terminal FM Analog Output Bias]
- H4-05 [Terminal AM Analog Output Gain]
- H4-06 [Terminal AM Analog Output Bias]

Set these parameters where the output voltage of 10 V and output current of 20 mA are 100% of the signal level. Use jumper switch S5 and H4-07 [Terminal FM Signal Level Select] or H4-08 [Terminal AM Signal Level Select] to select the voltage output and current output.

No.	Name	Range	Default
H4-02	Terminal FM Analog Output Gain	-999.9 - +999.9%	100.0%
H4-03	Terminal FM Analog Output Bias	-999.9 - +999.9%	0.0%
H4-05	Terminal AM Analog Output Gain	-999.9 - +999.9%	50.0%
H4-06	Terminal AM Analog Output Bias	-999.9 - +999.9%	0.0%
H4-07	Terminal FM Signal Level Select	0: 0 to 10 Vdc 2: 4 to 20 mA	0
H4-08	Terminal AM Signal Level Select	0: 0 to 10 Vdc 2: 4 to 20 mA	0

Figure 5.62 and Figure 5.63 show the gain and bias when H4-07 = 0 [0 to 10 Vdc] and H4-08 = 0 [0 to 10 Vdc].

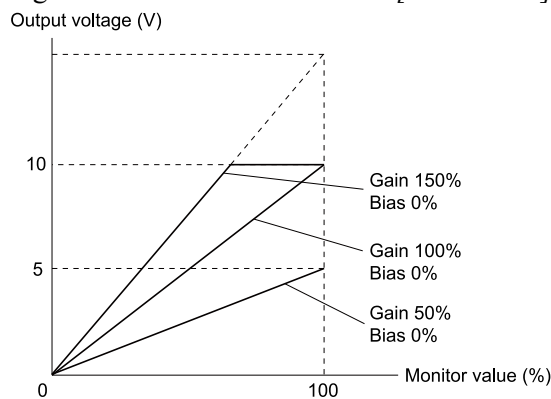

Figure 5.62 Analog Output Gain/Bias Configuration Example 1

For example, when the parameter value set to analog output is 0, and a 3 V signal is output to terminal FM, H4-03 [Terminal FM Analog Output Bias] is set to 30%.

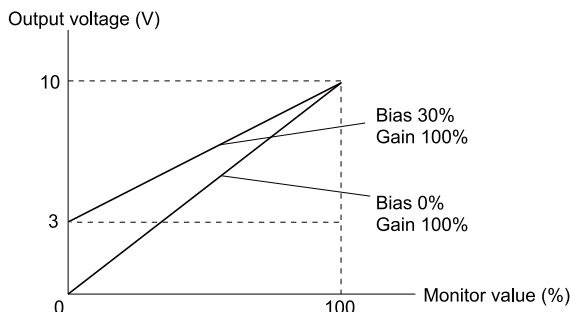

Figure 5.63 Analog Output Gain/Bias Configuration Example 2

Calibrate Terminal FM

Stop the drive to calibrate meters. Use this procedure to calibrate:

1. Show *H4-02 [Terminal FM Analog Output Gain]* on the keypad.
Terminal FM outputs the analog signal when the monitor item that you set in *H4-01 [Terminal FM Analog Output Select]* is 100%.
2. Adjust *H4-02* while referencing the meter scale connected to terminal FM.
3. Show *H4-03 [Terminal FM Analog Output Bias]* on the keypad.
Terminal FM outputs the analog signal when the monitor item that you set in *H4-01* is 0%.
4. Adjust *H4-03* while referencing the meter scale connected to terminal FM.

Calibrate Terminal AM

Stop the drive to calibrate meters. Use this procedure to calibrate:

1. Show *H4-05 [Terminal AM Analog Output Gain]* on the keypad.
Terminal AM outputs the analog signal when the monitor item that you set in *H4-04 [Terminal AM Analog Output Select]* is 100%.
2. Adjust *H4-05* while referencing the meter scale connected to terminal AM.
3. Show *H4-06 [Terminal AM Analog Output Bias]* on the keypad.
Terminal AM outputs the analog signal when the monitor item that you set in *H4-04* is 0%.
4. Adjust *H4-06* while referencing the meter scale connected to terminal AM.

■ H4-01: Terminal FM Analog Output Select

No. (Hex.)	Name	Description	Default (Range)
H4-01 (041D)	Terminal FM Analog Output Select	Sets the monitor number to send from MFAO terminal FM.	102 (000 - 999)

Set the *x-xx* part of the *Ux-xx [Monitor]*. For example, set *H4-01 = 102* to monitor *U1-02 [Output Frequency]*.

Note:

When you use the terminal in through mode, set this parameter to *000* or *031*. You can set the terminal FM output level from the PLC through serial communications or the communication option.

■ H4-02: Terminal FM Analog Output Gain

No. (Hex.)	Name	Description	Default (Range)
H4-02 (041E) RUN	Terminal FM Analog Output Gain	Sets the gain of the monitor signal that is sent from MFAO terminal FM.	100.0% (-999.9 - +999.9%)

The analog signal output from the FM terminal is a maximum of ± 10 V (or 20 mA). Select the signal level with *H4-07 [Terminal FM Signal Level Select]*.

■ H4-03: Terminal FM Analog Output Bias

No. (Hex.)	Name	Description	Default (Range)
H4-03 (041F) RUN	Terminal FM Analog Output Bias	Sets the bias of the monitor signal that is sent from MFAO terminal FM.	0.0% (-999.9 - +999.9%)

The analog signal output from the FM terminal is a maximum of ± 10 V (or 20 mA). Select the signal level with *H4-07* [Terminal FM Signal Level Select].

■ H4-04: Terminal AM Analog Output Select

No. (Hex.)	Name	Description	Default (Range)
H4-04 (0420)	Terminal AM Analog Output Select	Sets the monitoring number to be output from the MFAO terminal AM.	103 (000 - 999)

Set the *x-xx* part of the *Ux-xx* [Monitor]. For example, set *H4-04* = 103 to monitor *U1-03* [Output Current].

Note:

When you use the terminal in through mode, set this parameter to 000 or 031. You can set the terminal AM output level from the PLC through serial communications or the communication option.

■ H4-05: Terminal AM Analog Output Gain

No. (Hex.)	Name	Description	Default (Range)
H4-05 (0421) RUN	Terminal AM Analog Output Gain	Sets the gain of the monitor signal that is sent from MFAO terminal AM.	50.0% (-999.9 - +999.9%)

The analog signal output from the AM terminal is a maximum of ± 10 V (or 20 mA). Select the signal level with *H4-08* [Terminal AM Signal Level Select].

Example settings:

When the output current of a monitoring item is 100% (drive rated current) in these examples, the voltage of AM terminal outputs at 5 V (50% of 10 V). Subsequently, the output current at the time the AM terminal outputs a maximum voltage of 10 V will be 200% of the drive rated current.

- *H4-04* = 103 [Terminal AM Analog Output Select = Output Current]
- *H4-05* = 50.0%
- *H4-06* = 0.0% [Terminal AM Analog Output Bias = 0.0%]
- *H4-08* = 0 [0 to 10 V]

■ H4-06: Terminal AM Analog Output Bias

No. (Hex.)	Name	Description	Default (Range)
H4-06 (0422) RUN	Terminal AM Analog Output Bias	Sets the bias of the monitor signal that is sent from MFAO terminal AM.	0.0% (-999.9 - +999.9%)

The analog signal output from the AM terminal is a maximum of ± 10 V (or 20 mA). Select the signal level with *H4-08* [Terminal AM Signal Level Select].

■ H4-07: Terminal FM Signal Level Select

No. (Hex.)	Name	Description	Default (Range)
H4-07 (0423)	Terminal FM Signal Level Select	Sets the MFAO terminal FM output signal level.	0 (0, 2)

Note:

Make sure that you also set jumper S5 on the control circuit terminal block when you change this parameter.

0 : 0 to 10 Vdc

2 : 4 to 20 mA

■ H4-08: Terminal AM Signal Level Select

No. (Hex.)	Name	Description	Default (Range)
H4-08 (0424)	Terminal AM Signal Level Select	Sets the MFAO terminal AM output signal level.	0 (0, 2)

Note:

Make sure that you also set jumper S5 on the control circuit terminal block when you change this parameter.

0 : 0 to 10 Vdc

2 : 4 to 20 mA

■ H4-20: Analog Power Monitor 100% Level

No. (Hex.)	Name	Description	Default (Range)
H4-20 (0B53)	Analog Power Monitor 100% Level	Sets the level at 10 V when you set U1-08 [Output Power] for analog output.	0.00 kW (0.00 - 650.00 kW)

Note:

- When $H4-20 = 0.00 \text{ kW}$, the output power monitor 10 V level = motor rated power.

◆ H5: Serial Communication

H5 parameters control the RS-485 input on terminals 1 to 4 of bypass controller TB3 on the bypass PCB.

■ H5-01: Drive Node Address

No. (Hex.)	Name	Description	Default (Range)
H5-01 (0425)	Drive Node Address	Sets the communication slave address for drives.	1FH (Determined by protocol)

Note:

- Setting range differs by protocol:
 - BACnet: 0 to 7F
 - P1: 0 to FF
 - N2: 0 to FF
 - Modbus: 0 to FF
- Cycle power to the bypass package or set $H5-20 = 1$ [Communication Parameters Reload = Reload Now] after you change the parameter setting.
- Setting 0 will not let the drive respond to serial communications.

To enable the drive to communicate with the controller (master) over serial communications, you must set the drive with a slave address. Set $H5-01 \neq 0$.

Set a slave address that is different from other slave devices.

■ H5-02: Communication Speed Selection

No. (Hex.)	Name	Description	Default (Range)
H5-02 (0426)	Communication Speed Selection	Sets the communications speed for serial communications.	3 (Determined by protocol)

Note:

- Setting range differs by protocol:
 - BACnet: 3, 4, 5, 7
 - P1: 2, 3
 - N2: 3
 - Modbus: 0 to 8
- Re-energize the drive or set $H5-20 = 1$ [*Communication Parameters Reload = Reload Now*] after you change the parameter setting.

- 0 : 1200 bps**
- 1 : 2400 bps**
- 2 : 4800 bps**
- 3 : 9600 bps**
- 4 : 19.2 kbps**
- 5 : 38.4 kbps**
- 6 : 57.6 kbps**
- 7 : 76.8 kbps**
- 8 : 115.2 kbps**

■ H5-03: Communication Parity Selection

No. (Hex.)	Name	Description	Default (Range)
H5-03 (0427)	Communication Parity Selection	Sets the communications parity used for serial communications.	0 (0 - 2)

Note:

Re-energize the drive or set $H5-20 = 1$ [*Communication Parameters Reload = Reload Now*] after you change the parameter setting.

- 0 : No parity**
- 1 : Even parity**
- 2 : Odd parity**

■ H5-04: Communication Error Stop Method

No. (Hex.)	Name	Description	Default (Range)
H5-04 (0428)	Communication Error Stop Method	Sets the motor Stopping Method when the drive detects a serial communication Error condition.	3 (0 - 4)

0 : Ramp to Stop

The drive ramps the motor to stop in the deceleration time. Fault relay output terminal MA-MC activates and MB-MC deactivates. In Bypass Mode, the motor will coast to stop.

1 : Coast to Stop

The output turns off and the motor coasts to stop. Fault relay output terminal MA-MC turns activates and MB-MC deactivates.

2 : Fast Stop (Use C1-09)

The drive stops the motor in the deceleration time set in $C1-09$ [*Fast Stop Time*]. Fault relay output terminal MA-MC activates and MB-MC deactivates.

3 : Alarm Only

The keypad shows a CE [*Serial Communication Error*] alarm and the drive continues operation. The output terminal set for *Alarm* [$H2-01$ to $H2-03 = 10$] activates.

4 : Run at H5-34 (CE Go-To-Freq)

The keypad shows a CE [*Run at H5-34 (CE Go-To-Freq)*] alarm and the drive will operate at the speed set in $H5-34$ [*Comm Error (CE) Go-To-Frequency*] when a Communication Error condition occurs.

When $H5-35$ [Comm Error (CE) Go-To-Timeout] > 0 and if the Communication Error condition continues for longer than the time set in $H5-35$, the drive will coast to stop and detect a CE [Serial Communication Error] fault.

Figure 5.64 shows the time chart for the conditions when the drive will detect a CE alarm or a CE fault.

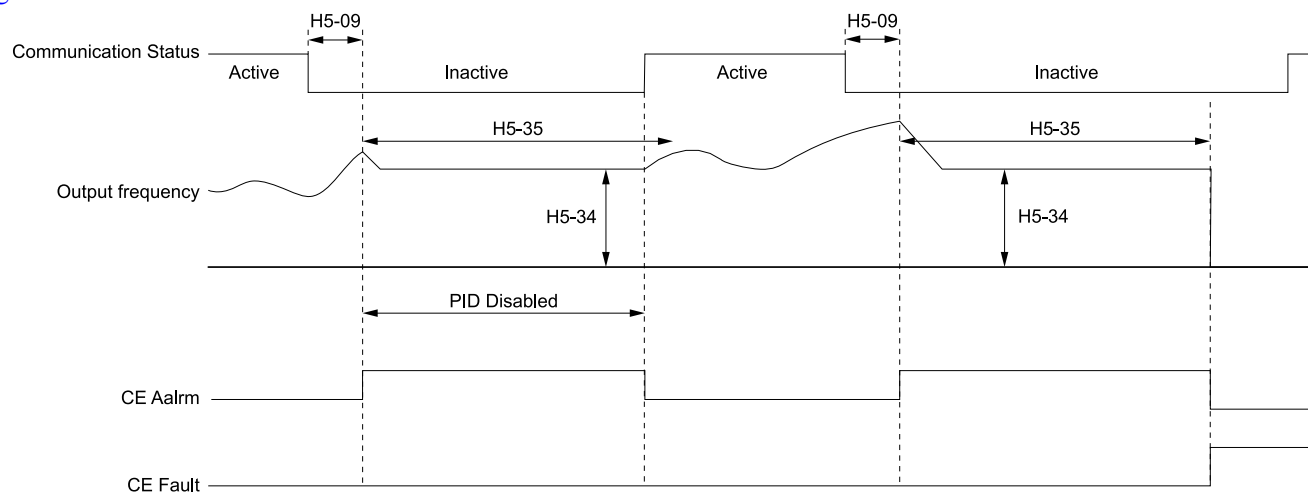

H5-09: CE Detection Time

H5-34: Comm Error (CE) Go-To-Frequency

H5-35: Comm Error (CE) Go-To-Timeout

CE Alarm: Run at H5-34 (CE Go-To-Freq)

CE Fault: Serial Communications Error

Figure 5.64 Communication Error Stopping Method when $H5-34 = 4$

Note:

The drive operation when $H5-04 = 4$ and a Communication Error condition occurs is different for different drive status:

- During Pre-charge, the drive will continue to operate at the Pre-Charge Frequency .
- During Sleep, the drive will wake up and operate at the speed set in $H5-34$.
- During Feedback Drop, the drive will wake up and operate at the speed set in $H5-34$.
- If the drive is stopped or in a fault retry condition, including CE fault, the drive will show a CE [Serial Communication Error] alarm.

■ H5-05: Comm Fault Detection Selection

No. (Hex.)	Name	Description	Default (Range)
H5-05 (0429)	Comm Fault Detection Selection	Sets the function that detects CE [Serial Communication Error] issues during serial communications.	1 (0, 1)

If the drive does not receive data from the master during the time set in $H5-09$ [CE Detection Time], it will detect a CE error.

0 : Disabled

Does not detect CE . The drive continues operation.

1 : Enabled

Detects CE . If the drive detects CE , it will operate as specified by the setting of $H5-04$ [Communication Error Stop Method].

■ H5-06: Drive Transmit Wait Time

No. (Hex.)	Name	Description	Default (Range)
H5-06 (042A)	Drive Transmit Wait Time	Sets the time to wait to send a response message after the drive receives a command message from the master.	5 ms (0 - 65 ms)

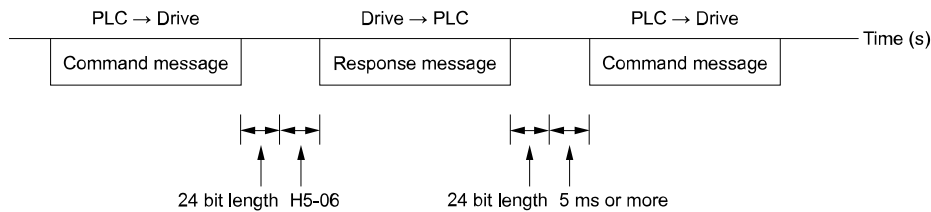

Figure 5.65 Drive Transmit Wait Time

■ H5-08: Communication Protocol Selection

No. (Hex.)	Name	Description	Default (Range)
H5-08 (062D)	Communication Protocol Selection	Selects the communication protocol.	3 (0 - 3)

0 : Modbus/MEMOBUS

1 : Metasys/N2

2 : Apogee/P1

3 : BACnet

■ H5-09: CE Detection Time

No. (Hex.)	Name	Description	Default (Range)
H5-09 (0435)	CE Detection Time	Sets the detection time for CE [Serial Communication Error] issues when communication stops.	2.0 s (0.0 - 10.0 s)

■ H5-10: Modbus Register 0025H Unit Sel

No. (Hex.)	Name	Description	Default (Range)
H5-10 (0436)	Modbus Register 0025H Unit Sel	Sets the unit of measure used for the serial communications monitor register 0025H (output voltage reference monitor).	0 (0, 1)

0 : 0.1 V units

1 : 1 V units

■ H5-11: Comm ENTER Command Mode

No. (Hex.)	Name	Description	Default (Range)
H5-11 (043C)	Comm ENTER Command Mode	Sets the function to make the Enter command necessary to change parameters through serial communications.	0 (0, 1)

0 : ENTER Command Required

You must use the Enter command to enable changes to parameters. Make all parameter changes then input the Enter command.

1 : ENTER Command Not Required

It is not necessary to input the Enter command to change parameters.

■ H5-14: BACnet Device Obj ID LOW BITS

No. (Hex.)	Name	Description	Default (Range)
H5-14 (310D)	BACnet Device Obj ID LOW BITS	Sets the lower bits of the BACnet device object ID as a 4-digit hexadecimal number.	0001 (0000 - FFFF)

This parameter and *H5-15 [BACnet Device Obj ID HIGH BITS]* set the Instance Identifier of the BACnet Device Object. The *H5-14* value is the least significant word and the *H5-15* value is the most significant word. Refer to these examples to set *H5-14* and *H5-15* correctly:

- Example 1: Set Device Object Instance Identifier of “1234”
The number of 1234 (decimal) is equal to 4D2 (hexadecimal). Set *H5-14* = 04D2 and *H5-15* = 0000.
- Example 2: Set Device Object Instance Identifier of “1234567”
The number of 1234567 (decimal) is equal to 12D687 (hexadecimal). Set *H5-14* = D687 and *H5-15* = 0012.

■ H5-15: BACnet Device Obj ID HIGH BITS

No. (Hex.)	Name	Description	Default (Range)
H5-15 (310E)	BACnet Device Obj ID HIGH BITS	Sets the upper bits of the BACnet device object ID as a 4-digit hexadecimal number.	0000 (0000 - 003F)

Parameter *H5-14 [BACnet Device Obj ID LOW BITS]* and this parameter set the Instance Identifier of the BACnet Device Object. The *H5-14* value is the least significant word and the *H5-15* value is the most significant word. Refer to these examples to set *H5-14* and *H5-15* correctly:

- Example 1: Set Device Object Instance Identifier of “1234”
The number of 1234 (decimal) is equal to 4D2 (hexadecimal). Set *H5-14* = 04D2 and *H5-15* = 0000.
- Example 2: Set Device Object Instance Identifier of “1234567”
The number of 1234567 (decimal) is equal to 12D687 (hexadecimal). Set *H5-14* = D687 and *H5-15* = 0012.

■ H5-18: Motor Speed Filter over Comms

No. (Hex.)	Name	Description	Default (Range)
H5-18 (11A2)	Motor Speed Filter over Comms	Sets the filter time constant used when monitoring motor speed during serial communications or with a communication option.	0 ms (0 - 100 ms)

Sets the filter time constant when you monitor the output frequency or motor speed during serial communications or use of the communication option.

These are the MEMOBUS registers:

- 003EH (Output Frequency)
- 003FH (Output Frequency)
- 0044H (*UI-05*: Motor Speed)
- 00ACH (*UI-05*: Motor Speed)
- 00ADH (*UI-05*: Motor Speed)

■ H5-20: Communication Parameters Reload

No. (Hex.)	Name	Description	Default (Range)
H5-20 (0B57)	Communication Parameters Reload	Sets the function to immediately enable updated serial communications parameters.	0 (0, 1)

0 : Reload at Next Power Cycle

1 : Reload Now

Note:

- The setting value automatically returns to *H5-20* = 0 after you enable MEMOBUS/Modbus communications parameter changes.
- The setting values of these parameters are enabled:
 - H5-01 [Drive Node Address]*
 - H5-02 [Communication Speed Selection]*
 - H5-03 [Communication Parity Selection]*
 - H5-06 [Drive Transmit Wait Time]*

■ H5-22: Speed Search from MODBUS

No. (Hex.)	Name	Description	Default (Range)
H5-22 (11CF)	Speed Search from MODBUS	Enables the serial communication register Speed Search function (bit 0 of 15DFH).	0 (0, 1)

0 : Disabled

1 : Enabled

If you set $H5-22 = 1$ and $H1-xx = 62$ [*Speed Search from Fref*] at the same time, the drive will detect *oPE03* [*Multi-Function Input Setting Err*].

■ H5-23: BACnet Max Master

No. (Hex.)	Name	Description	Default (Range)
H5-23 (158D)	BACnet Max Master	Sets the maximum number of master MAC ID to scan to when the drive polls for the next node (Poll for Master).	7F (1 - 7F)

■ H5-24: BACnet Max Info Frames

No. (Hex.)	Name	Description	Default (Range)
H5-24 (3DA0)	BACnet Max Info Frames	Sets the maximum number of information frames that the bypass will send per token cycle in BACnet.	3 (1 - 255)

■ H5-25: Function 5A Register 1 Selection

No. (Hex.)	Name	Description	Default (Range)
H5-25 (1589) RUN	Function 5A Register 1 Selection	Returns the contents of the specified serial communications register when responding to the master device.	0044H (U1-05) (0000H - FFFFH)

■ H5-26: Function 5A Register 2 Selection

No. (Hex.)	Name	Description	Default (Range)
H5-26 (158A) RUN	Function 5A Register 2 Selection	Returns the contents of the specified serial communications register when responding to the master device.	0045H (U1-06) (0000H - FFFFH)

■ H5-27: Function 5A Register 3 Selection

No. (Hex.)	Name	Description	Default (Range)
H5-27 (158B) RUN	Function 5A Register 3 Selection	Returns the contents of the specified serial communications register when responding to the master device.	0042H (U1-03) (0000H - FFFFH)

■ H5-28: Function 5A Register 4 Selection

No. (Hex.)	Name	Description	Default (Range)
H5-28 (158C) RUN	Function 5A Register 4 Selection	Returns the contents of the specified serial communications register when responding to the master device.	0049H (U1-10) (0000H - FFFFH)

■ H5-33: Power-up CALL Alarm

No. (Hex.)	Name	Description	Default (Range)
H5-33 (3FB3)	Power-up CALL Alarm	Enables and disables <i>CALL [Serial Comm Transmission Error]</i> alarm detection.	1 (0, 1)

0 : Disabled

1 : Enabled

■ H5-34: Comm Error (CE) Go-To-Frequency

No. (Hex.)	Name	Description	Default (Range)
H5-34 (3FB4) RUN	Comm Error (CE) Go-To-Frequency	Sets the speed at which the drive will run when <i>H5-04 = 4 [Communication Error Stop Method = Run at H5-34]</i> and there is a <i>CE</i> .	0.0 Hz (0.0 - 400.0 Hz)

■ H5-35: Comm Error (CE) Go-To-Timeout

No. (Hex.)	Name	Description	Default (Range)
H5-35 (3FB5) RUN	Comm Error (CE) Go-To-Timeout	When <i>H5-04 = 4 [Communication Error Stop Method = Run at H5-34]</i> and a <i>CE</i> is present, the drive will run at the <i>H5-34 [Comm Error (CE) Go-To-Frequency]</i> speed for this length of time before it triggers a <i>CE</i> fault.	0 s (0 - 6000 s)

Note:

Set this parameter to 0 s to disable the time-out.

■ H5-36: CE Fault Restart Select

No. (Hex.)	Name	Description	Default (Range)
H5-36 (3FB6)	CE Fault Restart Select	Sets the drive to restart (<i>L5-01 [Number of Auto-Restart Attempts]</i>) after a <i>CE</i> fault.	0 (0, 1)

0 : No Retry

1 : Retry

The drive will restart after the *L5-04 [Interval Method Restart Time]* timer is expired.

◆ H7: Virtual MFIO Selection

Use the virtual I/O function for these applications:

- Input the result of the output from the MFDO terminal to the MFDI terminal without external wiring.
- Input the result of the output from the MFAO terminal to the MFAI terminal without external wiring.

WARNING! Sudden Movement Hazard. Before you do a test run, make sure that the setting values for virtual input and output function parameters are correct. Virtual input and output functions can have different default settings and operation than wired input and output functions. Incorrect function settings can cause serious injury or death.

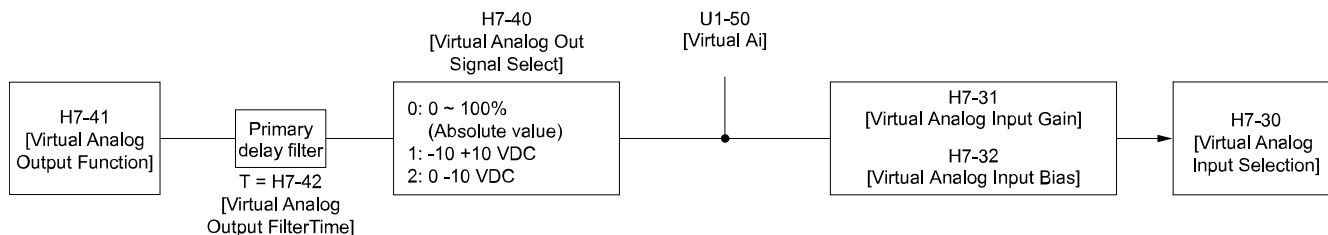

Figure 5.66 Virtual Analog I/O Functional Block Diagram

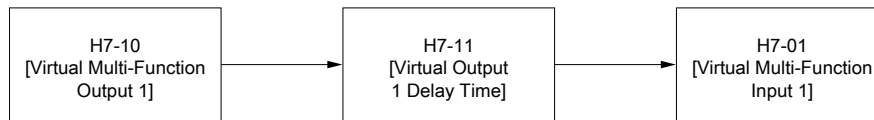

Figure 5.67 Virtual Digital I/O Functional Block Diagram

Note:

- Refer to H1-xx “MFDI Setting Values” for more information on the virtual digital input setting values.
- Refer to H2-xx “MFDO Setting Values” for more information on the virtual digital output setting values.
- Refer to H3-xx “MFAI Setting Values” for more information on the virtual analog input setting values.
- Refer to H4-xx “MFAO Setting Values” for more information on the virtual analog output setting values.
- If you will not use the terminal, set *H7-01* to *H7-04* = *F*. This function does not support the through mode function.

■ H7-00: Virtual MFIO selection

No. (Hex.)	Name	Description	Default (Range)
H7-00 (116F) Expert	Virtual MFIO selection	Sets the function to enable and disable the virtual I/O function. Set this parameter to 1 to operate the virtual I/O function.	0 (0, 1)

0 : Disabled

1 : Enabled

■ H7-01: Virtual Multi-Function Input 1

No. (Hex.)	Name	Description	Default (Range)
H7-01 (1185) Expert	Virtual Multi-Function Input 1	Sets the function that enters the virtual input set in <i>H7-10</i> [Virtual Multi-Function Output 1].	F (3 - 1A8)

■ H7-02: Virtual Multi-Function Input 2

No. (Hex.)	Name	Description	Default (Range)
H7-02 (1186) Expert	Virtual Multi-Function Input 2	Sets the function that enters the virtual input set in <i>H7-12</i> [Virtual Multi-Function Output 2].	F (3 - 1A8)

■ H7-03: Virtual Multi-Function Input 3

No. (Hex.)	Name	Description	Default (Range)
H7-03 (1187) Expert	Virtual Multi-Function Input 3	Sets the function that enters the virtual input set in <i>H7-14</i> [Virtual Multi-Function Output 3].	F (3 - 1A8)

■ H7-04: Virtual Multi-Function Input 4

No. (Hex.)	Name	Description	Default (Range)
H7-04 (1188) Expert	Virtual Multi-Function Input 4	Sets the function that enters the virtual input set in <i>H7-16</i> [Virtual Multi-Function Output 4].	F (3 - 1A8)

■ H7-10: Virtual Multi-Function Output 1

No. (Hex.)	Name	Description	Default (Range)
H7-10 (11A4) Expert	Virtual Multi-Function Output 1	Sets the function for virtual digital output 1.	F (0 - 1C4)

■ H7-11: Virtual Output 1 Delay Time

No. (Hex.)	Name	Description	Default (Range)
H7-11 (11A5) Expert	Virtual Output 1 Delay Time	Sets the minimum ON time for virtual digital output 1.	0.1 s (0.0 - 25.0 s)

■ H7-12: Virtual Multi-Function Output 2

No. (Hex.)	Name	Description	Default (Range)
H7-12 (11A6) Expert	Virtual Multi-Function Output 2	Sets the function for virtual digital output 2.	F (0 - 1C4)

■ H7-13: Virtual Output 2 Delay Time

No. (Hex.)	Name	Description	Default (Range)
H7-13 (11A7) Expert	Virtual Output 2 Delay Time	Sets the minimum ON time for virtual digital output 2.	0.1 s (0.0 - 25.0 s)

■ H7-14: Virtual Multi-Function Output 3

No. (Hex.)	Name	Description	Default (Range)
H7-14 (11A8) Expert	Virtual Multi-Function Output 3	Sets the function for virtual digital output 3.	F (0 - 1C4)

■ H7-15: Virtual Output 3 Delay Time

No. (Hex.)	Name	Description	Default (Range)
H7-15 (11A9) Expert	Virtual Output 3 Delay Time	Sets the minimum ON time for virtual digital output 3.	0.1 s (0.0 - 25.0 s)

■ H7-16: Virtual Multi-Function Output 4

No. (Hex.)	Name	Description	Default (Range)
H7-16 (11AA) Expert	Virtual Multi-Function Output 4	Sets the function for virtual digital output 4.	F (0 - 1C4)

■ H7-17: Virtual Output 4 Delay Time

No. (Hex.)	Name	Description	Default (Range)
H7-17 (11AB) Expert	Virtual Output 4 Delay Time	Sets the minimum ON time for virtual digital output 4.	0.1 s (0.0 - 25.0 s)

■ H7-30: Virtual Analog Input Selection

No. (Hex.)	Name	Description	Default (Range)
H7-30 (1177) Expert	Virtual Analog Input Selection	Sets the virtual analog input function.	F (0 - 2E)

■ H7-31: Virtual Analog Input Gain

No. (Hex.)	Name	Description	Default (Range)
H7-31 (1178) RUN Expert	Virtual Analog Input Gain	Sets the virtual analog input gain.	100.0% (-999.9 - 999.9%)

■ H7-32: Virtual Analog Input Bias

No. (Hex.)	Name	Description	Default (Range)
H7-32 (1179) RUN Expert	Virtual Analog Input Bias	Sets the virtual analog input bias.	0.0% (-999.9 - 999.9%)

■ H7-40: Virtual Analog Out Signal Select

No. (Hex.)	Name	Description	Default (Range)
H7-40 (1163)	Virtual Analog Out Signal Select	Sets the signal level of the virtual analog output.	0 (0 - 2)

0 : 0 to 100% (Absolute Value)

1 : -100 to 100%

2 : 0 to 100% (Lower Limit at 0)

■ H7-41: Virtual Analog Output Function

No. (Hex.)	Name	Description	Default (Range)
H7-41 (1164)	Virtual Analog Output Function	Sets the monitor to be output from the virtual analog output.	102 (0 - 631)

Set the *x-xx* part of the *Ux-xx [Monitor]*. For example, set *H7-41 = 102* to monitor *U1-02 [Output Frequency]*.

■ H7-42: Virtual Analog Output FilterTime

No. (Hex.)	Name	Description	Default (Range)
H7-42 (1165)	Virtual Analog Output FilterTime	Sets the time constant for a primary filter of the virtual analog output.	0.00 s (0.00 - 2.00 s)

5.8 L: Protection Functions

L parameters set the following functions.

- Motor Overload Protection
- Operation During Momentary Power Loss
- Stall Prevention
- Speed Detection
- Auto Restart
- Detection of Overtorque/Undertorque
- Torque Limit
- Hardware Protection

◆ L1: Motor Protection

L1 parameters set the motor overload protection function.

■ L1-01: Motor Overload (oL1) Protection

No. (Hex.)	Name	Description	Default (Range)
L1-01 (0480)	Motor Overload (oL1) Protection	Sets the motor overload protection with electronic thermal protectors.	1 (0, 1)

This parameter enables and disables the motor overload protection with electronic thermal protectors.

The cooling capability of the motor changes when the speed control range of the motor changes. Use an electronic thermal protector that aligns with the permitted load characteristics of the motor to select motor protection.

The electronic thermal protector of the drive uses these items to calculate motor overload tolerance and supply overload protection for the motor:

- Output Current
- Output Frequency
- Motor thermal characteristics
- Time characteristics

If the drive or bypass board detects motor overload, the drive will trigger an *oL1* [Motor Overload] or the bypass board will trigger an *FB05* [Motor Overload] and stop output.

Set *H2-01 = 1F* [Term M1-M2 Function Selection = Motor Overload Alarm (oL1)] to set a motor overload alarm. If the motor overload level is more than 90% (Drive Mode only) of the *oL1* detection level, the output terminal turns ON and triggers an overload alarm.

0 : Disabled

Disable built-in electronic motor protection when motor overload protection is not necessary or when the drive is operating more than one motor.

Refer to [Figure 5.68](#) for an example of the circuit configuration to connect more than one motor to one drive.

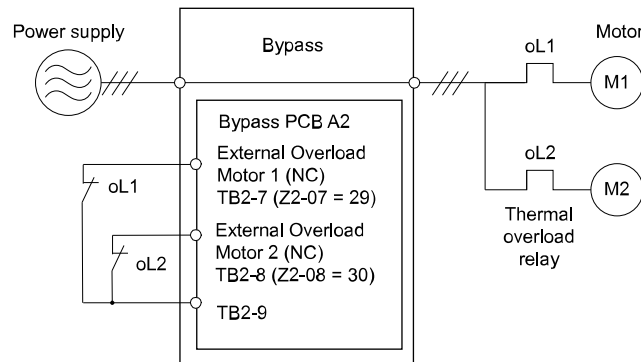

Figure 5.68 Protection Circuit Configuration to Connect More than One Motor to One Drive

NOTICE: When you connect more than one motor to one drive or when the motor amp rating is higher than the drive amp rating, set L1-01 = 0 [Motor Overload (oL1) Protection = Disabled] and install thermal overload relays for each motor. The electronic thermal protection of the drive will not function and it can cause damage to the motor.

1 : Variable Torque

Use this setting for general-purpose motors with a 60 Hz base frequency.

The overload tolerance decreases as motor speed decreases because the cooling fan speed decreases and the ability of the motor to cool decreases in the low speed range.

The overload tolerance characteristics of the motor change the trigger point for the electronic thermal protector. This provides motor overheat protection from low speed to high speed across the full speed range.

Load Tolerance	Cooling Capability	Overload Characteristics (at 100% motor load)
	<p>This motor is designed to operate with commercial line power. Operate at a 60 Hz base frequency to maximize the motor cooling ability.</p>	<p>If the motor operates at frequencies less than 60 Hz, the drive will detect oL1. The drive triggers a fault relay output and the motor coasts to stop.</p>

■ L1-02: Motor Overload Protection Time

No. (Hex.)	Name	Description	Default (Range)
L1-02 (0481)	Motor Overload Protection Time	Sets the operation time for the electronic thermal protector of the drive to prevent damage to the motor. Usually it is not necessary to change this setting.	1.0 min (0.1 - 5.0 min)

Set the overload tolerance time to the length of time that the motor can operate at 150% load from continuous operation at 100% load.

When the motor operates at 150% load continuously for 1 minute after continuous operation at 100% load (hot start), the default setting triggers the electronic thermal protector.

Figure 5.69 shows an example of the electronic thermal protector operation time. Motor overload protection operates in the range between a cold start and a hot start.

This example shows a general-purpose motor operating at the base frequency with L1-02 set to 1.0 min.

- Cold start
Shows the motor protection operation time characteristics when the overload occurs immediately after starting operation from a complete stop.
- Hot start

Shows the motor protection operation time characteristics when overload occurs from continuous operation below the motor rated current.

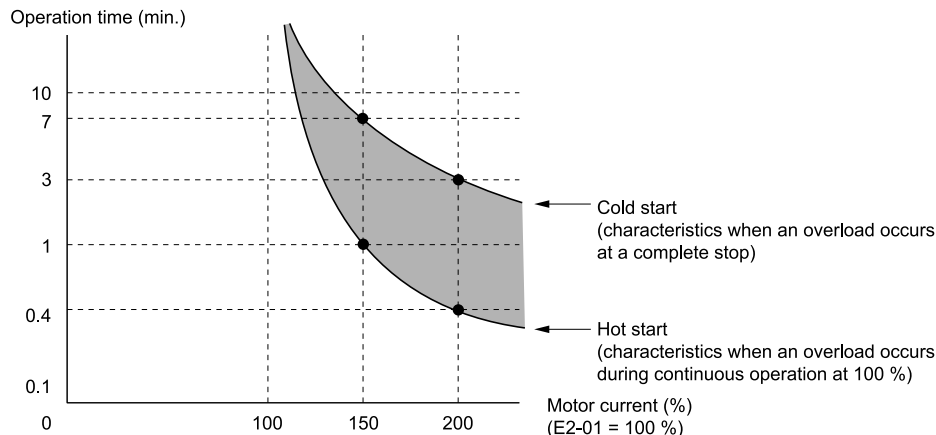

Figure 5.69 Protection Operation Time for a General-purpose Motor at Rated Output Frequency

■ L1-03: Motor Thermistor oH Alarm Select

No. (Hex.)	Name	Description	Default (Range)
L1-03 (0482)	Motor Thermistor oH Alarm Select	Sets drive operation when the PTC input signal entered into the drive is at the <i>oH3 [Motor Overheat Alarm]</i> detection level.	3 (0 - 3)

0 : Ramp to Stop

The drive ramps the motor to stop in the deceleration time. Fault relay output terminal MA-MC turns ON and MB-MC turns OFF.

1 : Coast to Stop

The output turns OFF and the motor coasts to stop. Fault relay output terminal MA-MC turns ON, and MB-MC turns OFF.

2 : Fast Stop (Use C1-09)

The drive stops the motor in the deceleration time set in *C1-09 [Fast Stop Time]*. Fault relay output terminal MA-MC turns ON, and MB-MC turns OFF.

3 : Alarm Only

The keypad shows *oH3*, and operation continues. The output terminal set for *Alarm [H2-01 to H2-03 = 10]* turns ON.

■ L1-04: Motor Thermistor oH Fault Select

No. (Hex.)	Name	Description	Default (Range)
L1-04 (0483)	Motor Thermistor oH Fault Select	Sets the drive operation when the PTC input signal to the drive is at the <i>oH4 [Motor Overheat Fault (PTC Input)]</i> detection level.	1 (0 - 2)

0 : Ramp to Stop

The drive ramps the motor to stop in the deceleration time. Fault relay output terminal MA-MC turns ON and MB-MC turns OFF.

1 : Coast to Stop

The output turns OFF and the motor coasts to stop. Fault relay output terminal MA-MC turns ON, and MB-MC turns OFF.

2 : Fast Stop (Use C1-09)

The drive stops the motor in the deceleration time set in *C1-09 [Fast Stop Time]*. Fault relay output terminal MA-MC turns ON, and MB-MC turns OFF.

■ L1-05: Motor Thermistor Filter Time

No. (Hex.)	Name	Description	Default (Range)
L1-05 (0484)	Motor Thermistor Filter Time	Sets the primary delay time constant for the PTC input signal entered to the drive. This parameter prevents accidental motor overheat faults.	0.20 s (0.00 - 10.00 s)

■ L1-08: oL1 Current Level

No. (Hex.)	Name	Description	Default (Range)
L1-08 (1103)	oL1 Current Level	Sets the reference current for the motor 1 thermal overload detection. When the current level > 0.0 A, you cannot set this value < 10% of drive rated current.	0.0 A (0.0 A or 10% to 150% of the drive rated current)

When $L1-08 = 0.0 A$, the drive uses $E2-01$ [Motor Rated Current (FLA)] to detect the motor overload protection.

When $L1-08 \neq 0.0 A$, the set value is the reference for motor overload protection.

Note:

- Display is in these units:
 -0.01 A: 2011 to 2046, 4005 to 4014
 -0.1 A: 2059 to 2273, 4021 to 4302
- When the current level > 0.0 A, you cannot set this value < 10% of drive rated current.

■ L1-13: Motor Overload Memory Selection

No. (Hex.)	Name	Description	Default (Range)
L1-13 (046D)	Motor Overload Memory Selection	Sets the function that keeps the current electronic thermal protector value after power loss.	2 (0 - 2)

0 : Disabled

1 : Enabled

2 : Enabled, using RTC

- The drive keeps the value of electronic thermal protector and integrates (resets) down the overload value based on real time.
- The drive saves the date and time on the EEPROM at power loss. When you set $L1-13 = 2$ and re-apply the power, the drive will calculate the length of time that it did not have power, read the value of the $oL1$ [Motor Overload] counter it saved before the power loss, and re-calculate the current $oL1$ counter value.

◆ L2: Power Loss Ride Through

$L2$ parameters set the drive operation during momentary power loss.

■ L2-01: Power Loss Ride Through Select

No. (Hex.)	Name	Description	Default (Range)
L2-01 (0485)	Power Loss Ride Through Select	Sets the drive operation after a momentary power loss.	2 (0 - 2)

The drive detects momentary power loss when the drive DC bus voltage is less than the value set in $L2-05$ [Undervoltage Detection Lvl ($Uv1$)].

0 : Disabled

The drive detects $Uv1$ [DC Bus Undervoltage] when there is a momentary power loss.

If you do not return power in 15 ms, it triggers $Uv1$ and the drive shuts off the output. The motor coasts to stop.

1 : Enabled for L2-02 Time

When power returns in the time set in $L2-02$ [Power Loss Ride Through Time], the drive will restart. If power does not return in the time set in $L2-02$, the drive will detect $Uv1$.

The drive momentarily turns OFF its output after a power loss. If the power returns in the time set to *L2-02*, the drive will do Speed Search and try to continue operation.

If the DC bus voltage is less than or equal to the *Uv1* detection level for the time set in *L2-02*, the drive will detect *Uv1* and output a fault signal.

Note:

- The necessary time for the drive to restart after power returns is different for different drive capacities.
- The upper limit of the possible momentary power loss Ride-Thru time is different for different drive models.

2 : Enabled while CPU Power Active

When power returns and the drive control circuit has power, the drive will restart. This will not trigger *Uv1*.

When there is a momentary power loss, the drive output will turn OFF. If the power returns and the drive control circuit has power, the drive will do Speed Search and try to continue operation. This will not trigger a *Uv1*. This function enables longer support for power loss than when *L2-01 = 1*.

Note:

When you set *L2-01*, make sure that you know these items:

- You can use a Momentary Power Loss Unit on models D007 to D059, B1P1, and B001 to B021 for a longer momentary power loss ride through time. A Momentary Power Loss Unit makes it possible to continue operation of the drive after a maximum of 2 seconds of power loss.
- When *L2-01 = 1 or 2*, *Uv [DC Bus Undervoltage]* will flash on the keypad while the drive is attempting to recover from a momentary power loss. The drive will not output a fault signal at this time.

■ L2-02: Power Loss Ride Through Time

No. (Hex.)	Name	Description	Default (Range)
L2-02 (0486)	Power Loss Ride Through Time	Sets the maximum time that the drive will wait until it tries to restart after power loss.	Determined by o2-04 (0.0 - 25.5 s)

This function is applicable when *L2-01 = 1 [Power Loss Ride Through Select = Enabled for L2-02 Time]*. If power loss operation is longer than the time set in this parameter, the drive will detect *Uv1 [DC Bus Undervoltage]*, turn OFF output, and the motor will coast to stop.

Note:

- The length of time that the drive can recover after a power loss changes when drive capacity changes.
- The upper limit of the possible momentary power loss Ride-Thru time changes when drive capacity changes.

■ L2-03: Minimum Baseblock Time

No. (Hex.)	Name	Description	Default (Range)
L2-03 (0487)	Minimum Baseblock Time	Sets the minimum time to continue the drive output block (baseblock) after a baseblock.	Determined by o2-04 (0.1 - 5.0 s)

Sets the length of time that the drive will wait for the residual voltage in the motor to dissipate in estimation to the secondary circuit time constant of the motor. If *oC [Overcurrent]* or *ov [DC Bus Overvoltage]* occur at the start of Speed Search, after power returns, or during DC Injection Braking, increase this setting.

■ L2-04: Powerloss V/f Recovery Ramp Time

No. (Hex.)	Name	Description	Default (Range)
L2-04 (0488)	Powerloss V/f Recovery Ramp Time	Sets the time for the drive output voltage to go back to the correct voltage after it completes speed searches.	Determined by o2-04 (0.0 - 5.0 s)

Sets the time for voltage to recover from 0 V to the value set in *E1-05 [Maximum Output Voltage]*.

■ L2-05: Undervoltage Detection Lvl (Uv1)

No. (Hex.)	Name	Description	Default (Range)
L2-05 (0489)	Undervoltage Detection Lvl (Uv1)	Sets the voltage at which the drive triggers a <i>Uv1 [DC Bus Undervoltage]</i> fault. Usually it is not necessary to change this setting.	Determined by o2-04 and E1-01 (208/240 V: 150 - 220 V, 480 V: 300 - 440 V)

NOTICE: Damage to Equipment. When you set this parameter to a value lower than the default, you must install an AC reactor on the input side of the power supply. If you do not install an AC reactor, it will cause damage to the drive circuitry.

◆ L3: Stall Prevention

L3 parameters set the Stall Prevention function and overvoltage suppression function.

■ Stall Prevention

If the load is too heavy or the acceleration and deceleration times are too short, the motor can slip too much because it cannot work at the same rate as the frequency reference. If the motor stalls during acceleration, current increases as the slip increases to cause an *oC [Overcurrent]*, *oL2 [Drive Overload]*, or *oL1 [Motor Overload]* and the drive will stop. If the motor stalls during deceleration, too much regenerative power will flow back into the DC bus capacitors and cause the drive to fault out from *ov [Overvoltage]* and stop the drive.

The stall prevention function will let the motor get to the set speed without stalling and it is not necessary for you to change the acceleration or deceleration time settings. You can set a separate stall prevention functions for acceleration, operating at constant speeds, and deceleration.

■ Overvoltage Suppression Function

This function decreases the regenerative torque limit and increases the output frequency when the DC bus voltage increases to prevent *ov*. This function can drive loads with cyclic regenerative operation, for example punch presses or other applications with repeated crank movements. When you use this function, set *L3-11 = 1 [Overvoltage Suppression Select = Enabled]*.

The drive adjusts the regenerative torque limit and the output frequency during overvoltage suppression to make sure that the DC bus voltage is not more than the level set in *L3-17 [DC Bus Regulation Level]*.

Set these parameters as necessary when you use the overvoltage suppression function:

- *L3-20 [DC Bus Voltage Adjustment Gain]*
- *L3-21 [OVSuppression Accel/Decel P Gain]*
- *L3-24 [Motor Accel Time @ Rated Torque]*
- *L3-25 [Load Inertia Ratio]*

Note:

- When overvoltage suppression is triggered, the motor speed is more than the frequency reference. Do not use overvoltage suppression for applications where the frequency reference and the motor speed must align.
- The overvoltage suppression function is enabled only when you operate immediately below the maximum frequency. Overvoltage suppression does not increase the output frequency to more than the maximum frequency. Make sure that the motor and machine specifications are correct for the application, then increase the maximum frequency.
- If there is a sudden increase to a regenerative load, *ov* can occur.

■ L3-01: Stall Prevention during Accel

No. (Hex.)	Name	Description	Default (Range)
L3-01 (048F)	Stall Prevention during Accel	Sets the method of Stall Prevention During Acceleration.	1 (0 - 2)

Stall prevention during acceleration prevents the stalling and stopping of motors when the drive detects *oC [Overcurrent]*, *oL2 [Drive Overloaded]*, or *oL1 [Motor Overload]* when there is a significant load applied during acceleration or when there are sudden acceleration times with respect to load inertia.

0 : Disabled

The Stall Prevention function does not operate during acceleration, and acceleration occurs for the set acceleration time. If the acceleration time is too short, the motor will not fully accelerate during the set time, which causes the drive to detect $oL1$ or $oL2$ and the motor to stop.

1 : Enabled

Enables the Stall Prevention During Acceleration function.

The drive stops acceleration if the output current is more than $L3-02$ [*Stall Prevent Level during Accel*]. If the output current is less than $L3-02 - 15\%$, the drive stops deceleration. The Stall Prevention function level automatically decreases for constant output ranges.

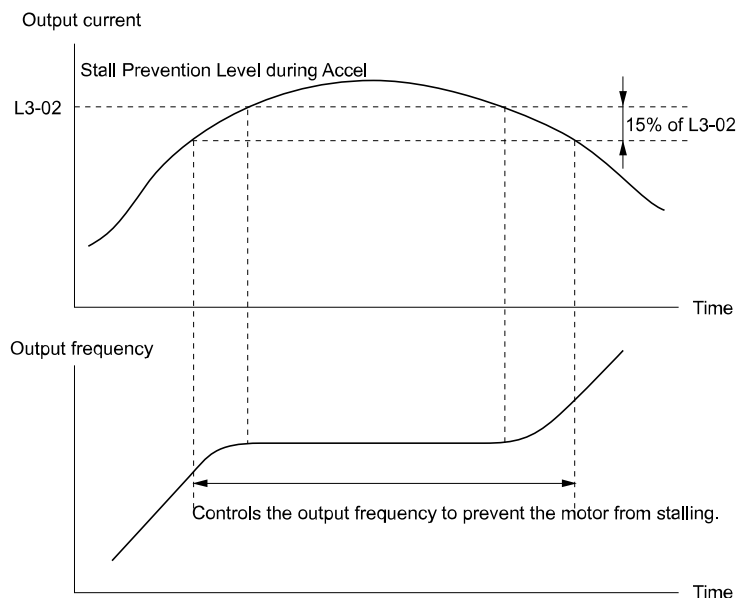

L3-02: Stall Prevent Level during Accel

Figure 5.70 Stall Prevention During Acceleration when Using Induction Motors

2 : Intelligent (Ignore Decel Ramp)

The drive ignores the acceleration time setting and the drive starts to accelerate in the minimum length of time. The drive automatically adjusts the acceleration rate to make sure that the output current is not more than $L3-02$.

■ L3-02: Stall Prevent Level during Accel

No. (Hex.)	Name	Description	Default (Range)
L3-02 (0490)	Stall Prevent Level during Accel	Sets the output current level to activate the Stall Prevention function during acceleration as a percentage of the drive rated output current.	Determined by L8-38 (0 - 120%)

Note:

- If you use a motor that is small compared to the drive and the motor stalls, decrease the setting value.
- When you operate the motor in the constant power range, set $L3-03$ [*Stall Prevent Limit during Accel*].

■ L3-03: Stall Prevent Limit during Accel

No. (Hex.)	Name	Description	Default (Range)
L3-03 (0491)	Stall Prevent Limit during Accel	Sets the lower limit for the stall prevention level used in the constant output range as a percentage of the drive rated output current.	50% (0 - 100%)

The stall prevention level set in $L3-02$ [*Stall Prevent Level during Accel*] is automatically reduced when the motor is running within the constant output range. Parameter $L3-03$ is the limit value used to prevent the stall prevention level during constant output ranges to fall below the minimum required level.

Note:

The function to automatically reduce the stall prevention level does not operate when $L3-01 = 3$ [Stall Prevention during Accel = Current Limit Method].

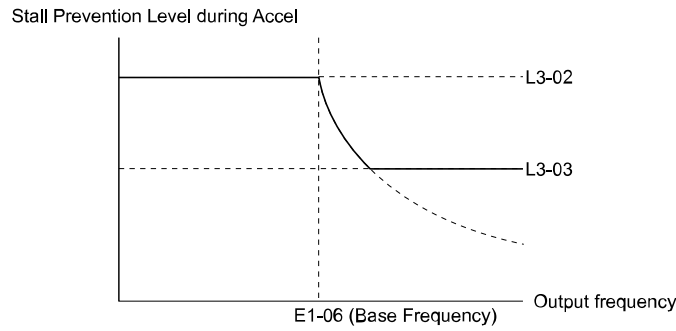

Figure 5.71 Stall Prevent Level during Accel/Limit

■ **L3-04: Stall Prevention during Decel**

No. (Hex.)	Name	Description	Default (Range)
L3-04 (0492)	Stall Prevention during Decel	Sets the method that the drive will use to prevent overvoltage faults when decelerating.	1 (0 - 4)

Stall Prevention during deceleration controls the deceleration as specified by the DC bus voltage and does not let high inertia or fast deceleration cause *ov* [Overvoltage] faults.

0 : Disabled

The drive decelerates as specified by the deceleration time. If the deceleration time is too short, the drive can detect an *ov* fault.

1 : General Purpose

The drive decelerates as specified by the deceleration time. When the DC bus voltage is more than the Stall Prevention level, the drive stops deceleration until the DC bus voltage is less than the Stall Prevention Level. The drive then starts to decelerate at the set deceleration time. Frequent use of Stall Prevention will help prevent *ov* faults when the deceleration time is shorter than the drive can usually accept.

Note:

The Decel Stall Prevention function will increase the deceleration time to stop and the deceleration time will be longer than the setting.

The input voltage setting of *E1-01* [Input AC Supply Voltage] sets the DC bus voltage level for Stall Prevention.

Table 5.43 Stall Prevention Level during Deceleration

Drive Input Voltage	Stall Prevention Level during Deceleration
208/240 V	377 V
480 V	754 V

Figure 5.72 shows the Stall Prevention during deceleration function.

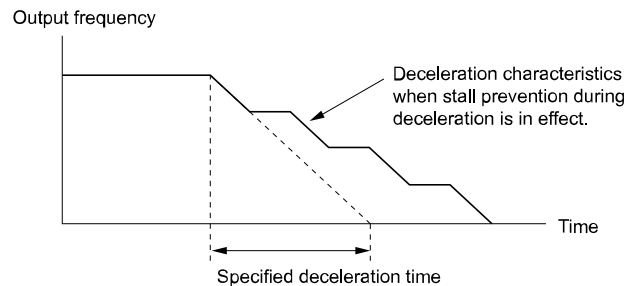

Figure 5.72 Stall Prevention Operation during Deceleration

2 : Intelligent (Ignore Decel Ramp)

The drive adjusts the deceleration rate to keep the DC bus voltage at the *L3-17 [DC Bus Regulation Level]* level. This makes the shortest possible deceleration time and will not let the motor stall. The drive ignores the selected deceleration time and the possible deceleration time cannot be less than 1/10 of the set deceleration time.

This function uses these parameters to adjust the deceleration rate:

- *L3-20 [DC Bus Voltage Adjustment Gain]*
- *L3-21 [OVSuppression Accel/Decel P Gain]*
- *L3-24 [Motor Accel Time @ Rated Torque]*
- *L3-25 [Load Inertia Ratio]*

4 : Overexcitation/High Flux

The drive enables Overexcitation/High Flux and enables a shorter deceleration time than when *L3-04 = 0*.

Note:

- If the overexcitation time is long and you decelerate frequently, the drive can detect *oL1 [Motor Overload]* faults. If the drive detects *oL1*, decrease the deceleration time.
- The deceleration time during Overexcitation Deceleration changes when the motor characteristics and machine inertia change. Adjust the *n3-13 [OverexcitationBraking (OEB) Gain]* and *n3-23 [Overexcitation Braking Operation]* levels. Refer to “n3: HighSlip/OverexciteBraking” for more information about the overexcitation function.

■ L3-05: Stall Prevention during RUN

No. (Hex.)	Name	Description	Default (Range)
L3-05 (0493)	Stall Prevention during RUN	Sets the function to enable and disable Stall Prevention During Run.	2 (0 - 2)

Stall Prevention function during run automatically decreases the speed when an *oL1 [Motor Overload]* occurs while the motor is running at constant speed to prevent the motor from stalling.

Note:

An output frequency lower than 6 Hz will disable Stall Prevention during Run. The *L3-05* and *L3-06 [Stall Prevent Level during Run]* settings do not have an effect.

0 : Disabled

The drive runs at the set frequency reference. A heavy load can cause the drive to detect *oC [Overcurrent]* or *oL1* and stall the motor.

1 : Deceleration Time 1 (C1-02)

The drive will decelerate for the time set in *C1-02 [Deceleration Time 1]* when the current is more than the Stall Prevention level set in *L3-06*. When the current level is less than the “*L3-06* setting value - 2%” for 100 ms, the drive accelerates again for the acceleration time applicable at that time until it reaches the set frequency.

2 : Deceleration Time 2 (C1-04)

This setting functions the same as *Setting 1 [Deceleration Time 1 (C1-02)]*. When the Stall Prevention function is enabled, the drive decelerates with the value set in *C1-04 [Deceleration Time 2]*.

■ L3-06: Stall Prevent Level during Run

No. (Hex.)	Name	Description	Default (Range)
L3-06 (0494)	Stall Prevent Level during Run	Sets the output current level to enable the Stall Prevention function during operation as a percentage of the drive rated output current.	Determined by L8-38 (5 - 120%)

Note:

- This parameter is applicable when *L3-05 = 1, 2 [Stall Prevention during RUN = Deceleration Time 1 (C1-02), Deceleration Time 2 (C1-04)]*.
- When *L3-23 = 1 [Stall P Reduction at Constant HP = Automatic Reduction @ CHP Region]*, the drive will automatically decrease the level in the constant output range.

Use an Analog Input to Change the Stall Prevent Level during Run

When *H3-xx = 8 [MFAI Function Selection = Stall Prevent Level During Run]*, you can change the stall prevention level during run through the input gain and bias settings for terminals A1 and A2.

If you set the input level for terminals A1 and A2 and L3-06, the drive will use the smaller value for Stall Prevent Level during Run.

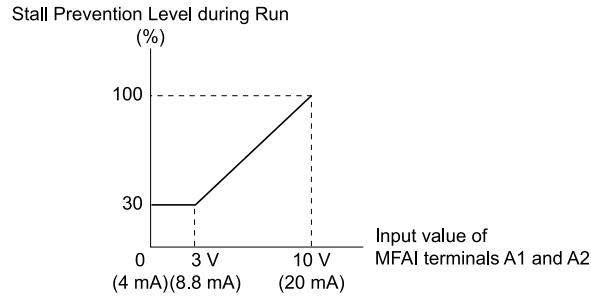

Figure 5.73 Stall Prevention Level during Run with Analog Input

■ L3-11: Overvoltage Suppression Select

No. (Hex.)	Name	Description	Default (Range)
L3-11 (04C7)	Overvoltage Suppression Select	Sets the overvoltage suppression function.	0 (0, 1)

0 : Disabled

The drive does not adjust the regenerative torque limit or the output frequency. If you apply a regenerative load, the drive can detect an *ov* [Overvoltage] fault.

1 : Enabled

When a regenerative load increases the DC bus voltage, the drive decreases the regenerative torque limit and increases the output frequency to prevent *ov*.

■ L3-17: DC Bus Regulation Level

No. (Hex.)	Name	Description	Default (Range)
L3-17 (0462)	DC Bus Regulation Level	Sets the target value for the DC bus voltage when the overvoltage suppression function and the Decel Stall Prevention function (Intelligent Stall Prevention) are active.	208/240 V: 375 V, 480 V: 750 V (208/240 V: 150 - 400 V, 480 V: 300 - 800 V)

Note:

This value is initialized when *E1-01* [Input AC Supply Voltage] is changed.

Sets this parameter for any of the following circumstances.

- L3-11 = 1 [OV Suppression Function Select = Enabled].
- L3-04 = 2 [Decel Stall Prevention Selection = Automatic Decel Reduction].

■ L3-20: DC Bus Voltage Adjustment Gain

No. (Hex.)	Name	Description	Default (Range)
L3-20 (0465) Expert	DC Bus Voltage Adjustment Gain	Sets the proportional gain used to control the DC bus voltage.	1.00 (0.00 - 5.00)

Set one of these parameters to enable L3-20:

- L3-04 = 2 [Decel Stall Prevention Selection = Automatic Decel Reduction]
- L3-11 = 1 [Overvoltage Suppression Select = Enabled]

Note:

- If stall prevention during deceleration function causes *ov* [Overvoltage] and *Uv1* [DC Bus Undervoltage] faults when you start deceleration and $L3-04 = 2$, gradually increase this parameter in 0.1-unit increments. If the setting value is too high, it can cause large speed or current ripples.
- If sudden increases in the regenerative load cause *ov* faults and $L3-11 = 1$, gradually increase this parameter in 0.1-unit increments. If the setting value is too high, it can cause large speed or current ripples.

■ L3-21: OVSUPPRESSION ACCEL/DECCEL P GAIN

No. (Hex.)	Name	Description	Default (Range)
L3-21 (0466) Expert	OVSUPPRESSION ACCEL/DECCEL P GAIN	Sets the proportional gain to calculate acceleration and deceleration rates.	1.00 (0.10 - 10.00)

Set one of these parameters to enable *L3-21*:

- $L3-04 = 2$ [Stall Prevention during Decel = Intelligent (Ignore Decel Ramp)]
- $L3-11 = 1$ [Overvoltage Suppression Select = Enabled]

Note:

- If stall prevention during deceleration function causes large speed or current ripples and $L3-04 = 2$, gradually decrease this parameter in 0.05-unit increments. If the drive detects *ov* [Overvoltage] or *oC* [Overcurrent], decrease this parameter. If you decrease the gain too much, it can cause a delay in control in the DC bus voltage or the deceleration time could be longer than the best deceleration time.
- If sudden increases in the regenerative load cause *ov* faults and $L3-11 = 1$, gradually increase this parameter in 0.1-unit increments. If there are large speed ripples, gradually decrease this parameter in 0.05-unit increments.

■ L3-23: STALL P REDUCTION AT CONSTANT HP

No. (Hex.)	Name	Description	Default (Range)
L3-23 (04FD)	STALL P REDUCTION AT CONSTANT HP	Sets the function to automatically decrease the Stall Prevention Level during Run for constant output ranges.	0 (0, 1)

0 : Use L3-06 for Entire Speed Range

The drive uses the level set in *L3-06* [Stall Prevent Level during Run] through the full speed range.

1 : Automatic Reduction @ CHP Region

The drive decreases the Stall Prevention level during run in the constant power range. The lower limit is 40% of the *L3-06* value.

■ L3-24: MOTOR ACCEL TIME @ RATED TORQUE

No. (Hex.)	Name	Description	Default (Range)
L3-24 (046E) Expert	MOTOR ACCEL TIME @ RATED TORQUE	Sets the motor acceleration time to reach the maximum frequency at the motor rated torque for stopped single-drive motors.	Determined by <i>o2-04</i> , <i>E2-11</i> (0.001 - 10.000 s)

Set one of these parameters to enable *L3-24*:

- $L3-04 = 2$ [Stall Prevention during Decel = Intelligent (Ignore Decel Ramp)]
- $L3-11 = 1$ [Overvoltage Suppression Select = Enabled]

Note:

When Auto-Tuning changes the value of *E2-11* [Motor Rated Power], the drive will automatically set *L3-24* to the value for a Yaskawa standard motor (4 poles).

Manually Adjust Parameters

Use this formula to find the motor acceleration time:

$$L3-24 = \frac{2\pi \cdot J_{\text{Motor}} \cdot n_{\text{rated}}}{60 \cdot T_{\text{rated}}}$$

- J_{Motor} = Moment of inertia of motor (kg m²)
- n_{rated} = Motor rated speed (min⁻¹, r/min)

5.8 L: Protection Functions

- $T_{\text{rated}} = \text{Motor rated torque (N}\cdot\text{m)}$

The rated torque is calculated using the following expression.

$$T_{\text{rated}} = \frac{60 \cdot P_{\text{Motor}} \cdot 10^3}{2\pi \cdot n_{\text{rated}}}$$

P_{Motor} = Motor Rated Power (kW)

■ L3-25: Load Inertia Ratio

No. (Hex.)	Name	Description	Default (Range)
L3-25 (046F) Expert	Load Inertia Ratio	Sets the ratio between motor inertia and machine inertia.	1.0 (0.1 - 1000.0)

Set one of these parameters to enable *L3-25*:

- *L3-04 = 2 [Stall Prevention during Decel = Intelligent (Ignore Decel Ramp)]*
- *L3-11 = 1 [Overvoltage Suppression Select= Enabled]*

Note:

If you set this value incorrectly when *L3-11 = 1*, it can cause large current ripples and *ov [Overvoltage]*, *Uv1 [DC Bus Undervoltage]*, or *oC [Overcurrent]* faults.

Manually Adjust Parameters

Use this formula to find the load inertia ratio:

$$\text{Load inertia ratio} = \frac{\text{Machine inertia (Motor shaft conversion value)}}{\text{Motor inertia}}$$

■ L3-26: Additional DC Bus Capacitors

No. (Hex.)	Name	Description	Default (Range)
L3-26 (0455) Expert	Additional DC Bus Capacitors	Sets the capacity for external main circuit capacitors. Usually it is not necessary to change this setting.	0 μF (0 to 65000 μF)

■ L3-27: Stall Prevention Detection Time

No. (Hex.)	Name	Description	Default (Range)
L3-27 (0456)	Stall Prevention Detection Time	Sets a delay time between reaching the Stall Prevention level and starting the Stall Prevention function.	50 ms (0 - 5000 ms)

■ L3-35: Speed Agree Width for Auto Decel

No. (Hex.)	Name	Description	Default (Range)
L3-35 (0747) Expert	Speed Agree Width for Auto Decel	Sets the width for speed agreement when <i>L3-04 = 2 [Decel Stall Prevention Selection = Automatic Decel Reduction]</i> . Usually it is not necessary to change this setting.	0.00 Hz (0.00 - 1.00 Hz)

Set this parameter when hunting occurs while you use a frequency reference through an analog input.

◆ L4: Speed Detection

L4 parameters set the output of signals to the MFDO terminals, for example frequency agree and frequency detection.

■ L4-01: Speed Agree Detection Level

No. (Hex.)	Name	Description	Default (Range)
L4-01 (0499)	Speed Agree Detection Level	Sets the level to detect speed agree or motor speed when $H2-01$ to $H2-03 = 2, 3, 4, 5$ [MFDO Function Selection = Speed Agree 1, User-set Speed Agree 1, Frequency Detection 1, Frequency Detection 2].	0.0 Hz (0.0 - 400.0 Hz)

■ L4-02: Speed Agree Detection Width

No. (Hex.)	Name	Description	Default (Range)
L4-02 (049A)	Speed Agree Detection Width	Sets the width to detect speed agree or motor speed when $H2-01$ to $H2-03 = 2, 3, 4, 5$ [MFDO Function Selection = Speed Agree 1, User-set Speed Agree 1, Frequency Detection 1, Frequency Detection 2].	2.0 Hz (0.0 - 20.0 Hz)

■ L4-03: Speed Agree Detection Level (+/-)

No. (Hex.)	Name	Description	Default (Range)
L4-03 (049B)	Speed Agree Detection Level (+/-)	Sets the speed agree detection level or motor speed detection level when $H2-01$ to $H2-03 = 13, 14, 15, 16$ [MFDO Function Selection = Speed Agree 2, User-set Speed Agree 2, Frequency Detection 3, Frequency Detection 4].	0.0 Hz (-400.0 - +400.0 Hz)

■ L4-04: Speed Agree Detection Width (+/-)

No. (Hex.)	Name	Description	Default (Range)
L4-04 (049C)	Speed Agree Detection Width (+/-)	Sets the width to detect speed agree or motor speed when $H2-01$ to $H2-03 = 13, 14, 15, 16$ [MFDO Function Selection = Speed Agree 2, User-set Speed Agree 2, Frequency Detection 3, Frequency Detection 4].	2.0 Hz (0.0 - 20.0 Hz)

■ L4-05: Fref Loss Detection Selection

No. (Hex.)	Name	Description	Default (Range)
L4-05 (049D)	Fref Loss Detection Selection	Sets the operation when the drive detects a loss of frequency reference.	1 (0, 1)

Enables the detection of a loss of an analog frequency reference when MFAI terminals (A1 and A2) input the frequency reference. Set $H2-01$ to $H2-03 = C$ [MFDO Function Selection = Frequency Reference Loss] to enable this function.

If the frequency reference is less than 10% in 400 ms, the drive detects frequency reference loss.

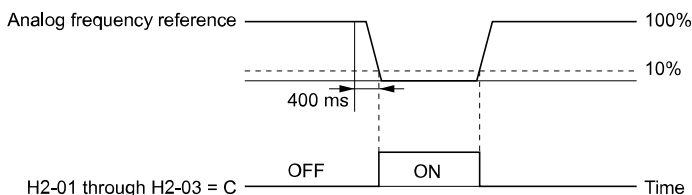

Figure 5.74 Detection of Frequency Reference Loss

0 : Stop

The drive follows the frequency reference and stops the motor.

1 : Run at (L4-06 x Last Reference)

The drive continues to operate at the frequency reference value set in L4-06 [FreqReference at Reference Loss]. When you return the external frequency reference value, the drive continues to operate with the frequency reference.

■ L4-06: Frequency Reference @Loss of Ref

No. (Hex.)	Name	Description	Default (Range)
L4-06 (04C2)	Frequency Reference @Loss of Ref	Sets the frequency reference as a percentage to continue drive operation after it detects a frequency reference loss. The value is a percentage of the frequency reference before the drive detected the loss.	80.0% (0.0 - 100.0%)

Set $L4-05 = 1$ [*FreqReference Loss Detect Select = Run@L4-06PrevRef*] to enable this parameter.

■ L4-07: Speed Agree Detection Selection

No. (Hex.)	Name	Description	Default (Range)
L4-07 (0470)	Speed Agree Detection Selection	Sets the condition that activates speed detection.	0 (0, 1)

0 : No Detection during Baseblock

Detects the frequency while the drive is operating. When the drive turns off its output, it will not detect frequency.

1 : Detection Always Enabled

◆ L5: Fault Restart

The Auto Restart function tries to keep machines operating when the drive detects a transient fault.

The drive can do a self-diagnostic check and continue the operation after a fault. If the cause of the fault goes away, the drive does speed search and restarts. It will not stop and the drive will not record a fault history. Use $L5-02$ [*Fault Contact at Restart Select*] to select the operation of fault relay signals during Auto Restart operation.

The Auto Restart function sets the drive to try to automatically restart the drive a set number of times in a set time. If the number of Auto Restart tries is more than the set value during the set time, drive output shuts off and operation stops. If this happens, remove the cause of the fault and manually restart the drive.

The drive can do Auto Restart when it detects these faults:

Note:

You can disable Auto Restart for faults if you must not restart the machine after the fault.

Table 5.44 List of Faults during which Auto Restart is Available

Fault	Name	Parameters to Disable Auto Restart	Fault	Name	Parameters to Disable Auto Restart
CE	Serial Communication Error	H5-36	oL1	Motor Overload	L5-07
FDBKL	WIRE Break	L5-42	oL2	Drive Overload	L5-07
GF	Ground Fault	L5-08	oL3	Overtorque Detection 1	L5-07
HFB	High Feedback Sensed	L5-41	oL4	Overtorque Detection 2	L5-07
LF	Output Phase Loss	-	ov	Overvoltage	L5-08
LFB	Low Feedback Sensed	L5-40	PF	Input Phase Loss	-
LOP	Loss of Prime	L5-51	STPo	Motor Step-Out Detected	-
NMS	Setpoint Not Met	L5-50	Uv1	DC Bus Undervoltage ^{*1}	L5-08
oC	Overcurrent	-	VLTS	Thermostat Fault	L5-53
oH1	Heatsink Overheat	L5-08			

*1 $Uv1$ is the target for the auto restart process when $L2-01 = 1$ or 2 [*Power Loss Ride Through Select = Enabled for L2-02 Time or Enabled while CPU Power Active*].

Note:

- The Fault Restart method is limited to the interval time that the drive will use *L5-04 [Interval Method Restart Time]*.
- When *L5-49 = 1 [Fault Retry Speed Search Select = Enabled]*, the drive will do a speed search when it resets and restarts after a fault.
- The drive will force the output frequency to zero during the auto-restart interval time.
- If you remove the Run (or HAND) command during the auto-restart interval time, the drive will immediately detect a fault and reset the fault.
- The *LOP [Loss of Prime]* fault uses *Y1-23 [Prime Loss Max Restart Time]* for Auto Restart time. The other faults use *L5-04* for Auto Restart time.
- When you enable Thrust or Pre-Charge Modes, the drive will operate them correctly

■ L5-01: Number of Auto-Restart Attempts

No. (Hex.)	Name	Description	Default (Range)
L5-01 (049E)	Number of Auto-Restart Attempts	Sets the number of times that the drive will try to restart.	0 (0 - 10 times)

The drive resets the number of Auto Restart attempts to 0 in these conditions:

- The drive operates correctly for 10 minutes after a fault restart.
- When you manually clear a fault after the drive triggers protective functions.
- When you re-energize the drive.

■ L5-02: Fault Contact at Restart Select

No. (Hex.)	Name	Description	Default (Range)
L5-02 (049F)	Fault Contact at Restart Select	Sets the function that sends signals to the MFDO terminal set for <i>Fault [H2-xx = E]</i> while the drive is automatically restarting.	0 (0, 1)

0 : Active Only when Not Restarting

The drive will only activate fault output when the drive cancels the Auto Restart function.

When you remove the Run command during the time set in *L5-04 [Interval Method Restart Time]*, the drive will cancel the Auto Restart function. At the same time, the drive will activate the fault output. Refer to [Figure 5.75](#) for more information.

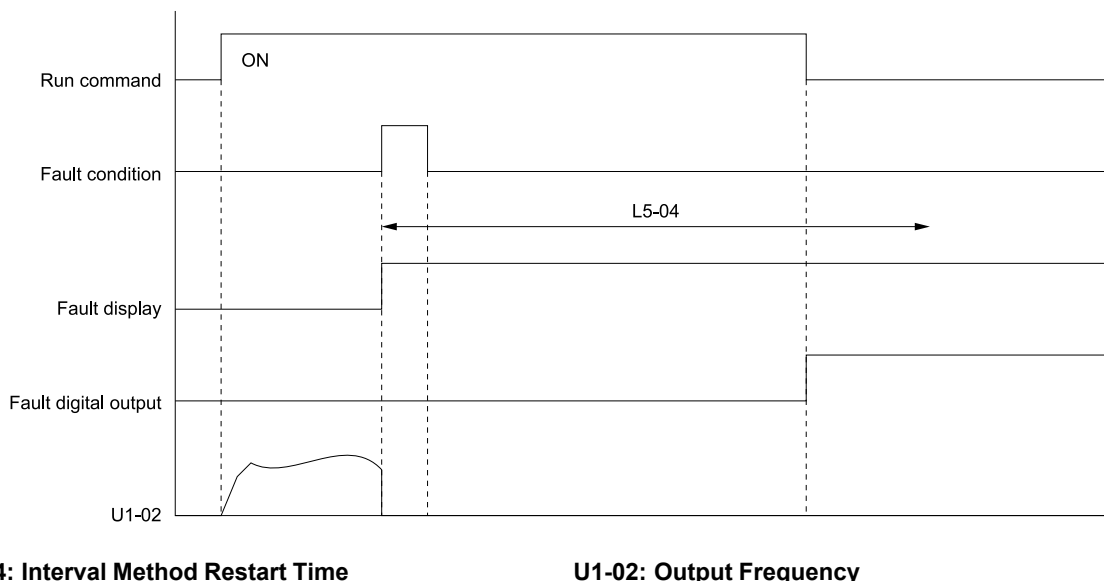

L5-04: Interval Method Restart Time

U1-02: Output Frequency

Figure 5.75 Time Chart for Early Cancellation of Auto-Restart Function

1 : Always Active

The drive always activates fault output.

■ L5-04: Interval Method Restart Time

No. (Hex.)	Name	Description	Default (Range)
L5-04 (046C)	Interval Method Restart Time	Sets the time interval between each Auto Restart attempt.	10.0 s (0.5 - 3600.0 s)

■ L5-07: Fault Reset Enable Select Grp1

No. (Hex.)	Name	Description	Default (Range)
L5-07 (0B2A)	Fault Reset Enable Select Grp1	Use these 4 digits to set the Auto Restart function for <i>oL1</i> to <i>oL4</i> . From left to right, the digits set <i>oL1</i> , <i>oL2</i> , <i>oL3</i> , and <i>oL4</i> , in order.	1111 (0000 - 1111)

0000 : Disabled

0001 : Enabled (—/—/—/oL4)

0010 : Enabled (—/—/oL3/—)

0011 : Enabled (—/—/oL3/oL4)

0100 : Enabled (—/oL2/—/—)

0101 : Enabled (—/oL2/—/oL4)

0110 : Enabled (—/oL2/oL3/—)

0111 : Enabled (—/oL2/oL3/oL4)

1000 : Enabled (oL1/—/—/—)

1001 : Enabled (oL1/—/—/oL4)

1010 : Enabled (oL1/—/oL3/—)

1011 : Enabled (oL1/—/oL3/oL4)

1100 : Enabled (oL1/oL2/—/—)

1101 : Enabled (oL1/oL2/—/oL4)

1110 : Enabled (oL1/oL2/oL3/—)

1111 : Enabled (oL1/oL2/oL3/oL4)

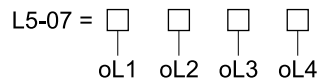

Figure 5.76 Setting Digits and Fault Code

■ L5-08: Fault Reset Enable Select Grp2

No. (Hex.)	Name	Description	Default (Range)
L5-08 (0B2B)	Fault Reset Enable Select Grp2	Use these 4 digits to set the Auto Restart function for <i>Uv1</i> , <i>ov</i> , <i>oH1</i> , and <i>GF</i> . From left to right, the digits set <i>Uv1</i> , <i>ov</i> , <i>oH1</i> , and <i>GF</i> , in order.	1111 (0000 - 1111)

0000 : Disabled

0001 : Enabled (—/—/—/GF)

0010 : Enabled (—/—/oH1/—)

0011 : Enabled (—/—/oH1/GF)

0100 : Enabled (—/ov/—/—)

0101 : Enabled (—/ov/—/GF)

0110 : Enabled (—/ov/oH1/—)

0111 : Enabled (—/ov/oH1/GF)

1000 : Enabled (Uv1/—/—/—)

1001 : Enabled (Uv1/—/—/GF)

1010 : Enabled (Uv1/—/oH1/—)
1011 : Enabled (Uv1/—/oH1/GF)
1100 : Enabled (Uv1/ov/—/—)
1101 : Enabled (Uv1/ov/—/GF)
1110 : Enabled (Uv1/ov/oH1/—)
1111 : Enabled (Uv1/ov/oH1/GF)

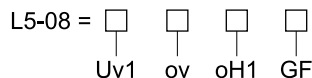

Figure 5.77 Setting Digits and Fault Code

■ L5-40: Low Feedback Flt Retry Selection

No. (Hex.)	Name	Description	Default (Range)
L5-40 (3670)	Low Feedback Flt Retry Selection	Sets the drive to do an Auto Restart when the drive detects an <i>LFB [Low Feedback Sensed]</i> fault.	0 (0, 1)

0 : No Retry

1 : Retry

- When $L5-40 = 1$ and $b5-09 = 1$ [*PID Output Level Selection = Reverse Output (Reverse Acting)*], the auto-restart timer will not start timing until after the feedback level increases to more than $Y1-08$ [*Low Feedback Level*] (+ $Y1-14$ [*High Feedback Hysteresis Level*]).
- The drive will set the output frequency to zero during the auto-restart interval time.
- If you remove the Run (or HAND) Command during the auto-restart interval time, the drive will immediately detect and reset the fault.
- When $L5-49 = 1$ [*Fault Retry Speed Search Select = Enabled*], the drive will do a speed search when it resets and restarts after a fault.
- When you enable Thrust or Pre-Charge Modes, the drive will operate them correctly.

When $L5-40 = 1$, the drive operation will change when $b5-09$ [*PID Output Level Selection*] changes:

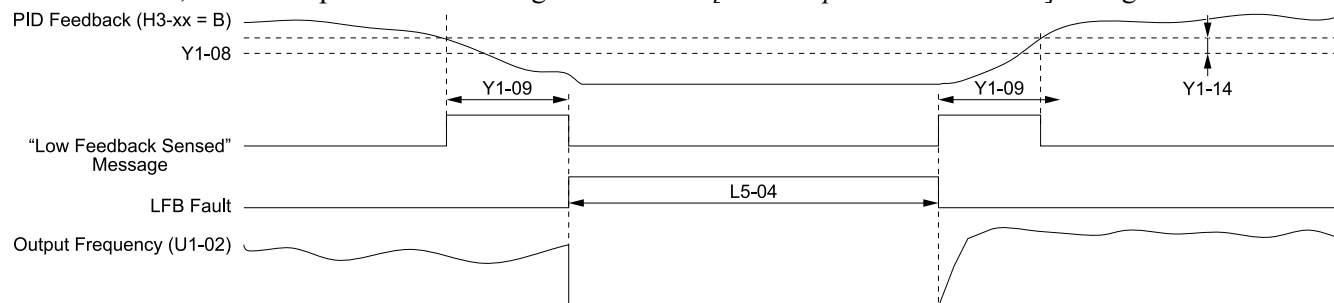

H3-xx = B: PID Feedback

L5-04: Interval Method Restart Time

Y1-08: Low Feedback Level

Y1-09: Low Feedback Lvl Fault Dly Time

Y1-14: Feedback Hysteresis Level

LFB Fault: Low Feedback Sensed

Figure 5.78 Auto Restart for Low Feedback Detection when $b5-09 = 0$ [Normal Output (Direct Acting)]

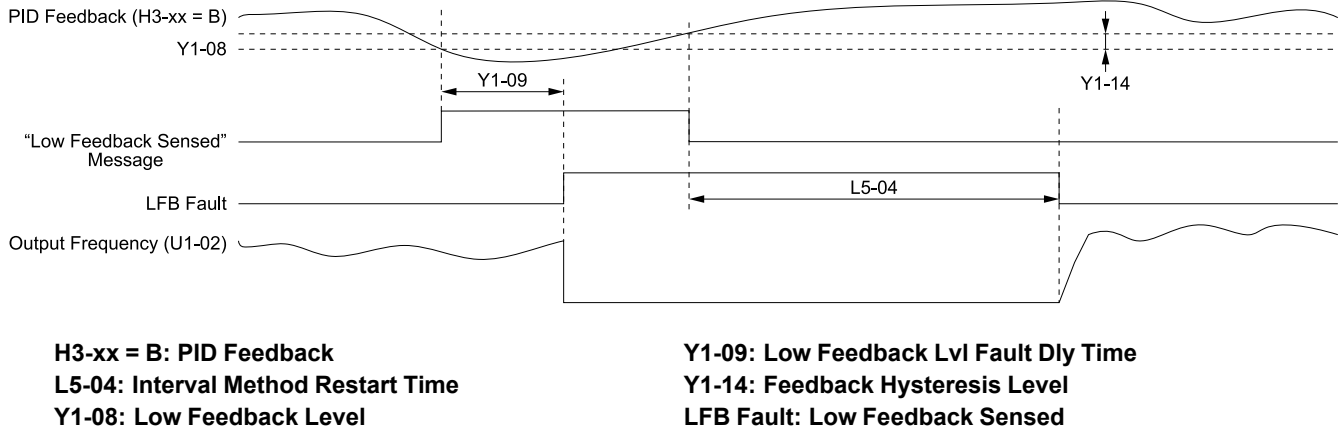

Figure 5.79 Auto Restart for Low Feedback Detection when b5-09 = 1

■ **L5-41: Hi Feedback Flt Retry Selection**

No. (Hex.)	Name	Description	Default (Range)
L5-41 (3671)	Hi Feedback Flt Retry Selection	Sets the drive to do an Auto Restart when the drive detects an <i>HFB</i> [High Feedback Sensed] fault.	0 (0, 1)

0 : No Retry

1 : Retry

- When $L5-41 = 1$ and $b5-09 = 0$ [*PID Output Level Selection = Normal Output (Direct Acting)*], the auto-restart timer will not start timing until after the feedback level decreases to less than $Y1-11$ [*High Feedback Level*] ($- Y1-14$ [*High Feedback Hysteresis Level*]).
- The drive will set the output frequency to zero during the auto-restart interval time.
- If you remove the Run (or HAND) Command during the auto-restart interval time, the drive will immediately detect and reset the fault.
- When $L5-49 = 1$ [*Fault Retry Speed Search Select = Enabled*], the drive will do a speed search when it resets and restarts after a fault.
- When you enable Thrust or Pre-Charge Modes, the drive will operate them correctly.

When $L5-41 = 1$, the drive operation will change when $b5-09$ [*PID Output Level Selection*] changes:

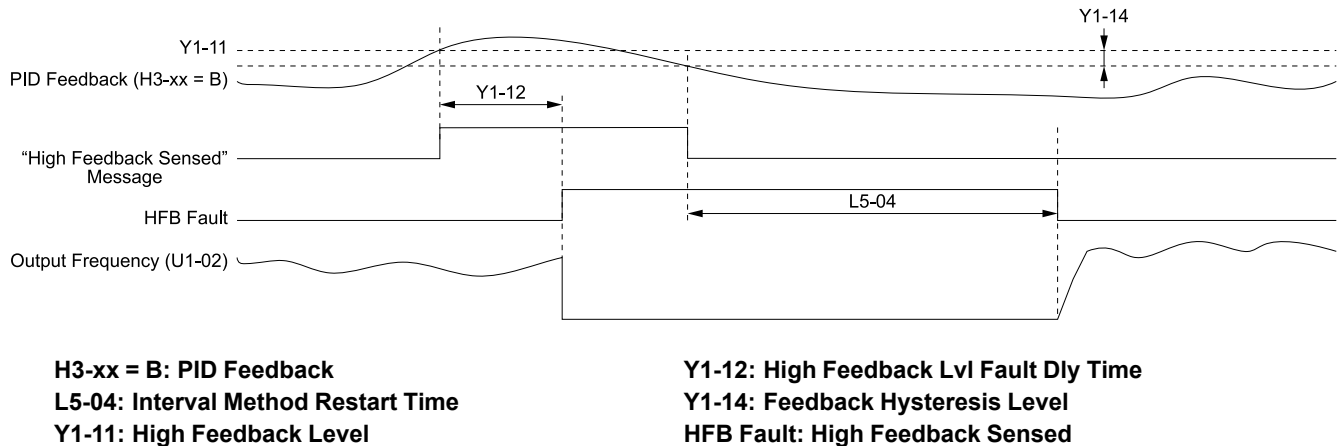
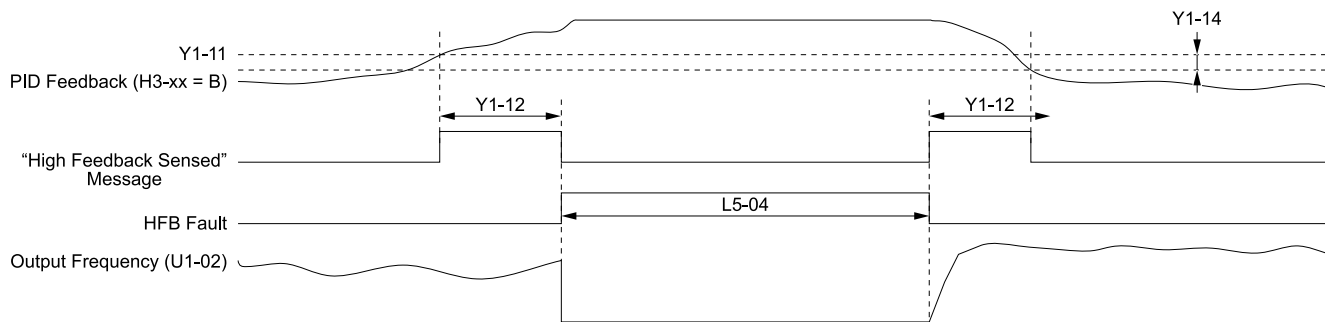

Figure 5.80 Auto Restart for High Feedback Detection when b5-09 = 0 [Normal Output (Direct Acting)]



H3-xx = B: PID Feedback

L5-04: Interval Method Restart Time

Y1-11: High Feedback Level

Y1-12: High Feedback Lvl Fault Dly Time

Y1-14: Feedback Hysteresis Level

HFB Fault: High Feedback Sensed

Figure 5.81 Auto Restart for High Feedback Detection when b5-09 = 1

■ L5-42: Feedback Loss Fault Retry Select

No. (Hex.)	Name	Description	Default (Range)
L5-42 (3672)	Feedback Loss Fault Retry Select	Sets the drive to try an Auto Restart when it drive detects an <i>FDBKL [WIRE Break]</i> fault.	0 (0, 1)

0 : No Retry

1 : Retry

■ L5-49: Fault Retry Speed Search Select

No. (Hex.)	Name	Description	Default (Range)
L5-49 (3679)	Fault Retry Speed Search Select	Sets the drive to do a speed search at the start of a Fault Retry.	1 (0, 1)

0 : Disabled

1 : Enabled

■ L5-50: Setpoint Not Met Fault Retry Sel

No. (Hex.)	Name	Description	Default (Range)
L5-50 (367A)	Setpoint Not Met Fault Retry Sel	Sets the drive to try an Auto Restart when it detects an <i>NMS [SetPoint Not Met]</i> fault.	0 (0, 1)

0 : No Retry

1 : Retry

■ L5-51: Loss of Prime Fault Retry Select

No. (Hex.)	Name	Description	Default (Range)
L5-51 (367B)	Loss of Prime Fault Retry Select	Sets the drive to try an Auto Restart if it detects an <i>LOP [Loss Of Prime]</i> fault.	0 (0, 1)

0 : No Retry

1 : Retry

■ L5-53: Thermostat Fault Retry Selection

No. (Hex.)	Name	Description	Default (Range)
L5-53 (3251)	Thermostat Fault Retry Selection	Sets the drive to try an Auto Restart if it detects a <i>VLTS</i> [Thermostat Fault] fault.	1 (0, 1)

Note:

- To use this function, set $S5-01 \neq 0$ [*HAND Frequency Reference Source* \neq *HAND Analog Input*]
- The drive will only restart after the Thermostat digital input deactivates and the $L5-04$ [*Interval Method Restart Time*] timer is expired.

0 : No Retry

1 : Retry

Figure 5.82 shows the drive operation for *VLTS* when $L5-53 = 1$ and $L5-01$ [*Number of Auto-Restart Attempts*] > 0 times. The drive will wait for the Thermostat digital input to deactivate + the $L5-04$ time before it will restart.

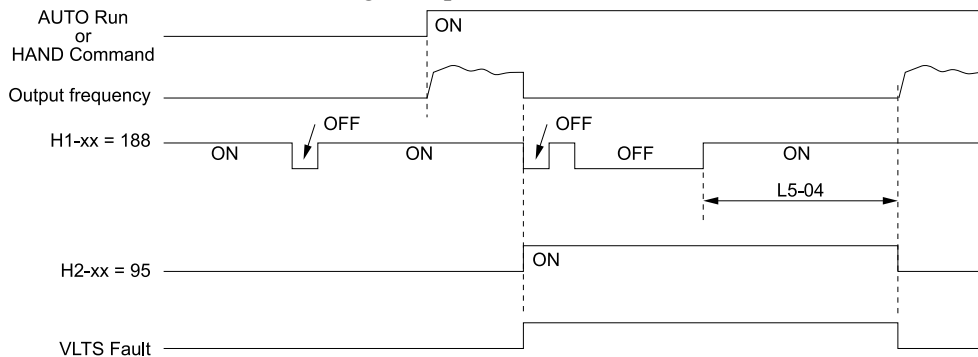

H1-xx = 188: !Thermostat Fault
H2-xx = 95: Thermostat Fault

L5-04: Interval Method Restart Time
VLTS Fault: Thermostat Fault

Figure 5.82 Thermostat Fault Behavior

◆ L6: Torque Detection

The overtorque/undertorque/underload detection function prevents damage to machinery and loads.

Overtorque is when there is too much load on the machine. If the motor current or output torque is at the overtorque detection level for the overtorque detection time, the drive will output an alarm and turn off the output.

Undertorque and underload are when a load suddenly decreases. When the motor current or output torque is at the undertorque/underload detection level for the undertorque detection time, the drive will output an alarm and turn off the output.

You can use the undertorque/undeload detection function to detect these conditions, for example:

- Machine belt breaks
- Unusual operation of the electromagnetic contactor on the drive output side
- Clogged output side air filters in fans and blowers

Note:

If there is *oC* [*Overcurrent*] or *oL1* [*Motor Overload*], the drive can stop during overtorque conditions. Use torque detection to identify overload conditions before the drive detects *oC* or *oL1* and stops. Use this function to detect problems in the application.

■ Parameter Setting

You can individually set the two overtorque/undertorque detection functions with the drive. Use the information in Table 5.45 to set the parameters.

Table 5.45 Overtorque/Undertorque Detection Parameters

Configuration Parameter	Overtorque/Undertorque Detection 1	Overtorque/Undertorque Detection 2
MFDO Function Select • Terminals M1-M2 • Terminals M3-M4 • Terminals M5-M6	H2-01, H2-02, and H2-03 = B *1 N.O.: Activated when detected	H2-01, H2-02, and H2-03 = 18 N.O.: Activated when detected
	H2-01, H2-02, and H2-03 = 17 N.C.: Disactivated when detected	H2-01, H2-02, and H2-03 = 19 N.C.: Disactivated when detected
Detection conditions and selection of operation after detection	L6-01	L6-04
Detection Level	L6-02 *2 Analog Input Terminal *3 H3-xx = 7	L6-05
Detection Time	L6-03	L6-06

*1 For UL6 [Underload or Belt Break Detected] detection, use the MFDO terminal set for H2-xx = 58 [UL6 Underload Detected].

*2 For UL6 detection, these parameters set the detection level:

- L6-02
- L6-13 [Motor Underload Curve Select]
- L6-14 [Motor Underload Level @ Min Freq]

*3 You can also use an analog input terminal to supply the torque detection level. To enable this function, set H3-xx = 7 [MFAI Function Selection = Overtorque/Undertorque DetectLvl]. When you set L6-02 and H3-xx = 7, the analog input has priority and L6-02 is disabled. You cannot use Overtorque/Undertorque Detection 2 to set the detection level for the analog input terminals.

Note:

The drive uses the current level (100% of the drive rated output current) to set the overtorque/undertorque detection level/

Time Chart for Detection of Overtorque/Undertorque/Underload

Overtorque Detection Time Chart

When you use Overtorque/Undertorque Detection 1, the drive detects overtorque if the motor current or motor torque is at the detection level set in L6-02 [Torque Detection Level 1] for the time set in L6-03 [Torque Detection Time 1]. Parameter L6-01 [Torque Detection Selection 1] sets the operation after detection.

When you use Overtorque/Undertorque Detection 2, set L6-04 [Torque Detection Selection 2], L6-05 [Torque Detection Level 2], and L6-06 [Torque Detection Time 2].

Use H2-01 to H2-03 [MFDO Function Selection] to set the terminal that outputs the alarm.

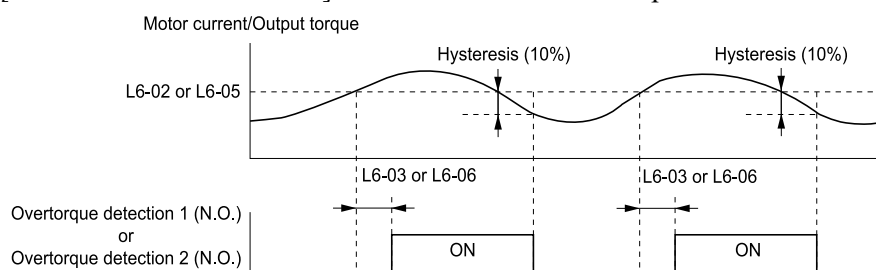

L6-02: Torque Detection Level 1

L6-03: Torque Detection Time 1

L6-05: Torque Detection Level 2

L6-06: Torque Detection Time 2

Figure 5.83 Time Chart for Overtorque Detection

Note:

The drive applies a hysteresis of approximately 10% of the drive rated output current or the motor rated torque to the overtorque/undertorque/underload detection function.

Undertorque Detection Time Chart

When you use Overtorque/Undertorque Detection 1, the drive detects undertorque if the motor current or motor torque is less than or equal to the detection level set in L6-02 for the time set in L6-03. Parameter L6-01 sets the operation after detection.

When you use Overtorque/Undertorque Detection 2, set the operation in L6-04, L6-05, and L6-06.

Use H2-01 to H2-03 [MFDO Function Selection] to set the terminal that outputs the alarm.

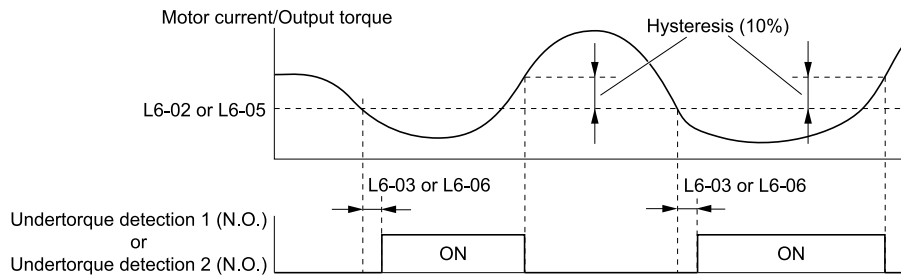

L6-02: Torque Detection Level 1
L6-03: Torque Detection Time 1

L6-05: Torque Detection Level 2
L6-06: Torque Detection Time 2

Figure 5.84 Time Chart for Undertorque Detection

Note:

The drive applies a hysteresis of approximately 10% of the drive rated output current or the motor rated torque to the overtorque/undertorque/underload detection function.

Underload Detection Time Chart

When *L6-01 = 9 [UL6 @ Speed Agree - Alarm only]* to *12 [UL6 @ RUN - Fault]*, the drive will detect underload if the motor current or output torque is less than or equal to the detection level for the time set in *L6-03*.

Note:

The linear curve of *L6-02*, *L6-13 [Motor Underload Curve Select]*, and *L6-14 [Motor Underload Level @ Min Freq]* sets the underload detection level.

Use *H2-01 to H2-03 [MFDO Function Selection]* to set the terminal that outputs the alarm.

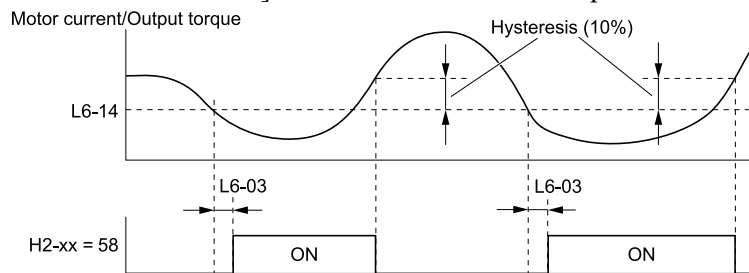

H2-xx = 58: UL6 Underload Detected
L6-03: Torque Detection Time 1

L6-14: Motor Underload Level @ Min Freq

Figure 5.85 Time Chart for Underload Detection at Minimum Frequency

Note:

The drive applies a hysteresis of approximately 10% of the drive rated output current or the motor rated torque to the overtorque/undertorque/underload detection function.

■ L6-01: Torque Detection Selection 1

No. (Hex.)	Name	Description	Default (Range)
L6-01 (04A1)	Torque Detection Selection 1	Sets the speed range that detects overtorque and undertorque and the operation of drives (operation status) after detection.	0 (0 - 12)

- The drive detects *oL [overtorque]* if the motor current or output torque is more than the level set in *L6-02 [Torque Detection Level 1]* for the time set in *L6-03 [Torque Detection Time 1]*.
- The drive detects *UL [undertorque]* if the motor current or output torque is less than the level set in *L6-02* for the time set in *L6-03*.
- The drive detects *UL6 [Underload or Belt Break Detected]* if the motor current or output torque is less than the linear curve set in *L6-02* and *L6-14 [Motor Underload Level @ Min Freq]*.

0 : Disabled

The drive will not detect overtorque or undertorque.

1 : oL @ Speed Agree - Alarm only

The drive detects overtorque when the output frequency aligns with the frequency reference. Detection does not occur during acceleration/deceleration. The drive outputs an *oL3* [*Overtorque Detection 1*] and operation continues.

2 : oL @ RUN - Alarm only

When the Run command is enabled, the drive constantly detects overtorque. The drive outputs an *oL3* and operation continues.

3 : oL @ Speed Agree - Fault

The drive detects overtorque when the output frequency aligns with the frequency reference. Detection does not occur during acceleration/deceleration. The drive outputs an *oL3* [*Overtorque Detection 1*] and operation stops.

4 : oL @ RUN - Fault

When the Run command is enabled, the drive constantly detects overtorque. The drive outputs an *oL3* and operation stops.

5 : UL @ Speed Agree - Alarm only

The drive detects undertorque when the output frequency aligns with the frequency reference. Detection does not occur during acceleration/deceleration. The drive outputs a *UL3* [*Undertorque Detection 1*] and operation continues.

6 : UL @ RUN - Alarm only

When the Run command is enabled, the drive constantly detects undertorque. The drive outputs a *UL3* and operation continues.

7 : UL @ Speed Agree - Fault

The drive detects undertorque when the output frequency aligns with the frequency reference. Detection does not occur during acceleration/deceleration. The drive outputs a *UL3* and operation stops.

8 : UL @ RUN - Fault

When the Run command is enabled, the drive constantly detects undertorque. The drive outputs a *UL3* and operation stops.

9 : UL6 @ Speed Agree - Alarm only

The drive detects and shows a *UL6* [*Underload or Belt Break Detected*] alarm during speed agree. The drive will clear the alarm when the output current increases to more than the *UL6* detection level plus 10% of the drive rated current.

10 : UL6 @ RUN - Alarm only

The drive detects and shows a *UL6* alarm while the drive is in the operation. The drive will clear the alarm when the output current increases to more than the *UL6* detection level plus 10% of the drive rated current.

11 : UL6 @ Speed Agree - Fault

The drive detects and shows a *UL6* fault during speed agree.

12 : UL6 @ RUN - Fault

The drive detects and shows a *UL6* fault while the drive is in the operation.

■ L6-02: Torque Detection Level 1

No. (Hex.)	Name	Description	Default (Range)
L6-02 (04A2)	Torque Detection Level 1	Sets the detection level for Overtorque/Undertorque Detection 1. In V/f control, drive rated output current = 100% value.	15% (0 - 300%)

Note:

You can also use an analog input terminal to supply the torque detection level. To enable this function, set $H3-xx = 7$ [*MFAI Function Select = Overtorque/Undertorque DetectLvl*]. If you set *L6-02* and $H3-x = 7$, the analog input is most important and the drive disables *L6-02*.

■ L6-03: Torque Detection Time 1

No. (Hex.)	Name	Description	Default (Range)
L6-03 (04A3)	Torque Detection Time 1	Sets the detection time for Overtorque/Undertorque Detection 1.	10.0 s (0.0 - 10.0 s)

■ L6-04: Torque Detection Selection 2

No. (Hex.)	Name	Description	Default (Range)
L6-04 (04A4)	Torque Detection Selection 2	Sets the speed range that detects overtorque and undertorque and the operation of drives (operation status) after detection.	0 (0 - 8)

The drive detects overtorque if the motor current or output torque is more than the level set in L6-05 [Torque Detection Level 2] for the length of time set in L6-06 [Torque Detection Time 2]. The drive detects undertorque if the motor current or output torque is less than the level set in L6-05 for the length the time set in L6-06.

0 : Disabled

The drive will not detect overtorque or undertorque.

1 : oL @ Speed Agree - Alarm only

The drive detects overtorque when the output frequency aligns with the frequency reference. Detection does not occur during acceleration/deceleration. The drive outputs an *oL4* [Overtorque Detection 2] and operation continues.

2 : oL @ RUN - Alarm only

When the Run command is enabled, the drive constantly detects overtorque. The drive outputs an *oL4* and operation continues.

3 : oL @ Speed Agree - Fault

The drive detects overtorque when the output frequency aligns with the frequency reference. Detection does not occur during acceleration/deceleration. The drive outputs an *oL4* [Overtorque Detection 2] and operation stops.

4 : oL @ RUN - Fault

When the Run command is enabled, the drive constantly detects overtorque. The drive outputs an *oL4* and operation stops.

5 : UL @ Speed Agree - Alarm only

The drive detects undertorque when the output frequency aligns with the frequency reference. Detection does not occur during acceleration/deceleration. The drive outputs a *UL4* [Undertorque Detection 2] and operation continues.

6 : UL @ RUN - Alarm only

When the Run command is enabled, the drive constantly detects undertorque. The drive outputs a *UL4* and operation continues.

7 : UL @ Speed Agree - Fault

The drive detects undertorque when the output frequency aligns with the frequency reference. Detection does not occur during acceleration/deceleration. The drive outputs a *UL4* and operation stops.

8 : UL @ RUN - Fault

When the Run command is enabled, the drive constantly detects undertorque. The drive outputs a *UL4* and operation stops.

■ L6-05: Torque Detection Level 2

No. (Hex.)	Name	Description	Default (Range)
L6-05 (04A5)	Torque Detection Level 2	Sets the detection level for Overtorque/Undertorque Detection 2. In V/f control, drive rated output current = 100% value.	150% (0 - 300%)

Note:

Overtorque/Undertorque Detection 2 cannot set the detection level for the analog input terminal.

■ L6-06: Torque Detection Time 2

No. (Hex.)	Name	Description	Default (Range)
L6-06 (04A6)	Torque Detection Time 2	Sets the detection time for Overtorque/Undertorque Detection 2.	0.1 s (0.0 - 10.0 s)

■ L6-13: Motor Underload Curve Select

No. (Hex.)	Name	Description	Default (Range)
L6-13 (062E)	Motor Underload Curve Select	Sets the motor underload protection (<i>UL6 [Undertorque Detection 6]</i>) based on motor load and sets the level of <i>L6-02 [Torque Detection Level 1]</i> to refer to <i>Fbase</i> or <i>Fmax</i> .	0 (0, 1)

0 : Base Frequency Enable

1 : Max Frequency Enable

If the output current is less than the curve for longer than the time set in *L6-03 [Torque Detection Time 1]*, the drive will detect a fault or an alarm as specified by *L6-01 [Torque Detection Selection 1]*.

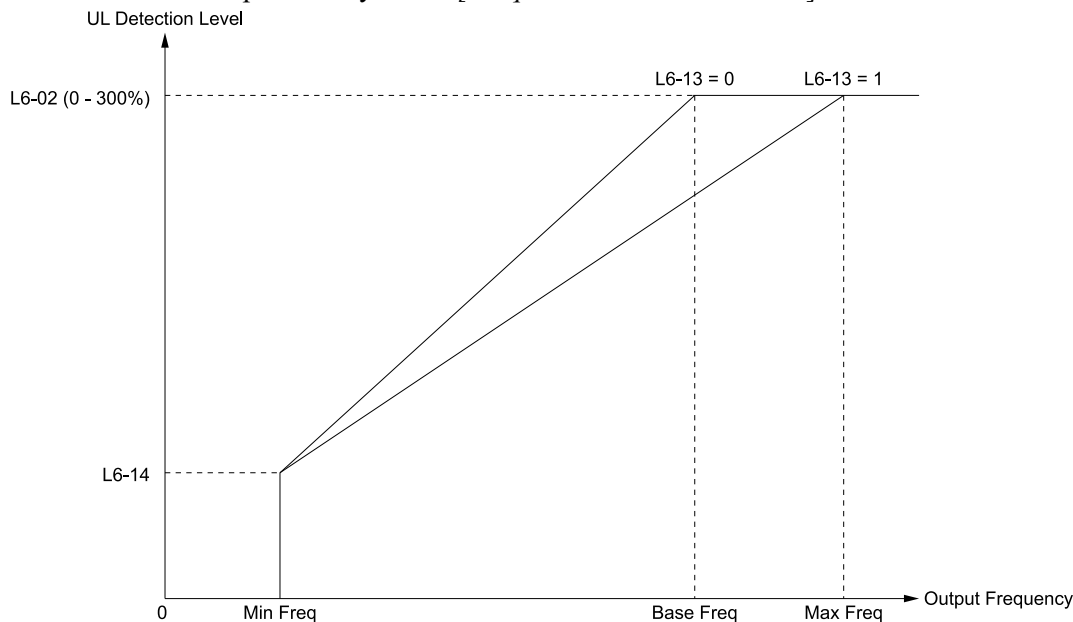

L6-02: Torque Detection Level 1
L6-13 = 0: Base Frequency Enable

L6-13 = 1: Max Frequency Enable
L6-14: Motor Underload Level @ Min Freq

Figure 5.86 UL6 Detection Curve

■ L6-14: Motor Underload Level @ Min Freq

No. (Hex.)	Name	Description	Default (Range)
L6-14 (062F)	Motor Underload Level @ Min Freq	Sets the <i>UL6 [Undertorque Detection 6]</i> detection level at minimum frequency by percentage of drive rated current.	15% (0 - 300%)

◆ L8: Drive Protection

L8 parameters set protective functions that prevent faults such as overheating, phase loss, and ground faults.

■ L8-02: Overheat Alarm Level

No. (Hex.)	Name	Description	Default (Range)
L8-02 (04AE)	Overheat Alarm Level	Sets the <i>oH</i> detection level temperature.	Determined by o2-04 (50 - 150 °C)

If the heatsink temperature is more than the temperature set in this parameter, the drive detects an overheat pre-alarm. To enable this function, set one of *H2-01* to *H2-03 [MFDO Function Select]* to 20 [*Drive Overheat Pre-Alarm (oH)*]. If the temperature increases to the overheat fault level, the drive will trigger an *oH1 [Heatsink Overheat]* fault and stop operation.

■ **L8-03: Overheat Pre-Alarm Selection**

No. (Hex.)	Name	Description	Default (Range)
L8-03 (04AF)	Overheat Pre-Alarm Selection	Sets drive operation if it detects an <i>oH</i> alarm.	4 (0 - 4)

0 : Ramp to Stop

The drive ramps the motor to stop in the deceleration time. Fault relay output terminal MA-MC activates and MB-MC deactivates.

1 : Coast to Stop

The output turns off and the motor coasts to stop. Fault relay output terminal MA-MC turns activates and MB-MC deactivates.

2 : Fast Stop (Use C1-09)

The drive stops the motor in the deceleration time set in *C1-09 [Fast Stop Time]*. Fault relay output terminal MA-MC activates and MB-MC deactivates.

3 : Alarm Only

The keypad shows *oH* and the drive continues operation. The output terminal set for *Alarm [H2-01 to H2-03 = 10]* activates.

4 : Operate at Reduced Speed (L8-19)

The drive decelerates to the level set in *L8-19 [Freq Reduction @ oH Pre-Alarm]* and continues operation. *oH* flashes on the keypad.

oH flashes on the keypad. When the alarm is output, the drive decelerates each 10 seconds. If the drive decelerates 10 times and the alarm continues to be output, the output terminal set for *oH Pre-Alarm Reduction Limit [H2-01 to H2-03 = 4D]* activates. When the alarm is not output during deceleration, the drive accelerates until it is at the frequency reference that was applicable before the alarm was turned off. **Figure 5.87** shows the output of the alarm and the drive operation at a decreased output frequency.

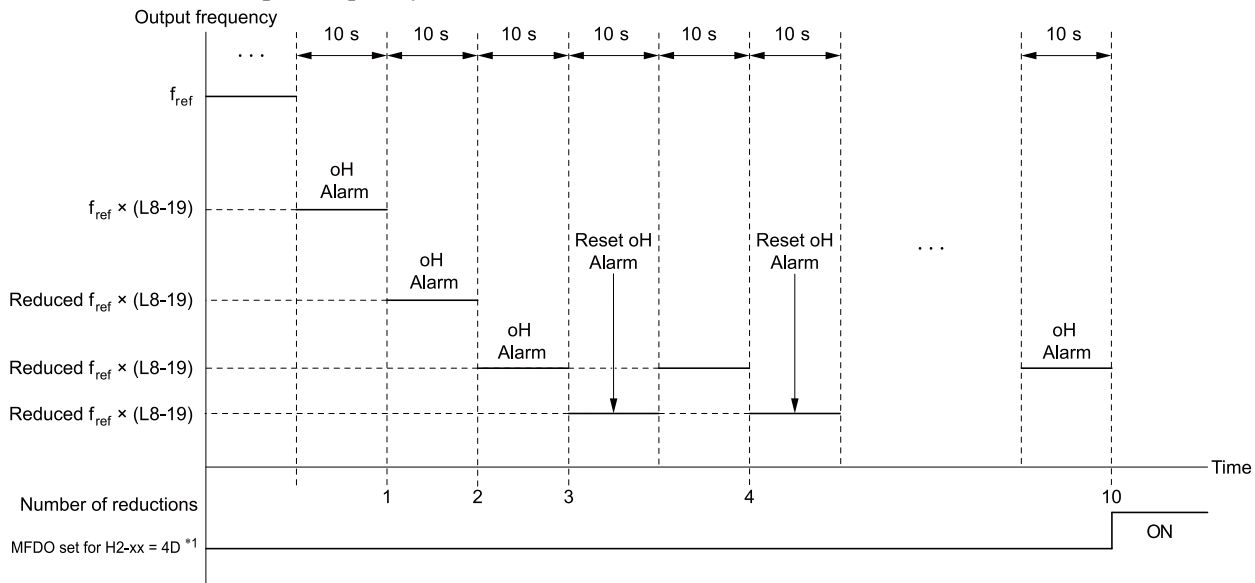

H2-xx = 4D: oH Pre-Alarm Reduction Limit
L8-19: Freq Reduction @ oH Pre-Alarm

oH Alarm: Heatsink Overheat

Figure 5.87 Drive Operation at a Decreased Output Frequency when the Overheat Alarm is Output

*1 If the *oH* alarm continues after 10 reduction cycles, the terminal set for *H2-xx = 4D [oH Pre-Alarm Reduction Limit]* will activate.

Note:

- The drive will use the largest value of *Y1-06 [Minimum Speed]*, *Y4-12 [Thrust Frequency]*, or *d2-02 [Frequency Reference Lower Limit]* as the lower limit for output frequency.
- Parameter *L8-97 [Carrier Freq Reduce during OH]* enables and disables the carrier frequency reduction during *oH* pre-alarm.

■ L8-05: Input Phase Loss Protection Sel

No. (Hex.)	Name	Description	Default (Range)
L8-05 (04B1)	Input Phase Loss Protection Sel	Sets the function to enable and disable input phase loss detection.	1 (0, 1)

0 : Disable

1 : Enabled

The drive measures ripples in DC bus voltage to detect input phase loss.

The drive detects phase loss when power supply phase loss occurs or the main circuit capacitor becomes unusable, which causes *PF [Input Phase Loss]* to show on the keypad.

Disable the detection of the input power supply phase loss function in these conditions:

- During deceleration
- The run command is not input
- The output current is less than 30% of the drive rated current.

■ L8-07: Output Phase Loss Protection Sel

No. (Hex.)	Name	Description	Default (Range)
L8-07 (04B3)	Output Phase Loss Protection Sel	Sets the function to enable and disable output phase loss detection. The drive starts output phase loss detection when the output current decreases to less than 5% of the drive rated current.	1

Note:

The drive can incorrectly start output phase loss detection when the motor rated current is very small compared to the drive rating.

0 : Disabled

1 : Fault when one phase is lost

If the drive loses one output phase, it will trigger *LF [Output Phase Loss]*.

The output turns off and the motor coasts to stop.

2 : Fault when two phases are lost

If the drive loses more than one output phase, it will trigger *LF [Output Phase Loss]*.

The output turns off and the motor coasts to stop.

■ L8-09: Output Ground Fault Detection

No. (Hex.)	Name	Description	Default (Range)
L8-09 (04B5)	Output Ground Fault Detection	Sets the function to enable and disable ground fault protection.	Determined by o2-04 (0, 1)

0 : Disable

The drive will not detect ground faults.

1 : Enabled

If there is high leakage current or a ground short circuit in one or two output phases, the drive will detect *GF [Ground Fault]*.

Note:

If the ground path impedance is low, the drive can detect *oC [Overcurrent]*, *SC [Out Short Circuit or IGBT Fault]*, or *ov [DC Bus Overvoltage]* instead of *GF*.

■ L8-10: Heatsink Fan Operation Selection

No. (Hex.)	Name	Description	Default (Range)
L8-10 (04B6)	Heatsink Fan Operation Selection	Sets operation of the heatsink cooling fan.	0 (0 - 2)

0 : During Run, w/ L8-11 Off-Delay

The drive turns on the fan when a Run command is active.

1 : Always On

The fan turns on when you supply power to the drive. When you release the Run command and the delay time set in *L8-11 [HeatsinkCoolingFan Off DelayTime]* is expired, the fan stops. This setting extends the fan lifetime.

2 : On when Drive Temp Reaches L8-64

The fan turns on when the drive detects that the main circuit is overheating.

■ L8-11: Heatsink Fan Off-Delay Time

No. (Hex.)	Name	Description	Default (Range)
L8-11 (04B7)	Heatsink Fan Off-Delay Time	Sets the length of time that the drive will wait before it stops the cooling fan after it cancels the Run command when <i>L8-10 = 0 [Heatsink Fan Operation Selection = During Run, w/ L8-11 Off-Delay]</i> .	300 s (0 - 300 s)

■ L8-12: Ambient Temperature Setting

No. (Hex.)	Name	Description	Default (Range)
L8-12 (04B8)	Ambient Temperature Setting	Sets the ambient temperature of the drive installation area.	40 °C (Determined by L8-35)

The drive automatically adjusts the drive rated current to the best value as specified by the set temperature. Set the ambient temperature of the area where you install the drive to a value that is more than the drive rating.

Refer to [Derating Depending on Ambient Temperature on page 544](#) for information about derating depending on ambient temperature.

■ L8-15: Drive oL2 @ Low Speed Protection

No. (Hex.)	Name	Description	Default (Range)
L8-15 (04BB)	Drive oL2 @ Low Speed Protection	Sets the function to decrease drive overload at low speeds to prevent damage to the main circuit transistor during low speed operation (at 6 Hz or slower) to prevent oL2 [<i>Drive Overloaded</i>].	1 (0, 1)

Note:

Contact Yaskawa or your nearest sales representative for consultation before disabling this function at low speeds. Frequent operation of drives under conditions of high output current in low speed ranges may shorten the service life of the drive IGBT due to heat stress.

0 : Disabled (No Additional Derate)

The drive does not decrease the overload protection level.

1 : Enabled (Reduced oL2 Level)

When the drive detects oL2 during low speed operation, it automatically decreases the overload detection level.

At zero speed, the drive derates the overload by 50%.

■ L8-18: Software Current Limit Selection

No. (Hex.)	Name	Description	Default (Range)
L8-18 (04BE)	Software Current Limit Selection	Set the software current limit selection function to prevent damage to the main circuit transistor caused by too much current.	0 (0, 1)

0 : Disabled

When the output current is at the software current limit value, the drive does not restrict the output voltage.

Note:

The drive may detect an oC [*Overcurrent*] when loads are particularly heavy or the acceleration time is particularly short.

1 : Enabled

When the output current is at the software current limit value, the drive decreases output voltage to decrease output current.

When the output current decreases to the software current limit level, the drive starts usual operation.

■ L8-19: Freq Reduction @ oH Pre-Alarm

No. (Hex.)	Name	Description	Default (Range)
L8-19 (04BF)	Freq Reduction @ oH Pre-Alarm	Sets the ratio at which the drive derates the frequency reference during an <i>oH</i> alarm.	20.0% (10.0 - 100.0%)

When $L8-03 = 4$ [*Overheat Pre-Alarm Selection = Operate at Reduced Speed (L8-19)*] and an *oH* alarm is output, this function is enabled.

■ L8-35: Installation Method Selection

No. (Hex.)	Name	Description	Default (Range)
L8-35 (04EC)	Installation Method Selection	Sets the type of drive installation.	2 (0 - 3)

Note:

- Parameter *A1-03* [*Initialize Parameters*] does not initialize this parameter.
- This parameter is set to the correct value from the factory.
- The drive will detect an *oPE02* [*Parameter Range Setting Error*] in these conditions:
 - If you set $L8-12 = 60\text{ }^{\circ}\text{C}$ and $L8-35 = 1$ or 3 on enclosures with drive models 2011 to 2114 and 4005 to 4124
 - If you set $L8-35 = 1$ or 3 on enclosures with drive models 2143 to 2273 and 4156 to 4302

The drive automatically adjusts the overload protection detection level to the best value as specified by the setting value. Refer to [Derating Depending on Ambient Temperature on page 544](#) for information on derating depending on ambient temperature.

0 : IP20/UL Open Type

Use this setting to install an IP20/UL Open Type drive.

Make sure that there is 60 mm (2.4 in) minimum of space between drives or between the drive and side of the enclosure panel.

1 : Side-by-Side Mounting

Use this setting to install more than one drive Side-by-Side.

Make sure that there is 2 mm (0.08 in) minimum of space between drives.

2 : IP20/UL Type 1

Use this setting to install an IP20/UL Type 1 drive.

3 : IP55/UL Type 12

Use this setting to install an IP55/UL Type 12 drive.

■ L8-38: Carrier Frequency Reduction

No. (Hex.)	Name	Description	Default (Range)
L8-38 (04EF)	Carrier Frequency Reduction	Sets the carrier frequency reduction function. The drive decreases the carrier frequency when the output current is more than a specified level.	Determined by o2-04 (1 - 3)

If you decrease the carrier frequency, it increases the overload tolerance. The overload capacity increases temporarily for *oL2* [*Drive Overloaded*] and lets the drive operate through transient load peaks and not trip.

1 : Enabled below 6 Hz

The drive decreases the carrier frequency at speeds less than 6 Hz when the current is more than 100% of the drive rated current.

When the current is less than 88% or the output frequency is more than 7 Hz, the drive goes back to the usual carrier frequency.

2 : Enabled for All Speeds

The drive decreases the carrier frequency at these speeds:

5.8 L: Protection Functions

- Output current is a minimum of 100% of the drive rated current and the frequency reference is less than 6 Hz.
- Output current is a minimum of 109% of the drive rated current and the frequency reference is 7 Hz or more.

When the drive switches the carrier frequency to the set value, it uses a hysteresis of 12%.

3 : Enable at Overload

The drive decreases the carrier frequency at one of these conditions:

- Output frequency is less than 6 Hz and output current is more than 120%
- Output frequency is 7 Hz or more and the IGBT temperature detected by thermistor is high

■ L8-41: High Current Alarm Selection

No. (Hex.)	Name	Description	Default (Range)
L8-41 (04F2)	High Current Alarm Selection	Sets the function to cause an <i>HCA</i> [<i>High Current Alarm</i>] when the output current is more than 150% of the drive rated current.	0 (0, 1)

0 : Disabled

The drive will not detect an *HCA*.

1 : Enabled

If the output current is more than 150% of the drive rated current, the drive will detect an *HCA*.

The MFDO terminal set for an alarm [*H2-01 to H2-03 = 10*] activates.

■ L8-97: Carrier Freq Reduce during OH

No. (Hex.)	Name	Description	Default (Range)
L8-97 (3104)	Carrier Freq Reduce during OH	Sets the function to decrease carrier frequency during oH pre-alarm.	0 (0, 1)

0 : Disabled

1 : Enabled

◆ L9: Drive Protection 2

L9 parameters are used to configure the protection function used to detect cooling fan faults.

■ L9-16: FAn1 Detect Time

No. (Hex.)	Name	Description	Default (Range)
L9-16 (11DC) Expert	FAn1 Detect Time	Sets the detection time for <i>FAn1</i> [<i>Drive Cooling Fan Fault</i>]. Yaskawa recommends that you do not change this parameter value.	4.0 s (0.0 - 30.0 s)

5.9 n: Special Adjustment

n parameters set these functions:

- Function to prevent hunting
- High-slip braking
- Fine-tune the parameters that adjust motor control

◆ n1: Hunting Prevention

The Hunting Prevention function will not let low inertia or operation with a light load cause hunting. Hunting frequently occurs when you have a high carrier frequency and an output frequency less than 30 Hz.

■ n1-01: Hunting Prevention Selection

No. (Hex.)	Name	Description	Default (Range)
n1-01 (0580)	Hunting Prevention Selection	Sets the function to prevent hunting.	1 (0, 1)

When drive response is more important than the decrease of motor vibration, disable this function.

If hunting occurs, or if you use a high carrier frequency or Swing PWM, set this parameter to 2 for better hunting prevention.

0 : Disabled

1 : Enabled (Normal)

■ n1-02: Hunting Prevention Gain Setting

No. (Hex.)	Name	Description	Default (Range)
n1-02 (0581) Expert	Hunting Prevention Gain Setting	Sets the performance of the hunting prevention function. Usually it is not necessary to change this parameter.	1.00 (0.00 - 2.50)

Adjust this parameter in these conditions:

- When $n1-01 = 1, 2$ [*Hunting Prevention Selection = Enabled (Normal), Enabled (High Carrier Frequency)*]: If oscillation occurs when you operate a motor with a light load, increase the setting value in 0.1-unit increments.
- When $n1-01 = 1, 2$, if the motor stalls: Decrease the setting value in 0.1-unit increments.

■ n1-03: Hunting Prevention Time Constant

No. (Hex.)	Name	Description	Default (Range)
n1-03 (0582) Expert	Hunting Prevention Time Constant	Sets the primary delay time constant of the hunting prevention function. Usually it is not necessary to change this parameter.	Determined by o2-04 (0 - 500 ms)

Adjust this parameter in these conditions:

- Load inertia is large: Increase the setting value. If the setting value is too high, response will be slower. Also, there will be oscillation when the frequency is low.
- Oscillation occurs at low frequencies: Decrease the setting value.

■ n1-05: Hunting Prevent Gain in Reverse

No. (Hex.)	Name	Description	Default (Range)
n1-05 (0530) Expert	Hunting Prevent Gain in Reverse	Sets the performance of the hunting prevention function. This parameter adjusts Reverse run. Usually it is not necessary to change this parameter.	0.00 (0.00 - 2.50)

Note:

When you set this parameter to 0, the value set in *n1-02 [Hunting Prevention Gain Setting]* is effective when the motor rotates in reverse.

Adjust this parameter in these conditions:

- When *n1-01 = 1, 2 [Hunting Prevention Selection = Enabled (Normal), Enabled (High Carrier Frequency)]*: If oscillation occurs when you operate a motor with a light load, increase the setting value in 0.1-unit increments.
- When *n1-01 = 1, 2*, if the motor stalls: Decrease the setting value in 0.1-unit increments.

■ **n1-13: DC Bus Stabilization Control**

No. (Hex.)	Name	Description	Default (Range)
n1-13 (1B59) Expert	DC Bus Stabilization Control	Sets the oscillation suppression function for the DC bus voltage.	0 (0, 1)

0 : Disabled

1 : Enabled

Note:

If the DC bus voltage does not become stable with light loads and the drive detects *ov [Overvoltage]*, set this parameter to 1.

■ **n1-14: DC Bus Stabilization Time**

No. (Hex.)	Name	Description	Default (Range)
n1-14 (1B5A) Expert	DC Bus Stabilization Time	Adjusts the responsiveness of the oscillation suppression function for the DC bus voltage. Set <i>n1-13 = 1 [DC Bus Stabilization Control = Enabled]</i> to enable this parameter.	100.0 ms (0.0 - 500.0 ms)

Note:

Adjust this parameter in 100 ms increments.

◆ **n3: High Slip Braking (HSB) and Overexcitation Braking**

n3 parameters configure High Slip Braking and Overexcitation Deceleration.

■ **High Slip Braking**

High slip braking quickly decelerates motors without using braking resistors.

This lets you stop a motor more quickly than with the ramp to stop processes. This function is best for applications that do not frequently stop the motor, for example the fast stop function for high-inertia loads. High Slip Braking starts when the MFDI for *High Slip Braking (HSB) Activate [H1-xx = 68]* activates.

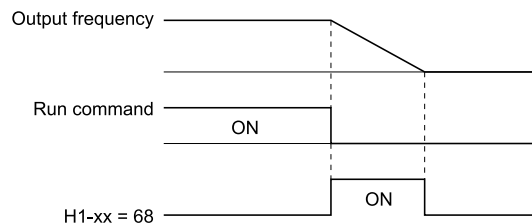

Figure 5.88 High Slip Braking Time Chart

Principles of Operation

HSB significantly decreases the frequency supplied to the motor at the same time that deceleration starts to increase motor slip.

The drive keeps the motor current at a constant level during deceleration to prevent overvoltage and do automatic braking and it also keeps a slip level that causes the maximum quantity of deceleration torque.

High Slip Braking Precautions

- Do not use the high slip braking function in these applications:

- Frequent deceleration
- Deceleration time differences
- Continuous regenerative loads
- When it is necessary to accelerate again during deceleration
- Motor loss increases during high slip braking. Use this function when the duty time factor is 5% ED or less and the braking time is 90 seconds or less. The load inertia and motor characteristics have an effect on the braking time.
- The drive ignores the configured deceleration time during high slip braking. To stop motors in the configured deceleration time, set $L3-04 = 4$ [*Stall Prevention during Decel = Overexcitation/High Flux*].
- You cannot use high slip braking to decelerate at user-defined speeds. To decelerate at user-defined speeds, use the overexcitation deceleration function.
- You cannot accelerate the motor again during high slip braking until you fully stop the motor and input the Run command again.

■ Overexcitation Deceleration

Overexcitation deceleration quickly decelerates motors without using braking resistors. This lets you stop a motor more quickly than with the ramp to stop processes.

Overexcitation deceleration increases excitation current during deceleration to cause a large quantity of braking torque through motor overexcitation. You can set the deceleration speed to adjust the deceleration time for overexcitation deceleration.

Overexcitation deceleration lets you accelerate the motor again during deceleration.

Enter the Run command during overexcitation deceleration to cancel overexcitation deceleration and accelerate the drive to the specified speed.

To enable this function, set $L3-04 = 4$ [*Stall Prevention during Decel = Overexcitation/High Flux*].

When $L3-04 = 4$, the motor will decelerate for the deceleration time set in $C1-02$ or $C1-04$. If the drive detects *ov* [*Overvoltage*], increase the deceleration time.

Notes on Overexcitation Deceleration

- Do not use Overexcitation Deceleration for these applications:
 - Frequent sudden decelerations
 - Continuous regenerative loads
 - Low inertia machines
 - Machines that have no tolerance for torque ripples
- Motor loss increases during overexcitation deceleration. Use this function when the duty time factor is 5% ED or less and the braking time is 90 seconds or less. The load inertia and motor characteristics have an effect on the braking time.

■ n3-01: HSB Deceleration Frequency Width

No. (Hex.)	Name	Description	Default (Range)
n3-01 (0588) Expert	HSB Deceleration Frequency Width	Sets the amount by which the output frequency is to be lowered during high-slip braking, as a percentage of $E1-04$ [<i>Maximum Output Frequency</i>], which represents the 100% value.	5% (1 - 20%)

When you must detect *ov* [*DC Bus Overvoltage*] during high-slip braking, set this parameter to a large value.

■ n3-02: HSB Current Limit Level

No. (Hex.)	Name	Description	Default (Range)
n3-02 (0589) Expert	HSB Current Limit Level	Sets the maximum current output during high-slip braking as a percentage, where $E2-01$ [<i>Motor Rated Current (FLA)</i>] is 100%. Also sets the current suppression to prevent exceeding drive overload tolerance.	Determined by L8-38 (0 - 200%)

When you decrease the setting value for current suppression, it will make the deceleration time longer.

- When you must detect *ov* [*DC Bus Overvoltage*] during high-slip braking, set this parameter to a low value.
- If the motor current increases during high-slip braking, decrease the setting value to prevent burn damage in the motor.

■ n3-03: HSB Dwell Time at Stop

No. (Hex.)	Name	Description	Default (Range)
n3-03 (058A) Expert	HSB Dwell Time at Stop	Sets the dwell time, a length of time when high-slip braking is ending and during which the motor speed decreases and runs at a stable speed. For a set length of time, the drive will hold the actual output frequency at the minimum output frequency set in <i>E1-09</i> .	1.0 s (0.0 - 10.0 s)

If there is too much inertia or when the motor is coasting to a stop after high-slip braking is complete, increase the setting value. If the setting value is too low, machine inertia can cause the motor to rotate after high-slip braking is complete.

■ n3-04: HSB Overload Time

No. (Hex.)	Name	Description	Default (Range)
n3-04 (058B) Expert	HSB Overload Time	Sets the time used to detect <i>oL7</i> [<i>High Slip Braking Overload</i>], which occurs when the output frequency does not change during high-slip braking. Usually it is not necessary to change this parameter.	40 s (30 - 1200 s)

If a force on the load side is rotating the motor or if there is too much load inertia connected to the motor, the drive will detect *oL7*.

The current flowing to the motor from the load can overheat the motor and cause burn damage to the motor. Set this parameter to prevent burn damage to the motor.

■ n3-13: OverexcitationBraking (OEB) Gain

No. (Hex.)	Name	Description	Default (Range)
n3-13 (0531)	OverexcitationBraking (OEB) Gain	Sets the gain value that the drive multiplies by the V/f pattern output value during overexcitation deceleration to calculate the overexcitation level.	1.10 (1.00 - 1.40)

The V/f pattern output value goes back to its usual level after the motor stops or accelerates again to the frequency reference speed.

The best value of this parameter changes when the flux saturation characteristics of the motor change.

- Gradually increase the value of *n3-13* to 1.25 or 1.30 to increase the braking power of Overexcitation Deceleration. If the gain is too much, the motor can have flux saturation and cause a large quantity of current to flow.
- This can increase the deceleration time. Decrease the setting value if flux saturation causes overcurrent. If you increase the setting value, the drive can detect *oC* [*Overcurrent*], *oL1* [*Motor Overload*], and *oL2* [*Drive Overload*]. Decrease the value of *n3-21* [*HSB Current Suppression Level*] to prevent *oC* and *oL*.
- If you use overexcitation deceleration frequently or if you use overexcitation deceleration for an extended period of time, it can increase motor temperature. Decrease the setting value in these conditions.
- If *ov* [*Overvoltage*] occurs, increase the deceleration time.

■ n3-21: HSB Current Suppression Level

No. (Hex.)	Name	Description	Default (Range)
n3-21 (0579)	HSB Current Suppression Level	Sets the upper limit of the current that is suppressed at the time of overexcitation deceleration as a percentage of the drive rated current.	100% (0 - 150%)

If flux saturation during Overexcitation Deceleration makes the motor current become more than the value set in this parameter, the drive will automatically decrease the overexcitation gain. If *oC* [*Overcurrent*], *oL1* [*Motor Overload*], or *oL2* [*Drive Overloaded*] occur during overexcitation deceleration, decrease the setting value.

If repetitive or long overexcitation deceleration cause the motor to overheat, decrease the setting value.

■ n3-23: Overexcitation Braking Operation

No. (Hex.)	Name	Description	Default (Range)
n3-23 (057B)	Overexcitation Braking Operation	Sets the direction of motor rotation where the drive will enable overexcitation.	0 (0 - 2)

0 : Disabled

1 : Enabled Only when Rotating FWD

2 : Enabled Only when Rotating REV

Note:

When $n3-23 = 1, 2$, the drive enables overexcitation only in the direction of motor rotation in which a regenerative load is applied. Increased motor loss can decrease *ov* [Overvoltage] faults.

5.10 o: Keypad-Related Settings

o parameters set keypad functions.

◆ o1: Keypad Display Selection

o1 parameters select the parameters shown on the initial keypad screen and to configure the parameter setting units and display units. These parameters also adjust the backlight and contrast of the LCD display.

■ Home Screen Display Format

o1-40 [Home Screen Display Selection] changes the display of the monitor shown on the Home screen. You can show numerical values or one of these three displays on the Home screen monitor:

Bar Graph Display

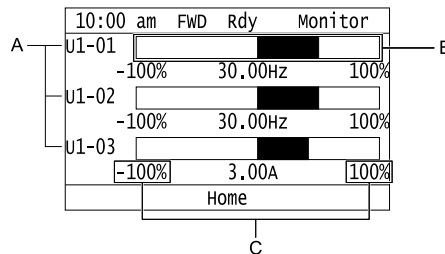

A - Select *Ux-xx* [Monitors] with *o1-24*, *o1-25*, and *o1-26*.

B - Configure display regions with *o1-41*, *o1-43*, and *o1-45*.

C - Select display ranges with *o1-42*, *o1-44*, and *o1-46*.

Analog Gauge Display

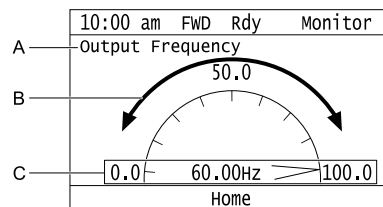

A - Select *Ux-xx* [Monitors] with *o1-24*.

B - Configure display regions with *o1-56*.

C - Select display ranges with *o1-55*.

Trend Plot Display

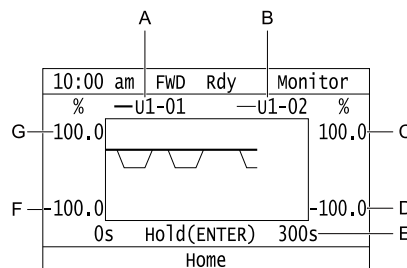

A - Select *Ux-xx* [Monitors] (Monitor 1) with *o1-24*.

B - Select *Ux-xx* [Monitors] (Monitor 2) with *o1-25*.

C - Set the maximum value of Monitor 2 with *o1-50*

D - Set the minimum value of Monitor 2 with *o1-49*

E - Set the time scale with *o1-51*

F - Set the minimum value of Monitor 1 with *o1-47*

G - Set the maximum value of Monitor 1 with *o1-48*

Full Screen Information Display

When you set $o1-82 = 1$ [*Message Screen Display = ON*], you can show an active status message in full screen on the keypad.

Table 5.46 Example of Message Displays for Pre-Charge

Default ($o1-82 = 0$)	Full Screen Message ($o1-82 = 1$)
<pre> 10:00 am FWD Rdy Home AUTO Pre-Charge: Exit in 10min Freq Reference (KPD) U1-01 Hz 45.00 Output Frequency U1-02 Hz 45.00 Menu </pre>	<pre> 10:00 am FWD Rdy Pre-Charge Mode Exit in 10min Home </pre>

Note:

- When $o1-80 = 0$ [*OFF*], drive Faults, $oFAxx$, or CPF s do not trigger a full-screen message to display.
- When $o1-81 = 0$ [*Alarm Screen Display = OFF*], drive Alarms do not trigger a full-screen message to display.
- When $o1-82 = 0$ [*Message Screen Display = OFF*], drive Messages do not trigger a full-screen message to display. The keypad will continue to show limit errors and other informative screens.
- You cannot select the display method of $oPExx$ [*Parameter Setting Errors*]. The keypad shows $oPExx$ errors as full screen displays and status monitor displays. Active $oPExx$ errors have display priority over active faults and alarms.

Status Monitor Display

When $o1-40 = 0$ [*Home Screen Display Selection = Custom Monitor*], the keypad will show the Status Monitor on the second and third lines of the HOME screen.

- The second line shows HOA status and other information, for example:
 - Fault/Alarm/ $oPExx$ / $oFAxx$ codes
 - Information Text status
- The third line shows information texts, for example:
 - Pre-Charge messages
 - Sleep messages

It will also show Information Text for Sequence Timer status.

Table 5.47 shows the examples of Status Monitor display during normal operation.

Table 5.47 Normal Operation Display

Custom Monitors Setting (o1-24 to o1-35)	Display with No Message	Display with Message
More than one monitor set	<pre> 10:00 am FWD Rdy Home OFF ----- Freq Reference 40.00 U1-01 Hz Output Frequency 40.00 U1-02 Hz Menu </pre>	<pre> 10:00 am FWD Rdy Home AUTO Pre-charge: Exit in 8sec ----- Freq Reference 40.00 U1-01 Hz Output Frequency 40.00 U1-02 Hz Menu </pre>
Only one monitor set	<pre> 10:00 am FWD Rdy Home OFF ----- Setpoint U5-99 % 80.00% Menu </pre>	<pre> 10:00 am FWD Rdy Home OFF Pre-charge: Exit in 8sec ----- Freq Reference U1-01 40.00Hz Menu </pre>
No monitor set	<pre> 10:00 am FWD Rdy Home OFF ----- Menu </pre>	<pre> 10:00 am FWD Rdy Home AUTO Sleep Active: wait for Start ----- Menu </pre>

The keypad will also show Information Text on the second and third lines. Information Texts are display indications of the current drive status. Information Texts are similar to Messages, but they cannot display as full-screen.

Table 5.48 Displays for Information Text

Keypad Display	Description
<pre> 10:00 am FWD Rdy Home OFF Parameters Locked ----- Freq Reference (KPD) 40.00 U1-01 Hz Output Frequency 40.00 U1-02 Hz Menu </pre>	The keypad shows Information Text only on the second line.
<pre> 10:00 am FWD Rdy Home OFF Parameters Locked Sequence Timer 1: RUN ----- Freq Reference (KPD) 40.00 U1-01 Hz Output Frequency 40.00 U1-02 Hz Menu </pre>	The keypad shows Information Texts on the second and third lines.

When an alarm occurs, the keypad will show the alarm code and alarm name on the second and third lines.

```

10:00 am FWD Rdy Home
AUTO UL3
Undertorque Detection 1
-----
Setpoint
U5-99 %                80.00
Output Frequency       54.21
U1-02 Hz
Menu
                    
```

Figure 5.89 Display for Alarm

When a fault occurs, the drive will reset the scroll position of the HOME screen display and show the related message on the second and third line.

Note:

The drive will not reset the HOME screen display if an alarm or message occurs.

10:00 am	FWD	Home
OFF	EF3	
External Fault (Terminal S3)		
Setpoint		80.00
U5-99 %		
Output Frequency		0.00
U1-02 Hz		
Reset	Menu	







Figure 5.90 Display for Fault

When the keypad must show more than one status (Alarms/Faults, Information Text, Messages) on the Status Monitor, the keypad will cycle a different display each 2 s.

If there is a new alarm or fault, it will stop the display cycle and the keypad will show the alarm or fault screen for 1 s. The keypad will then start the 2-second display cycles again from the Information Text display screen.

If the Information Text only has an effect on the second line, the keypad will show a Message or an Alarm on the third line. The Message display has priority because it is possible to have more than one active Message at the same time.

Table 5.49 Displays for More than One Status

Keypad Display		Description																																																																	
<table border="1"> <tr> <td>10:00 am</td> <td>FWD</td> <td>Rdy</td> <td>Home</td> </tr> <tr> <td>AUTO</td> <td>UL3</td> <td></td> <td></td> </tr> <tr> <td colspan="4">Undertorque Detection 1</td> </tr> <tr> <td>Freq Reference</td> <td></td> <td></td> <td>40.00</td> </tr> <tr> <td>U1-01 Hz</td> <td></td> <td></td> <td></td> </tr> <tr> <td>Output Frequency</td> <td></td> <td></td> <td>40.00</td> </tr> <tr> <td>U1-02 Hz</td> <td></td> <td></td> <td></td> </tr> <tr> <td colspan="4">Menu</td> </tr> </table>	10:00 am	FWD	Rdy	Home	AUTO	UL3			Undertorque Detection 1				Freq Reference			40.00	U1-01 Hz				Output Frequency			40.00	U1-02 Hz				Menu				 	<table border="1"> <tr> <td>10:00 am</td> <td>FWD</td> <td>Rdy</td> <td>Home</td> </tr> <tr> <td>AUTO</td> <td></td> <td></td> <td></td> </tr> <tr> <td colspan="4">Pre-charge: Exit in 8sec</td> </tr> <tr> <td>Freq Reference</td> <td></td> <td></td> <td>40.00</td> </tr> <tr> <td>U1-01 Hz</td> <td></td> <td></td> <td></td> </tr> <tr> <td>Output Frequency</td> <td></td> <td></td> <td>40.00</td> </tr> <tr> <td>U1-02 Hz</td> <td></td> <td></td> <td></td> </tr> <tr> <td colspan="4">Menu</td> </tr> </table>	10:00 am	FWD	Rdy	Home	AUTO				Pre-charge: Exit in 8sec				Freq Reference			40.00	U1-01 Hz				Output Frequency			40.00	U1-02 Hz				Menu				When the keypad must show an alarm and message at the same time, it will toggle the second and third lines each 2 s.
10:00 am	FWD	Rdy	Home																																																																
AUTO	UL3																																																																		
Undertorque Detection 1																																																																			
Freq Reference			40.00																																																																
U1-01 Hz																																																																			
Output Frequency			40.00																																																																
U1-02 Hz																																																																			
Menu																																																																			
10:00 am	FWD	Rdy	Home																																																																
AUTO																																																																			
Pre-charge: Exit in 8sec																																																																			
Freq Reference			40.00																																																																
U1-01 Hz																																																																			
Output Frequency			40.00																																																																
U1-02 Hz																																																																			
Menu																																																																			
<table border="1"> <tr> <td>10:00 am</td> <td>FWD</td> <td>Rdy</td> <td>Home</td> </tr> <tr> <td>AUTO</td> <td>Parameters Locked</td> <td></td> <td></td> </tr> <tr> <td colspan="4">Undertorque Detection 1</td> </tr> <tr> <td>Freq Reference (KPD)</td> <td></td> <td></td> <td>40.00</td> </tr> <tr> <td>U1-01 Hz</td> <td></td> <td></td> <td></td> </tr> <tr> <td>Output Frequency</td> <td></td> <td></td> <td>40.00</td> </tr> <tr> <td>U1-02 Hz</td> <td></td> <td></td> <td></td> </tr> <tr> <td colspan="4">Menu</td> </tr> </table>	10:00 am	FWD	Rdy	Home	AUTO	Parameters Locked			Undertorque Detection 1				Freq Reference (KPD)			40.00	U1-01 Hz				Output Frequency			40.00	U1-02 Hz				Menu				 	<table border="1"> <tr> <td>10:00 am</td> <td>FWD</td> <td>Rdy</td> <td>Home</td> </tr> <tr> <td>AUTO</td> <td>UL3</td> <td></td> <td></td> </tr> <tr> <td colspan="4">Undertorque Detection 1</td> </tr> <tr> <td>Freq Reference (KPD)</td> <td></td> <td></td> <td>40.00</td> </tr> <tr> <td>U1-01 Hz</td> <td></td> <td></td> <td></td> </tr> <tr> <td>Output Frequency</td> <td></td> <td></td> <td>40.00</td> </tr> <tr> <td>U1-02 Hz</td> <td></td> <td></td> <td></td> </tr> <tr> <td colspan="4">Menu</td> </tr> </table>	10:00 am	FWD	Rdy	Home	AUTO	UL3			Undertorque Detection 1				Freq Reference (KPD)			40.00	U1-01 Hz				Output Frequency			40.00	U1-02 Hz				Menu				When the keypad must show an Information Text only on the second line and an alarm at the same time, it will toggle the second line each 2 s.
10:00 am	FWD	Rdy	Home																																																																
AUTO	Parameters Locked																																																																		
Undertorque Detection 1																																																																			
Freq Reference (KPD)			40.00																																																																
U1-01 Hz																																																																			
Output Frequency			40.00																																																																
U1-02 Hz																																																																			
Menu																																																																			
10:00 am	FWD	Rdy	Home																																																																
AUTO	UL3																																																																		
Undertorque Detection 1																																																																			
Freq Reference (KPD)			40.00																																																																
U1-01 Hz																																																																			
Output Frequency			40.00																																																																
U1-02 Hz																																																																			
Menu																																																																			
<table border="1"> <tr> <td>10:00 am</td> <td>FWD</td> <td>Rdy</td> <td>Home</td> </tr> <tr> <td>AUTO</td> <td>Parameters Locked</td> <td></td> <td></td> </tr> <tr> <td colspan="4">Pre-charge: Exit in 8sec</td> </tr> <tr> <td>Freq Reference (KPD)</td> <td></td> <td></td> <td>40.00</td> </tr> <tr> <td>U1-01 Hz</td> <td></td> <td></td> <td></td> </tr> <tr> <td>Output Frequency</td> <td></td> <td></td> <td>40.00</td> </tr> <tr> <td>U1-02 Hz</td> <td></td> <td></td> <td></td> </tr> <tr> <td colspan="4">Menu</td> </tr> </table>	10:00 am	FWD	Rdy	Home	AUTO	Parameters Locked			Pre-charge: Exit in 8sec				Freq Reference (KPD)			40.00	U1-01 Hz				Output Frequency			40.00	U1-02 Hz				Menu				 	<table border="1"> <tr> <td>10:00 am</td> <td>FWD</td> <td>Rdy</td> <td>Home</td> </tr> <tr> <td>AUTO</td> <td></td> <td></td> <td></td> </tr> <tr> <td colspan="4">Pre-charge: Exit in 8sec</td> </tr> <tr> <td>Freq Reference (KPD)</td> <td></td> <td></td> <td>40.00</td> </tr> <tr> <td>U1-01 Hz</td> <td></td> <td></td> <td></td> </tr> <tr> <td>Output Frequency</td> <td></td> <td></td> <td>40.00</td> </tr> <tr> <td>U1-02 Hz</td> <td></td> <td></td> <td></td> </tr> <tr> <td colspan="4">Menu</td> </tr> </table>	10:00 am	FWD	Rdy	Home	AUTO				Pre-charge: Exit in 8sec				Freq Reference (KPD)			40.00	U1-01 Hz				Output Frequency			40.00	U1-02 Hz				Menu				When the keypad must show an Information Text only on the second line and a message at the same time, it will toggle the second line each 2 s.
10:00 am	FWD	Rdy	Home																																																																
AUTO	Parameters Locked																																																																		
Pre-charge: Exit in 8sec																																																																			
Freq Reference (KPD)			40.00																																																																
U1-01 Hz																																																																			
Output Frequency			40.00																																																																
U1-02 Hz																																																																			
Menu																																																																			
10:00 am	FWD	Rdy	Home																																																																
AUTO																																																																			
Pre-charge: Exit in 8sec																																																																			
Freq Reference (KPD)			40.00																																																																
U1-01 Hz																																																																			
Output Frequency			40.00																																																																
U1-02 Hz																																																																			
Menu																																																																			

Parameter Details

5.10 o: Keypad-Related Settings

Keypad Display		Description
		<p>When the keypad must show an Information Text and message at the same time, it will toggle the second and third lines each 2 s.</p> <p>When the keypad must show an alarm, Information Text, and message at the same time, it will toggle the second and third lines each 2 s.</p>

■ o1-03: Frequency Display Unit Selection

No. (Hex.)	Name	Description	Default (Range)
o1-03 (0502)	Frequency Display Unit Selection	Sets the display units for the frequency reference and output frequency.	0 (0 - 3)

Note:

- Select the units for these parameters:
 - d1-01 [Reference 1] to d1-08 [Reference 8], d1-17 [Jog Reference]
 - U1-01 [Frequency Reference]
 - U1-02 [Output Frequency]
 - U1-05 [Motor Speed]
 - U1-16 [SFS Output Frequency]
 - U4-14 [PeakHold Output Freq]
 - U5-07 [AUTO Mode Freq Ref]
 - U5-08 [HAND Mode Freq Ref]
 - Z1-14 [Run Delay Frequency Reference]
 - Z1-17 [Energy Savings Frequency Ref]
 - Z1-19 [Energy Savings Fref Deadband]
 - Z1-20 [Energy Savings Out Freq Deadband]
 - Z1-23 [Energy Savings Freq Ref Increase]
 - Z1-32 [Loss of Load Drive Frequency]

0 : 0.01Hz units

1 : 0.01% units

The maximum output frequency is 100%.

2 : min⁻¹ (r/min) unit

The drive uses the maximum output frequency and number of motor poles calculate this value automatically.

Note:

When you set o1-03 = 2 [r/min], make sure that you set the number of motor poles in E2-04 [Motor Pole Count].

3 : User Units (o1-09 -o1-11)

Uses o1-09 [Freq. Reference Display Units], o1-10 [User Units Maximum Value], and o1-11 [User Units Decimal Position] to set the unit of measure. The value of parameter o1-10 is the value when you remove the decimal point

from the maximum output frequency. Parameter *o1-11* is to the number of digits after the decimal point in the maximum output frequency.

To display a maximum output frequency of 100.00, set parameters to these values:

- *o1-10* = 10000
- *o1-11* = 2 [*User Units Decimal Position* = 2 Dec (*XXX.XX*)]

■ o1-05: LCD Contrast Adjustment

No. (Hex.)	Name	Description	Default (Range)
o1-05 (0504) RUN	LCD Contrast Adjustment	Sets the contrast of the LCD display on the keypad.	5 (0 - 10)

When you decrease the setting value, the contrast of the LCD display decreases. When you increase the setting value, the contrast increases.

■ o1-09: Freq. Reference Display Units

No. (Hex.)	Name	Description	Default (Range)
o1-09 (051C)	Freq. Reference Display Units	Sets the unit of display for the frequency reference parameters and frequency-related monitors when <i>o1-03</i> = 3 [<i>Frequency Display Unit Selection</i> = <i>User Units (o1-09 ~ o1-11)</i>].	50 (0 - 50)

0 : "WC: inches of water column

1 : PSI: pounds per square inch

2 : GPM: gallons/min

3 : °F: Fahrenheit

4 : ft³/min: cubic feet/min

5 : m³/h: cubic meters/hour

6 : L/h: liters/hour

7 : L/s: liters/sec

8 : bar: bar

9 : Pa: Pascal

10 : °C: Celsius

11 : m: meters

12 : ft: feet

13 : L/min: liters/min

14 : m³/min: cubic meters/min

15 : "Hg: Inch Mercury

16 : kPa: kilopascal

48 : %: Percent

49 : Custom(o1-13~15)

50 : None

■ o1-10: User Units Maximum Value

No. (Hex.)	Name	Description	Default (Range)
o1-10 (0520)	User Units Maximum Value	Sets the value that the drive shows as the maximum output frequency.	Determined by o1-03 (1 - 60000)

To display a maximum output frequency of 100.00, set parameters to these values:

- *o1-10* = 10000

5.10 o: Keypad-Related Settings

- *o1-11 = 2 [User Units Decimal Position = 2 Dec (XXX.XX)]*

Note:

Set *o1-03 = 3 [Frequency Display Unit Selection = User Units (o1-10 & o1-11)]* before you set *o1-10* and *o1-11*.

■ o1-11: User Units Decimal Position

No. (Hex.)	Name	Description	Default (Range)
o1-11 (0521)	User Units Decimal Position	Sets the number of decimal places for frequency reference and monitor values.	Determined by o1-03 (0 - 3)

0 : No Decimal Places (XXXXX)

1 : One Decimal Places (XXXX.X)

2 : Two Decimal Places (XXX.XX)

3 : Three Decimal Places (XX.XXX)

Note:

Set *o1-03 = 3 [Frequency Display Unit Selection = User Units (o1-10 & o1-11)]* before you set *o1-10 [User Units Maximum Value]* and *o1-11*.

■ o1-13: Freq. Reference Custom Unit 1

No. (Hex.)	Name	Description	Default (Range)
o1-13 (3105)	Freq. Reference Custom Unit 1	Sets the first character of the custom unit display when <i>o1-03 = 3 [Frequency Display Unit Selection = User Units]</i> and <i>o1-09 = 49 [Freq. Reference Display Units = Custom (o1-13~15)]</i> .	41 (20 - 7A)

Refer to [Custom Units on page 208](#) for more information about available selections.

■ o1-14: Freq. Reference Custom Unit 2

No. (Hex.)	Name	Description	Default (Range)
o1-14 (3106)	Freq. Reference Custom Unit 2	Sets the second character of the custom unit display when <i>o1-03 = 3 [Frequency Display Unit Selection = User Units]</i> and <i>o1-09 = 49 [Freq. Reference Display Units = Custom (o1-13~15)]</i> .	41 (20 - 7A)

Refer to [Custom Units on page 208](#) for more information about available selections.

■ o1-15: Freq. Reference Custom Unit 3

No. (Hex.)	Name	Description	Default (Range)
o1-15 (3107)	Freq. Reference Custom Unit 3	Sets the third character of the custom unit display when <i>o1-03 = 3 [Frequency Display Unit Selection = User Units]</i> and <i>o1-09 = 49 [Freq. Reference Display Units = Custom (o1-13~15)]</i> .	41 (20 - 7A)

Refer to [Custom Units on page 208](#) for more information about available selections.

■ o1-18: User Defined Parameter 1

No. (Hex.)	Name	Description	Default (Range)
o1-18 (310A)	User Defined Parameter 1	Lets you set values to use as reference information.	0 (0 - 999)

■ o1-19: User Defined Parameter 2

No. (Hex.)	Name	Description	Default (Range)
o1-19 (310B)	User Defined Parameter 2	Lets you set values to use as reference information.	0 (0 - 999)

■ o1-24 to o1-35: Custom Monitor 1 to 12

No. (Hex.)	Name	Description	Default (Range)
o1-24 to o1-35 (11AD - 11B8) RUN	Custom Monitor 1 to 12	Set a maximum of 12 monitors as user monitors. These parameters are only available on an HOA keypad.	o1-24: 101 o1-25: 102 o1-26: Determined by b5-01 o1-27 to o1-35: 0 (0, 101 - 1299)

These parameters save the monitor items selected by the HOA keypad [Custom Monitor].

Note:

- The default setting for *o1-26* changes when *b5-01* [PID Mode Setting] changes:
 - b5-01* = 0 [Disabled]: 103
 - b5-01* ≠ 0: 501
- You can show a maximum of three selected monitors on one HOA keypad screen.
 - When you select only one monitor, the text size of this monitor increases. For example, when *o1-25* to *o1-35* = 0, the text size of the monitor saved in *o1-24* increases.
 - When you select two monitors, the text size of these monitors increase.
 - When you select four or more monitors, the fourth monitor and all additional monitors are shown on the next screens.
- Monitors selected with *o1-24* to *o1-26* can be displayed as a bar graph, analog gauge, or trend plot.
 - Bar graph display: 3 monitors maximum
Select with *o1-24*, *o1-25*, and *o1-26*.
 - Analog gauge display: 1 monitor
Select with *o1-24*.
 - Trend plot display: 2 monitors
Select with *o1-24* and *o1-25*.
- You can only set parameters *o1-24* to *o1-26* with analog output monitors.
- You can set all monitors to parameters *o1-27* to *o1-35*.

■ o1-36: LCD Backlight Brightness

No. (Hex.)	Name	Description	Default (Range)
o1-36 (11B9) RUN	LCD Backlight Brightness	Sets the intensity of the HOA keypad backlight.	5 (1 - 5)

When you decrease the setting value, the intensity of the backlight decreases.

■ o1-37: LCD Backlight ON/OFF Selection

No. (Hex.)	Name	Description	Default (Range)
o1-37 (11BA) RUN	LCD Backlight ON/OFF Selection	Sets the automatic shut off function for the LCD backlight.	1 (0, 1)

Note:



Use *o1-36* [LCD Backlight Brightness] to adjust the intensity of the LCD backlight.

0 : OFF

The automatic backlight shut off function is enabled. The backlight will automatically turn off after the time set in *o1-38* [LCD Backlight Off-Delay] is expired.

Note:

When *o1-37* = 0 and the backlight is OFF, the keys other than  are disabled.

When the backlight is OFF, push a key on the keypad to temporarily turn the backlight ON. To use the key function to operate the drive, push the same key again. For example, push  to turn the backlight ON, then push  again to enter a Run command to the drive.

1 : ON

The automatic backlight shut off function is disabled. The backlight will always be ON.

■ o1-38: LCD Backlight Off-Delay

No. (Hex.)	Name	Description	Default (Range)
o1-38 (11BB) RUN	LCD Backlight Off-Delay	Sets the time until the LCD backlight automatically turns off.	60 s (10 - 300 s)

When $o1-37 = 0$ [LCD Backlight ON/OFF Selection= OFF], the backlight will automatically turn off after the time set in $o1-38$ expires.

When the backlight is off, push a key on the keypad to temporarily turn the backlight on. After the backlight turns on, it will turn off automatically after the time set in $o1-38$ is expired.

■ o1-39: Show Initial Setup Screen

No. (Hex.)	Name	Description	Default (Range)
o1-39 (11BC) RUN	Show Initial Setup Screen	Sets the function to show the HOA keypad initial setup screen each time you energize the drive. This parameter is only available on an HOA keypad.	1 (0, 1)

The initial setup screen shows a menu where you can select the display language, set the date, time, and other basic settings. When you set this parameter to 0, the drive will not show this screen each time you energize the drive.

0 : No

The drive will not show the initial setup display screen each time you energize the drive. The drive will show the Home screen.

1 : Yes

When you input the Run command before you energize the drive or when you turn on the Run command while the drive shows the initial setup screen, the drive will replace the initial setup screen with the Home screen.

■ o1-40: Home Screen Display Selection

No. (Hex.)	Name	Description	Default (Range)
o1-40 (11BD) RUN	Home Screen Display Selection	Sets the monitor display mode for the Home screen. This parameter is only available on an HOA keypad.	0 (0 - 3)

0 : Custom Monitor

1 : Bar Graph

2 : Analog Gauge

3 : Trend Plot

■ o1-41: 1st Monitor Area Selection

No. (Hex.)	Name	Description	Default (Range)
o1-41 (11C1) RUN	1st Monitor Area Selection	Sets the horizontal range used to display the monitor set in $o1-24$ [Custom Monitor 1] as a bar graph. This parameter is only available on an HOA keypad.	0 (0 - 1)

0 : +/- Area (- o1-42 ~ o1-42)

1 : + Area (0 ~ o1-42)

■ o1-42: 1st Monitor Area Setting

No. (Hex.)	Name	Description	Default (Range)
o1-42 (11C2) RUN	1st Monitor Area Setting	Sets the horizontal axis value used to display the monitor set in o1-24 [Custom Monitor 1] as a bar graph. This parameter is only available on an HOA keypad.	100.0% (0.0 - 100.0%)

■ o1-43: 2nd Monitor Area Selection

No. (Hex.)	Name	Description	Default (Range)
o1-43 (11C3) RUN	2nd Monitor Area Selection	Selects the horizontal range used to display the monitor set in o1-25 [Custom Monitor 2] as a bar graph. This parameter is only available on an HOA keypad.	0 (0 - 1)

0 : +/- Area (- o1-44 ~ o1-44)

1 : + Area (0 ~ o1-44)

■ o1-44: 2nd Monitor Area Setting

No. (Hex.)	Name	Description	Default (Range)
o1-44 (11C4) RUN	2nd Monitor Area Setting	Sets the horizontal axis value used to display the monitor set in o1-25 [Custom Monitor 2] as a bar graph. This parameter is only available on an HOA keypad.	100.0% (0.0 - 100.0%)

■ o1-45: 3rd Monitor Area Selection

No. (Hex.)	Name	Description	Default (Range)
o1-45 (11C5) RUN	3rd Monitor Area Selection	Sets the horizontal range used to display the monitor set in o1-26 [Custom Monitor 3] as a bar graph. This parameter is only available on an HOA keypad.	0 (0 - 1)

0 : +/- Area (- o1-46 ~ o1-46)

1 : + Area (0 ~ o1-46)

■ o1-46: 3rd Monitor Area Setting

No. (Hex.)	Name	Description	Default (Range)
o1-46 (11C6) RUN	3rd Monitor Area Setting	Sets the horizontal axis value used to display the monitor set in o1-26 [Custom Monitor 3] as a bar graph. This parameter is only available on an HOA keypad.	100.0% (0.0 - 100.0%)

■ o1-47: Trend Plot 1 Scale Minimum Value

No. (Hex.)	Name	Description	Default (Range)
o1-47 (11C7) RUN	Trend Plot 1 Scale Minimum Value	Sets the horizontal axis minimum value used to display the monitor set in o1-24 [Custom Monitor 1] as a trend plot. This parameter is only available on an HOA keypad.	-100.0% (-300.0 - +300.0%)

■ o1-48: Trend Plot 1 Scale Maximum Value

No. (Hex.)	Name	Description	Default (Range)
o1-48 (11C8) RUN	Trend Plot 1 Scale Maximum Value	Sets the horizontal axis maximum value used to display the monitor set in o1-24 [Custom Monitor 1] as a trend plot. This parameter is only available on an HOA keypad.	100.0% (-300.0 - +300.0%)

■ o1-49: Trend Plot 2 Scale Minimum Value

No. (Hex.)	Name	Description	Default (Range)
o1-49 (11C9) RUN	Trend Plot 2 Scale Minimum Value	Sets the horizontal axis minimum value used to display the monitor set in o1-25 [Custom Monitor 2] as a trend plot. This parameter is only available on an HOA keypad.	-100.0% (-300.0 - +300.0%)

■ o1-50: Trend Plot 2 Scale Maximum Value

No. (Hex.)	Name	Description	Default (Range)
o1-50 (11CA) RUN	Trend Plot 2 Scale Maximum Value	Sets the horizontal axis maximum value used to display the monitor set in o1-25 [Custom Monitor 2] as a trend plot. This parameter is only available on an HOA keypad.	100.0% (-300.0 - +300.0%)

■ o1-51: Trend Plot Time Scale Setting

No. (Hex.)	Name	Description	Default (Range)
o1-51 (11CB) RUN	Trend Plot Time Scale Setting	Sets the time scale (horizontal axis) to display the trend plot. When you change this setting, the drive automatically adjusts the data sampling time. This parameter is only available on an HOA keypad.	300 s (1 - 3600 s)

■ o1-55: Analog Gauge Area Selection

No. (Hex.)	Name	Description	Default (Range)
o1-55 (11EE) RUN	Analog Gauge Area Selection	Sets the range used to display the monitor set in o1-24 [Custom Monitor 1] as an analog gauge. This parameter is only available on an HOA keypad.	1 (0, 1)

0 : +/- Area (- o1-56 ~ o1-56)

1 : + Area (0 ~ o1-56)

■ o1-56: Analog Gauge Area Setting

No. (Hex.)	Name	Description	Default (Range)
o1-56 (11EF) RUN	Analog Gauge Area Setting	Sets the value used to display the monitor set in o1-24 [Custom Monitor 1] as an analog meter. This parameter is only available on an HOA keypad.	100.0% (0.0 - 100.0%)

■ o1-58: Motor Power Unit Selection

No. (Hex.)	Name	Description	Default (Range)
o1-58 (3125)	Motor Power Unit Selection	Sets the setting unit for parameters that set the motor rated power.	1 (0, 1)

The drive shows these parameter values in the set units:

- E2-11 [Motor Rated Power]
- T1-02 [Motor Rated Power]

0 : kW

Shows the motor output in kW units.

1 : HP

Shows the motor output in HP units.

■ o1-80: Fault Screen Display

No. (Hex.)	Name	Description	Default (Range)
o1-80 (31BA)	Fault Screen Display	Sets a full-screen display message to show on the keypad when a fault or CPF occurs.	1 (0, 1)

0 : OFF

1 : ON

■ o1-81: Alarm Screen Display

No. (Hex.)	Name	Description	Default (Range)
o1-81 (31BB)	Alarm Screen Display	Sets a full-screen display message to show on the keypad when an alarm occurs.	0 (0, 1)

0 : OFF

1 : ON

■ o1-82: Message Screen Display

No. (Hex.)	Name	Description	Default (Range)
o1-82 (31BC)	Message Screen Display	Sets a full-screen display message to show on the keypad when a status message is active.	0 (0, 1)

0 : OFF

1 : ON

◆ o2: Keypad Operation

■ o2-02: OFF Key Function Selection

No. (Hex.)	Name	Description	Default (Range)
o2-02 (0506)	OFF Key Function Selection	Sets the function to use  on the keypad to stop the drive when the Run command source for the drive is REMOTE (external) and not assigned to the keypad.	1 (0, 1)

0 : Disabled

1 : Enabled

 stays enabled when the Run command source is not assigned to the keypad.

To start the drive again after you push  to stop operation, turn the external Run command OFF and ON again.

■ o2-03: User Parameter Default Value

No. (Hex.)	Name	Description	Default (Range)
o2-03 (0507)	User Parameter Default Value	Sets the function to keep the settings of changed parameters as user parameter defaults to use during initialization.	0 (0 - 2)

When you set $o2-03 = 1$ [*Set defaults*], the drive saves changed parameter settings as user parameter setting values in a part of the memory that is isolated from drive parameters.

When you set $A1-03 = 1110$ [*Initialize Parameters = User Initialization*] to initialize the drive, the drive resets the internal parameter setting values to those user parameter setting values.

0 : No change

1 : Set defaults

Saves changed parameter setting values as user default settings.

5.10 o: Keypad-Related Settings

Set $o2-03 = 1$ then push  to save the user parameter setting values. After the drive saves the setting value, $o2-03$ automatically resets to 0.

2 : Clear all

Deletes all of the saved user parameter setting values.

Set $o2-03 = 2$ then push  to clear the user parameter setting values. The drive will automatically reset $o2-03$ to 0. If you delete the user parameter setting values, you cannot set $A1-03 = 1110$ to initialize parameters.

■ o2-04: Drive Model (KVA) Selection

No. (Hex.)	Name	Description	Default (Range)
o2-04 (0508)	Drive Model (KVA) Selection	This parameter is automatically read from the connected drive. Do not change this parameter.	Determined by the drive (-)

Note:

When the setting value of $o2-04$ changes, related parameter setting values also change. Refer to [Defaults by Bypass and Drive Model on page 689](#) for more information.



■ o2-05: Home Mode Freq Ref Entry Mode

No. (Hex.)	Name	Description	Default (Setting Range)
o2-05 (0509)	Home Mode Freq Ref Entry Mode	Sets the function that makes it necessary to push  to use the keypad to change the frequency reference value while in Drive Mode.	0 (0, 1)

0 : ENTER Key Required

You must push  to use the keypad to change the frequency reference value.

1 : Immediate / MOP-style

The frequency reference changes when you enter it with the keypad. This then changes the output frequency. It is not necessary to push . The drive keeps the frequency reference for 5 seconds after you use  and  on the keypad to change the frequency reference value.

■ o2-06: Keypad Disconnect Detection

No. (Hex.)	Name	Description	Default (Range)
o2-06 (050A)	Keypad Disconnect Detection	Sets the function that stops the drive if you disconnect the keypad connection cable from the drive or if you damage the cable while the keypad is the Run command source.	1 (0, 1)

If the keypad installed to the drive is disconnected, this parameter will determine if the drive continues to operate.

This parameter is enabled in these conditions:

- $b1-02 = 0$ [Run Command Selection 1 = Keypad]
- In HAND Mode
- $Z1-39 = 0$ [Drive/Bypass Source Select = Keypad]
- Hand/Off/Auto control is from the keypad.

0 : Disabled

The drive continues operation if it detects a keypad disconnection.

1 : Enabled

When the drive detects a keypad disconnection, the drive detects oPr [Keypad Connection Fault], and stops operation. The motor coasts to stop.

■ o2-09: Region Code

No. (Hex.)	Name	Description	Default (Range)
o2-09 (050D)	Region Code	This parameter is read-only	1 (1)

■ o2-19: Parameter Write during Uv

No. (Hex.)	Name	Description	Default (Range)
o2-19 (061F)	Parameter Write during Uv	Enables and disables the function to change parameter settings during a Uv [DC Bus Undervoltage] condition.	0 (0, 1)

0 : Disabled

1 : Enabled

■ o2-24: LED Light Function Selection

No. (Hex.)	Name	Description	Default (Range)
o2-24 (11FE)	LED Light Function Selection	Sets the function to show the LED status rings and keypad LED lamps.	0 (0 - 2)

Note:

When you use A1-03 [Initialize Parameters] to initialize the drive, the drive will not reset this parameter.

0 : Enable Status Ring & Keypad LED

1 : LED Status Ring Disable

2 : Keypad LED Light Disable

■ o2-27: bCE Detection Selection

No. (Hex.)	Name	Description	Default (Range)
o2-27 (1565)	bCE Detection Selection	Sets drive operation if the Bluetooth device is disconnected when you operate the drive in Bluetooth Mode.	3 (0 - 4)

0 : Ramp to Stop

1 : Coast to Stop

2 : Fast Stop (Use C1-09)

3 : Alarm Only

4 : No Alarm Display

◆ o3: Copy Function

o3 parameters set the operation of the parameter backup function.

■ o3-01: Copy Keypad Function Selection

No. (Hex.)	Name	Description	Default (Range)
o3-01 (0515)	Copy Keypad Function Selection	Sets the function that saves and copies drive parameters to a different drive with the keypad.	0 (0 - 4)

0 : Copy Select

1 : Backup (drive → keypad)

The parameter setting values are read from the drive and saved in the keypad.

2 : Restore (keypad → drive)

Copies the parameter setting values saved in the keypad to a different drive.

3 : Verify (check for mismatch)

Makes sure that the parameter setting values in the drive agree with the parameters saved in the keypad.

4 : Erase (backup data of keypad)

Deletes the parameter setting values saved in the keypad.

■ o3-02: Copy Allowed Selection

No. (Hex.)	Name	Description	Default (Range)
o3-02 (0516)	Copy Allowed Selection	Sets the copy function when $o3-01 = 1$ [<i>Copy Keypad Function Selection = Backup (drive → keypad)</i>].	0 (0, 1)

Note:

When you select [Parameter Backup] on the keypad menu screen to do the backup function, the drive automatically sets $o3-02 = 1$.

0 : Disabled

1 : Enabled

■ o3-04: Select Backup/Restore Location

No. (Hex.)	Name	Description	Default (Range)
o3-04 (0B3E)	Select Backup/Restore Location	Sets the storage location for drive parameters when you back up and restore parameters. This parameter is only available on an HOA keypad.	0 (0 - 3)

You can use the HOA keypad to make a maximum of 4 parameter backup sets.

0 : Memory Location 1

1 : Memory Location 2

2 : Memory Location 3

3 : Memory Location 4

■ o3-06: Auto Parameter Backup Selection

No. (Hex.)	Name	Description	Default (Range)
o3-06 (0BDE)	Auto Parameter Backup Selection	Sets the function that automatically backs up parameters. This parameter is only available on an HOA keypad.	1 (0, 1)

When you connect the drive and keypad, the drive will automatically back up drive parameters to the keypad as specified by $o3-06$ and $o3-07$.

0 : Disabled

1 : Enabled

Note:

When you replace the HOA keypad then energize the drive, the keypad automatically shows the restore operation screen to restore the drive configuration with the parameters backed up to the HOA keypad. If you connect an HOA keypad that does not have parameter backup data, the keypad will not show the restore operation screen.

■ o3-07: Auto Parameter Backup Interval

No. (Hex.)	Name	Description	Default (Range)
o3-07 (0BDF)	Auto Parameter Backup Interval	Sets the interval at which the automatic parameter backup function saves parameters from the drive to the keypad.	1 (0 - 3)

The drive saves parameter settings to the keypad at these times:

1. After you energize the drive and the auto backup period passes.
2. When you use ROM enter or the keypad to change parameters, the drive saves those changes in the drive, waits for the auto backup period to pass, then saves those parameters in the keypad.

Note:

The drive can write data to the keypad a maximum of 100,000 times. If you write data to the keypad more than 100,000 times, you must replace the keypad.

0 : Every 10 minutes

1 : Every 30 minutes

2 : Every 60 minutes

3 : Every 12 hours

◆ o4: Maintenance Mon Settings

o4 parameters set the expected service life to help you know when to replace parts. The drive will show an alarm to tell you when the replacement part interval is near.

■ o4-01: Elapsed Operating Time Setting

No. (Hex.)	Name	Description	Default (Range)
o4-01 (050B)	Elapsed Operating Time Setting	Sets the initial value of the cumulative drive operation time in 10-hour units.	0 h (0 - 9999 h)

When you select *o4-01* on the keypad, it will show the current value of *U4-01* in units of 10 hours (h). When you change the setting of *o4-01* through the monitor, the *U4-01* count starts again as specified by the setting of *o4-01*.

Note:

Set this parameter in 10-hour (h) units. When *o4-01* = 30, *U4-01* [Cumulative Ope Time] = 300 h.

■ o4-02: Elapsed Operating Time Selection

No. (Hex.)	Name	Description	Default (Range)
o4-02 (050C)	Elapsed Operating Time Selection	Sets the condition that counts the cumulative operation time.	1 (0, 1)

0 : U4-01 Shows Total Power-up Time

Counts the time from when you energize drive to when you de-energize the drive.

1 : U4-01 Shows Total RUN Time

Counts the time that the drive outputs voltage.

■ o4-03: Fan Operation Time Setting

No. (Hex.)	Name	Description	Default (Range)
o4-03 (050E)	Fan Operation Time Setting	Sets the value from which to start the cumulative drive cooling fan operation time in 10-hour units.	0 h (0 - 9999 h)

Use monitor *U4-03* [Cooling Fan Ope Time] to view the total operation time of the cooling fan. When you replace a cooling fan, set *o4-03* = 0 to reset *U4-03*. Select *o4-03* on the keypad to show the current value of *U4-03* in 10-hour (h) units. If you use the monitor to change *o4-03*, the recount of *U4-03* starts with the *o4-03* setting.

Note:

The drive sets *o4-03* in 10-hour (h) units. When *o4-03* = 30, *U4-03* [Cooling Fan Ope Time] will show "300 h".

■ o4-05: Capacitor Maintenance Setting

No. (Hex.)	Name	Description	Default (Range)
o4-05 (051D)	Capacitor Maintenance Setting	Sets the <i>U4-05</i> [CapacitorMaintenance] monitor value.	0% (0 - 150%)

When you replace a drive, set *o4-05* = 0 to reset *U4-05*. When the *o4-05* setting changes, the count of *U4-05* starts again as specified by the setting of *o4-05*. After you complete the configuration, *o4-05* automatically resets to 0.

Note:

The maintenance period changes for different operating environments.

■ o4-07: Softcharge Relay Maintenance Set

No. (Hex.)	Name	Description	Default (Range)
o4-07 (0523)	Softcharge Relay Maintenance Set	Sets the U4-06 [PreChargeRelayMainte] monitor value.	0% (0 - 150%)

When you replace a drive, set o4-07 = 0 to reset U4-06. When the o4-07 setting changes, the count of U4-06 starts again as specified by the setting of o4-07. After you complete the configuration, o4-07 automatically resets to 0.

Note:

The maintenance period changes for different operating environments.

■ o4-09: IGBT Maintenance Setting

No. (Hex.)	Name	Description	Default (Range)
o4-09 (0525)	IGBT Maintenance Setting	Sets the U4-07 [IGBT Maintenance] monitor value.	0% (0 - 150%)

When you replace a drive, set o4-09 = 0 to reset U4-07. When the o4-09 setting changes, the count of U4-07 starts again as specified by the setting of o4-09. After you complete the configuration, o4-09 automatically resets to 0.

Note:

The maintenance period changes for different operating environments.

■ o4-11: Fault Trace/History Init (U2/U3)

No. (Hex.)	Name	Description	Default (Range)
o4-11 (0510)	Fault Trace/History Init (U2/U3)	Resets the records of Monitors U2-xx [Fault Trace] and U3-xx [Fault History].	0 (0, 1)

Note:

When you initialize the drive with A1-03 [Initialize Parameters], the drive will not reset the records for U2-xx and U3-xx.

0 : Disabled

Keeps the records of Monitors U2-xx and U3-xx.

1 : Enabled

Resets the records for Monitors U2-xx and U3-xx. After the reset, the drive automatically resets o4-11 to 0.

■ o4-12: kWh Monitor Initialization

No. (Hex.)	Name	Description	Default (Range)
o4-12 (0512)	kWh Monitor Initialization	Resets the monitor values for U4-10 [kWh, Lower 4 Digits] and U4-11 [kWh, Upper 5 Digits].	0 (0, 1)

Note:

When you initialize the drive with A1-03 [Initialize Parameters], the drive will not reset U4-10 and U4-11.

0 : No Reset

Keeps the monitor values for U4-10 and U4-11.

1 : Reset

Resets the values of U4-10 and U4-11. After the reset, the drive automatically resets o4-12 to 0.

■ o4-13: RUN Command Counter @ Initialize

No. (Hex.)	Name	Description	Default (Range)
o4-13 (0528)	RUN Command Counter @ Initialize	Resets the monitor values for <i>U4-02 [Num of Run Commands]</i> , <i>U4-24 [Number of Runs (Low)]</i> , and <i>U4-25 [Number of Runs (High)]</i> .	0 (0, 1)

0 : No Reset

Keeps the monitor values for *U4-02*, *U4-24*, and *U4-25*.

1 : Reset

Resets the values of *U4-02*, *U4-24*, and *U4-25*. After the reset, the drive automatically resets *o4-13* to 0.

■ o4-22: Time Format

No. (Hex.)	Name	Description	Default (Range)
o4-22 (154F) RUN	Time Format	Sets the time display format. This parameter is only available on an HOA keypad.	1 (0 - 2)

Sets the display of the time shown in the upper-left of the HOA keypad screen.

0 : 24 Hour Clock

1 : 12 Hour Clock

2 : 12 Hour JP Clock

■ o4-23: Date Format

No. (Hex.)	Name	Description	Default (Range)
o4-23 (1550) RUN	Date Format	Sets the date display format. This parameter is only available on an HOA keypad.	2 (0 - 2)

Sets the date format that the drive uses for the fault history and other records.

0 : YYYY/MM/DD

1 : DD/MM/YYYY

2 : MM/DD/YYYY

Note:

The Fault History in the Monitor Mode shows when faults occurred. Refer to [Show Fault History on page 149](#) for more information.

■ o4-24: bAT Detection Selection

No. (Hex.)	Name	Description	Default (Range)
o4-24 (310F) RUN	bAT Detection Selection	Sets operation when the drive detects <i>bAT [Keypad Battery Low Voltage]</i> and <i>TiM [Keypad Time Not Set]</i> .	0 (0 - 2)

0 : Disable

The drive will not detect *bAT* or *TiM*.

1 : Enable (Alarm Detected)

TiM or *bAT* shows on the keypad, and operation continues. The output terminal set for Alarm [*H2-01* to *H2-03* = 10] activates.

2 : Enable (Fault Detected)

The drive output shuts off and the motor coasts to stop. Fault relay output terminal MA-MC activates, and MB-MC deactivates.

◆ o5: Log Function

The data log function saves drive status information as a CSV file in the microSD memory card in the keypad. *Monitors Ux-xx* are the source of data log information. You can record a maximum of 10 monitors.

Change the HOA keypad screen from the main menu to the Diagnostic Tools screen and select the data log function. Set the number of the monitor to record and the sampling time, then start to record the data log.

Table 5.50 Setting Parameters for Data Log Items

No.	Name	Default	Data Log Monitors
<i>o5-03</i>	Log Monitor Data 1	101	<i>U1-01 [Frequency Reference]</i>
<i>o5-04</i>	Log Monitor Data 2	102	<i>U1-02 [Output Frequency]</i>
<i>o5-05</i>	Log Monitor Data 3	103	<i>U1-03 [Output Current]</i>
<i>o5-06</i>	Log Monitor Data 4	107	<i>U1-07 [DC Bus Voltage]</i>
<i>o5-07</i>	Log Monitor Data 5	108	<i>U1-08 [Output Power]</i>
<i>o5-08</i>	Log Monitor Data 6	000	Not selected
<i>o5-09</i>	Log Monitor Data 7	000	Not selected
<i>o5-10</i>	Log Monitor Data 8	000	Not selected
<i>o5-11</i>	Log Monitor Data 9	000	Not selected
<i>o5-12</i>	Log Monitor Data 10	000	Not selected

Note:

- Do not de-energize the drive or disconnect the keypad from the drive during log transfer communication. A loss of connection can cause the log function to fail after you restore power or connect the keypad
- You can use a microSDHC card that has a maximum of 32 GB capacity.

■ Log File Specifications

Item	Specification
File storage location	A folder called [Log_File] is created in the root directory of the micro SD card.
Filename	GLOG0xxx.csv Note: [xxx] identifies a 3-digit decimal number
Maximum number of files	999 (GLOG0001.csv to GLOG0999.csv)
Character code	ASCII code
Line break code	<CR><LF>
Separating character	[,] (Commas)
Header Rows	First Row: Drive information including Drive Model, software version, control method, and sampling time Second Row: Log data information including the monitor number, number decimal points, and unit code

■ Log File Configuration

The [Log_Files] folder is created in the root directory of the micro SD card. This is where the log data is stored as CSV files. Log data files are created in this configuration. The number of rows changes when the number of selected monitors change.

First row	Drive information
Second row	Log data information
Third row	Log data 1
:	Log data 2
:	Log data 3
:	:
Last row	Log data n

5.10 o: Keypad-Related Settings

Unit Code (Hex.)	Unit	Unit Code (Hex.)	Unit	Unit Code (Hex.)	Unit	Unit Code (Hex.)	Unit
02	RPM	0A	Ω	12	us	1A	–
03	%	0B	ms	13	min	1B	–
04	VAC	0C	kHz	14	°C	1C	–
05	VDC	0D	PSI	15	W	1D	–
06	A	0E	MPM	16	kWH	1E	–
07	sec	0F	FPM	17	MWH	1F	–

Third and Subsequent Rows: Log Data

This example shows the data text strings and data generated for the third row of log data.

Example of generated data:

02,0012,160107111239,1770,1770,00BE,0118,0028,0000,0000,0000,0000,0000,0000,0000C

No.	Item	Number of Characters	Description
1	Attribute	2	[02] shows that the record is a monitor data record.
2	File number	4	The [xxx] part of the [GLOG0xxx.csv] filename is a 3-digit decimal number in hexadecimal format.
3	Time stamp	12	Data log data was retrieved (YYMMDDHHMMSS)
4	Log Monitor Data 1	4	Monitor number selected by o5-03 [Log Monitor Data 1]
5	Log Monitor Data 2	4	Monitor number selected by o5-04 [Log Monitor Data 2]
:	:	:	:
13	Log Monitor Data 10	4	Monitor number selected by o5-12 [Log Monitor Data 10]
14	Reserved	4	-
15	Encoding data	4	Encoding data for log monitor data 1 through 10 (Hex.) Bits 0 through 9 show the encoding of log monitor data 1 through 10. A bit value of 1 shows that the data represents a negative value. (Log monitor data 1 through 10 is absolute value data without encoding) Example when log monitor data 2, 5, and 8 show negative values: Bits 1, 4, and 7 have values of 1, and the encoding data = 0010010010 (Bin.) = 0092 (Hex.)
16	File number	6	Row number (Hex.) in the data log file

■ o5-01: Log Start/Stop Selection

No. (Hex.)	Name	Description	Default (Range)
o5-01 (1551) RUN	Log Start/Stop Selection	Sets the data log function. This parameter is only available on an HOA keypad.	0 (0 - 1)

Note:

You must insert a compatible SD card into the keypad before you enable this parameter.

0 : OFF

Stops the data log.

1 : ON

Starts the data log as specified by the sampling cycle set in o5-02 [Log Sampling Interval].

■ o5-02: Log Sampling Interval

No. (Hex.)	Name	Description	Default (Range)
o5-02 (1552) RUN	Log Sampling Interval	Sets the data log sampling cycle. This parameter is only available on an HOA keypad.	100 ms (100 - 60000 ms)

■ o5-03: Log Monitor Data 1

No. (Hex.)	Name	Description	Default (Range)
o5-03 (1553) RUN	Log Monitor Data 1	Sets the data log monitor. This parameter is only available on an HOA keypad.	101 (000, 101 - 1212)

Note:

Set the *U monitor* number you want to log.

For example, to display *U1-01 [Frequency Reference]*, set *o5-03 = 101*. When it is not necessary to set a data log monitor, set this parameter to *000*.

■ o5-04: Log Monitor Data 2

No. (Hex.)	Name	Description	Default (Range)
o5-04 (1554) RUN	Log Monitor Data 2	Sets the data log monitor. This parameter is only available on an HOA keypad.	102 (000, 101 - 1212)

Note:

Set the *U monitor* number you will log.

For example, to show *U1-02 [Output Frequency]*, set *o5-04 = 102*. When it is not necessary to set data log monitor, set this parameter to *000*.

■ o5-05: Log Monitor Data 3

No. (Hex.)	Name	Description	Default (Range)
o5-05 (1555) RUN	Log Monitor Data 3	Sets the data log monitor. This parameter is only available on an HOA keypad.	103 (000, 101 - 1212)

Note:

Set the *U monitor* number you want to log.

For example, to show *U1-03 [Output Current]*, set *o5-05 = 103*. When it is not necessary to set a data log monitor, set this parameter to *000*.

■ o5-06: Log Monitor Data 4

No. (Hex.)	Name	Description	Default (Range)
o5-06 (1556) RUN	Log Monitor Data 4	Sets the data log monitor. This parameter is only available on an HOA keypad.	107 (000, 101 - 1212)

Note:

Set the *U monitor* number you want to log.

For example, to show *U1-07 [DC Bus Voltage]*, set *o5-06 = 107*. When it is not necessary to set a data log monitor, set this parameter to *000*.

■ o5-07: Log Monitor Data 5

No. (Hex.)	Name	Description	Default (Range)
o5-07 (1557) RUN	Log Monitor Data 5	Sets the data log monitor. This parameter is only available on an HOA keypad.	108 (000, 101 - 1212)

Note:

Set the *U monitor* number you want to log.

For example, to show *U1-08 [Output Power]*, set *o5-07 = 108*. When it is not necessary to set a data log monitor, set this parameter to *000*.

■ o5-08: Log Monitor Data 6

No. (Hex.)	Name	Description	Default (Setting Range)
o5-08 (1558) RUN	Log Monitor Data 6	Sets the data log monitor. This parameter is only available on an HOA keypad.	0 (000, 101 - 1212)

Note:

• Set the *U monitor* number you want to log.

For example, to display *U1-01 [Frequency Reference]*, set *o5-08 = 101*. When it is not necessary to set a data log monitor, set this parameter to 0.

■ o5-09: Log Monitor Data 7

No. (Hex.)	Name	Description	Default (Range)
o5-09 (1559) RUN	Log Monitor Data 7	Sets the data log monitor. This parameter is only available on an HOA keypad.	000 (000, 101 - 1212)

Note:

Set the *U monitor* number you will log.

For example, to show *U1-01 [Frequency Reference]*, set *o5-09 = 101*. When it is not necessary to set data log monitor, set this parameter to 000.

■ o5-10: Log Monitor Data 8

No. (Hex.)	Name	Description	Default (Range)
o5-10 (155A) RUN	Log Monitor Data 8	Sets the data log monitor. This parameter is only available on an HOA keypad.	000 (000, 101 - 1212)

Note:

Set the *U monitor* number you want to log.

For example, to display *U1-01 [Frequency Reference]*, set *o5-10 = 101*. When it is not necessary to set a data log monitor, set this parameter to 000.

■ o5-11: Log Monitor Data 9

No. (Hex.)	Name	Description	Default (Range)
o5-11 (155B) RUN	Log Monitor Data 9	Sets the data log monitor. This parameter is only available on an HOA keypad.	000 (000, 101 - 1212)

Note:

Set the *U monitor* number you want to log.

For example, to display *U1-01 [Frequency Reference]*, set *o5-11 = 101*. When it is not necessary to set a data log monitor, set this parameter to 000.

■ o5-12: Log Monitor Data 10

No. (Hex.)	Name	Description	Default (Range)
o5-12 (155C) RUN	Log Monitor Data 10	Sets the data log monitor. This parameter is only available on an HOA keypad.	000 (000, 101 - 1212)

Note:

Set the *U monitor* number you want to log.

For example, to display *U1-01 [Frequency Reference]*, set *o5-12 = 101*. When it is not necessary to set a data log monitor, set this parameter to 000.

5.11 S: Special Applications

S parameters set these functions:

- Dynamic Noise Control
- Sequence Run Timers
- PI2 Control
- HAND/OFF/AUTO Mode Operation
- Emergency Override Function

◆ S1: Dynamic Noise Control

The Dynamic Audible Noise Control Function suppresses the output voltage to decrease audible noise.

This function can help you quickly restore output voltage after an impact caused a sudden increase in the time constant. Dynamic Audible Noise Control is useful in applications where load impact is common. You cannot use $b8-01 = 1$ [*Energy Saving Control Selection = Enabled*] and $S1-01 = 1$ [*Dynamic Noise Control = Enabled*] at the same time.

■ Set Parameters for Dynamic Noise Control

1. Set $S1-01 = 1$ [*Dynamic Noise Control = Enabled*] to enable Dynamic Noise Control.

Note:

- When $S1-01 = 1$, the tolerance to an impact load will decrease compared to V/f Control without Energy Saving.
- You must disable Dynamic Noise Control for applications without an impact load.

The current level increases from the added load and improves the drive responsiveness.

2. Increase $S1-02$ [*Voltage Reduction Rate*] to make the flux stronger and increase the torque.

Note:

The Dynamic Noise Control function will decrease the load movement to a minimum level.

3. Decrease $S1-03$ [*Voltage Restoration Level*] and $S1-04$ [*Voltage Restoration Off Level*] to recover the voltage more quickly during the impact load conditions.

Note:

Under certain conditions, voltage stability may be unsatisfactory.

4. Decrease $S1-05$ [*Volt Restore Sensitivity Time K*] to decrease the voltage level and increase the voltage restoration speed when the load increase.
5. Decrease $S1-06$ [*Volt Restore Impact Load Time K*] to increase drive response to an impact load.

When the output voltage is unstable, increase these values to decrease the load response:

- Difference between $S1-03$ and $S1-04$
- $S1-05$
- $S1-06$

■ S1-01: Dynamic Noise Control

No. (Hex.)	Name	Description	Default (Range)
S1-01 (3200)	Dynamic Noise Control	Sets the function that decreases the output voltage in variable torque applications to decrease audible noise.	1 (0, 1)

0 : Disabled

1 : Enabled

■ S1-02: Voltage Reduction Rate

No. (Hex.)	Name	Description	Default (Range)
S1-02 (3201)	Voltage Reduction Rate	Sets the rate at which the drive will decrease the output voltage as a percentage of the V/f pattern when operating with no load.	50.0% (50.0 - 100.0%)

■ S1-03: Voltage Restoration Level

No. (Hex.)	Name	Description	Default (Range)
S1-03 (3202)	Voltage Restoration Level	Sets the level at which the drive will start to restore the voltage as a percentage of the drive rated torque.	20.0% (0.0 - 90.0%)

■ S1-04: Voltage Restoration Off Level

No. (Hex.)	Name	Description	Default (Range)
S1-04 (3203)	Voltage Restoration Off Level	Sets the level at which voltage restoration for the V/f pattern is complete as a percentage of the drive rated torque. If the output is more than <i>S1-04</i> , the drive will control the voltage as specified by the V/f pattern setting.	50.0% (10.0 - 100.0%)

Note:

The lower limit of this parameter is the value of *S1-03 [Voltage Restoration Level]* + 10.0%.

■ S1-05: Volt Restore Sensitivity Time K

No. (Hex.)	Name	Description	Default (Range)
S1-05 (3204)	Volt Restore Sensitivity Time K	Sets the level of sensitivity of the output torque and LPF time constant for the voltage reduction rate. You can adjust the level of sensitivity with the load response.	1.000 s (0.000 - 3.000 s)

■ S1-06: Volt Restore Impact Load Time K

No. (Hex.)	Name	Description	Default (Range)
S1-06 (3205)	Volt Restore Impact Load Time K	Sets the voltage restoration time constant when you add an impact load.	0.050 s (0.000 - 1.000 s)

■ S1-07: Output Phase Loss Level

No. (Hex.)	Name	Description	Default (Range)
S1-07 (324C)	Output Phase Loss Level	Decreases the output phase loss level when Dynamic Noise control is active.	100.0% (10.0 - 100.0%)

◆ S2: Sequence Run Timers

S2 parameters set the programmable run timers for Real Time Clock (RTC). The timers set the drive to start and stop automatically at specified times. You can set the timers to run daily, on weekdays, on weekends, or only on specific days of the week.

■ Sequence Timer 1

When the current time reaches the *S2-01 [Timer 1 Start Time]* value, the drive will do the *S2-04 [Timer 1 Sequence Selection]* action. When the current time reaches the *S2-02 [Timer 1 Stop Time]* value, the drive will stop the *S2-04* action. To use this function, set the current day in *S2-03 [Timer 1 Day Selection]*.

- When *S2-04 = 0 [Digital Out Only]* or the terminal set for *H1-xx = 51 [MFDI Function Selection = Sequence Timer Disable]* is active:

Sequence Timer 1 has no effect on the drive Run command. The drive starts correctly based on the status of the Run command source set in *b1-02 [Run Command Selection 1]*.

- When $S2-04 = 1$ or 2 [*Run or Run - PID Disable*] and the terminal set for $H1-xx = 51$ is not active:
The drive will run during the active time of Sequence Timer 1 when the drive has a Run command. The drive uses the frequency reference set in $S2-05$ [*Timer 1 Reference Source*]. When $S2-04 = 2$, PID control is disabled.

If you activate the input from the terminal set for $H1-xx = 52$ [*Sequence Timer Cancel*] while Sequence Timer 1 is active, the timer will be disabled until the next scheduled sequence timer occurrence. To enable Sequence Timer 1 again, disable and enable the drive Run command again. While Sequence Timer 1 is active, the terminal set for $H2-xx = 51$ [*MFDO Function Selection = Sequence Timer 1*] will be active regardless of the $S2-04$ setting.

When $S2-01 = S2-02$, Sequence Timer 1 is active continuously for the days set in $S2-03$. The timer will start at the $S2-01/S2-02$ time on the first day and stop at the same time on the last day. When you set only one day in $S2-03$, the timer will stop at 11:59 on that day. When $S2-03 = 1$ [*Daily*], the timer will run from the start/stop time until 11:59 every day.

HOA Keypad will show these messages to identify the status of the drive and Sequence Timer 1:

- Sequence Timer 1 RUN: S2-04 = 1 or 2*, Sequence Timer 1 is active and the drive is running.
- Sequence Timer OFF*: The drive has a Run command, $S2-04 = 1$ or 2 and Sequence Timer 1 is not active.

When the drive is in *Sequence Timer OFF* condition, the drive should not detect Uv [*DC Bus Undervoltage*] or ov [*Overvoltage*] fault, but only detect as an alarm.

Note:

If $S2-03 > 0$ and the HOA keypad is not connected, the drive will detect oPr [*Keypad Connection Fault*]. The $o2-06$ [*Keypad Disconnect Detection*] setting does not have an effect.

■ Sequence Timers 2 to 4

These timers operate identically to Sequence Timer 1. Parameters $S2-06$ [*Timer 2 Start Time*] to $S2-20$ [*Timer 4 Reference Source*] set Sequence Timers 2 to 4.

■ Priority

When more than one sequence timers overlap, the timer with the lowest number has priority.

- Sequence Timer 1 = highest priority
- Sequence Timer 4 = lowest priority

Note:

Jog Forward/Reverse has higher priority than any of the Sequence Timers.

Figure 5.91 shows an example of sequence timer operation when you set the drive parameters as specified in Table 5.52.

Table 5.52 Parameter Settings for Example of Sequence Timer 1

Tine Display Format	Sequence Timer 1	Sequence Timer 2	Sequence Timer 3	Sequence Timer 4
o4-22 = 0 [24 Hour Clock]	S2-01 = 05:00	S2-06 = 19:00	S2-11 = 06:00	S2-16 = 17:00
	S2-02 = 15:00	S2-07 = 22:00	S2-12 = 14:00	S2-17 = 21:00
	S2-03 = 2 [Mon - Fri]	S2-08 = 2 [Mon - Fri]	S2-13 = 3 [Sat - Sun]	S2-18 = 10 [Sunday]
	S2-04 = 1 [Run]	S2-09 = 2 [Run - PI Disable]	S2-14 = 1 [Run]	S2-19 = 0 [Digital Out Only]
	S2-05 = 0 [Operator (d1-01/YA-01)]	S2-10 = 1 [Operator (d1-02/YA-02)]	S2-15 = 2 [Operator (d1-03/YA-03)]	-

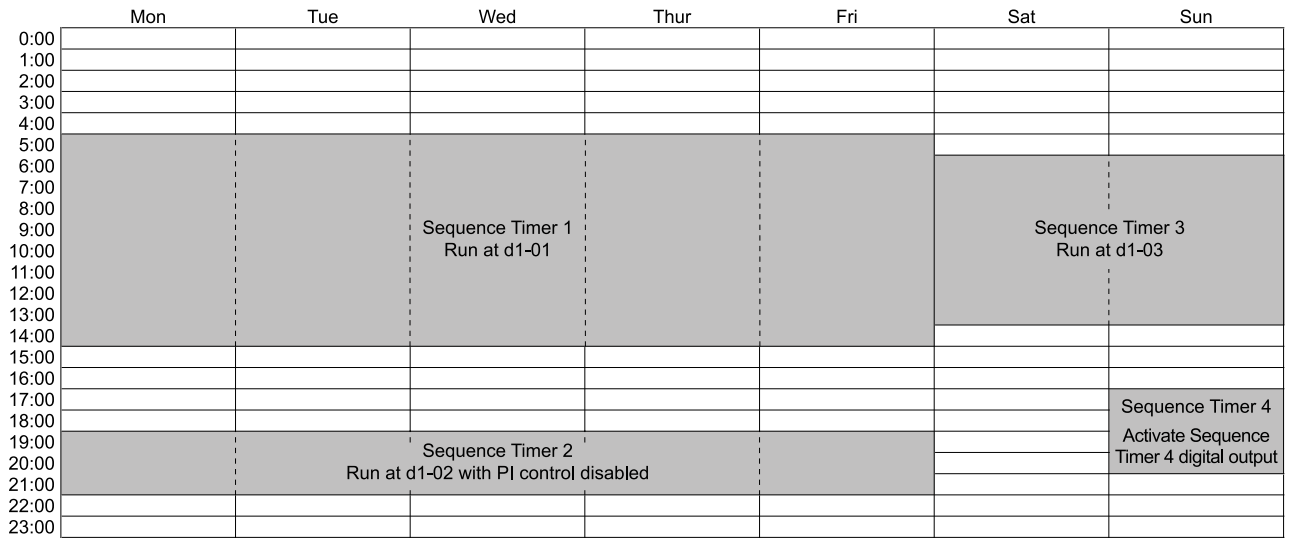

d1-01: Reference 1
d1-02: Reference 2

d1-03: Reference 3

Figure 5.91 Example of Sequence Timer 1

Figure 5.92 shows an example of sequence timer operation when you set the drive parameters as specified in Table 5.53.

Table 5.53 Parameter Settings for Example of Sequence Timer 2

Tine Display Format	Sequence Timer 1	Sequence Timer 2	Sequence Timer 3	Sequence Timer 4
o4-22 = 0 [24 Hour Clock]	S2-01 = 00:00	S2-06 = 06:00	-	-
	S2-02 = 00:00	S2-07 = 06:00	-	-
	S2-03 = 2 [Mon - Fri]	S2-08 = 3 [Sat - Sun]	S2-13 = 0 [Timer Disabled]	S2-18 = 10 [Timer Disabled]
	S2-04 = 1 [Run]	S2-09 = 1 [Run]	-	-
	S2-05 = 0 [Operator (d1-01/YA-01)]	S2-10 = 2 [Operator (d1-03/YA-03)]	-	-

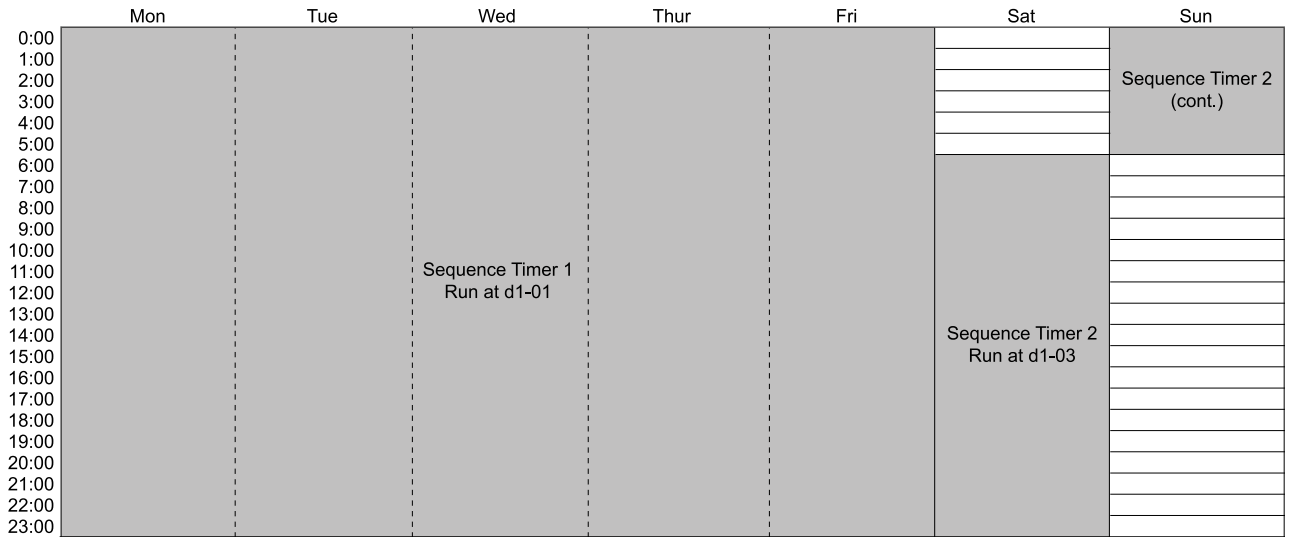

d1-01: Reference 1

d1-03: Reference 3

Figure 5.92 Example of Sequence Timer 2

Figure 5.93 shows an example of sequence timer operation when you set the drive parameters as specified in Table 5.54.

Table 5.54 Parameter Settings for Example of Sequence Timer 3

Tine Display Format	Sequence Timer 1	Sequence Timer 2	Sequence Timer 3	Sequence Timer 4
o4-22 = 0 [24 Hour Clock]	S2-01 = 05:00	S2-06 = 15:00	S2-11 = 09:00	-
	S2-02 = 15:00	S2-07 = 22:00	S2-12 = 24:00	-
	S2-03 = 2 [Mon - Fri]	S2-08 = 2 [Mon - Fri]	S2-13 = 9 [Saturday]	S2-18 = 0 [Timer Disabled]
	S2-04 = 1 [Run]	S2-09 = 2 [Run - PI Disable]	S2-14 = 1 [Run]	-
	S2-05 = 0 [Operator (d1-01/YA-01)]	S2-10 = 1 [Operator (d1-02/YA-02)]	S2-15 = 2 [Operator (d1-03/YA-03)]	-

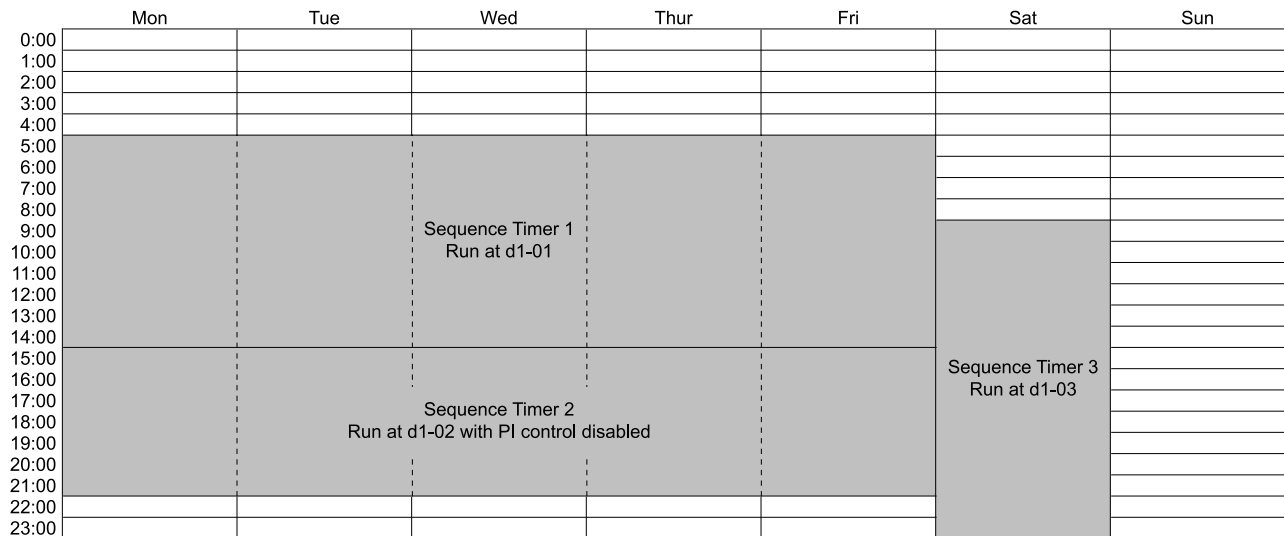

d1-01: Reference 1
d1-02: Reference 2

d1-03: Reference 3

Figure 5.93 Example of Sequence Timer 3

■ Sequence Timer Home Screen Text

When you set *o1-40 = 0 [Home Screen Display Selection = Custom Monitor]*, the message text on the Status Monitor will show the status of the Sequence Timer when the Sequence Timer has an effect on the drive Run condition.

- When you set the Sequence Timers to use for Digital Output only (*S2-04 [Timer 1 Sequence Selection]*, *S2-09 [Timer 2 Sequence Selection]*, *S2-14 [Timer 3 Sequence Selection]*, and *S2-19 [Timer 4 Reference Source] = 0 [Digital Out Only]*), the message text will not show the status of the Sequence Timer.
- When the drive uses the Sequence Timers to overwrite the Run command in AUTO (*S2-04*, *S2-09*, *S2-14*, or *S2-19 ≠ 0*), the drive will update the message text. Refer to [Table 5.55](#) for more information.

Table 5.55 Sequence Timer Home Screen Text

Status Monitor Display	Description
<pre> 10:00 am FWD Rdy Home OFF Seq Timer Set: wait for RUN Cmd Setpoint U5-99 % 80.00 Output Frequency U1-02 Hz 0.00 Menu </pre>	You set the Sequence Timers to operate the drive, but there is no Run command.
<pre> 10:00 am FWD Rdy Home AUTO Sequence Timer Active: IDLE Freq Reference U1-01 Hz 0.00 Output Frequency U1-02 Hz 0.00 Menu </pre>	You set the Sequence timers to operate the drive and applied the Run command, but the timer did not start.
<pre> 10:00 am FWD Rdy Home AUTO Sequence Timer 1: RUN Freq Reference U1-01 Hz 45.00 Output Frequency U1-02 Hz 45.00 Menu </pre>	You set the Sequence timers to operate the drive, applied the Run command, and the timer started to operate the drive. The message text shows the active timer number.

■ S2-01: Timer 1 Start Time

No. (Hex.)	Name	Description	Default (Range)
S2-01 (3206)	Timer 1 Start Time	Sets the start time for timer 1.	12:00 (12:00 AM - 11:59 PM)

Note:

- Default is when *o4-22 = 1 [Time Format = 12 Hour Clock]*. When *o4-22 = 0 [24 Hour Clock]*, default is 00:00. When *o4-22 = 2 [12 Hour JP Clock]*, default is 00:00 AM.
- Range is when *o4-22 = 1*. When *o4-22 = 0*, range is 00:00 to 24:00. When *o4-22 = 2*, range is 00:00 AM to 11:59 PM.

■ S2-02: Timer 1 Stop Time

No. (Hex.)	Name	Description	Default (Range)
S2-02 (3207)	Timer 1 Stop Time	Sets the stop time for timer 1.	12:00 (12:00 AM - 11:59 PM)

Note:

- Default is when *o4-22 = 1 [Time Format = 12 Hour Clock]*. When *o4-22 = 0 [24 Hour Clock]*, default is 00:00. When *o4-22 = 2 [12 Hour JP Clock]*, default is 00:00 AM.
- Range is when *o4-22 = 1*. When *o4-22 = 0*, range is 00:00 to 24:00. When *o4-22 = 2*, range is 00:00 AM to 11:59 PM.

■ S2-03: Timer 1 Day Selection

No. (Hex.)	Name	Description	Default (Range)
S2-03 (3208)	Timer 1 Day Selection	Sets the days for which sequence timer 1 is active.	0 (0 - 10)

0 : Timer Disabled

1 : Daily

2 : Mon - Fri

3 : Sat - Sun

4 : Monday

- 5 : Tuesday**
6 : Wednesday
7 : Thursday
8 : Friday
9 : Saturday
10 : Sunday

■ S2-04: Timer 1 Sequence Selection

No. (Hex.)	Name	Description	Default (Range)
S2-04 (3209)	Timer 1 Sequence Selection	Sets the drive response when sequence timer 1 is active.	0 (0 - 2)

0 : Digital Out Only

1 : Run

2 : Run - PID Disable

3 : Allow Alternation

■ S2-05: Timer 1 Reference Source

No. (Hex.)	Name	Description	Default (Range)
S2-05 (320A)	Timer 1 Reference Source	Selects the frequency reference source to run the drive when sequence timer 1 is active (only applicable when $S2-04 > 0$ [Timer 1 Sequence Selection \neq Digital Out Only]).	0 (0 - 8)

0 : Operator (d1-01/YA-01)

1 : Operator (d1-02/YA-02)

2 : Operator (d1-03/YA-03)

3 : Operator (d1-04/YA-04)

4 : Terminals

5 : Serial Com

6 : Option PCB

8 : Set by b1-01

Note:

For reference source 0 to 3, the drive will use $d1-xx$ frequency reference when PID mode is disabled and $YA-xx$ setpoint when PID is enabled.

■ S2-06: Timer 2 Start Time

No. (Hex.)	Name	Description	Default (Range)
S2-06 (320B)	Timer 2 Start Time	Sets the start time for timer 2.	12:00 (12:00 AM - 11:59 PM)

Note:

• Default is when $o4-22 = 1$ [Time Format = 12 Hour Clock]. When $o4-22 = 0$ [24 Hour Clock], default is 00:00. When $o4-22 = 2$ [12 Hour JP Clock], default is 00:00 AM.

• Range is when $o4-22 = 1$. When $o4-22 = 0$, range is 00:00 to 24:00. When $o4-22 = 2$, range is 00:00 AM to 11:59 PM.

■ S2-07: Timer 2 Stop Time

No. (Hex.)	Name	Description	Default (Range)
S2-07 (320C)	Timer 2 Stop Time	Sets the stop time for timer 2.	12:00 (12:00 AM - 11:59 PM)

Note:

- Default is when $o4-22 = 1$ [Time Format = 12 Hour Clock]. When $o4-22 = 0$ [24 Hour Clock], default is 00:00. When $o4-22 = 2$ [12 Hour JP Clock], default is 00:00 AM.
- Range is when $o4-22 = 1$. When $o4-22 = 0$, range is 00:00 to 24:00. When $o4-22 = 2$, range is 00:00 AM to 11:59 PM.

■ S2-08: Timer 2 Day Selection

No. (Hex.)	Name	Description	Default (Range)
S2-08 (320D)	Timer 2 Day Selection	Sets the days for which sequence timer 2 is active.	0 (0 - 10)

0 : Timer disabled**1 : Daily****2 : Mon - Fri****3 : Sat - Sun****4 : Monday****5 : Tuesday****6 : Wednesday****7 : Thursday****8 : Friday****9 : Saturday****10 : Sunday****■ S2-09: Timer 2 Sequence Selection**

No. (Hex.)	Name	Description	Default (Range)
S2-09 (320E)	Timer 2 Sequence Selection	Sets the drive response when sequence timer 2 is active.	0 (0 - 2)

0 : Digital Out Only**1 : Run****2 : Run - PID Disable****3 : Allow Alternation****■ S2-10: Timer 2 Reference Source**

No. (Hex.)	Name	Description	Default (Range)
S2-10 (320F)	Timer 2 Reference Source	Selects the frequency reference source to run the drive when sequence timer 2 is active (only applicable when $S2-09 > 0$ [Timer 2 Sequence Selection $\neq 0$]).	0 (0 - 8)

0 : Operator (d1-01/YA-01)**1 : Operator (d1-02/YA-02)****2 : Operator (d1-03/YA-03)****3 : Operator (d1-04/YA-04)****4 : Terminals****5 : Serial Com****6 : Option PCB****8 : Set by b1-01****Note:**

For reference source 0 to 3, the drive will use $d1-xx$ frequency reference when PID mode is disabled and $YA-xx$ setpoint when PID is enabled.

■ S2-11: Timer 3 Start Time

No. (Hex.)	Name	Description	Default (Range)
S2-11 (3210)	Timer 3 Start Time	Sets the start time for timer 3.	12:00 (12:00 AM - 11:59 PM)

Note:

- Default is when $o4-22 = 1$ [Time Format = 12 Hour Clock]. When $o4-22 = 0$ [24 Hour Clock], default is 00:00. When $o4-22 = 2$ [12 Hour JP Clock], default is 00:00 AM.
- Range is when $o4-22 = 1$. When $o4-22 = 0$, range is 00:00 to 24:00. When $o4-22 = 2$, range is 00:00 AM to 11:59 PM.

■ S2-12: Timer 3 Stop Time

No. (Hex.)	Name	Description	Default (Range)
S2-12 (3211)	Timer 3 Stop Time	Sets the stop time for timer 3.	12:00 (12:00 AM - 11:59 PM)

Note:

- Default is when $o4-22 = 1$ [Time Format = 12 Hour Clock]. When $o4-22 = 0$ [24 Hour Clock], default is 00:00. When $o4-22 = 2$ [12 Hour JP Clock], default is 00:00 AM.
- Range is when $o4-22 = 1$. When $o4-22 = 0$, range is 00:00 to 24:00. When $o4-22 = 2$, range is 00:00 AM to 11:59 PM.

■ S2-13: Timer 3 Day Selection

No. (Hex.)	Name	Description	Default (Range)
S2-13 (3212)	Timer 3 Day Selection	Sets the days for which sequence timer 3 is active.	0 (0 - 10)

0 : Timer Disabled

1 : Daily

2 : Mon - Fri

3 : Sat - Sun

4 : Monday

5 : Tuesday

6 : Wednesday

7 : Thursday

8 : Friday

9 : Saturday

10 : Sunday

■ S2-14: Timer 3 Sequence Selection

No. (Hex.)	Name	Description	Default (Range)
S2-14 (3213)	Timer 3 Sequence Selection	Sets the drive response when sequence timer 3 is active.	0 (0 - 2)

0 : Digital Out Only

1 : Run

2 : Run - PID Disable

3 : Allow Alternation

■ S2-15: Timer 3 Reference Source

No. (Hex.)	Name	Description	Default (Range)
S2-15 (3214)	Timer 3 Reference Source	Selects the frequency reference source to run the drive when sequence timer 3 is active (only applicable when $S2-14 > 0$ [Timer 3 Sequence Selection ≠ Digital Out Only]).	0 (0 - 8)

0 : Operator (d1-01/YA-01)

1 : Operator (d1-02/YA-02)

2 : Operator (d1-03/YA-03)

3 : Operator (d1-04/YA-04)

4 : Terminals

5 : Serial Com

6 : Option PCB

8 : Set by b1-01

Note:

For reference source 0 to 3, the drive will use *d1-xx* frequency reference when PID mode is disabled and *YA-xx* setpoint when PID is enabled.

■ S2-16: Timer 4 Start Time

No. (Hex.)	Name	Description	Default (Range)
S2-16 (3215)	Timer 4 Start Time	Sets the start time for timer 4.	12:00 (12:00 AM - 11:59 PM)

Note:

- Default is when $o4-22 = 1$ [Time Format = 12 Hour Clock]. When $o4-22 = 0$ [24 Hour Clock], default is 00:00. When $o4-22 = 2$ [12 Hour JP Clock], default is 00:00 AM.
- Range is when $o4-22 = 1$. When $o4-22 = 0$, range is 00:00 to 24:00. When $o4-22 = 2$, range is 00:00 AM to 11:59 PM.

■ S2-17: Timer 4 Stop Time

No. (Hex.)	Name	Description	Default (Range)
S2-17 (3216)	Timer 4 Stop Time	Sets the stop time for timer 4.	12:00 (12:00 AM - 11:59 PM)

Note:

- Default is when $o4-22 = 1$ [Time Format = 12 Hour Clock]. When $o4-22 = 0$ [24 Hour Clock], default is 00:00. When $o4-22 = 2$ [12 Hour JP Clock], default is 00:00 AM.
- Range is when $o4-22 = 1$. When $o4-22 = 0$, range is 00:00 to 24:00. When $o4-22 = 2$, range is 00:00 AM to 11:59 PM.

■ S2-18: Timer 4 Day Selection

No. (Hex.)	Name	Description	Default (Range)
S2-18 (3217)	Timer 4 Day Selection	Sets the days for which sequence timer 4 is active.	0 (0 - 10)

0 : Timer disabled

1 : Daily

2 : Mon - Fri

3 : Sat - Sun

4 : Monday

5 : Tuesday

6 : Wednesday

7 : Thursday

8 : Friday

9 : Saturday

10 : Sunday

■ S2-19: Timer 4 Sequence Selection

No. (Hex.)	Name	Description	Default (Range)
S2-19 (3218)	Timer 4 Sequence Selection	Sets the drive response when sequence timer 4 is active.	0 (0 - 2)

0 : Digital Out Only

1 : Run

2 : Run - PID Disable

3 : Allow Alternation

■ S2-20: Timer 4 Reference Source

No. (Hex.)	Name	Description	Default (Range)
S2-20 (3219)	Timer 4 Reference Source	Selects the frequency reference source to run the drive when sequence timer 4 is active (only applicable when $S2-19 > 0$ [Timer 4 Sequence Selection ≠ Digital Out Only]).	0 (0 - 8)

0 : Operator (d1-01/YA-01)

1 : Operator (d1-02/YA-02)

2 : Operator (d1-03/YA-03)

3 : Operator (d1-04/YA-04)

4 : Terminals

5 : Serial Com

6 : Option PCB

8 : Set by b1-01

Note:

For reference source 0 to 3, the drive will use $d1-xx$ frequency reference when PID mode is disabled and $YA-xx$ setpoint when PID is enabled.

◆ S3: PI2 Control

$S3$ parameters set the PI2 Control function. You can use this function to monitor the input, setpoint, feedback and output levels of the PI2 Control through several additional monitors. You can also set the drive to activate certain MFDO terminals when the PI2 feedback level is less than or more than a set value. The difference between the target and the feedback value (deviation) is fed into the PI controller and the PI controller outputs the frequency to $U5-xx$ for monitoring. Refer to [b5: PID Control on page 203](#) for more information.

■ PI2 Control Setpoint and Feedback

PI2 Control has three ways to set the target setpoint. This is the order of the input setpoints from most important to least important:

- MEMOBUS setpoint: 000DH (while 000FH, bit 4 = 1)
- Analog setpoint: $H3-xx = 25$ [MFAI Function Selection = PI2 Control Setpoint]
- Digital setpoint: $S3-05$ [PI2 Control Setpoint]

For the feedback, PI2 Control only has analog setting $H3-xx = 26$ [PI2 Control Feedback] as the feedback level.

■ PI2 Control Monitors

These monitors will work as the PI2 Control monitors for the setpoint, feedback, input, and output:

- $U5-17$ [PI2 Control Setpoint]: Uses the target setpoint, which is set as specified by the setpoint source the drive will use.
- $U5-18$ [PI2 Control Feedback]: Uses an analog input when $H3-xx = 26$ [PI2 Control Feedback].

- U5-19 [PI2 Control Input]: Input into the proportional and integral calculation as specified by the target setpoint and feedback.
- U5-20 [PI2 Control Output]: Different for different S3-01 [PI2 Control Enable Selection] and S3-12 [PI2 Control Disable Mode Sel] settings.
 - When S3-01 > 0 [Enabled], the drive will show the calculated PI2 Control output.
 - When S3-01 = 0 [Disabled], S3-12 [PI2 Control Disable Mode Sel] will set what to show.

■ **PI2 Control Block Diagram**

Figure 5.94 shows the general overview for the PI2 Control.

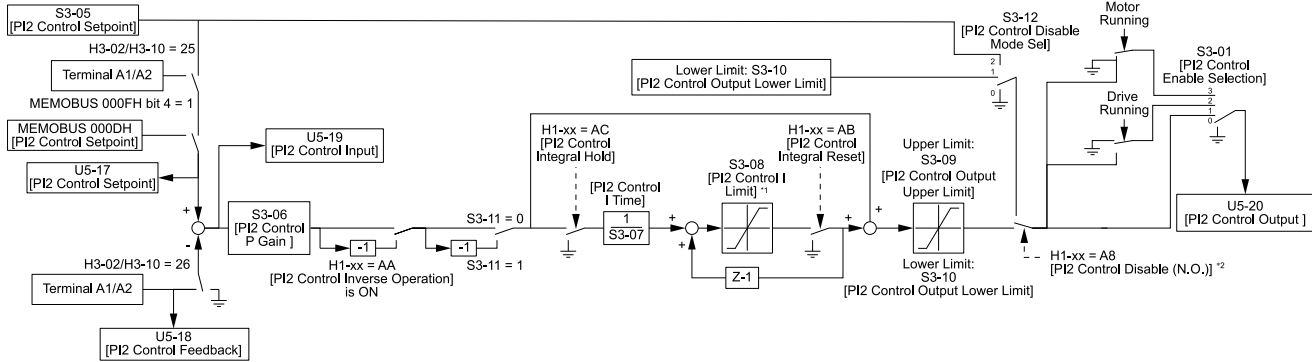

Figure 5.94 PI2 Control Block Diagram

- *1 The drive calculates the actual integral limit as:
 - Upper limit = Min (S3-08, S3-09 - PI2 P portion)
 - Lower limit = Min (-S3-08, S3-10 - PI2 P portion)
- *2 When the MFDI set for H1-xx = A8 [MFDI Function Selection = PI2 Control Disable] is activated, you must set the PI Integrator as:
 - S3-12 = 1 [Lower Limit (S3-10)]: PI Value = S3-10
 - S3-12 = 2 [Setpoint]: PI Value = S3-05

■ **S3-01: PI2 Control Enable Selection**

No. (Hex.)	Name	Description	Default (Range)
S3-01 (321A)	PI2 Control Enable Selection	Sets when the PI2 Control function is enabled:	0 (0 - 3)

0 : Disabled

1 : Always

PI2 Control is always active.

2 : Drive Running

PI2 Control is active only when the drive is running.

3 : Motor Running

PI2 Control is active when the drive receives a Run command and is not in baseblock, DC injection, or zero speed.

■ **S3-02: PI2 Control Transducer Scale**

No. (Hex.)	Name	Description	Default (Range)
S3-02 (321B) RUN	PI2 Control Transducer Scale	Sets the full scale (10 V or 20 mA) output of the pressure transducer that is connected to the analog input terminals programmed for PI2 (Setpoint or Feedback).	100.00 (1.00 - 600.00)

Note:

Parameters S3-04 [PI2 Control Unit Selection], S3-03 [PI2 Control Decimal Place Pos], and S3-02 [PI2 Control Transducer Scale] set the unit, resolution, and upper limit.

■ S3-03: PI2 Control Decimal Place Pos

No. (Hex.)	Name	Description	Default (Range)
S3-03 (321C) RUN	PI2 Control Decimal Place Pos	Sets the decimal place display for secondary PI units.	2 (0 - 3)

0 : No Decimal Places (XXXXX)

1 : One Decimal Places (XXXX.X)

2 : Two Decimal Places (XXX.XX)

3 : Three Decimal Places (XX.XXX)

■ S3-04: PI2 Control Unit Selection

No. (Hex.)	Name	Description	Default (Range)
S3-04 (321D) RUN	PI2 Control Unit Selection	Sets the units displayed for the PI2 Control parameters and monitor.	48 (0 - 50)

0 : "WC: inches of water column

1 : PSI: pounds per square inch

2 : GPM: gallons/min

3 : °F: Fahrenheit

4 : ft³/min: cubic feet/min

5 : m³/h: cubic meters/hour

6 : L/h: liters/hour

7 : L/s: liters/sec

8 : bar: bar

9 : Pa: Pascal

10 : °C: Celsius

11 : m: meters

12 : ft: feet

13 : L/min: liters/min

14 : m³/min: cubic meters/min

15 : "Hg: Inch Mercury

16 : kPa: kilopascal

48 : %: Percent

49 : Custom(S3-18~20)

50 : None

■ S3-05: PI2 Control Setpoint

No. (Hex.)	Name	Description	Default (Range)
S3-05 (321E) RUN	PI2 Control Setpoint	Sets the PI2 Control target setpoint.	0.00 (0.00 - 600.00)

Note:

Parameters S3-04 [PI2 Control Unit Selection], S3-03 [PI2 Control Decimal Place Pos], and S3-02 [PI2 Control Transducer Scale] set the unit, resolution, and upper limit.

■ S3-06: PI2 Control Proportional Gain

No. (Hex.)	Name	Description	Default (Range)
S3-06 (321F) RUN	PI2 Control Proportional Gain	Sets the proportional gain of the PI2 Control. Set this parameter to 0.00 to disable proportional control.	1.00 (0.00 - 25.00)

■ S3-07: PI2 Control Integral Time

No. (Hex.)	Name	Description	Default (Range)
S3-07 (3220) RUN	PI2 Control Integral Time	Sets the integral time for the suction pressure control. Set this parameter to 0.00 to disable the integrator.	1.0 s (0.0 - 360.0 s)

■ S3-08: PI2 Control Integral Max Limit

No. (Hex.)	Name	Description	Default (Range)
S3-08 (3221) RUN	PI2 Control Integral Max Limit	Sets the maximum output possible from the integrator.	100.0% (0.0 - 100.0%)

■ S3-09: PI2 Control Output Upper Limit

No. (Hex.)	Name	Description	Default (Range)
S3-09 (3222) RUN	PI2 Control Output Upper Limit	Sets the maximum output possible from the PI Auxiliary Control function.	100.0% (0.0 - 100.0%)

■ S3-10: PI2 Control Output Lower Limit

No. (Hex.)	Name	Description	Default (Range)
S3-10 (3223) RUN	PI2 Control Output Lower Limit	Sets the minimum output possible from the PI Auxiliary Control function.	0.0% (-100.0 - +100.0%)

■ S3-11: PI2 Control Output Level Sel

No. (Hex.)	Name	Description	Default (Range)
S3-11 (3224)	PI2 Control Output Level Sel	Sets the PI2 controller output direction.	0 (0, 1)

0 : Direct Acting (Normal Output)

When the feedback is higher than the setpoint, the speed decreases.

1 : Inverse Acting (Reverse Output)

When the feedback is lower than the setpoint, the speed decreases.

■ S3-12: PI2 Control Disable Mode Sel

No. (Hex.)	Name	Description	Default (Range)
S3-12 (3225) RUN	PI2 Control Disable Mode Sel	Sets what U5-20 [PI2 Control Output] will output when disabled.	0 (0 - 2)

0 : No Output (0%)

U5-20 will show only 0.

1 : Lower Limit (S3-10)

U5-20 will show the lower limit of the PI2 Control Output set with S3-10 [PI2 Control Output Lower Limit].

2 : Setpoint

U5-20 will show the target setpoint of the PI2 Control that aligns with U5-18 [PI2 Control Feedback].

■ S3-13: PI2 Control Low Feedback Lvl

No. (Hex.)	Name	Description	Default (Range)
S3-13 (3226) RUN	PI2 Control Low Feedback Lvl	Sets the secondary PI low feedback detection level.	0.00 (0.00 - 600.00)

Note:

Parameters S3-04 [PI2 Control Unit Selection], S3-03 [PI2 Control Decimal Place Pos], and S3-02 [PI2 Control Transducer Scale] set the unit, resolution, and upper limit.

■ S3-14: PI2 Control Low Feedback Time

No. (Hex.)	Name	Description	Default (Range)
S3-14 (3227) RUN	PI2 Control Low Feedback Time	Sets the secondary PI low feedback detection delay time in seconds.	1.0 s (0.0 - 25.5 s)

■ S3-15: PI2 Control High Feedback Lvl

No. (Hex.)	Name	Description	Default (Range)
S3-15 (3228) RUN	PI2 Control High Feedback Lvl	Sets the secondary PI high feedback detection level.	100.00 (0.00 - 600.00)

Note:

Parameters S3-04 [PI2 Control Unit Selection], S3-03 [PI2 Control Decimal Place Pos], and S3-02 [PI2 Control Transducer Scale] set the unit, resolution, and upper limit.

■ S3-16: PI2 Control High Feedback Time

No. (Hex.)	Name	Description	Default (Range)
S3-16 (3229) RUN	PI2 Control High Feedback Time	Sets the secondary PI high feedback detection delay time in seconds.	1.0 s (0.0 - 25.5 s)

■ S3-17: PI2 Control Feedback Det Sel

No. (Hex.)	Name	Description	Default (Range)
S3-17 (322A) RUN	PI2 Control Feedback Det Sel	Sets when the low and high feedback detection multifunction outputs (71h and 72h) for PI2 Control are active.	0 (0, 1)

0 : While PI2 Control Enabled

Low and high feedback level detection are active only when PI2 Control is active.

1 : Always

Low and high feedback level detection are always active.

Note:

Feedback level detection compares PI2 Control Feedback from analog input $H3-xx = 26$ [MFAI Function Selection = PI2 Control Feedback] to these parameters:

- $S3-13$ [PI2 Control Low Feedback Lvl] for low feedback level detection
- $S3-15$ [PI2 Control High Feedback Lvl] for high feedback level detection

■ **S3-18: PI2 Control Custom Unit 1**

No. (Hex.)	Name	Description	Default (Range)
S3-18 (322B) RUN	PI2 Control Custom Unit 1	Sets the first character of the PI2 Control custom unit display when $S3-04 = 49$ [PI2 Control Unit Selection = Custom(S3-18-20)].	41 (20 - 7A)

■ **S3-19: PI2 Control Custom Unit 2**

No. (Hex.)	Name	Description	Default (Range)
S3-19 (322C) RUN	PI2 Control Custom Unit 2	Sets the second character of the PI2 Control custom unit display when $S3-04 = 49$ [PI2 Control Unit Selection = Custom(S3-18-20)].	41 (20 - 7A)



■ **S3-20: PI2 Control Custom Unit 3**

No. (Hex.)	Name	Description	Default (Range)
S3-20 (322D) RUN	PI2 Control Custom Unit 3	Sets the third character of the PI2 Control custom unit display when $S3-04 = 49$ [PI2 Control Unit Selection = Custom(S3-18-20)].	41 (20 - 7A)

◆ **S5: Hand/Off/Auto Operation**

$S5$ parameters work together with $b1-01$, $b1-02$, and the bypass multi-function inputs to set the drive operation in HAND, OFF, or AUTO Mode.

Table 5.56 Definitions of Each Mode

Operation Mode	Description
AUTO	The drive operates as specified by the frequency reference and Run command from the sources set in $b1-01$ [Frequency Reference Selection 1] and $b1-02$ [Run Command Selection 1]. You can use the  to select AUTO Mode, or you can use a multi-function digital input.
HAND	The drive operates as specified by the frequency reference from the source set in $S5-01$ [HAND Frequency Reference Source]. You can use the  to select HAND Mode, or you can use a multi-function digital input.
OFF	The drive is stopped and will not run until you activate the MFDI set for $Z2-xx = 25, 26, \text{ or } 44$ [MFDI Function selection = Emergency Override Bypass, Emergency Override Drive (FWD) or Emergency Override Drive (REV)].

The Emergency Override function (Drive or Bypass) will force the drive to run. Operation mode does not have an effect. Refer to [Emergency Override on page 392](#) for details on Emergency Override.

You can use $Z1-06$ [Power Up Mode] to set which mode the drive will enter when it is first powered up.











Parameter $S5-02$ [HAND/AUTO Switchover During Run] sets the drive to change between HAND and AUTO Modes during run. When $S5-02 = 1$ [Enabled] and you push  or , the drive will change between HAND and AUTO Modes.

Table 5.57 PID (Process Control) Operation for Each Mode

Operation Mode	Description
AUTO	During AUTO operation, either a frequency reference or the process (Proportional Integral Derivative) controller can determine the speed of the drive. Parameter $b5-01$ [PID Mode Setting] enables PID operation during AUTO mode. The $b5$ [PID Control] parameters configure the PID controller.
HAND	During HAND operation, either a frequency reference or the process (PID) controller can determine the speed of the drive. Parameter $S5-03$ [HAND Mode PID Selection] enables PID operation during HAND mode. The $b5$ [PID Control] parameters configure the PID controller.

In the bypass, you can set Hand/Off/Auto to operate from the keypad or from the multi-function digital inputs. Setting the multi-function digital inputs to HAND and/or AUTO will take H/O/A control from the keypad. Refer to [Table 5.58](#) for information about the different H/O/A configurations and the correct parameter settings.

Table 5.58 Hand/Off/Auto Configurations

H/O/A Configuration	H/O/A Control Source	Description	b1-02 Setting	Diagram
Normal (default)	Keypad	Requires the drive to be in AUTO Mode before it will accept a Run command. Use  ,  , and  to change between HAND, OFF, and AUTO modes. For HAND mode, a Run command is not necessary. Switch into HAND mode to run the drive. Note: Do not program any digital inputs to HAND or AUTO.	7, 8, or 9	Figure 5.95
Forced AUTO	Keypad	Requires only a Run command. A Run command will automatically force the drive into AUTO Mode. To run the drive in AUTO, make sure that the drive is in STOP Mode, then do an OFF to ON transition of the Run command. Press  to put the drive into HAND mode (a Run command is not necessary). Press  to put the drive in OFF mode and stop the drive. Note: Do not program any digital inputs to HAND or AUTO.	1, 2, or 3	Figure 5.96
Keypad	Keypad	Full control from the keypad. <ul style="list-style-type: none"> Press  to make the drive run in AUTO Mode. Press  to make the drive run in HAND Mode. Press  to stop the drive. Note: Do not program any digital inputs to HAND or AUTO.	0	Figure 5.97
Normal with External HOA	Digital Inputs (2)	Requires an AUTO command from a digital input before the drive will accept a Run command. This mode is suitable for applications that use an external Hand/Off/Auto switch. Requires a HAND command from a digital input before the drive will run in HAND Mode. It is not possible to transition directly between HAND and AUTO Modes. You must enter STOP Mode first. Note: It is necessary to set these parameters: <ul style="list-style-type: none"> Z2-0x [Digital Input x Function (TB2-x)] = 31 [HAND Select] Z2-0x [Digital Input x Function (TB2-x)] = 32 [AUTO Select] 	7, 8, or 9	Figure 5.98
Forced AUTO with External HOA	Digital Input (1)	Requires only a Run command. A Run command will automatically force the drive into AUTO Mode. This mode is suitable for applications that use a single external switch to change between HAND and AUTO modes. It is possible to switch directly between HAND and AUTO Modes. Requires a HAND command from a digital input before the drive will run in HAND mode. Note: It is necessary to set Z2-0x [Digital Input x Function (TB2-x)] = 31 [HAND Select].	1, 2, or 3	Figure 5.99

■ H/O/A Configuration Diagrams

The diagrams in this section show operation for factory default and when only the listed parameters are changed.

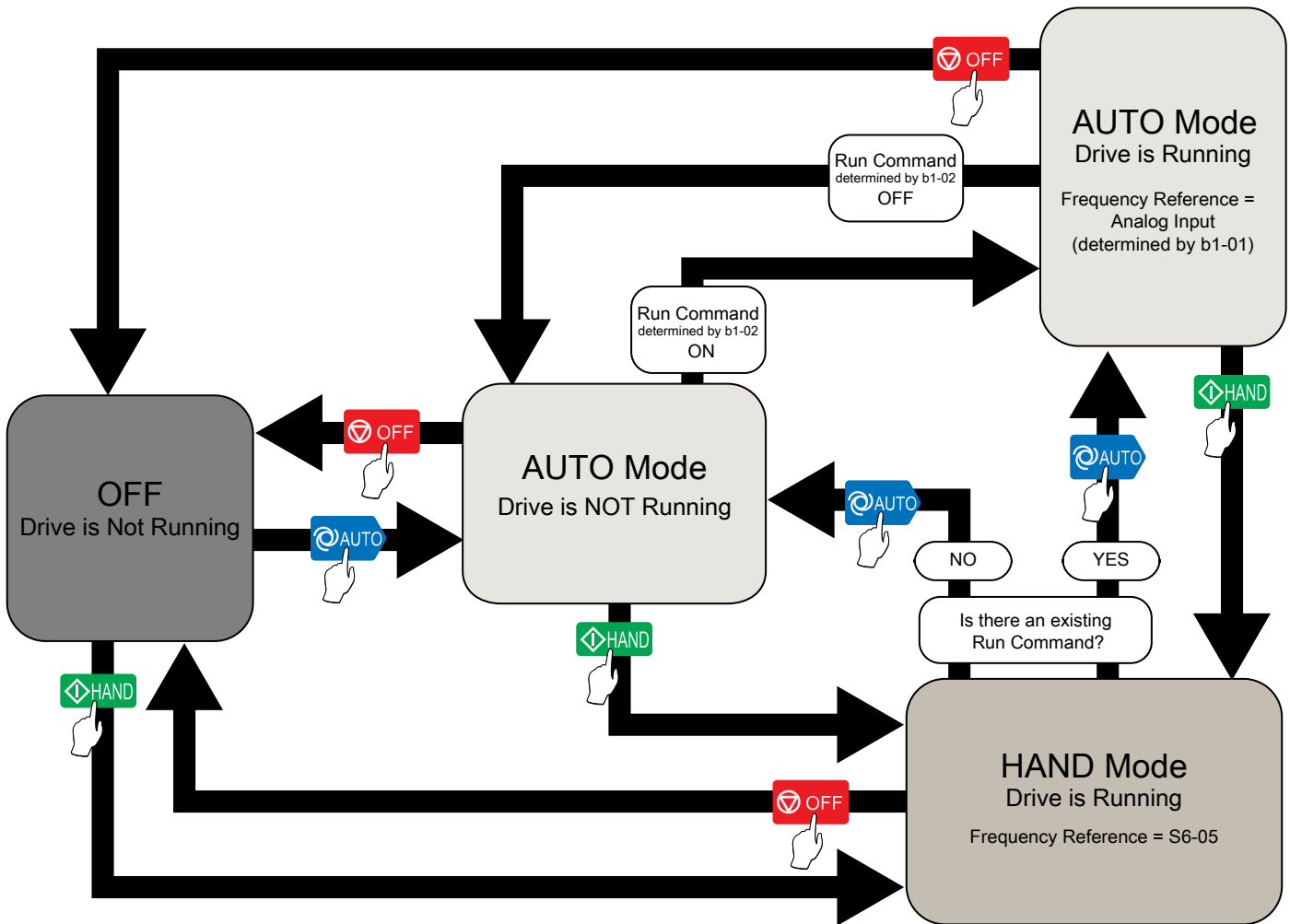

- AUTO command and Run command are necessary
- Keypad controls H/O/A
- $b1-02 = 7$ [AUTO + Terminals], 8 [AUTO + Serial], or 9 [AUTO + Option]

Figure 5.95 Normal H/O/A Configuration (Default) (b1-02 = 7, 8, or 9)

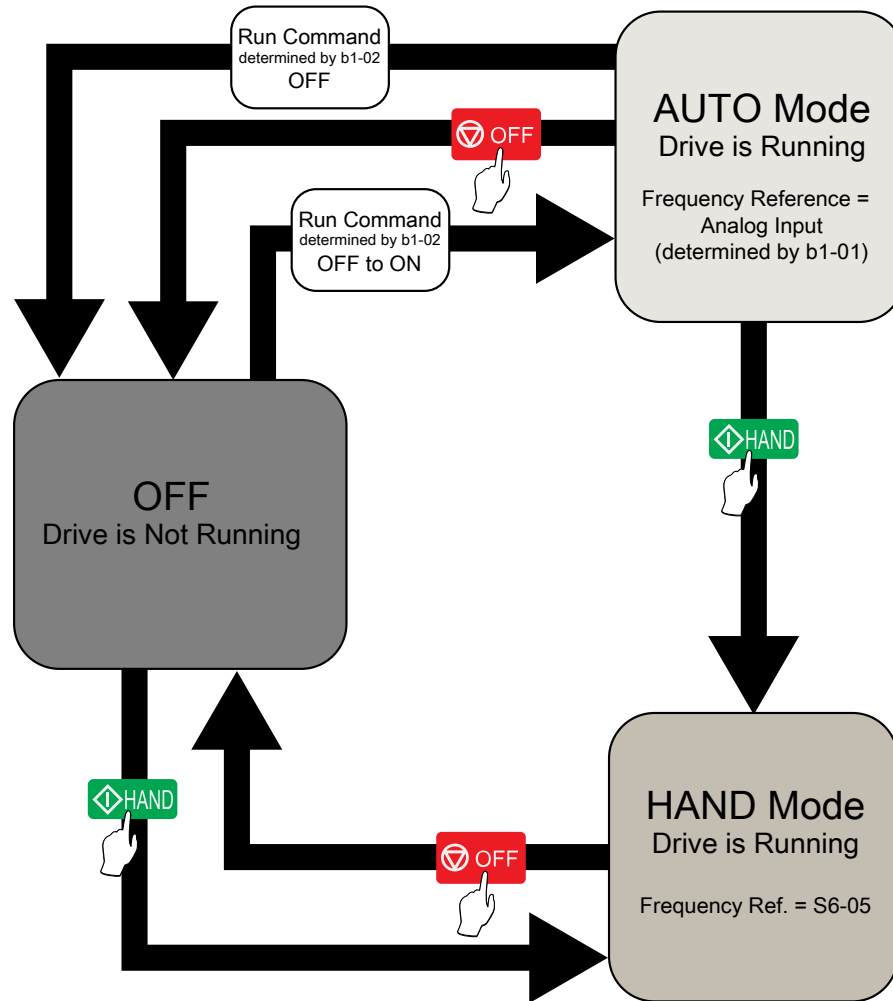

- Run command only (AUTO command not necessary)
- Keypad controls H/O/A
- $b1-02 = 1$ [Terminals], 2 [Serial Comm.], or 3 [Option]

Figure 5.96 Forced AUTO H/O/A Configuration ($b1-02 = 1, 2, \text{ or } 3$)

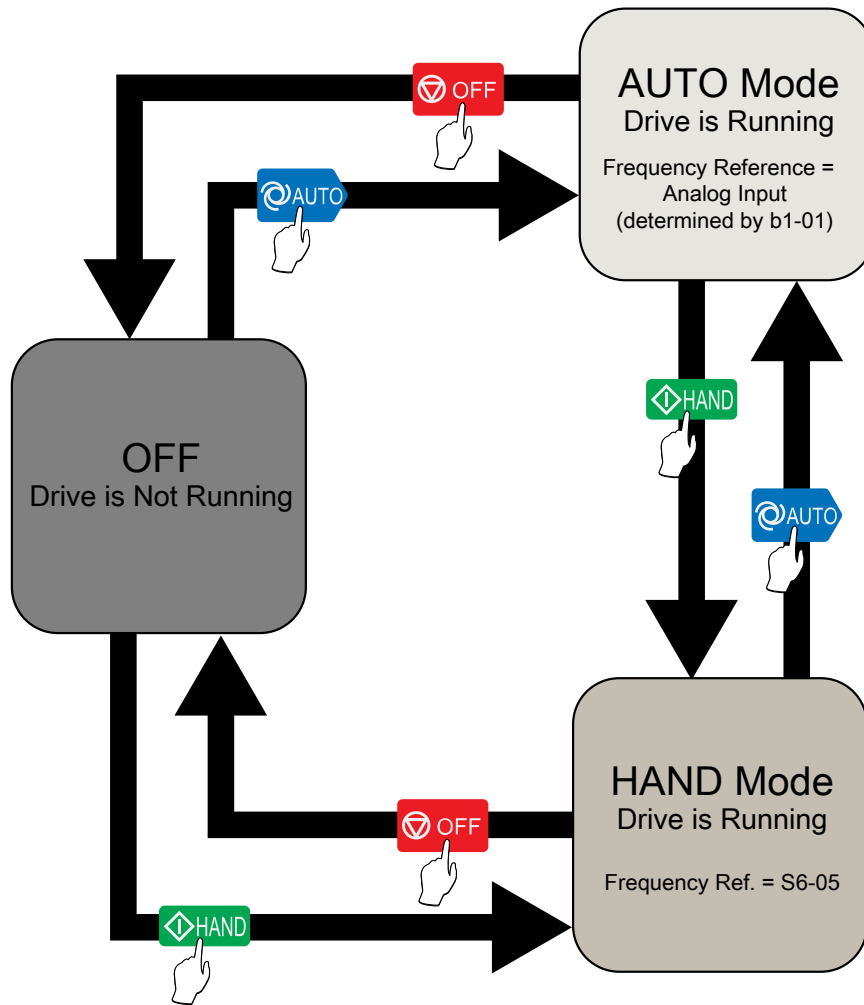

- Keypad controls H/O/A
- Keypad controls Run and Stop

Figure 5.97 Keypad H/O/A Configuration (b1-02 = 0)

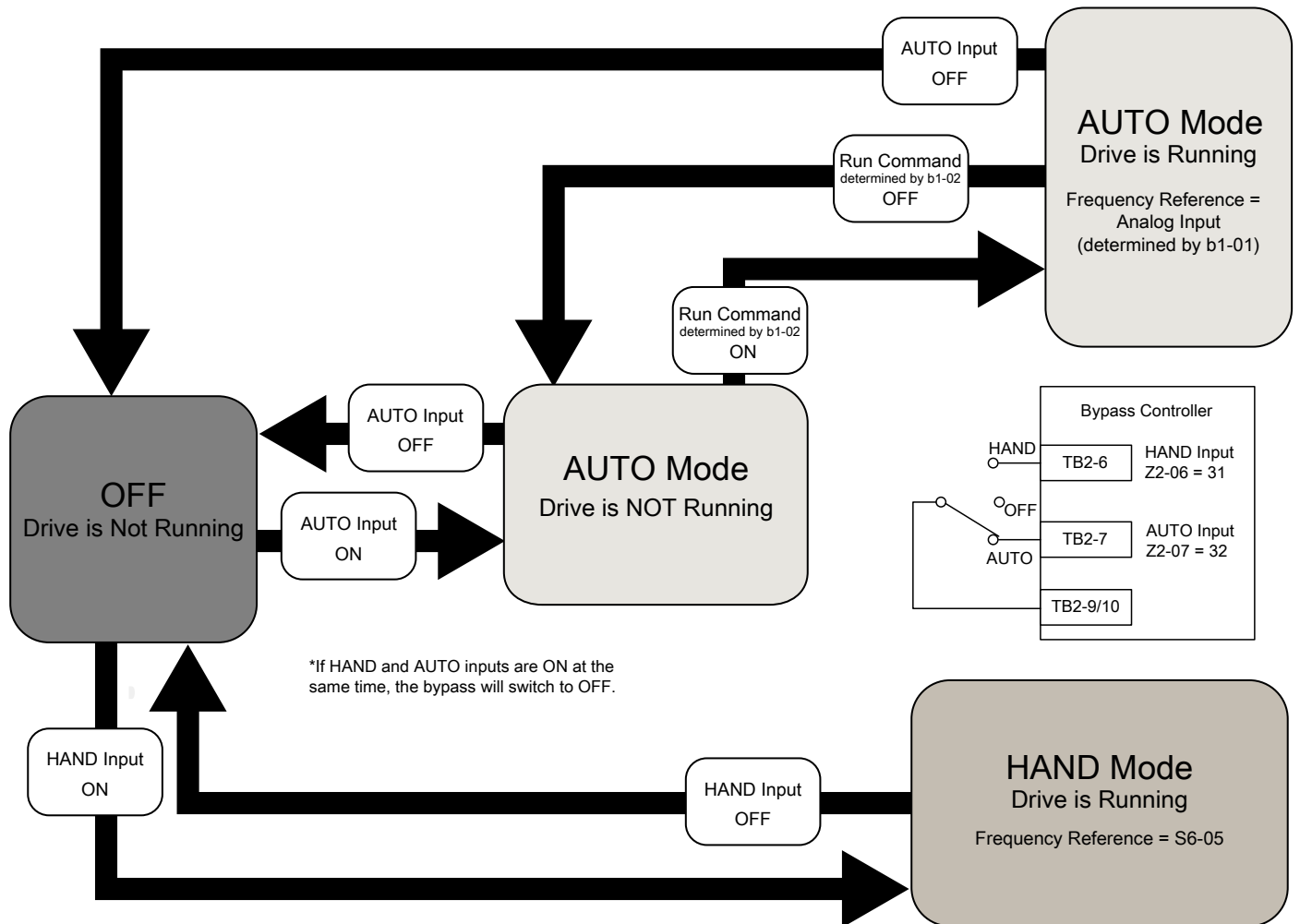

- AUTO command and Run command are necessary
- External digital inputs control H/O/A
- It is necessary to set: $Z2-0x = 31$ [HAND Select] and $Z2-0x = 32$ [AUTO Select]
- $b1-02 = 7$ [AUTO + Terminals], 8 [AUTO + Serial], or 9 [AUTO + Option]

Figure 5.98 Normal with External H/O/A Configuration (b1-02 = 7, 8, or 9)

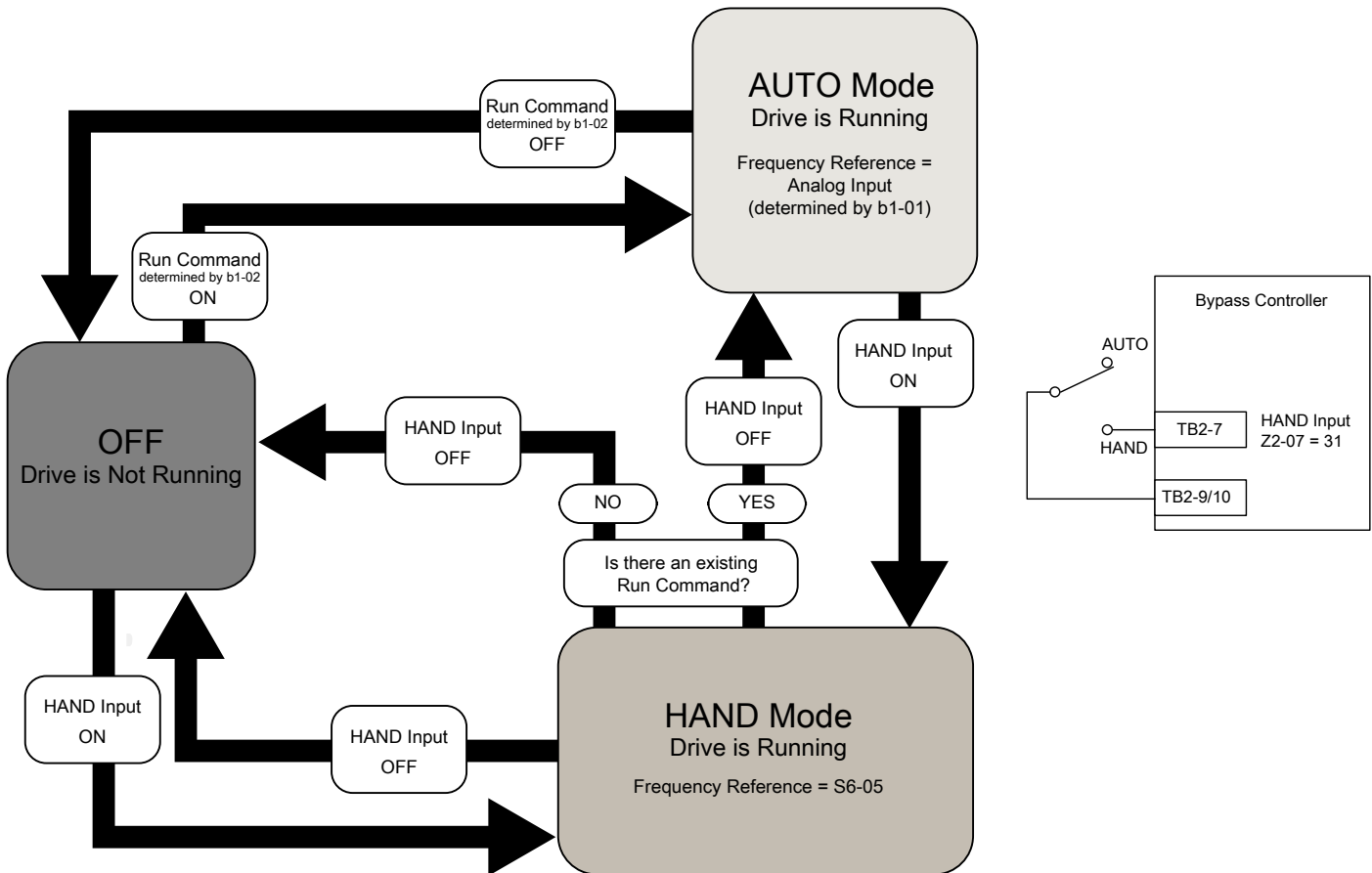

- Run command only (AUTO command not necessary)
- External digital input controls H/O/A
- It is necessary to set Z2-0x = 31 [HAND Select]
- b1-02 = 1 [Terminals], 2 [Serial Comm.], or 3 [Option]

Figure 5.99 Forced AUTO with External H/O/A Configuration (b1-02 = 1, 2, or 3)

■ S5-01: HAND Frequency Reference Source

No. (Hex.)	Name	Description	Default (Range)
S5-01 (322F)	HAND Frequency Reference Source	Sets the frequency reference source when HAND Mode is active.	1 (0 - 2)

0 : HAND Analog Input

The drive operates as specified by the frequency reference from the MFAI terminal set for H3-xx = 2E [MFAI Function Selection = Hand Frequency Ref or Setpoint].

1 : HAND Ref S5-05 or PID SP S5-06

The drive operates as specified by the frequency reference set in S5-05 [HAND Frequency Reference] or PID setpoint set in S5-06 [HAND Setpoint].

2 : Set by b1-01

The drive operates as specified by the frequency reference from the source set in b1-01.

■ S5-02: HAND/AUTO Switchover During Run

No. (Hex.)	Name	Description	Default (Range)
S5-02 (3230)	HAND/AUTO Switchover During Run	Sets the function to enable or disable switching between HAND and AUTO Mode during run.	1 (0, 1)

0 : Disabled

1 : Enabled

■ S5-03: HAND Mode PID Selection

No. (Hex.)	Name	Description	Default (Range)
S5-03 (3231) RUN	HAND Mode PID Selection	Sets the function to enable or disable PI function when HAND mode is active.	0 (0, 1)

0 : Disabled

1 : Enabled

Note:

If $b5-01 = 0$ [PID Mode Setting = Disabled], the drive disables Hand Mode PID.

■ S5-05: HAND Frequency Reference

No. (Hex.)	Name	Description	Default (Range)
S5-05 (3233) RUN	HAND Frequency Reference	Sets the frequency reference when HAND Mode is active, PID is disabled and $S5-01 = 1$ [HAND Frequency Reference Source = HAND Ref S5-05 or PID SP S5-06].	0.00 Hz (0.00 - 400.00 Hz)

■ S5-06: HAND Setpoint

No. (Hex.)	Name	Description	Default (Range)
S5-06 (3234) RUN	HAND Setpoint	Sets the System Setpoint when HAND Mode is active, PID is enabled and $S5-01 = 1$ [HAND Frequency Reference Source = HAND Ref S5-05 or PID SP S5-06].	0.0 (0.0 - 6000.0)

Note:

Parameters $b5-46$ [PID Unit Display Selection], $b5-38$ [PID User Unit Display Scaling], and $b5-39$ [PID User Unit Display Digits] set the unit, range, and resolution.

■ S5-07: Operation HAND Key

No. (Hex.)	Name	Description	Default (Range)
S5-07 (3235)	Operation HAND Key	Sets the HAND key on the HOA keypad to let you switch between HAND Mode and AUTO Mode.	1 (0, 1)

0 : Disabled

1 : Enabled

■ S5-08: HAND Reference Prime Loss Level

No. (Hex.)	Name	Description	Default (Range)
S5-08 (3D31) RUN	HAND Reference Prime Loss Level	Sets the level at which the drive will detect the Loss of Prime in the pump.	0.0 (0.0 - 1000.0)

Note:

- If these conditions occur at the same time, the drive will detect LOP [Loss of Prime]:
 - The monitor set by $Y1-18$ [Prime Loss Detection Method] $\leq S5-08$ for longer than $Y1-20$ [Prime Loss Time]
 - Output frequency $\geq S5-05$ [HAND Frequency Reference]
- The drive response to the Loss of Prime condition changes when the $Y1-22$ [Prime Loss Selection] setting changes.
- Parameter $Y1-18$ [Prime Loss Detection Method] sets the units for this parameter.

◆ S6: Protection

S6 parameters set the Emergency Override function.

■ Emergency Override

The Emergency Override function ignores faults and alarms that can stop the drive and will force the drive to run with a set speed or the frequency reference. You can use this function for an applications where it is necessary to continue the drive operation when there is an emergency situation with the installation.

Emergency Override function will be active when:

- The terminal set for *Z2-xx = 25, 26 or 44* [*Bypass MFDI Function Selection - Emergency Override Bypass, Emergency Override Drive FWD or REV*] is active
- You set bit 1 in MEMOBUS Register 15FBH for Emergency Override FWD or bit 2 in MEMOBUS register for Emergency Override REV

If FWD and REV Emergency Override selections are active at the same time, an *EF* [*External Fault*] will occur.

The values set in *S6-09* [*Emergency Override Min Speed*] and *S6-10* [*Emergency Override Max Speed*] are the lower limit and upper limit for the output frequency during Emergency Override. The drive applies upper and lower limit values to *S6-02* [*Emergency Override Ref Selection*].

While the drive is in Emergency Override Mode, the drive records the operation time in *U4-61* [*Total EMOVR Run Time*]. When the value is more than 60000 min, the alternation timer is at its maximum value. When you set *A1-03 = 2220* [*Initialize Parameters = 2-Wire Initialization*] to initialize the drive, the drive will not reset the counter.

Functions Ignored by Emergency Override

When the drive is in factory default setting, Emergency Override ignores these digital inputs:

- Customer Safeties
- BAS Interlock

The drive will give priority to these inputs over Emergency Override when you set *S6-08* [*EMOVR Drive Enable Input Mode*], *S6-16* [*EMOVR Customer Safety Mode*], or *S6-17* [*EMOVR BAS Interlock Mode*] correctly.

Table 5.59 Emergency Override Behaviors of each MFDI State and Parameter Setting

H1-xx [MFDI Function Selection]	MFDI State	Parameter Setting	EMOV Behavior
B1 [Customer Safeties]	OFF	S6-16 = 0 [Customer Safety Ignored]	Enabled
	ON		Enabled
	OFF	S6-16 = 1 [EMOVRun Only When Safety OK]	Disabled
	ON		Enabled
	OFF	S6-16 = 2 [EMOVRun Only When Safety NOT OK]	Enabled
	ON		Disabled
B2 [BAS Interlock]	OFF	S6-17 = 0 [BAS Interlock Ignored]	Enabled
	ON		Enabled
	OFF	S6-17 = 1 [EMOVRun Only When Interlock OK]	Disabled
	ON		Enabled
	OFF	S6-17 = 2 [EMOVRun When Interlock NOT OK]	Enabled
	ON		Disabled

Note:

When you program more than one input to the drive, for example Drive Enable and Customer Safeties, all the inputs must align with the conditions for Emergency Override to take effect.

Emergency Override Speed Command Operation

When Emergency Override is active, *S6-02* [*Emergency Override Reference Selection*] sets the frequency reference source:

- When *S6-02 = 0* [*Use S6-01 Reference*]:

The drive will operate at the speed set in *S6-01 [Emergency Override Speed]*.

- When *S6-02 = 1 [Use Frequency Reference]*:
The drive will use the currently selected AUTO mode frequency reference set in *b1-01 [Frequency Reference Selection 1]* as the run speed.

When *S6-02 = 0 or 1*, MEMOBUS register 3A94H can override the Emergency Override Speed when you set register 3A93H bit 3 to ON.

Note:

The drive will not memorize MEMOBUS registers 3A93H and 3A94H while you re-energize the drive.

Emergency Override PID Mode Operation

Emergency Override will operate in PID mode and maintain the setpoint when *S6-02 = 2 [System PID Mode]* or *S6-02 = 3 [Independent PID Mode]*.

- When *S6-02 = 2*:
Emergency Override uses the system units set in *b5-38 [PID User Unit Display Scaling]*, *b5-39 [PID User Unit Display Digits]*, and *b5-46 [PID Unit Display Selection]* and the normally selected PID Feedback and PID Setpoint. If it is necessary to override the PID Feedback and the PID Setpoint, set an analog input to *H3-xx = 2B [Emergency Override PID Feedback]* for the PID Feedback and *H3-xx = 2C [Emergency Override PID Setpoint]* for the PID Setpoint.
- When *S6-02 = 3*:
Emergency Override uses the dedicated units set in *S6-03 [EMOVR Independent PID Scale]*, *S6-04 [EMOVR Independent PID Unit]*, and *S6-05 [EMOVR Independent PID Unit Digit]*. The PID Setpoint uses the setpoint set in *S6-06 [EMOVR PID Setpoint]* if you do not set *H3-xx = 2C [Emergency Override PID Setpoint]*. The PID Feedback uses the system Feedback set in *H3-xx = B [PID Feedback]* if you do not set *H3-xx = 2B [Emergency Override PID Feedback]*.

When *S6-02 = 2 or 3*:

- MEMOBUS register 3A95H can override the Emergency Override PID Feedback when you set register 3A93H bit 4 to ON.
- MEMOBUS register 3A96H can override the Emergency Override PID Setpoint when you set register 3A93H bit 5 to ON.

Note:

- The drive will not memorize MEMOBUS registers 3A93H, 3A95H, and 3A96H while you re-energize the drive.
- When *S6-02 = 2 or 3*, the drive will also run in Standard PID mode when *b5-01 = 0 or 3 [PID Mode Setting = Disabled or Fref + PID Trim]*. The drive operation for Fref + PID Trim is not available during Emergency Override operation.

Interactions with Other Drive Functions

If the drive is detecting a fault that you can reset when the Emergency Override command is activated, the drive will clear the fault. These settings do not have an effect:

- The settings of *S6-11 [EMOVR Drive Protection Fault ON]* to *S6-14 [EMOVR Application 1 Fault ON]*
- How many Auto Restart Attempts remain

Note:

The drive cannot reset *Err [EEPROM Write Error]* or *SCF [Safety Circuit Fault]* faults.

The Emergency Override function has priority over these functions:

- Fault Restart operation
 - *L5-01 [Number of Auto-Restart Attempts]*
When the Emergency Override is active, the drive resets the internal counter of *L5-01* to 0 and the drive will allow an infinite number of Auto Restart Attempts.
 - Fault retry parameters: *H5-36 [CE Fault Restart Select]*, *L5-07 [Fault Reset Enable Select Grp1]*, *L5-08 [Fault Reset Enable Select Grp2]*, and *L5-53 [Thermostat Fault Retry Selection]*
When Emergency Override is active, the drive ignores these parameter settings and the drive will always allow an infinite number of Auto Restart Attempts.
- Fast Stop operation
- *CALL [Serial Comm Transmission Error]* detection
- PID Sleep function (*Y2-02 [Sleep Level]*)
- All Run commands and direction commands

If the drive has an applicable Run command from terminals when the drive was previously in Emergency Override and the Emergency Override digital input is now OFF, the drive will respond as specified by *S5-02 [HAND/AUTO Switchover During Run]* .

During Emergency Override, the drive ignores the faults in [Table 5.60](#) when *S6-07 = 0 [EMOVR Fault Suppression Mode = Fault Suppression]*:

Table 5.60 Faults Ignored during Emergency Override

Faults	Faults
bAT [Keypad Battery Low Voltage]	LF [Output Phase Loss]
bCE [Bluetooth Communication Error]	LF2 [Output Current Imbalance]
bUS [Option Communication Error]	MSL [Net Master Lost]
CE [Serial Communication Error]	nSE [Node Setup Error]
CoF [Current Offset Fault]	OD [Output Disconnect]
dEv [Speed Deviation]	oH3 [Motor Overheat (PTC Input)]
EF0 [Option Card External Fault]	oH4 [Motor Overheat Fault (PTC Input)]
EF1 - EF7 [External Fault (Terminal Sx)]	oL1 [Motor Overload]
Err [EEPROM Write Error]	oL2 [Drive Overloaded]
FAn1 [Drive Cooling Fan Fault]	oL3 [Overtorque Detection 1]
FB02 - Wait For Interlock Timeout	oL4 [Overtorque Detection 2]
FB03 - External Fault Bypass (EFB)	oL7 [High Slip Braking Overload]
FB05 - Motor Overload	oPr [Keypad Connection Fault]
FB06 - External Overload 1	oS [Overspeed]
FB07 - External Overload 2	ov2 [DC Bus Overvoltage 2]
FB08 - Brownout Detected	PE1 [PLC Fault 1]
FB09 - Blackout Detected	PE2 [PLC Fault 2]
FB10 - Loss of Drive Communications	PF [Input Phase Loss]
FB13 - Loss of Load	TiM [Keypad Time Not Set]
FB15 - Input Phase Loss	UL3 [Undertorque Detection 1]
FB16 - Input Phase Rotation	UL4 [Undertorque Detection 2]
FB17 - Load Verify Fault	UL6 [Underload or Belt Break Detected]
FB18 - Welded Bypass Contactor Detected	Uv1 [DC Bus Undervoltage]
HLCE [High Level Communications Error]	VLTS [Thermostat Fault]

Note:

- During Emergency Override, the drive will not prevent *oH [Heatsink Overheat]* and *oH1 [Heatsink Overheat]* faults. The drive will Auto Restart when *U4-08 [Heatsink Temperature]* is less than *L8-02 [Overheat Alarm Level]* for *oH* faults, or the drive Overheat Pre-Alarm Level for *oH1* faults.
- Emergency Override Fault Activation Bits set in *S6-11 [EMOVR Drive Protection Fault ON]* to *S6-14 [EMOVR Application 1 Fault ON]* and *S6-20 [EMOVR Bypass Fault ON]* enable the fault detection for the above functions, if necessary.

During Emergency Override, the drive ignores the alarms in [Table 5.61](#) when *S6-07 = 0*:

Table 5.61 Alarms Ignored during Emergency Override

Alarms	Alarms
bUS [Option Communication Error]	oL4 [Overtorque Detection 2]
CE [Serial Communication Error]	SAFE [Customer Safeties]
dnE [Drive Disabled]	UL3 [Undertorque Detection 1]
INTLK [BAS Interlock]	UL4 [Undertorque Detection 2]
oH3 [Motor Overheat (PTC Input)]	UL6 [Underload or Belt Break Detected]
oL3 [Overtorque Detection 1]	

The drive ignores these alarms, but it enables these MFDO functions during Emergency Override operation:

- $H2-xx = B$ [MFDO Function Selection = Torque Detection 1 (N.O.)]
- $H2-xx = 17$ [Torque Detection 1 (N.C.)]
- $H2-xx = 18$ [Torque Detection 2 (N.O.)]
- $H2-xx = 19$ [Torque Detection 2 (N.C.)]
- $H2-xx = 58$ [UL6 Underload Detected]

Emergency Override Test Mode

Emergency Override Test Mode lets you test Emergency Override operation while all drive faults stay enabled. Parameter $S6-07$ [EMOVR Fault Suppression Mode] controls this function.

To test Emergency Override operation, use this procedure:

1. Set $S6-07 = 1$ [Test Mode].
The keypad will show an [Emergency Override Test Pending] message.
2. Activate a bypass MFDI terminal set for $Z2-xx = 25, 26, \text{ or } 44$ [Bypass MFDI Function Selection - Emergency Override Bypass, Emergency Override Drive FWD or REV].
The drive will start the Test Mode operation. The keypad will show an [Emergency Override Test Mode] message.

When the Emergency Override MFDI deactivates and the drive fully stops, Test Mode deactivates. Parameter $S6-07$ then automatically returns to setting 0 [Fault Suppression].

Note:

- The drive will keep the $S6-07$ setting during a power-loss condition.
- Parameter $o1-82$ [Message Screen Display] sets how the drive will show the messages on the keypad. Refer to [Full Screen Information Display on page 347](#) for more information.

■ S6-01: Emergency Override Speed

No. (Hex.)	Name	Description	Default (Range)
S6-01 (3236)	Emergency Override Speed	Sets the speed command for emergency override mode when $S6-02 = 0$ [Emergency Override Ref Selection = Use S6-01 Reference].	1.50 Hz (1.50 - 60.00 Hz)

■ S6-02: Emergency Override Ref Selection

No. (Hex.)	Name	Description	Default (Range)
S6-02 (3237)	Emergency Override Ref Selection	Sets the Emergency Override Speed Source:	0 (0 - 3)

0 : Use S6-01 Reference

1 : Use Frequency Reference

2 : System PID Mode

3 : Independent PID Mode

■ S6-03: EMOVR Independent PID Scale

No. (Hex.)	Name	Description	Default (Range)
S6-03 (323A)	EMOVR Independent PID Scale	Sets the scaling on the Emergency PID Feedback and Setpoint (if programmed) Analog Inputs.	100.00 (0.10 - 600.00)

Note:

- $S6-05$ [EMOVR Independent PID Unit Digit] sets the resolution for this parameter.
- $S6-04$ [EMOVR Independent PID Unit] sets the units for this parameter.

■ S6-04: EMOVR Independent PID Unit

No. (Hex.)	Name	Description	Default (Range)
S6-04 (323B)	EMOVR Independent PID Unit	Sets the units displayed for S6-06 [EMOVR PID Setpoint] when S6-02 = 3 [Emergency Override Ref Selection = Independent PID Mode].	48 (0 - 50)

0 : “WC: inches of water column

1 : PSI: pounds per square inch

2 : GPM: gallons/min

3 : °F: Fahrenheit

4 : ft³/min: cubic feet/min

5 : m³/h: cubic meters/hour

6 : L/h: liters/hour

7 : L/s: liters/sec

8 : bar: bar

9 : Pa: Pascal

10 : °C: Celsius

11 : m: meters

12 : ft: feet

13 : L/min: liters/min

14 : m³/min: cubic meters/min

15 : “Hg: Inch Mercury

16 : kPa: kilopascal

48 : %: Percent

49 : Custom(b5-68~70)

50 : None

■ S6-05: EMOVR Independent PID Unit Digit

No. (Hex.)	Name	Description	Default (Range)
S6-05 (323C)	EMOVR Independent PID Unit Digit	Sets the number of digits for S6-06 [EMOVR PID Setpoint] when S6-02 = 3 [Emergency Override Ref Selection = Independent PID Mode].	2 (0 - 3)

0 : No Decimal Places (XXXXX)

1 : One Decimal Places (XXXX.X)

2 : Two Decimal Places (XXX.XX)

3 : Three Decimal Places (XX.XXX)

■ S6-06: EMOVR PID Setpoint

No. (Hex.)	Name	Description	Default (Range)
S6-06 (323D) RUN	EMOVR PID Setpoint	Sets the PID Setpoint when S6-02 = 3 [Emergency Override Ref Selection = Independent PID Mode].	0.00 (0 - 600.00)

Note:

When S6-02 = 3: units and resolution are dependent on S6-04 [EMOVR Independent PID Unit] and S6-05 [EMOVR Independent PID Unit Digit]. Value is internally limited to 300% of S6-03 [EMOVR Independent PID Scale].

■ S6-07: EMOVR Fault Suppression Mode

No. (Hex.)	Name	Description	Default (Range)
S6-07 (323E)	EMOVR Fault Suppression Mode	Sets the drive to let Emergency Override disable faults during operation.	0 (0, 1)

0 : Fault Suppression

1 : Test Mode

■ S6-08: EMOVR Drive Enable Input Mode

No. (Hex.)	Name	Description	Default (Range)
S6-08 (323F)	EMOVR Drive Enable Input Mode	Sets whether the Drive Enable Input (if programmed) must be inactive (drive is disabled) for Emergency Override to function.	0 (0, 1)

0 : Drive Enable Status Ignored

1 : EMOVRRun Only When Drive Disabled

Note:

You must program Drive Enable to a Digital Input for this parameter to have an effect.

■ S6-09: Emergency Override Min Speed

No. (Hex.)	Name	Description	Default (Range)
S6-09 (3240)	Emergency Override Min Speed	When Emergency Override is active, the output frequency is lower-limited to this value.	0.00 Hz (0.00 - 400.00 Hz)

■ S6-10: Emergency Override Max Speed

No. (Hex.)	Name	Description	Default (Range)
S6-10 (3241)	Emergency Override Max Speed	When Emergency Override is active, the output frequency is upper-limited to this value.	0.00 Hz (0.00 - 400.00)

Note:

Set this parameter to 0.00 Hz to disable the limit.

■ S6-11: EMOVR Drive Protection Fault ON

No. (Hex.)	Name	Description	Default (Range)
S6-11 (3242) Expert	EMOVR Drive Protection Fault ON	Sets the bit to enable fault detection during Emergency Override.	0 (0 - FFFF)

bit 0 : Uv1 - DC Bus Undervoltage

bit 1 : CoF - Current Offset Fault

bit 2 : Reserved

bit 3 : Err - EEPROM Write Error

bit 4 : Reserved

bit 5 : Reserved

bit 6 : oL2 - Drive Overload

bit 7 : oPr - Operator Connection

bit 8 : PF - Input Phase Loss

bit 9 : Reserved

bit 10 : Reserved

- bit 11 : oH - Heatsink Overheat**
- bit 12 : oH1 - Heatsink Overheat**
- bit 13 : OD - Output Disconnect**
- bit 14 : FAN1 - Cooling Fan Fault**
- bit 15 : ov2 - DC Bus Overvoltage 2**

Note:

The drive sets the bits in Hex.

■ S6-12: EMOVR Motor Protection Fault ON

No. (Hex.)	Name	Description	Default (Range)
S6-12 (3243) Expert	EMOVR Motor Protection Fault ON	Sets the bit to enable fault detection during Emergency Override.	0 (0 - FFFF)

- bit 0 : LF - Output Phase Loss**
- bit 1 : LF2 - Output Current Imbalance**
- bit 2 : oH3 - Motor Overheat PTC Input**
- bit 3 : oH4 - Motor Overheat PTC Input**
- bit 4 : Reserved**
- bit 5 : oL1 - Motor Overload**
- bit 6 : oL3 - Overtorque Detection 1**
- bit 7 : oL4 - Overtorque Detection 2**
- bit 8 : oL7 - High Slip Braking Overload**
- bit 9 : Reserved**
- bit 10 : UL3 - Undertorque Detection 1**
- bit 11 : UL4 - Undertorque Detection 2**
- bit 12 : UL6 - Motor Underload**
- bit 13 : Reserved**
- bit 14 : oS - Overspeed**
- bit 15 : dEv: Speed Deviation**

Note:

The drive sets the bits in Hex.

■ S6-13: EMOVR Option Fault ON

No. (Hex.)	Name	Description	Default (Range)
S6-13 (3244) Expert	EMOVR Option Fault ON	Sets the bit to enable fault detection during Emergency Override.	0 (0 - FFFF)

- bit 0 : bUS - Option Communication**
- bit 1 : CE - Communication Error**
- bit 2 : E5 - SI-T3 Watch Dog Timer**
- bit 3 : EF0 - Option Card External Fault**
- bit 4 : PE1 - PLC Fault 1**
- bit 5 : PE2 - PLC Fault 2**
- bit 6 : nSE - Node Setup Error**
- bit 7 to 15 : Reserved**

Note:

The drive sets the bits in Hex.

■ S6-14: EMOVR Application 1 Fault ON

No. (Hex.)	Name	Description	Default (Range)
S6-14 (3245) Expert	EMOVR Application 1 Fault ON	Sets the bit to enable fault detection during Emergency Override.	0 (0 - FFFF)

bit 0 : EFx - External Faults

bit 1 : Reserved

bit 2 : HLCE - High Level Communications Error

bit 3 : bAT - HOA Keypad Battery Voltage Low

bit 4 : TiM - Keypad Time Not Set

bit 5 : bCE - Bluetooth Communication Fault

bit 6 : Reserved

bit 7 : Reserved

bit 8 : Reserved

bit 9 : MSL - Net Master Lost

bit 10 : VLTS - Thermostat Fault

bit 11 to 15 : Reserved

Note:

The drive sets the bits in Hex.

■ S6-16: EMOVR Customer Safety Mode

No. (Hex.)	Name	Description	Default (Range)
S6-16 (3247)	EMOVR Customer Safety Mode	Sets the status for the customer safety input (when programmed) that must occur for Emergency Override to function.	0 (0 - 2)

0 : Customer Safety Ignored

1 : EMOVRun Only When Safety OK

2 : EMOVRun Only When Safety NOT OK

Note:

You must set a customer safety to a Digital Input for this parameter to have an effect.

■ S6-17: EMOVR BAS Interlock Mode

No. (Hex.)	Name	Description	Default (Range)
S6-17 (3248)	EMOVR BAS Interlock Mode	Sets the status for the BAS Interlock input (when programmed) that must occur for Emergency Override to function.	0 (0 - 2)

0 : BAS Interlock Ignored

1 : EMOVRun Only When Interlock OK

2 : EMOVRun When Interlock NOT OK

Note:

Parameter has no effect if BAS Interlock is not programmed to a Digital Input.

■ S6-20: EMOVR Bypass Fault ON

No. (Hex.)	Name	Description	Default (Range)
S6-20 (324B) Expert	EMOVR Bypass Fault ON	Sets the bit to enable fault detection during Emergency Override.	0 (0 - FFFF)

bit 0 : FB02 Wait For Interlock Timeout

bit 1 : FB03 External Fault Bypass (EFB)

bit 2 : FB05 Motor Overload

bit 3 : FB06 External Overload 1

bit 4 : FB07 External Overload 2

bit 5 : FB08 Brownout Detected

bit 6 : FB09 Blackout Detected

bit 7 : FB10 Loss of Drive Communications

bit 8 : FB13 Loss of Load

bit 9 : FB15 Input Phase Loss

bit 10 : FB16 Input Phase Rotation

bit 11 : FB17 Load Verify Fault

bit 12 : FB18 Welded Bypass Contactor Detected

■ S6-23: OV2 Detect Time

No. (Hex.)	Name	Description	Default (Range)
S6-23 (324E)	OV2 Detect Time	Sets the detection time of <i>ov2</i> [DC Bus Overvoltage 2] in 0.1 s increments.	10.0 s (0.0 - 1200.0 s)

Note:

Set this parameter to 0.0 s to disable *ov2* detection.

5.12 Y: Application Features

◆ Y1: Application Basics

■ Y1-04: Sleep Wake-up Level

No. (Hex.)	Name	Description	Default (Range)
Y1-04 (3C03) RUN	Sleep Wake-up Level	Sets the level that feedback must be less than for the time set in <i>Y1-05 [Sleep Wake-up Level Delay Time]</i> to start the system. This level also sets the wake up level when the drive is in Sleep Mode. When <i>Y1-04 < 0</i> , the feedback level must decrease this amount to less than the setpoint.	0.0 (-999.9 - +999.9)

Note:

- When PID operates in reverse mode, the feedback value must increase to more than the start level for the time set in *Y1-05* for the system to start.
- When *Y2-01 = 5 [Sleep Level Type = Output Frequency (non-PID)]*, the drive will ignore this parameter.
- Set this parameter to 0.0 to disable the function.
- Range is 0.00 to 99.99 with sign-bit “-” or “+” indicating Delta to Setpoint.
- Display unit and scaling change when the system units change.

■ Y1-05: Sleep Wake-up Level Delay Time

No. (Hex.)	Name	Description	Default (Range)
Y1-05 (3C04) RUN	Sleep Wake-up Level Delay Time	Sets the drive to start the System again when the feedback decreases to less than <i>Y1-04 [Sleep Wake-up Level]</i> for the time set in this parameter.	1 s (0 - 3600 s)

■ Y1-06: Minimum Speed

No. (Hex.)	Name	Description	Default (Range)
Y1-06 (3C05) RUN	Minimum Speed	Sets the minimum frequency at which the drive will run. The drive applies this setting to HAND and AUTO modes.	0.0 Hz Determined by Y1-07

Note:

The unit, decimal place, and setting range change when the *Y1-07 [Minimum Speed Units]* setting changes:

- *Y1-07 = 0 [Hz]*: The setting range is 0.0 Hz to *E1-04* Hz.
- *Y1-07 = 1 [RPM]*: The setting range is 0 RPM to (*E1-04* × 60) RPM.

■ Y1-07: Minimum Speed Units

No. (Hex.)	Name	Description	Default (Range)
Y1-07 (3C06)	Minimum Speed Units	Sets the units and decimal place for <i>Y1-06 [Minimum Speed]</i> .	0 (0, 1)

0 : Hz

1 : RPM

Note:

Changing *Y1-07* will set *Y1-06 [Minimum Speed]* to the default value.

■ Y1-08: Low Feedback Level

No. (Hex.)	Name	Description	Default (Range)
Y1-08 (3C07) RUN	Low Feedback Level	Sets the lower detection level for the PID feedback.	0.00% (0.00 - 99.99%)

Note:

- Unit and decimal place change when the system units change.
- Range is 0.00 to 99.99 with sign-bit “-” indicating Delta to Setpoint.

■ Y1-09: Low Feedback Lvl Fault Dly Time

No. (Hex.)	Name	Description	Default (Range)
Y1-09 (3C08) RUN	Low Feedback Lvl Fault Dly Time	Sets the delay time for the drive to detect an <i>LFB [Low Feedback Sensed]</i> fault after the feedback level decreases to less than the value set in <i>Y1-08 [Low Feedback Level]</i> .	10 s (0 - 3600 s)

Note:

Set *Y1-10 = 0 [Low Feedback Selection = Fault (and Digital Output)]* to enable this parameter.

■ Y1-10: Low Feedback Selection

No. (Hex.)	Name	Description	Default (Range)
Y1-10 (3C09)	Low Feedback Selection	Sets the drive response when the feedback decreases to less than <i>Y1-08 [Low Feedback Level]</i> for longer than the time set in <i>Y1-09 [Low Feedback Lvl Fault Dly Time]</i> .	0 (0 - 2)

The drive enables the Low Feedback detection when:

- Parameter *Y1-08 > 0.0*
- Drive is running in AUTO Mode, including sleep boost and feedback drop detection (*b5-09 = 0 [PID Output Level Selection = Normal Output (Direct Acting)]*)
- There is a Run command, including sleep and timer operation (*b5-09 = 1 [Reverse Output (Reverse Acting)]*)

0 : Fault (and Digital Output)

The keypad will show *LFB [Low Feedback Sensed]* and the motor coasts to stop. The output terminal set for *H2-xx = 97 [MFDO Function Selection = Low Feedback]* will activate.

To deactivate the digital output, do a Fault Reset.

1 : Alarm (and Digital Output)

The keypad will show *LOFB [Low Feedback Sensed]* and the output terminal set for *H2-xx = 97* will activate.

To deactivate the digital output and clear the alarm, increase the feedback to more than *Y1-08 + Y1-14 [Feedback Hysteresis Level]*, or make sure that one or more of the conditions that enable Low Feedback detection are no longer true.

2 : Digital Output Only

The output terminal set for *H2-xx = 97* will activate.

To deactivate the digital output and clear the alarm, increase the feedback to more than *Y1-08 + Y1-14*, or make sure that one or more of the conditions that enable Low Feedback detection are no longer true.

■ Y1-11: High Feedback Level

No. (Hex.)	Name	Description	Default (Range)
Y1-11 (3C0A) RUN	High Feedback Level	Sets the upper detection level for the PID feedback.	0.00% (0.00 - 99.99%)

Note:

- Unit and decimal place change when the system units change.
- Range is 0.00 to 99.99 with sign-bit “+” indicating Delta to Setpoint.

■ Y1-12: High Feedback Lvl Fault Dly Time

No. (Hex.)	Name	Description	Default (Range)
Y1-12 (3C0B) RUN	High Feedback Lvl Fault Dly Time	Sets the delay time between when the drive detects high feedback until the drive faults on an <i>HFB [High Feedback Sensed]</i> fault.	5 s (0 - 3600 s)

Note:

This parameter is effective only when $Y1-13 = 0$ [*High Feedback Selection = Fault (and Digital Output)*].

■ Y1-13: High Feedback Selection

No. (Hex.)	Name	Description	Default (Range)
Y1-13 (3C0C)	High Feedback Selection	Sets the drive response when the feedback increased to more than $Y1-11$ [<i>High Feedback Level</i>] for longer than the time set in $Y1-12$ [<i>High Feedback Lvl Fault Dly Time</i>].	0 (0 - 2)

The drive enables the High Feedback detection when:

- Parameter $Y1-11 > 0.0$
- There is a Run command, including sleep and timer operation ($b5-09 = 0$ [*PID Output Level Selection = Normal Output (Direct Acting)*])
- Drive is running in AUTO Mode, including feedback drop detection ($b5-09 = 1$ [*Reverse Output (Reverse Acting)*])

0 : Fault (and Digital Output)

The keypad will show *HFB [High Feedback Sensed]* and the motor coasts to stop. The output terminal set for $H2-xx = 96$ [*MFDO Function Selection = High Feedback*] will activate.

To deactivate the digital output, do a Fault Reset.

1 : Alarm (and Digital Output)

The keypad will show *HIFB [High Feedback Sensed]* and the output terminal set for $H2-xx = 96$ will activate.

To deactivate the digital output and clear the alarm, decrease the feedback to be less than $Y1-11 - Y1-14$ [*Feedback Hysteresis Level*], or make sure that one or more of the conditions that enable High Feedback detection are no longer true.

2 : Digital Output Only

The output terminal set for $H2-xx = 96$ will activate.

To deactivate the digital output and clear the alarm, decrease the feedback to be less than $Y1-11 - Y1-14$, or make sure that one or more of the conditions that enable High Feedback detection are no longer true.

■ Y1-14: Feedback Hysteresis Level

No. (Hex.)	Name	Description	Default (Range)
Y1-14 (3C0D) RUN	Feedback Hysteresis Level	Sets the hysteresis level for low and high level feedback detection.	0.0% (0.0 - 10.00%)

Note:

Unit and decimal place change when the system units change.

■ Y1-15: Maximum Setpoint Difference

No. (Hex.)	Name	Description	Default (Range)
Y1-15 (3C0E) RUN	Maximum Setpoint Difference	Sets a percentage of difference between the setpoint and the feedback. The difference must be more than this value for the time set in $Y1-16$ [<i>Not Maintaining Setpoint Time</i>] to trigger the drive response set in $Y1-17$ [<i>Not Maintaining Setpoint Sel</i>].	0.0% (0.0 - 6000.0%)

Note:

- Unit and decimal place change when the system units change.
- If there is a fault, the drive will coast to a stop.
- Set this parameter to 0.0 to disable the function.
- This function is only active during run when in Auto Mode.

■ **Y1-16: Not Maintaining Setpoint Time**

No. (Hex.)	Name	Description	Default (Range)
Y1-16 (3C0F) RUN	Not Maintaining Setpoint Time	Sets the delay time before a Setpoint Not Met condition occurs. The drive must detect the setpoint difference set in <i>Y1-15 [Maximum Setpoint Difference]</i> before the timer will start.	60 s (0 - 3600 s)

Note:

Set *Y1-15 = 0 [Maximum Setpoint Difference = 0]* to disable this function.

■ **Y1-17: Not Maintaining Setpoint Sel**

No. (Hex.)	Name	Description	Default (Range)
Y1-17 (3C10)	Not Maintaining Setpoint Sel	Sets the drive response when the feedback increases to more or decreases to less than the setpoint for more than the amount set in <i>Y1-15 [Maximum Setpoint Difference]</i> .	0 (0 - 2)

The drive enables the Not Maintaining Set Point detection when:

- Drive is operating in PID control (*b5-01 ≠ 0 [PID Mode Setting ≠ Disabled]*)
- Drive is operating in AUTO Mode
- Drive is not in Pre-Charge Mode
- Drive is not in the sleep state
- Parameter *Y1-15 > 0 [Maximum Setpoint Difference > 0]*

0 : Fault (and Digital Output)

The keypad will show an *NMS [Setpoint Not Met]* fault and the motor coasts to stop. The output terminal set for *H2-xx = AC [Setpoint Not Maintained]* will activate.

To deactivate the digital output, do a Fault Reset.

- If Not Maintaining Setpoint condition continues for longer than *Y1-16 [Not Maintaining Setpoint Time]* the drive will detect an *NMS* fault.
- If the feedback increases or decreases to less than *Y1-15* from the setpoint before *Y1-16* expires, the drive will deactivate the output terminal, clear the alarm, and reset *Y1-16*.

1 : Alarm (and Digital Output)

The keypad will show an *NMS [Setpoint Not Met]* alarm and the output terminal set for *H2-xx = AC* will activate.

To deactivate the digital output and clear the alarm, increase or decrease the feedback to less than *Y1-15* from the setpoint.

Note:

There is no time limit for this condition.

2 : Digital Output Only

The drive will detect Not Maintaining Setpoint and the output terminal set for *H2-xx = AC* will activate.

To deactivate the digital output, increase or decrease the feedback to less than *Y1-15* from the setpoint.

Note:

There is no time limit for this condition.

■ **Y1-18: Prime Loss Detection Method**

No. (Hex.)	Name	Description	Default (Range)
Y1-18 (3C11)	Prime Loss Detection Method	Sets the units and quantity that the drive will use to determine <i>LOP [Loss of Prime]</i> .	0 (0 - 2)

0 : Current (A)

The drive compares the *U1-03 [Output Current]*, *U1-08 [Output Power]*, or *U1-09 [Torque Ref]* value with these *LOP* Detection Level parameters:

- *b5-84 [Feedback Loss Loss Of Prime Lvl]*
- *S5-08 [HAND Reference Prime Loss Level]*
- *Y1-19 [Prime Loss Level]*
- *Y4-05 [Pre-Charge Loss of Prime Level]*

1 : Power (kW)**2 : Torque (%)****■ Y1-19: Prime Loss Level**

No. (Hex.)	Name	Description	Default (Range)
Y1-19 (3C12) RUN	Prime Loss Level	Sets the level to detect the <i>LOP [Loss of Prime]</i> in the pump when in Auto or Sleep Boost Mode.	0.0 (0.0 - 1000.0)

■ Y1-20: Prime Loss Time

No. (Hex.)	Name	Description	Default (Range)
Y1-20 (3C13) RUN	Prime Loss Time	Sets the delay time before the drive detects an <i>LOP [Loss of Prime]</i> condition. The timer starts when the drive detects the conditions in <i>Y1-18 [Prime Loss Detection Method]</i> and <i>Y1-19 [Prime Loss Level]</i> .	20 s (0 - 600 s)

■ Y1-21: Prime Loss Activation Freq

No. (Hex.)	Name	Description	Default (Range)
Y1-21 (3C14)	Prime Loss Activation Freq	Sets the frequency level above which the drive enables Loss of Prime detection.	0.0 Hz (0.0 - 400.0)

■ Y1-22: Prime Loss Selection

No. (Hex.)	Name	Description	Default (Range)
Y1-22 (3C15)	Prime Loss Selection	Sets the drive response when the drive is in the Loss of Prime condition.	0 (0 - 2)

0 : Fault (and Digital Output)

The keypad shows an *LOP [Loss of Prime]* fault and the motor coasts to stop. The output terminal set for *H2-xx = 94 [MFDO Function Selection = Loss of Prime]* will activate.

To deactivate the digital output, do a Fault Reset.

1 : Alarm (and Digital Output)

The keypad shows an *LOP [Loss of Prime]* alarm and the output terminal set for *H2-xx = 94* will activate.

2 : Digital Output Only

The output terminal set for *H2-xx = 94* will activate.

■ Y1-23: Prime Loss Max Restart Time

No. (Hex.)	Name	Description	Default (Range)
Y1-23 (3C16)	Prime Loss Max Restart Time	Sets the time in minutes that the drive will wait before it tries a restart after a restart fails or after it does not do a restart because of a fault.	0.2 min (0.2 - 6000.0 min)

■ Y1-40: Maximum Speed

No. (Hex.)	Name	Description	Default (Range)
Y1-40 (3C27) RUN	Maximum Speed	Sets the maximum speed.	0.0 Hz (0.0 - 416.0)

Note:

This parameter is not effective when $Y1-40 = 0.0$ Hz or $Y1-40 > E1-04$ [Maximum Output Frequency] \times $d2-01$ [Frequency Reference Upper Limit].

◆ Y2: PID Sleep and Protection

■ Sleep Function

The Sleep Function uses the monitor data set in $Y2-01$ [Sleep Level Type] to know if the drive is necessary in the system and turn off the drive.

This function helps to save the energy and prevent the deterioration on the motor.

*1 When $Y2-01 = 5$ [Output Frequency (non-PID)], the drive will ignore the Start Level set in $Y1-04$ [Sleep Wake-up Level]. Set $Y2-02 > 0$ to enable the Sleep Function. The drive will enable the Sleep Function regardless of the $b5-01$ setting or the status of the MFDI set for $H1-xx = 19$ [PID Disable].

Sleep Activation Level and Sleep Level

• Sleep Activation Level:

This level sets when the Sleep Function should start operation. You can use $Y2-04$ [Sleep Activation Level] or Minimum Speed (the largest value from $d2-02$, $Y1-06$, and $Y4-12$) to set this level.

When the output frequency increases to more than the Sleep Activation Level, the Sleep Function will start to monitor the system.

• Sleep Level:

This is the level that the drive uses to go to sleep (stop). You can use $Y2-02$ [Sleep Level] or Minimum Speed to set this level.

Delta to Setpoint Entry for Sleep Wake-up Level

Delta to Setpoint Entry lets you set $Y1-04$ [Sleep Wake-up Level] relative to the current setpoint and set a PID setpoint when PID is not active.

Parameter/Condition	Delta Entry	Absolute Entry
Y1-04 $b5-09 = 0$ [PID Output Level Selection = Normal Output (Direct Acting)]	-0.00 to -99.99	0.00 to 99.99
Y1-04 $b5-09 = 1$ [Reverse Output (Reverse Acting)]	+0.00 to +99.99	0.00 to 99.99

Table 5.62 Absolute Mode and Delta to Setpoint Mode

Entry Mode	Keypad Display	Description							
Absolute	<table border="1"> <tr><td>10:00 am FWD Parameters</td></tr> <tr><td>Sleep Wake-up Level</td></tr> <tr><td>Y1-04 Absolute Mode</td></tr> <tr><td>020.00 %</td></tr> <tr><td>Default : 0.00%</td></tr> <tr><td>Range : 0.00~99.99</td></tr> <tr><td>Back Default Min/Max</td></tr> </table>	10:00 am FWD Parameters	Sleep Wake-up Level	Y1-04 Absolute Mode	020.00 %	Default : 0.00%	Range : 0.00~99.99	Back Default Min/Max	The value set for $Y1-04$ represents the feedback level that will wake-up the drive. You can set $Y1-04$ as an absolute value.
10:00 am FWD Parameters									
Sleep Wake-up Level									
Y1-04 Absolute Mode									
020.00 %									
Default : 0.00%									
Range : 0.00~99.99									
Back Default Min/Max									
Delta to Setpoint	<table border="1"> <tr><td>10:00 am FWD Parameters</td></tr> <tr><td>Sleep Wake-up Level</td></tr> <tr><td>Y1-04 Delta to Setpoint Mode</td></tr> <tr><td>Δ20.00 %</td></tr> <tr><td>Default : 0.00%</td></tr> <tr><td>Range : 0.00~99.99</td></tr> <tr><td>Back Default Min/Max</td></tr> </table>	10:00 am FWD Parameters	Sleep Wake-up Level	Y1-04 Delta to Setpoint Mode	Δ20.00 %	Default : 0.00%	Range : 0.00~99.99	Back Default Min/Max	When the left-most digit changes to a Δ (delta), you can set a Sleep Wake-up Level relative to the setpoint. The effective Wake-up Level changes when $b5-09$ changes: <ul style="list-style-type: none"> $b5-09 = 0$: "Setpoint - $Y1-04$" $b5-09 = 1$: "Setpoint + $Y1-04$"
10:00 am FWD Parameters									
Sleep Wake-up Level									
Y1-04 Delta to Setpoint Mode									
Δ20.00 %									
Default : 0.00%									
Range : 0.00~99.99									
Back Default Min/Max									

■ Y2-01: Sleep Level Type

No. (Hex.)	Name	Description	Default (Range)
Y2-01 (3C64)	Sleep Level Type	Sets the data source that the drive uses to know when to activate the Sleep Function.	5 (0 - 5)

0 : Output Frequency

1 : Output Current

2 : Feedback

3 : Output Speed (RPM)

5 : Output Frequency (non-PID)

Note:

- Feedback depends on PID direction operation.
- When the Sleep Function is active, the keypad will show the “Sleep” Alarm.

■ Y2-02: Sleep Level

No. (Hex.)	Name	Description	Default (Range)
Y2-02 (3C65) RUN	Sleep Level	Sets the level that the level type set in Y2-01 [<i>Sleep Level Type</i>] must be at for the time set in Y2-03 [<i>Sleep Delay Time</i>] for the drive to enter Sleep Mode.	0.0 (0.0 - 6000.0)

When the monitor data of the level type set in Y2-01 is less than this level for longer than the time set in Y2-03, the drive will enter Sleep Mode.

Note:

- When you set this parameter to 0.0, this function will not be active.
- This function is active only when the drive operates in AUTO Mode.
- When $Y2-01 = 5$ [*Output Frequency (non-PID)*], the drive will disable the Sleep function when you set this parameter to 0.0.
- When $Y2-01 \neq 5$, the drive will set the sleep level to the largest value from d2-02 [*Frequency Reference Lower Limit*], Y1-06 [*Minimum Speed*], and Y4-12 [*Thrust Frequency*] when you set this parameter to 0.0.

■ Y2-03: Sleep Delay Time

No. (Hex.)	Name	Description	Default (Range)
Y2-03 (3C66) RUN	Sleep Delay Time	Sets the delay time before the drive enters Sleep Mode when the drive is at the sleep level set in Y2-02 [<i>Sleep Level</i>].	5 s (0 - 3600 s)

■ Y2-04: Sleep Activation Level

No. (Hex.)	Name	Description	Default (Range)
Y2-04 (3C67) RUN	Sleep Activation Level	Sets the level above which the output frequency must increase to activate the Sleep Function when $Y2-01 = 0, 3, \text{ or } 5$ [<i>Sleep Level Type = Output Frequency, Output Speed (RPM), or Output Frequency (non-PID)</i>].	0.0 (0.0 - 6000.0)

Note:

When you set this parameter to 0.0, this function will not be active, and the Sleep Function will activate above the minimum speed (largest value from d2-02 [*Frequency Reference Lower Limit*], Y1-06 [*Minimum Speed*], and Y4-12 [*Thrust Frequency*]).

■ Y2-05: Sleep Boost Level

No. (Hex.)	Name	Description	Default (Range)
Y2-05 (3C68) RUN	Sleep Boost Level	Sets the quantity of boost that the drive applies to the setpoint before it goes to sleep.	0.00% (0.00 - 600.00%)

Note:

Set this parameter to 0.00 to disable Sleep Boost Function.

■ Y2-06: Sleep Boost Hold Time

No. (Hex.)	Name	Description	Default (Range)
Y2-06 (3C69) RUN	Sleep Boost Hold Time	Sets the length of time that the drive will keep the boosted pressure before it goes to sleep.	5.0 s (0.5 - 160.0 s)

■ Y2-07: Sleep Boost Max Time

No. (Hex.)	Name	Description	Default (Range)
Y2-07 (3C6A) RUN	Sleep Boost Max Time	Sets the length of time that the system (feedback) has to reach the boosted setpoint. The system must reach the boosted setpoint in the time set in this parameter, or it will go to sleep.	20.0 s (1.0 - 160.0 s)

■ Y2-08: Delta Feedback Drop Level

No. (Hex.)	Name	Description	Default (Range)
Y2-08 (3C6B) RUN	Delta Feedback Drop Level	Sets the level of the PID Error (set-point minus feedback) to deactivate the Sleep Mode operation.	0.00% (0.00 - 600.00%)

When the drive enters Sleep Mode, the software monitors the feedback to detect a flow-no flow condition. The drive will deactivate the Sleep Mode operation and will go back to its normal operation when:

- The PID Error is more than this level in the time set in Y2-09 [*Feedback Drop Detection Time*]
- The output frequency is more than the level set in Y1-06 [*Minimum Speed*]

Note:

Set this parameter to 0.00 to disable the function.

■ Y2-09: Feedback Drop Detection Time

No. (Hex.)	Name	Description	Default (Range)
Y2-09 (3C6C) RUN	Feedback Drop Detection Time	Sets the time during which the software monitors the feedback to detect a flow/no-flow condition. Refer to Y2-08 [<i>Delta Feedback Drop Level</i>] for more information.	10.0 s (0.0 - 3600.0 s)

■ Y2-23: Anti-No-Flow Bandwidth

No. (Hex.)	Name	Description	Default (Range)
Y2-23 (3C7A) RUN	Anti-No-Flow Bandwidth	Sets the quantity of PI error bandwidth that the drive uses to detect an Anti- No-Flow condition. A setting of 0.00% disables Anti-No-Flow detection.	0.00% (0.00 - 2.00%)

Note:

Do not set this parameter value too high, because operation can become unstable.

■ Y2-24: Anti-No-Flow Detection Time

No. (Hex.)	Name	Description	Default (Range)
Y2-24 (3C7B) RUN	Anti-No-Flow Detection Time	Sets the time delay before the drive starts the increased deceleration rate after it detects Anti-No-Flow.	10.0 s (1.0 - 60.0 s)

■ Y2-25: Anti-No-Flow Release Level

No. (Hex.)	Name	Description	Default (Range)
Y2-25 (3C7C) RUN	Anti-No-Flow Release Level	Sets the amount below the setpoint which the feedback must decrease before the drive will disengage Anti-No-Flow and return to normal PI operation.	0.30% (0.00 - 10.00%)

Note:

The display unit and scaling change when the System Units change.

◆ Y4: Application Advanced

■ Y4-01: Pre-Charge Level

No. (Hex.)	Name	Description	Default (Range)
Y4-01 (3CFA) RUN	Pre-Charge Level	Sets the level at which the drive will activate the pre-charge function when the drive is running at the frequency set in <i>Y4-02 [Pre-Charge Frequency]</i> .	0.00% (0.00 - 600.00%)

Note:

The drive will stop when one of these conditions is true:

- The feedback level increases to more than *Y4-01*
- The pre-charge time set in *Y4-03 [Pre-Charge Time]* expires

■ Y4-02: Pre-Charge Frequency

No. (Hex.)	Name	Description	Default (Range)
Y4-02 (3CFB) RUN	Pre-Charge Frequency	Sets the frequency at which the pre-charge function will operate.	0.0 Hz (0.0 - 400.0 Hz)

■ Y4-03: Pre-Charge Time

No. (Hex.)	Name	Description	Default (Range)
Y4-03 (3CFC) RUN	Pre-Charge Time	Sets the length of time that the Pre-Charge function will run.	0.0 min (0.0 - 3600.0 min)

Note:

Set this parameter to 0.0 to disable the function.

■ Y4-05: Pre-Charge Loss of Prime Level

No. (Hex.)	Name	Description	Default (Range)
Y4-05 (3CFE) RUN	Pre-Charge Loss of Prime Level	Sets the level at which the drive will detect loss of prime in the pump.	0.0 A (0.0 - 1000.0 A)

■ Y4-11: Thrust Acceleration Time

No. (Hex.)	Name	Description	Default (Range)
Y4-11 (3D04) RUN	Thrust Acceleration Time	Sets the time at which the drive output frequency will ramp up to the reference frequency set in <i>Y4-12 [Thrust Frequency]</i> .	1.0 s (0.0 - 600.0 s)

When *Y4-11 = 0.0*, the drive will use the standard acceleration rate.

■ Y4-12: Thrust Frequency

No. (Hex.)	Name	Description	Default (Range)
Y4-12 (3D05) RUN	Thrust Frequency	Sets the Thrust Frequency that the drive will use to know which acceleration and deceleration time to use. The drive will accelerate to this frequency in the Y4-11 [Thrust Acceleration Time] time and decelerate from this frequency in the Y4-13 [Thrust Deceleration Time] time.	0.0 Hz (0.0 - 400.0 Hz)

WARNING! Sudden Movement Hazard. When you set Thrust Frequency, do not re-energize the drive while you enter the Run command. If you de-energized the drive while it is running, the drive can automatically start when you energize it and it can cause serious injury or death.

At start, the drive will use the Y4-11 [Thrust Acceleration Time] time until the output frequency increases to Y4-12. During the Y4-11 time, the terminal set for H2-xx = AB [MFDO Function Selection = Thrust Mode] will be active. When the output frequency is at or more than Y4-12, the drive will use the active acceleration and deceleration times set in C1-01 [Acceleration Time 1] to C1-04 [Deceleration Time 2]. At stop, when the output frequency decreases to Y4-12, the drive will use Y4-13 [Thrust Deceleration Time] for the remaining deceleration time.

Figure 5.100 shows an example of drive operation during Thrust mode when b1-03 = 0 [Stopping Method Selection = Ramp to Stop].

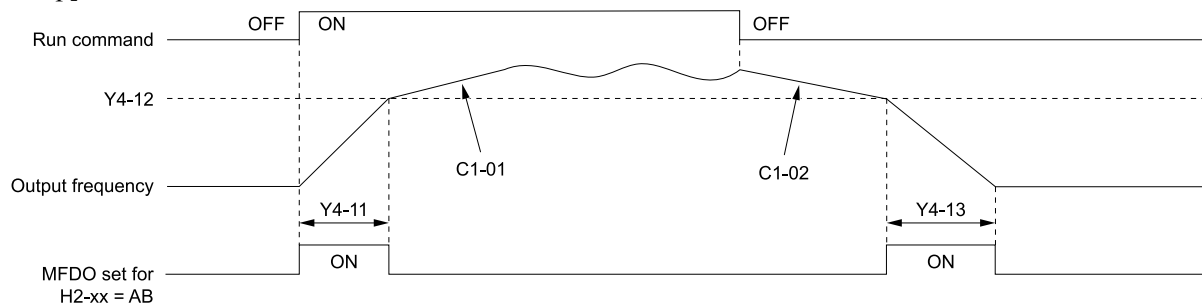

C1-01: Acceleration Time 1

C1-02: Deceleration Time 1

H2-xx = AB: Thrust Mode

Y4-11: Thrust Acceleration Time

Y4-12: Thrust Frequency

Y4-13: Thrust Deceleration Time

Figure 5.100 Thrust Frequency

■ Y4-13: Thrust Deceleration Time

No. (Hex.)	Name	Description	Default (Range)
Y4-13 (3D06) RUN	Thrust Deceleration Time	Sets the length of time necessary for the drive to go from the Thrust Frequency in Y4-12 [Thrust Frequency] to stop when Thrust Mode is active.	5.0 s (0.0 - 600.0 s)

When $Y4-13 > 0.0$, the drive will decelerate from the Y4-12 value to zero in exactly the Y4-13 time.

When $Y4-13 = 0$, the drive will use the standard deceleration rate.

■ Y4-18: Differential Level

No. (Hex.)	Name	Description	Default (Range)
Y4-18 (3D0B) RUN	Differential Level	Sets the maximum difference that the drive will allow when it subtracts the Differential Feedback from the Primary PID Feedback.	0.00% (-99.99 - +99.99%)

Note:

- The drive will respond as specified by the setting in Y4-20 [Differential Level Detection Selection] when the difference increases to more than the value set in this parameter for the time set in Y4-19 [Differential Level Detection Time].
- Set this parameter to 0.00 to disable Differential Feedback Detection.

■ Y4-19: Differential Lvl Detection Time

No. (Hex.)	Name	Description	Default (Range)
Y4-19 (3D0C) RUN	Differential Lvl Detection Time	Sets the length of time that the difference between PID Feedback and the Differential Feedback must be more than Y4-18 [Differential Level] before the drive will respond as specified by Y4-20 [Differential Level Detection Selection].	10 s (0 - 3600 s)

■ Y4-20: Differential Level Detection Sel

No. (Hex.)	Name	Description	Default (Range)
Y4-20 (3D0D) RUN	Differential Level Detection Sel	Sets the drive response during a Differential Level Detected condition.	0 (0 - 2)

0 : Fault (and Digital Out)

1 : Alarm (and Digital Out)

2 : Digital Out Only

■ Y4-22: Low City On-Delay Time

No. (Hex.)	Name	Description	Default (Range)
Y4-22 (3D0F) RUN	Low City On-Delay Time	Sets the length of time that the drive will wait to stop when the drive detects a Low City Pressure condition.	10 s (1 - 1000 s)

■ Y4-23: Low City Off-Delay Time

No. (Hex.)	Name	Description	Default (Range)
Y4-23 (3D10) RUN	Low City Off-Delay Time	Sets the length of time that the drive will wait to start again after you clear a Low City Pressure condition.	5 s (0 - 1000 s)

■ Y4-24: Low City Alarm Text

No. (Hex.)	Name	Description	Default (Range)
Y4-24 (3D11) RUN	Low City Alarm Text	Sets the alarm message to show on the keypad when the drive detects a Low City Pressure condition.	0 (0 - 2)

0 : Low City Pressure

1 : Low Suction Pressure

2 : Low Water in Tank

■ Y4-36: Pressure Reached Exit Conditions

No. (Hex.)	Name	Description	Default (Range)
Y4-36 (3D1D) RUN	Pressure Reached Exit Conditions	Sets how the digital output responds to Feedback changes after it activates.	1 (0, 1)

0 : Hysteresis Above & Below

The terminal set for $H2-xx = 42$ [MFDO Function Selection = Pressure Reached] will deactivate when the Feedback is less than the "Setpoint - Hysteresis" or more than the "Setpoint + Hysteresis" for the time set in Y4-39 [Pressure Reached Off Delay Time].

1 : Hysteresis 1-Way

- When $b5-09 = 0$ [*Normal Output (Direct Acting)*]:
The terminal set for $H2-xx = 42$ will deactivate only when the Feedback is less than the “Setpoint - Hysteresis” for the time set in Y4-39. When the Feedback is more than the Setpoint, the terminal will stay active.
- When $b5-09 = 1$ [*Reverse Output (Reverse Acting)*]:
The terminal set for $H2-xx = 42$ will deactivate only when the Feedback is more than the “Setpoint + Hysteresis” for the time set in Y4-39. When the Feedback is less than the Setpoint, the terminal will stay active.

■ Y4-37: Pressure Reached Hysteresis Lvl

No. (Hex.)	Name	Description	Default (Range)
Y4-37 (3D1E) RUN	Pressure Reached Hysteresis Lvl	Sets the hysteresis level that will cause the drive to exit the Pressure Reached condition.	0.30% (0.1 - 10.00%)

■ Y4-38: Pressure Reached On Delay Time

No. (Hex.)	Name	Description	Default (Range)
Y4-38 (3D1F) RUN	Pressure Reached On Delay Time	Sets the length of time that the drive will wait before it activates the Pressure Reached condition.	1.0 s (0.1 - 60.0 s)

■ Y4-39: Pressure Reached Off Delay Time

No. (Hex.)	Name	Description	Default (Range)
Y4-39 (3D20) RUN	Pressure Reached Off Delay Time	Sets the length of time that the drive will wait before it deactivates the Pressure Reached condition.	1.0 s (0.1 - 60.0 s)

■ Y4-40: Pressure Reached Detection Sel

No. (Hex.)	Name	Description	Default (Range)
Y4-40 (3D21) RUN	Pressure Reached Detection Sel	Sets the drive status that triggers the Pressure Reached Detection digital output.	0 (0 - 2)

0 : Always

The digital output set for $H2-xx = 42$ [*MFDO Function Selection = Pressure Reached*] will activate in all drive statuses. The digital output will engage when the drive is stopped or sleeping.

1 : Drive Running

The digital output set for $H2-xx = 42$ will activate only when the drive supplies the output voltage (not base blocked) to the motor. The digital output will not engage when the drive is sleeping.

2 : Run Command

The digital output set for $H2-xx = 42$ will activate only when there is an active Run command, for example, AUTO or HAND.

■ Y4-41: Diff Lvl Src Fdbk Backup Select

No. (Hex.)	Name	Description	Default (Range)
Y4-41 (3D22) RUN	Diff Lvl Src Fdbk Backup Select	Sets the function to enable or disable <i>Differential Level Source</i> [$H3-xx = 2D$] as the backup transducer if there is a failure with the primary PID Feedback transducer [$H3-xx = B$] and the PID Feedback Backup transducer [$H3-xx = 24$] is not available.	0 (0, 1)

0 : Disabled

1 : Enabled

■ Y4-42: Output Disconnect Detection Sel

No. (Hex.)	Name	Description	Default (Range)
Y4-42 (3D23)	Output Disconnect Detection Sel	This parameter applies only when in Drive Mode. It sets the drive response if the connection between the drive and the motor is disconnected.	0 (0 - 3)

Note:

1. Loss Of Load [Z1-31 to Z1-36], Load Verify [Z1-53], and Bypass Energy Savings [Z1-16] can interfere with the correct operation of Output Disconnect Detection.
2. When the Output Disconnect is active, the drive internally disables Output Phase Loss Detection of more than one phase.
3. The Output Current Limit function is not active when operating in Bypass Mode.

0 : Disabled

1 : Alarm - Speed Search

The drive will show an *OD [Output Disconnect]* alarm. When you close the output again, the drive will do a baseblock and a Speed Search for the correct recovery.

Note:

If at any time the customer Run command is removed, the drive will clear the *OD* alarm and enter a normal stopped state.

2 : Alarm - Start at Zero

The drive will show an *OD* alarm. When you close the output again, the drive will do a baseblock and let the soft-starter to ramp up from zero for the correct recovery.

Note:

If at any time the customer Run command is removed, the drive will clear the *OD* alarm and enter a normal stopped state.

3 : Fault

The drive will coast to stop and show an *OD [Output Disconnect]* fault.

Note:

You cannot Auto-Restart the drive after an *OD* fault.

■ Y4-43: Output Disconnect Inject Current

No. (Hex.)	Name	Description	Default (Range)
Y4-43 (3D24)	Output Disconnect Inject Current	Sets the level of DC injection current during output disconnect as a percentage of the drive rated current.	30% (5 - 50%)

◆ YA: Preset Setpoint

■ Setpoint Selection

Parameters *YA-01 [Setpoint 1]* to *YA-04 [Setpoint 4]* set the PID setpoint.

The priority over PID setpoint changes when the settings of MFDI functions *H1-xx = 3E* and *3F [PID Setpoint Selection 1 and 2]* change. Table 5.63 shows how the different MFDI functions (*H1-xx = 3E* and *3F [PID Setpoint Selection 1 and 2]*) have an effect on the PID setpoint value.

Table 5.63 Switching of MFDI and PID Setpoint Value

H1-xx = 3E	H1-xx = 3F	PID Setpoint Value
OFF	OFF	One of these values: <ul style="list-style-type: none"> • Frequency Reference (determined by <i>b1-01 [Frequency Reference Selection 1]</i>) • <i>YA-01 [Setpoint 1]</i> (when <i>b1-01 = 0 [Keypad]</i>) • Analog Setpoint (when <i>H3-xx = C [MFAI Function Selection = PID Setpoint]</i>) • MEMOBUS setpoint
ON	OFF	<i>YA-02 [Setpoint2]</i>
OFF	ON	<i>YA-03 [Setpoint3]</i>
ON	ON	<i>YA-04 [Setpoint4]</i>

You can also use $H1-xx = 83$ to 85 [Dedicated Multi-Setpoint YA-02 to YA-04] to select the digital setpoints as an alternative to $3E$ and $3F$. Table 5.64 shows which Setpoint is active as specified by the Dedicated Multi-Setpoint Selections.

Table 5.64 Dedicated Multi-Setpoint Selections and Active Setpoints

Alternate Multi-Setpoint YA-02 H1-xx = 83	Alternate Multi-Setpoint YA-03 H1-xx = 84	Alternate Multi-Setpoint YA-04 H1-xx = 85	Setpoint
OFF	OFF	OFF	YA-01
ON	ON/OFF	ON/OFF	YA-02
OFF	ON	ON/OFF	YA-03
OFF	OFF	ON	YA-04

Note:

- For all sources, you can change the value of setpoint with other functions, for example Sleep Boost function.
- If you set a minimum of one PID Setpoint Selection ($H1-xx = 3E$ or $3F$) and a minimum one Alternate Multi-Setpoint Selection ($H1-xx = 83, 84, \text{ or } 85$), the drive will detect an $oPE03$ [Multi-Function Input Setting Err].

System Feedback Monitor

Monitor $U1-61$ [System Feedback] shows the currently set PID Feedback from these four sources:

- $H3-xx = B$ [MFAI Function Selection = PID Feedback]
- $H3-xx = 24$ [PID Feedback Backup]
- $H3-xx = 2D$ [Differential Level Source]

Monitor $U1-61$ will show the PID Feedback when the PID is disabled.

Note:

The System Feedback ignores these feedback sources, which are only shown in $U5-01$ [PID Feedback]:

- MEMOBUS Register 15FF (Hex.) [Memobus PID Feedback]
- $H3-xx = 2B$ [Emergency Override PID Feedback]
- MEMOBUS Register 3A95 (Hex.) [Emergency Override PID Feedback]

Automatic Setpoint Display Switch-over when in PID Mode

When the drive is in PID mode, the Home screen will change to show $U5-99$ [Setpoint]. It will not show $U1-01$ [Frequency Reference].

When $b1-01 = 0$ [Frequency Reference Selection 1 = Keypad] and you push  on the Home screen, the keypad will show $YA-01, YA-02, YA-03, \text{ or } YA-04$ and let you change it.

■ YA-01: Setpoint 1

No. (Hex.)	Name	Description	Default (Range)
YA-01 (3E58) RUN	Setpoint 1	Sets the PID Setpoint when $b1-01 = 0$ [Frequency Reference Selection 1 = Keypad or Multi-Speed Selection].	0.00 (0.00 - 600.00)

Note:

Parameters $b5-46$ [PID Unit Display Selection], $b5-38$ [PID User Unit Display Scaling], and $b5-39$ [PID User Unit Display Digits] set the unit, range, and resolution.

■ YA-02: Setpoint 2

No. (Hex.)	Name	Description	Default (Range)
YA-02 (3E59) RUN	Setpoint 2	Sets the PID Setpoint as specified by the Multi-Setpoint digital inputs.	0.00 (0.00 - 600.00)

Note:

Parameters $b5-46$ [PID Unit Display Selection], $b5-38$ [PID User Unit Display Scaling], and $b5-39$ [PID User Unit Display Digits] set the unit, range, and resolution.

■ YA-03: Setpoint 3

No. (Hex.)	Name	Description	Default (Range)
YA-03 (3E5A) RUN	Setpoint 3	Sets the PID Setpoint as specified by the Multi-Setpoint digital inputs.	0.00 (0.00 - 600.00)

Note:

Parameters *b5-46 [PID Unit Display Selection]*, *b5-38 [PID User Unit Display Scaling]*, and *b5-39 [PID User Unit Display Digits]* set the unit, range, and resolution.

■ YA-04: Setpoint 4

No. (Hex.)	Name	Description	Default (Range)
YA-04 (3E5B) RUN	Setpoint 4	Sets the PID Setpoint as specified by the Multi-Setpoint digital inputs.	0.00 (0.00 - 600.00)

Note:

Parameters *b5-46 [PID Unit Display Selection]*, *b5-38 [PID User Unit Display Scaling]*, and *b5-39 [PID User Unit Display Digits]* set the unit, range, and resolution.

◆ YC: Foldback Features

YC parameters set Output Current Limit function.

■ Output Current Limit

The Output Current Limit function sets the current limit of motor. This function prevents long-term overload conditions of motor when there is bearing degradation.

The drive will try to decrease the frequency reference to limit the output current. Parameter *YC-02 [Current Limit]* sets the current limit setpoint. When the motor current increases to more than the setpoint, the drive will decrease the output frequency. The Output Current Limit function is not active when operating in Bypass Mode.

■ YC-01: Output Current Limit Select

No. (Hex.)	Name	Description	Default (Range)
YC-01 (3EBC)	Output Current Limit Select	Sets the function to enable or disable the output current regulator.	0 (0, 1)

0 : Disabled

1 : Enabled

■ YC-02: Current Limit

No. (Hex.)	Name	Description	Default (Range)
YC-02 (3EBD) RUN	Current Limit	Sets the current limit.	0.0 A (0.0 - 1000.0 A)

Note:

Value is internally limited to 300% of the drive rated current set in *n9-01 [Inverter Rated Current]*.

◆ YF: PI Auxiliary Control

PI Auxiliary Control lets the drive control pressure when the PI Auxiliary Level is adequate. When the PI Auxiliary Control Level decreases to the PI Auxiliary Control Setpoint set in parameter *YF-03 [PI Aux Control Setpoint]*, the

drive will regulate based on the PI Aux Level and the pressure will decrease. The drive also goes to sleep, wakes up, and detects an alarm and/or fault based on the PI Auxiliary Control level.

■ Enable PI Aux Level Control Features

Set $YF-01 = 1$ [*PI Aux Control Selection = Enabled*] to enable PI Aux Level Control and PI Aux Low Level Detection.

Figure 5.101 shows the primary PID and PI Auxiliary Control Diagram when $YF-01 = 1$.

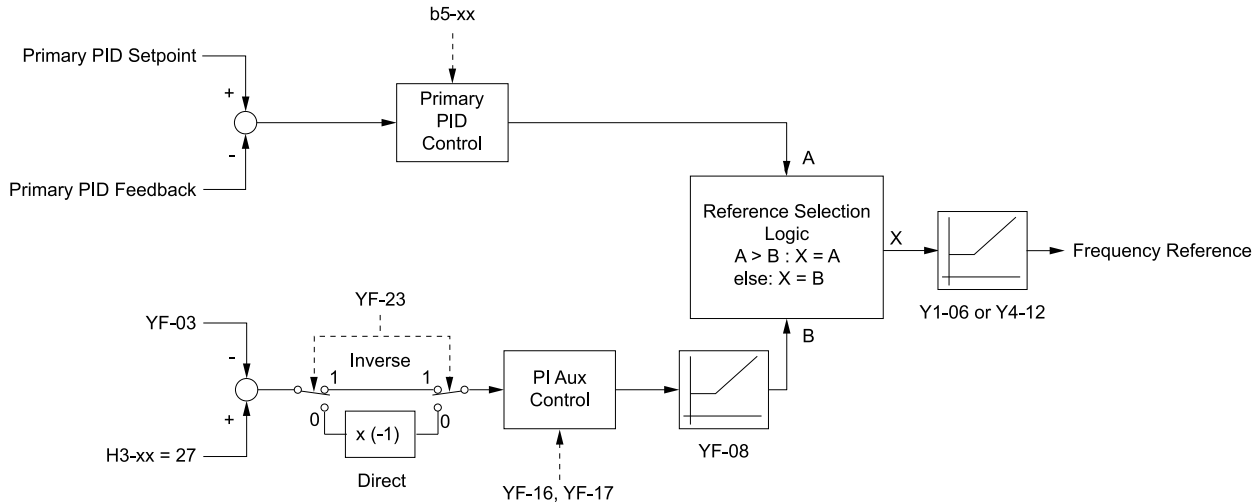

b5-xx: PID Control

H3-xx = 27: PI Auxiliary Control Feedback

Y1-06: Minimum Speed

Y4-12: Thrust Frequency

YF-03: PI Aux Control Setpoint

YF-08: PI Aux Control Minimum Speed

YF-16: PI Auxiliary Control P Gain

YF-17: PI Auxiliary Control I Time

YF-23: PI Aux Ctrl Output Level Select

Figure 5.101 Primary PID and PI Auxiliary Control Diagram

■ High PI Auxiliary Feedback Level Detection

Table 5.65 Absolute Mode and Delta to Setpoint Mode

Entry Mode	Keypad Display		Description
	YF-09	YF-12	
Absolute	10:00 am FWD Parameters PI Aux Control Low Lvl Detection Absolute Mode 020.00 % Default : 0.00% Range : 0.00~99.99 Back Default Min/Max	10:00 am FWD Parameters PI Aux Control High Level Detect Absolute Mode 020.00 % Default : 0.00% Range : 0.00~99.99 Back Default Min/Max	The values set for <i>YF-09</i> and <i>YF-12</i> represent the feedback level that will cause a Low PI Auxiliary Feedback and High PI Auxiliary Feedback. You can set these parameters as an absolute value.
Delta to Setpoint	10:00 am FWD Parameters PI Aux Control Low Lvl Detection Delta to Setpoint Mode Δ20.00 % Default : 0.00% Range : 0.00~99.99 Back Default Min/Max	10:00 am FWD Parameters PI Aux Control High Level Detect Delta to Setpoint Mode Δ20.00 % Default : 0.00% Range : 0.00~99.99 Back Default Min/Max	When the left-most digit changes to a Δ (delta), you can set the Low Feedback Level and High Feedback Level relative to the setpoint. The effective Low PI Auxiliary Feedback Level is "Setpoint - <i>YF-09</i> ", and the effective High PI Auxiliary Feedback Level is "Setpoint + <i>YF-12</i> ".

■ YF-01: PI Aux Control Selection

No. (Hex.)	Name	Description	Default (Range)
YF-01 (3F50)	PI Aux Control Selection	Sets the PI Auxiliary Control function.	0 (0, 1)

0 : Disabled

1 : Enabled

- A staged Lead drive will de-stage when *U5-16 [PI Aux Ctrl Feedback]* is less than *YF-04 [PI Aux Control Minimum Level]* for the time set in *YF-05 [PI Aux Control Sleep Delay Time]*.
- A staged Lead drive will de-stage when *U5-16* is more than *YF-24 [PI Auxiliary Ctrl Maximum Level]* for the time set in *YF-05*.

■ YF-02: PI Aux Control Transducer Scale

No. (Hex.)	Name	Description	Default (Range)
YF-02 (3F51) RUN	PI Aux Control Transducer Scale	Sets the full scale (10 V or 20 mA) output of the pressure transducer connected to the analog input terminal programmed for <i>H3-xx = 27 [PI Aux Control Feedback Level]</i> .	145.0 (1.0 - 6000.0)

Note:

Parameters *YF-21 [PI Aux Ctrl Level Unit Selection]* and *YF-22 [PI Aux Level Decimal Place Pos]* set the unit and resolution.

■ YF-03: PI Aux Control Setpoint

No. (Hex.)	Name	Description	Default (Range)
YF-03 (3F52) RUN	PI Aux Control Setpoint	Sets the level to which the drive will try to regulate.	20.0 PSI (0.0 - 6000.0)

Note:

Parameters *YF-21 [PI Aux Ctrl Level Unit Selection]* and *YF-22 [PI Aux Level Decimal Place Pos]* set the unit and resolution.

■ YF-04: PI Aux Control Minimum Level

No. (Hex.)	Name	Description	Default (Range)
YF-04 (3F53) RUN	PI Aux Control Minimum Level	Sets the level below which the drive must be for longer than <i>YF-05 [PI Aux Control Sleep Delay Time]</i> before the drive goes to sleep and turns off all lag pumps.	10.0 PSI (0.0 - 6000.0)

Note:

- Set this parameter to 0.0 to disable the function.
- Parameters *YF-21 [PI Aux Ctrl Level Unit Selection]* and *YF-22 [PI Aux Level Decimal Place Pos]* set the unit and resolution.

■ YF-05: PI Aux Control Sleep Delay Time

No. (Hex.)	Name	Description	Default (Range)
YF-05 (3F54) RUN	PI Aux Control Sleep Delay Time	Sets the length of time that the drive will delay before it goes to sleep after the level is less than <i>YF-04 [PI Aux Control Minimum Level]</i> (when <i>YF-23 = 1 [PI Aux Ctrl Output Level Select = Inverse Acting]</i>) or more than <i>YF-24 [PI Auxiliary Ctrl Maximum Level]</i> (when <i>YF-23 = 0 [Direct Acting]</i>).	5 s (0 - 3600 s)

■ YF-06: PI Aux Control Wake-up Level

No. (Hex.)	Name	Description	Default (Range)
YF-06 (3F55) RUN	PI Aux Control Wake-up Level	Sets the level to wake up the drive when the drive after <i>YF-04 [PI Aux Control Minimum Level]</i> or <i>YF-24 [PI Auxiliary Ctrl Maximum Level]</i> put the drive to sleep.	30.0 PSI (-999.9 - +999.9 PSI)

Note:

- Parameter *YF-23 [PI Aux Ctrl Output Level Select]* sets the condition to wake up the drive.
 - YF-23 = 0 [Direct Acting]*: The PI Aux Feedback must be less than the level set in this parameter for longer than the time set in *YF-07* to wake up.
 - YF-23 = 1 [Inverse Acting]*: The PI Aux Feedback must be more than the level set in this parameter for longer than the time set in *YF-07 [PI Aux Control Wake-up Time]* to wake up.
- Parameters *YF-21 [PI Aux Ctrl Level Unit Selection]* and *YF-22 [PI Aux Level Decimal Place Pos]* set the unit and resolution.

■ YF-07: PI Aux Control Wake-up Time

No. (Hex.)	Name	Description	Default (Range)
YF-07 (3F56)	PI Aux Control Wake-up Time	Sets the time to wake up the drive when the drive after <i>YF-04 [PI Aux Control Minimum Level]</i> or <i>YF-24 [PI Auxiliary Ctrl Maximum Level]</i> put the drive to sleep.	1 s (0 - 3600 s)

Note:

- Parameter *YF-23 [PI Aux Ctrl Output Level Select]* sets the condition to wake up the drive.
- *YF-23 = 0 [Direct Acting]*: The PI Aux Feedback must be less than the level set in *YF-06* for longer than the time set in *YF-07* to wake up.
 - *YF-23 = 1 [Inverse Acting]*: The PI Aux Feedback must be more than the level set in *YF-06 [PI Aux Control Wake-up Level]* for longer than the time set in *YF-07* to wake up.

■ YF-08: PI Aux Control Minimum Speed

No. (Hex.)	Name	Description	Default (Range)
YF-08 (3F57) RUN	PI Aux Control Minimum Speed	Sets the minimum speed at which the drive can run when the PI Auxiliary Control has an effect on the output speed.	0.00 Hz (0.00 - 400.00 Hz)

Note:

The drive will use *Y1-06 [Minimum Speed]* and *Y4-12 [Thrust Frequency]* as the minimum speed when PI Aux Control does not have an effect on the output speed or when you set *YF-08 < Y1-06 and Y4-12*.

■ YF-09: PI Aux Control Low Level Detect

No. (Hex.)	Name	Description	Default (Range)
YF-09 (3F58) RUN	PI Aux Control Low Level Detect	Sets the level below which the drive must be for longer than <i>YF-10 [PI Aux Control Low Lvl Det Time]</i> to respond as specified by <i>YF-11 [PI Aux Control Low Level Det Sel]</i> .	0.0 PSI (-999.9 - +999.9 PSI)

Note:

- Set this parameter to 0.0 to disable the function.
- Parameter *YF-10* only applies to when *YF-11 = 2 and 3 [Fault and Auto-Restart (time set by YF-15)]*.
- Parameters *YF-21 [PI Aux Ctrl Level Unit Selection]* and *YF-22 [PI Aux Level Decimal Place Pos]* set the unit and resolution.

■ YF-10: PI Aux Low Level Detection Time

No. (Hex.)	Name	Description	Default (Range)
YF-10 (3F59) RUN	PI Aux Low Level Detection Time	Sets the length of time that the PI Aux Feedback must be less than <i>YF-09 [PI Aux Control Low Lvl Detection]</i> to trigger a drive response when <i>YF-11 = 2 and 3 [PI Aux Control Low Level Det Sel = Fault and Auto-Restart (time set by YF-15)]</i> .	0.1 s (0.0 - 300.0 s)

■ YF-11: PI Aux Control Low Level Det Sel

No. (Hex.)	Name	Description	Default (Range)
YF-11 (3F5A)	PI Aux Control Low Level Det Sel	Sets drive response when the PI Aux Feedback decreases to less than <i>YF-09 [PI Aux Control Low Lvl Detection]</i> for longer than <i>YF-10 [PI Aux Control Low Lvl Det Time]</i> .	1 (0 - 3)

Note:

- Set $YF-01 = 1$ [*PI Aux Control Selection = Enabled*] and $YF-09$ [*PI Aux Control Low Level Detect*] > 0 to enable PI Aux Low Level Detection.
- Parameter $YF-10$ only applies when $YF-11 = 2$ or 3 .

0 : No Display

When the PI Aux Feedback decreases to less than the $YF-09$ [*PI Aux Control Low Level Detect*] level, the digital output set for $H2-xx = 9E$ [*MFDO Function Selection = Low PI Auxiliary Control Level*] will activate. When the level increases to more than the $YF-09$ level, the digital output will immediately deactivate.

1 : Alarm Only

When the PI Aux Feedback decreases to less than $YF-09$ level, the keypad will show an $LOAUX$ [*Low PI Aux Feedback Level*] alarm and the digital output set for $H2-xx = 9E$ will activate. When the feedback increases to more than $YF-09$ level, the drive will clear the alarm and the digital output will deactivate.

2 : Fault

When the output frequency is more than zero, and the PI Aux Feedback decreases to less than the $YF-09$ level, the digital output set for $H2-xx = 9E$ and an $LOAUX$ alarm will immediately activate. If the feedback stays less than the $YF-09$ level for the time set in $YF-10$ [*PI Aux Low Level Detection Time*], the drive will detect an $LOAUX$ [*Low PI Aux Feedback Level*] fault.

3 : Auto-Restart (time set by YF-15)

When the output frequency is more than zero, and the PI Aux Feedback decreases to less than the $YF-09$ level, the digital output set for $H2-xx = 9E$ and an $LOAUX$ alarm will immediately activate. If the feedback stays less than the $YF-09$ level for the time set in $YF-10$ [*PI Aux Low Level Detection Time*], the drive will detect an $LOAUX$ fault.

When $L5-01$ [*Number of Auto-Restart Attempts*] > 0 and if the drive detects an $LOAUX$ fault, the drive will automatically try an Auto-Restart after $YF-15$ [*PI Aux Level Detect Restart Time*] is expired. If the feedback is not more than the $YF-09$ level, the Auto-Restart counter will increment and the drive will stay faulted.

■ YF-12: PI Aux Control High Level Detect

No. (Hex.)	Name	Description	Default (Range)
YF-12 (3F5B) RUN	PI Aux Control High Level Detect	Sets the value above which the level must be for longer than $YF-13$ [<i>PI Aux High Level Detection Time</i>] to respond as specified by $YF-14$ [<i>PI Aux Hi Level Detection Select</i>].	0.0 PSI (-999.9 - +999.9 PSI)

Note:

- Set this parameter to 0.0 to disable the function.
- Parameter $YF-13$ only applies to when $YF-14 = 2$ and 3 [*Fault and Auto-Restart (time set by YF-15)*].
- Parameters $YF-21$ [*PI Aux Ctrl Level Unit Selection*] and $YF-22$ [*PI Aux Level Decimal Place Pos*] set the unit and resolution.

■ YF-13: PI Aux High Level Detection Time

No. (Hex.)	Name	Description	Default (Range)
YF-13 (3F5C) RUN	PI Aux High Level Detection Time	Sets the length of time that the level must be more than $YF-12$ [<i>PI Aux Control High Level Detect</i>] before the drive will respond when $YF-14 = 2, 3$ [<i>PI Aux Hi Level Detection Select</i>].	0.1 s (0.0 - 300.0 s)

■ YF-14: PI Aux Control Hi Level Det Sel

No. (Hex.)	Name	Description	Default (Range)
YF-14 (3F5D)	PI Aux Control Hi Level Det Sel	Sets the drive response when the PI Aux Feedback increases to more than the $YF-12$ [<i>PI Aux Control High Level Detect</i>] level for longer than the time set in $YF-13$ [<i>PI Aux High Level Detection Time</i>].	1 (0 - 3)

Note:

- Set $YF-01 = 1$ [*PI Aux Control Selection = Enabled*] and $YF-12$ [*PI Aux Control High Level Detect*] > 0 to enable PI Aux High Level Detection.
- Parameter $YF-13$ only applies when $YF-14 = 2$ or 3

0 : NoDisplay (Digital Output Only)

When the PI Aux Feedback increases to more than the *YF-12* level, the digital output set for *H2-xx = 9F* [*MFDO Function Selection = High PI Auxiliary Control Level*] will immediately activate. When the level decreases to less than the *YF-12* level, the digital output will immediately deactivate.

1 : Alarm Only

When the PI Aux Feedback increases to more than *YF-12* level, the keypad will show an *HIAUX* [*High PI Aux Feedback Level*] alarm and the digital output set for *H2-xx = 9F* will activate. When the feedback decreases to less than *YF-12* level, the drive will clear the alarm and the digital output will deactivate.

2 : Fault

When the output frequency is more than zero, and the PI Aux Feedback increases to more than *YF-12* level, the digital output set for *H2-xx = 9F* and an *HIAUX* alarm will immediately activate. If the feedback stays more than the *YF-12* level for the time set in *YF-13* [*PI Aux High Level Detection Time*], the drive will then detect an *HIAUX* [*High PI Aux Feedback Level*] fault.

3 : Auto-Restart (time set by YF-15)

When the output frequency is more than zero, and the PI Aux Feedback increases to more than *YF-12* level, the digital output set for *H2-xx = 9F* and an *HIAUX* alarm will immediately activate. If the feedback stays more than the *YF-12* level for the time set in *YF-13*, the drive will then detect an *HIAUX* fault.

When *L5-01* [*Number of Auto-Restart Attempts*] > 0 and if the drive detects an *HIAUX* fault, the drive will automatically try an Auto-Restart after *YF-15* [*PI Aux Level Detect Restart Time*] is expired. If the feedback is not less than the *YF-12* level, the Auto-Restart counter will increment and the drive will stay faulted.

■ YF-15: PI Aux Level Detect Restart Time

No. (Hex.)	Name	Description	Default (Range)
YF-15 (3F5E)	PI Aux Level Detect Restart Time	Sets the length of time the drive will wait before it tries an Auto-Restart of <i>LOAUX</i> [<i>Low PI Aux Feedback Level</i>] or <i>HIAUX</i> [<i>High PI Aux Feedback Level</i>] fault.	5.0 min (0.1 - 6000.0 min)

■ YF-16: PI Auxiliary Control P Gain

No. (Hex.)	Name	Description	Default (Range)
YF-16 (3F5F) RUN	PI Auxiliary Control P Gain	Sets the proportional gain for the suction pressure control.	2.00 (0.00 - 25.00)

■ YF-17: PI Auxiliary Control I Time

No. (Hex.)	Name	Description	Default (Range)
YF-17 (3F60) RUN	PI Auxiliary Control I Time	Sets the integral time for the suction pressure control.	5.0 s (0.0 - 360.0 s)

Note:

Set this parameter to 0.0 to disable the integrator.

■ YF-18: PI Aux Control Detect Time Unit

No. (Hex.)	Name	Description	Default (Range)
YF-18 (3F61)	PI Aux Control Detect Time Unit	Sets the time unit for <i>YF-10</i> [<i>PI Aux Control Low Lvl Det Time</i>] and <i>YF-13</i> [<i>PI Aux High Level Detection Time</i>].	1 (0, 1)

0 : Minutes (min)

1 : Seconds (sec)

■ YF-19: PI Aux Ctrl Feedback WireBreak

No. (Hex.)	Name	Description	Default (Range)
YF-19 (3F62)	PI Aux Ctrl Feedback WireBreak	Sets how the analog input selected for PI Aux Feedback will respond when it is programmed to receive a 4 mA to 20 mA signal and the signal is lost.	2 (0 - 2)

0 : Disabled

1 : Alarm Only

The keypad will show an *AUXFB [PI Aux Feedback Level Loss]* alarm.

2 : Fault (no retry, coast to stop)

When the drive is in AUTO, HAND, or Sleep mode, the keypad will show an *AUXFB [PI Aux Feedback Level Loss]* fault.

Note:

If the drive has not received a Run command, the keypad will only show an *AUXFB* alarm.

■ YF-20: PI Aux Main PI Speed Control

No. (Hex.)	Name	Description	Default (Range)
YF-20 (3F63)	PI Aux Main PI Speed Control	Sets if the PI Auxiliary Controller has an effect on output speed.	1 (0, 1)

0 : Disabled

1 : Enabled

■ YF-21: PI Aux Ctrl Level Unit Selection

No. (Hex.)	Name	Description	Default (Range)
YF-21 (3F64)	PI Aux Ctrl Level Unit Selection	Set the units shown for the PI Aux Level parameters and monitors.	1 (0 - 50)

0 : "WC: inches of water column

1 : PSI: pounds per square inch

2 : GPM: gallons/min

3 : °F: Fahrenheit

4 : ft³/min: cubic feet/min

5 : m³/h: cubic meters/hour

6 : L/h: liters/hour

7 : L/s: liters/sec

8 : bar: bar

9 : Pa: Pascal

10 : °C: Celsius

11 : m: meters

12 : ft: feet

13 : L/min: liters/min

14 : m³/min: cubic meters/min

15 : "Hg: Inch Mercury

16 : kPa: kilopascal

48 : %: Percent

49 : Custom (YF-32 ~ 34)

50 : None

■ YF-22: PI Aux Level Decimal Place Pos

No. (Hex.)	Name	Description	Default (Range)
YF-22 (3F65)	PI Aux Level Decimal Place Pos	Sets the number of decimal places for the PI Aux Level parameters and monitors.	1 (0 - 3)

0 : No Decimal Places (XXXXX)

1 : One Decimal Places (XXXX.X)

2 : Two Decimal Places (XXX.XX)

3 : Three Decimal Places (XX.XXX)

■ YF-23: PI Aux Ctrl Output Level Select

No. (Hex.)	Name	Description	Default (Range)
YF-23 (3F66)	PI Aux Ctrl Output Level Select	Sets the PI Auxiliary Controller to be Direct-acting or Inverse-acting.	1 (0, 1)

0 : Direct Acting

When the feedback is higher than the setpoint, the speed will be lower.

1 : Inverse Acting

When the feedback is lower than the setpoint, the speed will be lower.

■ YF-24: PI Auxiliary Ctrl Maximum Level

No. (Hex.)	Name	Description	Default (Range)
YF-24 (3F67) RUN	PI Auxiliary Ctrl Maximum Level	Sets the maximum level for PI Auxiliary Control. When the level is more than this setting for longer than <i>YF-05 [PI Aux Control Sleep Delay Time]</i> , the drive will go to sleep and turn off all lag drives.	0.0 PSI (0.0 - 6000.0 PSI)

Note:

- Set this parameter to 0.0 to disable the function.
- Parameters *YF-21 [PI Aux Ctrl Level Unit Selection]* and *YF-22 [PI Aux Level Decimal Place Pos]* set the unit and resolution.

■ YF-25: PI Aux Control Activation Level

No. (Hex.)	Name	Description	Default (Range)
YF-25 (3F68) RUN	PI Aux Control Activation Level	Sets the level to activate the PI Auxiliary Control.	0.0 PSI (0.0 - 6000.0 PSI)

Note:

- The drive response changes when the *YF-23 [PI Aux Ctrl Output Level Select]* setting changes.
 - *YF-23 = 0 [Direct Acting]:*
When the PI Aux Feedback level is more than this setting for longer than *YF-26 [PI Aux Control Activation Delay]*, the drive will activate the PI Auxiliary Control to control the output frequency.
 - *YF-23 = 1 [Inverse Acting]:*
When the PI Aux Feedback level is less than this setting for longer than *YF-26*, the drive will activate PI Auxiliary Control to control the output frequency.
- When you set this parameter to 0.0 PSI, PI Auxiliary Control is always enabled.
- Parameters *YF-21 [PI Aux Ctrl Level Unit Selection]* and *YF-22 [PI Aux Level Decimal Place Pos]* set the unit and resolution.

■ YF-26: PI Aux Control Activation Delay

No. (Hex.)	Name	Description	Default (Range)
YF-26 (3F69) RUN	PI Aux Control Activation Delay	Sets the delay time to activate the PI Auxiliary Control.	2 s (0 - 3600 s)

Note:

- The drive response changes when the *YF-23 [PI Aux Ctrl Output Level Select]* setting changes.
 - *YF-23 = 0 [Direct Acting]*:
When the PI Aux Feedback level is more than *YF-25 [PI Aux Control Activation Level]* for longer than this time, the drive will activate the PI Auxiliary Control to control the output frequency.
 - *YF-23 = 1 [Inverse Acting]*:
When the PI Aux Feedback level is less than *YF-25* for longer than this time, the drive will activate PI Auxiliary Control to control the output frequency.
- When you set this parameter to 0.0 PSI, PI Auxiliary Control is always enabled.

■ YF-32: PI Aux Custom Unit Character 1

No. (Hex.)	Name	Description	Default (Range)
YF-32 (3F6F)	PI Aux Custom Unit Character 1	Sets the first character of the PI Aux custom unit display when <i>YF-21 = 49 [PI Aux Ctrl Level Unit Selection = Custom (YF-32 ~ 34)]</i> .	41 (20 - 7A)

Refer to [Custom Units on page 208](#) for more information about available selections.

■ YF-33: PI Aux Custom Unit Character 2

No. (Hex.)	Name	Description	Default (Range)
YF-33 (3F70)	PI Aux Custom Unit Character 2	Sets the second character of the PI Aux custom unit display when <i>YF-21 = 49 [PI Aux Ctrl Level Unit Selection = Custom (YF-32 ~ 34)]</i> .	41 (20 - 7A)

Refer to [Custom Units on page 208](#) for more information about available selections.

■ YF-34: PI Aux Custom Unit Character 3

No. (Hex.)	Name	Description	Default (Range)
YF-34 (3F71)	PI Aux Custom Unit Character 3	Sets the third character of the PI Aux custom unit display when <i>YF-21 = 49 [PI Aux Ctrl Level Unit Selection = Custom (YF-32 ~ 34)]</i> .	41 (20 - 7A)

Refer to [Custom Units on page 208](#) for more information about available selections.

■ YF-35: PI Aux Minimum Transducer Scale

No. (Hex.)	Name	Description	Default (Range)
YF-35 (3F72)	PI Aux Minimum Transducer Scale	Sets the minimum scale output of the pressure transducer that is connected to the terminal set for <i>H3-xx = 27 [MFAI Function Selection = PI Auxiliary Control Feedback]</i> .	0.0 PSI (-999.9 - +999.9 PSI)

Note:

- To enable this parameter, set it to less than *YF-02 [PI Aux Control Transducer Scale]*. If you set it to more than *YF-02*, it will disable the PI Auxiliary Feedback (set to 0).
- Parameters *YF-21 [PI Aux Ctrl Level Unit Selection]* and *YF-22 [PI Aux Level Decimal Place Pos]* set the unit and resolution.

5.13 Z: Bypass Parameters

◆ Z1: Bypass Control System

■ Z1-05: Auto Transfer To Bypass

No. (Hex.)	Name	Description	Default (Range)
Z1-05 (85CA)	Auto Transfer To Bypass	When the drive is running and there is a drive fault, operation will switch to Bypass Mode. When you remove the fault, the operation will go back to Drive Mode	0 (0, 1)

■ Z1-06: Power Up Mode

No. (Hex.)	Name	Description	Default (Range)
Z1-06 (85CB)	Power Up Mode	Sets the mode of bypass control at power-up.	1 (0 - 5)

Note:

If you program $Z2-0x = 31$ and 32 [Digital Input x Function Select = HAND Select and AUTO Select], the bypass will ignore this parameter.

0 : OFF-DRIVE

When bypass powers up, it will be in "OFF" mode and will need an "AUTO" or "HAND" command to run.

1 : AUTO-DRIVE

When bypass powers up, it will be in Drive Mode and will accept a Run command..

3 : AUTO-BYPASS

When bypass powers up, it will be in Bypass Mode and will accept a Run command.

5 : Powerup HOA Memory

When bypass powers up, it will power up into the same HOA and Drive/Bypass mode it was in when it powered down.

■ Z1-10: Emergency Override Transfer

No. (Hex.)	Name	Description	Default (Range)
Z1-10 (85CF)	Emergency Override Transfer	Enables and disables the function to auto transfer to EMOV bypass if the drive declares a fault when the bypass is running in EMOV drive.	1 (0, 1)

0 : Disabled

1 : Enabled

■ Z1-11: Motor AND/OR Function

No. (Hex.)	Name	Description	Default (Range)
Z1-11 (85D0)	Motor AND/OR Function	-	0 (0 - 10)

Note:

This parameter works together with $Z2-0x = 27$ and 28 [Digital Input x Function Select = Motor OR Select and Motor AND Select].

0 : Disabled

1 : Always Motor 1

2 : Always Motor 2

3 : Always Motor 1 AND 2

4 : OR in HAND and AUTO

5 : MOTOR 1 in HAND OR in AUTO

6 : MOTOR 2 in HAND OR in AUTO

7 : AND/OR in HAND and AUTO

8 : MOTOR 1 in HAND AND/OR in AUTO

9 : MOTOR 2 in HAND AND/OR in AUTO

10 : MOTOR 1,2 in HAND AND/OR in AUTO

■ Z1-12: Run Delay Time

No. (Hex.)	Name	Description	Default (Range)
Z1-12 (85D1)	Run Delay Time	When the Run command is issued, the drive will run at speed set in Z1-14 [Run Delay Frequency Reference]. After the time set in this parameter, the frequency reference will return to its programmed source (b1-01 or HAND frequency reference).	0.0 s (0.0 to 300.0 s)

Note:

- This function is available in Drive Mode only.
- This function is disabled when Z1-13 = 1 [Pre Interlock Run Select = Enabled].
- This function operates in both HAND and AUTO Modes.

■ Z1-13: Pre Interlock Run Select

No. (Hex.)	Name	Description	Default (Range)
Z1-13 (85D2)	Pre Interlock Run Select	Determines if the drive will run at a preset speed when the BAS Interlock Digital Input is open and a Run command is present.	0 (0, 1)

0 : Disabled

If the BAS Interlock Input is open the drive will NOT start and will display "AL02 Interlock Open" alarm.

1 : Enabled (DRIVE Mode)

In Drive Mode, if the BAS Interlock Input is open, the drive will operate at the preset speed set in parameter Z1-14 [Run Delay Frequency Reference]. At the same time, the keypad will show an AL02 Interlock Open alarm.

1 : Enabled (BYPASS Mode)

In Bypass Mode, if the BAS Interlock Input is open, the bypass will NOT start and the keypad will show an AL02 Interlock Open alarm.

■ Z1-14: Run Delay Frequency Reference

No. (Hex.)	Name	Description	Default (Range)
Z1-14 (85D3)	Run Delay Frequency Reference	Sets the frequency that the bypass uses when it delays the Run command.	60.00 Hz (0.00 - Max. Freq.)

Note:

Actual values depend on unit settings of drive parameters o1-03, o1-09, o1-10, and o1-11.

■ Z1-15: Interlock Wait Time

No. (Hex.)	Name	Description	Default (Range)
Z1-15 (85D4)	Interlock Wait Time	When you enter a Run command, it asserts the damper actuator output. When you program an input for Interlock and the time set to this parameter expires before the Interlock input activates, it will trigger a fault.	0.0 s (0.0 - 300.0 s)

Run Delay with Preset Speed Examples

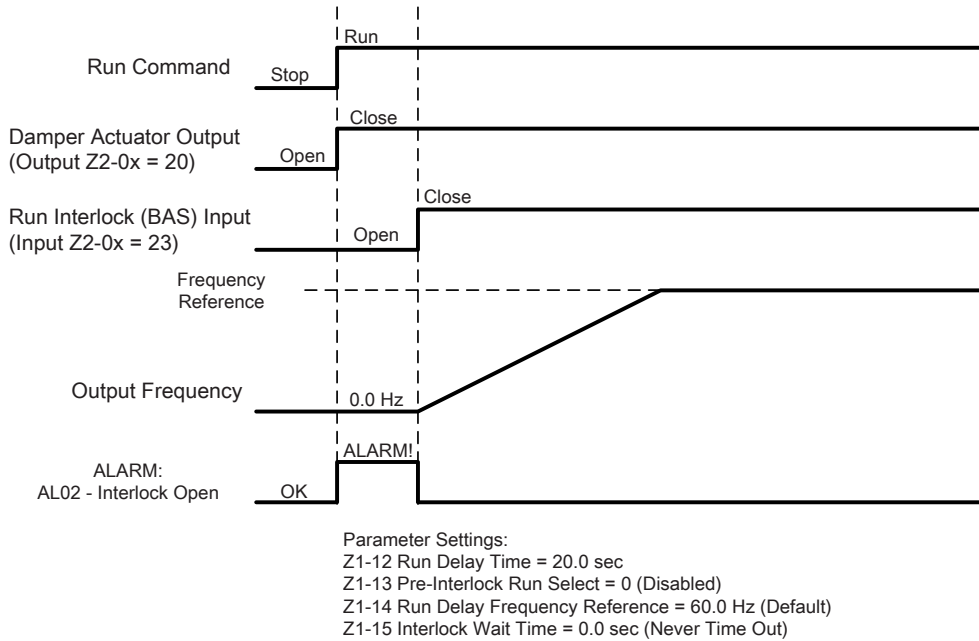

Figure 5.102 Run Delay with Preset Speed Example: Default Settings

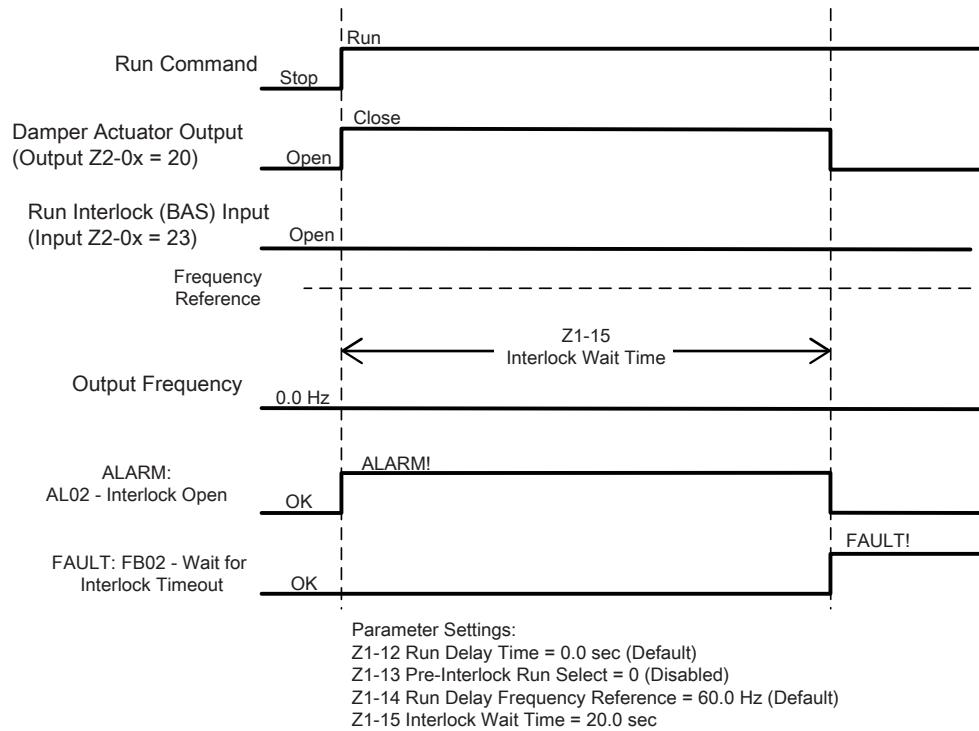

Figure 5.103 Run Delay with Preset Speed Example: BAS Interlock Wait Time Fault

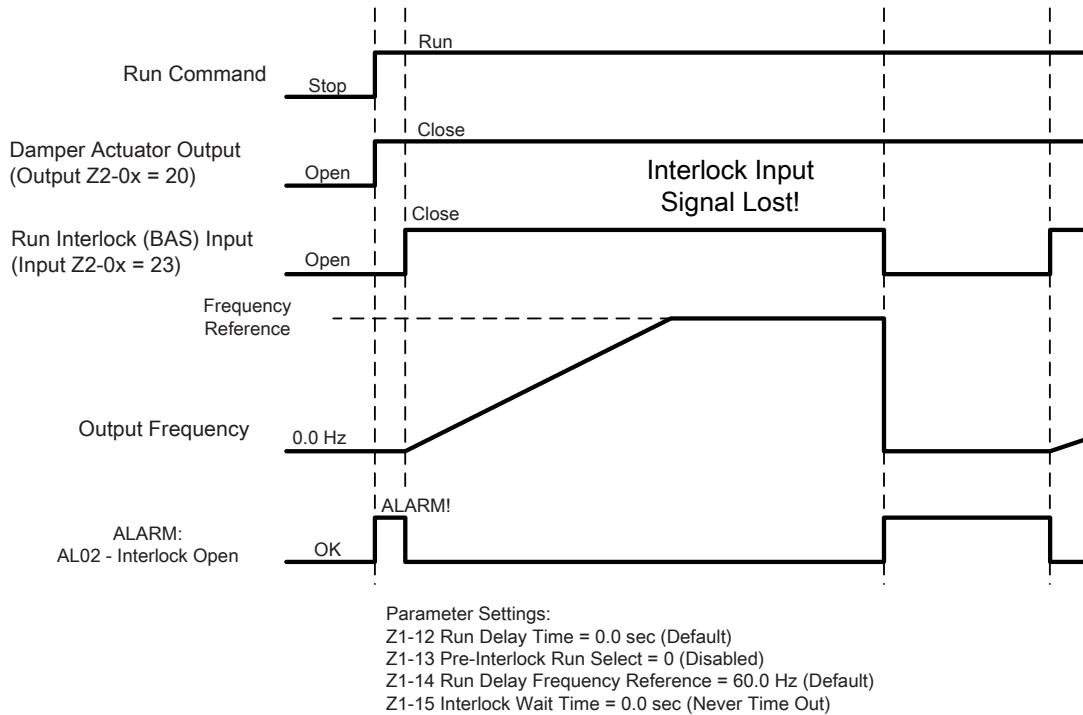

Figure 5.104 Run Interlock Lost Example: Default Settings

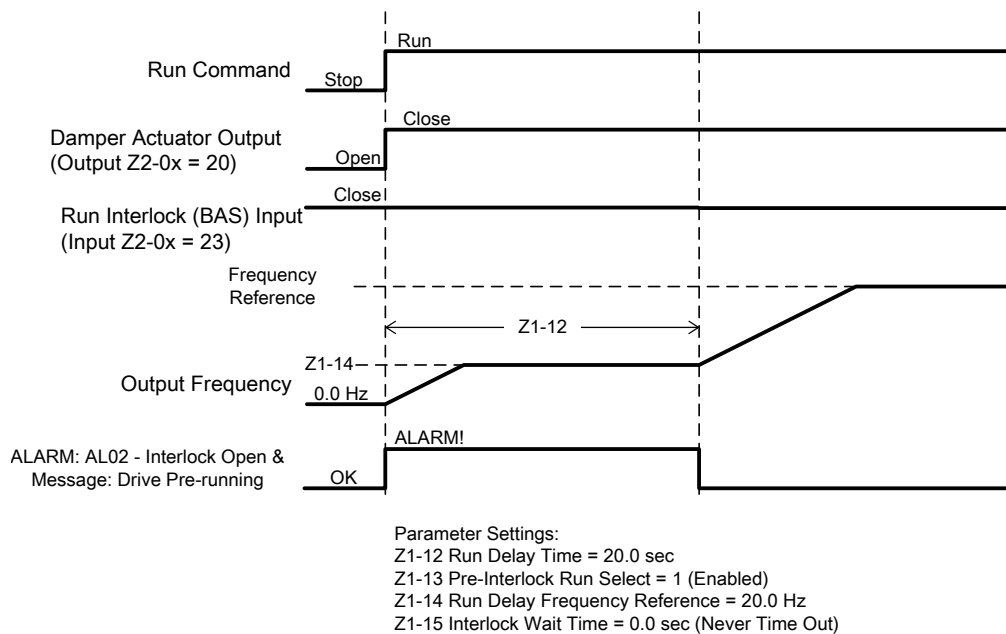

Figure 5.105 Run Delay with Preset Speed Example: Preset Speed

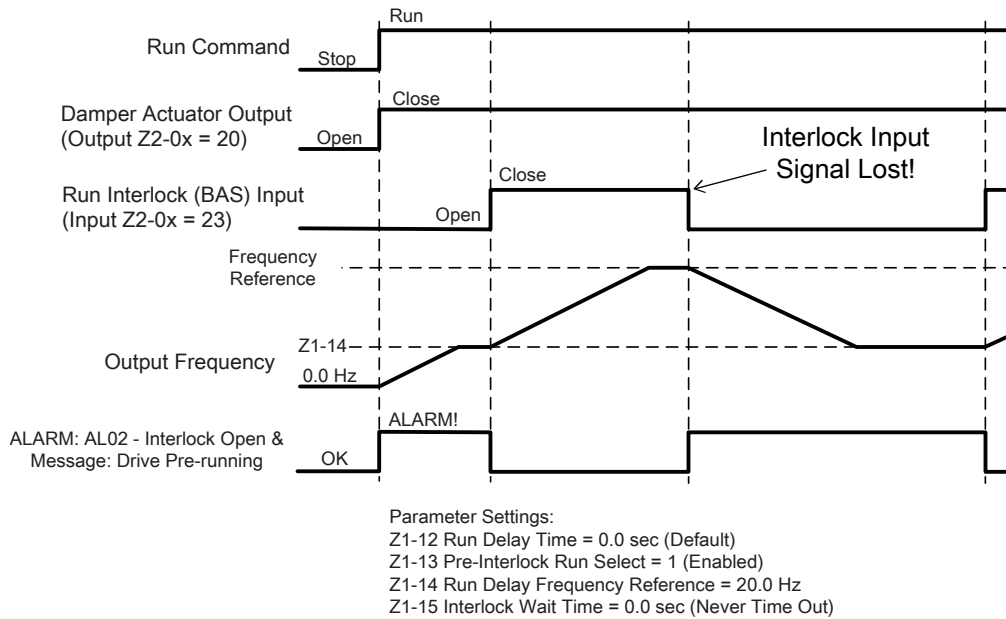

Figure 5.106 Run Interlock with Preset Speed Example: Interlock Signal Lost

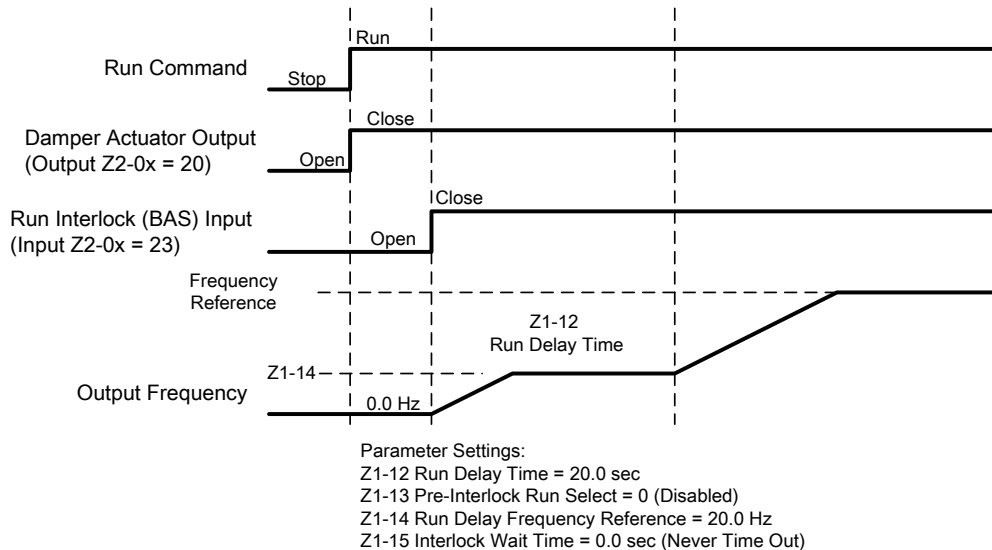

Figure 5.107 Run Delay with Preset Speed Example: Preset Speed with Run Delay

■ Z1-16 to Z1-25: Bypass Energy Savings

This feature helps you save energy and decrease harmonics by automatically switching to Bypass while in Drive Mode.

You can use one of two methods with Z1-16 [Energy Savings Mode] to switch into Energy Savings:

Frequency Only

When Z1-16 = 1 [Frequency], it will enable Energy Savings based on frequency only. The bypass will automatically switch to Bypass when the unit meets these conditions for Z1-22 [Energy Savings Mode Time]:

- Drive frequency reference is in Z1-19 [Energy Savings Mode Frequency Reference Deadband] of Z1-17 [Energy Savings Mode Frequency].
- Drive output frequency is in Z1-20 [Energy Savings Mode Output Frequency Deadband] of Z1-17 [Energy Savings Mode Frequency].

Frequency and Output Current

When $Z1-16 = 2$ [*Frequency + Current*], it will enable Energy Savings based on frequency and output current. The bypass will automatically switch to Bypass when it meets the *Frequency Only* conditions and the drive output current is in $Z1-21$ [*Energy Savings Mode Output Current Deadband*] of $Z1-18$ [*Energy Savings Mode Output Current Level*].

When the above conditions are met, the system:

1. Increases the drive frequency reference by the value in $Z1-23$ [*Energy Savings Mode Frequency Reference Increase*].
2. Waits for the drive output frequency to align with the frequency reference
3. Sets the drive to baseblock
4. Removes the effect of $Z1-23$ from the drive frequency reference
5. Delays based on the time set to $L2-03$ [*Minimum Baseblock Time*]
6. Opens drive output contactor K2
7. Delays based on the time set to $Z1-24$ [*Contactor Open Delay Time*]
8. Closes Bypass contactor K3 and transfers to Bypass.

When the drive frequency reference is not in the $Z1-19$ [*Energy Savings Mode Frequency Reference Deadband*] of $Z1-17$ [*Energy Savings Mode Frequency*], the system:

1. Transfers motor control to the drive
2. Opens Bypass contactor K3 while the drive stays baseblocked
3. Delays based on the sum of $Z1-24$ [*Contactor Open Delay Time*] and $L2-03$ [*Minimum Baseblock Time*]
4. Closes drive output contactor K2
5. Delays based on the time set to $Z1-25$ [*Contact Close Delay Time*]
6. Releases the drive from baseblock
7. The drive uses Speed Search to catches a spinning motor and follows the frequency reference to take control. The following figure shows an example of the sequence that is followed when entering and exiting the Energy Savings Mode.

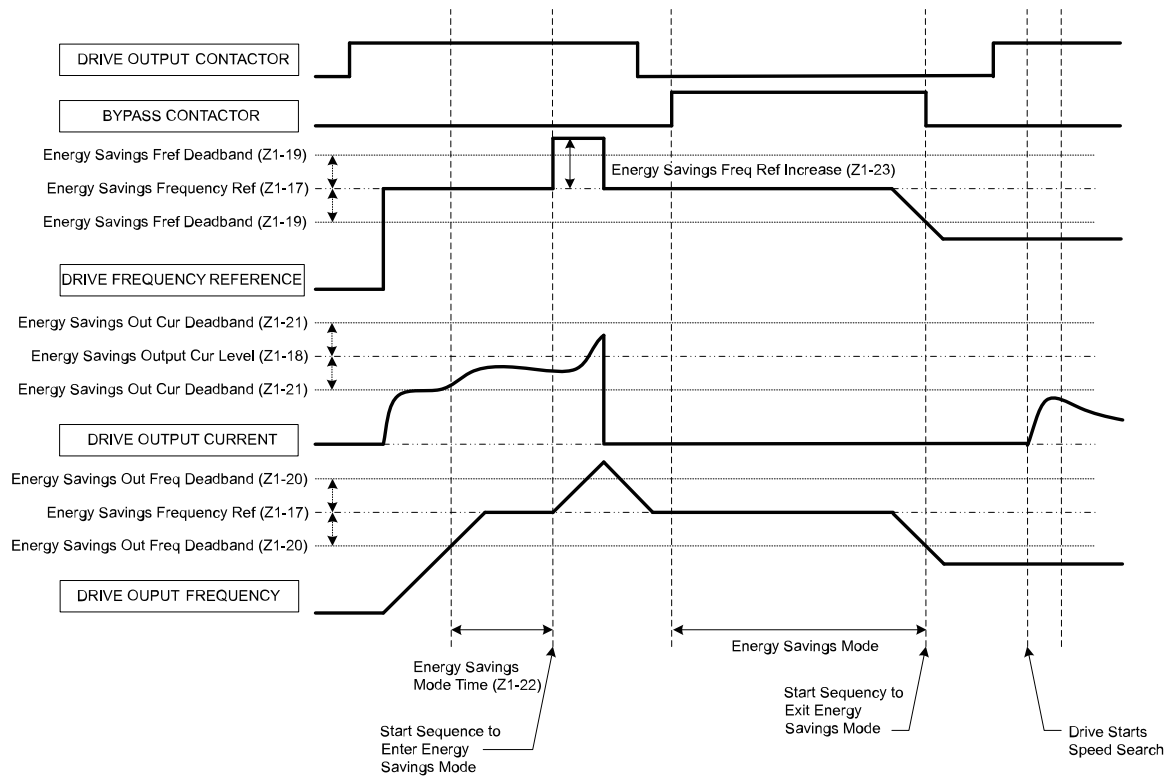

Figure 5.108 Drive Bypass Energy Savings Mode Sequence Example

■ Z1-16: Energy Savings Mode

No. (Hex.)	Name	Description	Default (Range)
Z1-16 (85D5)	Energy Savings Mode	Enables the contactor-based Energy Savings function and determines which conditions must be met before the bypass will enter into Energy Savings Mode.	0 (0 - 2)

0 : Disabled

Energy Savings Mode is disabled

1 : Frequency

The frequency reference and output frequency must be in their defined windows.

Frequency Reference must be between Z1-17 +/- Z1-19.

Output Frequency must be between Z1-17 +/- Z1-20.

2 : Frequency + Current

The frequency reference, output frequency, and drive output current must be in their defined windows.

Frequency Reference must be between Z1-17 +/- Z1-19.

Output Frequency must be between Z1-17 +/- Z1-20.

Drive Output Current must be between Z1-18 +/- Z1-21.

■ Z1-17: Energy Savings Frequency Ref

No. (Hex.)	Name	Description	Default (Range)
Z1-17 (85D6)	Energy Savings Frequency Ref	Both frequency reference and output frequency must be within the window defined by this parameter, Z1-19 [Energy Savings Fref Deadband], and Z1-20 [Energy Savings Out Freq Deadband] for Energy Savings operation.	60.00 Hz (0.00 - Max. Freq.)

Note:

- Actual values depend on unit settings of drive parameters *o1-03, o1-09, o1-10, and o1-11*.
- Used when $Z1-16 = 1$ or 2 [Energy Savings Mode = Frequency or Frequency + Current] .
- Typically set at the incoming line frequency for best operation.
- If the drive is in PID mode [$b5-01 > 0$], the output of the PID controller (the frequency reference) sets the entry and exit points of Energy Savings.

■ Z1-18: Energy Savings Output Cur Level

No. (Hex.)	Name	Description	Default (Range)
Z1-18 (85D7)	Energy Savings Output Cur Level	Drive output current must be in the window defined by this parameter and Z1-21 [Energy Savings Out Cur Deadband] to enter Energy Savings Mode.	0.0% (0.0 - 100.0%)

Note:

- Used only when $Z1-16 = 2$ [Energy Savings Mode = Frequency + Current].
- Not used to set when to exit Energy Savings Mode.

■ Z1-19: Energy Savings Fref Deadband

No. (Hex.)	Name	Description	Default (Range)
Z1-19 (85D8)	Energy Savings Fref Deadband	Used with Z1-17 [Energy Savings Frequency Ref] to set when to enter and exit Energy Savings Mode.	0.50 Hz (0.00 - 5.00 Hz)

■ Z1-20: Energy Savings Out Freq Deadband

No. (Hex.)	Name	Description	Default (Range)
Z1-20 (85D9)	Energy Savings Out Freq Deadband	Used with Z1-17 [Energy Savings Frequency Ref] to set when to enter Energy Savings Mode.	0.50 Hz (0.00 - 5.00 Hz)

■ Z1-21: Energy Savings Out Cur Deadband

No. (Hex.)	Name	Description	Default (Range)
Z1-21 (85DA)	Energy Savings Out Cur Deadband	Used with Z1-18 [Energy Savings Output Cur Level] to set when to enter Energy Savings Mode.	15.0% (0.0 - 30.0%)

■ Z1-22: Energy Savings Mode Time

No. (Hex.)	Name	Description	Default (Range)
Z1-22 (85DB)	Energy Savings Mode Time	Sets the length of time that all conditions must be in the set limits before transferring into Energy Savings Mode.	30 s (10 - 3600 s)

■ Z1-23: Energy Savings Freq Ref Increase

No. (Hex.)	Name	Description	Default (Range)
Z1-23 (85DC)	Energy Savings Freq Ref Increase	Sets the value to add to the drive Frequency Reference when transferring to Bypass Energy Savings Mode.	6.00 Hz (0.00 - 10.00 Hz)

WARNING! Sudden Movement Hazard. This parameter can cause operation higher than the E1-04 [Maximum Output Frequency] setting of the drive.

Note:

Actual values depend on unit settings of drive parameters *o1-03, o1-09, o1-10, and o1-11*.

■ Z1-24: Contactor Open Delay

No. (Hex.)	Name	Description	Default (Range)
Z1-24 (85DD)	Contactor Open Delay	Sets the time to delay after commanding the drive output contactor K2 or bypass contactor K3 or 2-Motor OR/AND contactors K4 and K5 to open to let the contacts open.	0.2 s (0.0 - 5.0 s)

■ Z1-25: Contactor Close Delay

No. (Hex.)	Name	Description	Default (Range)
Z1-25 (85DE)	Contactor Close Delay	Sets the time to delay after commanding the drive output contactor K2 or bypass contactor K3 or 2-Motor OR/AND contactors K4 and K5 to close to let the contacts close.	0.2 s (0.0 - 5.0 s)

■ Z1-27: Brownout Voltage Level

No. (Hex.)	Name	Description	Default (Range)
Z1-27 (85E0)	Brownout Voltage Level	Sets the voltage level below which is a brownout condition.	98 V (0 - 150 V)

Note:

Voltage level is measured on the output of the built-in 120 VAC control transformer.

■ Z1-28: Brownout Detection Time

No. (Hex.)	Name	Description	Default (Range)
Z1-28 (85E1)	Brownout Detection Time	Sets the length of time that the Bypass voltage must be less than the Brownout Voltage Level before the Bypass will trigger a Brownout fault.	3.0 s (1.0 - 300.0 s)

■ Z1-29: Blackout Voltage Level

No. (Hex.)	Name	Description	Default (Range)
Z1-29 (85E2)	Blackout Voltage Level	Sets the voltage level to determine a blackout condition. Use Z1-60 [Blackout Operation Select] to set power blackout behavior.	75 V (0 - 150 V)

Note:

Voltage level is measured on the output of the built-in 120 VAC control transformer.

■ Loss of Load

Loss of load detection determines if the motor current is less than a desired level.

Depending on the setting of Z1-31 [Loss of Load Detection Select], a Loss of Load condition can cause a fault and stop operation, or it can cause an alarm and continue operation. You can set different current detection levels and time delays for DRIVE and BYPASS Modes.

- Drive Mode

Loss of Load is detected when there is a Run command (Hand or Auto), the output frequency of the drive is equal to or more than the value set in Z1-32 [Loss of Load Drive Frequency], AND the motor current is less than Z1-33 [Loss of Load Drive Out Current] for the length of time set in Z1-34 [Loss of Load Drive Det Time].

- Bypass Mode

Loss of Load is detected when there is a Run command (Hand or Auto), AND the motor current is less than Z1-35 [Loss of Load Bypass Current] for the length of time set in Z1-36 [Loss of Load Bypass Det Time].

■ Z1-31: Loss of Load Detection Select

No. (Hex.)	Name	Description	Default (Range)
Z1-31 (85E4)	Loss of Load Detection Select	Sets the function to detect loss of load.	0 (0 - 2)

0 : Disabled**1 : Enable and Fault**

When the bypass detects Loss of Load, it will cause an *FB13 - Loss of Load Detected* fault. The motor will coast to a stop.

2 : Enable and Alarm

When the bypass detects Loss of Load, it will cause an *AL13 - Loss of Load Detected* alarm and operation will continue.

■ Z1-32: Loss of Load Drive Frequency

No. (Hex.)	Name	Description	Default (Range)
Z1-32 (85E5)	Loss of Load Drive Frequency	Sets the value to which the drive output frequency must be equal to or more than for the drive to detect a loss of load.	60.00 Hz (0.00 - Max Freq.)

Note:

Actual values depend on unit settings of drive parameters *o1-03, o1-09, o1-10, and o1-11*.

■ Z1-33: Loss of Load Drive Out Current

No. (Hex.)	Name	Description	Default (Range)
Z1-33 (85E6)	Loss of Load Drive Out Current	For Drive Mode only, the drive output current must be less than this level to detect a Loss of Load condition.	0.0 A (0.0 - 999.9 A)

■ Z1-34: Loss of Load Drive Det Time

No. (Hex.)	Name	Description	Default (Range)
Z1-34 (85E7)	Loss of Load Drive Det Time	The loss of load conditions must be met for the length of time in this parameter before the bypass will detect a loss of load in Drive Mode.	1.0 s (0.0 - 300.0 s)

■ Z1-35: Loss of Load Bypass Current

No. (Hex.)	Name	Description	Default (Range)
Z1-35 (85E8)	Loss of Load Bypass Current	For Bypass Mode only, the motor current must be less than this level to detect a Loss of Load condition.	0.0 A (0.0 - 999.9 A)

■ Z1-36: Loss of Load Bypass Det Time

No. (Hex.)	Name	Description	Default (Range)
Z1-36 (85E9)	Loss of Load Bypass Det Time	The motor current must be less than the value set in <i>Z1-35 [Loss of Load Bypass Current]</i> for the length of time set in this parameter before the bypass will detect a loss of load in Bypass Mode.	1.0 s (0.0 - 300.0 s)

■ Z1-39: Drive/Bypass Source Select

No. (Hex.)	Name	Description	Default (Range)
Z1-39 (85EC)	Drive/Bypass Source Select	Sets the function to select the Drive or the Bypass as the source of Drive/Bypass Mode selection.	0 (0 - 3)

0 : Keypad

The HOA keypad selects the Drive or Bypass as the source.

Drive/Bypass hotkeys work. The bypass digital input *Z2-0x = 33* Drive/Bypass is disabled.

1 : Digital Input

Z2-xx parameters select the Drive or Bypass as the source.

The Drive/Bypass hotkeys are disabled. The bypass digital input *Z2-0x = 33* Drive/Bypass works.

2 : Serial Communications

The serial communications protocol selected in *H5-08* selects the Drive or Bypass as the source.

The hotkey and DI are disabled, Drive/Bypass by register 8400, bit 12 only (via BACNet, Modbus, P1, N2).

3 : Option PCB

The hotkey and DI are disabled, Drive/Bypass by register 8400, bit 12 only (via Option PCB).

■ Z1-40: Auto Transfer Delay Time

No. (Hex.)	Name	Description	Default (Range)
Z1-40 (85ED)	Auto Transfer Delay Time	When you enable Auto Transfer and the bypass detects a drive fault, the bypass controller will wait for the length of time set in this parameter before it switches to bypass.	0.0 s (0.0 - 300.0 s)

■ Z1-42: Soft Starter Selection

No. (Hex.)	Name	Description	Default (Range)
Z1-42 (85EF)	Soft Starter Selection	This parameter is normally set at the factory and does not require adjustment. Set this parameter when you use a soft starter used in bypass operation and when you will use the soft starter for a "soft stop".	0 (0 - 2)

Note:

When [*Z1-42 = 1 or 2*] to enable the soft starter:

- The bypass automatically disables welded contactor detection. Parameter *Z1-55 [Welded Contactor Detection]* does not have an effect.
- The bypass automatically sets *Z2-08 = 29 [Digital Input 8 Function (TB2-8) = External Overload Motor 1 (NC)]* and *Z2-16 = 0 [Digital Input 8 Invert Select = Normal (Non-inverted)]*.

When you change *Z1-42* FROM 1 or 2 TO 0, the bypass does not automatically change *Z2-08* and *Z2-16* back to their default values. These parameters stay at their previous settings.

When you use serial communications or an option card to set *Z1-42*, *Z2-08 [Digital Input 8 Function (TB2-8)]* and *Z2-16 [Digital Input 8 Invert Select]* will not change unless *H5-11 = 1 [Comm ENTER Command Mode = ENTER Command Not Required]*.

0 : Not Installed – Contactor Only

Turns off the cabinet fans (if equipped) when in Bypass Mode.

1 : Installed – Coast To Stop

Cabinet fans (if equipped) will run in both Drive and Bypass Modes. Set soft starter.

2 : Installed – Ramp To Stop

Allows "Soft Start" and "Soft Stop" operation when the unit has a soft-starter. Additional wiring and configuration is necessary for the soft starter.

This setting disables Energy Savings Mode.

■ Z1-43: Soft Starter Delay Timer

No. (Hex.)	Name	Description	Default (Range)
Z1-43 (85F0)	Soft Starter Delay Timer	This parameter is normally set at the factory and does not require adjustment. Sets the delay time between closing contactor K3 and energizing the soft starter.	2.0 s (0.0 - 60.0 s)

Note:

This parameter is enabled when *Z1-42 = 1 or 2 [Soft Starter Selection = Installed - Coast To Stop or Installed - Ramp To Stop]*.

■ Z1-44: Soft Starter Rampdown Timeout

No. (Hex.)	Name	Description	Default (Range)
Z1-44 (85F1)	Soft Starter Rampdown Timeout	Sets the maximum wait time for the current to be less than 5% of <i>E2-01</i> after removing the soft starter Run command.	15.0 s (1.0 - 60.0 s)

If the current is not less than 5% of *E2-01* in the set time, the soft starter digital output turns off.

Adjust this parameter to a value slightly longer than the ramp-down time that is programmed into the soft starter (if equipped).

Note:

This parameter is enabled when $Z1-42 = 2$ *[[Soft Starter Selection = Installed - Ramp To Stop]*.

■ Z1-50: Bypass Input Phase Loss Level

No. (Hex.)	Name	Description	Default (Range)
Z1-50 (85F7)	Bypass Input Phase Loss Level	The bypass measures the current unbalance between phases to detect input phase loss. Usually it is not necessary to change this parameter.	25.0% (5.0 - 50.0%)

Input phase loss is only detected when in running in Bypass Mode.

To disable Bypass Input Phase Loss detection, set $Z1-51$ *[[Bypass Input Phase Loss Delay]]* = 0.0 sec.

Sets the current unbalance level between phases as a percentage of $E2-01$ when operating in Bypass Mode. Use this function with $Z1-51$ to detect input or output phase loss during bypass operation.

The unbalance level is determined by measuring the RMS current in each of the output phases. The amount of current unbalance between the phases is calculated using the this formula:

$$\text{Unbalance Level} = (I_{(\max)} - I_{(\min)}) / I_{(\max)} \times 100\%$$

When the unbalance level is more than $Z1-50$ for longer than $Z1-51$, it triggers $FB15$ – *Input Phase Loss* and the bypass coasts to stop.

■ Z1-51: Bypass Input Phase Loss Delay

No. (Hex.)	Name	Description	Default (Range)
Z1-51 (85F8)	Bypass Input Phase Loss Delay	Sets the trip time for an input phase loss condition in Bypass Mode.	5.0 s (0.0 - 30.0 s)

Note:

When you set this parameter to 0.0, it will disable bypass phase loss detection.

■ Z1-52: Input Phase Rotation Detection

No. (Hex.)	Name	Description	Default (Range)
Z1-52 (85F9)	Input Phase Rotation Detection	Sets bypass response when the Bypass Mode phase rotation is incorrect.	0 (0 - 2)

Controls the behavior of the bypass phase rotation detection when operating in Bypass Mode.

0 : Disabled

The unit ignores input phase rotation when operating in Drive Mode. Input phase rotation determines motor direction when operating in Bypass Mode.

1 : Alarm

If input phase rotation is reversed and $Z1-52 = 1$, when operation starts in Bypass Mode, it will trigger an $AL16$ – *Input Phase Rotation* alarm and operation continues.

2 : Fault

If input phase rotation is reversed and $Z1-52 = 2$, when operation starts in Bypass Mode, it will trigger an $FB16$ – *Input Phase Rotation* fault and the drive will coast to stop.

■ Z1-53: Load Verify Detection

No. (Hex.)	Name	Description	Default (Range)
Z1-53 (85FA)	Load Verify Detection	Enables and disables verification that the motor is running when commanded to run.	0 (0, 1)

0 : Disabled

1 : Enabled

When this function is enabled and the bypass detects a loss of output current, for example an open external motor disconnect or a zero frequency reference command for longer than 10 seconds, it will trigger a *FB17 - Load Verify Fault* and the bypass will coast to stop, and digital outputs programmed to *Damper Act Out [Z2-2x = 20]* will open. The bypass disables the *Load Lost* fault during emergency override operation.

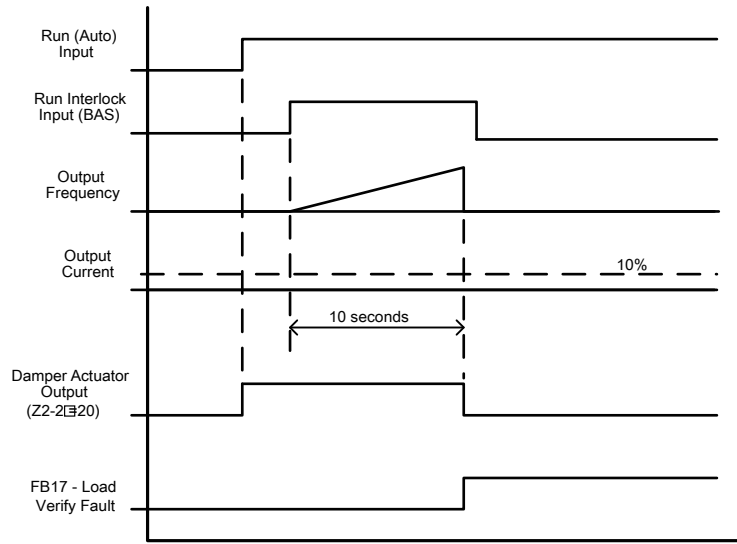

Figure 5.109 Motor Disconnected at Start

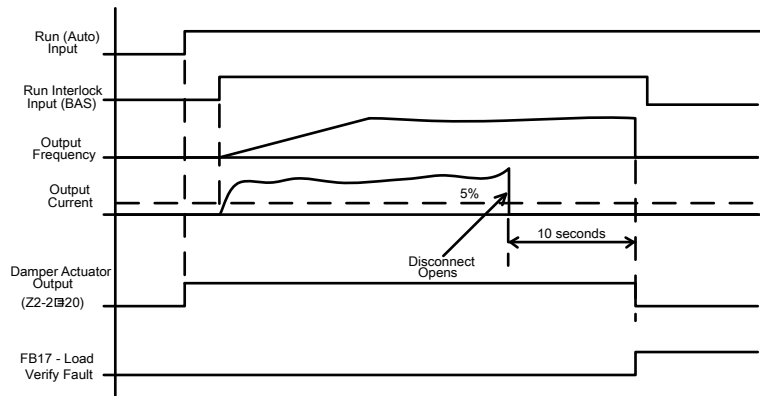

Figure 5.110 Motor Disconnected during Run

■ Z1-55: Welded Contactor Detection

No. (Hex.)	Name	Description	Default (Range)
Z1-55 (85FC)	Welded Contactor Detection	Enables and disables detection of K3 “welded contactor” condition.	0 (0, 1)

0 : Disabled

1 : Enabled

Note:

When *Z1-42 = 1 or 2 [Soft Starter Selection = Installed – Coast To Stop or Installed – Ramp To Stop]*, the bypass will automatically disable welded contactor detection.

This detection is active when you take the bypass out of bypass run mode or when you first apply power to the bypass package.

The bypass will trigger *FB18 - Welded Bypass Contactor Detected* when it detects this condition. Cycle power to the bypass package to clear this fault.

■ Z1-56: Test Mode

No. (Hex.)	Name	Description	Default (Range)
Z1-56 (85FD) RUN	Test Mode	Sets the behavior of the drive input contactor K1 during Bypass Mode.	0 (0, 1)

0 : Drive Power Off during Bypass

In a 3-contactor bypass configuration, this setting, when the bypass system switches to Bypass Mode, contactor K1 opens and the HV600 drive disconnects from incoming power. When the bypass system switches to Drive mode, contactor K1 closes and the HV600 drive can operate.

1 : Drive Power On during Bypass

Contactors K1 stays closed in Drive Mode and Bypass Mode. This setting will keep the status ring active or to decrease the length of time that for the drive to start operating when the system switches from Bypass Mode to Drive Mode.

■ Z1-60: Blackout Operation Select

No. (Hex.)	Name	Description	Default (Range)
Z1-60 (8601)	Blackout Operation Select	Sets bypass behavior when contactor voltage is less than Z1-29 [Blackout Voltage Level].	1 (0 - 3)

Note:

Restart Delay works best when:

- A keypad is connected
- There is a good battery in the keypad
- The date and time are set correctly in the keypad

0 : Fault

If there is a brief power loss, the bypass will detect an *FB09 - Blackout Detected* fault all contactors will open.

1 : Restart Delay with Speed Search

If there is a brief power loss, the bypass will delay the operation restart for the time set in Z1-61 [Power Loss Restart Delay Time]. During the restart delay, the bypass will display the *AL09 - Restart Delay Active* alarm. When the time elapses, the drive will do a speed-search on start.

2 : Restart Delay from Zero Speed

If there is a brief power loss, the bypass will delay the operation restart for the time set in Z1-61 [Power Loss Restart Delay Time]. During the restart delay, the bypass will display the *AL09 - Restart Delay Active* alarm. When the time elapses, the drive will start operation from zero speed.

Note:

If the power loss is long enough to lose control power, the drive will do speed search.

3 : Disabled

If there is a brief power loss, the bypass will not delay the operation restart. If control power was not lost, the drive will restart from 0 Hz. If control power was lost, the drive will do speed search.

■ Z1-61: Power Loss Restart Delay Time

No. (Hex.)	Name	Description	Default (Range)
Z1-61 (8602)	Power Loss Restart Delay Time	Sets the time delay for restart. This parameter works together Z1-60 [Blackout Operation Select]	10 s (1 - 300 s)

■ Z1-70: Green Contactor Mode

No. (Hex.)	Name	Description	Default (Range)
Z1-70 (860B)	Green Contactor Mode	Green Contactor Mode opens the output and motor contactors when the bypass unit is idle and does not have a Run command.	0 (0, 1)

0 : Disabled

1 : Enabled

■ Z1-94: Current Transformer Turns

No. (Hex.)	Name	Description	Default (Range)
Z1-94 (8623)	Current Transformer Turns	This parameter will indicate to the bypass controller how many times the motor leads pass through bypass current transformers. This parameter is typically set at the Yaskawa factory and does not require adjustment.	0 (0 - 2)

0 : Automatic

1 : Force 1 Turn

2 : Force 2 Turns

■ Z1-98: Minimum Drive SW Ver

No. (Hex.)	Name	Description	Default (Range)
Z1-98 (8627) Expert	Minimum Drive SW Ver	Only change this parameter under the guidance of Yaskawa technical support (1-800-YASKAWA). If you change this parameter incorrectly, it can cause incorrect operation of the bypass system.	Depends on software version (00000 - 65535)

Bypass SW VST800440 : Default: 0

Bypass SW VST800441 : Default: 0

Bypass SW VST800442 : Default: 0

Bypass SW VST800443 : Default: 1013

Bypass SW VST800444 : Default: 1013

Bypass SW VST800445 : Default: 1013

Bypass SW VST800446 : Default: 1013

Bypass SW VST800447 : Default : 1013

Bypass SW VST800448 : Default : 1013

■ Z1-99: Maximum Drive SW Ver

No. (Hex.)	Name	Description	Default (Range)
Z1-99 (8628) Expert	Maximum Drive SW Ver	Only change this parameter under the guidance of Yaskawa technical support (1-800-YASKAWA). If you change this parameter incorrectly, it can cause incorrect operation of the bypass system.	Depends on software version (00000 - 65535)

Bypass SW VST800440 : Default: 1010

Bypass SW VST800441 : Default: 1011

Bypass SW VST800442 : Default: 1012

Bypass SW VST800443 : Default: 1013

Bypass SW VST800444 : Default: 1014

Bypass SW VST800445 : Default: 1015

Bypass SW VST800446 : Default: 1016

Bypass SW VST800447 : Default: 1017

Bypass SW VST800448 : Default: 1017

FB30 Conflicting SW Check Ub-99 Disable

You can use Z1-98 and Z1-99 to resolve an *FB30 - Conflicting SW check* fault. Set Z1-98 or Z1-99 so that $Z1-98 \leq U1-25 \leq Z1-99$. Set A1-01 = 3 to be able to change these parameters.

Note:

Please use the table below or consult Yaskawa Technical Support to determine which features, parameters, or functions could be affected if you disable firmware version checking.

Table 5.66 Drive/Bypass Controller Firmware Compatibility Table

Drive Software Version (U1-25)	Bypass Controller Software Version (Ub-18)					
	00442	00443	00444	00445	00446	00447, 00448
01011	Leave Z1-98 and Z1-99 at default *1	Set Z1-98 = 01011 *2	Set Z1-98 = 01011 *2	Set Z1-98 = 01011 *2	Set Z1-98 = 01011 *2	Set Z1-98 = 01011 *2
01012	Leave Z1-98 and Z1-99 at default *1	Set Z1-98 = 01012 *2	Set Z1-98 = 01012 *2	Set Z1-98 = 01012 *2	Set Z1-98 = 01012 *2	Set Z1-98 = 01012 *2
01013	Set Z1-99 = 01013 *3	Leave Z1-98 and Z1-99 at default *1	Leave Z1-98 and Z1-99 at default *1	Leave Z1-98 and Z1-99 at default *1	Leave Z1-98 and Z1-99 at default *1	Leave Z1-98 and Z1-99 at default *1
01014	Set Z1-99 = 01014 *3 *4	Set Z1-99 = 01014 *4	Leave Z1-98 and Z1-99 at default *1	Leave Z1-98 and Z1-99 at default *1	Leave Z1-98 and Z1-99 at default *1	Leave Z1-98 and Z1-99 at default *1
01015	Set Z1-99 = 01015 *3 *4	Set Z1-99 = 01015 *4	Set Z1-99 = 01015 *1	Leave Z1-98 and Z1-99 at default *1	Leave Z1-98 and Z1-99 at default *1	Leave Z1-98 and Z1-99 at default *1
01016	Set Z1-99 = 01016 *3 *4	Set Z1-99 = 01016 *4	Set Z1-99 = 01016 *1	Set Z1-99 = 01016 *1	Leave Z1-98 and Z1-99 at default *1	Leave Z1-98 and Z1-99 at default *1
01017	Set Z1-99 = 01017 *1	Set Z1-99 = 01017 *1	Set Z1-99 = 01017 *1	Set Z1-99 = 01017 *1	Set Z1-99 = 01017 *1	Leave Z1-98 and Z1-99 at default *1

*1 This combination is allowed. No features, parameters, or functions are affected.

*2 You will be able to view b3-39 on the keypad, but the parameter will not have an effect.

*3 You will not be able to view b3-39 and you cannot change the setting.

*4 This combination is NOT ALLOWED for HV600 drive model CIPR-HV60U4008CVA. You must upgrade the bypass controller software for this model.

◆ Z2: Bypass Control Input/Output

■ Z2-01 to Z2-08 Digital Input 1 to 8 Function Selection

The drive has 8 digital input terminals. Refer to [Table 5.67](#) for default settings and functions.

Table 5.67 Digital Input Default Settings and Functions

No.	Name	Default	Function
Z2-01	Digital Input 1 Function Select (TB2-1)	21	Run (AUTO)
Z2-02	Digital Input 2 Function Select (TB2-2)	22	Run Enable - Safety (NC)
Z2-03	Digital Input 3 Function Select (TB2-3)	23	Run Interlock (BAS)
Z2-04	Digital Input 4 Function Select (TB2-4)	24	Remote Transfer to Bypass
Z2-05	Digital Input 5 Function Select (TB2-5)	25	Emergency Override Bypass
Z2-06	Digital Input 6 Function Select (TB2-6)	0	Not Used
Z2-07	Digital Input 7 Function Select (TB2-7)	0	Not Used
Z2-08	Digital Input 8 Function Select (TB2-8)	0 or 29	Not Used or External Overload Motor 1 (NC)

Table 5.68 Digital Input Setting Values

Setting Value	Function	Reference	Setting Value	Function	Reference
0	Not Used	442	3	Drive S3 Passthrough	443
1	Drive S1 Passthrough	442	4	Drive S4 Passthrough	443
2	Drive S2 Passthrough	442	5	Drive S5 Passthrough	443

5.13 Z: Bypass Parameters

Setting Value	Function	Reference
6	Drive S6 Passthrough	443
7	Drive S7 Passthrough	443
21	Run (AUTO)	443
22	Run Enable - Safety (NC)	443
23	Run Interlock (BAS)	443
24	Remote Transfer to Bypass	443
25	Emergency Override Bypass	444
26	Emergency Override Drive (FWD)	444
27	Motor OR Select	444
28	Motor AND Select	444
29	External Overload Motor 1 (NC)	444
30	External Overload Motor 2 (NC)	444
31	HAND Select	445
32	AUTO Select	445
33	Drive/Bypass Select	445

Setting Value	Function	Reference
34	Fault Reset	446
35	External Fault (EF0)	446
36	External Fault (EFB)	446
37	Run Reverse (AUTO)	446
38	Fire Stat Switch (NC)	446
39	Freeze Stat Switch (NC)	447
40	Smoke Alarm (NC)	447
41	OverPressure Switch (NC)	447
42	Low Suction Switch (NC)	447
43	Vibration Switch (NC)	447
44	Emergency Override Drive (REV)	448
45	Serial Hardware Test (RS-485)	448
46	Low City Pressure	448
47	Motor Preheat	448

■ Z2-01: Digital Input 1 Function (TB2-1)

No. (Hex.)	Name	Description	Default (Range)
Z2-01 (8563)	Digital Input 1 Function (TB2-1)	Sets the function for bypass digital input 1.	21 (0 - 47)

■ Z2-02: Digital Input 2 Function (TB2-2)

No. (Hex.)	Name	Description	Default (Range)
Z2-02 (8564)	Digital Input 2 Function (TB2-2)	Sets the function for bypass digital input 2.	22 (0 - 47)

■ Z2-03: Digital Input 3 Function (TB2-3)

No. (Hex.)	Name	Description	Default (Range)
Z2-03 (8565)	Digital Input 3 Function (TB2-3)	Sets the function for bypass digital input 3.	23 (0 - 47)

■ Z2-04: Digital Input 4 Function (TB2-4)

No. (Hex.)	Name	Description	Default (Range)
Z2-04 (8566)	Digital Input 4 Function (TB2-4)	Sets the function for bypass digital input 4.	24 (0 - 47)

■ Z2-05: Digital Input 5 Function (TB2-5)

No. (Hex.)	Name	Description	Default (Range)
Z2-05 (8567)	Digital Input 5 Function (TB2-5)	Sets the function for bypass digital input 5.	25 (0 - 47)

■ Z2-06: Digital Input 6 Function (TB2-6)

No. (Hex.)	Name	Description	Default (Range)
Z2-06 (8568)	Digital Input 6 Function (TB2-6)	Sets the function for bypass digital input 6.	0 (0 - 47)

■ Z2-07: Digital Input 7 Function (TB2-7)

No. (Hex.)	Name	Description	Default (Range)
Z2-07 (8569)	Digital Input 7 Function (TB2-7)	Sets the function for bypass digital input 7.	0 (0 - 47)

■ Z2-08: Digital Input 8 Function (TB2-8)

No. (Hex.)	Name	Description	Default (Range)
Z2-08 (856A)	Digital Input 8 Function (TB2-8)	Sets the function for bypass digital input 8.	0 (0 - 47)

■ Z2-09: Digital Input 1 Invert Select

No. (Hex.)	Name	Description	Default (Range)
Z2-09 (856B)	Digital Input 1 Invert Select	Inverts the output of the function selected in Digital Input 1.	0 (0, 1)

0 : Normal (Non-inverted)

1 : Inverted

■ Z2-10: Digital Input 2 Invert Select

No. (Hex.)	Name	Description	Default (Range)
Z2-10 (856C)	Digital Input 2 Invert Select	Inverts the output of the function selected in Digital Input 2.	0 (0, 1)

0 : Normal (Non-inverted)

1 : Inverted

■ Z2-11: Digital Input 3 Invert Select

No. (Hex.)	Name	Description	Default (Range)
Z2-11 (856D)	Digital Input 3 Invert Select	Inverts the output of the function selected in Digital Input 3.	0 (0, 1)

0 : Normal (Non-inverted)

1 : Inverted

■ Z2-12: Digital Input 4 Invert Select

No. (Hex.)	Name	Description	Default (Range)
Z2-12 (856E)	Digital Input 4 Invert Select	Inverts the output of the function selected in Digital Input 4.	0 (0, 1)

0 : Normal (Non-inverted)

1 : Inverted

■ Z2-13: Digital Input 5 Invert Select

No. (Hex.)	Name	Description	Default (Range)
Z2-13 (856F)	Digital Input 5 Invert Select	Inverts the output of the function selected in Digital Input 5.	0 (0, 1)

0 : Normal (Non-inverted)

1 : Inverted

■ Z2-14: Digital Input 6 Invert Select

No. (Hex.)	Name	Description	Default (Range)
Z2-14 (8570)	Digital Input 6 Invert Select	Inverts the output of the function selected in Digital Input 6.	0 (0, 1)

0 : Normal (Non-inverted)

1 : Inverted

■ Z2-15: Digital Input 7 Invert Select

No. (Hex.)	Name	Description	Default (Range)
Z2-15 (8571)	Digital Input 7 Invert Select	Inverts the output of the function selected in Digital Input 7.	0 (0, 1)

0 : Normal (Non-inverted)

1 : Inverted

■ Z2-16: Digital Input 8 Invert Select

No. (Hex.)	Name	Description	Default (Range)
Z2-16 (8572)	Digital Input 8 Invert Select	Inverts the output of the function selected in Digital Input 8.	0 (0, 1)

0 : Normal (Non-inverted)

1 : Inverted

■ Digital Input Setting Value

Selects a function set with Z2-01 to Z2-08.

0: Not Used

Setting Value	Function	Description
0	Not Used	Use this setting for unused terminals or to use terminals in through mode.

Input terminals programmed to this value will have no effect on the operation of the bypass package. It is possible, however, to read the status of the terminal over various serial communications protocols.

It is possible to program multiple digital input terminals to *Not Used* [Z2-0x = 0].

1: Drive S1 Passthrough

Setting Value	Function	Description
1	Drive S1 Passthrough	Simulates a digital input on drive digital input terminal S1. Use H1-01 [Terminal S1 Function Selection] to program the function.

2: Drive S2 Passthrough

Setting Value	Function	Description
2	Drive S2 Passthrough	Simulates a digital input on drive digital input terminal S2. Use H1-02 [Terminal S2 Function Selection] to program the function.

3: Drive S3 Passthrough

Setting Value	Function	Description
3	Drive S3 Passthrough	Simulates a digital input on drive digital input terminal S3. Use H1-03 [Terminal S3 Function Selection] to program the function.

4: Drive S4 Passthrough

Setting Value	Function	Description
4	Drive S4 Passthrough	Simulates a digital input on drive digital input terminal S4. Use H1-04 [Terminal S4 Function Selection] to program the function.

5: Drive S5 Passthrough

Setting Value	Function	Description
5	Drive S5 Passthrough	Simulates a digital input on drive digital input terminal S5. Use H1-05 [Terminal S5 Function Selection] to program the function.

6: Drive S6 Passthrough

Setting Value	Function	Description
6	Drive S6 Passthrough	Simulates a digital input on drive digital input terminal S6. Use H1-06 [Terminal S6 Function Selection] to program the function.

7: Drive S7 Passthrough

Setting Value	Function	Description
7	Drive S7 Passthrough	Simulates a digital input on drive digital input terminal S7. Use H1-07 [Terminal S7 Function Selection] to program the function.

21: Run (AUTO)

Setting Value	Function	Description
21	Run (AUTO)	Starts and stops the bypass.

22: Run Enable - Safety (NC)

Setting Value	Function	Description
22	Run Enable - Safety (NC)	Stops the bypass. Normally closed signal.

This is a normally-closed signal. When the signal is open, the bypass will not run. If the bypass is already running, it will stop the bypass.

Open: If the signal is open and there is no Run command, the keypad will show *Safety Open*. If the signal is open and a Run command is present, the alarm LED will flash and the keypad will show *SAFE - Safety Open*.

Closed: Normal operation

23: Run Interlock (BAS)

Setting Value	Function	Description
23	Run Interlock (BAS)	Stops the drive and triggers alarm AL02. Normally closed signal.

This is a normally-closed signal. In the factory-default programming, when the signal is open, the bypass will not run. If the bypass is already running, it will stop the bypass.

You can use Z1-13 and Z1-15 [Pre Interlock Run Select and Interlock Wait Time] to adjust this behavior to use an interlock signal, for example a damper end-switch.

Open: When the signal is open and no Run command is present, the keypad does not show a message. If the signal is open and a Run command is present, the alarm LED will flash and the AL02 - Interlock Open alarm will show on the keypad.

Closed: Normal operation

24: Remote Transfer to Bypass

Setting Value	Function	Description
24	Remote Transfer to Bypass	Forces the bypass into Bypass Mode.

Open: Bypass will operate in its selected mode (Drive or Bypass).

Closed: Forces the bypass to operate in Bypass Mode. If the drive is running, it will stop the drive and switch to bypass operation.

25: Emergency Override Bypass

Setting Value	Function	Description
25	Emergency Override Bypass	Forces the bypass to operate in Bypass Mode.

Open: Normal operation

Closed: Forces the bypass to run in Bypass Mode. Run commands and HAND/OFF/AUTO status do not have an effect. The bypass will ignore the faults and alarms set to ignore in *S6-11 to S6-20*.

26: Emergency Override Drive (FWD)

Setting Value	Function	Description
26	Emergency Override Drive (FWD)	Forces the bypass to operate in the forward direction in Drive Mode.

Open: Normal operation

Closed: Forces the bypass run in the forward direction in Drive Mode. Run commands and HAND/OFF/AUTO status do not have an effect. The bypass will ignore the faults and alarms set to ignore in *S6-11 to S6-20*.

If there is an unrecoverable fault during Emergency Override Drive (FWD) operation, *Z1-10 [Emergency Override Transfer]* sets if it will automatically switch to Bypass Mode to keep the motor running.

27: Motor OR Select

Setting Value	Function	Description
27	Motor OR Select	Sets the command for the bypass to operate motor 1 or motor 2.

This selection is used only when one bypass operates two motors. Parameter *Z1-11* sets exactly how and when this will function.

Open: Motor 1 is in operation.

Closed: Motor 2 is in operation.

28: Motor AND Select

Setting Value	Function	Description
28	Motor AND Select	Sets the command for the bypass to operate motor 1 and motor 2 at the same time.

This selection is used only when one bypass operates two motors. Parameter *Z1-11* sets exactly how and when this will function.

Open: Motor 1 only.

Closed: Motor 1 AND Motor 2 are in operation.

29: External Overload Motor 1 (NC)

Setting Value	Function	Description
29	External Overload Motor 1 (NC)	Input for an external motor overload relay. Normally closed signal.

This selection is used only for bypasses that are configured with an external motor overload.

Open: All operation stops. The keypad shows fault *FB06 - External Overload Motor 1*.

Closed: Normal operation.

30: External Overload Motor 2 (NC)

Setting Value	Function	Description
30	External Overload Motor 2 (NC)	Input for an external motor overload relay (Motor 2). Normally closed signal.

This selection is used only for bypasses that are configured with an external motor overload.

Open: All operation stops. The keypad shows fault *FB07 - External Overload Motor 2*.

Closed: Normal operation.

31: HAND Select

Setting Value	Function	Description
31	HAND Select	Selects HAND Mode from the digital inputs instead of the keypad.

32: AUTO Select

Setting Value	Function	Description
32	AUTO Select	Selects AUTO Mode from the digital inputs instead of the keypad.

The combination of digital input selections *31 [HAND Select]* and *32 [AUTO Select]* will automatically take over HAND/OFF/AUTO selection from the keypad when programmed. The bypass ignores *Z1-06 [Power Up Mode]*. When a bypass digital input is programmed to either HAND Select or AUTO Select, the bypass ignores *Z1-06 [Power Up Mode]*.

The configuration and operation of these digital inputs are different for different *b1-02 [Run Command Selection 1]* settings.

Table 5.69 HOA Behavior when b1-02 = 7, 8, or 9

HAND Input [H2-0x = 31]	AUTO Input [H2-0x = 32]	HOA Mode	Description
Open	Open	OFF	Stopped. Run command has no effect.
Open	Closed	AUTO	Will run when there is an active Run command set in <i>b1-02 [Run Command Selection 1]</i> . Uses <i>b1-01 [Frequency Reference Selection 1]</i> as the frequency reference source.
Closed	Open	HAND	Uses the HAND frequency reference set in <i>S5-01 to S5-08</i> to run.
Closed	Closed	OFF	Stopped. Run command has no effect.

Note:

When *b1-02 = 7, 8, or 9 [Run Command Selection 1 = AUTO Command + Term Run, AUTO Command + Serial Run, or AUTO Command + Option Run]*, you must program both the HAND and AUTO digital inputs or the keypad will show an *oPE34 HAND/OFF/AUTO Input Setting* fault.



Table 5.70 HOA Behavior when b1-02 = 1, 2, or 3

HAND Input [H2-0x = 31]	HOA Mode	Description
Open	AUTO	Will run when there is an active Run command set in <i>b1-02 [Run Command Selection 1]</i> . Uses <i>b1-01 [Frequency Reference Selection 1]</i> as the frequency reference source.
Closed	HAND	Uses the HAND frequency reference set in <i>S5-01 to S5-08</i> to run.

Note:

When *b1-02 = 1, 2, or 3 [Run Command Selection 1 = Digital Input, Serial Communications, or Option PCB]*, if you program a digital input to AUTO, the keypad will show an *oPE34 HAND/OFF/AUTO Input Setting* fault.

Table 5.71 HOA Behavior when b1-02 = 0

Key Press	HOA Mode	Description
	AUTO	Uses the AUTO frequency set in <i>b1-01 [Frequency Reference Selection 1]</i> to run.
	HAND	Uses the HAND frequency reference set in <i>S5-01 to S5-08</i> to run.
	OFF	Stopped

Note:

When *b1-02 = 0 [Run Command Selection 1 = Keypad]*, the bypass will not allow HAND/OFF/AUTO control from the digital inputs. If you program a digital input to HAND or AUTO, the keypad will show an *oPE34 HAND/OFF/AUTO Input Setting* fault.

33: Drive/Bypass Select

Setting Value	Function	Description
33	Drive/Bypass Select	Sets the bypass to operate in Bypass Mode or Drive Mode.

5.13 Z: Bypass Parameters

You can move the selection of Drive and Bypass Modes from the digital operator to a digital input. Set $ZI-39 = 1$ [*Drive/Bypass Source = Digital Input*] to activate this digital input selection.

Open: Drive Mode Selected

Closed: Bypass Mode Selected

34: Fault Reset

Setting Value	Function	Description
34	Fault Reset	Resets any faults that are present.

This selection lets you use a digital input to reset faults and keep the ability to reset faults from the keypad. It will reset faults that come from the drive and reset faults that are internal to the bypass controller.

It is necessary to remove the Run command before you can reset most faults.

Open: Normal operation

Closed: Reset faults

35: External Fault (EF0)

Setting Value	Function	Description
35	External Fault (EF0)	Forces the drive into an <i>EF0</i> fault condition.

This selection will force the drive into an *EF0* fault condition. Parameters *F6-02* and *F6-03* [*Comm External Fault (EF0) Detect and Comm External Fault (EF0) Select*] set behavior.

Open: Normal operation

Closed: Force *EF0* fault in the drive.

36: External Fault (EFB)

Setting Value	Function	Description
36	External Fault (EFB)	Triggers external fault <i>EFB</i> on the bypass.

This selection will force the bypass controller into an *FB03 - External Fault Bypass (EFB)* fault. In Drive Mode, the drive will coast to stop and ignore its programmed stopping method set in *b1-04*. In Bypass Mode, the K3 contactor will open.

Open: Normal operation

Closed: Force *FB03 - External Fault Bypass* fault.

37: Run Reverse (AUTO)

Setting Value	Function	Description
37	Run Reverse (AUTO)	Starts and stops the bypass in reverse.

This selection runs the drive in the reverse direction. You must set $b1-04 = 0$ [*Reverse Operation Selection = Reverse Enabled*] to use this function.

Note:

In Bypass Mode, direction is ALWAYS forward.

Open: Stop/Fwd operation

Closed: Reverse drive operation

38: Fire Stat Switch (NC)

Setting Value	Function	Description
38	Fire Stat Switch (NC)	Stops the drive from running and shows "Fire Stat" on the keypad.

This is a normally-closed signal. When the signal is open, the bypass will not run or it will stop the bypass if it is already running.

Open: If this signal is open and there is no Run command present, the keypad will show "Fire Stat Open". If the signal is open and a Run command is present, the alarm LED will flash and the keypad will show the alarm *FIRE_ST Fire Stat Open*.

Closed: Normal operation

39: Freeze Stat Switch (NC)

Setting Value	Function	Description
39	Freeze Stat Switch (NC)	Stops the drive from running and shows "Freeze Stat" on the keypad.

This is a normally-closed signal. When the signal is open, the bypass will not run or it will stop the bypass if it is already running.

Open: If this signal is open and there is no Run command present, the keypad will show "Freeze Stat Open". If the signal is open and a Run command is present, the alarm LED will flash and the keypad will show the alarm *FREEZ_ST - Freeze Stat Open*.

Closed: Normal operation

40: Smoke Alarm (NC)

Setting Value	Function	Description
40	Smoke Alarm (NC)	Stops the drive from running and shows "Smoke Alarm Active" on the keypad.

This is a normally-closed signal. When the signal is open, the bypass will not run or it will stop the bypass if it is already running.

Open: If this signal is open and there is no Run command present, the keypad will show "Smoke Alarm Active". If the signal is open and a Run command is present, the alarm LED will flash and the keypad will show the alarm *SMK_ALRM - Smoke Alarm Active*.

Closed: Normal operation

41: OverPressure Switch (NC)

Setting Value	Function	Description
41	OverPressure Switch (NC)	Stops the drive from running and shows "Over Pressure Detected" on the keypad.

This is a normally-closed signal. When the signal is open, the bypass will not run or it will stop the bypass if it is already running.

Open: If this signal is open and there is no Run command present, the keypad will show "Over Pressure Detected". If the signal is open and a Run command is present, the alarm LED will flash and the keypad will show the alarm *OV_PRESS - Over Pressure Detected*.

Closed: Normal operation

42: Low Suction Switch (NC)

Setting Value	Function	Description
42	Low Suction Switch (NC)	Stops the drive from running and shows "Low Suction Detected" on the keypad.

This is a normally-closed signal. When the signal is open, the bypass will not run or it will stop the bypass if it is already running.

Open: If this signal is open and there is no Run command present, the keypad will show "Low Suction Detected". If the signal is open and a Run command is present, the alarm LED will flash and the keypad will show the alarm *LOW_SUCT - Low Suction Detected*.

Closed: Normal operation

43: Vibration Switch (NC)

Setting Value	Function	Description
43	Vibration Switch (NC)	Stops the drive from running and shows "Vibration Detected" on the keypad.

This is a normally-closed signal. When the signal is open, the bypass will not run or it will stop the bypass if it is already running.

Open: If this signal is open and there is no Run command present, the keypad will show "Vibration Detected". If the signal is open and a Run command is present, the alarm LED will flash and the keypad will show the alarm *VIBRATION - Vibration Detected*.

Closed: Normal operation

44: Emergency Override Drive (REV)

Setting Value	Function	Description
44	Emergency Override Drive (REV)	Forces the bypass to operate in Drive Mode in the reverse direction.

Open: Normal operation

Closed: Forces the bypass run in the Drive Mode in the reverse direction. Run commands and HAND/OFF/AUTO status do not have an effect. The bypass will ignore the faults and alarms set to ignore in *S6-11 to S6-20*. You must set *b1-04 = 0 [Reverse Operation Selection = Reverse Enabled]* to use this function.

45: Serial Hardware Test (RS-485)

Setting Value	Function	Description
45	Serial Hardware Test (RS-485)	Sets the function for the bypass control to self-test the RS-485 serial communications operation.

Forces a test of the RS-485 serial communications hardware on the bypass control board.

Disconnect the RS-485 terminals (TB3) before you do a communications hardware self-test.

Open: Normal operation

Closed: Do the communications test

Results of the communications test are shown on the keypad.

46: Low City Pressure

Setting Value	Function	Description
46	Low City Pressure	Indicates that sufficient or insufficient pressure is present on the inlet to the pump. Used mainly for pressure booster situations.

This selection is stops bypass operation if an external pressure switch indicates that the pressure that is feeding a booster pump is not sufficient.

Use *Y4-22 to Y4-24 [Low City On-Delay Time to Low City Alarm Text]* to configure this feature.

Open: Normal operation (operation automatically resumes)

Closed: Low City Pressure Alarm, operation stops

47: Motor Preheat

Setting Value	Function	Description
47	Motor Preheat	Sets the command to apply the motor pre-heat current. Use <i>b2-09 [Pre-heat Current 2]</i> to adjust.

The bypass can send a small amount of DC current to the motor during the OFF condition to try to prevent condensation inside of the motor. When selected, this input turns the motor pre-heat ON and OFF.

Open: Normal Operation

Closed: Motor Preheat current applied during OFF operation.

■ Z2-23 to Z2-26 Digital Output 7 to 10 Function Selection

The bypass has 4 user-programmable digital outputs. Refer to [Table 5.72](#) for default settings and functions.

Table 5.72 Digital Output Default Settings and Functions

No.	Name	Default	Function
Z2-23	Digital Output 7 (TB1 1~3)	7	RUN Active
Z2-24	Digital Output 8 (TB1 4~6)	10	HAND mode Active
Z2-25	Digital Output 9 (TB1 7~9)	12	AUTO mode Active
Z2-26	Digital Output 10 (TB1 10~12)	15	Fault Active

Table 5.73 Digital Output Setting Values

Setting Value	Function	Reference	Setting Value	Function	Reference
0	Serial Communication Control	450	15	Fault Active	451
1	K1 Drive Input Contactor (if equipped)	450	16	Drive Fault Active	451
2	K2 Drive Output Contactor	450	17	Bypass Fault Active	451
3	K3 Bypass Contactor	450	18	Auto Transfer Active	452
4	K4 Motor 1 Contactor (if equipped)	450	19	Serial Run Active	452
5	K5 Motor 2 Contactor (if equipped)	450	20	Damper Actuator Output	452
6	READY	450	21	ON Always	452
7	RUN Active	450	22	Loss of Load Detected	452
8	Drive RUN active	450	23	Run Verify Active	452
9	Bypass RUN active	450	24	Soft Starter Run Command (if equipped)	452
10	HAND mode Active	451	25	Safeties Closed	452
11	OFF mode Active	451	26	Mirror HV600 M1-M2	453
12	Auto mode Active	451	27	Mirror HV600 M3-M4	453
13	Drive Mode Selected	451	28	Mirror HV600 M5-M6	453
14	Bypass Mode Selected	451	99	Not Used	453

■ Z2-23: Digital Output 7 (TB1 1~3)

No. (Hex.)	Name	Description	Default (Range)
Z2-23 (8579)	Digital Output 7 (TB1 1~3)	Sets the function for bypass digital output 7.	7 (0 - 99)

Normally Open: TB1 - Terminals 2 and 3

Normally Closed: TB1 - Terminals 2 and 1

■ Z2-24: Digital Output 8 (TB1 4~6)

No. (Hex.)	Name	Description	Default (Range)
Z2-24 (857A)	Digital Output 8 (TB1 4~6)	Sets the function for bypass digital output 8.	10 (0 - 99)

Normally Open: TB1 - Terminals 5 and 6

Normally Closed: TB1 - Terminals 5 and 4

■ Z2-25: Digital Output 9 (TB1 7~9)

No. (Hex.)	Name	Description	Default (Range)
Z2-25 (857B)	Digital Output 9 (TB1 7~9)	Sets the function for bypass digital output 9.	12 (0 - 99)

Normally Open: TB1 - Terminals 8 and 9

Normally Closed: TB1 - Terminals 8 and 7

■ Z2-26: Digital Output 10 (TB1 10~12)

No. (Hex.)	Name	Description	Default (Range)
Z2-26 (857C)	Digital Output 10 (TB1 10~12)	Sets the function for bypass digital output 10.	15 (0 - 99)

Normally Open: TB1 - Terminals 11 and 12

Normally Closed: TB1 - Terminals 11 and 10

■ Digital Output Setting Value

Selects a function set with Z2-23 to Z2-26.

0: Serial Communication Control

Setting Value	Function	Description
0	Serial Communication Control	Activates when $b1-01 = 2$ [Frequency Reference Selection 1 = Serial Communications], and/or $b1-02 = 2$ or 8 [Run Command Selection 1 = Serial Communications or AUTO Command + Serial Run] to set the bypass for control by serial communications.

Note:

This does not apply when Option PCB-based serial communications control the bypass.

1: K1 Drive Input Contactor

Setting Value	Function	Description
1	K1 Drive Input Contactor	Active when the K1 (Drive Input Power) contactor is energized.

2: K2 Drive Output Contactor

Setting Value	Function	Description
2	K2 Drive Output Contactor	Active when the K2 (Drive Output) contactor is energized.

3: K3 Bypass Contactor

Setting Value	Function	Description
3	K3 Bypass Contactor	Active when the K3 (Bypass Run) contactor is energized.

4: K4 Motor 1 Contactor

Setting Value	Function	Description
4	K4 Motor 1 Contactor	Active when the K4 (Motor 1) contactor is energized.

5: K5 Motor 2 Contactor

Setting Value	Function	Description
5	K5 Motor 2 Contactor	Active when the K5 (Motor 2) contactor is energized.

6: READY

Setting Value	Function	Description
6	READY	Active when the system is ready to operate.

ON : System is ready to operate

OFF : System is faulted, in Programming Mode, or one of the safety digital inputs is open

7: RUN Active

Setting Value	Function	Description
7	RUN Active	Active when the system is running in Drive Mode or Bypass Mode.

8: Drive RUN active

Setting Value	Function	Description
8	Drive RUN active	The digital output activates when the system is in Drive Mode and the HV600 drive is running.

ON : Running in Drive Mode

OFF : Not running or in Bypass Mode

Note:

This output stays active during Energy Savings Mode $Z1-16 = 1, 2$ [Energy Savings Mode = Frequency, Frequency + Current].

9: Bypass RUN active

Setting Value	Function	Description
9	Bypass RUN active	The digital output activates when the system is in Bypass Mode and is running. Contactor K3 is closed.

ON : Running in Bypass Mode

OFF : Not running or in Drive Mode

Note:

This output stays active during Energy Savings Mode $Z1-16 = 1, 2$ [Energy Savings Mode = Frequency, Frequency + Current.

10: HAND mode Active

Setting Value	Function	Description
10	HAND mode Active	The digital output activates when the system is running in HAND Mode during Drive Mode and Bypass Mode.

ON : Running in HAND Mode

OFF : Not running or in AUTO Mode

11: OFF mode Active

Setting Value	Function	Description
11	OFF mode Active	The digital output activates when the HAND/OFF/AUTO selection is in OFF Mode or if system is faulted. It is also active when in Emergency Override Mode.

ON : System is in OFF Mode or is faulted

OFF : HAND Mode, AUTO Mode (even if not running), Emergency Override.

12: Auto mode Active

Setting Value	Function	Description
12	Auto mode Active	The digital output activates when the HAND/OFF/AUTO selection is in AUTO Mode. It will activate when the system is running and when the system is not running and in Drive Mode and Bypass Mode.

ON : System is in AUTO Mode

OFF : HAND Mode, OFF Mode, Faulted, Emergency Override

13: Drive Mode Selected

Setting Value	Function	Description
13	Drive Mode Selected	The digital output activates when Drive Mode is selected. It stays active during Remote Transfer to Bypass, Emergency Override Bypass, Energy Savings, Fault condition, and when the system is not running.

ON : Drive Mode is selected

OFF : Bypass Mode is selected

14: Bypass Mode Selected

Setting Value	Function	Description
14	Bypass Mode Selected	The digital output activates when Bypass Mode is selected. It stays active during Emergency Override Drive, Fault condition, and when the system is not running.

ON : Bypass Mode is selected

OFF : Drive Mode is selected

15: Fault Active

Setting Value	Function	Description
15	Fault Active	Set when there is an active Drive fault or Bypass fault.

16: Drive Fault Active

Setting Value	Function	Description
16	Drive Fault Active	There is a fault in the HV600 drive.

The digital output activates when the HV600 drive is in a faulted condition, including during an *FB10 – Loss of Drive Communications* fault.

17: Bypass Fault Active

Setting Value	Function	Description
17	Bypass Fault Active	There is a fault in the bypass.

5.13 Z: Bypass Parameters

The digital output activates when there is a bypass control fault. This includes all *FBxx* faults (except *FB10*). The HV600 drive is NOT in a faulted condition.

18: Auto Transfer Active

Setting Value	Function	Description
18	Auto Transfer Active	There is a drive fault that activated Auto Transfer to Bypass.

The digital output activates when a drive fault causes the system to transfer to Bypass Mode. This is applicable only when $Z1-05 = 1$ [*Auto Transfer To Bypass = Enabled*].

19: Serial Run Active

Setting Value	Function	Description
19	Serial Run Active	Serial Communications is commanding a RUN.

The digital output activates when serial communications (RS-485 – Terminal TB3) is commanding a RUN and $b1-02 = 2$ or 8 [*Run Command Selection 1 = Serial Communications or AUTO Command + Serial Run*].

20: Damper Actuator Output

Setting Value	Function	Description
20	Damper Actuator Output	System commanded to RUN in Drive Mode or Bypass Mode.

This is a digital output for connection to an actuator that will open a damper. The output activates when the system is going to run. Parameters *Z1-12 to Z1-15* determine the operation of this digital output. Refer to [Run Delay with Preset Speed Examples on page 426](#) for information.

21: ON Always

Setting Value	Function	Description
21	ON Always	This digital output is always active.

This input indicates when power is applied to the system. This input can be useful for troubleshooting and commissioning.

22: Loss of Load Detected

Setting Value	Function	Description
22	Loss of Load Detected	The motor current is less than the set value/values.

The digital output activates when the system detects a loss of load condition. It is also active when there is an [*FB13 – Loss of Load Detected*] fault. Parameters *Z1-31 to Z1-36* set loss of load detection.

23: Run Verify Active

Setting Value	Function	Description
23	Run Verify Active	The digital output closes when the drive or bypass output current is more than 10% of <i>E2-01</i> .

24: Soft Starter Run Command

Setting Value	Function	Description
24	Soft Starter Run Command	Controls the Run command to the soft starter. Use <i>Z1-42 to Z1-44</i> [<i>Soft Starter Selection to Soft Starter Rampdown Timeout</i>] to configure the soft starter.

25: Safeties Closed

Setting Value	Function	Description
25	Safeties Closed	All of the programmed safety digital inputs are satisfied.

The digital output activates when ALL of the digital inputs programmed safety signals are satisfied. This includes the *H2-0x* digital input settings: [*22 – Run Eable – Safety (NC)*], [*38 – fire Stat Switch (NC)*], [*39 – Freeze Stat Switch (NC)*], [*40 – Smoke Alarm (NC)*], [*41 – Overpressure Switch (NC)*], [*42 – Low Suction Switch (NC)*], [*43 – Vibration Switch*], [*48 – Low Water (NC)*] and [*49 – High Water (NC)*].

26: Mirror HV600 M1-M2

Setting Value	Function	Description
26	Mirror HV600 M1-M2	The digital output activates when the HV600 drive digital output (M1-M2) is closed.

Use *H2-01 [Term H2-01 – M1-M2 Function Selection]* to set the M1-M2 digital output. Refer to *H2: Digital Outputs on page 620* for more information about setting values.

Note:

When the drive unit is OFF (in Bypass Mode in a 3-contactor configured bypass), this output will be OFF.

ON : Digital Output M1-M2 on HV600 is closed

OFF : Digital Output M1-M2 on HV600 is open

27: Mirror HV600 M3-M4

Setting Value	Function	Description
27	Mirror HV600 M3-M4	The digital output activates when the HV600 drive digital output (M3-M4) is closed.

Use *H2-02 [Term H2-02 – M3-M4 Function Selection]* to set the M3-M4 digital output. Refer to *H2: Digital Outputs on page 620* for more information about setting values.

Note:

When the drive unit is OFF (in Bypass Mode in a 3-contactor configured bypass), this output will be OFF.

ON : Digital Output M3-M4 on HV600 is closed

OFF : Digital Output M3-M4 on HV600 is open

28: Mirror HV600 M5-M6

Setting Value	Function	Description
28	Mirror HV600 M5-M6	The digital output activates when the HV600 drive digital output (M5-M6) is closed.

Use *H2-03 [Term H2-03 – M5-M6 Function Selection]* to set the M5-M6 digital output. Refer to *H2: Digital Outputs on page 620* for more information about setting values.

Note:

When the drive unit is OFF (in Bypass Mode in a 3-contactor configured bypass), this output will be OFF.

ON : Digital Output M5-M6 on HV600 is closed

OFF : Digital Output M5-M6 on HV600 is open

99: Not Used

Setting Value	Function	Description
99	Not Used	This setting allows serial communications to control the output.

Commanded by:

MEMOBUS/Modbus address: 8403H

or

BACnet: BO8 to BO11

■ Z2-30: Analog Input Signal Level Select

No. (Hex.)	Name	Description	Default (Range)
Z2-30 (8580)	Analog Input Signal Level Select	Sets the input signal level for the analog input on the bypass control board A2 Terminal TB4-2.	0 (0 - 3)

0 : 0 to 10V (Lower Limit at 0)

2 : 4 to 20 mA

3 : 0 to 20 mA

5.13 Z: Bypass Parameters

Note:

- When you set this parameter to 0 [0 to 10V (Lower Limit at 0)], set DIP switch S2 to “V”.
- When you set this parameter to 2 or 3 [4 to 20 mA or 0 to 20 mA], set DIP switch S2 to “I”.

■ Z2-32: Analog Input Gain Setting

No. (Hex.)	Name	Description	Default (Range)
Z2-32 (8582)	Analog Input Gain Setting	Sets the gain of the analog signal input to the analog input on the bypass control board A2 Terminal TB4-2..	100.0% (-999.9 - +999.9%)

■ Z2-33: Analog Input Bias Setting

No. (Hex.)	Name	Description	Default (Range)
Z2-33 (8583)	Analog Input Bias Setting	Sets the bias of the analog signal input to the analog input on the bypass control board A2 Terminal TB4-2.	0.0% (-999.9 - +999.9%)

Example Analog Input Settings	Bypass Control Board (A2) Terminal TB4-2 Analog Input Setting	Frequency Reference
Frequency reference with the gain setting adjusted	<ul style="list-style-type: none"> • Z2-32 = 200.0 [Analog Input Gain Setting = 200%] • Z2-33 = 0.0 [Analog Input Bias Setting = 0.0%] 	<ul style="list-style-type: none"> • When you input a 10 V signal, the frequency reference will be 200%. • When you input a 5 V signal, the frequency reference will be 100%. <p>When you input a 5 V or more signal, E1-04 [Maximum Output Frequency] will limit the drive output and the frequency reference will be 100%.</p>
Frequency reference with the negative number bias set	<ul style="list-style-type: none"> • Z2-32 = 100.0 [100.0%] • Z2-33 = -25.0 [-25.0%] 	<ul style="list-style-type: none"> • When you input a 0 V signal, the frequency reference will be -25%. • When you input a 0 V to 2 V signal, the frequency reference will be 0%. • When you input a 2 V to 10 V signal, the frequency reference will be 0% to 100%.

◆ Z3: Bypass Control Serial Comm

■ Z3-12: Network Digital Inputs

No. (Hex.)	Name	Description	Default (Range)
Z3-12 (850B)	Network Digital Inputs	Enables and disables control of the digital inputs over a network. When this is enabled, it is not necessary to wire to the physical digital input.	0 (0, 1)

0 : Disabled

Serial communications physical digital inputs are ignored.

For MEMOBUS/Modbus ($H5-08 = 0$): Command Register 8402H is disabled. The drive digital inputs in Command Register 0001H (bits 4 to A) are also disabled.

For Metasys N2 ($H5-08 = 1$): Binary Outputs B05, B06, B07, B08, and B09 are disabled.

For P1 Apogee ($H5-08 = 2$): Points LDO44, LDO45, LDO46, LDO47, and LDO48 are disabled.

For BACnet ($H5-08 = 3$): BV7, BV8, BV9, BV10, BV11, BV72, BV73, BV74, BV75, BV76, BV77, BV78, and BV79 are disabled.

1 : Enabled

Physical digital inputs S1 to S8 are logically ORed with the serial communications digital inputs.

Drive digital are also logically ORed with register 0001H.

WARNING! Sudden Movement Hazard. Clear all personnel from the drive, motor, and machine area before you reapply power. Set this parameter to 0 to prevent serial communications from triggering undesired and unexpected system operation. If you set this parameter to 1, the system can run unexpectedly or not stop when required, even when you de-energize the physical digital input. Failure to obey can cause injury to personnel.

■ Z3-13: BACnet Register Retention

No. (Hex.)	Name	Description	Default (Range)
Z3-13 (850C)	BACnet Register Retention	Sets what to restore when you lose power then reapply power.	0 (0 - 3)

Determines whether to restore the frequency reference, bypass command, or both upon the reapplication of power after losing power. The feature restores all bypass command register values except fault reset bit (BV70) and Ext Fault EFB (BV71). The Run command bits will only be restored if the bypass unit was running on power down.

Set $Z1-06 \neq 0$ to allow the bypass to start running upon application of power.

Note: 1. Parameter is effective only when $H5-08 = 3$ [Serial Communications Protocol Select = BACnet], $b1-01 = 2$ [Speed Reference Select = Bypass Serial], and/or $b1-02 = 2$ [Run Command Select = Bypass Serial].

0 : Disabled

When you reapply power, it will not restore BACNet objects.

1 : Restore Frequency Reference Only

When you reapply power, it will restore the frequency reference object (AV2).

2 : Restore Commands Only

When you reapply power, it will restore various command objects, including the Run commands.

This setting will save BACNet objects:

BV58, BV59, BV60, BV61, BV62, BV63, BV64, BV65, BV69.

3 : Restore Commands and Freq Ref

When you reapply power, it will restore the frequency reference object (AV2) and various command objects.

This setting will save BACNet objects:

BV58, BV59, BV60, BV61, BV62, BV63, BV64, BV65, BV69.

■ Z3-16: Apogee Run Enable LDO35

No. (Hex.)	Name	Description	Default (Range)
Z3-16 (850F)	Apogee Run Enable LDO35	This parameter is applicable only when $H5-08 = 2$ [Communication Protocol Selection = Apogee/PI].	0 (0, 1)

0 : Disabled

Point LDO 35 will have no effect. The bypass can run regardless of the data written to Point 35.

1 : Enabled

Point LDO 35 is active. If data of "0" is written to point 35 via the network, or if there is no data written to point 35, the bypass cannot run. The bypass will only run when data of "1" is written to point 35 via the network.

Troubleshooting

6.1	Section Safety	458
6.2	Types of Faults, Minor Faults, Alarms, and Errors	460
6.3	Faults, Minor Faults, Alarms, and Error Codes Listed Alphabetically.....	461
6.4	Faults, Minor Faults, Alarms, and Error Codes Listed by Decimal Value for Use with BACnet/Modbus	468
6.5	Faults	474
6.6	Minor Faults/Alarms	498
6.7	Parameter Setting Errors.....	511
6.8	Auto-Tuning Errors	514
6.9	Backup Function Operating Mode Display and Errors.....	517
6.10	Bypass Status Messages	518
6.11	Diagnosing and Resetting Faults.....	519
6.12	Troubleshooting Without Fault Display.....	520

6.1 Section Safety

DANGER

Electrical Shock Hazard

Do not examine, connect, or disconnect wiring on an energized bypass. Before servicing, disconnect all power to the equipment and wait for the time specified on the warning label at a minimum. The internal capacitor stays charged after the bypass is de-energized. The charge indicator LED extinguishes when the DC bus voltage decreases below 50 Vdc. When all indicators are OFF, remove the covers before measuring for dangerous voltages to make sure that the bypass is safe.

If you do work on the bypass when it is energized, it will cause serious injury or death from electrical shock.

WARNING

Electrical Shock Hazard

Do not operate the bypass when covers are missing. Replace covers and shields before you operate the bypass. Use the bypass only as specified by the instructions.

Some figures in this section include bypasses without covers or safety shields to more clearly show the inside of the bypass. If covers or safety shields are missing from the bypass, it can cause serious injury or death.

Always ground the motor-side grounding terminal.

If you do not ground the equipment correctly, it can cause serious injury or death if you touch the motor case.

After the bypass blows a fuse or trips a GFCI, do not immediately energize the bypass or operate peripheral devices. Wait for the time specified on the warning label at a minimum and make sure that all indicators are OFF. Then check the wiring and peripheral device ratings to find the cause of the problem. If you do not know the cause of the problem, contact Yaskawa before you energize the bypass or peripheral devices.

If you do not fix the problem before you operate the bypass or peripheral devices, it can cause serious injury or death.

Only let approved personnel install, wire, maintain, examine, replace parts, and repair the bypass.

If personnel are not approved, it can cause serious injury or death.

Do not wear loose clothing or jewelry when you do work on the bypass. Tighten loose clothing and remove all metal objects, for example watches or rings.

Loose clothing can catch on the bypass and jewelry can conduct electricity and cause serious injury or death.

Do not remove covers or touch circuit boards while the bypass is energized.

If you touch the internal components of an energized bypass, it can cause serious injury or death.

Do not modify the bypass body, drive body, bypass circuitry, or drive circuitry.

Modifications to bypass and drive body and circuitry can cause serious injury or death, will cause damage to the bypass and drive, and will void the warranty. Yaskawa is not responsible for modifications of the product made by the user.

Fire Hazard

Tighten all terminal screws to the correct tightening torque.

Connections that are too loose or too tight can cause incorrect operation and damage to the bypass. Incorrect connections can also cause death or serious injury from fire.

Tighten screws at an angle in the specified range shown in this manual.

If you tighten the screws at an angle not in the specified range, you can have loose connections that can cause damage to the terminal block or start a fire and cause serious injury or death.

⚠ WARNING**Damage to Equipment**

Do not apply incorrect voltage to the main circuit of the bypass. Operate the bypass in the specified range of the input voltage on the nameplate.

Voltages that are higher than the permitted nameplate tolerance can cause damage to the bypass.

Fire Hazard

Do not put flammable or combustible materials on top of the bypass and do not install the bypass near flammable or combustible materials. Attach the bypass to metal or other noncombustible material.

Flammable and combustible materials can start a fire and cause serious injury or death.

Crush Hazard

Wear eye protection when you do work on the bypass.

If you do not use correct safety equipment, it can cause serious injury or death.

Use a crane or hoist to move large bypasses when necessary.

If you try to move a large bypass without a crane or hoist, it can cause serious injury or death.

NOTICE**Damage to Equipment**

When you touch the bypass, drive, and circuit boards, make sure that you observe correct electrostatic discharge (ESD) procedures.

If you do not follow procedures, it can cause ESD damage to the drive and bypass circuitry.

Do not break the electrical connection between the bypass and the motor when the bypass is outputting voltage.

Incorrect equipment sequencing can cause damage to the bypass.

Make sure that all connections are correct after you install the bypass and connect peripheral devices.

Incorrect connections can cause damage to the bypass.

Note:

Do not use unshielded wire for control wiring. Use shielded, twisted-pair wires and ground the shield to the ground terminal of the bypass. Unshielded wire can cause electrical interference and unsatisfactory system performance.

6.2 Types of Faults, Minor Faults, Alarms, and Errors

If the bypass or motor do not operate correctly, check the keypad for a code or message.



If problems occur that are not identified in this manual, contact the nearest Yaskawa representative with this information:

- Bypass model
- Bypass software version
- Date of purchase
- Description of the problem (such as failure conditions)

Table 6.1 contains descriptions of the different types of faults, minor faults, alarms, and errors that can occur during operation.

Contact Yaskawa if there is damage to the bypass. Contact information is on the back cover of the manual.

Table 6.1 Types of Faults, Minor Faults, Alarms, and Errors

Type	Response
Faults	<p>Drive faults thrown by the HV600 drive will stop the bypass from running the drive, but will not stop it from running in Bypass Mode.</p> <p>If $Z1-05 = 1$ [Auto Transfer To Bypass = Enabled], a drive fault will cause the unit to start running in Bypass Mode.</p> <p>System faults (FB0x) will stop the drive and also stop the bypass from running in Bypass Mode.</p> <p>When the bypass detects a fault, it will cause these conditions:</p> <ul style="list-style-type: none"> • The keypad shows the fault code and  and ALM/ERR of the LED Status Ring illuminate continuously. • The keypad shows the fault code and  and ALM/ERR on the LED Status Ring illuminate continuously when $o2-24 = 0$ or 1 [LED Light Function Selection = Enable Status Ring & Keypad LED or LED Status Ring Disable]. • The bypass shuts off output, and the motor coasts to a stop. Some faults let the user select a motor stopping method. • On the bypass control board (A2), fault output contacts TB1-11 and TB1-12 will turn ON, and TB1-10 and TB1-11 will turn OFF. This requires that $Z2-26 = 15$ [Digital Output 10 (TB110-12) = Fault Active], which is the default setting. <p>The bypass will not operate until you clear the fault with a Fault Reset and the bypass goes back to usual status.</p>
Minor Faults/Alarms	<p>When the bypass detects a minor fault or an alarm, it will cause these conditions:</p> <ul style="list-style-type: none"> • The keypad shows the alarm code and  and ALM/ERR on the LED Status Ring flash when $o2-24 = 0$ or 1. • The bypass will continue to operate the motor. Some alarms let the user select a motor stopping method. • If the bypass detects a minor fault, the terminal set to $H2-01$ to $H2-03 = 10$ [MFDO Function Select = Alarm] will switch ON. If you do not set parameters $H2-01$ to $H2-03$, the bypass will not trigger MFDO terminals when it detects a minor fault. • The bypass will not output a minor fault signal when it detects an alarm. <p>It is not necessary to do Fault Reset.</p>
Operation Errors	<p>An error occurs when parameter settings do not agree or a parameter combination is incorrect. The bypass will not operate until you set the parameters correctly.</p> <p>When the bypass detects an operation error, these conditions will result:</p> <ul style="list-style-type: none"> • The keypad shows the error code. • Multi-function outputs do not output an alarm signal. <p>Find the parameters that caused the error and correct the settings.</p>
Auto-Tuning Errors	<p>An error occurs during Auto-Tuning.</p> <p>When the bypass detects a tuning error, it will cause these conditions:</p> <ul style="list-style-type: none"> • The keypad shows the error code. • Multi-function outputs do not output an alarm signal. • The motor coasts to stop. <p>Remove the cause of the error and do Auto-Tuning again.</p>
Copy Function Errors	<p>An error occurs when you use the keypad for a backup, restore, or verify operation.</p> <p>When the bypass detects a copy function error, it will cause these conditions:</p> <ul style="list-style-type: none"> • The keypad shows the error code. • Multi-function outputs do not output an alarm signal. <p>Push a key on the keypad to clear the error. Remove the cause of the error and try the backup, restore, or verify operation again.</p>

6.3 Faults, Minor Faults, Alarms, and Error Codes Listed Alphabetically

Table 6.2 shows the possible fault, minor fault, alarm, and error codes.

The display codes are in alphabetical order. Search the table for the code shown on the keypad, and identify its causes and possible solutions.

Drive Faults thrown by the HV600 drive will stop the bypass from running the drive but will not stop it from running in Bypass Mode.

System Faults will stop the drive and also keep it from running in Bypass Mode.

Note:

The number in parentheses adjacent to the code in the table identifies the fault code or minor fault code (hex. number) that was read during serial communications.

Example: AFBL (00A2)

Table 6.2 List of Fault, Minor Fault, Alarm, and Error Codes

Display (Hex.)	Name	ALM LED	Type	Ref.
AFBL (00A2)	Analog Fbk Lost, Switched to Net	Flashing	Alarm	498
AL02 (00B2)	Interlock Open	Flashing	Alarm	498
AL03 (00B3)	Emergency Override Bypass	Flashing	Alarm	498
AL09 (00B9)	Restart Delay Active	Flashing	Alarm	498
AL13 (00BD)	Loss of Load Detected	Flashing	Alarm	498
AL16 (00C0)	Input Phase Rotation	Flashing	Alarm	498
AL17 (00C1)	Remote Xfer disabled in Reverse	Flashing	Alarm	498
AL18 (00C2)	Auto Xfer disabled in Reverse	Flashing	Alarm	498
AuDis (00A3)	Low PI Aux Fdbk Drive Disabled	Flashing	Alarm	498
AuFbl (00A5)	PI Aux Fdbk Lost Switched to Net	Flashing	Alarm	498
AUXFB (00A4)	PI Aux Feedback Level Loss	Flashing	Alarm	498
AUXFB (0420)	PI Aux Feedback Level Loss	Illuminated	Drive Fault	474
bAT (0085)	Keypad Battery Low Voltage	Flashing	Alarm	499
bAT (0402)	Keypad Battery Low Voltage	Illuminated	Drive Fault	474
bb (0008)	Baseblock	Flashing	Alarm	499
bCE (0416)	Bluetooth Communication Fault	Illuminated	Drive Fault	474
bCE (008A)	Bluetooth Communication Error	Flashing	Alarm	499
BuDif (00A6)	Main Fdbk Lost, Using Diff Fdbk	Flashing	Alarm	499
Bu-Fb (0090)	Main Fdbk Lost Using Backup Fdbk	Flashing	Alarm	499
BuFbl (0091)	Backup Fdbk Lost Chk/Repl Xducer	Flashing	Alarm	499
bUS (0015)	Option Communication Error	Flashing	Alarm	499
bUS (0022)	Option Communication Error	Illuminated	Drive Fault	474
bUSy	Busy	-	Not an alarm.	500
CALL (001D)	Serial Comm Transmission Error	Flashing	Alarm	500
CE (0092)	Run at H5-34 (CE Go-To-Freq)	Flashing	Alarm	501
CE (0014)	Serial Communication Error	Flashing	Alarm	500
CE (0021)	Serial Communication Error	Illuminated	Drive Fault	474
CoF (0046)	Current Offset Fault	Illuminated	Drive Fault	475
CPF00 (0081)	Control Circuit Error	Illuminated	Drive Fault	475
CPF01 (0082)	Control Circuit Error	Illuminated	Drive Fault	475

6.3 Faults, Minor Faults, Alarms, and Error Codes Listed Alphabetically

Display (Hex.)	Name	ALM LED	Type	Ref.
CPF02 (0083)	A/D Conversion Error	Illuminated	Drive Fault	475
CPF03 (0084)	Control Board Connection Error	Illuminated	Drive Fault	475
CPF06 (0087)	EEPROM Memory Data Error	Illuminated	Drive Fault	476
CPF07 (0088)	Terminal Board Connection Error	Illuminated	Drive Fault	476
CPF08 (0089)	Terminal Board Connection Error	Illuminated	Drive Fault	476
CPF11 (008C)	RAM Fault	Illuminated	Drive Fault	476
CPF12 (008D)	FLASH Memory Fault	Illuminated	Drive Fault	476
CPF13 (008E)	Watchdog Circuit Exception	Illuminated	Drive Fault	476
CPF14 (008F)	Control Circuit Fault	Illuminated	Drive Fault	476
CPF16 (0091)	Clock Fault	Illuminated	Drive Fault	477
CPF17 (0092)	Timing Fault	Illuminated	Drive Fault	477
CPF18 (0093)	Control Circuit Fault	Illuminated	Drive Fault	477
CPF19 (0094)	Control Circuit Fault	Illuminated	Drive Fault	477
CPF20 (0095)	Control Circuit Error	Illuminated	Drive Fault	477
CPF21 (0096)	Control Circuit Error	Illuminated	Drive Fault	477
CPF22 (0097)	Hybrid IC Error	Illuminated	Drive Fault	477
CPF23 (0098)	Control Board Connection Error	Illuminated	Drive Fault	477
CPF24 (0099)	Drive Unit Signal Fault	Illuminated	Drive Fault	478
CPF26 (009B)	BB Circuit Error	Illuminated	Drive Fault	478
CPF27 (009C)	PWM Set Reg Error	Illuminated	Drive Fault	478
CPF28 (009D)	PWM Pattern Error	Illuminated	Drive Fault	478
CPF29 (009E)	On-Delay Error	Illuminated	Drive Fault	478
CPF30 (009F)	BB On Error	Illuminated	Drive Fault	478
CPF31 (00A0)	ASIC Code Error	Illuminated	Drive Fault	478
CPF32 (00A1)	ASIC Startup Error	Illuminated	Drive Fault	478
CPF33 (00A2)	Watch-dog Error	Illuminated	Drive Fault	479
CPF34 (00A3)	Power/Clock Error	Illuminated	Drive Fault	479
CPF35 (00A4)	Ext A/D Conv Error	Illuminated	Drive Fault	479
CPF36 (00A5)	ASIC COM Error	Illuminated	Drive Fault	479
CPF37 (00A6)	ASIC COM Error	Illuminated	Drive Fault	479
CPF38 (00A7)	EEPROM Data Error	Illuminated	Drive Fault	479
CPF39 (00A8)	CPU-ASIC Communication Error	Illuminated	Drive Fault	479
CPyE	Error Writing Data	-	Backup Function Runtime Error	517
CrST	Cannot Reset	Flashing	Not an alarm.	501
CSEr	Control Mode Mismatch	-	Backup Function Runtime Error	517
CyPo (0029)	Cycle Power to Accept Changes	Flashing	Alarm	501
dFPS	Drive Model Mismatch	-	Backup Function Runtime Error	517
DIFF (0093)	Differential Feedback Exceeded	Flashing	Alarm	501
DIFF (0421)	Differential Feedback Exceeded	Illuminated	Drive Fault	480
dnE (002A)	Drive Disabled	Flashing	Alarm	501
dv7 (005B)	Polarity Judge Timeout	Illuminated	Drive Fault	480
EF (0007)	FWD/REV Run Command Input Error	Flashing	Alarm	502
EF0 (001A)	Option Card External Fault	Flashing	Alarm	502

6.3 Faults, Minor Faults, Alarms, and Error Codes Listed Alphabetically

Display (Hex.)	Name	ALM LED	Type	Ref.
EF0 (0027)	Option Card External Fault	Illuminated	Drive Fault	480
EF1 (0039)	External Fault (Terminal S1)	Flashing	Alarm	502
EF1 (0042)	External Fault (Terminal S1)	Illuminated	Drive Fault	480
EF2 (003A)	External Fault (Terminal S2)	Flashing	Alarm	502
EF2 (0043)	External Fault (Terminal S2)	Illuminated	Drive Fault	480
EF3 (0009)	External Fault (Terminal S3)	Flashing	Alarm	502
EF3 (0011)	External Fault (Terminal S3)	Illuminated	Drive Fault	480
EF4 (000A)	External Fault (Terminal S4)	Flashing	Alarm	502
EF4 (0012)	External Fault (Terminal S4)	Illuminated	Drive Fault	481
EF5 (000B)	External Fault (Terminal S5)	Flashing	Alarm	502
EF5 (0013)	External Fault (Terminal S5)	Illuminated	Drive Fault	481
EF6 (000C)	External Fault (Terminal S6)	Flashing	Alarm	502
EF6 (0014)	External Fault (Terminal S6)	Illuminated	Drive Fault	481
EF7 (000D)	External Fault (Terminal S7)	Flashing	Alarm	503
EF7 (0015)	External Fault (Terminal S7)	Illuminated	Drive Fault	481
End1	Excessive Rated Voltage Setting	Flashing	An Auto-Tuning Error	514
End2	Iron Core Saturation Coefficient	Flashing	An Auto-Tuning Error	514
End3	Rated Current Setting Alarm	Flashing	An Auto-Tuning Error	514
End4	Adjusted Slip Calculation Error	Flashing	An Auto-Tuning Error	514
End5	Resistance Tuning Error	Flashing	An Auto-Tuning Error	514
End6	Leakage Inductance Alarm	Flashing	An Auto-Tuning Error	514
End7	No-Load Current Alarm	Flashing	An Auto-Tuning Error	514
EOF (0067)	Emergency Override FWD	Flashing	Alarm	503
EOR (0068)	Emergency Override REV	Flashing	Alarm	503
EP24v (0081)	External Power 24V Supply	Flashing	Alarm	503
Er-01	Motor Data Error	Flashing	An Auto-Tuning Error	514
Er-02	Drive in an Alarm State	Flashing	An Auto-Tuning Error	515
Er-03	STOP Button was Pressed	Flashing	An Auto-Tuning Error	515
Er-04	Line-to-Line Resistance Error	Flashing	An Auto-Tuning Error	515
Er-05	No-Load Current Error	Flashing	An Auto-Tuning Error	515
Er-08	Rated Slip Error	Flashing	An Auto-Tuning Error	515
Er-09	Acceleration Error	Flashing	An Auto-Tuning Error	516
Er-12	Current Detection Error	Flashing	An Auto-Tuning Error	516
Er-13	Leakage Inductance Error	Flashing	An Auto-Tuning Error	516
Er-18	Back EMF Error	Flashing	An Auto-Tuning Error	516
Er-25	HighFreq Inject Param Tuning Err	Flashing	An Auto-Tuning Error	516
Err (001F)	EEPROM Write Error	Illuminated	Drive Fault	481
FAn1 (0413)	Drive Cooling Fan Fault	Illuminated	Drive Fault	481
FB02 (043A)	Wait For Interlock Timeout	Illuminated	System Fault	482
FB03 (043B)	External Fault Bypass (EFB)	Illuminated	System Fault	482
FB05 (043D)	Motor Overload	Illuminated	System Fault	482
FB06 (043E)	External Overload 1	Illuminated	System Fault	483
FB07 (043F)	External Overload 2	Illuminated	System Fault	483

6.3 Faults, Minor Faults, Alarms, and Error Codes Listed Alphabetically

Display (Hex.)	Name	ALM LED	Type	Ref.
FB08 (0440)	Brownout Detected	Illuminated	System Fault	483
FB09 (0441)	Blackout Detected	Illuminated	System Fault	483
FB10 (0442)	Loss of Drive Communications	Illuminated	Drive Fault	483
FB13 (0445)	Loss of Load	Illuminated	System Fault	483
FB15 (0447)	Input Phase Loss	Illuminated	System Fault	484
FB16 (0448)	Input Phase Rotation	Illuminated	System Fault	484
FB17 (0449)	Load Verify Fault	Illuminated	System Fault	484
FB18 (044A)	Welded Bypass Contactor Detected	Illuminated	System Fault	484
FB26 (0452)	Option on Drive Detected	Illuminated	Drive Fault	484
FB27 (0453)	Drive Hardware Fault (CPFx ofX)	Illuminated	Drive Fault	484
FB28 (0454)	Drive Faulted	Illuminated	System Fault	484
FB30 (0456)	Conflicting SW Check UB-99	Illuminated	Drive Fault	485
FDBKL (0094)	Feedback Loss Wire Break	Flashing	Alarm	503
FDBKL (0422)	WIRE Break	Illuminated	Drive Fault	485
FIRE_ST (00CA)	Fire Stat Open	Flashing	Alarm	503
FREEZ_ST (00CB)	Freeze Stat Open	Flashing	Alarm	504
FLGT (0095)	Feedback Loss, Go To Freq b5-83	Flashing	Alarm	503
FR<MS (009E)	Freq Ref < Minimum Speed (Y1-06)	Flashing	Alarm	504
FR<TH (009F)	Freq. Reference < Thrust (Y4-12)	Flashing	Alarm	504
GF (0006)	Ground Fault	Illuminated	Drive Fault	485
HCA (0034)	High Current Alarm	Flashing	Alarm	504
HFB (0423)	High Feedback Sensed	Illuminated	Drive Fault	486
HIAUX (0096)	High PI Aux Feedback Level	Flashing	Alarm	504
HIAUX (0424)	High PI Aux Feedback Level	Illuminated	Drive Fault	486
HIFB (0097)	High Feedback Sensed	Flashing	Alarm	504
iFEr	Communication Err	-	Backup Function Runtime Error	517
INTLK (0069)	BAS Interlock	Flashing	Alarm	505
LCP (00A7)	Low City Pressure	Flashing	Alarm	505
LF (001C)	Output Phase Loss	Illuminated	Drive Fault	486
LF2 (0036)	Output Current Imbalance	Illuminated	Drive Fault	486
LFB (0425)	Low Feedback Sensed	Illuminated	Drive Fault	486
LOAUX (0099)	Low PI Aux Feedback Level	Flashing	Alarm	505
LOAUX (0426)	Low PI Aux Feedback Level	Illuminated	Drive Fault	486
LoG	Com Error / Abnormal SD Card	Flashing	Alarm	505
LOFB (009A)	Low Feedback Sensed	Flashing	Alarm	505
LOP (009B)	Loss of Prime	Flashing	Alarm	505
LOP (0427)	Loss of Prime	Illuminated	Drive Fault	487
LOW_SUCT (00CE)	Low Suction Detected	Flashing	Alarm	505
LSP (00A8)	Low Suction Pressure	Flashing	Alarm	506
LT-1 (0035)	Cooling Fan Maintenance Time	Flashing	Alarm	506
LT-2 (0036)	Capacitor Maintenance Time	Flashing	Alarm	506
LT-3 (0043)	SoftChargeBypassRelay MainteTime	Flashing	Alarm	506
LT-4 (0044)	IGBT Maintenance Time (50%)	Flashing	Alarm	506

6.3 Faults, Minor Faults, Alarms, and Error Codes Listed Alphabetically

Display (Hex.)	Name	ALM LED	Type	Ref.
LWT (00A9)	Low Water In Tank	Flashing	Alarm	506
ndAT	Model,VolClass,Capacity Mismatch	-	Backup Function Runtime Error	517
NMS (009C)	Setpoint Not Met	Flashing	Alarm	506
NMS (0429)	Setpoint Not Met	Illuminated	Drive Fault	487
oC (0007)	Overcurrent	Illuminated	Drive Fault	487
OD (009D)	Output Disconnect	Flashing	Alarm	506
OD (042A)	Output Disconnect	Illuminated	Drive Fault	488
oFA00 (0101)	Option Not Compatible with Port	Illuminated	Drive Fault	488
oFA01 (0102)	Option Fault/Connection Error	Illuminated	Drive Fault	488
oFA05 (0106)	Option A/D Error	Illuminated	Drive Fault	488
oFA06 (0107)	Option Communication Error	Illuminated	Drive Fault	488
oFA10 (0111)	Option RAM Error	Illuminated	Drive Fault	488
oFA11 (0112)	Option Ope Mode Error	Illuminated	Drive Fault	488
oFA12 (0113)	Drive Receive CRC Error	Illuminated	Drive Fault	489
oFA13 (0114)	Drive Receive Frame Error	Illuminated	Drive Fault	489
oFA14 (0115)	Drive Receive Abort Error	Illuminated	Drive Fault	489
oFA15 (0116)	Option Receive CRC Error	Illuminated	Drive Fault	489
oFA16 (0117)	Option Receive Frame Error	Illuminated	Drive Fault	489
oFA17 (0118)	Option Receive Abort Error	Illuminated	Drive Fault	489
oFA30 (0131)	COM ID Error	Illuminated	Drive Fault	489
oFA31 (0132)	Type Code Error	Illuminated	Drive Fault	489
oFA32 (0133)	SUM Check Error	Illuminated	Drive Fault	490
oFA33 (0134)	Option Receive Time Over	Illuminated	Drive Fault	490
oFA34 (0135)	Memobus Time Over	Illuminated	Drive Fault	490
oFA35 (0136)	Drive Receive Time Over 1	Illuminated	Drive Fault	490
oFA36 (0137)	CI Check Error	Illuminated	Drive Fault	490
oFA37 (0138)	Drive Receive Time Over 2	Illuminated	Drive Fault	490
oFA38 (0139)	Control Reference Error	Illuminated	Drive Fault	490
oFA39 (013A)	Drive Receive Time Over 3	Illuminated	Drive Fault	490
oFA40 (013B)	CtrlResSel 1Err	Illuminated	Drive Fault	491
oFA41 (013C)	Drive Receive Time Over 4	Illuminated	Drive Fault	491
oFA42 (013D)	CtrlResSel 2Err	Illuminated	Drive Fault	491
oFA43 (013E)	Drive Receive Time Over 5	Illuminated	Drive Fault	491
oH (0003)	Heatsink Overheat	Flashing	Alarm	507
oH (0009)	Heatsink Overheat	Illuminated	Drive Fault	491
oH1 (000A)	Heatsink Overheat	Illuminated	Drive Fault	491
oH2 (0004)	External Overheat (H1-XX=B)	Flashing	Alarm	507
oH3 (001D)	Motor Overheat (PTC Input)	Illuminated	Drive Fault	491
oH3 (0022)	Motor Overheat (PTC Input)	Flashing	Alarm	507
oH4 (0020)	Motor Overheat Fault (PTC Input)	Illuminated	Drive Fault	492
oL1 (000B)	Motor Overload	Illuminated	Drive Fault	492
oL2 (000C)	Drive Overload	Illuminated	Drive Fault	493
oL3 (0005)	Overtorque 1	Flashing	Alarm	507

6.3 Faults, Minor Faults, Alarms, and Error Codes Listed Alphabetically

Display (Hex.)	Name	ALM LED	Type	Ref.
oL3 (000D)	Overtorque Detection 1	Illuminated	Drive Fault	494
oL4 (0006)	Overtorque 2	Flashing	Alarm	508
oL4 (000E)	Overtorque Detection 2	Illuminated	Drive Fault	494
oL7 (002B)	High Slip Braking Overload	Illuminated	Drive Fault	494
oPE01	Drive Capacity Setting Fault	Flashing	Parameter Setting Error	511
oPE02	Parameter Range Setting Error	Flashing	Parameter Setting Error	511
oPE03	Multi-Function Input Setting Err	Flashing	Parameter Setting Error	511
oPE05	Run Cmd/Freq Ref Source Sel Err	Flashing	Parameter Setting Error	512
oPE07	Analog Input Selection Error	Flashing	Parameter Setting Error	512
oPE08	Parameter Selection Error	Flashing	Parameter Setting Error	512
oPE09	PID Control Selection Fault	Flashing	Parameter Setting Error	512
oPE10	V/f Data Setting Error	Flashing	Parameter Setting Error	512
oPE11	Carrier Frequency Setting Error	Flashing	Parameter Setting Error	513
oPE16	Energy Saving Constants Error	Flashing	Parameter Setting Error	513
oPE20	No Motor Overload Set	Flashing	Parameter Setting Error	513
oPE29	Baud Rate Setting Error	Flashing	Parameter Setting Error	513
oPE34	HAND/OFF/AUTO Input Setting	Flashing	Parameter Setting Error	513
oPE36	Bypass Energy Savings Setting Err	Flashing	Parameter Setting Error	513
oPr (001E)	Keypad Connection Fault	Illuminated	Drive Fault	494
ov (0002)	DC Bus Overvoltage	Flashing	Alarm	508
ov (0008)	Overvoltage	Illuminated	Drive Fault	494
ov2 (0405)	DC Bus Overvoltage 2	Illuminated	Drive Fault	495
ovEr	Too Many Parameters Changed	-	Not an alarm.	508
OV_PRESS (00CD)	Over Pressure Detected	Flashing	Alarm	508
PA1 (003F)	PLC Error 1	Flashing	Alarm	508
PASS	Serial Communication Test	Flashing	Not an alarm.	508
PE1 (0047) PE2 (0048)	PLC Faults	Illuminated	Drive Fault	495
PF (0047)	Input Phase Loss	Flashing	Alarm	508
PF (001B)	Input Phase Loss	Illuminated	Drive Fault	495
PSE (0437)	JOHB-SMP3 Protocol set Error	Illuminated	Drive Fault	495
rdEr	Error Reading Data	-	Backup Function Runtime Error	517
SAFE (00C9)	Safety Open	Flashing	Alarm	509
SC (0005)	Short Circuit/IGBT Failure	Illuminated	Drive Fault	496
SCF (040F)	Safety Circuit Fault	Illuminated	Drive Fault	496
SE (0020)	Modbus Test Mode Error	Flashing	Alarm	509
SEr (003B)	Speed Search Retries Exceeded	Illuminated	Drive Fault	496
SMK_ALARM (00CC)	Smoke Alarm Active	Flashing	Alarm	509
STo (003C)	Safe Torque OFF	-	Alarm	509
SToF (003B)	Safe Torque OFF	Flashing	Alarm	509
TiM (0089)	Keypad Time Not Set	Flashing	Alarm	509
TiM (0401)	Keypad Time Not Set	Illuminated	Drive Fault	496
TrPC (0042)	IGBT Maintenance Time (90%)	Flashing	Alarm	509

6.3 Faults, Minor Faults, Alarms, and Error Codes Listed Alphabetically

Display (Hex.)	Name	ALM LED	Type	Ref.
UL3 (001E)	Undertorque Detection 1	Flashing	Alarm	510
UL3 (0029)	Undertorque Detection 1	Illuminated	Drive Fault	496
UL4 (001F)	Undertorque Detection 2	Flashing	Alarm	510
UL4 (002A)	Undertorque Detection 2	Illuminated	Drive Fault	496
UL6 (004E)	Underload or Belt Break Detected	Flashing	Alarm	510
UL6 (005A)	Underload or Belt Break Detected	Illuminated	Drive Fault	496
Uv (0001)	DC Bus Undervoltage	Flashing	Alarm	510
Uv1 (0002)	DC Bus Undervoltage	Illuminated	Drive Fault	497
Uv2 (0003)	Control Power Undervoltage	Illuminated	Drive Fault	497
Uv3 (0004)	Soft Charge Answerback Fault	Illuminated	Drive Fault	497
vAEr	Voltage Class, Capacity Mismatch	-	Backup Function Runtime Error	517
VBRATION (00CF)	Vibration Detected	Flashing	Alarm	510
vFyE	Parameters do not Match	-	Backup Function Runtime Error	517
VLTS (042B)	Thermostat Fault	Illuminated	Drive Fault	497

6.4 Faults, Minor Faults, Alarms, and Error Codes Listed by Decimal Value for Use with BACnet/Modbus

Table 6.3 shows the list of faults by decimal number. Faults are read in Modbus register 0080 or BACnet AV42.

Table 6.4 shows the list of minor faults and alarms by decimal number. Minor fault and alarm decimal numbers are read in Modbus register 007F.

The display codes are in decimal order. Search the tables for the decimal code, and identify its causes and possible solutions.

Drive Faults thrown by the HV600 drive will stop the bypass from running the drive but will not stop it from running in Bypass Mode.

System Faults will stop the drive and also stop it from running in Bypass Mode.

Note:

The number in parentheses adjacent to the code in the table identifies the fault code or minor fault code (hex. number) that was read during serial communications.

Example: AFBL (00A2)

Table 6.3 List of Faults by Decimal

Decimal Value	Display (Hex.)	Name	ALM LED	Type	Ref.
2	Uv1 (0002)	DC Bus Undervoltage	Illuminated	Drive Fault	497
3	Uv2 (0003)	Control Power Undervoltage	Illuminated	Drive Fault	497
4	Uv3 (0004)	Soft Charge Answerback Fault	Illuminated	Drive Fault	497
5	SC (0005)	Short Circuit/IGBT Failure	Illuminated	Drive Fault	496
6	GF (0006)	Ground Fault	Illuminated	Drive Fault	485
7	oC (0007)	Overcurrent	Illuminated	Drive Fault	487
8	ov (0008)	Overvoltage	Illuminated	Drive Fault	494
9	oH (0009)	Heatsink Overheat	Illuminated	Drive Fault	491
10	oH1 (000A)	Heatsink Overheat	Illuminated	Drive Fault	491
11	oL1 (000B)	Motor Overload	Illuminated	Drive Fault	492
12	oL2 (000C)	Drive Overload	Illuminated	Drive Fault	493
13	oL3 (000D)	Overtorque Detection 1	Illuminated	Drive Fault	494
14	oL4 (000E)	Overtorque Detection 2	Illuminated	Drive Fault	494
17	EF3 (0011)	External Fault (Terminal S3)	Illuminated	Drive Fault	480
18	EF4 (0012)	External Fault (Terminal S4)	Illuminated	Drive Fault	481
19	EF5 (0013)	External Fault (Terminal S5)	Illuminated	Drive Fault	481
20	EF6 (0014)	External Fault (Terminal S6)	Illuminated	Drive Fault	481
21	EF7 (0015)	External Fault (Terminal S7)	Illuminated	Drive Fault	481
25	dEv (0019)	Speed Deviation	Illuminated	Drive Fault	479
27	PF (001B)	Input Phase Loss	Illuminated	Drive Fault	495
28	LF (001C)	Output Phase Loss	Illuminated	Drive Fault	486
29	oH3 (001D)	Motor Overheat (PTC Input)	Illuminated	Drive Fault	491
30	oPr (001E)	Keypad Connection Fault	Illuminated	Drive Fault	494
31	Err (001F)	EEPROM Write Error	Illuminated	Drive Fault	481
32	oH4 (0020)	Motor Overheat Fault (PTC Input)	Illuminated	Drive Fault	492
33	CE (0021)	Serial Communication Error	Illuminated	Drive Fault	474
34	bUS (0022)	Option Communication Error	Illuminated	Drive Fault	474
39	EF0 (0027)	Option Card External Fault	Illuminated	Drive Fault	480

6.4 Faults, Minor Faults, Alarms, and Error Codes Listed by Decimal Value for Use with BACnet/Modbus

Decimal Value	Display (Hex.)	Name	ALM LED	Type	Ref.
41	UL3 (0029)	Undertorque Detection 1	Illuminated	Drive Fault	496
42	UL4 (002A)	Undertorque Detection 2	Illuminated	Drive Fault	496
43	oL7 (002B)	High Slip Braking Overload	Illuminated	Drive Fault	494
54	LF2 (0036)	Output Current Imbalance	Illuminated	Drive Fault	486
59	SEr (003B)	Speed Search Retries Exceeded	Illuminated	Drive Fault	496
66	EF1 (0042)	External Fault (Terminal S1)	Illuminated	Drive Fault	480
67	EF2 (0043)	External Fault (Terminal S2)	Illuminated	Drive Fault	480
70	CoF (0046)	Current Offset Fault	Illuminated	Drive Fault	475
71	PE1 (0047)	PLC Faults	Illuminated	Drive Fault	495
72	PE2 (0048)	PLC Faults	Illuminated	Drive Fault	495
90	UL6 (005A)	Underload or Belt Break Detected	Illuminated	Drive Fault	496
91	dv7 (005B)	Polarity Judge Timeout	Illuminated	Drive Fault	480
129	CPF00 (0081)	Control Circuit Error	Illuminated	Drive Fault	475
130	CPF01 (0082)	Control Circuit Error	Illuminated	Drive Fault	475
131	CPF02 (0083)	A/D Conversion Error	Illuminated	Drive Fault	475
132	CPF03 (0084)	Control Board Connection Error	Illuminated	Drive Fault	475
135	CPF06 (0087)	EEPROM Memory Data Error	Illuminated	Drive Fault	476
136	CPF07 (0088)	Terminal Board Connection Error	Illuminated	Drive Fault	476
137	CPF08 (0089)	Terminal Board Connection Error	Illuminated	Drive Fault	476
140	CPF11 (008C)	RAM Fault	Illuminated	Drive Fault	476
141	CPF12 (008D)	FLASH Memory Fault	Illuminated	Drive Fault	476
142	CPF13 (008E)	Watchdog Circuit Exception	Illuminated	Drive Fault	476
143	CPF14 (008F)	Control Circuit Fault	Illuminated	Drive Fault	476
145	CPF16 (0091)	Clock Fault	Illuminated	Drive Fault	477
146	CPF17 (0092)	Timing Fault	Illuminated	Drive Fault	477
147	CPF18 (0093)	Control Circuit Fault	Illuminated	Drive Fault	477
148	CPF19 (0094)	Control Circuit Fault	Illuminated	Drive Fault	477
149	CPF20 (0095)	Control Circuit Error	Illuminated	Drive Fault	477
150	CPF21 (0096)	Control Circuit Error	Illuminated	Drive Fault	477
151	CPF22 (0097)	Hybrid IC Error	Illuminated	Drive Fault	477
152	CPF23 (0098)	Control Board Connection Error	Illuminated	Drive Fault	477
153	CPF24 (0099)	Drive Unit Signal Fault	Illuminated	Drive Fault	478
155	CPF26 (009B)	BB Circuit Error	Illuminated	Drive Fault	478
156	CPF27 (009C)	PWM Set Reg Error	Illuminated	Drive Fault	478
157	CPF28 (009D)	PWM Pattern Error	Illuminated	Drive Fault	478
158	CPF29 (009E)	On-Delay Error	Illuminated	Drive Fault	478
159	CPF30 (009F)	BB On Error	Illuminated	Drive Fault	478
160	CPF31 (00A0)	ASIC Code Error	Illuminated	Drive Fault	478
161	CPF32 (00A1)	ASIC Startup Error	Illuminated	Drive Fault	478
162	CPF33 (00A2)	Watch-dog Error	Illuminated	Drive Fault	479
163	CPF34 (00A3)	Power/Clock Error	Illuminated	Drive Fault	479
164	CPF35 (00A4)	Ext A/D Conv Error	Illuminated	Drive Fault	479
165	CPF36 (00A5)	ASIC COM Error	Illuminated	Drive Fault	479

6.4 Faults, Minor Faults, Alarms, and Error Codes Listed by Decimal Value for Use with BACnet/Modbus

Decimal Value	Display (Hex.)	Name	ALM LED	Type	Ref.
166	CPF37 (00A6)	ASIC COM Error	Illuminated	Drive Fault	479
167	CPF38 (00A7)	EEPROM Data Error	Illuminated	Drive Fault	479
168	CPF39 (00A8)	CPU-ASIC Communication Error	Illuminated	Drive Fault	479
257	oFA00 (0101)	Option Not Compatible with Port	Illuminated	Drive Fault	488
258	oFA01 (0102)	Option Fault/Connection Error	Illuminated	Drive Fault	488
262	oFA05 (0106)	Option A/D Error	Illuminated	Drive Fault	488
263	oFA06 (0107)	Option Communication Error	Illuminated	Drive Fault	488
273	oFA10 (0111)	Option RAM Error	Illuminated	Drive Fault	488
274	oFA11 (0112)	Option Ope Mode Error	Illuminated	Drive Fault	488
275	oFA12 (0113)	Drive Receive CRC Error	Illuminated	Drive Fault	489
276	oFA13 (0114)	Drive Receive Frame Error	Illuminated	Drive Fault	489
277	oFA14 (0115)	Drive Receive Abort Error	Illuminated	Drive Fault	489
278	oFA15 (0116)	Option Receive CRC Error	Illuminated	Drive Fault	489
279	oFA16 (0117)	Option Receive Frame Error	Illuminated	Drive Fault	489
280	oFA17 (0118)	Option Receive Abort Error	Illuminated	Drive Fault	489
305	oFA30 (0131)	COM ID Error	Illuminated	Drive Fault	489
306	oFA31 (0132)	Type Code Error	Illuminated	Drive Fault	489
307	oFA32 (0133)	SUM Check Error	Illuminated	Drive Fault	490
308	oFA33 (0134)	Option Receive Time Over	Illuminated	Drive Fault	490
309	oFA34 (0135)	Memobus Time Over	Illuminated	Drive Fault	490
310	oFA35 (0136)	Drive Receive Time Over 1	Illuminated	Drive Fault	490
311	oFA36 (0137)	CI Check Error	Illuminated	Drive Fault	490
312	oFA37 (0138)	Drive Receive Time Over 2	Illuminated	Drive Fault	490
313	oFA38 (0139)	Control Reference Error	Illuminated	Drive Fault	490
314	oFA39 (013A)	Drive Receive Time Over 3	Illuminated	Drive Fault	490
315	oFA40 (013B)	CtrlResSel 1Err	Illuminated	Drive Fault	491
316	oFA41 (013C)	Drive Receive Time Over 4	Illuminated	Drive Fault	491
317	oFA42 (013D)	CtrlResSel 2Err	Illuminated	Drive Fault	491
318	oFA43 (013E)	Drive Receive Time Over 5	Illuminated	Drive Fault	491
1025	TiM (0401)	Keypad Time Not Set	Illuminated	Drive Fault	496
1026	bAT (0402)	Keypad Battery Low Voltage	Illuminated	Drive Fault	474
1029	ov2 (0405)	DC Bus Overvoltage 2	Illuminated	Drive Fault	495
1039	SCF (040F)	Safety Circuit Fault	Illuminated	Drive Fault	496
1043	FAn1 (0413)	Drive Cooling Fan Fault	Illuminated	Drive Fault	481
1046	bCE (0416)	Bluetooth Communication Fault	Illuminated	Drive Fault	474
1056	AUXFB (0420)	PI Aux Feedback Level Loss	Illuminated	Drive Fault	474
1057	DIFF (0421)	Differential Feedback Exceeded	Illuminated	Drive Fault	480
1058	FDBKL (0422)	WIRE Break	Illuminated	Drive Fault	485
1059	HFB (0423)	High Feedback Sensed	Illuminated	Drive Fault	486
1060	HIAUX (0424)	High PI Aux Feedback Level	Illuminated	Drive Fault	486
1061	LFB (0425)	Low Feedback Sensed	Illuminated	Drive Fault	486
1062	LOAUX (0426)	Low PI Aux Feedback Level	Illuminated	Drive Fault	486
1063	LOP (0427)	Loss of Prime	Illuminated	Drive Fault	487

6.4 Faults, Minor Faults, Alarms, and Error Codes Listed by Decimal Value for Use with BACnet/Modbus

Decimal Value	Display (Hex.)	Name	ALM LED	Type	Ref.
1065	NMS (0429)	Setpoint Not Met	Illuminated	Drive Fault	487
1066	OD (042A)	Output Disconnect	Illuminated	Drive Fault	488
1067	VLTS (042B)	Thermostat Fault	Illuminated	Drive Fault	497
1079	PSE (0437)	JOHB-SMP3 Protocol set Error	Illuminated	Drive Fault	495
1082	FB02 (043A)	Wait For Interlock Timeout	Illuminated	System Fault	482
1083	FB03 (043B)	External Fault Bypass (EFB)	Illuminated	System Fault	482
1085	FB05 (043D)	Motor Overload	Illuminated	System Fault	482
1086	FB06 (043E)	External Overload 1	Illuminated	System Fault	483
1087	FB07 (043F)	External Overload 2	Illuminated	System Fault	483
1088	FB08 (0440)	Brownout Detected	Illuminated	System Fault	483
1089	FB09 (0441)	Blackout Detected	Illuminated	System Fault	483
1090	FB10 (0442)	Loss of Drive Communications	Illuminated	Drive Fault	483
1093	FB13 (0445)	Loss of Load	Illuminated	System Fault	483
1095	FB15 (0447)	Input Phase Loss	Illuminated	System Fault	484
1096	FB16 (0448)	Input Phase Rotation	Illuminated	System Fault	484
1097	FB17 (0449)	Load Verify Fault	Illuminated	System Fault	484
1098	FB18 (044A)	Welded Bypass Contactor Detected	Illuminated	System Fault	484
1106	FB26 (0452)	Option on Drive Detected	Illuminated	Drive Fault	484
1107	FB27 (0453)	Drive Hardware Fault (CPFx oFx)	Illuminated	Drive Fault	484
1108	FB28 (0454)	Drive Faulted	Illuminated	System Fault	484
1110	FB30 (0456)	Conflicting SW Check UB-99	Illuminated	Drive Fault	485

Table 6.4 List of Minor Faults and Alarms by Decimal

Minor fault and alarm decimal numbers are read in Modbus register 007F.

Decimal Value	Display (Hex.)	Name	ALM LED	Type	Ref.
1	Uv (0001)	DC Bus Undervoltage	Flashing	Alarm	510
2	ov (0002)	DC Bus Overvoltage	Flashing	Alarm	508
3	oH (0003)	Heatsink Overheat	Flashing	Alarm	507
4	oH2 (0004)	External Overheat (H1-XX=B)	Flashing	Alarm	507
5	oL3 (0005)	Overtorque 1	Flashing	Alarm	507
6	oL4 (0006)	Overtorque 2	Flashing	Alarm	508
7	EF (0007)	FWD/REV Run Command Input Error	Flashing	Alarm	502
8	bb (0008)	Baseblock	Flashing	Alarm	499
9	EF3 (0009)	External Fault (Terminal S3)	Flashing	Alarm	502
10	EF4 (000A)	External Fault (Terminal S4)	Flashing	Alarm	502
11	EF5 (000B)	External Fault (Terminal S5)	Flashing	Alarm	502
12	EF6 (000C)	External Fault (Terminal S6)	Flashing	Alarm	502
13	EF7 (000D)	External Fault (Terminal S7)	Flashing	Alarm	503
20	CE (0014)	Serial Communication Error	Flashing	Alarm	500
21	bUS (0015)	Option Communication Error	Flashing	Alarm	499
26	EF0 (001A)	Option Card External Fault	Flashing	Alarm	502
29	CALL (001D)	Serial Comm Transmission Error	Flashing	Alarm	500
30	UL3 (001E)	Undertorque Detection 1	Flashing	Alarm	510
31	UL4 (001F)	Undertorque Detection 2	Flashing	Alarm	510

6.4 Faults, Minor Faults, Alarms, and Error Codes Listed by Decimal Value for Use with BACnet/Modbus

Decimal Value	Display (Hex.)	Name	ALM LED	Type	Ref.
32	SE (0020)	Modbus Test Mode Error	Flashing	Alarm	509
34	oH3 (0022)	Motor Overheat (PTC Input)	Flashing	Alarm	507
41	CyPo (0029)	Cycle Power to Accept Changes	Flashing	Alarm	501
42	dnE (002A)	Drive Disabled	Flashing	Alarm	501
52	HCA (0034)	High Current Alarm	Flashing	Alarm	504
53	LT-1 (0035)	Cooling Fan Maintenance Time	Flashing	Alarm	506
54	LT-2 (0036)	Capacitor Maintenance Time	Flashing	Alarm	506
57	EF1 (0039)	External Fault (Terminal S1)	Flashing	Alarm	502
58	EF2 (003A)	External Fault (Terminal S2)	Flashing	Alarm	502
59	SToF (003B)	Safe Torque OFF	Flashing	Alarm	509
60	STo (003C)	Safe Torque OFF	-	Alarm	509
63	PA1 (003F)	PLC Error 1	Flashing	Alarm	509
66	TrPC (0042)	IGBT Maintenance Time (90%)	Flashing	Alarm	509
67	LT-3 (0043)	SoftChargeBypassRelay MainteTime	Flashing	Alarm	506
68	LT-4 (0044)	IGBT Maintenance Time (50%)	Flashing	Alarm	506
71	PF (0047)	Input Phase Loss	Flashing	Alarm	508
78	UL6 (004E)	Underload or Belt Break Detected	Flashing	Alarm	510
103	EOF (0067)	Emergency Override FWD	Flashing	Alarm	503
104	EOR (0068)	Emergency Override REV	Flashing	Alarm	503
105	INTLK (0069)	BAS Interlock	Flashing	Alarm	505
129	EP24v (0081)	External Power 24V Supply	Flashing	Alarm	503
133	bAT (0085)	Keypad Battery Low Voltage	Flashing	Alarm	499
137	TiM (0089)	Keypad Time Not Set	Flashing	Alarm	509
138	bCE (008A)	Bluetooth Communication Error	Flashing	Alarm	499
144	Bu-Fb (0090)	Main Fdbk Lost Using Backup Fdbk	Flashing	Alarm	499
145	BuFbl (0091)	Backup Fdbk Lost Chk/Repl Xducer	Flashing	Alarm	499
146	CE (0092)	Run at H5-34 (CE Go-To-Freq)	Flashing	Alarm	501
147	DIFF (0093)	Differential Feedback Exceeded	Flashing	Alarm	501
148	FDBKL (0094)	Feedback Loss Wire Break	Flashing	Alarm	503
149	FLGT (0095)	Feedback Loss, Go To Freq b5-83	Flashing	Alarm	503
150	HIAUX (0096)	High PI Aux Feedback Level	Flashing	Alarm	504
151	HIFB (0097)	High Feedback Sensed	Flashing	Alarm	504
153	LOAUX (0099)	Low PI Aux Feedback Level	Flashing	Alarm	505
154	LOFB (009A)	Low Feedback Sensed	Flashing	Alarm	505
155	LOP (009B)	Loss of Prime	Flashing	Alarm	505
156	NMS (009C)	Setpoint Not Met	Flashing	Alarm	506
157	OD (009D)	Output Disconnect	Flashing	Alarm	506
158	FR<MS (009E)	Freq Ref < Minimum Speed (Y1-06)	Flashing	Alarm	504
159	FR<TH (009F)	Freq. Reference < Thrust (Y4-12)	Flashing	Alarm	504
162	AFBL (00A2)	Analog Fbk Lost, Switched to Net	Flashing	Alarm	498
163	AuDis (00A3)	Low PI Aux Fdbk Drive Disabled	Flashing	Alarm	498
164	AUXFB (00A4)	PI Aux Feedback Level Loss	Flashing	Alarm	498
165	AuFbl (00A5)	PI Aux Fdbk Lost Switched to Net	Flashing	Alarm	498

6.4 Faults, Minor Faults, Alarms, and Error Codes Listed by Decimal Value for Use with BACnet/Modbus

Decimal Value	Display (Hex.)	Name	ALM LED	Type	Ref.
166	BuDif (00A6)	Main Fdbk Lost, Using Diff Fdbk	Flashing	Alarm	499
167	LCP (00A7)	Low City Pressure	Flashing	Alarm	505
168	LSP (00A8)	Low Suction Pressure	Flashing	Alarm	506
169	LWT (00A9)	Low Water In Tank	Flashing	Alarm	506
178	AL02 (00B2)	Interlock Open	Flashing	Alarm	498
179	AL03 (00B3)	Emergency Override Bypass	Flashing	Alarm	498
185	AL09 (00B9)	Restart Delay Active	Flashing	Alarm	498
189	AL13 (00BD)	Loss of Load Detected	Flashing	Alarm	498
192	AL16 (00C0)	Input Phase Rotation	Flashing	Alarm	498
193	AL17 (00C1)	Remote Xfer disabled in Reverse	Flashing	Alarm	498
194	AL18 (00C2)	Auto Xfer disabled in Reverse	Flashing	Alarm	498
201	SAFE (00C9)	Safety Open	Flashing	Alarm	509
202	FIRE_ST (00CA)	Fire Stat Open	Flashing	Alarm	503
203	FREEZ_ST (00CB)	Freeze Stat Open	Flashing	Alarm	504
204	SMK_ALRM (00CC)	Smoke Alarm Active	Flashing	Alarm	509
205	OV_PRESS (00CD)	Over Pressure Detected	Flashing	Alarm	508
206	LOW_SUCT (00CE)	Low Suction Detected	Flashing	Alarm	505
207	VBRATION (00CF)	Vibration Detected	Flashing	Alarm	510

6.5 Faults

This section gives information about some of the causes and possible solutions of faults. You must use the Fault Reset operation to remove the fault before you can operate the drive. Use the information in this table to remove the cause of the fault.

Code	Name	Causes	Possible Solutions
AUXFB	PI Aux Feedback Level Loss	The analog input from the terminal set for <i>PI Auxiliary Control Feedback Level</i> [H3-xx = 27] is more than 21 mA or less than 3 mA for longer than 1 s.	Repair transducer or wiring.
Note: Do a Fault Reset to clear the fault.			
Code	Name	Causes	Possible Solutions
bAT	Keypad Battery Low Voltage	The keypad battery voltage is low.	Replace the keypad battery.
Note: Use o4-24 [bAT Detection Selection] to enable/disable bAT detection.			
Code	Name	Causes	Possible Solutions
bCE	Bluetooth Communication Fault	The smartphone or tablet with DriveWizard Mobile installed is too far from the keypad.	Use the smartphone or tablet 10 m (32.8 ft) or nearer to the keypad. Note: bCE can occur when the smartphone or tablet is 10 m (32.8 ft) or nearer to the keypad depending on the specifications of the smartphone or tablet.
		Radio waves from a different device are causing interference with communications between the smartphone or tablet and keypad.	Make sure that no device around the keypad uses the same radio bandwidth (2400 MHz to 2480 MHz), and prevent radio interference.
Note: <ul style="list-style-type: none"> The drive detects this error when you use the Bluetooth LCD keypad and operate the drive with a smartphone or tablet. Do a Fault Reset to clear the fault. Set the stopping method for this fault in o2-27 [bCE Detection Selection]. 			
Code	Name	Causes	Possible Solutions
bUS	Option Communication Error	The drive did not receive a signal from the controller.	Correct wiring errors.
		The communications cable wiring is incorrect.	
		There is a short-circuit in the communications cable or the communications cable is not connected.	<ul style="list-style-type: none"> Repair short circuits and connect cables. Replace the defective communications cable.
		Electrical interference caused a communication data error.	<ul style="list-style-type: none"> Examine the control circuit lines, main circuit lines, and ground wiring, and decrease the effects of electrical interference. Make sure that a magnetic contactor is not the source of the electrical interference, then use a Surge Protective Device if necessary. Use only the recommended cables or other shielded line. Ground the shield on the controller side or the drive input power side. Separate the communication wiring from drive power lines, and install a noise filter to the input side of the power supply for communication. Decrease the effects of electrical interference from the controller.
		The option is incorrectly installed to the bypass control board A2.	Correctly install the option to the bypass control board A2.
		The option is damaged.	If the fault continues and the wiring is correct, replace the option.
Note: <ul style="list-style-type: none"> The drive detects this error if the Run command or frequency reference is assigned to the option card. Do a Fault Reset to clear the fault. If the drive detects this error, the drive will operate the motor as specified by the stopping method set in F6-01 [Communication Error Selection]. 			
Code	Name	Causes	Possible Solutions
CE	Serial Communication Error	The communications cable wiring is incorrect.	Correct wiring errors.
		There is a short circuit in the communications cable or the communications cable is not connected.	<ul style="list-style-type: none"> Repair short circuits and connect cables. Replace the defective communications cable.

Code	Name	Causes	Possible Solutions
		Electrical interference caused a communication data error.	<ul style="list-style-type: none"> Examine the control circuit lines, main circuit lines, and ground wiring, and decrease the effects of electrical interference. Make sure that a magnetic contactor is not the source of the electrical interference, then use a Surge Protective Device if necessary. Use only the recommended cables or other shielded line. Ground the shield on the controller side or the drive input power side. Separate the communication wiring from drive power lines, and install a noise filter to the input side of the power supply for communication. Decrease the effects of electrical interference from the controller.
Note: <ul style="list-style-type: none"> The drive detects this error if it does not correctly receive control data for the <i>CE</i> detection time set to <i>H5-09 [CE Detection Time]</i>. Do a Fault Reset to clear the fault. If the drive detects this error, the drive will operate the motor as specified by the stopping method set in <i>H5-04 [Communication Error Stop Method]</i>. 			
Code	Name	Causes	Possible Solutions
CoF	Current Offset Fault	The drive starts operation while the induced voltage stays in the motor (during coasting to a stop or after fast deceleration).	<ul style="list-style-type: none"> Make a sequence that does not restart operation when induced voltage stays in the motor. Set <i>b3-01 = 1 [Speed Search at Start Selection = Enabled]</i>. Use <i>Speed Search from Fmax or Fref [H1-xx = 61, 62]</i> to do a speed search through one of the external terminals.
		A drive hardware problem occurred.	Replace the drive.
Note: <ul style="list-style-type: none"> The drive detects this error if the current offset value is more than the permitted setting range while the drive automatically adjusts the current offset. Do a Fault Reset to clear the fault. 			
Code	Name	Causes	Possible Solutions
CPF00	Control Circuit Error	A drive hardware problem occurred.	<ul style="list-style-type: none"> Re-energize the drive. If the fault stays, replace the control board or the drive. For information about replacing the control board, contact Yaskawa or your nearest sales representative.
Note: <ul style="list-style-type: none"> Do a Fault Reset to clear the fault. Fault trace is not available for these faults. 			
Code	Name	Causes	Possible Solutions
CPF01	Control Circuit Error	A drive hardware problem occurred.	<ul style="list-style-type: none"> Re-energize the drive. If the fault stays, replace the control board or the drive. For information about replacing the control board, contact Yaskawa or your nearest sales representative.
Note: <ul style="list-style-type: none"> Do a Fault Reset to clear the fault. Fault trace is not available for these faults. 			
Code	Name	Causes	Possible Solutions
CPF02	A/D Conversion Error	A drive hardware problem occurred.	<ul style="list-style-type: none"> Re-energize the drive. If the fault stays, replace the control board or the drive. For information about replacing the control board, contact Yaskawa or your nearest sales representative.
Note: <ul style="list-style-type: none"> Do a Fault Reset to clear the fault. Fault trace is not available for these faults. 			
Code	Name	Causes	Possible Solutions
CPF03	Control Board Connection Error	A drive hardware problem occurred.	<ul style="list-style-type: none"> Re-energize the drive. If the fault stays, replace the control board or the drive. For information about replacing the control board, contact Yaskawa or your nearest sales representative.
Note: <ul style="list-style-type: none"> Do a Fault Reset to clear the fault. Fault trace is not available for these faults. 			

6.5 Faults

Code	Name	Causes	Possible Solutions
CPF06	EEPROM Memory Data Error	The drive power supply was de-energized while a communication option card entered a parameter Write command.	Set <i>A1-03 = 2220</i> [<i>Initialize Parameters = 2-Wire Initialization</i>] and initialize the drive.
		An EEPROM peripheral circuit error occurred.	<ul style="list-style-type: none"> Re-energize the drive. If the fault stays, replace the control board or the drive. For information about replacing the control board, contact Yaskawa or your nearest sales representative.
Note: <ul style="list-style-type: none"> The drive detects this error if there is an error in the data written to the EEPROM of the drive. Do a Fault Reset to clear the fault. Fault trace is not available for this fault. 			
Code	Name	Causes	Possible Solutions
CPF07	Terminal Board Connection Error	A drive hardware problem occurred.	<ul style="list-style-type: none"> Re-energize the drive. If the fault stays, replace the control board or the drive. For information about replacing the control board, contact Yaskawa or your nearest sales representative.
Note: <ul style="list-style-type: none"> Do a Fault Reset to clear the fault. Fault trace is not available for these faults. 			
Code	Name	Causes	Possible Solutions
CPF08	Terminal Board Connection Error	A drive hardware problem occurred.	<ul style="list-style-type: none"> Re-energize the drive. If the fault stays, replace the control board or the drive. For information about replacing the control board, contact Yaskawa or your nearest sales representative.
Note: <ul style="list-style-type: none"> Do a Fault Reset to clear the fault. Fault trace is not available for these faults. 			
Code	Name	Causes	Possible Solutions
CPF11	RAM Fault	A drive hardware problem occurred.	<ul style="list-style-type: none"> Re-energize the drive. If the fault stays, replace the control board or the drive. For information about replacing the control board, contact Yaskawa or your nearest sales representative.
Note: <ul style="list-style-type: none"> Do a Fault Reset to clear the fault. Fault trace is not available for these faults. 			
Code	Name	Causes	Possible Solutions
CPF12	FLASH Memory Fault	A drive hardware problem occurred.	<ul style="list-style-type: none"> Re-energize the drive. If the fault stays, replace the control board or the drive. For information about replacing the control board, contact Yaskawa or your nearest sales representative.
Note: <ul style="list-style-type: none"> Do a Fault Reset to clear the fault. Fault trace is not available for these faults. 			
Code	Name	Causes	Possible Solutions
CPF13	Watchdog Circuit Exception	A drive hardware problem occurred.	<ul style="list-style-type: none"> Re-energize the drive. If the fault stays, replace the control board or the drive. For information about replacing the control board, contact Yaskawa or your nearest sales representative.
Note: <ul style="list-style-type: none"> Do a Fault Reset to clear the fault. Fault trace is not available for these faults. 			
Code	Name	Causes	Possible Solutions
CPF14	Control Circuit Fault	A drive hardware problem occurred.	<ul style="list-style-type: none"> Re-energize the drive. If the fault stays, replace the control board or the drive. For information about replacing the control board, contact Yaskawa or your nearest sales representative.
Note: <ul style="list-style-type: none"> Do a Fault Reset to clear the fault. Fault trace is not available for these faults. 			

Code	Name	Causes	Possible Solutions
CPF16	Clock Fault	A drive hardware problem occurred.	<ul style="list-style-type: none"> Re-energize the drive. If the fault stays, replace the control board or the drive. For information about replacing the control board, contact Yaskawa or your nearest sales representative.
Note: <ul style="list-style-type: none"> Do a Fault Reset to clear the fault. Fault trace is not available for these faults. 			
Code	Name	Causes	Possible Solutions
CPF17	Timing Fault	A drive hardware problem occurred.	<ul style="list-style-type: none"> Re-energize the drive. If the fault stays, replace the control board or the drive. For information about replacing the control board, contact Yaskawa or your nearest sales representative.
Note: <ul style="list-style-type: none"> Do a Fault Reset to clear the fault. Fault trace is not available for these faults. 			
Code	Name	Causes	Possible Solutions
CPF18	Control Circuit Fault	A drive hardware problem occurred.	<ul style="list-style-type: none"> Re-energize the drive. If the fault stays, replace the control board or the drive. For information about replacing the control board, contact Yaskawa or your nearest sales representative.
Note: <ul style="list-style-type: none"> Do a Fault Reset to clear the fault. Fault trace is not available for these faults. 			
Code	Name	Causes	Possible Solutions
CPF19	Control Circuit Fault	A drive hardware problem occurred.	<ul style="list-style-type: none"> Re-energize the drive and check if the fault still remains. Replace the control board or the entire drive if the fault continues. Contact Yaskawa or your nearest sales representative for instructions on replacing the control board.
Note: <ul style="list-style-type: none"> Do a Fault Reset to clear the fault. Fault trace is not available for these faults. 			
Code	Name	Causes	Possible Solutions
CPF20	Control Circuit Error	A drive hardware problem occurred.	<ul style="list-style-type: none"> Re-energize the drive. If the fault stays, replace the control board or the drive. For information about replacing the control board, contact Yaskawa or your nearest sales representative.
Note: <ul style="list-style-type: none"> Do a Fault Reset to clear the fault. Fault trace is not available for these faults. 			
Code	Name	Causes	Possible Solutions
CPF21	Control Circuit Error	A drive hardware problem occurred.	<ul style="list-style-type: none"> Re-energize the drive. If the fault stays, replace the control board or the drive. For information about replacing the control board, contact Yaskawa or your nearest sales representative.
Note: <ul style="list-style-type: none"> Do a Fault Reset to clear the fault. Fault trace is not available for these faults. 			
Code	Name	Causes	Possible Solutions
CPF22	Hybrid IC Error	A drive hardware problem occurred.	<ul style="list-style-type: none"> Re-energize the drive. If the fault stays, replace the control board or the drive. For information about replacing the control board, contact Yaskawa or your nearest sales representative.
Note: <ul style="list-style-type: none"> Do a Fault Reset to clear the fault. Fault trace is not available for these faults. 			
Code	Name	Causes	Possible Solutions
CPF23	Control Board Connection Error	A drive hardware problem occurred.	<ul style="list-style-type: none"> Re-energize the drive. If the fault stays, replace the control board or the drive. For information about replacing the control board, contact Yaskawa or your nearest sales representative.
Note: <ul style="list-style-type: none"> Do a Fault Reset to clear the fault. Fault trace is not available for these faults. 			

6.5 Faults

Code	Name	Causes	Possible Solutions
CPF24	Drive Unit Signal Fault	A drive hardware problem occurred.	<ul style="list-style-type: none"> Re-energize the drive. If the fault stays, replace the control board or the drive. For information about replacing the control board, contact Yaskawa or your nearest sales representative.
Note: <ul style="list-style-type: none"> Do a Fault Reset to clear the fault. Fault trace is not available for these faults. 			
Code	Name	Causes	Possible Solutions
CPF26	BB Circuit Error	A drive hardware problem occurred.	<ul style="list-style-type: none"> Re-energize the drive. If the fault stays, replace the control board or the drive. For information about replacing the control board, contact Yaskawa or your nearest sales representative.
Note: <ul style="list-style-type: none"> Do a Fault Reset to clear the fault. Fault trace is not available for these faults. 			
Code	Name	Causes	Possible Solutions
CPF27	PWM Set Reg Error	A drive hardware problem occurred.	<ul style="list-style-type: none"> Re-energize the drive. If the fault stays, replace the control board or the drive. For information about replacing the control board, contact Yaskawa or your nearest sales representative.
Note: <ul style="list-style-type: none"> Do a Fault Reset to clear the fault. Fault trace is not available for these faults. 			
Code	Name	Causes	Possible Solutions
CPF28	PWM Pattern Error	A drive hardware problem occurred.	<ul style="list-style-type: none"> Re-energize the drive. If the fault stays, replace the control board or the drive. For information about replacing the control board, contact Yaskawa or your nearest sales representative.
Note: <ul style="list-style-type: none"> Do a Fault Reset to clear the fault. Fault trace is not available for these faults. 			
Code	Name	Causes	Possible Solutions
CPF29	On-Delay Error	A drive hardware problem occurred.	<ul style="list-style-type: none"> Re-energize the drive. If the fault stays, replace the control board or the drive. For information about replacing the control board, contact Yaskawa or your nearest sales representative.
Note: <ul style="list-style-type: none"> Do a Fault Reset to clear the fault. Fault trace is not available for these faults. 			
Code	Name	Causes	Possible Solutions
CPF30	BB On Error	A drive hardware problem occurred.	<ul style="list-style-type: none"> Re-energize the drive. If the fault stays, replace the control board or the drive. For information about replacing the control board, contact Yaskawa or your nearest sales representative.
Note: <ul style="list-style-type: none"> Do a Fault Reset to clear the fault. Fault trace is not available for these faults. 			
Code	Name	Causes	Possible Solutions
CPF31	ASIC Code Error	A drive hardware problem occurred.	<ul style="list-style-type: none"> Re-energize the drive. If the fault stays, replace the control board or the drive. For information about replacing the control board, contact Yaskawa or your nearest sales representative.
Note: <ul style="list-style-type: none"> Do a Fault Reset to clear the fault. Fault trace is not available for these faults. 			
Code	Name	Causes	Possible Solutions
CPF32	ASIC Startup Error	A drive hardware problem occurred.	<ul style="list-style-type: none"> Re-energize the drive. If the fault stays, replace the control board or the drive. For information about replacing the control board, contact Yaskawa or your nearest sales representative.
Note: <ul style="list-style-type: none"> Do a Fault Reset to clear the fault. Fault trace is not available for these faults. 			

Code	Name	Causes	Possible Solutions
CPF33	Watch-dog Error	A drive hardware problem occurred.	<ul style="list-style-type: none"> Re-energize the drive. If the fault stays, replace the control board or the drive. For information about replacing the control board, contact Yaskawa or your nearest sales representative.
Note: <ul style="list-style-type: none"> Do a Fault Reset to clear the fault. Fault trace is not available for these faults. 			
Code	Name	Causes	Possible Solutions
CPF34	Power/Clock Error	A drive hardware problem occurred.	<ul style="list-style-type: none"> Re-energize the drive. If the fault stays, replace the control board or the drive. For information about replacing the control board, contact Yaskawa or your nearest sales representative.
Note: <ul style="list-style-type: none"> Do a Fault Reset to clear the fault. Fault trace is not available for these faults. 			
Code	Name	Causes	Possible Solutions
CPF35	Ext A/D Conv Error	A drive hardware problem occurred.	<ul style="list-style-type: none"> Re-energize the drive. If the fault stays, replace the control board or the drive. For information about replacing the control board, contact Yaskawa or your nearest sales representative.
Note: <ul style="list-style-type: none"> Do a Fault Reset to clear the fault. Fault trace is not available for these faults. 			
Code	Name	Causes	Possible Solutions
CPF36	ASIC COM Error	A drive hardware problem occurred.	<ul style="list-style-type: none"> Re-energize the drive. If the fault stays, replace the control board or the drive. For information about replacing the control board, contact Yaskawa or your nearest sales representative.
Note: <ul style="list-style-type: none"> Do a Fault Reset to clear the fault. Fault trace is not available for these faults. 			
Code	Name	Causes	Possible Solutions
CPF37	ASIC COM Error	A drive hardware problem occurred.	<ul style="list-style-type: none"> Re-energize the drive. If the fault stays, replace the control board or the drive. For information about replacing the control board, contact Yaskawa or your nearest sales representative.
Note: <ul style="list-style-type: none"> Do a Fault Reset to clear the fault. Fault trace is not available for these faults. 			
Code	Name	Causes	Possible Solutions
CPF38	EEPROM Memory Data Error	A drive hardware problem occurred.	<ul style="list-style-type: none"> Re-energize the drive. If the fault stays, replace the control board or the drive. For information about replacing the control board, contact Yaskawa or your nearest sales representative.
Note: <ul style="list-style-type: none"> Do a Fault Reset to clear the fault. Fault trace is not available for these faults. 			
Code	Name	Causes	Possible Solutions
CPF39	CPU-ASIC Communication Error	A drive hardware problem occurred.	<ul style="list-style-type: none"> Re-energize the drive. If the fault stays, replace the control board or the drive. For information about replacing the control board, contact Yaskawa or your nearest sales representative.
Note: <ul style="list-style-type: none"> Do a Fault Reset to clear the fault. Fault trace is not available for these faults. 			
Code	Name	Causes	Possible Solutions
dEv	Speed Deviation	The load is too heavy.	Decrease the load.
		Acceleration and deceleration times are set too short.	Increase the values set in <i>C1-01</i> to <i>C1-04</i> [<i>Acceleration/Deceleration Time</i>].
		The <i>dEv</i> detection level settings are incorrect.	Adjust <i>F1-10</i> [<i>Speed Deviation Detection Level</i>] and <i>F1-11</i> [<i>Speed Deviation Detect DelayTime</i>].
		The load is locked up.	Examine the machine.

6.5 Faults

Code	Name	Causes	Possible Solutions
		The holding brake is stopping the motor.	Release the holding brake.
Note: <ul style="list-style-type: none"> The drive detects this error if the difference between the detected speed and the speed reference is more than the setting of <i>F1-10</i> for longer than <i>F1-11</i>. Do a Fault Reset to clear the fault. If the drive detects this error, the drive will operate the motor as specified by the stopping method set in <i>F1-04</i> [<i>Speed Deviation Detection Select</i>]. 			
Code	Name	Causes	Possible Solutions
DIFF	Differential Feedback Exceeded	The difference between the PID Feedback and <i>Differential Level Source</i> [<i>H3-xx = 2D</i>] is more than the level set in <i>Y4-18</i> [<i>Differential Level</i>] for the time set in <i>Y4-19</i> [<i>Differential Lvl Detection Time</i>].	<ul style="list-style-type: none"> Replace the feedback transducer or transducers. Make sure that the settings of <i>Y4-18</i> [<i>Differential Level</i>] to <i>Y4-20</i> [<i>Differential Level Detection Sel</i>] are correct.
Note: Do a Fault Reset to clear the fault.			
Code	Name	Causes	Possible Solutions
dv7	Polarity Judge Timeout	There is a disconnection in the motor coil winding.	Measure the motor line-to-line resistance and replace the motor if a coil is disconnected.
		The screws on the drive output terminals are loose.	Tighten the terminal screws to the correct tightening torque.
Note: <ul style="list-style-type: none"> The drive detects this error if it cannot detect polarity in a pre-set length of time. Do a Fault Reset to clear the fault. 			
Code	Name	Causes	Possible Solutions
EF0	Option Card External Fault	The communication option received an external fault from the controller.	<ol style="list-style-type: none"> Find the device that caused the external fault and remove the cause. Clear the external fault input from the controller.
		A programming error occurred on the controller side.	Examine the operation of the controller program.
Note: <ul style="list-style-type: none"> The drive detects this fault if the alarm function on the external device side is operating. Do a Fault Reset to clear the fault. If the drive detects this fault, it will operate the motor as specified by the stop method set in <i>F6-03</i> [<i>Comm External Fault (EF0) Select</i>]. 			
Code	Name	Causes	Possible Solutions
EF1	External Fault (Terminal S1)	MFDI terminal S1 caused an external fault through an external device.	<ol style="list-style-type: none"> Find the device that caused the external fault and remove the cause. Clear the external fault input in the MFDI.
		The wiring is incorrect.	Correctly connect the signal line to MFDI terminal S1.
		<i>External Fault</i> [<i>H1-01 = 20 to 2B</i>] is set to MFDI terminal S1, but the terminal is not in use.	Correctly set the MFDI.
Note: Do a Fault Reset to clear the fault.			
Code	Name	Causes	Possible Solutions
EF2	External Fault (Terminal S2)	MFDI terminal S2 caused an external fault through an external device.	<ol style="list-style-type: none"> Find the device that caused the external fault and remove the cause. Clear the external fault input in the MFDI.
		The wiring is incorrect.	Correctly connect the signal line to MFDI terminal S2.
		<i>External Fault</i> [<i>H1-02 = 20 to 2B</i>] is set to MFDI terminal S2, but the terminal is not in use.	Correctly set the MFDI.
Note: Do a Fault Reset to clear the fault.			
Code	Name	Causes	Possible Solutions
EF3	External Fault (Terminal S3)	MFDI terminal S3 caused an external fault through an external device.	<ol style="list-style-type: none"> Find the device that caused the external fault and remove the cause. Clear the external fault input in the MFDI.
		The wiring is incorrect.	Correctly connect the signal line to MFDI terminal S3.
		<i>External Fault</i> [<i>H1-03 = 20 to 2B</i>] is set to MFDI terminal S3, but the terminal is not in use.	Correctly set the MFDI.
Note: Do a Fault Reset to clear the fault.			

Code	Name	Causes	Possible Solutions
EF4	External Fault (Terminal S4)	MFDI terminal S4 caused an external fault through an external device.	<ol style="list-style-type: none"> Find the device that caused the external fault and remove the cause. Clear the external fault input in the MFDI.
		The wiring is incorrect.	Correctly connect the signal line to MFDI terminal S4.
		<i>External Fault [H1-04 = 20 to 2B]</i> is set to MFDI terminal S4, but the terminal is not in use.	Correctly set the MFDI.
Note: Do a Fault Reset to clear the fault.			
Code	Name	Causes	Possible Solutions
EF5	External Fault (Terminal S5)	MFDI terminal S5 caused an external fault through an external device.	<ol style="list-style-type: none"> Find the device that caused the external fault and remove the cause. Clear the external fault input in the MFDI.
		The wiring is incorrect.	Correctly connect the signal line to MFDI terminal S5.
		<i>External Fault [H1-05 = 20 to 2B]</i> is set to MFDI terminal S5, but the terminal is not in use.	Correctly set the MFDI.
Note: Do a Fault Reset to clear the fault.			
Code	Name	Causes	Possible Solutions
EF6	External Fault (Terminal S6)	MFDI terminal S6 caused an external fault through an external device.	<ol style="list-style-type: none"> Find the device that caused the external fault and remove the cause. Clear the external fault input in the MFDI.
		The wiring is incorrect.	Correctly connect the signal line to MFDI terminal S6.
		<i>External Fault [H1-06 = 20 to 2B]</i> is set to MFDI terminal S6, but the terminal is not in use.	Correctly set the MFDI.
Note: Do a Fault Reset to clear the fault.			
Code	Name	Causes	Possible Solutions
EF7	External Fault (Terminal S7)	MFDI terminal S7 caused an external fault through an external device.	<ol style="list-style-type: none"> Find the device that caused the external fault and remove the cause. Clear the external fault input in the MFDI.
		The wiring is incorrect.	Correctly connect the signal line to MFDI terminal S7.
		<i>External Fault [H1-07 = 20 to 2B]</i> is set to MFDI terminal S7, but the terminal is not in use.	Correctly set the MFDI.
Note: Do a Fault Reset to clear the fault.			
Code	Name	Causes	Possible Solutions
Err	EEPROM Write Error	There was a problem with the EEPROM hardware.	<ul style="list-style-type: none"> Re-energize the drive. If the fault stays, replace the control board or the drive. Contact Yaskawa or your nearest sales representative to replace the board.
		Electrical interference corrupted the data while it was writing to the EEPROM of the drive.	<ul style="list-style-type: none"> Push ENTER Key. Set the parameters again.
Note: Do a Fault Reset to clear the fault.			
Code	Name	Causes	Possible Solutions
FAn1	Drive Cooling Fan Fault	The cooling fan stopped operating correctly.	<ul style="list-style-type: none"> Examine cooling fan operation. Re-energize the drive. Examine U4-03 [Cooling Fan Ope Time] and U4-04 [Cool Fan Maintenance]. If the performance life of the cooling fan is expired or if there is damage to the fan, replace the fan.
		The circulation fan is damaged.	<ul style="list-style-type: none"> Examine circulation fan operation. Re-energize the drive. Examine U4-03 [Cooling Fan Ope Time] and U4-04 [Cool Fan Maintenance]. If there is damage to the circulation fan or if the performance life of the fan is expired, replace the fan.
Note: Do a Fault Reset to clear the fault.			

6.5 Faults

Code	Name	Causes	Possible Solutions
FB02	Wait For Interlock Timeout	The digital input set to Run Interlock is open. This will usually be Terminal TB2-3 on bypass control PCB A2.	<ul style="list-style-type: none"> Install a NC BAS Interlock Circuit/Damper Interlock between TB2-3 and TB2-9 on the bypass control board A2. Install a jumper between TB2-3 and TB2-9 on the bypass control board A2.. Use this method when you will add a BAS (Building Automation System) Interlock circuit in the future or if you will not use a Building Automation System interlock circuit. Make sure that the input assigned for the Interlock is active in the timeout period set in Z1-15.
Note: Do a Fault Reset to clear the fault.			
Code	Name	Causes	Possible Solutions
FB03	External Fault Bypass (EFB)	An digital input set for external fault (EFB) was activated.	Remove the cause of the external fault.
		An external fault (EFB) was received from the serial communications network.	<ul style="list-style-type: none"> Remove the cause of the external fault. Remove the external fault input from the controller. Make sure that the controller program is correct.
Note: Do a Fault Reset to clear the fault.			
Code	Name	Causes	Possible Solutions
FB05	Motor Overload	The load is too heavy.	Decrease the load. Note: You can only reset FB05 when U4-16 [Motor oL1 Level] < 100.
		The acceleration/deceleration times or cycle times are too short.	<ul style="list-style-type: none"> Examine the acceleration/deceleration times and the motor start/stop frequencies (cycle times). Increase the values set in C1-01 to C1-04 [Acceleration/Deceleration Times].
		Overload occurred while running at low speed.	<ul style="list-style-type: none"> Decrease the load when running at low speed. Increase the motor speed. If the motor is run frequently at low speeds, replace the motor with a larger motor or use a drive-dedicated motor. Note: For general-purpose motors, overload can occur while running at low speed when operating at below the rated current.
		Starting the motor too often in Bypass Mode.	Decrease the number of times the motor is started in Bypass Mode.
		The V/f pattern does not fit the motor qualities.	<ul style="list-style-type: none"> Examine the ratios between the V/f pattern frequency and voltage. Decrease the voltage if it is too high compared to the frequency. Adjust E1-04 to E1-10 [V/f Pattern Parameters]. Decrease the values set in E1-08 [Mid Point A Voltage] and E1-10 [Minimum Output Voltage]. Note: If the values set in E1-08 and E1-10 are too low, the overload tolerance will decrease at low speeds.
		E1-06 [Base Frequency] is set incorrectly.	Set E1-06 to the rated frequency shown on the motor nameplate.
		One drive is operating more than one motor.	Set L1-01 = 0 [Motor Overload (oL1) Protection = Disabled], connect thermal overload relay to each motor to prevent damage to the motors.
		The electronic thermal protector is operating at an incorrect level.	<ul style="list-style-type: none"> Set E2-01 [Motor Rated Current (FLA)] correctly to the value specified by the motor nameplate. Check that L1-08 = 0.0 A [oL1 Current Level = 0.0] or the correct value specified by the motor nameplate.
		There is increased motor loss from overexcitation operation.	<ul style="list-style-type: none"> Lower the value set in n3-13 [OverexcitationBraking (OEB) Gain]. Set L3-04 ≠ 4 [Stall Prevention during Decel ≠ Overexcitation/High Flux]. Set n3-23 = 0 [Overexcitation Braking Operation = Disabled].
The speed search-related parameters are set incorrectly.	<ul style="list-style-type: none"> Examine the settings for all speed search related parameters. Adjust b3-03 [Speed Search Deceleration Time]. Set b3-24 = 1 [Speed Search Method Selection = Speed Estimation] after Auto-Tuning. 		
Phase loss in the input power supply is causing the output current to change.	Make sure that there is no phase loss, and repair problems.		

Code	Name	Causes	Possible Solutions
		Overload occurred during overexcitation deceleration.	<ul style="list-style-type: none"> Decrease the value set in n3-13 [OverexcitationBraking (OEB) Gain]. Decrease the value set in n3-21 [HSB Current Suppression Level].
Note: Do a Fault Reset to clear the fault.			
Code	Name	Causes	Possible Solutions
FB06	External Overload 1	The load is too heavy.	Decrease the load.
		The cycle times for acceleration and deceleration are too short.	Increase the acceleration and deceleration times in C1-01 and C1-02.
		The external motor overload is set incorrectly.	Adjust the dial on the external motor overload to align with the motor nameplate rating.
		External motor overload wiring error.	Make sure that the wiring is correct between the normally-closed control contacts on the external motor overload and the digital input [Z2-0x] programmed to 29 [External Overload Motor 1 (NC)].
Note: Do a Fault Reset to clear the fault.			
Code	Name	Causes	Possible Solutions
FB07	External Overload 2	The load is too heavy.	Decrease the load.
		The cycle times for acceleration and deceleration are too short.	Increase the acceleration and deceleration times in C1-01 and C1-02.
		The external motor overload is set incorrectly.	Adjust the dial on the external motor overload to align with the motor nameplate rating.
		External motor overload wiring error.	Make sure that the wiring is correct between the normally-closed control contacts on the external motor overload and the digital input [Z2-0x] programmed to 30 [External Overload Motor 2 (NC)].
Note: Do a Fault Reset to clear the fault.			
Code	Name	Causes	Possible Solutions
FB08	Brownout Detected	Input power is too low.	Make sure that the input power is sufficient to power the bypass.
		The brownout settings are incorrect.	Make sure that Z1-27 [Brownout Voltage Level] and Z1-28 [Brownout Time] are correct.
Note: Do a Fault Reset to clear the fault.			
Code	Name	Causes	Possible Solutions
FB09	Blackout Detected	Input power is too low.	Make sure that the input power is sufficient to power the bypass.
		The blackout settings are incorrect.	<ul style="list-style-type: none"> Make sure that Z1-29 [Blackout Voltage Level] is correct. Set Z1-60 ≠0 [Blackout Operation Select ≠Fault].
Note: Do a Fault Reset to clear the fault.			
Code	Name	Causes	Possible Solutions
FB10	Loss of Drive Communications	The cable between the bypass controller and the drive is disconnected or damaged.	Make sure that the cable between the bypass controller board (A2) connector CN6 to drive terminal CN6 is connected at both ends and is not damaged.
		The drive does not have power (look at the CHARGE LED to verify).	<ul style="list-style-type: none"> If equipped, check the drive input disconnect switch, the drive input fuses, and/or correct operation of the K1 input contactor. Switch the system into Bypass Mode.
		The bypass controller circuit is defective.	Replace the bypass control board.
		The drive circuitry is defective.	Replace the drive.
Note: Do a Fault Reset to clear the fault.			
Code	Name	Causes	Possible Solutions
FB13	Loss of Load	The motor is disconnected from the drive	Check the continuity between the drive/bypass and the motor.
		The load is disconnected from the motor.	Check the belt/coupling between the motor and the load.
		The Loss of Load settings are incorrect.	Make sure that the settings in Z1-31 to Z1-36 are correct.
Note: Do a Fault Reset to clear the fault.			

6.5 Faults

Code	Name	Causes	Possible Solutions
FB15	Input Phase Loss	Bypass Mode current unbalance condition is more than the unbalance level limit in Z1-50 for the length of time in Z1-51.	<ul style="list-style-type: none"> Make sure that the input wiring including fuses, breakers, and connections upstream from the bypass is correct. Make sure that the motor wiring and connections are correct. To disable this fault, set Z1-51 [Bypass Input Phase Loss Delay] to 0.0 sec.
Note: Do a Fault Reset to clear the fault.			
Code	Name	Causes	Possible Solutions
FB16	Input Phase Rotation	Incorrect phase rotation while Z1-52 = 2 in Bypass Mode.	<ul style="list-style-type: none"> Make sure that the sequence (phase rotation) of the input wiring to the bypass package is correct. To disable this fault, set Z1-52 [Input Phase Rotation Detection] to 0 or 1
Note: Do a Fault Reset to clear the fault.			
Code	Name	Causes	Possible Solutions
FB17	Load Verify Fault	The drive or bypass output current is less than 5% of E2-01, Motor Rated Current for longer than 10 seconds.	<ul style="list-style-type: none"> Close all external output disconnects. Make sure that the frequency reference or PID output > 0. Check motor wiring. Set d2-02 > 0.0% To disable this fault, set Z1-53 = 0 [Load Verify Detection = Disabled].
Note: Do a Fault Reset to clear the fault.			
Code	Name	Causes	Possible Solutions
FB18	Welded Bypass Contactor Detected	The bypass detected a welded contactor condition.	Inspect the K3 bypass contactor.
Note: Do a Fault Reset to clear the fault.			
Code	Name	Causes	Possible Solutions
FB26	Option on Drive Detected	There is a communications option PCB connected to the CN5 port on the drive.	Remove the option PCB from the drive and install it in the CN5 port of the bypass controller.
Note: Do a Fault Reset to clear the fault.			
Code	Name	Causes	Possible Solutions
FB27	Drive Hardware Fault (CPFx oFx)	There is a CPFxx or oFA fault on the drive.	Remove the cause of the fault on the drive.
Note: Do a Fault Reset to clear the fault.			
Code	Name	Causes	Possible Solutions
FB28	Drive Faulted	Generic fault code to identify a drive fault that was duplicated or not detected by the bypass.	Investigate and remove the cause of the drive fault.
Note: Do a Fault Reset to clear the fault.			

Code	Name	Causes	Possible Solutions																
FB30	Conflicting SW Check UB-99	<p>The bypass controller software version does not align with the drive software version.</p> <p>The bypass controller firmware is for a different drive series than HV600. You can see the drive series on the keypad during a power-up sequence (splash screen).</p>	<p>Do ONE of these solutions:</p> <ol style="list-style-type: none"> Update the firmware in the HV600 drive to align with what is displayed in bypass monitor <i>Ub-99</i> (set <i>A1-01</i> = 3 to be able to view this monitor). Update the firmware in the bypass controller to one that aligns with the firmware in the HV600 drive as listed in the table below: <table border="1"> <thead> <tr> <th>HV600 Drive Software (Read from U1-25)</th> <th>Update Bypass Controller Firmware Version to:</th> </tr> </thead> <tbody> <tr> <td>01011</td> <td>00442</td> </tr> <tr> <td>01012</td> <td>00442</td> </tr> <tr> <td>01013</td> <td>00444</td> </tr> <tr> <td>01014</td> <td>00444</td> </tr> <tr> <td>01015</td> <td>00445</td> </tr> <tr> <td>01016</td> <td>00446</td> </tr> <tr> <td>01017</td> <td>00447 or 00448 *1</td> </tr> </tbody> </table> <p>*1 If your bypass controller has firmware version 00448 or later, do not downgrade to an older version of firmware.</p> <ol style="list-style-type: none"> Disable firmware version checking. Set <i>Z1-98</i> or <i>Z1-99</i> so that $Z1-98 \leq U1-25 \leq Z1-99$. (set <i>A1-01</i> = 3 to be able to change these parameters). Refer to the <i>Z1-99 [Maximum Drive SW Ver]</i> Parameter Details description in the Technical Reference for more information. 	HV600 Drive Software (Read from U1-25)	Update Bypass Controller Firmware Version to:	01011	00442	01012	00442	01013	00444	01014	00444	01015	00445	01016	00446	01017	00447 or 00448 *1
HV600 Drive Software (Read from U1-25)	Update Bypass Controller Firmware Version to:																		
01011	00442																		
01012	00442																		
01013	00444																		
01014	00444																		
01015	00445																		
01016	00446																		
01017	00447 or 00448 *1																		

Note:

- Do a Fault Reset to clear the fault.
- If this fault is detected, the bypass will still function in Bypass Mode. Only operation in Drive Mode is prohibited.
- The HV600 drive firmware number is shown in bypass monitor *U1-25*.
- The bypass controller firmware version is shown in bypass monitor *Ub-18*.

Code	Name	Causes	Possible Solutions
FDBKL	WIRE Break	<p>The analog input from the terminal set for <i>PID Feedback [H3-xx = B]</i> is more than 21mA or less than 3mA for longer than 1 s in these conditions:</p> <ul style="list-style-type: none"> <i>b5-82</i> = 2 [<i>Feedback Loss 4 ~ 20mA Detect Sel = Fault</i>] <i>b5-01</i> ≠ 0 [<i>PID Mode Setting ≠ Disabled</i>] <i>H3-01</i> or <i>H3-09</i> = 2 [<i>Terminal A1/A2 Signal Level Selection = 4 to 20 mA</i>] 	Make sure that you install the PID feedback source and it operates correctly.

Note:

- Do a Fault Reset to clear the fault.
- If the drive detects this fault, it will operate the motor as specified by the settings of *b5-82*.
- Parameter *L5-42 [Feedback Loss Fault Retry Select]* sets the Auto Restart function of this fault.

Code	Name	Causes	Possible Solutions
GF	Ground Fault	Overheating caused damage to the motor or the motor insulation is not satisfactory.	Measure the motor insulation resistance, and replace the motor if there is electrical conduction or unserviceable insulation.
		The motor main circuit cable is contacting ground to make a short circuit.	<ul style="list-style-type: none"> Examine the motor main circuit cable for damage, and repair short circuits. Measure the resistance between the motor main circuit cable and the ground terminal. If there is electrical conduction, replace the cable.
		An increase in the stray capacitance of the cable and the ground terminal caused an increase in the leakage current.	<ul style="list-style-type: none"> If the wiring length of the cable is more than 100 m, decrease the carrier frequency. Decrease the stray capacitance.
		There was a problem with the drive hardware.	Replace the control board or the drive. For information about replacing the control board, contact Yaskawa or your nearest sales representative.

Note:

- The drive detects this fault if a current short to ground was more than 50% of rated current on the output side of the drive.
- Do a Fault Reset to clear the fault.
- L5-08 [Fault Reset Enable Select Grp2]* disables the Auto Restart function.

6.5 Faults

Code	Name	Causes	Possible Solutions
HFB	High Feedback Sensed	The feedback level is more than the level set in <i>Y1-11 [High Feedback Level]</i> for the time set in <i>Y1-12 [High Feedback Lvl Fault Dly Time]</i> .	<ul style="list-style-type: none"> Decrease the feedback level less than <i>Y1-11</i>. Set <i>Y1-11</i> and <i>Y1-12</i> correctly.
Note: <ul style="list-style-type: none"> Do a Fault Reset to clear the fault. If the drive detects this fault, it will respond as specified by the setting of <i>Y1-13 [High Feedback Selection]</i>. Parameter <i>L5-41 [Hi Feedback Flt Retry Selection]</i> sets the Auto Restart function of this fault. 			
Code	Name	Causes	Possible Solutions
HIAUX	High PI Aux Feedback Level	PI Auxiliary Feedback is more than the level set in <i>YF-12 [PI Aux Control High Level Detect]</i> for the time set in <i>YF-13 [PI Aux High Level Detection Time]</i> in these conditions: <ul style="list-style-type: none"> The drive operates in AUTO Mode. The output frequency > 0. 	<ul style="list-style-type: none"> Decrease the PI Auxiliary Feedback level less than <i>YF-12</i>. Set <i>YF-12</i> and <i>YF-13</i> correctly.
Note: <ul style="list-style-type: none"> Do a Fault Reset to clear the fault. Parameter <i>YF-14 [PI Aux Hi Level Detection Select]</i> sets the Auto Restart function of this fault. 			
Code	Name	Causes	Possible Solutions
LF	Output Phase Loss	The motor main circuit cable is disconnected.	Connect motor main circuit cable wiring. Correct wiring errors in the main circuit drive input power.
		There is a disconnection in the motor coil winding.	If a coil is disconnected, measure the motor Line-to-Line Resistance and replace the motor.
		The screws on the drive output terminals are loose.	Tighten the terminal screws to the correct tightening torque.
		The rated current of the motor is less than 5% of the drive rated output current.	Examine the drive capacity or the motor output to be applied.
		You are trying to use a single-phase motor.	The drive cannot operate a single-phase motor.
		The output transistor in the drive is damaged.	<ul style="list-style-type: none"> Re-energize the drive. If the fault stays, replace the control board or the drive. For information about replacing the control board, contact Yaskawa or your nearest sales representative.
		One of the output contactors K2 (K4 or K5 if equipped) is defective.	Contact Yaskawa or your nearest sales representative.
Note: <ul style="list-style-type: none"> The drive detects this fault if phase loss occurs on the output side of the drive. Do a Fault Reset to clear the fault. Set <i>L8-07 [Output Phase Loss Protection Sel]</i> to enable and disable <i>LF</i> detection. 			
Code	Name	Causes	Possible Solutions
LF2	Output Current Imbalance	Phase loss occurred in the wiring on the output side of the drive.	Examine for wiring errors or disconnected wires on the output side of the drive, and repair problems.
		The output terminal screws of the drive are loose.	Tighten the terminal screws to the correct tightening torque.
		The drive output circuit is broken.	<ul style="list-style-type: none"> Re-energize the drive. If the fault stays, replace the control board or the drive. For information about replacing the control board, contact Yaskawa or your nearest sales representative.
Code	Name	Causes	Possible Solutions
LFB	Low Feedback Sensed	The feedback level is less than the level set in <i>Y1-08 [Low Feedback Level]</i> for the time set in <i>Y1-09 [Low Feedback Lvl Fault Dly Time]</i> .	<ul style="list-style-type: none"> Increase the feedback level to more than <i>Y1-08</i>. Set <i>Y1-08</i> and <i>Y1-09</i> correctly.
Note: <ul style="list-style-type: none"> Do a Fault Reset to clear the fault. If the drive detects this fault, it will respond as specified by the setting of <i>Y1-10 [Low Feedback Selection]</i>. Parameter <i>L5-40 [Low Feedback Flt Retry Selection]</i> sets the Auto Restart function of this fault. 			
Code	Name	Causes	Possible Solutions
LOAUX	Low PI Aux Feedback Level	When the drive operates in AUTO Mode or HAND Mode, PI Auxiliary Feedback is less than the level set in <i>YF-09 [PI Aux Control Low Lvl Detection]</i> for the time set in <i>YF-10 [PI Aux Control Low Lvl Det Time]</i> and the drive is running.	<ul style="list-style-type: none"> Increase the PI Auxiliary Feedback level to be more than <i>YF-09</i>. Set <i>YF-09</i> and <i>YF-10</i> correctly.
Note: <ul style="list-style-type: none"> Do a Fault Reset to clear the fault. Parameter <i>YF-11 [PI Aux Control Low Level Det Sel]</i> sets the Auto Restart function of this fault. 			

Code	Name	Causes	Possible Solutions
LOP	Loss of Prime	The drive used the <i>Y1-18 [Prime Loss Detection Method]</i> setting and measured a pump load that is less than the level set in <i>Y1-19 [Prime Loss Level]</i> for the time set in <i>Y1-20 [Prime Loss Time]</i> , and the output frequency is <i>Y1-21 [Prime Loss Activation Freq]</i> or more.	<ul style="list-style-type: none"> Examine for a dry well, air in the system, or no water in the system. Use preferred priming method suggested by the pump manufacturer to restart the pump. When there is resistance in the pump, let the system pump water again. Set <i>Y1-18</i> to <i>Y1-21</i> correctly.
Note: <ul style="list-style-type: none"> Do a Fault Reset to clear the fault. If the drive detects this fault, it will respond as specified by the setting of <i>Y1-22 [Prime Loss Selection]</i>. Parameters <i>L5-51 [Loss of Prime Fault Retry Select]</i> and <i>Y1-23 [Prime Loss Max Restart Time]</i> set the Auto Restart function of this fault. 			
Code	Name	Causes	Possible Solutions
NMS	Setpoint Not Met	The feedback deviates from the setpoint at a level more than <i>Y1-15 [Maximum Setpoint Difference]</i> for the time set in <i>Y1-16 [Not Maintaining Setpoint Time]</i> .	<ul style="list-style-type: none"> Examine for a blocked impeller, over cycling, or broken pipe. Set <i>Y1-15</i> and <i>Y1-16</i> correctly.
Note: <ul style="list-style-type: none"> Do a Fault Reset to clear the fault. If the drive detects this fault, it will respond as specified by the setting of <i>Y1-17 [Not Maintaining Setpoint Sel]</i>. Parameter <i>L5-50 [Setpoint Not Met Fault Retry Sel]</i> sets the Auto Restart function of this fault. 			
Code	Name	Causes	Possible Solutions
oC	Overcurrent	The load is too large.	<ul style="list-style-type: none"> Measure the current flowing into the motor. Replace the drive with a larger capacity model if the current value is more than the drive rated current. Decrease the load or replace with a larger drive to prevent sudden changes in the current level.
		Overheating caused damage to the motor or the motor insulation is not satisfactory.	Measure the motor insulation resistance, and replace the motor if there is electrical conduction or unserviceable insulation.
		The motor main circuit cable is contacting ground to make a short circuit.	<ul style="list-style-type: none"> Examine the motor main circuit cable for damage, and repair short circuits. Measure the resistance between the motor main circuit cable and the ground terminal. If there is electrical conduction, replace the cable.
		A short circuit or ground fault on the drive output side caused damage to the output transistor of the drive.	<ul style="list-style-type: none"> Make sure that there is not a short circuit in terminals - and terminals U/T1, V/T2, and W/T3. If there is a short circuit, contact Yaskawa or your nearest sales representative.
		The acceleration time is too short.	<ul style="list-style-type: none"> Calculate the torque necessary during acceleration related to the load inertia and the specified acceleration time. Increase the values set in <i>C1-01</i> or <i>C1-03 [Acceleration Times]</i> to get the necessary torque. Increase the values set in <i>C2-01</i> to <i>C2-04 [S-Curve Characteristics]</i> to get the necessary torque. Replace the drive with a larger capacity model.
		The drive is trying to operate a specialized motor or a motor that is larger than the maximum applicable motor output of the drive.	<ul style="list-style-type: none"> Examine the motor nameplate, the motor, and the drive to make sure that the drive rated current is larger than the motor rated current. Replace the drive with a larger capacity model.
		A magnetic contactor was switched at the output.	Set the operation sequence to not turn ON or OFF the magnetic contactor while the drive is outputting voltage.
		The V/f pattern settings are incorrect.	<ul style="list-style-type: none"> Examine the ratios between the V/f pattern frequency and voltage. Decrease the voltage if it is too high compared to the frequency. Adjust <i>E1-04</i> to <i>E1-10 [V/f Pattern Parameters]</i>.
		The torque compensation gain is too large.	Decrease the value set in <i>C4-01 [Torque Compensation Gain]</i> to make sure that the motor does not stall.
		Electrical interference caused a problem.	Examine the control circuit lines, main circuit lines, and ground wiring, and decrease the effects of electrical interference.
		The gain during overexcitation operation is too large.	<ul style="list-style-type: none"> Find the time when the fault occurs. If the fault occurs at the same time as overexcitation operation, decrease the value set in <i>n3-13 [OverexcitationBraking (OEB) Gain]</i> and consider the motor flux saturation.
The drive received a Run command while the motor was coasting.	<ul style="list-style-type: none"> Examine the sequence and input the Run command after the motor fully stops. Set <i>b3-01 = 1 [Speed Search at Start Selection = Enabled]</i> or set <i>H1-xx = 61, 62 [Speed Search from Fmax or Fref]</i> to input speed search commands from the MFDI terminals. 		
The motor main circuit cable is too long.	Replace the drive with a larger capacity model.		

6.5 Faults

Code	Name	Causes	Possible Solutions
		The relay or contactor on the soft-charge bypass relay is damaged.	<ul style="list-style-type: none"> Re-energize the drive. If the fault stays, replace the control board or the drive.
		An overcurrent condition occurred during overexcitation deceleration.	<ul style="list-style-type: none"> Decrease the value set in <i>n3-13 [OverexcitationBraking (OEB) Gain]</i>. Decrease the value set in <i>n3-21 [HSB Current Suppression Level]</i>.
Note: <ul style="list-style-type: none"> This fault occurs if the drive sensors detect a drive output current more than the specified overcurrent detection level. Do a Fault Reset to clear the fault. 			
Code	Name	Causes	Possible Solutions
OD	Output Disconnect	The output circuit between the drive and the motor is open, and the drive output current is less than 5% of <i>E2-01 [Motor Rated Current (FLA)]</i> .	<ul style="list-style-type: none"> Close the disconnected output circuit between the drive and the motor. You can adjust <i>Y4-42 [Output Disconnect Detection Sel]</i> to disable this fault.
Note: <ul style="list-style-type: none"> Do a Fault Reset to clear the fault. If the drive detects this fault, it will respond as specified by the setting of <i>Y4-42 [Output Disconnect Detection Sel]</i>. 			
Code	Name	Causes	Possible Solutions
oFA00	Option Not Compatible with Port	<p>The option card connected to connector CN5 is not compatible or it is not functioning correctly.</p> <p>The DIP switches on a JOHB-SMP3 Multi-Protocol Ethernet card are set incorrectly for your protocol.</p>	<p>Remove the option PCB connected to CN5 on the bypass controller.</p> <p>Check the DIP switch settings for your protocol. Refer to the instructions packaged with the JOHB-SMP3 card for more information.</p>
Note: <ul style="list-style-type: none"> Do a Fault Reset to clear the fault. Fault trace is not available for this fault. 			
Code	Name	Causes	Possible Solutions
oFA01	Option Fault/Connection Error	The option card connected to connector CN5 is not compatible.	<ol style="list-style-type: none"> De-energize the drive. Refer to the option card manual and correctly connect the option card to the connector on the bypass controller.
Note: <ul style="list-style-type: none"> Do a Fault Reset to clear the fault. 			
Code	Name	Causes	Possible Solutions
oFA05	Option A/D Error	A fault occurred in the option card.	<ol style="list-style-type: none"> De-energize the drive. Make sure that the option card is correctly connected to the connector. If the problem continues, replace the option card.
Note: <ul style="list-style-type: none"> Do a Fault Reset to clear the fault. 			
Code	Name	Causes	Possible Solutions
oFA06	Option Communication Error	A fault occurred in the option card.	<ol style="list-style-type: none"> De-energize the drive. Make sure that the option card is correctly connected to the connector. If the problem continues, replace the option card.
Note: <ul style="list-style-type: none"> Do a Fault Reset to clear the fault. 			
Code	Name	Causes	Possible Solutions
oFA10	Option RAM Error	A fault occurred in the option card.	<ol style="list-style-type: none"> De-energize the drive. Make sure that the option card is correctly connected to the connector. If the problem continues, replace the option card.
Note: <ul style="list-style-type: none"> Do a Fault Reset to clear the fault. 			
Code	Name	Causes	Possible Solutions
oFA11	Option Ope Mode Error	A fault occurred in the option card.	<ol style="list-style-type: none"> De-energize the drive. Make sure that the option card is correctly connected to the connector. If the problem continues, replace the option card.
Note: <ul style="list-style-type: none"> Do a Fault Reset to clear the fault. 			

Code	Name	Causes	Possible Solutions
oFA12	Drive Receive CRC Error	A fault occurred in the option card.	<ol style="list-style-type: none"> 1. De-energize the drive. 2. Make sure that the option card is correctly connected to the connector. 3. If the problem continues, replace the option card.
Note: Do a Fault Reset to clear the fault.			
Code	Name	Causes	Possible Solutions
oFA13	Drive Receive Frame Error	A fault occurred in the option card.	<ol style="list-style-type: none"> 1. De-energize the drive. 2. Make sure that the option card is correctly connected to the connector. 3. If the problem continues, replace the option card.
Note: Do a Fault Reset to clear the fault.			
Code	Name	Causes	Possible Solutions
oFA14	Drive Receive Abort Error	A fault occurred in the option card.	<ol style="list-style-type: none"> 1. De-energize the drive. 2. Make sure that the option card is correctly connected to the connector. 3. If the problem continues, replace the option card.
Note: Do a Fault Reset to clear the fault.			
Code	Name	Causes	Possible Solutions
oFA15	Option Receive CRC Error	A fault occurred in the option card.	<ol style="list-style-type: none"> 1. De-energize the drive. 2. Make sure that the option card is correctly connected to the connector. 3. If the problem continues, replace the option card.
Note: Do a Fault Reset to clear the fault.			
Code	Name	Causes	Possible Solutions
oFA16	Option Receive Frame Error	A fault occurred in the option card.	<ol style="list-style-type: none"> 1. De-energize the drive. 2. Make sure that the option card is correctly connected to the connector. 3. If the problem continues, replace the option card.
Note: Do a Fault Reset to clear the fault.			
Code	Name	Causes	Possible Solutions
oFA17	Option Receive Abort Error	A fault occurred in the option card.	<ol style="list-style-type: none"> 1. De-energize the drive. 2. Make sure that the option card is correctly connected to the connector. 3. If the problem continues, replace the option card.
Note: Do a Fault Reset to clear the fault.			
Code	Name	Causes	Possible Solutions
oFA30	COM ID Error	A fault occurred in the option card.	<ol style="list-style-type: none"> 1. De-energize the drive. 2. Make sure that the option card is correctly connected to the connector. 3. If the problem continues, replace the option card.
Note: Do a Fault Reset to clear the fault.			
Code	Name	Causes	Possible Solutions
oFA31	Type Code Error	A fault occurred in the option card.	<ol style="list-style-type: none"> 1. De-energize the drive. 2. Make sure that the option card is correctly connected to the connector. 3. If the problem continues, replace the option card.
Note: Do a Fault Reset to clear the fault.			

6.5 Faults

Code	Name	Causes	Possible Solutions
oFA32	SUM Check Error	A fault occurred in the option card.	<ol style="list-style-type: none"> 1. De-energize the drive. 2. Make sure that the option card is correctly connected to the connector. 3. If the problem continues, replace the option card.
Note: Do a Fault Reset to clear the fault.			
Code	Name	Causes	Possible Solutions
oFA33	Option Receive Time Over	A fault occurred in the option card.	<ol style="list-style-type: none"> 1. De-energize the drive. 2. Make sure that the option card is correctly connected to the connector. 3. If the problem continues, replace the option card.
Note: Do a Fault Reset to clear the fault.			
Code	Name	Causes	Possible Solutions
oFA34	Memobus Time Over	A fault occurred in the option card.	<ol style="list-style-type: none"> 1. De-energize the drive. 2. Make sure that the option card is correctly connected to the connector. 3. If the problem continues, replace the option card.
Note: Do a Fault Reset to clear the fault.			
Code	Name	Causes	Possible Solutions
oFA35	Drive Receive Time Over 1	A fault occurred in the option card.	<ol style="list-style-type: none"> 1. De-energize the drive. 2. Make sure that the option card is correctly connected to the connector. 3. If the problem continues, replace the option card.
Note: Do a Fault Reset to clear the fault.			
Code	Name	Causes	Possible Solutions
oFA36	CI Check Error	A fault occurred in the option card.	<ol style="list-style-type: none"> 1. De-energize the drive. 2. Make sure that the option card is correctly connected to the connector. 3. If the problem continues, replace the option card.
Note: Do a Fault Reset to clear the fault.			
Code	Name	Causes	Possible Solutions
oFA37	Drive Receive Time Over 2	A fault occurred in the option card.	<ol style="list-style-type: none"> 1. De-energize the drive. 2. Make sure that the option card is correctly connected to the connector. 3. If the problem continues, replace the option card.
Note: Do a Fault Reset to clear the fault.			
Code	Name	Causes	Possible Solutions
oFA38	Control Reference Error	A fault occurred in the option card.	<ol style="list-style-type: none"> 1. De-energize the drive. 2. Make sure that the option card is correctly connected to the connector. 3. If the problem continues, replace the option card.
Note: Do a Fault Reset to clear the fault.			
Code	Name	Causes	Possible Solutions
oFA39	Drive Receive Time Over 3	A fault occurred in the option card.	<ol style="list-style-type: none"> 1. De-energize the drive. 2. Make sure that the option card is correctly connected to the connector. 3. If the problem continues, replace the option card.
Note: Do a Fault Reset to clear the fault.			

Code	Name	Causes	Possible Solutions
oFA40	CtrlResSel 1Err	A fault occurred in the option card.	<ol style="list-style-type: none"> De-energize the drive. Make sure that the option card is correctly connected to the connector. If the problem continues, replace the option card.
Note: Do a Fault Reset to clear the fault.			
Code	Name	Causes	Possible Solutions
oFA41	Drive Receive Time Over 4	A fault occurred in the option card.	<ol style="list-style-type: none"> De-energize the drive. Make sure that the option card is correctly connected to the connector. If the problem continues, replace the option card.
Note: Do a Fault Reset to clear the fault.			
Code	Name	Causes	Possible Solutions
oFA42	CtrlResSel 2Err	A fault occurred in the option card.	<ol style="list-style-type: none"> De-energize the drive. Make sure that the option card is correctly connected to the connector. If the problem continues, replace the option card.
Note: Do a Fault Reset to clear the fault.			
Code	Name	Causes	Possible Solutions
oFA43	Drive Receive Time Over 5	A fault occurred in the option card.	<ol style="list-style-type: none"> De-energize the drive. Make sure that the option card is correctly connected to the connector. If the problem continues, replace the option card.
Note: Do a Fault Reset to clear the fault.			
Code	Name	Causes	Possible Solutions
oH	Heatsink Overheat	The ambient temperature is high and the heatsink temperature of the drive is more than the value set in L8-02 [Overheat Alarm Level].	<ul style="list-style-type: none"> Measure the ambient temperature. Increase the airflow in the control panel. Install a cooling device (cooling fan or air conditioner) to lower the ambient temperature. Remove objects near the drive that are producing too much heat.
		The load is too heavy.	<ul style="list-style-type: none"> Measure the output current. Decrease the load. Decrease the value set in C6-02 [Carrier Frequency Selection].
		The internal cooling fan of the drive stopped.	<ol style="list-style-type: none"> Use the procedures in this manual to replace the cooling fan. Set o4-03 = 0 [Fan Operation Time Setting = 0 h].
Note: <ul style="list-style-type: none"> The drive detects this fault if the heatsink temperature of the drive is more than the value set in L8-02. Do a Fault Reset to clear the fault. If the drive detects this fault, it will operate the motor as specified by the Stopping Method set in L8-03 [Overheat Pre-Alarm Selection]. 			
Code	Name	Causes	Possible Solutions
oH1	Heatsink Overheat	The ambient temperature is high and the heatsink temperature of the drive is more than the oH1 detection level.	<ul style="list-style-type: none"> Measure the ambient temperature. Increase the airflow in the control panel. Install a cooling device (cooling fan or air conditioner) to lower the ambient temperature. Remove objects near the drive that are producing too much heat.
		The load is too heavy.	<ul style="list-style-type: none"> Measure the output current. Decrease the load. Decrease the value set in C6-02 [Carrier Frequency Selection].
Note: <ul style="list-style-type: none"> The drive detects this fault if the heatsink temperature of the drive is more than the oH1 detection level. o2-04 [Drive Model (KVA) Selection] determines the oH1 detection level. Do a Fault Reset to clear the fault. L5-08 [Fault Reset Enable Select Grp2] disables the Auto Restart function. 			
Code	Name	Causes	Possible Solutions
oH3	Motor Overheat (PTC Input)	The thermistor wiring that detects motor temperature is defective.	Correct wiring errors.
		A fault occurred on the machine. Example: The machine is locked.	Examine the machine and remove the cause of the fault

6.5 Faults

Code	Name	Causes	Possible Solutions
		The motor has overheated.	<ul style="list-style-type: none"> Check the load level, acceleration/deceleration time, and motor start/stop frequency (cycle time). Decrease the load. Increase the values set in <i>C1-01 to C1-04 [Acceleration/Deceleration Times]</i>. Set <i>E2-01 [Motor Rated Current (FLA)]</i> correctly to the value specified by the motor nameplate. Make sure that the motor cooling system is operating correctly, and repair or replace it if it is damaged. Adjust <i>E1-04 to E1-10 [V/f Pattern Parameters]</i>. Decrease the values set in <i>E1-08 [Mid Point A Voltage]</i> and <i>E1-10 [Minimum Output Voltage]</i>. <p>Note: If the values set in <i>E1-08</i> and <i>E1-10</i> are too low, the overload tolerance will decrease at low speeds.</p>
<p>Note:</p> <ul style="list-style-type: none"> When <i>H3-02</i> or <i>H3-10 = E [MFAI Function Selection = Motor Temperature (PTC Input)]</i>, the drive detects this fault if the motor overheat signal entered to analog input terminals A1 or A2 is more than the alarm detection level. Do a Fault Reset to clear the fault. If the drive detects this fault, it will operate the motor as specified by the Stopping Method set in <i>L1-03 [Motor Thermistor oH Alarm Select]</i>. 			
Code	Name	Causes	Possible Solutions
oH4	Motor Overheat Fault (PTC Input)	The motor has overheated.	<ul style="list-style-type: none"> Check the load level, acceleration/deceleration time, and motor start/stop frequency (cycle time). Decrease the load. Increase the values set in <i>C1-01 to C1-04 [Acceleration/Deceleration Times]</i>. Set <i>E2-01 [Motor Rated Current (FLA)]</i> correctly to the value specified by the motor nameplate. Make sure that the motor cooling system is operating correctly, and repair or replace it if it is damaged. Adjust <i>E1-04 to E1-10 [V/f Pattern Parameters]</i>. Decrease the values set in <i>E1-08 [Mid Point A Voltage]</i> and <i>E1-10 [Minimum Output Voltage]</i>. <p>Note: If <i>E1-08</i> and <i>E1-10</i> are set too low, the overload tolerance will decrease at low speeds.</p>
<p>Note:</p> <ul style="list-style-type: none"> The drive detects this fault if the motor overheat signal that was entered to an analog input terminals A1 or A2 is more than the alarm detection level. (If <i>H3-02</i> or <i>H3-10 = E [MFAI Function Select = Motor Temperature (PTC Input)]</i> was set.) Do a Fault Reset to clear the fault. 			
Code	Name	Causes	Possible Solutions
oL1	Motor Overload	The load is too heavy.	Decrease the load. Note: Reset <i>oL1</i> when <i>U4-16 [Motor oL1 Level] < 100</i> .
		The acceleration/deceleration times or cycle times are too short.	<ul style="list-style-type: none"> Examine the acceleration/deceleration times and the motor start/stop frequencies (cycle times). Increase the values set in <i>C1-01 to C1-04 [Acceleration/Deceleration Times]</i>.
		Overload occurred while running at low speed.	<ul style="list-style-type: none"> Decrease the load when running at low speed. Increase the motor speed. If the motor is run frequently at low speeds, replace the motor with a larger motor or use a drive-dedicated motor. <p>Note: For general-purpose motors, overload can occur while running at low speed when operating at below the rated current.</p>
		The V/f pattern does not fit the motor qualities.	<ul style="list-style-type: none"> Examine the ratios between the V/f pattern frequency and voltage. Decrease the voltage if it is too high compared to the frequency. Adjust <i>E1-04 to E1-10 [V/f Pattern Parameters]</i>. Decrease the values set in <i>E1-08 [Mid Point A Voltage]</i> and <i>E1-10 [Minimum Output Voltage]</i>. <p>Note: If the values set in <i>E1-08</i> and <i>E1-10</i> are too low, the overload tolerance will decrease at low speeds.</p>
		<i>E1-06 [Base Frequency]</i> is set incorrectly.	Set <i>E1-06</i> to the rated frequency shown on the motor nameplate.
		One drive is operating more than one motor.	Set <i>L1-01 = 0 [Motor Overload (oL1) Protection = Disabled]</i> , connect thermal overload relay to each motor to prevent damage to the motor.
		The electronic thermal protector qualities and the motor overload properties do not align.	Connect a thermal overload relay to the motor.

Code	Name	Causes	Possible Solutions
		The electronic thermal protector is operating at an incorrect level.	Set <i>E2-01 [Motor Rated Current (FLA)]</i> correctly to the value specified by the motor nameplate.
		There is increased motor loss from overexcitation operation.	<ul style="list-style-type: none"> Lower the value set in <i>n3-13 [OverexcitationBraking (OEB) Gain]</i>. Set <i>L3-04 ≠ 4 [Stall Prevention during Decel ≠ Overexcitation/ High Flux]</i>. Set <i>n3-23 = 0 [Overexcitation Braking Operation = Disabled]</i>.
		The speed search-related parameters are set incorrectly.	<ul style="list-style-type: none"> Examine the settings for all speed search related parameters. Adjust <i>b3-03 [Speed Search Deceleration Time]</i>. Set <i>b3-24 = 1 [Speed Search Method Selection = Speed Estimation]</i> after Auto-Tuning.
		Phase loss in the input power supply is causing the output current to change.	Make sure that there is no phase loss, and repair problems.
		Overload occurred during overexcitation deceleration.	<ul style="list-style-type: none"> Decrease the value set in <i>n3-13 [OverexcitationBraking (OEB) Gain]</i>. Decrease the value set in <i>n3-21 [HSB Current Suppression Level]</i>.
<p>Note:</p> <ul style="list-style-type: none"> Parameter <i>E2-01</i> normally sets the motor overload level. In special applications, for example motors with a service factor of greater than 1, you can use <i>L1-08 [oL1 Current Level for Motor 1]</i>. Do a Fault Reset to clear the fault. <i>L5-07 [Fault Reset Enable Select Grp1]</i> disables the Auto Restart function. 			
Code	Name	Causes	Possible Solutions
oL2	Drive Overload	The load is too large.	Decrease the load.
		The acceleration/deceleration times or cycle times are too short.	<ul style="list-style-type: none"> Examine the acceleration/deceleration times and the motor start/ stop frequencies (cycle times). Increase the values set in <i>C1-01 to C1-04 [Acceleration/ Deceleration Times]</i>.
		The V/f pattern does not fit the motor qualities.	<ul style="list-style-type: none"> Examine the ratios between the V/f pattern frequency and voltage. Decrease the voltage if it is too high compared to the frequency. Adjust <i>E1-04 to E1-10 [V/f Pattern Parameters]</i>. Decrease the values set in <i>E1-08 [Mid Point A Voltage]</i> and <i>E1-10 [Minimum Output Voltage]</i>. <p>Note: If the values set in <i>E1-08</i> and <i>E1-10</i> are too low, the overload tolerance will decrease at low speeds.</p>
		The drive capacity is too small.	Replace the drive with a larger capacity model.
		Overload occurred while running at low speed.	<ul style="list-style-type: none"> Decrease the load when running at low speed. Replace the drive with a larger capacity model. Decrease the value set in <i>C6-02 [Carrier Frequency Selection]</i>.
		The torque compensation gain is too large.	Decrease the value set in <i>C4-01 [Torque Compensation Gain]</i> to make sure that the motor does not stall.
		The speed search-related parameters are set incorrectly.	<ul style="list-style-type: none"> Examine the settings for all speed search-related parameters. Adjust <i>b3-03 [Speed Search Deceleration Time]</i>. Set <i>b3-24 = 1 [Speed Search Method Selection = Speed Estimation]</i> after Auto-Tuning.
		Phase loss in the input power supply is causing the output current to change.	<ul style="list-style-type: none"> Correct errors with the wiring for main circuit drive input power. Make sure that there is no phase loss, and repair problems.
		Overload occurred during overexcitation deceleration.	<ul style="list-style-type: none"> Decrease the value set in <i>n3-13 [OverexcitationBraking (OEB) Gain]</i>. Decrease the value set in <i>n3-21 [HSB Current Suppression Level]</i>.
<p>Note:</p> <ul style="list-style-type: none"> The drive detects this fault if the electronic thermal protector of the drive started the drive overload protection. Do a Fault Reset to clear the fault. <i>L5-07 [Fault Reset Enable Select Grp1]</i> disables the Auto Restart function. 			

6.5 Faults

Code	Name	Causes	Possible Solutions
oL3	Overtorque Detection 1	A fault occurred on the machine. Example: The machine is locked.	Examine the machine and remove the cause of the fault.
		The parameters are incorrect for the load.	Adjust L6-02 [Torque Detection Level 1] and L6-03 [Torque Detection Time 1] settings.
Note: <ul style="list-style-type: none"> The drive detects this fault if the drive output current is more than the level set in L6-02 for longer than L6-03. Do a Fault Reset to clear the fault. If the drive detects this fault, it will operate the motor as specified by the Stopping Method set in L6-01 [Torque Detection Selection 1]. L5-07 [Fault Reset Enable Select Grp1] disables the Auto Restart function. 			
Code	Name	Causes	Possible Solutions
oL4	Overtorque Detection 2	A fault occurred on the machine. Example: The machine is locked.	Examine the machine and remove the cause of the fault.
		The parameters are incorrect for the load.	Adjust L6-05 [Torque Detection Level 2] and L6-06 [Torque Detection Time 2] settings.
Note: <ul style="list-style-type: none"> The drive detects this fault if the drive output current is more than the level set in L6-05 for longer than L6-06. Do a Fault Reset to clear the fault. If the drive detects this fault, it will operate the motor as specified by the Stopping Method set in L6-04 [Torque Detection Selection 2]. L5-07 [Fault Reset Enable Select Grp1] disables the Auto Restart function. 			
Code	Name	Causes	Possible Solutions
oL7	High Slip Braking Overload	The load inertia is too large.	Decrease deceleration times in C1-02 and C1-04 [Deceleration Times] for applications that do not use High Slip Braking.
		An external force on the load side rotated the motor.	
		Something is preventing deceleration on the load side.	
		The value set in n3-04 [HSB Overload Time] is too small.	<ul style="list-style-type: none"> Increase the value set in n3-04. Connect a thermal overload relay to the motor, and set n3-04 = 1200 s (maximum value).
Note: <ul style="list-style-type: none"> The drive detects this fault if the output frequency is constant for longer than n3-04. Do a Fault Reset to clear the fault. 			
Code	Name	Causes	Possible Solutions
oPr	Keypad Connection Fault	The keypad is not securely connected to the connector on the bypass controller.	Examine the connection between the keypad and the bypass controller.
		The connection cable between the bypass controller and the keypad is disconnected.	<ul style="list-style-type: none"> Remove the keypad and connect it again. If the cable is damaged, replace it.
Note: <ul style="list-style-type: none"> The bypass controller detects this fault if these conditions are correct: <ul style="list-style-type: none"> -o2-06 = 1 [Keypad Disconnect Detection = Enabled]. -b1-02 = 0 [Run Command Selection 1 = Keypad], or the bypass controller is operating in HAND Mode with the keypad. -Z1-39 = 0 [Drive/Bypass Source Select = Keypad] Do a Fault Reset to clear the fault. 			
Code	Name	Causes	Possible Solutions
ov	Overvoltage	Deceleration time is too short and regenerative energy is flowing from the motor into the drive.	<ul style="list-style-type: none"> Set L3-04 = 1 [Stall Prevention during Decel = General Purpose]. Increase the values set in C1-02 or C1-04 [Deceleration Times]. Do Deceleration Rate Auto-Tuning.
		The acceleration time is too short.	<ul style="list-style-type: none"> Make sure that sudden drive acceleration does not cause the fault. Increase the values set in C1-01 or C1-03 [Acceleration Times]. Increase the value set in C2-02 [S-Curve Time @ End of Accel]. Set L3-11 = 1 [Overvoltage Suppression Select = Enabled].
		The drive output cable or motor is shorted to ground (the current short to ground is charging the main circuit capacitor of the drive through the power supply).	<ol style="list-style-type: none"> Examine the motor main circuit cable, terminals, and motor terminal box, and then remove ground faults. Re-energize the drive.
		If the drive detects ov in these conditions, the speed search-related parameters are incorrect: <ul style="list-style-type: none"> During speed search During momentary power loss recovery When the drive starts again automatically When you do rotational Auto-Tuning 	<ul style="list-style-type: none"> Examine the settings for all speed search related parameters. Set b3-19 ≠ 0 [Speed Search Restart Attempts ≠ 0 times]. Adjust b3-03 [Speed Search Deceleration Time] setting. Do Stationary Auto-Tuning for Line-to-Line Resistance and then set b3-24 = 1 [Speed Search Method Selection = Speed Estimation]. Increase the value set in L2-04 [Powerloss V/f Recovery Ramp Time].

Code	Name	Causes	Possible Solutions
		The power supply voltage is too high.	Decrease the power supply voltage to align with the drive rated voltage.
		Electrical interference caused a drive malfunction.	<ul style="list-style-type: none"> Examine the control circuit lines, main circuit lines, and ground wiring, and decrease the effects of electrical interference. Make sure that a magnetic contactor is not the source of the electrical interference, then use a Surge Protective Device if necessary.
		The load inertia is set incorrectly.	<ul style="list-style-type: none"> Examine the load inertia settings with overvoltage suppression or stall prevention during deceleration. Adjust <i>L3-25 [Load Inertia Ratio]</i> to align with the qualities of the machine.
		There is motor hunting.	Adjust <i>n1-02 [Hunting Prevention Gain Setting]</i> settings.
Note: <ul style="list-style-type: none"> The drive detects this error if the DC bus voltage is more than the <i>ov</i> detection level while the drive is running. The <i>ov</i> detection level is approximately 410 V for 208/240 V bypasses. The detection level is approximately 820 V for 480 V bypasses. Do a Fault Reset to clear the fault. Parameter <i>L5-08 [Fault Reset Enable Select Grp2]</i> disables the Auto Restart function. 			
Code	Name	Causes	Possible Solutions
ov2	DC Bus Overvoltage 2	The wiring is too long and DC bus voltage is too large.	<ul style="list-style-type: none"> Shorten the shielded motor cable. Decrease the carrier frequency. If the power supply has a neutral ground, switch on the internal EMC filter.
Note: <ul style="list-style-type: none"> The drive detects this fault when the DC bus voltage increases to more than the Stall Prevention Level during Deceleration for the time set in <i>S6-23 [OV2 Detect Time]</i>. Do a Fault Reset to clear the fault. This fault is resettable, but will not auto-restart. 			
Code	Name	Causes	Possible Solutions
PE1, PE2	PLC Faults	The communication option detected a fault.	Refer to the manual for the communication option card.
Note: Do a Fault Reset to clear the fault.			
Code	Name	Causes	Possible Solutions
PF	Input Phase Loss	There is a phase loss in the drive input power.	Correct errors with the wiring for main circuit drive input power.
		There is loose wiring in the drive input power terminals.	Tighten the terminal screws to the correct tightening torque.
		The drive input power voltage is changing too much.	<ul style="list-style-type: none"> Examine the input power for problems. Make the drive input power stable. If the input power supply is good, examine the magnetic contactor on the main circuit side for problems.
		There is unsatisfactory balance between voltage phases.	<ul style="list-style-type: none"> Examine the input power for problems. Make the drive input power stable. Set <i>L8-05 = 0 [Input Phase Loss Protection Sel = Disabled]</i>.
		The main circuit capacitors have become unserviceable.	<ul style="list-style-type: none"> Examine the capacitor maintenance time in monitor <i>U4-05 [Capacitor Maintenance]</i>. If <i>U4-05</i> is more than 90%, replace the control board or the drive. For information about replacing the control board, contact Yaskawa or your nearest sales representative. If drive input power is correct and the fault stays, replace the control board or the drive. For information about replacing the control board, contact Yaskawa or your nearest sales representative.
Note: <ul style="list-style-type: none"> The drive detects this error if the DC bus voltage changes irregularly without regeneration. Do a Fault Reset to clear the fault. Use <i>L8-05</i> to enable and disable <i>PF</i> detection. 			
Code	Name	Causes	Possible Solutions
PSE	JOHB-SMP3 Protocol Set Error	<ul style="list-style-type: none"> The DIP switches on the JOHB-SMP3 Multi-Protocol Ethernet Card are at factory default settings. The DIP switches on the JOHB-SMP3 are not set to a valid protocol. 	Remove power from the drive, wait for the charge light to go out, then set the DIP switches on the JOHB-SMP3 to the desired protocol. Note: Refer to the instructions packaged with the JOHB-SMP3 for more information about DIP switch settings.
Note: Do a Fault Reset to clear the fault.			

6.5 Faults

Code	Name	Causes	Possible Solutions
SC	Short Circuit/IGBT Failure	Overheating caused damage to the motor or the motor insulation is not satisfactory.	Measure the motor insulation resistance, and replace the motor if there is electrical conduction or unserviceable insulation.
		The motor main circuit cable is contacting ground to make a short circuit.	<ul style="list-style-type: none"> Examine the motor main circuit cable for damage, and repair short circuits. Measure the resistance between the motor main circuit cable and the ground terminal. If there is electrical conduction, replace the cable.
		A short circuit or ground fault on the drive output side caused damage to the output transistor of the drive.	<ul style="list-style-type: none"> Make sure that there is not a short circuit in terminal B1 and terminals U/T1, V/T2, and W/T3. Make sure that there is not a short circuit in terminals - and terminals U/T1, V/T2, and W/T3. If there is a short circuit, contact Yaskawa or your nearest sales representative.
Note: <ul style="list-style-type: none"> The drive detects this error if there is a short circuit or ground fault on the drive output side, or an IGBT failure. Do a Fault Reset to clear the fault. 			
Code	Name	Causes	Possible Solutions
SCF	Safety Circuit Fault	The safety circuit is broken.	Replace the control board or the drive. For information about replacing the control board, contact Yaskawa or your nearest sales representative.
Note: <ul style="list-style-type: none"> Do a Fault Reset to clear the fault. 			
Code	Name	Causes	Possible Solutions
SEr	Speed Search Retries Exceeded	The speed search-related parameters are set incorrectly.	<ul style="list-style-type: none"> Decrease <i>b3-10</i> [<i>Speed Estimation Detection Gain</i>]. Increase <i>b3-17</i> [<i>Speed Est Retry Current Level</i>]. Increase <i>b3-18</i> [<i>Speed Est Retry Detection Time</i>]. Do Auto-Tuning again.
		The motor is coasting in the opposite direction of the Run command.	Set <i>b3-14</i> = 1 [<i>Bi-directional Speed Search = Enabled</i>].
Note: <ul style="list-style-type: none"> The drive detects this error if the number of speed search restarts is more than <i>b3-19</i> [<i>Speed Search Restart Attempts</i>]. Do a Fault Reset to clear the fault. 			
Code	Name	Causes	Possible Solutions
TiM	Keypad Time Not Set	There is a battery in the keypad, but the date and time are not set.	Use the keypad to set the date and time.
Note: <ul style="list-style-type: none"> Do a Fault Reset to clear the fault. Parameter <i>o4-24</i> [<i>bAT Detection Selection</i>] enables and disables <i>TiM</i> detection. 			
Code	Name	Causes	Possible Solutions
UL3	Undertorque Detection 1	A fault occurred on the machine. Example: There is a broken pulley belt.	Examine the machine and remove the cause of the fault.
		The parameters are incorrect for the load.	Adjust <i>L6-02</i> [<i>Torque Detection Level 1</i>] and <i>L6-03</i> [<i>Torque Detection Time 1</i>] settings.
Note: <ul style="list-style-type: none"> The drive detects this error if the drive output current is less than the level set in <i>L6-02</i> for longer than <i>L6-03</i>. Do a Fault Reset to clear the fault. If the drive detects this error, it will operate the motor as specified by the Stopping Method set in <i>L6-01</i> [<i>Torque Detection Selection 1</i>]. 			
Code	Name	Causes	Possible Solutions
UL4	Undertorque Detection 2	A fault occurred on the machine. Example: There is a broken pulley belt.	Examine the machine and remove the cause of the fault.
		The parameters are incorrect for the load.	Adjust <i>L6-05</i> [<i>Torque Detection Level 2</i>] and <i>L6-06</i> [<i>Torque Detection Time 2</i>] settings.
Note: <ul style="list-style-type: none"> The drive detects this error if the drive output current is less than the level set in <i>L6-05</i> for longer than <i>L6-06</i>. Do a Fault Reset to clear the fault. If the drive detects this error, it will operate the motor as specified by the Stopping Method set in <i>L6-04</i> [<i>Torque Detection Selection 2</i>]. 			
Code	Name	Causes	Possible Solutions
UL6	Underload or Belt Break Detected	The output current decreased less than the motor underload curve set in <i>L6-14</i> [<i>Motor Underload Level @ Min Freq</i>] for longer than the time set in <i>L6-03</i> [<i>Torque Detection Time 1</i>].	Adjust the <i>L6-14</i> setting to set the output current to stay the level more than the motor underload curve during usual operations.
Note: <ul style="list-style-type: none"> Do a Fault Reset to clear the fault. 			

Code	Name	Causes	Possible Solutions
Uv1	DC Bus Undervoltage	There is a phase loss in the drive input power.	Correct errors with the wiring for main circuit drive input power.
		There is loose wiring in the drive input power terminals.	Tighten the terminal screws to the correct tightening torque.
		The drive input power voltage is changing too much.	<ul style="list-style-type: none"> Examine the input power for problems. Make the drive input power stable. If the input power supply is good, examine the magnetic contactor on the main circuit side for problems.
		There was a loss of power.	Use a better power supply.
		The main circuit capacitors have become unserviceable.	Examine the capacitor maintenance time in monitor <i>U4-05 [CapacitorMaintenance]</i> . If <i>U4-05</i> is more than 90%, replace the control board or the drive. For information about replacing the control board, contact Yaskawa or your nearest sales representative.
		The relay or contactor on the soft-charge bypass relay is damaged.	<i>U4-06 [PreChargeRelayMainte]</i> shows the performance life of the soft-charge bypass relay. If <i>U4-06</i> is more than 90%, replace the board or the drive. For information about replacing the board, contact Yaskawa or your nearest sales representative.
Note: <ul style="list-style-type: none"> The drive detects this error if the DC bus voltage decreases below the level set in <i>L2-05 [Undervoltage Detection Lvl (Uv1)]</i> while the drive is running. The <i>Uv1</i> detection level is approximately 190 V for 208/240 V bypasses. The detection level is approximately 380 V for 480 V bypasses. The detection level is approximately 350 V when <i>E1-01 [Input AC Supply Voltage] < 400</i>. Do a Fault Reset to clear the fault. Fault trace is not available for this fault. <i>L5-08 [Fault Reset Enable Select Grp2]</i> disables the Auto Restart function. 			
Code	Name	Causes	Possible Solutions
Uv2	Control Power Undervoltage	The value set in <i>L2-02 [Power Loss Ride Through Time]</i> increased and the momentary power loss recovery unit is not connected to the drive.	Connect the momentary power loss recovery unit to the drive.
		There was a problem with the drive hardware.	<ul style="list-style-type: none"> Re-energize the drive. If the fault stays, replace the control board or the drive. For information about replacing the control board, contact Yaskawa or your nearest sales representative.
Note: <ul style="list-style-type: none"> The drive detects this error if the control power supply voltage decreases. Do a Fault Reset to clear the fault. Fault trace is not available for this fault. 			
Code	Name	Causes	Possible Solutions
Uv3	Soft Charge Answerback Fault	The relay or contactor on the soft-charge bypass relay is damaged.	<ul style="list-style-type: none"> Re-energize the drive. If the fault stays, replace the control board or the drive. Check monitor <i>U4-06 [PreChargeRelayMainte]</i>, which shows the performance life of the soft-charge bypass relay. If <i>U4-06</i> is more than 90%, replace the board or the drive. For information about replacing the board, contact Yaskawa or your nearest sales representative.
Note: <ul style="list-style-type: none"> Do a Fault Reset to clear the fault. Fault trace is not available for this fault. 			
Code	Name	Causes	Possible Solutions
VLTS	Thermostat Fault	The digital input from the terminal set for <i>Thermostat Fault [HI-xx = 88]</i> is active.	Examine the wiring or wait for the motor to cool.
Note: <ul style="list-style-type: none"> Do a Fault Reset to clear the fault. Parameter <i>L5-53 [Thermostat Fault Retry Selection]</i> sets the Auto Restart function of this fault. 			

6.6 Minor Faults/Alarms

This section gives information about the causes and possible solutions when a minor fault or alarm occurs. Use the information in this table to remove the cause of the minor fault or alarm.

Code	Name	Causes	Possible Solutions
AFBL	Analog Fbk Lost, Switched to Net	The analog input source is defective or broken.	Make sure that you install the PID Feedback source and it operates correctly.
		The parameter setting is $H3-xx \neq B$ [MFAL Function Selection \neq PID Feedback].	Set $H3-xx = B$ to use the analog input source for PID Feedback.
Note: If the drive detects this error, the terminal set to $H2-01$ to $H2-03 = 10$ [MFDO Function Selection = Alarm] will activate.			
Code	Name	Causes	Possible Solutions
AuDis	Low PI Aux Fdbk Drive Disabled	<ul style="list-style-type: none"> PI Auxiliary Feedback is less than the $YF-06$ [PI Aux Control Wake-up Level] setting, and the drive is stopped or running as a Lag drive. 	<ul style="list-style-type: none"> Make sure that the $YF-06$ setting is correct. Wait for the PI Auxiliary Feedback to recover.
Note: If the drive detects this error, the terminal set to $H2-01$ to $H2-03 = 10$ [MFDO Function Selection = Alarm] will activate.			
Code	Name	Causes	Possible Solutions
AL02	Interlock Open	The digital input set to interlock is open	Make sure that the damper is functioning correctly. The damper could be opening and the switch could be open.
Code	Name	Causes	Possible Solutions
AL03	Emergency Override Bypass	The digital input terminal set to $H2-0x = 25$ [Digital input function selection = Emergency Override Bypass] activated.	When the emergency condition is gone, deactivate the digital input set to <i>Emergency Override Bypass</i> .
Code	Name	Causes	Possible Solutions
AL09	Restart Delay Active	The restart delay is active and the drive received a Run command.	<ul style="list-style-type: none"> This is not an alarm. It is information to show that the drive is not running. When you remove the Run command to the drive, the $AL09$ alarm will go away. Parameters $Z1-60$ [Blackout Operation Select] and $Z1-61$ [Power Loss Restart Delay Time] set restart delay.
Code	Name	Causes	Possible Solutions
AL13	Loss of Load Detected	The motor is disconnected from the load.	Replace the belt or coupling between the motor and the load. If the bypass detected this alarm incorrectly, make sure that parameters $Z1-31$ to $Z1-36$ are correct for your application.
Code	Name	Causes	Possible Solutions
AL16	Input Phase Rotation	The phase rotation is incorrect while $Z1-52 = 1$ in Bypass Mode.	Make sure that the sequence (phase rotation) of the input wiring to the bypass package is correct.
Code	Name	Causes	Possible Solutions
AL17	Remote Xfer disabled in Reverse	The drive is running in reverse and it received a Remote Transfer command.	This is not an alarm. It is information to show that the bypass cannot remote transfer when the drive is running in reverse.
Code	Name	Causes	Possible Solutions
AL18	Auto Xfer disabled in Reverse	When auto transfer is enabled, the drive detects a fault and it cannot transfer while it is running in reverse.	This is not an alarm. It is information to show that the drive cannot auto transfer when reverse run is active.
Code	Name	Causes	Possible Solutions
AuFbl	PI Aux Fdbk Lost Switched to Net	The analog input source is defective or broken.	Make sure that you install the Auxiliary PI Feedback source and it operates correctly.
Note: <ul style="list-style-type: none"> The drive detects this error if it detected a wire-break with the <i>PI Auxiliary Control Feedback</i> [$H3-xx = 27$] analog signal and it uses PI Auxiliary Feedback. If the drive detects this error, the terminal set to $H2-01$ to $H2-03 = 10$ [MFDO Function Selection = Alarm] will activate. 			
Code	Name	Causes	Possible Solutions
AUXFB	PI Aux Feedback Level Loss	The analog input from the terminal set to $H3-xx = 27$ [MFAL Function Selection = PI Auxiliary Control Feedback Level] is more than 21 mA or less than 3 mA for longer than 1 s.	Repair transducer or wiring.
Note: If the drive detects this error, the terminal set to $H2-01$ to $H2-03 = 10$ [MFDO Function Selection = Alarm] will activate.			

Code	Name	Causes	Possible Solutions
bAT	Keypad Battery Low Voltage	The keypad battery voltage is low.	Replace the keypad battery.
Note: <ul style="list-style-type: none"> If the drive detects this error, the terminal set to $H2-01$ to $H2-03 = 10$ [MFDO Function Selection = Alarm] will activate. Set $o4-24$ [bAT Detection Selection] to enable/disable bAT detection. 			
Code	Name	Causes	Possible Solutions
bb	Baseblock	An external baseblock command was entered through one of the drive MFDI terminals Sx, and the drive output stopped as shown by an external baseblock command.	Examine the external sequence and timing of the baseblock command input.
Note: The drive will not output a minor fault signal for this alarm.			
Code	Name	Causes	Possible Solutions
bCE	Bluetooth Communication Error	The smartphone or tablet with DriveWizard Mobile is too far from the keypad.	Move to 10 m (32.8 ft) or less from the keypad. Note: bCE can occur when the smartphone or tablet is 10 m (32.8 ft) or nearer to the keypad for different smartphone and tablet specifications.
		Radio waves from a different device are causing interference with communications between the smartphone or tablet and keypad.	Make sure that no device around the keypad uses the same radio bandwidth (2400 MHz to 2480 MHz), and prevent radio interference.
Note: <ul style="list-style-type: none"> The drive detects this error when you use a smartphone or tablet and a Bluetooth LCD keypad to operate the drive. If the drive detects this error, the terminal set to $H2-01$ to $H2-03 = 10$ [MFDO Function Selection = Alarm] will activate. Use $o2-27$ [bCE Detection selection] to enable and disable bCE detection. 			
Code	Name	Causes	Possible Solutions
BuDif	Main Fdbk Lost, Using Diff Fdbk	Parameter $Y4-41 = 1$ [Diff Lvl Src Fdbk Backup Select = Enabled] and the drive detected a wire-break on the analog input terminal set for PID Feedback [H3-xx = B].	Examine the connection of the Main PID Feedback Transducer.
		Main PID Feedback Transducer is broken.	Replace Main PID Feedback Transducer.
Note: <ul style="list-style-type: none"> The drive detects this error if it does not receive the PID Feedback signal and it uses Differential Feedback [H3-xx = 2D] as backup. If the drive detects this error, the terminal set to $H2-01$ to $H2-03 = 10$ [MFDO Function Selection = Alarm] will activate. 			
Code	Name	Causes	Possible Solutions
Bu-Fb	Main Fdbk Lost Using Backup Fdbk	The drive detected wire-break on the analog input terminal set to $H3-xx = B$ [MFAI Function Selection = PID Feedback].	Examine the connection of the Main PID Feedback Transducer.
		Main PID Feedback Transducer is broken.	Replace Main PID Feedback Transducer.
Note: If the drive detects this error, the terminal set to $H2-01$ to $H2-03 = 10$ [MFDO Function Selection = Alarm] will activate.			
Code	Name	Causes	Possible Solutions
BuFbl	Backup Fdbk Lost Chk/Repl Xducer	The drive detected wire-break on the analog input terminal set for PID Feedback Backup [H3-xx = 24].	Examine the connection of the Differential PID Feedback transducer.
		Backup PID Feedback Transducer is broken.	Replace Backup PID Feedback Transducer.
		Parameter $Y4-41 = 1$ [Diff Lvl Src Fdbk Backup Select = Enabled] and the drive detected a wire-break on the analog input terminal set for Differential Level Source [H3-xx = 2D].	Examine the connection of the Differential PID Feedback transducer.
		Parameter $Y4-41 = 1$ and the Differential PID Feedback Transducer is broken.	<ul style="list-style-type: none"> Replace the Differential PID Feedback Transducer. Set $Y4-41 = 0$ [Disabled].
Note: <ul style="list-style-type: none"> The drive detects this error if it does not receive the PID Feedback Backup signal. If the drive detects this error, the terminal set to $H2-01$ to $H2-03 = 10$ [MFDO Function Selection = Alarm] will activate. 			
Code	Name	Causes	Possible Solutions
bUS	Option Communication Error	The communications cable wiring is incorrect.	Correct wiring errors.
		There is a short-circuit in the communications cable or the communications cable is not connected.	<ul style="list-style-type: none"> Repair short circuits and connect cables. Replace the defective communications cable.

6.6 Minor Faults/Alarms

Code	Name	Causes	Possible Solutions
		Electrical interference caused a communication data error.	<ul style="list-style-type: none"> Examine the control circuit lines, main circuit lines, and ground wiring, and decrease the effects of electrical interference. Make sure that a magnetic contactor is not the source of the electrical interference, then use a Surge Protective Device if necessary. Use only the recommended cables or other shielded line. Ground the shield on the controller side or the drive input power side. Separate the communication wiring from drive power lines, and install a noise filter to the input side of the power supply for communication. Decrease the effects of electrical interference from the controller.
		The option card is incorrectly installed to the bypass controller.	Correctly install the option card to the bypass controller.
		The option card is damaged.	If the alarm continues and the wiring is correct, replace the option card.

Note:

- The drive detects this error if the Run command or frequency reference is assigned to the option card.
- If the drive detects this error, the terminal set to *H2-01 to H2-03 = 10 [MFDO Function Selection = Alarm]* will activate.
- If the drive detects this error, it will operate the motor as specified by the stopping method set in *F6-01 [Communication Error Selection]*.

Code	Name	Causes	Possible Solutions
bUSy	Busy	You set the bypass controller to use serial communications to change parameters, but you used the keypad to change parameters.	Use serial communications to enter the enter command, then use the keypad to change the parameter.
		You tried to change a parameter while the bypass controller was changing a setting.	Wait until the process is complete.

Code	Name	Causes	Possible Solutions
CALL	Serial Comm Transmission Error	The communications cable wiring is incorrect.	Correct wiring errors.
		There is a short circuit in the communications cable or the communications cable is not connected.	<ul style="list-style-type: none"> Repair the short-circuited or disconnected portion of the cable. Replace the defective communications cable.
		A programming error occurred on the controller side.	Examine communications at start-up and correct programming errors.
		There is damage to the communications circuitry.	<ul style="list-style-type: none"> Do a self-diagnostics check. If the problem continues, replace the control board or the drive. Contact Yaskawa or your nearest sales representative to replace the control board.
		The termination resistor setting for RS-485 based communications is incorrect.	On the last drive of an RS-485 based network, set DIP switch S2 to the ON position to enable the termination resistor.

Note:

- The drive detects this error if it does not correctly receive communications from the controller when the drive is first energized.
- Parameter *H5-33 [Power-up CALL Alarm]* enables or disables the detection of this alarm at power-up.
- In bypass controller software versions 00444 and later, HAND operation is available during a *CALL* alarm.

Code	Name	Causes	Possible Solutions
CE	Serial Communication Error	The communications cable wiring is incorrect.	Correct wiring errors.
		There is a short circuit in the communications cable or the communications cable is not connected.	<ul style="list-style-type: none"> Repair short circuits and connect cables. Replace the defective communications cable.
		Electrical interference caused a communication data error.	<ul style="list-style-type: none"> Examine the control circuit lines, main circuit lines, and ground wiring, and decrease the effects of electrical interference. Make sure that a magnetic contactor is not the source of the electrical interference, then use a Surge Protective Device if necessary. Use only the recommended cables or other shielded line. Ground the shield on the controller side or the drive input power side. Separate the communication wiring from drive power lines, and install a noise filter to the input side of the power supply for communication. Decrease the effects of electrical interference from the controller.
		The communication protocol is not compatible.	<ul style="list-style-type: none"> Examine the values set in <i>H5-xx</i>. Examine the settings on the controller side and correct the difference in communication conditions.
		The value set in <i>H5-09 [CE Detection Time]</i> is too small for the communications cycle.	<ul style="list-style-type: none"> Change the controller software settings. Increase the value set in <i>H5-09</i>.

Code	Name	Causes	Possible Solutions
		The controller software or hardware is causing a communication problem.	Examine the controller and remove the cause of the problem.
<p>Note:</p> <ul style="list-style-type: none"> This alarm is a different alarm from <i>CE [Run at H5-34 (CE Go-To-Freq)]</i>. The keypad will show this alarm when: <ul style="list-style-type: none"> –<i>H5-04 ≠ 4 [Communication Error Stop Method ≠ Run at H5-34 (CE Go-To-Freq)]</i> –<i>H5-04 = 4</i> but the drive cannot operate at the selected frequency The drive detects this error if it does not correctly receive control data for the <i>CE</i> detection time set to <i>H5-09</i>. If the drive detects this error, it will operate the motor as specified by the stopping method set in <i>H5-04</i>. 			
Code	Name	Causes	Possible Solutions
CE	Run at H5-34 (CE Go-To-Freq)	The communications cable wiring is incorrect.	Correct wiring errors.
		There is a short circuit in the communications cable or the communications cable is not connected.	<ul style="list-style-type: none"> Repair short circuits and connect cables. Replace the defective communications cable.
		Electrical interference caused a communication data error.	<ul style="list-style-type: none"> Examine the control circuit lines, main circuit lines, and ground wiring, and decrease the effects of electrical interference. Make sure that a magnetic contactor is not the source of the electrical interference, then use a Surge Protective Device if necessary. Use only recommended shielded line. Ground the shield on the controller side or on the drive input power side. Separate the communication wiring from drive power lines, and install a noise filter to the input side of the power supply for communication. Decrease the effects of electrical interference from the controller.
		The communication protocol is not compatible.	<ul style="list-style-type: none"> Examine the values set in <i>H5-xx</i>. Examine the settings on the controller side and correct the difference in communication conditions.
		The value set in <i>H5-09 [CE Detection Time]</i> is too small for the communications cycle.	<ul style="list-style-type: none"> Make sure that the settings are compatible. Change the software settings in the PLC. Increase the value set in <i>H5-09</i>.
		The controller software or hardware is causing a communication problem.	Examine the controller and remove the cause of the problem.
<p>Note:</p> <ul style="list-style-type: none"> This alarm is a different alarm from the standard <i>CE [Serial Communication Error]</i>. The keypad will show this alarm only when <i>H5-04 = 4 [Communication Error Stop Method = Run at H5-34 (CE Go-To-Freq)]</i>. If the drive cannot operate at the selected frequency, the keypad will show the standard <i>CE</i> alarm. The drive detects this error if it does not correctly receive control data for the <i>CE</i> detection time set to <i>H5-09</i>. 			
Code	Name	Causes	Possible Solutions
CrST	Cannot Reset	The drive received a fault reset command when a Run command was active.	Turn off the Run command or switch into OFF mode, then reset the fault.
Code	Name	Causes	Possible Solutions
CyPo	Cycle Power to Accept Changes	Although <i>F6-15 = 1 [Comm. Option Parameters Reload = Reload Now]</i> , the drive does not update the communication option parameters.	De-energize then re-energize the bypass to activate the new option communication parameters.
Code	Name	Causes	Possible Solutions
DIFF	Differential Feedback Exceeded	The difference between the PID Feedback and <i>Differential Level Source [H3-xx = 2D]</i> is more than the level set in <i>Y4-18 [Pre-Charge Loss of Prime Level 2]</i> for the time set in <i>Y4-19 [Differential Lvl Detection Time]</i> .	<ul style="list-style-type: none"> Replace the feedback transducer or transducers. Set <i>Y4-18</i> and <i>Y4-19</i> correctly.
<p>Note:</p> <ul style="list-style-type: none"> If the drive detects this error, it will respond as specified by the setting of <i>Y4-20 [Differential Level Detection Sel]</i>. If the drive detects this error, the terminal set to <i>H2-01 to H2-03 = 10 [MFDO Function Selection = Alarm]</i> will activate. 			
Code	Name	Causes	Possible Solutions
dnE	Drive Disabled	A terminal set for <i>H1-xx = 6A [MFDI Function Selection = Drive Enable]</i> deactivated.	Examine the operation sequence.
<p>Note:</p> <p>If the drive detects this error, the terminal set to <i>H2-01 to H2-03 = 10 [MFDO Function Selection = Alarm]</i> will activate.</p>			
Code	Name	Causes	Possible Solutions
EF	FWD/REV Run Command Input Error	The drive received a forward command and a reverse command at the same time for longer than 0.5 s.	Examine the forward and reverse command sequence and correct the problem.
<p>Note:</p> <ul style="list-style-type: none"> If the drive detects <i>EF</i>, the motor will ramp to stop. If the drive detects this error, the terminal set to <i>H2-01 to H2-03 = 10 [MFDO Function Selection = Alarm]</i> will activate. 			



6.6 Minor Faults/Alarms

Code	Name	Causes	Possible Solutions
EF0	Option Card External Fault	The communication option card received an external fault from the controller.	1. Find the device that caused the external fault and remove the cause. 2. Clear the external fault input from the controller.
		Programming error occurred on the controller side.	Examine the operation of the controller program.
Note: • The drive detects this error if the alarm function on the external device side is operating. • Use F6-03 [Comm External Fault (EF0) Select] to set the stopping method for this fault.			
Code	Name	Causes	Possible Solutions
EF1	External Fault (Terminal S1)	MFDI terminal S1 caused an external fault through an external device.	1. Find the device that caused the external fault and remove the cause. 2. Clear the external fault input in the MFDI.
		The wiring is incorrect.	Correctly connect the signal line to MFDI terminal S1.
		External Fault [HI-01 = 2C to 2F] is set to MFDI terminal S1, but the terminal is not in use.	Correctly set the MFDI.
Note: If the drive detects this error, the terminal set to H2-01 to H2-03 = 10 [MFDO Function Selection = Alarm] will activate.			
Code	Name	Causes	Possible Solutions
EF2	External Fault (Terminal S2)	MFDI terminal S2 caused an external fault through an external device.	1. Find the device that caused the external fault and remove the cause. 2. Clear the external fault input in the MFDI.
		The wiring is incorrect.	Correctly connect the signal line to MFDI terminal S2.
		External Fault [HI-02 = 2C to 2F] is set to MFDI terminal S2, but the terminal is not in use.	Correctly set the MFDI.
Note: If the drive detects this error, the terminal set to H2-01 to H2-03 = 10 [MFDO Function Selection = Alarm] will activate.			
Code	Name	Causes	Possible Solutions
EF3	External Fault (Terminal S3)	MFDI terminal S3 caused an external fault through an external device.	1. Find the device that caused the external fault and remove the cause. 2. Clear the external fault input in the MFDI.
		The wiring is incorrect.	Correctly connect the signal line to MFDI terminal S3.
		External Fault [HI-03 = 2C to 2F] is set to MFDI terminal S3, but the terminal is not in use.	Correctly set the MFDI.
Note: If the drive detects this error, the terminal set to H2-01 to H2-03 = 10 [MFDO Function Selection = Alarm] will activate.			
Code	Name	Causes	Possible Solutions
EF4	External Fault (Terminal S4)	MFDI terminal S4 caused an external fault through an external device.	1. Find the device that caused the external fault and remove the cause. 2. Clear the external fault input in the MFDI.
		The wiring is incorrect.	Correctly connect the signal line to MFDI terminal S4.
		External Fault [HI-04 = 2C to 2F] is set to MFDI terminal S4, but the terminal is not in use.	Correctly set the MFDI.
Note: If the drive detects this error, the terminal set to H2-01 to H2-03 = 10 [MFDO Function Selection = Alarm] will activate.			
Code	Name	Causes	Possible Solutions
EF5	External Fault (Terminal S5)	MFDI terminal S5 caused an external fault through an external device.	1. Find the device that caused the external fault and remove the cause. 2. Clear the external fault input in the MFDI.
		The wiring is incorrect.	Correctly connect the signal line to MFDI terminal S5.
		External Fault [HI-05 = 2C to 2F] is set to MFDI terminal S5, but the terminal is not in use.	Correctly set the MFDI.
Note: If the drive detects this error, the terminal set to H2-01 to H2-03 = 10 [MFDO Function Selection = Alarm] will activate.			
Code	Name	Causes	Possible Solutions
EF6	External Fault (Terminal S6)	MFDI terminal S6 caused an external fault through an external device.	1. Find the device that caused the external fault and remove the cause. 2. Clear the external fault input in the MFDI.
		The wiring is incorrect.	Correctly connect the signal line to MFDI terminal S6.

Code	Name	Causes	Possible Solutions
		<i>External Fault [H1-06 = 2C to 2F]</i> is set to MFDI terminal S6, but the terminal is not in use.	Correctly set the MFDI.
Note: If the drive detects this error, the terminal set to <i>H2-01 to H2-03 = 10 [MFDO Function Selection = Alarm]</i> will activate.			
Code	Name	Causes	Possible Solutions
EF7	External Fault (Terminal S7)	MFDI terminal S7 caused an external fault through an external device.	1. Find the device that caused the external fault and remove the cause. 2. Clear the external fault input in the MFDI.
		The wiring is incorrect.	Correctly connect the signal line to MFDI terminal S7.
		<i>External Fault [H1-07 = 2C to 2F]</i> is set to MFDI terminal S7, but the terminal is not in use.	Correctly set the MFDI.
Note: If the drive detects this error, the terminal set to <i>H2-01 to H2-03 = 10 [MFDO Function Selection = Alarm]</i> will activate.			
Code	Name	Causes	Possible Solutions
EOF	Emergency Override FWD	The digital input terminal set to <i>H1-xx = AF [MFDI Function Selection = Emergency Override FWD]</i> activated.	When the emergency condition is gone, deactivate the digital input set to <i>Emergency Override FWD</i> .
Note: If the drive detects this error, the terminal set to <i>H2-01 to H2-03 = 10 [MFDO Function Selection = Alarm]</i> will activate.			
Code	Name	Causes	Possible Solutions
EOR	Emergency Override REV	The digital input terminal set to <i>H1-xx = B0 [MFDI Function Selection = Emergency Override REV]</i> activated.	When the emergency condition is gone, deactivate the digital input set to <i>Emergency Override REV</i> .
Note: If the drive detects this error, the terminal set to <i>H2-01 to H2-03 = 10 [MFDO Function Selection = Alarm]</i> will activate.			
Code	Name	Causes	Possible Solutions
EP24v	External Power 24V Supply	The voltage of the main circuit power supply decreased, and the 24 V power supply is supplying power to the drive.	<ul style="list-style-type: none"> Examine the main circuit power supply. Turn ON the main circuit power supply to run the drive.
Note: <ul style="list-style-type: none"> Set <i>o2-26 [Ext. Power 24V Supply Display]</i> to enable or disable <i>EP24v</i> detection. The drive will not output an alarm signal for this alarm. 			
Code	Name	Causes	Possible Solutions
FDBKL	Feedback Loss Wire Break	<p>The analog input from the terminal set to <i>H3-xx = B [MFAI Function Selection = PID Feedback]</i> is more than 21 mA or less than 3 mA for longer than 1 s in these conditions:</p> <ul style="list-style-type: none"> <i>b5-82 = 1 [Feedback Loss 4 ~ 20mA Detect Sel = Alarm Only]</i> <i>b5-01 ≠ 0 [PID Mode Setting ≠ Disabled]</i> <i>H3-01 or H3-09 = 2 [Terminal A1/A2 Signal Level Selection = 4 to 20 mA]</i> 	Make sure that you install the PID feedback source and it operates correctly.
Note: <ul style="list-style-type: none"> If the drive detects this error, the terminal set to <i>H2-01 to H2-03 = 10 [MFDO Function Selection = Alarm]</i> will activate. If the drive detects this error, it will operate the motor as specified by the settings of <i>b5-82</i>. Parameter <i>L5-42 [Feedback Loss Fault Retry Select]</i> sets the Auto Restart function of this error. 			
Code	Name	Causes	Possible Solutions
FLGT	Feedback Loss, Go To Freq b5-83	<p>The analog input from the terminal set to <i>H3-xx = B [MFAI Function Selection = PID Feedback]</i> is more than 21 mA or less than 3 mA for longer than 1 s in these conditions:</p> <ul style="list-style-type: none"> <i>b5-82 = 3 [Feedback Loss 4 ~ 20mA Detect Sel = Run At b5-83]</i> <i>b5-01 ≠ 0 [PID Mode Setting ≠ Disabled]</i> <i>H3-01 or H3-09 = 2 [Terminal A1/A2 Signal Level Selection = 4 to 20 mA]</i> 	Make sure that you install the PID feedback source and it operates correctly.
Note: <ul style="list-style-type: none"> If the drive detects this error, the terminal set to <i>H2-01 to H2-03 = 10 [MFDO Function Selection = Alarm]</i> will activate. If the drive detects this error, it will operate the motor at the speed set in <i>b5-83 [Feedback Loss Goto Frequency]</i> as specified by the setting of <i>b5-82</i>. 			
Code	Name	Causes	Possible Solutions
FIRE_ST	Fire Stat Open	The bypass detected a Fire Stat condition.	<ul style="list-style-type: none"> Check the digital input programmed for Fire Stat Switch (<i>Z2-0x = 38</i>). Check the connected device for continuity. Check Bypass Digital Input Invert Settings in <i>Z2-09 to Z2-16</i>.

6.6 Minor Faults/Alarms

Code	Name	Causes	Possible Solutions
FREEZ_ST	Freeze Stat Open	The bypass detected a Freeze Stat condition.	<ul style="list-style-type: none"> Check the digital input programmed for Freeze Stat Switch (Z2-0x = 39). Check the connected device for continuity. Check Bypass Digital Input Invert Settings in Z2-09 to Z2-16.
Code	Name	Causes	Possible Solutions
FR<MS	Freq Ref < Minimum Speed (Y1-06)	<p>The drive frequency reference setting is less than the value set in Y1-06 [Minimum Speed] in these conditions:</p> <ul style="list-style-type: none"> The drive is not in PI Mode The drive is running Minimum Speed is enabled (Y1-06 > 0.00) Y1-06 > Y4-12 [Thrust Frequency] 	Increase the frequency reference to a value more than Y1-06.
<p>Note:</p> <ul style="list-style-type: none"> If the drive detects this error, the terminal set to H2-01 to H2-03 = 10 [MFDO Function Selection = Alarm] will activate. If the drive detects this error, it internally sets the frequency reference to the value set in Y1-06. 			
Code	Name	Causes	Possible Solutions
FR<TH	Freq. Reference < Thrust (Y4-12)	<p>The drive frequency reference setting is less than the value set in Y4-12 [Thrust Frequency] in these conditions:</p> <ul style="list-style-type: none"> The drive is not in PI Mode The drive is running Thrust is enabled (Y4-11 [Thrust Acceleration Time] > 0.00 and Y4-12 > Y1-06 [Minimum Speed]) 	Increase the frequency reference to a value more than Y4-12.
<p>Note:</p> <ul style="list-style-type: none"> If the drive detects this error, the terminal set to H2-01 to H2-03 = 10 [MFDO Function Selection = Alarm] will activate. If the drive detects this error, it internally sets the frequency reference to the value set in Y4-12. 			
Code	Name	Causes	Possible Solutions
HCA	High Current Alarm	The load is too heavy.	<ul style="list-style-type: none"> Decrease the load for applications with repetitive starts and stops. Replace the drive with a larger capacity model.
		The acceleration time is too short.	<ul style="list-style-type: none"> Calculate the torque necessary during acceleration related to the load inertia and the specified acceleration time. Increase the values set in C1-01 or C1-03 [Acceleration Times] until you get the necessary torque. Increase the values set in C2-01 to C2-04 [S-Curve Characteristics] until you get the necessary torque. Replace the drive with a larger capacity model.
		The drive is trying to operate a specialized motor or a motor that is larger than the maximum applicable motor output of the drive.	<ul style="list-style-type: none"> Examine the motor nameplate, the motor, and the drive to make sure that the drive rated current is larger than the motor rated current. Replace the drive with a larger capacity model.
		The current level temporarily increased because of speed search after a momentary power loss or while trying to Auto Restart.	If speed search or Auto Restart cause an increase in current, the drive can temporarily show this alarm. The time that the drive shows the alarm is short. No more steps are necessary to clear the alarm.
<p>Note:</p> <ul style="list-style-type: none"> The drive detects this error if the drive output current is more than the overcurrent alarm level (150% of the rated current). If the drive detects this error, the terminal set to H2-01 to H2-03 = 10 [MFDO Function Selection = Alarm] will activate. 			
Code	Name	Causes	Possible Solutions
HIAUX	High PI Aux Feedback Level	<p>PI Auxiliary Feedback is more than the level set in YF-12 [PI Aux Control High Level Detect] for the time set in YF-13 [PI Aux High Level Detection Time] in these conditions:</p> <ul style="list-style-type: none"> The drive operates in AUTO Mode. The output frequency > 0. 	<ul style="list-style-type: none"> Decrease the PI Auxiliary Feedback level to less than YF-12. Set YF-12 and YF-13 correctly.
<p>Note:</p> <p>If the drive detects this error, the terminal set to H2-01 to H2-03 = 10 [MFDO Function Selection = Alarm] will activate.</p>			
Code	Name	Causes	Possible Solutions
HIFB	High Feedback Sensed	The feedback level is more than the level set in Y1-11 [High Feedback Level].	<ul style="list-style-type: none"> Decrease the feedback level to less than Y1-11 - Y1-14 [Hysteresis Level]. Set Y1-11 and Y1-12 correctly.
<p>Note:</p> <ul style="list-style-type: none"> If the drive detects this error, the terminal set to H2-01 to H2-03 = 10 [MFDO Function Selection = Alarm] will activate. If the drive detects this error, it will respond as specified by the setting of Y1-13 [High Feedback Selection]. 			

Code	Name	Causes	Possible Solutions
INTLK	BAS Interlock	The digital input terminal set to $H1-xx = B2$ [MFDI Function Selection = BAS Interlock] deactivates.	Make sure the cause of interlock.
Note:  If the drive detects this error,  will only flash when there is a Run command.			
Code	Name	Causes	Possible Solutions
LCP	Low City Pressure	Insufficient pressure is present on the inlet to the pump in these conditions: <ul style="list-style-type: none"> $Y4-24 = 0$ [Low City Alarm Text = Low City Pressure] The terminal set for $Z2-0x = 46$ [Bypass MFDI Function Selection - Low City Pressure] activates 	<ul style="list-style-type: none"> Examine the pressure switch contact for correct operation. Make sure that control wiring to drive terminal strip from pressure switch contact. Make sure that suction pressure is present with an isolated measuring device. Set $Y4-22$ [Low City On-Delay Time] and $Y4-23$ [Low City Off-Delay Time] correctly. Deactivate the digital input terminals set to $Z2-0x = 46$ [Bypass MFDI Function Selection - Low City Pressure].
Note: If the drive detects this error during run, it coasts to stop and does not operate until the digital input has deactivated for the time set in $Y4-22$.			
Code	Name	Causes	Possible Solutions
LOAUX	Low PI Aux Feedback Level	When the drive operates in AUTO Mode or HAND Mode, PI Auxiliary Feedback is less than the level set in $YF-09$ [PI Aux Control Low Lvl Detection] for the time set in $YF-10$ [PI Aux Control Low Lvl Det Time] and the drive is running.	<ul style="list-style-type: none"> Increase the PI Auxiliary Feedback level more than $YF-09$. Set $YF-09$ and $YF-10$ correctly.
Note: If the drive detects this error, the terminal set to $H2-01$ to $H2-03 = 10$ [MFDO Function Selection = Alarm] will activate.			
Code	Name	Causes	Possible Solutions
LOFB	Low Feedback Sensed	The feedback level is less than the level set in $Y1-08$ [Low Feedback Level] for the time set in $Y1-09$ [Low Feedback Lvl Fault Dly Time].	<ul style="list-style-type: none"> Increase the feedback level to more than $Y1-08 + Y1-14$ [High Feedback Hysteresis Level]. Set $Y1-08$ and $Y1-09$ correctly.
Note: <ul style="list-style-type: none"> If the drive detects this error, the terminal set to $H2-01$ to $H2-03 = 10$ [MFDO Function Selection = Alarm] will activate. If the drive detects this fault, it will respond as specified by the setting of $Y1-10$ [Low Feedback Selection]. 			
Code	Name	Causes	Possible Solutions
LoG	Com Error / Abnormal SD Card	There is not a micro SD card in the keypad.	Put a micro SD card in the keypad.
		<ul style="list-style-type: none"> The drive is connected to USB. The number of log communication files is more than 1000. The micro SD card does not have available memory space. The line number data in a log communication file was changed. A communication error between the keypad and drive occurred during a log communication. 	Set $o5-01 = 0$ [Log Start/Stop Selection = OFF].
Note: If the drive detects this error, the terminal set to $H2-01$ to $H2-03 = 6A$ [MFDO Function Selection = Data Logger Error] will activate.			
Code	Name	Causes	Possible Solutions
LOP	Loss of Prime	The pump load that measured based on the $Y1-18$ [Prime Loss Detection Method] setting is less than the level set in $Y1-19$ [Prime Loss Level] for the time set in $Y1-20$ [Prime Loss Time], and the output frequency is $Y1-21$ [Prime Loss Activation Freq] or more.	<ul style="list-style-type: none"> Examine a dry well, air in the system, or no water in the system. Use preferred priming method suggested by the pump manufacturer to restart the pump. When there is resistance in the pump, allow the system to pump water again. Set $Y1-18$ to $Y1-21$ correctly.
Note: <ul style="list-style-type: none"> If the drive detects this error, the terminal set to $H2-01$ to $H2-03 = 10$ [MFDO Function Selection = Alarm] will activate. If the drive detects this fault, it will respond as specified by the setting of $Y1-22$ [Prime Loss Selection]. 			
Code	Name	Causes	Possible Solutions
LOW_SUCT	Low Suction Detected	The bypass detected a Low Suction condition.	<ul style="list-style-type: none"> Check the digital input programmed for Low Suction Switch ($Z2-0x = 42$). Check the connected device for continuity. Check Bypass Digital Input Invert Settings in $Z2-09$ to $Z2-16$.

6.6 Minor Faults/Alarms

Code	Name	Causes	Possible Solutions
LSP	Low Suction Pressure	An external input has indicated that an insufficient suction pressure condition exists in these conditions: <ul style="list-style-type: none"> • $Y4-24 = 1$ [Low City Alarm Text = Low Suction Pressure] • The terminal set for $H1-xx = B8$ or $1B8$ [MFDI Function Selection = Low City Pressure or !Low City Pressure] activates 	<ul style="list-style-type: none"> • Examine the pressure switch contact for correct operation. • Make sure that control wiring to drive terminal strip from pressure switch contact. • Make sure that suction pressure is present with an isolated measuring device. • Increase the system pressure. • Set $Y4-22$ [Low City On-Delay Time] and $Y4-23$ [Low City Off-Delay Time] correctly. • Deactivate the digital input terminals set to $H1-xx = B8$ or $1B8$.
Note: <ul style="list-style-type: none"> • If the drive detects this error, the terminal set to $H2-01$ to $H2-03 = 10$ [MFDI Function Selection = Alarm] will activate. • If the drive detects this error during run, it coasts to stop and does not operate until the digital input has deactivated for the time set in $Y4-22$. 			
Code	Name	Causes	Possible Solutions
LT-1	Cooling Fan Maintenance Time	The cooling fan is at 90% of its performance life estimate.	<ol style="list-style-type: none"> 1. Replace the cooling fan. 2. Set $o4-03 = 0$ [Fan Operation Time Setting = 0 h] to reset the cooling fan operation time.
Note: When the performance life estimate is expired, the terminal set to $H2-01$ to $H2-03 = 2F$ [MFDI Function Selection = Maintenance Notification] will activate.			
Code	Name	Causes	Possible Solutions
LT-2	Capacitor Maintenance Time	The capacitors for the main circuit and control circuit are at 90% of their performance life estimate.	Replace the control board or the drive. For information about replacing the control board, contact Yaskawa or your nearest sales representative.
Note: When the performance life estimate is expired, the terminal set to $H2-01$ to $H2-03 = 2F$ [MFDI Function Selection = Maintenance Notification] will activate.			
Code	Name	Causes	Possible Solutions
LT-3	SoftChargeBypassRelay MainteTime	The soft charge bypass relay is at 90% of its performance life estimate.	Replace the control board or the drive. For information about replacing the control board, contact Yaskawa or your nearest sales representative.
Note: When the performance life estimate is expired, the terminal set to $H2-01$ to $H2-03 = 2F$ [MFDI Function Selection = Maintenance Notification] will activate.			
Code	Name	Causes	Possible Solutions
LT-4	IGBT Maintenance Time (50%)	The IGBT is at 50% of its performance life estimate.	Check the load, carrier frequency, and output frequency.
Note: When the performance life estimate is expired, the terminal set to $H2-01$ to $H2-03 = 2F$ [MFDI Function Selection = Maintenance Notification] will activate.			
Code	Name	Causes	Possible Solutions
LWT	Low Water In Tank	An external input has indicated that the water level in the tank is too low in these conditions: <ul style="list-style-type: none"> • $Y4-24 = 2$ [Low City Alarm Text = Low Water in Tank] • The terminal set for $H1-xx = B8$ or $1B8$ [MFDI Function Selection = Low City Pressure or !Low City Pressure] activates 	<ul style="list-style-type: none"> • Examine the pressure switch contact for correct operation. • Make sure that control wiring to drive terminal strip from pressure switch contact. • Make sure that suction pressure is present with an isolated measuring device. • Increase the water level. • Set $Y4-22$ [Low City On-Delay Time] and $Y4-23$ [Low City Off-Delay Time] correctly. • Deactivate the digital input terminals set to $H1-xx = B8$ or $1B8$.
Note: <ul style="list-style-type: none"> • If the drive detects this error, the terminal set to $H2-01$ to $H2-03 = 10$ [MFDI Function Selection = Alarm] will activate. • If the drive detects this error during run, it coasts to stop and does not operate until the digital input has deactivated for the time set in $Y4-22$. 			
Code	Name	Causes	Possible Solutions
NMS	Setpoint Not Met	The feedback deviates from the setpoint at a level more than $Y1-15$ [Maximum Setpoint Difference] for the time set in $Y1-16$ [Not Maintaining Setpoint Time].	<ul style="list-style-type: none"> • Examine for a blocked impeller, over cycling, or broken pipe. • Set $Y1-15$ and $Y1-16$ correctly.
Note: <ul style="list-style-type: none"> • If the drive detects this error, the terminal set to $H2-01$ to $H2-03 = 10$ [MFDI Function Selection = Alarm] will activate. • If the drive detects this error, it will respond as specified by the setting of $Y1-17$ [Not Maintaining Setpoint Sel]. 			
Code	Name	Causes	Possible Solutions
OD	Output Disconnect	The output circuit between the drive and the motor is open, and the drive output current is less than 5% of $E2-01$ [Motor Rated Current (FLA)].	<ul style="list-style-type: none"> • Close the disconnected output circuit between the drive and the motor. • If you do not use a motor disconnect, set $Y4-42 = 0$ [Disabled].
Note: <ul style="list-style-type: none"> • If the drive detects this error, the terminal set to $H2-01$ to $H2-03 = 10$ [MFDI Function Selection = Alarm] will activate. • If the drive detects this error, it will respond as specified by the setting of $Y4-42$ [Output Disconnect Detection Sel]. 			

Code	Name	Causes	Possible Solutions
oH	Heatsink Overheat	The ambient temperature is high and the heatsink temperature is more than the L8-02 [Overheat Alarm Level].	<ul style="list-style-type: none"> Measure the ambient temperature. Increase the airflow around the drive. Install a cooling device (cooling fan or air conditioner) to decrease the ambient temperature. Remove objects near the drive that are producing too much heat.
		There is not sufficient airflow around the drive.	<ul style="list-style-type: none"> Give the drive the correct installation space as shown in the manual. Make sure that there is sufficient circulation around the control panel. Examine the drive for dust or other unwanted materials that could clog the cooling fan. Remove unwanted materials that prevent air circulation.
		The internal cooling fan or fans stopped.	<ol style="list-style-type: none"> Replace the cooling fan. Set o4-03 = 0 [Fan Operation Time Setting = 0 h] to reset the cooling fan operation time.
<p>Note:</p> <ul style="list-style-type: none"> The drive detects this error if the heatsink temperature of the drive is more than L8-02. If the drive detects this error, the terminal set to H2-01 to H2-03 = 10 [MFDO Function Selection = Alarm] will activate. Use L8-03 [Overheat Pre-Alarm Selection] to the stopping method for this fault. 			
Code	Name	Causes	Possible Solutions
oH2	External Overheat (H1-XX=B)	An external device sent an oH2 alarm.	<ol style="list-style-type: none"> Find the external device that output the overheat alarm. Remove the cause of the problem. Clear the Overheat Alarm (oH2) [H1-xx = B] in MFDI terminals S1 to S7.
<p>Note:</p> <p>If the drive detects this error, the terminal set to H2-01 to H2-03 = 10 [MFDO Function Selection = Alarm] will activate.</p>			
Code	Name	Causes	Possible Solutions
oH3	Motor Overheat (PTC Input)	The thermistor wiring that detects motor temperature is defective.	Correct wiring errors.
		A fault occurred on the machine. Example: The machine is locked.	Examine the machine and remove the cause of the fault
		The motor has overheated.	<ul style="list-style-type: none"> Check the load level, acceleration/deceleration time, and motor start/stop frequency (cycle time). Decrease the load. Increase the values set in C1-01 to C1-04 [Acceleration/Deceleration Times]. Set E2-01 [Motor Rated Current (FLA)] correctly to the value specified by the motor nameplate. Make sure that the motor cooling system is operating correctly, and repair or replace it if it is damaged. Adjust E1-04 to E1-10 [V/f Pattern Parameters]. Decrease the values set in E1-08 [Mid Point A Voltage] and E1-10 [Minimum Output Voltage]. <p>Note:</p> <p>If the values set in E1-08 and E1-10 are too low, the overload tolerance will decrease at low speeds.</p>
<p>Note:</p> <ul style="list-style-type: none"> When H3-02 or H3-10 = E [MFAI Function Selection = Motor Temperature (PTC Input)], the drive detects this fault if the motor overheat signal entered to analog input terminals A1 and A2 is more than the alarm detection level. If the drive detects this error, the terminal set to H2-01 to H2-03 = 10 [MFDO Function Selection = Alarm] will activate. If the drive detects this error, it will operate the motor as specified by the stopping method set in L1-03 [Motor Thermistor oH Alarm Select]. 			
Code	Name	Causes	Possible Solutions
oL3	Overtorque 1	A fault occurred on the machine. Example: The machine is locked.	Examine the machine and remove the cause of the fault.
		The parameters are incorrect for the load.	Adjust L6-02 [Torque Detection Level 1] and L6-03 [Torque Detection Time 1] settings.
<p>Note:</p> <ul style="list-style-type: none"> The drive detects this fault if the drive output current is more than the level set in L6-02 for longer than L6-03. If the drive detects this error, the terminal set to H2-01 to H2-03 = 10 [MFDO Function Selection = Alarm] will activate. Use L6-01 [Torque Detection Selection 1] to set the conditions that trigger the minor fault. 			

6.6 Minor Faults/Alarms

Code	Name	Causes	Possible Solutions
oL4	Overtorque 2	A fault occurred on the machine. Example: The machine is locked.	Examine the machine and remove the cause of the fault.
		The parameters are incorrect for the load.	Adjust L6-05 [Torque Detection Level 2] and L6-06 [Torque Detection Time 2] settings.
Note: <ul style="list-style-type: none"> The drive detects this error if the drive output current is more than the level set in L6-05 for longer than L6-06. If the drive detects this error, the terminal set to H2-01 to H2-03 = 10 [MFDO Function Selection = Alarm] will activate. Use L6-04 [Torque Detection Selection 2] to set the conditions that trigger the minor fault. 			
Code	Name	Causes	Possible Solutions
ov	DC Bus Overvoltage	The drive output cable or motor is shorted to ground (the current short to ground is charging the main circuit capacitor of the drive through the power supply).	<ol style="list-style-type: none"> Examine the motor main circuit cable, terminals, and motor terminal box, and then remove ground faults. Re-energize the drive.
		The power supply voltage is too high.	Decrease the power supply voltage to align with the drive rated voltage.
		Electrical interference caused a drive malfunction.	<ul style="list-style-type: none"> Examine the control circuit lines, main circuit lines, and ground wiring, and minimize the effects of noise. Find the source of the noise. If a magnetic contactor is the source, use Surge Protective Device if necessary. Set L5-01 ≠ 0 [Number of Auto-Restart Attempts ≠ 0 times].
Note: <ul style="list-style-type: none"> The drive detects this error if the DC bus voltage is more than the ov detection level when the Run command has not been input (while the drive is stopped). The ov detection level is approximately 410 V for 208/240 V bypasses. The detection level is approximately 820 V for 480 V bypasses. If the drive detects this error, the terminal set to H2-01 to H2-03 = 10 [MFDO Function Selection = Alarm] will activate. 			
Code	Name	Causes	Possible Solutions
ovEr	Too Many Parameters Changed	You tried to change more than 150 parameters.	<p>Make sure that parameters that do not have an effect on drive operation are at their default settings.</p> <p>Note:</p> <ul style="list-style-type: none"> You can change 150 parameters maximum. If you change parameters that have dependencies, the drive can detect ovEr when the number of changed parameters is fewer than 150.
Code	Name	Causes	Possible Solutions
OV_PRESS	Over Pressure Detected	The bypass detected an Over Pressure condition.	<ul style="list-style-type: none"> Check the digital input programmed for Over Pressure Switch (Z2-0x = 41). Check the connected device for continuity. Check Bypass Digital Input Invert Settings in Z2-09 to Z2-16.
Code	Name	Causes	Possible Solutions
PA1	PLC Error 1	The network speed on one port does not align with the network speed on the other port.	Make sure that the network speeds on both ports are the same.
Code	Name	Causes	Possible Solutions
PASS	Serial Communication Test	The serial communications test is complete.	The PASS display will turn off after communications test mode is cleared.
Code	Name	Causes	Possible Solutions
PF	Input Phase Loss	There is a phase loss in the drive input power.	Correct errors with the wiring for main circuit drive input power.
		Loose wiring in the input power terminals.	Tighten the terminal screws to the correct tightening torque.
		The drive input power voltage is changing too much.	<ul style="list-style-type: none"> Examine the input power for problems. Make the drive input power stable.
		Unsatisfactory balance between voltage phases.	<ul style="list-style-type: none"> Examine the input power for problems. Make the drive input power stable. If the input power supply is good, examine the magnetic contactor on the main circuit side for problems.

Code	Name	Causes	Possible Solutions
		The main circuit capacitors are unserviceable.	<ul style="list-style-type: none"> Examine the capacitor maintenance time in monitor U4-05 [CapacitorMaintenance]. If U4-05 is more than 90%, replace the capacitor. Contact Yaskawa or your nearest sales representative for more information.
			<ul style="list-style-type: none"> Examine the input power for problems. Re-energize the drive. If the alarm stays, replace the circuit board or the drive. Contact Yaskawa or your nearest sales representative for more information.
Note: <ul style="list-style-type: none"> The drive detects this error if the DC bus voltage changes irregularly without regeneration. If the drive detects this error, the terminal set to H2-01 to H2-03 = 10 [MFDO Function Selection = Alarm] will activate. Use L8-05 [Input Phase Loss Protection Sel] to enable and disable PF detection. 			
Code	Name	Causes	Possible Solutions
SAFE	Safety Open	The bypass detected a Open Safety condition.	<ul style="list-style-type: none"> Check the digital input programmed for Run Enable - Safety (NC) Z2-0x = 22. Check the connected device for continuity. Check the Bypass Digital Input Invert settings in Z2-09 to Z2-16.
Code	Name	Causes	Possible Solutions
SE	Modbus Test Mode Error	Serial Hardware communications self-diagnostics [Z2-xx = 45] was done while the drive was running.	Stop the drive and do MEMOBUS/Modbus communications self-diagnostics.
Note: <p>If drive detects this error, the terminal set to H2-01 to H2-03 = 10 [MFDO Function Selection = Alarm] will activate.</p>			
Code	Name	Causes	Possible Solutions
SMK_ALRM	Smoke Alarm Active	The bypass detected a Smoke Alarm condition.	<ul style="list-style-type: none"> Check the digital input programmed for Smoke Alarm (Z2-0x = 40). Check the connected device for continuity. Check Bypass Digital Input Invert Settings in Z2-09 to Z2-16.
Code	Name	Causes	Possible Solutions
STo	Safe Torque OFF	Safe Disable inputs H1-HC and H2-HC are open.	<ul style="list-style-type: none"> Make sure that the Safe Disable signal is input from an external source to terminal H1-HC and H2-HC. When the Safe Disable function is not in use, use a jumper to connect terminals H1-HC and H2-HC.
		There is internal damage to the two Safe Disable channels.	Replace the board or the drive. Contact Yaskawa or your nearest sales representative to replace the board.
Note: <ul style="list-style-type: none"> The drive will not output an alarm signal for this alarm. If the drive detects this error, the terminal set to H2-01 to H2-03 = 21 [MFDO Function Selection = Safe Torque OFF] will activate. 			
Code	Name	Causes	Possible Solutions
SToF	Safe Torque OFF Hardware	One of the two terminals H1-HC or H2-HC received the Safe Disable input signal.	<ul style="list-style-type: none"> Make sure that the Safe Disable signal is input from an external source to terminals H1-HC or H2-HC. When the Safe Disable function is not in use, use a jumper to connect terminals H1-HC and H2-HC.
		The Safe Disable input signal is wired incorrectly.	
		There is internal damage to one Safe Disable channel.	Replace the board or the drive. Contact Yaskawa or your nearest sales representative to replace the board.
Note: <p>If the drive detects this error, the terminal set to H2-01 to H2-03 = 10 [MFDO Function Selection = Alarm] will activate.</p>			
Code	Name	Causes	Possible Solutions
TiM	Keypad Time Not Set	There is a battery in the keypad, but you have not set the date and time.	Use the keypad to set the date and time.
Note: <ul style="list-style-type: none"> Parameter o4-24 [bAT Detection selection] enables and disables TiM detection. If the drive detects this error, the terminal set to H2-01 to H2-03 = 10 [MFDO Function Selection = Alarm] will activate. 			
Code	Name	Causes	Possible Solutions
TrPC	IGBT Maintenance Time (90%)	The IGBT is at 90% of its performance life estimate.	Replace the IGBT or the drive. For more information, contact Yaskawa or your nearest sales representative.
Note: <p>If the drive detects this error, the terminal set to H2-01 to H2-03 = 10 [MFDO Function Selection = Alarm] will activate.</p>			

6.6 Minor Faults/Alarms

Code	Name	Causes	Possible Solutions
UL3	Undertorque Detection 1	A fault occurred on the machine. Example: There is a broken pulley belt.	Examine the machine and remove the cause of the fault.
		The parameters are incorrect for the load.	Adjust L6-02 [Torque Detection Level 1] and L6-03 [Torque Detection Time 1] settings.
Note: <ul style="list-style-type: none"> The drive detects this error if the drive output current is less than the level set in L6-02 for longer than L6-03. If the drive detects this error, the terminal set to H2-01 to H2-03 = 10 [MFDO Function Selection = Alarm] will activate. If the drive detects this error, it will operate the motor as specified by the Stopping Method set in L6-01 [Torque Detection Selection 1]. 			
Code	Name	Causes	Possible Solutions
UL4	Undertorque Detection 2	A fault occurred on the machine. Example: There is a broken pulley belt.	Examine the machine and remove the cause of the fault.
		The parameters are incorrect for the load.	Adjust L6-05 [Torque Detection Level 2] and L6-06 [Torque Detection Time 2] settings.
Note: <ul style="list-style-type: none"> The drive detects this error if the drive output current is less than the level set in L6-05 for longer than L6-06. If detected, the terminal set to H2-01 to H2-03 = 10 [MFDO Function Selection = Alarm] will activate. If the drive detects this error, it will operate the motor as specified by the Stopping Method set in L6-04 [Torque Detection Selection 2]. 			
Code	Name	Causes	Possible Solutions
UL6	Underload or Belt Break Detected	The output current decreased less than the motor underload curve set in L6-14 [Motor Underload Level @ Min Freq] for longer than the time set in L6-03 [Torque Detection Time 1].	Examine parameters L6-13 [Motor Underload Curve Select] and L6-14.
		The belt has broken disconnecting the motor from the load.	
Note: If the drive detects this error, the terminal set to H2-01 to H2-03 = 10 [MFDO Function Selection = Alarm] will activate.			
Code	Name	Causes	Possible Solutions
Uv	Undervoltage	The drive input power voltage is changing too much.	<ul style="list-style-type: none"> Examine the input power for problems. Make the drive input power stable. If the input power supply is good, examine the magnetic contactor on the main circuit side for problems.
		There is a phase loss in the drive input power.	Correct errors with the wiring for main circuit drive input power.
		There is loose wiring in the drive input power terminals.	Tighten the terminal screws to the correct tightening torque.
		There was a loss of power.	Use a better power supply.
		The main circuit capacitors have become unserviceable.	Examine the capacitor maintenance time in monitor U4-05 [Capacitor Maintenance]. If U4-05 is more than 90%, replace the control board or the drive. For information about replacing the control board, contact Yaskawa or your nearest sales representative.
		The drive input power transformer is too small and voltage drops when the power is switched on.	<ul style="list-style-type: none"> Check for an alarm when a molded-case circuit breaker, Leakage Breaker (ELCB or GFCI) (with overcurrent protective function), or magnetic contactor is ON. Check the capacity of the drive power supply transformer.
Note: <ul style="list-style-type: none"> The drive detects this error if one of these conditions is correct when the Run command has not been input (while the drive is stopped). <ul style="list-style-type: none"> The DC bus voltage < L2-05 [Undervoltage Detection Lvl (Uv1)]. The Contactor that prevents inrush current in the drive was opened. If the drive detects this error, the terminal set to H2-01 to H2-03 = 10 [MFDO Function Selection = Alarm] will activate. 			
Code	Name	Causes	Possible Solutions
VBRATION	Vibration Detected	The bypass detected a Vibration condition.	<ul style="list-style-type: none"> Check the digital input programmed for Vibration Switch (Z2-0x = 43). Check the connected device for continuity. Check Bypass Digital Input Invert Settings in Z2-09 to Z2-16.

6.7 Parameter Setting Errors

Parameter setting errors occur when multiple parameter settings do not agree, or when parameter setting values are not correct. Refer to the table in this section, examine the parameter setting that caused the error, and remove the cause of the error. You must first correct the parameter setting errors before you can operate the drive. The drive will not send notification signals for the faults and alarms when these parameter setting errors occur.

Code	Name	Causes	Possible Solutions
oPE01	Drive Capacity Setting Error	The value set in <i>o2-04 [Drive Model (KVA) Selection]</i> does not agree with the drive model.	Consult Yaskawa technical support.
Code	Name	Causes	Possible Solutions
oPE02	Parameter Range Setting Error	Parameters settings are not in the applicable setting range.	<ol style="list-style-type: none"> 1. Push  to show <i>U1-18 [oPE Fault Parameter]</i>, and find parameters that are not in the applicable setting range. 2. Correct the parameter settings. <p>Note: If more than one error occurs at the same time, other <i>oPExx</i> errors have priority over <i>oPE02</i>.</p>
		You set $E2-01 \leq E2-03$ [<i>Motor Rated Current (FLA) ≤ Motor No-Load Current</i>].	<p>Make sure that $E2-01 > E2-03$.</p> <p>Note: If it is necessary to set $E2-01 < E2-03$, first lower the value set in $E2-03$, and then set $E2-01$.</p>
		You set $S3-09 < S3-10$ [<i>PI2 Control Output Upper Limit < PI2 Control Output Lower Limit</i>].	Make sure that $S3-09 > S3-10$ at all times.
		You set $S3-13 > S3-15$ [<i>PI2 Control Low Feedback Lvl > PI2 Control High Feedback Lvl</i>].	Make sure that $S3-13 < S3-15$ at all times.
Code	Name	Causes	Possible Solutions
oPE03	Multi-Function Input Setting Err	The settings for these parameters do not agree: <ul style="list-style-type: none"> • <i>Z2-01 to Z2-08 [Digital Input 1 Function (TB2-1) to Digital Input 8 Function (TB2-8)]</i> • <i>H1-01 to H1-07 [Terminals S1 to S7 Function Selection]</i> 	Correct the parameter settings.
		The settings for the bypass MFDIs <i>Z2-01 to Z2-08</i> overlap and/or the setting for the drive MFDIs <i>H1-01 to H1-07</i> overlap <p>Note: This does not include $H1-xx = 20$ to $2F$ [<i>MFDI Function Selection = External Fault</i>].</p>	Check the settings and make sure that you did not program two or more MFDIs to the same value.
		A minimum of two of these MFDI combinations are set to Digital Inputs (<i>H1-xx</i> and <i>H7-01 to H7-04</i>) at the same time: <ul style="list-style-type: none"> • Setting value <i>1E [Reference Sample Hold]</i> • Setting values <i>44 to 46 [Add Offset Frequency 1 to 3 (d7-01 to d7-03)]</i> 	Remove the function settings that are not in use.
		These commands are set in Digital Inputs (<i>H1-xx</i> and <i>H7-01 to H7-04</i>) at the same time: <ul style="list-style-type: none"> • Setting values <i>61 [Speed Search from Fmax]</i> and <i>62 [Speed Search from Fref]</i> 	Remove the function settings that are not in use.
		These groups of MFDI functions are not set to Digital Inputs (<i>H1-xx</i> and <i>H7-01 to H7-04</i>) at the same time: <ul style="list-style-type: none"> • Setting values <i>3E [PID Setpoint Selection 1]</i> and <i>3F [PID Setpoint Selection 2]</i> • Setting values <i>83 [Dedicated Multi-Setpoint YA-02]</i>, <i>84 [Dedicated Multi-Setpoint YA-03]</i>, and <i>85 [Dedicated Multi-Setpoint YA-04]</i> 	Set the MFDI groups correctly.
		Settings for N.C. and N.O. input [<i>H1-xx</i>] for these functions were selected at the same time: <ul style="list-style-type: none"> • Setting value <i>15 [Fast Stop (N.O.)]</i> • Setting value <i>17 [Fast Stop (N.C.)]</i> 	Remove one of the function settings.
		These MFDI functions are set at the same time: <ul style="list-style-type: none"> • $H1-xx = 6A$ [<i>Drive Enable</i>] • $H1-xx = 70$ [<i>Drive Enable 2</i>] 	Remove one of the function settings.

6.7 Parameter Setting Errors

Code	Name	Causes	Possible Solutions
		<p>These parameters are set at the same time:</p> <ul style="list-style-type: none"> • $H1-xx = 62$ [Speed Search from Fref] • $H5-22 = 1$ [Speed Search from MODBUS = Enabled] <p>Parameter $S3-01 \neq 0$ [PI2 Control Enable Selection ≠ Disabled] and MFDI set for $H1-xx = AD$ [Select PI2 Control PI Parameters] is ON or MFDI set for $H1-xx = 1AD$ [Select PI2 Control PI Parameters] is OFF.</p>	<p>Remove one of the function settings.</p> <ul style="list-style-type: none"> • Set $S3-01 = 0$ to use $H1-xx = AD$ or $1AD$ for the adjustments of $S3-06$ [PI2 Control Proportional Gain] and $S3-07$ [PI2 Control Integral Time] instead of the primary PI controller Proportional and Integral adjustments. • When PI2 Control is necessary, remove the MFDI function setting.
Code	Name	Causes	Possible Solutions
oPE05	Run Cmd/Freq Ref Source Sel Err	There is an option card installed on the drive.	Remove the option card from the drive. If it is compatible, install the option card on the bypass control board.
		The setting to assign the Run command or frequency reference to an option card is incorrect.	Correct the parameter settings.
		$Z1-39 = 3$ [Drive/Bypass Source Select = Option PCB] is set, but there is no option card connected.	Connect an option card.
		$b1-01 = 3$ [Frequency Reference Selection 1 = Option PCB] is set, but there is no option card connected.	
		$b1-02 = 3$ [Run Command Selection 1 = Option PCB] is set, but there is no option card connected.	
Code	Name	Causes	Possible Solutions
oPE07	Analog Input Selection Error	The settings for $H3-02$ and $H3-10$ [MFAI Function Selection] and $H7-30$ [Virtual Analog Input Selection] overlap.	<p>Set $H3-02$, $H3-10$, and $H7-30$ correctly to prevent overlap.</p> <p>Note: It is possible to set these functions to multiple analog input terminals at the same time:</p> <ul style="list-style-type: none"> • Setting value 0 [Frequency Reference] • Setting values F and $1F$ [Not Used]
Code	Name	Causes	Possible Solutions
oPE08	Parameter Selection Error	<p>You set these parameters:</p> <ul style="list-style-type: none"> • $S1-01 = 1$ [Dynamic Noise Control = Enabled] • $Y4-42 \neq 0$ [Output Disconnect Detection Sel ≠ Disabled] 	Set $S1-01 = 0$ or $Y4-42 = 0$.
		You set $L6-02$ [Torque Detection Level 1] < $L6-14$ [Motor Underload Level @ Min Freq].	Set parameters to be $L6-02 \geq L6-14$.
Code	Name	Causes	Possible Solutions
oPE09	PID Control Selection Fault	<p>These parameters are set at the same time:</p> <ul style="list-style-type: none"> • $b5-01 = 1$ • $b5-11 = 1$ [PID Output Reverse Selection = Negative Output Accepted] <p>And one of these parameters is set:</p> <ul style="list-style-type: none"> • $d2-02 \neq 0.0$ [Frequency Reference Lower Limit ≠ 0.0%] • $Y1-06 \neq 0.0$ [Minimum Speed ≠ 0.0%] • $Y4-12 \neq 0.0$ [Thrust Frequency ≠ 0.0%] • $YF-01 \neq 0$ [PI Aux Control Selection ≠ Disabled] 	Correct the parameter settings.
		<p>Parameter $b5-01 = 3$ and one of these parameters is set at the same time:</p> <ul style="list-style-type: none"> • $d2-02 \neq 0.0$ • $Y1-06 \neq 0.0$ • $Y4-12 \neq 0.0$ • $YF-01 \neq 0$ 	Correct the parameter settings.
<p>Note: The drive detects this error if the PID control function selection is incorrect. (When $b5-01 = 1$ or 3 [PID Mode Setting = Standard or Fref + PID Trim])</p>			
Code	Name	Causes	Possible Solutions
oPE10	V/f Data Setting Error	<p>The parameters that set the V/f pattern do not satisfy these conditions:</p> <ul style="list-style-type: none"> • $E1-09 \leq E1-07 < E1-06 \leq E1-11 \leq E1-04$ [Minimum Output Frequency ≤ Mid Point A Frequency < Base Frequency ≤ Mid Point B Frequency ≤ Maximum Output Frequency] 	Set the parameters correctly to satisfy the conditions.

Code	Name	Causes	Possible Solutions		
oPE11	Carrier Frequency Setting Error	These parameters are set at the same time: <ul style="list-style-type: none"> • $C6-05 > 6$ [Carrier Freq Proportional Gain > 6] • $C6-04 > C6-03$ [Carrier Frequency Lower Limit > Carrier Frequency Upper Limit] <p>Note: When $C6-05 < 7$, $C6-04$ becomes disabled. $C6-03$ stays active.</p>	Set $C6-02$ to $C6-05$ correctly.		
		$C6-02$ to $C6-05$ settings are not in the applicable setting range.			
Code	Name	Causes	Possible Solutions		
oPE16	Energy Saving Constants Error	These parameters are set at the same time: <ul style="list-style-type: none"> • $b8-01 = 1$ [Energy Saving Control Selection = Enabled] • $S1-01 = 1$ [Dynamic Noise Control = Enabled] 	Disable Energy Saving Control or Dynamic Noise Control.		
Code	Name	Causes	Possible Solutions		
oPE20	No Motor Overload Set	$L1-01 = 0$ [Motor Overload (oL1) Protection = Disabled] and $Z2-0x \neq 29$ or 30 [Digital Input x Function (TB2-x) \neq External Overload Motor 1 (NC) or External Overload Motor 1 (NC)].	<ul style="list-style-type: none"> • Set $L1-01 = 1$ [Motor Overload (oL1) Protection = Enabled]. • Set one digital input to motor overload $Z2-0x = 29$ or 30 and connect a thermal motor overload relay to that input. 		
Code	Name	Causes	Possible Solutions		
oPE29	Baud Rate Setting Error	The baud rate setting [$H5-02$] does not align with the currently selected protocol [$H5-08$]. One of these contradictory settings is true: <ul style="list-style-type: none"> • $H5-08 = 1$ and $H5-02 \neq 3$ [Communication Protocol Selection = Metasys/N2 and Communication Speed Selection \neq 9600 bps] • $H5-08 = 2$ and $H5-02 \neq 2, 3$ [Communication Protocol Selection = Apogee/P1 and Communication Speed Selection \neq 4800 bps, 9600 bps] • $H5-08 = 3$ and $H5-02 \neq 3, 4, 5, 7$ [Communication Protocol Selection = BACnet and Communication Speed Selection \neq 9600 bps, 19.2 kbps, 38.4 kbps, 76.8 kbps] 	Correct the parameter settings.		
Code	Name	Causes	Possible Solutions		
oPE34	HAND/OFF/AUTO Input Setting	Parameter $b1-02 = 7$ to 9 and only HAND or AUTO MFDI [$Z2-0x = 31$ or 32] is programmed.	Program HAND and AUTO MFDIs [$Z2-0x = 31$ and 32].		
		Parameter $b1-02 = 1$ to 3 and the AUTO MFDI [$Z2-0x = 32$] is programmed	Un-program HAND and AUTO MFDIs, so neither are selected.		
		Parameter $b1-02 = 0$ and either HAND or AUTO MFDI [$Z2-0x = 31$ or 32] are programmed.	Un-program the AUTO MFDI.		
oPE34	HAND/OFF/AUTO Input Setting	Parameter $b1-02 = 0$ and either HAND or AUTO MFDI [$Z2-0x = 31$ or 32] are programmed.	Un-program the HAND and AUTO MFDIs.		
		Code	Name	Causes	Possible Solutions
		oPE36	Bypass Energy Savings Setting Err	These parameters are set at the same time: <ul style="list-style-type: none"> • $Z1-16 \neq 0$ [Energy Savings Mode \neq Disabled] • $Y4-42 \neq 0$ [Output Disconnect Detection Sel \neq Disabled] 	Set $Z1-16$ or $Y4-42 = 0$.

6.8 Auto-Tuning Errors

This table gives information about errors detected during Auto-Tuning. If the drive detects an Auto-Tuning error, the keypad will show the error and the motor will coast to stop. The drive will not send notification signals for faults and alarms when Auto-Tuning errors occur.

Two types of Auto-Tuning errors are: *Endx* and *Erx*. *Endx* identifies that Auto-Tuning has successfully completed with calculation errors. Find and repair the cause of the error and do Auto-Tuning again, or set the motor parameters manually. You can use the drive in the application if you cannot find the cause of the *Endx* error.

Erx identifies that Auto-Tuning was not successful. Find and repair the cause of the error and do Auto-Tuning again.

Code	Name	Causes	Possible Solutions
End1	Excessive Rated Voltage Setting	The torque reference was more than 20% during Auto-Tuning or the no-load current that was measured after Auto-Tuning is more than 80%.	<ul style="list-style-type: none"> Make sure that the input motor nameplate data is correct. Do Auto-Tuning again and correctly set the motor nameplate data. If you can uncouple the motor and load, remove the motor from the machine and do Rotational Auto-Tuning again. If you cannot uncouple the motor and load, use the results from Auto-Tuning.
Code	Name	Causes	Possible Solutions
End2	Iron Core Saturation Coefficient	The motor nameplate data entered during Auto-Tuning is incorrect.	<ul style="list-style-type: none"> Make sure that the input motor nameplate data is correct. Do Auto-Tuning again and correctly set the motor nameplate data.
Code	Name	Causes	Possible Solutions
End3	Rated Current Setting Alarm	The rated current value is incorrect.	Do Auto-Tuning again and set the correct rated current shown on the motor nameplate.
Code	Name	Causes	Possible Solutions
End4	Adjusted Slip Calculation Error	The Auto-Tuning results were not in the applicable parameter setting range.	<ul style="list-style-type: none"> Make sure the input motor nameplate data is correct. Do Rotational Auto-Tuning again and correctly set the motor nameplate data. If you cannot uncouple the motor and load, do Stationary Auto-Tuning 2.
		The motor rated slip that was measured after Stationary Auto-Tuning was 0.2 Hz or lower.	
		The secondary resistor measurement results were not in the applicable range.	
Code	Name	Causes	Possible Solutions
End5	Resistance Tuning Error	The Auto-Tuning results of the Line-to-Line Resistance were not in the applicable range.	<ul style="list-style-type: none"> Make sure that the input motor nameplate data is correct. Examine and repair damaged motor wiring.
Code	Name	Causes	Possible Solutions
End6	Leakage Inductance Alarm	The Auto-Tuning results were not in the applicable parameter setting range.	Make sure that the input motor nameplate data is correct, and do Auto-Tuning again.
Code	Name	Causes	Possible Solutions
End7	No-Load Current Alarm	The Auto-Tuning results of the motor no-load current value were not in the applicable range.	Examine and repair damaged motor wiring.
		Auto-Tuning results were less than 5% of the motor rated current.	Make sure that the input motor nameplate data is correct, and do Auto-Tuning again.
Code	Name	Causes	Possible Solutions
Er-01	Motor Data Error	The motor nameplate data entered during Auto-Tuning is incorrect.	<ul style="list-style-type: none"> Make sure that the motor nameplate data is correct. Do Auto-Tuning again and correctly set the motor nameplate data.
		The combination of the motor rated power and motor rated current do not match.	<ul style="list-style-type: none"> Examine the combination of drive capacity and motor output. Do Auto-Tuning again, and correctly set the motor rated power and motor rated current.
		The combination of the motor rated current that was entered during Auto-Tuning and <i>E2-03</i> [Motor No-Load Current] do not match.	<ul style="list-style-type: none"> Examine the motor rated current and the no-load current. Set <i>E2-03</i> correctly. Do Auto-Tuning again, and correctly set the motor rated current.
		The combination of the setting values of Motor Base Frequency and Motor Base Speed do not match.	Do Auto-Tuning again, and correctly set the Motor Base Frequency and Motor Base Speed.

Code	Name	Causes	Possible Solutions
Er-02	Drive in an Alarm State	The motor nameplate data entered during Auto-Tuning is incorrect.	<ul style="list-style-type: none"> Make sure that the motor nameplate data entered in Auto-Tuning is correct. Do Auto-Tuning again and correctly set the motor nameplate data.
		You did Auto-Tuning while the drive had a minor fault or alarm.	Clear the minor fault or alarm and do Auto-Tuning again.
		There is a defective motor cable or cable connection.	Examine and repair motor wiring.
		The load is too large.	<ul style="list-style-type: none"> Decrease the load. Examine the machine area to see if, for example, the motor shaft is locked.
		The drive detected a minor fault during Auto-Tuning.	<ol style="list-style-type: none"> Stop Auto-Tuning. Examine the minor fault code and remove the cause of the problem. Do Auto-Tuning again.
Code	Name	Causes	Possible Solutions
Er-03	OFF Button was Pressed	You pushed  during Auto-Tuning.	Auto-Tuning did not complete correctly. Do Auto-Tuning again.
Code	Name	Causes	Possible Solutions
Er-04	Line-to-Line Resistance Error	The Auto-Tuning results were not in the applicable parameter setting range.	<ul style="list-style-type: none"> Examine and repair motor wiring. Disconnect the machine from the motor and do Rotational Auto-Tuning again.
		Auto-Tuning did not complete in a pre-set length of time.	
		There is a defective motor cable or cable connection.	<ul style="list-style-type: none"> Make sure that the input motor nameplate data is correct. Do Auto-Tuning again and correctly set the motor nameplate data.
		The motor nameplate data entered during Auto-Tuning is incorrect.	
Code	Name	Causes	Possible Solutions
Er-05	No-Load Current Error	The Auto-Tuning results were not in the applicable parameter setting range.	<ul style="list-style-type: none"> Examine and repair motor wiring. Disconnect the machine from the motor and do Rotational Auto-Tuning again.
		Auto-Tuning did not complete in a pre-set length of time.	
		The motor nameplate data entered during Auto-Tuning is incorrect.	<ul style="list-style-type: none"> Make sure that the input motor nameplate data is correct. Do Auto-Tuning again and correctly set the motor nameplate data.
		Rotational Auto-Tuning was done with a load that was more than 30% of the rating connected to the motor.	<ul style="list-style-type: none"> Disconnect the machine from the motor and do Rotational Auto-Tuning again. If you cannot uncouple the motor and load, make sure that the load is less than 30% of the motor rating. If a mechanical brake is installed in the motor, release the brake during Rotational Auto-Tuning.
Code	Name	Causes	Possible Solutions
Er-08	Rated Slip Error	The motor nameplate data entered during Auto-Tuning is incorrect.	<ul style="list-style-type: none"> Make sure that the input motor nameplate data is correct. Do Auto-Tuning again and correctly set the motor nameplate data.
		Auto-Tuning did not complete in a pre-set length of time.	<ul style="list-style-type: none"> Examine and repair the motor wiring. If the motor and machine are connected during Rotational Auto-Tuning, decouple the motor from the machinery.
		The Auto-Tuning results were not in the applicable parameter setting range.	
		Rotational Auto-Tuning was done with a load that was more than 30% of the rating connected to the motor.	<ul style="list-style-type: none"> Disconnect the machine from the motor and do Rotational Auto-Tuning again. If you cannot uncouple the motor and load, make sure that the load is less than 30% of the motor rating. If a mechanical brake is installed in the motor, release the brake during Rotational Auto-Tuning.

6.8 Auto-Tuning Errors

Code	Name	Causes	Possible Solutions
Er-09	Acceleration Error	The motor did not accelerate for the specified acceleration time.	<ol style="list-style-type: none"> Increase the value set in <i>C1-01 [Acceleration Time 1]</i>. Disconnect the machine from the motor and do Rotational Auto-Tuning again.
		Rotational Auto-Tuning was done with a load that was more than 30% of the rating connected to the motor.	<ul style="list-style-type: none"> Disconnect the machine from the motor and do Rotational Auto-Tuning again. If you cannot uncouple the motor and load, make sure that the load is less than 30% of the motor rating. If a mechanical brake is installed in the motor, release the brake during Rotational Auto-Tuning.
Code	Name	Causes	Possible Solutions
Er-12	Current Detection Error	There is a phase loss in the wiring between the output terminal block (or motor overload) and the motor.	Examine and repair wiring.
		The current exceeded the current rating of the drive.	<ul style="list-style-type: none"> Check the motor wiring for any short circuits between the wires. Check and turn ON any magnetic contactors used between motors. Replace the control board or the drive. For information about replacing the control board, contact Yaskawa or your nearest sales representative.
		The output current is too low.	
		You tried Auto-Tuning without a motor connected to the drive.	Connect the motor and do Auto-Tuning.
		There was a current detection signal error.	Replace the control board or the drive. For information about replacing the control board, contact Yaskawa or your nearest sales representative.
Code	Name	Causes	Possible Solutions
Er-13	Leakage Inductance Error	The motor rated current value is incorrect.	Correctly set the rated current indicated on the motor nameplate and do Auto-Tuning again.
		The drive could not complete tuning for leakage inductance in fewer than 300 s.	Examine and repair motor wiring.
Code	Name	Causes	Possible Solutions
Er-18	Back EMF Error	The result of the induced voltage tuning was not in the applicable range.	<ol style="list-style-type: none"> Make sure that the input motor nameplate data is correct. Do Auto-Tuning again and correctly set the motor nameplate data.
Code	Name	Causes	Possible Solutions
Er-25	HighFreq Inject Param Tuning Err	The motor data is incorrect.	<p>Do Stationary Auto-Tuning again.</p> <p>Note: If the drive detects <i>Er-25</i> after you do Stationary Auto-Tuning, it is possible that the motor cannot use high frequency injection. For more information, contact Yaskawa or your nearest sales representative.</p>

6.9 Backup Function Operating Mode Display and Errors

◆ Operating Mode Display

When the drive does backup function tasks with the HOA keypad, the keypad will show the current task. These indicators do not show that an error has occurred.

Keypad Display	Name	Display	State
Drive and Keypad mismatch. Should the parameters be restored?	Detection of inconsistency between the drive and keypad	Normally displayed	The drive detected the connection of a keypad from a different drive. Select [Yes] to copy parameters backed up in the keypad to the connected drive.
Restore Restore from keypad	Restoring parameters	Flashing	The parameters stored in the keypad have been restored to the drive.
End	Backup/restore/verify operation ended normally	Normally displayed	The parameter backup, restore, or verify operation ended normally.
Backup Backup from Drive	Backing up parameters	Flashing	The parameters stored in the drive are being backed up to the keypad.
Verify Keypad & Drive	Verifying parameters	Flashing	The parameter settings stored in the keypad and the parameter settings in the drive align or are being compared.

◆ Backup Function Runtime Errors

When an error occurs, the keypad shows a code to identify the error.

The table in this section shows the error codes. Refer to this table to remove the cause of the errors.

Note:

Push any key on the keypad to clear an error.

Code	Name	Causes	Possible Solutions
CPyE	Error Writing Data	Parameter restore did not end correctly.	Restore the parameters.
Code	Name	Causes	Possible Solutions
CSEr	Control Mode Mismatch	The keypad is broken.	Replace the keypad.
Code	Name	Causes	Possible Solutions
dFPS	Drive Model Mismatch	You tried to restore parameters to a different drive model than the one that you backed up.	<ol style="list-style-type: none"> Examine the drive model that you used to back up the parameters. Restore the parameters.
Code	Name	Causes	Possible Solutions
iFEr	Keypad Communication Error	There was a communications error between the keypad and the drive.	Examine the connector or cable connection.
Code	Name	Causes	Possible Solutions
ndAT	Error Received Data	The parameter settings for model and specifications (power supply voltage and capacity) are different between the keypad and the drive.	<ol style="list-style-type: none"> Make sure that drive model and the value set in <i>o2-04 [Drive Model (KVA) Selection]</i> agree. Restore the parameters.
		The parameters are not stored in the keypad.	<ol style="list-style-type: none"> Connect a keypad that has the correct parameters. Restore the parameters.
Code	Name	Causes	Possible Solutions
rdEr	Error Reading Data	You tried to back up the data when <i>o3-02 = 0 [Copy Allowed Selection = Disabled]</i> .	Set <i>o3-02 = 1 [Enabled]</i> and back up again.
Code	Name	Causes	Possible Solutions
vAEr	Voltage Class, Capacity Mismatch	The power supply specifications or drive capacity parameter settings are different between the keypad and the drive.	<ol style="list-style-type: none"> Make sure that drive model and the value set in <i>o2-04 [Drive Model (KVA) Selection]</i> agree. Restore the parameters.
Code	Name	Causes	Possible Solutions
vFyE	Parameters do not Match	The parameters that are backed up in the keypad and the parameters in the drive are not the same.	<ol style="list-style-type: none"> Restore or backup the parameter again. Verify the parameters.

6.10 Bypass Status Messages

The bypass HOA keypad will show these status messages on line 1 of the keypad display during the conditions listed below. These are not faults or alarms.

Keypad Display	Description
Powering Up	Shown on initial power up of the bypass system. This message goes away when the power up initialization is complete and communication is established to the drive, or when the bypass determines that the drive is not connected or energized.
Idle	The bypass is in an Idle state with no active Run command. There are no active faults or alarms.
Drive Not Ready	The drive is not in a ready state. The drive will not run if a Run command is asserted. You can run the system in Bypass Mode.
Safety Open	A safety programmed to a bypass digital input is not closed and there is no active Run command. This message will change to an alarm when there is an active Run command.
Fire Stat Open	A Fire Stat safety programmed to a bypass digital input is not closed and there is no active Run command. This message will change to an alarm when there is an active Run command.
Freeze Stat Open	A Freeze Stat safety programmed to a bypass digital input is not closed and there is no active Run command. This message will change to an alarm when there is an active Run command.
Smoke Alarm active	A Smoke Alarm safety programmed to a bypass digital input is not closed and there is no active Run command. This message will change to an alarm when there is an active Run command.
Over Pressure Detected	An Over Pressure safety programmed to a bypass digital input is not closed and there is no active Run command. This message will change to an alarm when there is an active Run command.
Low Suction Detected	A Low Suction safety programmed to a bypass digital input is not closed and there is no active Run command. This message will change to an alarm when there is an active Run command.
Vibration Detected	A Vibration safety programmed to a bypass digital input is not closed and there is no active Run command. This message will change to an alarm when there is an active Run command.
Interlock Open	Programmed BAS Interlock is not closed. The unit will not run when it receives a Run command.
Drive Pre Running	The drive received a Run command and the drive is entering the programmed pre-run. When the pre-run conditions are finished, the drive will enter drive run.
Drive Run Commanded	The bypass has commanded the drive to run, but it has not yet detected that the drive is running.
Restart Delay Active	There is an active Run Command, but the programmed restart delay is active and the drive cannot run. The keypad shows this display on power-up or when there is a brief power loss to the bypass unit.
Drive Running	The unit is running in Drive Mode.
Drive Stopping	The Run command to the drive was removed, and the drive is ramping to stop.
Running in Bypass	The unit is running in Bypass Mode.
Entering Energy Savings	Energy savings conditions have been detected. This functionality is programmed using parameters Z1-16 through Z1-23. When entering energy savings, the unit is running at the energy savings bump frequency and when it is finished, it will switch into the bypass run state.
Energy Savings Active	Energy Savings Mode is active and the unit is running in Bypass Mode.
Exiting Energy Savings	Energy Savings conditions are no longer present and the unit is leaving Energy Savings and returning to Drive Mode. The exit conditions are when the frequency reference changes from the programmed Energy Savings frequency reference in Z1-17.
Auto Transfer Active	Auto transfer was enabled in Z1-05 and the unit detected a drive fault during an active drive run. The unit will run in Bypass Mode.
Remote Transfer Active	A Remote Transfer was asserted and the unit is currently running in Bypass Mode.
Emergency Override Drive FWD	An Emergency Override Drive FWD was asserted by a bypass digital input or through serial or option board communications to the bypass board.
Emergency Override Drive REV	An Emergency Override Drive REV was asserted by a bypass digital input or through serial or option board communications to the bypass board.
Emergency Override Bypass	An Emergency Override Bypass was asserted by a bypass digital input or through serial or option board communications to the bypass board. This message also appears when Emergency Override Drive was active, there was a drive fault, and Z1-10 = 1 [Transfer to Bypass].
Faulted	The unit is in Drive Mode it detected a drive fault or bypass fault, or the unit is in Bypass Mode and it detected a bypass-specific fault.
Soft Start On Delay	There is a Run command and the unit is waiting for the programmed on delay time in Z1-43 before asserting the soft starter run.
Soft Starter Ramping down	Parameter Z1-42 = 2 [Ramp to Stop] and the Run command was removed. The soft starter will ramp to stop.

6.11 Diagnosing and Resetting Faults

When a fault occurs and the drive stops, do the procedures in this section to remove the cause of the fault, then re-energize the drive.

◆ Fault and Power Loss Occur at the Same Time

WARNING! Crush Hazard. Wear eye protection when you do work on the bypass. If you do not use correct safety equipment, it can cause serious injury or death.

WARNING! Electrical Shock Hazard. After the bypass blows a fuse or trips a GFCI, do not immediately energize the bypass or operate peripheral devices. Wait for the time specified on the warning label at a minimum and make sure that all indicators are OFF. Then check the wiring and peripheral device ratings to find the cause of the problem. If you do not know the cause of the problem, contact Yaskawa before you energize the bypass or peripheral devices. If you do not fix the problem before you operate the bypass or peripheral devices, it can cause serious injury or death.

1. Connect to the USB connector on the bypass PCB and use DriveWizard HVAC software.
2. Connect to the drive, then select “Status & Fault History” to show fault codes and operating status of the bypass immediately before the fault occurred.
3. Use the information in the Troubleshooting tables to remove the fault.

Note:

1. To find the faults that were triggered, check the fault history in U2-02 [Previous Fault]. To find information about drive status (such as frequency, current, and voltage) when the faults were triggered, check U2-03 to U2-20.
2. If the fault display stays after you re-energize the drive, remove the cause of the fault and reset.

◆ Fault Occurs Without Power Loss

1. Examine the fault code shown on the keypad.
2. Use the information in the Troubleshooting tables to remove the fault.
3. Do a fault reset.



◆ Fault Reset

If a fault occurs, you must remove the cause of the fault and re-energize the drive. Table 6.5 lists the different methods to reset the drive after a fault.

Note:

You must remove the Run command or make sure that the bypass is in the OFF state before you can do a fault reset.

Table 6.5 Fault Reset Methods

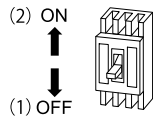
Methods	Description
Method 1	While the keypad is showing the fault or alarm code, push  (Reset) or  on the keypad.
Method 2	Switch ON the MFDI Terminal set to Z2-0x = 34 [Bypass MFDI Function Select = Fault Reset].
Method 3	<ol style="list-style-type: none"> 1. De-energize the drive main circuit power supply. 2. Energize the drive again after the keypad display goes out. 

Note:

If the drive receives a Run command from a communication option or control circuit terminal, the drive will not reset the fault. Remove the Run command then try to clear the fault. If you do a fault reset when the drive has a Run command, the keypad will show minor fault C_rST [Remove RUN Command to Reset].

6.12 Troubleshooting Without Fault Display

Note:

Make sure that you use a keypad with FLASH number 1004 or later. Keypads with FLASH numbers 1003 and earlier will not show characters correctly.

If the bypass or motor operate incorrectly, but the keypad does not show a fault or error code, refer to the items this section.

- Motor hunting and oscillation
- Unsatisfactory motor torque
- Unsatisfactory speed precision
- Unsatisfactory motor torque and speed response
- Motor noise





◆ Typical Problems

Symptom	Reference
The Parameter Settings Will Not Change	520
The Motor Does Not Rotate After Entering Run Command	521
The Motor Rotates in the Opposite Direction from the Run Command	521
The Motor Rotates in Only One Direction	522
The Motor Is Too Hot	522
oPE02 Error Occurs When Decreasing the Motor Rated Current Setting	522
The Motor Stalls during Acceleration or Accel/Decel Time Is Too Long	522
The Drive Frequency Reference Is Different than the Controller Frequency Reference Command	523
There Is Too Much Motor Oscillation and the Rotation Is Irregular	523
There Is Audible Noise from the Drive or Motor Cables When the Drive Is Energized	524
The Ground Fault Circuit Interrupter (GFCI) Trips During Run	524
Motor Rotation Causes Unexpected Audible Noise from Connected Machinery	524
Motor Rotation Causes Oscillation or Hunting	524
PID Output Fault	525
The Motor Rotates after the Drive Output Is Shut Off	525
The Output Frequency Is Lower Than the Frequency Reference	525
The Motor Is Making an Audible Noise	525
The Motor Will Not Restart after a Loss of Power	525

◆ The Parameter Settings Will Not Change

Causes	Possible Solutions
The drive is operating the motor (the drive is in Drive Mode).	Stop the drive and change to Programming Mode.
Parameter $A1-01 = 0$ [Access Level Selection = Operation Only].	Set $A1-01 = 2$ [Access Level Selection = Advanced Level] or $A1-01 = 3$ [Expert Level].
You entered an incorrect password in $A1-04$ [Password].	<ul style="list-style-type: none"> • Enter the correct password to $A1-04$ again. • If you forgot the password, set the password again with $A1-04$ and $A1-05$ [Password Setting]. <p>Note: If you set the password, you cannot change these parameters until the password aligns:</p> <ul style="list-style-type: none"> • $A1-01$ [Access Level Selection] • $A1-03$ [Initialize Parameters] • $A1-06$ [Application Preset] • $A2-01$ to $A2-32$ [User Parameter 1 to User Parameter 32]
The drive detected Uv [Undervoltage].	<ul style="list-style-type: none"> • View $U1-07$ [DC Bus Voltage] to see the power supply voltage. • Examine the main circuit wiring.

◆ The Motor Does Not Rotate After Entering Run Command

Causes	Possible Solutions
The drive is not in Drive Mode.	<ol style="list-style-type: none"> 1. Make sure that the keypad shows [Rdy]. 2. If the keypad does not show [Rdy], go back to the Home screen.
Auto-Tuning completed.	Go back to the Home screen on the keypad. Note: When Auto-Tuning completes, the drive changes to Programming Mode. The drive will not accept a Run command unless the drive is in Drive Mode.
The drive stopped, you pushed  , and changed the Run command source to the keypad.	Do one of these two: <ul style="list-style-type: none"> • Push . • Re-energize the drive.
The drive received a fast stop command.	Turn off the fast stop input signal.
The settings for the source that supplies the Run command are incorrect.	Set <i>b1-02 [Run Command Selection 1]</i> correctly.
The frequency reference source is set incorrectly.	Set <i>b1-01 [Frequency Reference Selection 1]</i> correctly.
There is defective wiring in the control circuit terminals.	<ul style="list-style-type: none"> • Correctly wire the drive control circuit terminals. • View <i>Ub-02 [Bypass Digital Input Status]</i> for input terminal status.
The settings for voltage input and current input of the master frequency reference are incorrect.	Examine terminal TB4-2: Switch S2 and Z2-30 [<i>Analog Input Signal Level Select</i>] signal level settings:
The frequency reference is too low.	<ul style="list-style-type: none"> • View <i>U1-01 [Freq Reference]</i>. • Increase the frequency reference to a value higher than <i>E1-09 [Minimum Output Frequency]</i>.
The MFAI setting is incorrect.	Make sure that the settings for the analog input (TB4-2 on th bypass controller) are correct: <ul style="list-style-type: none"> • Z3-32 [<i>Analog Input Gain Setting</i>] • Z3-33 [<i>Analog Input Bias Setting</i>]
 was pushed.	Turn the Run command OFF then ON from an external input. Note: When you push  during operation, the drive will coast to stop. Set <i>o2-02 = 0 [STOP Key Function Selection = Disabled]</i> to disable the  function.

◆ The Motor Rotates in the Opposite Direction from the Run Command in Drive Mode

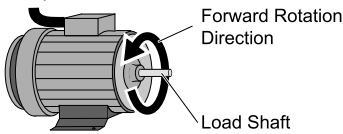
Causes	Possible Solutions
The phase wiring between the drive and motor is incorrect.	<ul style="list-style-type: none"> • Examine the wiring between the drive and motor. • Connect bypass Motor Output Terminals TB1-1, TB1-2, and TB1-3 in correct sequence to agree with motor terminals U, V, and W. • Switch two motor cables TB1-1, TB1-2, and TB1-3 to reverse motor direction.
The forward direction for the motor is set incorrectly.	<ul style="list-style-type: none"> • Connect bypass Motor Output Terminals TB1-1, TB1-2, and TB1-3 in correct sequence to agree with motor terminals U, V, and W. • Switch two motor cables TB1-1, TB1-2, and TB1-3 to reverse motor direction. <div style="text-align: center;">  <p>Forward Rotation Direction</p> <p>Load Shaft</p> </div> <p>Figure 6.1 Forward Rotating Motor</p> <p>Note:</p> <ul style="list-style-type: none"> • For Yaskawa motors, the forward direction is counterclockwise when looking from the motor shaft side. • Refer to the motor specifications, and make sure that the forward rotation direction is correct for the application. The forward rotation direction of motors can be different for different motor manufacturers and types.
The signal connections for forward run and reverse run on the drive control circuit terminals and control panel side are incorrect.	Correctly wire the control circuit.
The motor is running at almost 0 Hz and the Speed Search estimated the speed to be in the opposite direction.	Set <i>b3-14 = 0 [Bi-directional Speed Search = Disabled]</i> , then the drive will only do speed search in the specified direction.

◆ The Motor Rotates in the Opposite Direction from the Run Command in Bypass Mode

Causes	Possible Solutions
The power coming into the bypass is connected incorrectly.	Switch any two incoming power cables at the circuit breaker or disconnect switch.

◆ The Motor Rotates in Only One Direction

Causes	Possible Solutions
The drive will not let the motor rotate in reverse.	Set $b1-04 = 0$ [Reverse Operation Selection = Reverse Enabled].

◆ The Motor Is Too Hot

Causes	Possible Solutions
The load is too heavy.	<ul style="list-style-type: none"> Decrease the load. Increase the acceleration and deceleration times. Examine the values set in $L1-01$ [Motor Overload (oL1) Protection], $L1-02$ [Motor Overload Protection Time], and $E2-01$ [Motor Rated Current (FLA)]. Use a larger motor. <p>Note: The motor also has a short-term overload rating. Examine this rating carefully before setting drive parameters.</p>
The motor is running continuously at a very low speed.	<ul style="list-style-type: none"> Change the run speed. Use a drive-dedicated motor.
The voltage insulation between motor phases is not sufficient.	<ul style="list-style-type: none"> Use a motor with a voltage tolerance that is higher than the maximum voltage surge. Use a drive-dedicated motor that is rated for use with AC drives for applications that use a motor on drives rated higher than 480 V. Install an AC reactor on the output side of the drive and set $C6-02 = 1$ [Carrier Frequency Selection = 2.0 kHz]. <p>Note: When the motor is connected to the drive output terminals U/T1, V/T2, and W/T3, surges occur between the drive switching and the motor coils. These surges can be three times the drive input power supply voltage (600 V for a 208/240 V bypass, 1200 V for a 480 V bypass).</p>
The air around the motor is too hot.	<ul style="list-style-type: none"> Measure the ambient temperature. Decrease the temperature in the area until it is in the specified temperature range.
The motor fan stopped or is clogged.	<ul style="list-style-type: none"> Clean the motor fan. Make the drive environment better.

◆ oPE02 Error Occurs When Decreasing the Motor Rated Current Setting

Causes	Possible Solutions
Motor rated current and the motor no-load current setting in the drive are incorrect.	<ul style="list-style-type: none"> You are trying to set the motor rated current in $E2-01$ [Motor Rated Current (FLA)] to a value lower than the no-load current set in $E2-03$ [Motor No-Load Current]. Make sure that value set in $E2-01$ is higher than $E2-03$. If it is necessary to set $E2-01$ lower than $E2-03$, first decrease the value set to $E2-03$, then change the $E2-01$ setting as necessary.

◆ The Motor Stalls during Acceleration or Accel/Decel Time Is Too Long

Causes	Possible Solutions
The drive and motor system reached the torque limit or current suppression will not let the drive accelerate.	<ul style="list-style-type: none"> Decrease the load. Use a larger motor. <p>Note: Although the drive has a Stall Prevention function and a Torque Compensation Limit function, accelerating too fast or trying to drive a load that is too large can exceed the limits of the motor.</p>
Torque limit is set incorrectly.	Set the torque limit correctly.
The acceleration time setting is too short.	Examine the values set in $C1-01$ or $C1-03$ [Acceleration Times] and set them to applicable values.

Causes	Possible Solutions
The load is too heavy.	<ul style="list-style-type: none"> • Increase the acceleration time. • Examine the mechanical brake and make sure that it is fully releasing. • Decrease the load to make sure that the output current stays less than the motor rated current. • Use a larger motor. <p>Note:</p> <ul style="list-style-type: none"> • In extruder and mixer applications, the load can increase as the temperature decreases. • Although the drive has a Stall Prevention function and a Torque Compensation Limit function, accelerating too fast or trying to drive a load that is too large can exceed the limits of the motor.
The frequency reference is low.	<ul style="list-style-type: none"> • Examine <i>E1-04 [Maximum Output Frequency]</i> and increase the setting if it is set too low. • Examine <i>U1-01 [Frequency Reference]</i> for the correct frequency reference. • Examine the multi-function input terminals to see if a frequency reference signal switch has been set. • Examine the value of <i>Z2-32 [Analog Input Gain Setting]</i> when you use a bypass analog input.
The frequency reference is set incorrectly.	<p>When <i>H3-02, H3-10 = 1 [MFAI Function Selection = Frequency Gain]</i> are set, see if voltage (current) has been set.</p> <ul style="list-style-type: none"> • Check the values set in <i>H3-02 and H3-10</i>. • Use <i>U1-13 and U1-14 [Terminal A1, A2 Input Voltage]</i> or <i>Ub-22 [Bypass Analog Input]</i> to make sure that the analog input values set into terminal A1, A2, and TB4-2 are applicable.
The motor characteristics and drive parameter settings are not compatible.	<ul style="list-style-type: none"> • Set the correct V/f pattern to agree with the characteristics of the motor. • Examine the V/f pattern set in <i>E1-03 [V/f Pattern Selection]</i>. • Perform Rotational Auto-Tuning.
The Stall Prevention level during acceleration setting is too low.	<p>Increase the value set in <i>L3-02 [Stall Prevent Level during Accel]</i>.</p> <p>Note:</p> <p>If the <i>L3-02</i> value is too low, the acceleration time can be unsatisfactorily long.</p>
The Stall Prevention level during run setting is too low.	<p>Increase the value set in <i>L3-06 [Stall Prevent Level during Run]</i>.</p> <p>Note:</p> <p>If the <i>L3-06</i> value is too low, speed will decrease while the drive outputs torque.</p>
Drive reached the limitations of the V/f motor control method.	<ul style="list-style-type: none"> • When the motor cable is longer than 50 m (164 ft), do Auto-Tuning for line-to-line resistance. • Set the V/f pattern to "High Starting Torque".

◆ The Drive Frequency Reference Is Different than the Controller Frequency Reference Command

Causes	Possible Solutions
The analog input gain and bias for the frequency reference input are set incorrectly.	<p>Examine the gain and bias settings for the analog inputs that set the frequency reference.</p> <ul style="list-style-type: none"> • Terminal TB4-2: <i>Z2-30 [Analog Input Signal Level Select]</i>, <i>Z2-32 [Analog Input Gain Setting]</i>, <i>Z2-33 Analog Input Bias Setting</i>.
The drive is receiving frequency gain and bias signals from the analog input terminals A1 and A2.	<ul style="list-style-type: none"> • Examine <i>H3-02, H3-10 [MFAI Function Selection]</i>. If these are set for either <i>1 [Frequency Gain]</i> or <i>D [Frequency Bias]</i>, change the settings. • Use <i>U1-13 and U1-14 [Terminal A1, A2 Input Voltage]</i> to make sure that the analog input values set to terminals A1 and A2 are applicable.
PID control is enabled.	<p>If PID control is not necessary, set <i>b5-01 = 0 [PID Mode Setting = Disabled]</i>.</p> <p>Note:</p> <p>When PID control is enabled, the drive adjusts the output frequency as specified by the target value. The drive will only accelerate to the maximum output frequency set in <i>E1-04 [Maximum Output Frequency]</i> while PID control is active.</p>

◆ There Is Too Much Motor Oscillation and the Rotation Is Irregular

Causes	Possible Solutions
Unsatisfactory balance of motor phases.	<ul style="list-style-type: none"> • Make sure that the drive input power voltage supplies stable power. • Set <i>L8-05 = 0 [Input Phase Loss Protect Select = Disabled]</i>.
The motor is hunting.	Set <i>n1-01 = 1 [Hunting Prevention Selection = Enabled]</i> .

◆ There Is Audible Noise from the Drive or Motor Cables When the Drive Is Energized

Causes	Possible Solutions
The output transistor switching in the drive is making too much noise.	<ul style="list-style-type: none"> • Use <i>C6-02 [Carrier Frequency Selection]</i> to increase the carrier frequency. • Connect a noise filter to the input side of the drive power supply. • Connect a noise filter to the output side of the drive. • Isolate the control circuit wiring from the main circuit wiring. • Use a metal cable gland to wire the drive. • Shield the periphery of the drive with metal. • Make sure that the drive and motor are grounded correctly. • Make sure that ground faults have not occurred in the wiring or motor.

◆ The Ground Fault Circuit Interrupter (GFCI) Trips During Run

Causes	Possible Solutions
There is too much leakage current from the drive.	<ul style="list-style-type: none"> • Increase the GFCI sensitivity or use GFCI with a higher threshold. • Use <i>C6-02 [Carrier Frequency Selection]</i> to decrease the carrier frequency. • Decrease the length of the cable used between the drive and the motor. • Install a noise filter or AC reactor on the output side of the drive. Set <i>C6-02 = 1 [2.0 kHz]</i> when connecting an AC reactor. • Disable the internal EMC filter.

◆ Motor Rotation Causes Unexpected Audible Noise from Connected Machinery

Causes	Possible Solutions
The carrier frequency and the resonant frequency of the connected machinery are the same.	<ul style="list-style-type: none"> • Adjust <i>C6-02 to C6-05 [Carrier Frequency]</i>. • Set <i>C6-02 = 1 to 6 [Carrier Frequency Selection = Frequency other than Swing PWM]</i>. <p>Note: If <i>C6-02 = 7 to A [Carrier Frequency Selection = Swing PWM]</i>, the drive will not know if the noise comes from the drive or the machine.</p>
The drive output frequency and the resonant frequency of the connected machinery are the same.	<ul style="list-style-type: none"> • Adjust <i>d3-01 to d3-04 [Jump Frequency]</i>. • Put the motor on a rubber pad to decrease vibration.

◆ Motor Rotation Causes Oscillation or Hunting

Causes	Possible Solutions
The frequency reference is assigned to an external source, and there is electrical interference in the signal.	<p>Make sure that electrical interference does not have an effect on the signal lines.</p> <ul style="list-style-type: none"> • Isolate control circuit wiring from main circuit wiring. • Use twisted-pair cables or shielded wiring for the control circuit. • Increase the value of <i>H3-13 [Analog Input Filter Time Constant]</i>.
The cable between the drive and motor is too long.	<ul style="list-style-type: none"> • Do Auto-Tuning. • Make the wiring as short as possible.
The PID parameters are not sufficiently adjusted.	Adjust <i>b5-xx [PID control]</i> .

◆ PID Output Fault

Causes	Possible Solutions
There is no PID feedback input.	<ul style="list-style-type: none"> Examine the MFAI terminal settings. See if H3-02, H3-10 = B [MFAI Function Selection = PID Feedback] is set. Make sure that the MFAI terminal settings agree with the signal inputs. Examine the connection of the feedback signal. Make sure that b5-xx [PID Control] is set correctly. <p>Note: If there is no PID feedback input to the terminal, the detected value is 0, which causes a PID fault and also causes the drive to operate at maximum frequency.</p>
The detection level and the target value do not agree.	<p>Use H3-03, H3-11 [Terminal A1, A2 Gain Setting] to adjust PID target and feedback signal scaling.</p> <p>Note: PID control keeps the difference between the target value and detection value at 0. Set the input level for the values relative to each other.</p>
Reverse drive output frequency and speed detection. When output frequency increases, the sensor detects a speed decrease.	Set b5-09 = 1 [PID Output Level Selection = Reverse Output (Reverse Acting)].

◆ The Motor Rotates after the Drive Output Is Shut Off

Causes	Possible Solutions
DC Injection Braking is too low and the drive cannot decelerate correctly.	<ul style="list-style-type: none"> Increase the value set in b2-02 [DC Injection Braking Current]. Increase the value set in b2-04 [DC Inject Braking Time at Stop].
The stopping method makes the drive coast to stop.	Set b1-03 = 0 or 2 [Stopping Method Selection = Ramp to Stop, DC Injection Braking to Stop].

◆ The Output Frequency Is Lower Than the Frequency Reference

Causes	Possible Solutions
The frequency reference is in the Jump frequency range.	<p>Adjust d3-01 to d3-03 [Jump Frequency 1 to 3] and d3-04 [Jump Frequency Width].</p> <p>Note: Enabling the Jump frequency prevents the drive from outputting the frequencies specified in the Jump range.</p>
The upper limit for the frequency reference has been exceeded.	<p>Set E1-04 [Maximum Output Frequency] and d2-01 [Frequency Reference Upper Limit] to the best values for the application.</p> <p>Note: This calculation supplies the upper value for the output frequency: $E1-04 \times d2-01 / 100$</p>
A large load triggered Stall Prevention function during acceleration.	<ul style="list-style-type: none"> Decrease the load. Adjust L3-02 [Stall Prevent Level during Accel].
L3-01 = 3 [Stall Prevention during Accel = Current Limit Method] has been set.	<ol style="list-style-type: none"> Make sure that the V/f pattern and motor parameter settings are appropriate, and set them correctly. If this does not solve the problem, and it is not necessary to limit the current level of stall during acceleration, adjust L3-02. If this does not solve the problem, set L3-01 = 1 [Enabled].
The motor is rotating at this speed: $b2-01$ [DC Injection/Zero SpeedThreshold] \leq Motor Speed $<$ $E1-09$ [Minimum Output Frequency]	Set E1-09 $<$ b2-01.

◆ The Motor Is Making an Audible Noise

Causes	Possible Solutions
100% of the rated output current of the drive was exceeded while operating at low speeds.	<ul style="list-style-type: none"> If the sound is coming from the motor, set L8-38 = 0 [Carrier Frequency Reduction = Disabled]. If oL2 [Drive Overloaded] occurs frequently after setting L8-38 = 0, replace the drive with a high-capacity drive.

◆ The Motor Will Not Restart after a Loss of Power

Causes	Possible Solutions
The drive did not receive a Run command after applying power.	<ul style="list-style-type: none"> Examine the sequence and wiring that enters the Run command. Set up a relay to make sure that the Run command stays enabled during a loss of power.

Specifications

7.1	Section Safety	528
7.2	208 V Narrow Model Specifications	529
7.3	480 V Narrow Model Specifications	531
7.4	208 V Enclosed Model Specifications	533
7.5	240 V Enclosed Model Specifications	535
7.6	480 V Enclosed Model Specifications	537
7.7	Common Bypass Specifications	539
7.8	Drive Watt Loss	541
7.9	Drive Derating	543
7.10	Peripheral Devices and Options	548

7.1 Section Safety

 **DANGER**

Do not ignore the safety messages in this manual.

If you ignore the safety messages in this manual, it will cause serious injury or death. The manufacturer is not responsible for injuries or damage to equipment.

7.2 208 V Narrow Model Specifications

Table 7.1 208 V Narrow Ratings

Model		D002	D003	D004	D007	D010	D016
Maximum Applicable Motor Output (HP) *2		0.5	0.75	1	2	3	5
Input	Rated Input Current (A)	2.9	4.0	5.1	8.0	11.1	17.2
	Rated Voltage Rated Frequency	Three-Phase 208 Vac 50/60 Hz					
	Allowable Voltage Fluctuation	-15 to 10%					
	Allowable Frequency Fluctuation	±5%					
Output	Rated Output Current (A)	2.4 *3	3.5 *3	4.6 *3	7.5 *3	10.6 *3	16.7 *3
	Minimum Applicable Motor Current (A)	1.5	1.5	1.5	1.5	1.5	3.75
	Overload Tolerance	110% of rated output current for 60 s 150% peak					
	Carrier Frequency	User adjustable between 1 and 12.5 kHz (Maximum Frequency varies with Rated Output Capacity)					
	Maximum Output Voltage (V)	Three-Phase 208 Vac					
	Maximum Output Frequency (Hz)	240 Hz					
Harmonics Reduction	Input Power (kVA)	Built-in					
EMC	Filter (IEC/EN 61800-3 Category 2)	Built-in					

- *1 The maximum applicable motor output is based on 4-pole, general-purpose 220 V motor ratings. The rated output current of the drive output amps must be equal to or more than the motor rated current.
- *2 The maximum applicable motor output complies with 208 V motor ratings as specified in NEC Table 430.250. The rated output current of the drive output amps must be equal to or more than the motor rated current.
- *3 Carrier frequency is 5 kHz. You must derate the current to increase the carrier frequency.

Table 7.2 208 V Narrow Ratings

Model		D024	D030	D046	D059	D074
Maximum Applicable Motor Output (HP) *2		7.5	10	15	20	25
Input	Rated Input Current (A)	24.7	31.3	46.7	59.9	75.3
	Rated Voltage Rated Frequency	Three-Phase 208 Vac 50/60 Hz				
	Allowable Voltage Fluctuation	-15 to 10%				
	Allowable Frequency Fluctuation	±5%				
Output	Rated Output Current (A)	24.2 *3	30.8 *3	46.2 *3	59.4 *3	74.8 *3
	Minimum Applicable Motor Current (A)	3.75	3.75	7.5	7.5	15
	Overload Tolerance	110% of rated output current for 60 s 150% peak				
	Carrier Frequency	User adjustable between 1 and 12.5 kHz (Maximum Frequency varies with Rated Output Capacity)				
	Maximum Output Voltage (V)	Three-Phase 208 Vac				
	Maximum Output Frequency (Hz)	240 Hz				
Harmonics Reduction	Input Power (kVA)	Built-in				
EMC	Filter (IEC/EN 61800-3 Category 2)	Built-in				

- *1 The maximum applicable motor output is based on 4-pole, general-purpose 220 V motor ratings. The rated output current of the drive output amps must be equal to or more than the motor rated current.

7.2 208 V Narrow Model Specifications

- *2 The maximum applicable motor output complies with 208 V motor ratings as specified in NEC Table 430.250. The rated output current of the drive output amps must be equal to or more than the motor rated current.
- *3 Carrier frequency is 5 kHz. You must derate the current to increase the carrier frequency.

7.3 480 V Narrow Model Specifications

Table 7.3 480 V Narrow Ratings

Model		B1P1	B001	B002	B003	B004	B007	B011	B014
Maximum Applicable Motor Output (HP) *2		0.5	0.75	1	2	3	5	7.5	10
Input	Rated Input Current (A)	1.3	1.8	2.3	3.6	5.0	7.8	11.2	14.2
	Rated Voltage Rated Frequency	Three-Phase 480 Vac 50/60 Hz							
	Allowable Voltage Fluctuation	-15 to 10%							
	Allowable Frequency Fluctuation	±5%							
Output	Rated Output Current (A)	1.1 *3	1.6 *3	2.1 *3	3.4 *3	4.8 *3	7.6 *3	11.0 *3	14.0 *3
	Minimum Applicable Motor Current (A)	1.5	1.5	1.5	1.5	1.5	1.5	1.5	3.75
	Overload Tolerance	110% of rated output current for 60 s 150% peak							
	Carrier Frequency	User adjustable between 1 and 12.5 kHz (Maximum Frequency varies with Rated Output Capacity)							
	Maximum Output Voltage (V)	Three-Phase 480 Vac							
	Maximum Output Frequency (Hz)	240 Hz							
Harmonics Reduction	Input Power (kVA)	Built-in							
EMC	Filter (IEC/EN 61800-3 Category 2)	Built-in							

- *1 The maximum applicable motor output is based on 4-pole, general-purpose 220 V motor ratings. The rated output current of the drive output amps must be equal to or more than the motor rated current.
- *2 The maximum applicable motor output complies with 208 V motor ratings as specified in NEC Table 430.250. The rated output current of the drive output amps must be equal to or more than the motor rated current.
- *3 Carrier frequency is 5 kHz. You must derate the current to increase the carrier frequency.

Table 7.4 480 V Narrow Ratings

Model		B021	B027	B034	B040	B052	B065	B077	
Maximum Applicable Motor Output (HP) *2		15	20	25	30	40	50	60	
Input	Rated Input Current (A)	21.2	27.2	34.2	40.2	52.2	65.2	77.2	
	Rated Voltage Rated Frequency	Three-Phase 480 Vac 50/60 Hz							
	Allowable Voltage Fluctuation	-15 to 10%							
	Allowable Frequency Fluctuation	±5%							
Output	Rated Output Current (A)	21.0 *3	27.0 *3	34.0 *3	40.0 *3	52.0 *3	65.0 *3	77.0 *3	
	Minimum Applicable Motor Current (A)	3.75	3.75	7.5	7.5	7.5	7.5	15	
	Overload Tolerance	110% of rated output current for 60 s 150% peak							
	Carrier Frequency	User adjustable between 1 and 12.5 kHz (Maximum Frequency varies with Rated Output Capacity)							
	Maximum Output Voltage (V)	Three-Phase 480 Vac							
	Maximum Output Frequency (Hz)	240 Hz							

7.3 480 V Narrow Model Specifications

Model		B021	B027	B034	B040	B052	B065	B077
Harmonics Reduction	Input Power (kVA)	Built-in						
EMC	Filter (IEC/EN 61800-3 Category 2)	Built-in						

- *1 The maximum applicable motor output is based on 4-pole, general-purpose 220 V motor ratings. The rated output current of the drive output amps must be equal to or more than the motor rated current.
- *2 The maximum applicable motor output complies with 208 V motor ratings as specified in NEC Table 430.250. The rated output current of the drive output amps must be equal to or more than the motor rated current.
- *3 Carrier frequency is 5 kHz. You must derate the current to increase the carrier frequency.

7.4 208 V Enclosed Model Specifications

Table 7.5 208 V Enclosed Ratings

Model		D002	D003	D004	D007	D010	D016
Maximum Applicable Motor Output (HP) *2		0.5	0.75	1	2	3	5
Input	Rated Input Current (A)	3.8	4.9	6.0	8.9	12.0	18.1
	Rated Voltage Rated Frequency	Three-Phase 208 Vac 50/60 Hz					
	Allowable Voltage Fluctuation	-15 to 10%					
	Allowable Frequency Fluctuation	±5%					
Output	Rated Output Current (A)	2.4 *3	3.5 *3	4.6 *3	7.5 *3	10.6 *3	16.7 *3
	Minimum Applicable Motor Current (A)	1.5	1.5	1.5	1.5	1.5	3.75
	Overload Tolerance	110% of rated output current for 60 s 150% peak					
	Carrier Frequency	User adjustable between 1 and 12.5 kHz (Maximum Frequency varies with Rated Output Capacity)					
	Maximum Output Voltage (V)	Three-Phase 208 Vac					
	Maximum Output Frequency (Hz)	240 Hz					
Harmonics Reduction	Input Power (kVA)	Built-in					
EMC	Filter (IEC/EN 61800-3 Category 2)	Built-in					

- *1 The maximum applicable motor output is based on 4-pole, general-purpose 220 V motor ratings. The rated output current of the drive output amps must be equal to or more than the motor rated current.
- *2 The maximum applicable motor output complies with 208 V motor ratings as specified in NEC Table 430.250. The rated output current of the drive output amps must be equal to or more than the motor rated current.
- *3 Carrier frequency is 5 kHz. You must derate the current to increase the carrier frequency.

Table 7.6 208 V Enclosed Ratings

Model		D024	D030	D046	D059	D074
Maximum Applicable Motor Output (HP) *2		7.5	10	15	20	25
Input	Rated Input Current (A)	25.6	32.2	48.6	61.8	77.2
	Rated Voltage Rated Frequency	Three-Phase 208 Vac 50/60 Hz				
	Allowable Voltage Fluctuation	-15 to 10%				
	Allowable Frequency Fluctuation	±5%				
Output	Rated Output Current (A)	24.2 *3	30.8 *3	46.2 *3	59.4 *3	74.8 *3
	Minimum Applicable Motor Current (A)	3.75	3.75	7.5	7.5	15
	Overload Tolerance	110% of rated output current for 60 s 150% peak				
	Carrier Frequency	User adjustable between 1 and 12.5 kHz (Maximum Frequency varies with Rated Output Capacity)				
	Maximum Output Voltage (V)	Three-Phase 208 Vac				
	Maximum Output Frequency (Hz)	240 Hz				
Harmonics Reduction	Input Power (kVA)	Built-in				
EMC	Filter (IEC/EN 61800-3 Category 2)	Built-in				

- *1 The maximum applicable motor output is based on 4-pole, general-purpose 220 V motor ratings. The rated output current of the drive output amps must be equal to or more than the motor rated current.

7.4 208 V Enclosed Model Specifications

- *2 The maximum applicable motor output complies with 208 V motor ratings as specified in NEC Table 430.250. The rated output current of the drive output amps must be equal to or more than the motor rated current.
- *3 Carrier frequency is 5 kHz. You must derate the current to increase the carrier frequency.

Table 7.7 208 V Enclosed Ratings

Model		D088	D114	D143	D169	D211	D273
Maximum Applicable Motor Output (HP) *2		30	40	50	60	75	100
Input	Rated Input Current (A)	90.4	116.4	145.4	171.4	212.4	275.4
	Rated Voltage Rated Frequency	Three-Phase 208 Vac 50/60 Hz					
	Allowable Voltage Fluctuation	-15 to 10%					
	Allowable Frequency Fluctuation	±5%					
Output	Rated Output Current (A)	88 *3	114 *3	143 *3	169 *3	211 *3	273 *3
	Minimum Applicable Motor Current (A)	15	15	30	30	30	45
	Overload Tolerance	110% of rated output current for 60 s 150% peak					
	Carrier Frequency	User adjustable between 1 and 12.5 kHz (Maximum Frequency varies with Rated Output Capacity)					
	Maximum Output Voltage (V)	Three-Phase 208 Vac					
	Maximum Output Frequency (Hz)	240 Hz					
Harmonics Reduction	Input Power (kVA)	Built-in					
EMC	Filter (IEC/EN 61800-3 Category 2)	Built-in					

- *1 The maximum applicable motor output is based on 4-pole, general-purpose 220 V motor ratings. The rated output current of the drive output amps must be equal to or more than the motor rated current.
- *2 The maximum applicable motor output complies with 208 V motor ratings as specified in NEC Table 430.250. The rated output current of the drive output amps must be equal to or more than the motor rated current.
- *3 Carrier frequency is 5 kHz. You must derate the current to increase the carrier frequency.

7.5 240 V Enclosed Model Specifications

Table 7.8 240 V Enclosed Ratings

Model		A002	A003	A004	A006	A009	A015
Maximum Applicable Motor Output (HP) *2		0.5	0.75	1	2	3	5
Input	Rated Input Current (A)	3.5	4.5	5.5	8.1	10.9	16.5
	Rated Voltage Rated Frequency	Three-Phase 208 Vac 50/60 Hz					
	Allowable Voltage Fluctuation	-15 to 10%					
	Allowable Frequency Fluctuation	±5%					
Output	Rated Output Current (A)	2.2 *3	3.2 *3	4.2 *3	6.8 *3	9.6 *3	15.2 *3
	Minimum Applicable Motor Current (A)	1.5	1.5	1.5	1.5	1.5	3.75
	Overload Tolerance	110% of rated output current for 60 s 150% peak					
	Carrier Frequency	User adjustable between 1 and 12.5 kHz (Maximum Frequency varies with Rated Output Capacity)					
	Maximum Output Voltage (V)	Three-Phase 208 Vac					
	Maximum Output Frequency (Hz)	240 Hz					
Harmonics Reduction	Input Power (kVA)	Built-in					
EMC	Filter (IEC/EN 61800-3 Category 2)	Built-in					

*1 The maximum applicable motor output is based on 4-pole, general-purpose 220 V motor ratings. The rated output current of the drive output amps must be equal to or more than the motor rated current.

*2 The maximum applicable motor output complies with 208 V motor ratings as specified in NEC Table 430.250. The rated output current of the drive output amps must be equal to or more than the motor rated current.

*3 Carrier frequency is 5 kHz. You must derate the current to increase the carrier frequency.

Table 7.9 240 V Enclosed Ratings

Model		A022	A028	A042	A054	A068	A080
Maximum Applicable Motor Output (HP) *2		7.5	10	15	20	25	30
Input	Rated Input Current (A)	23.3	29.3	44.1	56.1	70.1	82.1
	Rated Voltage Rated Frequency	Three-Phase 208 Vac 50/60 Hz					
	Allowable Voltage Fluctuation	-15 to 10%					
	Allowable Frequency Fluctuation	±5%					
Output	Rated Output Current (A)	22 *3	28 *3	42 *3	54 *3	68 *3	80 *3
	Minimum Applicable Motor Current (A)	3.75	3.75	7.5	7.5	15	15
	Overload Tolerance	110% of rated output current for 60 s 150% peak					
	Carrier Frequency	User adjustable between 1 and 12.5 kHz (Maximum Frequency varies with Rated Output Capacity)					
	Maximum Output Voltage (V)	Three-Phase 208 Vac					
	Maximum Output Frequency (Hz)	240 Hz					
Harmonics Reduction	Input Power (kVA)	Built-in					
EMC	Filter (IEC/EN 61800-3 Category 2)	Built-in					

7.5 240 V Enclosed Model Specifications

- *1 The maximum applicable motor output is based on 4-pole, general-purpose 220 V motor ratings. The rated output current of the drive output amps must be equal to or more than the motor rated current.
- *2 The maximum applicable motor output complies with 208 V motor ratings as specified in NEC Table 430.250. The rated output current of the drive output amps must be equal to or more than the motor rated current.
- *3 Carrier frequency is 5 kHz. You must derate the current to increase the carrier frequency.

Table 7.10 240 V Enclosed Ratings

Model		A104	A130	A154	A192	A248
Maximum Applicable Motor Output (HP) *2		40	50	60	75	100
Input	Rated Input Current (A)	106.1	132.1	156.1	193.3	250.1
	Rated Voltage	Three-Phase 208 Vac 50/60 Hz				
	Rated Frequency					
	Allowable Voltage Fluctuation	-15 to 10%				
	Allowable Frequency Fluctuation	±5%				
Output	Rated Output Current (A)	104 *3	130 *3	154 *3	192 *3	248 *3
	Minimum Applicable Motor Current (A)	15	30	30	30	45
	Overload Tolerance	110% of rated output current for 60 s 150% peak				
	Carrier Frequency	User adjustable between 1 and 12.5 kHz (Maximum Frequency varies with Rated Output Capacity)				
	Maximum Output Voltage (V)	Three-Phase 208 Vac				
	Maximum Output Frequency (Hz)	240 Hz				
Harmonics Reduction	Input Power (kVA)	Built-in				
EMC	Filter (IEC/EN 61800-3 Category 2)	Built-in				

- *1 The maximum applicable motor output is based on 4-pole, general-purpose 220 V motor ratings. The rated output current of the drive output amps must be equal to or more than the motor rated current.
- *2 The maximum applicable motor output complies with 208 V motor ratings as specified in NEC Table 430.250. The rated output current of the drive output amps must be equal to or more than the motor rated current.
- *3 Carrier frequency is 5 kHz. You must derate the current to increase the carrier frequency.

7.6 480 V Enclosed Model Specifications

Table 7.11 480 V Enclosed Ratings

Model		B1P1	B001	B002	B003	B004	B007	B011	B014
Maximum Applicable Motor Output (HP) *2		0.5	0.75	1	2	3	5	7.5	10
Input	Rated Input Current (A)		2.2	2.7	4.0	5.4	8.2	11.6	14.6
	Rated Voltage Rated Frequency	Three-Phase 480 Vac 50/60 Hz							
	Allowable Voltage Fluctuation	-15 to 10%							
	Allowable Frequency Fluctuation	±5%							
Output	Rated Output Current (A)		1.6 *3	2.1 *3	3.4 *3	4.8 *3	7.6 *3	11.0 *3	14.0 *3
	Minimum Applicable Motor Current (A)	1.5	1.5	1.5	1.5	1.5	1.5	1.5	3.75
	Overload Tolerance	110% of rated output current for 60 s 150% peak							
	Carrier Frequency	User adjustable between 1 and 12.5 kHz (Maximum Frequency varies with Rated Output Capacity)							
	Maximum Output Voltage (V)	Three-Phase 480 Vac							
	Maximum Output Frequency (Hz)	240 Hz							
Harmonics Reduction	Input Power (kVA)	Built-in							
EMC	Filter (IEC/EN 61800-3 Category 2)	Built-in							

- *1 The maximum applicable motor output is based on 4-pole, general-purpose 220 V motor ratings. The rated output current of the drive output amps must be equal to or more than the motor rated current.
- *2 The maximum applicable motor output complies with 208 V motor ratings as specified in NEC Table 430.250. The rated output current of the drive output amps must be equal to or more than the motor rated current.
- *3 Carrier frequency is 5 kHz. You must derate the current to increase the carrier frequency.

Table 7.12 480 V Enclosed Ratings

Model		B021	B027	B034	B040	B052	B065	B077
Maximum Applicable Motor Output (HP) *2		15	20	25	30	40	50	60
Input	Rated Input Current (A)	21.6	27.6	35.0	41.0	53.0	66.0	78.0
	Rated Voltage Rated Frequency	Three-Phase 480 Vac 50/60 Hz						
	Allowable Voltage Fluctuation	-15 to 10%						
	Allowable Frequency Fluctuation	±5%						
Output	Rated Output Current (A)	21.0 *3	27.0 *3	34.0 *3	40.0 *3	52.0 *3	65.0 *3	77.0 *3
	Minimum Applicable Motor Current (A)	3.75	3.75	7.5	7.5	7.5	7.5	15
	Overload Tolerance	110% of rated output current for 60 s 150% peak						
	Carrier Frequency	User adjustable between 1 and 12.5 kHz (Maximum Frequency varies with Rated Output Capacity)						
	Maximum Output Voltage (V)	Three-Phase 480 Vac						
	Maximum Output Frequency (Hz)	240 Hz						

7.6 480 V Enclosed Model Specifications

Model		B021	B027	B034	B040	B052	B065	B077
Harmonics Reduction	Input Power (kVA)	Built-in						
EMC	Filter (IEC/EN 61800-3 Category 2)	Built-in						

- *1 The maximum applicable motor output is based on 4-pole, general-purpose 220 V motor ratings. The rated output current of the drive output amps must be equal to or more than the motor rated current.
- *2 The maximum applicable motor output complies with 208 V motor ratings as specified in NEC Table 430.250. The rated output current of the drive output amps must be equal to or more than the motor rated current.
- *3 Carrier frequency is 5 kHz. You must derate the current to increase the carrier frequency.

Table 7.13 480 V Enclosed Ratings

Model		B096	B124	B156	B180	B240	B302
Maximum Applicable Motor Output (HP) *2		75	100	125	150	200	250
Input	Rated Input Current (A)	97.0	125.0	157.0	180.6	241.0	303.0
	Rated Voltage Rated Frequency	Three-Phase 480 Vac 50/60 Hz					
	Allowable Voltage Fluctuation	-15 to 10%					
	Allowable Frequency Fluctuation	±5%					
Output	Rated Output Current (A)	96 *3	124 *3	156 *3	180 *3	240 *3	302 *3
	Minimum Applicable Motor Current (A)	15	15	30	30	30	45
	Overload Tolerance	110% of rated output current for 60 s 150% peak					
	Carrier Frequency	User adjustable between 1 and 12.5 kHz (Maximum Frequency varies with Rated Output Capacity)					
	Maximum Output Voltage (V)	Three-Phase 480 Vac					
	Maximum Output Frequency (Hz)	240 Hz					
Harmonics Reduction	Input Power (kVA)	Built-in					
EMC	Filter (IEC/EN 61800-3 Category 2)	Built-in					

- *1 The maximum applicable motor output is based on 4-pole, general-purpose 220 V motor ratings. The rated output current of the drive output amps must be equal to or more than the motor rated current.
- *2 The maximum applicable motor output complies with 208 V motor ratings as specified in NEC Table 430.250. The rated output current of the drive output amps must be equal to or more than the motor rated current.
- *3 Carrier frequency is 5 kHz. You must derate the current to increase the carrier frequency.

7.7 Common Bypass Specifications

Note:

To get the longest product life, install the bypass in an environment that meets the necessary specifications.

Table 7.14 Control Characteristics

Item	Specification
Control Method	V/f Control (V/f)
Frequency Control Range	0.01 Hz to 400 Hz
Frequency Accuracy (Temperature Fluctuation)	Digital inputs: Within $\pm 0.01\%$ of the maximum output frequency ($-10\text{ }^{\circ}\text{C}$ to $+40\text{ }^{\circ}\text{C}$ ($14\text{ }^{\circ}\text{F}$ to $104\text{ }^{\circ}\text{F}$)) Analog inputs: Within $\pm 0.4\%$ of the maximum output frequency ($25\text{ }^{\circ}\text{C} \pm 10\text{ }^{\circ}\text{C}$ ($77\text{ }^{\circ}\text{F} \pm 18\text{ }^{\circ}\text{F}$))
Frequency Setting Resolution	Digital inputs: 0.01 Hz Analog inputs: 1/2048 of the maximum output frequency (11-bit)
Output Frequency Resolution	0.001 Hz
Frequency Setting Signal	Main speed frequency reference: 0 Vdc to 10 Vdc (20 k Ω), 4 mA to 20 mA (250 Ω), 0 mA to 20 mA (250 Ω)
Starting Torque	140%/3 Hz
Speed Control Range	1:40
Accel/Decel Time	0.1 s to 6000.0 s The bypass can set two pairs of different acceleration and deceleration times.
V/f Characteristics	Select from 15 pre-defined V/f patterns, or a user-set V/f pattern.
Main Control Functions	Restart After Momentary Power Loss, Speed Search, Overtorque/Undertorque Detection, 8 Step Speed (max.), Accel/Decel Switch, S-curve Acceleration/Deceleration, Auto-Tuning (Rotational and Stationary), Cooling Fan ON/OFF Switch, Slip Compensation, Torque Compensation, Jump Frequency, Upper/Lower Limits for Frequency Reference, DC Injection Braking at Start and Stop, Overexcitation Braking, High Slip Braking, PID Control (with Sleep Function), Energy Saving Control, APOGEE FLN Communication (RS-485 4.8 or 9.6 kbps), BACnet Communication (RS-485 max. 76.8 kbps), MEMOBUS/Modbus Communication (RS-485 max. 115.2 kbps), Metasys N2 Communication (RS-485 9.6 kbps), Auto Restart, Application Presets, Overexcitation Deceleration, Overvoltage Suppression

Table 7.15 Protection Functions

Item	Specification
Motor Protection (Drive and Bypass Modes)	Electronic thermal overload protection
Momentary Overcurrent Protection (Drive Mode)	Bypass stops when the output current is more than 175% of the rated output current.
Overload Protection (Drive Mode)	Bypass stops when the output current is more than these overload tolerances: <ul style="list-style-type: none"> • 110% of the rated output current for 60 seconds • 140% of the rated output current for 2.5 seconds when the bypass output frequency is 3 Hz The permitted frequency of overload is one time each 10 minutes. Note: If output frequency < 6 Hz, the bypass can trigger the overload protection function when the output current is in the overload tolerance range.
Overvoltage Protection (Drive Mode)	208/240 V: Stops when the DC bus voltage is more than approximately 410 V 480 V: Stops when the DC bus voltage is more than approximately 820 V
Undervoltage Protection (Drive Mode)	208/240 V: Stops when the DC bus voltage decreases to less than approximately 190 V 480 V: <ul style="list-style-type: none"> • Stops when the DC bus voltage decreases to less than approximately 350 V when you use an input voltage less than 400 V • Stops when the DC bus voltage decreases to less than approximately 380 V when you use an input voltage less than 460 V • Stops when the DC bus voltage decreases to less than approximately 440 V when you use an input voltage of 460 V or more
Brownout Protection (Drive and Bypass Modes)	-
Momentary Power Loss Ride-thru (Drive and Bypass Modes)	Immediately stops when power loss is 15 ms or longer. Will automatically restart after power is restored. (depending on parameter settings)

7.7 Common Bypass Specifications

Item	Specification
Heatsink Overheat Protection (Drive Mode)	The bypass stops when the thermistor detects an IGBT temperature more than approximately 100 °C (212 °F). The trip temperature level is different for different models.
Stall Prevention (Drive Mode)	Stall prevention is available during acceleration, deceleration, and during run.
Ground Fault Protection (Drive Mode)	Electronic circuit protection Note: This protection detects ground faults during run. The bypass will not provide protection when: <ul style="list-style-type: none"> • There is a low-resistance ground fault for the motor cable or terminal block • Energizing the bypass when there is a ground fault.
DC Bus Charge LED (Drive Mode)	Charge LED illuminates when DC bus voltage is more than 50 V.

Table 7.16 Environment

Item	Specification
Area of Use	Indoors
Ambient Temperature Setting	IP20/UL Type 1: -10 °C to +40 °C (14 °F to 104 °F) IP55/UL Type 12: -10 °C to +40 °C (14 °F to 104 °F) <ul style="list-style-type: none"> • Do not let the bypass freeze.
Humidity	95% RH or less Do not let condensation form on the bypass.
Storage Temperature	-20 °C to +70 °C (-40 °F to +158 °F) (short-term temperature during transportation)
Surrounding Area	Pollution degree 2 or less Install the bypass in an area without: <ul style="list-style-type: none"> • Oil mist, corrosive or flammable gas, or dust • Metal powder, oil, water, or other unwanted materials • Radioactive materials or flammable materials, including wood • Harmful gas or fluids • Salt • Direct sunlight
Altitude	1000 m (3281 ft) maximum Note: Derate the output current by 1% for each 100 m (328 ft) to install the bypass in altitudes between 1000 m to 4000 m (3281 ft to 13123 ft). It is not necessary to derate the rated voltage in these conditions: <ul style="list-style-type: none"> • When you install the bypass at 2000 m (6562 ft) or lower • When you install the bypass between 2000 m to 4000 m (6562 ft to 13123 ft) and ground the neutral point on the power supply.
Vibration	<ul style="list-style-type: none"> • 10 Hz to 20 Hz: 1 G (9.8 m/s², 32.15 ft/s²) • 20 Hz to 55 Hz: H6BPD002 to D030, H6BPB1P1, B001 to B034: 0.6 G (5.9 m/s², 19.36 ft/s²) H6BPD046 to H6BPD074, H6BPB040 to B077: 0.2 G (1.96 m/s², 6.43 ft/s²) • 20 Hz to 55 Hz: H6B1D002 to D030, H6B1A002 to A028, H6B1B1P1, B001 to B034: 0.6 G (5.9 m/s², 19.36 ft/s²) H6B1D046 to D273, H6B1A042 to A248, H6B1B040 to B302: 0.2 G (1.96 m/s², 6.43 ft/s²)
Installation Orientation	Install the bypass vertically for sufficient airflow to cool the bypass.

Table 7.17 Certifications and Standard Compliance

Item	Specification
c-UL-us	UL 508A
Seismic Certification	<ul style="list-style-type: none"> • CBC, IBC, ASCE7, ICC-ES 156 • HCAI (Special Seismic Certification Preapproval OSP-0687)

Table 7.18 Enclosure Ratings

Item	Specification
Protection Design	IP20/UL Type 1 IP55/UL Type 12

7.8 Drive Watt Loss

◆ 208 V Models

Table 7.19 Drive Watt Loss (NEMA Rating)

Bypass Model	Drive Model	Rated Output Current A	Carrier Frequency kHz	Interior Unit Loss W	Cooling Fin Loss W	Total Loss W
D002 to D010	2011	10.6	5.0	45	86	131
D016	2017	16.7	5.0	56	140	196
D024	2024	24.2	5.0	75	184	259
D030	2031	30.8	5.0	89	244	333
D046	2046	46.2	5.0	116	314	430
D059	2059	59.4	5.0	148	418	566
D074	2075	74.8	5.0	175	538	713
D088	2088	88	5.0	201	615	816
D114	2114	114	5.0	246	780	1026
D143	2143	143	5.0	244	937	1180
D169	2169	169	5.0	279	1132	1411
D211	2211	211	5.0	331	1321	1651
D273	2273	273	5.0	423	1821	2244

◆ 240 V Models

Table 7.20 Drive Watt Loss (NEMA Rating)

Bypass Model	Drive Model	Rated Output Current A	Carrier Frequency kHz	Interior Unit Loss W	Cooling Fin Loss W	Total Loss W
A002 to A009	2011	10.6	5.0	45	86	131
A015	2017	16.7	5.0	56	140	196
A022	2024	24.2	5.0	75	184	259
A028	2031	30.8	5.0	89	244	333
A042	2046	46.2	5.0	116	314	430
A054	2059	59.4	5.0	148	418	566
A068	2075	74.8	5.0	175	538	713
A080	2088	88	5.0	201	615	816
A104	2114	114	5.0	246	780	1026
A130	2143	143	5.0	244	937	1180
A154	2169	169	5.0	279	1132	1411
A192	2211	211	5.0	331	1321	1651
A248	2273	273	5.0	423	1821	2244

◆ 480 V Models

Table 7.21 Drive Watt Loss (NEMA Rating)

Bypass Model	Drive Model	Rated Output Current A	Carrier Frequency kHz	Interior Unit Loss W	Cooling Fin Loss W	Total Loss W
B1P1, B001 to B004	4005	4.8	5.0	36	39	75
B007	4008	7.6	5.0	45	63	108
B011	4011	11	5.0	56	142	198
B014	4014	14	5.0	66	196	262
B021	4021	21	5.0	89	212	301
B027	4027	27	5.0	112	285	397
B034	4034	34	5.0	128	327	455
B040	4040	40	5.0	145	373	518
B052	4052	52	5.0	178	470	648
B065	4065	65	5.0	224	600	824
B077	4077	77	5.0	271	819	1090
B096	4096	96	5.0	323	973	1295
B124	4124	124	5.0	423	1294	1717
B156	4156	156	5.0	332	1448	1780
B180	4180	180	5.0	395	1707	2102
B240	4240	240	5.0	406	1810	2216
B302	4302	302	5.0	866	2847	3712

7.9 Drive Derating

You must derate the drive capacity to operate the drive above the rated temperature, altitude, and default carrier frequency.

◆ Carrier Frequency Settings and Rated Current Values

Table 7.22, Table 7.23, and Table 7.24 show how the drive rated output current changes when the *C6-02* [Carrier Frequency Selection] value changes. The output current value changes linearly as the carrier frequency changes. You can use the values from the tables to calculate a frequency that is not shown.

Note:

The drive will apply derating for the rated output current value based on the carrier frequency only to the reference output current value of the *oL2* [Drive Overload]. The derated value for the 100% rated output current in parameters and monitors will not be the same as the rated output current value shown in the Model Specifications tables.

■ 208 V Models

Table 7.22 Carrier Frequency and Rated Current Derating

Bypass Model	Drive Model	Rated Current (A)				
		2 kHz	5 kHz	8 kHz	10 kHz	12.5 kHz
D002 to D010	2011	10.6	10.6	8.9	7.8	6.4
D016	2017	16.7	16.7	14.0	12.2	10.0
D024	2024	24.2	24.2	20.3	17.7	14.5
D030	2031	30.8	30.8	25.9	22.6	18.5
D046	2046	46.2	46.2	38.8	33.9	27.7
D059	2059	59.4	59.4	49.9	43.6	35.6
D074	2075	74.8	74.8	62.8	54.9	44.9
D088	2088	88.0	88.0	73.9	64.5	52.8
D114	2114	114	114	95.8	83.6	68.4
D143	2143	143	143	114.4	95.3	-
D169	2169	169	169	135.2	112.7	-
D211	2211	211	211	168.8	140.7	-
D273	2273	273	273	218.4	182	-

■ 240 V Models

Table 7.23 Carrier Frequency and Rated Current Derating

Bypass Model	Drive Model	Rated Current (A)				
		2 kHz	5 kHz	8 kHz	10 kHz	12.5 kHz
A002 to A009	2011	10.6	10.6	8.9	7.8	6.4
A015	2017	16.7	16.7	14.0	12.2	10.0
A022	2024	24.2	24.2	20.3	17.7	14.5
A028	2031	30.8	30.8	25.9	22.6	18.5
A042	2046	46.2	46.2	38.8	33.9	27.7
A054	2059	59.4	59.4	49.9	43.6	35.6
A068	2075	74.8	74.8	62.8	54.9	44.9
A080	2088	88.0	88.0	73.9	64.5	52.8
A104	2114	114	114	95.8	83.6	68.4
A130	2143	143	143	114.4	95.3	-

7.9 Drive Derating

Bypass Model	Drive Model	Rated Current (A)				
		2 kHz	5 kHz	8 kHz	10 kHz	12.5 kHz
A154	2169	169	169	135.2	112.7	-
A192	2211	211	211	168.8	140.7	-
A248	2273	273	273	218.4	182	-

■ 480 V Models

Table 7.24 Carrier Frequency and Rated Current Derating

Bypass Model	Drive Model	Rated Current (A)				
		2 kHz	5 kHz	8 kHz	10 kHz	12.5 kHz
B1P1, B001 to B004	4005	4.8	4.8	4.0	3.5	2.9
B007	4008	7.6	7.6	6.4	5.6	4.6
B011	4011	11.0	11.0	9.2	8.1	6.6
B014	4014	14.0	14.0	11.8	10.3	8.4
B021	4021	21.0	21.0	17.6	15.4	12.6
B027	4027	27.0	27.0	22.7	19.8	16.2
B034	4034	34.0	34.0	28.6	24.9	20.4
B040	4040	40.0	40.0	33.6	29.3	24.0
B052	4052	52.0	52.0	43.7	38.1	31.2
B065	4065	65.0	65.0	54.6	47.7	39.0
B077	4077	77.0	77.0	64.7	56.5	46.2
B096	4096	96.0	96.0	80.6	70.4	57.6
B124	4124	124	124	99.2	92.7	-
B156	4156	156	156	124.8	104	-
B180	4180	180	180	144	120	-
B240	4240	240	224	176	144	-
B302	4302	302	281.9	221.5	181.2	-

◆ Derating Depending on Ambient Temperature

When you install drives in a place where ambient temperatures are higher than the rated conditions or install drives side-by-side in the enclosure panel, set L8-12 [Ambient Temperature] and L8-35 [Installation Method Selection]. Derate the output current as specified in Figure 7.1 to Figure 7.4.

No. (Hex.)	Name	Description	Default (Range)
L8-12 (04B8)	Ambient Temperature Setting	Sets the ambient temperature of the drive installation area.	40 °C (Determined by L8-35)

No. (Hex.)	Name	Description	Default (Range)
L8-35 (04EC)	Installation Method Selection	Sets the type of drive installation.	2 (0 - 3)

Note:

The drive will detect an oPE02 [Parameter Range Setting Error] in these conditions:

- If you set L8-12 = 60 °C and L8-35 = 1 or 3 for models 2011 to 2114 and 4005 to 4124
- If you set L8-35 = 1 or 3 for models 2143 to 2273 and 4156 to 4302

0 : IP20/UL Open Type

Use this setting to install an IP20/UL Open Type drive. The applicable output current to operate the drive changes when the ambient temperature changes:

- -10 °C to +50 °C (14 °F to 122 °F): You can operate the drive with 100% output current without derating.
- 50 °C to 60 °C (122 °F to 140 °F): Derate the output current from 100% to 80%.

Make sure that there is 60 mm (2.4 in) minimum of space between drives or between the drive and side of the enclosure panel.

1 : Side-by-Side Mounting

Use this setting to install more than one drive Side-by-Side. The applicable output current to operate the drive changes when the ambient temperature changes:

- -10 °C to +40 °C (14 °F to 104 °F): You can operate the drive with 100% output current without derating.
- 40 °C to 50 °C (104 °F to 122 °F): Derate the output current from 100% to 80%.

Make sure that there is 2 mm (0.08 in) minimum of space between drives.

2 : IP20/UL Type 1

Use this setting to install an IP20/UL Type 1 drive. The applicable output current to operate the drive changes when the drive model and ambient temperature change:

- For drive models 4005 and 4008 (bypass models B003 to B007)
 - -10 °C to +40 °C (14 °F to 104 °F): You can operate the drive with 100% output current without derating.
 - 40 °C to 60 °C (104 °F to 140 °F): Derate the output current from 100% to 80%.
- For drive models 4011 to 4027 (bypass models B011 to B027)
 - -10 °C to +50 °C (14 °F to 122 °F): You can operate the drive with 100% output current without derating.
 - 50 °C to 60 °C (122 °F to 140 °F): Derate the output current from 100% to 80%.
- For drive models 4034 to 4065 (bypass models B034 to B065)
 - -10 °C to +45 °C (14 °F to 113 °F): You can operate the drive with 100% output current without derating.
 - 45 °C to 50 °C (113 °F to 122 °F): Derate the output current from 100% to 90%.
 - 50 °C to 60 °C (122 °F to 140 °F): Derate the output current from 90% to 70%.
- For drive models 2011 to 2273 and 4077 to 4302 (bypass models D002 to D273, A002 to A248, and B302)
 - -10 °C to +40 °C (14 °F to 104 °F): You can operate the drive with 100% output current without derating.
 - 40 °C to 60 °C (104 °F to 140 °F): Derate the output current from 100% to 60%.

3 : IP55/UL Type 12

Use this setting to install an IP55/UL Type 12 drive. The applicable output current to operate the drive changes when the ambient temperature changes:

- -10 °C to +40 °C (14 °F to 104 °F): You can operate the drive with 100% output current without derating.
- 40 °C to 50 °C (104 °F to 122 °F): Derate the output current from 100% to 80%.

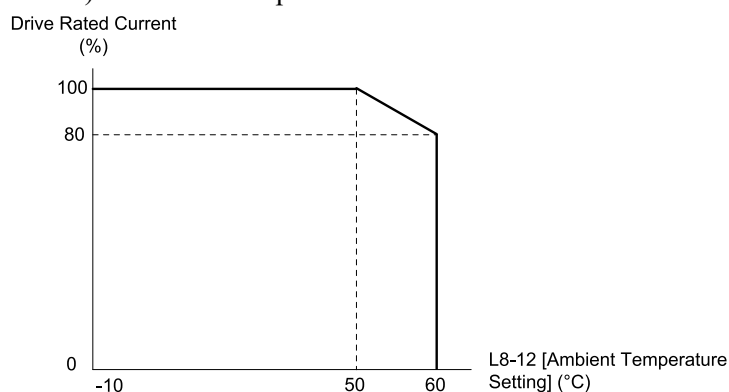

Figure 7.1 Derating for IP20/UL Open Type (L8-35 = 0)

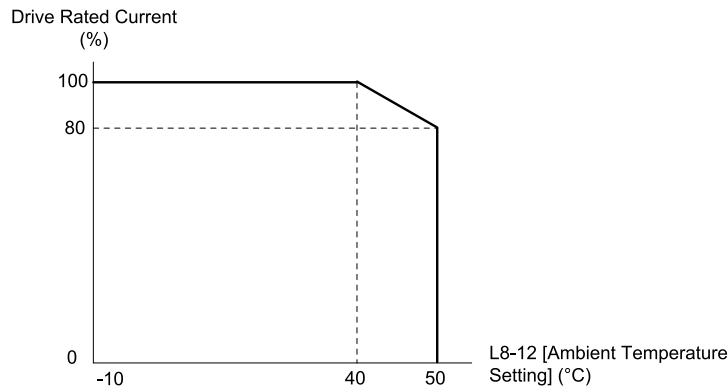
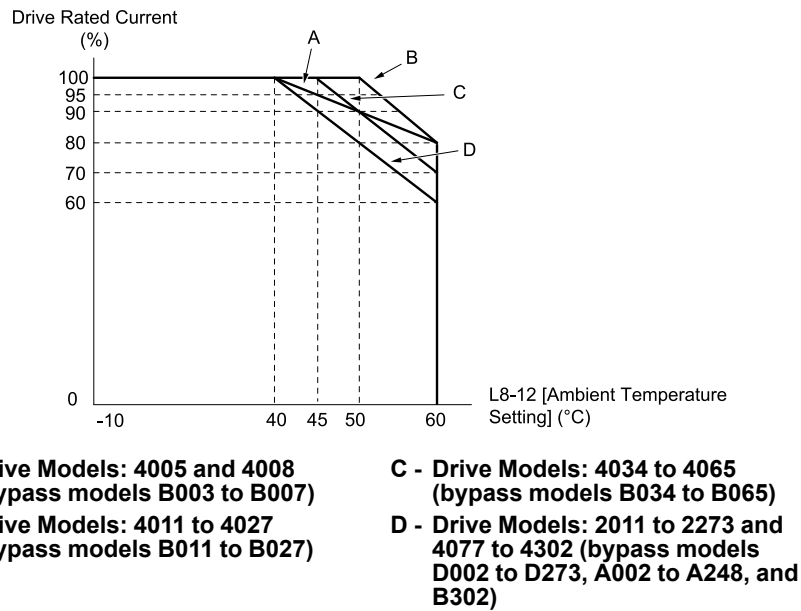

Figure 7.2 Derating for Side-by-Side Mounting (L8-35 = 1)



A - Drive Models: 4005 and 4008 (bypass models B003 to B007)

B - Drive Models: 4011 to 4027 (bypass models B011 to B027)

C - Drive Models: 4034 to 4065 (bypass models B034 to B065)

D - Drive Models: 2011 to 2273 and 4077 to 4302 (bypass models D002 to D273, A002 to A248, and B302)

Figure 7.3 Derating for IP20/UL Type 1 (L8-35 = 2)

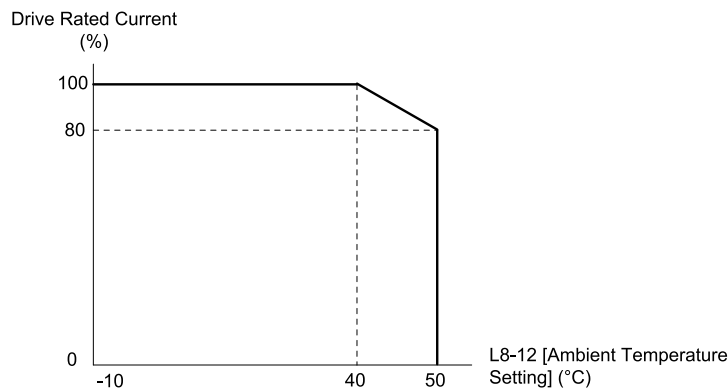

Figure 7.4 Derating for IP55/UL Type 12 (L8-35 = 3)

◆ Altitude Derating

Install the bypass in a location that has an altitude of 1000 m (3281 ft) or lower.

Derate the output current by 1% for each 100 m (328 ft) to install the bypass in altitudes between 1000 to 4000 m (3281 to 13123 ft).

It is not necessary to derate the rated voltage in these conditions:

- Installing the bypass at 2000 m (6562 ft) or lower
 - Installing the bypass between 2000 to 4000 m (6562 to 13123 ft) and grounding the neutral point on the power supply.
- If you do not ground the bypass with a neutral network, contact Yaskawa or your nearest sales representative.

7.10 Peripheral Devices and Options

◆ Bypass Communication Options

There are many available peripheral devices and options for the bypass.

Refer to the HV600 catalog (CA.HV600.01) for information about available options, including:

- Main circuit options
- Frequency settings and monitor options
- Keypad options
- Attachment options
- Engineering tools

Contact Yaskawa or your nearest sales representative to make an order.

Refer to the instruction manual for each option for wiring information.

◆ Tools Required for Option Installation

- A Phillips screwdriver (M3 metric or #1, #2 U.S. standard) to install the option and remove the bypass front cover. Screw sizes vary by capacity. Select a screwdriver appropriate for the capacity.

Note:

Use a short-shaft, magnetic screwdriver when installing the option card into the narrow enclosure models H6BPD002 to D074 and B1P1, B001 to B077.

- A straight-edge screwdriver (blade depth: 0.4 mm, width: 2.5 mm) to wire the option terminal block when installing the SI-W3 LonWorks option.

Note:

This manual does not list the tools required to prepare the option cables for wiring.

◆ Bypass Options

These configurations are available for the bypass:

■ Option B

Three-contactor bypass: Isolates the drive circuit by adding a separate drive input contactor.

■ Option D

Ethernet/IP option.

■ Option G

Drive Input Disconnect Switch: Provides a disconnect means for the input side of the Drive, for Drive isolation capability during bypass operation. This disconnect is located inside the enclosure with an integral operating handle.

■ Option L

Serial Communication, Echelon LonWorks: An isolated circuit board provides LonTalk protocol for network communication to a BAS. This option plugs into the CN5 connection on the bypass control circuit board.

■ Option M

Lockable Circuit Breaker SCCR panel rating of 100 kA (no external customer fuses or internal fuses are necessary)

■ Option W

Custom Nameplate: Provides a custom nameplate for placement on the front of the bypass.

◆ Option Installation Procedure

■ Before You Install the Option

NOTICE: Install communications options on the bypass control PCB. Do not install communications options on the drive PCB. Improperly connected communications options will cause erroneous operation.

■ Verify Bypass Operation

Verify that the bypass functions normally without the option installed. Refer to *Electrical Installation* for information on wiring and connecting the bypass.

■ Prepare Network Cables for SI-W3 LonWorks Options

Use only LonWorks network cables.

Refer to the Echelon website for more information on network cabling (www.echelon.com). The performance cannot be guaranteed if you use non-LonWorks network cables.

Separate the LonWorks cables from the wiring to the main circuit and other lines.

Determine the length of cable required to connect from the option to a network device and attach all connectors to network cables.

The communication terminal is a pluggable terminal block that serves as the connection point of the LonWorks network cable to the option.

Terminal	Terminal No.	Name	Description
1	1	A	Signal Line A
2	2	SLD	Shield
3	3	B	Signal Line B

NOTICE: Heat shrink tubing or electrical tape may be required to ensure that cable shielding does not touch contact with other wiring. Insufficient insulation may cause a short circuit that can damage the option or the bypass.

Note:

- Use shielded wires and shielded twisted-pair wires. If the grounding is not correct, electrical interference can cause the drive or devices around it to malfunction.
- Do not use wiring that is longer than 50 m (164 ft) to supply the frequency reference with an analog signal from a remote source. Wiring that is too long can cause unsatisfactory system performance.

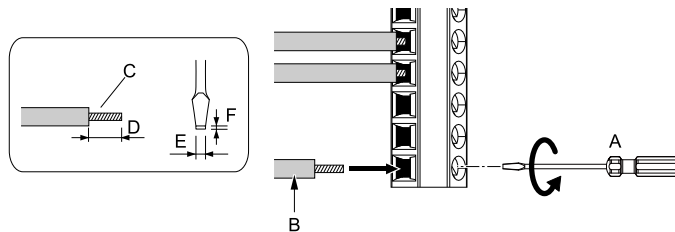

- A -** Loosen the screws and put the wire into the opening on the terminal block.
- B -** Wire with a crimp ferrule attached, or use wire that is not soldered with the core wires lightly twisted.
- C -** Pull back the shielding and lightly twist the end with your fingers to keep the ends from fraying.

- D -** If you do not use crimp ferrules, remove approximately 5.5 mm (0.21 in) of the covering at the end of the wire.
- E -** Blade width of 2.5 mm (0.1 in) or less
- F -** Blade depth of 0.4 mm (0.01 in) or less

WARNING! Fire Hazard. Tighten all terminal screws to the correct tightening torque. Connections that are too loose or too tight can cause incorrect operation and damage to the bypass. Incorrect connections can also cause death or serious injury from fire.

NOTICE: Do not tin stranded wire with solder. Soldered wire connections can become loose over time and cause unsatisfactory system performance.

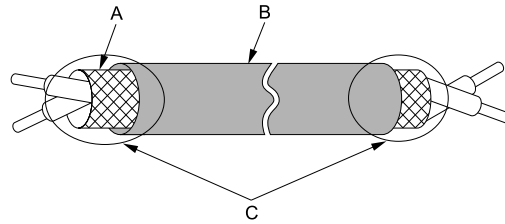

A - Shield
B - Sheath

C - Insulate with electrical tape or shrink tubing.

Figure 7.5 Prepare the Ends of Shielded Wire

■ Prepare Network Cables for Ethernet-based Options

Determine the length of cable required to connect from the option to a network device and attach all connectors to network cables before you install the option.

The Ethernet-based option options will have one or two RJ45 ports available for connections. The user must supply the mating RJ45 modular connector and cable.

Table 7.25 8-Way Modular Connector (Customer-Supplied)

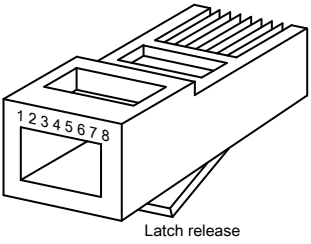
Male 8-Way Modular Connector	Pin	Description
	1 (Pair 2)	Transmit data (TXD) +
	2 (Pair 2)	Transmit data (TXD) -
	3 (Pair 3)	Receive data (RXD) +
	4 (Pair 1)	Not used for 10 Mbps and 100 Mbps networks
	5 (Pair 1)	Not used for 10 Mbps and 100 Mbps networks
	6 (Pair 3)	Receive data (RXD) -
	7 (Pair 4)	Not used for 10 Mbps and 100 Mbps networks
	8 (Pair 4)	Not used for 10 Mbps and 100 Mbps networks

Communication Protocol	Description
EtherNet/IP	Only use cable recommended for EtherNet/Industrial Protocol (EtherNet/IP™). Using a cable not specifically recommended may cause the option or bypass to malfunction. Refer to the ODVA website for more information on network cabling (www.odva.org).
Modbus TCP/IP	Only use cable recommended for Modbus TCP/IP. Using a cable not specifically recommended may cause the option or bypass to malfunction. Refer to the Modbus-IDA website for more information on network cabling (www.modbus.org).
PROFINET	Only use cable recommended for PROFINET. Using a cable not specifically recommended may cause the option or bypass to malfunction. Refer to the PROFIBUS and PROFINET International (PI) website for more information (www.profibus.com).
BACnet/IP	Only use shielded Cat5e cable or better. Using a cable not specifically recommended may cause the option or bypass to malfunction.

■ Install the Option

1. De-energize the system at the power source. Observe correct lockout/tagout safety procedures and wait for the CHARGE light to completely go out on the drive unit.
2. Remove the bypass cover or open the cabinet door to access the bypass PCB A2.
3. Install the option to bypass PCB A2.

- Use the two screws included in the option kit to fasten the option card to the metal standoffs on the bypass PCB A2. Use a short-shaft, magnetic screwdriver for narrow enclosure models H6BPxxxx. Tighten each screw to 0.5 to 0.6 N•m (4.4 to 5.3 in lbs).

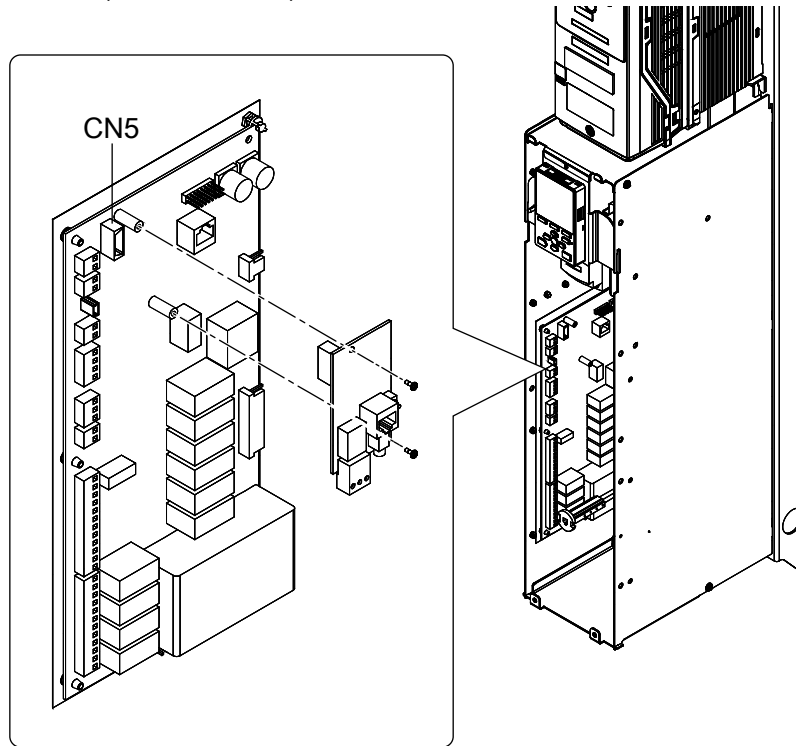

Figure 7.6 Insert Option into Bypass PCB CN5 Connector Port

- Firmly insert the end of the customer-supplied network cable into the CN1 connection port on the option board. When you have a dual-port option, connect two network cables to the two RJ45 ports. Available connection topologies are different for different options. Refer to the option manual for your communication protocol for more information.

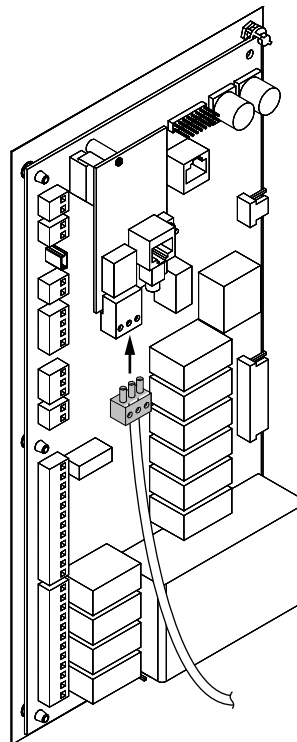

Figure 7.7 Connect Network Cable to Option (SI-W3 LonWorks Example)

NOTICE: *Separate the communication wiring from the input power, motor, and 120 Vac control wiring. Electrical interference can cause communication data errors.*

6. Make sure that you did not pinch cables between the front cover and the bypass enclosure, then replace and secure the front cover or cabinet door.
7. Set the bypass parameters for option functionality. Refer to the option manual for your communication protocol for programming information.

Periodic Inspection and Maintenance

This chapter gives information about how to examine and maintain drives in use, how to replace cooling fans and other parts, and how to store drives.

8.1	Section Safety	554
8.2	Inspection.....	556
8.3	Maintenance	559
8.4	Replace Drive Cooling Fans and Circulation Fans.....	561
8.5	Replace the Keypad Battery	587
8.6	Storage Guidelines	589

8.1 Section Safety

DANGER

Electrical Shock Hazard

Do not examine, connect, or disconnect wiring on an energized bypass. Before servicing, disconnect all power to the equipment and wait for the time specified on the warning label at a minimum. The internal capacitor stays charged after the bypass is de-energized. The charge indicator LED extinguishes when the DC bus voltage decreases below 50 Vdc. When all indicators are OFF, remove the covers before measuring for dangerous voltages to make sure that the bypass is safe.

If you do work on the bypass when it is energized, it will cause serious injury or death from electrical shock.

Disconnect all power to the bypass and wait for the time specified on the warning label before you remove covers. Check the bypass for dangerous voltages before servicing or repair work.

If you do work on the bypass when it is energized and there is no cover over the electronic circuits, it will cause serious injury or death from electrical shock. The bypass has internal capacitors that stay charged after you de-energize the bypass.

WARNING

Electrical Shock Hazard

Do not operate the bypass when covers are missing. Replace covers and shields before you operate the bypass. Use the bypass only as specified by the instructions.

Some figures in this section include bypasses without covers or safety shields to more clearly show the inside of the bypass. If covers or safety shields are missing from the bypass, it can cause serious injury or death.

Always ground the motor-side grounding terminal.

If you do not ground the equipment correctly, it can cause serious injury or death if you touch the motor case.

Only let approved personnel install, wire, maintain, examine, replace parts, and repair the bypass.

If personnel are not approved, it can cause serious injury or death.

Do not wear loose clothing or jewelry when you do work on the bypass. Tighten loose clothing and remove all metal objects, for example watches or rings.

Loose clothing can catch on the bypass and jewelry can conduct electricity and cause serious injury or death.

Fire Hazard

Tighten all terminal screws to the correct tightening torque.

Connections that are too loose or too tight can cause incorrect operation and damage to the bypass. Incorrect connections can also cause death or serious injury from fire.

Damage to Equipment

Do not apply incorrect voltage to the main circuit of the bypass. Operate the bypass in the specified range of the input voltage on the nameplate.

Voltages that are higher than the permitted nameplate tolerance can cause damage to the bypass.

Fire Hazard

Do not put flammable or combustible materials on top of the bypass and do not install the bypass near flammable or combustible materials. Attach the bypass to metal or other noncombustible material.

Flammable and combustible materials can start a fire and cause serious injury or death.

⚠ WARNING**Electrical Shock Hazard**

Do not modify the bypass body, drive body, bypass circuitry, or drive circuitry.

Modifications to bypass and drive body and circuitry can cause serious injury or death, will cause damage to the bypass and drive, and will void the warranty. Yaskawa is not responsible for modifications of the product made by the user.

Sudden Movement Hazard

Make sure that you align the phase order for the bypass and motor when you connect the motor to output terminals U/T1, V/T2, and W/T3.

If the phase order is incorrect, it can cause the motor to run in reverse. If the motor accidentally runs in reverse, it can cause serious injury or death.

⚠ CAUTION**Burn Hazard**

Do not touch a hot drive heatsink. De-energize the drive, wait for a minimum of 15 minutes, then make sure that the heatsink is cool before you replace the cooling fans.

If you touch a hot drive heatsink, it can burn you.

NOTICE**Damage to Equipment**

When you touch the drive and bypass circuit boards, make sure that you observe correct electrostatic discharge (ESD) procedures.

If you do not follow procedures, it can cause ESD damage to the drive and bypass circuitry.

Use the instructions in this manual to replace the cooling fans. When you do maintenance on the fans, replace all the fans to increase product life.

If you install the fans incorrectly, it can cause damage to the drive and bypass.

Make sure that all connections are correct after you install the bypass and connect peripheral devices.

Incorrect connections can cause damage to the bypass.

Do not energize and de-energize the bypass more frequently than one time each 30 minutes.

If you frequently energize and de-energize the bypass, it can cause failure.

Do not operate a bypass or connected equipment that has damaged or missing parts.

You can cause damage to the bypass and connected equipment.

Note:

Do not use unshielded cable for control wiring. Use shielded, twisted-pair wires and ground the shield to the ground terminal of the bypass. Incorrect wiring can cause electrical interference and unsatisfactory system performance.

8.2 Inspection

Power electronics have limited life and can show changes in performance and deterioration of performance after years of use in usual conditions. To help prevent these problems, it is important to do preventive maintenance and regular inspection, and replace parts on the drive.

Drives contain different types of power electronics, for example power transistors, semiconductors, capacitors, resistors, fans, and relays. The electronics in the drive are necessary for correct motor control.

Follow the inspection lists in this chapter as a part of a regular maintenance program.

Note:

Examine the drive one time each year at a minimum.

The operating conditions, environmental conditions, and use conditions will have an effect on the examination frequency for connected equipment.

Examine the drive more frequently if you use the drive in bad conditions or in these conditions:

- High ambient temperatures
- Frequent starting and stopping
- Changes in the AC power supply or load
- Too much vibration or shock loading
- Dust, metal dust, salt, sulfuric acid, or chlorine atmospheres
- Unsatisfactory storage conditions.

◆ Recommended Daily Inspection

Table 8.1 gives information about the recommended daily inspection for Yaskawa drives. Examine the items in Table 8.1 each day to make sure that the components do not become unserviceable or fail. Make a copy of this checklist and put a check mark in the “Checked” column after each inspection.

Table 8.1 Daily Inspection Checklist

Inspection Area	Inspection Points	Corrective Action	Checked
Motor	Examine for unusual oscillation or noise coming from the motor.	<ul style="list-style-type: none"> • Check the load coupling. • Measure motor vibration. • Tighten all loose components. 	
Cooling System	Examine for unusual heat from the drive or motor and visible discoloration.	<ul style="list-style-type: none"> • Check for a load that is too heavy. • Tighten loose screws. • Check for a dirty heatsink or motor. • Measure the ambient temperature. 	
	Examine the cooling fans, circulation fans, and circuit board cooling fans.	<ul style="list-style-type: none"> • Check for a clogged or dirty fan. • Use the performance life monitor to check for correct fan operation. 	
Surrounding Environment	Make sure that the installation environment is applicable.	Remove the source of contamination or correct unsatisfactory environment.	
Load	Make sure that the drive output current is not more than the motor or drive rating for an extended period of time.	<ul style="list-style-type: none"> • Check for a load that is too heavy. • Check the correct motor parameter settings. 	
Power Supply Voltage	Examine main power supply and control voltages.	<ul style="list-style-type: none"> • Correct the voltage or power supply to agree with nameplate specifications. • Verify all main circuit phases. 	

◆ Recommended Periodic Inspection

Table 8.2 to Table 8.6 give information about the recommended periodic inspections for Yaskawa drives. Examine the drive one time each year at a minimum. The operating conditions, environmental conditions, and use conditions will have an effect on the examination frequency for connected equipment. You must use your experience with the application to select the correct inspection frequency for each drive installation. Periodic inspections will help to prevent performance deterioration and product failure. Make a copy of this checklist and put a check mark in the “Checked” column after each inspection.

DANGER! Electrical Shock Hazard. Do not examine, connect, or disconnect wiring on an energized bypass. Before servicing, disconnect all power to the equipment and wait for the time specified on the warning label at a minimum. The internal capacitor stays charged after the bypass is de-energized. The charge indicator LED extinguishes when the DC bus voltage decreases below 50 Vdc. When all indicators are OFF, remove the covers before measuring for dangerous voltages to make sure that the bypass is safe. If you do work on the bypass when it is energized, it will cause serious injury or death from electrical shock.

Table 8.2 Main Circuit Periodic Inspection Checklist

Inspection Area	Inspection Points	Corrective Action	Checked
General	<ul style="list-style-type: none"> Examine equipment for discoloration from too much heat or deterioration. Examine for damaged parts. 	<ul style="list-style-type: none"> Replace damaged components as necessary. The drive does not have many serviceable parts and it could be necessary to replace the drive. 	
	Examine for dirt, unwanted particles, or dust on components.	<ul style="list-style-type: none"> Examine enclosure door seal. Use a vacuum cleaner to remove unwanted particles and dust without touching the components. If you cannot remove unwanted particles and dust with a vacuum cleaner, replace the components. 	
Conductors and Wiring	<ul style="list-style-type: none"> Examine wiring and connections for discoloration or damage. Examine wiring and connections for discoloration from too much heat. Examine wire insulation and shielding for discoloration and wear. 	Repair or replace damaged wiring.	
Terminal Block	Examine terminals for stripped, damaged, or loose connections.	<ul style="list-style-type: none"> Tighten loose screws. Replace damaged screws or terminals. 	
Electromagnetic Contactors and Relays	<ul style="list-style-type: none"> Examine contactors and relays for too much noise during operation. Examine coils for signs of too much heat, such as melted or broken insulation. 	<ul style="list-style-type: none"> Check coil voltage for overvoltage or undervoltage conditions. Replace broken relays, contactors, or circuit boards that you can remove. 	
Electrolytic capacitor	<ul style="list-style-type: none"> Examine for leaks, discoloration, or cracks. Examine if the cap has come off, if there is swelling, or if there are leaks from broken sides. 	The drive does not have many serviceable parts and it could be necessary to replace the drive.	
Diodes, IGBT (Power Transistor)	Examine for dust or other unwanted material collected on the surface.	Use a vacuum cleaner to remove unwanted particles and dust without touching the components.	

Table 8.3 Motor Periodic Inspection Checklist

Inspection Area	Inspection Points	Corrective Action	Checked
Operation Check	Check for increased vibration or unusual noise.	Stop the motor and contact approved maintenance personnel as necessary.	

Table 8.4 Control Circuit Periodic Inspection Checklist

Inspection Area	Inspection Points	Corrective Action	Checked
General	<ul style="list-style-type: none"> Examine terminals for stripped, damaged, or loose connections. Make sure that all terminals have been correctly tightened. 	<ul style="list-style-type: none"> Tighten loose screws. Replace damaged screws or terminals. If terminals are integral to a circuit board, it could be necessary to replace the control board or the drive. 	
Circuit Boards	<ul style="list-style-type: none"> Check for odor, discoloration, or rust. Make sure that all connections are correctly fastened. Make sure that the surface of the circuit board does not have dust or oil mist. 	<ul style="list-style-type: none"> Tighten loose connections. Use a vacuum cleaner to remove unwanted particles and dust without touching the components. If you cannot remove unwanted particles and dust with a vacuum cleaner, replace the components. Do not use solvents to clean the board. The drive does not have many serviceable parts and it could be necessary to replace the drive. 	

Table 8.5 Cooling System Periodic Inspection Checklist

Inspection Area	Inspection Points	Corrective Action	Checked
Cooling fan	<ul style="list-style-type: none"> Check for unusual oscillation or unusual noise. Check for damaged or missing fan blades. 	Clean or replace the fans as necessary.	
Heatsink	<ul style="list-style-type: none"> Examine for dust or other unwanted material collected on the surface. Examine for dirt. 	Use a vacuum cleaner to remove unwanted particles and dust without touching the components.	
Air Duct	Examine air intake, exhaust openings and make sure that there are no unwanted materials on the surface.	Clear blockages and clean air duct as necessary.	

Table 8.6 Keypad Periodic Inspection Checklist

Inspection Area	Inspection Points	Corrective Action	Checked
General	<ul style="list-style-type: none"> • Make sure that the keypad shows the data correctly. • Examine for dust or other unwanted material that collected on components in the area. • Examine if the clock battery is expired. 	<ul style="list-style-type: none"> • If you have problems with the display or the keys, contact Yaskawa or your nearest sales representative. • Clean the keypad. • Replace the battery. 	

8.3 Maintenance

The drive Maintenance Monitors keep track of component wear and tell the user when the end of the estimated performance life is approaching. The Maintenance Monitors prevent the need to shut down the full system for unexpected problems. Users can set alarm notifications for the maintenance periods for these drive components:

- Cooling fan
- Electrolytic capacitor
- Soft charge bypass relay
- IGBT

Contact Yaskawa or your nearest sales representative for more information about part replacement.

◆ Replaceable Parts

You can replace these parts of the drive:

- Control circuit terminal board
- Cooling fan, circulation fan
- Keypad

Note:

Make sure that you use a keypad with FLASH number 1004 or later. Keypads with FLASH numbers 1003 and earlier will not show characters correctly.

If there is a failure in the main circuit, replace the drive.

If the drive is in the warranty period, contact Yaskawa or your nearest sales representative before you replace parts. Yaskawa reserves the right to replace or repair the drive as specified by the Yaskawa warranty policy.

DANGER! Electrical Shock Hazard. Do not examine, connect, or disconnect wiring on an energized bypass. Before servicing, disconnect all power to the equipment and wait for the time specified on the warning label at a minimum. The internal capacitor stays charged after the bypass is de-energized. The charge indicator LED extinguishes when the DC bus voltage decreases below 50 Vdc. When all indicators are OFF, remove the covers before measuring for dangerous voltages to make sure that the bypass is safe. If you do work on the bypass when it is energized, it will cause serious injury or death from electrical shock.

◆ Part Replacement Guidelines

Table 8.7 shows the standard replacement period for replacement parts. When you replace these parts, make sure that you use Yaskawa replacement parts for the applicable model and design revision number of your drive.

Table 8.7 Standard Replacement Period

Parts	Standard Replacement Period
Cooling fan	10 years
Electrolytic capacitor ^{*1}	10 years

*1 If there is damage to parts that you cannot repair or replace, replace the drive.

Note:

The performance life estimate uses these operating conditions. Yaskawa provides these conditions so you can replace parts to maintain performance. Unsatisfactory conditions or heavy use will make it necessary for you to replace some parts more frequently than other parts.

Operating conditions for performance life estimate:

- Yearly average
 - IP20/Open Type enclosure: 40 °C (104 °F)
 - IP20/UL Type 1 and External Heatsink Installation of IP55/UL Type 12: 30 °C (86 °F)
- Load factor
 - 80% maximum
- Operation time
 - 24 hours a day

◆ Monitors that Show the Lifespan of Drive Components

The drive keypad shows percentage values for the replacement parts to help you know when you must replace those components. Use the monitors in Table 8.8 to see how close you are to the end of the useful life of a component.

8.3 Maintenance

When the monitor value is 100%, the component is at the end of its useful life and there is an increased risk of drive malfunction. Yaskawa recommends that you check the maintenance period regularly to make sure that you get the maximum performance life.

Table 8.8 Performance Life Monitors

Monitor No.	Parts	Description
U4-03	Cooling fan	Shows the total operation time of fans as 0 to 99999 hours. After this value is 99999, the drive automatically resets it to 0.
U4-04		Shows the total fan operation time as a percentage of the specified maintenance period.
U4-05	Electrolytic capacitor	Shows the total capacitor usage time as a percentage of the specified maintenance period.
U4-06	Soft charge bypass relay	Shows the number of times the drive is energized as a percentage of the performance life of the inrush circuit.
U4-07	IGBT	Shows the percentage of the maintenance period reached by the IGBTs.

◆ Alarm Outputs for Maintenance Monitors

You can use *H2-xx* [*Multi-Function Digital Out*] to send a message that tells you when a specified component is near the end of its performance life estimate. Set *H2-xx* to the applicable value for your component as shown in [Table 8.9](#).

When the specified component is near the end of its performance life estimate, the MFDO terminals set for *H2-xx* = *2F* [*Maintenance Notification*] will turn ON, and the keypad will show an alarm that identifies the component to replace.

Table 8.9 Maintenance Period Alarms

Display	Alarm Name	Cause	Possible Solutions	Digital Outputs (Setting Value in H2-xx)
LT-1	Cooling Fan Maintenance Time	The cooling fan is at 90% of its expected performance life.	Replace the cooling fan, then set <i>o4-03</i> = 0 [<i>Fan Operation Time Setting = 0 h</i>] to reset the cooling fan operation time.	2F
LT-2	Capacitor Maintenance Time	The capacitors for the main circuit and control circuit are at 90% of expected performance life.	Replace the board or the drive. Contact Yaskawa or your nearest sales representative to replace the board.	
LT-3	SoftChargeBypassRelay Maintenance Time	The soft charge bypass relay is at 90% of its performance life estimate.	Replace the board or the drive. Contact Yaskawa or your nearest sales representative to replace the board.	
LT-4	IGBT Maintenance Time (50%)	The IGBT is at 50% of its expected performance life.	Check the load, carrier frequency, and output frequency.	
TrPC	IGBT Maintenance Time (90%)	The IGBT is at 90% of its expected performance life.	Replace the IGBT or the drive.	10

◆ Related Parameters

Replace the component, then set *o4-03*, *o4-05*, *o4-07*, and *o4-09* [*Maintenance Setting*] = 0 to reset the Maintenance Monitor. If you do not reset these parameters after you replace the parts, the Maintenance Monitor function will continue to count down the performance life from the value from the previous part. If you do not reset the Maintenance Monitor, the drive will not have the correct value of the performance life for the new part.

Note:

The maintenance period is different for different operating environments.

Table 8.10 Maintenance Setting Parameters

No.	Name	Function
o4-03	Fan Operation Time Setting	Sets the value from which to start the cumulative drive cooling fan operation time in 10-hour units. Note: When <i>o4-03</i> = 30 has been set, the drive will count the operation time for the cooling fan from 300 hours and <i>U4-03</i> [<i>Cooling Fan Open Time</i>] will show 300 h.
o4-05	Capacitor Maintenance Setting	Sets the value from which to start the count for the main circuit capacitor maintenance period as a percentage.
o4-07	Softcharge Relay Maintenance Set	Sets as a percentage the value from which to start the count for the soft charge bypass relay maintenance time.
o4-09	IGBT Maintenance Setting	Sets the value from which to start the count for the IGBT maintenance period as a percentage.

8.4 Replace Drive Cooling Fans and Circulation Fans

CAUTION! *Injury to Personnel. Some fan units are not easily accessible from a standing position. Make sure that you can safely and comfortably remove and replace the fan. If you try to remove a fan that you cannot easily access, the fan unit can fall and cause minor to moderate injury.*

NOTICE: *Use the instructions in this manual to replace the cooling fans. When you do maintenance on the fans, replace all the fans to increase product life. If you install the fans incorrectly, it can cause damage to the drive and bypass.*

◆ Cooling Fans and Circulation Fans

Bypass Model	Drive Model	Drive Cooling Fans	Drive Circulation Fans	Drive Fan Replacement Procedure	Reference
B1P1, B001 - B007	4005, 4008	-	-	-	-
D002 - D030 A002 - A028 B011 - B034	2011 - 2031 4011 - 4034	1	-	Procedure A	561
D046, D059 A042 - A054 B040 - B052	2046, 2059 4040 - 4052	1	-	Procedure B	566
B065	4065	1	1		
D074 - D114 A068 - A104 B077 - B124	2075 - 2114 4077 - 4124	2	-	Procedure C	572
D143 - D273 A130 - A248 B156 - B240	2143 - 2273 4156 - 4240	2	-	Procedure D	577
B302	4302	2	1	Procedure E	580

◆ Replace a Fan (Procedure A)

DANGER! *Electrical Shock Hazard. Do not examine, connect, or disconnect wiring on an energized bypass. Before servicing, disconnect all power to the equipment and wait for the time specified on the warning label at a minimum. The internal capacitor stays charged after the bypass is de-energized. The charge indicator LED extinguishes when the DC bus voltage decreases below 50 Vdc. When all indicators are OFF, remove the covers before measuring for dangerous voltages to make sure that the bypass is safe. If you do work on the bypass when it is energized, it will cause serious injury or death from electrical shock.*

CAUTION! *Burn Hazard. Do not touch a hot drive heatsink. De-energize the drive, wait for a minimum of 15 minutes, then make sure that the heatsink is cool before you replace the cooling fans. If you touch a hot drive heatsink, it can burn you.*

NOTICE: *Use the instructions in this manual to replace the cooling fans. When you do maintenance on the fans, replace all the fans to increase product life. If you install the fans incorrectly, it can cause damage to the drive and bypass.*

■ Remove a Cooling Fan

1. Push the tab on the back side of the fan finger guard and pull up to remove the fan finger guard from the drive.

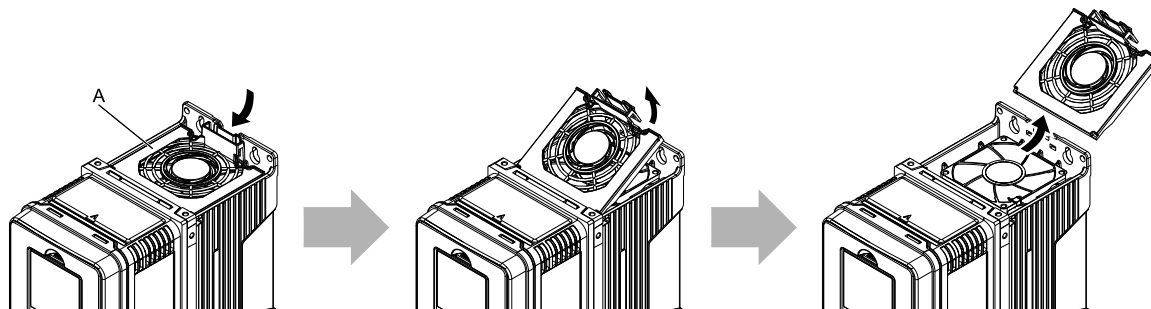

A - Fan finger guard

Figure 8.1 Remove the Fan Finger Guard

2. Pull the cooling fan straight up from the drive. Remove the protective tube on the power supply connector and disconnect the connector to remove the fan from the drive.

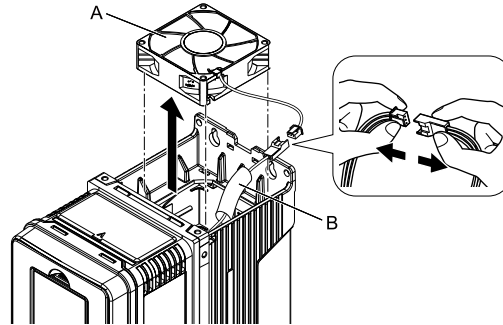

A - Cooling fan

B - Protective tube

Figure 8.2 Remove the Cooling Fan

■ Install a Cooling Fan

Reverse the removal procedure to install a cooling fan.

1. Connect the drive and the fan connectors, and attach the protective tube.

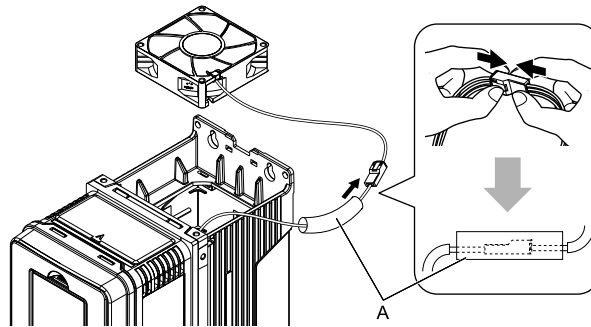

A - Protective tube

Figure 8.3 Connect the Power Supply Connector

2. Align the notches on the fan with the pin on the drive and install the cooling fan in the drive.

Note:

The positions of notch on the fan and alignment pin on the drive are different for different drive models. Use these figures to make sure that you use correct positions for your drive.

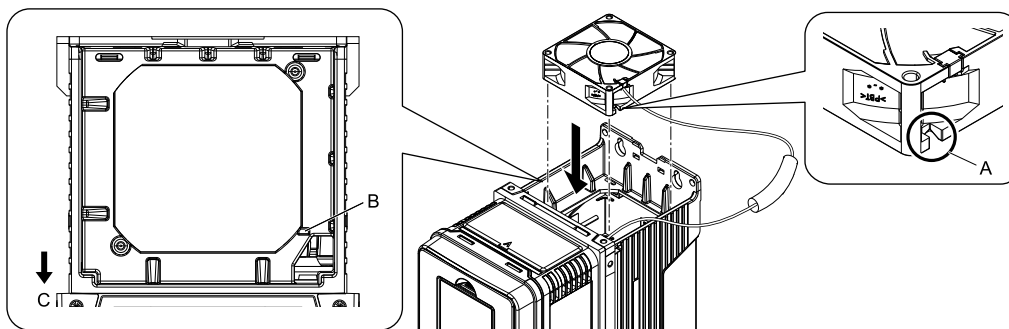

A - Notch on fan

B - Alignment pin on drive

C - Front of drive

Figure 8.4 Install the Cooling Fan (Drive Models: 2011, 2017, 4011, 4014)

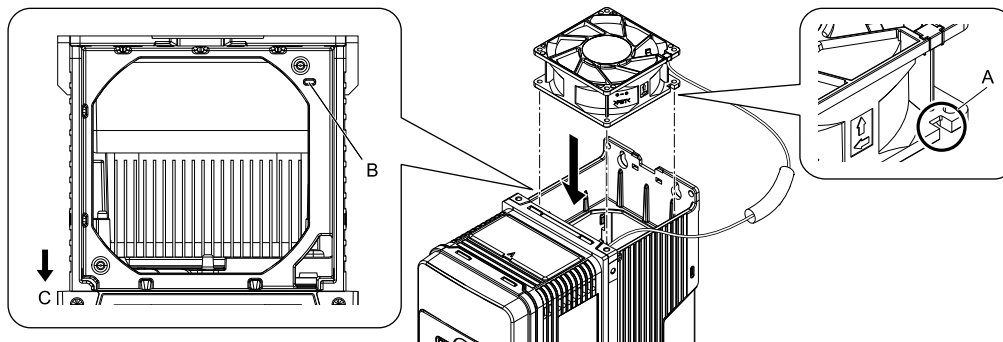

A - Notch on fan
 B - Alignment pin on drive
 C - Front of drive

Figure 8.5 Install the Cooling Fan (Drive Models: 2024, 2031, 4021 to 4034)

- Put the cable and connector in the recess of the drive.

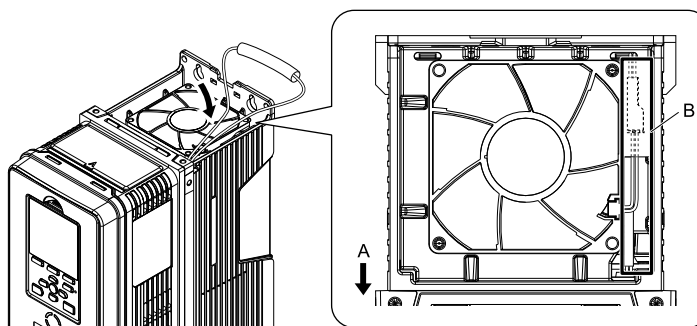

A - Front of drive
 B - Recess for cable and connector

Figure 8.6 Put the Cable in the Drive Recess

*1 Make sure that the cable and connector are in the correct space.

- Hold the fan finger guard at an angle and put the connector tabs on the fan finger guard into the holes on the drive.

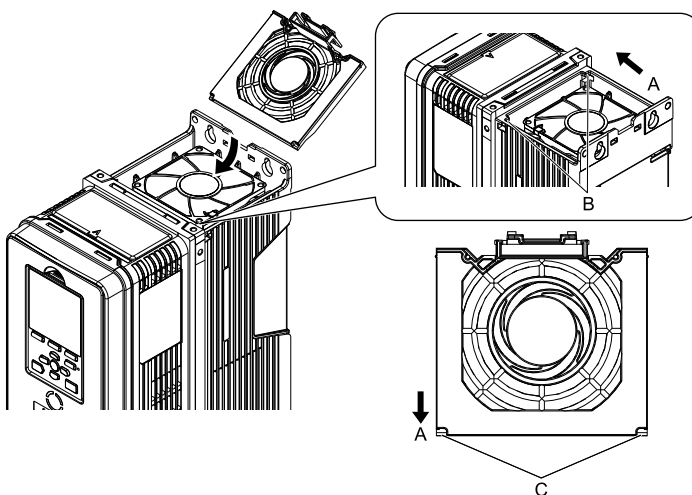

A - Front of drive
 B - Drive holes
 C - Tabs

Figure 8.7 Install the Fan Finger Guard

5. Push the tab on the back side of the fan finger guard and click it into place on the drive.

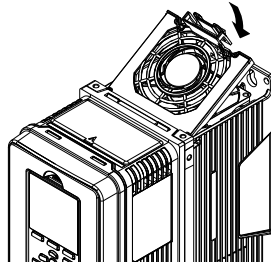

Figure 8.8 Install the Fan Finger Guard

6. Energize the drive and set $o4-03 = 0$ [Fan Operation Time Setting = 0 h] to reset the cooling fan operation time.

■ Remove a Circulation Fan

Note:

Use this procedure only when you use one of these drive models:

- 2024CVx, 2031CVx
- 4021CVx to 4034CVx

Remove the drive cover before you start this procedure.

CAUTION! *Crush Hazard. Loosen the cover screws. Do not fully remove them. If you fully remove the cover screws, the terminal cover can fall and cause moderate injury.*

1. Disconnect the connector and remove the cable from the hook.

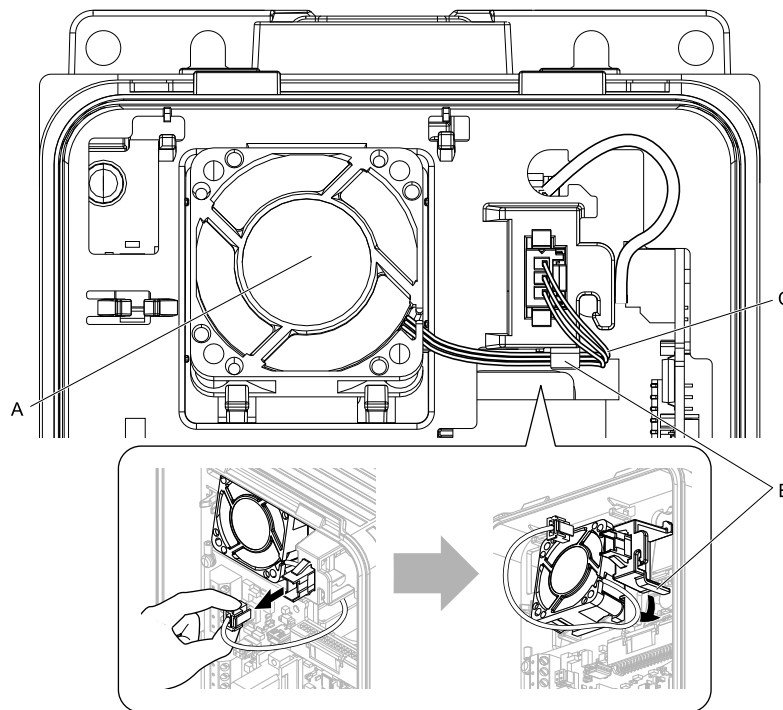

A - Circulation fan
B - Hook

C - Fan cable

Figure 8.9 Disconnect the Connector and Remove the Cable

2. Push the fan toward the bottom of the drive to push on the tabs at the bottom of the fan, then pull the fan forward to remove it from the drive.

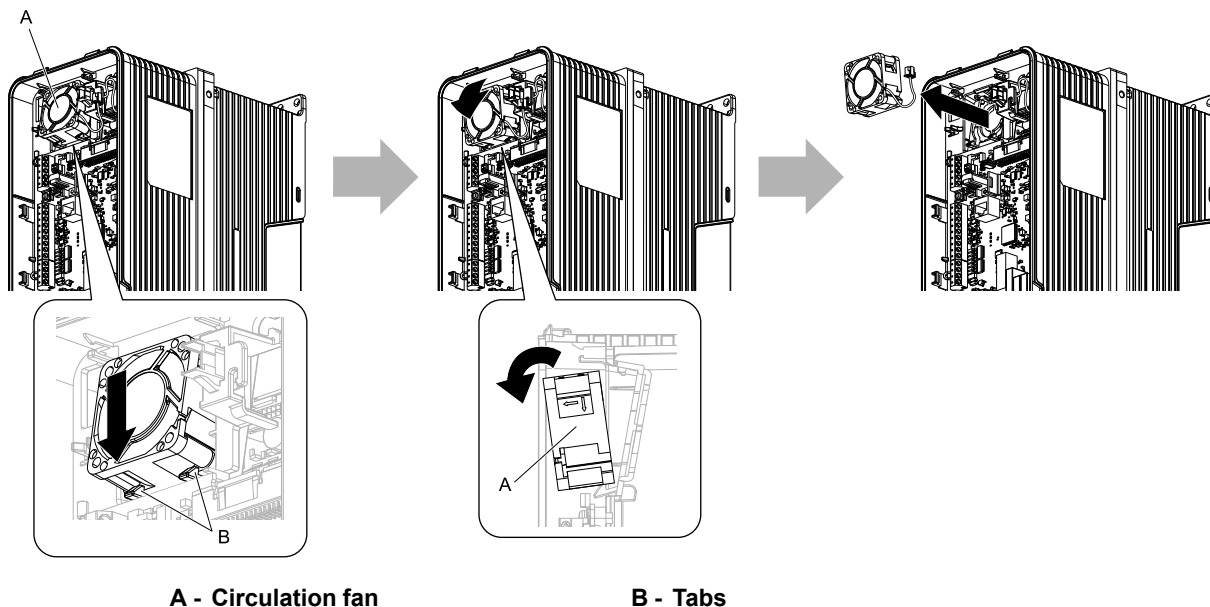

Figure 8.10 Remove the Circulation Fan

■ Install a Circulation Fan

Note:

Use this procedure only when you use one of these drive models:

- 2024CVx, 2031CVx
- 4021CVx to 4034CVx

Reverse the removal procedure to install a circulation fan.

1. Put the side of the fan nearest to the top of the drive in first, and push it until the tabs click into position.

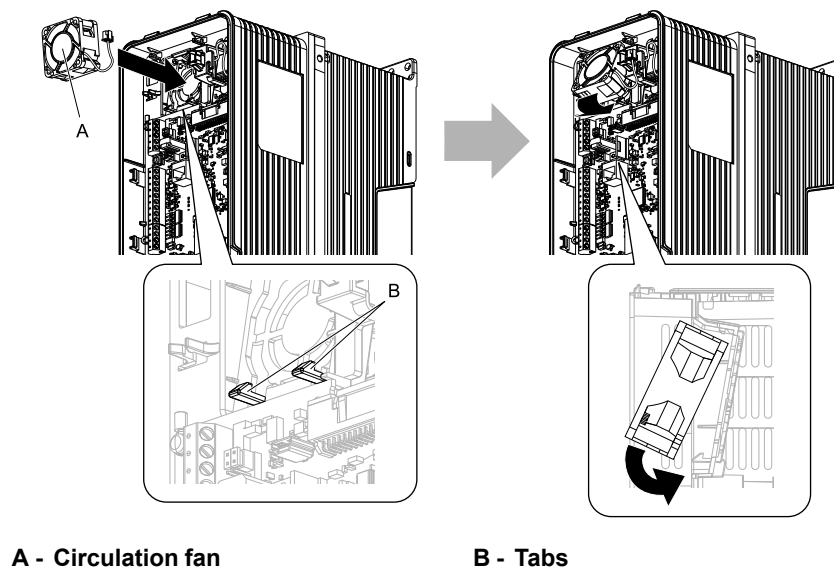

Figure 8.11 Install the Circulation Fan

- Put the cable back into its initial position and connect the power supply connector.

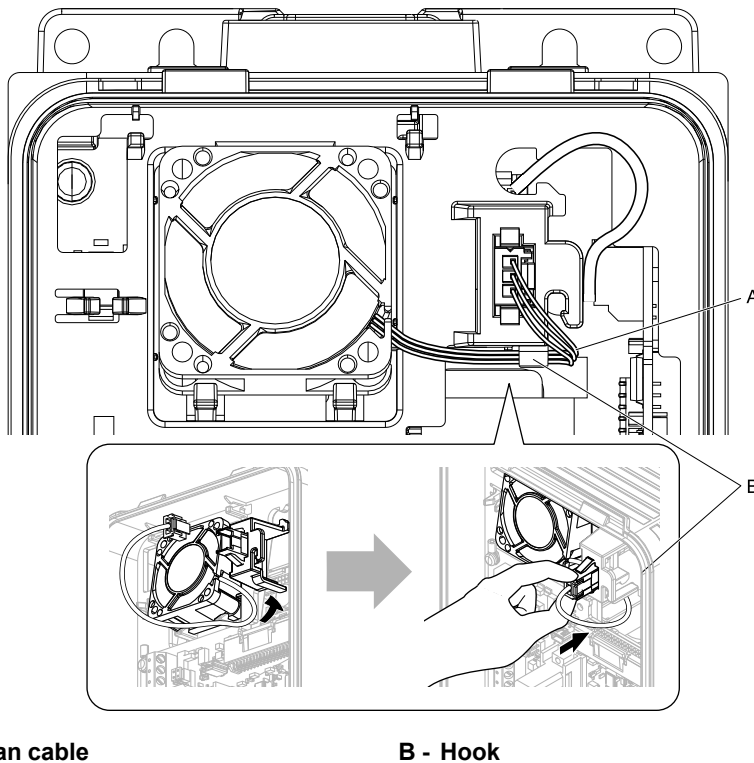

Figure 8.12 Put the Cable Back into the Drive and Connect the Power Supply Connector

◆ Replace a Fan (Procedure B)

DANGER! Electrical Shock Hazard. Do not examine, connect, or disconnect wiring on an energized bypass. Before servicing, disconnect all power to the equipment and wait for the time specified on the warning label at a minimum. The internal capacitor stays charged after the bypass is de-energized. The charge indicator LED extinguishes when the DC bus voltage decreases below 50 Vdc. When all indicators are OFF, remove the covers before measuring for dangerous voltages to make sure that the bypass is safe. If you do work on the bypass when it is energized, it will cause serious injury or death from electrical shock.

CAUTION! Burn Hazard. Do not touch a hot drive heatsink. De-energize the drive, wait for a minimum of 15 minutes, then make sure that the heatsink is cool before you replace the cooling fans. If you touch a hot drive heatsink, it can burn you.

NOTICE: Use the instructions in this manual to replace the cooling fans. When you do maintenance on the fans, replace all the fans to increase product life. If you install the fans incorrectly, it can cause damage to the drive and bypass.

■ Remove a Cooling Fan

- Push the tab on the back side of the fan finger guard and pull up to remove the fan finger guard from the drive.

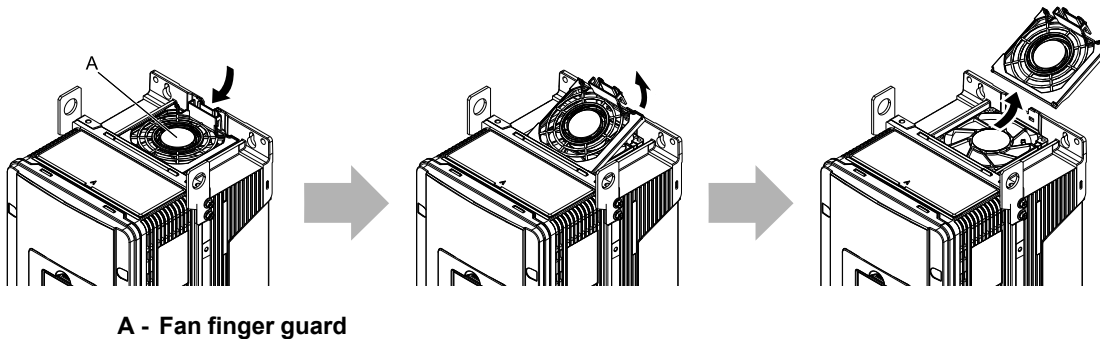
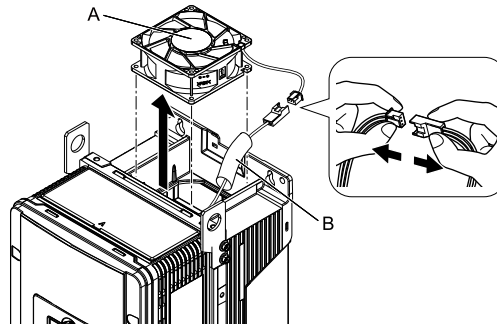

Figure 8.13 Remove the Fan Finger Guard

2. Pull the cooling fan straight up from the drive. Remove the protective tube on the power supply connector and disconnect the connector to remove the fan from the drive.



A - Cooling fan

B - Protective tube

Figure 8.14 Remove the Cooling Fans

■ Install a Cooling Fan

Reverse the removal procedure to install a cooling fan.

1. Connect the drive and the fan connectors, and attach the protective tube.

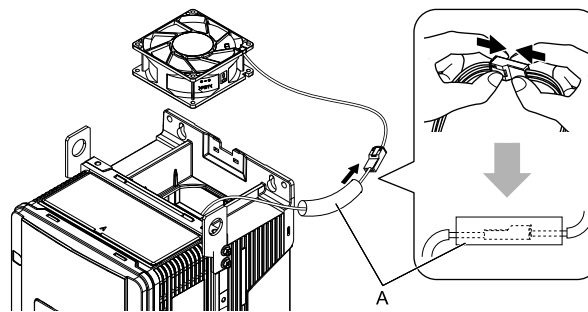

A - Protective tube

Figure 8.15 Connect the Power Supply Connector

2. Align the notch on the fan with the pin on the drive and install the cooling fan in the drive.

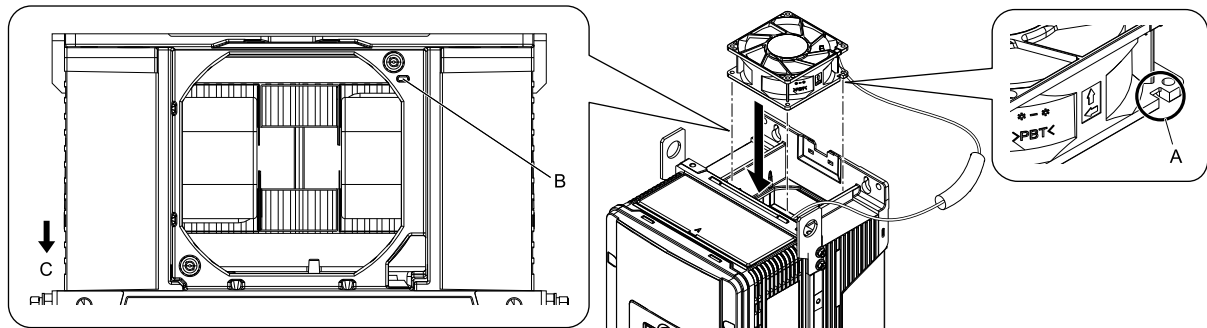

A - Notch on fan

B - Alignment pin on drive

C - Front of drive

Figure 8.16 Install the Cooling Fan

3. Put the cable and connector in the recess of the drive.

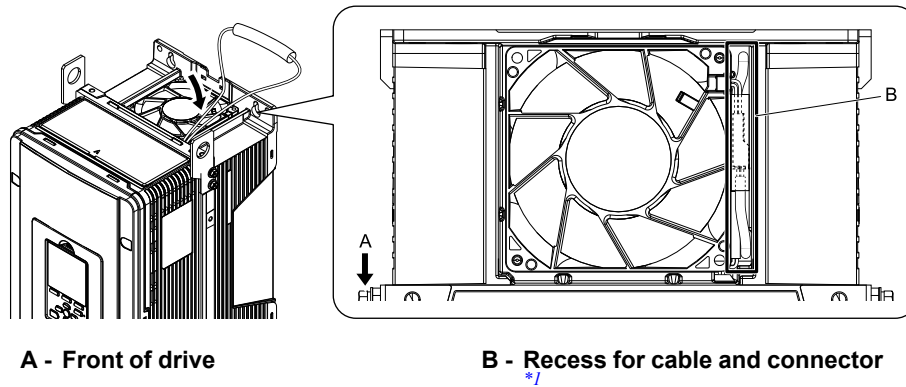

Figure 8.17 Put the Cable in the Drive Recess

*1 Make sure that the cable and connector are in the correct space.

4. Hold the fan finger guard at an angle and put the connector tabs on the fan finger guard into the holes on the drive.

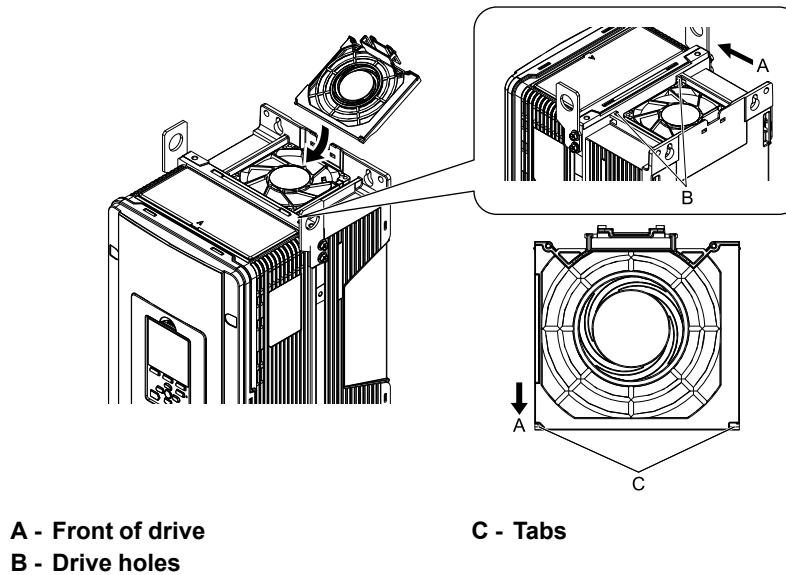

Figure 8.18 Install the Fan Finger Guard

5. Push the tab on the back side of the fan finger guard and click it into place on the drive.

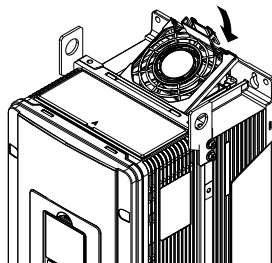

Figure 8.19 Install the Fan Finger Guard

6. Energize the drive and set o4-03 = 0 [Fan Operation Time Setting = 0 h] to reset the cooling fan operation time.

■ Remove a Circulation Fan

Note:

Use this procedure only when you use one of these drive models:

- 2046CVx, 2059CVx
- 4065CFx, 4040CVx to 4065CVx

Remove the drive cover before you start this procedure.

CAUTION! *Crush Hazard. Loosen the cover screws. Do not fully remove them. If you fully remove the cover screws, the terminal cover can fall and cause moderate injury.*

1. Remove the cable from the hooks.

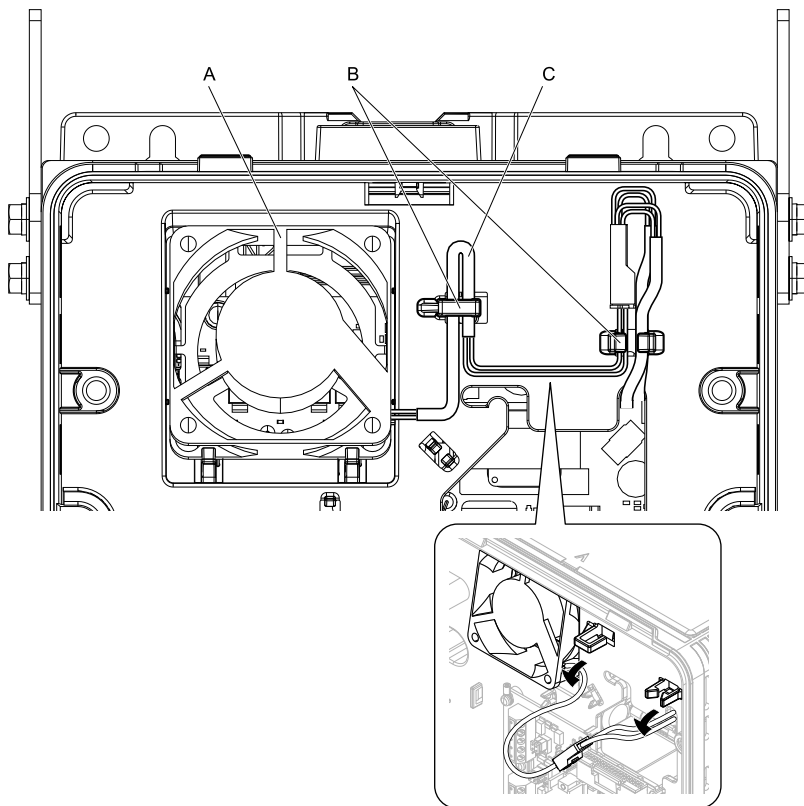

A - Circulation fan
B - Hooks

C - Fan cable

Figure 8.20 Remove the Cable

2. Disconnect the power supply connector.

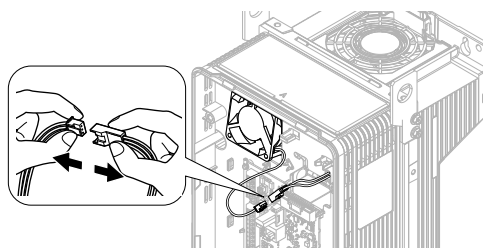

Figure 8.21 Disconnect the Power Supply Connector

3. Push the fan toward the bottom of the drive to push on the tabs at the bottom of the fan, then pull the fan forward to remove it from the drive.

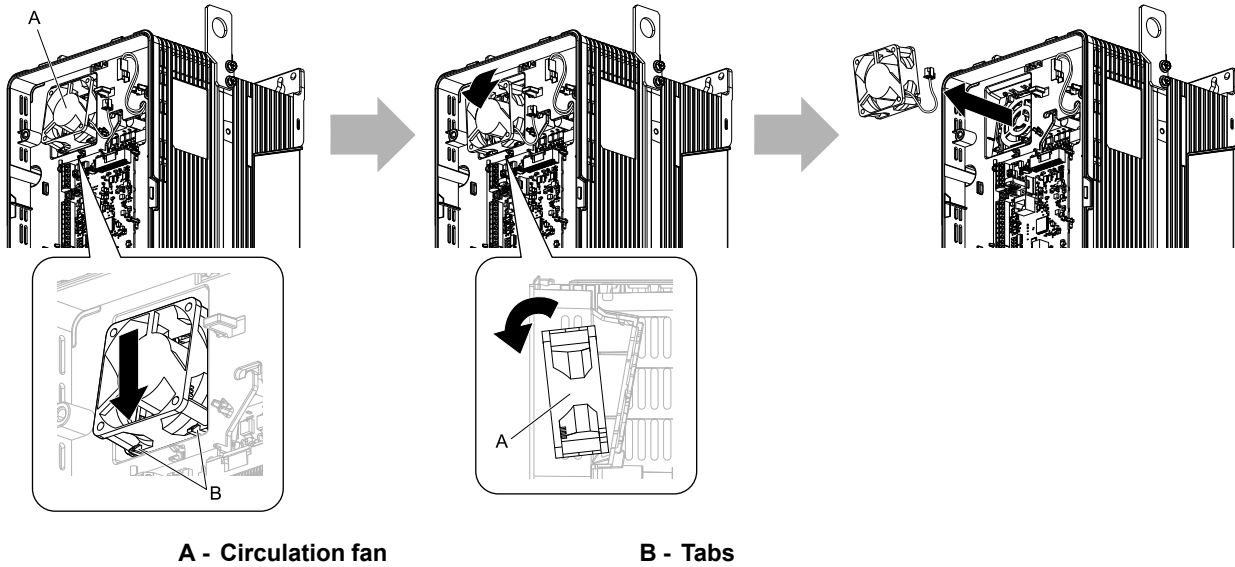

Figure 8.22 Remove the Circulation Fan

■ Install a Circulation Fan

Note:

Use this procedure only when you use one of these drive models:

- 2046CVx, 2059CVx
- 4065CFx, 4040CVx to 4065CVx

Reverse the removal procedure to install a circulation fan.

1. Align the notch on the fan with the pin on the drive and install the fan in the drive.

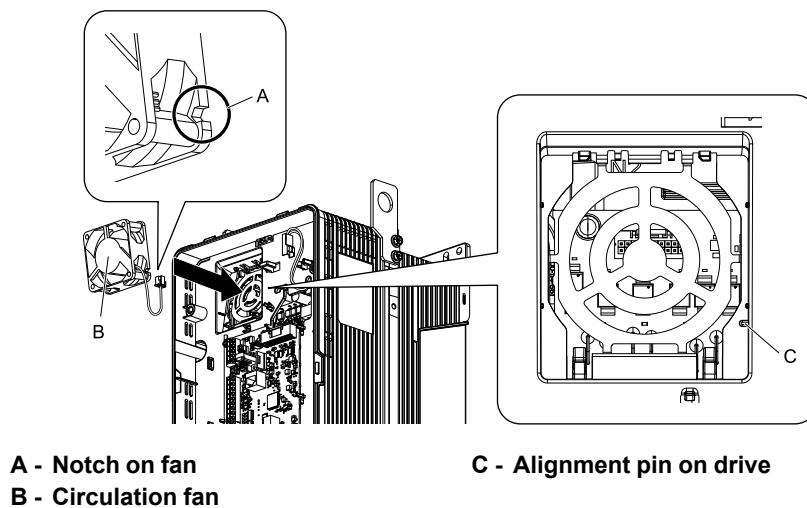
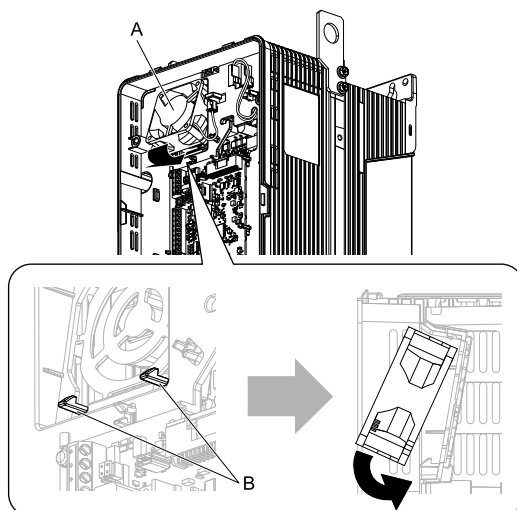
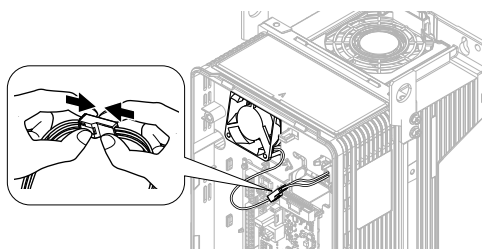

Figure 8.23 Install the Circulation Fan

- Put the side of the fan nearest to the top of the drive in first, and push it until the tabs click into position.

**A - Circulation fan****B - Tabs****Figure 8.24 Install the Circulation Fan**

- Connect the power supply connector.

**Figure 8.25 Connect the Power Supply Connector**

- Put the cables and connector back into their initial positions.

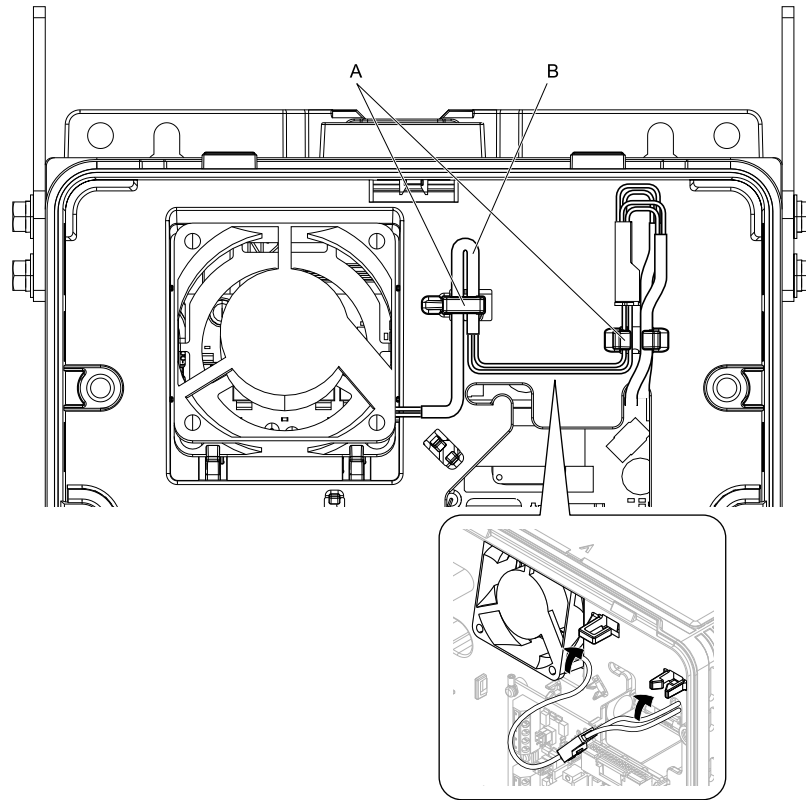

A - Hooks

B - Fan cable

Figure 8.26 Put the Cables Back into the Drive

◆ Replace a Fan (Procedure C)

DANGER! Electrical Shock Hazard. Do not examine, connect, or disconnect wiring on an energized bypass. Before servicing, disconnect all power to the equipment and wait for the time specified on the warning label at a minimum. The internal capacitor stays charged after the bypass is de-energized. The charge indicator LED extinguishes when the DC bus voltage decreases below 50 Vdc. When all indicators are OFF, remove the covers before measuring for dangerous voltages to make sure that the bypass is safe. If you do work on the bypass when it is energized, it will cause serious injury or death from electrical shock.

CAUTION! Burn Hazard. Do not touch a hot drive heatsink. De-energize the drive, wait for a minimum of 15 minutes, then make sure that the heatsink is cool before you replace the cooling fans. If you touch a hot drive heatsink, it can burn you.

NOTICE: Use the instructions in this manual to replace the cooling fans. When you do maintenance on the fans, replace all the fans to increase product life. If you install the fans incorrectly, it can cause damage to the drive and bypass.

■ Remove the Cooling Fans

1. Push the tabs on the left and right sides of the fan finger guard and pull up to remove the fan finger guard from the drive.

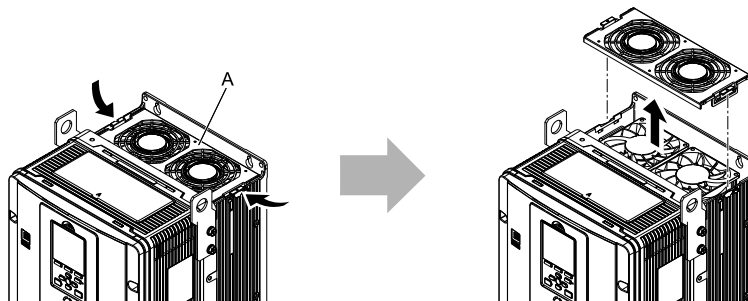

A - Fan finger guard

Figure 8.27 Remove the Fan Finger Guard

2. Pull the cooling fans straight up from the drive. Remove the protective tubes on the power supply connectors and disconnect the connectors to remove the fans from the drive.

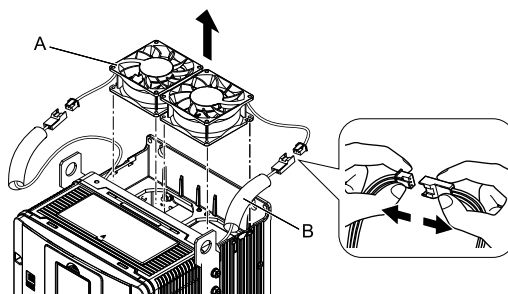

A - Cooling fan

B - Protective tube

Figure 8.28 Remove the Cooling Fans

■ Install the Cooling Fans

Reverse the removal procedure to install the cooling fans.

1. Connect the drive and the fan connectors, and attach the protective tubes.

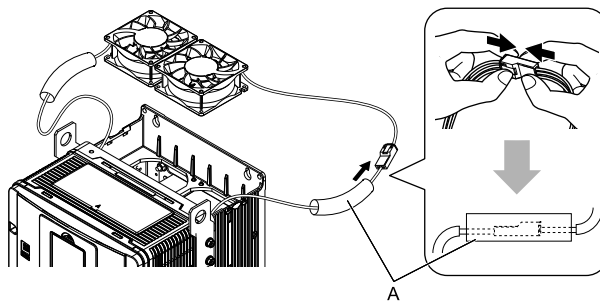

A - Protective tube

Figure 8.29 Connect the Power Supply Connectors

- Align the notches on the fan with the pins on the drive and install the cooling fans in the drive.

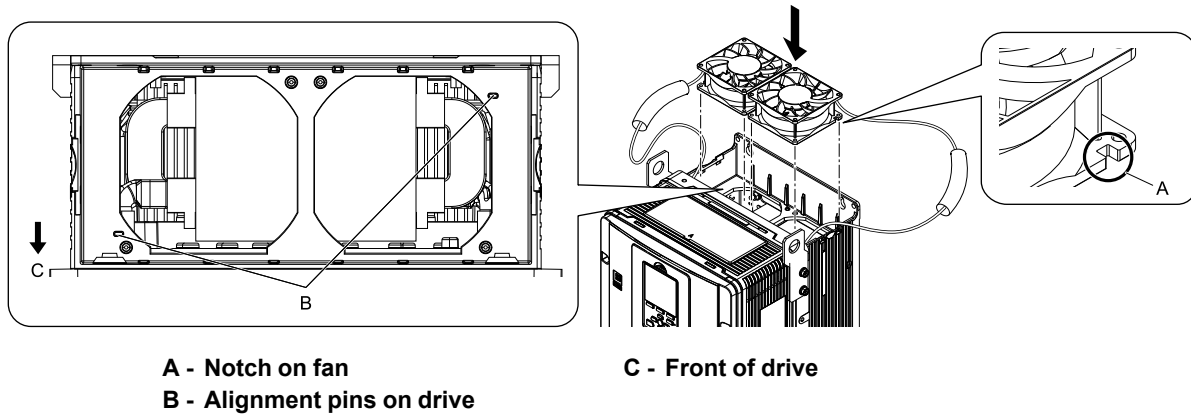

Figure 8.30 Install the Cooling Fans

- Put the cables and connectors in the recess of the drive.

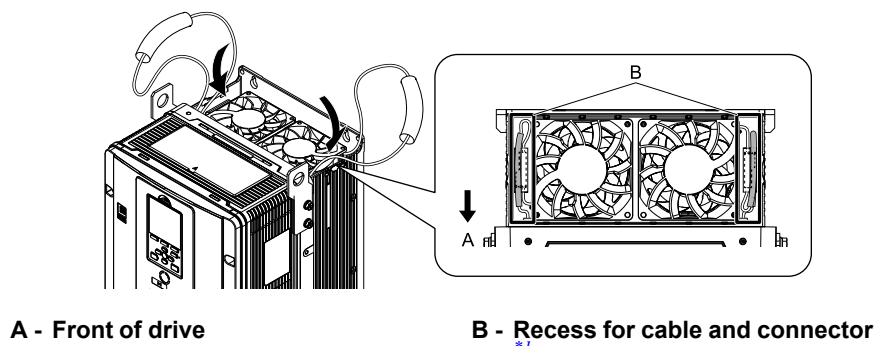

Figure 8.31 Put the Cables and Connectors in the Drive Recess

*1 Make sure that the cable and connector are in the correct space.

- Install the fan finger guard straight until the tabs click into place.

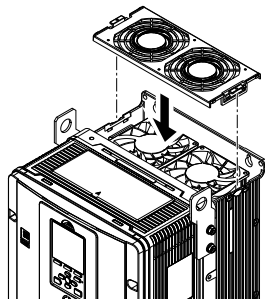

Figure 8.32 Install the Fan Finger Guard

- Energize the drive and set $\alpha 4-03 = 0$ [Fan Operation Time Setting = 0 h] to reset the cooling fan operation time.

■ Remove a Circulation Fan

Note:

Use this procedure only when you use one of these drive models:

- 2075CVx to 2114CVx
- 4077CVx to 4124CVx

Remove the drive cover before you start this procedure.

CAUTION! Crush Hazard. Loosen the cover screws. Do not fully remove them. If you fully remove the cover screws, the terminal cover can fall and cause moderate injury.

1. Pull the connector toward the top of the drive to remove from the hook then remove the cables from the hooks.

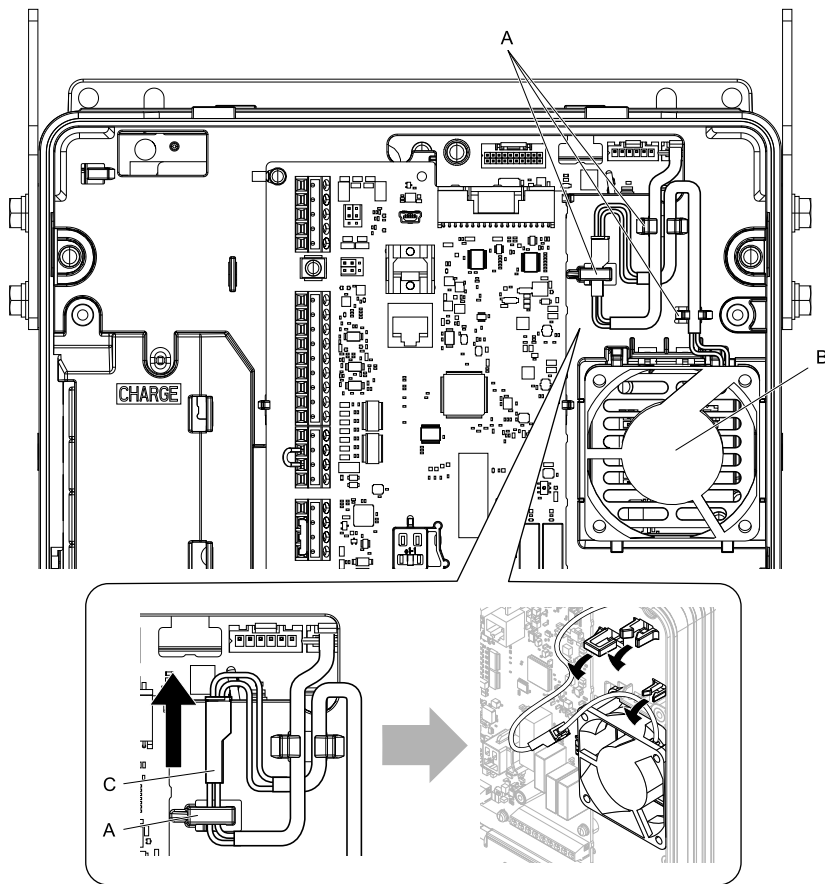

A - Hooks
B - Circulation fan

C - Power supply connector

Figure 8.33 Remove the Cables

2. Disconnect the power supply connector.

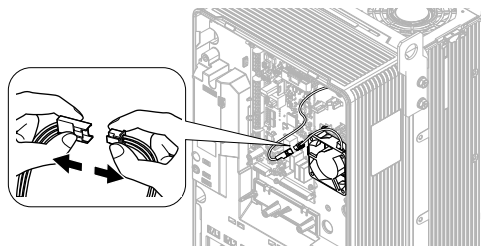

Figure 8.34 Disconnect the Connector

3. Push the fan toward the top of the drive to push on the tabs at the top of the fan, then pull the bottom of the fan forward to remove it from the drive.

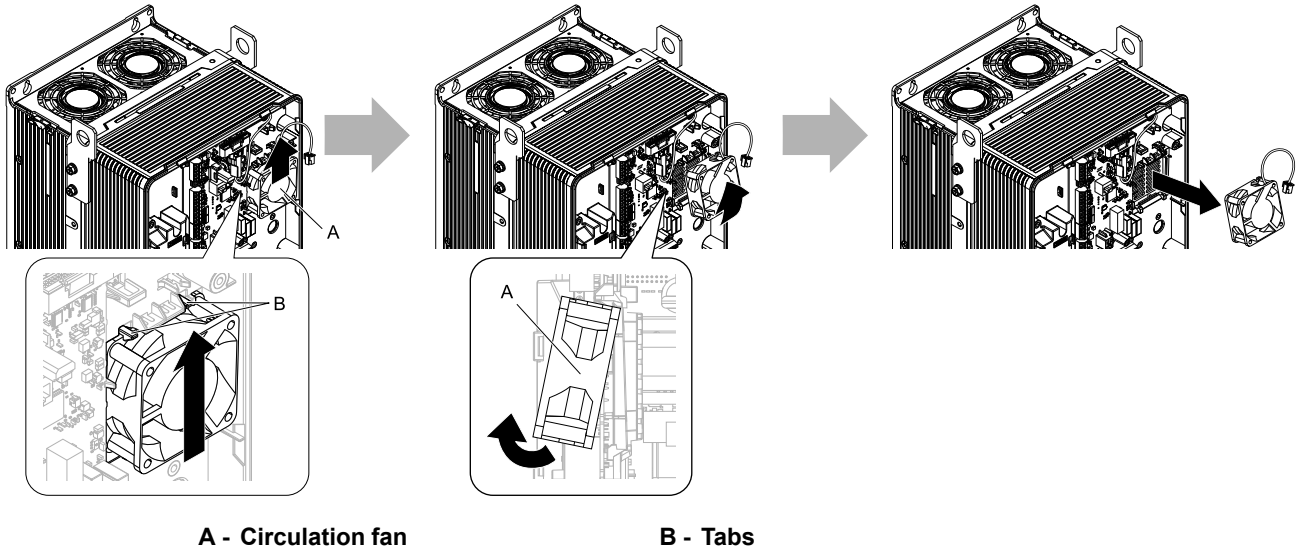

Figure 8.35 Remove the Circulation Fan

■ Install a Circulation Fan

Note:

Use this procedure only when you use one of these drive models:

- 2075CVx to 2114CVx
- 4077CVx to 4124CVx

Reverse the removal procedure to install a circulation fan.

1. Put the bottom of the fan on the tabs in position A then push the fan until the tabs in position B click into position to put the fan back into the drive.

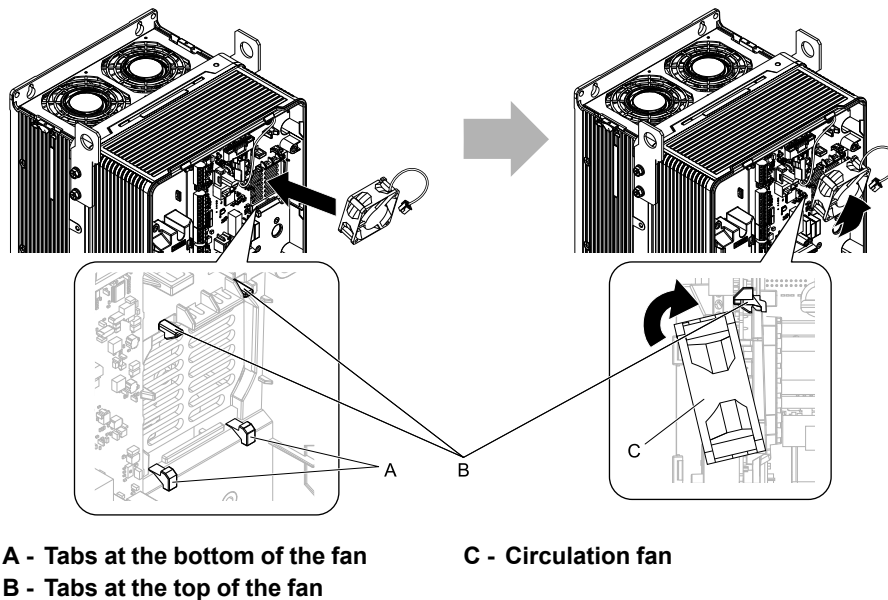

Figure 8.36 Install the Circulation Fan

2. Connect the power supply connector.

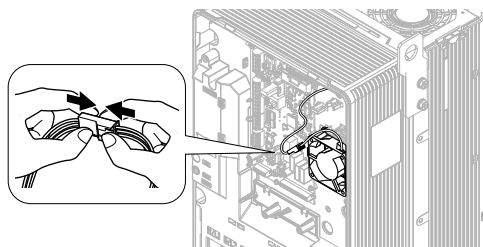
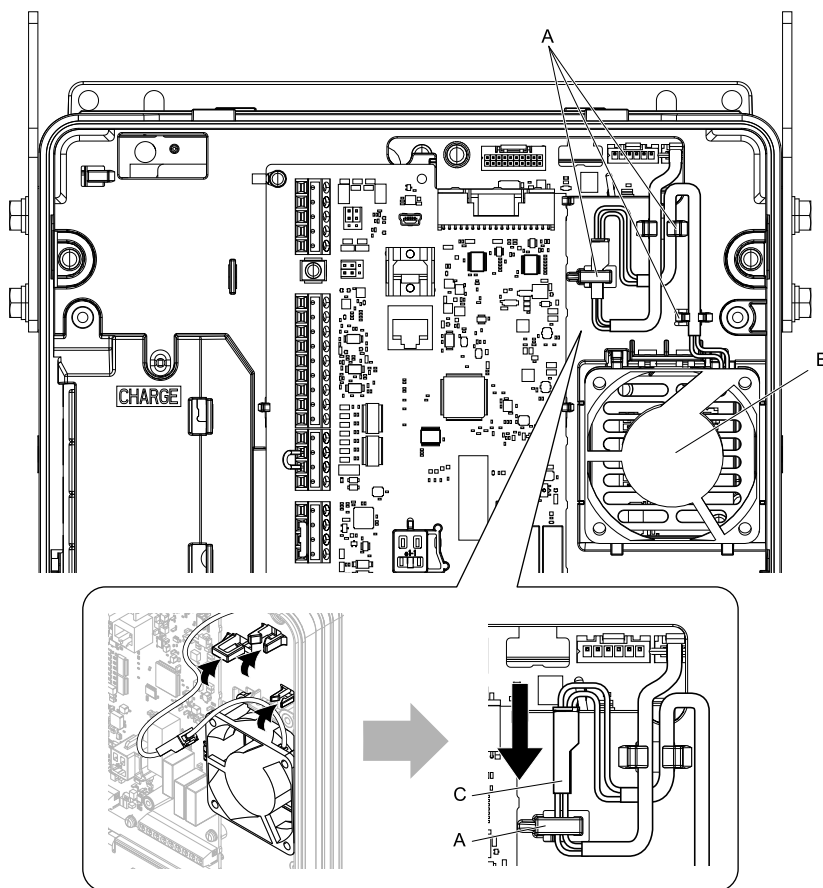

Figure 8.37 Connect the Power Supply Connector

3. Put the cables and connector back into their initial position.



A - Hooks
B - Circulation fan

C - Cable connector

Figure 8.38 Put the Cable and Connector Back into the Drive

◆ Replace a Fan (Procedure D)

DANGER! *Electrical Shock Hazard. Do not examine, connect, or disconnect wiring on an energized bypass. Before servicing, disconnect all power to the equipment and wait for the time specified on the warning label at a minimum. The internal capacitor stays charged after the bypass is de-energized. The charge indicator LED extinguishes when the DC bus voltage decreases below 50 Vdc. When all indicators are OFF, remove the covers before measuring for dangerous voltages to make sure that the bypass is safe. If you do work on the bypass when it is energized, it will cause serious injury or death from electrical shock.*

CAUTION! *Burn Hazard. Do not touch a hot drive heatsink. De-energize the drive, wait for a minimum of 15 minutes, then make sure that the heatsink is cool before you replace the cooling fans. If you touch a hot drive heatsink, it can burn you.*

NOTICE: *Use the instructions in this manual to replace the cooling fans. When you do maintenance on the fans, replace all the fans to increase product life. If you install the fans incorrectly, it can cause damage to the drive and bypass.*

■ Remove the Cooling Fans

1. Push the tabs on the left and right sides of the fan finger guard and pull up to remove the fan finger guard from the drive.

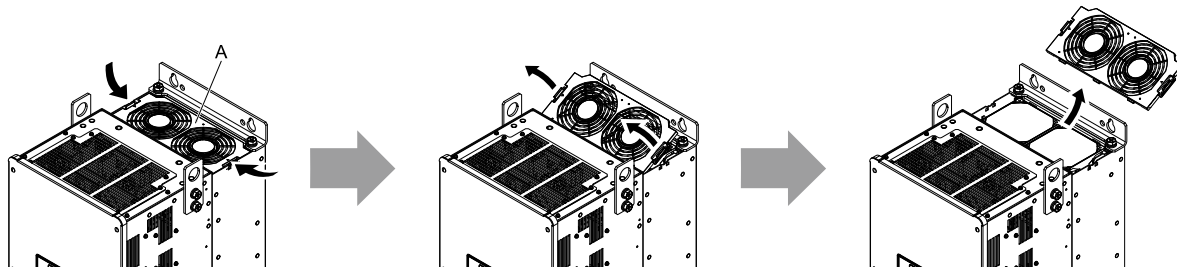

A - Fan finger guard

Figure 8.39 Remove the Fan Finger Guard

2. Pull the cooling fans straight up from the drive. Remove the protective tubes on the power supply connectors and disconnect the connectors to remove the fans from the drive.

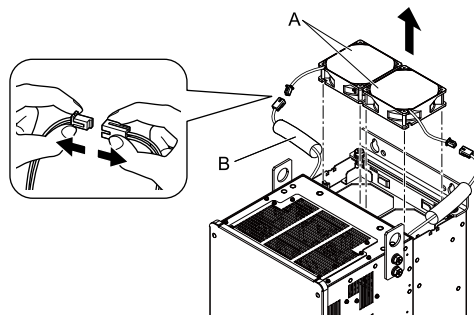

A - Cooling fans

B - Protective tubes

Figure 8.40 Remove the Cooling Fans

■ Install the Cooling Fans

Reverse the removal procedure to install the cooling fans.

1. Connect the power supply connectors, and attach the protective tubes.

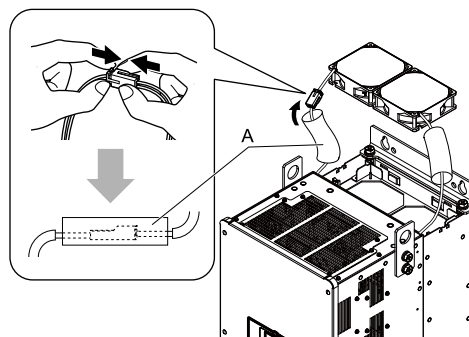

A - Protective tube

Figure 8.41 Connect the Power Supply Connectors

- Align the notches on the fan with the pins on the drive and install the cooling fan in the drive.

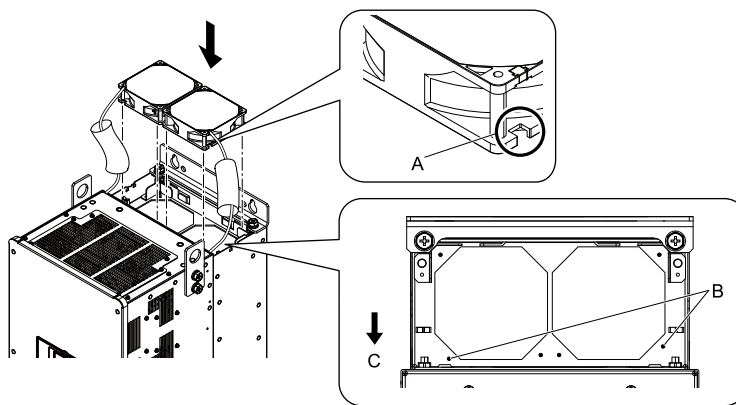

A - Notch on fan
B - Alignment pins on drive

C - Front of drive

Figure 8.42 Install the Cooling Fans

- Put the cables and connectors in the recess of the drive.

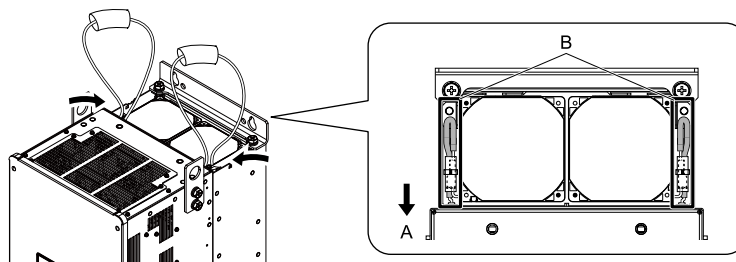

A - Front of drive

B - Recess for cable and connector

Figure 8.43 Put the Cables and Connectors in the Drive Recess

*1 Make sure that the cable and connector are in the correct space.

- Hold the fan finger guard at an angle and put the connector tabs on the fan finger guard into the holes on the drive.

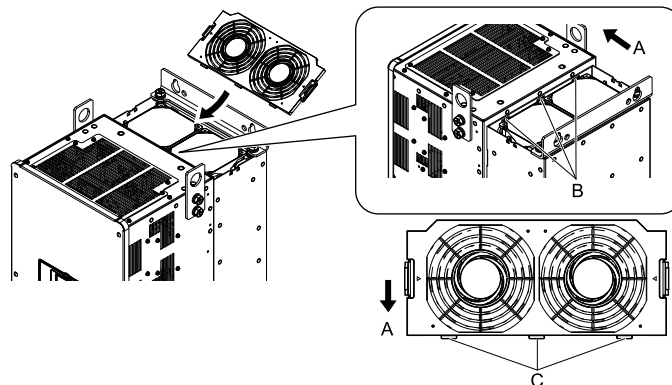

A - Front of drive
B - Drive holes

C - Tabs

Figure 8.44 Install the Fan Finger Guard

5. Push the tabs on the left and right sides of the fan finger guard and click it into place on the drive.

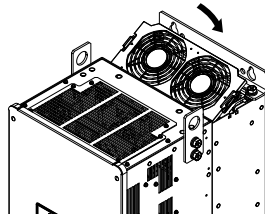

Figure 8.45 Install the Fan Finger Guard

6. Energize the drive and set o4-03 = 0 [Fan Operation Time Setting = 0 h] to reset the cooling fan operation time.

◆ Replace a Fan (Procedure E)

DANGER! *Electrical Shock Hazard. Do not examine, connect, or disconnect wiring on an energized bypass. Before servicing, disconnect all power to the equipment and wait for the time specified on the warning label at a minimum. The internal capacitor stays charged after the bypass is de-energized. The charge indicator LED extinguishes when the DC bus voltage decreases below 50 Vdc. When all indicators are OFF, remove the covers before measuring for dangerous voltages to make sure that the bypass is safe. If you do work on the bypass when it is energized, it will cause serious injury or death from electrical shock.*

CAUTION! *Burn Hazard. Do not touch a hot drive heatsink. De-energize the drive, wait for a minimum of 15 minutes, then make sure that the heatsink is cool before you replace the cooling fans. If you touch a hot drive heatsink, it can burn you.*

NOTICE: *Use the instructions in this manual to replace the cooling fans. When you do maintenance on the fans, replace all the fans to increase product life. If you install the fans incorrectly, it can cause damage to the drive and bypass.*

■ Remove the Cooling Fans

1. Push the tabs on the back side of each fan finger guard and pull up to remove the fan finger guards from the drive.

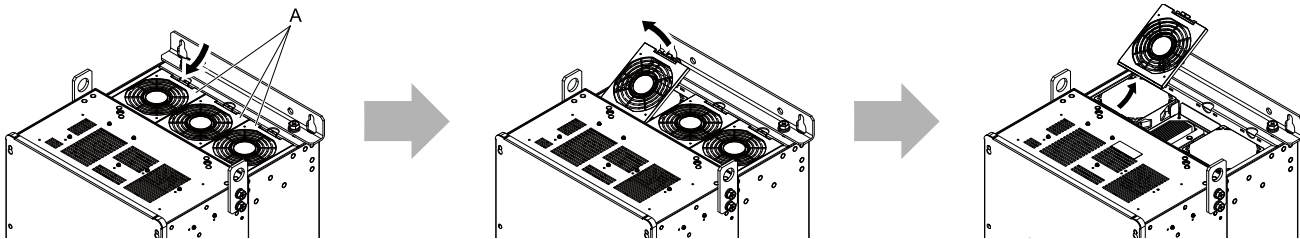

A - Fan finger guard

Figure 8.46 Remove the Fan Finger Guard

2. Pull the cooling fans straight up from the drive. Remove the protective tubes on the power supply connectors and disconnect the connectors to remove the fans from the drive.

Note:

The number of fans is different for different drive models.

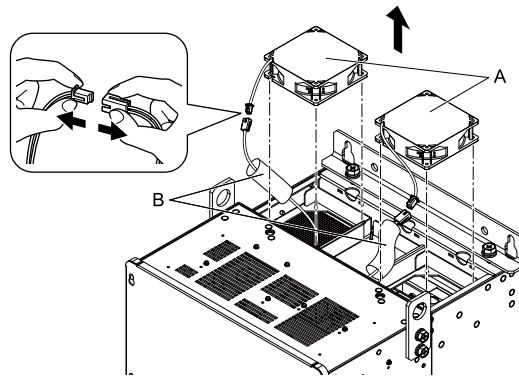

A - Cooling fans

B - Protective tubes

Figure 8.47 Remove the Cooling Fans

■ Install the Cooling Fans

Reverse the removal procedure to install the fan units.

1. Connect the power supply connectors, and attach the protective tube.

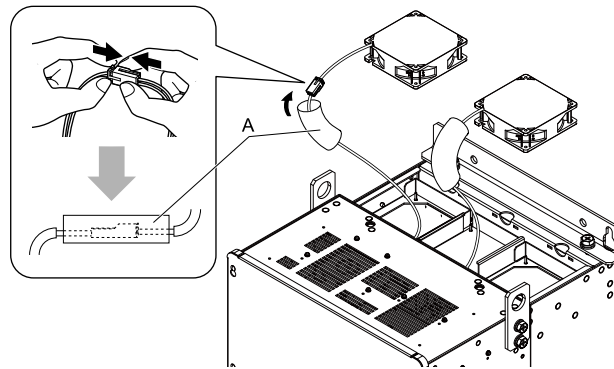

A - Protective tubes

Figure 8.48 Connect the Power Supply Connectors

2. Align the notches on the fan with the pins on the drive and install the cooling fan in the drive.

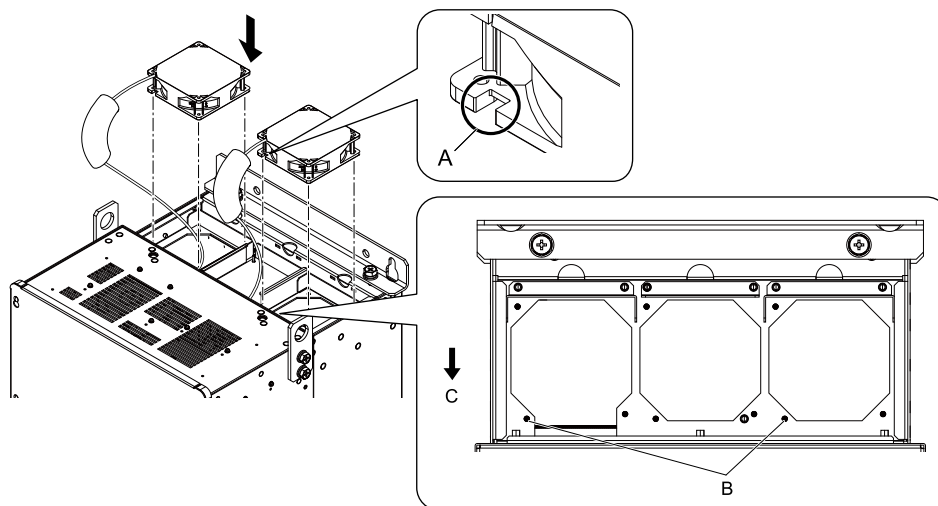

A - Notch on fan

B - Alignment pins on drive

C - Front of drive

Figure 8.49 Install the Cooling Fans

8.4 Replace Drive Cooling Fans and Circulation Fans

- Put the cables and connectors in the recess of the drive.

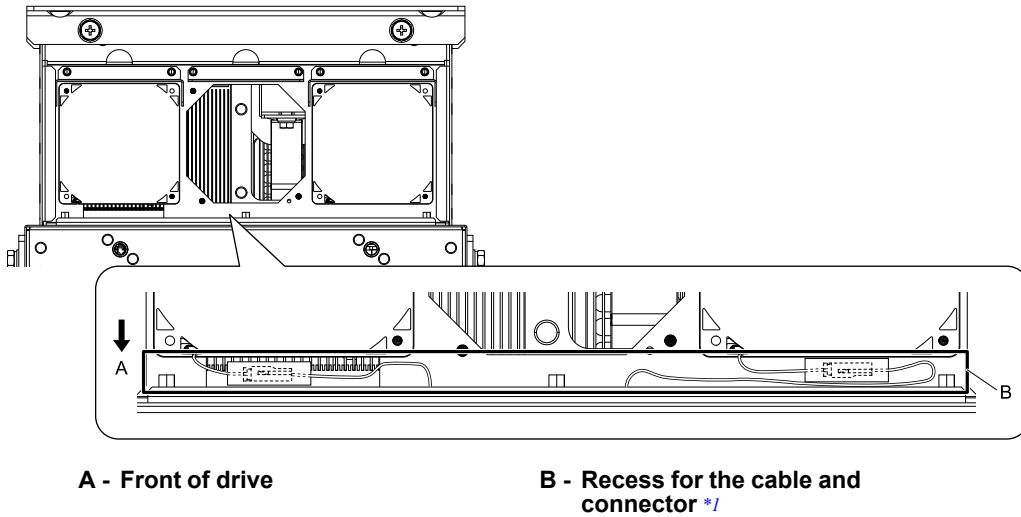

Figure 8.50 Put the Cables and Connectors in the Drive Recess

*1 Make sure that the cable and connector are in the correct space.

- Hold the fan finger guard at an angle and put the connector tabs on the fan finger guard into the receiving areas on the drive.

Note:

When you install the cooling fan, make sure that you do not pinch cables between the fan finger guard and the drive.

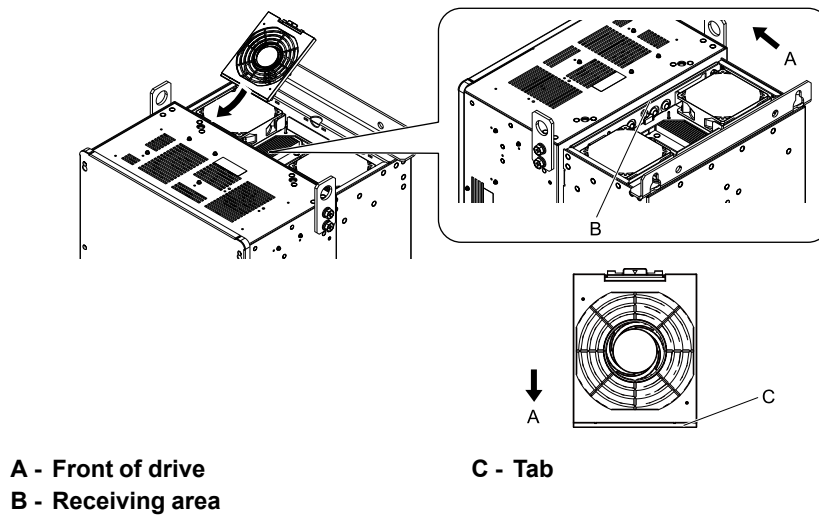

Figure 8.51 Install the Fan Finger Guard

5. Push the tab on the back side of the fan finger guard and click it into place on the drive.

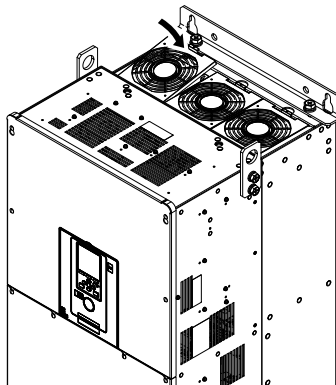

Figure 8.52 Install the Fan Finger Guard

6. Energize the drive and set $\alpha 4-03 = 0$ [Fan Operation Time Setting = 0 h] to reset the cooling fan operation time.

■ Remove a Circulation Fan

Remove the drive cover before you start this procedure.

CAUTION! Crush Hazard. Loosen the cover screws. Do not fully remove them. If you fully remove the cover screws, the terminal cover can fall and cause moderate injury.

1. Remove the cables from the clamps.

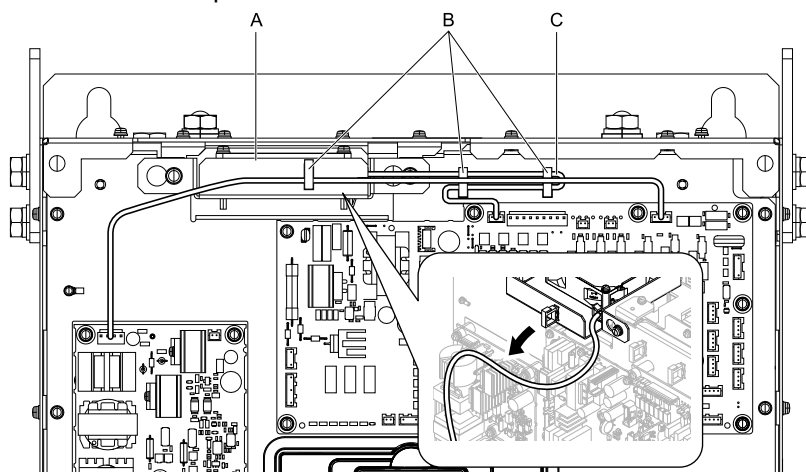

A - Fan unit
B - Clamps

C - Fan cable

Figure 8.53 Remove the Fan Cables

2. Loosen the fan unit screws and slide the fan unit to the right.

Note:

To remove the fan unit, it is only necessary to loosen the screws.

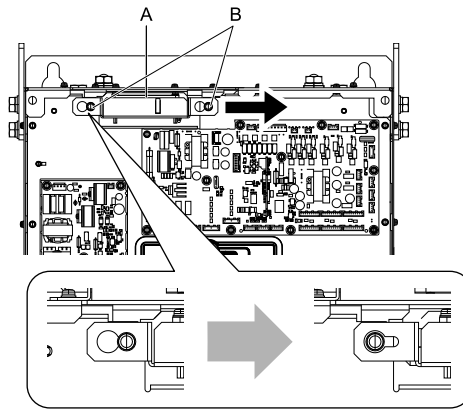

A - Fan unit

B - Screws

Figure 8.54 Slide the Fan Unit

3. Disconnect the relay connector and remove the fan unit.

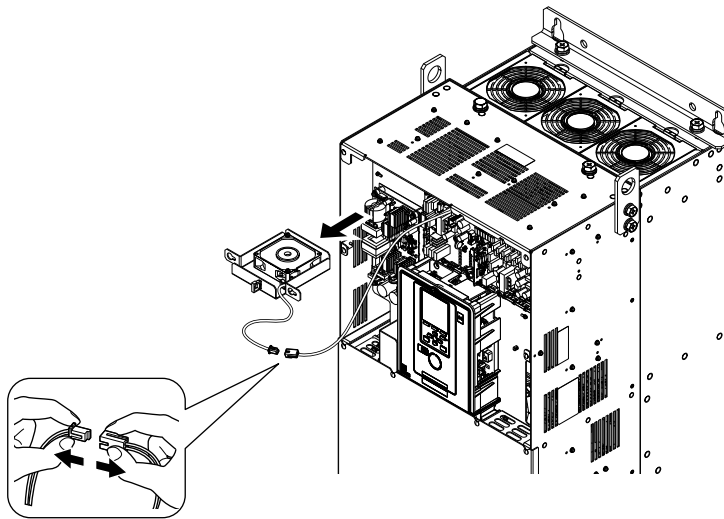
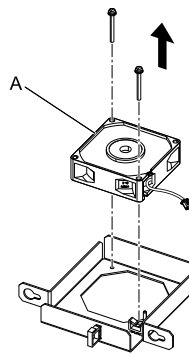

Figure 8.55 Remove the Fan Unit

4. Remove the screws that safety the cooling fan and remove the fan.



A - Cooling fan

Figure 8.56 Remove the Cooling Fan

■ Install a Circulation Fan

Reverse the removal procedure to install a circulation fan.

1. Connect the power supply connector.

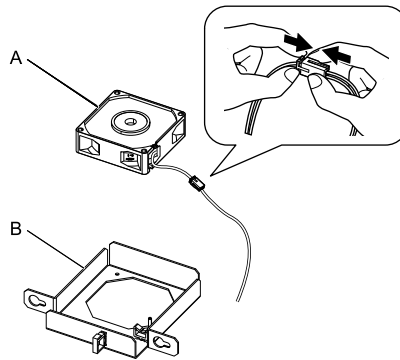

A - Cooling fan

B - Fan unit base

Figure 8.57 Connect the Power Supply Connector

2. Align the pins on the fan unit base with the notches on the fan and put the fan unit base in the fan unit, then use the screws to safety it.

Tighten the screws to a correct tightening torque:

- 0.98 N·m to 1.33 N·m (8.67 in·lb to 11.77 in·lb)

A - Cooling fan
B - Fan unit baseC - Alignment pin on fan unit base
D - Circulation fan connector

Figure 8.58 Install the Cooling Fan

3. Safety the fan cable through the clamp.

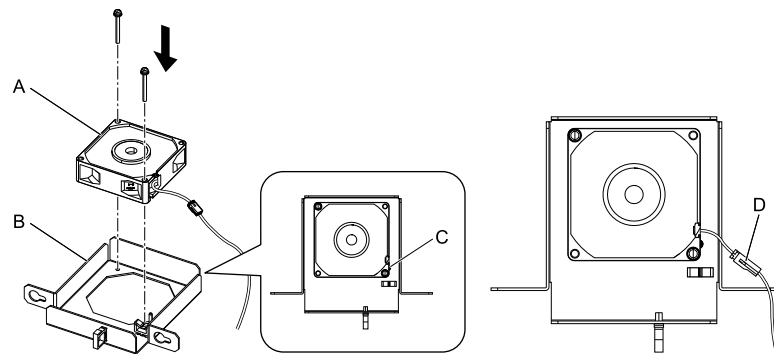
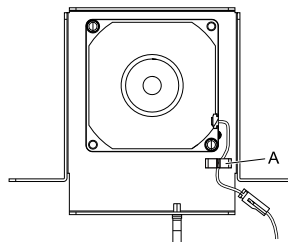

A - Clamp

Figure 8.59 Safety the Fan Cable

4. Put the fan unit into the specified location and slide it to the left, then use screws to safety it to the drive.

Tighten the screws to a correct tightening torque:

- 0.98 N·m to 1.33 N·m (8.67 in·lb to 11.77 in·lb)

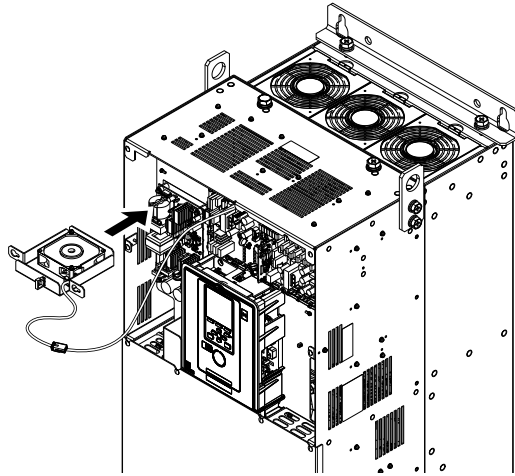
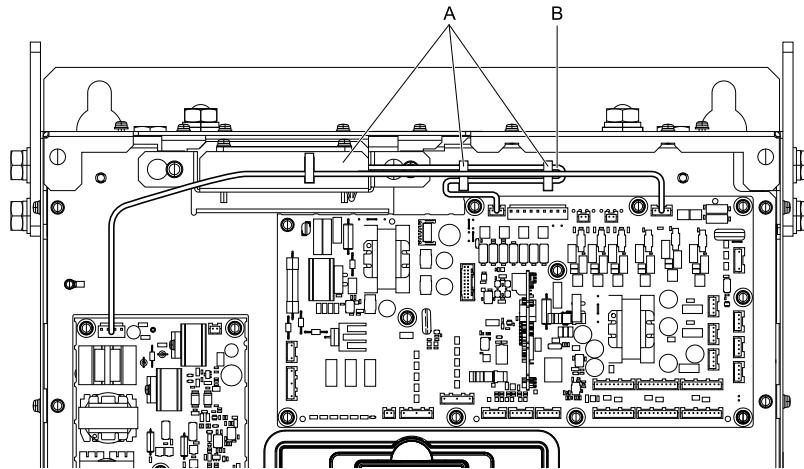

Figure 8.60 Install the Fan Unit

5. Safety the cables through the clamps.



A - Clamps

B - Fan cable

6. Install the drive cover.
7. Energize the drive and set $o4-03 = 0$ [*Fan Operation Time Setting = 0 h*] to reset the cooling fan operation time.

8.5 Replace the Keypad Battery

When the keypad battery is expired, the date and time go back to the default settings. Use this procedure to replace the battery.

WARNING! Fire Hazard. Handle keypad batteries properly. Do not charge the battery or disassemble the keypad. If the battery explodes, it can cause a fire.

To replace the battery, use a Hitachi Maxell “CR2016 Lithium Manganese Dioxide Lithium Battery” or an equivalent battery with these properties:

- Nominal voltage: 3 V
- Operating temperature range: -20 °C to + 85°C (-4 °F to +185 °F)

WARNING! Fire Hazard. Do not disassemble batteries. Do not expose batteries to heat or fire. If the battery explodes, it can cause a fire.

NOTICE: Damage to Equipment. The keypad battery stays in use after you de-energize the bypass. When you will keep the bypass de-energized for long periods of time, remove the battery from the keypad. When the expected life of the battery is complete, replace the battery immediately. A dead battery in the keypad can leak and cause damage to the keypad and bypass.

The performance life estimate of a new battery is:

- Ambient temperature 20 °C (68 °F): 5 years
- Ambient temperature -10 °C to +50 °C (14 °F to 122 °F): 3.5 years

1. De-energize the drive and remove the keypad.
2. Use a slotted screwdriver or other tool to turn the battery cover counterclockwise and remove the cover.

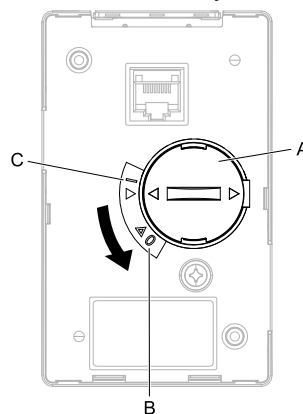

A - Battery cover
B - Opened

C - Closed

Figure 8.61 Remove the Battery Cover

3. Remove the used battery from the keypad.
4. Insert the new battery.

Note:

- The battery cover side is the positive pole. Make sure that the polarity is correct when you put the battery in the keypad.
- Discard the used battery as specified by local regulations.

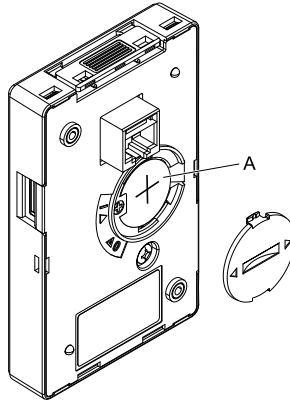

A - Battery

Figure 8.62 Insert the New Battery

5. Put the battery cover on the keypad and use a slotted screwdriver to turn the battery cover clockwise to close it.
6. Install the keypad on the drive.
7. Apply power to the bypass, use the “Initial Setup” selection on the main menu, then select “Set Date / Time” to set the date and time.

8.6 Storage Guidelines

The chemicals in the electrolytic capacitors and other electronic parts of the drive change over time. When you store the drive for long periods of time, use the information in this section to help keep the performance life estimates.

◆ Storage Location

- Temperature and Humidity

When you store the drive for approximately one month, for example during shipping, you can put the drive in a location where the temperature is $-20\text{ }^{\circ}\text{C}$ to $+70\text{ }^{\circ}\text{C}$ ($-4\text{ }^{\circ}\text{F}$ to $+158\text{ }^{\circ}\text{F}$). Correctly package and store the drive during shipping to prevent vibration and impact damage.

Do not put the drive in direct sunlight or where there will be condensation or ice. Put the drive in a location where the relative humidity is 95% or less.

- Dust and Oil Mist

Do not keep the drive locations with dust or oil mist. For example, cement factories and cotton mills.

- Corrosive Gas

Do not keep the drive in locations with corrosive gas. For example, chemical plants, refineries, and sewage plants.

- Salt Damage

Do not keep the drive in salty locations. For example, locations near the ocean, and salt damage-designated locations.

Do not keep the drive in unsatisfactory locations. Keep all drives in storage rooms that are safe from unsatisfactory elements.

◆ Regular Application of Power

To prevent deterioration of the capacitors, Yaskawa recommends that you apply power to the drive a minimum of one time each year for a minimum of 30 minutes.

If you store the drive for longer than two years and do not apply power, Yaskawa recommends that you use a variable power source and gradually increase the power from 0 V to the rated drive voltage over a period of 2 to 3 minutes. Apply power for a minimum of 1 hour with no load to reform the main circuit electrolytic capacitor. When you operate the drive after you apply power, wire the drive correctly and check for drive faults, overcurrents, motor vibration, motor speed differences, and other defects during operation.

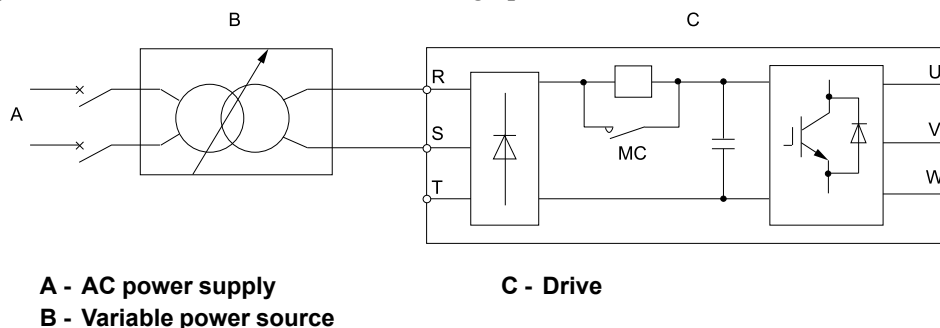

Figure 8.63 Power Distribution Method

Parameter List

9.1	Section Safety	592
9.2	How to Read the Parameter List	593
9.3	Parameter Groups	594
9.4	A: Initialization Parameters	595
9.5	b: Application	598
9.6	C: Tuning	605
9.7	d: Reference Settings	607
9.8	E: Motor Parameters	609
9.9	F: Options	611
9.10	H: Terminal Functions	616
9.11	L: Protection Functions	633
9.12	n: Special Adjustment	640
9.13	o: Keypad-Related Settings	641
9.14	S: Special Applications	647
9.15	Y: Application Features	656
9.16	Z: Bypass Parameters	664
9.17	U: Monitors	672
9.18	Defaults by Bypass and Drive Model	689

9.1 Section Safety

 **DANGER**

Do not ignore the safety messages in this manual.

If you ignore the safety messages in this manual, it will cause serious injury or death. The manufacturer is not responsible for injuries or damage to equipment.

9.2 How to Read the Parameter List

◆ Terms that Identify Parameters

Icon	Description
Hex.	Hexadecimal numbers that represent MEMOBUS addresses to change parameters over network communication.
RUN	You can change the parameter setting during Run.
Expert	The parameter is available in Expert Mode only. ^{*1}

*1 Set $A1-01 = 3$ [*Access Level Selection = Expert Level*] to show and set Expert Mode parameters on the keypad.

9.3 Parameter Groups

Parameter Group	Name
A1	Initialization
A2	User Parameters
b1	Operation Mode Selection
b2	DC Injection Braking
b3	Speed Search
b4	Timer Function
b5	PID Control
b8	Energy Saving
C1	Accel & Decel Time
C2	S-Curve Characteristics
C3	Slip Compensation
C4	Torque Compensation
C6	Carrier Frequency
d1	Frequency Reference
d2	Reference Limits
d3	Jump Frequency
d4	Frequency Ref Up/Down & Hold
d6	Field Weakening
d7	Offset Frequency
E1	V/f Pattern for Motor 1
E2	Motor Parameters
F6	Communication Options
F7	Ethernet Options
H1	Digital Inputs
H2	Digital Outputs
H3	Analog Inputs
H4	Analog Outputs
H5	Serial Communication
H7	Virtual Inputs / Outputs
L1	Motor Protection
L2	Power Loss Ride Through
L3	Stall Prevention
L4	Speed Detection

Parameter Group	Name
L5	Fault Restart
L6	Torque Detection
L8	Drive Protection
L9	Drive Protection 2
n1	Hunting Prevention
n3	High Slip/Overexcite Braking
o1	Keypad Display
o2	Keypad Operation
o3	Copy Keypad Function
o4	Maintenance Monitors
o5	Log Function
S1	Dynamic Noise Control
S2	Sequence Run Timers
S3	PI2 Control
S5	HAND/OFF/AUTO Operation
S6	Protection
Y1	Application Basics
Y2	PID Sleep and Protection
Y4	Application Advanced
YA	Preset Setpoint
YC	Foldback Features
YF	PI Auxiliary Control
Z1	Bypass Control System
Z2	Bypass Digital Inputs/Outputs
Z3	Bypass Serial Communications
U1	Operation Status Monitors
U2	Fault Trace
U3	Fault History
U4	Maintenance Monitors
U5	PID Monitors
U6	Operation Status Monitors
Ub	Bypass Control Monitors
UC	BACnet Diagnostic Monitors

9.4 A: Initialization Parameters

◆ A1: Initialization

No. (Hex.)	Name	Description	Default (Range)
A1-00 (0100) RUN	Language Selection	Sets the language for the HOA keypad. Note: When you use <i>A1-03 [Initialize Parameters]</i> to initialize the drive, the drive will not reset this parameter. 0 : English 5 : Spanish	0 (0, 5)
A1-01 (0101) RUN	Access Level Selection	Sets user access to parameters. The access level controls which parameters the keypad will display and which parameters you can set. 0 : Operation Only 1 : User Parameters 2 : Advanced Level 3 : Expert Level 4 : Lock Parameters	2 (0 - 4)
A1-03 (0103)	Initialize Parameters	Sets parameters to default values. 0 : No Initialization 1110 : User Initialization 2220 : 2-Wire Initialization	0 (0, 1110, 2220)
A1-04 (0104)	Password	Entry point for the password set in <i>A1-05 [Password Setting]</i> . The user can view the settings of parameters that are locked without entering the password. Enter the correct password in this parameter to change parameter settings.	0000 (0000 - 9999)
A1-05 (0105)	Password Setting	Sets a password to lock parameters and prevent changes to parameter settings. Enter the correct password in <i>A1-04 [Password]</i> to unlock parameters and accept changes.	0000 (0000 - 9999)
A1-06 (0127)	Application Preset	Sets the drive to operate in selected application conditions. 0 : No Preset Selected 1 : General Purpose Fan 2 : Fan w/ PID Control 3 : Return Fan w/ PID Control 4 : Cooling Tower Fan 5 : Cooling Tower Fan w/ PID 6 : Secondary Pump 7 : Pump w/ PID Control	0 (0 - 7)
A1-11 (111D) Expert	Firmware Update Lock	Protects the drive firmware. When you enable the protection, you cannot update the bypass controller firmware. 0 : Disabled 1 : Enabled	0 (0, 1)
A1-12 (1564)	Bluetooth ID	Sets the password necessary to use Bluetooth to control the drive with a smartphone or tablet.	- (0000 - 9999)

◆ A2: User Parameters

No. (Hex.)	Name	Description	Default (Range)
A2-01 (0106)	User Parameter 1	Sets the parameter number to be shown for number 1 of the [User Custom Parameters] under the main menu. You can select a maximum of 32 parameters for the drive and set them to parameters <i>A2-01</i> to <i>A2-32</i> .	b1-01 (A1-00 - Z3-16)
A2-02 (0107)	User Parameter 2	Sets the parameter number to be shown for number 2 of the [User Custom Parameters] under the main menu. You can select a maximum of 32 parameters for the drive and set them to parameters <i>A2-01</i> to <i>A2-32</i> .	b1-02 (A1-00 - Z3-16)
A2-03 (0108)	User Parameter 3	Sets the parameter number to be shown for number 3 of the [User Custom Parameters] under the main menu. You can select a maximum of 32 parameters for the drive and set them to parameters <i>A2-01</i> to <i>A2-32</i> .	b1-03 (A1-00 - Z3-16)
A2-04 (0109)	User Parameter 4	Sets the parameter number to be shown for number 4 of the [User Custom Parameters] under the main menu. You can select a maximum of 32 parameters for the drive and set them to parameters <i>A2-01</i> to <i>A2-32</i> .	C1-01 (A1-00 - Z3-16)
A2-05 (010A)	User Parameter 5	Sets the parameter number to be shown for number 5 of the [User Custom Parameters] under the main menu. You can select a maximum of 32 parameters for the drive and set them to parameters <i>A2-01</i> to <i>A2-32</i> .	C1-02 (A1-00 - Z3-16)

9.4 A: Initialization Parameters

No. (Hex.)	Name	Description	Default (Range)
A2-06 (010B)	User Parameter 6	Sets the parameter number to be shown for number 6 of the [User Custom Parameters] under the main menu. You can select a maximum of 32 parameters for the drive and set them to parameters A2-01 to A2-32.	C6-02 (A1-00 - Z3-16)
A2-07 (010C)	User Parameter 7	Sets the parameter number to be shown for number 7 of the [User Custom Parameters] under the main menu. You can select a maximum of 32 parameters for the drive and set them to parameters A2-01 to A2-32.	d1-01 (A1-00 - Z3-16)
A2-08 (010D)	User Parameter 8	Sets the parameter number to be shown for number 8 of the [User Custom Parameters] under the main menu. You can select a maximum of 32 parameters for the drive and set them to parameters A2-01 to A2-32.	d1-02 (A1-00 - Z3-16)
A2-09 (010E)	User Parameter 9	Sets the parameter number to be shown for number 9 of the [User Custom Parameters] under the main menu. You can select a maximum of 32 parameters for the drive and set them to parameters A2-01 to A2-32.	d1-03 (A1-00 - Z3-16)
A2-10 (010F)	User Parameter 10	Sets the parameter number to be shown for number 10 of the [User Custom Parameters] under the main menu. You can select a maximum of 32 parameters for the drive and set them to parameters A2-01 to A2-32.	d1-04 (A1-00 - Z3-16)
A2-11 (0110)	User Parameter 11	Sets the parameter number to be shown for number 11 of the [User Custom Parameters] under the main menu. You can select a maximum of 32 parameters for the drive and set them to parameters A2-01 to A2-32.	d1-17 (A1-00 - Z3-16)
A2-12 (0111)	User Parameter 12	Sets the parameter number to be shown for number 12 of the [User Custom Parameters] under the main menu. You can select a maximum of 32 parameters for the drive and set them to parameters A2-01 to A2-32.	E1-01 (A1-00 - Z3-16)
A2-13 (0112)	User Parameter 13	Sets the parameter number to be shown for number 13 of the [User Custom Parameters] under the main menu. You can select a maximum of 32 parameters for the drive and set them to parameters A2-01 to A2-32.	E1-03 (A1-00 - Z3-16)
A2-14 (0113)	User Parameter 14	Sets the parameter number to be shown for number 14 of the [User Custom Parameters] under the main menu. You can select a maximum of 32 parameters for the drive and set them to parameters A2-01 to A2-32.	E1-04 (A1-00 - Z3-16)
A2-15 (0114)	User Parameter 15	Sets the parameter number to be shown for number 15 of the [User Custom Parameters] under the main menu. You can select a maximum of 32 parameters for the drive and set them to parameters A2-01 to A2-32.	E1-05 (A1-00 - Z3-16)
A2-16 (0115)	User Parameter 16	Sets the parameter number to be shown for number 16 of the [User Custom Parameters] under the main menu. You can select a maximum of 32 parameters for the drive and set them to parameters A2-01 to A2-32.	E1-06 (A1-00 - Z3-16)
A2-17 (0116)	User Parameter 17	Sets the parameter number to be shown for number 17 of the [User Custom Parameters] under the main menu. You can select a maximum of 32 parameters for the drive and set them to parameters A2-01 to A2-32. You can set A2-17 to A2-32 when A2-33 = 0 [User Parameter Auto Selection = Disabled: Manual Entry Required].	E1-09 (A1-00 - Z3-16)
A2-18 (0117)	User Parameter 18	Sets the parameter number to be shown for number 18 of the [User Custom Parameters] under the main menu. You can select a maximum of 32 parameters for the drive and set them to parameters A2-01 to A2-32. You can set A2-17 to A2-32 when A2-33 = 0 [User Parameter Auto Selection = Disabled: Manual Entry Required].	E1-13 (A1-00 - Z3-16)
A2-19 (0118)	User Parameter 19	Sets the parameter number to be shown for number 19 of the [User Custom Parameters] under the main menu. You can select a maximum of 32 parameters for the drive and set them to parameters A2-01 to A2-32. You can set A2-17 to A2-32 when A2-33 = 0 [User Parameter Auto Selection = Disabled: Manual Entry Required].	E2-01 (A1-00 - Z3-16)
A2-20 (0119)	User Parameter 20	Sets the parameter number to be shown for number 20 of the [User Custom Parameters] under the main menu. You can select a maximum of 32 parameters for the drive and set them to parameters A2-01 to A2-32. You can set A2-17 to A2-32 when A2-33 = 0 [User Parameter Auto Selection = Disabled: Manual Entry Required].	E2-04 (A1-00 - Z3-16)
A2-21 (011A)	User Parameter 21	Sets the parameter number to be shown for number 21 of the [User Custom Parameters] under the main menu. You can select a maximum of 32 parameters for the drive and set them to parameters A2-01 to A2-32. You can set A2-17 to A2-32 when A2-33 = 0 [User Parameter Auto Selection = Disabled: Manual Entry Required].	E2-11 (A1-00 - Z3-16)
A2-22 (011B)	User Parameter 22	Sets the parameter number to be shown for number 22 of the [User Custom Parameters] under the main menu. You can select a maximum of 32 parameters for the drive and set them to parameters A2-01 to A2-32. You can set A2-17 to A2-32 when A2-33 = 0 [User Parameter Auto Selection = Disabled: Manual Entry Required].	H4-02 (A1-00 - Z3-16)
A2-23 (011C)	User Parameter 23	Sets the parameter number to be shown for number 23 of the [User Custom Parameters] under the main menu. You can select a maximum of 32 parameters for the drive and set them to parameters A2-01 to A2-32. You can set A2-17 to A2-32 when A2-33 = 0 [User Parameter Auto Selection = Disabled: Manual Entry Required].	L1-01 (A1-00 - Z3-16)
A2-24 (011D)	User Parameter 24	Sets the parameter number to be shown for number 24 of the [User Custom Parameters] under the main menu. You can select a maximum of 32 parameters for the drive and set them to parameters A2-01 to A2-32. You can set A2-17 to A2-32 when A2-33 = 0 [User Parameter Auto Selection = Disabled: Manual Entry Required].	L3-04 (A1-00 - Z3-16)
A2-25 (011E)	User Parameter 25	Sets the parameter number to be shown for number 25 of the [User Custom Parameters] under the main menu. You can select a maximum of 32 parameters for the drive and set them to parameters A2-01 to A2-32. You can set A2-17 to A2-32 when A2-33 = 0 [User Parameter Auto Selection = Disabled: Manual Entry Required].	- (A1-00 - Z3-16)

No. (Hex.)	Name	Description	Default (Range)
A2-26 (011F)	User Parameter 26	Sets the parameter number to be shown for number 26 of the [User Custom Parameters] under the main menu. You can select a maximum of 32 parameters for the drive and set them to parameters A2-01 to A2-32. You can set A2-17 to A2-32 when A2-33 = 0 [User Parameter Auto Selection = Disabled: Manual Entry Required].	- (A1-00 - Z3-16)
A2-27 (0120)	User Parameter 27	Sets the parameter number to be shown for number 27 of the [User Custom Parameters] under the main menu. You can select a maximum of 32 parameters for the drive and set them to parameters A2-01 to A2-32. You can set A2-17 to A2-32 when A2-33 = 0 [User Parameter Auto Selection = Disabled: Manual Entry Required].	- (A1-00 - Z3-16)
A2-28 (0121)	User Parameter 28	Sets the parameter number to be shown for number 28 of the [User Custom Parameters] under the main menu. You can select a maximum of 32 parameters for the drive and set them to parameters A2-01 to A2-32. You can set A2-17 to A2-32 when A2-33 = 0 [User Parameter Auto Selection = Disabled: Manual Entry Required].	- (A1-00 - Z3-16)
A2-29 (0122)	User Parameter 29	Sets the parameter number to be shown for number 29 of the [User Custom Parameters] under the main menu. You can select a maximum of 32 parameters for the drive and set them to parameters A2-01 to A2-32. You can set A2-17 to A2-32 when A2-33 = 0 [User Parameter Auto Selection = Disabled: Manual Entry Required].	- (A1-00 - Z3-16)
A2-30 (0123)	User Parameter 30	Sets the parameter number to be shown for number 30 of the [User Custom Parameters] under the main menu. You can select a maximum of 32 parameters for the drive and set them to parameters A2-01 to A2-32. You can set A2-17 to A2-32 when A2-33 = 0 [User Parameter Auto Selection = Disabled: Manual Entry Required].	- (A1-00 - Z3-16)
A2-31 (0124)	User Parameter 31	Sets the parameter number to be shown for number 31 of the [User Custom Parameters] under the main menu. You can select a maximum of 32 parameters for the drive and set them to parameters A2-01 to A2-32. You can set A2-17 to A2-32 when A2-33 = 0 [User Parameter Auto Selection = Disabled: Manual Entry Required].	- (A1-00 - Z3-16)
A2-32 (0125)	User Parameter 32	Sets the parameter number to be shown for number 32 of the [User Custom Parameters] under the main menu. You can select a maximum of 32 parameters for the drive and set them to parameters A2-01 to A2-32. You can set A2-17 to A2-32 when A2-33 = 0 [User Parameter Auto Selection = Disabled: Manual Entry Required].	- (A1-00 - Z3-16)
A2-33 (0126)	User Parameter Auto Selection	Sets the automatic save feature for changes to parameters A2-17 to A2-32 [User Parameters 17 to 32]. 0 : Disabled: Manual Entry Required 1 : Enabled: Auto Save Recent Parm	Determined by A1-06 (0, 1)

9.5 b: Application

◆ b1: Operation Mode Selection

No. (Hex.)	Name	Description	Default (Range)
b1-01 (0180)	Frequency Reference Selection 1	Sets the input method for the frequency reference. 0 : Keypad 1 : Analog Input 2 : Serial Communications 3 : Option PCB	1 (0 - 3)
b1-02 (0181)	Run Command Selection 1	Sets the input method for the Run command. 0 : Keypad 1 : Digital Input 2 : Serial Communications 3 : Option PCB 7 : AUTO Command + Term Run 8 : AUTO Command + Serial Run 9 : AUTO Command + Option Run	7 (0 - 9)
b1-03 (0182)	Stopping Method Selection	Sets the method to stop the motor after removing a Run command or entering a Stop command. 0 : Ramp to Stop 1 : Coast to Stop 2 : DC Injection Braking to Stop 3 : Coast to Stop with Timer	1 (0 - 3)
b1-04 (0183)	Reverse Operation Selection	Sets the reverse operation function. Disable reverse operation in fan or pump applications where reverse rotation is dangerous. 0 : Reverse Enabled 1 : Reverse Disabled	1 (0, 1)
b1-08 (0187)	Run Command Select in PRG Mode	Sets the conditions for the drive to accept a Run command entered from an external source when using the keypad to set parameters. 0 : Disregard RUN while Programming 1 : Accept RUN while Programming 2 : Allow Programming Only at Stop	0 (0 - 2)
b1-11 (01DF)	Run Delay @ Stop	Sets the amount of time that the drive will not accept the Run command again after the Run command is lost. Note: • This parameter will operate for both AUTO Mode and HAND Mode. • This parameter will operate when the drive goes to sleep then wakes up. • The time set in this parameter does not apply for faults or Auto-Restarts. • When there is an active Run command while the time set in <i>b1-11</i> is active, the keypad will show a <i>[Start Delay]</i> message as specified by the <i>01-82 [Message Screen Display]</i> display format.	0.0 s (0.0 - 6000.0 s)
b1-12 (01E0)	Run Delay Memory Selection	Sets how the drive saves the Run Delay Timer to the EEPROM during power loss. 0 : Disabled 1 : Only at Stop 2 : Running & Stop	2 (0 - 2)
b1-17 (01C6)	Run Command at Power Up	Sets drive response when you apply power to drive that has an external Run command. Set this parameter in applications where energizing or de-energizing the drive enables the Run command. 0 : Disregard Existing RUN Command 1 : Accept Existing RUN Command	1 (0, 1)
b1-40 (3BCF)	Deceleration Abort Time	Sets the maximum time until the drive shuts off the output to decelerate to stop. Note: Set this parameter to 0.0 s to disable this function.	0.0 s (0.0 - 6000.0 s)

◆ b2: DC Injection Braking

No. (Hex.)	Name	Description	Default (Range)
b2-01 (0189)	DC Injection/Zero SpeedThreshold	Sets the frequency to start DC Injection Braking. Note: This parameter is available when $b1-03 = 0$ [Stopping Method Selection = Ramp to Stop].	0.5 Hz (0.0 - 10.0 Hz)
b2-02 (018A)	DC Injection Braking Current	Sets the DC Injection Braking current as a percentage of the drive rated current.	50% (0 - 100%)
b2-03 (018B)	DC Inject Braking Time at Start	Sets the DC Injection Braking Time at stop.	0.00 s (0.00 - 10.00 s)
b2-04 (018C)	DC Inject Braking Time at Stop	Sets the DC Injection Braking Time at stop.	0.00 s (0.00 - 10.00 s)
b2-09 (01E1)	Pre-heat Current 2	Sets the percentage of motor rated output current used for the motor pre-heat function.	5% (0 - 100%)

◆ b3: Speed Search

No. (Hex.)	Name	Description	Default (Range)
b3-01 (0191)	Speed Search at Start Selection	Sets the Speed Search at Start function where the drive will perform Speed Search with each Run command. 0 : Disabled 1 : Enabled	0 (0, 1)
b3-02 (0192)	SpeedSearch Deactivation Current	Sets the current level that stops Speed Search as a percentage of the drive rated output current. Usually it is not necessary to change this setting.	120% (0 - 200%)
b3-03 (0193)	Speed Search Deceleration Time	Sets the deceleration time during Speed Search operation. Set the length of time to decelerate from the maximum output frequency to the minimum output frequency.	2.0 s (0.1 - 10.0 s)
b3-04 (0194)	V/f Gain during Speed Search	Sets the ratio used to reduce the V/f during searches to reduce the output current during speed searches.	Determined by o2-04 (10 - 100)
b3-05 (0195)	Speed Search Delay Time	Sets the Speed Search delay time to activate a magnetic contactor installed between the drive and motor.	0.2 s (0.0 - 100.0 s)
b3-06 (0196) Expert	Speed Estimation Current Level 1	Sets the level of current that flows to the motor during Speed Estimation Speed Search as a coefficient of the motor rated current. Usually it is not necessary to change this setting.	Determined by o2-04 (0.0 - 2.0)
b3-07 (0197) Expert	Speed Estimation Current Level 2	Sets the level of current that flows to the motor during Speed Estimation Speed Search as a coefficient of $E2-03$ [Motor No-Load Current]. Usually it is not necessary to change this setting.	1.0 (0.0 - 3.0)
b3-08 (0198)	Speed Estimation ACR P Gain	Sets the proportional gain for the automatic current regulator during Speed Estimation Speed Search. Also adjusts speed search responsiveness. Usually it is not necessary to change this setting.	Determined by o2-04 (0.00 - 6.00)
b3-09 (0199)	Speed Estimation ACR I Time	Sets the integral time for the automatic current regulator during Speed Estimation Speed Search. Also adjusts speed search responsiveness. Usually it is not necessary to change this setting.	2.0 ms (0.0 - 1000.0 ms)
b3-10 (019A) Expert	Speed Estimation Detection Gain	Sets the gain to correct estimated frequencies from Speed Estimation Speed Search.	1.05 (1.00 - 1.20)
b3-11 (019B) Expert	Spd Est Method Switch-over Level	Uses the quantity of voltage in the motor to automatically switch the search method within the type of speed measurement. Note: • 208/240 V at 100% = 200 V • 480 V at 100% = 400 V	5.0% (0.5 - 100.0%)
b3-12 (019C) Expert	Speed Search Current Deadband	Sets the minimum current detection level during Speed Search. If the drive does not do Speed Estimation, increase this setting in 0.1-unit increments.	determined by o2-04 (2.0 - 10.0)
b3-14 (019E)	Bi-directional Speed Search	Sets the direction of Speed Search to the direction of the frequency reference or in the motor rotation direction as detected by the drive. 0 : Disabled 1 : Enabled	0 (0, 1)

9.5 b: Application

No. (Hex.)	Name	Description	Default (Range)
b3-17 (01F0) Expert	Speed Est Retry Current Level	Sets the current level for the search retry function in Speed Estimation Speed Search as a percentage where drive rated current is a setting value of 100%.	110% (0 - 200%)
b3-18 (01F1) Expert	Speed Est Retry Detection Time	Sets the length of time that the drive will wait to retry Speed Estimation Speed Search when too much current flow stopped the Speed Search.	0.10 s (0.00 - 1.00 s)
b3-19 (01F2)	Speed Search Restart Attempts	Sets the number of times to restart Speed Search if Speed Search does not complete.	3 times (0 - 10 times)
b3-24 (01C0)	Speed Search Method Selection	Sets the Speed Search method when you start the motor or when you return power after a momentary power loss. Note: Set b3-24 = 1. If b3-24 = 2, the drive will detect oPE08 [Parameter Selection Error]. 1 : Speed Estimation 2 : Current Detection 2	2 (1, 2)
b3-25 (01C8) Expert	Speed Search Wait Time	Sets the length of time the drive will wait to start the Speed Search Retry function.	0.5 s (0.0 - 30.0 s)
b3-26 (01C7) Expert	Direction Determination Level	Sets the level to find the motor rotation direction. Increase the value if the drive cannot find the direction.	1000 (40 to 60000)
b3-27 (01C9) Expert	Speed Search RUN/BB Priority	Sets the conditions necessary to start Speed Search. 0 : SS Only if RUN Applied Before BB 1 : SS Regardless of RUN/BB Sequence	0 (0, 1)
b3-31 (0BC0) Expert	Spd Search Current Reference Lvl	Sets the current level that decreases the output current during Current Detection Speed Search.	1.50 (1.50 - 3.50)
b3-32 (0BC1) Expert	Spd Search Current Complete Lvl	Sets the current level that completes Speed Search.	1.20 (0.00 - 1.49)
b3-39 (1B8F) Expert	Regen Judgement LV of Spd Search	Regen Judgement LV of Spd Search. Note: Available in HV600 Bypass software versions 00443 and later and HV600 drive software versions 1013 and later.	15% (0 - 50%)
b3-56 (3126)	InverseRotationSearch WaitTime	Sets the wait time until the drive starts inverse rotation search after it completes forward search when you do inverse rotation search during Current Detection Speed Search.	Determined by o2-04 (0.1 - 5.0 s)

◆ b4: Timer Function

No. (Hex.)	Name	Description	Default (Range)
b4-01 (01A3)	Timer Function ON-Delay Time	Sets the ON-delay time for the timer input.	0.0 s (0.0 - 3000.0 s)
b4-02 (01A4)	Timer Function OFF-Delay Time	Sets the OFF-delay time for the timer input.	0.0 s (0.0 - 3000.0 s)
b4-03 (0B30) Expert	Terminal M1-M2 ON-Delay Time	Sets the delay time to activate the contact after the function set in H2-01 activates.	0 ms (0 - 65000 ms)
b4-04 (0B31) Expert	Terminal M1-M2 OFF-Delay Time	Sets the delay time to deactivate the contact after the function set in H2-01 deactivates.	0 ms (0 - 65000 ms)
b4-05 (0B32) Expert	Terminal M3-M4 ON-Delay Time	Sets the delay time to activate the contact after the function set in H2-02 activates.	0 ms (0 - 65000 ms)
b4-06 (0B33) Expert	Terminal M3-M4 OFF-Delay Time	Sets the delay time to deactivate the contact after the function set in H2-02 deactivates.	0 ms (0 - 65000 ms)

No. (Hex.)	Name	Description	Default (Range)
b4-07 (0B34) Expert	Terminal M5-M6 ON-Delay Time	Sets the delay time to activate the contact after the function set in <i>H2-03</i> activates.	0 ms (0 - 65000 ms)
b4-08 (0B35) Expert	Terminal M5-M6 OFF-Delay Time	Sets the delay time to deactivate the contact after the function set in <i>H2-03</i> deactivates.	0 ms (0 - 65000 ms)

◆ b5: PID Control

No. (Hex.)	Name	Description	Default (Range)
b5-01 (01A5)	PID Mode Setting	Sets the type of PID control. 0 : Disabled 1 : Standard 3 : Fref + PID Trim	0 (0 - 3)
b5-02 (01A6) RUN	Proportional Gain (P)	Sets the proportional gain (P) that is applied to PID input.	2.00 (0.00 - 25.00)
b5-03 (01A7) RUN	Integral Time (I)	Sets the integral time (I) that is applied to PID input.	0.5 s (0.0 - 360.0 s)
b5-04 (01A8) RUN	Integral Limit	Sets the upper limit for integral control (I) as a percentage of the Maximum Output Frequency.	100.0% (0.0 - 100.0%)
b5-05 (01A9) RUN	Derivative Time (D)	Sets the derivative time (D) for PID control. This parameter adjusts system responsiveness.	0.00 s (0.00 - 10.00 s)
b5-06 (01AA) RUN	PID Output Limit	Sets the maximum possible output from the PID controller as a percentage of the Maximum Output Frequency.	100.0% (0.0 - 100.0%)
b5-07 (01AB) RUN	PID Offset Adjustment	Sets the offset for the PID control output as a percentage of the Maximum Output Frequency.	0.0% (-100.0 - +100.0%)
b5-08 (01AC) RUN Expert	PID Primary Delay Time Constant	Sets the primary delay time constant for the PID control output. Usually it is not necessary to change this setting.	0.00 s (0.00 - 10.00 s)
b5-09 (01AD)	PID Output Level Selection	Sets the polarity of the PID output. 0 : Normal Output (Direct Acting) 1 : Reverse Output (Reverse Acting)	0 (0, 1)
b5-10 (01AE) RUN	PID Output Gain Setting	Sets the amount of gain to apply to the PID output.	1.00 (0.00 - 25.00)
b5-11 (01AF)	PID Output Reverse Selection	Sets the function that enables and disables reverse motor rotation for negative PID control output. 0 : Lower Limit is Zero 1 : Negative Output Accepted	0 (0, 1)
b5-17 (01B5) RUN	PID Accel/Decel Time	Raises or lowers the PID setpoint using the acceleration and deceleration times set to the drive. This is a soft-starter for the PID setpoint.	0.0 s (0.0 - 6000.0 s)
b5-28 (01EA)	PID Feedback Square Root Sel	Enables and disables the square root of the PID Feedback compared to the PID Setpoint to set an appropriate drive output for the correct system regulation. 0 : Disabled 1 : Enabled	0 (0, 1)
b5-29 (01EB)	PID Feedback Square Root Gain	Sets the multiplier applied to the square root of the feedback.	0.00 (0.00 - 2.00)
b5-30 (01EC)	PID Feedback Offset	Sets PID feedback Offset as a percentage of maximum frequency.	0.00% (0.00 - 100.00%)

9.5 b: Application

No. (Hex.)	Name	Description	Default (Range)
b5-34 (019F) RUN	PID Output Lower Limit Level	Sets the output lower limit for the PID control as a percentage of the Maximum Output Frequency.	0.0% (-100.0 - +100.0%)
b5-35 (01A0) RUN	PID Input Limit Level	Sets the output upper limit for the PID control as a percentage of the Maximum Output Frequency.	1000.0% (0.0 - 1000.0%)
b5-38 (01FE)	PID User Unit Display Scaling	Sets the value that the drive sets or shows as the PID setpoint when at the maximum output frequency.	100.00% (0.01 - 600.00%)
b5-39 (01FF)	PID User Unit Display Digits	Sets the number of digits to set and show the PID setpoint. 0 : No Decimal Places (XXXXX) 1 : One Decimal Places (XXXX.X) 2 : Two Decimal Places (XXX.XX) 3 : Three Decimal Places (XX.XXX)	2 (0 - 3)
b5-41 (0160)	PID Output 2 Unit	Sets the display units in U5-14 [PID Out2 Upr4 Digits] and U5-15 [PID Out2 Lwr4 Digits]. 0 : "WC: inches of water column 1 : PSI: pounds per square inch 2 : GPM: gallons/min 3 : °F: Fahrenheit 4 : ft ³ /min: cubic feet/min 5 : m ³ /h: cubic meters/hour 6 : L/h: liters/hour 7 : L/s: liters/sec 8 : bar: bar 9 : Pa: Pascal 10 : °C: Celsius 11 : m: meters 12 : ft: feet 13 : L/min: liters/min 14 : m ³ /min: cubic meters/min 15 : "Hg: Inch Mercury 16 : kPa: kilopascal 48 : %: Percent 49 : Custom(b5-68~70) 50 : None	0 (0 - 50)
b5-42 (0161) RUN	PID Output 2 Calc Mode	Sets how to calculate the original PID output. 0 : Linear 1 : Square Root 2 : Quadratic 3 : Cubic Note: Used for U5-14 [PID Out2 Upr4 Digits] and U5-15 [PID Out2 Lwr4 Digits] only.	0 (0 - 3)
b5-43 (0162) RUN	PID Out2 Monitor MAX Upper4 Dig	Sets the upper 4 digits of the maximum monitor value. Used with b5-44 [PID Out2 Monitor MAX Lower4 Dig] to set maximum monitor value of U5-14 [PID Out2 Upr4 Digits] and U5-15 [PID Out2 Lwr4 Digits] at maximum frequency. Note: Used for U5-14 [PID Out2 Upr4 Digits] and U5-15 [PID Out2 Lwr4 Digits] only.	0 (0 - 9999)
b5-44 (0163) RUN	PID Out2 Monitor MAX Lower4 Dig	Sets the lower 4 digits of the maximum monitor value. Used with b5-43 [PID Out2 Monitor MAX Upper4 Dig] to set maximum monitor value of U5-14 [PID Out2 Upr4 Digits] and U5-15 [PID Out2 Lwr4 Digits] at maximum frequency. Note: Used for U5-14 [PID Out2 Upr4 Digits] and U5-15 [PID Out2 Lwr4 Digits] only.	0.00 (0.00 - 99.99)
b5-45 (0164) RUN	PID Out2 Monitor MIN for Linear	Sets the minimum display value to show when at zero speed. Only effective when b5-42 = 0 [PID Output 2 Calc Mode = Linear]. Note: Used for U5-14 [PID Out2 Upr4 Digits] and U5-15 [PID Out2 Lwr4 Digits] only.	0.0 (0.0 - 999.9)

No. (Hex.)	Name	Description	Default (Range)
b5-46 (0165)	PID Unit Display Selection	Sets the units-text for the PID Display. 0 : "WC: inches of water column 1 : PSI: pounds per square inch 2 : GPM: gallons/min 3 : °F: Fahrenheit 4 : ft ³ /min: cubic feet/min 5 : m ³ /h: cubic meters/hour 6 : L/h: liters/hour 7 : L/s: liters/sec 8 : bar: bar 9 : Pa: Pascal 10 : °C: Celsius 11 : m: meters 12 : ft: feet 13 : L/min: liters/min 14 : m ³ /min: cubic meters/min 15 : "Hg: Inch Mercury 16 : kPa: kilopascal 48 : %: Percent 49 : Custom(b5-68~70) 50 : None	48 (0 - 50)
b5-53 (0B8F) RUN	PID Integrator Ramp Limit	Sets the responsiveness of PID control when the PID feedback changes quickly.	0.0 Hz (0.0 - 10.0 Hz)
b5-61 (119A)	PID Trim Mode Lower Limit Sel	Sets the function that adjusts the PID output in relation to the frequency reference. 0 : Disabled 1 : Enabled	0 (0, 1)
b5-62 (119B)	PID Trim Mode Lower Limit Value	Sets the PID Trim Mode Lower Limit Value as a percentage of the maximum output frequency.	0.00% (0.00 - 100.00%)
b5-68 (3C1F)	System Unit Custom Character 1	Sets the first character of the custom unit display when <i>b5-46 = 49 [PID Unit Display Selection = Custom (B5-68~70)]</i> .	41 (20 - 7A)
b5-69 (3C20)	System Unit Custom Character 2	Sets the second character of the custom unit display when <i>b5-46 = 49 [PID Unit Display Selection = Custom (B5-68~70)]</i> .	41 (20 - 7A)
b5-70 (3C21)	System Unit Custom Character 3	Sets the third character of the custom unit display when <i>b5-46 = 49 [PID Unit Display Selection = Custom (B5-68~70)]</i> .	41 (20 - 7A)
b5-71 (3C22)	Min PID Transducer Scaling	Sets the minimum PID level corresponding to the lowest analog input signal level. Note: • To enable this parameter, you must set <i>b5-71 < b5-38 [PID User Unit Display Scaling]</i> . If you set <i>b5-71 > b5-38</i> , the drive will disable all PID analog inputs. • Parameters <i>b5-46 [PID Unit Display Selection]</i> , <i>b5-38</i> , and <i>b5-39 [PID User Unit Display Digits]</i> set the unit, range, and resolution.	0.00 (-99.99 - +99.99)
b5-82 (31B0)	Feedback Loss 4 ~ 20mA Detect Sel	Sets the drive to do a 4 to 20 mA wire-break detection on the analog input set for PID feedback. 0 : Disabled 1 : Alarm Only 2 : Fault 3 : Run At b5-83	2 (0 - 3)
b5-83 (31B1) RUN	Feedback Loss GoTo Frequency	Sets the speed at which the drive will run if the drive detects a 4 to 20 mA wire-break on the PID Feedback and <i>b5-82 = 3 [Feedback Loss 4 ~ 20mA Detect Sel = Run At b5-83]</i> .	0.0 Hz (0.0 - 400.0 Hz)
b5-84 (31B2) RUN	Feedback Loss Loss Of Prime Lvl	Sets the level at which the drive will detect Loss of Prime in the pump. Note: • Loss of Prime condition occurs when the measured quantity set by <i>Y1-18 [Prime Loss Detection Method]</i> decreases to this level for the time set in <i>Y1-20 [Loss of Prime Time]</i> and the output frequency is at the <i>Y4-02 [Pre-Charge Frequency]</i> level. The drive will respond to the Loss of Prime condition as specified by <i>Y1-22 [Loss of Prime Selection]</i> . • Display unit and scaling are dependent on System Units.	0.0 A (0.0 - 1000.0 A)

9.5 b: Application

No. (Hex.)	Name	Description	Default (Range)
b5-85 (31B3) RUN	Feedback Loss GoTo Freq Timeout	When <i>b5-82 = 3 [Feedback Loss 4 ~ 20mA Detect Sel = Run At b5-83]</i> and the Feedback signal is lost, the drive will run at the <i>b5-83 [Feedback Loss Goto Frequency]</i> speed for this length of time, after which the drive will fault on <i>FDBKL [WIRE Break]</i> . Note: Set this parameter to 0.0 s to disable the function.	0 s (0 - 6000 s)
b5-86 (31B4) RUN	Feedback Loss Start Delay	When you initiate an AUTO Run command, the drive will wait for this length of time before it will fault on <i>FDBKL [WIRE Break]</i> or use parameter <i>b5-83 [Feedback Loss Goto Frequency]</i> .	0.0 s (0.0 - 120.0 s)

◆ b8: Energy Saving

No. (Hex.)	Name	Description	Default (Range)
b8-01 (01CC)	Energy Saving Control Selection	Sets the Energy-saving control function. 0 : Disabled 1 : Enabled	0 (0, 1)
b8-04 (01CF) Expert	Energy Saving Coefficient Value	Sets the Energy-saving control coefficient to maintain maximum motor efficiency. The default setting is for Yaskawa motors. Note: • When you do Rotational Auto-Tuning, the drive will automatically set the energy-saving coefficient. • The minimum values and the maximum values are different for different drive models: • 2011 to 2024, 4005 to 4008: 0.0 - 2000.0 • 2031 to 2273, 4011 to 4302: 0.00 - 655.00	Determined by E2-11 and o2-04 (0.00 - 655.00)
b8-05 (01D0) Expert	Power Detection Filter Time	Sets the time constant to measure output power.	20 ms (0 - 2000 ms)
b8-06 (01D1) Expert	Search Operation Voltage Limit	Sets the voltage limit for Search Operation as a percentage of the motor rated voltage.	0% (0 - 100%)

9.6 C: Tuning

◆ C1: Accel & Decel Time

No. (Hex.)	Name	Description	Default (Range)
C1-01 (0200) RUN	Acceleration Time 1	Sets the length of time to accelerate from zero to maximum output frequency.	30.0 s (0.1 - 6000.0 s)
C1-02 (0201) RUN	Deceleration Time 1	Sets the length of time to decelerate from maximum output frequency to zero.	30.0 s (0.1 - 6000.0 s)
C1-03 (0202) RUN	Acceleration Time 2	Sets the length of time to accelerate from zero to maximum output frequency.	30.0 s (0.1 - 6000.0 s)
C1-04 (0203) RUN	Deceleration Time 2	Sets the length of time to decelerate from maximum output frequency to zero.	30.0 s (0.1 - 6000.0 s)
C1-09 (0208) RUN	Fast Stop Time	Sets the length of time that the drive will decelerate to zero for a Fast Stop. Note: Decelerating too quickly can cause an <i>ov [Overvoltage]</i> fault that shuts off the drive while the motor to coasts to a stop. Set a Fast Stop time in <i>C1-09</i> that prevents motor coasting and makes sure that the motor stops quickly and safely.	10.0 s (0.1 - 6000.0 s)

◆ C2: S-Curve Characteristics

No. (Hex.)	Name	Description	Default (Range)
C2-01 (020B)	S-Curve Time @ Start of Accel	Sets the S-curve acceleration time at start.	0.20 s (0.00 - 10.00 s)
C2-02 (020C)	S-Curve Time @ End of Accel	Sets the S-curve acceleration time at completion.	0.20 s (0.00 - 10.00 s)
C2-03 (020D)	S-Curve Time @ Start of Decel	Sets the S-curve deceleration time at start.	0.20 s (0.00 - 10.00 s)
C2-04 (020E)	S-Curve Time @ End of Decel	Sets the S-curve deceleration time at completion.	0.00 s (0.00 - 10.00 s)

◆ C3: Slip Compensation

No. (Hex.)	Name	Description	Default (Range)
C3-01 (020F) RUN	Slip Compensation Gain	Sets the gain for the slip compensation function. Usually it is not necessary to change this setting. Note: Correctly set these parameters before you change the slip compensation gain: • <i>E2-01 [Motor Rated Current (FLA)]</i> • <i>E2-02 [Motor Rated Slip]</i> • <i>E2-03 [Motor No-Load Current]</i>	0.0 (0.0 - 2.5)
C3-02 (0210) RUN	Slip Compensation Delay Time	Sets the slip compensation delay time when speed is unstable or when the slip compensation response is too slow. Usually it is not necessary to change this setting.	2000 ms (0 - 10000 ms)

◆ C4: Torque Compensation

No. (Hex.)	Name	Description	Default (Range)
C4-01 (0215) RUN	Torque Compensation Gain	Sets the gain for the torque compensation function. Use this parameter value for motor 1 when you operate multiple motors.	1.00 (0.00 - 2.50)
C4-02 (0216) RUN	Torque Compensation Delay Time	Sets the torque compensation delay time. Usually it is not necessary to change this setting.	200 ms (0 - 60000 ms)

◆ C6: Carrier Frequency

No. (Hex.)	Name	Description	Default (Range)
C6-02 (0224)	Carrier Frequency Selection	<p>Sets the carrier frequency for the transistors in the drive.</p> <p>1 : 2.0 kHz 2 : 5.0 kHz 3 : 8.0 kHz 4 : 10.0 kHz 5 : 12.5 kHz 7 : Swing PWM1 (Audible Sound 1) 8 : Swing PWM2 (Audible Sound 2) 9 : Swing PWM3 (Audible Sound 3) A : Swing PWM4 (Audible Sound 4) B : Leakage Current Rejection PWM F : User Defined (C6-03 to C6-05)</p> <p>Note:</p> <ul style="list-style-type: none"> The carrier frequency for Swing PWM 1 to 4 is equivalent to 2.0 kHz. Swing PWM applies a special PWM pattern to decrease the audible noise. Setting B uses a PWM pattern that decreases the leakage current that the drive detects over long wiring distances. This can help decrease alarm detection and decrease problems with the current monitor from leakage current over long wiring distances. 	Determined by o2-04 (1 - F)
C6-03 (0225)	Carrier Frequency Upper Limit	Sets the upper limit of the carrier frequency. Set $C6-02 = F$ [Carrier Frequency Selection = User Defined (C6-03 to C6-05)] to set this parameter.	Determined by C6-02 (1.0 - 12.5 kHz)
C6-04 (0226)	Carrier Frequency Lower Limit	Sets the lower limit of the carrier frequency. Set $C6-02 = F$ [Carrier Frequency Selection = User Defined (C6-03 to C6-05)] to set this parameter.	Determined by C6-02 (1.0 - 12.5 kHz)
C6-05 (0227)	Carrier Freq Proportional Gain	Sets the proportional gain for the carrier frequency. Set $C6-02 = F$ [Carrier Frequency Selection = User Defined (C6-03 to C6-05)] to set this parameter.	Determined by C6-02 (0 - 99)

9.7 d: Reference Settings

◆ d1: Frequency Reference

No. (Hex.)	Name	Description	Default (Range)
d1-01 (0280) RUN	Reference 1	Sets the frequency reference in the units from <i>o1-03</i> [<i>Frequency Display Unit Selection</i>].	0.00 Hz (0.00 - 400.00 Hz)
d1-02 (0281) RUN	Reference 2	Sets the frequency reference in the units from <i>o1-03</i> [<i>Frequency Display Unit Selection</i>].	0.00 Hz (0.00 - 400.00 Hz)
d1-03 (0282) RUN	Reference 3	Sets the frequency reference in the units from <i>o1-03</i> [<i>Frequency Display Unit Selection</i>].	0.00 Hz (0.00 - 400.00 Hz)
d1-04 (0283) RUN	Reference 4	Sets the frequency reference in the units from <i>o1-03</i> [<i>Frequency Display Unit Selection</i>].	0.00 Hz (0.00 - 400.00 Hz)
d1-05 (0284) RUN	Reference 5	Sets the frequency reference in the units from <i>o1-03</i> [<i>Frequency Display Unit Selection</i>].	0.00 Hz (0.00 - 400.00 Hz)
d1-06 (0285) RUN	Reference 6	Sets the frequency reference in the units from <i>o1-03</i> [<i>Frequency Display Unit Selection</i>].	0.00 Hz (0.00 - 400.00 Hz)
d1-07 (0286) RUN	Reference 7	Sets the frequency reference in the units from <i>o1-03</i> [<i>Frequency Display Unit Selection</i>].	0.00 Hz (0.00 - 400.00 Hz)
d1-08 (0287) RUN	Reference 8	Sets the frequency reference in the units from <i>o1-03</i> [<i>Frequency Display Unit Selection</i>].	0.00 Hz (0.00 - 400.00 Hz)
d1-17 (0292) RUN	Jog Reference	Sets the Jog frequency reference in the units from <i>o1-03</i> [<i>Frequency Display Unit Selection</i>]. Set <i>H1-xx = 6</i> [<i>MFDI Function Selection = Jog Reference Selection</i>] to use the Jog frequency reference.	6.00 Hz (0.00 - 400.00 Hz)

◆ d2: Reference Limits

No. (Hex.)	Name	Description	Default (Range)
d2-01 (0289)	Frequency Reference Upper Limit	Sets maximum limit for all frequency references. The maximum output frequency is 100%.	100.0% (0.0 - 110.0%)
d2-02 (028A)	Frequency Reference Lower Limit	Sets minimum limit for all frequency references. The maximum output frequency is 100%.	0.0% (0.0 - 110.0%)
d2-03 (0293)	Analog Frequency Ref Lower Limit	Sets the lower limit for the master frequency reference (the first frequency of the multi-step speed reference) as a percentage. The maximum output frequency is 100%.	0.0% (0.0 - 110.0%)

◆ d3: Jump Frequency

No. (Hex.)	Name	Description	Default (Range)
d3-01 (0294)	Jump Frequency 1	Sets the median value of the frequency band that the drive will avoid.	0.0 Hz (0.0 - 400.0 Hz)
d3-02 (0295)	Jump Frequency 2	Sets the median value of the frequency band that the drive will avoid.	0.0 Hz (0.0 - 400.0 Hz)
d3-03 (0296)	Jump Frequency 3	Sets the median value of the frequency band that the drive will avoid.	0.0 Hz (0.0 - 400.0 Hz)
d3-04 (0297)	Jump Frequency Width	Sets the width of the frequency band that the drive will avoid.	1.0 Hz (0.0 - 20.0 Hz)

◆ d4: Frequency Ref Up/Down & Hold

No. (Hex.)	Name	Description	Default (Range)
d4-01 (0298)	Freq Reference Hold Selection	<p>Sets the function that saves the frequency reference after a Stop command or when de-energizing the drive.</p> <p>Set <i>H1-xx</i> [MFDI Function Selection] to one of these values to enable this parameter:</p> <ul style="list-style-type: none"> • <i>A</i> [Accel/Decel Ramp Hold] • <i>10/11</i> [Up/Down Command] <p>0 : Disabled 1 : Enabled</p>	0 (0, 1)

◆ d6: Field Weakening

No. (Hex.)	Name	Description	Default (Range)
d6-01 (02A0)	Field Weakening Level	Sets the drive output voltage as a percentage of <i>E1-05</i> [Maximum Output Voltage] when <i>H1-xx</i> = <i>63</i> [Field Weakening] is activated.	80% (0 - 100%)
d6-02 (02A1)	Field Weakening Frequency Limit	Sets the minimum output frequency to start field weakening.	0.0 Hz (0.0 - 400.0 Hz)

◆ d7: Offset Frequency

No. (Hex.)	Name	Description	Default (Range)
d7-01 (02B2) RUN	Offset Frequency 1	Uses <i>H1-xx</i> = <i>44</i> [MFDI Function Select = Add Offset Frequency 1 (d7-01)] as a percentage of the Maximum Output Frequency to add or subtract the set frequency to/from the frequency reference.	0.0% (-100.0 - +100.0%)
d7-02 (02B3) RUN	Offset Frequency 2	Uses <i>H1-xx</i> = <i>45</i> [MFDI Function Select = Add Offset Frequency 2 (d7-02)] as a percentage of the Maximum Output Frequency to add or subtract the set frequency to/from the frequency reference.	0.0% (-100.0 - +100.0%)
d7-03 (02B4) RUN	Offset Frequency 3	Uses <i>H1-xx</i> = <i>46</i> [MFDI Function Select = Add Offset Frequency 3 (d7-03)] as a percentage of the Maximum Output Frequency to add or subtract the set frequency to/from the frequency reference.	0.0% (-100.0 - +100.0%)

9.8 E: Motor Parameters

◆ E1: V/f Pattern for Motor 1

No. (Hex.)	Name	Description	Default (Range)
E1-01 (0300)	Input AC Supply Voltage	Sets the drive input voltage.	208/240 V: 240 V, 480 V: 480 V (208/240 V: 155 - 255 V, 480 V: 310 - 510 V)
E1-03 (0302)	V/f Pattern Selection	<p>Sets the V/f pattern for the drive and motor. You can use one of the preset patterns or you can make a custom pattern.</p> <p>0 : Const Trq, 50Hz base, 50Hz max 1 : Const Trq, 60Hz base, 60Hz max 2 : Const Trq, 50Hz base, 60Hz max 3 : Const Trq, 60Hz base, 72Hz max 4 : VT, 50Hz, 65% Vmid reduction 5 : VT, 50Hz, 50% Vmid reduction 6 : VT, 60 Hz, 65% Vmid reduction 7 : VT, 60Hz, 50% Vmid reduction 8 : High Trq, 50Hz, 25% Vmin boost 9 : High Trq, 50Hz, 65% Vmin boost A : High Trq, 60Hz, 25% Vmin boost B : High Trq, 60Hz, 65% Vmin boost C : High Freq, 60Hz base, 90Hz max D : High Freq, 60Hz base, 120Hz max E : High Freq, 60Hz base, 180Hz max F : Custom</p> <p>Note:</p> <ul style="list-style-type: none"> Set the correct V/f pattern for the application and operation area. An incorrect V/f pattern can decrease motor torque and increase current from overexcitation. Parameter A1-03 [Initialize Parameters] will not initialize the value of E1-03. 	F (0 - F)
E1-04 (0303)	Maximum Output Frequency	Sets the maximum output frequency for the V/f pattern.	60.0 Hz (40.0 to 400.0 Hz)
E1-05 (0304)	Maximum Output Voltage	Sets the maximum output voltage for the V/f pattern.	208/240 V: 230.0 V, 480 V: 460.0 V (208/240 V: 0.0 - 255.0 V, 480 V: 0.0 - 510.0 V)
E1-06 (0305)	Base Frequency	Sets the base frequency for the V/f pattern.	60.0 Hz (0.0 - E1-04)
E1-07 (0306)	Mid Point A Frequency	Sets a middle output frequency for the V/f pattern.	30.0 Hz (0.0 - E1-04)
E1-08 (0307)	Mid Point A Voltage	Sets a middle output voltage for the V/f pattern.	Determined by o2-04 (208/240 V: 0.0 - 255.0 V, 480 V: 0.0 - 510.0 V)
E1-09 (0308)	Minimum Output Frequency	Sets the minimum output frequency for the V/f pattern.	1.5 Hz (Determined by E1-04)
E1-10 (0309)	Minimum Output Voltage	Sets the minimum output voltage for the V/f pattern.	10.2 V (208/240 V: 0.0 - 255.0 V, 480 V: 0.0 - 510.0 V)
E1-11 (030A) Expert	Mid Point B Frequency	Sets a middle output frequency for the V/f pattern.	0.0 Hz (0.0 - E1-04)
E1-12 (030B) Expert	Mid Point B Voltage	Sets a middle point voltage for the V/f pattern.	0.0 V (208/240 V: 0.0 - 255.0 V, 480 V: 0.0 - 510.0 V)
E1-13 (030C) Expert	Base Voltage	Sets the base voltage for the V/f pattern.	0.0 V (208/240 V: 0.0 - 255.0 V, 480 V: 0.0 - 510.0 V)

◆ E2: Motor Parameters

No. (Hex.)	Name	Description	Default (Range)
E2-01 (030E)	Motor Rated Current (FLA)	Sets the motor rated current in amps.	Determined by o2-04 (10% to 200% of the drive rated current)
E2-02 (030F)	Motor Rated Slip	Sets motor rated slip.	Determined by o2-04 (0.000 - 20.000 Hz)
E2-03 (0310)	Motor No-Load Current	Sets the no-load current for the motor in amps when operating at the rated frequency and the no-load voltage.	Determined by o2-04 (0 to E2-01)
E2-04 (0311)	Motor Pole Count	Sets the number of motor poles.	4 (2 - 120)
E2-05 (0312)	Motor Line-to-Line Resistance	Sets the line-to-line resistance for the motor stator windings.	Determined by o2-04 (0.000 - 65.000 Ω)
E2-06 (0313)	Motor Leakage Inductance	Sets the voltage drop from motor leakage inductance when the motor is operating at the rated frequency and rated current. This value is a percentage of Motor Rated Voltage.	Determined by o2-04 (0.0 - 60.0%)
E2-10 (0317)	Motor Iron Loss	Sets the motor iron loss.	Determined by o2-04 (0 - 65535 W)
E2-11 (0318)	Motor Rated Power	Sets the motor rated output in the units from 01-58 [Motor Power Unit Selection].	Determined by o2-04 (0.00 - 650.00 HP)

9.9 F: Options

◆ F6: Communication Options

No. (Hex.)	Name	Description	Default (Range)
F6-01 (03A2)	Communication Error Selection	Sets the method to stop the motor or let the motor continue operating when the drive detects <i>bUS</i> [Option Communication Error]. 0 : Ramp to Stop 1 : Coast to Stop 2 : Fast Stop (Use C1-09) 3 : Alarm Only 4 : Alarm (Run at d1-04) 5 : Alarm - Ramp Stop	1 (0 - 5)
F6-02 (03A3)	Comm External Fault (EF0) Detect	Sets the conditions at which <i>EF0</i> [Option Card External Fault] is detected. 0 : Always Detected 1 : Detected during RUN Only	0 (0, 1)
F6-03 (03A4)	Comm External Fault (EF0) Select	Sets the method to stop the motor or let the motor continue operating when the drive detects an <i>EF0</i> [Option Card External Fault]. 0 : Ramp to Stop 1 : Coast to Stop 2 : Fast Stop (Use C1-09) 3 : Alarm Only	1 (0 - 3)
F6-04 (03A5)	bUS Error Detection Time	Sets the delay time for the drive to detect <i>bUS</i> [Option Communication Error]. Note: When you install an option card in the drive, the parameter value changes to 0.0 s.	2.0 s (0.0 - 5.0 s)
F6-07 (03A8)	Multi-Step Ref @ NetRef/ ComRef	Sets the function that enables and disables the multi-step speed reference when the frequency reference source is NetRef or ComRef (communication option card or serial communications). 0 : Disable Multi-Step References 1 : Enable Multi-Step References	0 (0, 1)
F6-08 (036A)	Comm Parameter Reset @Initialize	Sets the function to initialize <i>F6-xx</i> and <i>F7-xx</i> parameters when the drive is initialized with <i>A1-03</i> [Initialize Parameters]. 0 : No Reset - Parameters Retained 1 : Reset Back to Factory Default	0 (0, 1)
F6-14 (03BB)	BUS Error Auto Reset	Sets the automatic reset function for <i>bUS</i> [Option Communication Errors]. 0 : Disabled 1 : Enabled	0 (0, 1)
F6-15 (0B5B)	Comm. Option Parameters Reload	Sets the update method when you change <i>F6-xx</i> , <i>F7-xx</i> [Communication Options]. 0 : Reload at Next Power Cycle 1 : Reload Now 2 : Cancel Reload Request	0 (0 - 2)
F6-48 (02FE)	BACnet Device Object Identifier 0	Sets the Instance Identifier of the BACnet Device Object, where the <i>F6-48</i> value is the least significant word. Available in bypass software versions 00446 and later. Note: This parameter and <i>F6-49</i> set the Instance Identifier of the BACnet Device Object. Example 1: Set the Device Object Instance Identifier to 1234. 1234 decimal is equal to 4D2H (hexadecimal). Set <i>F6-48</i> = 4D2H and <i>F6-49</i> = 0. Example 2: Set the Device Object Instance Identifier to 1234567. 1234567 decimal is equal to 12D687H. Set <i>F6-48</i> = D687H and <i>F6-49</i> = 12H.	1 (0 - FFFFH)
F6-49 (02FF)	BACnet Device Object Identifier 1	Sets the Instance Identifier of the BACnet Device Object, where the <i>F6-49</i> value is the most significant word. Available in bypass software versions 00446 and later. Note: This parameter and <i>F6-48</i> set the Instance Identifier of the BACnet Device Object. Example 1: Set the Device Object Instance Identifier to 1234. 1234 decimal is equal to 4D2H (hexadecimal). Set <i>F6-48</i> = 4D2H and <i>F6-49</i> = 0. Example 2: Set the Device Object Instance Identifier to 1234567. 1234567 decimal is equal to 12D687H. Set <i>F6-48</i> = D687H and <i>F6-49</i> = 12H.	0 (0 - 3FH)
F6-54 (03C5)	DeviceNet Idle Fault Detection	Sets the function to detect <i>EF0</i> [Option Card External Fault] when the drive does not receive data from the DeviceNet master. 0 : Enabled 1 : Disabled, No Fault Detection 2 : Vendor Specific 3 : RUN Forward 4 : Reverse run	0 (0 - 4)

◆ F7: Ethernet Options

Note:

You must cycle power or set $F6-15 = 1$ [*Comm. Option Parameters Reload = Reload Now*] for F7-xx parameters to take effect.

No. (Hex.)	Name	Description	Default (Range)
F7-01 (03E5)	IP Address 1	Sets the first octet of the IP Address for the device that is connecting to the network. Restart the drive after you change this parameter. Note: When $F7-13 = 0$ [<i>Address Mode at Startup = Static</i>]: • Use parameters F7-01 to F7-04 [<i>IP Address 4</i>] to set the IP Address. Be sure to set a different IP address for each drive on the network. • Also set parameters F7-01 to F7-12.	192 (0 - 255)
F7-02 (03E6)	IP Address 2	Sets the second octet of the IP Address for the device that is connecting to the network. Restart the drive after you change this parameter. Note: When $F7-13 = 0$ [<i>Address Mode at Startup = Static</i>]: • Use parameters F7-01 to F7-04 [<i>IP Address 4</i>] to set the IP Address. Be sure to set a different IP address for each drive on the network. • Also set parameters F7-01 to F7-12.	168 (0 - 255)
F7-03 (03E7)	IP Address 3	Sets the third octet of the IP Address for the device that is connecting to the network. Restart the drive after you change this parameter. Note: When $F7-13 = 0$ [<i>Address Mode at Startup = Static</i>]: • Use parameters F7-01 to F7-04 [<i>IP Address 4</i>] to set the IP Address. Be sure to set a different IP address for each drive on the network. • Also set parameters F7-01 to F7-12.	1 (0 - 255)
F7-04 (03E8)	IP Address 4	Sets the fourth octet of the IP Address for the device that is connecting to the network. Restart the drive after you change this parameter. Note: When $F7-13 = 0$ [<i>Address Mode at Startup = Static</i>]: • Use parameters F7-01 to F7-04 [<i>IP Address 4</i>] to set the IP Address. Be sure to set a different IP address for each drive on the network. • Also set parameters F7-01 to F7-12.	20 (0 - 255)
F7-05 (03E9)	Subnet Mask 1	Sets the first octet of the subnet mask of the connected network. Note: Set this parameter when $F7-13 = 0$ [<i>Address Mode at Startup = Static</i>].	255 (0 - 255)
F7-06 (03EA)	Subnet Mask 2	Sets the second octet of the subnet mask of the connected network. Note: Set this parameter when $F7-13 = 0$ [<i>Address Mode at Startup = Static</i>].	255 (0 - 255)
F7-07 (03EB)	Subnet Mask 3	Sets the third octet of the subnet mask of the connected network. Note: Set this parameter when $F7-13 = 0$ [<i>Address Mode at Startup = Static</i>].	255 (0 - 255)
F7-08 (03EC)	Subnet Mask 4	Sets the fourth octet of the subnet mask of the connected network. Note: Set this parameter when $F7-13 = 0$ [<i>Address Mode at Startup = Static</i>].	0 (0 - 255)
F7-09 (03ED)	Gateway Address 1	Sets the first octet of the gateway address of the connected network. Note: Set this parameter when $F7-13 = 0$ [<i>Address Mode at Startup = Static</i>].	192 (0 - 255)
F7-10 (03EE)	Gateway Address 2	Sets the second octet of the gateway address of the connected network. Note: Set this parameter when $F7-13 = 0$ [<i>Address Mode at Startup = Static</i>].	168 (0 - 255)
F7-11 (03EF)	Gateway Address 3	Sets the third octet of the gateway address of the connected network. Note: Set this parameter when $F7-13 = 0$ [<i>Address Mode at Startup = Static</i>].	1 (0 - 255)
F7-12 (03F0)	Gateway Address 4	Sets the fourth octet of the gateway address of the connected network. Note: Set this parameter when $F7-13 = 0$ [<i>Address Mode at Startup = Static</i>].	1 (0 - 255)

No. (Hex.)	Name	Description	Default (Range)
F7-13 (03F1)	Address Mode at Startup	Sets the method to set option card IP addresses. 0 : Static 1 : BOOTP 2 : DHCP Note: • The following setting values are available when using the PROFINET communication option card (SI-EP3). –0: Static (It is possible for the PLC to override this setting, if so configured) –1: BOOTP (In PROFINET, this setting does NOT use BOOTP. It uses a PROFINET-specific method, DCP) (In BACnet/IP, this setting is the same as DHCP). –2: DHCP (In PROFINET, this setting does NOT use DHCP. It uses a PROFINET-specific method, DCP) • When F7-13 = 0, set parameters F7-01 to F7-12 [IP Address 1 to Gateway Address 4] to set the IP Address. Be sure to set a different IP address for each drive on the network.	2 (0 - 2)
F7-14 (03F2)	Duplex Mode Selection	Sets the duplex mode setting method. 0 : Half/Half 1 : Auto/Auto 2 : Full/Full 3 : Half/Auto 4 : Half/Full 5 : Auto/Half 6 : Auto/Full 7 : Full/Half 8 : Full/Auto	1 (0 - 8)
F7-15 (03F3)	Communication Speed Selection	Sets the communications speed. 10 : 10/10 Mbps 100 : 100/100 Mbps 101 : 10/100 Mbps 102 : 100/10 Mbps Note: You must set F7-14 = 0, 2, 4, or 7 for this parameter to have an effect.	10 (10, 100 - 102)
F7-16 (03F4)	Timeout Value	Sets the detection time for a communications timeout. Note: Set this parameter to 0.0 to disable the connection timeout function.	0.0 s (0.0 - 30.0 s)
F7-17 (03F5)	EtherNet/IP Speed Scaling Factor	Sets the scaling factor for the speed monitor in the EtherNet/IP Class ID 2AH Object.	0 (-15 - +15)
F7-18 (03F6)	EtherNet/IP Current Scale Factor	Sets the scaling factor for the output current monitor in the EtherNet/IP Class ID 2AH Object.	0 (-15 - +15)
F7-19 (03F7)	EtherNet/IP Torque Scale Factor	Sets the scaling factor for the torque monitor in the EtherNet/IP Class ID 2AH Object.	0 (-15 - +15)
F7-20 (03F8)	EtherNet/IP Power Scaling Factor	Sets the scaling factor for the power monitor in the EtherNet/IP Class ID 2AH Object.	0 (-15 - +15)
F7-21 (03F9)	EtherNet/IP Voltage Scale Factor	Sets the scaling factor for the voltage monitor in the EtherNet/IP Class ID 2AH Object.	0 (-15 - +15)
F7-22 (03FA)	EtherNet/IP Time Scaling	Sets the scaling factor for the time monitor in the EtherNet/IP Class ID 2AH Object.	0 (-15 - +15)
F7-23 (03FB)	Dynamic Out Param 1 for CommCard	Sets Output Assembly 116 when you use an Ethernet/IP option. The drive writes the values from Output Assembly 116 to the MEMOBUS/Modbus address register that is stored for each parameter. The drive will not write the values from Output Assembly 116 to the registers when the MEMOBUS/Modbus address is 0. When you use a ProfiNet option, set this parameter to set to configurable output 1.	0 (0 - FFFF)
F7-24 (03FC)	Dynamic Out Param 2 for CommCard	Sets Output Assembly 116 when you use an Ethernet/IP option. The drive writes the values from Output Assembly 116 to the MEMOBUS/Modbus address register that is stored for each parameter. The drive will not write the values from Output Assembly 116 to the registers when the MEMOBUS/Modbus address is 0. When you use a ProfiNet option, set this parameter to set to configurable output 2.	0 (0 - FFFF)
F7-25 (03FD)	Dynamic Out Param 3 for CommCard	Sets Output Assembly 116 when you use an Ethernet/IP option. The drive writes the values from Output Assembly 116 to the MEMOBUS/Modbus address register that is stored for each parameter. The drive will not write the values from Output Assembly 116 to the registers when the MEMOBUS/Modbus address is 0. When you use a ProfiNet option, set this parameter to set to configurable output 3.	0 (0 - FFFF)
F7-26 (03FE)	Dynamic Out Param 4 for CommCard	Sets Output Assembly 116 when you use an Ethernet/IP option. The drive writes the values from Output Assembly 116 to the MEMOBUS/Modbus address register that is stored for each parameter. The drive will not write the values from Output Assembly 116 to the registers when the MEMOBUS/Modbus address is 0. When you use a ProfiNet option, set this parameter to set to configurable output 4.	0 (0 - FFFF)

9.9 F: Options

No. (Hex.)	Name	Description	Default (Range)
F7-27 (03FF)	Dynamic Out Param 5 for CommCard	Sets Output Assembly 116 when you use an Ethernet/IP option. The drive writes the values from Output Assembly 116 to the MEMOBUS/Modbus address register that is stored for each parameter. The drive will not write the values from Output Assembly 116 to the registers when the MEMOBUS/Modbus address is 0. When you use a ProfiNet option, set this parameter to set to configurable output 5.	0 (0 - FFFF)
F7-28 (0370)	Dynamic Out Param 6 for CommCard	Sets Output Assembly 116 when you use an Ethernet/IP option. The drive writes the values from Output Assembly 116 to the MEMOBUS/Modbus address register that is stored for each parameter. The drive will not write the values from Output Assembly 116 to the registers when the MEMOBUS/Modbus address is 0.	0 (0 - FFFF)
F7-29 (0371)	Dynamic Out Param 7 for CommCard	Sets Output Assembly 116 when you use an Ethernet/IP option. The drive writes the values from Output Assembly 116 to the MEMOBUS/Modbus address register that is stored for each parameter. The drive will not write the values from Output Assembly 116 to the registers when the MEMOBUS/Modbus address is 0.	0 (0 - FFFF)
F7-30 (0372)	Dynamic Out Param 8 for CommCard	Sets Output Assembly 116 when you use an Ethernet/IP option. The drive writes the values from Output Assembly 116 to the MEMOBUS/Modbus address register that is stored for each parameter. The drive will not write the values from Output Assembly 116 to the registers when the MEMOBUS/Modbus address is 0.	0 (0 - FFFF)
F7-31 (0373)	Dynamic Out Param 9 for CommCard	Sets Output Assembly 116 when you use an Ethernet/IP option. The drive writes the values from Output Assembly 116 to the MEMOBUS/Modbus address register that is stored for each parameter. The drive will not write the values from Output Assembly 116 to the registers when the MEMOBUS/Modbus address is 0.	0 (0 - FFFF)
F7-32 (0374)	Dynamic Out Param 10 for CommCard	Sets Output Assembly 116 when you use an Ethernet/IP option. The drive writes the values from Output Assembly 116 to the MEMOBUS/Modbus address register that is stored for each parameter. The drive will not write the values from Output Assembly 116 to the registers when the MEMOBUS/Modbus address is 0.	0 (0 - FFFF)
F7-33 (0375)	Dynamic In Param 1 for CommCard	Sets Input Assembly 166 when you use an Ethernet/IP option. The drive sends the values from the MEMOBUS/Modbus address registers stored for each parameter to Input Assembly 166. The drive returns the default register value for the option card when the MEMOBUS/Modbus address is 0 and the value sent to Input Assembly 166 is not defined. When you use a ProfiNet option, set this parameter to set to configurable input 1.	0 (0 - FFFF)
F7-34 (0376)	Dynamic In Param 2 for CommCard	Sets Input Assembly 166 when you use an Ethernet/IP option. The drive sends the values from the MEMOBUS/Modbus address registers stored for each parameter to Input Assembly 166. The drive returns the default register value for the option card when the MEMOBUS/Modbus address is 0 and the value sent to Input Assembly 166 is not defined. When you use a ProfiNet option, set this parameter to set to configurable input 2.	0 (0 - FFFF)
F7-35 (0377)	Dynamic In Param 3 for CommCard	Sets Input Assembly 166 when you use an Ethernet/IP option. The drive sends the values from the MEMOBUS/Modbus address registers stored for each parameter to Input Assembly 166. The drive returns the default register value for the option card when the MEMOBUS/Modbus address is 0 and the value sent to Input Assembly 166 is not defined. When you use a ProfiNet option, set this parameter to set to configurable input 3.	0 (0 - FFFF)
F7-36 (0378)	Dynamic In Param 4 for CommCard	Sets Input Assembly 166 when you use an Ethernet/IP option. The drive sends the values from the MEMOBUS/Modbus address registers stored for each parameter to Input Assembly 166. The drive returns the default register value for the option card when the MEMOBUS/Modbus address is 0 and the value sent to Input Assembly 166 is not defined. When you use a ProfiNet option, set this parameter to set to configurable input 4.	0 (0 - FFFF)
F7-37 (0379)	Dynamic In Param 5 for CommCard	Sets Input Assembly 166 when you use an Ethernet/IP option. The drive sends the values from the MEMOBUS/Modbus address registers stored for each parameter to Input Assembly 166. The drive returns the default register value for the option card when the MEMOBUS/Modbus address is 0 and the value sent to Input Assembly 166 is not defined. When you use a ProfiNet option, set this parameter to set to configurable input 5.	0 (0 - FFFF)
F7-38 (037A)	Dynamic In Param 6 for CommCard	Sets Input Assembly 166 when you use an Ethernet/IP option. The drive sends the values from the MEMOBUS/Modbus address registers stored for each parameter to Input Assembly 166. The drive returns the default register value for the option card when the MEMOBUS/Modbus address is 0 and the value sent to Input Assembly 166 is not defined.	0 (0 - FFFF)
F7-39 (037B)	Dynamic In Param 7 for CommCard	Sets Input Assembly 166 when you use an Ethernet/IP option. The drive sends the values from the MEMOBUS/Modbus address registers stored for each parameter to Input Assembly 166. The drive returns the default register value for the option card when the MEMOBUS/Modbus address is 0 and the value sent to Input Assembly 166 is not defined.	0 (0 - FFFF)
F7-40 (037C)	Dynamic In Param 8 for CommCard	Sets Input Assembly 166 when you use an Ethernet/IP option. The drive sends the values from the MEMOBUS/Modbus address registers stored for each parameter to Input Assembly 166. The drive returns the default register value for the option card when the MEMOBUS/Modbus address is 0 and the value sent to Input Assembly 166 is not defined.	0 (0 - FFFF)
F7-41 (037D)	Dynamic In Param 9 for CommCard	Sets Input Assembly 166 when you use an Ethernet/IP option. The drive sends the values from the MEMOBUS/Modbus address registers stored for each parameter to Input Assembly 166. The drive returns the default register value for the option card when the MEMOBUS/Modbus address is 0 and the value sent to Input Assembly 166 is not defined.	0 (0 - FFFF)
F7-42 (037E)	Dynamic In Param 10 for CommCard	Sets Input Assembly 166 when you use an Ethernet/IP option. The drive sends the values from the MEMOBUS/Modbus address registers stored for each parameter to Input Assembly 166. The drive returns the default register value for the option card when the MEMOBUS/Modbus address is 0 and the value sent to Input Assembly 166 is not defined.	0 (0 - FFFF)
F7-43 (1BCE)	PLC Cnxn Close Behavior@Run	Sets the drive response when a PLC closes a connection while the drive has an active Run command from the network. 0 : Continue 1 : Clear Run Command 2 : Fault	0 (0 - 2)

No. (Hex.)	Name	Description	Default (Range)
F7-50 (1BC1)	BACnet/IP Port	Sets the UDP port on which the drive will receive incoming BACnet messages. Available in bypass software versions 00446 and later.	47808 (1024 - 65535)
F7-51 (1BE9)	BBMD Foreign Register Addr 1	Sets the first octet of the IP Address of the BACnet Broadcast Management Device (BBMD) to which the drive will register as a foreign device. Available in bypass software versions 00446 and later.	0 (0 - 255)
F7-52 (1BEA)	BBMD Foreign Register Addr 2	Sets the second octet of the IP Address of the BACnet Broadcast Management Device (BBMD) to which the drive will register as a foreign device. Available in bypass software versions 00446 and later.	0 (0 - 255)
F7-53 (1BEB)	BBMD Foreign Register Addr 3	Sets the third octet of the IP Address of the BACnet Broadcast Management Device (BBMD) to which the drive will register as a foreign device. Available in bypass software versions 00446 and later.	0 (0 - 255)
F7-54 (1BEC)	BBMD Foreign Register Addr 4	Sets the fourth octet of the IP Address of the BACnet Broadcast Management Device (BBMD) to which the drive will register as a foreign device. Available in bypass software versions 00446 and later.	0 (0 - 255)
F7-55 (1BED)	BBMD Foreign Register Port	Sets the UDP port of the BBMD device to which the drive will register. Available in bypass software versions 00446 and later.	47808 (1024 - 65535)
F7-56 (1BEE)	BBMD Foreign Register Time	Sets the time interval in which the drive will repeat BBMD foreign registration. Available in bypass software versions 00446 and later.	3600 s (0 - 65535 s)
F7-57 (1BEF)	BACnet/IP BUS Timeout Value	Sets the length of time that the drive will wait after it receives a Run command or frequency reference command before it detects a <i>bUS</i> fault. Available in bypass software versions 00446 and later.	3600 s (0 - 65535 s)

9.10 H: Terminal Functions

◆ H1: Digital Inputs

No. (Hex.)	Name	Description	Default (Range)
H1-01 (0438)	Terminal S1 Function Selection	Sets the function for MFDI terminal S1.	40 (3 to 1A8)
H1-02 (0439)	Terminal S2 Function Selection	Sets the function for MFDI terminal S2.	F (3 to 1A8)
H1-03 (0400)	Terminal S3 Function Selection	Sets the function for MFDI terminal S3.	24 (3 to 1A8)
H1-04 (0401)	Terminal S4 Function Selection	Sets the function for MFDI terminal S4.	14 (3 to 1A8)
H1-05 (0402)	Terminal S5 Function Selection	Sets the function for MFDI terminal S5.	3 (3 to 1A8)
H1-06 (0403)	Terminal S6 Function Selection	Sets the function for MFDI terminal S6.	4 (3 to 1A8)
H1-07 (0404)	Terminal S7 Function Selection	Sets the function for MFDI terminal S7.	6 (3 to 1A8)
H1-61 (39E1) RUN	Terminal S1 On-Delay Time	Sets the length of time necessary for Terminal S1 to be closed before the drive does the programmed function.	0.00 s (0.00 - 300.00 s)
H1-62 (39E2) RUN	Terminal S2 On-Delay Time	Sets the length of time necessary for Terminal S2 to be closed before the drive does the programmed function.	0.00 s (0.00 - 300.00 s)
H1-63 (39E3) RUN	Terminal S3 On-Delay Time	Sets the length of time necessary for Terminal S3 to be closed before the drive does the programmed function.	0.00 s (0.00 - 300.00 s)
H1-64 (39E4) RUN	Terminal S4 On-Delay Time	Sets the length of time necessary for Terminal S4 to be closed before the drive does the programmed function.	0.00 s (0.00 - 300.00 s)
H1-65 (39E5) RUN	Terminal S5 On-Delay Time	Sets the length of time necessary for Terminal S5 to be closed before the drive does the programmed function.	0.00 s (0.00 - 300.00 s)
H1-66 (39E6) RUN	Terminal S6 On-Delay Time	Sets the length of time necessary for Terminal S6 to be closed before the drive does the programmed function.	0.00 s (0.00 - 300.00 s)
H1-67 (39E7) RUN	Terminal S7 On-Delay Time	Sets the length of time necessary for Terminal S7 to be closed before the drive does the programmed function.	0.00 s (0.00 - 300.00 s)
H1-71 (39EB) RUN	Terminal S1 Off-Delay Time	Sets the length of time necessary for Terminal S1 to be open before the drive removes the programmed function.	0.00 s (0.00 - 300.00 s)
H1-72 (39EC) RUN	Terminal S2 Off-Delay Time	Sets the length of time necessary for Terminal S2 to be open before the drive removes the programmed function.	0.00 s (0.00 - 300.00 s)
H1-73 (39ED) RUN	Terminal S3 Off-Delay Time	Sets the length of time necessary for Terminal S3 to be open before the drive removes the programmed function.	0.00 s (0.00 - 300.00 s)
H1-74 (39EE) RUN	Terminal S4 Off-Delay Time	Sets the length of time necessary for Terminal S4 to be open before the drive removes the programmed function.	0.00 s (0.00 - 300.00 s)
H1-75 (39EF) RUN	Terminal S5 Off-Delay Time	Sets the length of time necessary for Terminal S5 to be open before the drive removes the programmed function.	0.00 s (0.00 - 300.00 s)

No. (Hex.)	Name	Description	Default (Range)
H1-76 (39F0) RUN	Terminal S6 Off-Delay Time	Sets the length of time necessary for Terminal S6 to be open before the drive removes the programmed function.	0.00 s (0.00 - 300.00 s)
H1-77 (39F1) RUN	Terminal S7 Off-Delay Time	Sets the length of time necessary for Terminal S7 to be open before the drive removes the programmed function.	0.00 s (0.00 - 300.00 s)

■ H1-xx: MFDI Setting Values

Setting Value	Function	Description
3	Multi-Step Speed Reference 1	Uses speed references <i>d1-01</i> to <i>d1-08</i> to set a multi-step speed reference.
4	Multi-Step Speed Reference 2	Uses speed references <i>d1-01</i> to <i>d1-08</i> to set a multi-step speed reference.
5	Multi-Step Speed Reference 3	Uses speed references <i>d1-01</i> to <i>d1-08</i> to set a multi-step speed reference.
6	Jog Reference Selection	Sets the drive to use the JOG Frequency Reference (JOG command) set in <i>d1-17</i> [Jog Reference]. The JOG Frequency Reference (JOG command) overrides the <i>d1-01</i> to <i>d1-08</i> [References 1 to 8] settings.
7	Accel/Decel Time Selection 1	Sets the drive to use <i>Acceleration/Deceleration Time 1</i> [C1-01, C1-02] or <i>Acceleration/Deceleration Time 2</i> [C1-03, C1-04].
8	Baseblock Command (N.O.)	Sets the command that stops drive output and coasts the motor to stop when the input is ON. ON : Baseblock (drive output stop) OFF : Normal operation
9	Baseblock Command (N.C.)	Sets the command that stops drive output and coasts the motor to stop when the input terminal is OFF. ON : Normal operation OFF : Baseblock (drive output stop)
A	Accel/Decel Ramp Hold	Momentarily pauses motor acceleration and deceleration when the terminal is turned ON, retains the output frequency that was stored in the drive at the time of the pause, and restarts motor operation.
B	Overheat Alarm (oH2)	Sets the drive to display an <i>oH2</i> [Drive Overheat Warning] alarm when the input terminal is ON. The alarm does not have an effect on drive operation.
C	Analog Terminal Enable Selection	Sets the command that enables or disables the terminals selected in <i>H3-14</i> [Analog Input Terminal Enable Sel]. ON : Input to the terminal selected with <i>H3-14</i> is enabled OFF : Input to the terminal selected with <i>H3-14</i> is disabled
F	Not Used	Use this setting for unused terminals or to use terminals in through mode.
14	Fault Reset	Sets the command to reset the current fault when the Run command is inactive. Note: • The drive ignores the fault reset command when the Run command is active. Remove the Run command before trying to reset a fault. • This will only reset drive-specific faults. It will not reset bypass (FBxx) faults. Set <i>Z2-0x = 34</i> and a bypass digital input to reset ALL faults.
15	Fast Stop (N.O.)	Sets the command to ramp to stop in the deceleration time set in <i>C1-09</i> [Fast Stop Time] when the input terminal is activated while the drive is operating.
17	Fast Stop (N.C.)	Sets the command to ramp to stop in the deceleration time set in <i>C1-09</i> [Fast Stop Time] when the input terminal is activated while the drive is operating.
18	Timer Function	Sets the command to start the timer function. Use this setting with <i>Timer Output</i> [H2-xx = 12].
19	PID Disable	Sets the command to disable PID control when <i>b5-01 = 1</i> or <i>3</i> [PID Mode Setting = Standard or Fref + PID Trim]. ON : PID control disabled OFF : PID control enabled
1E	Reference Sample Hold	Sets the command to sample the frequency reference at terminals A1 or A2 and hold the frequency reference at that frequency.
20	External Fault (NO-Always-Ramp)	When the terminal activates, the drive ramps to stop in the selected deceleration time. Fault relay output terminal MA-MC will turn ON, and MB-MC will turn OFF. The drive always detects external faults whether the drive is stopped or running.
21	External Fault (NC-Always-Ramp)	When the terminal deactivates, the drive ramps to stop in the selected deceleration time. Fault relay output terminal MA-MC will turn ON, and MB-MC will turn OFF. The drive always detects external faults whether the drive is stopped or running.
22	External Fault (NO-@Run-Ramp)	When the terminal activates during run, the drive ramps to stop in the selected deceleration time. Fault relay output terminal MA-MC will turn ON, and MB-MC will turn OFF. The drive does not detect external faults while the drive is stopped.
23	External Fault (NC-@Run-Ramp)	When the terminal deactivates during run, the drive ramps to stop in the selected deceleration time. Fault relay output terminal MA-MC will turn ON, and MB-MC will turn OFF. The drive does not detect external faults while the drive is stopped.
24	External Fault (NO-Always-Coast)	When the terminal activates, the drive shuts off the output and the motor coasts to stop. Fault relay output terminal MA-MC will turn ON, and MB-MC will turn OFF. The drive always detects external faults whether the drive is stopped or running.

9.10 H: Terminal Functions

Setting Value	Function	Description
25	External Fault (NC-Always-Coast)	When the terminal deactivates, the drive shuts off the output and the motor coasts to stop. Fault relay output terminal MA-MC will turn ON, and MB-MC will turn OFF. The drive always detects external faults whether the drive is stopped or running.
26	External Fault (NO-@Run-Coast)	When the terminal activates during run, the drive shuts off the output and the motor coasts to stop. Fault relay output terminal MA-MC will turn ON, and MB-MC will turn OFF. The drive does not detect external faults while the drive is stopped.
27	External Fault (NC-@Run-Coast)	When the terminal deactivates during run, the drive shuts off the output and the motor coasts to stop. Fault relay output terminal MA-MC will turn ON, and MB-MC will turn OFF. The drive does not detect external faults while the drive is stopped.
28	External Fault (NO-Always-FStop)	When the terminal activates, the drive stops the motor in the deceleration time set to <i>C1-09 [Fast Stop Time]</i> . Fault relay output terminal MA-MC will turn ON, and MB-MC will turn OFF. The drive always detects external faults whether the drive is stopped or running.
29	External Fault (NC-Always-FStop)	When the terminal deactivates, the drive stops the motor in the deceleration time set to <i>C1-09 [Fast Stop Time]</i> . Fault relay output terminal MA-MC will turn ON, and MB-MC will turn OFF. The drive always detects external faults whether the drive is stopped or running.
2A	External Fault (NO-@Run-FStop)	When the terminal activates during run, the drive stops the motor in the deceleration time set to <i>C1-09 [Fast Stop Time]</i> . Fault relay output terminal MA-MC will turn ON, and MB-MC will turn OFF. The drive does not detect external faults while the drive is stopped.
2B	External Fault (NC-@Run-FStop)	When the terminal deactivates during run, the drive stops the motor in the deceleration time set to <i>C1-09 [Fast Stop Time]</i> . Fault relay output terminal MA-MC will turn ON, and MB-MC will turn OFF. The drive does not detect external faults while the drive is stopped.
2C	External Fault (NO-Always-Alarm)	When the terminal activates, the keypad shows <i>EFx [External Fault (Terminal Sx)]</i> and the output terminal set for <i>Alarm [H2-01 to H2-03 = 10]</i> activates. The drive continues operation. The drive always detects external faults whether the drive is stopped or running.
2D	External Fault (NC-Always-Alarm)	When the terminal deactivates, the keypad shows <i>EFx [External Fault (Terminal Sx)]</i> and the output terminal set for <i>Alarm [H2-01 to H2-03 = 10]</i> activates. The drive continues operation. The drive always detects external faults whether the drive is stopped or running.
2E	External Fault (NO-@Run-Alarm)	When the terminal activates during run, the keypad shows <i>EFx [External Fault (Terminal Sx)]</i> and the output terminal set for <i>Alarm [H2-01 to H2-03 = 10]</i> activates. The drive continues operation. The drive does not detect external faults while the drive is stopped.
2F	External Fault (NC-@Run-Alarm)	When the terminal deactivates during run, the keypad shows <i>EFx [External Fault (Terminal Sx)]</i> and the output terminal set for <i>Alarm [H2-01 to H2-03 = 10]</i> activates. The drive continues operation. The drive does not detect external faults while the drive is stopped.
30	PID Integrator Reset	Sets the command to reset and hold the PID control integral to 0 when the terminal is ON.
31	PID Integrator Hold	Sets the command to hold the integral value of the PID control while the terminal is activated.
34	PID Soft Starter Disable	Sets the PID soft starter function. ON : No OFF : Yes
35	PID Input (Error) Invert	Sets the command to turn the terminal ON and OFF to switch the PID input level (polarity).
3E	PID Setpoint Selection 1	Sets the function to switch the PID setpoint to <i>YA-02 [Setpoint 2]</i> or <i>YA-04 [Setpoint 4]</i> . Set this function and <i>H1-xx = 3F [PID Setpoint Selection 2]</i> at the same time. Note: If you use this function and one of <i>H1-xx = 83 to 85 [Dedicated Multi-Setpoint YA-02 to YA-04]</i> at the same time, the drive will detect an <i>oPE03 [Multi-Function Input Setting Err]</i> . ON : <i>YA-02</i> or <i>YA-04</i> is PID setpoint. OFF : The frequency reference, <i>YA-01 [Setpoint 1]</i> , or <i>YA-03 [Setpoint 3]</i> is PID setpoint.
3F	PID Setpoint Selection 2	Sets the function to switch the PID setpoint to <i>YA-03 [Setpoint 3]</i> or <i>YA-04 [Setpoint 4]</i> . Set this function and <i>H1-xx = 3E [PID Setpoint Selection 1]</i> at the same time. Note: If you use this function and one of <i>H1-xx = 83 to 85 [Dedicated Multi-Setpoint YA-02 to YA-04]</i> at the same time, the drive will detect an <i>oPE03 [Multi-Function Input Setting Err]</i> . ON : <i>YA-03</i> or <i>YA-04</i> is PID setpoint. OFF : The frequency reference, <i>YA-01 [Setpoint 1]</i> , or <i>YA-02 [Setpoint 2]</i> is PID setpoint.
40	Forward RUN (2-Wire)	Terminals assigned to this value will have no effect. Set <i>Z2-0x = 21</i> and use a bypass digital input instead.
44	Add Offset Frequency 1 (d7-01)	Sets the function to add the offset frequency set in <i>d7-01 [Offset Frequency 1]</i> to the frequency reference when the terminal activates.
45	Add Offset Frequency 2 (d7-02)	Sets the function to add the offset frequency set in <i>d7-02 [Offset Frequency 2]</i> to the frequency reference when the terminal activates.
46	Add Offset Frequency 3 (d7-03)	Sets the function to add the offset frequency set in <i>d7-03 [Offset Frequency 3]</i> to the frequency reference when the terminal activates.
51	Sequence Timer Disable	Sets the command to disable Sequence Timers. ON : Sequence Timer is Disabled
52	Sequence Timer Cancel	Sets the command to cancel the currently active Sequence Timer. ON : Cancel Active Sequence Timer
61	Speed Search from Fmax	Sets the function to start speed search using an external reference although <i>b3-01 = 0 [Speed Search Selection at Start = Disabled]</i> . Note: The drive will detect <i>oPE03 [Multi-Function Input Setting Err]</i> when <i>H1-xx = 61</i> and <i>62</i> are set at the same time.

Setting Value	Function	Description
62	Speed Search from Fref	Sets the function to use an external reference to start speed search although $b3-01 = 0$ [Speed Search Selection at Start = Disabled]. Note: The drive will detect $oPE03$ [Multi-Function Input Setting Err] when $H1-xx = 61$ and 62 are set at the same time.
63	Field Weakening	Sets the function to send the Field Weakening Level and Field Weakening Frequency Limit commands set in $d6-01$ [Field Weakening Level] and $d6-02$ [Field Weakening Frequency Limit] when the input terminal is activated.
68	High Slip Braking (HSB) Activate	Sets the command to use high-slip braking to stop the motor.
6A	Drive Enable	This will only function in Drive Mode. Sets the function to show dnE [Drive Enabled] on the keypad and ignore Run commands when the terminal is OFF.
70	Drive Enable 2	This will only function in Drive Mode. Sets the function to show dnE [Drive Enabled] on the keypad and ignore Run commands when the terminal is OFF. ON : Run command is accepted. OFF : Run command is disabled. When the drive is running, it stops according to $b1-03$ setting.
82	PI Switch to Aux	Sets $YF-xx$ [PI Auxiliary Control] parameters as primary PI loop parameters and disables $b5-xx$ [PID Control]. Note: When this input is active, $YF-xx$ [PI Auxiliary Control] parameters will always be the primary PI loop parameters. Parameter $YF-20$ [PI Aux Main PI Speed Control] does not have an effect.
83	Dedicated Multi-Setpoint YA-02	Sets the function to set the PID setpoint to $YA-02$ [Setpoint 2]. Note: If you use this function and one of $H1-xx = 3E$ or $3F$ [PID Setpoint Selection 1 or 2] at the same time, the drive will detect an $oPE03$ [Multi-Function Input Setting Err]. ON : $YA-02$ is PID setpoint. OFF : $YA-01$ [Setpoint 1], $YA-03$ [Setpoint 3], or $YA-04$ [Setpoint 4] is PID setpoint.
84	Dedicated Multi-Setpoint YA-03	Sets the function to set the PID setpoint to $YA-03$ [Setpoint 3]. Set this function and $H1-xx = 83$ [Dedicated Multi-Setpoint YA-02] at the same time. Note: If you use this function and one of $H1-xx = 3E$ or $3F$ [PID Setpoint Selection 1 or 2] at the same time, the drive will detect an $oPE03$ [Multi-Function Input Setting Err]. ON : $YA-03$ is PID setpoint. OFF : $YA-01$ [Setpoint 1], $YA-02$ [Setpoint 2], or $YA-04$ [Setpoint 4] is PID setpoint.
85	Dedicated Multi-Setpoint YA-04	Sets the function to set the PID setpoint to $YA-04$ [Setpoint 4]. Set this function, $H1-xx = 83$ [Dedicated Multi-Setpoint YA-02], and $H1-xx = 84$ [Dedicated Multi-Setpoint YA-03] at the same time. Note: If you use this function and one of $H1-xx = 3E$ or $3F$ [PID Setpoint Selection 1 or 2] at the same time, the drive will detect an $oPE03$ [Multi-Function Input Setting Err]. ON : $YA-04$ is PID setpoint. OFF : $YA-01$ [Setpoint 1], $YA-02$ [Setpoint 2], or $YA-03$ [Setpoint 3] is PID setpoint.
88	Thermostat Fault	Sets the drive to show the $VLTS$ [Thermostat Fault] when the input terminal is ON. Note: This function is active when the drive is running.
A8	PI2 Control Disable	Sets the command to disable the PI2 Control function. Parameter $S3-12$ [PI2 Control Disable Mode Sel] sets the output performance. ON : Enabled OFF : Disabled
AA	PI2 Control Inverse Operation	Sets the command to change the sign of the PI2 Control input.
AB	PI2 Control Integral Reset	Sets the command to reset the PI2 Control integral value. Note: This input has priority over $H1-xx = AC$ [MFDI Function Selection = PI2 Control Integral Hold].
AC	PI2 Control Integral Hold	Sets the command to lock the PI2 Control integral value.
AD	Select PI2 Control PI Parameters	Sets the command to use the $S3-06$ [PI2 Control Proportional Gain] and $S3-07$ [PI2 Control Integral Time] values instead of the $b5-02$ [Proportional Gain (P)] and $b5-03$ [Integral Time (I)] values. Set $S3-01 = 0$ [PI2 Control Enable Selection = Disabled] to enable this function. Note: This multi-function input does not have an effect on PI2 Control. Use this input for the primary PI controller ($b5-xx$).
B9	Disable Pre-charge	Sets the command to disable the Pre-charge function. ON : Pre-charge function is disabled
188	!Thermostat Fault	Sets the drive to show the $VLTS$ [Thermostat Fault] when the input terminal is OFF. Note: This function is active when the drive is running.
1A8	!PI2 Control Disable	Sets the command to disable the PI2 Control function. Parameter $S3-12$ [PI2 Control Disable Mode Sel] sets the output performance. ON : Disabled OFF : Enabled

◆ H2: Digital Outputs

No. (Hex.)	Name	Description	Default (Range)
H2-01 (040B)	Term M1-M2 Function Selection	Sets the function for MFDO terminal M1-M2. Note: Set this parameter to <i>F</i> when the terminal is not being used or to use the terminal in through mode.	0 (0 - 1FF)
H2-02 (040C)	Term M3-M4 Function Selection	Sets the function for MFDO terminal M3-M4. Note: Set this parameter to <i>F</i> when the terminal is not being used or to use the terminal in through mode.	1 (0 - 1FF)
H2-03 (040D)	Term M5-M6 Function Selection	Sets the function for MFDO terminal M5-M6. Note: When you do not use this terminal, or when you will use the terminal in through mode, set this parameter to <i>F</i> .	2 (0 - 1FF)
H2-06 (0437)	Watt Hour Output Unit Selection	Sets the unit for the output signal when H2-01 to H2-03 = 39 [MFDO Function Selection = Watt Hour Pulse Output]. 0 : 0.1 kWh units 1 : 1 kWh units 2 : 10 kWh units 3 : 100 kWh units 4 : 1000 kWh units	0 (0 - 4)
H2-07 (0B3A)	Modbus Register 1 Address Select	Sets the address of the MEMOBUS/Modbus register output to the MFDO terminal.	0001 (0001 - 1FFF)
H2-08 (0B3B)	Modbus Register 1 Bit Select	Sets the bit of the MEMOBUS/Modbus register output to the MFDO terminal.	0000 (0000 - FFFF)
H2-09 (0B3C)	Modbus Register 2 Address Select	Sets the address of the MEMOBUS/Modbus register output to the MFDO terminal.	0001 (0001 - 1FFF)
H2-10 (0B3D)	Modbus Register 2 Bit Select	Sets the bit of the MEMOBUS/Modbus register output to the MFDO terminal.	0000 (0000 - FFFF)
H2-40 (0B58)	Mbus Reg 15E0h bit0 Output Func	Sets the MFDO for bit 0 of MEMOBUS register 15E0 (Hex.).	F (0 - 1FF)
H2-41 (0B59)	Mbus Reg 15E0h bit1 Output Func	Sets the MFDO for bit 1 of MEMOBUS register 15E0 (Hex.).	F (0 - 1FF)
H2-42 (0B5A)	Mbus Reg 15E0h bit2 Output Func	Sets the MFDO for bit 2 of MEMOBUS register 15E0 (Hex.).	F (0 - 1FF)
H2-60 (1B46) Expert	Term M1-M2 Secondary Function	Sets the second function for terminal M1-M2. Outputs the logical calculation results of the terminals assigned to functions by H2-01 [Term M1-M2 Function Selection].	F (0 - FF)
H2-61 (1B47) Expert	Terminal M1-M2 Logical Operation	Sets the logical operation for the functions set in H2-01 [Term M1-M2 Function Selection] and H2-60 [Term M1-M2 Secondary Function].	0 (0 - 8)
H2-62 (1B48) Expert	Terminal M1-M2 Delay Time	Sets the minimum on time used to output the logical calculation results from terminal M1-M2.	0.1 s (0.0 - 25.0 s)
H2-63 (1B49) Expert	Term M3-M4 Secondary Function	Sets the second function for terminal M3-M4. Outputs the logical calculation results of the terminals assigned to functions by H2-02 [Term M3-M4 Function Selection].	F (0 - FF)
H2-64 (1B4A) Expert	Terminal M3-M4 Logical Operation	Sets the logical operation for the functions set in H2-02 [Term M3-M4 Function Selection] and H2-63 [Term M3-M4 Secondary Function].	0 (0 - 8)
H2-65 (1B4B) Expert	Terminal M3-M4 Delay Time	Sets the minimum on time used to output the logical calculation results from terminal M3-M4.	0.1 s (0.0 - 25.0 s)
H2-66 (1B4C) Expert	Term M5-M6 Secondary Function	Sets the second function for terminal M5-M6. Outputs the logical calculation results of the terminals assigned to functions by H2-03 [Terminal M5-M6 Function Select].	F (0 - FF)

No. (Hex.)	Name	Description	Default (Range)
H2-67 (1B4D) Expert	Terminal M5-M6 Logical Operation	Sets the logical operation for the functions set in H2-03 [Term M5-M6 Function Selection] and H2-66 [Term M5-M6 Secondary Function].	0 (0 - 8)
H2-68 (1B4E) Expert	Terminal M5-M6 Delay Time	Sets the minimum on time used to output the logical calculation results from terminal M5-M6.	0.1 s (0.0 - 25.0 s)

■ H2-xx: MFDO Setting Values

Note:

The functions listed here will only activate when you operate in Drive Mode. They will not activate in Bypass Mode.

Setting Value	Function	Description
0	During Run	The terminal activates when you input a Run command and when the drive is outputting voltage. ON : Drive is running OFF : Drive is stopped
1	Zero Speed	The terminal activates when the output frequency < E1-09 [Minimum Output Frequency]. ON : Output frequency < E1-09. OFF : Output frequency ≥ E1-09.
2	Speed Agree 1	The terminal activates when the output frequency is in the range of the frequency reference ± L4-02 [Speed Agree Detection Width]. Note: The detection function operates in the two motor rotation directions. ON : The output frequency is in the range of "frequency reference ± L4-02". OFF : The output frequency does not align with the frequency reference although the drive is running.
3	User-Set Speed Agree 1	The terminal activates when the output frequency is in the range of L4-01 [Speed Agree Detection Level] ± L4-02 [Speed Agree Detection Width] and in the range of the frequency reference ± L4-02. Note: The detection function operates in the two motor rotation directions. The drive uses the L4-01 value as the forward/reverse detection level. ON : The output frequency is in the range of "L4-01 ± L4-02" and the range of frequency reference ± L4-02. OFF : The output frequency is not in the range of "L4-01 ± L4-02" or the range of frequency reference ± L4-02.
4	Frequency Detection 1	The terminal deactivates when the output frequency > "L4-01 [Speed Agree Detection Level] + L4-02 [Speed Agree Detection Width]". After the terminal deactivates, the terminal stays deactivated until the output frequency is at the value of L4-01. Note: The detection function operates in the two motor rotation directions. The drive uses the L4-01 value as the forward/reverse detection level. ON : The output frequency < L4-01, or the output frequency ≤ "L4-01 + L4-02" OFF : The output frequency > "L4-01 + L4-02"
5	Frequency Detection 2	The terminal activates when the output frequency > L4-01 [Speed Agree Detection Level]. After the terminal activates, the terminal stays activated until the output frequency is at the value of "L4-01 - L4-02 [Speed Agree Detection Width]". Note: The detection function operates in the two motor rotation directions. The drive uses the L4-01 value as the forward/reverse detection level. ON : The output frequency > L4-01 OFF : The output frequency < "L4-01 - L4-02", or the output frequency ≤ L4-01
6	Drive Ready	The terminal activates when the drive is ready and running.
7	DC Bus Undervoltage	The terminal activates when the DC bus voltage or control circuit power supply is at the voltage set in L2-05 [Undervoltage Detection Lvl (Uv1)] or less. The terminal also activates when there is a fault with the DC bus voltage. ON : The DC bus voltage ≤ L2-05 OFF : The DC bus voltage > L2-05
8	During Baseblock (N.O.)	The terminal activates during baseblock. When the drive is in baseblock, the drive output transistor stops switching and does not make DC bus voltage. ON : During baseblock OFF : The drive is not in baseblock.
9	Frequency Reference from Keypad	Shows the selected frequency reference source. This terminal has no function when part of a bypass configuration.
B	Torque Detection 1 (N.O.)	The terminal activates when the drive detects overtorque or undertorque. ON : The output current/torque > L6-02 [Torque Detection Level 1], or the output current/torque < L6-02 for longer than the time set in L6-03 [Torque Detection Time 1].
C	Frequency Reference Loss	The terminal activates when the drive detects a loss of frequency reference. This terminal has no function when part of a bypass configuration.

9.10 H: Terminal Functions

Setting Value	Function	Description
E	Fault	The terminal activates when the drive detects a fault. Note: The terminal will not activate for CPF00 and CPF01 [Control Circuit Error] faults.
F	Not Used	Use this setting for unused terminals or to use terminals in through mode. Also use this setting as the PLC contact output via serial communication or the communication option. This signal does not function if signals from the PLC are not configured.
10	Alarm	The terminal activates when the drive detects a minor fault. The terminal will not activate for bypass-specific alarms.
11	Fault Reset Command Active	The terminal activates when the drive receives the Reset command from the control circuit terminal, serial communications, or the communication option.
12	Timer Output	Use this setting when the drive uses the timer function as an output terminal.
13	Speed Agree 2	The terminal activates when the output frequency is in the range of the frequency reference $\pm L4-04$ [Speed Agree Detection Width (+/-)]. Note: The detection function operates in the two motor rotation directions. ON : The output frequency is in the range of "frequency reference $\pm L4-04$ ". OFF : The output frequency is not in the range of "frequency reference $\pm L4-04$ ".
14	User-Set Speed Agree 2	The terminal activates when the output frequency is in the range of $L4-03$ [Speed Agree Detection Level (+/-)] $\pm L4-04$ [Speed Agree Detection Width (+/-)] and in the range of the frequency reference $\pm L4-04$. Note: The detection level set in $L4-03$ is a signed value. The drive will only detect in one direction. ON : The output frequency is in the range of " $L4-03 \pm L4-04$ " and the range of frequency reference $\pm L4-04$. OFF : The output frequency is not in the range of " $L4-03 \pm L4-04$ " or the range of frequency reference $\pm L4-04$.
15	Frequency Detection 3	The terminal deactivates when the output frequency $> "L4-03$ [Speed Agree Detection Level (+/-)] $+ L4-04$ [Speed Agree Detection Width (+/-)]". After the terminal deactivates, the terminal stays deactivated until the output frequency is at the value of $L4-03$. Note: The detection level set in $L4-03$ is a signed value. The drive will only detect in one direction. ON : The output frequency $< L4-03$, or the output frequency $\leq L4-03 + L4-04$. OFF : The output frequency $> "L4-03 + L4-04"$.
16	Frequency Detection 4	The terminal activates when the output frequency $> L4-03$ [Speed Agree Detection Level (+/-)]. After the terminal activates, the terminal stays activated until the output frequency is at the value of " $L4-03 - L4-04$ ". Note: The detection level set in $L4-03$ is a signed value. The drive will only detect in one direction. ON : The output frequency $> L4-03$. OFF : The output frequency $< "L4-03 - L4-04"$, or the output frequency $\leq L4-03$.
17	Torque Detection 1 (N.C.)	The terminal deactivates when the drive detects overtorque or undertorque. OFF : The output current/torque $> L6-02$ [Torque Detection Level 1], or the output current/torque $< L6-02$ for longer than the time set in $L6-03$ [Torque Detection Time 1].
18	Torque Detection 2 (N.O.)	The terminal activates when the drive detects overtorque or undertorque. ON : The output current/torque $> L6-05$ [Torque Detection Level 2], or the output current/torque $< L6-05$ for longer than the time set in $L6-06$ [Torque Detection Time 2].
19	Torque Detection 2 (N.C.)	The terminal deactivates when the drive detects overtorque or undertorque. OFF : The output current/torque $> L6-05$ [Torque Detection Level 2], or the output current/torque $< L6-05$ for longer than the time set in $L6-06$ [Torque Detection Time 2].
1A	During Reverse	The terminal activates when the motor operates in the reverse direction. ON : The motor is operating in the reverse direction. OFF : The motor is operating in the forward direction or the motor stopped.
1B	During Baseblock (N.C.)	The terminal deactivates during baseblock. When the drive is in baseblock, the drive output transistor stops switching and does not make DC bus voltage. ON : The drive is not in baseblock. OFF : During baseblock
1E	Executing Auto-Restart	The terminal activates when the Auto Restart function is trying to restart after a fault.
1F	Motor Overload Alarm (oL1)	The terminal activates when the electronic thermal protection value of the motor overload protective function is a minimum of 90% of the detection level.
20	Drive Overheat Pre-Alarm (oH)	The terminal activates when the drive heatsink temperature is at the level set with $L8-02$ [Overheat Alarm Level].
21	Safe Torque OFF	The terminal activates (safety stop state) when the safety circuit and safety diagnosis circuit are operating correctly and when terminals H1-HC and H2-HC are OFF (Open). ON : Safety stop state OFF : Safety circuit fault or RUN/READY

Setting Value	Function	Description
2F	Maintenance Notification	The terminal activates when drive components are at their estimated maintenance period. Tells the user about the maintenance period for these items: <ul style="list-style-type: none"> • IGBT • Cooling fan • Capacitor • Soft charge bypass relay
37	During Frequency Output	The terminal activates when the drive outputs frequency. ON : The drive outputs frequency. OFF : The drive does not output frequency.
38	Drive Enabled	This terminal activates when the H1-xx = 6A [Drive Enable] terminal activates.
39	Watt Hour Pulse Output	Outputs the pulse that shows the watt hours.
3A	Drive Overheat Alarm	The terminal activates when the drive heatsink temperature is at the L8-02 [Overheat Alarm Level] setting while L8-03 = 4 [Overheat Pre-Alarm Selection = Operate at Reduced Speed (L8-19)] and the drive is running.
3D	During Speed Search	The terminal activates when the drive is doing speed search.
42	Pressure Reached	The terminal activates when the drive is at the Pressure Setpoint.
4C	During Fast Stop	The terminal activates when the fast stop is in operation.
4D	oH Pre-Alarm Reduction Limit	The terminal activates when L8-03 = 4 [Overheat Pre-Alarm Selection = Operate at Reduced Speed (L8-19)] and oH [Heatsink Overheat] does not clear after the drive decreases the frequency for 10 cycles.
51	Sequence Timer 1	The terminal activates when Sequence Timer 1 is active.
52	Sequence Timer 2	The terminal activates when Sequence Timer 2 is active.
53	Sequence Timer 3	The terminal activates when Sequence Timer 3 is active.
54	Sequence Timer 4	The terminal activates when Sequence Timer 4 is active.
58	UL6 Underload Detected	The terminal activates when the drive detected UL6 [Underload or Belt Break Detected].
60	Internal Cooling Fan Failure	The terminal activates when the drive detects a cooling fan failure in the drive.
62	Modbus Reg 1 Status Satisfied	The terminal activates when the bit specified by H2-08 [Modbus Register 1 Bit Select] for the MEMOBUS register address set with H2-07 [Modbus Register 1 Address Select] activates.
63	Modbus Reg 2 Status Satisfied	The terminal activates when the bit specified by H2-10 [Modbus Register 2 Bit Select] for the MEMOBUS register address set with H2-09 [Modbus Register 2 Address Select] activates.
69	External Power 24V Supply	The terminal activates when there is an external 24V power supply between terminals PS-AC. ON : An external 24V power supply supplies power. OFF : An external 24V power supply does not supply power.
6A	Data Logger Error	The terminal activates when the drive detects LoG [Com Error / Abnormal SD card].
71	Low PI2 Control Feedback Level	The terminal activates when the PI2 Control Feedback Level is less than S3-13 [PI2 Control Low Feedback Lvl].
72	High PI2 Control Feedback Level	The terminal activates when the PI2 Control Feedback Level is more than S3-15 [PI2 Control High Feedback Lvl].
89	Output Current Lim	The terminal activates when the output current limit is limiting the drive output speed.
94	Loss of Prime	The terminal activates when the drive is in an LOP [Loss of Prime] condition.
95	Thermostat Fault	The terminal activates when the terminal set for H1-xx = 88 [MFDI Function Selection = Thermostat Fault] is active.
96	High Feedback	The terminal activates when the drive is in a High Feedback Condition as specified by Y1-11 [High Feedback Level] and Y1-12 [High Feedback Lvl Fault Dly Time] and when the drive detects an HFB [High Feedback Sensed] fault or an HIFB [High Feedback Sensed] alarm.
97	Low Feedback	The terminal activates when the drive is in a Low Feedback Condition as specified by Y1-08 [Low Feedback Level] and Y1-09 [Low Feedback Lvl Fault Dly Time] and when the drive detects an LFB [Low Feedback Sensed] fault or an LOFB [High Feedback Sensed] alarm.
9E	Low PI Auxiliary Control Level	The terminal activates when the PI Aux Feedback Level is less than YF-09 [PI Aux Control Low Level Detect] or if the drive detects an LOAUX [Low PI Aux Feedback Level] fault.
9F	High PI Auxiliary Control Level	The terminal activates when the PI Aux Feedback Level is more than YF-12 [PI Aux Control High Level Detect] or if the drive detects an HIAUX [High PI Aux Feedback Level] fault.
A9	RELAY Operator Control	The terminal changes to OFF or ON when you push the RELAY (F3) button. When the terminal is ON, push F3 to turn it OFF. When the terminal is OFF, push F3 to turn in ON.
AB	Thrust Mode	The terminal activates when the output frequency is between 0.0 Hz and the value set in Y4-12 [Thrust Frequency] and the Thrust Bearing function is active.
AC	Setpoint Not Maintained	The terminal activates when the drive detects NMS [Setpoint Not Met] condition.

9.10 H: Terminal Functions

Setting Value	Function	Description
B2	BAS Interlock	The terminal activates when the Run command is active or the drive is outputting the voltage. The drive will use this as an actuation signal for an external damper.
B8	Pump Fault	The terminal activates when one of these faults is active: <i>LFB [Low Feedback Sensed]</i> , <i>HFB [High Feedback Sensed]</i> , <i>NMS [Setpoint Not Met]</i> , or <i>EFx [External Fault (Terminal Sx)]</i> .
B9	Transducer Loss	The terminal activates when the current into the analog input associated with PID feedback is more than 21 mA or less than 3 mA, or an <i>FDBKL [WIRE Break]</i> Fault or an <i>FDBKL [Feedback Loss Wire Break]</i> Alarm is active.
BA	PI Auxiliary Control Active	The terminal activates when the PI Auxiliary Controller has an effect on the output speed.
BB	Differential Feedback Exceeded	The terminal activates when the difference between the PID Feedback and the value from the terminal set for <i>H3-xx = 2D [Differential Feedback]</i> is more than <i>Y4-18 [Differential Level]</i> for the time set in <i>Y4-19 [Differential Lvl Detection Time]</i> .
BC	Sleep Active	The terminal activates when the Sleep function is active and the drive is not operating. Note: The terminal will not activate for Sleep Boost function.
BD	Start Delay	The terminal activates when the Feedback is more than the start level or the Feedback is less than the Inverse PID and the start timer is timing. Note: You must set <i>Y1-04 [Sleep Wake-up Level] ≠ 0</i> and <i>Y1-05 [Sleep Wake-up Level Delay Time] ≠ 0</i> to use this function.
BE	Pre-Charge	The terminal activates when the drive is in Pre-Charge Mode.
C0	HAND Mode	The terminal activates when the drive is in HAND Mode operation.
C1	AUTO Mode	The terminal activates when the drive is in AUTO Mode operation.
C2	OFF Mode	The terminal activates when the drive is in OFF Mode operation.
C3	Main Feedback Lost	The terminal activates when the drive loses the main PID feedback.
C4	Backup Feedback Lost	The terminal activates when the drive loses the backup PID feedback.
100	!During Run	The terminal deactivates when you input a Run command and when the drive is outputting voltage. ON : Drive is stopping OFF : Drive is running
101	!Zero Speed	The terminal deactivates when the output frequency < <i>E1-09 [Minimum Output Frequency]</i> . ON : Output frequency ≥ value of <i>E1-09</i> . OFF : Output frequency < value of <i>E1-09</i> .
102	!Speed Agree 1	The terminal deactivates when the output frequency is in the range of the frequency reference ± <i>L4-02 [Speed Agree Detection Width]</i> . Note: The detection function operates in the two motor rotation directions. ON : The output frequency does not align with the frequency reference although the drive is running. OFF : The output frequency is in the range of "frequency reference ± <i>L4-02</i> ".
103	!User-Set Speed Agree 1	The terminal deactivates when the output frequency is in the range of <i>L4-01 [Speed Agree Detection Level] ± L4-02 [Speed Agree Detection Width]</i> and in the range of the frequency reference ± <i>L4-02</i> . Note: The detection function operates in the two motor rotation directions. The drive uses the <i>L4-01</i> value as the forward/reverse detection level. ON : The output frequency is not in the range of " <i>L4-01 ± L4-02</i> " or the range of frequency reference ± <i>L4-02</i> . OFF : The output frequency is in the range of " <i>L4-01 ± L4-02</i> " and the range of frequency reference ± <i>L4-02</i> .
104	!Frequency Detection 1	The terminal activates when the output frequency > " <i>L4-01 [Speed Agree Detection Level] + L4-02 [Speed Agree Detection Width]</i> ". After the terminal activates, the terminal stays activated until the output frequency is at the value of <i>L4-01</i> . Note: The detection function operates in the two motor rotation directions. The drive uses the <i>L4-01</i> value as the forward/reverse detection level. ON : The output frequency > " <i>L4-01 + L4-02</i> ". OFF : The output frequency < <i>L4-01</i> , or the output frequency ≤ " <i>L4-01 + L4-02</i> "
105	!Frequency Detection 2	The terminal deactivates when the output frequency > <i>L4-01 [Speed Agree Detection Level]</i> . After the terminal deactivates, the terminal stays deactivated until the output frequency is at the value of " <i>L4-01 - L4-02 [Speed Agree Detection Width]</i> ". Note: The detection function operates in the two motor rotation directions. The drive uses the <i>L4-01</i> value as the forward/reverse detection level. ON : The output frequency < " <i>L4-01 - L4-02</i> ", or the output frequency ≤ <i>L4-01</i> OFF : The output frequency > <i>L4-01</i>
106	!Drive Ready	The terminal deactivates when the drive is ready and running.
107	!DC Bus Undervoltage	The terminal deactivates when the DC bus voltage or control circuit power supply is at the voltage set in <i>L2-05 [Undervoltage Detection Lvl (Uv1)]</i> or less. The terminal also deactivates when there is a fault with the DC bus voltage. ON : The DC bus voltage > <i>L2-05</i> OFF : The DC bus voltage ≤ <i>L2-05</i>

Setting Value	Function	Description
108	!During Baseblock (N.O.)	The terminal deactivates during baseblock. When the drive is in baseblock, the drive output transistor stops switching and does not make DC bus voltage. ON : The drive is not in baseblock. OFF : During baseblock.
109	!Frequency Reference from Keypad	Shows the selected frequency reference source. ON : Parameter <i>b1-01</i> [<i>Frequency Reference Selection 1</i>] is the frequency reference source. OFF : The keypad is the frequency reference source.
10B	!Torque Detection 1 (N.O.)	The terminal deactivates when the drive detects overtorque or undertorque. OFF : The output current/torque > <i>L6-02</i> [<i>Torque Detection Level 1</i>], or < <i>L6-02</i> for longer than the time set with <i>L6-03</i> [<i>Torque Detection Time 1</i>].
10C	!Frequency Reference Loss	The terminal deactivates when the drive detects a loss of frequency reference.
10E	!Fault	The terminal deactivates when the drive detects a fault. Note: The terminal will not deactivate for <i>CPF00</i> and <i>CPF01</i> [<i>Control Circuit Error</i>] faults.
110	!Alarm	The terminal deactivates when the drive detects a minor fault.
111	!Fault Reset Command Active	The terminal deactivates when the drive receives the Reset command from the control circuit terminal, serial communications, or the communication option.
112	!Timer Output	Use this setting when the drive uses the timer function as an output terminal.
113	!Speed Agree 2	The terminal deactivates when the output frequency is in the range of the frequency reference \pm <i>L4-04</i> [<i>Speed Agree Detection Width (+/-)</i>]. Note: The detection function operates in the two motor rotation directions. ON : The output frequency is not in the range of "frequency reference \pm <i>L4-04</i> ". OFF : The output frequency is in the range of "frequency reference \pm <i>L4-04</i> ".
114	!User-Set Speed Agree 2	The terminal deactivates when the output frequency is in the range of <i>L4-03</i> [<i>Speed Agree Detection Level (+/-)</i>] \pm <i>L4-04</i> [<i>Speed Agree Detection Width (+/-)</i>] and in the range of the frequency reference \pm <i>L4-04</i> . Note: The detection level set in <i>L4-03</i> is a signed value. The drive will only detect in one direction. ON : The output frequency is not in the range of " <i>L4-03</i> \pm <i>L4-04</i> " or the range of frequency reference \pm <i>L4-04</i> . OFF : The output frequency is in the range of " <i>L4-03</i> \pm <i>L4-04</i> " and the range of frequency reference \pm <i>L4-04</i> .
115	!Frequency Detection 3	The terminal activates when the output frequency > " <i>L4-03</i> [<i>Speed Agree Detection Level (+/-)</i>] + <i>L4-04</i> [<i>Speed Agree Detection Width (+/-)</i>]" . After the terminal activates, the terminal stays activated until the output frequency is at the value of <i>L4-03</i> . Note: The detection level set in <i>L4-03</i> is a signed value. The drive will only detect in one direction. ON : The output frequency > " <i>L4-03</i> + <i>L4-04</i> " OFF : The output frequency < <i>L4-03</i> , or the output frequency \leq " <i>L4-03</i> + <i>L4-04</i> "
116	!Frequency Detection 4	The terminal deactivates when the output frequency > <i>L4-03</i> [<i>Speed Agree Detection Level (+/-)</i>]. After the terminal deactivates, the terminal stays deactivated until the output frequency is at the value of " <i>L4-03</i> - <i>L4-04</i> ". Note: The detection level set in <i>L4-03</i> is a signed value. The drive will only detect in one direction. ON : The output frequency < " <i>L4-03</i> - <i>L4-04</i> ", or the output frequency \leq <i>L4-03</i> OFF : The output frequency > <i>L4-03</i>
117	!Torque Detection 1 (N.C.)	The terminal activates when the drive detects overtorque or undertorque. ON : The output current/torque > <i>L6-02</i> [<i>Torque Detection Level 1</i>], or the output current/torque < <i>L6-02</i> for longer than the time set in <i>L6-03</i> [<i>Torque Detection Time 1</i>].
118	!Torque Detection 2 (N.O.)	The terminal deactivates when the drive detects overtorque or undertorque. OFF : The output current/torque > <i>L6-05</i> [<i>Torque Detection Level 2</i>], or the output current/torque < <i>L6-05</i> for longer than the time set in <i>L6-06</i> [<i>Torque Detection Time 2</i>].
119	!Torque Detection 2 (N.C.)	The terminal activates when the drive detects overtorque or undertorque. ON : The output current/torque > <i>L6-05</i> [<i>Torque Detection Level 2</i>], or the output current/torque < <i>L6-05</i> for longer than the time set in <i>L6-06</i> [<i>Torque Detection Time 2</i>].
11A	!During Reverse	The terminal deactivates when the motor operates in the reverse direction. ON : The motor is operating in the forward direction or the motor stopped. OFF : The motor is operating in the reverse direction.
11B	!During Baseblock (N.C.)	The terminal activates during baseblock. When the drive is in baseblock, the drive output transistor stops switching and does not make DC bus voltage. ON : During baseblock. OFF : The drive is not in baseblock.
11E	!Executing Auto-Restart	The terminal deactivates when the Auto Restart function is trying to restart after a fault.
11F	!Motor Overload Alarm (oL1)	The terminal deactivates when the electronic thermal protection value of the motor overload protective function is a minimum of 90% of the detection level.
120	!Drive Overheat Pre-Alarm (oH)	The terminal deactivates when the drive heatsink temperature is at the level set with <i>L8-02</i> [<i>Overheat Alarm Level</i>].

9.10 H: Terminal Functions

Setting Value	Function	Description
121	!Safe Torque OFF	The terminal deactivates (safety stop state) when the safety circuit and safety diagnosis circuit are operating correctly and when terminals H1-HC and H2-HC are OFF (Open). ON : Safety circuit fault or RUN/READY OFF : Safety stop state
12F	!Maintenance Notification	The terminal deactivates when drive components are at their estimated maintenance period. Tells the user about the maintenance period for these items: <ul style="list-style-type: none"> • IGBT • Cooling fan • Capacitor • Soft charge bypass relay
137	!During Frequency Output	The terminal deactivates when the drive outputs frequency. ON : The drive does not output frequency. OFF : The drive outputs frequency.
138	!Drive Enabled	This terminal deactivates when the H1-xx = 6A [Drive Enable] terminal deactivates.
139	!Watt Hour Pulse Output	Outputs the pulse that shows the watt hours.
13A	!Drive Overheat Alarm	The terminal deactivates when the drive heatsink temperature is at the L8-02 [Overheat Alarm Level] setting while L8-03 = 4 [Overheat Pre-Alarm Selection = Operate at Reduced Speed (L8-19)] and the drive is running.
13D	!During Speed Search	The terminal deactivates when the drive is doing speed search.
142	!Pressure Reached	The terminal deactivates when the drive is at the Pressure Setpoint.
14C	!During Fast Stop	The terminal deactivates when the fast stop is in operation.
14D	!oH Pre-Alarm Reduction Limit	The terminal deactivates when L8-03 = 4 [Overheat Pre-Alarm Selection = Operate at Reduced Speed (L8-19)] and oH [Heatsink Overheat] does not clear after the drive decreases the frequency for 10 cycles.
151	!Sequence Timer 1	The terminal deactivates when Sequence Timer 1 is active.
152	!Sequence Timer 2	The terminal deactivates when Sequence Timer 2 is active.
153	!Sequence Timer 3	The terminal deactivates when Sequence Timer 3 is active.
154	!Sequence Timer 4	The terminal deactivates when Sequence Timer 4 is active.
158	!UL6 Underload Detected	The terminal deactivates when the drive detected UL6 [Underload or Belt Break Detected].
160	!Internal Cooling Fan Failure	The terminal deactivates when the drive detects a cooling fan failure in the drive.
162	!Modbus Reg 1 Status Satisfied	The terminal deactivates when the bit specified by H2-08 [Modbus Register 1 Bit Select] for the MEMOBUS register address set with H2-07 [Modbus Register 1 Address Select] activates.
163	!Modbus Reg 2 Status Satisfied	The terminal deactivates when the bit specified by H2-10 [Modbus Register 2 Bit Select] for the MEMOBUS register address set with H2-09 [Modbus Register 2 Address Select] activates.
169	!External Power 24V Supply	The terminal deactivates when there is an external 24V power supply between terminals PS-AC. ON : An external 24V power supply does not supply power. OFF : An external 24V power supply supplies power.
16A	!Data Logger Error	The terminal deactivates when the drive detects LoG [Com Error / Abnormal SD card].
171	!Low PI2 Control Feedback Level	The terminal deactivates when the PI2 Control Feedback Level is less than S3-13 [PI2 Control Low Feedback Lvl].
172	!High PI2 Control Feedback Level	The terminal deactivates when the PI2 Control Feedback Level is more than S3-15 [PI2 Control High Feedback Lvl].
189	!Output Current Lim	The terminal deactivates when the output current limit is limiting the drive output speed.
194	!Loss of Prime	The terminal deactivates when the drive is in an LOP [Loss of Prime] condition.
195	!Thermostat Fault	The terminal deactivates when the terminal set for H1-xx = 88 [MFDI Function Selection = Thermostat Fault] is active.
196	!High Feedback	The terminal deactivates when the drive is in a High Feedback Condition as specified by Y1-11 [High Feedback Level] and Y1-12 [High Feedback Lvl Fault Dly Time] and when the drive detects an HFB [High Feedback Sensed] fault or an HIFB [High Feedback Sensed] alarm.
197	!Low Feedback	The terminal deactivates when the drive is in a Low Feedback Condition as specified by Y1-08 [Low Feedback Level] and Y1-09 [Low Feedback Lvl Fault Dly Time] and when the drive detects an LFB [Low Feedback Sensed] fault or an LOFB [High Feedback Sensed] alarm.
19E	!Low PI Auxiliary Control Level	The terminal deactivates when the PI Aux Feedback Level is less than YF-09 [PI Aux Control Low Level Detect] or if the drive detects an LOAUX [Low PI Aux Feedback Level] fault.
19F	!High PI Auxiliary Control Level	The terminal deactivates when the PI Aux Feedback Level is more than YF-12 [PI Aux Control High Level Detect] or if the drive detects an HIAUX [High PI Aux Feedback Level] fault.
1A9	!RELAY Operator Control	The terminal changes to OFF or ON when you push the RELAY (F3) button. When the terminal is ON, push F3 to turn it OFF. When the terminal is OFF, push F3 to turn in ON.

Setting Value	Function	Description
1AB	!Thrust Mode	The terminal deactivates when the output frequency is between 0.0 Hz and the value set in Y4-12 [Thrust Frequency] and the Thrust Bearing function is active.
1AC	!Setpoint Not Maintained	The terminal deactivates when the drive detects NMS [Setpoint Not Met] condition.
1B2	!BAS Interlock	The terminal deactivates when the Run command is active or the drive is outputting the voltage. The drive will use this as an actuation signal for an external damper.
1B8	!Pump Fault	The terminal deactivates when one of these faults is active: LFB [Low Feedback Sensed], HFB [High Feedback Sensed], NMS [Setpoint Not Met], or Efx [External Fault (Terminal Sx)].
1B9	!Transducer Loss	The terminal deactivates when the current into the analog input associated with PID feedback is more than 21 mA or less than 3 mA, or an FDBKL [WIRE Break] Fault or an FDBKL [Feedback Loss Wire Break] Alarm is active.
1BA	!PI Auxiliary Control Active	The terminal deactivates when the PI Auxiliary Controller has an effect on the output speed.
1BB	!Differential Feedback Exceeded	The terminal deactivates when the difference between the PID Feedback and the value from the terminal set for H3-xx = 2D [Differential Feedback] is more than Y4-18 [Differential Level] for the time set in Y4-19 [Differential Lvl Detection Time].
1BC	!Sleep Active	The terminal deactivates when the Sleep function is active and the drive is not operating. Note: The terminal will not deactivate for Sleep Boost function.
1BD	!Start Delay	The terminal deactivates when the Feedback is more than the start level or the Feedback is less than the Inverse PID and the start timer is timing. Note: You must set Y1-04 [Sleep Wake-up Level] ≠ 0 and Y1-05 [Sleep Wake-up Level Delay Time] ≠ 0 to use this function.
1BE	!Pre-Charge	The terminal deactivates when the drive is in Pre-Charge Mode.
1C0	!HAND Mode	The terminal deactivates when the drive is in HAND Mode operation.
1C1	!AUTO Mode	The terminal deactivates when the drive is in AUTO Mode operation.
1C2	!OFF Mode	The terminal deactivates when the drive is in OFF Mode operation.
1C3	!Main Feedback Lost	The terminal deactivates when the drive loses the main PID feedback.
1C4	!Backup Feedback Lost	The terminal deactivates when the drive loses the backup PID feedback.

◆ H3: Analog Inputs

No. (Hex.)	Name	Description	Default (Range)
H3-01 (0410)	Terminal A1 Signal Level Select	Sets the input signal level for MFAI terminal A1. 0 : 0 to 10V (Lower Limit at 0) 2 : 4 to 20 mA 3 : 0 to 20 mA	0 (0 - 3)
H3-02 (0434)	Terminal A1 Function Selection	Sets the function for MFAI terminal A1.	0 (0 - 31)
H3-03 (0411) RUN	Terminal A1 Gain Setting	Sets the gain of the analog signal input to MFAI terminal A1.	100.0% (-999.9 - +999.9%)
H3-04 (0412) RUN	Terminal A1 Bias Setting	Sets the bias of the analog signal input to MFAI terminal A1.	0.0% (-999.9 - +999.9%)
H3-09 (0417)	Terminal A2 Signal Level Select	Sets the input signal level for MFAI terminal A2. 0 : 0-10V (LowLim=0) 2 : 4 to 20 mA 3 : 0 to 20 mA	2 (0 - 3)
H3-10 (0418)	Terminal A2 Function Selection	Sets the function for MFAI terminal A2. Note: The default setting for H3-10 changes when b5-01 [PID Mode Setting] changes: • b5-01 = 0 [Disabled]: 0 • b5-01 ≠ 0: B	Determined by b5-01 (0 - 31)
H3-11 (0419) RUN	Terminal A2 Gain Setting	Sets the gain of the analog signal input to MFAI terminal A2.	100.0% (-999.9 - +999.9%)
H3-12 (041A) RUN	Terminal A2 Bias Setting	Sets the bias of the analog signal input to MFAI terminal A2.	0.0% (-999.9 - +999.9%)

9.10 H: Terminal Functions

No. (Hex.)	Name	Description	Default (Range)
H3-13 (041B)	Analog Input FilterTime Constant	Sets the time constant for primary delay filters on MFAI terminals.	0.03 s (0.00 - 2.00 s)
H3-14 (041C)	Analog Input Terminal Enable Sel	Sets which terminal or terminals to enable when $H1-xx = C$ [MFDI Function Selection = Analog Terminal Enable Selection] is activated. 1 : Terminal A1 only 2 : Terminal A2 only 3 : Terminals A1 and A2	2 (1 - 3)
H3-16 (02F0)	Terminal A1 Offset	Sets the offset level for analog signals input to terminal A1. Usually it is not necessary to change this setting.	0 (-500 - +500)
H3-17 (02F1)	Terminal A2 Offset	Sets the offset level for analog signals input to terminal A2. Usually it is not necessary to change this setting.	0 (-500 - +500)
H3-40 (0B5C)	Mbus Reg 15C1h Input Function	Sets the MEMOBUS AI1 function.	F (4 - 2E)
H3-41 (0B5F)	Mbus Reg 15C2h Input Function	Sets the MEMOBUS AI2 function.	F (4 - 2E)
H3-42 (0B62)	Mbus Reg 15C3h Input Function	Sets the MEMOBUS AI3 function.	F (4 - 2E)
H3-43 (117F)	Mbus Reg Inputs FilterTime Const	Sets the time constant to apply a primary delay filter to the MEMOBUS analog input register values.	0.00 s (0.00 - 2.00 s)

■ H3-xx: MFAI Setting Values

Setting Value	Function	Description
0	Frequency Reference	This selection has no effect. Use bypass analog input (TB4-2) as the frequency reference. Refer to the Bypass Controller section on page 93 for more information.
1	Frequency Gain	The drive multiplies the analog frequency reference with the input value from the MFAI set with this function.
2	Auxiliary Frequency Reference 1	Sets Reference 2 through multi-step speed reference to enable the command reference (Auxiliary Frequency Reference 1) from the analog input terminal set here. This value is a percentage where the Maximum Output Frequency setting is a setting value of 100%.
3	Auxiliary Frequency Reference 2	Sets Reference 3 through multi-step speed reference to enable the command reference (Auxiliary Frequency Reference 2) from the analog input terminal set here. This value is a percentage where the Maximum Output Frequency setting is a setting value of 100%.
4	Output Voltage Bias	Set this parameter to input a bias signal and amplify the output voltage.
5	Accel/Decel Time Gain	Enters a signal to adjust the gain used for $C1-01$ to $C1-04$ [Acceleration/Deceleration Times 1 and 2] and $C1-09$ [Fast Stop Time] when the full scale analog signal (10 V or 20 mA) is 100%.
6	DC Injection Braking Current	Enters a signal to adjust the current level used for DC Injection Braking when the drive rated output current is 100%.
7	Torque Detection Level	Enters a signal to adjust the overtorque/undertorque detection level. Note: Use this function with $L6-01$ [Torque Detection Selection 1]. This parameter functions as an alternative to $L6-02$ [Torque Detection Level 1].
8	Stall Prevent Level During Run	Enters a signal to adjust the stall prevention level during run if the drive rated current is 100%.
9	Output Frequency Lower Limit	Enters a signal to adjust the output frequency lower limit level as a percentage of the maximum output frequency.
B	PID Feedback	Enter the PID feedback value as a percentage of the maximum output frequency.
C	PID Setpoint	Enters the PID setpoint as a percentage of the maximum output frequency.
D	Frequency Bias	Enters the bias value added to the frequency reference as a percentage of the maximum output frequency.
E	Motor Temperature (PTC Input)	Uses the motor Positive Temperature Coefficient (PTC) thermistor to prevent heat damage to the motor as a percentage of the current value when the 10 V analog signal is input.
F	Not Used	Use this setting for unused terminals or to use terminals in through mode.
16	Differential PID Feedback	Enters the PID differential feedback value if the full scale analog signal (10 V or 20 mA) is 100%.
1F	Not Used	Use this setting for unused terminals or to use terminals in through mode.
24	PID Feedback Backup	Enters the PID Feedback Backup signal for the drive to use when it loses the primary PID feedback set for $H3-xx = B$ [PID Feedback]. Note: The full-scale of the analog signal goes from $b5-71$ [Min PID Transducer Scaling] to $b5-38$ [PID User Unit Display Scaling].

Setting Value	Function	Description
25	PI2 Control Setpoint	Enters the PI2 Control setpoint level as a percentage of the S3-02 [PI2 Control Transducer Scale] value. Note: Parameters S3-03 [PI2 Control Decimal Place Pos] and S3-04 [PI2 Control Unit Selection] set the resolution and unit.
26	PI2 Control Feedback	Enters the PI2 Control feedback level as a percentage of the S3-02 [PI2 Control Transducer Scale] value. Note: Parameters S3-03 [PI2 Control Decimal Place Pos] and S3-04 [PI2 Control Unit Selection] set the resolution and unit.
27	PI Auxiliary Control Feedback	Enters the PI Auxiliary Control feedback value when YF-01 = 1 [PI Aux Control Selection = Enabled]. Note: • The full-scale of the analog signal goes from 0% to YF-02 [PI Aux Control Transducer Scale]. • Parameter YF-22 [PI Aux Level Decimal Place Pos] sets the resolution.
2B	Emergency Override PID Feedback	This input is the PID Feedback source when Emergency Override is running in PID mode (S6-02 = 2 or 3 [Emergency Override Ref Selection = System PID Mode or Independent PID Mode]). Note: • When S6-02 = 2 [Emergency Override Ref Selection = System PID Mode], the full-scale of the analog signal goes from b5-71 [Min PID Transducer Scaling] to b5-38 [PID User Unit Display Scaling]. • When S6-02 = 3 [Independent PID Mode], the full-scale of the analog signal goes from b5-71 to S6-03 [EMOVR Independent PID Scale]. • When you set MEMOBUS register 3A93h bit 4, register 3A95h becomes the Emergency Override Feedback source.
2C	Emergency Override PID Setpoint	This input is the PID Setpoint source when Emergency Override is running in PID mode (S6-02 = 2 or 3 [Emergency Override Ref Selection = System PID Mode or Independent PID Mode]). Note: • When S6-02 = 2 [Emergency Override Ref Selection = System PID Mode], the full-scale of the analog signal goes from b5-71 [Min PID Transducer Scaling] to b5-38 [PID User Unit Display Scaling]. • When S6-02 = 3 [Independent PID Mode], the full-scale of the analog signal goes from b5-71 to S6-03 [EMOVR Independent PID Scale]. • When you set MEMOBUS register 3A93h bit 5, register 3A96h becomes the Emergency Override Setpoint source.
2D	Differential Level Source	Enters a feedback value to calculate the Differential Level between the Differential Level Source feedback and the primary PID Feedback [H3-xx = B]. Note: The full-scale of the analog signal goes from b5-71 [Min PID Transducer Scaling] to b5-38 [PID User Unit Display Scaling].
2E	HAND Frequency Ref or Setpoint	Enters the S5-05 [HAND Frequency Reference] value or the S5-06 [HAND Setpoint] value. When S5-01 = 0 [HAND Frequency Reference Source = HAND Analog Input] and S5-03 = 0 [HAND Mode PI Selection = Disabled], the drive enters HAND Frequency Reference. When b5-01 ≠ 0, S5-01 = 0, and S5-03 = 1 [Enabled], the drive enters HAND Setpoint. Note: • When PID is enabled, the full-scale of the analog signal goes from b5-71 [Min PID Transducer Scaling] to b5-38 [PID User Unit Display Scaling]. • When PID is disabled, the drive enters this analog signal as the percentage of the E1-04 [Maximum Output Frequency] value.

◆ H4: Analog Outputs

No. (Hex.)	Name	Description	Default (Range)
H4-01 (041D)	Terminal FM Analog Output Select	Sets the monitor number to send from MFAO terminal FM. Set the x-xx part of the Ux-xx [Monitor]. For example, set H4-01 = 102 to monitor U1-02 [Output Frequency].	102 (000 - 999)
H4-02 (041E) RUN	Terminal FM Analog Output Gain	Sets the gain of the monitor signal that is sent from MFAO terminal FM. Sets the analog signal output level from the terminal FM at 10 V or 20 mA as 100% when an output for monitoring items is 100%.	100.0% (-999.9 - +999.9%)
H4-03 (041F) RUN	Terminal FM Analog Output Bias	Sets the bias of the monitor signal that is sent from MFAO terminal FM. Set the level of the analog signal sent from terminal FM at 10 V or 20 mA as 100% when an output for monitoring items is 0%.	0.0% (-999.9 - +999.9%)
H4-04 (0420)	Terminal AM Analog Output Select	Sets the monitoring number to be output from the MFAO terminal AM. Set the x-xx part of the Ux-xx [Monitor]. For example, set H4-04 = 103 to monitor U1-03 [Output Current].	103 (000 - 999)
H4-05 (0421) RUN	Terminal AM Analog Output Gain	Sets the gain of the monitor signal that is sent from MFAO terminal AM. When an output for monitoring items is 0%, this parameter sets the analog signal output level from the AM terminal at 10 V or 20 mA as 100%.	50.0% (-999.9 - +999.9%)
H4-06 (0422) RUN	Terminal AM Analog Output Bias	Sets the bias of the monitor signal that is sent from MFAO terminal AM. When an output for monitoring items is 0%, this parameter sets the analog signal output level from the AM terminal at 10 V or 20 mA as 0%.	0.0% (-999.9 - +999.9%)
H4-07 (0423)	Terminal FM Signal Level Select	Sets the MFAO terminal FM output signal level. Note: Set jumper S5 on the control circuit terminal block accordingly when you change this parameter. 0 : 0 to 10 Vdc 2 : 4 to 20 mA	0 (0, 2)

9.10 H: Terminal Functions

No. (Hex.)	Name	Description	Default (Range)
H4-08 (0424)	Terminal AM Signal Level Select	Sets the MFAO terminal AM output signal level. Note: Set jumper S5 on the control circuit terminal block accordingly when you change this parameter. 0 : 0 to 10 Vdc 2 : 4 to 20 mA	0 (0, 2)
H4-20 (0B53)	Analog Power Monitor 100% Level	Sets the level at 10 V when you set <i>U1-08 [Output Power]</i> for analog output.	0.00 kW (0.00 - 650.00 kW)

◆ H5: Serial Communication

Note:

H5-xx parameters affect the bypass controller RS-485 terminals, TB3 Terminals 1 to 4.

No. (Hex.)	Name	Description	Default (Range)
H5-01 (0425)	Drive Node Address	Sets the communication slave address for drives. Note: • Restart the drive after you change the parameter setting. • Setting 0 will not let the drive respond to serial communications.	1FH (Determined by protocol)
H5-02 (0426)	Communication Speed Selection	Sets the communications speed for serial communications. Note: Re-energize the drive or set <i>H5-20 = 1 [Communication Parameters Reload = Reload Now]</i> after you change the parameter setting. 0 : 1200 bps 1 : 2400 bps 2 : 4800 bps 3 : 9600 bps 4 : 19.2 kbps 5 : 38.4 kbps 6 : 57.6 kbps 7 : 76.8 kbps 8 : 115.2 kbps	3 (Determined by protocol)
H5-03 (0427)	Communication Parity Selection	Sets the communications parity used for serial communications. Note: Re-energize the drive or set <i>H5-20 = 1 [Communication Parameters Reload = Reload Now]</i> after you change the parameter setting. 0 : No parity 1 : Even parity 2 : Odd parity	0 (0 - 2)
H5-04 (0428)	Communication Error Stop Method	Sets the motor Stopping Method when the drive detects a serial communication Error condition. 0 : Ramp to Stop 1 : Coast to Stop 2 : Fast Stop (Use C1-09) 3 : Alarm Only 4 : Run at H5-34 (CE Go-To-Freq)	3 (0 - 4)
H5-05 (0429)	Comm Fault Detection Selection	Sets the function that detects <i>CE [Serial Communication Error]</i> issues during serial communications. 0 : Disabled 1 : Enabled	1 (0, 1)
H5-06 (042A)	Drive Transmit Wait Time	Sets the time to wait to send a response message after the drive receives a command message from the master. Note: Restart the drive after changing the parameter setting.	5 ms (0 - 65 ms)
H5-08 (062D)	Communication Protocol Selection	Selects the communication protocol. 0 : Modbus/MEMOBUS 1 : Metasys/N2 2 : Apogee/P1 3 : BACnet	3 (0 - 3)
H5-09 (0435)	CE Detection Time	Sets the detection time for <i>CE [Serial Communication Error]</i> issues when communication stops.	2.0 s (0.0 - 10.0 s)
H5-10 (0436)	Modbus Register 0025H Unit Sel	Sets the unit of measure used for the serial communications monitor register 0025H (output voltage reference monitor). 0 : 0.1 V units 1 : 1 V units	0 (0, 1)

No. (Hex.)	Name	Description	Default (Range)
H5-11 (043C)	Comm ENTER Command Mode	Sets the function to make the Enter command necessary to change parameters through serial communications. 0 : ENTER Command Required 1 : ENTER Command Not Required	0 (0, 1)
H5-14 (310D)	BACnet Device Obj ID LOW BITS	Sets the lower bits of the BACnet device object ID as a 4-digit hexadecimal number.	0001 (0000 - FFFF)
H5-15 (310E)	BACnet Device Obj ID HIGH BITS	Sets the upper bits of the BACnet device object ID as a 4-digit hexadecimal number.	0000 (0000 - 003F)
H5-18 (11A2)	Motor Speed Filter over Comms	Sets the filter time constant used when monitoring motor speed during serial communications or with a communication option.	0 ms (0 - 100 ms)
H5-20 (0B57)	Communication Parameters Reload	Sets the function to immediately enable updated serial communications parameters. 0 : Reload at Next Power Cycle 1 : Reload Now	0 (0, 1)
H5-22 (11CF)	Speed Search from MODBUS	Enables the serial communication register Speed Search function (bit 0 of 15DFH). 0 : Disabled 1 : Enabled	0 (0, 1)
H5-23 (158D)	BACnet Max Master	Sets the maximum number of master MAC ID to scan to when the drive polls for the next node (Poll for Master).	7F (1 - 7F)
H5-24 (3DA0)	BACnet Max Info Frames	Sets the maximum number of information frames that the bypass will send per token cycle in BACnet.	3 (1 - 255)
H5-25 (1589) RUN	Function 5A Register 1 Selection	Returns the contents of the specified serial communications register when responding to the master device.	0044H (U1-05) (0000H - FFFFH)
H5-26 (158A) RUN	Function 5A Register 2 Selection	Returns the contents of the specified serial communications register when responding to the master device.	0045H (U1-06) (0000H - FFFFH)
H5-27 (158B) RUN	Function 5A Register 3 Selection	Returns the contents of the specified serial communications register when responding to the master device.	0042H (U1-03) (0000H - FFFFH)
H5-28 (158C) RUN	Function 5A Register 4 Selection	Returns the contents of the specified serial communications register when responding to the master device.	0049H (U1-10) (0000H - FFFFH)
H5-33 (3FB3)	Power-up CALL Alarm	Enables and disables <i>CALL [Serial Comm Transmission Error]</i> alarm detection. 0 : Disabled 1 : Enabled	1 (0, 1)
H5-34 (3FB4) RUN	Comm Error (CE) Go-To-Frequency	Sets the speed at which the drive will run when <i>H5-04 = 4 [Communication Error Stop Method = Run at H5-34]</i> and there is a <i>CE</i> .	0.0 Hz (0.0 - 400.0 Hz)
H5-35 (3FB5) RUN	Comm Error (CE) Go-To-Timeout	When <i>H5-04 = 4 [Communication Error Stop Method = Run at H5-34]</i> and a <i>CE</i> is present, the drive will run at the <i>H5-34 [Comm Error (CE) Go-To-Frequency]</i> speed for this length of time before it triggers a <i>CE</i> fault. Note: Set this parameter to 0 s to disable the time-out.	0 s (0 - 6000 s)
H5-36 (3FB6)	CE Fault Restart Select	Sets the drive to restart (<i>L5-01 [Number of Auto-Restart Attempts]</i>) after a <i>CE</i> fault. 0 : No Retry 1 : Retry	0 (0, 1)

◆ H7: Virtual MFIO selection

No. (Hex.)	Name	Description	Default (Range)
H7-00 (116F) Expert	Virtual MFIO selection	Sets the function to enable and disable the virtual I/O function. Set this parameter to 1 to operate the virtual I/O function. 0 : Disabled 1 : Enabled	0 (0, 1)
H7-01 (1185) Expert	Virtual Multi-Function Input 1	Sets the function that enters the virtual input set in <i>H7-10 [Virtual Multi-Function Output 1]</i> .	F (3 - 1A8)

9.10 H: Terminal Functions

No. (Hex.)	Name	Description	Default (Range)
H7-02 (1186) Expert	Virtual Multi-Function Input 2	Sets the function that enters the virtual input set in H7-12 [Virtual Multi-Function Output 2].	F (3 - 1A8)
H7-03 (1187) Expert	Virtual Multi-Function Input 3	Sets the function that enters the virtual input set in H7-14 [Virtual Multi-Function Output 3].	F (3 - 1A8)
H7-04 (1188) Expert	Virtual Multi-Function Input 4	Sets the function that enters the virtual input set in H7-16 [Virtual Multi-Function Output 4].	F (3 - 1A8)
H7-10 (11A4) Expert	Virtual Multi-Function Output 1	Sets the function for virtual digital output 1.	F (0 - 1C4)
H7-11 (11A5) Expert	Virtual Output 1 Delay Time	Sets the minimum ON time for virtual digital output 1.	0.1 s (0.0 - 25.0 s)
H7-12 (11A6) Expert	Virtual Multi-Function Output 2	Sets the function for virtual digital output 2.	F (0 - 1C4)
H7-13 (11A7) Expert	Virtual Output 2 Delay Time	Sets the minimum ON time for virtual digital output 2.	0.1 s (0.0 - 25.0 s)
H7-14 (11A8) Expert	Virtual Multi-Function Output 3	Sets the function for virtual digital output 3.	F (0 - 1C4)
H7-15 (11A9) Expert	Virtual Output 3 Delay Time	Sets the minimum ON time for virtual digital output 3.	0.1 s (0.0 - 25.0 s)
H7-16 (11AA) Expert	Virtual Multi-Function Output 4	Sets the function for virtual digital output 4.	F (0 - 1C4)
H7-17 (11AB) Expert	Virtual Output 4 Delay Time	Sets the minimum ON time for virtual digital output 4.	0.1 s (0.0 - 25.0 s)
H7-30 (1177) Expert	Virtual Analog Input Selection	Sets the virtual analog input function.	F (0 - 2E)
H7-31 (1178) RUN Expert	Virtual Analog Input Gain	Sets the virtual analog input gain.	100.0% (-999.9 - 999.9%)
H7-32 (1179) RUN Expert	Virtual Analog Input Bias	Sets the virtual analog input bias.	0.0% (-999.9 - 999.9%)
H7-40 (1163)	Virtual Analog Out Signal Select	Sets the signal level of the virtual analog output. 0 : 0 to 100% (Absolute Value) 1 : -100 to 100% 2 : 0 to 100% (Lower Limit at 0)	0 (0 - 2)
H7-41 (1164)	Virtual Analog Output Function	Sets the monitor to be output from the virtual analog output. Set the x-xx part of the Ux-xx [Monitor]. For example, set H7-41 = 102 to monitor U1-02 [Output Frequency].	102 (0 - 631)
H7-42 (1165)	Virtual Analog Output FilterTime	Sets the time constant for a primary filter of the virtual analog output.	0.00 s (0.00 - 2.00 s)

9.11 L: Protection Functions

◆ L1: Motor Protection

No. (Hex.)	Name	Description	Default (Range)
L1-01 (0480)	Motor Overload (oL1) Protection	Sets the motor overload protection with electronic thermal protectors. 0 : Disabled 1 : Variable Torque Note: When you connect only one motor to a drive, set <i>L1-01 = 1 [Variable Torque]</i> . External thermal relays are not necessary in these conditions.	1 (0, 1)
L1-02 (0481)	Motor Overload Protection Time	Sets the operation time for the electronic thermal protector of the drive to prevent damage to the motor. Usually it is not necessary to change this setting.	1.0 min (0.1 - 5.0 min)
L1-03 (0482)	Motor Thermistor oH Alarm Select	Sets drive operation when the PTC input signal entered into the drive is at the <i>oH3 [Motor Overheat Alarm]</i> detection level. 0 : Ramp to Stop 1 : Coast to Stop 2 : Fast Stop (Use C1-09) 3 : Alarm Only	3 (0 - 3)
L1-04 (0483)	Motor Thermistor oH Fault Select	Sets the drive operation when the PTC input signal to the drive is at the <i>oH4 [Motor Overheat Fault (PTC Input)]</i> detection level. 0 : Ramp to Stop 1 : Coast to Stop 2 : Fast Stop (Use C1-09)	1 (0 - 2)
L1-05 (0484)	Motor Thermistor Filter Time	Sets the primary delay time constant for the PTC input signal entered to the drive. This parameter prevents accidental motor overheat faults.	0.20 s (0.00 - 10.00 s)
L1-08 (1103)	oL1 Current Level	Sets the reference current for the motor 1 thermal overload detection. When the current level > 0.0 A, you cannot set this value < 10% of drive rated current.	0.0 A (0.0 A or 10% to 150% of the drive rated current)
L1-13 (046D)	Motor Overload Memory Selection	Sets the function that keeps the current electronic thermal protector value after power loss. 0 : Disabled 1 : Enabled 2 : Enabled, using RTC	2 (0 - 2)

◆ L2: Power Loss Ride Through

No. (Hex.)	Name	Description	Default (Range)
L2-01 (0485)	Power Loss Ride Through Select	Sets the drive operation after a momentary power loss. 0 : Disabled 1 : Enabled for L2-02 Time 2 : Enabled while CPU Power Active	2 (0 - 2)
L2-02 (0486)	Power Loss Ride Through Time	Sets the maximum time that the drive will wait until it tries to restart after power loss.	Determined by o2-04 (0.0 - 25.5 s)
L2-03 (0487)	Minimum Baseblock Time	Sets the minimum time to continue the drive output block (baseblock) after a baseblock.	Determined by o2-04 (0.1 - 5.0 s)
L2-04 (0488)	Powerloss V/f Recovery Ramp Time	Sets the time for the drive output voltage to go back to the correct voltage after it completes speed searches.	Determined by o2-04 (0.0 - 5.0 s)
L2-05 (0489)	Undervoltage Detection Lvl (Uv1)	Sets the voltage at which the drive triggers a <i>Uv1 [DC Bus Undervoltage]</i> fault. Usually it is not necessary to change this setting.	Determined by o2-04 and E1-01 (208/240 V: 150 - 220 V, 480 V: 300 - 440 V)

◆ L3: Stall Prevention

No. (Hex.)	Name	Description	Default (Range)
L3-01 (048F)	Stall Prevention during Accel	Sets the method of Stall Prevention During Acceleration. 0 : Disabled 1 : Enabled 2 : Intelligent (Ignore Decel Ramp)	1 (0 - 2)
L3-02 (0490)	Stall Prevent Level during Accel	Sets the output current level to activate the Stall Prevention function during acceleration as a percentage of the drive rated output current.	Determined by L8-38 (0 - 120%)
L3-03 (0491)	Stall Prevent Limit during Accel	Sets the lower limit for the stall prevention level used in the constant output range as a percentage of the drive rated output current.	50% (0 - 100%)
L3-04 (0492)	Stall Prevention during Decel	Sets the method that the drive will use to prevent overvoltage faults when decelerating. 0 : Disabled 1 : General Purpose 2 : Intelligent (Ignore Decel Ramp) 4 : Overexcitation/High Flux	1 (0 - 4)
L3-05 (0493)	Stall Prevention during RUN	Sets the function to enable and disable Stall Prevention During Run. Note: An output frequency lower than 6 Hz will disable Stall Prevention during Run. The L3-05 and L3-06 [Stall Prevent Level during Run] settings do not have an effect. 0 : Disabled 1 : Deceleration Time 1 (C1-02) 2 : Deceleration Time 2 (C1-04)	2 (0 - 2)
L3-06 (0494)	Stall Prevent Level during Run	Sets the output current level to enable the Stall Prevention function during operation as a percentage of the drive rated output current. Note: This parameter is applicable when L3-05 = 1, 2 [Stall Prevention during RUN = Deceleration Time 1 (C1-02), Deceleration Time 2 (C1-04)].	Determined by L8-38 (5 - 120%)
L3-11 (04C7)	Overvoltage Suppression Select	Sets the overvoltage suppression function. 0 : Disabled 1 : Enabled	0 (0, 1)
L3-17 (0462)	DC Bus Regulation Level	Sets the target value for the DC bus voltage when the overvoltage suppression function and the Decel Stall Prevention function (Intelligent Stall Prevention) are active.	208/240 V: 375 V, 480 V: 750 V (208/240 V: 150 - 400 V, 480 V: 300 - 800 V)
L3-20 (0465) Expert	DC Bus Voltage Adjustment Gain	Sets the proportional gain used to control the DC bus voltage.	1.00 (0.00 - 5.00)
L3-21 (0466) Expert	OVSuppression Accel/Decel P Gain	Sets the proportional gain to calculate acceleration and deceleration rates.	1.00 (0.10 - 10.00)
L3-23 (04FD)	Stall P Reduction at Constant HP	Sets the function to automatically decrease the Stall Prevention Level during Run for constant output ranges. 0 : Use L3-06 for Entire Speed Range 1 : Automatic Reduction @ CHP Region	0 (0, 1)
L3-24 (046E) Expert	Motor Accel Time @ Rated Torque	Sets the motor acceleration time to reach the maximum frequency at the motor rated torque for stopped single-drive motors.	Determined by o2-04, E2-11 (0.001 - 10.000 s)
L3-25 (046F) Expert	Load Inertia Ratio	Sets the ratio between motor inertia and machine inertia.	1.0 (0.1 - 1000.0)
L3-26 (0455) Expert	Additional DC Bus Capacitors	Sets the capacity for external main circuit capacitors. Usually it is not necessary to change this setting.	0 μF (0 to 65000 μF)
L3-27 (0456)	Stall Prevention Detection Time	Sets a delay time between reaching the Stall Prevention level and starting the Stall Prevention function.	50 ms (0 - 5000 ms)
L3-35 (0747) Expert	Speed Agree Width for Auto Decel	Sets the width for speed agreement when L3-04 = 2 [Decel Stall Prevention Selection = Automatic Decel Reduction]. Usually it is not necessary to change this setting.	0.00 Hz (0.00 - 1.00 Hz)

9.11 L: Protection Functions

No. (Hex.)	Name	Description	Default (Range)
L5-08 (0B2B)	Fault Reset Enable Select Grp2	Use these 4 digits to set the Auto Restart function for <i>UvI</i> , <i>ov</i> , <i>oHI</i> , and <i>GF</i> . From left to right, the digits set <i>UvI</i> , <i>ov</i> , <i>oHI</i> , and <i>GF</i> , in order. 0000 : Disabled 0001 : Enabled (—/—/—/GF) 0010 : Enabled (—/—/oHI/—) 0011 : Enabled (—/—/oHI/GF) 0100 : Enabled (—/ov/—/—) 0101 : Enabled (—/ov/—/GF) 0110 : Enabled (—/ov/oHI/—) 0111 : Enabled (—/ov/oHI/GF) 1000 : Enabled (UvI/—/—/—) 1001 : Enabled (UvI/—/—/GF) 1010 : Enabled (UvI/—/oHI/—) 1011 : Enabled (UvI/—/oHI/GF) 1100 : Enabled (UvI/ov/—/—) 1101 : Enabled (UvI/ov/—/GF) 1110 : Enabled (UvI/ov/oHI/—) 1111 : Enabled (UvI/ov/oHI/GF)	1111 (0000 - 1111)
L5-40 (3670)	Low Feedback Flt Retry Selection	Sets the drive to do an Auto Restart when the drive detects an <i>LFB [Low Feedback Sensed]</i> fault. 0 : No Retry 1 : Retry	0 (0, 1)
L5-41 (3671)	Hi Feedback Flt Retry Selection	Sets the drive to do an Auto Restart when the drive detects an <i>HFB [High Feedback Sensed]</i> fault. 0 : No Retry 1 : Retry	0 (0, 1)
L5-42 (3672)	Feedback Loss Fault Retry Select	Sets the drive to try an Auto Restart when it drive detects an <i>FDBKL [WIRE Break]</i> fault. 0 : No Retry 1 : Retry	0 (0, 1)
L5-49 (3679)	Fault Retry Speed Search Select	Sets the drive to do a speed search at the start of a Fault Retry. 0 : Disabled 1 : Enabled	1 (0, 1)
L5-50 (367A)	Setpoint Not Met Fault Retry Sel	Sets the drive to try an Auto Restart when it detects an <i>NMS [SetPoint Not Met]</i> fault. 0 : No Retry 1 : Retry	0 (0, 1)
L5-51 (367B)	Loss of Prime Fault Retry Select	Sets the drive to try an Auto Restart if it detects an <i>LOP [Loss Of Prime]</i> fault. 0 : No Retry 1 : Retry	0 (0, 1)
L5-53 (3251)	Thermostat Fault Retry Selection	Sets the drive to try an Auto Restart if it detects a <i>VLTS [Thermostat Fault]</i> fault. Note: • To use this function, set <i>S5-01</i> ≠ 0 [<i>HAND Frequency Reference Source</i> ≠ <i>HAND Analog Input</i>] • The drive will only restart after the Thermostat digital input de-activates and the <i>L5-04 [Interval Method Restart Time]</i> timer is expired. 0 : No Retry 1 : Retry	1 (0, 1)

◆ L6: Torque Detection

No. (Hex.)	Name	Description	Default (Range)
L6-01 (04A1)	Torque Detection Selection 1	Sets the speed range that detects overtorque and undertorque and the operation of drives (operation status) after detection. 0 : Disabled 1 : oL @ Speed Agree - Alarm only 2 : oL @ RUN - Alarm only 3 : oL @ Speed Agree - Fault 4 : oL @ RUN - Fault 5 : UL @ Speed Agree - Alarm only 6 : UL @ RUN - Alarm only 7 : UL @ Speed Agree - Fault 8 : UL @ RUN - Fault 9 : UL6 @ Speed Agree - Alarm only 10 : UL6 @ RUN - Alarm only 11 : UL6 @ Speed Agree - Fault 12 : UL6 @ RUN - Fault	0 (0 - 12)
L6-02 (04A2)	Torque Detection Level 1	Sets the detection level for Overtorque/Undertorque Detection 1. In V/f control, drive rated output current = 100% value.	15% (0 - 300%)
L6-03 (04A3)	Torque Detection Time 1	Sets the detection time for Overtorque/Undertorque Detection 1.	10.0 s (0.0 - 10.0 s)
L6-04 (04A4)	Torque Detection Selection 2	Sets the speed range that detects overtorque and undertorque and the operation of drives (operation status) after detection. 0 : Disabled 1 : oL @ Speed Agree - Alarm only 2 : oL @ RUN - Alarm only 3 : oL @ Speed Agree - Fault 4 : oL @ RUN - Fault 5 : UL @ Speed Agree - Alarm only 6 : UL @ RUN - Alarm only 7 : UL @ Speed Agree - Fault 8 : UL @ RUN - Fault	0 (0 - 8)
L6-05 (04A5)	Torque Detection Level 2	Sets the detection level for Overtorque/Undertorque Detection 2. In V/f control, drive rated output current = 100% value.	150% (0 - 300%)
L6-06 (04A6)	Torque Detection Time 2	Sets the detection time for Overtorque/Undertorque Detection 2.	0.1 s (0.0 - 10.0 s)
L6-13 (062E)	Motor Underload Curve Select	Sets the motor underload protection (UL6 [Undertorque Detection 6]) based on motor load and sets the level of L6-02 [Torque Detection Level 1] to refer to Fbase or Fmax. 0 : Base Frequency Enable 1 : Max Frequency Enable	0 (0, 1)
L6-14 (062F)	Motor Underload Level @ Min Freq	Sets the UL6 [Undertorque Detection 6] detection level at minimum frequency by percentage of drive rated current.	15% (0 - 300%)

◆ L8: Drive Protection

No. (Hex.)	Name	Description	Default (Range)
L8-02 (04AE)	Overheat Alarm Level	Sets the oH detection level temperature.	Determined by o2-04 (50 - 150 °C)
L8-03 (04AF)	Overheat Pre-Alarm Selection	Sets drive operation if it detects an oH alarm. 0 : Ramp to Stop 1 : Coast to Stop 2 : Fast Stop (Use C1-09) 3 : Alarm Only 4 : Operate at Reduced Speed (L8-19)	4 (0 - 4)
L8-05 (04B1)	Input Phase Loss Protection Sel	Sets the function to enable and disable input phase loss detection. 0 : Disable 1 : Enabled Note: This parameter only affects operation in Drive Mode. Use Z1-50 and Z1-52 [Bypass Input Phase Loss Level and Bypass Input Phase Loss Delay] for Bypass Mode operation.	1 (0, 1)

9.11 L: Protection Functions

No. (Hex.)	Name	Description	Default (Range)
L8-07 (04B3)	Output Phase Loss Protection Sel	Sets the function to enable and disable output phase loss detection. The drive starts output phase loss detection when the output current decreases to less than 5% of the drive rated current. Note: • The drive can incorrectly start output phase loss detection when the motor rated current is very small compared to the drive rating. • This parameter only affects operation in Drive Mode. 0 : Disabled 1 : Fault when one phase is lost 2 : Fault when two phases are lost	1
L8-09 (04B5)	Output Ground Fault Detection	Sets the function to enable and disable ground fault protection. 0 : Disabled 1 : Enabled Note: This parameter only affects operation in Drive Mode.	Determined by o2-04 (0, 1)
L8-10 (04B6)	Heatsink Fan Operation Selection	Sets operation of the heatsink cooling fan. 0 : During Run, w/ L8-11 Off-Delay 1 : Always On 2 : On when Drive Temp Reaches L8-64	0 (0 - 2)
L8-11 (04B7)	Heatsink Fan Off-Delay Time	Sets the length of time that the drive will wait before it stops the cooling fan after it cancels the Run command when L8-10 = 0 [Heatsink Fan Operation Selection = During Run, w/ L8-11 Off-Delay].	300 s (0 - 300 s)
L8-12 (04B8)	Ambient Temperature Setting	Sets the ambient temperature of the drive installation area. Note: The setting range changes when the L8-35 [Installation Method Selection] setting changes. • When L8-35 = 0 or 2 [IP20/UL Open Type or IP20/UL Type 1]: -10 °C ~ +60 °C • When L8-35 = 1 or 3 [Side-by-Side Mounting or IP55/UL Type 12]: -10 °C ~ +50 °C	40 °C (Determined by L8-35)
L8-15 (04BB)	Drive oL2 @ Low Speed Protection	Sets the function to decrease drive overload at low speeds to prevent damage to the main circuit transistor during low speed operation (at 6 Hz or slower) to prevent oL2 [Drive Overloaded]. Note: Contact Yaskawa or your nearest sales representative before disabling this function at low speeds. If you frequently operate drives with high output current in low speed ranges, it can cause heat stress and decrease the life span of drive IGBTs. 0 : Disabled (No Additional Derate) 1 : Enabled (Reduced oL2 Level)	1 (0, 1)
L8-18 (04BE)	Software Current Limit Selection	Set the software current limit selection function to prevent damage to the main circuit transistor caused by too much current. 0 : Disabled 1 : Enabled	0 (0, 1)
L8-19 (04BF)	Freq Reduction @ oH Pre-Alarm	Sets the ratio at which the drive derates the frequency reference during an oH alarm.	20.0% (10.0 - 100.0%)
L8-35 (04EC)	Installation Method Selection	Sets the type of drive installation. 0 : IP20/UL Open Type 1 : Side-by-Side Mounting 2 : IP20/UL Type 1 3 : IP55/UL Type 12	2 (0 - 3)
L8-38 (04EF)	Carrier Frequency Reduction	Sets the carrier frequency reduction function. The drive decreases the carrier frequency when the output current is more than a specified level. 1 : Enabled below 6 Hz 2 : Enabled for All Speeds 3 : Enable at Overload	Determined by o2-04 (1 - 3)
L8-41 (04F2)	High Current Alarm Selection	Sets the function to cause an HCA [High Current Alarm] when the output current is more than 150% of the drive rated current. 0 : Disabled 1 : Enabled	0 (0, 1)
L8-97 (3104)	Carrier Freq Reduce during OH	Sets the function to decrease carrier frequency during oH pre-alarm. 0 : Disabled 1 : Enabled	0 (0, 1)

◆ L9: Drive Protection 2

No. (Hex.)	Name	Description	Default (Range)
L9-16 (11DC) Expert	FAn1 Detect Time	Sets the detection time for <i>FAn1 [Drive Cooling Fan Fault]</i> . Yaskawa recommends that you do not change this parameter value.	4.0 s (0.0 - 30.0 s)

9.12 n: Special Adjustment

◆ n1: Hunting Prevention

No. (Hex.)	Name	Description	Default (Range)
n1-01 (0580)	Hunting Prevention Selection	Sets the function to prevent hunting. 0 : Disabled 1 : Enabled (Normal)	1 (0, 1)
n1-02 (0581) Expert	Hunting Prevention Gain Setting	Sets the performance of the hunting prevention function. Usually it is not necessary to change this parameter.	1.00 (0.00 - 2.50)
n1-03 (0582) Expert	Hunting Prevention Time Constant	Sets the primary delay time constant of the hunting prevention function. Usually it is not necessary to change this parameter.	Determined by o2-04 (0 - 500 ms)
n1-05 (0530) Expert	Hunting Prevent Gain in Reverse	Sets the performance of the hunting prevention function. This parameter adjusts Reverse run. Usually it is not necessary to change this parameter.	0.00 (0.00 - 2.50)
n1-13 (1B59) Expert	DC Bus Stabilization Control	Sets the oscillation suppression function for the DC bus voltage. 0 : Disabled 1 : Enabled	0 (0, 1)
n1-14 (1B5A) Expert	DC Bus Stabilization Time	Adjusts the responsiveness of the oscillation suppression function for the DC bus voltage. Set <i>n1-13</i> = 1 [<i>DC Bus Stabilization Control</i> = Enabled] to enable this parameter.	100.0 ms (0.0 - 500.0 ms)

◆ n3: High Slip/Overexcite Braking

No. (Hex.)	Name	Description	Default (Range)
n3-01 (0588) Expert	HSB Deceleration Frequency Width	Sets the amount by which the output frequency is to be lowered during high-slip braking, as a percentage of <i>E1-04</i> [Maximum Output Frequency], which represents the 100% value.	5% (1 - 20%)
n3-02 (0589) Expert	HSB Current Limit Level	Sets the maximum current output during high-slip braking as a percentage, where <i>E2-01</i> [Motor Rated Current (FLA)] is 100%. Also sets the current suppression to prevent exceeding drive overload tolerance.	Determined by L8-38 (0 - 200%)
n3-03 (058A) Expert	HSB Dwell Time at Stop	Sets the dwell time, a length of time when high-slip braking is ending and during which the motor speed decreases and runs at a stable speed. For a set length of time, the drive will hold the actual output frequency at the minimum output frequency set in <i>E1-09</i> .	1.0 s (0.0 - 10.0 s)
n3-04 (058B) Expert	HSB Overload Time	Sets the time used to detect <i>oL7</i> [High Slip Braking Overload], which occurs when the output frequency does not change during high-slip braking. Usually it is not necessary to change this parameter.	40 s (30 - 1200 s)
n3-13 (0531)	OverexcitationBraking (OEB) Gain	Sets the gain value that the drive multiplies by the V/f pattern output value during overexcitation deceleration to calculate the overexcitation level.	1.10 (1.00 - 1.40)
n3-21 (0579)	HSB Current Suppression Level	Sets the upper limit of the current that is suppressed at the time of overexcitation deceleration as a percentage of the drive rated current.	100% (0 - 150%)
n3-23 (057B)	Overexcitation Braking Operation	Sets the direction of motor rotation where the drive will enable overexcitation. 0 : Disabled 1 : Enabled Only when Rotating FWD 2 : Enabled Only when Rotating REV	0 (0 - 2)

9.13 o: Keypad-Related Settings

◆ o1: Keypad Display



No. (Hex.)	Name	Description	Default (Range)
o1-03 (0502)	Frequency Display Unit Selection	Sets the display units for the frequency reference and output frequency. 0 : 0.01Hz units 1 : 0.01% units 2 : min ⁻¹ (r/min) unit 3 : User Units (o1-09 ~o1-11)	0 (0 - 3)
o1-05 (0504) RUN	LCD Contrast Adjustment	Sets the contrast of the LCD display on the keypad.	5 (0 - 10)
o1-09 (051C)	Freq. Reference Display Units	Sets the unit of display for the frequency reference parameters and frequency-related monitors when <i>o1-03 = 3 [Frequency Display Unit Selection = User Units (o1-09 ~ o1-11)]</i> . 0 : "WC: inches of water column 1 : PSI: pounds per square inch 2 : GPM: gallons/min 3 : °F: Fahrenheit 4 : ft ³ /min: cubic feet/min 5 : m ³ /h: cubic meters/hour 6 : L/h: liters/hour 7 : L/s: liters/sec 8 : bar: bar 9 : Pa: Pascal 10 : °C: Celsius 11 : m: meters 12 : ft: feet 13 : L/min: liters/min 14 : m ³ /min: cubic meters/min 15 : "Hg: Inch Mercury 16 : kPa: kilopascal 48 : %: Percent 49 : Custom(o1-13~15) 50 : None	50 (0 - 50)
o1-10 (0520)	User Units Maximum Value	Sets the value that the drive shows as the maximum output frequency.	Determined by o1-03 (1 - 60000)
o1-11 (0521)	User Units Decimal Position	Sets the number of decimal places for frequency reference and monitor values. 0 : No Decimal Places (XXXXX) 1 : One Decimal Places (XXXX.X) 2 : Two Decimal Places (XXX.XX) 3 : Three Decimal Places (XX.XXX)	Determined by o1-03 (0 - 3)
o1-13 (3105)	Freq. Reference Custom Unit 1	Sets the first character of the custom unit display when <i>o1-03 = 3 [Frequency Display Unit Selection = User Units]</i> and <i>o1-09 = 49 [Freq. Reference Display Units = Custom (o1-13~15)]</i> .	41 (20 - 7A)
o1-14 (3106)	Freq. Reference Custom Unit 2	Sets the second character of the custom unit display when <i>o1-03 = 3 [Frequency Display Unit Selection = User Units]</i> and <i>o1-09 = 49 [Freq. Reference Display Units = Custom (o1-13~15)]</i> .	41 (20 - 7A)
o1-15 (3107)	Freq. Reference Custom Unit 3	Sets the third character of the custom unit display when <i>o1-03 = 3 [Frequency Display Unit Selection = User Units]</i> and <i>o1-09 = 49 [Freq. Reference Display Units = Custom (o1-13~15)]</i> .	41 (20 - 7A)
o1-18 (310A)	User Defined Parameter 1	Lets you set values to use as reference information.	0 (0 - 999)
o1-19 (310B)	User Defined Parameter 2	Lets you set values to use as reference information.	0 (0 - 999)
o1-24 (11AD) RUN	Custom Monitor 1	Sets Custom Monitor 1. You can set a maximum of 12 monitors as user monitors. This parameter is only available on an HOA keypad.	101 (0, 31, 101 - 1201)
o1-25 (11AE) RUN	Custom Monitor 2	Sets Custom Monitor 2. You can set a maximum of 12 monitors as user monitors. This parameter is only available on an HOA keypad.	102 (0, 31, 101 - 1201)

9.13 o: Keypad-Related Settings

No. (Hex.)	Name	Description	Default (Range)
o1-26 (11AF) RUN	Custom Monitor 3	Sets Custom Monitor 3. You can set a maximum of 12 monitors as user monitors. This parameter is only available on an HOA keypad. Note: The default setting changes when <i>b5-01 [PID Mode Setting]</i> changes: • <i>b5-01 = 0 [Disabled]</i> : 103 • <i>b5-01 ≠ 0</i> : 501	Determined by <i>b5-01</i> (0, 31, 101 - 1201)
o1-27 (11B0) RUN	Custom Monitor 4	Sets Custom Monitor 4. You can set a maximum of 12 monitors as user monitors. This parameter is only available on an HOA keypad.	0 (0, 101 - 1212)
o1-28 (11B1) RUN	Custom Monitor 5	Sets Custom Monitor 5. You can set a maximum of 12 monitors as user monitors. This parameter is only available on an HOA keypad.	0 (0, 101 - 1212)
o1-29 (11B2) RUN	Custom Monitor 6	Sets Custom Monitor 6. You can set a maximum of 12 monitors as user monitors. This parameter is only available on an HOA keypad.	0 (0, 101 - 1212)
o1-30 (11B3) RUN	Custom Monitor 7	Sets Custom Monitor 7. You can set a maximum of 12 monitors as user monitors. This parameter is only available on an HOA keypad.	0 (0, 101 - 1212)
o1-31 (11B4) RUN	Custom Monitor 8	Sets Custom Monitor 8. You can set a maximum of 12 monitors as user monitors. This parameter is only available on an HOA keypad.	0 (0, 101 - 1212)
o1-32 (11B5) RUN	Custom Monitor 9	Sets Custom Monitor 9. You can set a maximum of 12 monitors as user monitors. This parameter is only available on an HOA keypad.	0 (0, 101 - 1212)
o1-33 (11B6) RUN	Custom Monitor 10	Sets Custom Monitor 10. You can set a maximum of 12 monitors as user monitors. This parameter is only available on an HOA keypad.	0 (0, 101 - 1212)
o1-34 (11B7) RUN	Custom Monitor 11	Sets Custom Monitor 11. You can set a maximum of 12 monitors as user monitors. This parameter is only available on an HOA keypad.	0 (0, 101 - 1212)
o1-35 (11B8) RUN	Custom Monitor 12	Sets Custom Monitor 12. You can set a maximum of 12 monitors as user monitors. This parameter is only available on an HOA keypad.	0 (0, 101 - 1212)
o1-36 (11B9) RUN	LCD Backlight Brightness	Sets the intensity of the HOA keypad backlight.	5 (1 - 5)
o1-37 (11BA) RUN	LCD Backlight ON/OFF Selection	Sets the automatic shut off function for the LCD backlight. 0 : OFF 1 : ON	1 (0, 1)
o1-38 (11BB) RUN	LCD Backlight Off-Delay	Sets the time until the LCD backlight automatically turns off.	60 s (10 - 300 s)
o1-39 (11BC) RUN	Show Initial Setup Screen	Sets the function to show the HOA keypad initial setup screen each time you energize the drive. This parameter is only available on an HOA keypad. 0 : No 1 : Yes	1 (0, 1)
o1-40 (11BD) RUN	Home Screen Display Selection	Sets the monitor display mode for the Home screen. This parameter is only available on an HOA keypad. 0 : Custom Monitor 1 : Bar Graph 2 : Analog Gauge 3 : Trend Plot	0 (0 - 3)
o1-41 (11C1) RUN	1st Monitor Area Selection	Sets the horizontal range used to display the monitor set in <i>o1-24 [Custom Monitor 1]</i> as a bar graph. This parameter is only available on an HOA keypad. 0 : +/- Area (- o1-42 ~ o1-42) 1 : + Area (0 ~ o1-42)	0 (0 - 1)
o1-42 (11C2) RUN	1st Monitor Area Setting	Sets the horizontal axis value used to display the monitor set in <i>o1-24 [Custom Monitor 1]</i> as a bar graph. This parameter is only available on an HOA keypad.	100.0% (0.0 - 100.0%)

No. (Hex.)	Name	Description	Default (Range)
o1-43 (11C3) RUN	2nd Monitor Area Selection	Selects the horizontal range used to display the monitor set in o1-25 [Custom Monitor 2] as a bar graph. This parameter is only available on an HOA keypad. 0 : +/- Area (- o1-44 ~ o1-44) 1 : + Area (0 ~ o1-44)	0 (0 - 1)
o1-44 (11C4) RUN	2nd Monitor Area Setting	Sets the horizontal axis value used to display the monitor set in o1-25 [Custom Monitor 2] as a bar graph. This parameter is only available on an HOA keypad.	100.0% (0.0 - 100.0%)
o1-45 (11C5) RUN	3rd Monitor Area Selection	Sets the horizontal range used to display the monitor set in o1-26 [Custom Monitor 3] as a bar graph. This parameter is only available on an HOA keypad. 0 : +/- Area (- o1-46 ~ o1-46) 1 : + Area (0 ~ o1-46)	0 (0 - 1)
o1-46 (11C6) RUN	3rd Monitor Area Setting	Sets the horizontal axis value used to display the monitor set in o1-26 [Custom Monitor 3] as a bar graph. This parameter is only available on an HOA keypad.	100.0% (0.0 - 100.0%)
o1-47 (11C7) RUN	Trend Plot 1 Scale Minimum Value	Sets the horizontal axis minimum value used to display the monitor set in o1-24 [Custom Monitor 1] as a trend plot. This parameter is only available on an HOA keypad.	-100.0% (-300.0 - +300.0%)
o1-48 (11C8) RUN	Trend Plot 1 Scale Maximum Value	Sets the horizontal axis maximum value used to display the monitor set in o1-24 [Custom Monitor 1] as a trend plot. This parameter is only available on an HOA keypad.	100.0% (-300.0 - +300.0%)
o1-49 (11C9) RUN	Trend Plot 2 Scale Minimum Value	Sets the horizontal axis minimum value used to display the monitor set in o1-25 [Custom Monitor 2] as a trend plot. This parameter is only available on an HOA keypad.	-100.0% (-300.0 - +300.0%)
o1-50 (11CA) RUN	Trend Plot 2 Scale Maximum Value	Sets the horizontal axis maximum value used to display the monitor set in o1-25 [Custom Monitor 2] as a trend plot. This parameter is only available on an HOA keypad.	100.0% (-300.0 - +300.0%)
o1-51 (11CB) RUN	Trend Plot Time Scale Setting	Sets the time scale (horizontal axis) to display the trend plot. When you change this setting, the drive automatically adjusts the data sampling time. This parameter is only available on an HOA keypad.	300 s (1 - 3600 s)
o1-55 (11EE) RUN	Analog Gauge Area Selection	Sets the range used to display the monitor set in o1-24 [Custom Monitor 1] as an analog gauge. This parameter is only available on an HOA keypad. 0 : +/- Area (- o1-56 ~ o1-56) 1 : + Area (0 ~ o1-56)	1 (0, 1)
o1-56 (11EF) RUN	Analog Gauge Area Setting	Sets the value used to display the monitor set in o1-24 [Custom Monitor 1] as an analog meter. This parameter is only available on an HOA keypad.	100.0% (0.0 - 100.0%)
o1-58 (3125)	Motor Power Unit Selection	Sets the setting unit for parameters that set the motor rated power. 0 : kW 1 : HP	1 (0, 1)
o1-80 (31BA)	Fault Screen Display	Sets a full-screen display message to show on the keypad when a fault or CPF occurs. 0 : OFF 1 : ON	1 (0, 1)
o1-81 (31BB)	Alarm Screen Display	Sets a full-screen display message to show on the keypad when an alarm occurs. 0 : OFF 1 : ON	0 (0, 1)
o1-82 (31BC)	Message Screen Display	Sets a full-screen display message to show on the keypad when a status message is active. 0 : OFF 1 : ON	0 (0, 1)

◆ o2: Keypad Operation

No. (Hex.)	Name	Description	Default (Range)
o2-02 (0506)	OFF Key Function Selection	Sets the function to use  on the keypad to stop the drive when the Run command source for the drive is REMOTE (external) and not assigned to the keypad. 0 : Disabled 1 : Enabled	1 (0, 1)
o2-03 (0507)	User Parameter Default Value	Sets the function to keep the settings of changed parameters as user parameter defaults to use during initialization. 0 : No change 1 : Set defaults 2 : Clear all	0 (0 - 2)
o2-04 (0508)	Drive Model (KVA) Selection	This parameter is automatically read from the connected drive. Do not change this parameter.	Determined by the drive (-)
o2-05 (0509)	Home Mode Freq Ref Entry Mode	Sets the function that makes it necessary to push  to use the keypad to change the frequency reference value while in Drive Mode. 0 : ENTER Key Required 1 : Immediate / MOP-style	0 (0, 1)
o2-06 (050A)	Keypad Disconnect Detection	Sets the function that stops the drive if you disconnect the keypad connection cable from the drive or if you damage the cable while the keypad is the Run command source. 0 : Disabled 1 : Enabled	1 (0, 1)
o2-09 (050D)	Region Code	This parameter is read-only	1 (1)
o2-19 (061F)	Parameter Write during Uv	Enables and disables the function to change parameter settings during a Uv [DC Bus Undervoltage] condition. 0 : Disabled 1 : Enabled	0 (0, 1)
o2-24 (11FE)	LED Light Function Selection	Sets the function to show the LED status rings and keypad LED lamps. Note: When you use A1-03 [Initialize Parameters] to initialize the drive, the drive will not reset this parameter. 0 : Enable Status Ring & Keypad LED 1 : LED Status Ring Disable 2 : Keypad LED Light Disable	0 (0 - 2)
o2-27 (1565)	bCE Detection Selection	Sets drive operation if the Bluetooth device is disconnected when you operate the drive in Bluetooth Mode. 0 : Ramp to Stop 1 : Coast to Stop 2 : Fast Stop (Use C1-09) 3 : Alarm Only 4 : No Alarm Display	3 (0 - 4)

◆ o3: Copy Keypad Function

No. (Hex.)	Name	Description	Default (Range)
o3-01 (0515)	Copy Keypad Function Selection	Sets the function that saves and copies drive parameters to a different drive with the keypad. 0 : Copy Select 1 : Backup (drive → keypad) 2 : Restore (keypad → drive) 3 : Verify (check for mismatch) 4 : Erase (backup data of keypad)	0 (0 - 4)
o3-02 (0516)	Copy Allowed Selection	Sets the copy function when o3-01 = 1 [Copy Keypad Function Selection = Backup (drive → keypad)]. 0 : Disabled 1 : Enabled	0 (0, 1)

No. (Hex.)	Name	Description	Default (Range)
o3-04 (0B3E)	Select Backup/Restore Location	Sets the storage location for drive parameters when you back up and restore parameters. This parameter is only available on an HOA keypad. 0 : Memory Location 1 1 : Memory Location 2 2 : Memory Location 3 3 : Memory Location 4	0 (0 - 3)
o3-06 (0BDE)	Auto Parameter Backup Selection	Sets the function that automatically backs up parameters. This parameter is only available on an HOA keypad. 0 : Disabled 1 : Enabled	1 (0, 1)
o3-07 (0BDF)	Auto Parameter Backup Interval	Sets the interval at which the automatic parameter backup function saves parameters from the drive to the keypad. Note: This parameter is only available when using an LCD keypad. 0 : Every 10 minutes 1 : Every 30 minutes 2 : Every 60 minutes 3 : Every 12 hours	1 (0 - 3)

◆ o4: Maintenance Monitors

No. (Hex.)	Name	Description	Default (Range)
o4-01 (050B)	Elapsed Operating Time Setting	Sets the initial value of the cumulative drive operation time in 10-hour units.	0 h (0 - 9999 h)
o4-02 (050C)	Elapsed Operating Time Selection	Sets the condition that counts the cumulative operation time. 0 : U4-01 Shows Total Power-up Time 1 : U4-01 Shows Total RUN Time	1 (0, 1)
o4-03 (050E)	Fan Operation Time Setting	Sets the value from which to start the cumulative drive cooling fan operation time in 10-hour units.	0 h (0 - 9999 h)
o4-05 (051D)	Capacitor Maintenance Setting	Sets the U4-05 [<i>CapacitorMaintenance</i>] monitor value.	0% (0 - 150%)
o4-07 (0523)	Softcharge Relay Maintenance Set	Sets the U4-06 [<i>PreChargeRelayMainte</i>] monitor value.	0% (0 - 150%)
o4-09 (0525)	IGBT Maintenance Setting	Sets the U4-07 [<i>IGBT Maintenance</i>] monitor value.	0% (0 - 150%)
o4-11 (0510)	Fault Trace/History Init (U2/U3)	Resets the records of Monitors U2-xx [<i>Fault Trace</i>] and U3-xx [<i>Fault History</i>]. 0 : Disabled 1 : Enabled	0 (0, 1)
o4-12 (0512)	kWh Monitor Initialization	Resets the monitor values for U4-10 [<i>kWh, Lower 4 Digits</i>] and U4-11 [<i>kWh, Upper 5 Digits</i>]. 0 : No Reset 1 : Reset	0 (0, 1)
o4-13 (0528)	RUN Command Counter @ Initialize	Resets the monitor values for U4-02 [<i>Num of Run Commands</i>], U4-24 [<i>Number of Runs (Low)</i>], and U4-25 [<i>Number of Runs (High)</i>]. 0 : No Reset 1 : Reset	0 (0, 1)
o4-22 (154F) RUN	Time Format	Sets the time display format. This parameter is only available on an HOA keypad. 0 : 24 Hour Clock 1 : 12 Hour Clock 2 : 12 Hour JP Clock	1 (0 - 2)
o4-23 (1550) RUN	Date Format	Sets the date display format. This parameter is only available on an HOA keypad. 0 : YYYY/MM/DD 1 : DD/MM/YYYY 2 : MM/DD/YYYY	2 (0 - 2)
o4-24 (310F) RUN	bAT Detection Selection	Sets operation when the drive detects bAT [<i>Keypad Battery Low Voltage</i>] and TiM [<i>Keypad Time Not Set</i>]. 0 : Disable 1 : Enable (Alarm Detected) 2 : Enable (Fault Detected)	0 (0 - 2)

◆ o5: Log Function

No. (Hex.)	Name	Description	Default (Range)
o5-01 (1551) RUN	Log Start/Stop Selection	Sets the data log function. This parameter is only available on an HOA keypad. 0 : OFF 1 : ON Note: You must insert a compatible SD card into the keypad before you enable this parameter.	0 (0 - 1)
o5-02 (1552) RUN	Log Sampling Interval	Sets the data log sampling cycle. This parameter is only available on an HOA keypad.	100 ms (100 - 60000 ms)
o5-03 (1553) RUN	Log Monitor Data 1	Sets the data log monitor. This parameter is only available on an HOA keypad.	101 (000, 101 - 1212)
o5-04 (1554) RUN	Log Monitor Data 2	Sets the data log monitor. This parameter is only available on an HOA keypad.	102 (000, 101 - 1212)
o5-05 (1555) RUN	Log Monitor Data 3	Sets the data log monitor. This parameter is only available on an HOA keypad.	103 (000, 101 - 1212)
o5-06 (1556) RUN	Log Monitor Data 4	Sets the data log monitor. This parameter is only available on an HOA keypad.	107 (000, 101 - 1212)
o5-07 (1557) RUN	Log Monitor Data 5	Sets the data log monitor. This parameter is only available on an HOA keypad.	108 (000, 101 - 1212)
o5-08 (1558) RUN	Log Monitor Data 6	Sets the data log monitor. This parameter is only available on an HOA keypad.	0 (000, 101 - 1212)
o5-09 (1559) RUN	Log Monitor Data 7	Sets the data log monitor. This parameter is only available on an HOA keypad.	000 (000, 101 - 1212)
o5-10 (155A) RUN	Log Monitor Data 8	Sets the data log monitor. This parameter is only available on an HOA keypad.	000 (000, 101 - 1212)
o5-11 (155B) RUN	Log Monitor Data 9	Sets the data log monitor. This parameter is only available on an HOA keypad.	000 (000, 101 - 1212)
o5-12 (155C) RUN	Log Monitor Data 10	Sets the data log monitor. This parameter is only available on an HOA keypad.	000 (000, 101 - 1212)

9.14 S: Special Applications

◆ S1: Dynamic Noise Control

No. (Hex.)	Name	Description	Default (Range)
S1-01 (3200)	Dynamic Noise Control	Sets the function that decreases the output voltage in variable torque applications to decrease audible noise. 0 : Disabled 1 : Enabled	1 (0, 1)
S1-02 (3201)	Voltage Reduction Rate	Sets the rate at which the drive will decrease the output voltage as a percentage of the V/f pattern when operating with no load.	50.0% (50.0 - 100.0%)
S1-03 (3202)	Voltage Restoration Level	Sets the level at which the drive will start to restore the voltage as a percentage of the drive rated torque.	20.0% (0.0 - 90.0%)
S1-04 (3203)	Voltage Restoration Off Level	Sets the level at which voltage restoration for the V/f pattern is complete as a percentage of the drive rated torque. If the output is more than S1-04, the drive will control the voltage as specified by the V/f pattern setting. Note: The lower limit of this parameter is the value of S1-03 [Voltage Restoration Level] + 10.0%.	50.0% (10.0 - 100.0%)
S1-05 (3204)	Volt Restore Sensitivity Time K	Sets the level of sensitivity of the output torque and LPF time constant for the voltage reduction rate. You can adjust the level of sensitivity with the load response.	1.000 s (0.000 - 3.000 s)
S1-06 (3205)	Volt Restore Impact Load Time K	Sets the voltage restoration time constant when you add an impact load.	0.050 s (0.000 - 1.000 s)
S1-07 (324C)	Output Phase Loss Level	Decreases the output phase loss level when Dynamic Noise control is active.	100.0% (10.0 - 100.0%)

◆ S2: Sequence Run Timers

No. (Hex.)	Name	Description	Default (Range)
S2-01 (3206)	Timer 1 Start Time	Sets the start time for timer 1. Note: • Default is when o4-22 = 1 [Time Format = 12 Hour Clock]. When o4-22 = 0 [24 Hour Clock], default is 00:00. When o4-22 = 2 [12 Hour JP Clock], default is 00:00 AM. • Range is when o4-22 = 1. When o4-22 = 0, range is 00:00 to 24:00. When o4-22 = 2, range is 00:00 AM to 11:59 PM.	12:00 (12:00 AM - 11:59 PM)
S2-02 (3207)	Timer 1 Stop Time	Sets the stop time for timer 1. Note: • Default is when o4-22 = 1 [Time Format = 12 Hour Clock]. When o4-22 = 0 [24 Hour Clock], default is 00:00. When o4-22 = 2 [12 Hour JP Clock], default is 00:00 AM. • Range is when o4-22 = 1. When o4-22 = 0, range is 00:00 to 24:00. When o4-22 = 2, range is 00:00 AM to 11:59 PM.	12:00 (12:00 AM - 11:59 PM)
S2-03 (3208)	Timer 1 Day Selection	Sets the days for which sequence timer 1 is active. 0 : Timer Disabled 1 : Daily 2 : Mon - Fri 3 : Sat - Sun 4 : Monday 5 : Tuesday 6 : Wednesday 7 : Thursday 8 : Friday 9 : Saturday 10 : Sunday	0 (0 - 10)
S2-04 (3209)	Timer 1 Sequence Selection	Sets the drive response when sequence timer 1 is active. 0 : Digital Out Only 1 : Run 2 : Run - PID Disable	0 (0 - 2)

9.14 S: Special Applications

No. (Hex.)	Name	Description	Default (Range)
S2-05 (320A)	Timer 1 Reference Source	<p>Selects the frequency reference source to run the drive when sequence timer 1 is active (only applicable when $S2-04 > 0$ [Timer 1 Sequence Selection ≠ Digital Out Only]).</p> <p>0 : Operator (d1-01/YA-01) 1 : Operator (d1-02/YA-02) 2 : Operator (d1-03/YA-03) 3 : Operator (d1-04/YA-04) 4 : Terminals 5 : Serial Com 6 : Option PCB 8 : Set by b1-01</p> <p>Note: For reference source 0 to 3, the drive will use $d1-xx$ frequency reference when PID mode is disabled and $YA-xx$ setpoint when PID is enabled.</p>	0 (0 - 8)
S2-06 (320B)	Timer 2 Start Time	<p>Sets the start time for timer 2.</p> <p>Note: • Default is when $o4-22 = 1$ [Time Format = 12 Hour Clock]. When $o4-22 = 0$ [24 Hour Clock], default is 00:00. When $o4-22 = 2$ [12 Hour JP Clock], default is 00:00 AM. • Range is when $o4-22 = 1$. When $o4-22 = 0$, range is 00:00 to 24:00. When $o4-22 = 2$, range is 00:00 AM to 11:59 PM.</p>	12:00 (12:00 AM - 11:59 PM)
S2-07 (320C)	Timer 2 Stop Time	<p>Sets the stop time for timer 2.</p> <p>Note: • Default is when $o4-22 = 1$ [Time Format = 12 Hour Clock]. When $o4-22 = 0$ [24 Hour Clock], default is 00:00. When $o4-22 = 2$ [12 Hour JP Clock], default is 00:00 AM. • Range is when $o4-22 = 1$. When $o4-22 = 0$, range is 00:00 to 24:00. When $o4-22 = 2$, range is 00:00 AM to 11:59 PM.</p>	12:00 (12:00 AM - 11:59 PM)
S2-08 (320D)	Timer 2 Day Selection	<p>Sets the days for which sequence timer 2 is active.</p> <p>0 : Timer disabled 1 : Daily 2 : Mon - Fri 3 : Sat - Sun 4 : Monday 5 : Tuesday 6 : Wednesday 7 : Thursday 8 : Friday 9 : Saturday 10 : Sunday</p>	0 (0 - 10)
S2-09 (320E)	Timer 2 Sequence Selection	<p>Sets the drive response when sequence timer 2 is active.</p> <p>0 : Digital Out Only 1 : Run 2 : Run - PID Disable</p>	0 (0 - 2)
S2-10 (320F)	Timer 2 Reference Source	<p>Selects the frequency reference source to run the drive when sequence timer 2 is active (only applicable when $S2-09 > 0$ [Timer 2 Sequence Selection ≠ 0]).</p> <p>0 : Operator (d1-01/YA-01) 1 : Operator (d1-02/YA-02) 2 : Operator (d1-03/YA-03) 3 : Operator (d1-04/YA-04) 4 : Terminals 5 : Serial Com 6 : Option PCB 8 : Set by b1-01</p> <p>Note: For reference source 0 to 3, the drive will use $d1-xx$ frequency reference when PID mode is disabled and $YA-xx$ setpoint when PID is enabled.</p>	0 (0 - 8)
S2-11 (3210)	Timer 3 Start Time	<p>Sets the start time for timer 3.</p> <p>Note: • Default is when $o4-22 = 1$ [Time Format = 12 Hour Clock]. When $o4-22 = 0$ [24 Hour Clock], default is 00:00. When $o4-22 = 2$ [12 Hour JP Clock], default is 00:00 AM. • Range is when $o4-22 = 1$. When $o4-22 = 0$, range is 00:00 to 24:00. When $o4-22 = 2$, range is 00:00 AM to 11:59 PM.</p>	12:00 (12:00 AM - 11:59 PM)
S2-12 (3211)	Timer 3 Stop Time	<p>Sets the stop time for timer 3.</p> <p>Note: • Default is when $o4-22 = 1$ [Time Format = 12 Hour Clock]. When $o4-22 = 0$ [24 Hour Clock], default is 00:00. When $o4-22 = 2$ [12 Hour JP Clock], default is 00:00 AM. • Range is when $o4-22 = 1$. When $o4-22 = 0$, range is 00:00 to 24:00. When $o4-22 = 2$, range is 00:00 AM to 11:59 PM.</p>	12:00 (12:00 AM - 11:59 PM)

No. (Hex.)	Name	Description	Default (Range)
S2-13 (3212)	Timer 3 Day Selection	Sets the days for which sequence timer 3 is active. 0 : Timer Disabled 1 : Daily 2 : Mon - Fri 3 : Sat - Sun 4 : Monday 5 : Tuesday 6 : Wednesday 7 : Thursday 8 : Friday 9 : Saturday 10 : Sunday	0 (0 - 10)
S2-14 (3213)	Timer 3 Sequence Selection	Sets the drive response when sequence timer 3 is active. 0 : Digital Out Only 1 : Run 2 : Run - PID Disable	0 (0 - 2)
S2-15 (3214)	Timer 3 Reference Source	Selects the frequency reference source to run the drive when sequence timer 3 is active (only applicable when $S2-14 > 0$ [Timer 3 Sequence Selection \neq Digital Out Only]). 0 : Operator (d1-01/YA-01) 1 : Operator (d1-02/YA-02) 2 : Operator (d1-03/YA-03) 3 : Operator (d1-04/YA-04) 4 : Terminals 5 : Serial Com 6 : Option PCB 8 : Set by b1-01 Note: For reference source 0 to 3, the drive will use $d1-xx$ frequency reference when PID mode is disabled and $YA-xx$ setpoint when PID is enabled.	0 (0 - 8)
S2-16 (3215)	Timer 4 Start Time	Sets the start time for timer 4. Note: • Default is when $o4-22 = 1$ [Time Format = 12 Hour Clock]. When $o4-22 = 0$ [24 Hour Clock], default is 00:00. When $o4-22 = 2$ [12 Hour JP Clock], default is 00:00 AM. • Range is when $o4-22 = 1$. When $o4-22 = 0$, range is 00:00 to 24:00. When $o4-22 = 2$, range is 00:00 AM to 11:59 PM.	12:00 (12:00 AM - 11:59 PM)
S2-17 (3216)	Timer 4 Stop Time	Sets the stop time for timer 4. Note: • Default is when $o4-22 = 1$ [Time Format = 12 Hour Clock]. When $o4-22 = 0$ [24 Hour Clock], default is 00:00. When $o4-22 = 2$ [12 Hour JP Clock], default is 00:00 AM. • Range is when $o4-22 = 1$. When $o4-22 = 0$, range is 00:00 to 24:00. When $o4-22 = 2$, range is 00:00 AM to 11:59 PM.	12:00 (12:00 AM - 11:59 PM)
S2-18 (3217)	Timer 4 Day Selection	Sets the days for which sequence timer 4 is active. 0 : Timer disabled 1 : Daily 2 : Mon - Fri 3 : Sat - Sun 4 : Monday 5 : Tuesday 6 : Wednesday 7 : Thursday 8 : Friday 9 : Saturday 10 : Sunday	0 (0 - 10)

9.14 S: Special Applications

No. (Hex.)	Name	Description	Default (Range)
S2-19 (3218)	Timer 4 Sequence Selection	Sets the drive response when sequence timer 4 is active. 0 : Digital Out Only 1 : Run 2 : Run - PID Disable	0 (0 - 2)
S2-20 (3219)	Timer 4 Reference Source	Selects the frequency reference source to run the drive when sequence timer 4 is active (only applicable when $S2-19 > 0$ [Timer 4 Sequence Selection ≠ Digital Out Only]). 0 : Operator (d1-01/YA-01) 1 : Operator (d1-02/YA-02) 2 : Operator (d1-03/YA-03) 3 : Operator (d1-04/YA-04) 4 : Terminals 5 : Serial Com 6 : Option PCB 8 : Set by b1-01 Note: For reference source 0 to 3, the drive will use $d1-xx$ frequency reference when PID mode is disabled and $YA-xx$ setpoint when PID is enabled.	0 (0 - 8)

◆ S3: PI2 Control

No. (Hex.)	Name	Description	Default (Range)
S3-01 (321A)	PI2 Control Enable Selection	Sets when the PI2 Control function is enabled: 0 : Disabled 1 : Always 2 : Drive Running 3 : Motor Running	0 (0 - 3)
S3-02 (321B) RUN	PI2 Control Transducer Scale	Sets the full scale (10 V or 20 mA) output of the pressure transducer that is connected to the analog input terminals programmed for PI2 (Setpoint or Feedback). Note: Parameters $S3-04$ [PI2 Control Unit Selection], $S3-03$ [PI2 Control Decimal Place Pos], and $S3-02$ [PI2 Control Transducer Scale] set the unit, resolution, and upper limit.	100.00 (1.00 - 600.00)
S3-03 (321C) RUN	PI2 Control Decimal Place Pos	Sets the decimal place display for secondary PI units. 0 : No Decimal Places (XXXXX) 1 : One Decimal Places (XXXX.X) 2 : Two Decimal Places (XXX.XX) 3 : Three Decimal Places (XX.XXX)	2 (0 - 3)
S3-04 (321D) RUN	PI2 Control Unit Selection	Sets the units displayed for the PI2 Control parameters and monitor. 0 : "WC: inches of water column 1 : PSI: pounds per square inch 2 : GPM: gallons/min 3 : °F: Fahrenheit 4 : ft ³ /min: cubic feet/min 5 : m ³ /h: cubic meters/hour 6 : L/h: liters/hour 7 : L/s: liters/sec 8 : bar: bar 9 : Pa: Pascal 10 : °C: Celsius 11 : m: meters 12 : ft: feet 13 : L/min: liters/min 14 : m ³ /min: cubic meters/min 15 : "Hg: Inch Mercury 16 : kPa: kilopascal 48 : %: Percent 49 : Custom($S3-18-20$) 50 : None	48 (0 - 50)
S3-05 (321E) RUN	PI2 Control Setpoint	Sets the PI2 Control target setpoint. Note: Parameters $S3-04$ [PI2 Control Unit Selection], $S3-03$ [PI2 Control Decimal Place Pos], and $S3-02$ [PI2 Control Transducer Scale] set the unit, resolution, and upper limit.	0.00 (0.00 - 600.00)

No. (Hex.)	Name	Description	Default (Range)
S3-06 (321F) RUN	PI2 Control Proportional Gain	Sets the proportional gain of the PI2 Control. Set this parameter to 0.00 to disable proportional control.	1.00 (0.00 - 25.00)
S3-07 (3220) RUN	PI2 Control Integral Time	Sets the integral time for the suction pressure control. Set this parameter to 0.00 to disable the integrator.	1.0 s (0.0 - 360.0 s)
S3-08 (3221) RUN	PI2 Control Integral Max Limit	Sets the maximum output possible from the integrator.	100.0% (0.0 - 100.0%)
S3-09 (3222) RUN	PI2 Control Output Upper Limit	Sets the maximum output possible from the PI Auxiliary Control function.	100.0% (0.0 - 100.0%)
S3-10 (3223) RUN	PI2 Control Output Lower Limit	Sets the minimum output possible from the PI Auxiliary Control function.	0.0% (-100.0 - +100.0%)
S3-11 (3224)	PI2 Control Output Level Sel	Sets the PI2 controller output direction. 0 : Direct Acting (Normal Output) 1 : Inverse Acting (Reverse Output)	0 (0, 1)
S3-12 (3225) RUN	PI2 Control Disable Mode Sel	Sets what U5-20 [PI2 Control Output] will output when disabled. 0 : No Output (0%) 1 : Lower Limit (S3-10) 2 : Setpoint	0 (0 - 2)
S3-13 (3226) RUN	PI2 Control Low Feedback Lvl	Sets the secondary PI low feedback detection level. Note: Parameters S3-04 [PI2 Control Unit Selection], S3-03 [PI2 Control Decimal Place Pos], and S3-02 [PI2 Control Transducer Scale] set the unit, resolution, and upper limit.	0.00 (0.00 - 600.00)
S3-14 (3227) RUN	PI2 Control Low Feedback Time	Sets the secondary PI low feedback detection delay time in seconds.	1.0 s (0.0 - 25.5 s)
S3-15 (3228) RUN	PI2 Control High Feedback Lvl	Sets the secondary PI high feedback detection level. Note: Parameters S3-04 [PI2 Control Unit Selection], S3-03 [PI2 Control Decimal Place Pos], and S3-02 [PI2 Control Transducer Scale] set the unit, resolution, and upper limit.	100.00 (0.00 - 600.00)
S3-16 (3229) RUN	PI2 Control High Feedback Time	Sets the secondary PI high feedback detection delay time in seconds.	1.0 s (0.0 - 25.5 s)
S3-17 (322A) RUN	PI2 Control Feedback Det Sel	Sets when the low and high feedback detection multifunction outputs (71h and 72h) for PI2 Control are active. 0 : While PI2 Control Enabled 1 : Always Note: Feedback level detection compares PI2 Control Feedback from analog input H3-xx = 26 [MFAI Function Selection = PI2 Control Feedback] to these parameters: • S3-13 [PI2 Control Low Feedback Lvl] for low feedback level detection • S3-15 [PI2 Control High Feedback Lvl] for high feedback level detection	0 (0, 1)
S3-18 (322B) RUN	PI2 Control Custom Unit 1	Sets the first character of the PI2 Control custom unit display when S3-04 = 49 [PI2 Control Unit Selection = Custom(S3-18-20)].	41 (20 - 7A)
S3-19 (322C) RUN	PI2 Control Custom Unit 2	Sets the second character of the PI2 Control custom unit display when S3-04 = 49 [PI2 Control Unit Selection = Custom(S3-18-20)].	41 (20 - 7A)
S3-20 (322D) RUN	PI2 Control Custom Unit 3	Sets the third character of the PI2 Control custom unit display when S3-04 = 49 [PI2 Control Unit Selection = Custom(S3-18-20)].	41 (20 - 7A)

◆ S5: Hand/Off/Auto Operation

No. (Hex.)	Name	Description	Default (Range)
S5-01 (322F)	HAND Frequency Reference Source	Sets the frequency reference source when HAND Mode is active. 0 : HAND Analog Input 1 : HAND Ref S5-05 or PID SP S5-06 2 : Set by b1-01	1 (0 - 2)
S5-02 (3230)	HAND/AUTO Switchover During Run	Sets the function to enable or disable switching between HAND and AUTO Mode during run. 0 : Disabled 1 : Enabled	1 (0, 1)
S5-03 (3231) RUN	HAND Mode PID Selection	Sets the function to enable or disable PI function when HAND mode is active. 0 : Disabled 1 : Enabled Note: If b5-01 = 0 [PID Mode Setting = Disabled], the drive disables Hand Mode PID.	0 (0, 1)
S5-05 (3233) RUN	HAND Frequency Reference	Sets the frequency reference when HAND Mode is active, PID is disabled and S5-01 = 1 [HAND Frequency Reference Source = HAND Ref S5-05 or PID SP S5-06].	0.00 Hz (0.00 - 400.00 Hz)
S5-06 (3234) RUN	HAND Setpoint	Sets the System Setpoint when HAND Mode is active, PID is enabled and S5-01 = 1 [HAND Frequency Reference Source = HAND Ref S5-05 or PID SP S5-06]. Note: Parameters b5-46 [PID Unit Display Selection], b5-38 [PID User Unit Display Scaling], and b5-39 [PID User Unit Display Digits] set the unit, range, and resolution.	0.0 (0.0 - 6000.0)
S5-07 (3235)	Operation HAND Key	Sets the HAND key on the HOA keypad to let you switch between HAND Mode and AUTO Mode. 0 : Disabled 1 : Enabled	1 (0, 1)
S5-08 (3D31) RUN	HAND Reference Prime Loss Level	Sets the level at which the drive will detect the Loss of Prime in the pump. Note: • If these conditions occur at the same time, the drive will detect LOP [Loss of Prime]: –The monitor set by Y1-18 [Prime Loss Detection Method] ≤ S5-08 for longer than Y1-20 [Prime Loss Time] –Output frequency ≥ S5-05 [HAND Frequency Reference] • The drive response to the Loss of Prime condition changes when the Y1-22 [Prime Loss Selection] setting changes. • Parameter Y1-18 [Prime Loss Detection Method] sets the units for this parameter.	0.0 (0.0 - 1000.0)

◆ S6: Protection

No. (Hex.)	Name	Description	Default (Range)
S6-01 (3236)	Emergency Override Speed	Sets the speed command for emergency override mode when S6-02 = 0 [Emergency Override Ref Selection = Use S6-01 Reference]. Note: Parameter default is lower-limited to E1-09. The default setting will automatically increase when E1-09 > S6-01.	1.50 Hz (1.50 - 60.00 Hz)
S6-02 (3237)	Emergency Override Ref Selection	Sets the Emergency Override Speed Source: 0 : Use S6-01 Reference 1 : Use Frequency Reference 2 : System PID Mode 3 : Independent PID Mode	0 (0 - 3)
S6-03 (323A)	EMOVR Independent PID Scale	Sets the scaling on the Emergency PID Feedback and Setpoint (if programmed) Analog Inputs. Note: • S6-05 [EMOVR Independent PID Unit Digit] sets the resolution for this parameter. • S6-04 [EMOVR Independent PID Unit] sets the units for this parameter.	100.00 (0.10 - 600.00)

No. (Hex.)	Name	Description	Default (Range)
S6-04 (323B)	EMOVR Independent PID Unit	Sets the units displayed for S6-06 [EMOVR PID Setpoint] when S6-02 = 3 [Emergency Override Ref Selection = Independent PID Mode]. 0 : "WC: inches of water column 1 : PSI: pounds per square inch 2 : GPM: gallons/min 3 : °F: Fahrenheit 4 : ft³/min: cubic feet/min 5 : m³/h: cubic meters/hour 6 : L/h: liters/hour 7 : L/s: liters/sec 8 : bar: bar 9 : Pa: Pascal 10 : °C: Celsius 11 : m: meters 12 : ft: feet 13 : L/min: liters/min 14 : m³/min: cubic meters/min 15 : "Hg: Inch Mercury 16 : kPa: kilopascal 48 : %: Percent 49 : Custom(b5-68-70) 50 : None	48 (0 - 50)
S6-05 (323C)	EMOVR Independent PID Unit Digit	Sets the number of digits for S6-06 [EMOVR PID Setpoint] when S6-02 = 3 [Emergency Override Ref Selection = Independent PID Mode]. 0 : No Decimal Places (XXXXX) 1 : One Decimal Places (XXXX.X) 2 : Two Decimal Places (XXX.XX) 3 : Three Decimal Places (XX.XXX)	2 (0 - 3)
S6-06 (323D) RUN	EMOVR PID Setpoint	Sets the PID Setpoint when S6-02 = 3 [Emergency Override Ref Selection = Independent PID Mode]. Note: When S6-02 = 3: units and resolution are dependent on S6-04 [EMOVR Independent PID Unit] and S6-05 [EMOVR Independent PID Unit Digit]. Value is internally limited to 300% of S6-03 [EMOVR Independent PID Scale].	0.00 (0 - 600.00)
S6-07 (323E)	EMOVR Fault Suppression Mode	Sets the drive to let Emergency Override disable faults during operation. 0 : Fault Suppression 1 : Test Mode	0 (0, 1)
S6-08 (323F)	EMOVR Drive Enable Input Mode	Sets whether the Drive Enable Input (if programmed) must be inactive (drive is disabled) for Emergency Override to function. 0 : Drive Enable Status Ignored 1 : EMOVRun Only When Drive Disabled Note: You must program Drive Enable to a Digital Input for this parameter to have an effect.	0 (0, 1)
S6-09 (3240)	Emergency Override Min Speed	When Emergency Override is active, the output frequency is lower-limited to this value.	0.00 Hz (0.00 - 400.00 Hz)
S6-10 (3241)	Emergency Override Max Speed	When Emergency Override is active, the output frequency is upper-limited to this value. Note: Set this parameter to 0.00 Hz to disable the limit.	0.00 Hz (0.00 - 400.00)

9.14 S: Special Applications

No. (Hex.)	Name	Description	Default (Range)
S6-11 (3242) Expert	EMOVR Drive Protection Fault ON	<p>Sets the bit to enable fault detection during Emergency Override.</p> <ul style="list-style-type: none"> bit 0 : Uv1 - DC Bus Undervoltage bit 1 : CoF - Current Offset Fault bit 2 : Reserved bit 3 : Err - EEPROM Write Error bit 4 : Reserved bit 5 : Reserved bit 6 : oL2 - Drive Overload bit 7 : oPr - Operator Connection bit 8 : PF - Input Phase Loss bit 9 : Reserved bit 10 : Reserved bit 11 : oH - Heatsink Overheat bit 12 : oH1 - Heatsink Overheat bit 13 : OD - Output Disconnect bit 14 : FAn1 - Cooling Fan Fault bit 15 : ov2 - DC Bus Overvoltage 2 <p>Note: The drive sets the bits in Hex.</p>	0 (0 - FFFF)
S6-12 (3243) Expert	EMOVR Motor Protection Fault ON	<p>Sets the bit to enable fault detection during Emergency Override.</p> <ul style="list-style-type: none"> bit 0 : LF - Output Phase Loss bit 1 : LF2 - Output Current Imbalance bit 2 : oH3 - Motor Overheat PTC Input bit 3 : oH4 - Motor Overheat PTC Input bit 4 : Reserved bit 5 : oL1 - Motor Overload bit 6 : oL3 - Overtorque Detection 1 bit 7 : oL4 - Overtorque Detection 2 bit 8 : oL7 - High Slip Braking Overload bit 9 : Reserved bit 10 : UL3 - Undertorque Detection 1 bit 11 : UL4 - Undertorque Detection 2 bit 12 : UL6 - Motor Underload bit 13 : Reserved bit 14 : oS - Overspeed bit 15 : dEv: Speed Deviation <p>Note: The drive sets the bits in Hex.</p>	0 (0 - FFFF)
S6-13 (3244) Expert	EMOVR Option Fault ON	<p>Sets the bit to enable fault detection during Emergency Override.</p> <ul style="list-style-type: none"> bit 0 : bUS - Option Communication bit 1 : CE - Communication Error bit 2 : E5 - SI-T3 Watch Dog Timer bit 3 : EF0 - Option Card External Fault bit 4 : PE1 - PLC Fault 1 bit 5 : PE2 - PLC Fault 2 bit 6 : nSE - Node Setup Error bit 7 to 15 : Reserved <p>Note: The drive sets the bits in Hex.</p>	0 (0 - FFFF)
S6-14 (3245) Expert	EMOVR Application 1 Fault ON	<p>Sets the bit to enable fault detection during Emergency Override.</p> <ul style="list-style-type: none"> bit 0 : EFx - External Faults bit 1 : Reserved bit 2 : HLCE - High Level Communications Error bit 3 : bAT - HOA Keypad Battery Voltage Low bit 4 : TiM - Keypad Time Not Set bit 5 : bCE - Bluetooth Communication Fault bit 6 : Reserved bit 7 : Reserved bit 8 : Reserved bit 9 : MSL - Net Master Lost bit 10 : VLTS - Thermostat Fault bit 11 to 15 : Reserved <p>Note: The drive sets the bits in Hex.</p>	0 (0 - FFFF)

No. (Hex.)	Name	Description	Default (Range)
S6-16 (3247)	EMOVR Customer Safety Mode	Sets the status for the customer safety input (when programmed) that must occur for Emergency Override to function. 0 : Customer Safety Ignored 1 : EMOVRun Only When Safety OK 2 : EMOVRun Only When Safety NOT OK Note: You must set one of the bypass control digital inputs to a safety [Z2-0x = 22, 38-43] for this parameter to have an effect.	0 (0 - 2)
S6-17 (3248)	EMOVR BAS Interlock Mode	Sets the status for the BAS Interlock input (when programmed) that must occur for Emergency Override to function. 0 : BAS Interlock Ignored 1 : EMOVRun Only When Interlock OK 2 : EMOVRun When Interlock NOT OK Note: You must set one of the bypass control digital inputs to Run Interlock (BAS) [Z2-0x = 23] for this parameter to have an effect.	0 (0 - 2)
S6-20 (324B) Expert	EMOVR Bypass Fault ON	Sets the bit to enable fault detection during Emergency Override. bit 0 : FB02 bit 1 : FB03 bit 2 : FB05 bit 3 : FB06 bit 4 : FB07 bit 5 : FB08 bit 6 : FB09 bit 7 : FB10 bit 8 : FB13 bit 9 : FB15 bit 10 : FB16 bit 11 : FB17 bit 12 : FB18	0 (0 - FFFF)
S6-23 (324E)	OV2 Detect Time	Sets the detection time of ov2 [DC Bus Overvoltage 2] in 0.1 s increments. Note: Set this parameter to 0.0 s to disable ov2 detection.	10.0 s (0.0 - 1200.0 s)

9.15 Y: Application Features

◆ Y1: Application Basics

No. (Hex.)	Name	Description	Default (Range)
Y1-04 (3C03) RUN	Sleep Wake-up Level	Sets the level that feedback must be less than for the time set in <i>Y1-05 [Sleep Wake-up Level Delay Time]</i> to start the system. This level also sets the wake up level when the drive is in Sleep Mode. When <i>Y1-04 < 0</i> , the feedback level must decrease this amount to less than the setpoint. Note: • When PID operates in reverse mode, the feedback value must increase to more than the start level for the time set in <i>Y1-05</i> for the system to start. • When <i>Y2-01 = 5 [Sleep Level Type = Output Frequency (non-PID)]</i> , the drive will ignore this parameter. • Set this parameter to 0.0 to disable the function. • Range is 0.00 to 99.99 with sign-bit "-" or "+" indicating Delta to Setpoint. • Display unit and scaling change when the system units change.	0.0 (-999.9 - +999.9)
Y1-05 (3C04) RUN	Sleep Wake-up Level Delay Time	Sets the drive to start the System again when the feedback decreases to less than <i>Y1-04 [Sleep Wake-up Level]</i> for the time set in this parameter.	1 s (0 - 3600 s)
Y1-06 (3C05) RUN	Minimum Speed	Sets the minimum frequency at which the drive will run. The drive applies this setting to HAND and AUTO modes. Note: The unit, decimal place, and setting range change when the <i>Y1-07 [Minimum Speed Units]</i> setting changes: • <i>Y1-07 = 0 [Hz]</i> : The setting range is 0.0 Hz to <i>E1-04</i> Hz. • <i>Y1-07 = 1 [RPM]</i> : The setting range is 0 RPM to (<i>E1-04</i> × 60) RPM.	0.0 Hz Determined by Y1-07
Y1-07 (3C06)	Minimum Speed Units	Sets the units and decimal place for <i>Y1-06 [Minimum Speed]</i> . 0 : Hz 1 : RPM Note: Changing <i>Y1-07</i> will set <i>Y1-06 [Minimum Speed]</i> to the default value.	0 (0, 1)
Y1-08 (3C07) RUN	Low Feedback Level	Sets the lower detection level for the PID feedback. Note: • Unit and decimal place change when the system units change. • Range is 0.00 to 99.99 with sign-bit "-" indicating Delta to Setpoint.	0.00% (0.00 - 99.99%)
Y1-09 (3C08) RUN	Low Feedback Lvl Fault Dly Time	Sets the delay time for the drive to detect an <i>LFB [Low Feedback Sensed]</i> fault after the feedback level decreases to less than the value set in <i>Y1-08 [Low Feedback Level]</i> . Note: Set <i>Y1-10 = 0 [Low Feedback Selection = Fault (and Digital Output)]</i> to enable this parameter.	10 s (0 - 3600 s)
Y1-10 (3C09)	Low Feedback Selection	Sets the drive response when the feedback decreases to less than <i>Y1-08 [Low Feedback Level]</i> for longer than the time set in <i>Y1-09 [Low Feedback Lvl Fault Dly Time]</i> . 0 : Fault (and Digital Output) 1 : Alarm (and Digital Output) 2 : Digital Output Only	0 (0 - 2)
Y1-11 (3C0A) RUN	High Feedback Level	Sets the upper detection level for the PID feedback. Note: • Unit and decimal place change when the system units change. • Range is 0.00 to 99.99 with sign-bit "+" indicating Delta to Setpoint.	0.00% (0.00 - 99.99%)
Y1-12 (3C0B) RUN	High Feedback Lvl Fault Dly Time	Sets the delay time between when the drive detects high feedback until the drive faults on an <i>HFB [High Feedback Sensed]</i> fault. Note: This parameter is effective only when <i>Y1-13 = 0 [High Feedback Selection = Fault (and Digital Output)]</i> .	5 s (0 - 3600 s)
Y1-13 (3C0C)	High Feedback Selection	Sets the drive response when the feedback increased to more than <i>Y1-11 [High Feedback Level]</i> for longer than the time set in <i>Y1-12 [High Feedback Lvl Fault Dly Time]</i> . 0 : Fault (and Digital Output) 1 : Alarm (and Digital Output) 2 : Digital Output Only	0 (0 - 2)
Y1-14 (3C0D) RUN	Feedback Hysteresis Level	Sets the hysteresis level for low and high level feedback detection. Note: Unit and decimal place change when the system units change.	0.0% (0.0 - 10.00%)

No. (Hex.)	Name	Description	Default (Range)
Y1-15 (3C0E) RUN	Maximum Setpoint Difference	Sets a percentage of difference between the setpoint and the feedback. The difference must be more than this value for the time set in Y1-16 [Not Maintaining Setpoint Time] to trigger the drive response set in Y1-17 [Not Maintaining Setpoint Sel]. Note: • Unit and decimal place change when the system units change. • If there is a fault, the drive will coast to a stop. • Set this parameter to 0.0 to disable the function. • This function is only active during run when in Auto Mode.	0.0% (0.0 - 6000.0%)
Y1-16 (3C0F) RUN	Not Maintaining Setpoint Time	Sets the delay time before a Setpoint Not Met condition occurs. The drive must detect the setpoint difference set in Y1-15 [Maximum Setpoint Difference] before the timer will start. Note: Set Y1-15 = 0 [Maximum Setpoint Difference = 0] to disable this function.	60 s (0 - 3600 s)
Y1-17 (3C10)	Not Maintaining Setpoint Sel	Sets the drive response when the feedback increases to more or decreases to less than the setpoint for more than the amount set in Y1-15 [Maximum Setpoint Difference]. 0 : Fault (and Digital Output) 1 : Alarm (and Digital Output) 2 : Digital Output Only	0 (0 - 2)
Y1-18 (3C11)	Prime Loss Detection Method	Sets the units and quantity that the drive will use to determine LOP [Loss of Prime]. 0 : Current (A) 1 : Power (kW) 2 : Torque (%)	0 (0 - 2)
Y1-19 (3C12) RUN	Prime Loss Level	Sets the level to detect the LOP [Loss of Prime] in the pump when in Auto or Sleep Boost Mode.	0.0 (0.0 - 1000.0)
Y1-20 (3C13) RUN	Prime Loss Time	Sets the delay time before the drive detects an LOP [Loss of Prime] condition. The timer starts when the drive detects the conditions in Y1-18 [Prime Loss Detection Method] and Y1-19 [Prime Loss Level].	20 s (0 - 600 s)
Y1-21 (3C14)	Prime Loss Activation Freq	Sets the frequency level above which the drive enables Loss of Prime detection.	0.0 Hz (0.0 - 400.0)
Y1-22 (3C15)	Prime Loss Selection	Sets the drive response when the drive is in the Loss of Prime condition. 0 : Fault (and Digital Output) 1 : Alarm (and Digital Output) 2 : Digital Output Only	0 (0 - 2)
Y1-23 (3C16)	Prime Loss Max Restart Time	Sets the time in minutes that the drive will wait before it tries a restart after a restart fails or after it does not do a restart because of a fault.	0.2 min (0.2 - 6000.0 min)
Y1-40 (3C27) RUN	Maximum Speed	Sets the maximum speed. Note: This parameter is not effective when Y1-40 = 0.0 Hz or Y1-40 > E1-04 [Maximum Output Frequency] × d2-01 [Frequency Reference Upper Limit].	0.0 Hz (0.0 - 416.0)

◆ Y2: PID Sleep and Protection

No. (Hex.)	Name	Description	Default (Range)
Y2-01 (3C64)	Sleep Level Type	Sets the data source that the drive uses to know when to activate the Sleep Function. 0 : Output Frequency 1 : Output Current 2 : Feedback 3 : Output Speed (RPM) 5 : Output Frequency (non-PID) Note: • Feedback depends on PID direction operation. • When the Sleep Function is active, the keypad will show the "Sleep" Alarm.	5 (0 - 5)
Y2-02 (3C65) RUN	Sleep Level	Sets the level that the level type set in Y2-01 [Sleep Level Type] must be at for the time set in Y2-03 [Sleep Delay Time] for the drive to enter Sleep Mode. Note: • When you set this parameter to 0.0, this function will not be active. • This function is active only when the drive operates in AUTO Mode. • When Y2-01 = 5 [Output Frequency (non-PID)], the drive will disable the Sleep function when you set this parameter to 0.0. • When Y2-01 ≠ 5, the drive will set the sleep level to the largest value from d2-02 [Frequency Reference Lower Limit], Y1-06 [Minimum Speed], and Y4-12 [Thrust Frequency] when you set this parameter to 0.0.	0.0 (0.0 - 6000.0)

9.15 Y: Application Features

No. (Hex.)	Name	Description	Default (Range)
Y2-03 (3C66) RUN	Sleep Delay Time	Sets the delay time before the drive enters Sleep Mode when the drive is at the sleep level set in Y2-02 [Sleep Level].	5 s (0 - 3600 s)
Y2-04 (3C67) RUN	Sleep Activation Level	Sets the level above which the output frequency must increase to activate the Sleep Function when Y2-01 = 0, 3, or 5 [Sleep Level Type = Output Frequency, Output Speed (RPM), or Output Frequency (non-PID)]. Note: When you set this parameter to 0.0, this function will not be active, and the Sleep Function will activate above the minimum speed (largest value from d2-02 [Frequency Reference Lower Limit], Y1-06 [Minimum Speed], and Y4-12 [Thrust Frequency]).	0.0 (0.0 - 6000.0)
Y2-05 (3C68) RUN	Sleep Boost Level	Sets the quantity of boost that the drive applies to the setpoint before it goes to sleep. Note: Set this parameter to 0.00 to disable Sleep Boost Function.	0.00% (0.00 - 600.00%)
Y2-06 (3C69) RUN	Sleep Boost Hold Time	Sets the length of time that the drive will keep the boosted pressure before it goes to sleep.	5.0 s (0.5 - 160.0 s)
Y2-07 (3C6A) RUN	Sleep Boost Max Time	Sets the length of time that the system (feedback) has to reach the boosted setpoint. The system must reach the boosted setpoint in the time set in this parameter, or it will go to sleep.	20.0 s (1.0 - 160.0 s)
Y2-08 (3C6B) RUN	Delta Feedback Drop Level	Sets the level of the PID Error (set-point minus feedback) to deactivate the Sleep Mode operation. Note: Set this parameter to 0.00 to disable the function.	0.00% (0.00 - 600.00%)
Y2-09 (3C6C) RUN	Feedback Drop Detection Time	Sets the time during which the software monitors the feedback to detect a flow/no-flow condition. Refer to Y2-08 [Delta Feedback Drop Level] for more information.	10.0 s (0.0 - 3600.0 s)
Y2-23 (3C7A) RUN	Anti-No-Flow Bandwidth	Sets the quantity of PI error bandwidth that the drive uses to detect an Anti- No-Flow condition. A setting of 0.00% disables Anti-No-Flow detection. Note: Do not set this parameter value too high, because operation can become unstable.	0.00% (0.00 - 2.00%)
Y2-24 (3C7B) RUN	Anti-No-Flow Detection Time	Sets the time delay before the drive starts the increased deceleration rate after it detects Anti-No-Flow.	10.0 s (1.0 - 60.0 s)
Y2-25 (3C7C) RUN	Anti-No-Flow Release Level	Sets the amount below the setpoint which the feedback must decrease before the drive will disengage Anti-No-Flow and return to normal PI operation. Note: The display unit and scaling change when the System Units change.	0.30% (0.00 - 10.00%)

◆ Y4: Application Advanced

No. (Hex.)	Name	Description	Default (Range)
Y4-01 (3CFA) RUN	Pre-Charge Level	Sets the level at which the drive will activate the pre-charge function when the drive is running at the frequency set in Y4-02 [Pre-Charge Frequency]. Note: The drive will stop when one of these conditions is true: • The feedback level increases to more than Y4-01 • The pre-charge time set in Y4-03 [Pre-Charge Time] expires	0.00% (0.00 - 600.00%)
Y4-02 (3CFB) RUN	Pre-Charge Frequency	Sets the frequency at which the pre-charge function will operate.	0.0 Hz (0.0 - 400.0 Hz)
Y4-03 (3CFC) RUN	Pre-Charge Time	Sets the length of time that the Pre-Charge function will run. Note: Set this parameter to 0.0 to disable the function.	0.0 min (0.0 - 3600.0 min)
Y4-05 (3CFE) RUN	Pre-Charge Loss of Prime Level	Sets the level at which the drive will detect loss of prime in the pump.	0.0 A (0.0 - 1000.0 A)
Y4-11 (3D04) RUN	Thrust Acceleration Time	Sets the time at which the drive output frequency will ramp up to the reference frequency set in Y4-12 [Thrust Frequency].	1.0 s (0.0 - 600.0 s)

No. (Hex.)	Name	Description	Default (Range)
Y4-12 (3D05) RUN	Thrust Frequency	Sets the Thrust Frequency that the drive will use to know which acceleration and deceleration time to use. The drive will accelerate to this frequency in the Y4-11 [Thrust Acceleration Time] time and decelerate from this frequency in the Y4-13 [Thrust Deceleration Time] time.	0.0 Hz (0.0 - 400.0 Hz)
Y4-13 (3D06) RUN	Thrust Deceleration Time	Sets the length of time necessary for the drive to go from the Thrust Frequency in Y4-12 [Thrust Frequency] to stop when Thrust Mode is active.	5.0 s (0.0 - 600.0 s)
Y4-18 (3D0B) RUN	Differential Level	Sets the maximum difference that the drive will allow when it subtracts the Differential Feedback from the Primary PID Feedback. Note: • The drive will respond as specified by the setting in Y4-20 [Differential Level Detection Selection] when the difference increases to more than the value set in this parameter for the time set in Y4-19 [Differential Level Detection Time]. • Set this parameter to 0.00 to disable Differential Feedback Detection.	0.00% (-99.99 - +99.99%)
Y4-19 (3D0C) RUN	Differential Lvl Detection Time	Sets the length of time that the difference between PID Feedback and the Differential Feedback must be more than Y4-18 [Differential Level] before the drive will respond as specified by Y4-20 [Differential Level Detection Selection].	10 s (0 - 3600 s)
Y4-20 (3D0D) RUN	Differential Level Detection Sel	Sets the drive response during a Differential Level Detected condition. 0 : Fault (and Digital Out) 1 : Alarm (and Digital Out) 2 : Digital Out Only	0 (0 - 2)
Y4-22 (3D0F) RUN	Low City On-Delay Time	Sets the length of time that the drive will wait to stop when the drive detects a Low City Pressure condition.	10 s (1 - 1000 s)
Y4-23 (3D10) RUN	Low City Off-Delay Time	Sets the length of time that the drive will wait to start again after you clear a Low City Pressure condition.	5 s (0 - 1000 s)
Y4-24 (3D11) RUN	Low City Alarm Text	Sets the alarm message to show on the keypad when the drive detects a Low City Pressure condition. 0 : Low City Pressure 1 : Low Suction Pressure 2 : Low Water in Tank	0 (0 - 2)
Y4-36 (3D1D) RUN	Pressure Reached Exit Conditions	Sets how the digital output responds to Feedback changes after it activates. 0 : Hysteresis Above & Below 1 : Hysteresis 1-Way	1 (0, 1)
Y4-37 (3D1E) RUN	Pressure Reached Hysteresis Lvl	Sets the hysteresis level that will cause the drive to exit the Pressure Reached condition.	0.30% (0.1 - 10.00%)
Y4-38 (3D1F) RUN	Pressure Reached On Delay Time	Sets the length of time that the drive will wait before it activates the Pressure Reached condition.	1.0 s (0.1 - 60.0 s)
Y4-39 (3D20) RUN	Pressure Reached Off Delay Time	Sets the length of time that the drive will wait before it deactivates the Pressure Reached condition.	1.0 s (0.1 - 60.0 s)
Y4-40 (3D21) RUN	Pressure Reached Detection Sel	Sets the drive status that triggers the Pressure Reached Detection digital output. 0 : Always 1 : Drive Running 2 : Run Command	0 (0 - 2)
Y4-41 (3D22) RUN	Diff Lvl Src Fdbk Backup Select	Sets the function to enable or disable <i>Differential Level Source</i> [H3-xx = 2D] as the backup transducer if there is a failure with the primary PID Feedback transducer [H3-xx = B] and the PID Feedback Backup transducer [H3-xx = 24] is not available. 0 : Disabled 1 : Enabled	0 (0, 1)

9.15 Y: Application Features

No. (Hex.)	Name	Description	Default (Range)
Y4-42 (3D23)	Output Disconnect Detection Sel	This parameter applies only when in Drive Mode. It sets the drive response if the connection between the drive and the motor is disconnected. 0 : Disabled 1 : Alarm - Speed Search 2 : Alarm - Start at Zero 3 : Fault Note: 1. Loss Of Load [Z1-31 to Z1-36], Load Verify [Z1-53], and Bypass Energy Savings [Z1-16] can interfere with the correct operation of Output Disconnect Detection. 2. When the Output Disconnect is active, the drive internally disables Output Phase Loss Detection of more than one phase. 3. The Output Current Limit function is not active when operating in Bypass Mode.	0 (0 - 3)
Y4-43 (3D24)	Output Disconnect Inject Current	Sets the level of DC injection current during output disconnect as a percentage of the drive rated current.	30% (5 - 50%)

◆ YA: Preset Setpoint

No. (Hex.)	Name	Description	Default (Range)
YA-01 (3E58) RUN	Setpoint 1	Sets the PID Setpoint when $b1-01 = 0$ [Frequency Reference Selection 1 = Keypad or Multi-Speed Selection]. Note: Parameters $b5-46$ [PID Unit Display Selection], $b5-38$ [PID User Unit Display Scaling], and $b5-39$ [PID User Unit Display Digits] set the unit, range, and resolution.	0.00 (0.00 - 600.00)
YA-02 (3E59) RUN	Setpoint 2	Sets the PID Setpoint as specified by the Multi-Setpoint digital inputs. Note: Parameters $b5-46$ [PID Unit Display Selection], $b5-38$ [PID User Unit Display Scaling], and $b5-39$ [PID User Unit Display Digits] set the unit, range, and resolution.	0.00 (0.00 - 600.00)
YA-03 (3E5A) RUN	Setpoint 3	Sets the PID Setpoint as specified by the Multi-Setpoint digital inputs. Note: Parameters $b5-46$ [PID Unit Display Selection], $b5-38$ [PID User Unit Display Scaling], and $b5-39$ [PID User Unit Display Digits] set the unit, range, and resolution.	0.00 (0.00 - 600.00)
YA-04 (3E5B) RUN	Setpoint 4	Sets the PID Setpoint as specified by the Multi-Setpoint digital inputs. Note: Parameters $b5-46$ [PID Unit Display Selection], $b5-38$ [PID User Unit Display Scaling], and $b5-39$ [PID User Unit Display Digits] set the unit, range, and resolution.	0.00 (0.00 - 600.00)

◆ YC: Foldback Features

No. (Hex.)	Name	Description	Default (Range)
YC-01 (3EBC)	Output Current Limit Select	Sets the function to enable or disable the output current regulator. 0 : Disabled 1 : Enabled	0 (0, 1)
YC-02 (3EBD) RUN	Current Limit	Sets the current limit. Note: Value is internally limited to 300% of the drive rated current set in $n9-01$ [Inverter Rated Current].	0.0 A (0.0 - 1000.0 A)

◆ YF: PI Auxiliary Control

No. (Hex.)	Name	Description	Default (Range)
YF-01 (3F50)	PI Aux Control Selection	Sets the PI Auxiliary Control function. 0 : Disabled 1 : Enabled	0 (0, 1)
YF-02 (3F51) RUN	PI Aux Control Transducer Scale	Sets the full scale (10 V or 20 mA) output of the pressure transducer connected to the analog input terminal programmed for $H3-xx = 27$ [PI Aux Control Feedback Level]. Note: Parameters $YF-21$ [PI Aux Ctrl Level Unit Selection] and $YF-22$ [PI Aux Level Decimal Place Pos] set the unit and resolution.	145.0 (1.0 - 6000.0)

No. (Hex.)	Name	Description	Default (Range)
YF-03 (3F52) RUN	PI Aux Control Setpoint	Sets the level to which the drive will try to regulate. Note: Parameters <i>YF-21 [PI Aux Ctrl Level Unit Selection]</i> and <i>YF-22 [PI Aux Level Decimal Place Pos]</i> set the unit and resolution.	20.0 PSI (0.0 - 6000.0)
YF-04 (3F53) RUN	PI Aux Control Minimum Level	Sets the level below which the drive must be for longer than <i>YF-05 [PI Aux Control Sleep Delay Time]</i> before the drive goes to sleep and turns off all lag pumps. Note: • Set this parameter to 0.0 to disable the function. • Parameters <i>YF-21 [PI Aux Ctrl Level Unit Selection]</i> and <i>YF-22 [PI Aux Level Decimal Place Pos]</i> set the unit and resolution.	10.0 PSI (0.0 - 6000.0)
YF-05 (3F54) RUN	PI Aux Control Sleep Delay Time	Sets the length of time that the drive will delay before it goes to sleep after the level is less than <i>YF-04 [PI Aux Control Minimum Level]</i> (when <i>YF-23 = 1 [PI Aux Ctrl Output Level Select = Inverse Acting]</i>) or more than <i>YF-24 [PI Auxiliary Ctrl Maximum Level]</i> (when <i>YF-23 = 0 [Direct Acting]</i>).	5 s (0 - 3600 s)
YF-06 (3F55) RUN	PI Aux Control Wake-up Level	Sets the level to wake up the drive when the drive after <i>YF-04 [PI Aux Control Minimum Level]</i> or <i>YF-24 [PI Auxiliary Ctrl Maximum Level]</i> put the drive to sleep. Note: • Parameter <i>YF-23 [PI Aux Ctrl Output Level Select]</i> sets the condition to wake up the drive. – <i>YF-23 = 0 [Direct Acting]</i> : The PI Aux Feedback must be less than the level set in this parameter for longer than the time set in <i>YF-07</i> to wake up. – <i>YF-23 = 1 [Inverse Acting]</i> : The PI Aux Feedback must be more than the level set in this parameter for longer than the time set in <i>YF-07 [PI Aux Control Wake-up Time]</i> to wake up. • Parameters <i>YF-21 [PI Aux Ctrl Level Unit Selection]</i> and <i>YF-22 [PI Aux Level Decimal Place Pos]</i> set the unit and resolution.	30.0 PSI (-999.9 - +999.9 PSI)
YF-07 (3F56)	PI Aux Control Wake-up Time	Sets the time to wake up the drive when the drive after <i>YF-04 [PI Aux Control Minimum Level]</i> or <i>YF-24 [PI Auxiliary Ctrl Maximum Level]</i> put the drive to sleep. Note: Parameter <i>YF-23 [PI Aux Ctrl Output Level Select]</i> sets the condition to wake up the drive. • <i>YF-23 = 0 [Direct Acting]</i> : The PI Aux Feedback must be less than the level set in <i>YF-06</i> for longer than the time set in <i>YF-07</i> to wake up. • <i>YF-23 = 1 [Inverse Acting]</i> : The PI Aux Feedback must be more than the level set in <i>YF-06 [PI Aux Control Wake-up Level]</i> for longer than the time set in <i>YF-07</i> to wake up.	1 s (0 - 3600 s)
YF-08 (3F57) RUN	PI Aux Control Minimum Speed	Sets the minimum speed at which the drive can run when the PI Auxiliary Control has an effect on the output speed. Note: The drive will use <i>Y1-06 [Minimum Speed]</i> and <i>Y4-12 [Thrust Frequency]</i> as the minimum speed when PI Aux Control does not have an effect on the output speed or when you set <i>YF-08 < Y1-06 and Y4-12</i> .	0.00 Hz (0.00 - 400.00 Hz)
YF-09 (3F58) RUN	PI Aux Control Low Level Detect	Sets the level below which the drive must be for longer than <i>YF-10 [PI Aux Control Low Lvl Det Time]</i> to respond as specified by <i>YF-11 [PI Aux Control Low Level Det Sel]</i> . Note: • Set this parameter to 0.0 to disable the function. • Parameter <i>YF-10</i> only applies to when <i>YF-11 = 2 and 3 [Fault and Auto-Restart (time set by YF-15)]</i> . • Parameters <i>YF-21 [PI Aux Ctrl Level Unit Selection]</i> and <i>YF-22 [PI Aux Level Decimal Place Pos]</i> set the unit and resolution.	0.0 PSI (-999.9 - +999.9 PSI)
YF-10 (3F59) RUN	PI Aux Low Level Detection Time	Sets the length of time that the PI Aux Feedback must be less than <i>YF-09 [PI Aux Control Low Lvl Detection]</i> to trigger a drive response when <i>YF-11 = 2 and 3 [PI Aux Control Low Level Det Sel = Fault and Auto-Restart (time set by YF-15)]</i> .	0.1 s (0.0 - 300.0 s)
YF-11 (3F5A)	PI Aux Control Low Level Det Sel	Sets drive response when the PI Aux Feedback decreases to less than <i>YF-09 [PI Aux Control Low Lvl Detection]</i> for longer than <i>YF-10 [PI Aux Control Low Lvl Det Time]</i> . 0 : No Display 1 : Alarm Only 2 : Fault 3 : Auto-Restart (time set by YF-15) Note: • Set <i>YF-01 = 1 [PI Aux Control Selection = Enabled]</i> and <i>YF-09 [PI Aux Control Low Level Detect] > 0</i> to enable PI Aux Low Level Detection. • Parameter <i>YF-10</i> only applies when <i>YF-11 = 2 or 3</i> .	1 (0 - 3)
YF-12 (3F5B) RUN	PI Aux Control High Level Detect	Sets the value above which the level must be for longer than <i>YF-13 [PI Aux High Level Detection Time]</i> to respond as specified by <i>YF-14 [PI Aux Hi Level Detection Select]</i> . Note: • Set this parameter to 0.0 to disable the function. • Parameter <i>YF-13</i> only applies to when <i>YF-14 = 2 and 3 [Fault and Auto-Restart (time set by YF-15)]</i> . • Parameters <i>YF-21 [PI Aux Ctrl Level Unit Selection]</i> and <i>YF-22 [PI Aux Level Decimal Place Pos]</i> set the unit and resolution.	0.0 PSI (-999.9 - +999.9 PSI)
YF-13 (3F5C) RUN	PI Aux High Level Detection Time	Sets the length of time that the level must be more than <i>YF-12 [PI Aux Control High Level Detect]</i> before the drive will respond when <i>YF-14 = 2, 3 [PI Aux Hi Level Detection Select]</i> .	0.1 s (0.0 - 300.0 s)

9.15 Y: Application Features

No. (Hex.)	Name	Description	Default (Range)
YF-14 (3F5D)	PI Aux Control Hi Level Det Sel	Sets the drive response when the PI Aux Feedback increases to more than the <i>YF-12 [PI Aux Control High Level Detect]</i> level for longer than the time set in <i>YF-13 [PI Aux High Level Detection Time]</i> . 0 : NoDisplay (Digital Output Only) 1 : Alarm Only 2 : Fault 3 : Auto-Restart (time set by YF-15) Note: • Set <i>YF-01 = 1 [PI Aux Control Selection = Enabled]</i> and <i>YF-12 [PI Aux Control High Level Detect] > 0</i> to enable PI Aux High Level Detection. • Parameter <i>YF-13</i> only applies when <i>YF-14 = 2 or 3</i>	1 (0 - 3)
YF-15 (3F5E)	PI Aux Level Detect Restart Time	Sets the length of time the drive will wait before it tries an Auto-Restart of <i>LOAUX [Low PI Aux Feedback Level]</i> or <i>HIAUX [High PI Aux Feedback Level]</i> fault.	5.0 min (0.1 - 6000.0 min)
YF-16 (3F5F) RUN	PI Auxiliary Control P Gain	Sets the proportional gain for the suction pressure control.	2.00 (0.00 - 25.00)
YF-17 (3F60) RUN	PI Auxiliary Control I Time	Sets the integral time for the suction pressure control. Note: Set this parameter to 0.0 to disable the integrator.	5.0 s (0.0 - 360.0 s)
YF-18 (3F61)	PI Aux Control Detect Time Unit	Sets the time unit for <i>YF-10 [PI Aux Control Low Lvl Det Time]</i> and <i>YF-13 [PI Aux High Level Detection Time]</i> . 0 : Minutes (min) 1 : Seconds (sec)	1 (0, 1)
YF-19 (3F62)	PI Aux Ctrl Feedback WireBreak	Sets how the analog input selected for PI Aux Feedback will respond when it is programmed to receive a 4 mA to 20 mA signal and the signal is lost. 0 : Disabled 1 : Alarm Only 2 : Fault (no retry, coast to stop)	2 (0 - 2)
YF-20 (3F63)	PI Aux Main PI Speed Control	Sets if the PI Auxiliary Controller has an effect on output speed. 0 : Disabled 1 : Enabled	1 (0, 1)
YF-21 (3F64)	PI Aux Ctrl Level Unit Selection	Set the units shown for the PI Aux Level parameters and monitors. 0 : "WC: inches of water column 1 : PSI: pounds per square inch 2 : GPM: gallons/min 3 : °F: Fahrenheit 4 : ft ³ /min: cubic feet/min 5 : m ³ /h: cubic meters/hour 6 : L/h: liters/hour 7 : L/s: liters/sec 8 : bar: bar 9 : Pa: Pascal 10 : °C: Celsius 11 : m: meters 12 : ft: feet 13 : L/min: liters/min 14 : m ³ /min: cubic meters/min 15 : "Hg: Inch Mercury 16 : kPa: kilopascal 48 : %: Percent 49 : Custom (YF-32 ~ 34) 50 : None	1 (0 - 50)
YF-22 (3F65)	PI Aux Level Decimal Place Pos	Sets the number of decimal places for the PI Aux Level parameters and monitors. 0 : No Decimal Places (XXXXX) 1 : One Decimal Places (XXXX.X) 2 : Two Decimal Places (XXX.XX) 3 : Three Decimal Places (XX.XXX)	1 (0 - 3)
YF-23 (3F66)	PI Aux Ctrl Output Level Select	Sets the PI Auxiliary Controller to be Direct-acting or Inverse-acting. 0 : Direct Acting 1 : Inverse Acting	1 (0, 1)

No. (Hex.)	Name	Description	Default (Range)
YF-24 (3F67) RUN	PI Auxiliary Ctrl Maximum Level	Sets the maximum level for PI Auxiliary Control. When the level is more than this setting for longer than <i>YF-05 [PI Aux Control Sleep Delay Time]</i> , the drive will go to sleep and turn off all lag drives. Note: <ul style="list-style-type: none">Set this parameter to 0.0 to disable the function.Parameters <i>YF-21 [PI Aux Ctrl Level Unit Selection]</i> and <i>YF-22 [PI Aux Level Decimal Place Pos]</i> set the unit and resolution.	0.0 PSI (0.0 - 6000.0 PSI)
YF-25 (3F68) RUN	PI Aux Control Activation Level	Sets the level to activate the PI Auxiliary Control. Note: <ul style="list-style-type: none">The drive response changes when the <i>YF-23 [PI Aux Ctrl Output Level Select]</i> setting changes.<ul style="list-style-type: none"><i>YF-23 = 0 [Direct Acting]:</i> When the PI Aux Feedback level is more than this setting for longer than <i>YF-26 [PI Aux Control Activation Delay]</i>, the drive will activate the PI Auxiliary Control to control the output frequency.<i>YF-23 = 1 [Inverse Acting]:</i> When the PI Aux Feedback level is less than this setting for longer than <i>YF-26</i>, the drive will activate PI Auxiliary Control to control the output frequency.When you set this parameter to 0.0 PSI, PI Auxiliary Control is always enabled.Parameters <i>YF-21 [PI Aux Ctrl Level Unit Selection]</i> and <i>YF-22 [PI Aux Level Decimal Place Pos]</i> set the unit and resolution.	0.0 PSI (0.0 - 6000.0 PSI)
YF-26 (3F69) RUN	PI Aux Control Activation Delay	Sets the delay time to activate the PI Auxiliary Control. Note: <ul style="list-style-type: none">The drive response changes when the <i>YF-23 [PI Aux Ctrl Output Level Select]</i> setting changes.<ul style="list-style-type: none"><i>YF-23 = 0 [Direct Acting]:</i> When the PI Aux Feedback level is more than <i>YF-25 [PI Aux Control Activation Level]</i> for longer than this time, the drive will activate the PI Auxiliary Control to control the output frequency.<i>YF-23 = 1 [Inverse Acting]:</i> When the PI Aux Feedback level is less than <i>YF-25</i> for longer than this time, the drive will activate PI Auxiliary Control to control the output frequency.When you set this parameter to 0.0 PSI, PI Auxiliary Control is always enabled.	2 s (0 - 3600 s)
YF-32 (3F6F)	PI Aux Custom Unit Character 1	Sets the first character of the PI Aux custom unit display when <i>YF-21 = 49 [PI Aux Ctrl Level Unit Selection = Custom (YF-32 ~ 34)]</i> .	41 (20 - 7A)
YF-33 (3F70)	PI Aux Custom Unit Character 2	Sets the second character of the PI Aux custom unit display when <i>YF-21 = 49 [PI Aux Ctrl Level Unit Selection = Custom (YF-32 ~ 34)]</i> .	41 (20 - 7A)
YF-34 (3F71)	PI Aux Custom Unit Character 3	Sets the third character of the PI Aux custom unit display when <i>YF-21 = 49 [PI Aux Ctrl Level Unit Selection = Custom (YF-32 ~ 34)]</i> .	41 (20 - 7A)
YF-35 (3F72)	PI Aux Minimum Transducer Scale	Sets the minimum scale output of the pressure transducer that is connected to the terminal set for <i>H3-xx = 27 [MFAI Function Selection = PI Auxiliary Control Feedback]</i> . Note: <ul style="list-style-type: none">To enable this parameter, set it to less than <i>YF-02 [PI Aux Control Transducer Scale]</i>. If you set it to more than <i>YF-02</i>, it will disable the PI Auxiliary Feedback (set to 0).Parameters <i>YF-21 [PI Aux Ctrl Level Unit Selection]</i> and <i>YF-22 [PI Aux Level Decimal Place Pos]</i> set the unit and resolution.	0.0 PSI (-999.9 - +999.9 PSI)

9.16 Z: Bypass Parameters

◆ Z1: Bypass Control System

No. (Hex.)	Name	Description	Default (Range)
Z1-05 (85CA)	Auto Transfer To Bypass	When the drive is running and there is a drive fault, operation will switch to Bypass Mode. When you remove the fault, the operation will go back to Drive Mode. 0 : Disabled 1 : Enabled	0 (0, 1)
Z1-06 (85CB)	Power Up Mode	Sets the mode of bypass control at power-up. 0 : OFF-DRIVE 1 : AUTO-DRIVE 3 : AUTO-BYPASS 5 : Powerup HOA Memory	1 (0 -5)
Z1-10 (85CF)	Emergency Override Transfer	Enables and disables the function to auto transfer to EMOV bypass if the drive declares a fault when the bypass is running in EMOV drive. 0 : Disabled 1 : Enabled	1 (0, 1)
Z1-11 (85D0)	Motor AND/OR Function	- 0 : Disabled 1 : Always Motor 1 2 : Always Motor 2 3 : Always Motor 1 AND 2 4 : OR in HAND and AUTO 5 : MOTOR 1 in HAND OR in AUTO 6 : MOTOR 2 in HAND OR in AUTO 7 : AND/OR in HAND and AUTO 8 : MOTOR 1 in HAND AND/OR in AUTO 9 : MOTOR 2 in HAND AND/OR in AUTO 10 : MOTOR 1,2 in HAND AND/OR in AUTO	0 (0 - 10)
Z1-12 (85D1)	Run Delay Time	When the Run command is issued, the drive will run at speed set in Z1-14 [Run Delay Frequency Reference]. After the time set in this parameter, the frequency reference will return to its programmed source (b1-01 or HAND frequency reference).	0.0 s (0.0 to 300.0 s)
Z1-13 (85D2)	Pre Interlock Run Select	Determines if the drive will run at a preset speed when the BAS Interlock Digital Input is open and a Run command is present. 0 : Disabled 1 : Enabled (DRIVE Mode) 1 : Enabled (BYPASS Mode)	0 (0, 1)
Z1-14 (85D3)	Run Delay Frequency Reference	Sets the frequency that the bypass uses when it delays the Run command.	60.00 Hz (0.00 - Max. Freq.)
Z1-15 (85D4)	Interlock Wait Time	When you enter a Run command, it asserts the damper actuator output. When you program an input for Interlock and the time set to this parameter expires before the Interlock input activates, it will trigger a fault. Note: Set this parameter to 0.0 s to disable this function.	0.0 s (0.0 - 300.0 s)
Z1-16 (85D5)	Energy Savings Mode	Enables the contactor-based Energy Savings function and determines which conditions must be met before the bypass will enter into Energy Savings Mode. 0 : Disabled 1 : Frequency 2 : Frequency + Current Note: If the motor is running in reverse, Energy Savings will not function.	0 (0 - 2)
Z1-17 (85D6)	Energy Savings Frequency Ref	Both frequency reference and output frequency must be within the window defined by this parameter, Z1-19 [Energy Savings Fref Deadband], and Z1-20 [Energy Savings Out Freq Deadband] for Energy Savings operation.	60.00 Hz (0.00 - Max. Freq.)
Z1-18 (85D7)	Energy Savings Output Cur Level	Drive output current must be in the window defined by this parameter and Z1-21 [Energy Savings Out Cur Deadband] to enter Energy Savings Mode.	0.0% (0.0 - 100.0%)
Z1-19 (85D8)	Energy Savings Fref Deadband	Used with Z1-17 [Energy Savings Frequency Ref] to set when to enter and exit Energy Savings Mode. Note: Units, default, and range are different for different o1-03 [Frequency Display Unit Selection] values.	0.50 Hz (0.00 - 5.00 Hz)

No. (Hex.)	Name	Description	Default (Range)
Z1-20 (85D9)	Energy Savings Out Freq Deadband	Used with Z1-17 [Energy Savings Frequency Ref] to set when to enter Energy Savings Mode. Note: Units, default, and range are different for different o1-03 [Frequency Display Unit Selection] values.	0.50 Hz (0.00 - 5.00 Hz)
Z1-21 (85DA)	Energy Savings Out Cur Deadband	Used with Z1-18 [Energy Savings Output Cur Level] to set when to enter Energy Savings Mode.	15.0% (0.0 - 30.0%)
Z1-22 (85DB)	Energy Savings Mode Time	Sets the length of time that all conditions must be in the set limits before transferring into Energy Savings Mode.	30 s (10 - 3600 s)
Z1-23 (85DC)	Energy Savings Freq Ref Increase	Sets the value to add to the drive Frequency Reference when transferring to Bypass Energy Savings Mode. WARNING! Sudden Movement Hazard. This parameter can cause operation higher than the E1-04 [Maximum Output Frequency] setting of the drive. Note: Units, default, and range are different for different o1-03 [Frequency Display Unit Selection] values.	6.00 Hz (0.00 - 10.00 Hz)
Z1-24 (85DD)	Contactors Open Delay	Sets the time to delay after commanding the drive output contactor K2 or bypass contactor K3 or 2-Motor OR/AND contactors K4 and K5 to open to let the contacts open.	0.2 s (0.0 - 5.0 s)
Z1-25 (85DE)	Contactors Close Delay	Sets the time to delay after commanding the drive output contactor K2 or bypass contactor K3 or 2-Motor OR/AND contactors K4 and K5 to close to let the contacts close.	0.2 s (0.0 - 5.0 s)
Z1-27 (85E0)	Brownout Voltage Level	Sets the voltage level below which is a brownout condition. Note: Voltage level is measured on the output of the built-in 120 VAC control transformer.	98 V (0 - 150 V)
Z1-28 (85E1)	Brownout Detection Time	Sets the length of time that the Bypass voltage must be less than the Brownout Voltage Level before the Bypass will trigger a Brownout fault.	3.0 s (1.0 - 300.0 s)
Z1-29 (85E2)	Blackout Voltage Level	Sets the voltage level to determine a blackout condition. Use Z1-60 [Blackout Operation Select] to set power blackout behavior. Note: Voltage level is measured on the output of the built-in 120 VAC control transformer.	75 V (0 - 150 V)
Z1-31 (85E4)	Loss of Load Detection Select	Sets the function to detect loss of load. 0 : Disabled 1 : Enable and Fault 2 : Enable and Alarm	0 (0 - 2)
Z1-32 (85E5)	Loss of Load Drive Frequency	Sets the value to which the drive output frequency must be equal to or more than for the drive to detect a loss of load.	60.00 Hz (0.00 - Max Freq.)
Z1-33 (85E6)	Loss of Load Drive Out Current	For Drive Mode only, the drive output current must be less than this level to detect a Loss of Load condition.	0.0 A (0.0 - 999.9 A)
Z1-34 (85E7)	Loss of Load Drive Det Time	The loss of load conditions must be met for the length of time in this parameter before the bypass will detect a loss of load in Drive Mode.	1.0 s (0.0 - 300.0 s)
Z1-35 (85E8)	Loss of Load Bypass Current	For Bypass Mode only, the motor current must be less than this level to detect a Loss of Load condition.	0.0 A (0.0 - 999.9 A)
Z1-36 (85E9)	Loss of Load Bypass Det Time	The motor current must be less than the value set in Z1-35 [Loss of Load Bypass Current] for the length of time set in this parameter before the bypass will detect a loss of load in Bypass Mode.	1.0 s (0.0 - 300.0 s)
Z1-39 (85EC)	Drive/Bypass Source Select	Sets the function to select the Drive or the Bypass as the source of Drive/Bypass Mode selection. 0 : Keypad 1 : Digital Input 2 : Serial Communications 3 : Option PCB	0 (0 - 3)
Z1-40 (85ED)	Auto Transfer Delay Time	When you enable Auto Transfer and the bypass detects a drive fault, the bypass controller will wait for the length of time set in this parameter before it switches to bypass.	0.0 s (0.0 - 300.0 s)

9.16 Z: Bypass Parameters

No. (Hex.)	Name	Description	Default (Range)
Z1-42 (85EF)	Soft Starter Selection	<p>This parameter is normally set at the factory and does not require adjustment. Set this parameter when you use a soft starter used in bypass operation and when you will use the soft starter for a "soft stop".</p> <p>0 : Not Installed – Contactor Only 1 : Installed – Coast To Stop 2 : Installed – Ramp To Stop</p> <p>Note: When [Z1-42 = 1 or 2] to enable the soft starter: • The bypass automatically disables welded contactor detection. Parameter Z1-55 [Welded Contactor Detection] does not have an effect. • The bypass automatically sets Z2-08 = 29 [Digital Input 8 Function (TB2-8) = External Overload Motor 1 (NC)] and Z2-16 = 0 [Digital Input 8 Invert Select = Normal (Non-inverted)].</p> <p>When you change Z1-42 FROM 1 or 2 TO 0, the bypass does not automatically change Z2-08 and Z2-16 back to their default values. These parameters stay at their previous settings.</p> <p>When you use serial communications or an option card to set Z1-42, Z2-08 [Digital Input 8 Function (TB2-8)] and Z2-16 [Digital Input 8 Invert Select] will not change unless H5-11 = 1 [Comm ENTER Command Mode = ENTER Command Not Required].</p>	0 (0 - 2)
Z1-43 (85F0)	Soft Starter Delay Timer	<p>This parameter is normally set at the factory and does not require adjustment. Sets the delay time between closing contactor K3 and energizing the soft starter.</p> <p>Note: This parameter is enabled when Z1-42 = 1 or 2 [Soft Starter Selection = Installed - Coast To Stop or Installed - Ramp To Stop].</p>	2.0 s (0.0 - 60.0 s)
Z1-44 (85F1)	Soft Starter Rampdown Timeout	Sets the maximum wait time for the current to be less than 5% of E2-01 after removing the soft starter Run command.	15.0 s (1.0 - 60.0 s)
Z1-50 (85F7)	Bypass Input Phase Loss Level	<p>The bypass measures the current unbalance between phases to detect input phase loss. Usually it is not necessary to change this parameter.</p> <p>Sets the current level between phases in Bypass Mode.</p>	25.0% (5.0 - 50.0%)
Z1-51 (85F8)	Bypass Input Phase Loss Delay	<p>Sets the trip time for an input phase loss condition in Bypass Mode.</p> <p>Note: When you set this parameter to 0.0, it will disable bypass phase loss detection.</p>	5.0 s (0.0 - 30.0 s)
Z1-52 (85F9)	Input Phase Rotation Detection	<p>Sets bypass response when the Bypass Mode phase rotation is incorrect.</p> <p>0 : Disabled 1 : Alarm 2 : Fault</p>	0 (0 - 2)
Z1-53 (85FA)	Load Verify Detection	<p>Enables and disables verification that the motor is running when commanded to run.</p> <p>0 : Disabled 1 : Enabled</p>	0 (0, 1)
Z1-55 (85FC)	Welded Contactor Detection	<p>Enables and disables detection of K3 "welded contactor" condition.</p> <p>0 : Disabled 1 : Enabled</p> <p>Note: When Z1-42 = 1 or 2 [Soft Starter Selection = Installed – Coast To Stop or Installed – Ramp To Stop], the bypass will automatically disable welded contactor detection.</p>	0 (0, 1)
Z1-56 (85FD) RUN	Test Mode	<p>Sets the behavior of the drive input contactor K1 during Bypass Mode.</p> <p>0 : Drive Power Off during Bypass 1 : Drive Power On during Bypass</p>	0 (0, 1)
Z1-60 (8601)	Blackout Operation Select	<p>Sets bypass behavior when contactor voltage is less than Z1-29 [Blackout Voltage Level].</p> <p>0 : Fault 1 : Restart Delay with Speed Search 2 : Restart Delay from Zero Speed 3 : Disabled</p> <p>Note: Restart Delay works best when: • A keypad is connected • There is a good battery in the keypad • The date and time are set correctly in the keypad</p>	1 (0 - 3)
Z1-61 (8602)	Power Loss Restart Delay Time	Sets the time delay for restart. This parameter works together Z1-60 [Blackout Operation Select]	10 s (1 - 300 s)
Z1-70 (860B)	Green Contactor Mode	<p>Green Contactor Mode opens the output and motor contactors when the bypass unit is idle and does not have a Run command.</p> <p>0 : Disabled 1 : Enabled</p>	0 (0, 1)

No. (Hex.)	Name	Description	Default (Range)
Z1-94 (8623)	Current Transformer Turns	This parameter will indicate to the bypass controller how many times the motor leads pass through bypass current transformers. This parameter is typically set at the Yaskawa factory and does not require adjustment. Note: • This parameter is available in bypass software versions 0444 and later. • To display this parameter on the keypad, you must use drive model 4005. • If you set <i>A1-02</i> = 2220 to initialize, it will not reset this parameter. 0 : Automatic 1 : Force 1 Turn 2 : Force 2 Turns	0 (0 - 2)
Z1-98 (8627) Expert	Minimum Drive SW Ver	Only change this parameter under the guidance of Yaskawa technical support (1-800-YASKAWA). If you change this parameter incorrectly, it can cause incorrect operation of the bypass system. Bypass SW VST800440 : Default: 0 Bypass SW VST800441 : Default: 0 Bypass SW VST800442 : Default: 0 Bypass SW VST800443 : Default: 1013 Bypass SW VST800444 : Default: 1013 Bypass SW VST800445 : Default: 1013 Bypass SW VST800446 : Default: 1013 Bypass SW VST800447 : Default : 1013 Bypass SW VST800448 : Default : 1013	Depends on software version (00000 - 65535)
Z1-99 (8628) Expert	Maximum Drive SW Ver	Only change this parameter under the guidance of Yaskawa technical support (1-800-YASKAWA). If you change this parameter incorrectly, it can cause incorrect operation of the bypass system. Bypass SW VST800440 : Default: 1010 Bypass SW VST800441 : Default: 1011 Bypass SW VST800442 : Default: 1012 Bypass SW VST800443 : Default: 1013 Bypass SW VST800444 : Default: 1014 Bypass SW VST800445 : Default: 1015 Bypass SW VST800446 : Default: 1016 Bypass SW VST800447 : Default: 1017 Bypass SW VST800448 : Default: 1017	Depends on software version (00000 - 65535)

◆ Z2: Bypass Control Input/Output

No. (Hex.)	Name	Description	Default (Range)
Z2-01 (8563)	Digital Input 1 Function (TB2-1)	Sets the function for bypass digital input 1.	21 (0 - 47)
Z2-02 (8564)	Digital Input 2 Function (TB2-2)	Sets the function for bypass digital input 2.	22 (0 - 47)
Z2-03 (8565)	Digital Input 3 Function (TB2-3)	Sets the function for bypass digital input 3.	23 (0 - 47)
Z2-04 (8566)	Digital Input 4 Function (TB2-4)	Sets the function for bypass digital input 4.	24 (0 - 47)
Z2-05 (8567)	Digital Input 5 Function (TB2-5)	Sets the function for bypass digital input 5.	25 (0 - 47)
Z2-06 (8568)	Digital Input 6 Function (TB2-6)	Sets the function for bypass digital input 6.	0 (0 - 47)
Z2-07 (8569)	Digital Input 7 Function (TB2-7)	Sets the function for bypass digital input 7.	0 (0 - 47)
Z2-08 (856A)	Digital Input 8 Function (TB2-8)	Sets the function for bypass digital input 8.	0 (0 - 47)
Z2-09 (856B)	Digital Input 1 Invert Select	Inverts the output of the function selected in Digital Input 1. 0 : Normal (Non-inverted) 1 : Inverted	0 (0, 1)
Z2-10 (856C)	Digital Input 2 Invert Select	Inverts the output of the function selected in Digital Input 2. 0 : Normal (Non-inverted) 1 : Inverted	0 (0, 1)

9.16 Z: Bypass Parameters

No. (Hex.)	Name	Description	Default (Range)
Z2-11 (856D)	Digital Input 3 Invert Select	Inverts the output of the function selected in Digital Input 3. 0 : Normal (Non-inverted) 1 : Inverted	0 (0, 1)
Z2-12 (856E)	Digital Input 4 Invert Select	Inverts the output of the function selected in Digital Input 4. 0 : Normal (Non-inverted) 1 : Inverted	0 (0, 1)
Z2-13 (856F)	Digital Input 5 Invert Select	Inverts the output of the function selected in Digital Input 5. 0 : Normal (Non-inverted) 1 : Inverted	0 (0, 1)
Z2-14 (8570)	Digital Input 6 Invert Select	Inverts the output of the function selected in Digital Input 6. 0 : Normal (Non-inverted) 1 : Inverted	0 (0, 1)
Z2-15 (8571)	Digital Input 7 Invert Select	Inverts the output of the function selected in Digital Input 7. 0 : Normal (Non-inverted) 1 : Inverted	0 (0, 1)
Z2-16 (8572)	Digital Input 8 Invert Select	Inverts the output of the function selected in Digital Input 8. 0 : Normal (Non-inverted) 1 : Inverted	0 (0, 1)
Z2-23 (8579)	Digital Output 7 (TB1 1~3)	Sets the function for bypass digital output 7. Normally Open: TB1 - Terminals 2 and 3 Normally Closed: TB1 - Terminals 2 and 1	7 (0 - 99)
Z2-24 (857A)	Digital Output 8 (TB1 4~6)	Sets the function for bypass digital output 8. Normally Open: TB1 - Terminals 5 and 6 Normally Closed: TB1 - Terminals 5 and 4	10 (0 - 99)
Z2-25 (857B)	Digital Output 9 (TB1 7~9)	Sets the function for bypass digital output 9. Normally Open: TB1 - Terminals 8 and 9 Normally Closed: TB1 - Terminals 8 and 7	12 (0 - 99)
Z2-26 (857C)	Digital Output 10 (TB1 10~12)	Sets the function for bypass digital output 10. Normally Open: TB1 - Terminals 11 and 12 Normally Closed: TB1 - Terminals 11 and 10	15 (0 - 99)
Z2-30 (8580)	Analog Input Signal Level Select	Sets the input signal level for the analog input on the bypass control board A2 Terminal TB4-2. 0 : 0 to 10V (Lower Limit at 0) 2 : 4 to 20 mA 3 : 0 to 20 mA	0 (0 - 3)
Z2-32 (8582)	Analog Input Gain Setting	Sets the gain of the analog signal input to the analog input on the bypass control board A2 Terminal TB4-2..	100.0% (-999.9 - +999.9%)
Z2-33 (8583)	Analog Input Bias Setting	Sets the bias of the analog signal input to the analog input on the bypass control board A2 Terminal TB4-2.	0.0% (-999.9 - +999.9%)

■ Z2-xx: Digital Input Setting Values

Setting Value	Function	Description
0	Not Used	Use this setting for unused terminals or to use terminals in through mode.
1	Drive S1 Passthrough	Simulates a digital input on drive digital input terminal S1. Use H1-01 [Terminal S1 Function Selection] to program the function.
2	Drive S2 Passthrough	Simulates a digital input on drive digital input terminal S2. Use H1-02 [Terminal S2 Function Selection] to program the function.
3	Drive S3 Passthrough	Simulates a digital input on drive digital input terminal S3. Use H1-03 [Terminal S3 Function Selection] to program the function.
4	Drive S4 Passthrough	Simulates a digital input on drive digital input terminal S4. Use H1-04 [Terminal S4 Function Selection] to program the function.
5	Drive S5 Passthrough	Simulates a digital input on drive digital input terminal S5. Use H1-05 [Terminal S5 Function Selection] to program the function.
6	Drive S6 Passthrough	Simulates a digital input on drive digital input terminal S6. Use H1-06 [Terminal S6 Function Selection] to program the function.
7	Drive S7 Passthrough	Simulates a digital input on drive digital input terminal S7. Use H1-07 [Terminal S7 Function Selection] to program the function.
21	Run (AUTO)	Starts and stops the bypass.
22	Run Enable - Safety (NC)	Stops the bypass. Normally closed signal.
23	Run Interlock (BAS)	Stops the drive and triggers alarm AL02. Normally closed signal.

Setting Value	Function	Description
24	Remote Transfer to Bypass	Forces the bypass into Bypass Mode.
25	Emergency Override Bypass	Forces the bypass to operate in Bypass Mode.
26	Emergency Override Drive (FWD)	Forces the bypass to operate in the forward direction in Drive Mode.
27	Motor OR Select	Sets the command for the bypass to operate motor 1 or motor 2.
28	Motor AND Select	Sets the command for the bypass to operate motor 1 and motor 2 at the same time.
29	External Overload Motor 1 (NC)	Input for an external motor overload relay. Normally closed signal.
30	External Overload Motor 2 (NC)	Input for an external motor overload relay (Motor 2). Normally closed signal.
31	HAND Select	Selects HAND Mode from the digital inputs instead of the keypad.
32	AUTO Select	Selects AUTO Mode from the digital inputs instead of the keypad.
33	Drive/Bypass Select	Sets the bypass to operate in Bypass Mode or Drive Mode. ON : Bypass Mode is selected OFF : Drive Mode is selected
34	Fault Reset	Resets any faults that are present.
35	External Fault (EF0)	Forces the drive into an <i>EF0</i> fault condition.
36	External Fault (EFB)	Triggers external fault <i>EFB</i> on the bypass.
37	Run Reverse (AUTO)	Starts and stops the bypass in reverse.
38	Fire Stat Switch (NC)	Stops the drive from running and shows "Fire Stat" on the keypad.
39	Freeze Stat Switch (NC)	Stops the drive from running and shows "Freeze Stat" on the keypad.
40	Smoke Alarm (NC)	Stops the drive from running and shows "Smoke Alarm Active" on the keypad.
41	OverPressure Switch (NC)	Stops the drive from running and shows "Over Pressure Detected" on the keypad.
42	Low Suction Switch (NC)	Stops the drive from running and shows "Low Suction Detected" on the keypad.
43	Vibration Switch (NC)	Stops the drive from running and shows "Vibration Detected" on the keypad.
44	Emergency Override Drive (REV)	Forces the bypass to operate in Drive Mode in the reverse direction.
45	Serial Hardware Test (RS-485)	Sets the function for the bypass control to self-test the RS-485 serial communications operation.
46	Low City Pressure	Indicates that sufficient or insufficient pressure is present on the inlet to the pump. Used mainly for pressure booster situations.
47	Motor Preheat	Sets the command to apply the motor pre-heat current. Use <i>b2-09 [Pre-heat Current 2]</i> to adjust.

■ Z2-xx: Digital Output Setting Values

Setting Value	Function	Description
0	Serial Communication Control	Activates when <i>b1-01 = 2 [Frequency Reference Selection 1 = Serial Communications]</i> , and/or <i>b1-02 = 2 or 8 [Run Command Selection 1 = Serial Communications or AUTO Command + Serial Run]</i> to set the bypass for control by serial communications. Note: This does not apply when Option PCB-based serial communications control the bypass.
1	K1 Drive Input Contactor	Active when the K1 (Drive Input Power) contactor is energized.
2	K2 Drive Output Contactor	Active when the K2 (Drive Output) contactor is energized.
3	K3 Bypass Contactor	Active when the K3 (Bypass Run) contactor is energized.
4	K4 Motor 1 Contactor	Active when the K4 (Motor 1) contactor is energized.
5	K5 Motor 2 Contactor	Active when the K5 (Motor 2) contactor is energized.
6	READY	Active when the system is ready to operate. ON : System is ready to operate OFF : System is faulted, in Programming Mode, or one of the safety digital inputs is open
7	RUN Active	Active when the system is running in Drive Mode or Bypass Mode.
8	Drive RUN active	The digital output activates when the system is in Drive Mode and the HV600 drive is running. ON : Running in Drive Mode OFF : Not running or in Bypass Mode

9.16 Z: Bypass Parameters

Setting Value	Function	Description
9	Bypass RUN active	The digital output activates when the system is in Bypass Mode and is running. Contactor K3 is closed. ON : Running in Bypass Mode OFF : Not running or in Drive Mode
10	HAND mode Active	The digital output activates when the system is running in HAND Mode during Drive Mode and Bypass Mode. ON : Running in HAND Mode OFF : Not running or in AUTO Mode
11	OFF mode Active	The digital output activates when the HAND/OFF/AUTO selection is in OFF Mode or if system is faulted. It is also active when in Emergency Override Mode. ON : System is in OFF Mode or is faulted OFF : HAND Mode, AUTO Mode (even if not running), Emergency Override.
12	Auto mode Active	The digital output activates when the HAND/OFF/AUTO selection is in AUTO Mode. It will activate when the system is running and when the system is not running and in Drive Mode and Bypass Mode. ON : System is in AUTO Mode OFF : HAND Mode, OFF Mode, Faulted, Emergency Override
13	Drive Mode Selected	The digital output activates when Drive Mode is selected. It stays active during Remote Transfer to Bypass, Emergency Override Bypass, Energy Savings, Fault condition, and when the system is not running. ON : Drive Mode is selected OFF : Bypass Mode is selected
14	Bypass Mode Selected	The digital output activates when Bypass Mode is selected. It stays active during Emergency Override Drive, Fault condition, and when the system is not running. ON : Bypass Mode is selected OFF : Drive Mode is selected
15	Fault Active	Set when there is an active Drive fault or Bypass fault.
16	Drive Fault Active	There is a fault in the HV600 drive.
17	Bypass Fault Active	There is a fault in the bypass.
18	Auto Transfer Active	There is a drive fault that activated Auto Transfer to Bypass.
19	Serial Run Active	Serial Communications is commanding a RUN.
20	Damper Actuator Output	System commanded to RUN in Drive Mode or Bypass Mode.
21	ON Always	This digital output is always active.
22	Loss of Load Detected	The motor current is less than the set value/values.
23	Run Verify Active	The digital output closes when the drive or bypass output current is more than 10% of E2-01. The digital output opens when the drive or bypass output current is less than 5% of E2-01.
24	Soft Starter Run Command	Controls the Run command to the soft starter. Use Z1-42 to Z1-44 [<i>Soft Starter Selection to Soft Starter Rampdown Timeout</i>] to configure the soft starter. Use this setting when a soft-starter is part of the bypass package.
25	Safeties Closed	All of the programmed safety digital inputs are satisfied.
26	Mirror HV600 M1-M2	The digital output activates when the HV600 drive digital output (M1-M2) is closed. ON : Digital Output M1-M2 on HV600 is closed OFF : Digital Output M1-M2 on HV600 is open
27	Mirror HV600 M3-M4	The digital output activates when the HV600 drive digital output (M3-M4) is closed. ON : Digital Output M3-M4 on HV600 is closed OFF : Digital Output M3-M4 on HV600 is open
28	Mirror HV600 M5-M6	The digital output activates when the HV600 drive digital output (M5-M6) is closed. ON : Digital Output M5-M6 on HV600 is closed OFF : Digital Output M5-M6 on HV600 is open
99	Not Used	This setting allows serial communications to control the output.

◆ Z3: Bypass Control Serial Comm

No. (Hex.)	Name	Description	Default (Range)
Z3-12 (850B)	Network Digital Inputs	Enables and disables control of the digital inputs over a network. When this is enabled, it is not necessary to wire to the physical digital input. 0 : Disabled 1 : Enabled	0 (0, 1)
Z3-13 (850C)	BACnet Register Retention	Sets what to restore when you lose power then reapply power. WARNING! Sudden Movement Hazard. Clear all personnel from the drive, motor, and machine area before you reapply power. If you set this parameter to 2 or 3, the bypass unit can start before it receives a valid network message. Failure to obey can cause injury to personnel. 0 : Disabled 1 : Restore Frequency Reference Only 2 : Restore Commands Only 3 : Restore Commands and Freq Ref	0 (0 - 3)
Z3-16 (850F)	Apogee Run Enable LDO35	This parameter is applicable only when $H5-08 = 2$ [Communication Protocol Selection = Apogee/PI]. Sets whether the data in point LDO 35 will have an effect on the ability of the bypass to run. 0 : Disabled 1 : Enabled	0 (0, 1)

9.17 U: Monitors

◆ U1: Operation Status Monitors

No. (Hex.)	Name	Description	MFAO Signal Level
U1-01 (0040)	Frequency Reference (AI)	Shows the frequency reference value. Parameter <i>o1-03 [Keypad Display Unit Selection]</i> sets the display units. Unit: 0.01 Hz	10 V = Maximum frequency (0 V to +10 V)
U1-02 (0041)	Output Frequency	Shows the output frequency. Parameter <i>o1-03 [Keypad Display Unit Selection]</i> sets the display units. Unit: 0.01 Hz	10 V = Maximum frequency (0 V to +10 V)
U1-03 (0042)	Output Current	Shows the drive unit output current. The keypad shows the value of <i>U1-03</i> in amperes (A). When you use serial communications to show the monitor, the current is "8192 = drive rated current (A)". Use the formula: "Numerals being displayed / 8192 × drive rated current (A)" to use the serial communication current value shown in the monitor. Note: Use monitor <i>Ub-01</i> to show output current for both drive and bypass modes. Unit: Determined by the drive model. • 0.01 A: 2011 to 2046, 4005 to 4014 • 0.1 A: 2059 to 2273, 4021 to 4302	10 V = Drive rated current
U1-04 (0043)	Control Method	Shows the drive control method. 0 : V/f Control	No signal output available
U1-06 (0045)	Output Voltage Ref	Shows the output voltage reference. Unit: 0.1 V	208/240 V: 10 V = 200 Vrms 480 V: 10 V = 400 Vrms
U1-07 (0046)	DC Bus Voltage	Shows the DC bus voltage. Unit: 1 V	208/240 V: 10 V = 400 V 480 V: 10 V = 800 V
U1-08 (0047)	Output Power	Shows the internally-calculated output power. Unit: Determined by the drive model. • 0.01 kW: 2011 to 2046, 4005 to 4014 • 0.1 kW: 2059 to 2273, 4021 to 4302	10 V: Drive capacity (motor rated power) kW (-10 V to +10 V)
U1-10 (0049)	Input Terminal Status	Shows the status of the MFDI terminal where 1 = (ON) and 0 = (OFF). For example, <i>U1-10</i> shows "00000011" when terminals S1 and S2 are ON. bit0 : Terminal S1 (MFDI 1) bit1 : Terminal S2 (MFDI 2) bit2 : Terminal S3 (MFDI 3) bit3 : Terminal S4 (MFDI 4) bit4 : Terminal S5 (MFDI 5) bit5 : Terminal S6 (MFDI 6) bit6 : Terminal S7 (MFDI 7) bit7 : Not used (normal value of 0).	No signal output available
U1-11 (004A)	Output Terminal Status	Shows the status of the MFDO terminal where 1 = (ON) and 0 = (OFF). For example, <i>U1-11</i> shows "00000011" when terminals M1 and M3 are ON. Note: When <i>H2-xx = 100 to 1C4 [Inverse Output of Function]</i> , the monitor will show the value before inversion. bit 0 : Terminals M1-M2 bit 1 : Terminals M3-M4 bit 2 : Terminals M5-M6 bit 3 : Not used (normal value of 0). bit 4 : Not used (normal value of 0). bit 5 : Not used (normal value of 0). bit 6 : Not used (normal value of 0). bit 7 : Fault relay MA/MB-MC	No signal output available
U1-12 (004B)	Drive Status	Shows drive status where 1 = ON and 0 = OFF. For example, <i>U1-12</i> shows "00000101" during run with the Reverse Run command. bit0 : During Run bit1 : During zero-speed bit2 : During reverse bit3 : During fault reset signal input bit4 : During speed agreement bit5 : Drive ready bit6 : During minor fault detection bit7 : During fault detection	No signal output available

No. (Hex.)	Name	Description	MFAO Signal Level
U1-13 (004E)	Terminal A1 Level	Shows the signal level of terminal A1. Unit: 0.1%	10 V = 100% (0 V to +10 V)
U1-14 (004F)	Terminal A2 Level	Shows the signal level of terminal A2. Unit: 0.1%	10 V = 100% (0 V to +10 V)
U1-16 (0053)	SFS Output Frequency	Shows the output frequency after soft start. Shows the frequency with acceleration and deceleration times and S-curves. Parameter <i>o1-03 [Keypad Display Unit Selection]</i> sets the display units. Unit: 0.01 Hz	10 V = Maximum frequency (0 V to +10 V)
U1-18 (0061)	oPE Fault Parameter	Shows the parameter number that caused the <i>oPE02 [Parameter Range Setting Error]</i> or <i>oPE08 [Parameter Selection Error]</i> .	No signal output available
U1-19 (0066)	Serial Error Code	Shows the contents of the serial communication error where 1 = "error" and 0 = "no error". For example, <i>U1-19</i> shows "00000001" when there is a CRC error. bit0 : CRC Error bit1 : Data Length Error bit2 : Not used (normal value of 0). bit3 : Parity Error bit4 : Overrun Error bit5 : Framing Error bit6 : Timed Out bit7 : Not used (normal value of 0).	No signal output available
U1-25 (004D)	SoftwareNumber Flash	Shows the FLASH ID.	No signal output available
U1-26 (005B)	SoftwareNumber ROM	Shows the ROM ID.	No signal output available
U1-60 (1089)	System Setpoint	Shows the PID Setpoint. Unit: 0.01% Note: Parameters <i>b5-46 [PID Unit Display Selection]</i> , <i>b5-38 [PID User Unit Display Scaling]</i> , and <i>b5-39 [PID User Unit Display Digits]</i> set the unit, range, and resolution.	No signal output available
U1-61 (108A)	System Feedback	Shows the PID Feedback. Unit: 0.01% Note: Parameters <i>b5-46 [PID Unit Display Selection]</i> , <i>b5-38 [PID User Unit Display Scaling]</i> , and <i>b5-39 [PID User Unit Display Digits]</i> set the unit, range, and resolution.	No signal output available
U1-64 (108D)	Motor Speed	Shows the absolute value of the parameter <i>U1-02 [Output Frequency]</i> converted to RPM. Unit: 1 RPM	No signal output available
U1-99 (3BAE)	Anti-No-Flow Timer	Shows the value of the anti-no-flow timer. When this value is at the <i>Y2-24 [Anti-No-Flow Detection Time]</i> setting, the anti-no-flow feature starts to decrease the output frequency. Unit: 0.1 s	No signal output available

◆ U2: Fault Trace

No. (Hex.)	Name	Description	MFAO Signal Level
U2-01 (0080)	Current Fault	Shows the fault that the drive has when viewing the monitor.	No signal output available
U2-02 (0081)	Previous Fault	Shows the fault that occurred most recently.	No signal output available
U2-03 (0082)	Freq Reference@Fault	Shows the frequency reference at the fault that occurred most recently. Use <i>U1-01 [Frequency Reference]</i> to monitor the frequency reference value. Unit: 0.01 Hz	No signal output available
U2-04 (0083)	Output Freq @ Fault	Shows the output frequency at the fault that occurred most recently. Use <i>U1-02 [Output Frequency]</i> to monitor the actual output frequency. Unit: 0.01 Hz	No signal output available

9.17 U: Monitors

No. (Hex.)	Name	Description	MFAO Signal Level
U2-05 (0084)	Output Current@Fault	Shows the motor current at the fault that occurred most recently. Use <i>Ub-01 [Motor Current]</i> to monitor the output current. The keypad shows the value of <i>Ub-01</i> in amperes (A). When you use serial communications to show the monitor, the current is "8192 = drive rated current (A)". Use the formula: "Numerals being displayed / 8192 × drive rated current (A)" to use the serial communication current value shown in the monitor. Unit: Determined by the drive model. <ul style="list-style-type: none"> • 0.01 A: 2011 to 2046, 4005 to 4014 • 0.1 A: 2059 to 2273, 4021 to 4302 	No signal output available
U2-07 (0086)	Output Voltage@Fault	Shows the output voltage reference at the fault that occurred most recently. Use <i>U1-06 [Output Voltage Ref]</i> to monitor the output voltage reference. Unit: 0.1 V	No signal output available
U2-08 (0087)	DC Bus Voltage@Fault	Shows the DC bus voltage at the fault that occurred most recently. Use <i>U1-07 [DC Bus Voltage]</i> to monitor the DC bus voltage. Unit: 1 V	No signal output available
U2-09 (0088)	Output Power @ Fault	Shows the output power at the fault that occurred most recently. Use <i>U1-08 [Output Power]</i> to monitor the output power. Unit: 0.1 kW	No signal output available
U2-11 (008A)	Byp Inp Terminal Status @ Fault	Shows the status of the bypass digital input terminals at the most recent fault where 1 = (ON) and 0 = (OFF). For example, <i>U2-11</i> shows "00000011" when terminals TB2-1 and TB2-2 are ON. Use <i>Ub-02 [Bypass Digital Input Status]</i> to monitor the terminal status. <ul style="list-style-type: none"> bit 0 : Digital Input 1 (TB2-1) bit 1 : Digital Input 2 (TB2-2) bit 2 : Digital Input 3 (TB2-3) bit 3 : Digital Input 4 (TB2-4) bit 4 : Digital Input 5 (TB2-5) bit 5 : Digital Input 6 (TB2-6) bit 6 : Digital Input 7 (TB2-7) bit 7 : Digital Input 8 (TB2-8) 	No signal output available
U2-12 (008B)	Byp Relay Status @ Fault	Shows the status of the bypass digital output terminals at the most recent fault where 1 = (ON) and 0 = (OFF). For example, <i>U2-12</i> shows "00000011" when terminals M1 and M3 are ON. Use <i>Ub-02 [Bypass Digital Output Status]</i> to monitor the terminal status. <ul style="list-style-type: none"> bit 0 : K1 (Input Contactor) bit 1 : K2 (Output Contactor) bit 2 : K3 (Bypass Contactor) bit 3 : K4 (Motor 1 Output Contactor) bit 4 : K5 (Motor 2 Output Contactor) bit 5 : Fan Output Relay bit 6 : Digital Output 7 (TB1 1~3) (Z2-23) bit 7 : Digital Output 8 (TB1 4~6) (Z2-24) 	No signal output available
U2-13 (008C)	Bypass Status @ Fault	Shows the status of the bypass at the most recent fault where 1 = (ON) and 0 = (OFF). For example, <i>U2-13</i> shows "00000001" during run. Use <i>Ub-05 [Bypass Status 1]</i> to monitor the bypass. <ul style="list-style-type: none"> bit 0 : Hand Mode Active bit 1 : Off Mode Active bit 2 : Auto Mode Active bit 3 : Drive Mode bit 4 : Bypass Mode bit 5 : Emergency Override Bypass bit 6 : Emergency Override Drive bit 7 : Safety Open 	No signal output available
U2-14 (008D)	Elapsed Time @ Fault	Shows the cumulative operation time of the drive at the fault that occurred most recently. Use <i>U4-01 [Cumulative Ope Time]</i> to monitor the cumulative operation time. Unit: 1 h	No signal output available
U2-15 (07E0)	SFS Output @ Fault	Shows the output frequency after soft start at the fault that occurred most recently. Use <i>U1-16 [SFS Output Frequency]</i> to monitor the output frequency after soft start. Unit: 0.01 Hz	No signal output available
U2-16 (07E1)	q-Axis Current@Fault	Shows the q-Axis current of the motor at the fault that occurred most recently. Use <i>U6-01 [Iq Secondary Current]</i> to monitor the q-Axis current of the motor. Unit: 0.1 %	No signal output available

No. (Hex.)	Name	Description	MFAO Signal Level
U2-20 (008E)	Heatsink Temp @Fault	Shows the heatsink temperature at the fault that occurred most recently. Use U4-08 [Heatsink Temperature] to monitor the temperature of the heatsink. Unit: 1 °C	No signal output available
U2-30 (3008)	Fault 1 YYYY	Shows the year when the most recent fault occurred.	No signal output available
U2-31 (3009)	Fault 1 MMDD	Shows the month and day when the most recent fault occurred.	No signal output available
U2-32 (300A)	Fault 1 HHMM	Shows the time when the most recent fault occurred.	No signal output available

◆ U3: Fault History

No. (Hex.)	Name	Description	MFAO Signal Level
U3-01 (0090)	1st MostRecent Fault	Shows the fault history of the most recent fault. Note: The drive saves this fault history to two types of registers at the same time for serial communications.	No signal output available
U3-02 (0091)	2nd MostRecent Fault	Shows the fault history of the second most recent fault. Note: The drive saves this fault history to two types of registers at the same time for serial communications.	No signal output available
U3-03 (0092)	3rd MostRecent Fault	Shows the fault history of the third most recent fault. Note: The drive saves this fault history to two types of registers at the same time for serial communications.	No signal output available
U3-04 (0093)	4th MostRecent Fault	Shows the fault history of the fourth most recent fault. Note: The drive saves this fault history to two types of registers at the same time for serial communications.	No signal output available
U3-05 (0804)	5th MostRecent Fault	Shows the fault history of the fifth most recent fault.	No signal output available
U3-06 (0805)	6th MostRecent Fault	Shows the fault history of the sixth most recent fault.	No signal output available
U3-07 (0806)	7th MostRecent Fault	Shows the fault history of the seventh most recent fault.	No signal output available
U3-08 (0807)	8th MostRecent Fault	Shows the fault history of the eighth most recent fault.	No signal output available
U3-09 (0808)	9th MostRecent Fault	Shows the fault history of the ninth most recent fault.	No signal output available
U3-10 (0809)	10th MostRecentFault	Shows the fault history of the tenth most recent fault.	No signal output available
U3-11 (0094)	ElapsedTime@1stFault	Shows the cumulative operation time when the most recent fault occurred. Note: The drive saves this cumulative operation time to two types of registers at the same time for serial communications. Unit: 1 h	No signal output available
U3-12 (0095)	ElapsedTime@2ndFault	Shows the cumulative operation time when the second most recent fault occurred. Note: The drive saves this cumulative operation time to two types of registers at the same time for serial communications. Unit: 1 h	No signal output available
U3-13 (0096)	ElapsedTime@3rdFault	Shows the cumulative operation time when the third most recent fault occurred. Note: The drive saves this cumulative operation time to two types of registers at the same time for serial communications. Unit: 1 h	No signal output available

9.17 U: Monitors

No. (Hex.)	Name	Description	MFAO Signal Level
U3-14 (0097)	ElapsedTime@4thFault	Shows the cumulative operation time when the fourth most recent fault occurred. Note: The drive saves this cumulative operation time to two types of registers at the same time for serial communications. Unit: 1 h	No signal output available
U3-15 (080E)	ElapsedTime@5thFault	Shows the cumulative operation time when the fifth most recent fault occurred. Unit: 1 h	No signal output available
U3-16 (080F)	ElapsedTime@6thFault	Shows the cumulative operation time when the sixth most recent fault occurred. Unit: 1 h	No signal output available
U3-17 (0810)	ElapsedTime@7thFault	Shows the cumulative operation time when the seventh most recent fault occurred. Unit: 1 h	No signal output available
U3-18 (0811)	ElapsedTime@8thFault	Shows the cumulative operation time when the eighth most recent fault occurred. Unit: 1 h	No signal output available
U3-19 (0812)	ElapsedTime@9thFault	Shows the cumulative operation time when the ninth most recent fault occurred. Unit: 1 h	No signal output available
U3-20 (0813)	ElapsedTime@10 Fault	Shows the cumulative operation time when the tenth most recent fault occurred. Unit: 1 h	No signal output available
U3-21 (300B)	Fault 1 YYYY	Shows the year when the most recent fault occurred.	No signal output available
U3-22 (300C)	Fault 1 MMDD	Shows the month and day when the most recent fault occurred.	No signal output available
U3-23 (300D)	Fault 1 HHMM	Shows the time when the most recent fault occurred.	No signal output available
U3-24 (300E)	Fault 2 YYYY	Shows the year when the second most recent fault occurred.	No signal output available
U3-25 (300F)	Fault 2 MMDD	Shows the month and day when the second most recent fault occurred.	No signal output available
U3-26 (3010)	Fault 2 HHMM	Shows the time when the second most recent fault occurred.	No signal output available
U3-27 (3011)	Fault 3 YYYY	Shows the year when the third most recent fault occurred.	No signal output available
U3-28 (3012)	Fault 3 MMDD	Shows the month and day when the third most recent fault occurred.	No signal output available
U3-29 (3013)	Fault 3 HHMM	Shows the time when the third most recent fault occurred.	No signal output available
U3-30 (3014)	Fault 4 YYYY	Shows the year when the fourth most recent fault occurred.	No signal output available
U3-31 (3015)	Fault 4 MMDD	Shows the month and day when the fourth most recent fault occurred.	No signal output available
U3-32 (3016)	Fault 4 HHMM	Shows the time when the fourth most recent fault occurred.	No signal output available
U3-33 (3017)	Fault 5 YYYY	Shows the year when the fifth most recent fault occurred.	No signal output available
U3-34 (3018)	Fault 5 MMDD	Shows the month and day when the fifth most recent fault occurred.	No signal output available
U3-35 (3019)	Fault 5 HHMM	Shows the time when the fifth most recent fault occurred.	No signal output available
U3-36 (301A)	Fault 6 YYYY	Shows the year when the sixth most recent fault occurred.	No signal output available
U3-37 (301B)	Fault 6 MMDD	Shows the month and day when the sixth most recent fault occurred.	No signal output available
U3-38 (301C)	Fault 6 HHMM	Shows the time when the sixth most recent fault occurred.	No signal output available
U3-39 (301D)	Fault 7 YYYY	Shows the year when the seventh most recent fault occurred.	No signal output available

No. (Hex.)	Name	Description	MFAO Signal Level
U3-40 (301E)	Fault 7 MMDD	Shows the month and day when the seventh most recent fault occurred.	No signal output available
U3-41 (301F)	Fault 7 HHMM	Shows the time when the seventh most recent fault occurred.	No signal output available
U3-42 (3020)	Fault 8 YYYY	Shows the year when the eighth most recent fault occurred.	No signal output available
U3-43 (3021)	Fault 8 MMDD	Shows the month and day when the eighth most recent fault occurred.	No signal output available
U3-44 (3022)	Fault 8 HHMM	Shows the time when the eighth most recent fault occurred.	No signal output available
U3-45 (3023)	Fault 9 YYYY	Shows the year when the ninth most recent fault occurred.	No signal output available
U3-46 (3024)	Fault 9 MMDD	Shows the month and day when the ninth most recent fault occurred.	No signal output available
U3-47 (3025)	Fault 9 HHMM	Shows the time when the ninth most recent fault occurred.	No signal output available
U3-48 (3026)	Fault 10 YYYY	Shows the year when the tenth most recent fault occurred.	No signal output available
U3-49 (3027)	Fault 10 MMDD	Shows the month and day when the tenth most recent fault occurred.	No signal output available
U3-50 (3028)	Fault 10 HHMM	Shows the time when the tenth most recent fault occurred.	No signal output available

◆ U4: Maintenance Monitors

No. (Hex.)	Name	Description	MFAO Signal Level
U4-01 (004C)	Cumulative Ope Time	Shows the cumulative operation time of the drive. Use parameter <i>o4-01 [Elapsed Operating Time Setting]</i> to reset this monitor. Use parameter <i>o4-02 [Elapsed Operating Time Selection]</i> to select the cumulative operation times from: <ul style="list-style-type: none"> The time from when the drive is energized until it is de-energized. The time at which the Run command is turned ON. The maximum value that the monitor will show is <i>99999</i> . After this value is more than <i>99999</i> , the drive automatically resets it and starts to count from <i>0</i> again. Unit: 1 h Note: The MEMOBUS/Modbus communication data is shown in 10 h units.	10 V: 99999 h
U4-02 (0075)	Num of Run Commands	Shows how many times that the drive has received a Run command. Use parameter <i>o4-13 [RUN Command Counter @ Initialize]</i> to reset this monitor. The maximum value that the monitor will show is <i>65535</i> . After this value is more than <i>65535</i> , the drive automatically resets it and starts to count from <i>0</i> again. Unit: 1	10 V: 65535 times
U4-03 (0067)	Cooling Fan Ope Time	Shows the cumulative operation time of the cooling fans. Use parameter <i>o4-03 [Fan Operation Time Setting]</i> to reset this monitor. The maximum value that the monitor will show is <i>99999</i> . After this value is more than <i>99999</i> , the drive automatically resets it and starts to count from <i>0</i> again. Unit: 1 h Note: The MEMOBUS/Modbus communication data is shown in 10 h units. Use register 009BH for data in 1 h units.	10 V: 99999 h
U4-04 (007E)	Cool Fan Maintenance	Shows the cumulative operation time of the cooling fans as a percentage of the replacement life of the cooling fans. Use parameter <i>o4-03 [Fan Operation Time Setting]</i> to reset this monitor. Unit: 1% Note: Replace the cooling fans when this monitor is 90%.	10 V: 100%

9.17 U: Monitors

No. (Hex.)	Name	Description	MFAO Signal Level
U4-05 (007C)	CapacitorMaintenance	Shows the operation time of the electrolytic capacitors for the main circuit and control circuit as a percentage of the replacement life of the electrolytic capacitors. Use parameter <i>o4-05 [Capacitor Maintenance Setting]</i> to reset this monitor. Unit: 1% Note: Replace the electrolytic capacitor when this monitor is 90%.	10 V: 100%
U4-06 (07D6)	PreChargeRelayMainte	Shows the operation time of the soft charge bypass relay as a percentage of the replacement life of the soft charge bypass relay. Use parameter <i>o4-07 [Softcharge Relay Maintenance Set]</i> to reset this monitor. Unit: 1% Note: Replace the drive when this monitor is 90%.	10 V: 100%
U4-07 (07D7)	IGBT Maintenance	Shows the operation time of the IGBTs as a percentage of the replacement life of the IGBTs. Set parameter <i>o4-09 [IGBT Maintenance Setting]</i> to reset this monitor. Unit: 1% Note: Replace the drive when this monitor is 90%.	10 V: 100%
U4-08 (0068)	Heatsink Temperature	Shows the heatsink temperature of the drive. Unit: 1 °C	10 V: 100 °C
U4-09 (005E)	LED Check	Turns on the LED Status Ring and all of the keypad LEDs to make sure that the LEDs operate correctly. 1. Set <i>o2-24 = 0 [LED Light Function Selection = Enable Status Ring & Keypad LED]</i> . 2. Push  with <i>U4-09</i> shown on the keypad. All LEDs on the keypad and LED Status Ring will turn on. Note: When Safety input 2 CH is open (STo), READY will flash.	No signal output available
U4-10 (005C)	kWh, Lower 4 Digits	Shows the lower 4 digits of the watt hour value for the drive. Unit: 1 kWh Note: The watt hour is displayed in 9 digits. Monitor <i>U4-11 [kWh, Upper 5 Digits]</i> shows the upper 5 digits and <i>U4-10</i> shows the lower 4 digits. Example for 12345678.9 kWh: <i>U4-10: 678.9 kWh</i> <i>U4-11: 12345 MWh</i>	No signal output available
U4-11 (005D)	kWh, Upper 5 Digits	Shows the upper 5 digits of the watt hour value for the drive. Unit: 1 MWh Note: Monitor <i>U4-11</i> shows the upper 5 digits and <i>U4-10 [kWh, Lower 4 Digits]</i> shows the lower 4 digits. Example for 12345678.9 kWh: <i>U4-10: 678.9 kWh</i> <i>U4-11: 12345 MWh</i>	No signal output available
U4-13 (07CF)	Peak Hold Current	Shows the hold value of the peak value (rms) for the drive output current. Use <i>U4-14 [PeakHold Output Freq]</i> to show the drive output frequency at the time that the drive holds the output current. The drive will hold the peak hold current at the next start up and restart of the power supply. The drive keeps the held value during baseblock (during stop). The keypad shows the value of <i>U4-13</i> in amperes (A). When you use serial communications to show the monitor, the current is "8192 = drive rated current (A)." Use the formula: "Numerals being displayed / 8192 × drive rated current (A)" to use the serial communication current value shown in the monitor. Unit: Determined by the drive model. • 0.01 A: 2011 to 2046, 4005 to 4014 • 0.1 A: 2059 to 2273, 4021 to 4302	No signal output available
U4-14 (07D0)	PeakHold Output Freq	Shows the output frequency at which the peak value (rms) of the drive output current is held. The peak hold current can be monitored by <i>U4-13 [Peak Hold Current]</i> . The peak hold output frequency will be cleared at the next startup and restart of the power supply. The drive keeps the value that was under hold during baseblock (during stop). Unit: 0.01 Hz	No signal output available
U4-16 (07D8)	Motor oL1 Level	Shows the integrated value of <i>oL1 [Motor Overload]</i> as a percentage of <i>oL1</i> detection level. Unit: 0.1%	10 V: 100%

No. (Hex.)	Name	Description	MFAO Signal Level
U4-18 (07DA)	Reference Source	Shows the selected frequency reference source. The keypad shows the frequency reference source as "XY-nn" as specified by these rules: X: Frequency reference <ul style="list-style-type: none"> • 1: b1-01 [Frequency Reference Selection 1] Y-nn: Frequency reference source <ul style="list-style-type: none"> • 0-01: Keypad (d1-01 [Reference 1]) • 1-00: Analog input (unassigned) • 1-01: MFAI terminal A1 • 1-02: MFAI terminal A2 • 2-02 to 2-17: Multi-step speed reference (d1-02 to d1-17 [Reference 2 to 8, Jog Reference]) • 3-01: Serial communications • 4-01: Communication option card • 7-01: Reserved • 9-01: Reserved • B-00: Hand Reference 1 (Analog) • B-01: Hand Reference 1 (S5-05 [HAND Frequency Reference]) 	No signal output available
U4-19 (07DB)	Modbus FreqRef (dec)	Shows the frequency reference sent to the drive from the MEMOBUS/Modbus communications as a decimal. Unit: 0.01%	10 V: Maximum frequency (0 V to +10 V)
U4-20 (07DC)	Option Freq Ref (dec)	Shows the frequency reference sent to the drive from the communication option as a decimal.	10 V: Maximum frequency (0 V to +10 V)
U4-21 (07DD)	Run Command Source	Shows the selected Run command source. The keypad shows the Run command source as "XY-nn" as specified by these rules: X: Run command <ul style="list-style-type: none"> • 0: OFF • 1: AUTO • 2: HAND • 3: JOG, Emergency Override Y: Run command source <ul style="list-style-type: none"> • 0: Keypad • 1: Control circuit terminal • 3: Serial communications • 4: Communication option card • 7: Reserved nn: Run command limit status data <ul style="list-style-type: none"> • 00: No limit status. • 01: The Run command stayed ON when the drive stopped in Programming Mode. • 03: The Run command is in standby after the drive was energized until the soft charge bypass contactor turns ON. Note: The drive will detect $Uv1$ [DC Bus Undervoltage] or Uv [Undervoltage] if the soft charge bypass contactor does not turn ON after 10 s. <ul style="list-style-type: none"> • 04: Will not restart after run stop. • 05: An MFDI terminal caused a Fast stop or you pushed  on the keypad to ramp the motor to stop. • 06: $b1-17 = 0$ [Run Command at Power Up = Disregard Existing RUN Command]. • 07: During baseblock while coast with timer. • 08: Frequency reference is less than $E1-09$ [Minimum Output Frequency] during baseblock. • 09: Waiting for the Enter command from PLC. 	No signal output available

9.17 U: Monitors

No. (Hex.)	Name	Description	MFAO Signal Level
U4-22 (07DE)	Modbus CmdData (hex)	Shows the operation signal (register 0001H) sent to the drive from MEMOBUS/Modbus communications as a 4-digit hexadecimal number (zero suppress). The keypad shows the operation signal as specified by these rules: bit 0 : Forward run/Stop bit 1 : Reverse run/Stop bit 2 : External fault bit 3 : Fault Reset bit 4 : Multi-function input 1 bit 5 : Multi-function input 2 bit 6 : Multi-function input 3 bit 7 : Multi-function input 4 bit 8 : Multi-function input 5 bit 9 : Multi-function input 6 bit A : Multi-function input 7 bit B : Not used (normal value of 0). bit C : Not used (normal value of 0). bit D : Not used (normal value of 0). bit E : Not used (normal value of 0). bit F : Not used (normal value of 0).	No signal output available
U4-23 (07DF)	Option CmdData (hex)	Shows the operation signal (register 0001H) sent to the drive from MEMOBUS/Modbus communications as a 4-digit hexadecimal number. The keypad shows the operation signal as specified by these rules: bit 0 : Forward run/Stop bit 1 : Reverse run/Stop bit 2 : External fault bit 3 : Fault Reset bit 4 : Multi-function input 1 bit 5 : Multi-function input 2 bit 6 : Multi-function input 3 bit 7 : Multi-function input 4 bit 8 : Multi-function input 5 bit 9 : Multi-function input 6 bit A : Multi-function input 7 bit B : Not used (normal value of 0). bit C : Not used (normal value of 0). bit D : Not used (normal value of 0). bit E : Not used (normal value of 0). bit F : Not used (normal value of 0).	No signal output available
U4-24 (07E6)	Number of Runs (Low)	Shows the lower 4 digits of the drive run count. Note: The drive run count is an 8-digit number. Monitor <i>U4-25 [Number of Runs(High)]</i> shows the upper 4 digits and <i>U4-24</i> shows the lower 4 digits.	No signal output available
U4-25 (07E7)	Number of Runs(High)	Shows the lower 4 digits of the drive run count. Note: The drive run count is an 8-digit number. Monitor <i>U4-25</i> shows the upper 4 digits and <i>U4-24 [Number of Runs (Low)]</i> shows the lower 4 digits.	No signal output available
U4-61 (3096) Expert	Total EMOVR Run Time	Shows the length of time that the drive operated in Emergency Override Mode. Unit: 1 min Note: • The maximum value is 60,000 min. • This monitor does not accumulate operation time when <i>S6-07 = 1 [EMOVR Fault Suppression Mode = Test Mode]</i> .	No signal output available
U4-75 (1BC4)	Comm Option Type	Displays the Hex address of the communication option currently connected to the bypass. 1: Modbus TCP/IP (SI-EM3) 2: EtherNet/IP (SI-EN3) or PROFINET (SI-EP3) 11: LonWorks (SI-W3) 70: No Protocol Selected (JOHB-SMP3) 71: Modbus TCP/IP (JOHB-SMP3) 72: EtherNet/IP (JOHB-SMP3) 75: BACnet/IP (JOHB-SMP3) 78: PROFINET (JOHB-SMP3) FF: No option connected	No signal output available
U4-76 (1BC5)	MAC Address1 1, 2	Displays the first and second octets of MAC address 1. Note: When you use a communication option other than JOHB-SMP3, this monitor shows "00-00".	No signal output available

No. (Hex.)	Name	Description	MFAO Signal Level
U4-77 (1BC6)	MAC Address1 3, 4	Displays the third and fourth octets of MAC address 1. Note: When you use a communication option other than JOHB-SMP3, this monitor shows "00-00".	No signal output available
U4-78 (1BC7)	MAC Address1 5, 6	Displays the fifth and sixth octets of MAC address 1. Note: When you use a communication option other than JOHB-SMP3, this monitor shows "00-00".	No signal output available
U4-79 (1BC8) Expert	MAC Address2 1, 2	Displays the first and second octets of MAC address 2. Note: When you use a communication option other than JOHB-SMP3, this monitor shows "00-00".	No signal output available
U4-80 (1BC9) Expert	MAC Address2 3, 4	Displays the third and fourth octets of MAC address 2. Note: When you use a communication option other than JOHB-SMP3, this monitor shows "00-00".	No signal output available
U4-81 (1BCA) Expert	MAC Address2 5, 6	Displays the fifth and sixth octets of MAC address 2. Note: When you use a communication option other than JOHB-SMP3, this monitor shows "00-00".	No signal output available
U4-82 (1BCB) Expert	MAC Address3 1, 2	Displays the first and second octets of MAC address 3. Note: When you use a communication option other than JOHB-SMP3, this monitor shows "00-00".	No signal output available
U4-83 (1BCC) Expert	MAC Address3 3, 4	Displays the third and fourth octets of MAC address 3. Note: When you use a communication option other than JOHB-SMP3, this monitor shows "00-00".	No signal output available
U4-84 (1BCD) Expert	MAC Address3 5, 6	Displays the fifth and sixth octets of MAC address 3. Note: When you use a communication option other than JOHB-SMP3, this monitor shows "00-00".	No signal output available

◆ U5: PID Monitors

No. (Hex.)	Name	Description	MFAO Signal Level
U5-01 (0057)	PID Feedback	Shows the PID control feedback value. Unit: 0.01% Note: Parameters <i>b5-46 [PID Unit Display Selection]</i> , <i>b5-38 [PID User Unit Display Scaling]</i> , and <i>b5-39 [PID User Unit Display Digits]</i> set the unit, range, and resolution.	10 V = Maximum frequency (-10 V to +10 V)
U5-02 (0063)	PID Input	Shows the change between the PID setpoint and PID feedback (the quantity of PID input) as a percentage of the maximum output frequency. Unit: 0.01%	10 V: Maximum frequency (0 V to +10 V)
U5-03 (0064)	PID Output	Shows the PID control output as a percentage of the maximum output frequency. Unit: 0.01%	10 V: Maximum frequency (0 V to +10 V)
U5-04 (0065)	PID Setpoint	Shows the PID setpoint. Unit: 0.01% Note: Parameters <i>b5-46 [PID Unit Display Selection]</i> , <i>b5-38 [PID User Unit Display Scaling]</i> , and <i>b5-39 [PID User Unit Display Digits]</i> set the unit, range, and resolution.	10 V = Maximum frequency (-10 V to +10 V)
U5-05 (07D2)	PID DifferentialFdbk	Shows the PID differential feedback value as a percentage of the maximum output frequency. This monitor is available after you set <i>H3-02</i> or <i>H3-10 = 16 [Terminal A1/A2 Function Selection = Differential PID Feedback]</i> . Unit: 0.01%	10 V = Maximum frequency (-10 V to +10 V)
U5-06 (07D3)	PID FdbkDif PID Fdbk	Shows the difference from calculating " <i>U5-05 [PID DifferentialFdbk] - U5-01 [PID Feedback]</i> ". Unit: 0.01% Note: <i>U5-01 [PID Feedback] = U5-06</i> when <i>H3-02</i> or <i>H3-10 ≠ 16 [Terminal A1/A2 Function Selection ≠ Differential PID Feedback]</i> .	10 V = Maximum frequency (-10 V to +10 V)
U5-07 (0072)	AUTO Mode Freq Ref	Shows the Frequency reference value at AUTO Mode. Unit: 0.01 Hz Note: Parameter <i>o1-03 [Frequency Display Unit Selection]</i> sets the display unit.	No signal output available

9.17 U: Monitors

No. (Hex.)	Name	Description	MFAO Signal Level
U5-08 (0073)	HAND Mode Freq Ref	Shows the Frequency reference value at HAND Mode. Unit: 0.01 Hz Note: Parameter <i>o1-03 [Frequency Display Unit Selection]</i> sets the display unit.	No signal output available
U5-14 (086B)	PID Out2 Upr4 Digits	Shows the custom PI output. Monitor <i>U5-14</i> shows the upper four digits and <i>U5-15 [PID Out2 Lwr4 Digits]</i> shows the lower four digits. The drive uses <i>b5-43 [PID Out2 Monitor MAX Upper4 Dig]</i> and <i>b5-44 [PID Out2 Monitor MAX Lower4 Dig]</i> to scale the monitors. Unit: 1 Note: Parameter <i>b5-41 [PID Output 2 Unit]</i> sets the display unit.	10 V = b5-43 × 10000
U5-15 (086C)	PID Out2 Lwr4 Digits	Shows the custom PI output. Monitor <i>U5-14</i> shows the upper four digits and <i>U5-15 [PID Out2 Lwr4 Digits]</i> shows the lower four digits. The drive uses <i>b5-43 [PID Out2 Monitor MAX Upper4 Dig]</i> and <i>b5-44 [PID Out2 Monitor MAX Lower4 Dig]</i> to scale the monitors. Unit: 0.01 Note: Parameter <i>b5-41 [PID Output 2 Unit]</i> sets the display unit.	b5-43 > 0: 10 V = 10000 b5-43 = 0: 10 V = b5-44
U5-16 (086D)	PI Aux Ctrl Feedback	Shows the PI Auxiliary Control Feedback level from the terminal set for <i>H3-xx = 27 [PI Auxiliary Control Feedback]</i> . Unit: PSI Note: Parameters <i>YF-21 [PI Aux Ctrl Level Unit Selection]</i> and <i>YF-22 [PI Aux Level Decimal Place Pos]</i> set the unit and resolution.	No signal output available
U5-17 (086E)	PI2 Control Setpoint	Shows the PI2 Control setpoint. Note: Parameters <i>S3-04 [PI2 Control Unit Selection]</i> and <i>S3-03 [PI2 Control Decimal Place Pos]</i> set the unit and resolution.	10 V = S3-02
U5-18 (086F)	PI2 Control Feedback	Shows the PI2 Control Feedback Level from the terminal set for <i>H3-xx = 26 [PI2 Control Feedback]</i> . Note: Parameters <i>S3-04 [PI2 Control Unit Selection]</i> and <i>S3-03 [PI2 Control Decimal Place Pos]</i> set the unit and resolution.	10 V = S3-02
U5-19 (0870)	PI2 Control Input	Shows the PI2 Control input (deviation between PI target and feedback). Note: Parameters <i>S3-04 [PI2 Control Unit Selection]</i> and <i>S3-03 [PI2 Control Decimal Place Pos]</i> set the unit and resolution.	10 V = S3-02
U5-20 (0871)	PI2 Control Output	Shows the PI2 Control output. Note: • Parameters <i>S3-04 [PI2 Control Unit Selection]</i> and <i>S3-03 [PI2 Control Decimal Place Pos]</i> set the unit and resolution. • The drive operation while <i>H1-xx = A8 or 1A8 [PI2 Control Disable]</i> changes when the <i>S3-12 [PI2 Control Disable Mode Sel]</i> setting changes.	10 V = S3-02
U5-30 (3000)	Time Hr Min HHMM	Shows the current time (Hours and Minutes).	No signal output available
U5-31 (3001)	Date Year	Shows the current year.	No signal output available
U5-32 (3002)	Date Mo Day MMDD	Shows the current date (Month and Date).	No signal output available
U5-33 (3003)	Date Week	Shows the current date of the week. bit 0 : Sunday bit 1 : Monday bit 2 : Tuesday bit 3 : Wednesday bit 4 : Thursday bit 5 : Friday bit 6 : Saturday bit 7 : Not used (normal value of 0).	No signal output available

No. (Hex.)	Name	Description	MFAO Signal Level
U5-79 (3B9A)	PID Feedback Backup	Shows the <i>PID Feedback Backup</i> [H3-xx = 24] signal that the drive uses when it loses the <i>PID Feedback</i> [H3-xx = B]. Unit: 0.01% Note: Display unit and scaling are dependent on System Units.	No signal output available
U5-81 (3B9C)	Diff Level Source	Shows the Differential Feedback signal from the terminal set for H3-xx = 2D [Differential Level Source]. Unit: 0.00% Note: Unit and display scaling are dependent on System Units.	No signal output available
U5-99 (1599)	Setpoint	Shows the PID setpoint command. Unit: 0.01% Note: Parameters b5-46 [PID Unit Display Selection], b5-38 [PID User Unit Display Scaling], and b5-39 [PID User Unit Display Digits] set the unit, range, and resolution.	10 V = Maximum frequency (-10 V to +10 V)

◆ U6: Operation Status Monitors

No. (Hex.)	Name	Description	MFAO Signal Level
U6-01 (0051)	Iq Secondary Current	Shows the value calculated for the motor secondary current (q-Axis) as a percentage of the motor rated secondary current. Unit: 0.1%	10 V: Motor secondary rated current (0 V to +10 V)
U6-17 (07D1) Expert	Energy Save Coeff	Shows the total time of direction of motor rotation detections for Speed Estimation Speed Searches. This value adjusts b3-26 [Direction Determination Level]. Note: Upper limit is +32767 and lower limit is -32767.	No signal output available
U6-21 (07D5)	Offset Frequency	Shows the total value of d7-01 to d7-03 [Offset Frequency 1 to 3] selected with Add Offset Frequency 1 to 3 [H1-xx = 44 to 46]. Unit: 0.1%	10 V: Maximum Frequency
U6-31 (007B)	TorqueDetect Monitor	Monitors the torque reference or the output current after applying the filter. Unit: 0.1%	10 V:100%
U6-36 (0720) Expert	Comm Errors-Host	Shows the number of inter-CPU communication errors. When you de-energize the drive, this value resets to 0.	No signal output available
U6-37 (0721) Expert	Comm Errors-Sensor	Shows the number of inter-CPU communication errors. When you de-energize the drive, this value resets to 0.	No signal output available
U6-80 (07B0)	Option IP Address 1	Shows the currently available local IP Address (1st octet).	No signal output available
U6-81 (07B1)	Option IP Address 2	Shows the currently available local IP Address (2nd octet).	No signal output available
U6-82 (07B2)	Option IP Address 3	Shows the currently available local IP Address (3rd octet).	No signal output available
U6-83 (07B3)	Option IP Address 4	Shows the currently available local IP Address (4th octet).	No signal output available
U6-84 (07B4)	Online Subnet 1	Shows the currently available subnet mask (1st octet).	No signal output available
U6-85 (07B5)	Online Subnet 2	Shows the currently available subnet mask (2nd octet).	No signal output available
U6-86 (07B6)	Online Subnet 3	Shows the currently available subnet mask (3rd octet).	No signal output available
U6-87 (07B7)	Online Subnet 4	Shows the currently available subnet mask (4th octet).	No signal output available
U6-88 (07B8)	Online Gateway 1	Shows the currently available Gateway address (1st octet).	No signal output available
U6-89 (07B9)	Online Gateway 2	Shows the currently available Gateway address (2nd octet).	No signal output available

No. (Hex.)	Name	Description	MFAO Signal Level
U6-90 (07F0)	Online Gateway 3	Shows the currently available Gateway address (3rd octet).	No signal output available
U6-91 (07F1)	Online Gateway 4	Shows the currently available Gateway address (4th octet).	No signal output available
U6-92 (07F2)	Online Speed	Shows the currently available communications speed. 10: 10 Mbps 100: 100 Mbps	No signal output available
U6-93 (07F3)	Online Duplex	Shows the currently available Duplex setting.	No signal output available
U6-98 (07F8)	First Fault	Shows the contents of the most recent communication options fault (Modbus TCP/IP, EtherNet/IP).	No signal output available
U6-99 (07F9)	Current Fault	Shows the contents of current fault from communication options (Modbus TCP/IP, EtherNet/IP).	No signal output available

◆ Ub: Bypass Control Monitors

No. (Hex.)	Name	Description	MFAO Signal Level
Ub-01 (8780)	Motor Current	Format is XXX.X amps. The number of decimal places depends on drive kVA rating. Unit: Amp	No signal output available
Ub-02 (8781)	Bypass Digital Input Status	View status of bypass digital inputs XXXXXXXX Where X = 0 (not asserted) or 1 (asserted) The right-most digit is the status of digital input 1. This monitor will show the digital input status and any digital input forced to "ON" over serial communications. Unit: - bit 0 : Digital Input 1 (TB2-1) bit 1 : Digital Input 2 (TB2-2) bit 2 : Digital Input 3 (TB2-3) bit 3 : Digital Input 4 (TB2-4) bit 4 : Digital Input 5 (TB2-5) bit 5 : Digital Input 6 (TB2-6) bit 6 : Digital Input 7 (TB2-7) bit 7 : Digital Input 8 (TB2-8)	No signal output available
Ub-03 (8782)	Bypass Digital Output Status	View status of bypass digital outputs XXXXXXXX Where X = 0 (not asserted) or 1 (asserted) The right-most digit is the status of K1 (Input Contactor). Unit: - bit 0 : K1 (Input Contactor) bit 1 : K2 (Output Contactor) bit 2 : K3 (Bypass Contactor) bit 3 : K4 (Motor 1 Output Contactor) bit 4 : K5 (Motor 2 Output Contactor) bit 5 : Fan Output Relay bit 6 : Digital Output 7 (TB1 1-3) (Z2-23) bit 7 : Digital Output 8 (TB1 4-6) (Z2-24) bit 8 : Digital Output 9 (TB1 7-9) (Z2-25) bit 9 : Digital Output 10 (TB1 10-12) (Z2-26) bit 10, 11 : Reserved	No signal output available
Ub-04 (8783)	Bypass Dig Out Status D09/D10	View status of bypass digital outputs XXXXXXXX Where X = 0 (not asserted) or 1 (asserted) The right-most digit is the status of digital output 9. Unit: - bit 0 : Digital Output 9 (TB1 7-9) (Z2-25) bit 1 : Digital Output 10 (TB1 10 ~ 12) (Z2-26)	No signal output available

No. (Hex.)	Name	Description	MFAO Signal Level
Ub-05 (8784)	Bypass Status 1	bit 0 : HAND Mode : 0: Not in HAND : 1: In HAND Mode bit 1 : OFF Mode : 0: Not in OFF : 1: In OFF Mode bit 2 : AUTO Mode : 0: Not in AUTO : 1: In AUTO Mode bit 3 : DRIVE mode (cmd) : 0: Drive mode not commanded : 1: Drive mode commanded bit 4 : BYPASS mode (cmd) : 0: Bypass mode not commanded : 1: Bypass mode commanded bit 5 : Emergency override BYP Act : 0: Not active : 1: Emergency override bypass is active bit 6 : Emergency override DRV Act : 0: Not active : 1: EMOV Drive is active (Emergency override drive) bit 7 : Safety Open : 0: All programmed safeties closed : 1: At least one programmed safety open bit 8 : Alarm Active : 0: No Alarm : 1: Alarm bit 9 : Drive Run active : 0: Not running in drive : 1: Running in drive mode bit 10 : Bypass run active : 0: Not running in bypass : 1: Running in bypass mode bit 11 : Emergency override Drive REV : 0: running FWD : 1: running REV bit 12 : Drive comms active : 0: Drive comms Not active : 1: Drive comms active bit 13 : System READY : 0: Not READY : 1: READY Note: Bits 12 and 13 are not shown on the keypad. You can use serial communications to read them. Unit: -	No signal output available

9.17 U: Monitors

No. (Hex.)	Name	Description	MFAO Signal Level
Ub-06 (8785)	Bypass Status 2	bit 0 : Interlock Open : 0: Interlock is pen : 1: Interlock is closed bit 1 : RUN active : 0: No RUN active : 1: Bypass or Drive run active bit 2 : Fault active : 0: Fault not active : 1: Fault active bit 3 : Auto Xfer Active : 0: Auto Xfer not Active : 1: Auto Xfer Active bit 4 : Remote Xfer Active : 0: Remote Xfer not Active : 1: Remote Xfer Active bit 5 : Energy Sav Active : 0: Energy Savings not Active : 1: Energy Savings Active bit 6 : Motor 1 Selected : 0: Motor 1 not Selected : 1: Motor 1 Selected bit 7 : Motor 2 Selected : 0: Motor 2 not selected : 1: Motor 2 selected bit 8 : Run verify detected : 0: Run verify not detected : 1: Run verify detected bit 9 : Restart delay active : 0: Restart delay not active : 1: Restart delay active bit 10 to 15 : Reserved Unit: -	No signal output available
Ub-07 (8786)	Bypass Fault Status 1	bit 0 : Drive Fault bit 1 : Safety Open bit 2 : FB02-Wait For Interlock Timeout bit 3 : FB03-External Fault Bypass (EFB) bit 4 : FB13-Loss Of Load bit 5 : FB05-Motor Overload (Internal, Electronic) bit 6 : FB06-External Overload 1 bit 7 : FB07-External Overload 2 bit 8 to 11 : Reserved Unit: -	No signal output available
Ub-08 (8787)	Bypass Fault Status 2	bit 0 : FB08-Brownout Detected bit 1 : FB09-Blackout Detected bit 2 : FB10-Loss of Drive Communications bit 3 : FB15-Input Phase Loss bit 4 : FB26-Option on Drive Detected bit 5 : FB13-Loss of Load bit 6 : CE-Serial Communications Error bit 7 : FB16-Input Phase Rotation bit 8 : FB18-Welded Bypass Contactor Detected bit 9 to 11 : Reserved Unit: -	No signal output available
Ub-09 (8788)	Current Fault	Displays the current fault. Unit: -	No signal output available
Ub-10 (8789)	Current Fault YYYY	Displays the year of the current fault. Unit: -	No signal output available
Ub-11 (878A)	Current Fault MMDD	Displays the month and day of the current fault. Unit: -	No signal output available
Ub-12 (878B)	Current Fault HHMM	Displays the hour and minute of the current fault. Unit: -	No signal output available

No. (Hex.)	Name	Description	MFAO Signal Level
Ub-13 (878C)	Previous Fault	Displays the previous fault. Unit: -	No signal output available
Ub-14 (878D)	Previous Fault YYYY	Displays the year of the previous fault. Unit: -	No signal output available
Ub-15 (878E)	Previous Fault MMDD	Displays the month and day of the previous fault. Unit: -	No signal output available
Ub-16 (878F)	Previous Fault HHMM	Displays the hour and minute of the previous fault. Unit: -	No signal output available
Ub-17 (8790)	Contacting Voltage	Displays the measured voltage for the power going to the contactor coils. Unit: 1 Vac	No signal output available
Ub-18 (8791)	Software Version	Displays the software version currently programmed into the bypass. Unit: -	No signal output available
Ub-19 (8792)	Date Year YYYY	Displays the current year. Unit: -	No signal output available
Ub-20 (8793)	Date Month Day MMDD	Displays the current date (Month and Date). Unit: -	No signal output available
Ub-21 (8794)	Time Hour Min HHMM	Displays the current time (Hours and Minutes). Unit: -	No signal output available
Ub-22 (8795)	Bypass Analog Input	Bypass MFAI level Unit: 0-100%	No signal output available
Ub-23 (8796)	Motor 1 Overload	Motor 1 Overload level Unit: 0-100%	No signal output available
Ub-24 (8797)	Motor 2 Overload	Motor 2 Overload level Unit: 0-100%	No signal output available
Ub-94 (87DD)	Bypass CPU Usage	Current Bypass CPU Load Unit: 0-100%	No signal output available
Ub-95 (87DE)	Line Frequency	Calculated AC line frequency Unit: Hz	No signal output available
Ub-96 (87DF)	By Phase Loss Level	Current Phase Loss level Unit: 0-100%	No signal output available
Ub-99 (87E2) Expert	Desired HV600 software version	Shows the latest version of HV600 software that this version of HV600 Bypass software supports. Unit: -	No signal output available

◆ UC: BACnet Diagnostic Monitors

No. (Hex.)	Name	Description	MFAO Signal Level
UC-01 (3DB0)	BN MSTP Net Health	Shows a number between 0.0% and 100.0% that identifies the health of the MSTP network. This number is dependent on the number of CRC errors, token losses, token retries, and net deadtime perceived. Unit: 0.1%	No signal output available
UC-02 (3DB1)	BACnet Tokens Rx	Shows the number of received MSTP Tokens after you energize the drive. Unit: 1	No signal output available
UC-03 (3DB2)	BACnet Tokens Tx	Shows the number of transmitted MSTP Tokens after you energize the drive. Unit: 1	No signal output available
UC-04 (3DB3)	BACnet Messages Rx	Shows the number of messages with data (non-token, non-polling) received by the drive. Unit: 1	No signal output available
UC-05 (3DB4)	BACnet Messages Tx	Shows the number of messages with data (non-token, non-polling) transmitted by the drive. Unit: 1	No signal output available
UC-06 (3DB5)	MSTP Next Node Addr	Shows the next known node in the MSTP loop. This is the node to which the drive will pass the token. Unit: Hex	No signal output available
UC-07 (3DB6)	MSTP Prev Node Addr	Shows the previous known node in the MSTP loop. This is the node from which the drive received the token. Unit: Hex	No signal output available

9.17 U: Monitors

No. (Hex.)	Name	Description	MFAO Signal Level
UC-08 (3DB7)	MSTP H MAC Found	Shows the highest MAC address found on the network. This will report the highest value MAC address to which the token was passed by any node on the MSTP loop. Unit: Hex	No signal output available
UC-09 (3DB8)	MSTP L MAC Found	Shows the lowest MAC address found on the network. This will report the lowest value MAC address to which the token was passed by any node on the MSTP loop. Unit: Hex	No signal output available
UC-10 (3DB9)	MSTP # Nodes Found	Shows the number of unique nodes that transmitted a token on the local MSTP loop. Unit: 1	No signal output available
UC-11 (3DBA)	# of BN COV Sbscrt	Shows the number of COV subscriptions requested by the nodes on the BACnet network. This is limited to the number of objects that support COV subscriptions. Unit: 1	No Signal output available
UC-12 (3DBB)	MSTP Loop Tlme	Shows the number of milliseconds between drive transmitted token and drive token received, showing how long the MSTP loop took to pass the token to all nodes on the MSTP network. Unit: 1 ms	No signal output available
UC-13 (3DBC) Expert	BN MSTP CRC Errors	Shows the number of CRC errors detected after you energize the drive. Unit: 1	No signal output available
UC-14 (3DBD) Expert	BN MSTP Tokens Lost	Shows the number of token losses seen by the unit since power-on. This is sensed by a net deadtime of more than 500 ms. Unit: 1	No signal output available
UC-15 (3DBE) Expert	BN MSTP Tokens Retry	Shows the number of token retries seen by the unit since power-on. This is sensed by two subsequent token frames seen from the same node to the same node with the same CRC. Unit: 1	No signal output available
UC-16 (3DBF) Expert	BN MSTP Silence Avg	Shows the average net deadtime (space between active messages), averaged over a 60 packet period. Unit: 1.0 ms	No signal output available

9.18 Defaults by Bypass and Drive Model

The values for parameter *o2-04* change the default settings for the parameters in these tables:

◆ 208/240 V

No.	Name	Unit	Default								
			D002 D003 D004 D007 D010	A002 A003 A004 A006 A009	D016 A015	D024 A022	D030 A028	D046 A042	D059 A054	D074 A068	D088 A080
o2-04	Drive Model (KVA) Selection	Hex.	65		67	68	6A	6B	6D	6E	6F
E2-11	Motor Rated Power	HP (kW)	3 (2.2)		5 (3.7)	7.5 (5.5)	10 (7.5)	15 (11)	20 (15)	25 (18.5)	30 (22)
b3-04	V/f Gain during Speed Search	%	100		100	100	100	100	100	100	100
b3-06	Speed Estimation Current Level 1	-	0.5		0.5	0.5	0.5	0.5	0.5	0.5	0.5
b3-08	Speed Estimation ACR P Gain	-	0.50		0.50	0.50	0.50	0.50	0.50	0.50	0.50
b3-11	Spd Est Method Switch-over Level	%	5.0		5.0	5.0	5.0	5.0	5.0	5.0	5.0
b3-12	Speed Search Current Deadband	-	2.5		2.5	2.5	2.5	2.5	2.5	2.5	2.5
b3-26	Direction Determination Level	-	1000		1000	1000	1000	1000	1000	1000	1000
b8-04	Energy Saving Coefficient Value	-	156.8		122.9	94.75	72.69	70.44	63.13	57.87	51.79
C6-02	Carrier Frequency Selection	-	2		2	2	2	2	2	2	2
E2-01	Motor Rated Current (FLA)	A	10.6		16.7	24.2	30.8	46.2	59.4	74.8	88
E2-02	Motor Rated Slip	Hz	2.90		2.73	1.50	1.30	1.70	1.60	1.67	1.70
E2-03	Motor No-Load Current	A	3.00		4.50	5.10	8.00	11.2	15.2	15.7	18.5
E2-05	Motor Line-to-Line Resistance	Ω	1.601		0.771	0.399	0.288	0.230	0.138	0.101	0.079
E2-06	Motor Leakage Inductance	%	18.4		19.6	18.2	15.5	19.5	17.2	20.1	19.5
E2-10	Motor Iron Loss	W	77		112	172	262	245	272	505	538
L2-02	Power Loss Ride Through Time	s	0.7		0.9	1.5	1.8	2.0	2.0	2.0	2.0
L2-03	Minimum Baseblock Time	s	0.5		0.6	0.7	0.8	0.9	1	1	1

9.18 Defaults by Bypass and Drive Model

No.	Name	Unit	Default								
			D002 D003 D004 D007 D010	A002 A003 A004 A006 A009	D016 A015	D024 A022	D030 A028	D046 A042	D059 A054	D074 A068	D088 A080
-	Bypass Model	-									
o2-04	Drive Model (KVA) Selection	Hex.	65		67	68	6A	6B	6D	6E	6F
E2-11	Motor Rated Power	HP (kW)	3 (2.2)		5 (3.7)	7.5 (5.5)	10 (7.5)	15 (11)	20 (15)	25 (18.5)	30 (22)
L2-04	Powerloss V/f Recovery Ramp Time	s	0.3		0.3	0.3	0.3	0.3	0.6	0.6	0.6
L2-05	Undervoltage Detection Lvl (Uv1)	-	190		190	190	190	190	190	190	190
L3-24	Motor Accel Time for Inertia Cal	s	0.145		0.154	0.168	0.175	0.265	0.244	0.317	0.355
L8-02	Overheat Alarm Level	°C	95		95	125	125	125	125	115	115
L8-09	Output Ground Fault Detection	-	0		0	0	0	0	1	1	1
L8-35	Installation Method Selection	-	2		2	2	2	2	2	2	2
L8-38	Carrier Frequency Reduction	-	2		2	2	2	2	2	2	2
n1-01	Hunting Prevention Selection	-	1		1	1	1	1	1	1	1
n1-03	Hunting Prevention Time Constant	ms	10		10	10	10	10	10	10	10

No.	Name	Unit	Default				
			D114 A104	D143 A130	D169 A154	D211 A192	D273 A248
-	Drive Model	-					
o2-04	Drive Model (KVA) Selection	Hex.	70	72	73	74	75
E2-11	Motor Rated Power	HP (kW)	40 (30)	50 (37)	60 (45)	75 (55)	100 (75)
b3-04	V/f Gain during Speed Search	%	80	80	80	80	80
b3-06	Speed Estimation Current Level 1	-	0.5	0.5	0.5	0.5	0.7
b3-08	Speed Estimation ACR P Gain	-	0.50	0.50	0.50	0.50	0.50
b3-11	Spd Est Method Switch-over Level	%	5.0	5.0	5.0	5.0	5.0
b3-12	Speed Search Current Deadband	-	2.5	2.5	2.5	2.5	2.5
b3-26	Direction Determination Level	-	1000	1000	1000	1000	1000
b8-04	Energy Saving Coefficient Value	-	46.27	38.16	35.78	31.35	23.10
C6-02	Carrier Frequency Selection	-	2	2	2	2	2
E2-01	Motor Rated Current (FLA)	A	114	143	169	211	273

No.	Name	Unit	Default				
			D114 A104	D143 A130	D169 A154	D211 A192	D273 A248
-	Drive Model	-	D114 A104	D143 A130	D169 A154	D211 A192	D273 A248
o2-04	Drive Model (KVA) Selection	Hex.	70	72	73	74	75
E2-11	Motor Rated Power	HP (kW)	40 (30)	50 (37)	60 (45)	75 (55)	100 (75)
E2-02	Motor Rated Slip	Hz	1.80	1.33	1.60	1.43	1.39
E2-03	Motor No-Load Current	A	21.9	38.2	44.0	45.6	72.0
E2-05	Motor Line-to-Line Resistance	Ω	0.064	0.039	0.030	0.022	0.023
E2-06	Motor Leakage Inductance	%	20.8	18.8	20.2	20.5	20.0
E2-10	Motor Iron Loss	W	699	823	852	960	1200
L2-02	Power Loss Ride Through Time	s	2.0	2.0	2.0	2.0	2.0
L2-03	Minimum Baseblock Time	s	1.1	1.1	1.2	1.3	1.5
L2-04	Powerloss V/f Recovery Ramp Time	s	0.6	0.6	1	1	1
L2-05	Undervoltage Detection Lvl (Uv1)	-	190	190	190	190	190
L3-24	Motor Accel Time for Inertia Cal	s	0.323	0.32	0.387	0.317	0.533
L8-02	Overheat Alarm Level	°C	115	110	110	110	110
L8-09	Output Ground Fault Detection	-	1	1	1	1	1
L8-35	Installation Method Selection	-	2	2	2	0	0
L8-38	Carrier Frequency Reduction	-	2	2	2	2	2
n1-01	Hunting Prevention Selection	-	1	1	1	1	1
n1-03	Hunting Prevention Time Constant	ms	10	10	10	10	10

◆ 480 V

No.	Name	Unit	Default							
			B1P1 B001 B002 B003 B004	B007	B011	B014	B021	B027	B034	B040
-	Bypass Model	-	B1P1 B001 B002 B003 B004	B007	B011	B014	B021	B027	B034	B040
o2-04	Drive Model (KVA) Selection	Hex.	95	97 and BB	99	9A	9B	9D	9E	9F
E2-11	Motor Rated Power	HP (kW)	3 (2.2)	5 (3.7)	7.5 (5.5)	10 (7.5)	15 (11)	20 (15)	25 (18.5)	30 (22)
b3-04	V/f Gain during Speed Search	%	100	100	100	100	100	100	100	100
b3-06	Speed Estimation Current Level 1	-	0.5	0.5	0.5	0.5	0.5	0.5	0.5	0.5
b3-08	Speed Estimation ACR P Gain	-	0.50	0.50	0.50	0.50	0.50	0.50	0.50	0.50

9.18 Defaults by Bypass and Drive Model

No.	Name	Unit	Default							
			B1P1 B001 B002 B003 B004	B007	B011	B014	B021	B027	B034	B040
-	Bypass Model	-								
o2-04	Drive Model (KVA) Selection	Hex.	95	97 and BB	99	9A	9B	9D	9E	9F
E2-11	Motor Rated Power	HP (kW)	3 (2.2)	5 (3.7)	7.5 (5.5)	10 (7.5)	15 (11)	20 (15)	25 (18.5)	30 (22)
b3-11	Spd Est Method Switch-over Level	%	5.0	5.0	5.0	5.0	5.0	5.0	5.0	5.0
b3-12	Speed Search Current Deadband	-	2.5	2.5	2.5	2.5	2.5	2.5	2.5	2.5
b3-26	Direction Determination Level	-	1000	1000	1000	1000	1000	1000	1000	1000
b8-04	Energy Saving Coefficient Value	-	313.6	245.8	189.5	145.38	140.88	126.26	115.74	103.58
C6-02	Carrier Frequency Selection	-	2	2	2	2	2	2	2	2
E2-01	Motor Rated Current (FLA)	A	4.80	7.60	11.00	14.00	21.0	27.0	34.0	40.0
E2-02	Motor Rated Slip	Hz	3.00	2.70	1.50	1.30	1.70	1.60	1.67	1.70
E2-03	Motor No-Load Current	A	1.5	2.3	2.6	4	5.6	7.6	7.8	9.2
E2-05	Motor Line-to-Line Resistance	Ω	6.495	3.333	1.595	1.152	0.922	0.550	0.403	0.316
E2-06	Motor Leakage Inductance	%	18.7	19.3	18.2	15.5	19.6	17.2	20.1	23.5
E2-10	Motor Iron Loss	W	77	130	193	263	385	440	508	586
L2-02	Power Loss Ride Through Time	s	0.7	0.9	1.3	1.3	1.7	2.0	2.0	2.0
L2-03	Minimum Baseblock Time	s	0.4	0.5	0.6	0.7	0.8	0.9	1.0	1.0
L2-04	Powerloss V/f Recovery Ramp Time	s	0.3	0.3	0.3	0.3	0.3	0.3	0.6	0.6
L2-05	Undervoltage Detection Lvl (Uv1)	-	380	380	380	380	380	380	380	380
L3-24	Motor Accel Time for Inertia Cal	s	0.166	0.145	0.154	0.168	0.175	0.265	0.244	0.317
L8-02	Overheat Alarm Level	°C	115	97: 115 BB: 95	95	95	127	127	127	123
L8-09	Output Ground Fault Detection	-	0	0	0	0	0	0	0	1
L8-35	Installation Method Selection	-	2	97: 2 BB: 3	2	2	2	2	2	2
L8-38	Carrier Frequency Reduction	-	2	2	2	2	2	2	2	2

No.	Name	Unit	Default							
-	Bypass Model	-	B1P1 B001 B002 B003 B004	B007	B011	B014	B021	B027	B034	B040
o2-04	Drive Model (KVA) Selection	Hex.	95	97 and BB	99	9A	9B	9D	9E	9F
E2-11	Motor Rated Power	HP (kW)	3 (2.2)	5 (3.7)	7.5 (5.5)	10 (7.5)	15 (11)	20 (15)	25 (18.5)	30 (22)
n1-01	Hunting Prevention Selection	-	1	1	1	1	1	1	1	1
n1-03	Hunting Prevention Time Constant	ms	10	10	10	10	10	10	10	10

No.	Name	Unit	Default								
-	Bypass Model	-	B052	B065	B077	B096	B124	B156	B180	B240	B302
o2-04	Drive Model (KVA) Selection	Hex.	A0	A2	A3	A4	A5	A6	A7	A8	A9
E2-11	Motor Rated Power	HP (kW)	30 (22)	40 (30)	50 (37)	60 (45)	75 (55)	100 (75)	125 (90)	150 (110)	200 (160)
b3-04	V/f Gain during Speed Search	%	100	100	100	100	80	60	60	60	60
b3-06	Speed Estimation Current Level 1	-	0.5	0.5	0.5	0.5	0.5	0.7	0.7	0.7	0.7
b3-08	Speed Estimation ACR P Gain	-	0.50	0.50	0.50	0.50	0.50	0.80	0.80	0.80	0.80
b3-11	Spd Est Method Switch-over Level	%	5.0	5.0	5.0	5.0	5.0	5.0	5.0	5.0	5.0
b3-12	Speed Search Current Deadband	-	2.5	2.5	2.5	2.5	2.5	2.5	2.5	2.5	2.5
b3-26	Direction Determination Level	-	1000	1000	1000	1000	1000	1000	1000	1000	1000
b8-04	Energy Saving Coefficient Value	-	103.58	92.54	76.32	71.56	67.2	46.2	38.91	36.23	30.13
C6-02	Carrier Frequency Selection	-	2	2	2	2	2	2	2	2	1
E2-01	Motor Rated Current (FLA)	A	52.0	65.0	77.0	96.0	124.0	156.0	180.0	240.0	302.0
E2-02	Motor Rated Slip	Hz	1.70	1.80	1.33	1.60	1.46	1.39	1.40	1.40	1.35
E2-03	Motor No-Load Current	A	9.2	10.9	19.1	22	24	36	40	49.00	70
E2-05	Motor Line-to-Line Resistance	Ω	0.316	0.269	0.155	0.122	0.088	0.092	0.056	0.05	0.029
E2-06	Motor Leakage Inductance	%	23.5	20.7	18.8	19.9	20.0	20.0	20.0	20.00	20.0
E2-10	Motor Iron Loss	W	586	750	925	1125	1260	1600	1760	2150	2850

9.18 Defaults by Bypass and Drive Model

No.	Name	Unit	Default								
			B052	B065	B077	B096	B124	B156	B180	B240	B302
-	Bypass Model	-	B052	B065	B077	B096	B124	B156	B180	B240	B302
o2-04	Drive Model (KVA) Selection	Hex.	A0	A2	A3	A4	A5	A6	A7	A8	A9
E2-11	Motor Rated Power	HP (kW)	30 (22)	40 (30)	50 (37)	60 (45)	75 (55)	100 (75)	125 (90)	150 (110)	200 (160)
L2-02	Power Loss Ride Through Time	s	2.0	2.0	2.0	2.0	2.0	2.0	2.0	2.0	2.0
L2-03	Minimum Baseblock Time	s	1.0	1.1	1.1	1.2	1.2	1.3	1.5	1.7	1.8
L2-04	Powerloss V/f Recovery Ramp Time	s	0.6	0.6	0.6	0.6	1.0	1.0	1.0	1.0	1.0
L2-05	Undervoltage Detection Lvl (Uv1)	-	380	380	380	380	380	380	380	380	380
L3-24	Motor Accel Time for Inertia Cal	s	0.355	0.323	0.320	0.387	0.317	0.533	0.592	0.646	0.777
L8-02	Overheat Alarm Level	°C	123	123	120	124	124	110	120	120	125
L8-09	Output Ground Fault Detection	-	1	1	1	1	1	1	1	1	1
L8-35	Installation Method Selection	-	2	2	2	2	2	2	0	0	0
L8-38	Carrier Frequency Reduction	-	2	2	2	2	2	2	2	2	2
n1-01	Hunting Prevention Selection	-	1	1	1	1	1	1	1	1	1
n1-03	Hunting Prevention Time Constant	ms	10	10	10	10	30	30	30	30	30

Network Communications

10.1	Section Safety	696
10.2	Fieldbus Network Support	697
10.3	BACnet Communications.....	698
10.4	APOGEE FLN (P1) Communications.....	717
10.5	Metasys N2 Communications	728
10.6	MEMOBUS/Modbus Communications.....	738

10.1 Section Safety

 **DANGER**

Do not ignore the safety messages in this manual.

If you ignore the safety messages in this manual, it will cause serious injury or death. The manufacturer is not responsible for injuries or damage to equipment.

10.2 Fieldbus Network Support

You can use a PLC or building automation controller to control and monitor the bypass through the network. The bypass has a standard RS-485 interface (serial communications). Install a separately sold communication option on the bypass to support other network communications.

◆ Available Communication Options

Refer to [Table 10.1](#) for the fieldbus networks that are compatible with the bypass. Contact Yaskawa or your nearest sales representative to order a communication option.

Table 10.1 Available Fieldbus Network

Type of Communications	Option Models	Type of Communications	Option Models
LonWorks	SI-W3	Dual port Modbus TCP/IP	SI-EM3D
Modbus TCP/IP	SI-EM3	Dual port EtherNet/IP	SI-EN3D
PROFINET	SI-EP3	BACnet/IP	JOHB-SMP3
EtherNet/IP	SI-EN3		

10.3 BACnet Communications

This section gives detailed information about the parameters, error codes, and communication procedures for BACnet communications.

◆ Configure Master/Slave

You can monitor and control the bypasses from a controller on a Building Automation and Control network (BACnet) with RS-485 technology and Master-Slave/Token-Passing (MS-TP) protocol. The drives agree with the device profile of the BACnet Application Specific Controller (B-ASC).

A maximum of 127 bypasses can communicate on a single BACnet MS-TP network depending on network conditions. When more bypasses or BACnet devices are necessary, a BACnet router is necessary to let another MS-TP network be available with a possible maximum of another 127 bypasses.

You can use parameters to set the MSTP MAC address, MSTP baud rate, and Device Object ID. You can also use parameters to set Device object properties Max Masters and Max Info Frames. Set other Device Object properties, for example Device Object Name and Device Object Location, through the BACnet network after you connect the bypass and the bypass is communicating.

When you set the addressing, a controller can start communication to the bypass. The bypass will do the specified function and send a response back to the controller. The bypass will usually respond immediately, but can delay its response until it gets the token for commands that can take longer local processing time.

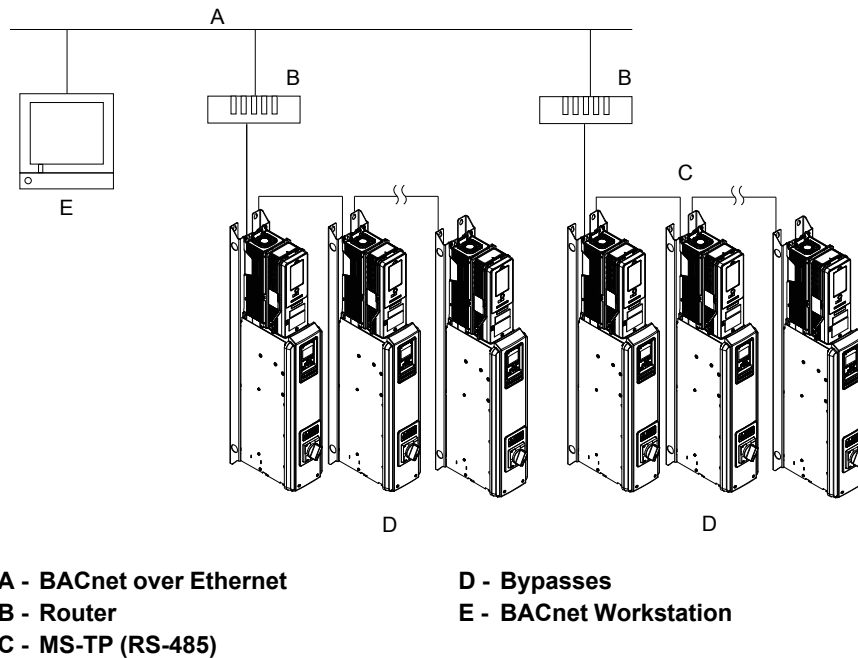

Figure 10.1 Connection Example of Multiple Bypasses to a BACnet Workstation

◆ Communication Specifications

Table 10.2 lists the specifications for the BACnet communications.

Table 10.2 BACnet Specifications

Item	Specifications
Interface	Master-Slave/Token-Passing (MS-TP)
	RS-485
Communication parameter	Communications speed: 9.6, 19.2, 38.4, 76.8 kbps
	Data length: 8 bit (fixed)
	Parity: even, odd, none
	Stop Bit: 1 bit (fixed)
Communication protocol	BACnet MS-TP
Number of possible units to connect	Maximum: 127 units for each MS-TP network segment depending on network conditions.

◆ Communication with the Controller

This section gives information about the settings for the termination resistor and how to connect to BACnet communications.

■ Connect Communications Cable

Use this procedure to start communication between the controller and bypass.

1. De-energize the bypass then connect the communications cable to the controller and the bypass. The bypass uses terminal TB3 for serial communications.

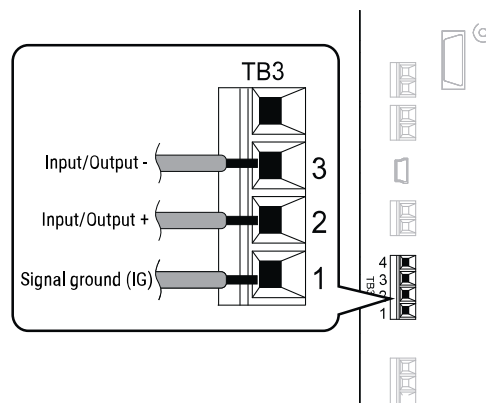

Figure 10.2 Communications Cable Connection Terminal (TB3)

Note:

Isolate the communications wiring from the main circuit wiring and other high-power wiring. Use shielded wires for the communications wiring and connect cable sheaths as shown in "Wiring Diagram for More than One Bypass". Incorrect wiring procedures could cause bypass malfunction because of electrical interference.

2. Enable the termination resistor ONLY when the bypass is at the end of the communications network. Set DIP switch S1 to the "ON" position to enable the termination resistor. Refer to "Set the Termination Resistor" for more information.
3. Energize the bypass.
4. Use the keypad to set the necessary communications parameters *H5-01 to H5-11*.
 - *H5-01 [Drive Node Address]*
 - *H5-02 [Communication Speed Selection]*
 - *H5-04 [Stopping Method after Com Error]*
 - *H5-05 [Comm Fault Detection Select]*
 - *H5-08 [Communication Protocol Selection]*
 - *H5-09 [CE Detection Time]*
5. Because communications parameters do not take effect immediately, either de-energize and re-energize the bypass or set *H5-20 = 1 [Communication Parameters Reload = Reload Now]*.

The bypass is prepared to start communication with the controller.

■ **Set the Termination Resistor**

You must enable the termination resistor on the serial terminals of the devices on the two physical ends of the network to use serial communications. Use DIP switch S1 on the bypass control PCB to enable and disable the built-in termination resistor. Refer to [Figure 10.3](#) for an example of how to set DIP switch S1. Use the tip of a tweezers or a small flat-blade screwdriver to set the DIP switch. When you install the bypass at the end of the network line, set DIP switch S1 to “ON” to enable the termination resistor. Set DIP switch S1 to “OFF” on all other bypasses.

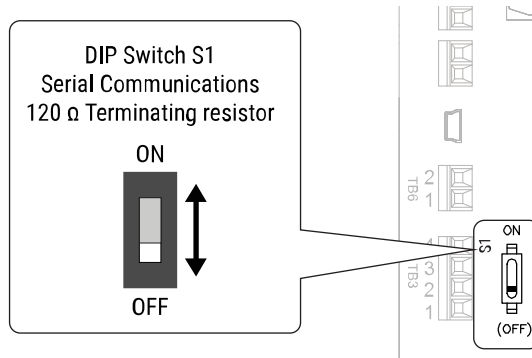

Figure 10.3 Termination Resistor DIP Switch S1

■ **Wiring Diagram for More than One Bypass**

[Figure 10.4](#) shows how to wire more than one connected bypass using serial communications.

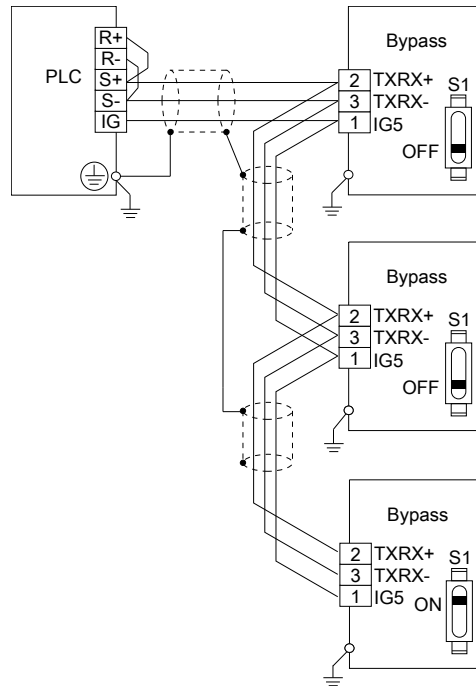

Figure 10.4 Wiring Diagram for More than One Bypass

Note:

When you install the bypass at the end of the network line, set DIP switch S1 to “ON” to enable the termination resistor. Set DIP switch S1 to “OFF” on all other bypasses.

◆ **Bypass Operations by Serial Communications**

Parameters will apply to the settings when the bypass is running during serial communications. This section gives information about the available functions and their related parameters.

■ Executable Functions

A controller can do these operations with serial communications. Parameter settings (except *H5-xx*) do not have an effect on the availability of these operations.

- Monitor the bypass status and operate the bypass
- Set and view parameters
- Fault Reset Procedure

■ Bypass Control

To use external commands to set the frequency references and motor run/stop with serial communications, set these parameters as specified by the application:

- *b1-01 = 2 [Frequency Reference Selection 1 = Serial Communications]*
- *b1-02 = 2 or 8 [Run Command Selection 1 = Serial Communications or AUTO Command + Serial Run]*

For more information about operation mode selection, refer to *b1-01* and *b1-02*.

◆ BACnet Objects Supported

■ Present Value Access

The Present Value (PV) of BACnet objects can always be read. Some PVs can also be written or commanded. A commandable PV is similar to a writable PV, but the value is actually written into a priority array. The value that then has the highest priority in the array will be used by the drive.

Table 10.3 Present Value Access Types and Descriptions

PV Access	Name	Description
C	Commandable	Value written to a priority array. The highest priority value in the array is then written to the drive.
R	Readable	Value is read-only
W	Writable	Value written to the drive

■ Supported Properties of Objects

Table 10.4 Object Properties

Property	Object Type						
	Device	Analog Input (AI)	Analog Output (AO)	Analog Value (AV)	Binary Input (BI)	Binary Output (BO)	Binary Value (BV)
Object_Identifier	Yes	Yes	Yes	Yes	Yes	Yes	Yes
Object_Name	Yes	Yes	Yes	Yes	Yes	Yes	Yes
Location	Yes	-	-	-	-	-	-
Object_Type	Yes	Yes	Yes	Yes	Yes	Yes	Yes
System_Status	Yes	-	-	-	-	-	-
Vendor_Name	Yes	-	-	-	-	-	-
Vendor_Identifier	Yes	-	-	-	-	-	-
Model_Name	Yes	-	-	-	-	-	-
Firmware_Revision	Yes	-	-	-	-	-	-
Protocol_Version	Yes	-	-	-	-	-	-
Protocol_Revision	Yes	-	-	-	-	-	-
Protocol_Services_Supported	Yes	-	-	-	-	-	-
Protocol_Object_Types_Supported	Yes	-	-	-	-	-	-
Object_List	Yes	-	-	-	-	-	-
Max_ADPU_Length_Accepted	Yes	-	-	-	-	-	-

10.3 BACnet Communications

Property	Object Type						
	Device	Analog Input (AI)	Analog Output (AO)	Analog Value (AV)	Binary Input (BI)	Binary Output (BO)	Binary Value (BV)
Segmentation_Supported	Yes	-	-	-	-	-	-
Local_Time	Yes	-	-	-	-	-	-
Local_Date	Yes	-	-	-	-	-	-
ADPU_Timeout	Yes	-	-	-	-	-	-
Number_Of_ADPU_Retries	Yes	-	-	-	-	-	-
Max_Masters	Yes	-	-	-	-	-	-
Max_Info_Frames	Yes	-	-	-	-	-	-
Device_Address_Binding	Yes	-	-	-	-	-	-
Database_Revision	Yes	-	-	-	-	-	-
Active_COV_Subscriptions	Yes	-	-	-	-	-	-
Present_Value	-	Yes	Yes	Yes	Yes	Yes	Yes
Status_Flags	-	Yes	Yes	Yes	Yes	Yes	Yes
Event_State	-	-	-	-	-	-	-
Reliability	-	Yes	Yes	Yes	Yes	Yes	Yes
Out_Of_Service	-	Yes	Yes	Yes	Yes	Yes	Yes
Units	-	Yes	Yes	Yes	-	-	-
Priority_Array	-	-	Yes */	Yes */	-	Yes	Yes
Relinquish_Default	-	-	Yes */	Yes */	-	Yes	Yes
Polarity	-	-	-	-	Yes	Yes	-
Inactive_Text	-	-	-	-	Yes	Yes	Yes
Active_Text	-	-	-	-	Yes	Yes	Yes
COV_Increment *2	-	Yes	Yes	Yes	-	-	-
Property_List	Yes	Yes	Yes	Yes	Yes	Yes	Yes
Local Time	Yes	-	-	-	-	-	-
Local Date	Yes	-	-	-	-	-	-

*1 For Commandable Object Instances only.

*2 COV function is only available on objects that are not commandable and not writable.

■ Analog Input Objects

Object ID	Object Name (Network Display, if Different)	Modbus Reg.	Precision	Range	Units	PV Access
AI1	Drive Analog Input 1 Level (Drv Anlg In 1 Level)	004Eh	XXX.X	0-100.0	%	R
AI2	Drive Analog Input 2 Level (Drv Anlg In 2 Level)	004Fh	XXX.X	0-100.0	%	R
AI3	Not Used AI3	0050h	XXX.X	0-100.0	%	R
AI4	Bypass Analog Input 1 Level (Byp Anlg In 1 Level)	8795h	XXX.X	0-100.0	%	R
AI5	Not Used AI5	-	-	-	-	R
AI6	Display Format o1-03	0502h	XXXXX	0-65535	-	R
AI7	Scale Format b5-20	01E2h	XXXXX	0-65535	-	R

Object ID	Object Name (<i>Network Display, if Different</i>)	Modbus Reg.	Precision	Range	Units	PV Access
AI8	Inverter Model o2-04	0508h	XXXXXX	0-65535	-	R
AI9	Rated Current n9-01	05D0h	XXXX.X (for drives rated higher than 11 kVA) XXX.XX (for drives rated 11 kVA or lower)	0-6553.5 (for drives rated higher than 11 kVA) 0-65535 (for drives rated 11 kVA or lower)	A	R
AI10	Motor Current UB-01	8780h	XXXX.X (for drives rated higher than 11 kVA) XXX.XX (for drives rated 11 kVA or lower)	0-6553.5 (for drives rated higher than 11 kVA) 0-65535 (for drives rated 11 kVA or lower)	A	R
AI11	Contactors Voltage	8790h	XXXXXX	0-65535	V	R

■ Analog Output Objects

Object ID	Object Name (<i>Network Display</i>)	Modbus Reg.	Precision	Range	Units	PV Access
AO1	Drive Terminal FM Analog Output Level Command (set H4-01 = 0) (<i>Drv Anlg Out1 Level</i>)	0007h	XXX.X	0-100.0	%	C
AO2	Drive Terminal AM Analog Output Level Command (Set H4-04 = 0) (<i>Drv Anlg Out2 Level</i>)	0008h	XXX.X	0-100.0	%	C

■ Analog Value Objects

Object ID	Object Name (<i>Network Display, if Different</i>)	Modbus Reg.	Precision	Range	Units	PV Access
AV1	Drive Operation Command (<i>Operation Cmd</i>) Note: Do not command bypass using AV1. Use BV58 to BV71 instead.	0001h	-	0-65535	Bitmap	C
AV2	Frequency Cmd	0002h	XXX.XX Determined by o1-03	0-600.00	Determined by o1-03	C
AV3	PI Setpoint Cmd	0006h	XXX.XX	0-100.00	%	C

10.3 BACnet Communications

Object ID	Object Name (<i>Network Display, if Different</i>)	Modbus Reg.	Precision	Range	Units	PV Access
AV4	Drive Multi-Function Output Command <i>(MF Output Cmd)</i> <ul style="list-style-type: none"> • bit 0: Multi-Function Digital Output 1 (terminal M1-M2) • bit 1: Multi-Function Digital Output 2 (terminal M3-M4) • bit 2: Multi-Function Digital Output 3 (terminal M5-M6) • bit 3: Reserved • bit 4: Reserved • bit 5: Reserved • bit 6: Enables the function in bit 7 • bit 7: Fault Contact Output (terminal MA-MB-MC) • bit 8 to F: Reserved <p>Note: When using AV4, do not use BO1 to BO3 or BV12.</p>	0009h	-	0-255	Bitmap	C
AV5	Drive Reference Select Command <i>(Reference Select Cmd)</i> <ul style="list-style-type: none"> • bit 0: Reserved • bit 1: PID Setpoint Input • bit 2: Reserved • bit 3: Reserved • bit 4: PI2 Target Input • bit 5 to B: Reserved • bit C: Multi-Function Input 5 • bit D: Multi-Function Input 6 • bit E: Multi-Function Input 7 • bit F: Reserved <p>Note: When you use AV5, you must not use AV1, BO4, or BV9 to BV11.</p>	000Fh	-	0-32767	Bitmap	C
AV6	System Status <i>(Drive Status)</i> <ul style="list-style-type: none"> • bit 0: During Run (drive or bypass) • bit 1: During Reverse • bit 2: System ready • bit 3: System faulted • bit 4: Data Setting Error • bit 5: Multi-Function Digital Output 1 (terminal M1-M2) • bit 6: Multi-Function Digital Output 2 (terminal M3-M4) • bit 7: Multi-Function Digital Output 3 (terminal M5-M6) • bit 8 to D: Reserved • bit E: ComRef status • bit F: ComCtrl status 	0020h	-	0-65535	Bitmap	R

Object ID	Object Name (<i>Network Display, if Different</i>)	Modbus Reg.	Precision	Range	Units	PV Access
AV7	Fault Details <ul style="list-style-type: none"> • bit 0: oC [Overcurrent], GF [Ground Fault] • bit 1: ov [Overvoltage] • bit 2: oL2 [Drive Overload] • bit 3: oH1 [Heatsink Overheat], oH2 [External Overheat (H1-XX=B)] • bit 4 to 6: Reserved • bit 7: EF to EF7 [External Fault] • bit 8: CPFxx [Hardware Fault] (includes oFAxx) • bit 9: oL1 [Motor Overload], oL3 [Overtorque Detection 1], UL3 [Undertorque Detection 1] • bit A: Reserved • bit B: Uv [DC Bus Undervoltage] • bit C: Uv1 [DC Bus Undervoltage], Uv2 [Control Power Undervoltage], Uv3 [Soft Charge Answerback Fault] • bit D: LF [Output Phase Loss], PF [Input Phase Loss] • bit E: CE [Serial Communication Error], bUS [Option Communication Error] • bit F: oPr [Keypad Connection Fault] 	0021h	-	0-65535	Bitmap	R
AV8	Data Link Status <ul style="list-style-type: none"> • bit 0: Writing Data • bit 1: Reserved • bit 2: Reserved • bit 3: Upper or lower limit error • bit 4: Data conformity error • bit 5: Writing to EEPROM • bit 6 to F: Reserved 	0022h	-	0-63	Bitmap	R
AV9	Frequency Reference	0040h	XXX.XX Determined by o1-03	0-600.00	Determined by o1-03	R
AV10	Output Frequency	0041h	XXX.XX Determined by o1-03	0-600.00	Determined by o1-03	R
AV11	Output Voltage	0045h	XXXX.X	0-6553.5	V	R
AV12	Output Current	0026h	XXXX.X	0-6553.5	A	R
AV13	Output Power	0047h	XXXX.X > 11kVA XXX.XX <= 11kVA	0-6553.5 > 11kVA 0-655.35 <= 11kVA	KW	R
AV14	Torque Reference	0048h	XXXX.X	0-100.0	%	R
AV15	Drive Multi-Function Input Status (<i>MF Input Status</i>)	002Bh	XXX	0-127	Bitmap	R
AV16	Drive Status 2	002Ch	XXXXX	0-65535	Bitmap	R
AV17	Drive Multi-Function Output Status (<i>MF Output Status</i>)	002Dh	XXX	0-135	Bitmap	R

10.3 BACnet Communications

Object ID	Object Name (<i>Network Display, if Different</i>)	Modbus Reg.	Precision	Range	Units	PV Access
AV18	DC Bus Voltage	0031h	XXXX.X	0-6553.5	V	R
AV19	PI Feedback Level	0038h	XXXX.X	0-100.0	%	R
AV20	PI Input Level	0039h	XXXX.X	0-100.0	%	R
AV21	PI Output Level	003Ah	XXXX.X	0-100.0	%	R
AV22	Drive SW Num	004Dh	XXXXXX	0-65535	-	R
AV23	Bypass SW Num	8791h	XXXXXX	0-65535	-	R
AV24	Comm Error Detail	003Dh	XXX	0-127	Bitmap	R
AV25	KVA Setting	0508h	XXXXXX	-	Enumerated Data Vendor Specific	R
AV26	Control Method	0043h	XXXXXX	-	Enumerated Data Vendor Specific	R
AV27	Accel Time	0200h	XXXX.X	0-6000.0	S	W
AV28	Decel Time	0201h	XXXX.X	0-6000.0	S	W
AV29	Parameter Number	####h Determined in runtime	XXXXXX	0-65535	-	W
AV30	Parameter Data	####h Determined in runtime	XXXXXX	0-65535	-	W
AV31	Motor Current	8780h	XXXX.X > 11 kVA XXX.XX <= 11 kVA	0-6553.5 > 11 kVA 0-655.35 <= 11 kVA	A	R
AV32	120V to Kx Coils	8790h	XXXXXX	0-65535	V	R
AV33	Drive kWh consumed (<i>kWh consumed</i>)	005Ch -005Dh	XXXXXXXXXX	0-999999999	kWh	R
AV34	Not Used AV34	-	-	-	-	R
AV35	Drive Run Time	004Ch	XXXXXX	0-65535	Hours	R
AV36	Out Freq in %	003Fh	XXX.XX	0-100.00	%	R
AV37	Out Freq in RPM	003Eh	XXXXXX	0-65535	RPM	R
AV38	Torque Iq (U6-01)	0051h	XXXX.X	0-6553.5	%	R
AV39	Drive HOA Status	004Bh	X	0-2	-	R
AV40	Last Drive Fault Refer to page 468 for information on fault decimal values.	0081h	XXXXXX	0-65535	-	R
AV41	Last Bypass Fault Refer to page 468 for information on fault decimal values.	878Ch	XXXXXX	0-65535	-	R
AV42	Current Sys Fault (<i>Current Sys Flt</i>) Refer to 468 for information on fault decimal values.	0080h	XXXXXX	0-65535	-	R

■ Binary Input Objects

Object ID	Object Name (<i>Network Display, if Different</i>)	Modbus Reg.	Active Text	Inactive Text	PV Access
BI1	Drive Input Terminal 1 (<i>Input Terminal 1</i>)	002Bh:bit 0	ON	OFF	R
BI2	Drive Input Terminal 2 (<i>Input Terminal 2</i>)	002Bh:bit 1	ON	OFF	R
BI3	Drive Input Terminal 3 (<i>Input Terminal 3</i>)	002Bh:bit 2	ON	OFF	R

Object ID	Object Name (<i>Network Display, if Different</i>)	Modbus Reg.	Active Text	Inactive Text	PV Access
BI4	Drive Input Terminal 4 (<i>Input Terminal 4</i>)	002Bh:bit 3	ON	OFF	R
BI5	Drive Input Terminal 5 (<i>Input Terminal 5</i>)	002Bh:bit 4	ON	OFF	R
BI6	Drive Input Terminal 6 (<i>Input Terminal 6</i>)	002Bh:bit 5	ON	OFF	R
BI7	Drive Input Terminal 7 (<i>Input Terminal 7</i>)	002Bh:bit 6	ON	OFF	R
BI8	Drive MF Output 1 (<i>Multi Function Out 1</i>)	0020h:bit 5	ON	OFF	R
BI9	Drive MF Output 2 (<i>Multi Function Out 2</i>)	0020h:bit 6	ON	OFF	R
BI10	BYP DI-1 STAT	8781h:bit 0	ON	OFF	R
BI11	BYP DI-2 STAT	8781h:bit 1	ON	OFF	R
BI12	BYP DI-3 STAT	8781h:bit 2	ON	OFF	R
BI13	BYP DI-4 STAT	8781h:bit 3	ON	OFF	R
BI14	BYP DI-5 STAT	8781h:bit 4	ON	OFF	R
BI15	BYP DI-6 STAT	8781h:bit 5	ON	OFF	R
BI16	BYP DI-7 STAT	8781h:bit 6	ON	OFF	R
BI17	BYP DI-8 STAT	8781h:bit 7	ON	OFF	R
BI18	BYP DO-1 STAT	8782h:bit 0	ON	OFF	R
BI19	BYP DO-2 STAT	8782h:bit 1	ON	OFF	R
BI20	BYP DO-3 STAT	8782h:bit 2	ON	OFF	R
BI21	BYP DO-4 STAT	8782h:bit 3	ON	OFF	R
BI22	BYP DO-5 STAT	8782h:bit 4	ON	OFF	R
BI23	BYP DO-6 STAT	8782h:bit 5	ON	OFF	R
BI24	BYP DO-7 STAT	8782h:bit 6	ON	OFF	R
BI25	BYP DO-8 STAT	8782h:bit 7	ON	OFF	R
BI26	BYP DO-9 STAT	8783h:bit 0	ON	OFF	R
BI27	BYP DO-10 STAT	8783h:bit 1	ON	OFF	R
BI28	Drive Fault Status	004Bh:bit 7	ON	OFF	R
BI29	Drive Alarm Status	004Bh:bit 6	ON	OFF	R
BI30	Sys Alarm Status	8784h:bit 8	ON	OFF	R

■ Binary Output Objects

Object ID	Object Name	Modbus Reg.	Active Text	Inactive Text	PV Access
BO1	MF Output M1 - M2	0009h: Bit 0	ON	OFF	C
BO2	MF Output M3 - M4	0009h: Bit 1	ON	OFF	C
BO3	MF Output M5 – M6	0009h: Bit 2	ON	OFF	C
BO4	Ref Sel:PI Setpoint	000Fh: Bit 1	ON	OFF	C
BO5	Ref Sel:Term S5 IN	0001h: Bit 8	ON	OFF	C
BO6	Ref Sel:Term S6 IN	0001h: Bit 9	ON	OFF	C
BO7	Ref Sel:Term S7 IN	0001h: Bit A	ON	OFF	C
BO8 <i>*1</i>	BYP DO-07 COMMAND	8403h: Bit 6	ON	OFF	C

10.3 BACnet Communications

Object ID	Object Name	Modbus Reg.	Active Text	Inactive Text	PV Access
BO9 <i>*1</i>	BYP DO-08 COMMAND	8403h: Bit 7	ON	OFF	C
BO10 <i>*1</i>	BYP DO-09 COMMAND	8403h: Bit 8	ON	OFF	C
BO11 <i>*1</i>	BYP DO-10 COMMAND	8403h: Bit 9	ON	OFF	C

*1 Set the corresponding Z2-xx parameter = 99 - *Not Used*.

■ Binary Value Objects

Object ID	Object Name (<i>Network Display, if Different</i>)	Modbus Reg.	Active Text	Inactive Text	PV Access
BV1	Not Used BV001	-	-	-	C
BV2	Not Used BV002	-	-	-	C
BV3	Drive External Fault Command (<i>Ext Fault Cmd</i>)	0001h: Bit 2	FAULT	OFF	C
BV4	Drive Fault Reset Command (<i>Fault Reset Cmd</i>)	0001h: Bit 3	RESET	OFF	C
BV5	Not Used BV005	-	-	-	C
BV6	Not Used BV006	-	-	-	C
BV7	Drive Multi-Function Input 3 Command (<i>MF Input 3 Cmd</i>)	0001h: Bit 6	ON	OFF	C
BV8	Drive Multi-Function Input 4 Command (<i>MF Input 4 Cmd</i>)	0001h: Bit 7	ON	OFF	C
BV9	Drive Multi-Function Input 5 Command (<i>MF Input 5 Cmd</i>)	0001h: Bit 8	ON	OFF	C
BV10	Drive Multi-Function Input 6 Command (<i>MF Input 6 Cmd</i>)	0001h: Bit 9	ON	OFF	C
BV11	Drive Multi-Function Input 7 Command (<i>MF Input 7 Cmd</i>)	0001h: Bit A	ON	OFF	C
BV12	Set Fault Contact Cmd (<i>Set Flt Contact Cmd</i>)	0009h: Bit 6&7	ENABLE	OFF	C
BV13	RUN-STOP	0020h: Bit 0	RUN	OFF	R
BV14	REV-FWD	0020h: Bit 1	REV	FWD	R
BV15	READY	0020h: Bit 2	READY	OFF	R
BV16	FAULT	0020h: Bit 3	FAULTED	OFF	R
BV17	Data Set Error	0020h: Bit 4	ERR	OFF	R
BV18	Overcurrent – Ground Fault (<i>Overcurrent– Gnd Fault</i>)	0021h: Bit 0	OC – GF	OFF	R
BV19	Main Circuit Overvoltage (<i>Main Ckt Overvoltage</i>)	0021h: Bit 1	OV	OFF	R
BV20	Drive Overload	0021h: Bit 2	OL2	OFF	R
BV21	Drive Overheat	0021h: Bit 3	OH1-OH2	OFF	R
BV22	Fuse Blown	0021h: Bit 5	PUF	OFF	R
BV23	PI Feedback Loss	0021h: Bit 6	FBL	OFF	R
BV24	External Fault	0021h: Bit 7	EF0 – EF	OFF	R
BV25	Hardware Error	0021h: Bit 8	CPF	OFF	R

Object ID	Object Name (<i>Network Display, if Different</i>)	Modbus Reg.	Active Text	Inactive Text	PV Access
BV26	Motor Overload – Overtorque (<i>Mtr OvrLd – OvrTorque</i>)	0021h: Bit 9	OL1 – OL3	OFF	R
BV27	Overspeed	0021h: Bit A	OS –DEV	OFF	R
BV28	Main Circuit Undervoltage (<i>Main Ckt Undervoltage</i>)	0021h: Bit B	UV	OFF	R
BV29	MCU, Control Power Supply Error (<i>MCU Cntrl Pwr Sy Err</i>)	0021h: Bit C	UV1-2-3	OFF	R
BV30	Output Phase Loss	0021h: Bit D	LF	OFF	R
BV31	Communication Error	0021h: Bit E	CE	OFF	R
BV32	Operator Disconnect	0021h: Bit F	OPR	OFF	R
BV33	Operating	002Ch: Bit 0	OPERATING	OFF	R
BV34	Zero Speed	002Ch: Bit 1	ON	OFF	R
BV35	Frequency Agree	002Ch: Bit2	ON	OFF	R
BV36	Desired Frequency Agree (<i>Desired Freq Agree</i>)	002Ch: Bit 3	ON	OFF	R
BV37	Frequency Detect 1	002Ch: Bit 4	ON	OFF	R
BV38	Frequency Detect 2	002Ch: Bit 5	ON	OFF	R
BV39	Drive Startup Complete (<i>Drv Startup Complete</i>)	002Ch: Bit 6	ON	OFF	R
BV40	Low Voltage Detect	002Ch: Bit 7	ON	OFF	R
BV41	Base Block	002Ch: Bit 8	ON	OFF	R
BV42	Frequency Reference Mode (<i>Frequency Ref Mode</i>)	002Ch: Bit 9	COM	LOCAL	R
BV43	Run Command Mode	002Ch: Bit A	COM	LOCAL	R
BV44	Over Torque Detect	002Ch: Bit B	ON	OFF	R
BV45	Frequency Reference Lost (<i>Frequency Ref Lost</i>)	002Ch: Bit C	ON	OFF	R
BV46	Retry Error	002Ch: Bit D	ON	OFF	R
BV47	Modbus Comms Error	002Ch: Bit E	ON	OFF	R
BV48	Modbus Timeout Error	002Ch: Bit F	ON	OFF	R
BV49	CRC Error	003Dh: Bit 0	ON	OFF	R
BV50	Invalid Data Length	003Dh: Bit 1	ON	OFF	R
BV51	Parity Error	003Dh: Bit 3	ON	OFF	R
BV52	Overrun Error	003Dh: Bit 4	ON	OFF	R
BV53	Framing Error	003Dh: Bit 5	ON	OFF	R
BV54	Timeout Error	003Dh: Bit 6	ON	OFF	R
BV55	Parameter Accept	Object activates an internal bit that performs desired object function	ON	OFF	W
BV56	Parameter Enter	Object activates an internal bit that performs desired object function	ON	OFF	W
BV57	Drive Comms Error	002Ch: Bit F	ON	OFF	R
BV58	Bypass Forward Run Cmd (<i>BYP Run Fwd CMD</i>)	0001h: Bit 0	ON	OFF	C
BV59	Bypass Reverse Run Cmd (<i>BYP Run Rev CMD</i>)	0001h: Bit 1	ON	OFF	C

10.3 BACnet Communications

Object ID	Object Name (<i>Network Display, if Different</i>)	Modbus Reg.	Active Text	Inactive Text	PV Access
BV60	Emergency Override Drive Reverse (<i>Em Over DRV REV CMD</i>)	8400h: Bit F	ON	OFF	C
BV61	Bypass Transfer to Bypass Cmd (<i>BYP Xfer to BYP CMD</i>)	8400h: Bit 3	ON	OFF	C
BV62	Emergency Override Bypass (<i>Em Over BYPASS CMD</i>)	8400h: Bit 4	ON	OFF	C
BV63	Emergency Override Drive Forward (<i>Em Over DRV FWD CMD</i>)	8400h: Bit 5	ON	OFF	C
BV64	Bypass Motor OR Select Command (<i>BYP Mtr OR Sel CMD</i>)	8400h: Bit 6	ON	OFF	C
BV65	Bypass Motor AND Select Command (<i>BYP Mtr AND Sel CMD</i>)	8400h: Bit 7	ON	OFF	C
BV66	Not Used BV066	-	ON	OFF	R
BV67	Not Used BV067	-	ON	OFF	R
BV68	Not Used BV068	-	ON	OFF	R
BV69	Bypass BYPASS Select Command (<i>BYP BYPASS Sel CMD</i>)	8400h: Bit C	ON	OFF	C
BV70	Bypass Fault Reset Command (<i>BYP Fault Reset CMD</i>)	8400h: Bit D	ON	OFF	C
BV71	Bypass External Fault Command (<i>BYP Ext Fault CMD</i>)	8400h: Bit E	ON	OFF	C
BV72	Bypass DI-01 Command (<i>BYP DI-01 Command</i>)	8402h: Bit 0	ON	OFF	C
BV73	Bypass DI-02 Command (<i>BYP DI-02 Command</i>)	8402h: Bit 1	ON	OFF	C
BV74	Bypass DI-03 Command (<i>BYP DI-03 Command</i>)	8402h: Bit 2	ON	OFF	C
BV75	Bypass DI-04 Command (<i>BYP DI-04 Command</i>)	8402h: Bit 3	ON	OFF	C
BV76	Bypass DI-05 Command (<i>BYP DI-05 Command</i>)	8402h: Bit 4	ON	OFF	C
BV77	Bypass DI-06 Command (<i>BYP DI-06 Command</i>)	8402h: Bit 5	ON	OFF	C
BV78	Bypass DI-07 Command (<i>BYP DI-07 Command</i>)	8402h: Bit 6	ON	OFF	C
BV79	Bypass DI-08 Command (<i>BYP DI-08 Command</i>)	8402h: Bit 7	ON	OFF	C
BV80	Bypass HAND Mode Status (<i>BYP HAND Mode Status</i>)	8784h: Bit 0	ON	OFF	R
BV81	Bypass OFF Mode Status (<i>BYP OFF Mode Status</i>)	8784h: Bit 1	ON	OFF	R
BV82	Bypass AUTO Mode Status (<i>BYP AUTO Mode Status</i>)	8784h: Bit 2	ON	OFF	R
BV83	Bypass DRIVE Mode Status (<i>BYP DRV Mode Status</i>)	8784h: Bit 3	ON	OFF	R
BV84	Bypass BYPASS Mode Status (<i>BYP BYPASS Mode Stat</i>)	8784h: Bit 4	ON	OFF	R

Object ID	Object Name (<i>Network Display, if Different</i>)	Modbus Reg.	Active Text	Inactive Text	PV Access
BV85	Bypass Emergency Run Bypass Status (<i>BYP Smk Prg BYP Stat</i>)	8784h: Bit 5	ON	OFF	R
BV86	Bypass Emergency Run Drive Fwd Status (<i>BYP Smk Prg DRV Stat</i>)	8784h: Bit 6	ON	OFF	R
BV87	Bypass Safety Status (<i>BYP Safety Status</i>)	8784h: Bit 7	ON	OFF	R
BV88	Bypass BAS Interlock Status (<i>BYP BAS Interlk Stat</i>)	8785h: Bit 0	ON	OFF	R
BV89	Bypass Run Status (<i>BYP RUN Status</i>)	8785h: Bit 1	ON	OFF	R
BV90	Bypass Fault Status (<i>BYP Fault Status</i>)	8785h: Bit 2	ON	OFF	R
BV91	Bypass Auto Transfer Status (<i>BYP Auto Xfer Status</i>)	8785h: Bit 3	ON	OFF	R
BV92	Bypass Remote Transfer Status (<i>BYP Remote Xfer Stat</i>)	8785h: Bit 4	ON	OFF	R
BV93	Bypass Energy Savings Status (<i>BYP Energy Save Stat</i>)	8785h: Bit 5	ON	OFF	R
BV94	Bypass Motor 1 Select Status (<i>BYP Motor 1 Sel Stat</i>)	8785h: Bit 6	ON	OFF	R
BV95	Bypass Motor 2 Select Status (<i>BYP Motor 2 Sel Stat</i>)	8785h: Bit 7	ON	OFF	R
BV96	Bypass Drive Fault Status (<i>BYP Drive Flt Status</i>)	8786h: Bit 0	ON	OFF	R
BV97	Bypass Safety Fault Status (<i>BYP Safety Flt Stat</i>)	8786h: Bit 1	ON	OFF	R
BV98	Bypass BAS Interlock Fault Status (<i>BYP BAS ILock Status</i>)	8786h: Bit 2	ON	OFF	R
BV99	Bypass External Fault Status (<i>BYP Ext Fault Stat</i>)	8786h: Bit 3	ON	OFF	R
BV100	Not Used BV100	-	-	-	R
BV101	Bypass Motor OL Status (<i>BYP Motor OL Stat</i>)	8786h: Bit 5	ON	OFF	R
BV102	Bypass Motor 1 OL Status (<i>BYP Motor 1 OL Stat</i>)	8786h: Bit 6	ON	OFF	R
BV103	Bypass Motor 2 OL Status (<i>BYP Mtr 2 OL Stat</i>)	8786h: Bit 7	ON	OFF	R
BV104	Bypass Input Phase Loss Status (<i>BYP Input Phase Loss</i>)	8787h: Bit 0	ON	OFF	R
BV105	Bypass Drive Comms Status (<i>BYP Drive Comms</i>)	8787h: Bit 2	ON	OFF	R
BV106	Bypass Loss of Load Status (<i>BYP Loss OfLoad</i>)	8787h: Bit 5	ON	OFF	R
BV107	Option Board on Drive Status (<i>BYP Option Brd Comms</i>)	8787h: Bit 4	ON	OFF	R

■ Device Object

The Device Object is the BACnet device to the network in this manual. The Device Object Instance ID, the Device Object Name, and the Device Object Location are configurable. Refer to [Table 10.5](#) for more information.

Table 10.5 Device Objects

Item	Description	Data Type
Device Object Instance ID	A unique internetwork-wide numerical value. To set this ID, set <i>H5-14 [BACnet Device Obj ID LOW BITS]</i> and <i>H5-15 [BACnet Device Obj ID HIGH BITS]</i> .	22-bit value Range: 0 - 4, 194, 302
Device Object Name	A unique internetwork-wide character string that is writable from the BACnet network.	40-character strings
Device Object Location	Character field to describe the location of the device that is writable from the Bacnet network.	40-character strings

Note:

Any changes to the parameter settings and any new string written will not take effect until you de-energize the drive.

◆ Accessing Drive Parameters and the Enter Command

■ Read Drive Parameters

To read the drive parameters that are not listed in the analog or digital objects, use AV29 and AV30 as shown in this procedure:

1. Write the desired Modbus register to AV29 in decimal value.
2. Read the decimal value at the given register from AV30.

For example, to read the Frequency Reference Upper Limit, read from parameter *d2-01 [Frequency Reference Upper Limit]*.

Parameter *d2-01* is located at Modbus register 0289H, which is decimal 649.

Set AV29 to "649."

Read AV30 to get the value.

■ Write Drive Parameters

To write the drive parameters that are not listed in the analog or digital objects, use AV29, AV30, and BV55 or BV56 as shown in this procedure:

1. In AV29, write the desired Modbus register number in decimal format.
2. In AV30, write the value that you want to put into the register set in AV29 in decimal format.

At this point the value is written to the drive, but the location is pending.

If necessary, write in more values this way, the drive will accept these settings by one of two methods:

- Set BV55 to "ON" to move data to active memory.
- Set BV56 to "ON" to move data into active memory and save to non-volatile memory.

For example, to reset the KWH Monitor, write a value of "1" to parameter *o4-12 [kWh Monitor Initialization]*.

Parameter *o4-12* is located at Modbus register 0512 (Hex.), which is decimal 1298.

Set AV29 to "1298."

Set AV30 to "1."

Set BV55 to "ON."

■ Enter Command

Enter Commands are only necessary to use AV29 and AV30 to access drive parameters. Enter commands are not necessary to read or write to the other BACnet objects.

This section gives information about the Enter command.

Types of Enter Commands

The drive supports two Enter commands shown in [Table 10.6](#).

Table 10.6 Types of Enter Commands

BACnet Object	Modbus Address (Hex.)	Description
BV55 (Write "ON")	0910 (Write 0)	This updates the data on the RAM, but does not write data to the EEPROM. This process saves the parameter changes until you de-energize the drive.
BV56 (Write "ON")	0900 (Write 0)	When you write parameter data to the EEPROM, you will enable the data on the RAM at the same time. This process saves the parameter changes until you de-energize the drive.

Note:

You can write the EEPROM to the drive a maximum of 100,000 times. Do not frequently execute the Enter command (0900 (Hex.)) that is written to EEPROM. The Enter command registers 0900 (Hex.) and 0910 (Hex.) are write-only. If these registers are read, the register address will not be applicable, but BACnet objects BV55 and BV56 can be read without error.

◆ Self-Diagnostics

The bypass can use Self-Diagnostics to verify the hardware transceiver on the control circuit. Self-Diagnostics connects the transmission terminal to the reception terminal on the control circuit and transmits the data to itself to make sure that the bypass can communicate correctly.

Use this procedure to do Self-Diagnostics:

DANGER! Electrical Shock Hazard. Do not examine, connect, or disconnect wiring on an energized bypass. Before servicing, disconnect all power to the equipment and wait for the time specified on the warning label at a minimum. The internal capacitor stays charged after the bypass is de-energized. The charge indicator LED extinguishes when the DC bus voltage decreases below 50 Vdc. When all indicators are OFF, remove the covers before measuring for dangerous voltages to make sure that the bypass is safe. If you do work on the bypass when it is energized, it will cause serious injury or death from electrical shock.

1. Energize the bypass.
2. Set Z2-06 = 45 [Digital Input 6 Function (TB2-6) - Serial Hardware Test (RS-485)].
3. De-energize the bypass.
4. Disconnect the RS-485 terminals (TB3).
5. Connect a jumper between control circuit terminals TB2-6 and TB2-9 or TB2-10.

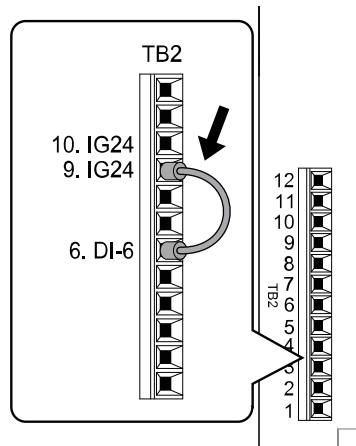

Figure 10.5 Self-Diagnostics Jumper Terminals

6. Energize the bypass.
7. When normal, the keypad will show *PASS* [Serial Communication Test].

Note:

If there is an error, the keypad will show *CE* [Serial Communication Error]. Disconnect the bypass from the network and test the bypass again. If the error stays, there is a possible hardware problem. If there is no error, there is a possible network wiring problem.

8. De-energize the bypass.
9. Disconnect the jumper from Step 4. Set Z2-06 to its initial function.

Self-Diagnostics is complete and the bypass returns to its usual function.

◆ BACnet Protocol Implementation Conformance Statement

- Date: 3/1/2020
- Vendor Name: Yaskawa
- Product Name: VFD Bypass
- Product Model Number: HV600 Bypass
- Application Software Version: VST8004xx
- Firmware Revision: 2.01
- BACnet Protocol Revision: 14
- Product Description:

The Yaskawa VFD Bypass is a high performance product specifically designed for commercial building automation applications. The Yaskawa BACnet feature connects the VFD Bypass to a standard BACnet MS/TP network. These products may be fully controlled and monitored over BACnet. All Bypass and drive parameters are available for reading and writing.
- BACnet Standardized Device Profile (Annex L):
 - BACnet Cross-Domain Advanced Operator Workstation (B-XAWS)
 - BACnet Advanced Operator Workstation (B-AWS)
 - BACnet Operator Workstation (B-OWS)
 - BACnet Operator Display (B-OD)
 - BACnet Advanced Life Safety Workstation (B-ALSWS)
 - BACnet Life Safety Workstation (B-LSWS)
 - BACnet Life Safety Annunciator Panel (B-LSAP)
 - BACnet Advanced Access Control Workstation (B-AACWS)
 - BACnet Access Control Workstation (B-ACWS)
 - BACnet Access Control Security Display (B-ACSD)
 - BACnet Building Controller (B-BC)
 - BACnet Advanced Application Controller (B-AAC)
 - BACnet Application Specific Controller (B-ASC)
 - BACnet Smart Actuator (B-SA)
 - BACnet Smart Sensor (B-SS)
 - BACnet Advanced Life Safety Controller (B-ALSC)
 - BACnet Life Safety Controller (B-LSC)
 - BACnet Advanced Access Control Controller (B-AACC)
 - BACnet Access Control Controller (B-ACC)
 - BACnet Router (B-RTR)
 - BACnet Gateway (B-GW)
 - BACnet Broadcast Management Device (B-BBMD)
 - BACnet Access Control Door Controller (B-ACDC)
 - BACnet Access Control Credential Reader (B-ACCR)
 - BACnet General (B-GENERAL)
- List all BACnet Interoperability Building Blocks Supported (Annex K):
 - Data Sharing-ReadProperty-B (DS-RP-B)
 - Data Sharing-WriteProperty-B (DS-WP-B)
 - Data Sharing-ReadPropertyMultiple-B (DS-RPM-B)
 - Data Sharing-WritePropertyMultiple-B (DS-WPM-B)
 - Data Sharing-Change Of Value-B (DS-COV-B)
 - Data Sharing-Change Of Value Property-B (DS-COVP-B)
 - Device Management-Dynamic Device Binding-B (DM-DDB-B)
 - Device Management-Dynamic Object Binding-B (DM-DOB-B)
 - Device Management-DeviceCommunicationControl-B (DM-DCC-B)
 - Device Management-ReinitializeDevice-B (DM-RD-B)
 - Device Management-TimeSynchronization-B (DM-TS-B)
- Segmentation Capability:

- Able to transmit segmented messages / Window Size:
- Able to receive segmented messages / Window Size:
- Standard Object Types Supported:

Object Types	Descriptions
Device Object	Optional Writeable: – Max_Info_Frames – Max_Master
Analog Input Object	Optional properties supported: – COV_Increment Optional Writeable: – COV_Increment - supported on various instances
Analog Output Object	-
Analog Value Object	Optional properties supported: – COV_Increment Optional Writeable: – COV_Increment - supported on various instances
Binary Input Object	-
Binary Output Object	-
Binary Value Object	-

- Data Link Layer Options:
 - ARCNET (ATA 878.1), 2.5 Mb. (Clause 8)
 - ARCNET (ATA 878.1), EIA-485 (Clause 8), baud rate(s):
 - BACnet IP, (Annex J)
 - BACnet IP, (Annex J), BACnet Broadcast Management Device (BBMD)
 - BACnet IP, (Annex J), Network Address Translation (NAT Traversal)
 - BACnet IPv6, (Annex U)
 - BACnet IPv6, (Annex U), BACnet Broadcast Management Device (BBMD)
 - BACnet/ZigBee (Annex O)
 - Ethernet, ISO 8802-3 (Clause 7)
 - LonTalk, ISO/IEC 14908.1 (Clause 11), medium:
 - MS/TP master (Clause 9), baud rate(s): 9600, 19200, 38400, 76800
 - MS/TP slave (Clause 9), baud rate(s)
 - Point-To-Point, EIA 232 (Clause 10), baud rate(s):
 - Point-To-Point, modem, (Clause 10), baud rate(s):
 - Other:
- Device Address Binding:

Is static device binding supported? (This is currently necessary for two-way communication with MS/TP slaves and certain other devices.) Yes No
- Networking Options:
 - Router, Clause 6 - List all routing configurations, e.g., ARCNET-Ethernet, Ethernet-MS/TP, etc.
 - Annex H, BACnet Tunneling Router over IP
- Character Sets Supported:

Indicating support for multiple character sets does not imply that they can all be supported simultaneously.

 - ISO 10646 (UTF-8)
 - IBM/Microsoft DBCS
 - ISO 8859-1
 - ISO 10646 (UCS-2)
 - ISO 10646 (UCS-4)
 - JIS X 0208
- Gateway Options:

If this product is a communication gateway, describe the types of non-BACnet equipment/networks(s) that the gateway supports:
Not supported

10.3 BACnet Communications

If this product is a communication gateway which presents a network of virtual BACnet devices, a separate PICS shall be provided that describes the functionality of the virtual BACnet devices. That PICS shall describe a superset of the functionality of all types of virtual BACnet devices that can be presented by the gateway.

- Network Security Options:
 - Non-secure Device - is capable of operating without BACnet Network Security
 - Secure Device - is capable of using BACnet Network Security (NS-SD BIBB)
 - Multiple Application-Specific Keys
 - Supports encryption (NS-ED BIBB)
 - Key Server (NS-KS BIBB)

10.4 APOGEE FLN (P1) Communications

This section gives detailed information about the parameters, error codes and communication procedures for APOGEE FLN (P1) communications.

◆ APOGEE FLN Set-Up

A Yaskawa America, Inc. representative is responsible for proper configuration of the drive for its primary application, while a Siemens Building Technologies, Inc. representative is responsible for field panel programming to make use of the drive functionality in the building automation system. As such, there must be coordination between the Yaskawa America and Siemens Building Technologies representatives to ensure that the programming of the drive is consistent with the particular application requirements. After verifying that the drive installation and wiring are correct, apply power to the drive. [Table 10.7](#) lists the parameters and values required for proper APOGEE FLN communication and control.

Table 10.7 Drive APOGEE FLN Communication Parameter Settings

Parameter No.	HOA Keypad Display	APOGEE FLN Setting
b1-01	Frequency Reference Selection 1	2: Serial Communications
b1-02	Run Command Selection 1	2: Serial Communications or 8: AUTO Command + Serial Run
H5-01	Drive Node Address	Select the drive address (default = 1Fh (31 dec))
H5-02	Communication Speed Selection	2: 4800 bps or 3: 9600 bps
H5-08	Communication Protocol Selection	2: Apogee/P1
Z3-16	Apogee Run Enable LD035	1: Enabled

NOTICE: Damage to Equipment. Do not change the APOGEE FLN (P1) communication parameter settings. A Yaskawa representative must set the parameters to their correct values. Incorrect parameter settings can cause damage to the drive or building equipment.

◆ Communication Specifications

[Table 10.8](#) lists the specifications for the APOGEE FLN (P1).

Table 10.8 APOGEE FLN (P1) Specifications

Item	Specification
Interface	FLN
	RS-485
Communication parameter	Communication speed: 4.8 kbps, 9.6 kbps
	Data length: 8 bit (fixed)
	Parity: even, odd, none
	Stop bit: 1 bit (fixed)
Communication protocol	APOGEE FLN P1
Number of possible units to connect	Maximum: 97 units for each FLN network segment

◆ Communication with the Controller

This section gives information about the settings for the termination resistor and how to connect to APOGEE FLN (P1) communications.

■ Connect Communications Cable

Use this procedure to start communication between the controller and bypass.

1. De-energize the bypass then connect the communications cable to the controller and the bypass. The bypass uses terminal TB3 for serial communications.

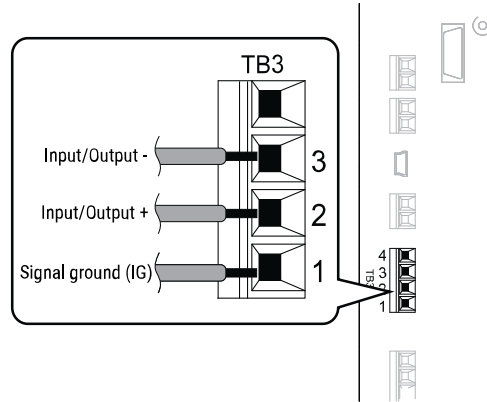

Figure 10.6 Communications Cable Connection Terminal (TB3)

Note:

Isolate the communications wiring from the main circuit wiring and other high-power wiring. Use shielded wires for the communications wiring and connect cable sheaths as shown in “Wiring Diagram for More than One Bypass”. Incorrect wiring procedures could cause bypass malfunction because of electrical interference.

2. Enable the termination resistor ONLY when the bypass is at the end of the communications network. Set DIP switch S1 to the “ON” position to enable the termination resistor. Refer to “Set the Termination Resistor” for more information.
3. Energize the bypass.
4. Use the keypad to set the necessary communications parameters *H5-01 to H5-11*.
 - *H5-01 [Drive Node Address]*
 - *H5-02 [Communication Speed Selection]*
 - *H5-04 [Stopping Method after Com Error]*
 - *H5-05 [Comm Fault Detection Select]*
 - *H5-08 [Communication Protocol Selection]*
 - *H5-09 [CE Detection Time]*
5. Because communications parameters do not take effect immediately, either de-energize and re-energize the bypass or set *H5-20 = 1 [Communication Parameters Reload = Reload Now]*.

The bypass is prepared to start communication with the controller.

■ Set the Termination Resistor

You must enable the termination resistor on the serial terminals of the devices on the two physical ends of the network to use serial communications. Use DIP switch S1 on the bypass control PCB to enable and disable the built-in termination resistor. Refer to [Figure 10.7](#) for an example of how to set DIP switch S1. Use the tip of a tweezers or a small flat-blade screwdriver to set the DIP switch. When you install the bypass at the end of the network line, set DIP switch S1 to “ON” to enable the termination resistor. Set DIP switch S1 to “OFF” on all other bypasses.

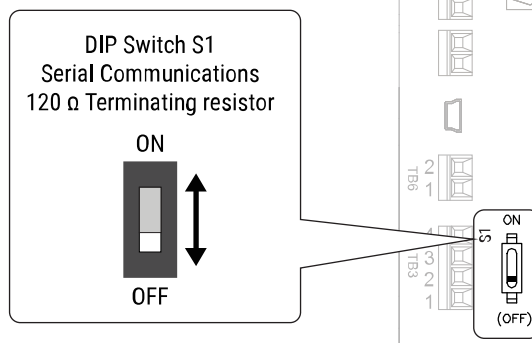

Figure 10.7 Termination Resistor DIP Switch S1

■ Wiring Diagram for More than One Bypass

Figure 10.8 shows how to wire more than one connected bypass using serial communications.

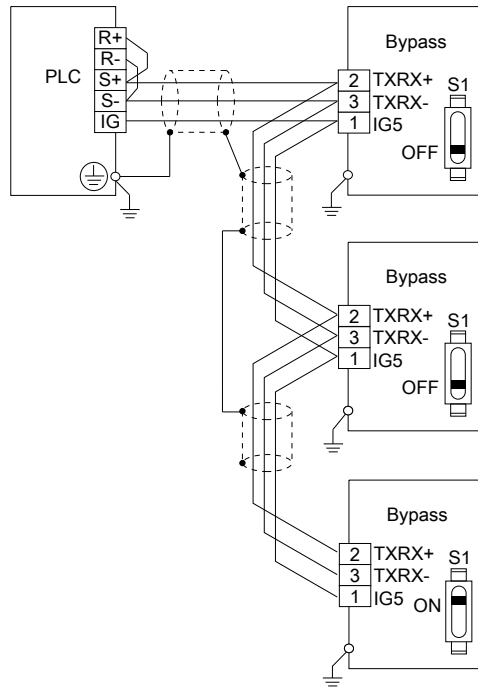

Figure 10.8 Wiring Diagram for More than One Bypass

Note:

When you install the bypass at the end of the network line, set DIP switch S1 to “ON” to enable the termination resistor. Set DIP switch S1 to “OFF” on all other bypasses.

■ Recommended Cable

Table 10.9 APOGEE FLN Cable Specifications

Specification	Description
Cable configuration	Twisted shielded pair
Gauge	<ul style="list-style-type: none"> Stranded wire: 0.2 mm² to 1.0 mm² (24 AWG to 16 AWG) Sold wire: 0.2 mm² to 1.5 mm² (24 AWG to 16 AWG)
Wire lay	Minimum 6 twists per foot
Shields	100% foil with drain wire
NEC type	UL type CMP
Temperature	-20 °C to +60 °C

Note:

Cable lengths cannot be longer than 152 m (500 ft) at 4800 bps.

◆ Slope and Intercept Conversion

Several parameters are available for monitoring purposes. The available parameters include FREQUENCY OUTPUT (Point 3), SPEED (Point 5), CURRENT (Point 6), TORQUE (Point 7), POWER (Point 8), DRIVE TEMPERATURE (Point 9), KWH (Point 10), and RUN TIME (Point 12). These points can be unbundled for monitoring or used in various global control strategies.

■ Bypass Controlled Feedback

The most typical application is Supervisory Control. The sensor for the control variable (for example, water temperature) is hard-wired to the bypass and the control device (fan) is modulated using the PI control loop built into

the bypass. The setpoint for the control variable (water temperature set point) is unbundled and commanded by the field panel, based on the building control strategy implemented in PPCL.

When this strategy is used, the point to unbundle and command for the set point is INPUT REF 1 (Point 60). The control variable (for example, water temperature) can be monitored by unbundling PI FEEDBACK (Point 62). These points are provided in units of percent, where 0% and 100% correspond to the range of the sensor being used to measure the control variable. These points have default units in Hz. If other units are required, unbundle these points with appropriate slopes and intercepts. The new intercept will be equal to the lowest value of the desired range.

The following formulas allow the user to define a new slope and intercept to convert the unit.

$$\text{New Slope} = \frac{(\text{Desired Range}) \times (\text{Slope of Existing Point})}{(\text{Range of Existing Point})}$$

$$\text{New Slope} = \frac{(60 - 0) \text{ Hz} \times (0.01)}{(100 - 0)\%} = 0.006$$

Conversion Example

The bypass is controlling a fan, which in turn is controlling the water temperature from a cooling tower. The temperature sensor has a range of -1 °C to +121 °C (30 °F to 250 °F). To unbundle the set point (INPUT REF 1), for commanding in degrees Fahrenheit, where 0 to 60 Hz is equal to -1 °C to +121 °C: New Intercept = 30 (the temperature that corresponds to 0%)

$$\text{New Slope} = \frac{(\text{Desired Range}) \times (\text{Slope of Existing Point})}{(\text{Range of Existing Point})}$$

$$\text{New Slope} = \frac{(250 - 30) \text{ °F} \times (0.1)}{(100 - 0)\%} = 0.22$$

Note:

1. Desired Range = Range Maximum - Range Minimum
2. Range of Existing Point = Existing Range Maximum - Existing Range Minimum

■ Field Panel Controlled Feedback

In this strategy, the sensor is connected to the APOGEE FLN network at a remote location, and the control loop is executed in PPCL. The drive speed command is passed from the field panel to the drive by commanding INPUT REF 1 (Point 60).

NOTICE: Damage to Equipment. Yaskawa does not recommend a field panel controlled feedback strategy because it closes the loop over the network. If you use field panel controlled feedback, it will cause a delay in processor scan time and network traffic. It can cause a decrease or loss of control and cause damage to HVAC equipment.

Unbundle the Feedback

To unbundle the feedback (PI FEEDBACK) for monitoring in degrees Fahrenheit:

New Intercept = 30

$$\text{New Slope} = \frac{(\text{Desired Range}) \times (\text{Slope of Existing Point})}{(\text{Range of Existing Point})}$$

$$\text{New Slope} = \frac{(250 - 30) \text{ °F} \times (0.01)}{(100 - 0)\%} = 0.022$$

Note:

1. Desired Range = Range Maximum - Range Minimum
2. Range of Existing Point = Existing Range Maximum - Existing Range Minimum

■ Other Functionalities

Enable these functions during start-up:

- Enable the Bypass to Run
RUN ENABLE (Point 35) will operate only when Z3-16 = 1 [Apogee Run Enable LD035 =Enable]. If Z3-16 = 0, Point 35 will have no effect.
- Start and Stop the Bypass
CMD.RUN.STOP (Point 24) can be commanded to run the bypass in the forward direction. STOP.RUN (Point 23) shows the current status of the bypass.
- Change Directions

CMD REV.STOP (Point 22) can be commanded to run the bypass in the reverse direction. FWD.REV (Point 21) shows the current direction of the bypass rotation.

NOTICE: *Damage to Equipment. Make sure that the motor direction is correct when you set b1-04 = 0 [Reverse Operation Selection = Reverse Enabled]. Incorrect motor direction can cause damage to equipment.*

- **Lock the Bypass Panel**
Locking the panel prevents the user from using the HAND and OFF keys locally at the drive panel. LOCK PANEL (Point 33) can be commanded to lock and unlock the panel.
- **Digital Outputs**
MULTI OUT 1 (Point 40), MULTI OUT 2 (Point 41), and MULTI OUT 3 (Point 42) are physical digital outputs on the bypass. Their purpose depends on how the bypass has been set-up. The bypass can be programmed so that these points can display various limits, warnings, and status conditions. Some examples include frequency limit, over current, and motor over temperature fault.
- **Loop Gain**
PID P GAIN (Point 63) and PID I TIME (Point 64) are the gain and integral time parameters similar to the P and I gains in the APOGEE FLN Terminal Equipment Controllers. The PI loop of the drive is structured differently than the Siemens loop, so there is not a one-to-one correspondence between the gains.
- **Reading and Resetting Faults**
OK.FAULT (Point 93) shows the current status of the drive. FAULT CODE (Point 17) contains the code for the most current fault. LST FLT CODE (Point 66) contains the code for the previous fault. See table below for descriptions of the fault codes. The drive can be reset back to OK mode by commanding RESET FAULT (Point 94) to RESET.

◆ APOGEE FLN Point Database

This section shows the APOGEE FLN point database for Application 2721.

■ APOGEE FLN Point List Summary

This database is for APOGEE FLN Application 2721 and features 92 logical points: 29 Logical Analog Inputs (LAI), 31 Logical Analog Outputs (LAO), 19 Logical Digital Inputs (LDI) and 13 Logical Digital Outputs (LDO). These points set, control, or monitor the operation of the drive.

Information to consider when referencing this table:

1. This application does not use the points that are not listed.
2. A single value in a column means that the value is the same in English units and in SI units.

Table 10.10 APOGEE FLN Application 2721 Point Number Summary

Point No.	Point Type	Point Name	Factory Default (SI Units)	Eng. Units (SI Units)	Slope (SI Units)	Intercept (SI Units)	On Text	Off Text	Parameter
01	LAO	CTRL ADDRESS	31	-	1	0	-	-	H5-01
02	LAO	APPLICATION	2721	-	1	0	-	-	-
03 *J	LAI	FREQ OUTPUT	0	Hz	0.01	0	-	-	U1-02
04 *J	LAI	PCT OUTPUT	0	%	0.01	0	-	-	-
05 *J	LAI	SPEED	0	RPM	0.01	0	-	-	-
06 *J	LAI	CURRENT	0	A	0.01/0.1	0	-	-	UB-01
07 *J	LAI	TORQUE	0	%	0.1	0	-	-	-
08 *J	LAI	POWER	0	kW	0.1	0	-	-	U1-08
09 *J	LAI	DRIVE TEMP	0	° C/F	1	0	-	-	U4-08
10 *J	LAI	DRIVE KWH	0	kWh	0.1	0	-	-	U4-10
11 *J	LAI	MWH	0	mWh	1	0	-	-	U4-11
12 *J	LAI	RUN TIME	0	h	1	0	-	-	U4-01
13 *J	LAI	DC BUS VOLT	0	V	1	0	-	-	U1-07
14 *J	LAI	AC OUT VOLT	0	V	0.1	0	-	-	U1-06
15	LAI	PAR N9.01	0	A	0.01/0.1	0	-	-	-

10.4 APOGEE FLN (P1) Communications

Point No.	Point Type	Point Name	Factory Default (SI Units)	Eng. Units (SI Units)	Slope (SI Units)	Intercept (SI Units)	On Text	Off Text	Parameter
16 */	LAI	RUN TIMEX10K	0	10kh	1	0	-	-	U4-01
17 */ */	LAI	FAULT CODE	0	-	1	0	-	-	U2-01
18 */	LDI	MINOR FLT	NO FLT	-	1	0	FAULT	NO FLT	UB-05 (bit 8)
19 */	LDI	MAJOR FLT	NO FLT	-	1	0	FAULT	NO FLT	UB-06 (bit 2)
20	-	N/A	-	-	-	-	-	-	-
21 */	LDI	FWD.REV	FWD	-	1	0	REV	FWD	U1-12 (bit 2)
22 */	LDO	CMD.REV.STOP	STOP	-	1	0	REV	STOP	-
23 */	LDI	RUN.STOP	STOP	-	1	0	RUN	STOP	UB-06 (bit 1)
24 */	LDO	CMD.RUN.STOP	STOP	-	1	0	FWD	STOP	-
25 */	LDI	ZERO SPEED	OFF	-	1	0	ON	OFF	U1-12 (bit 1)
26 */	LDI	SPEED AGREE	NO AGR	-	1	0	AGREE	NO AGR	U1-12 (bit 4)
27 */	LDI	DRIVE READY	NOTRDY	-	1	0	READY	NOTRDY	-
28 */	LDI	LOC.REM MON	REMOTE	-	1	0	LOCAL	REMOTE	UB-05 (bit 0)
29 */	-	N/A	-	-	-	-	-	-	-
30	LAO	CURRENT LIM	0	A	0.01/0.1	0	-	-	E2-01
31	LAO	ACCEL TIME 1	0	s	0.1	0	-	-	C1-01
32	LAO	DECEL TIME 1	0	s	0.1	0	-	-	C1-02
33	LDO	LOCK PANEL	UNLOCK	-	1	0	LOCK	UNLOCK	-
34	-	N/A	-	-	-	-	-	-	-
35 */	LDO	RUN ENABLE	STOP	-	1	0	ENABLE	STOP	-
36	LAO	STALL PRE RN	115	%	1	5	-	-	L3-06
37	LAO	STALL PRE AC	120	%	1	0	-	-	L3-02
38	LAO	FREQ UP LIM	100	%	0.1	0	-	-	d2-01
39	LAO	FREQ LOW LIM	0	%	0.1	0	-	-	d2-02
40 */	LDI	MULTI OUT 1	OFF	-	1	0	ON	OFF	UB-03 (bit 6)
41 */	LDI	MULTI OUT 2	OFF	-	1	0	ON	OFF	UB-03 (bit 7)
42 */	LDI	MULTI OUT 3	OFF	-	1	0	ON	OFF	UB-03 (bit 8)
43 */	LDI	SAFETY ILOCK	OFF	-	1	0	ON	OFF	UB-05 (bit 7)
44 */	LDO	MF INP 1	OFF	-	1	0	ON	OFF	-
45 */	LDO	MF INP 2	OFF	-	1	0	ON	OFF	-
46 */	LDO	MF INP 3	OFF	-	1	0	ON	OFF	-
47 */	LDO	MF INP 4	OFF	-	1	0	ON	OFF	-
48 */	LDO	MF INP 5	OFF	-	1	0	ON	OFF	-
49	LAO	JUMP FREQ 1	0	Hz	0.1	0	-	-	d3-01
50	LAO	JUMP FREQ 2	0	Hz	0.1	0	-	-	d3-02
51	LAO	JUMP FREQ 3	0	Hz	0.1	0	-	-	d3-03
52	LAO	JUMP FREQ BW	0	Hz	0.1	0	-	-	d3-04
53	LAO	NUM AUTOSTRT	0	-	1	0	-	-	L5-01
54	LAO	POWER LOSS RT	0.1	s	0.1	0	-	-	L2-02
55	LAO	RUN OP MODE	7	-	1	0	-	-	b1-02
56	LAO	REF OP MODE	1	-	1	0	-	-	b1-01

Point No.	Point Type	Point Name	Factory Default (SI Units)	Eng. Units (SI Units)	Slope (SI Units)	Intercept (SI Units)	On Text	Off Text	Parameter
57	LAO	OPER DISP MD	0	-	1	0	-	-	o1-03
58 */	LDI	MF IN 1 MON	OFF	-	1	0	ON	OFF	UB-02 (bit 2)
59 */	LDI	MF IN 2 MON	OFF	-	1	0	ON	OFF	UB-02 (bit 3)
60 */	LAO	INPUT REF 1	0	Hz	0.01	0	-	-	-
61	LAO	INPUT REF 2	0	Hz	0.01	0	-	-	d1-02
62 */	LAI	PID FEEDBACK	0	%	0.01	0	-	-	U5-01
63	LAO	PID P GAIN	2	-	0.01	0	-	-	b5-02
64	LAO	PID I TIM	1	s	0.1	0	-	-	b5-03
65	LDO	PID MODE SEL	DISABLE	-	1	0	ENABLE	DISABLE	b5-01
66 */	LAI	LST FLT CODE	0	-	1	0	-	-	U2-02
67 */	LAI	FREF FLT	0	Hz	0.01	0	-	-	U2-03
68 */	LAI	OUT FREQ FLT	0	Hz	0.01	0	-	-	U2-04
69 */	LAI	OUT CUR FLT	0	A	0.01/0.1	0	-	-	U2-05
70	LAO	RD PARAM NUM	1	-	1	0	-	-	-
71	LAI	RD PARAM DAT	0	-	1	0	-	-	-
72	LAO	WR PARAM NUM	1	-	1	0	-	-	-
73	LAO	WR PARAM DAT	0	-	1	0	-	-	-
74 */	LDI	MF IN 3 MON	OFF	-	1	0	ON	OFF	UB-02 (bit 4)
75 */	LAI	OUT VOLT FLT	0	V	0.1	0	-	-	U2-07
76 */	LAI	DC BUS FLT	0	V	1	0	-	-	U2-08
77 */	LAI	OUT PWR FLT	0	kW	0.1	0	-	-	U2-09
78 */	LDI	MF IN 4 MON	OFF	-	1	0	ON	OFF	UB-02 (bit 5)
79 */	LAI	PID DEVIATE	0	%	0.01	0	-	-	U5-02
80	LAO	PID I LIMIT	100	%	0.1	0	-	-	b5-04
81	LAO	PID UP LIMIT	100	%	0.1	0	-	-	b5-06
82	LAO	PID OFFS ADJ	100	%	0.1	-100	-	-	b5-07
83	LAO	PID PRI DYTM	0	s	0.1	0	-	-	b5-08
84	-	N/A	-	-	-	-	-	-	-
85	-	N/A	-	-	-	-	-	-	-
86	-	N/A	-	-	-	-	-	-	-
87 */	LAI	PID OUT CAP	0	%	0.01	0	-	-	U5-14
88 */	LAI	PID REF	0	%	0.01	0	-	-	U5-04
89 */	LAI	COMM ERR CD	0	-	1	0	-	-	U1-19
90	LDO	COMM FLT ENA	DISABLE	-	1	0	ENABLE	DISABLE	H5-05
91	LAO	CBL LOSS FREQ	0	Hz	0.01	0	-	-	H5-34
92	LAO	CBL LOSS TMR	2	s	0.1	0	-	-	H5-09
93 */	LDI	OK.FAULT	OK	-	1	0	FAULT	OK	UB-06 (bit 2)
94 */	LDO	RESET FAULT	NO	-	1	0	RESET	NO	-
95 */	LDI	DRV COMM ERR	NO FLT	-	1	0	FAULT	NO FLT	-
96 */	LDO	EXTERNAL FLT	OK	-	1	0	FAULT	OK	-
97 */	LDI	MF IN 5 MON	OFF	-	1	0	ON	OFF	UB-02 (bit 6)

10.4 APOGEE FLN (P1) Communications

Point No.	Point Type	Point Name	Factory Default (SI Units)	Eng. Units (SI Units)	Slope (SI Units)	Intercept (SI Units)	On Text	Off Text	Parameter
98	-	N/A	-	-	-	-	-	-	-
99 */	LAI	ERROR STATUS	0	-	1	0	-	-	U1-19

*1 These point numbers can be unbundled at the field panel.

*1 Refer to *Faults, Minor Faults, Alarms, and Error Codes Listed by Decimal Value for Use with BACnet/Modbus on page 468* for information on fault decimal values.

*1 To allow Point 35 to operate as a “Run Enable” signal, set $Z3-16 = 1$ [Enable]. If $Z3-16 = 0$ [Disable], Point 35 will have no effect.

◆ Cable Loss Configuration and Behavior

This section gives information about the configurable cable loss feature of the bypass. This feature lets you configure the response to a loss of communication.

■ Bypass Behavior at Loss of Communication

After some interval without receiving a message, you can set the bypass to response to one of these:

- Continue at last speed
- Continue at last speed with Alarm
- Continue at preset speed
- Ramp to Stop with CE fault
- Coast to Stop with CE fault

■ APOGEE FLN Points

You can use three APOGEE FLN points to select the behavior:

- POINT 92 - CBL LOSS TMR
- POINT 91 - CBL LOSS FRQ
- POINT 90 - COMM FLT ENA

Table 10.11 Cable Loss Behavior Summary

Behavior	H5-04 [Communication Error Stop Method]	CBL LOSS TMR (Point 92)	CBL LOSS FRQ (Point 91)	COMM FLT ENA (Point 90)
Decelerate to stop (stop time in C1-02) CE fault	0 [Ramp to Stop]	Timeout interval	x	ON
Coast to stop CE fault	1 [Coast to Stop]	Timeout interval	x	ON
Emergency stop (stop time in C1-09) CE fault	2 [Fast Stop (Use C1-09)]	Timeout interval	x	ON
Continue at last speed	3 [Alarm Only]	0	x	x
Continue at last speed with alarm	3 [Alarm Only]	Timeout interval	x	ON
Continue at preset speed with alarm	4 [Run at H5-34 (CE Go-To-Freq)]	Timeout interval	Preset speed	ON

Note:

1. You must establish Communication for these features to function as described. If you energize the drive without a cable connected or with the master controller offline, a communications timeout does not occur.
2. For modes which describe the drive running after a communications timeout, a Run command must have been issued (RUN ENABLE (Point 35) = “ON” and either CMD RUN.FWD (Point 22) = “ON” or CMD RUN.REV (Point 24) = “ON”) prior to loss of communications. For safety purposes, the drive will not automatically restart from a stopped condition. If a user requires the drive to restart automatically, additional external wiring is required to accomplish this (consult factory).

Upon expiration of the communications timeout interval, a CE [Serial Communication Error] fault will be declared and will remain until communication is restored.

Continue at Last Speed

In this mode, CBL LOSS TMR (POINT 92) is set to 0, disabling the cable loss feature. The other two settings, CBL LOSS FRQ (POINT 91) and COMM FLT ENA (POINT 90), are ignored. If communication is lost, the drive

maintains its last commanded state. The drive will not display an alarm or fault to indicate it has lost communication. This behavior can also be achieved by setting parameter $H5-04 = 3$. The drive will display an alarm and continue running. For this specific condition, the COMM FLT ENA (POINT 90) must be enabled and CBL LOSS TMR (POINT 91) should be set to a value other than 0. A CE drive alarm will be set.

Continue at Preset Speed

In this mode, CBL LOSS TMR (POINT 92) is set to the desired interval, CBL LOSS FRQ (POINT 91) is set to the desired preset speed and the parameter is set to $H5-04 = 4$. If the time between messages exceeds the timeout interval, the drive speed command, INPUT REF 1, (Point 60) is set to the CBL LOSS FRQ (POINT 91) and the drive continues running at this new speed. COMM FLT ENA (POINT 90) must be set to ON.

Stop

COMM FLT ENA (POINT 90) must be set to ON. In this mode, CBL LOSS TMR (POINT 92) is set to the desired interval and parameter $H5-04$ is set to a value of 0, 1, or 2. If the time between messages is longer than the timeout interval, the speed command of the drive, INPUT REF 1, (Point 60) is set to 0. The stopping method is determined by the setting of $H5-04$. A CE drive fault will be set. $H5-04 = 0$ selects Ramp to Stop. $H5-04 = 1$ selects Coast to Stop. The drive does not attempt to control the rate of deceleration. $H5-04 = 2$ selects Fast Stop. The deceleration time is determined by the setting of drive parameter $C1-09$.

Note:

The behavior of the drive at cable loss is controlled by parameter $H5-04$. This drive parameter works with the points as described in the table above to determine how the drive will respond to a cable loss. If the cable loss fault is disabled, the drive will continue in its last state, if running the drive will continue to run at the last commanded frequency.

Stop with Fault (CE)

In this mode, CBL LOSS TMR (POINT 92) is set to the desired interval, COMM FLT ENA (POINT 90) or is set to "ON" and either CMD RUN.FWD (Point 22) or CMD RUN.REV (Point 24) is also set to "ON". If the time between messages exceeds the timeout interval, a "CE" fault is declared and the drive stops. The stopping method is controlled by the setting of $H5-04$ and is described above. CBL LOSS FRQ (POINT 91) is ignored.

◆ Mailbox Functions

This section defines the APOGEE FLN points that read and write parameters.

■ Reading a Parameter

These two are the points to read any parameter:

- #70: Specifies the parameter to be read from
- #71: Reports the value of the parameter specified in Point #70

When this point is read, it retrieves data from the parameter and sends it to the controller.

Example:

1. Writing a value of 387 (183H) to Point #70 specifies parameter $b1-04$ [*Reverse Operation Selection*].
2. Reading Point #71 returns the current setting of $b1-04$ to the controller.

■ Writing to a Drive Parameter

Two two are the points to write to any drive parameter:

- #72: Specifies the parameter to be written to
- #73: Entry location of the value to be written to the parameter specified in Point #72

When this point is written to, it will write the value to the drive. An enter or accept command does not need to be sent for the data to be taken by the drive. The behavior of the write is the same as with the keypad. If the drive is running, there are a limited number of drive parameters that can be written to.

Example:

1. Writing a value of 387 (183H) to Point #72 specifies drive parameter $b1-04$ [*Reverse Operation Selection*].
2. Writing a value of 1 to Point #73 enables the drive for reverse run.

◆ Self-Diagnostics

The bypass can use Self-Diagnostics to verify the hardware transceiver on the control circuit. Self-Diagnostics connects the transmission terminal to the reception terminal on the control circuit and transmits the data to itself to make sure that the bypass can communicate correctly.

Use this procedure to do Self-Diagnostics:

DANGER! Electrical Shock Hazard. Do not examine, connect, or disconnect wiring on an energized bypass. Before servicing, disconnect all power to the equipment and wait for the time specified on the warning label at a minimum. The internal capacitor stays charged after the bypass is de-energized. The charge indicator LED extinguishes when the DC bus voltage decreases below 50 Vdc. When all indicators are OFF, remove the covers before measuring for dangerous voltages to make sure that the bypass is safe. If you do work on the bypass when it is energized, it will cause serious injury or death from electrical shock.

1. Energize the bypass.
2. Set Z2-06 = 45 [Digital Input 6 Function (TB2-6) - Serial Hardware Test (RS-485)].
3. De-energize the bypass.
4. Disconnect the RS-485 terminals (TB3).
5. Connect a jumper between control circuit terminals TB2-6 and TB2-9 or TB2-10.

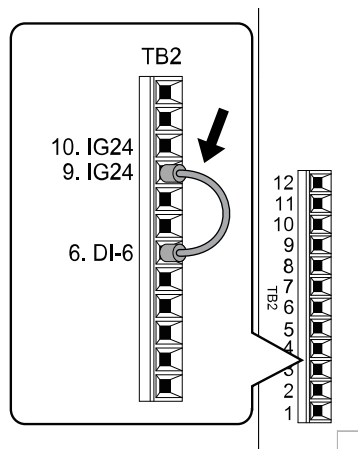

Figure 10.9 Self-Diagnostics Jumper Terminals

6. Energize the bypass.
7. When normal, the keypad will show *PASS* [Serial Communication Test].

Note:

If there is an error, the keypad will show *CE* [Serial Communication Error]. Disconnect the bypass from the network and test the bypass again. If the error stays, there is a possible hardware problem. If there is no error, there is a possible network wiring problem.

8. De-energize the bypass.
9. Disconnect the jumper from Step 4. Set Z2-06 to its initial function.

Self-Diagnostics is complete and the bypass returns to its usual function.

◆ Troubleshooting Checklist

Checked	No.	Item to Check
	1	Connect power to the bypass and verify that the bypass operates correctly in HAND Mode from the keypad without being connected to the network. Record the bypass model number at this time: Model Number:
	2	Record the control board part number: Control Board Part Number:
	3	All network devices have unique addresses and bypasses are addressed between 1 to 98 (1 to 62 hex). Drive Address:

Checked	No.	Item to Check
	4	Set <i>b1-02 [Run Command Selection 1]</i> correctly. b1-02:
	5	Set <i>b1-01 [Frequency Reference Selection 1]</i> correctly. b1-01:
	6	Use the correct cable type. Mfg: P/N:
	7	All cable connections are correct per device schematic and are secure.
	8	All cables have been checked for continuity. There are no breaks or shorts.
	9	The network is correctly terminated.
	10	The shield is continuous throughout the network and is properly grounded on each end.
	11	The network cable is routed away from any high voltage cable(s) or source(s).
	12	All network devices have been tested for conformance with the APOGEE FLN specification.

10.5 Metasys N2 Communications

This section gives detailed information about the parameters, error codes and communication procedures for Metasys N2 communications.

◆ Configure Master/Slave

You can monitor and control the bypass from a controller on a Metasys N2 network (N2) with RS-485 technology. The bypasses act as slaves on the N2 network.

A possible maximum of 255 bypasses can communicate on a single N2 network. When more bypasses or N2 devices are necessary, another N2 network is necessary.

You can use a parameter to set the N2 node address. This gives the physical address of the bypass on the MS-TP network.

When you set the addressing, a controller can start communication to the bypass. The bypass will do the specified function and send a response back to the controller.

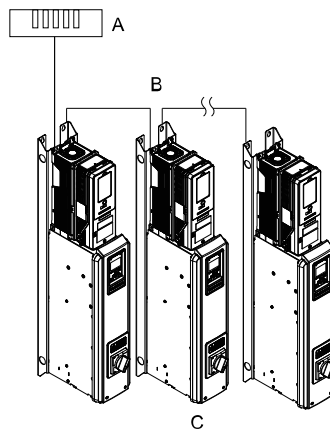

A - Metasys Field Controller
B - N2

C - Bypasses

Figure 10.10 Connection Example of Multiple Bypasses to a Metasys N2 Network

◆ Communication Specifications

Table 10.12 lists the specifications for the Metasys N2 communications.

Table 10.12 Metasys N2 Specifications

Item	Specifications
Interface	RS-485
Communication parameter	Communication speed: 9.6 kbps
	Data length: 8 bit (fixed)
	Parity: none
	Stop bit: 1 bit (fixed)
Communication protocol	Metasys N2
Number of possible units to connect	Maximum: 255 units for each N2 network segment

◆ Communication with the Controller

This section explains how to connect the bypass to an N2 network and the network termination required for a connection.

■ Connect Communications Cable

Use this procedure to start communication between the controller and the bypass.

1. De-energize the bypass then connect the communications cable to the controller and the bypass. The bypass uses terminal TB3 for serial communications.

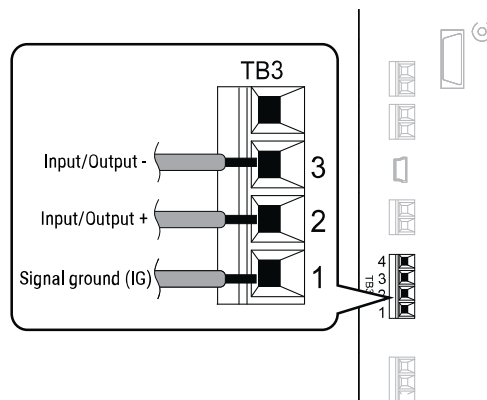

Figure 10.11 Communications Cable Connection Terminal (TB3)

Note:

Isolate the communications wiring from the main circuit wiring and other high-power wiring. Use shielded wires for the communications wiring and connect cable sheaths as shown in “Wiring Diagram for More than One Bypass”. Incorrect wiring procedures could cause bypass malfunction because of electrical interference.

2. Enable the termination resistor ONLY when the bypass is at the end of the communications network. Set DIP switch S1 to the “ON” position to enable the termination resistor. Refer to “Set the Termination Resistor” for more information.
3. Energize the bypass.
4. Use the keypad to set the necessary communications parameters *H5-01 to H5-11*.
 - *H5-01 [Drive Node Address]*
 - *H5-02 [Communication Speed Selection]*
 - *H5-04 [Stopping Method after Com Error]*
 - *H5-05 [Comm Fault Detection Select]*
 - *H5-08 [Communication Protocol Selection]*
 - *H5-09 [CE Detection Time]*
5. Because communications parameters do not take effect immediately, either de-energize and re-energize the bypass or set *H5-20 = 1 [Communication Parameters Reload = Reload Now]*.

The bypass is prepared to start communication with the controller.

■ Set the Termination Resistor

You must enable the termination resistor on the serial terminals of the devices on the two physical ends of the network to use serial communications. Use DIP switch S1 on the bypass control PCB to enable and disable the built-in termination resistor. Refer to [Figure 10.12](#) for an example of how to set DIP switch S1. Use the tip of a tweezers or a small flat-blade screwdriver to set the DIP switch. When you install the bypass at the end of the network line, set DIP switch S1 to “ON” to enable the termination resistor. Set DIP switch S1 to “OFF” on all other bypasses.

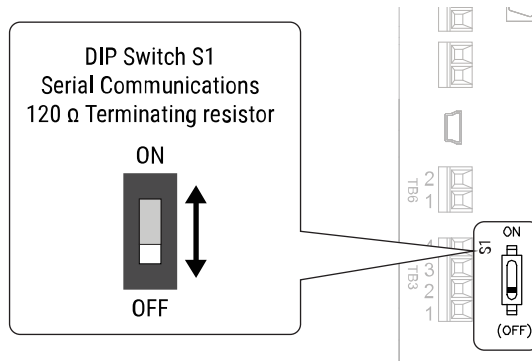

Figure 10.12 Termination Resistor DIP Switch S1

■ Wiring Diagram for More than One Bypass

Figure 10.13 shows how to wire more than one connected bypass using serial communications.

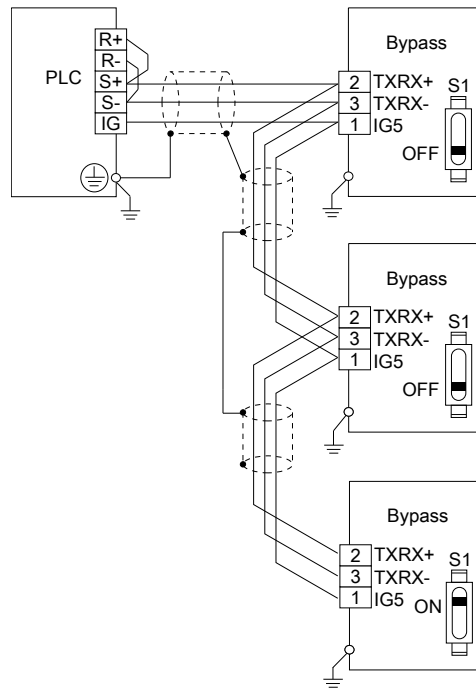

Figure 10.13 Wiring Diagram for More than One Bypass

Note:

When you install the bypass at the end of the network line, set DIP switch S1 to "ON" to enable the termination resistor. Set DIP switch S1 to "OFF" on all other bypasses.

◆ Bypass Operations by Serial Communications

Parameters will apply to the settings when the bypass is running during serial communications. This section gives information about the available functions and their related parameters.

■ Executable Functions

A controller can do these operations with serial communications. Parameter settings (except *H5-xx*) do not have an effect on the availability of these operations.

- Monitor the bypass status and operate the bypass
- Set and view parameters
- Fault Reset Procedure

■ Bypass Control

To use external commands to set the frequency references and motor run/stop with serial communications, set these parameters as specified by the application:

- $b1-01 = 2$ [*Frequency Reference Selection 1 = Serial Communications*]
- $b1-02 = 2$ or 8 [*Run Command Selection 1 = Serial Communications or AUTO Command + Serial Run*]

For more information about operation mode selection, refer to $b1-01$ and $b1-02$.

■ Bypass Functions

Enable these functions during start-up:

- Start and Stop the Bypass
Set the Run Forward Command (BO 1) to run the bypass in the forward direction. Run/Stop Monitor (BI 1) shows the current run status of the bypass. Forward/Reverse Monitor (BI 2) shows the current direction.
- Lock the Bypass Panel
Locking the panel prevents the user from using the HAND and OFF keys locally at the bypass panel. Panel Lock (BO 10) can be commanded to lock and unlock the panel.
- Digital Inputs
Multi-Function Input TB2-3 (BO 5) to Multi-Function Input TB2-7 (BO 9) are the physical digital inputs on the bypass controller. The bypass programming determines their functions and you can use an external device, for example a physical pressure switch, or the network can set these inputs. Refer to the section on Multi-Function Inputs ($Z2-03$ to $Z2-07$) for detailed information about the use and programming of the multi-function inputs. You can use Multi-Function input 3 Monitor (BI 15) to Multi-Function Input 7 Monitor (BI 19) to monitor the multi-function input status.
Note:
The multi-function inputs can be set by both external devices or over the network. Use caution when Z3-12 is enabled and when connecting the multi-function inputs to external devices to ensure correct system operation.
- Digital Outputs
Multi-Function Output DO-7 (BI 10) through Multi-Function Output DO-9 (BI 12) are the physical digital outputs on the bypass. The bypass programming determines their functions Refer to the section on Multi-Function Outputs ($Z2-23$ ~ $Z2-25$) for detailed information about the use and programming of the multi-function outputs.
- Loop Gain
PI Proportional Gain (AO 4) and PI Integral Time (AO 5) are the gain and integral time parameters used by the bypass. The PI loop is structured differently than the Metasys loop. Refer to the User Manual section on PID for information on how the PI loop functions.
- Reading and Resetting Faults
The Fault Monitor (BI 4) and Bypass Ready Monitor (BI 3) show the current status of the bypass. The Fault Code (AI 10) contains the code for the most current fault. The LST Fault Code (AI 19) contains the code for the previous fault. Refer to Alarm Register Contents for descriptions of the fault codes. The bypass faults can be reset through the Fault Reset Command (BO 4). The Fault Reset Command is only available when the Run Forward Command and the Run Reverse Command are both OFF.

■ Cable Loss Configuration and Behavior

This section describes the configurable cable loss feature of the bypass. This feature offers a user maximum flexibility in determining bypass response to a loss of communication.

- Behavior at Loss of Communication
The bypass can be configured to respond to an interval without receipt of a message in one of these methods:
 - Continue at last speed
 - Continue at last speed with alarm
 - Continue at preset speed
 - Ramp to Stop with $EF0$ [*Option Card External Fault*]
 - Coast to Stop with $EF0$
 - Emergency Stop with $EF0$
- Metasys N2 I/O

Three Metasys N2 outputs are used to select the desired behavior:

- AO 21 - Cable Loss Timeout
- AO 22 - Cable Loss Speed
- BO 11 - Communication Fault

Table 10.13 Cable Loss Behavior Summary

Behavior	H5-04 [Communication Error Stop Method]	Cable Loss Timeout (AO 21)	Cable Loss Speed (AO 22)	Communication Fault Enable (BO 11)
Decelerate to stop (stop time in <i>C1-02</i>) with <i>EF0</i> fault	0 [Ramp to Stop]	Timeout Interval	x	ON
Coast to stop with <i>EF0</i> fault	1 [Coast to Stop]	Timeout Interval	x	ON
Emergency stop (stop time in <i>C1-09</i>) with <i>EF0</i> fault	2 [Fast Stop (Use <i>C1-09</i>)]	Timeout Interval	x	ON
Continue at last speed	3 [Alarm Only]	0	x	x
Continue at last speed with alarm	3 [Alarm Only]	Timeout Interval	x	ON
Continue at preset speed with alarm	4 [Run at H5-34 (CE Go-To-Freq)]	Timeout Interval	Preset speed	ON

Note:

1. Communication must first be established and then lost for these features to function as described. If a bypass is powered-up without a cable connected or with the master controller offline, a communications timeout does not occur.
2. For modes that describe the bypass running after a communications timeout, a Run command must have been issued (BO 1 = "ON" or BO 2 = "ON") prior to loss of communications. For safety purposes, the bypass will not automatically restart from a stopped condition. If a user requires the bypass to restart automatically, additional external wiring is required to accomplish this (consult factory).

Upon expiration of the communications timeout interval, the FAULT LED lights and remains lit until communication is restored.

- **Continue at Last Speed**

In this mode, Cable Loss Timeout (AO 21) is set to 0, disabling the cable loss feature. The other two settings Cable Loss Speed (AO 22) and Communication Fault Enable (BO 11) are ignored. If communication is lost, the bypass simply maintains its last commanded state. The bypass will not display an alarm or fault to indicate it has lost communication. This behavior can also be achieved by setting *H5-04* = 3. The bypass will display an alarm and continue running. For this specific condition, the Communication Fault Enable (BO 11) must be enabled and Cable Loss Timeout (AO 21) should be set to a value other than 0.

- **Continue at Preset Speed**

In this mode, Cable Loss Timeout (AO 21) is set to the desired interval, Cable Loss Speed (AO 22) is set to the desired preset speed and *H5-04* = 4. If the time between messages exceeds the timeout interval, the drive speed command (AO 1) is set to the Cable Loss Speed (AO 22) and the drive continues running at this new speed. Communication Fault Enable (BO 11) must be set to "ON".

- **Stop with Fault (EF0)**

Communication Fault Enable (BO 11) must be set to "ON". In this mode, Cable Loss Timeout (AO 21) is set to the desired interval and parameter *H5-04* = 0, 1, or 2. If the time between messages exceeds the timeout interval, the bypass will declare a *CE* fault. The stopping method is determined by the setting of *H5-04*:

- *H5-04* = 0 selects Ramp to Stop. The deceleration time or the slope of the ramp is determined by *C1-02*
- *H5-04* = 1 selects Coast to Stop. The bypass does not attempt to control the rate of deceleration.
- *H5-04* = 2 selects Emergency or Fast Stop. The deceleration time is determined by *C1-09*.

Note:

The behavior of the bypass at cable loss is controlled by *H5-04*. This parameter works with the points as described in the table above to determine how the bypass will respond to a cable loss. If the cable loss fault is disabled, the bypass will continue in its last state, if running the bypass will continue to run at the last commanded frequency.

◆ Communications Timing

To prevent overrun of the slave side, the master cannot send a message to the same drive for a selected length of time. To prevent overrun of the master side, the slave cannot send a response message to the master for a selected length of time.

This section gives information about message timing.

■ Command Message from Master to Slave

To prevent data loss and overrun, after the master receives a message from the slave, the master cannot send the same type of command message to the same slave for a selected length of time. The minimum wait time is different for each type of message. Refer to [Table 10.14](#) to find the minimum wait times.

Table 10.14 Minimum Wait Time to Send a Message

Command Type	Example	Minimum Wait Time
1	<ul style="list-style-type: none"> Operation commands (Run command, stop command) I/O settings Reading the motor and parameter setting values 	5 ms ^{*1}
2	Writing a parameter	H5-11 = 0: 50 ms H5-11 = 1: 200 ms ^{*1}
3	Writing of modified data with the Enter command	200 ms to 2 s, depending on the number of parameters that were changed ^{*1}
4	Enter with storage to drive EEPROM after initialization	5 s

*1 When the drive receives a message in the minimum wait time, it does command type 1 and sends a response message. If the drive receives command type 2 or command type 3 messages in the minimum wait time, it will trigger a communications error or the drive will ignore the command.

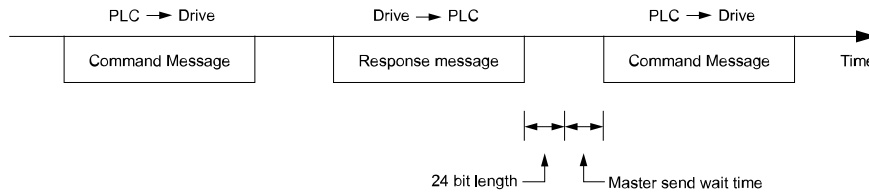

Figure 10.14 Minimum Wait Time to Send a Message

You must set the timer in the master to measure the length of time for the slave to respond to the master. If you set the timer, but the slave does not send a response message in a specified length of time, the master will send the message again.

■ Response Message from Slave

The slave receives the command message from the master then processes the data it received. The slave then waits for the time set in *H5-06 [Drive Transmit Wait Time]* then sends a response message to the master. If overrun occurs on the master, increase the wait time set in *H5-06*.

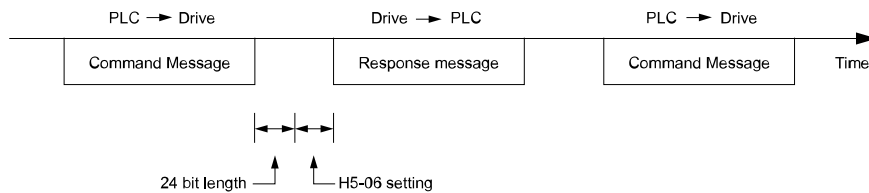

Figure 10.15 Response Wait Time

◆ Metasys N2 Point Database

This section describes the Metasys N2 point database. This database features 100 logical points: 38 Analog Inputs (AI), 32 Analog Outputs (AO), 19 Binary Inputs (BI) and 11 Binary Outputs (BO). These points configure, control, and monitor the operation of the drive.

■ Metasys N2 Analog Input (AI) Summary

Table 10.15 Metasys N2 Analog Input Summary (Drive to Metasys N2)

Object ID	Object Name	Units	Drive Parameters
AI 1	Speed Reference	0.01 Hz	U1-01
AI 2	Output Speed	0.01 Hz	U1-02

10.5 Metasys N2 Communications

Object ID	Object Name	Units	Drive Parameters
AI 3	Output Current	0.1 A	UB-01
AI 4	kWatt Hour Meter	kWh	U4-10
AI 5	Output Power	0.1 kWh	U1-08
AI 6	Drive Temperature	1 °C	U4-08
AI 7	PI Feedback	0.01%	U5-01
AI 8	AC Output Voltage	0.1 Vac	U1-06
AI 9	DC Bus Voltage	1 Vdc	U1-07
AI 10	Fault Code	-	U2-01
AI 11	Elapsed Time - Hours	1 hour	U4-01
AI 12	Elapsed Time - 10K Hours	10K hours	U4-01
AI 13	MWatt Hour meter	MWh	U4-11
AI 14	Drive Rated Current	A	-
AI 15	Communication Error Code	-	U1-19
AI 16	PI Deviation	0.01%	U5-02
AI 17	PI Output Capacity	0.01%	U5-03
AI 18	PI Reference	0.01%	U5-04
AI 19 ^{*1}	Last Fault Code	-	U2-02
AI 20	Freq Ref @ Fault	0.01 Hz	U2-03
AI 21	Output Freq @ Fault	0.01 Hz	U2-04
AI 22	Output Current @ Fault	0.1 A	U2-05
AI 23	Out Volt Ref @ Fault	0.1 Vac	U2-07
AI 24	DC Bus Volts @ Fault	1 Vdc	U2-08
AI 25	Output Power @ Fault	0.1 kW	U2-09
AI 26	By Input Terminal Status @ Fault	-	U2-11
AI 27	By Output Terminal Status @ Fault	-	U2-12
AI 28	Bypass Operation Status @ Fault	-	U2-13
AI 29	Elapsed Operation Time @ Fault	1 hour	U2-14
AI 30 ^{*1}	Most Recent Fault	-	U3-01
AI 31 ^{*1}	2nd Most Recent Fault	-	U3-02
AI 32 ^{*1}	3rd Most Recent Fault	-	U3-03
AI 33 ^{*1}	4th Most Recent Fault	-	U3-04
AI 34	Elapsed Time @ Current Fault	1 hour	U3-11
AI 35	Elapsed Time @ 2nd Fault	1 hour	U3-12
AI 36	Elapsed Time @ 3rd Fault	1 hour	U3-13
AI 37	Elapsed Time @ 4th Fault	1 hour	U3-14
AI 38	Read Parameter Data	-	-

*1 Refer to *Faults, Minor Faults, Alarms, and Error Codes Listed by Decimal Value for Use with BACnet/Modbus on page 468* for information on fault decimal values.

■ Metasys N2 Analog Output (AO) Summary

Table 10.16 Metasys N2 Analog Output Summary (Drive to Metasys N2)

Object ID	Object Name	Units	Default Value	Drive Parameters
AO 1	Speed Command	0.01 Hz	-	-
AO 2	Acceleration Time	s	30.0	C1-01

Object ID	Object Name	Units	Default Value	Drive Parameters
AO 3	Deceleration Time	s	30.0	C1-02
AO 4	PI Proportional Gain	-	2.00	b5-02
AO 5	PI Integral Time	s	5.0	b5-03
AO 6	Stall Prevention Level - Run	%	120	L3-06
AO 7	Stall Prevention Level - Accel	%	120	L3-02
AO 8	Reference Operation Mode Select	-	1	b1-01
AO 9	Run Operation Mode Select	-	1	b1-02
AO 10	PI Mode Select	-	0	b5-01
AO 11	Frequency Command Upper Limit	% of Max	100.0	d2-01
AO 12	Frequency Command Lower Limit	% of Max	0.0	d2-02
AO 13	Motor Rated Current	A	Motor model dependent	E2-01
AO 14	Jump Frequency 1	0.1 Hz	0.0	d3-01
AO 15	Jump Frequency 2	0.1 Hz	0.0	d3-02
AO 16	Jump Frequency 3	0.1 Hz	0.0	d3-03
AO 17	Jump Frequency Bandwidth	0.1 Hz	1.0	d3-04
AO 18	Number of Auto Restarts	-	0	L5-01
AO 19	Operator Display Mode	-	0	o1-03
AO 20	Power Loss Ride-Thru	s	Drive model dependent	L2-02
AO 21	Cable Loss Timeout	s	2.0	H5-09
AO 22	Cable Loss Speed	0.01 Hz	0.00	H5-34
AO 23	PI Integral Limit	0.1%	100.0	b5-04
AO 24	PI Upper Limit Value	0.1	100.0	b5-06
AO 25	PI Offset Adjustment	0.1	0.0	b5-07
AO 26	PI Primary Delay Time	0.01	0.00	b5-08
AO 27	Not Used	-	-	-
AO 28	Not Used	-	-	-
AO 29	Not Used	-	-	-
AO 30	Read Parameter Number	-	-	-
AO 31	Write Parameter Number	-	-	-
AO 32	Write Parameter Data	-	-	-

■ Metasys N2 Binary Input (BI) Summary

Table 10.17 Metasys N2 Binary Input Summary (Drive to Metasys N2)

Object ID	Object Name	Default	OFF (0) State	ON (1) State
BI 1	System Run/Stop Monitor	0	Stopped	Running
BI 2	System Forward/Reverse Monitor	0	Forward	Reverse
BI 3	System Ready Monitor	0	Not Ready	Ready
BI 4	Fault Monitor	0	Not Faulted	Faulted
BI 5	Zero Speed	0	Not Zero Speed	Zero Speed
BI 6	Speed Agree	0	Not Speed Agree	Speed Agree
BI 7	Minor Fault	0	No Minor Fault	Minor Fault
BI 8	Major Fault	0	No Major Fault	Major Fault
BI 9	Communication Error Monitor	0	No Error	Error

10.5 Metasys N2 Communications

Object ID	Object Name	Default	OFF (0) State	ON (1) State
BI 10	Digital Output 7 (TB1 1-3) (Z2-23)	0	OFF	ON
BI 11	Digital Output 8 (TB1 4-6) (Z2-24)	0	OFF	ON
BI 12	Digital Output 9 (TB1 7-9) (Z2-25)	0	OFF	ON
BI 13	Safety Interlock Monitor	0	Safety Clear Terminal 3 Closed	Safety Set Terminal 3 Open
BI 14	HAND/AUTO Reference Monitor	0	AUTO or OFF	HAND
BI 15	Digital Input TB2-3 Monitor	0	OFF	ON
BI 16	Digital Input TB2-4 Monitor	0	OFF	ON
BI 17	Digital Input TB2-5 Monitor	0	OFF	ON
BI 18	Digital Input TB2-6 Monitor	0	OFF	ON
BI 19	Digital Input TB2-7 Monitor	0	OFF	ON

■ Metasys N2 Binary Output (BO) Summary

Table 10.18 Metasys N2 Binary Output Summary (Drive to Metasys N2)

Object ID	Object Name	Default	OFF (0) State	ON (1) State
BO 1	Run Forward Command	0	Stop	Forward
BO 2	Run Reverse Command	0	Stop	Reverse
BO 3	Serial Fault (EFB) Command	0	No Fault	Fault
BO 4	Fault Reset Command	0	No Reset	Reset
BO 5	Digital Input 3 (TB2-3) (Z2-03) ^{*1}	0	OFF	ON
BO 6	Digital Input 4 (TB2-4) (Z2-04) ^{*1}	0	OFF	ON
BO 7	Digital Input 5 (TB2-5) (Z2-05) ^{*1}	0	OFF	ON
BO 8	Digital Input 6 (TB2-6) (Z2-06) ^{*1}	0	OFF	ON
BO 9	Digital Input 7 (TB2-7) (Z2-07) ^{*1}	0	OFF	ON
BO10	Panel Lock	0	HAND and OFF Keys Enabled	HAND and OFF Keys Disabled
BO 11	Communication Fault Enable	0	CE Not Activated if Cable Loss Occurs	CE Activated if Cable Loss Occurs

*1 When Z3-12 = 0, this input is disabled.

◆ Mailbox Functions

This section defines the Metasys N2 points that read and write parameters.

■ Reading a Parameter

Two points are defined for reading parameters:

- AO 30 - Specifies the parameter to be read
- AI 38 - Reports the value of the parameter specified in AO 30.

When this point is read, it retrieves data from the parameter and sends it to the controller

Example: Writing a value of 387 (183 hex) to AO 30 specifies parameter *b1-04*. Reading AI 38 returns the current setting of parameter *b1-04* to the controller.

■ Writing to a Parameter

Two points are defined for writing to parameters:

- AO 31 - Specifies the parameter to be written to
- AO 32 - Entry location of the value to be written to the parameter specified in AO 31. When this point is written to, it will write the value to the bypass. An ENTER or ACCEPT command does not need to be sent for the data to be taken by the bypass. The behavior of the write is the same as with the keypad. If the bypass is running, there are a limited number of parameters that can be written to.

Example: Writing a value of 387 (183 hex) to AO 31 specifies parameter *b1-04*. Writing a value of 1 to AO 32 sets *b1-04 = 1* and enables the bypass for reverse run.

◆ Self-Diagnostics

The bypass can use Self-Diagnostics to verify the hardware transceiver on the control circuit. Self-Diagnostics connects the transmission terminal to the reception terminal on the control circuit and transmits the data to itself to make sure that the bypass can communicate correctly.

Use this procedure to do Self-Diagnostics:

DANGER! Electrical Shock Hazard. Do not examine, connect, or disconnect wiring on an energized bypass. Before servicing, disconnect all power to the equipment and wait for the time specified on the warning label at a minimum. The internal capacitor stays charged after the bypass is de-energized. The charge indicator LED extinguishes when the DC bus voltage decreases below 50 Vdc. When all indicators are OFF, remove the covers before measuring for dangerous voltages to make sure that the bypass is safe. If you do work on the bypass when it is energized, it will cause serious injury or death from electrical shock.

1. Energize the bypass.
2. Set Z2-06 = 45 [Digital Input 6 Function (TB2-6) - Serial Hardware Test (RS-485)].
3. De-energize the bypass.
4. Disconnect the RS-485 terminals (TB3).
5. Connect a jumper between control circuit terminals TB2-6 and TB2-9 or TB2-10.

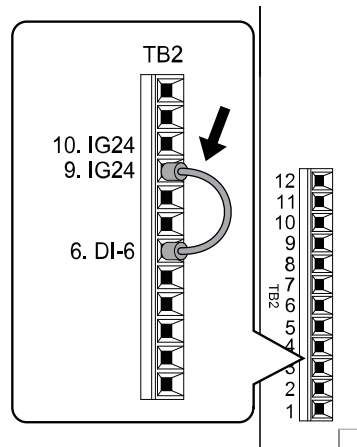

Figure 10.16 Self-Diagnostics Jumper Terminals

6. Energize the bypass.
7. When normal, the keypad will show *PASS* [Serial Communication Test].

Note:

If there is an error, the keypad will show *CE* [Serial Communication Error]. Disconnect the bypass from the network and test the bypass again. If the error stays, there is a possible hardware problem. If there is no error, there is a possible network wiring problem.

8. De-energize the bypass.
9. Disconnect the jumper from Step 4. Set Z2-06 to its initial function.

Self-Diagnostics is complete and the bypass returns to its usual function.

10.6 MEMOBUS/Modbus Communications

This section gives detailed information about the parameters, error codes and communication procedures for MEMOBUS/Modbus communications.

◆ Configure Master/Slave

You can use the MEMOBUS/Modbus protocol for serial communication with programmable controllers.

The MEMOBUS/Modbus communication uses one master and a maximum of 31 slave bypasses. Serial communications usually starts with a signal from the master to the slave bypass.

A slave bypass that receives a command from the master does the specified function and then sends a response back to the master. You must set the address number for each slave bypass before you start communications to make sure that the master uses the correct address numbers.

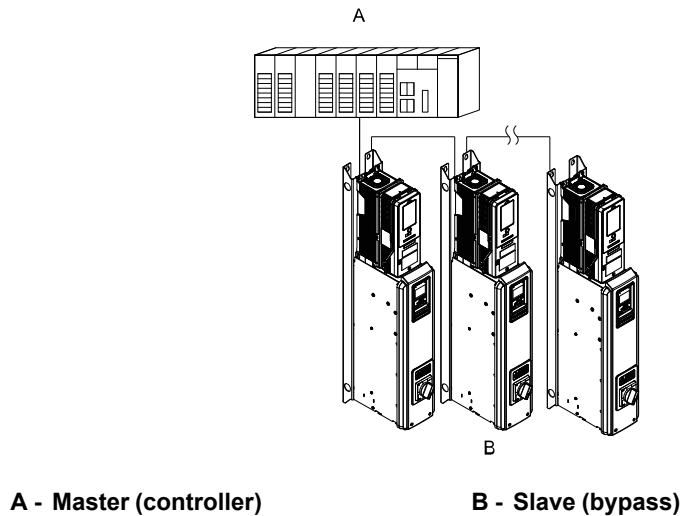

Figure 10.17 Master and Slave Connection Example

◆ Communication Specifications

Table 10.19 lists the specifications for the MEMOBUS/Modbus communications.

Table 10.19 MEMOBUS/Modbus Specifications

Item	Specification
Interface	RS-485
Synchronization method	Asynchronous (start-stop synchronization)
Communication parameter	Communications speed: 1.2, 2.4, 4.8, 9.6, 19.2, 38.4, 57.6, 76.8, 115.2 kbps
	Data length: 8 bit (fixed)
	Parity: even, odd, none
	Stop bit 1 bit (fixed)
Communication protocol	MEMOBUS/Modbus standard (RTU mode only)
Number of possible units to connect	Maximum: 31 units

◆ Communication with the Controller

This section gives information about the settings for the termination resistor and how to connect to MEMOBUS/Modbus communications. MEMOBUS/Modbus communications uses an RS-485 interface (2-wire sequence).

■ Connect Communications Cable

Use this procedure to start communication between the controller and the bypass.

1. De-energize the bypass then connect the communications cable to the controller and the bypass. The bypass uses terminal TB3 for serial communications.

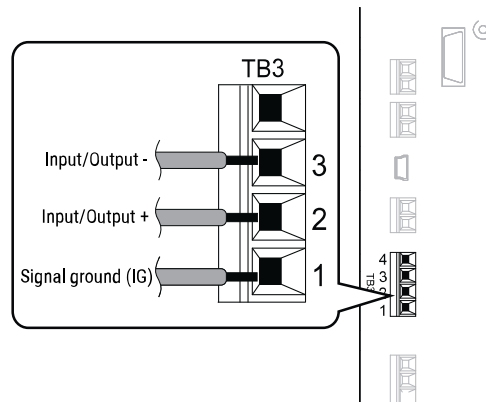

Figure 10.18 Communications Cable Connection Terminal (TB3)

Note:

Isolate the communications wiring from the main circuit wiring and other high-power wiring. Use shielded wires for the communications wiring and connect cable sheaths as shown in “Wiring Diagram for More than One Bypass”. Incorrect wiring procedures could cause bypass malfunction because of electrical interference.

2. Enable the termination resistor ONLY when the bypass is at the end of the communications network. Set DIP switch S1 to the “ON” position to enable the termination resistor. Refer to “Set the Termination Resistor” for more information.
3. Energize the bypass.
4. Use the keypad to set the necessary communications parameters *H5-01 to H5-11*.
 - *H5-01 [Drive Node Address]*
 - *H5-02 [Communication Speed Selection]*
 - *H5-04 [Stopping Method after Com Error]*
 - *H5-05 [Comm Fault Detection Select]*
 - *H5-08 [Communication Protocol Selection]*
 - *H5-09 [CE Detection Time]*
5. Because communications parameters do not take effect immediately, either de-energize and re-energize the bypass or set *H5-20 = 1 [Communication Parameters Reload = Reload Now]*.

The bypass is prepared to start communication with the controller.

■ Set the Termination Resistor

You must enable the termination resistor on the serial terminals of the devices on the two physical ends of the network to use serial communications. Use DIP switch S1 on the bypass control PCB to enable and disable the built-in termination resistor. Refer to [Figure 10.19](#) for an example of how to set DIP switch S1. Use the tip of a tweezers or a small flat-blade screwdriver to set the DIP switch. When you install the bypass at the end of the network line, set DIP switch S1 to “ON” to enable the termination resistor. Set DIP switch S1 to “OFF” on all other bypasses.

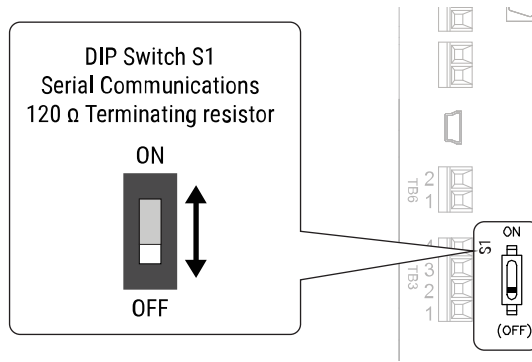

Figure 10.19 Termination Resistor DIP Switch S1

■ Wiring Diagram for More than One Bypass

Figure 10.20 shows how to wire more than one connected bypass using serial communications.

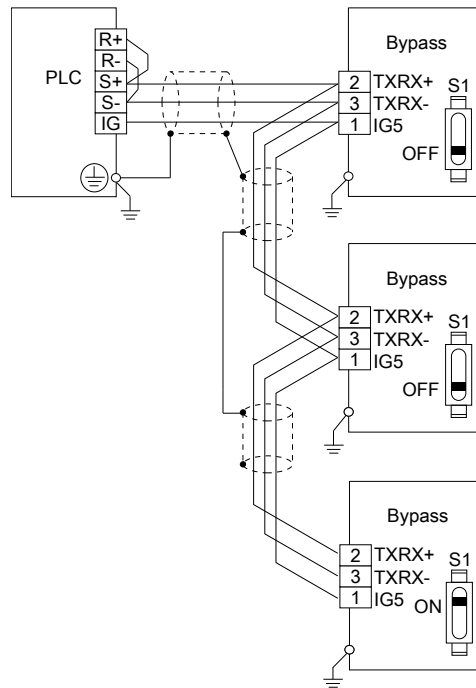

Figure 10.20 Wiring Diagram for More than One Bypass

Note:

When you install the bypass at the end of the network line, set DIP switch S1 to "ON" to enable the termination resistor. Set DIP switch S1 to "OFF" on all other bypasses.

◆ Bypass Operations by Serial Communications

Parameters will apply to the settings when the bypass is running during serial communications. This section gives information about the available functions and their related parameters.

■ Executable Functions

A controller can do these operations with serial communications. Parameter settings (except *H5-xx*) do not have an effect on the availability of these operations.

- Monitor the bypass status and operate the bypass
- Set and view parameters
- Fault Reset Procedure

■ Bypass Control

To use external commands to set the frequency references and motor run/stop with serial communications, set these parameters as specified by the application:

- $b1-01 = 2$ [Frequency Reference Selection 1 = Serial Communications]
- $b1-02 = 2$ or 8 [Run Command Selection 1 = Serial Communications or AUTO Command + Serial Run]

For more information about operation mode selection, refer to $b1-01$ and $b1-02$.

◆ Communications Timing

To prevent overrun of the slave side, the master cannot send a message to the same drive for a selected length of time. To prevent overrun of the master side, the slave cannot send a response message to the master for a selected length of time.

This section gives information about message timing.

■ Command Message from Master to Slave

To prevent data loss and overrun, after the master receives a message from the slave, the master cannot send the same type of command message to the same slave for a selected length of time. The minimum wait time is different for each type of message. Refer to [Table 10.20](#) to find the minimum wait times.

Table 10.20 Minimum Wait Time to Send a Message

Command Type	Example	Minimum Wait Time
1	<ul style="list-style-type: none"> • Operation commands (Run command, stop command) • I/O settings • Reading the motor and parameter setting values 	5 ms ^{*1}
2	Writing a parameter	H5-11 = 0: 50 ms H5-11 = 1: 200 ms ^{*1}
3	Writing of modified data with the Enter command	200 ms to 2 s, depending on the number of parameters that were changed ^{*1}
4	Enter with storage to drive EEPROM after initialization	5 s

*1 When the drive receives a message in the minimum wait time, it does command type 1 and sends a response message. If the drive receives command type 2 or command type 3 messages in the minimum wait time, it will trigger a communications error or the drive will ignore the command.

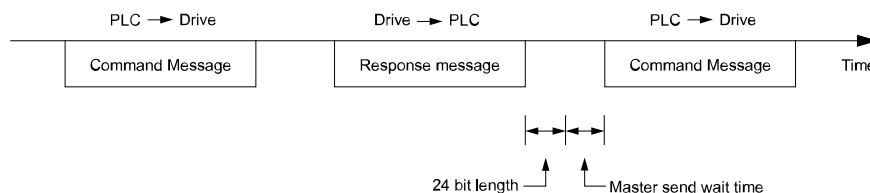

Figure 10.21 Minimum Wait Time to Send a Message

You must set the timer in the master to measure the length of time for the slave to respond to the master. If you set the timer, but the slave does not send a response message in a specified length of time, the master will send the message again.

■ Response Message from Slave

The slave receives the command message from the master then processes the data it received. The slave then waits for the time set in $H5-06$ [Drive Transmit Wait Time] then sends a response message to the master. If overrun occurs on the master, increase the wait time set in $H5-06$.

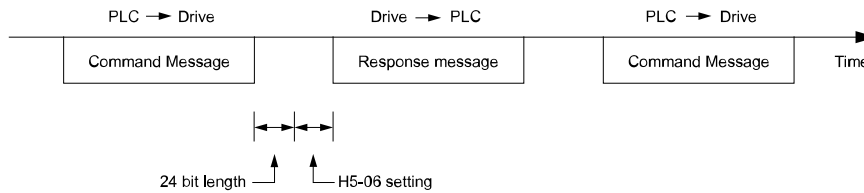

Figure 10.22 Response Wait Time

◆ Message Format

■ Communication Message Description

In MEMOBUS/Modbus communications, the master sends commands to the slave, then the slave responds. The master and slave send their messages in the configuration in Figure 10.23. The length of the data changes when the description of the command (function) changes.

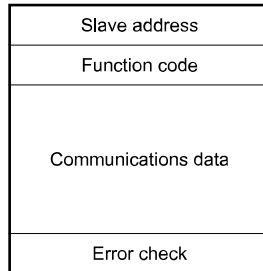

Figure 10.23 Message Format

■ Slave Address

Set the slave address of the drive to 01 to FF (Hex.).

■ Broadcast Messages

When the master broadcasts to a slave address of 00 (Hex), all slaves will receive the message. Slaves will provide no response to a broadcast message.

■ Function Code

There are five function codes that set commands. Table 10.21 shows the different codes.

Table 10.21 Function Codes

Function Code (Hex.)	Subfunction Code (Hex.)	Function	Command Message		Response Message	
			Minimum Data Length (byte)	Maximum Data Length (byte)	Minimum Data Length (byte)	Maximum Data Length (byte)
03	-	Read Multiple Holding Registers	8	8	7	37
08	-	Loopback Test	8	8	8	8
10	-	Writing to Multiple Holding Registers	11	41	8	8
5A	-	Writing to Multiple Holding Registers / Reading the Register Indicated	11	41	17	17
67	010D	Reading the Contents of Non-Consecutive Holding Registers	10	248	10	248
	010E	Writing to Non-Consecutive Holding Registers	14	250	8	8

■ Communications Data

Communications data is a series of data that uses the combination of the communications register number and the data for these registers. The data length changes when the description of the command changes. For a loopback test, it switches to test code.

The communications register for the drive has a 2-byte length. Data that is written to the register for the drive is usually 2 bytes. Register data that is read from the drive is also 2 bytes.

■ Error Check

Error check uses the CRC-16 method to detect transmission errors. Use the procedure in this section to calculate CRC-16.

Command Data

When the drive receives data, it will make sure that there are no errors in the data. The drive uses the procedure below to calculate CRC-16, then the drive compares that data with the CRC-16 value in the message. If the CRC-16 values do not agree, the drive will not execute a command message.

When you calculate CRC-16 in MEMOBUS/Modbus communications, make sure that you set the start value as FFFF (Hex.). All 16 bits must be 1.

Use this procedure to calculate CRC-16:

1. Make sure that the start value is FFFF (Hex.).
2. Calculate the FFFF (Hex.) start value and the XOR of the slave address (exclusive OR).
3. Move the step 2 results one column to the right. Do this shift until the carry bit is 1.
4. When the carry bit is 1, calculate XOR via the result from the above step 3 and A001 (Hex.).
5. Do steps 3 and 4 until the 8th shift to the right.
6. Use the result of step 5 to calculate the XOR and the data of the following messages (function code, register address, data). Do steps 3 to 5 until the last data, then calculate.
7. The result of the last right shift or the value of the last XOR calculation is the result for CRC-16.

Table 10.22 lists examples of the CRC-16 calculation of slave address 02 (Hex.) and function code 03 (Hex.). The calculated results of CRC-16 for this section is D140 (Hex.).

Note:

The calculation example only gives information about some error checks with CRC-16. The drive will do the same error checks for the next data.

Table 10.22 CRC-16 Calculation Example

Description	Calculation	Overflow	Description	Calculation	Overflow
Initial value (FFFF (Hex.))	1111 1111 1111 1111	-	Function code 03 (Hex.)	0000 0011	-
Address 02 (Hex.)	0000 0010	-	XOR w result	1000 0001 0011 1101	-
XOR w initial value	1111 1111 1111 1101		Shift 1	0100 0000 1001 1110	1
Shift 1	0111 1111 1111 1110	1	XOR w A001 (Hex.)	1010 0000 0000 0001	-
XOR w A001 (Hex.)	1010 0000 0000 0001	-	XOR result	1110 0000 1001 1111	-
XOR result	1101 1111 1111 1111	-	Shift 2	0111 0000 0100 1111	1
Shift 2	0110 1111 1111 1111	1	XOR w A001 (Hex.)	1010 0000 0000 0001	-
XOR w A001 (Hex.)	1010 0000 0000 0001	-	XOR result	1101 0000 0100 1110	-
XOR result	1100 1111 1111 1110	-	Shift 3	0110 1000 0010 0111	0
Shift 3	0110 0111 1111 1111	0	Shift 4	0011 0100 0001 0011	1
Shift 4	0011 0011 1111 1111	1	XOR w A001 (Hex.)	1010 0000 0000 0001	-
XOR w A001 (Hex.)	1010 0000 0000 0001	-	XOR result	1001 0100 0001 0010	-
XOR result	1001 0011 1111 1110	-	Shift 5	0100 1010 0000 1001	0
Shift 5	0100 1001 1111 1111	0	Shift 6	0010 0101 0000 0100	1
Shift 6	0010 0100 1111 1111	1	XOR w A001 (Hex.)	1010 0000 0000 0001	-

10.6 MEMOBUS/Modbus Communications

Description	Calculation	Overflow	Description	Calculation	Overflow
XOR w A001 (Hex.)	1010 0000 0000 0001	-	XOR result	1000 0101 0000 0101	-
XOR result	1000 0100 1111 1110	-	Shift 7	0100 0010 1000 0010	1
Shift 7	0100 0010 0111 1111	0	XOR w A001 (Hex.)	1010 0000 0000 0001	-
Shift 8	0010 0001 0011 1111	1	XOR result	1110 0010 1000 0011	-
XOR w A001 (Hex.)	1010 0000 0000 0001	-	Shift 8	0111 0001 0100 0001	1
XOR result	1000 0001 0011 1110	-	XOR w A001 (Hex.)	1010 0000 0000 0001	-
Perform operations with next data (function code)			XOR result	1101 0001 0100 0000	-
				1101 0001 0100 0000	-
			CRC-16	D 1 4 0 (Lower) (Upper)	-
	Continue from here with next data.				

Response Data

The drive does the CRC-16 calculation for the response message and makes sure that the data does not have errors. Make sure that the calculated value is the same value as the CRC-16 in the response message.

◆ Examples of Messages for Commands/Responses

The items in this section are examples of messages for commands/responses.

■ Read Multiple Holding Registers

Uses function code 03 (Hex.) to read the contents of a maximum of 16 holding registers.

Table 10.23 shows example messages when the drive reads status signal from the drive of slave 2, the error contents, fault contents, and frequency references.

Table 10.23 Message Example When Reading the Contents of Holding Register

Byte	Command Message		Setting Data (Hex.)	Response Message (Normal)		Setting Data (Hex.)	Response Message (Fault)		Setting Data (Hex.)
0	Slave address		02	Slave address		02	Slave address		02
1	Function code		03	Function code		03	Function code		83
2	Starting No.	Upper	00	Data Qty		08	Error code		03
3		Lower	20	First storage register	Upper	00	CRC-16	Upper	F1
4	Data Qty	Upper	00		Next storage register	Lower		65	Lower
5		Lower	04	Next storage register		Upper	00	-	
6	CRC-16	Upper	45		Next storage register	Lower	00	-	
7		Lower	F0	Next storage register		Upper	00	-	
8	-				Next storage register	Lower	00	-	
9	-			Next storage register		Upper	01	-	
10	-				CRC-16	Lower	F4	-	
11	-			CRC-16		Upper	AF	-	
12	-				Lower	82	-		

■ Loopback Test

The loopback test uses function code 08 (Hex.) and returns the command message as a response message. This test checks communication between the master and slave. The test code and data can use desired values.

Table 10.24 shows examples of messages given out when the loopback test is done with the drive of slave 1.

Table 10.24 Message Examples from the Loopback Test

Byte	Command Message		Setting Data (Hex.)	Response Message (Normal)		Setting Data (Hex.)
0	Slave address		01	Slave address		01
1	Function code		08	Function code		08
2	Test code	Upper	00	Test code	Upper	00
3		Lower	00		Lower	00
4	Data	Upper	A5	Data	Upper	A5
5		Lower	37		Lower	37
6	CRC-16	Upper	DA	CRC-16	Upper	DA
7		Lower	8D		Lower	8D

■ Writing to Multiple Holding Registers

Function code 10H lets you write to write multiple MEMOBUS/Modbus registers with one message. This process works similar to reading registers, in that the address of the first register to be written and the data quantity are set in the command message. The data to be written must be consecutive so that the register addresses are in order, starting from the specified address in the command message. The data order must be high byte, then lower byte.

Table 10.25 shows example messages when you use the PLC to set Forward run in the drive of slave 1 with a 60.00 Hz frequency reference.

If parameter values are changed using the Write command, an Enter command is necessary to activate and save the data. Refer to [H5-11: Comm ENTER Command Mode on page 304](#) and [Enter Command on page 748](#) for more information.

Table 10.25 Message Example When Writing to Multiple Holding Registers

Byte	Command Message		Setting Data (Hex.)	Response Message (When Normal)		Setting Data (Hex.)	Response Message (When There is a Fault)		Setting Data (Hex.)
0	Slave address		01	Slave address		01	Slave address		01
1	Function code		10	Function code		10	Function code		90
2	Starting No.	Upper	00	Starting No.	Upper	00	Error code		02
3		Lower	01		Lower	01	CRC-16	Upper	CD
4	Data Quantity	Upper	00	Data Quantity	Upper	00		Lower	C1
5		Lower	02		Lower	02	-		
6	Byte No.		04	CRC-16	Upper	10	-		
7	First data	Upper	00		Lower	08	-		
8	Data Quantity	Lower	01	-		-			
9	Next data	Upper	17	-		-			
10		Lower	70	-		-			
11	CRC-16	Upper	6D	-		-			
12		Lower	B7	-		-			

Note:

The number of bytes set in the command message set the data quantity $\times 2$ during the command message. The response message uses the same formula.

■ Reading from More than One Holding Register/Reading the Indicated Register

The bypass uses function code 5A (Hex.) to write to more than one register, then it reads the contents of four holding registers at the same time.

The function for writing to more than one register is the same as the function for function code 10 (Hex.). You can write to a maximum of 16 holding registers.

The four holding registers to be read from are specified in [H5-25 to H5-28 \[Function 5A Register x Selection\]](#).

Table 10.26 shows example messages when you write to more than one holding register or when you read more than one command register. Table 10.26 uses this register data for the examples:

- The bypass for slave 1 is set for Forward run with a frequency reference of 60.00 Hz.
- The setting in H5-25 to H5-28 and the data in the specified holding registers are as follows.
 - H5-25 = 0044H: U1-05 [Motor Speed] = 60.00 Hz (6000 = 1770H)
 - H5-26 = 0045H: U1-06 [Output Voltage Ref] = 200.0 V (2000 = 07D0H)
 - H5-27 = 0042H: U1-03 [Output Current] = 50% of rated current (100% = 8192, 50% = 4096 = 1000H)
 - H5-28 = 0049H: U1-10 [Input Terminal Status] = 00H

If parameter values are changed using the Write command, an Enter command is necessary to activate and save the data. Refer to H5-11: Comm ENTER Command Mode on page 304 and Enter Command on page 748 for more information.

Table 10.26 Message Example When Reading from More than One Holding Register/Reading the Indicated Register

Byte	Command Message			Response Message (when normal)			Response Message (when there is a fault)		
			Setting Data (Hex.)			Setting Data (Hex.)			Setting Data (Hex.)
0	Slave address		01	Slave address		01	Slave address		01
1	Function Code		5A	Function Code		5A	Function Code		DA
2	Starting No.	Upper	00	Register status		0F	Register status		0F
3		Lower	01	Data in holding register 1 selected with H5-25	Upper	17	Data in holding register 1 selected with H5-25	Upper	17
4	Data Qty	Upper	00		Lower	70		Lower	70
5		Lower	02	Data in holding register 2 selected with H5-26	Upper	07	Data in holding register 2 selected with H5-26	Upper	07
6	Byte No.		04		Lower	D0		Lower	D0
7	First data	Upper	00	Data in holding register 3 selected with H5-27	Upper	10	Data in holding register 3 selected with H5-27	Upper	10
8		Lower	01		Lower	00		Lower	00
9	Next data	Upper	17	Data in holding register 4 selected with H5-28	Upper	00	Data in holding register 4 selected with H5-28	Upper	00
10		Lower	70		Lower	00		Lower	00
11	CRC-16	Upper	4F	Starting No.	Upper	00	Error Codes		02
12		Lower	43		Lower	01	CRC-16	Upper	E9
13	-			Data Qty	Upper	00		Lower	6C
14	-				Lower	02	-		
15	-			CRC-16	Upper	AC	-		
16	-				Lower	D0	-		

Note:

The number of bytes set in the command message set the data quantity $\times 2$ during the command message.

Register status	
bit 0	Data in register 1 selected with <i>H5-25</i> 1: Successfully read the register 0: Register read error
bit 1	Data in register 2 selected with <i>H5-26</i> 1: Successfully read the register 0: Register read error
bit 2	Data in register 3 selected with <i>H5-27</i> 1: Successfully read the register 0: Register read error
bit 3	Data in register 4 selected with <i>H5-28</i> 1: Successfully read the register 0: Register read error
bit 4	Not used
bit 5	Not used
bit 6	Not used
bit 7	Not used

■ Reading the Contents of Non-Consecutive Holding Registers

The bypass uses function code 67 (Hex.) and subfunction code 010D (Hex.) to read data with a maximum of 120 holding registers.

You must give the holding register number from which to read separately.

Table 10.27 shows example messages when you read the frequency reference and torque limit from the bypass for slave 1. Table 10.27 uses these specified holding registers data for the examples.

- 0040H: *U1-01 [Frequency Reference]* = 60.00 Hz (6000 = 1770H)
- 0046H: *U1-07 [DC Bus Voltage]* = 635 VDC (635 = 027BH)

Table 10.27 Message Example When Reading the Contents of Non-Consecutive Holding Registers

Byte	Command Message			Response Message (when normal)			Response Message (when there is a fault)		
			Setting Data (Hex.)			Setting Data (Hex.)			Setting Data (Hex.)
0	Slave address		01	Slave address		01	Slave address		01
1	Function Code		67	Function Code		67	Function Code		E7
2	Subfunction Code	Upper	01	Subfunction Code	Upper	01	Error Codes		02
3		Lower	0D		Lower	0D	CRC-16	Upper	EA
4	Data Qty	Upper	00	Byte No.	Upper	00		Lower	31
5		Lower	02		Lower	04	-		
6	Holding register 1 No.	Upper	00	Holding register 1 data	Upper	17	-		
7		Lower	40		Lower	70	-		
8	Holding register 2 No.	Upper	00	Holding register 2 data	Upper	02	-		
9		Lower	46		Lower	7B	-		
10	CRC-16	Upper	4B	CRC-16	Upper	06	-		
11		Lower	1A		Lower	10	-		

Note:

The number of bytes set within the response message sets twice the number of data contained in the command message.

■ Writing to Non-Consecutive Holding Registers

The bypass uses function code 67 (Hex.) and subfunction code 010E (Hex.) to read data with a maximum of 60 holding registers.

You must give the holding register number from which to write separately.

Table 10.28 shows example messages when you write the frequency reference and torque limit from the bypass for slave 1. Table 10.28 uses these specified holding registers data for the examples.

- 0002H: Frequency Reference = 60.00 Hz (6000 = 1770H)
- 0006H: PID Setpoint = 12.34% (1234 = 04D2H)

If parameter values are changed using the Write command, an Enter command is necessary to activate and save the data. Refer to *H5-11: Comm ENTER Command Mode on page 304* and *Enter Command on page 748* for more information.

Table 10.28 Message Example When Writing to Non-Consecutive Holding Registers

Byte	Command Message			Response Message (when normal)			Response Message (when there is a fault)		
			Setting Data (Hex.)			Setting Data (Hex.)			Setting Data (Hex.)
0	Slave address		01	Slave address		01	Slave address		01
1	Function Code			Function Code			Function Code		
2	Subfunction Code	Upper	01	Subfunction Code	Upper	01	Error Codes		02
3		Lower	0E		Lower	0E	CRC-16	Upper	EA
4	Data Qty	Upper	00	Data Qty	Upper	00		Lower	31
5		Lower	02		Lower	02	-		
6	Byte No.	Upper	00	CRC-16	Upper	D5	-		
7		Lower	04		Lower	FC	-		
8	Holding register 1 No.	Upper	00	-		-			
9		Lower	02	-		-			
10	Holding register 1 data	Upper	17	-		-			
11		Lower	70	-		-			
12	Holding register 2 No.	Upper	00	-		-			
13		Lower	06	-		-			
14	Holding register 2 data	Upper	04	-		-			
15		Lower	D2	-		-			
16	CRC-16	Upper	74	-		-			
17		Lower	CD	-		-			

Note:

The number of bytes set in the command message set the data quantity × 2 during the command message.

◆ Enter Command

When you use MEMOBUS/Modbus communications to write parameters from the PLC to the drive, an Enter command is required to activate and save those parameters. This section gives information about the Enter commands.

■ Types of Enter Commands

The drive supports the two Enter commands shown in Table 10.29.

Write 0 to register number 0900 or 0910 (Hex.) to enable the Enter command. You can only write to these registers. If you read to these registers, it will cause an error.

Table 10.29 Types of Enter Commands

Register No. (Hex.)	Description
0900	When you write parameter data to the EEPROM, you will enable the data on the RAM at the same time. This process saves the parameter changes even if you de-energize the drive.
0910	This updates the data on the RAM, but does not write data to the EEPROM. If you de-energize the drive, you will lose the parameter changes.

Note:

- You can write the EEPROM to the drive a maximum of 100,000 times. Do not frequently execute the Enter command (0900 (Hex.)) that is written to EEPROM.
- The Enter command register is write-only. If this register is read, it will cause a Register Number Error (02 (Hex.)).
- When the command data or broadcast message is transmitted to the drive, the Enter command is not necessary.

■ Automatic Enter Command

The drive can be set up to automatically perform an Enter command after a parameter is written. Parameter *H5-11* enables and disables this feature.

◆ Self-Diagnostics

The bypass can use Self-Diagnostics to verify the hardware transceiver on the control circuit. Self-Diagnostics connects the transmission terminal to the reception terminal on the control circuit and transmits the data to itself to make sure that the bypass can communicate correctly.

Use this procedure to do Self-Diagnostics:

DANGER! Electrical Shock Hazard. Do not examine, connect, or disconnect wiring on an energized bypass. Before servicing, disconnect all power to the equipment and wait for the time specified on the warning label at a minimum. The internal capacitor stays charged after the bypass is de-energized. The charge indicator LED extinguishes when the DC bus voltage decreases below 50 Vdc. When all indicators are OFF, remove the covers before measuring for dangerous voltages to make sure that the bypass is safe. If you do work on the bypass when it is energized, it will cause serious injury or death from electrical shock.

1. Energize the bypass.
2. Set Z2-06 = 45 [Digital Input 6 Function (TB2-6) - Serial Hardware Test (RS-485)].
3. De-energize the bypass.
4. Disconnect the RS-485 terminals (TB3).
5. Connect a jumper between control circuit terminals TB2-6 and TB2-9 or TB2-10.

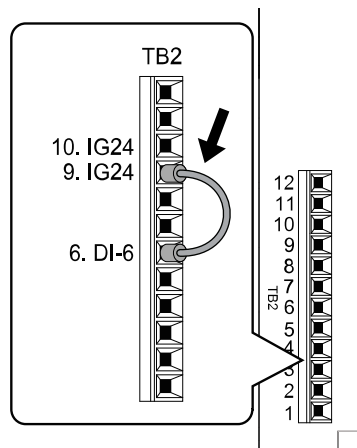

Figure 10.24 Self-Diagnostics Jumper Terminals

6. Energize the bypass.
7. When normal, the keypad will show *PASS* [Serial Communication Test].

Note:

If there is an error, the keypad will show *CE* [Serial Communication Error]. Disconnect the bypass from the network and test the bypass again. If the error stays, there is a possible hardware problem. If there is no error, there is a possible network wiring problem.

8. De-energize the bypass.
9. Disconnect the jumper from Step 4. Set Z2-06 to its initial function.

Self-Diagnostics is complete and the bypass returns to its usual function.

◆ Communications Data Table

Command Data on page 750 and *Monitor Data on page 754* show the communications data. The data types are command data, monitor data, and broadcast message.

Refer to the Parameter List for parameter communications registers.

■ Command Data

Note:

When writing a command register that contains reserved bits, always write reserved bits to a “0”. Do not write to reserved registers or monitor registers.

Table 10.30 MEMOBUS/Modbus Communications Command Data

Register No. (Hex.)	Description	
0000	Reserved	
0001	Run command, multi-function input command	
	bit 0	1: Forward run, 0: Stop 1: Run, 0: Stop
	bit 1	1: Reverse run, 0: Stop 1: Reverse, 0: Forward run
	bit 2	External fault 1: EF0 [Option Card External Fault]
	bit 3	Fault Reset Procedure 1: Reset command
	bit 4	Controls the drive digital inputs when Z3-12 = 1 [Network Digital Inputs = Enabled].
	bit 5	
	bit 6	
	bit 7	
	bit 8	
	bit 9	
	bit A	
	bit B	
bit C - F	Reserved	
0002	Frequency reference	01-03 [Frequency Display Unit Selection] (unsigned) sets the units.
0003	Output voltage gain	Units: 0.1 % Setting range: 20 (2.0%) to 2000 (200.0%), the default value at energize: 1000 (100.0%)
0004	Reserved	
0005	Reserved	
0006	PID setpoint (0.01% signed)	
0007	Setting for the drive multi-function analog monitor output terminal FM (10 V/4000H)	
0008	Setting for the drive multi-function analog monitor output terminal AM (10 V/4000H)	

Register No. (Hex.)	Description	
0009	MFDO setting	
	bit 0	Drive MFDO (terminal M1-M2) 1: ON, 0: OFF
	bit 1	Drive MFDO (terminal M3-M4) 1: ON, 0: OFF
	bit 2	Drive MFDO (terminal M5-M6) 1: ON, 0: OFF
	bit 3 - 5	Region Code
	bit 6	1: bit 7 function is enabled
	bit 7	Drive Fault relay output (terminal MA/MB-MC) 1: ON, 0: OFF
	bit 8 - F	Region Code
000A - 000C	Reserved	
000D	PI2 Control Setpoint	Units: 0.01% Setting range: -100.00% to +100.00% To enable this function, set MEMOBUS register 000F, bit 4 = 1.
000E	Reserved	
000F	Command selection setting	
	bit 0	Reserved
	bit 1	PID control target input 1: Enables target values from MEMOBUS/Modbus
	bit 2 - 3	Reserved
	bit 4	PI2 control target input 1: Enables setting values from MEMOBUS/Modbus
	bit 5	PID feedback from the MEMOBUS/Modbus 1: Enables PID feedback (15FF (Hex.)) from MEMOBUS/Modbus
	bit 6 - B	Reserved
	bit C	Terminal S5 input for broadcast message 1: Enabled, 0: Disabled
	bit D	Terminal S6 input for broadcast message 1: Enabled, 0: Disabled
	bit E	Terminal S7 input for broadcast message 1: Enabled, 0: Disabled
	bit F	Reserved
0010 - 001F	Reserved	
15FF	PID Feedback over comms	
3004	Time Setting Setting range: 0000 to 2359 (decimal), the default value at energize: 0000 Sets the hour and the minute in HHMM format. <ul style="list-style-type: none"> • HH: 00 to 23 (decimal) • MM: 00 to 59 (decimal) 	

10.6 MEMOBUS/Modbus Communications

Register No. (Hex.)	Description	
3005	<p>Year and Day Setting Setting range: 1600 to 9906 (decimal), the default value at energize: 1600 Sets the year and the day of the week in YYDW format.</p> <ul style="list-style-type: none"> • YY: the last two digits of the year from 16 to 99 (decimal) • DW: the day of the week <ul style="list-style-type: none"> – Sunday: 00 – Monday: 01 – Tuesday: 02 – Wednesday: 03 – Thursday: 04 – Friday: 05 – Saturday: 06 	
3006	<p>Date Setting Setting range: 101 to 1231 (decimal), the default setting at energize: 101 Sets the month and the date in MMDD format.</p> <ul style="list-style-type: none"> • MM: 01 to 12 (decimal) • DD: 01 to 31 (decimal) 	
3007	<p>Date and Time Information Setting Setting range: 0 to 8 (decimal), the default value at energize: 8 Sets the values specified in 3004H to 3006H as the date and time.</p> <ul style="list-style-type: none"> • Command Data: 1 • Response Data: 0 (normal), 8 (fault) 	
302F	<p>RTC Information Setting Uses the values specified in 3004H to 3006H to update the drive date or time instead of the RTC operator. To enable this function, set MEMOBUS register 3030H, bit 0 = 1. When you set 3030H, bit 1 = 1 and if you do not input 0 to this register in 2 min, the drive does not update the date or time and TIE fault occurs.</p> <ul style="list-style-type: none"> • Command Data: 0 	
3030	RTC Function Enable	
	bit 0	RTC Enter Enable 1: Enabled, 0: Disabled
	bit 1	RTC TIE Fault Enable 1: Enabled, 0: Disabled
	bit 2 - F	Reserved
3A93	HV600 Function Bits	
	bit 0	RTC Disable
	bit 1	Dynamic Noise Control Disable
	bit 2	Reserved
	bit 3	EM Override Freq Reference: Use 3A94H
	bit 4	EM Override PID Feedback: Use 3A95H
	bit 5	EM Override PID Setpoint: Use 3A96H
bit 6 - F	Reserved	
3A94	<p>Emergency Override Frequency Reference Frequency reference used during Emergency Override operation when you set $S6-02 = 0$ or 1 [<i>Emergency Override Ref Selection = Use Frequency Reference or System PID Mode</i>] and bit 3 of MEMOBUS register 3A93H. The $01-03$ [<i>Frequency Display Unit Selection</i>] setting changes the unit and scale of the input value. The upper limit value of this register is the maximum frequency of the drive set in $E1-04$ [<i>Maximum Output Frequency</i>] .</p>	

Register No. (Hex.)	Description																																
3A95	<p>Emergency Override PID Feedback PID feedback used during Emergency Override operation when you set <i>S6-02 = 2 or 3 [System PID Mode or Independent PID Mode]</i> and bit 4 of MEMOBUS register 3A93H. When <i>S6-02 = 2</i>, these parameters set the unit of the input value:</p> <ul style="list-style-type: none"> • <i>b5-38 [PID User Unit Display Scaling]</i> • <i>b5-39 [PID User Unit Display Digits]</i> • <i>b5-46 [PID Unit Display Selection]</i> <p>When <i>S6-02 = 3</i>, these parameters set the unit of the input value:</p> <ul style="list-style-type: none"> • <i>S6-03 [EMOVR Independent PID Scale]</i> • <i>S6-04 [EMOVR Independent PID Unit]</i> • <i>S6-05 [EMOVR Independent PID Unit Digit]</i> 																																
3A96	<p>Emergency Override PID Setpoint PID setpoint used during Emergency Override operation when you set <i>S6-02 = 2 or 3</i> and bit 5 of MEMOBUS register 3A93H. When <i>S6-02 = 2</i>, these parameters set the unit of the input value:</p> <ul style="list-style-type: none"> • <i>b5-38</i> • <i>b5-39</i> • <i>b5-46</i> <p>When <i>S6-02 = 3</i>, these parameters set the unit of the input value:</p> <ul style="list-style-type: none"> • <i>S6-03</i> • <i>S6-04</i> • <i>S6-05</i> 																																
8400	<p>Bypass Command Word</p> <table border="1" data-bbox="310 800 1531 1455"> <tr><td>bit 0</td><td>Reserved</td></tr> <tr><td>bit 1</td><td>Reserved</td></tr> <tr><td>bit 2</td><td>Reserved</td></tr> <tr><td>bit 3</td><td>Remote Xfer</td></tr> <tr><td>bit 4</td><td>Emergency Override Bypass</td></tr> <tr><td>bit 5</td><td>Emergency Override (FWD)</td></tr> <tr><td>bit 6</td><td>Motor OR</td></tr> <tr><td>bit 7</td><td>Motor AND</td></tr> <tr><td>bit 8</td><td>Reserved</td></tr> <tr><td>bit 9</td><td>Reserved</td></tr> <tr><td>bit 10</td><td>Reserved</td></tr> <tr><td>bit 11</td><td>Drive Sel - Z1-39</td></tr> <tr><td>bit 12</td><td>Bypass Sel - Z1-39</td></tr> <tr><td>bit 13</td><td>Fault reset</td></tr> <tr><td>bit 14</td><td>EFB</td></tr> <tr><td>bit 15</td><td>Emergency Override Drive (REV)</td></tr> </table>	bit 0	Reserved	bit 1	Reserved	bit 2	Reserved	bit 3	Remote Xfer	bit 4	Emergency Override Bypass	bit 5	Emergency Override (FWD)	bit 6	Motor OR	bit 7	Motor AND	bit 8	Reserved	bit 9	Reserved	bit 10	Reserved	bit 11	Drive Sel - Z1-39	bit 12	Bypass Sel - Z1-39	bit 13	Fault reset	bit 14	EFB	bit 15	Emergency Override Drive (REV)
bit 0	Reserved																																
bit 1	Reserved																																
bit 2	Reserved																																
bit 3	Remote Xfer																																
bit 4	Emergency Override Bypass																																
bit 5	Emergency Override (FWD)																																
bit 6	Motor OR																																
bit 7	Motor AND																																
bit 8	Reserved																																
bit 9	Reserved																																
bit 10	Reserved																																
bit 11	Drive Sel - Z1-39																																
bit 12	Bypass Sel - Z1-39																																
bit 13	Fault reset																																
bit 14	EFB																																
bit 15	Emergency Override Drive (REV)																																
8402	<p>Bypass MFDI command Controls the bypass digital inputs when <i>Z3-12 = 1 [Network Digital Inputs = Enabled]</i>.</p> <table border="1" data-bbox="310 1528 1531 1885"> <tr><td>bit 0</td><td>Bypass Multi-Function Digital Input 1 (TB2-1)</td></tr> <tr><td>bit 1</td><td>Bypass Multi-Function Digital Input 2 (TB2-2)</td></tr> <tr><td>bit 2</td><td>Bypass Multi-Function Digital Input 3 (TB2-3)</td></tr> <tr><td>bit 3</td><td>Bypass Multi-Function Digital Input 4 (TB2-4)</td></tr> <tr><td>bit 4</td><td>Bypass Multi-Function Digital Input 5 (TB2-5)</td></tr> <tr><td>bit 5</td><td>Bypass Multi-Function Digital Input 6 (TB2-6)</td></tr> <tr><td>bit 6</td><td>Bypass Multi-Function Digital Input 7 (TB2-7)</td></tr> <tr><td>bit 7</td><td>Bypass Multi-Function Digital Input 8 (TB2-8)</td></tr> <tr><td>All other bits</td><td>Reserved</td></tr> </table>	bit 0	Bypass Multi-Function Digital Input 1 (TB2-1)	bit 1	Bypass Multi-Function Digital Input 2 (TB2-2)	bit 2	Bypass Multi-Function Digital Input 3 (TB2-3)	bit 3	Bypass Multi-Function Digital Input 4 (TB2-4)	bit 4	Bypass Multi-Function Digital Input 5 (TB2-5)	bit 5	Bypass Multi-Function Digital Input 6 (TB2-6)	bit 6	Bypass Multi-Function Digital Input 7 (TB2-7)	bit 7	Bypass Multi-Function Digital Input 8 (TB2-8)	All other bits	Reserved														
bit 0	Bypass Multi-Function Digital Input 1 (TB2-1)																																
bit 1	Bypass Multi-Function Digital Input 2 (TB2-2)																																
bit 2	Bypass Multi-Function Digital Input 3 (TB2-3)																																
bit 3	Bypass Multi-Function Digital Input 4 (TB2-4)																																
bit 4	Bypass Multi-Function Digital Input 5 (TB2-5)																																
bit 5	Bypass Multi-Function Digital Input 6 (TB2-6)																																
bit 6	Bypass Multi-Function Digital Input 7 (TB2-7)																																
bit 7	Bypass Multi-Function Digital Input 8 (TB2-8)																																
All other bits	Reserved																																

10.6 MEMOBUS/Modbus Communications

Register No. (Hex.)	Description	
8403	Bypass MFDO command Controls the bypass digital outputs when the function is programmed to Unused.	
	bits 0 to 5	Reserved
	bit 6 <i>*1</i>	Multi-Function Digital Output 7 (TB1 1-3)
	bit 7 <i>*1</i>	Multi-Function Digital Output 8 (TB1 4-6)
	bit 8 <i>*1</i>	Multi-Function Digital Output 9 (TB1 7-9)
	bit 9 <i>*1</i>	Multi-Function Digital Output 10 (TB1 10-12)
	All other bits	Reserved

*1 Set the corresponding Z2-xx parameter = 99 - *Not Used*.

■ Monitor Data

You can only read monitor data.

Table 10.31 Monitor Data for MEMOBUS/Modbus Communication

Register No. (Hex.)	Description	
0020	Drive Status 1	
	bit 0	During drive run or bypass run Set during drive run or bypass run. 1: During run, 0: During stop
	bit 1	During reverse 1: During reverse, 0: Forward run
	bit 2	System ready 1: Ready, 0: Not ready
	bit 3	Drive faulted or bypass faulted 1: Fault
	bit 4	oPE fault on drive or bypass 1: oPExx error
	bit 5	MFDO (terminal M1-M2) 1: ON, 0: OFF
	bit 6	MFDO (terminal M3-M4) 1: ON, 0: OFF
	bit 7	MFDO (terminal M5-M6) 1: ON, 0: OFF
	bit 8 - B	Reserved
	bit C	Safe Torque OFF Hardware
	bit D	Safe Torque OFF
	bit E	Bypass ComRef status 1: Enabled
	bit F	Bypass ComCtrl status 1: Enabled
0021	Fault Description 1	
	bit 0	oC [Overcurrent], GF [Ground Fault]
	bit 1	ov [Overvoltage]
	bit 2	oL2 [Drive Overloaded]
	bit 3	oH1 [Heatsink Overheat], oH2 [External Overheat (H1-XX=B)]
	bit 4 - 6	Reserved
	bit 7	EF0 [Option Card External Fault], EF1 to EF7 [External Fault]
	bit 8	CPFxx [Hardware Fault] Note: Includes oFx.
	bit 9	oL1 [Motor Overload], oL3, oL4 [Overtorque Detection 1/2], UL3, UL4 [Undertorque Detection 1/2]
	bit A	oS [Overspeed], dEv [Speed Deviation]
	bit B	During Uv [Undervoltage] detection
	bit C	Uv1 [DC Bus Undervoltage], Uv2 [Control Power Undervoltage], Uv3 [Soft Charge Answerback Fault]
	bit D	LF [Output Phase Loss], PF [Input Phase Loss]
	bit E	CE [Modbus Communication Error], bUS [Option Communication Error]
bit F	oPr [Keypad Connection Fault]	

10.6 MEMOBUS/Modbus Communications

Register No. (Hex.)	Description	
0022	Fault Contents	
	bit 0	1: During data writing, during motor switching
	bit 1 - 2	Reserved
	bit 3	1: Upper/Lower Limit Fault
	bit 4	1: Data Integrity Fault
	bit 5	1: During EEPROM writing
	bit 6 - F	Reserved
0023	U1-01 [Frequency Reference] Note: o1-03 [Frequency Display Unit Selection] sets the units.	
0024	U1-02 [Output Frequency] Note: o1-03 [Frequency Display Unit Selection] sets the units.	
0025	U1-06 [Output Voltage Ref] (units: 0.1 V) Note: Use H5-10 [Modbus Register 0025H Unit Sel] to change the setting unit.	
0026	Ub-01 [Output Current] (units: 0.1 A)	
0027	U1-08 [Output Power]	
0028	Reserved	
0029	Fault Description 2	
	bit 0	Reserved
	bit 1	GF [Ground Fault]
	bit 2	PF [Input Phase Loss]
	bit 3	LF [Output Phase Loss]
	bit 4 - 5	Reserved
	bit 6	oH4 [Motor Overheat Fault (PTC Input)]
bit 7 - F	Reserved	
002A	Minor Fault Description 1	
	bit 0 - 1	Reserved
	bit 2	EF [FWD/REV Run Command Input Error]
	bit 3	bb [Baseblock]
	bit 4	oL3 [Overtorque 1]
	bit 5	oH [Heatsink Overheat]
	bit 6	ov [Overvoltage]
	bit 7	Uv [Undervoltage]
	bit 8	Reserved
	bit 9	CE [Run at H5-34 (CE Go-To-Freq)]
	bit A	bUS [Option Communication Error]
	bit B	UL3/UL4 [Undertorque Detection 1/2]
	bit C	oH3 [Motor Overheat (PTC Input)]
	bit D - E	Reserved
bit F	CALL [Serial Comm Transmission Error]	

Register No. (Hex.)	Description	
002B	Drive Input Terminal Status	
	bit 0	1: Drive Multi-Fuction Input Terminal S1 ON
	bit 1	1: Drive Multi-Fuction Input Terminal S2 ON
	bit 2	1: Drive Multi-Fuction Input Terminal S3 ON
	bit 3	1: Drive Multi-Fuction Input Terminal S4 ON
	bit 4	1: Drive Multi-Fuction Input Terminal S5 ON
	bit 5	1: Drive Multi-Fuction Input Terminal S6 ON
	bit 6	1: Drive Multi-Fuction Input Terminal S7 ON
	bit 7 - F	Reserved
002C	Drive Status 2	
	bit 0	During Run 1: During Run
	bit 1	During zero speed 1: During zero speed
	bit 2	Speed agreement 1: During agreement
	bit 3	User-defined speed agreement 1: During agreement
	bit 4	Frequency Detection 1 1: Output frequency \leq L4-01
	bit 5	Frequency Detection 2 1: Output frequency \geq L4-01
	bit 6	Drive ready 1: Run ready
	bit 7	During low voltage detection 1: During detection
	bit 8	During baseblock 1: Drive output during baseblock
	bit 9	Frequency reference mode 1: No communication option, 0: Communication option
	bit A	Run command mode 1: No communication option, 0: Communication option
	bit B	During overtorque/undertorque 1, 2 detection
	bit C	Frequency reference loss 1: Loss
	bit D	Executing Auto-Restart 1: Restart Enabled
	bit E	Faults 1: Fault generated
bit F	MEMOBUS/Modbus communications timeout 1: At Timeout Includes CE Go To Frequency alarm	

10.6 MEMOBUS/Modbus Communications

Register No. (Hex.)	Description	
002D	Drive Output Terminal Status	
	bit 0	Drive MFDO (terminal M1-M2) 1: ON, 0: OFF
	bit 1	Drive MFDO (terminal M3-M4) 1: ON, 0: OFF
	bit 2	Drive MFDO (terminal M5-M6) 1: ON, 0: OFF
	bit 3 - 6	Reserved
	bit 7	Drive Fault relay output (terminal MA/MB-MC) 1: ON, 0: OFF
	bit 8 - F	Reserved
002E - 0030	Reserved	
0031	U1-07 [DC Bus Voltage] (unit: 1 V)	
0032 - 0033	Reserved	
0034	Product code 1 [ASCII], product type (HV600 Bypass = 0G)	
0035	Product code 2 [ASCII], product type (HV600 Bypass = 6B)	
0036 - 0037	Reserved	
0038	PID Feedback: Unsigned, input is equivalent to 100%/maximum output frequency (Units: 0.1%)	
0039	PID Input: Signed, $\pm 100\%$ / \pm maximum output frequency (Units: 0.1%)	
003A	PID Output: Signed, $\pm 100\%$ / \pm maximum output frequency (Units: 0.1%)	
003B - 003C	Reserved	
003D	Bypass serial communications error description Note: The drive saves the description of the communications error until you reset the fault.	
	bit 0	CRC Error
	bit 1	Data Length Error
	bit 2	Reserved
	bit 3	Parity Error
	bit 4	Overrun Error
	bit 5	Framing Error
	bit 6	Timeout
bit 7 - F	Reserved	
003E	Output Frequency	Units: min^{-1} or r/min Note: Set E2-04 [Motor Pole Count].
003F		0.01% units
0040 - 004A	Used with U1-xx [Operation Status Monitors]. Refer to the U Monitor for parameter details.	

Register No. (Hex.)	Description	
004B	U1-12 [Drive Status]	
	bit 0	1: During Run
	bit 1	1: During zero speed
	bit 2	1: During reverse
	bit 3	1: During reset signal input
	bit 4	1: During speed agreement
	bit 5	1: Drive operation ready
	bit 6	1: Minor Fault
	bit 7	1: Fault
	bit 8	1: oPExx [Operation Error] generation
	bit 9	1: Recovery from momentary power loss, 0: Power recovery
	bit A - B	Reserved
	bit C	1: AUTO Mode
	bit D	1: HAND Mode
	bit E	1: ComRef status/ NetRef status
bit F	1: ComCtrl status/ NetCtrl status	
004C - 007E	Use with <i>U1-xx, U4-xx, U5-xx, U6-xx [Monitors]</i> . Refer to "U2: Fault Trace" and "U3: Fault History" for more information.	
007F	Minor Fault Code. Refer to 468 for more information.	
0080 - 0097	Use with <i>U2-xx, U3-xx [Monitors]</i> . Refer to "U Monitor" for more information, and refer to "Fault Trace/Fault History Descriptions" for more information about register values.	
0098 - 0099	U4-01 [Cumulative Ope Time] Example: When <i>U4-01 [Cumulative Ope Time]</i> is 12345, 0098 (Hex.) = 1234 and 0099 (Hex.) = 5.	
009A - 009B	U4-03 [Cooling Fan Ope Time] Example: When <i>U4-03 [Cooling Fan Ope Time]</i> is 12345, 009A (Hex.) = 1234 and 009B (Hex.) = 5.	
009C - 00AA	Reserved	
00AB	Drive rated current Note: The unit of display is different for different models. • 0.01 A: D002 to D046, A002 to A042, B1P1, B001 to B014 • 0.1 A: D059 to D273, A054 to A248, B021 to B302	
00AC to 00AF	Reserved	
00B0	Option codes connected to CN5	The drive stores option codes in the register. SI-EM3 = 1005 (Hex.) SI-EN3 = 1006 (Hex.) SI-W3 = 1003 (Hex.) JOHB-SMP3 (BACnet/IP) = 100C (Hex.)
00B1 - 00B4	Reserved	
00B5	U1-16 [SFS Output Frequency]	Units: min ⁻¹ or r/min Note: Set <i>E2-04 [Motor Pole Count]</i> .
00B6		Units: 0.01%
00B7	Frequency reference monitor	Units: min ⁻¹ or r/min Note: Set <i>E2-04 [Motor Pole Count]</i> .
00B8		Units: 0.01%
00B9 - 00BE	Reserved	
00BF	Operation error number <i>xx</i> of <i>oPExx</i> is displayed.	

10.6 MEMOBUS/Modbus Communications

Register No. (Hex.)	Description	
00C0	Fault Description 3	
	bit 0	Reserved
	bit 1	Uv1 [DC Bus Undervoltage]
	bit 2	Uv2 [Control Power Undervoltage]
	bit 3	Uv3 [Soft Charge Answerback Fault]
	bit 4	SC [Short Circuit/IGBT Failure]
	bit 5	GF [Ground Fault]
	bit 6	oC [Overcurrent]
	bit 7	ov [Overvoltage]
	bit 8	oH [Heatsink Overheat]
	bit 9	oH1 [Heatsink Overheat]
	bit A	oL1 [Motor Overload]
	bit B	oL2 [Drive Overloaded]
	bit C	oL3 [Overtorque Detection 1]
	bit D	oL4 [Overtorque Detection 2]
bit E - F	Reserved	
00C1	Fault Description 4	
	bit 0	EF3 [External Fault (Terminal S3)]
	bit 1	EF4 [External Fault (Terminal S4)]
	bit 2	EF5 [External Fault (Terminal S5)]
	bit 3	EF6 [External Fault (Terminal S6)]
	bit 4	EF7 [External Fault (Terminal S7)]
	bit 5 - 6	Reserved
	bit 7	oS [Overspeed]
	bit 8	dEv [Speed Deviation]
	bit 9	Reserved
	bit A	PF [Input Phase Loss]
	bit B	LF [Output Phase Loss]
	bit C	oH3 [Motor Overheat (PTC Input)]
	bit D	oPr [Keypad Connection Fault]
	bit E	Err [EEPROM Write Error]
bit F	oH4 [Motor Overheat Fault (PTC Input)]	
00C2	Fault Description 5	
	bit 0	CE [Serial Communication Error]
	bit 1	bUS [Option Communication Error]
	bit 2 - 5	Reserved
	bit 6	EF0 [Option Card External Fault]
	bit 7	Reserved
	bit 8	UL3 [Undertorque Detection 1]
	bit 9	UL4 [Undertorque Detection 2]
	bit A	oL7 [High Slip Braking Overload]
	bit B - E	Reserved
	bit F	Hardware Fault (includes <i>oFx</i> fault)

Register No. (Hex.)	Description	
00C3	Fault Description 6	
	bit 0 - 4	Reserved
	bit 5	LF2 [Output Current Imbalance]
	bit 6	STPo [Motor Step-Out Detected]
	bit 7 - 9	Reserved
	bit A	SEr [Speed Search Retries Exceeded]
	bit B - F	Reserved
00C4	Fault Description 7	
	bit 0	Reserved
	bit 1	EF1 [External Fault (Terminal S1)]
	bit 2	EF2 [External Fault (Terminal S2)]
	bit 3 - 4	Reserved
	bit 5	CoF [Current Offset Fault]
	bit 6 - F	Reserved
00C5	Fault Description 8	
	bit 0	Reserved
	bit 1	nSE [Node Setup Error]
	bit 2 - 8	Reserved
	bit 9	UL6 [Underload or Belt Break Detected]
	bit A	dv7 [Polarity Judge Timeout]
	bit B - F	Reserved
00C6	Fault Description 9	
	bit 0	LOP [Loss of Prime]
	bit 1 - 2	Reserved
	bit 3	LFB [Low Feedback Sensed]
	bit 4	HFB [High Feedback Sensed]
	bit 5	NMS [Setpoint Not Met]
	bit 6 - 7	Reserved
	bit 8	MSL [Net Master Lost]
	bit 9 - B	Reserved
	bit C	FDBKL [WIRE Break]
	bit D - F	Reserved
00C7	Fault Description 10	
	bit 0 - 3	Reserved
	bit 4	VLTS [Thermostat Fault]
	bit 5 - F	Reserved

10.6 MEMOBUS/Modbus Communications

Register No. (Hex.)	Description	
00C8	Minor Fault Description 2	
	bit 0	Uv [Undervoltage]
	bit 1	ov [Overvoltage]
	bit 2	oH [Heatsink Overheat]
	bit 3	Overheat Alarm (oH2)
	bit 4	oL3 [Overtorque 1]
	bit 5	oL4 [Overtorque 2]
	bit 6	EF [FWD/REV Run Command Input Error]
	bit 7	bb [Baseblock]
	bit 8	EF3 [External Fault (Terminal S3)]
	bit 9	EF4 [External Fault (Terminal S4)]
	bit A	EF5 [External Fault (Terminal S5)]
	bit B	EF6 [External Fault (Terminal S6)]
	bit C	EF7 [External Fault (Terminal S7)]
	bit D - E	Reserved
	bit F	oS [Overspeed]
00C9	Minor Fault Description 3	
	bit 0	dEv [Speed Deviation]
	bit 1	Reserved
	bit 2	oPr [Keypad Connection Fault]
	bit 3	CE [Run at H5-34 (CE Go-To-Freq)]
	bit 4	bUS [Option Communication Error]
	bit 5	CALL [Serial Comm Transmission Error]
	bit 6	oL1 [Motor Overload]
	bit 7	oL2 [Drive Overloaded]
	bit 8	Reserved
	bit 9	EF0 [Option Card External Fault]
	bit A	rUn [Motor Switch during Run]
	bit B	Reserved
	bit C	CALL [Serial Comm Transmission Error]
	bit D	UL3 [Undertorque Detection 1]
	bit E	UL4 [Undertorque Detection 2]
bit F	SE [Modbus Test Mode Error]	
00CA	Minor Fault Description 4	
	bit 0	Reserved
	bit 1	oH3 [Motor Overheat (PTC Input)]
	bit 2 - 8	Reserved
	bit 9	dnE [Drive Disabled]
bit A - F	Reserved	

Register No. (Hex.)	Description	
00CB	Minor Fault Description 5	
	bit 0 - 2	Reserved
	bit 3	HCA [High Current Alarm]
	bit 4	LT-1 [Cooling Fan Maintenance Time]
	bit 5	LT-2 [Capacitor Maintenance Time]
	bit 6 - 7	Reserved
	bit 8	EF1 [External Fault (Terminal S1)]
	bit 9	EF2 [External Fault (Terminal S2)]
	bit A	SToF [Safe Torque OFF Hardware]
	bit B - F	Reserved
00CC	Minor Fault Description 6	
	bit 0	Reserved
	bit 1	TrPC [IGBT Maintenance Time (90%)]
	bit 2	LT-3 [SoftChargeBypassRelay MainteTime]
	bit 3	LT-4 [IGBT Maintenance Time (50%)]
	bit 4 - A	Reserved
	bit B	LOP [Loss of Prime]
	bit C	Reserved
	bit D	UL6 [Underload or Belt Break Detected]
	bit E	Reserved
bit F	AFBL [Analog Fbk Lost, Switched to Net]	
00CD	Minor Fault Description 7	
	bit 0	NETSC [NETSCAN Waiting for Master]
	bit 1	Reserved
	bit 2	LOFB [Low Feedback Sensed]
	bit 3	HIFB [High Feedback Sensed]
	bit 4	Reserved
	bit 5	FR<MS [Freq Ref < Minimum Speed (Y1-06)]
	bit 6	FR<TH [Freq. Reference < Thrust (Y4-12)]
	bit 7	LCP [Low City Pressure]
	bit 8 - A	Reserved
	bit B	FDBKL [Feedback Loss Wire Break]
	bit C - E	Reserved
	bit F	LWT [Low Water in Tank]

10.6 MEMOBUS/Modbus Communications

Register No. (Hex.)	Description	
00CE	Minor Fault Description 8	
	bit 0 - 1	Reserved
	bit 2	TiM [Keypad Time Not Set]
	bit 3	bAT [Keypad Battery Low Voltage]
	bit 4	Reserved
	bit 5	NMS [Setpoint Not Met]
	bit 6	EOF [Emergency Override FWD]
	bit 7	EOR [Emergency Override REV]
	bit 8	FLGT [Feedback Loss, Go To Freq b5-83]
	bit 9 - F	Reserved
00CF	Reserved	
00D0	CPF Contents 1	
	bit 0 - 1	Reserved
	bit 2	CPF02 [Control Circuit Error]
	bit 3	CPF03 [Control Circuit Error]
	bit 4 - 5	Reserved
	bit 6	CPF06 [Control Circuit Error]
	bit 7	CPF07 [Control Circuit Error]
	bit 8	CPF08 [Control Circuit Error]
	bit 9 - A	Reserved
	bit B	CPF11 [Control Circuit Error]
	bit C	CPF12 [Control Circuit Error]
	bit D	CPF13 [Control Circuit Error]
	bit E	CPF14 [Control Circuit Error]
	bit F	Reserved
00D1	CPF Contents 2	
	bit 0	CPF16 [Control Circuit Error]
	bit 1	CPF17 [Control Circuit Error]
	bit 2	CPF18 [Control Circuit Error]
	bit 3	CPF19 [Control Circuit Error]
	bit 4	CPF20 [Control Circuit Error]
	bit 5	CPF21 [Control Circuit Error]
	bit 6	CPF22 [Control Circuit Error]
	bit 7	CPF23 [Control Circuit Error]
	bit 8	CPF24 [Control Circuit Error]
	bit 9	Reserved
	bit A	CPF26 [Control Circuit Error]
	bit B	CPF27 [Control Circuit Error]
	bit C	CPF28 [Control Circuit Error]
	bit D	CPF29 [Control Circuit Error]
	bit E	CPF30 [Control Circuit Error]
bit F	CPF31 [Control Circuit Error]	

Register No. (Hex.)	Description	
00D2	CPF Contents 3	
	bit 0	CPF32 [Control Circuit Error]
	bit 1	CPF33 [Control Circuit Error]
	bit 2	CPF34 [Control Circuit Error]
	bit 3	CPF35 [Control Circuit Error]
	bit 4	CPF36 [Control Circuit Error]
	bit 5	CPF37 [Control Circuit Error]
	bit 6	CPF38 [Control Circuit Error]
	bit 7	CPF39 [Control Circuit Error]
bit 8 - F	Reserved	
00D3 - 00D7	Reserved	
00D8	oFA0x Description (CN5)	
	bit 0	oFA00 [Option Not Compatible with Port]
	bit 1	oFA01 [Option Fault/Connection Error]
	bit 2 - 4	Reserved
	bit 5	oFA05 [Option A/D Error]
	bit 6	oFA06 [Option Communication Error]
	bit 7 - F	Reserved
00D9	oFA1x Description (CN5)	
	bit 0	oFA10 [Option RAM Error]
	bit 1	oFA11 [Option Ope Mode Error]
	bit 2	oFA12 [Drive Receive CRC Error]
	bit 3	oFA13 [Drive Receive Frame Error]
	bit 4	oFA14 [Drive Receive Abort Error]
	bit 5	oFA15 [Option Receive CRC Error]
	bit 6	oFA16 [Option Receive Frame Error]
	bit 7	oFA17 [Option Receive Abort Error]
bit 8 - F	Reserved	
00DA	Reserved	

10.6 MEMOBUS/Modbus Communications

Register No. (Hex.)	Description	
00DB	oFA3x Description (CN5)	
	bit 0	oFA30 [COM ID Error]
	bit 1	oFA31 [Type Code Error]
	bit 2	oFA32 [SUM Check Error]
	bit 3	oFA33 [Option Receive Time Over]
	bit 4	oFA34 [Memobus Time Over]
	bit 5	oFA35 [Drive Timeout Waiting for Response]
	bit 6	oFA36 [CI Check Error]
	bit 7	oFA37 [Drive Timeout Waiting for Response]
	bit 8	oFA38 [Control Reference Error]
	bit 9	oFA39 [Drive Timeout Waiting for Response]
	bit A	oFA40 [CtrlResSel 1Err]
	bit B	oFA41 [Drive Timeout Waiting for Response]
	bit C	oFA42 [CtrlResSel 2Err]
	bit D	oFA43 [Drive Timeout Waiting for Response]
bit E - F	Reserved	
00DC - 00E4	Reserved	
00E5	Minor Fault Description 9	
	bit 0	EP24v [External Power 24V Supply]
	bit 1 - 3	Reserved
	bit 4	bAT [Keypad Battery Low Voltage]
	bit 5 - 7	Reserved
	bit 8	TiM [Keypad Time Not Set]
	bit 9	bCE [Bluetooth Communication Error]
bit A - F	Reserved	
00E6 - 00E9	Reserved	
00EA	Fault Description 11	
	bit 0	TiM [Keypad Time Not Set]
	bit 1	bAT [Keypad Battery Low Voltage]
	bit 2- D	Reserved
	bit E	SCF [Safety Circuit Fault]
	bit F	Reserved
00EB - 00ED	Reserved	
00EE	Fault Description 12	
	bit 0 - 4	Reserved
	bit 5	bCE [Bluetooth Communication Fault]
bit 6 - F	Reserved	
00EF - 00FA	Reserved	
00FB	Drive Output Current Note: The unit of display is different for different models. • 0.01 A: D002 to D046, A002 to A042, B1P1, B001 to B014 • 0.1 A: D059 to D273, A054 to A248, B021 to B302	
8440	TimeHHMM	

Register No. (Hex.)	Description
8441	Date Year
8442	Date MMDD

◆ Error Codes

■ MEMOBUS/Modbus Communications Error Code List

Table 10.32 lists the MEMOBUS/Modbus communications error codes.

When an error occurs, remove the cause of the error and restart communications.

Table 10.32 MEMOBUS/Modbus Communications Error Codes

Error Code (Hex.)	Name	Cause
01	Function Code Error	The PLC set a function code that was not 03, 08, or 10 (Hex.)
02	Register Number Error	<ul style="list-style-type: none"> The register number that is trying to access is not registered. A starting number that was not 0001 or 0002 (Hex.) was set when broadcasting.
03	Bit Count Error	<ul style="list-style-type: none"> Read and write data quantities are more than the 1 to 16 range. (Command message data quantity is disabled.) The data that was read from non-consecutive holding registers contained more than 120 bytes. The data to be written to non-consecutive holding registers contained more than 60 bytes. In the write mode, the number of bytes in the message is not the number of data × 2.
21	Data Setting Error	<ul style="list-style-type: none"> Writing control data or parameters made the settings go out of the permitted setting range. A parameter setting error occurred when writing a parameter.
22	Write Mode Error	<ul style="list-style-type: none"> Tried to write a disabled parameter during run. When there was a CPF06 [Control Circuit Error], the master tried to write a parameter other than one of these: <ul style="list-style-type: none"> A1-00 [Language Selection] A1-01 [Access Level Selection] A1-03 [Initialize Parameters] A1-04 [Password] A1-05 [Password Setting] E1-03 [V/f Pattern Selection] o2-04 [Drive Model (KVA) Selection] Writes the read-only data.
23	DC Bus Undervoltage Write Error	During U_v [DC Bus Undervoltage], a U_v write disabled parameter was written.
24	Error Writing Data During Parameter Processing	Tried to write a parameter from the master during parameter processing on the drive side.
25	Writing into EEPROM Disabled	Writing into EEPROM write is disabled, but EEPROM write was executed from MEMOBUS/Modbus communications. When this error occurs, the keypad shows a message and the drive continues operation.

■ No Response from Slave

The slave ignores the command message from the master and will not send a response message in these conditions:

- When a communications error (overrun, framing, parity, CRC-16) is detected in the command message.
- When the slave address in the command message and the slave address for the drive side do not agree (Use H5-01 [Drive Node Address] to set the slave address of the drive)
- When the time interval between the data of which the message is composed is longer than 24 bits
- When the data length for the command message is not accurate

Note:

- If the keypad shows CALL [Serial Comm Transmission Error], refer to “Troubleshooting” to remove the cause of the error, and try to do communications again. If the keypad does not show CALL, check U1-19 [MEMOBUS/Modbus Error Code] for the error and error type.
- If you execute the write function code when the slave address in the command message is 00 (Hex.), all of the slaves will execute the write command, but they will not send response messages to the master.

Standards Compliance

This chapter gives information about how to make the machines and devices that use this product comply with UL standards, seismic standards, and European standards.

11.1	Section Safety	770
11.2	UL Standards	772
11.3	Seismic Standards	773

11.1 Section Safety

DANGER

Electrical Shock Hazard

Do not examine, connect, or disconnect wiring on an energized bypass. Before servicing, disconnect all power to the equipment and wait for the time specified on the warning label at a minimum. The internal capacitor stays charged after the bypass is de-energized. The charge indicator LED extinguishes when the DC bus voltage decreases below 50 Vdc. When all indicators are OFF, remove the covers before measuring for dangerous voltages to make sure that the bypass is safe.

If you do work on the bypass when it is energized, it will cause serious injury or death from electrical shock.

WARNING

Electrical Shock Hazard

Do not operate the bypass when covers are missing. Replace covers and shields before you operate the bypass. Use the bypass only as specified by the instructions.

Some figures in this section include bypasses without covers or safety shields to more clearly show the inside of the bypass. If covers or safety shields are missing from the bypass, it can cause serious injury or death.

Always ground the motor-side grounding terminal.

If you do not ground the equipment correctly, it can cause serious injury or death if you touch the motor case.

Do not remove covers or touch circuit boards while the bypass is energized.

If you touch the internal components of an energized bypass, it can cause serious injury or death.

Only let approved personnel install, wire, maintain, examine, replace parts, and repair the bypass.

If personnel are not approved, it can cause serious injury or death.

Do not wear loose clothing or jewelry when you do work on the bypass. Tighten loose clothing and remove all metal objects, for example watches or rings.

Loose clothing can catch on the bypass and jewelry can conduct electricity and cause serious injury or death.

Do not modify the bypass body, drive body, bypass circuitry, or drive circuitry.

Modifications to bypass and drive body and circuitry can cause serious injury or death, will cause damage to the bypass and drive, and will void the warranty. Yaskawa is not responsible for modifications of the product made by the user.

Fire Hazard

Tighten all terminal screws to the correct tightening torque.

Connections that are too loose or too tight can cause incorrect operation and damage to the bypass. Incorrect connections can also cause death or serious injury from fire.

Tighten screws at an angle in the specified range shown in this manual.

If you tighten the screws at an angle not in the specified range, you can have loose connections that can cause damage to the terminal block or start a fire and cause serious injury or death.

Damage to Equipment

Do not apply incorrect voltage to the main circuit of the bypass. Operate the bypass in the specified range of the input voltage on the nameplate.

Voltages that are higher than the permitted nameplate tolerance can cause damage to the bypass.

Fire Hazard

Do not put flammable or combustible materials on top of the bypass and do not install the bypass near flammable or combustible materials. Attach the bypass to metal or other noncombustible material.

Flammable and combustible materials can start a fire and cause serious injury or death.

⚠ WARNING**Crush Hazard**

Wear eye protection when you do work on the bypass.

If you do not use correct safety equipment, it can cause serious injury or death.

Electrical Shock Hazard

After the bypass blows a fuse or trips a GFCI, do not immediately energize the bypass or operate peripheral devices. Wait for the time specified on the warning label at a minimum and make sure that all indicators are OFF. Then check the wiring and peripheral device ratings to find the cause of the problem. If you do not know the cause of the problem, contact Yaskawa before you energize the bypass or peripheral devices.

If you do not fix the problem before you operate the bypass or peripheral devices, it can cause serious injury or death.

NOTICE**Damage to Equipment**

When you touch the bypass, drive, and circuit boards, make sure that you observe correct electrostatic discharge (ESD) procedures.

If you do not follow procedures, it can cause ESD damage to the drive and bypass circuitry.

Do not break the electrical connection between the bypass and the motor when the bypass is outputting voltage.

Incorrect equipment sequencing can cause damage to the bypass.

Make sure that all connections are correct after you install the bypass and connect peripheral devices.

Incorrect connections can cause damage to the bypass.

Note:

Do not use unshielded cable for control wiring. Use shielded, twisted-pair wires and ground the shield to the ground terminal of the bypass. Unshielded wire can cause electrical interference and unsatisfactory system performance.

11.2 UL Standards



Figure 11.1 UL/cUL Mark

The UL/cUL Mark identifies that this product conforms to rigid safety standards. This mark appears on products in the United States and Canada. It shows UL approval, which identifies that the product complies with safety standards after careful inspection and assessment. You must use UL Listed or UL Recognized parts for all primary components that are built into electrical equipment that has UL approval.

This product has been tested in accordance with UL standard UL508A, and has been verified to be in compliance with UL standards.

Machines and devices integrated with this product must satisfy the following conditions for compliance with UL standards.

◆ Area of Use

Install this product in a location with Overvoltage Category III and pollution degree 2 or less.

■ Ambient Temperature Setting

Maintain the ambient temperature within the following ranges according to the enclosure type.

- IP20/UL Type 1: -10 °C to +40 °C (14 °F to 104 °F)
- IP55/UL Type 12: -10 °C to +40 °C (14 °F to 104 °F)

11.3 Seismic Standards

Yaskawa bypasses that have the certification label in [Figure 11.2](#) are capable of structurally and operationally withstanding the seismic response criteria as defined in the International Building Code (IBC), ASCE7, and California Department of Health Care Access and Information (HCAI).

The models in this section were tested in compliance with AC-156 to meet the IBC seismic certification as shown on the certification labels.

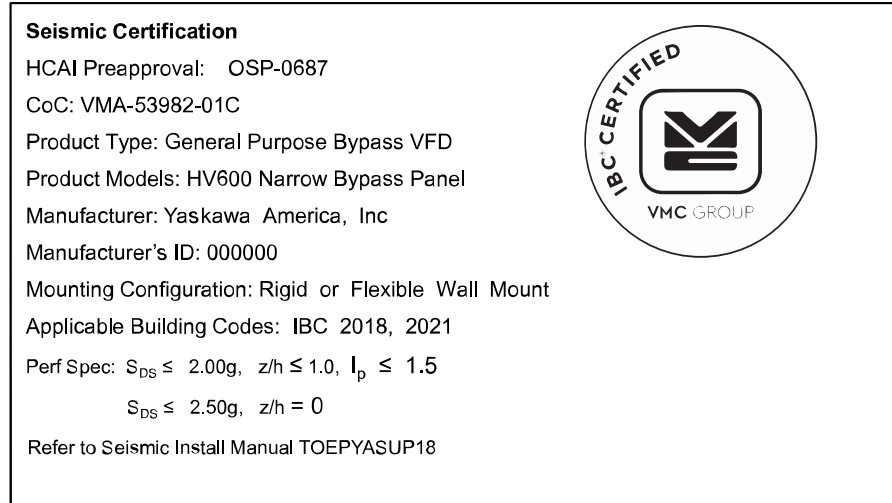

Figure 11.2 Seismic Certification Label Example for Bypasses

◆ IBC/HCAI Seismic Mounting Requirements for HV600 Bypass

Use the attachment hardware in [Table 11.1](#) to [Table 11.4](#) depending on your enclosure type to install your bypass to meet the IBC/HCAI seismic mounting requirements. Some models require the use of two #8-32 screws, at least 3/8” long, to secure the door.

■ IP20/UL Type 1 Enclosures

Table 11.1 IP20/UL Type 1 Narrow Bypass Attachment Methods and Hardware Specifications

Bypass Model H6BP	Attachment Method	Attachment Hardware		
		Quantity	Specifications	
D002 to D016 D024 to D074 B1P1, B001 to B014 B021 to B077	Direct to Steel	4	Anchor Material	ASTM A307
			Anchor Diameter	3/8 in
	Direct to Concrete ^{*1}	4	Anchor Material	Hilti KH-EZ Screw Anchor
			Anchor Diameter	3/8 in
			Minimum Embedment	3.25 in
			Critical Edge Distance	6.0 in
CMU	1500 PSI CMU with 2000 PSI grout			

*1 Refer to [Concrete Masonry Attachment Detail on page 775](#) for Direct to Concrete installations.

Table 11.2 IP20/UL Type 1 Enclosed Bypass Attachment Methods and Hardware Specifications

Bypass Model H6B1	Attachment Method	Attachment Hardware		
		Quantity	Specifications	
D002 to D016 D024 to D114 ^{*1} A002 to A015 A022 to A104 ^{*1} B1P1, B001 to B014 B021 to B124 ^{*1}	Direct to Steel	4	Anchor Material	ASTM A307
			Anchor Diameter	3/8 in
	Direct to Concrete ^{*2}	4	Anchor Material	Hilti KH-EZ Screw Anchor
			Anchor Diameter	3/8 in
			Minimum Embedment	3.25 in
			Critical Edge Distance	6.0 in
			CMU	1500 PSI CMU with 2000 PSI grout
D143, D169 ^{*1} A130, A154 ^{*1} B156 ^{*1}	Direct to Steel	4	Anchor Material	ASTM A307
			Anchor Diameter	1/2 in
	Direct to Concrete ^{*2} (IBC 2021 Excluded)	4	Anchor Material	Hilti HIT-HY 270 + HAS-V-36
			Anchor Diameter	1/2 in
			Minimum Embedment	4.50 in
			Critical Edge Distance	20.0 in
			CMU	1500 PSI CMU with 2000 PSI grout

*1 These models also require the use of two #8-32 seismic door securing screws.

*2 Refer to *Concrete Masonry Attachment Detail on page 775* for Direct to Concrete installations.

■ **IP55/UL Type 12 Enclosures**

Table 11.3 IP55/UL Type 12 Enclosed Bypass Attachment Methods and Hardware Specifications

Bypass Model H6B2	Attachment Method	Attachment Hardware		
		Quantity	Specifications	
D002 to D059 A002 to A054 B1P1, B001 to B065	Direct to Steel	4	Anchor Material	ASTM A307
			Anchor Diameter	3/8 in
	Direct to Concrete ^{*1}	4	Anchor Material	Hilti KH-EZ Screw Anchor
			Anchor Diameter	3/8 in
			Minimum Embedment	3.25 in
			Critical Edge Distance	6.0 in
			CMU	1500 PSI CMU with 2000 PSI grout
D074 to D169 A068 to A154 B077 to B156	Direct to Steel	4	Anchor Material	ASTM A307
			Anchor Diameter	1/2 in
	Direct to Concrete ^{*1} (IBC 2021 Excluded)	4	Anchor Material	Hilti HIT-HY 270 + HAS-V-36
			Anchor Diameter	1/2 in
			Minimum Embedment	4.50 in
			Critical Edge Distance	20.0 in
			CMU	1500 PSI CMU with 2000 PSI grout

*1 Refer to *Concrete Masonry Attachment Detail on page 775* for Direct to Concrete installations.

■ UL Type 3R Enclosures

Table 11.4 UL Type 3R Enclosed Bypass Attachment Methods and Hardware Specifications

Bypass Model H6B3	Attachment Method	Attachment Hardware		
		Quantity	Specifications	
D002 to D059 A002 to A054 B1P1, B001 to B065	Direct to Steel	4	Anchor Material	ASTM A307
			Anchor Diameter	3/8 in
	Direct to Concrete *1	4	Anchor Material	Hilti KH-EZ Screw Anchor
			Anchor Diameter	3/8 in
			Minimum Embedment	3.25 in
			Critical Edge Distance	6.0 in
	CMU	1500 PSI CMU with 2000 PSI grout		
D074 to D114 A068 to A104 B077 to B124	Direct to Steel	4	Anchor Material	ASTM A307
			Anchor Diameter	3/8 in
	Direct to Concrete *1 (IBC 2021 Excluded)	4	Anchor Material	Hilti HIT-HY 270 + HAS-V-36
			Anchor Diameter	3/8 in
			Minimum Embedment	4.50 in
			Critical Edge Distance	20.0 in
	CMU	1500 PSI CMU with 2000 PSI grout		
D143, D169 A130, A154 B156	Direct to Steel	4	Anchor Material	ASTM A307
			Anchor Diameter	1/2 in
	Direct to Concrete *1 (IBC 2021 Excluded)	4	Anchor Material	Hilti HIT-HY 270 + HAS-V-36
			Anchor Diameter	1/2 in
			Minimum Embedment	4.50 in
			Critical Edge Distance	20.0 in
	CMU	1500 PSI CMU with 2000 PSI grout		

*1 Refer to *Concrete Masonry Attachment Detail on page 775* for Direct to Concrete installations.

■ Concrete Masonry Attachment Detail

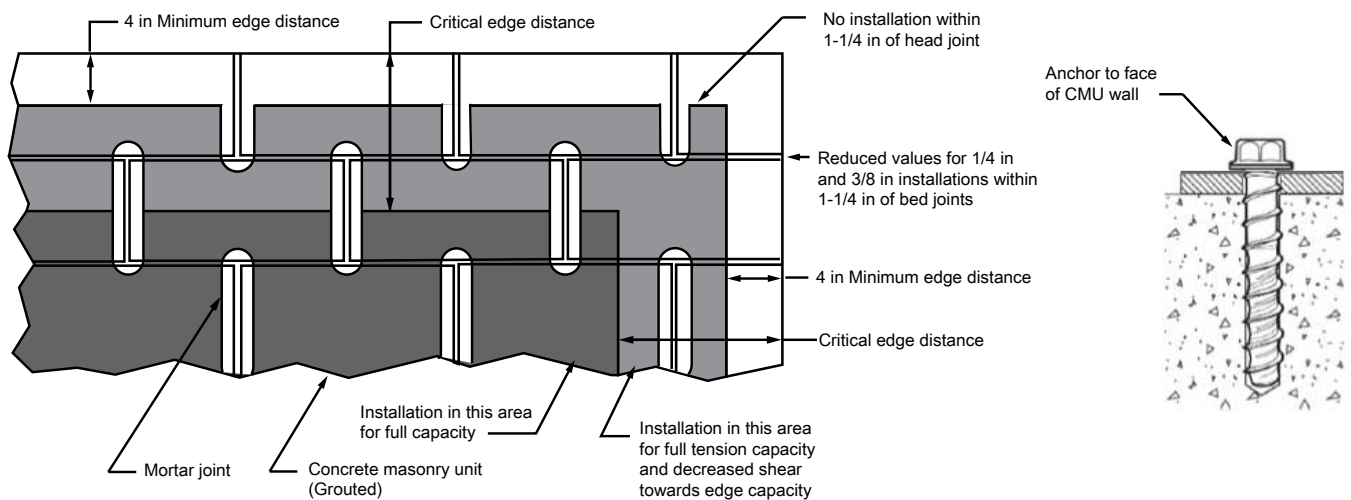

Note:
Anchorage Installation is restricted to shaded areas as per ESR 3056.

Disposal

12.1	Section Safety	778
12.2	Disposal Instructions	779
12.3	WEEE Directive	780

12.1 Section Safety

WARNING

Electrical Shock Hazard

De-energize the bypass and wait 5 minutes minimum until the Charge LED turns off. Remove the front cover and terminal cover to do work on wiring, circuit boards, and other parts. Use terminals for their correct function only.

Incorrect wiring, incorrect ground connections, and incorrect repair of protective covers can cause death or serious injury.

Only let approved personnel install, wire, maintain, examine, replace parts, and repair the bypass.

If personnel are not approved, it can cause serious injury or death.

Do not wear loose clothing or jewelry when you do work on the bypass. Tighten loose clothing and remove all metal objects, for example watches or rings.

Loose clothing can catch on the bypass and jewelry can conduct electricity and cause serious injury or death.

Fire Hazard

Handle keypad batteries properly. Do not charge the battery or disassemble the keypad.

If the battery explodes, it can cause a fire.

Do not disassemble batteries. Do not expose batteries to heat or fire.

If the battery explodes, it can cause a fire.

Crush Hazard

Wear eye protection when you do work on the bypass.

If you do not use correct safety equipment, it can cause serious injury or death.

Only approved personnel can operate a crane or hoist to move the bypass.

If unapproved personnel operate a crane or hoist, it can cause serious injury or death from falling equipment.

Use a crane or hoist to move large bypasses when necessary.

If you try to move a large bypass without a crane or hoist, it can cause serious injury or death.

CAUTION

Crush Hazard

Tighten terminal cover screws and hold the case safely when you move the bypass.

If the bypass or covers fall, it can cause moderate injury.

NOTICE

Damage to Equipment

The keypad battery stays in use after you de-energize the bypass. When you will keep the bypass de-energized for long periods of time, remove the battery from the keypad. When the expected life of the battery is complete, replace the battery immediately.

A dead battery in the keypad can leak and cause damage to the keypad and bypass.

12.2 Disposal Instructions

Correctly discard the drive, packing material, battery, and microSD card as specified by regional, local, and municipal laws and regulations for this product. (Example: European Waste 16 02 14)

Note:

- Remove the battery and microSD card from the keypad before you discard the drive.
- You cannot recycle the battery. Discard used batteries as specified by the battery manufacturer.
- Customers are responsible for microSD card data protection. PC functions that format and delete the data may not be sufficient to fully erase the microSD card data.
Yaskawa recommends that customers physically destroy the microSD card in a shredder or use data wipe software to fully erase the card.

12.3 WEEE Directive



The wheelee bin symbol on this product, its manual, or its packaging identifies that you must recycle it at the end of its product life.

You must discard the product at an applicable collection point for electrical and electronic equipment (EEE). Do not discard the product with usual waste.

Index

A

Acceleration and deceleration times	
Switching by external input	222
Acceleration time	
Parameter	222
Adjustment of control functionality	167
AFBL	498
AL02	498
AL03	498
AL09	498
AL13	498
AL16	498
AL17	498
AL18	498
Alarm	460, 498
ALM indicator	115
Altitude	
Derating	546
Environment	34
Ambient humidity	34
Ambient Temperature Setting	34
Derating	544
Parameter	338
Analog gauge	
Monitors	132
Analog input	
Function selection for terminals A1 and A2	290
Analog Output	
Gain/Bias Adjustment	298
Monitor Parameter Selection	298
Signal Level Selection	298
Terminal AM Monitor Selection	300
Terminal FM Monitor Selection	299
APOGEE FLN	
Communication specifications	717
Application Preset	173
Operation	163
AuDis	498
AuFbl	498
AUTO indicator	115, 117
AUTO key	115
AUTO LED	117
Auto-Tuning	165
Induction Motor	165
Precautions	165
Procedure	150
Rotational Auto-Tuning Precautions	166
Stationary Auto-Tuning for Line-to-Line Resistance precautions	166
Stationary Auto-Tuning Precautions	166
Stator resistance Auto-Tuning precautions	166
Auto-Tuning Error	460, 514
AUXFB	
Fault	474
Minor Fault	498

B

Backlight	
Timing of shut-off	159
Backup	

Parameters (drive to keypad)	141
Backup function	359
BACnet	
Communication specifications	698
Enter command	712
Self-diagnosis	713, 726, 737, 749
Bar graph	
Monitors	131
Base frequency	
Parameter	244
Base voltage	
Parameter	245
bAT	
Fault	474
Minor Fault	499
Battery	
Disposal	779
Replacement	587
Specifications	587
bb	499
bCE	
Fault	474
Minor Fault	499
Bu-Fb	499
BuDif	499
BuFbl	499
bUS	
bUS Error Detection Time	249
Fault	474
Minor Fault	499
Operation Selection after Detection	248
bUSy	500
Bypass	
Exterior Dimensions Diagram	54, 57, 61, 66
Bypass control circuit terminals	
Wiring	93

C

CALL	500
Capacitor Maintenance Setting	361
Carrier frequency	
Diminish	339
Parameter	226
Carrier Frequency	
Derating	543
CE	
Detection Selection	303
Detection Time	304
Fault	474
Minor Fault	500–501
Operation Selection after Detection	302
Circulation Fan	
Replacement	561
CoF	475
Communication option	
Parameter	248
Connection diagram	
Connection diagram	72
Control circuit terminals	
Wiring procedure for terminal block	97, 104
Cooling Fan	
Activation Conditions Setting	337
Estimated Lifespan	559

Off Delay Timer	338	IP20/UL Type 1	339
Replacement	561	IP55/UL Type 12	339
Copy Function Error	460, 517	Side-by-side	339
CPF00	475	dEv	
CPF01	475	Fault	479
CPF02	475	dFPS	517
CPF03	475	Diagnosing and Resetting Faults	519
CPF06	476	DIFF	
CPF07	476	Fault	480
CPF08	476	Minor Fault	501
CPF11	476	Disposal	
CPF12	476	Battery	779
CPF13	476	Drive	779–780
CPF14	476	microSD card	779
CPF16	477	Packing material	779–780
CPF17	477	dnE	501
CPF18	477	Down command	
CPF19	477	Parameter	235
CPF20	477	Drive	
CPF21	477	Disposal	779–780
CPF22	477	Exterior Dimensions Diagram	54, 57, 61, 66
CPF23	477	Initialization	171
CPF24	478	Initialize Parameters	171
CPF26	478	Inspection	556
CPF27	478	Long-Term Storage	589
CPF28	478	Rating (208 V)	529, 533
CPF29	478	Rating (240 V)	535
CPF30	478	Rating (480 V)	531, 537
CPF31	478	Drive control circuit terminals	
CPF32	478	Wiring	99
CPF33	479	Drive Model Selection	358
CPF34	479	Drive watt loss	541
CPF35	479	dv7	480
CPF36	479	Dynamic Noise Control	369
CPF37	479	E	
CPF38	479	EF	501
CPF39	479	EF0	
CPyE	517	Detection conditions	248
CrST	501	Detection conditions setting (DeviceNet)	251
CSEr	517	Fault	480
Cumulative Operation TimeSetting	361	Minor Fault	502
Current Detection Speed Search	194	Operation Selection after Detection	249
CyPo	501	EF1	
D		Fault	480
Data log	157	Minor Fault	502
Monitor selection	157	EF2	
Sampling time	158	Fault	480
Start procedure	156	Minor Fault	502
Stop procedure	156	EF3	
DC Injection Braking		Fault	480
Parameter	192	Minor Fault	502
Deceleration time		EF4	
Parameter	222	Fault	481
Delete		Minor Fault	502
Delete Backed-up Parameters	145	EF5	
Delta to Setpoint Entry		Fault	481
Sleep Wake-up level	406	Minor Fault	502
Derating		EF6	
Altitude	546	Fault	481
Ambient Temperature Setting	338, 544	Minor Fault	502
Carrier Frequency	543	EF7	
IP20/UL Open Type	339	Fault	481

Minor Fault.....	503	FB28	484
Elapsed Operating Time Selection.....	361	FB30	485
Electrolytic Capacitor		FDBKL	
Estimated Lifespan.....	559	Fault	485
Emergency Override.....	392	Minor Fault.....	503
Test Mode	395	Field weakening	
Enclosures.....	29	Parameter	236
End1.....	514	Fine tuning	167
End2.....	514	FIRE_ST	503
End3.....	514	Firmware update lock.....	181
End4.....	514	FLGT	503
End5.....	514	Foldback function	
End6.....	514	Output Current Limit.....	415
End7.....	514	FR<MS	504
Energy-saving control		FREEZ_ST.....	504
Parameter	220	Freq Ref Setting Method Select.....	358
Enter command.....	712, 748	Frequency Agreement	
EOF	503	Parameter	322
EOR	503	Frequency reference	183
EP24v	503	Command source correlation diagram.....	229
Er-01	514	Making changes using keypad.....	127
Er-02	515	Offset frequency addition	237
Er-03	515	Upper and lower frequency limits.....	233
Er-04	515	Frequency reference hold function	
Er-05	515	Parameter	235
Er-08	515	FR<TH.....	504
Er-09	516	G	
Er-12	516	GF	485
Er-13	516	Protection Functions	337
Er-18	516	Ground	
Er-25	516	Drive	87
Err	481	Ground Fault Detection	
Error Code List.....	461, 468	Protection Functions	337
Exterior Dimensions Diagram		H	
Drive	54, 57, 61, 66	HAND indicator.....	115, 117
F		HAND LED.....	117
Fan Operation Time Setting	361	HCA.....	504
FAn1	481	Alarm Settings	340
Fast Stop Time		HFB	486
Parameter	223	HIAUX	
Fault.....	460, 474	Fault	486
Fault Code List.....	461, 468	Minor Fault.....	504
Fault history		HIFB	504
Display procedure	149	High-Slip Braking	
Fault Reset	519	Parameter	342
Fault Restart		HOA Operation	
Parameter	324	AUTO Mode	384
FB02	482	HAND Mode.....	384
FB03	482	Legacy Mode.....	384
FB05	482	Normal Mode	384
FB06	483	OFF Mode	384
FB07	483	HOME screen.....	127
FB08	483	HOME screen display	346
FB09	483	Full Screen Information Display	347
FB10	483	Sequence Timer.....	373
FB13	483	Status Monitor Display	347
FB15	484	Horsepower	356
FB16	484	How to read catalog codes	25, 27
FB17	484	Humidity	
FB18	484	Environment.....	34
FB26	484		
FB27	484		

I		
iFEr.....	517	
IGBT Maintenance Setting	362	
Induction Motor		
Auto-Tuning.....	165	
Input Phase Detection		
Protection Functions	337	
Input voltage		
Parameter.....	239	
Inspection		
Drive	556	
Installation		
Front cover	44	
Terminal cover.....	44	
Installation environment	34	
INTLK.....	505	
IP20/UL Open Type		
Derating.....	339	
IP20/UL Type 1		
Derating.....	339	
IP55/UL Type 12		
Derating.....	339	
J		
Jog command	233	
Jump frequency		
Parameter	234	
K		
Keypad		
Application Preset	163	
Backlight setting.....	159	
Battery Replacement	587	
Data log setting	157	
Display drive information	161	
Display software version	161	
HOME screen	127	
Language selection	152, 170	
Meaning of indicators.....	115	
Method of operation.....	115	
Set date and time	153	
Set time	153	
Start/stop data logging	156	
Keypad Disconnect Detection	358	
Keypad Display	346	
Keypad Display Selection.....	350	
Keypad Operation	357	
Keypad-related settings.....	346	
kWh Monitor Initialization	362	
L		
Language selection.....	170	
Procedure	152	
LCD contrast adjustment.....	351	
LCP	505	
LED Light Function Selection	359	
LF	486	
Protective function	337	
LF2.....	486	
LFB	486	
Load Inertia Ratio		
Parameter	322	
LOAUX		
Fault	486	
Minor Fault.....	505	
LOFB	505	
LoG	505	
LOP		
Fault.....	487	
Minor Fault.....	505	
Low City Pressure		
Alarm text	411	
LOW_SUCT.....	505	
LSP.....	506	
LT-1	506	
LT-2	506	
LT-3	506	
LT-4	506	
LWT.....	506	
M		
Main circuit terminals		
Line voltage drop.....	81	
Wire gauge	81	
Wiring.....	79–80	
Wiring procedure for terminal block.....	90	
Main menu		
Display procedure	127	
Maintenance Period.....	361	
Maximum Output Frequency		
Parameter	244	
Maximum Output Voltage		
Parameter	244	
MEMOBUS		
Command data.....	750	
Communication error code.....	767	
Communication specifications.....	738	
Enter command	748	
Loopback test	744	
Monitor data.....	754	
Register reading	744	
Register writing.....	745	
Self-diagnosis	713, 726, 737, 749	
Wiring.....	738	
Metasys		
Communication specifications.....	728	
Self-diagnosis	713, 726, 737, 749	
microSD card		
Disposal.....	779	
Insertion slot	115	
Mid point B frequency		
Parameter	245	
Mid point B voltage		
Parameter	245	
Middle Output Frequency		
Parameter	244	
Middle Output Frequency Voltage		
Parameter	245	
Minimum output frequency		
Parameter	245	
Induction Motor		
Motor Parameters.....	245	
Minimum Output Voltage		
Parameter	245	
Minor Fault	460, 498	
Minor Fault Code List.....	461, 468	
Modbus		

Command data	750	oFA11	488
Communication error code	767	oFA12	489
Communication specifications	738	oFA13	489
Enter command	748	oFA14	489
Loopback test	744	oFA15	489
Monitor data	754	oFA16	489
Register reading	744	oFA17	489
Register writing	745	oFA30	489
Self-diagnosis	713, 726, 737, 749	oFA31	489
Wiring	738	oFA32	490
Momentary Power Loss	315	oFA33	490
Monitors		oFA34	490
Data log setting	157–158	oFA35	490
Display analog gauge	132	oFA36	490
Display bar graph	131	oFA37	490
Display procedure	128	oFA38	490
Set custom monitors	129	oFA39	490
Show custom monitors	130	oFA40	491
Start/stop data logging	156	oFA41	491
Trend Plot Display	134	oFA42	491
Motor		oFA43	491
Change direction of motor rotation	127	OFF key	115
Wiring	79–80	OFF Key Function Selection	357
Wiring distance	87	Off-Delay Timer	201
Motor Overheating		Offset frequency	
Operation During Detection of Alarms	313	Parameter	237
Operation During Detection of Faults (PTC Input)	313	oH	
Motor Overload		Alarm Settings	335
Electric Thermal Protection Operation Time	312	Fault	491
Protection Functions	311	Minor Fault	507
Motor Parameters	238, 245	oH1	491
Motor parameters (induction motors)	245	oH2	507
Leakage Inductance	247	Alarm Settings	336
Line-to-Line Resistance	247	oH3	
Motor Iron Loss	247	Fault	491
Motor rated power (kW)	247	Minor Fault	507
No-load Current	246	Operation During Detection of Alarms	313
Number of motor poles	246	oH4	492
Rated current	246	Operation During Detection of Faults (PTC Input)	313
Rated Slip	246	oL1	492
Motor Power Unit Selection	356	oL2	493
Multi-step speed operation	229	Protective function	338
Setting procedure	230	oL3	
N		Fault	494
N2		Minor Fault	507
Communication specifications	728	oL4	
Nameplate	23–25	Fault	494
ndAT	517	Minor Fault	508
NMS		oL7	494
Fault	487	On-Delay Timer	201
Minor Fault	506	oPE01	511
NumOfRunCommands Counter Initial	363	oPE02	511
O		oPE03	511
oC	487	oPE05	512
OD		oPE07	512
Fault	488	oPE08	512
Minor Fault	506	oPE09	512
oFA00	488	oPE10	512
oFA01	488	oPE11	513
oFA05	488	oPE16	513
oFA06	488	oPE20	513
oFA10	488	oPE29	513
		oPE34	513

oPE36	513
Operation During Momentary Power Loss	
Operation method selection	314
Parameter	314
Speed Search function	193
oPr	494
Option card	
Parameter	248
Options	548–549
Output Phase Loss Detection	
Protective function	337
ov	
Fault	494
Minor Fault	508
OV_PRESS	508
ov2	495
ov2 Detection	400
ovEr	508
Overexcitation deceleration	
Parameter	343
Overtorque detection	
Parameter	330
P	
P1	
Communication specifications	717
PA1	508
Parameter	
Access Level Selection	170
Automatic selection	182
Backup (drive to keypad)	141
Changing setting values	139
Checking modified parameters	146
Checking user custom parameters	140
Delete Backed-up Parameters	145
Modified Parameters Screen	146
Restore (Auto Backup)	162
Restore (keypad to drive)	142
Restoring default settings	148
User-set	182
Verify (keypad and drive)	144
Parameter Setting Errors	460, 511
PASS	508
Password	
Setting	173
Verification	172
PC	
Connection procedure	109
PE1	495
PE2	495
Peripheral Devices	548–549
PF	495, 508
Protection Functions	337
PI Auxiliary Control	415
High Feedback Level Detection	416
PI2 control	
control block diagram	380
PI2 Control	379
PID control	203
control block diagram	205
Feedback value input	204
fine tuning	206
Parameter	210

Setpoint input	204
Power loss	541
Pressure Reached Detection	412
Pressure-Reached Detection	
Exit conditions	411
Protection Functions	
DC bus undervoltage	316
Drive Overheating	336
GF	337
Ground Fault Detection	337
Input Phase Detection	337
Motor Overload	311
oH2	336
PF	337
Uv1	316
Protective function	
Drive Overheating	335
HCA	340
LF	337
Motor Overheating	313
Motor Overheating (PTC Input)	313
oH	335
oH3	313
oH4	313
oL2	338
Output Current Overload	340
Output Phase Loss Detection	337
Overload	338
Software Current Limit Selection	338
PSE	
Fault	495
R	
Rating (208 V)	
Drive	529, 533
Rating (240 V)	
Drive	535
Rating (480 V)	
Drive	531, 537
rdEr	517
Remove	
Front cover	44
Terminal cover	44
RESET key	115
Restore	
Parameters (Auto Backup)	162
Parameters (keypad to drive)	142
Reverse Operation Selection	187
RJ-45 connector	115
Rotational Auto-Tuning	
Induction Motor	165
Precautions	166
Run command	184
Run Command at Power Up	191
S	
S-curve characteristics	
Parameter	223
SAFE	509
Sampling time setting	
Data log	158
SC	496
SCF	496
Schematic	72

SE	509	Tightening torque	
Sequence Timer		Main circuit terminals.....	81
HOME screen display.....	373	TiM	
Sequence Timers	370	Fault	496
SEr	496	Minor Fault.....	509
Serial Communications		Timer function	
Parameter	301	Parameter	201
Set date and time		Torque Compensation	
Operation	153	Parameter	225
Set time		Trend Plot	
Operation	153	Monitors	134
Setpoint selection		Troubleshooting	
System Feedback Monitor.....	413	Code Displayed.....	461, 468
Side-by-side		No Code Displayed.....	520
Derating.....	339	Troubleshooting without Fault Display	520
Sleep Function		TrPC.....	509
Sleep.....	406	Tuning	222
Wake-up	406	U	
Sleep Wake-up level		U2, U3 Initialization	362
Absolute Mode.....	406	UL3	
Delta to Setpoint Mode.....	406	Fault	496
Slip compensation		Minor Fault.....	510
Parameter	224	UL4	
SMK_ALRM	509	Fault	496
Softcharge Relay Maintenance Set	362	Minor Fault.....	510
Software Current Limit Selection		UL6	
Protective function	338	Fault	496
Software version		Minor Fault.....	510
Display procedure	161	Undertorque detection	
Speed Agreement		Parameter	330
Parameter	322	Unit selector	356
Speed Detection		Up command	
Parameter	322	Parameter	235
Speed Estimation Speed Search.....	195	USB port	115
Speed Search function		Connecting a PC.....	109
Operation during momentary power loss.....	314	User Parameter Default Value	357
Parameter	193	User-Set Display Units Max Value	351
Stall Prevention function		User-SetDisplayUnits Dec Display	352
Parameter	316	Uv	510
Stationary Auto-Tuning		Uv1.....	497
Induction Motor	165	Detection level settings.....	316
Precautions	166	Uv2.....	497
Stationary Auto-Tuning for Line-to-Line Resistance	165	Uv3.....	497
Precautions	166	V	
Stator resistance Auto-Tuning		vAEr	517
Precautions	166	V/f Pattern.....	238
STo	509	VBRATION.....	510
SToF	509	Verify	
Stop command.....	184	Parameters (keypad and drive)	144
Stopping Method Selection.....	185	vFyE	517
T		Vibration-resistant.....	34
Temperature		VLTS.....	497
Environment.....	34	W	
Terminal function selection		WEEE.....	780
Terminal A1	107	Wire gauge	
Terminal A2	107	Main circuit terminals.....	81
Terminal AM.....	107	Voltage drop.....	81
Terminal FM	107	Wiring	
Test run		Control circuit terminal block	97, 104
Fine tuning	167	Control circuit terminals.....	93, 99
Thrust Mode		Main circuit terminal block	90
Thrust frequency.....	410		

Main circuit terminals.....	79–80
MEMOBUS/Modbus	738
Motor.....	79–80
Wiring diagram	
Wiring diagram	72
Wiring distance	
Drive and motor	87

Revision History

Date of Publication	Revision Number	Section	Revised Content
February 2024	<3>	All	Revision: Updated documentation to support firmware version 00448.
April 2023	<2>	All	Revision: Updated documentation to support firmware version 00447. Revised and corrected documentation.
May 2022	<1>	All	Revision: Updated documentation to support firmware versions 00444, 00445, and 00446. Added models H6BPB1P1 and H6B1B1P1. Added seismic certification data. Added Type 12 Narrow data.
May 2020	-	-	First Edition

YASKAWA

HV600 NARROW & ENCLOSED BYPASS TECHNICAL REFERENCE

YASKAWA AMERICA, INC.

2121, Norman Drive South, Waukegan, IL
60085, U.S.A.
+1-800-YASKAWA (927-5292)
<http://www.yaskawa.com>

DRIVE CENTER (INVERTER PLANT)

2-13-1, Nishimiyaichi, Yukuhashi, Fukuoka,
824-8511, Japan
Phone: +81-930-25-2548
<https://www.yaskawa.co.jp>

YASKAWA EUROPE GmbH

Hauptstr. 185, 65760 Eschborn, Germany
Phone: +49-6196-569-300
E-mail: support@yaskawa.eu.com
<http://www.yaskawa.eu.com>

YASKAWA ELÉTRICO DO BRASIL LTDA.

777, Avenida Piraporinha, Diadema, São
Paulo, 09950-000, Brasil
Phone: +55-11-3585-1100
<http://www.yaskawa.com.br>

In the event that the end user of this product is to be the military and said product is to be employed in any weapons systems or the manufacture thereof, the export will fall under the relevant regulations as stipulated in the Foreign Exchange and Foreign Trade Regulations. Therefore, be sure to follow all procedures and submit all relevant documentation according to any and all rules, regulations and laws that may apply.

Specifications are subject to change without notice for ongoing product modifications and improvements.

Original instructions.

© 2020 YASKAWA America, Inc.

YASKAWA America, Inc.

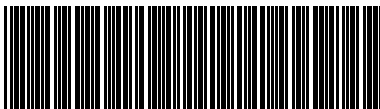

SIEPYAIH6B01

SIEPYAIH6B01
Revision: D <3>-0
Febrary 2024
Published in USA
2020_YAI