

YASKAWA

GA500 Drive

TECHNICAL REFERENCE

VERSATILE COMPACT TYPE

CATALOG CODE:

CIPR-GA50Uxxxxxxx

CAPACITIES:

200 V Class, Single-Phase Input: 1/6 to 5 HP

200 V Class, Three-Phase Input: 1/6 to 30 HP

400 V Class, Three-Phase Input: 1/2 to 40 HP

PDF

yaskawa.com/SIEPC71061752

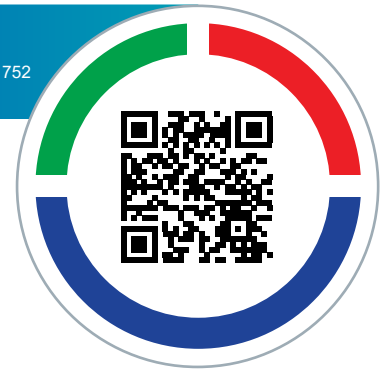

Simplify Drive Installation
Get DriveWizard® Mobile



<https://www.yaskawa.com/dwm>

DOCUMENT NUMBER: SIEPC71061752

This Page Intentionally Blank

Table of Contents

i.	Preface and General Precautions	13
i.1	Receiving	14
	Glossary	14
	About Registered Trademarks	14
i.2	Using the Product Safely	15
	Explanation of Signal Words	15
	Section Safety	15
	Warning Label Content and Location	17
i.3	Warranty Information	18
	Exclusion of Liability	18
1.	Receiving	19
1.1	Section Safety	20
1.2	Catalog Code and Nameplate Check	21
	Nameplate	21
	How to Read the Catalog Code	21
1.3	Features and Advantages of Control Methods	24
1.4	Finless-Type Drive	27
2.	Mechanical Installation	29
2.1	Section Safety	30
2.2	Installation Environment	31
2.3	Installation Position and Clearances	32
	Install Single Drive	32
	Install the Drive Horizontally	32
	Install Drives Side-by-Side	34
2.4	Moving the Drive	35
2.5	Drive Models and Drive Watt Loss	36
	Drive Watt Loss (without Built-in EMC Filter)	36
	Drive Watt Loss (with Built-in EMC Filter)	39
2.6	Removing/Reattaching Covers	43
	Remove the Front Cover	43
	Reattach the Front Cover	43
2.7	Remove and Reattach the Keypad	45
	Remove the Keypad	45
	Reattach the Keypad	45
2.8	Install the Keypad in a Control Panel or Another Device	46
	Operate the Keypad from a Remote Location	46

2.9	Installation Methods	47
	Standard Installation	47
	External Heatsink	47
	Finless-Type Drive Installation	47
2.10	Conditions	48
	Installation Environment	48
	Heatsink Plate Temperature	48
	Surface Finish of Metal Surface	49
	Thermal Compound	50
	Installation Position and Clearances	50
	Drive Watt Loss	50
	Screw Sizes and Tightening Torques	54
	Install the Finless-Type Drive	54
	Derating Depending on Ambient Temperature	55
	External Heatsink Selection	55
3.	Electrical Installation	59
3.1	Section Safety	60
3.2	Electrical Installation	63
	Standard Connection Diagram	63
3.3	Main Circuit Wiring	66
	Motor and Main Circuit Connections	66
	Configuration of Main Circuit Terminal Block	66
	Main Circuit Terminal Functions	75
	Wire Selection	75
	Main Circuit Terminal and Motor Wiring	83
3.4	Main Circuit Terminal Block Wiring Procedure	87
	Wire to the Main Circuit Terminal Block	87
3.5	Control Circuit Wiring	91
	Control Circuit Connection Diagram	91
	Control Circuit Terminal Block Functions	92
	Control Circuit Terminal Configuration	96
	Wiring the Control Circuit Terminal	97
	Switches and Jumpers on the Terminal Board	99
3.6	Control I/O Connections	101
	Set Sinking Mode/Sourcing Mode	101
	Pulse Train Output	101
	Set the Input Signal for the MFAI Terminal A2	102
	Set the Output Signal for the MFAO Terminal AM	103
	Switch ON Termination Resistor for MEMOBUS/Modbus Communications	103
3.7	Connect the Drive to a PC	104
3.8	External Interlock	105
3.9	Braking Resistor Installation	106
	Install a Braking Resistor: ERF-Type	106
	Install a Braking Resistor Unit: LKEB-Type	106
	Dynamic Braking Option Overload Protection	107
3.10	Drive Wiring Protection	108
	Installing a Ground Fault Circuit Interrupter (GFCI)	108
	Installing a Molded-Case Circuit Breaker (MCCB) or Ground Fault Circuit Interrupter (GFCI)	108
3.11	Dynamic Braking Option, Motor Protection	109

	Install an Electromagnetic Contactor (MC) at the Input Side of the Drive	109
	Installing a Thermal Overload Relay on the Drive Output	109
3.12	Improve the Power Factor	111
	Connect an AC Reactor or a DC Link Choke	111
3.13	Prevent Switching Surge	112
3.14	Decrease Noise	113
	Connect a Noise Filter to the Input Side (Primary Side)	113
	Connect a Noise Filter to the Output Side (Secondary Side)	113
3.15	Factory-Recommended Branch Circuit Protection for UL Listing	115
	UL Compliance	115
3.16	Wiring Checklist	117
3.17	Motor Application Precautions	119
	Precautions for Existing Standard Motors	119
	Precaution When You Use IE3 Premium Efficiency Motors	120
	Precautions for PM Motors	120
	Precautions for Specialized Motors	120
	Notes on the Power Transmission Mechanism	121
4.	Startup Procedure and Test Run	123
4.1	Section Safety	124
4.2	Overview of Keypad Components and Functions	125
	Indicator flashing statuses	127
	Keypad Mode and Menu Displays	128
4.3	Set up the Drive with General-Purpose Setup Mode	129
4.4	Drive Mode and Programming Mode	131
	Drive Mode	132
	Programming Mode	133
	Change Parameter Settings	134
	Verify and Set the Changed Parameters (Verify Menu)	134
	How to Switch between LOCAL and REMOTE	134
4.5	Start-up Procedures	136
	Flowchart A: Connect and Run the Motor with Minimal Setting Changes	136
	Sub-Chart A-1: Induction Motor Auto-Tuning and Test Run Procedure	138
	Sub-Chart A-2: PM Motor Auto-Tuning and Test Run Procedure	138
	Subchart A-3: EZ Open Loop Vector Control Test Run Procedure	139
4.6	Items to Check before Starting Up the Drive	141
	Check before You Energize the Drive	141
	Check after You Energize the Drive	141
4.7	Keypad Operation	142
	Digital character mapping table	142
	Show the Monitor	142
	Check Modified Parameters	142
	Set and View Necessary Parameters	143
	Change Parameter Settings	143
	Save a Backup of Parameters	144
	Write Backed-up Parameters to the Drive	145
	Verify Keypad Parameters and Drive Parameters	145
	Delete Parameters Backed Up to the Keypad	146
4.8	Automatic Parameter Settings Optimized for Specific Applications (Application Presets)	147
4.9	Auto-Tuning	148

Auto-Tuning for Induction Motors	148
Auto-Tuning for PM Motors	149
Auto-Tuning in EZ Open Loop Vector Control Method	150
ASR and Inertia Tuning	151
Precautions before Auto-Tuning	152
4.10 Test Run	155
No-Load Test Run	155
Do a No-Load Test Run	155
Actual-Load Test Run	155
Do an Actual-Load Test Run	156
4.11 Fine Tuning during Test Runs (Adjust the Control Function)	157
V/f Control	157
Open Loop Vector Control Method	158
Open Loop Vector Control for PM Motors	160
Advanced Open Loop Vector Control Method for PM Motors	161
EZ Open Loop Vector Control Method	161
4.12 Test Run Checklist	162
5. Standards Compliance	165
5.1 Section Safety	166
5.2 European Standards	168
EU Declaration of Conformity	168
CE Low Voltage Directive Compliance	168
EMC Directive	180
5.3 UL and CSA Standards	188
Area of Use	188
Wire the Main Circuit Terminal Block	188
Low Voltage Wiring for Control Circuit Terminals	200
CSA Standards	201
Drive Motor Overload and Overheat Protection	201
Conditions of Acceptability	206
5.4 China RoHS Compliance	208
Information on Hazardous Substances in This Product	208
5.5 对应中国RoHS指令	209
本产品中含有有害物质的信息	209
5.6 Safe Disable Input	210
Safe Disable Specifications	210
Notes	211
Using the Safe Disable Function	211
5.7 Seismic Standards	217
IBC/HCAI Seismic Mounting Requirements	217
IP20/UL Open Type and IP20/UL Type 1 Kit Enclosure	217
Concrete Masonry Attachment Detail	218
5.8 Australian Standard	219
6. Network Communications	221
6.1 Section Safety	222
6.2 Field Bus Network Support	223
6.3 MEMOBUS/Modbus Communications	224
Configure Master/Slave	224
Communication Specifications	224

Communication with the PLC	224
MEMOBUS/Modbus Drive Operations	226
Communications Timing	227
Message Format	227
Examples of Messages for Commands/Responses	230
Enter Command	234
Self-Diagnostics	235
Communications Data Table	235
Error Codes	252
7. Troubleshooting	255
7.1 Section Safety	256
7.2 Types of Faults, Minor Faults, Alarms, and Errors	258
7.3 List of Fault, Minor Fault, Alarm, and Error Codes	259
7.4 Fault	264
7.5 Minor Faults/Alarms	286
7.6 Parameter Setting Errors	296
7.7 Auto-Tuning Errors	301
7.8 Backup Function Operating Mode Display and Errors	305
7.9 Diagnosing and Resetting Faults	307
Fault and Power Loss Occur at the Same Time	307
Fault Occurs Without Power Loss	307
Fault Reset Procedure	307
7.10 Troubleshooting Without Fault Display	309
Typical Problems	309
The Parameter Settings Will Not Change	309
The Motor Does Not Rotate after You Enter a Run Command	310
The Motor Rotates in the Opposite Direction from the Run Command	311
The Motor Rotates in Only One Direction	311
The Motor Is Too Hot	311
The Correct Auto-Tuning Mode Is Not Available	312
The Motor Stalls during Acceleration or Accel/Decel Time Is Too Long	312
The Drive Frequency Reference Is Different than the Controller Frequency Reference Command	313
The Motor Speed Is Not Stable When Using a PM Motor	313
There Is Too Much Motor Oscillation and the Rotation Is Irregular	313
Deceleration Takes Longer Than Expected When Dynamic Braking Is Enabled	313
There Is Audible Noise from the Drive or Motor Cables when You Energize the Drive	314
The Ground Fault Circuit Interrupter (GFCI) Trips During Run	314
Motor Rotation Causes Unexpected Audible Noise from Connected Machinery	314
Motor Rotation Causes Oscillation or Hunting	314
PID Output Fault	315
The Starting Torque Is Not Sufficient	315
The Motor Rotates after the Drive Output Is Shut Off	315
The Output Frequency Is Lower Than the Frequency Reference	315
The Motor Will Not Restart after a Loss of Power	316
8. Periodic Inspection and Maintenance	317
8.1 Section Safety	318
8.2 Inspection	320
Recommended Daily Inspection	320
Recommended Periodic Inspection	320

8.3	Maintenance	323
8.4	Replace Cooling Fans	325
	Number of Cooling Fans	325
	Replace the Cooling Fan (Procedure A)	325
	Replace the Cooling Fan (Procedure B)	328
8.5	Replace the Drive	331
	About the Control Circuit Board	331
	Replace the Drive	331
8.6	Storage Guidelines	335
9.	Disposal	337
9.1	Section Safety	338
9.2	Disposal Instructions	339
9.3	WEEE Directive	340
10.	Specifications	341
10.1	Section Safety	342
10.2	Drive Duty Modes	343
10.3	Model-Specific Specifications (Single-Phase 200 V Class)	344
10.4	Model Specifications (Three-Phase 200 V Class)	345
10.5	Model Specifications (Three-Phase 400 V Class)	348
10.6	Drive Specifications	350
10.7	Drive Derating	353
	Carrier Frequency Settings and Rated Current Values	353
	Derating Depending on Ambient Temperature	355
	Altitude Derating	356
10.8	Drive Exterior and Mounting Dimensions	358
	Drive Models and Exterior and Mounting Dimensions	358
	IP20/UL Open Type	358
	Finless-Type Drive	363
10.9	Peripheral Devices and Options	367
11.	Parameter List	369
11.1	Section Safety	370
11.2	How to Read the Parameter List	371
	Icons and Terms that Identify Parameters and Control Modes	371
11.3	Parameter Groups	372
11.4	A: Initialization Parameters	373
	A1: Initialization	373
	A2: User Parameters	374
11.5	b: Application	376
	b1: Operation Mode Selection	376
	b2: DC Injection Braking and Short Circuit Braking	377
	b3: Speed Search	378
	b4: Timer Function	380
	b5: PID control	380
	b6: Dwell Function	384
	b8: Energy Saving	384
11.6	C: Tuning	386

	C1: Accel & Decel Time	386
	C2: S-Curve Characteristics	386
	C3: Slip Compensation	387
	C4: Torque Compensation	388
	C5: Automatic Speed Regulator (ASR: Automatic Speed Regulator)	388
	C6: Duty & Carrier Frequency	390
11.7	d: Reference Settings	391
	d1: Frequency Reference	391
	d2: Reference Limits	392
	d3: Jump Frequency	393
	d4: Frequency Ref Up/Down & Hold	393
	d6: Field Weakening /Forcing	394
	d7: Offset Frequency	394
11.8	E: Motor Parameters	395
	E1: V/f Pattern for Motor 1	395
	E2: Motor Parameters	396
	E3: V/f Pattern for Motor 2	396
	E4: Motor 2 Parameters	397
	E5: PM Motor Settings	398
	E9: Motor Setting	398
11.9	F: Options	400
	F1: Fault Detection in PG Speed Control	400
	F6: Communication Options	401
	F7: Communication Options	405
11.10	H: Terminal Functions	410
	H1: Digital Inputs	410
	H2: Digital Outputs	419
	H3: Analog Inputs	429
	H4: Analog Outputs	431
	H5: Modbus Communication	432
	H6: Pulse Train Input/Output	433
	H7: Virtual MFIO selection	434
11.11	L: Protection Functions	436
	L1: Motor Protection	436
	L2: Power Loss Ride Through	437
	L3: Stall Prevention	438
	L4: Speed Detection	440
	L5: Fault Restart	440
	L6: Torque Detection	442
	L7: Torque Limit	443
	L8: Drive Protection	443
11.12	n: Special Adjustment	446
	n1: Hunting Prevention	446
	n2: Auto Freq Regulator (AFR)	446
	n3: High Slip/Overexcite Braking	446
	n5: Feed Forward Control	447
	n6: Online Tuning	447
	n7: EZ Drive	448
	n8: PM Motor Control Tuning	448
	nA: PM Motor Control Tuning	452
11.13	o: Keypad-Related Settings	453
	o1: Keypad Display	453
	o2: Keypad Operation	455

o3: Copy Keypad Function	456
o4: Maintenance Monitors	457
o5: Log Function	458
11.14 q: DriveWorksEZ Parameters	459
q1-01 to qx-xx: Reserved for DriveWorksEZ	459
11.15 r: DWEZ Connection 1-20	460
r1-01 to r1-40: DriveWorksEZ Connection Parameters 1 to 20 (Upper / Lower)	460
11.16 T: Motor Tuning	461
T0: Tuning Mode Selection	461
T1: Induction Motor Auto-Tuning	461
T2: PM Motor Auto-Tuning	462
T3: ASR and Inertia Tuning	463
T4: EZ Tuning	463
11.17 U: Monitors	464
U1: Operation Status Monitors	464
U2: Fault Trace	466
U3: Fault History	468
U4: Maintenance Monitors	470
U5: PID Monitors	473
U6: Operation Status Monitors	474
U8: DriveWorksEZ Monitors	476
11.18 Parameters that Change from the Default Settings with A1-02 [Control Method Selection]	479
11.19 Parameters that Change from the Default Settings with E3-01 [Motor 2 Control Mode Selection]	483
11.20 Parameters Changed by E1-03 [V/f Pattern Selection]	484
11.21 Defaults by Drive Model and Duty Rating ND/HD	485
Single-Phase 200 V Class	485
Three-Phase 200 V Class	488
Three-Phase 400 V Class	492
12. Parameter Details	499
12.1 Section Safety	500
12.2 A: Initialization Parameters	501
A1: Initialization	501
A2: User Parameters	511
12.3 b: Application	513
b1: Operation Mode Selection	513
b2: DC Injection Braking and Short Circuit Braking	523
b3: Speed Search	526
b4: Timer Function	535
b5: PID control	537
b6: Dwell Function	553
b8: Energy Saving	554
12.4 C: Tuning	559
C1: Accel & Decel Time	559
C2: S-Curve Characteristics	565
C3: Slip Compensation	565
C4: Torque Compensation	569
C5: Auto Speed Regulator (ASR)	571
C6: Duty & Carrier Frequency	576

12.5	d: References	581
	d1: Frequency Reference	581
	d2: Reference Limits	587
	d3: Jump Frequency	588
	d4: Frequency Ref Up/Down & Hold	589
	d6: Field Weakening /Forcing	594
	d7: Offset Frequency	595
12.6	E: Motor Parameters	597
	E1: V/f Pattern for Motor 1	597
	E2: Motor Parameters	605
	E3: V/f Pattern for Motor 2	608
	E4: Motor 2 Parameters	610
	E5: PM Motor Settings	612
	E9: Motor Setting	615
12.7	F: Options	618
	F1: Fault Detection in PG Speed Control	618
	F6, F7: Communication Options	620
12.8	H: Terminal Function Selection	643
	H1: Digital Inputs	643
	MFDI Setting Values	647
	H2: MFDO	665
	H2 MFDO Parameters	668
	MFDO Setting Values	674
	H3: Analog Inputs	688
	H3: MFAI Parameters	690
	Multi-Function Analog Input Terminal Settings	693
	H4: Analog Outputs	699
	H5: Memobus/Modbus Communication	701
	H6: Pulse Train Input/Output	705
	H7: Virtual MFIO Selection	709
12.9	L: Protection Functions	713
	L1: Motor Protection	713
	L2: Power Loss Ride Through	720
	L3: Stall Prevention	730
	L4: Speed Detection	740
	L5: Fault Restart	742
	L6: Torque Detection	745
	L7: Torque Limit	750
	L8: Drive Protection	753
12.10	n: Special Adjustment	761
	n1: Hunting Prevention	761
	n2: Auto Freq Regulator (AFR)	762
	n3: High Slip Braking (HSB) and Overexcitation Braking	763
	n5: Feed Forward Control	767
	n6: Online Tuning	769
	n7: EZ Drive	770
	n8: PM Motor Control Tuning	771
	nA: PM Motor Control Tuning	782
12.11	o: Keypad-Related Settings	783
	o1: Keypad Display Selection	783
	o2: Keypad Operation	791
	o3: Copy Function	795
	o4: Maintenance Mon Settings	796
	o5: Log Function	799

12.12 T: Auto-Tuning	805
T0: Tuning Mode Selection	805
T1: Induction Motor Auto-Tuning	805
T2: PM Motor Auto-Tuning	808
T3: ASR and Inertia Tuning	811
T4: EZ Tuning	811
Index	813
Revision History	821

Preface and General Precautions

This chapter gives information about important safety precautions for the use of this product. Failure to obey these precautions can cause serious injury or death, or damage to the product or related devices and systems. Yaskawa must not be held responsible for any injury or equipment damage as a result of the failure to observe these precautions and instructions.

i.1	Receiving	14
i.2	Using the Product Safely	15
i.3	Warranty Information	18

i.1 Receiving

These instructions contain the information necessary to use the product correctly. Read and understand the safety information and precautions before you start to use the product.

◆ Glossary

Phrase	Definition
AOLV/PM	Advanced Open Loop Vector Control for Permanent Magnet Motors
Drive	YASKAWA AC Drive GA500
EDM	External Device Monitor
EZOLV	EZ Open Loop Vector Control
HD	Heavy Duty
IPM motor	Interior Permanent Magnet Synchronous Motor
MFAI	Multi-Function Analog Input
MFAO	Multi-Function Analog Output
MFDI	Multi-Function Digital Input
MFDO	Multi-Function Digital Output
ND	Normal Duty
OLV	Open Loop Vector Control
OLV/PM	Open Loop Vector Control for Permanent Magnet Motors
PM motor	Permanent Magnet Synchronous Motor (generic name for IPM motors and SPM motors)
SIL	Safety Integrity Level
SPM motor	Surface Permanent Magnet Synchronous Motor
V/f	V/f Control

◆ About Registered Trademarks

- CANopen is a registered trademark of CAN in Automation (CIA).
- CC-Link is a registered trademark of CC-Link Partner Association.
- DeviceNet is a registered trademark of Open DeviceNet Vendor Association, Inc. (ODVA).
- EtherCAT is a registered trademark of Beckhoff Automation GmbH.
- EtherNet/IP is a registered trademark of Open DeviceNet Vendor Association, Inc. (ODVA).
- LonWorks and LonTalk are registered trademarks of Echelon Corporation.
- MECHATROLINK-I, MECHATROLINK-II, and MECHATROLINK-III are registered trademarks of MECHATROLINK Members Association (MMA).
- Modbus is a registered trademark of Schneider Electric SA.
- PROFIBUS-DP and PROFINET are registered trademarks of PROFIBUS International.
- Other company names and product names in this document are trademarks or registered trademarks of the respective companies.

i.2 Using the Product Safely

◆ Explanation of Signal Words

⚠ WARNING

Read and understand this manual before you install, operate, or do maintenance on the drive. Install the drive as specified by this manual and local codes.

The symbols in this section identify safety messages in this manual. If you do not obey these safety messages, the hazards can cause serious injury, death, or damage to the products and related equipment and systems.

These identifier words categorize and emphasize important safety precautions in these instructions.

⚠ DANGER

This signal word identifies a hazard that will cause serious injury or death if you do not prevent it.

⚠ WARNING

This signal word identifies a hazard that can cause death or serious injuries if you do not prevent it.

⚠ CAUTION

This signal word identifies a hazardous situation, which, if not avoided, can cause minor or moderate injury.

NOTICE

This signal word identifies a property damage message that is not related to personal injury.

◆ Section Safety

General Precautions

- Some figures in the instructions include options and drives without covers or safety shields to more clearly show the inside of the drive. Replace covers and shields before operation. Use options and drives only as specified by the instructions.
- The figures in this manual are examples only. All figures do not apply to all products included in this manual.
- Yaskawa can change the products, specifications, and content of the instructions without notice to make the product and/or the instructions better.
- If you damage or lose these instructions, contact a Yaskawa representative or the nearest Yaskawa sales office on the rear cover of the manual, and tell them the document number on the front cover to order new copies.

⚠ DANGER

Do not ignore the safety messages in this manual.

If you ignore the safety messages in this manual, it will cause serious injury or death. The manufacturer is not responsible for injuries or damage to equipment.

Electrical Shock Hazard

Do not examine, connect, or disconnect wiring on an energized drive. Before servicing, disconnect all power to the equipment and wait for the time specified on the warning label at a minimum. The internal capacitor stays charged after the drive is de-energized. The charge indicator LED extinguishes when the DC bus voltage decreases below 50 Vdc. When all indicators are OFF, measure for dangerous voltages to make sure that the drive is safe.

If you do work on the drive when it is energized, it will cause serious injury or death from electrical shock.

⚠ WARNING

Crush Hazard

Test the system to make sure that the drive operates safely after you wire the drive and set parameters.

If you do not test the system, it can cause damage to equipment or serious injury or death.

Sudden Movement Hazard

Before you do a test run, make sure that the setting values for virtual input and output function parameters are correct. Virtual input and output functions can have different default settings and operation than wired input and output functions.

Incorrect function settings can cause serious injury or death.

Remove all personnel and objects from the area around the drive, motor, and machine and attach covers, couplings, shaft keys, and machine loads before you energize the drive.

If personnel are too close or if there are missing parts, it can cause serious injury or death.

Examine the I/O signals and internal sequence with the engineer who made the DriveWorksEZ program before you operate the drive.

If you do not know how the drive will operate, it can cause serious injury or death. When you use DriveWorksEZ to make custom programming, the drive I/O terminal functions change from factory settings and the drive will not operate as written in this manual.

Electrical Shock Hazard

Do not modify the drive body or drive circuitry.

Modifications to drive body and circuitry can cause serious injury or death, will cause damage to the drive, and will void the warranty. Yaskawa is not responsible for modifications of the product made by the user.

Only let approved personnel install, wire, maintain, examine, replace parts, and repair the drive.

If personnel are not approved, it can cause serious injury or death.

Do not remove covers or touch circuit boards while the drive is energized.

If you touch the internal components of an energized drive, it can cause serious injury or death.

After the drive blows a fuse or trips a GFCI, do not immediately energize the drive or operate peripheral devices. Wait for the time specified on the warning label at a minimum and make sure that all indicators are OFF. Then check the wiring and peripheral device ratings to find the cause of the problem. If you do not know the cause of the problem, contact Yaskawa before you energize the drive or peripheral devices.

If you do not fix the problem before you operate the drive or peripheral devices, it can cause serious injury or death.

Damage to Equipment

Do not apply incorrect voltage to the main circuit of the drive. Operate the drive in the specified range of the input voltage on the drive nameplate.

Voltages that are higher than the permitted nameplate tolerance can cause damage to the drive.

Fire Hazard

Install sufficient branch circuit short circuit protection as specified by applicable codes and this manual. The drive is suited for circuits that supply not more than 31,000 RMS symmetrical amperes, 240 Vac maximum (200 V Class), 480 Vac maximum (400 V Class).

Incorrect branch circuit short circuit protection can cause serious injury or death.

⚠ CAUTION

Crush Hazard

Tighten terminal cover screws and hold the case safely when you move the drive.

If the drive or covers fall, it can cause moderate injury.

NOTICE

Use an inverter-duty motor or vector-duty motor with reinforced insulation and windings applicable for use with an AC drive.

If the motor does not have the correct insulation, it can cause a short circuit or ground fault from insulation deterioration.

Damage to Equipment

When you touch the drive and circuit boards, make sure that you observe correct electrostatic discharge (ESD) procedures.

If you do not follow procedures, it can cause ESD damage to the drive circuitry.

Do not do a withstand voltage test or use a megohmmeter or megger insulation tester on the drive.

These tests can cause damage to the drive.

Do not operate a drive or connected equipment that has damaged or missing parts.

You can cause damage to the drive and connected equipment.

Do not use steam or other disinfectants to fumigate wood for packaging the drive. Use alternative methods, for example heat treatment, before you package the components.

Gas from wood packaging fumigated with halogen disinfectants, for example fluorine, chlorine, bromine, iodine or DOP gas (phthalic acid ester), can cause damage to the drive.

◆ Warning Label Content and Location

The drive warning label is in the location shown in [Figure i.1](#). Use the drive as specified by this information.



A - Warning label

Figure i.1 Warning Label Content and Location

i.3 Warranty Information

◆ Exclusion of Liability

- This product is not designed and manufactured for use in life-support machines or systems.
- Contact a Yaskawa representative or your Yaskawa sales representative if you are considering the application of this product for special purposes, such as machines or systems used for passenger cars, medicine, airplanes and aerospace, nuclear power, electric power, or undersea relaying.

⚠ WARNING

Injury to Personnel

When you use this product in applications where its failure could cause the loss of human life, a serious accident, or physical injury, you must install applicable safety devices.

If you do not correctly install safety devices, it can cause serious injury or death.

Receiving

This chapter gives information about the different drive models and features, and how to examine the drive when you receive it.

1.1	Section Safety	20
1.2	Catalog Code and Nameplate Check.....	21
1.3	Features and Advantages of Control Methods	24
1.4	Finless-Type Drive.....	27

1.1 Section Safety

 **DANGER**

Do not ignore the safety messages in this manual.

If you ignore the safety messages in this manual, it will cause serious injury or death. The manufacturer is not responsible for injuries or damage to equipment.

1.2 Catalog Code and Nameplate Check

Please examine these items after you received the drive:

- Examine the drive for damage or missing parts. Immediately contact the shipping company if the drive is damaged. The Yaskawa warranty does not cover damage from shipping.
- Examine the catalog code in the “C/C” section of the drive nameplate to make sure that you received the correct model.
- If you received a product different than what you ordered or your product has a defect, contact Yaskawa or your nearest sales representative.

◆ Nameplate

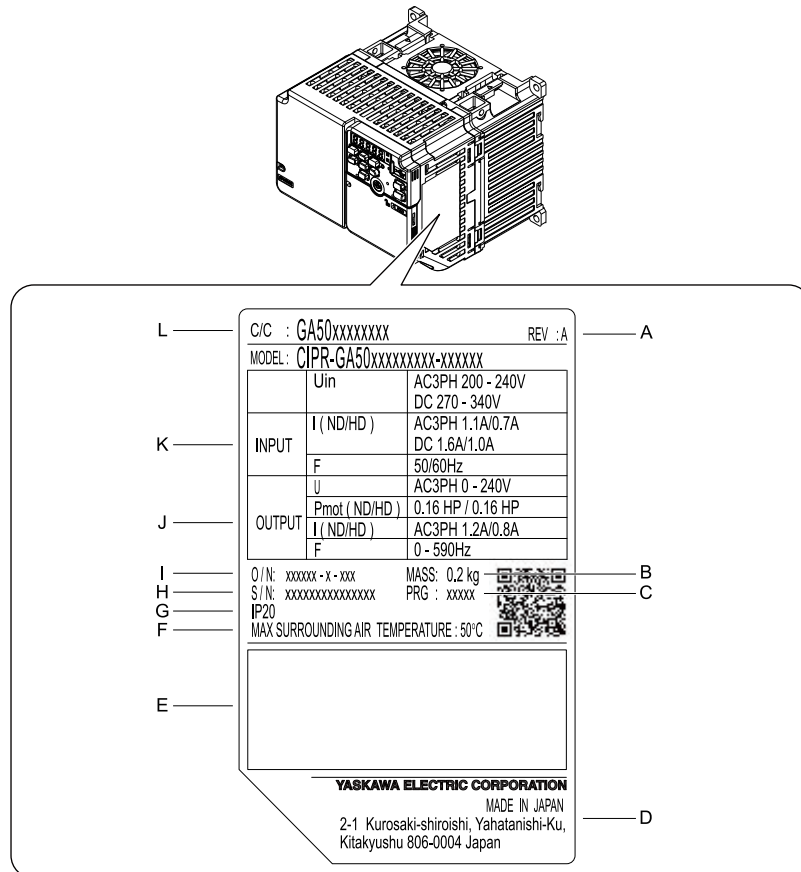

- | | |
|--|---------------------------------|
| A - Hardware revision | G - Enclosure protection design |
| B - Weight | H - Serial number |
| C - Drive software version | I - Lot number |
| D - The address of the head office of Yaskawa Electric Corporation | J - Output specifications |
| E - Accreditation standards | K - Input specifications |
| F - Surrounding air temperature | L - Catalog code |

Figure 1.1 Nameplate Information Example

◆ How to Read the Catalog Code

Use the information in [Figure 1.2](#) and [Table 1.1](#) to read the drive catalog code.

1.2 Catalog Code and Nameplate Check

GA50
1
A
2
4
3
004
4
A
5
A
6
A
7

Figure 1.2 Drive Catalog Code

Table 1.1 Catalog Code Details

No.	Description
1	Product series
2	Region code <ul style="list-style-type: none"> • A: Japan • B: China • C: Europe • T: Asia (Singapore, Taiwan, India, and Korea) • U: Americas
3	Input power supply voltage <ul style="list-style-type: none"> • B: Single-Phase AC 200 V Class • 2: Three-Phase AC 200 V Class • 4: Three-Phase AC 400 V Class
4	Rated output current ^{*1}
5	EMC noise filter A: No internal EMC filter E: Built-in EMC filter Note: No internal EMC filter for finless-type drives
6	Enclosure protection design <ul style="list-style-type: none"> • B: IP20/UL Open Type • J: Finless-Type (IP20/UL Open Type)
7	Environmental specification A: Standard

*1 Refer to [Rated Output Current on page 22](#) for more information about the rated output current.

■ Rated Output Current

Table 1.2, Table 1.3, and Table 1.4 give the rated output current values.

Note:

- Rated output current values are applicable for drives that operate at standard specifications.
- Derate the output current in applications that:
 - Increase the carrier frequency
 - Have high ambient temperature
 - Install drives side-by-side.
- Use C6-01 [*Normal / Heavy Duty Selection*] to select Normal Duty rating (ND) or Heavy Duty rating (HD).

Table 1.2 Single-Phase AC 200 V Class

Model	Heavy Duty Rating (HD) [C6-01 = 0]		Normal Duty Rating (ND) [C6-01 = 1] (Default)	
	Maximum Applicable Motor Output kW (HP)	Rated Output Current A	Maximum Applicable Motor Output kW (HP)	Rated Output Current A
B001	0.1 (1/6)	0.8	0.2 (1/6)	1.2
B002	0.2 (1/4)	1.6	0.4 (1/4)	1.9
B004	0.4 (1/2)	3.0	0.75 (3/4)	3.5
B006	0.75 (1)	5.0	1.1 (1.5)	6.0
B010	1.5 (2)	8.0	2.2 (3)	9.6
B012	2.2 (3)	11.0	3.0 (3)	12.2
B018	3.7 (5)	17.6	-	-

Table 1.3 Three-Phase AC 200 V Class

Model	Heavy Duty Rating (HD) [C6-01 = 0]		Normal Duty Rating (ND) [C6-01 = 1] (Default)	
	Maximum Applicable Motor Output kW (HP)	Rated Output Current A	Maximum Applicable Motor Output kW (HP)	Rated Output Current A
2001	0.1 (1/6)	0.8	0.2 (1/6)	1.2
2002	0.2 (1/4)	1.6	0.4 (1/4)	1.9
2004	0.4 (1/2)	3.0	0.75 (3/4)	3.5
2006	0.75 (1)	5.0	1.1 (1.5)	6.0
2010	1.5 (2)	8.0	2.2 (3)	9.6
2012	2.2 (3)	11.0	3.0 (4)	12.2
2021	3.7 (5)	17.6	5.5 (7.5)	21.0
2030	5.5 (7.5)	25.0	7.5 (10)	30.0
2042	7.5 (10)	33.0	11.0 (15)	42.0
2056	11.0 (15)	47.0	15.0 (20)	56.0
2070	15.0 (20)	60.0	18.5 (25)	70.0
2082	18.5 (25)	75.0	22.0 (30)	82.0

Table 1.4 Three-Phase AC 400 V Class

Model	Heavy Duty Rating (HD) [C6-01 = 0]		Normal Duty Rating (ND) [C6-01 = 1] (Default)	
	Maximum Applicable Motor Output kW (HP)	Rated Output Current A	Maximum Applicable Motor Output kW (HP)	Rated Output Current A
4001	0.2 (1/2)	1.2	0.4 (1/2)	1.2
4002	0.4 (3/4)	1.8	0.75 (1)	2.1
4004	0.75 (2)	3.4	1.5 (2)	4.1
4005	1.5 (3)	4.8	2.2 (3)	5.4
4007	2.2 (3)	5.6	3.0 (4)	7.1
4009	3.0 (4)	7.3	3.7 (5)	8.9
4012	3.7 (5)	9.2	5.5 (7.5)	11.9
4018	5.5 (10)	14.8	7.5 (10)	17.5
4023	7.5 (10)	18.0	11.0 (15)	23.4
4031	11.0 (15)	24.0	15.0 (20)	31.0
4038	15.0 (20)	31.0	18.5 (25)	38.0
4044	18.5 (25)	39.0	22.0 (30)	44.0
4060	22.0 (30)	45.0	30.0 (40)	60.0

1.3 Features and Advantages of Control Methods

This drive has 5 available control methods from which you can select for different applications. [Table 1.5](#), [Table 1.6](#), and [Table 1.7](#) give information about the features of each control method.

Table 1.5 Features and Advantages of V/f Control

Control Method Selection	Open Loop V/f Control (V/f)	Notes
Controlled Motor	Induction Motor	-
Parameter Settings	A1-02 = 0	-
Basic Control	V/f	-
Main Applications	<ul style="list-style-type: none"> General-purpose variable speed control Applications in which more than one motor are connected to one drive 	-
Maximum Output Frequency	590 Hz	-
Speed Control Range	1:40	This is the range of variable control. When you connect and operate motors in this mode, think about the increase in motor temperature.
Starting Torque	150% / 3 Hz	This is the motor torque that the drive can supply at low speed during start-up and the related output frequency (rotation speed). You must think about drive capacity when a large quantity of torque is necessary at low speed.
Auto-Tuning ^{*1}	Rotational and Line-to-Line Resistance (usually not necessary)	Automatically tunes electrical motor parameters.
Torque Limits	No	Controls maximum motor torque to prevent damage to machines and loads.
Speed Search ^{*1}	Yes	Immediately estimates (or detects) motor speed and direction when coasting to a stop to quickly start-up the drive without stopping the motor.
Automatic Energy-saving Control ^{*1}	Yes	Automatically adjusts the voltage that the drive applies to the motor to maximize motor efficiency for small and large loads.
High Slip Braking (HSB) ^{*1}	Yes	Increases motor loss to let the motor decelerate faster than usual without a braking resistor. Motor characteristics have an effect on this function.
Feed Forward Control	No	Compensates effects of the system inertia to increase the speed precision when the load changes.
KEB Ride-Thru Function ^{*1}	Yes	Quickly and safely stops the motor during power loss and automatically starts operation at the previous speed when the drive applies power again without coasting the motor.
Overexcitation Deceleration ^{*1}	Yes	Sets the V/f higher than the setting value during deceleration to increase motor loss and decrease deceleration time.
Overvoltage Suppression Function ^{*1}	Yes	Adjusts speed during regeneration to prevent overvoltage.

*1 Note these points when you use this function:

- When you can decouple the motor and machine for a test run, use Rotational Auto-Tuning. You must make adjustments to the control in the range where there is no vibration in the machine after Rotational Auto-Tuning.
- Motor loss increases during overexcitation braking and high-slip braking. Use a maximum braking frequency of 5% ED and a maximum braking time of 90 seconds. After you start high-slip braking, you cannot restart the motor until it stops. Use overexcitation braking to decelerate over a shorter time at a pre-determined speed.

Table 1.6 Features and Advantages of OLV Control

Control Method Selection	Open Loop Vector (OLV)	Notes
Controlled Motor	Induction Motor	-
Parameter Settings	A1-02 = 2 (Default)	-
Basic Control	Open Loop Current Vector Control	-
Main Applications	<ul style="list-style-type: none"> General-purpose variable speed control Applications in which high performance is necessary without machine encoders 	-
Maximum Output Frequency	590 Hz	-

Control Method Selection	Open Loop Vector (OLV)	Notes
Controlled Motor	Induction Motor	-
Speed Control Range	1:100	This is the range of variable control. When you connect and operate motors in this mode, think about the increase in motor temperature.
Starting Torque	150% / 1 Hz ^{*1}	This is the motor torque that the drive can supply at low speed during start-up and the related output frequency (rotation speed). You must think about drive capacity when a large quantity of torque is necessary at low speed.
Auto-Tuning ^{*2}	Rotational, Stationary, and Line-to-Line Resistance	Automatically tunes electrical motor parameters.
Torque Limits ^{*2}	Yes	Controls maximum motor torque to prevent damage to machines and loads.
Speed Search ^{*2}	Yes	Immediately estimates (or detects) motor speed and direction when coasting to a stop to quickly start-up the drive without stopping the motor.
Automatic Energy-saving Control ^{*2}	Yes	Automatically adjusts the voltage that the drive applies to the motor to maximize motor efficiency for small and large loads.
High Slip Braking (HSB) Activate	No	Increases motor loss to let the motor decelerate faster than usual without a braking resistor. Motor characteristics have an effect on this function.
Feed Forward Control	No	Compensates effects of the system inertia to increase the speed precision when the load changes.
KEB Ride-Thru Function ^{*2}	Yes	Quickly and safely stops the motor during power loss and automatically starts operation at the previous speed when the drive applies power again without coasting the motor.
Overexcitation Deceleration ^{*2}	Yes	Sets the V/f higher than the setting value during deceleration to increase motor loss and decrease deceleration time.
Overvoltage Suppression Function ^{*2}	Yes	Adjusts speed during regeneration to prevent overvoltage.

*1 Select the drive capacity accordingly.

*2 Note these points when you use this function:

- When you can decouple the motor and machine for a test run, use Rotational Auto-Tuning. You must make adjustments to the control in the range where there is no vibration in the machine after Rotational Auto-Tuning.
- For vector control, use a 1:1 drive to motor ratio. You cannot use vector control when more than one motor is connected to one drive. Select a drive capacity so that the motor rated current is 50% to 100% of the drive rated current. If the carrier frequency is too high, the drive rated current is derated.
- Motor loss increases during overexcitation braking and high-slip braking. Use a maximum braking frequency of 5% ED and a maximum braking time of 90 seconds. After you start high-slip braking, you cannot restart the motor until it stops. Use overexcitation braking to decelerate over a shorter time at a pre-determined speed.
- Acceleration and deceleration have priority over torque limits in Open Loop Vector Control during acceleration and deceleration (soft start changes). The drive will not operate until the speed is at the minimum frequency or the reverse direction of motor rotation when the motor speed decreases because of torque limits during constant speed control. Set $L7-07 = 1$ [Torque Limit during Accel/Decel = Proportional & Integral control] to enable torque limits during acceleration/deceleration (for winding applications).

Table 1.7 Features and Advantages of OLV/PM, AOLV/PM, and EZOLV Control

Control Method Selection	PM Open Loop Vector Control (OLV/PM)	PM Advanced Open Loop Vector (AOLV/PM)	EZ Open Loop Vector Control (EZOLV)	Notes
Controlled Motor	PM motor		Induction Motors/PM Motors/SynRM (Synchronous Reluctance Motors)	-
Parameter Settings	A1-02 = 5	A1-02 = 6	A1-02 = 8	-
Basic Control	PM Open Loop Vector Control (no speed controller)	PM Open Loop Current Vector Control (with speed controller)	Open Loop Current Vector Control	-
Main Applications	<ul style="list-style-type: none"> • General-purpose variable speed control for PM motors • Applications in which a high level of responsiveness and accurate speed control are not necessary. 	<ul style="list-style-type: none"> • General-purpose variable speed control for IPM motors • Applications in which high-precision speed control and torque limits are necessary. 	Low-speed torque applications Example: Fans and pumps	-
Maximum Output Frequency	590 Hz	270 Hz	120 Hz	-
Speed Control Range	1:10	1:10 1:100 ^{*1} ^{*2} ^{*3}	1:10	This is the range of variable control. When you connect and operate motors in this mode, think about the increase in motor temperature.

1.3 Features and Advantages of Control Methods

Control Method Selection	PM Open Loop Vector Control (OLV/PM)	PM Advanced Open Loop Vector (AOLV/PM)	EZ Open Loop Vector Control (EZOLV)	Notes
Controlled Motor	PM motor		Induction Motors/PM Motors/SynRM (Synchronous Reluctance Motors)	-
Starting Torque	100% / 5% speed	100% / 5% speed 100% / 0 min ⁻¹ *1	100% / 10% speed	This is the motor torque that the drive can supply at low speed during start-up and the related output frequency (rotation speed). You must think about drive capacity when a large quantity of torque is necessary at low speed.
Auto-Tuning *5	Stationary, Stator Resistance, Rotational	Stationary, Stator Resistance, Rotational	Line-to-Line Resistance	Automatically tunes electrical motor parameters.
Torque Limits *5	No	Yes	Yes	Controls maximum motor torque to prevent damage to machines and loads.
Speed Search *5	Yes	Yes	Yes (Although NOT operation in the reverse direction of the Run command)	Immediately estimates (or detects) motor speed and direction when coasting to a stop to quickly start-up the drive without stopping the motor.
Automatic Energy-saving Control *5	No	Yes (IPM motors only)	Yes	Automatically adjusts the voltage that the drive applies to the motor to maximize motor efficiency for small and large loads.
High Slip Braking (HSB) Activate	No (induction motor-specific function)	No (induction motor-specific function)	No	Increases motor loss to let the motor decelerate faster than usual without a braking resistor. Motor characteristics have an effect on this function.
Feed Forward Control *5	No	Yes	No	Compensates effects of the system inertia to increase the speed precision when the load changes.
KEB Ride-Thru Function *5	Yes	Yes	Yes	Quickly and safely stops the motor during power loss and automatically starts operation at the previous speed when the drive applies power again without coasting the motor.
Overexcitation Deceleration	No (induction motor-specific function)	No (induction motor-specific function)	No	Sets the V/f higher than the setting value during deceleration to increase motor loss and decrease deceleration time.
Overvoltage Suppression Function *5	Yes	Yes	Yes	Adjusts speed during regeneration to prevent overvoltage.

*1 Enabled when $n8-57 = 1$ [HFI Overlap Selection = Enabled].

*2 Rotational Auto-Tuning is necessary.

*3 Contact Yaskawa or your nearest sales representative to drive non-Yaskawa PM motors (SSR1 series standard specifications).

*4 Select the drive capacity accordingly.

*5 Note these points when you use this function:

- When you can decouple the motor and machine for a test run, use Rotational Auto-Tuning. You must make adjustments to the control in the range where there is no vibration in the machine after Rotational Auto-Tuning.
- For vector control, use a 1:1 drive to motor ratio. You cannot use vector control when more than one motor is connected to one drive. Select a drive capacity so that the motor rated current is 50% to 100% of the drive rated current. If the carrier frequency is too high, the drive rated current is derated.

1.4 Finless-Type Drive

Finless-type drives do not have cooling fins, which are the main heat-dissipating component of the drive. The finless-type drive uses the enclosure panel (metal plate) as a cooling fin to release the heat generated by the drive. This will let you install the drive in a smaller enclosure panel.

Finless-type drives are recognized components by UL (Underwriters Laboratories Inc.).

Machines and devices integrated with this product must satisfy *Conditions of Acceptability on page 206* conditions for compliance with UL standards.

Mechanical Installation

This chapter gives information about the correct environment and clearances to install the drive.

2.1	Section Safety	30
2.2	Installation Environment	31
2.3	Installation Position and Clearances	32
2.4	Moving the Drive.....	35
2.5	Drive Models and Drive Watt Loss	36
2.6	Removing/Reattaching Covers.....	43
2.7	Remove and Reattach the Keypad.....	45
2.8	Install the Keypad in a Control Panel or Another Device.....	46
2.9	Installation Methods	47
2.10	Conditions.....	48

2.1 Section Safety

WARNING

Electrical Shock Hazard

Only let approved personnel install, wire, maintain, examine, replace parts, and repair the drive.

If personnel are not approved, it can cause serious injury or death.

Do not modify the drive body or drive circuitry.

Modifications to drive body and circuitry can cause serious injury or death, will cause damage to the drive, and will void the warranty. Yaskawa is not responsible for modifications of the product made by the user.

Fire Hazard

Do not put flammable or combustible materials on top of the drive and do not install the drive near flammable or combustible materials. Attach the drive to metal or other noncombustible material.

Flammable and combustible materials can start a fire and cause serious injury or death.

When you install the drive in an enclosure, use a cooling fan or cooler to decrease the temperature around the drive. Make sure that the intake air temperature to the drive is 50 °C (122 °F) or less for IP20/UL Open Type drives, and 40 °C (104 °F) or less for IP20/UL Type 1 drives.

If the air temperature is too hot, the drive can become too hot and cause a fire and serious injury or death.

CAUTION

Crush Hazard

Tighten terminal cover screws and hold the case safely when you move the drive.

If the drive or covers fall, it can cause moderate injury.

NOTICE

Do not let unwanted objects, for example metal shavings or wire clippings, fall into the drive during drive installation. Put a temporary cover over the drive during installation. Remove the temporary cover before start-up.

Unwanted objects inside of the drive can cause damage to the drive.

Damage to Equipment

When you touch the drive and circuit boards, make sure that you observe correct electrostatic discharge (ESD) procedures.

If you do not follow procedures, it can cause ESD damage to the drive circuitry.

Install vibration-proof rubber on the base of the motor or use the frequency jump function in the drive to prevent specific frequencies that vibrate the motor.

Motor or system resonant vibration can occur in fixed speed machines that are converted to variable speed. Too much vibration can cause damage to equipment.

You can use the drive with an explosion-proof motor, but the drive is not explosion-proof. Install the drive only in the environment shown on the nameplate.

If you install the drive in a dangerous environment, it can cause damage to the drive.

Do not lift the drive with the covers removed.

If the drive does not have covers, you can easily cause damage to the internal parts of the drive.

2.2 Installation Environment

The installation environment is important for the lifespan of the product and to make sure that the drive performance is correct. Make sure that the installation environment aligns with these specifications.

Refer to *Conditions on page 48* for information about the installation of finless-type drives.

Environment	Conditions
Area of Use	Indoors
Power Supply	Overvoltage Category III (IEC60664)
Surrounding Air Temperature	IP20/UL Open Type: -10 °C to +50 °C (14 °F to 122 °F) IP20/UL Type 1: -10 °C to +40 °C (14 °F to 104 °F) <ul style="list-style-type: none"> When you install the drive in an enclosure, use a cooling fan or air conditioner to keep the internal air temperature in the permitted range. Do not let the drive freeze.
Humidity	95%RH or less Do not let condensation form on the drive.
Storage Temperature	-20 °C to +70 °C (-4 °F to +158 °F) (short-term temperature during transportation)
Surrounding Area	Pollution degree 2 or less (IEC 60664-1) Install the drive in an area without: <ul style="list-style-type: none"> Oil mist, corrosive or flammable gas, or dust Metal powder, oil, water, or other unwanted materials Radioactive or flammable materials. Harmful gas or fluids Salt Direct sunlight Keep wood and other flammable materials away from the drive.
Altitude	1000 m (3281 ft) Maximum Note: Derate the output current by 1% for each 100 m (328 ft) to install the drive in altitudes between 1000 m to 4000 m (3281 ft to 13123 ft). It is not necessary to derate the rated voltage in these conditions: <ul style="list-style-type: none"> Installing the drive at 2000 m (6562 ft) or lower Installing the drive between 2000 m to 4000 m (6562 ft to 13123 ft) and grounding the neutral point on the power supply. Contact Yaskawa or your nearest sales representative if you will not ground the neutral point.
Vibration	<ul style="list-style-type: none"> 10 Hz to 20 Hz: 1 G (9.8 m/s², 32.15 ft/s²) 20 Hz to 55 Hz: 0.6 G (5.9 m/s², 19.36 ft/s²)
Installation Orientation	Install the drive vertically or horizontally for sufficient airflow to cool the drive. Refer to the drive Technical Manual for more information.

NOTICE: Do not put drive peripheral devices, transformers, or other electronics near the drive. Shield the drive from electrical interference if components must be near the drive. Components near the drive can cause incorrect drive operation from electrical interference.

NOTICE: Do not let unwanted objects, for example metal shavings or wire clippings, fall into the drive during drive installation. Put a temporary cover over the drive during installation. Remove the temporary cover before start-up. Unwanted objects inside of the drive can cause damage to the drive.

2.3 Installation Position and Clearances

Install the drive as shown in [Figure 2.1](#) for sufficient airflow to cool the drive.

Refer to [Conditions on page 48](#) for more information about installation position and clearances of finless-type drives.

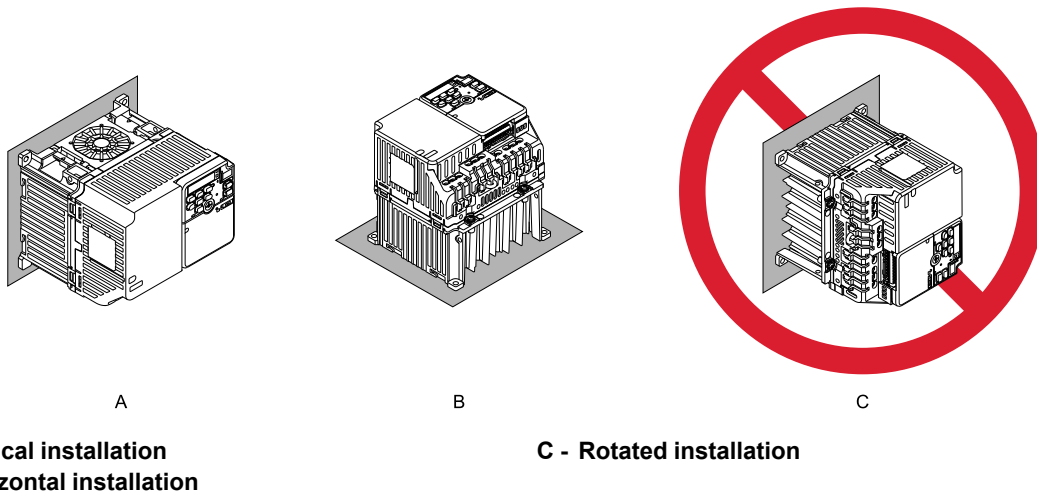
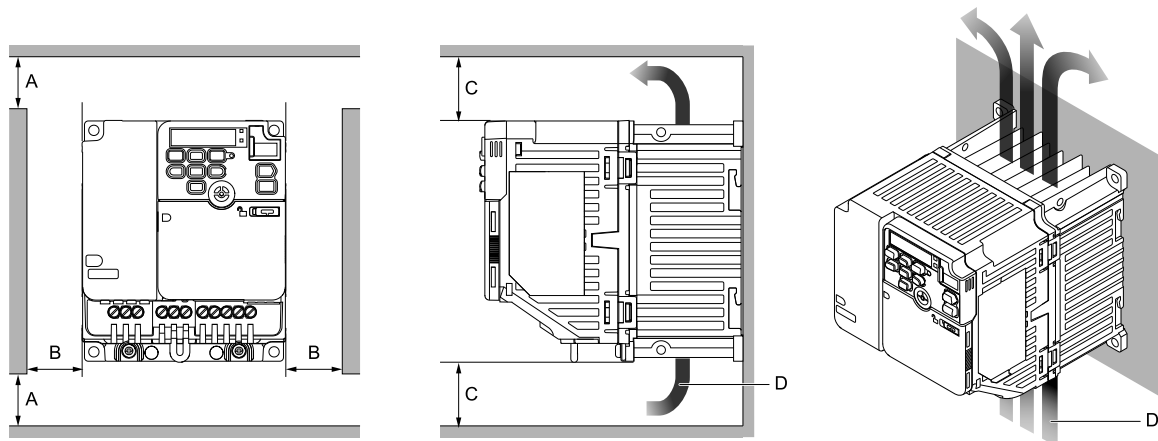

Figure 2.1 Installation Orientation

◆ Install Single Drive

Use the clearances specified in [Figure 2.2](#) to install the drive. Make sure that there is sufficient space for wiring and airflow.



A - 50 mm (2 in) minimum

B - 30 mm (1.18 in) minimum on each side

C - 100 mm (3.94 in) minimum above and below

D - Airflow direction

Figure 2.2 Installation Clearances for One Drive

◆ Install the Drive Horizontally

When you install drives horizontally, set $L8-12 = 40$ [Ambient Temperature Setting = 40 °C] and $L8-35 = 1$ [Installation Method Selection = Side-by-Side Mounting]. Use the clearances specified in [Figure 2.4](#) and [Figure 2.5](#) to install the drive. Make sure that there is sufficient space for wiring and airflow. To install the drive models B001 - B012, 2001 - 2021, and 4001 - 4012 horizontally, install an external cooling fan. Refer to [Table 2.1](#) for more information about the external cooling fan.

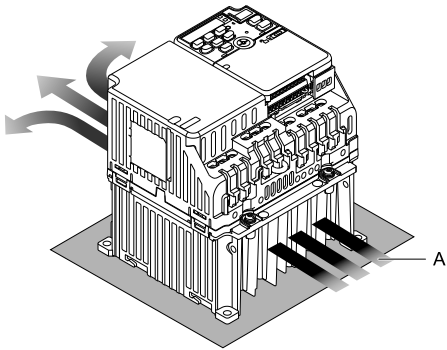

A - Airflow direction

Figure 2.3 Airflow Direction of Horizontal installation

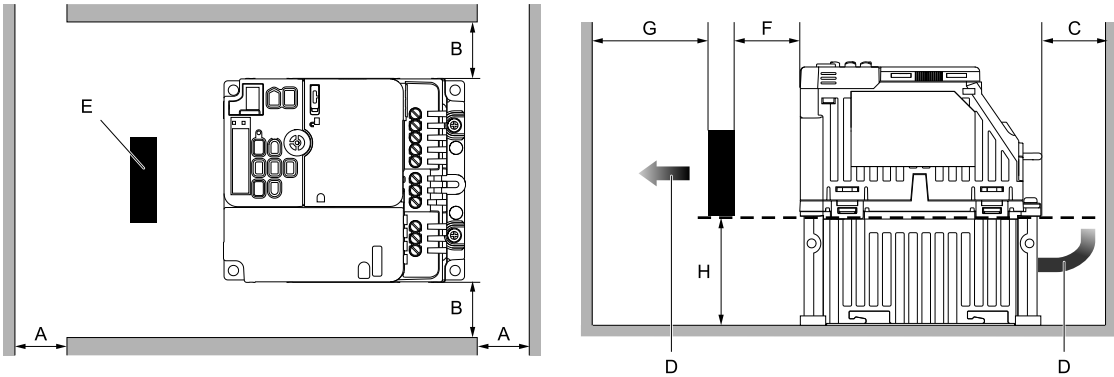

- A - 50 mm (2 in) minimum
- B - 30 mm (1.18 in) minimum on each side
- C - 100 mm (3.94 in) minimum below
- D - Airflow direction

- E - External cooling fan
- F - 30 mm (1.18 in) between the drive and the external cooling fan
- G - 120 mm (4.72 in) minimum between the external cooling fan and the enclosure panel
- H - Heatsink height

Figure 2.4 Installation Clearances for Horizontal Installation: B001 - B012, 2001 - 2021, and 4001 - 4012

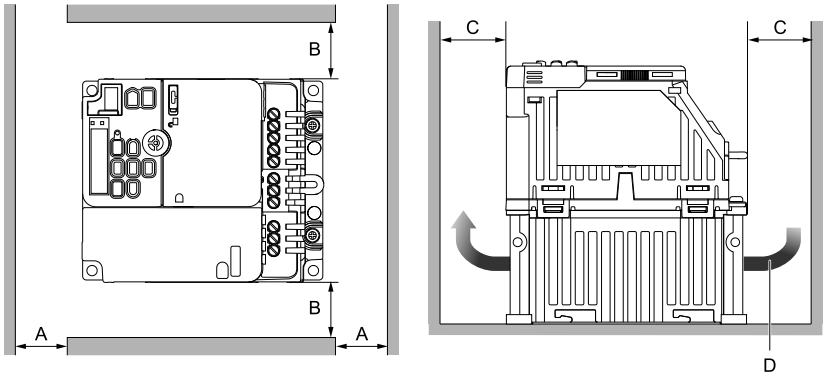

- A - 50 mm (2 in) minimum
- B - 30 mm (1.18 in) minimum on each side

- C - 100 mm (3.94 in) minimum above and below
- D - Airflow direction

Figure 2.5 Installation Clearances for Horizontal Installation: B018, 2030 - 2082, and 4018 - 4060

2.3 Installation Position and Clearances

Table 2.1 Specifications of External Cooling Fan for Horizontal (Floor) Installation

Model	Airflow (m ³ /min)	Static Pressure (Pa)
B001 - B004 2001 - 2006	0.18 minimum	63.7 minimum
B006 - B012 2010 - 2021 4001 - 4012	1.11 minimum	244 minimum
B018 2030 - 2082 4018 - 4060	External cooling fan is not necessary	

◆ Install Drives Side-by-Side

When you install drives side-by-side, set to $L8-35 = 1$ [*Installation Method Selection = Side-by-Side Mounting*].

Refer to [Derating Depending on Ambient Temperature on page 355](#) and set derating depending on ambient temperature.

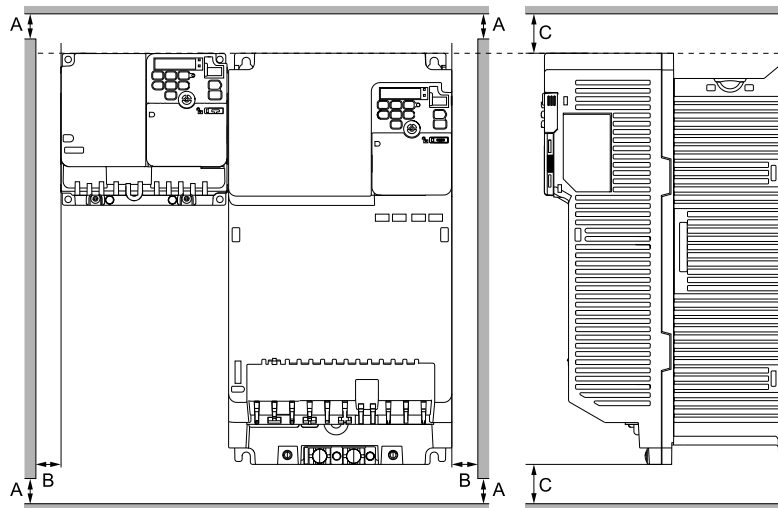

A - 50 mm (1.97 in) minimum

B - 30 mm (1.18 in) minimum on each side

C - 100 mm (3.94 in) minimum above and below

Figure 2.6 Installation Clearances for More than One Drive (Side-by-Side)

Note:

Align the tops of drives that have different dimensions to help when you replace cooling fans.

2.4 Moving the Drive

When you move and install this product, make sure that you obey local laws and regulations.

CAUTION! *Crush Hazard. Do not hold the drive by the keypad or front cover. Tighten the screws correctly when you move the drive. If the drive or covers fall, it can cause moderate injury.*

2.5 Drive Models and Drive Watt Loss

Specification	Model	Ref.
No internal EMC filter	BxxxA	36
	2xxxA	37
	4xxxA	38
Built-in EMC Filter	BxxxE	39
	2xxxE	40
	4xxxE	41

◆ Drive Watt Loss (without Built-in EMC Filter)

■ Single-Phase 200 V Class

Table 2.2 Drive Watt Loss (HD, Fc = 2 kHz)

Model	The rated output current A	Carrier Frequency kHz	Interior Unit Loss W	Cooling Fin Loss W	Total Loss W
B001	0.8	2	7	4	11
B002	1.6	2	10	7	17
B004	3	2	13	13	26
B006	5	2	17	23	40
B010	8	2	30	37	67
B012	11	2	40	48	88
B018 ^{*1}	17.6	2	49	72	121

*1 There is not a finless-type B018 model.

Table 2.3 Drive Watt Loss (HD, Fc = Default Setting)

Model	The rated output current A	Carrier Frequency kHz	Interior Unit Loss W	Cooling Fin Loss W	Total Loss W
B001	0.8	10	8	5	13
B002	1.6	10	10	9	19
B004	3	10	14	16	30
B006	5	10	18	28	46
B010	8	8	31	42	73
B012	11	8	41	55	96
B018 ^{*1}	17.6	8	53	98	151

*1 There is not a finless-type B018 model.

Table 2.4 Drive Watt Loss (ND)

Model	The rated output current A	Carrier Frequency kHz	Interior Unit Loss W	Cooling Fin Loss W	Total Loss W
B001	1.2	2	8	6	14
B002	1.9	2	14	11	25
B004	3.5	2	14	17	31
B006	6.0	2	17	26	43
B010	9.6	2	36	50	86
B012	12.2	2	48	60	108
B018 ^{*1}	-	2	49	92	141

*1 There is not a finless-type B018 model.

■ Three-Phase 200 V Class

Table 2.5 Drive Watt Loss (HD, Fc = 2 kHz)

Model	The rated output current A	Carrier Frequency kHz	Interior Unit Loss W	Cooling Fin Loss W	Total Loss W
2001	0.8	2	6	4	10
2002	1.6	2	7	7	14
2004	3.0	2	9	13	22
2006	5.0	2	13	22	35
2010	8.0	2	17	37	54
2012	11.0	2	23	49	72
2021	17.6	2	36	83	119
2030	25.0	2	45	163	208
2042	33.0	2	55	200	255
2056	47.0	2	77	269	346
2070	60.0	2	108	411	519
2082 <i>*1</i>	75.0	2	132	439	571

*1 There is not a finless-type 2082 model.

Table 2.6 Drive Watt Loss (HD, Fc = Default Setting)

Model	The rated output current A	Carrier Frequency kHz	Interior Unit Loss W	Cooling Fin Loss W	Total Loss W
2001	0.8	10	6	5	11
2002	1.6	10	7	8	15
2004	3.0	10	10	16	26
2006	5.0	10	14	27	41
2010	8.0	8	18	43	61
2012	11.0	8	24	56	80
2021	17.6	8	40	108	148
2030	25.0	8	49	187	236
2042	33.0	8	60	232	292
2056	47.0	8	85	318	403
2070	60.0	8	119	473	592
2082 <i>*1</i>	75.0	8	148	525	673

*1 There is not a finless-type 2082 model.

Table 2.7 Drive Watt Loss (ND)

Model	The rated output current A	Carrier Frequency kHz	Interior Unit Loss W	Cooling Fin Loss W	Total Loss W
2001	1.2	2	7	5	12
2002	1.9	2	9	9	18
2004	3.5	2	11	16	27
2006	6	2	14	25	39
2010	9.6	2	25	51	76
2012	12.2	2	30	61	91
2021	21	2	52	111	163
2030	30	2	63	240	303

2.5 Drive Models and Drive Watt Loss

Model	The rated output current A	Carrier Frequency kHz	Interior Unit Loss W	Cooling Fin Loss W	Total Loss W
2042	42	2	84	307	391
2056	56	2	109	367	476
2070	70	2	142	534	676
2082 <i>*1</i>	82	2	160	531	691

*1 There is not a finless-type 2082 model.

■ Three-Phase 400 V Class

Table 2.8 Drive Watt Loss (HD, Fc = 2 kHz)

Model	The rated output current A	Carrier Frequency kHz	Interior Unit Loss W	Cooling Fin Loss W	Total Loss W
4001	1.2	2	8	7	15
4002	1.8	2	10	10	20
4004	3.4	2	13	21	34
4005	4.8	2	15	29	44
4007	5.6	2	16	33	49
4009	7.3	2	21	45	66
4012	9.2	2	27	60	87
4018	14.8	2	48	126	174
4023	18	2	53	152	205
4031	24	2	68	191	259
4038	31	2	81	256	337
4044 <i>*1</i>	39	2	109	338	447
4060 <i>*1</i>	45	2	114	328	442

*1 There are not finless-type 4044 or 4060 models.

Table 2.9 Drive Watt Loss (HD, Fc = Default Setting)

Model	The rated output current A	Carrier Frequency kHz	Interior Unit Loss W	Cooling Fin Loss W	Total Loss W
4001	1.2	8	9	11	20
4002	1.8	8	11	16	27
4004	3.4	8	15	31	46
4005	4.8	8	18	42	60
4007	5.6	8	18	49	67
4009	7.3	8	25	65	90
4012	9.2	8	32	85	117
4018	14.8	8	55	166	221
4023	18	8	61	200	261
4031	24	8	79	255	334
4038	31	8	95	338	433
4044 <i>*1</i>	39	8	127	442	569
4060 <i>*1</i>	45	8	135	446	581

*1 There are not finless-type 4044 or 4060 models.

Table 2.10 Drive Watt Loss (ND)

Model	The rated output current A	Carrier Frequency kHz	Interior Unit Loss W	Cooling Fin Loss W	Total Loss W
4001	1.2	2	8	7	15
4002	2.1	2	13	12	25
4004	4.1	2	14	24	38
4005	5.4	2	16	32	48
4007	7.1	2	20	44	64
4009	8.9	2	28	58	86
4012	11.9	2	39	83	122
4018	17.5	2	52	155	207
4023	23.4	2	86	236	322
4031	31	2	101	284	385
4038	38	2	108	341	449
4044 <i>*1</i>	44	2	137	417	554
4060 <i>*1</i>	60	2	176	490	666

*1 There are not finless-type 4044 or 4060 models.

◆ Drive Watt Loss (with Built-in EMC Filter)

■ Single-Phase 200 V Class

Table 2.11 Drive Watt Loss (HD, Fc = 2 kHz)

Model	Rated Output Current A	Carrier Frequency kHz	Interior Unit Loss W	Cooling Fin Loss W	Total Loss W
B001E	0.8	2	8	4	12
B002E	1.6	2	12	7	19
B004E	3	2	17	13	30
B006E	5	2	20	23	43
B010E	8	2	34	37	71
B012E	11	2	45	48	93

Table 2.12 Drive Watt Loss (HD, Fc = Default Setting)

Model	Rated Output Current A	Carrier Frequency kHz	Interior Unit Loss W	Cooling Fin Loss W	Total Loss W
B001E	0.8	10	9	5	14
B002E	1.6	10	12	9	21
B004E	3	10	18	16	34
B006E	5	10	21	28	49
B010E	8	8	35	42	77
B012E	11	8	46	55	101

Table 2.13 Drive Watt Loss (ND)

Model	Rated Output Current A	Carrier Frequency kHz	Interior Unit Loss W	Cooling Fin Loss W	Total Loss W
B001E	1.2	2	9	6	15
B002E	1.9	2	18	11	29
B004E	3.5	2	19	17	36
B006E	6.0	2	20	26	46

2.5 Drive Models and Drive Watt Loss

Model	Rated Output Current A	Carrier Frequency kHz	Interior Unit Loss W	Cooling Fin Loss W	Total Loss W
B010E	9.6	2	44	50	94
B012E	12.2	2	56	60	116

■ Three-Phase 200 V Class

Table 2.14 Drive Watt Loss (HD, Fc = 2 kHz)

Model	Rated Output Current A	Carrier Frequency kHz	Interior Unit Loss W	Cooling Fin Loss W	Total Loss W
2001E	0.8	2	7	4	11
2002E	1.6	2	8	7	15
2004E	3.0	2	12	13	25
2006E	5.0	2	20	22	42
2010E	8.0	2	18	37	55
2012E	11.0	2	24	49	73
2021E	17.6	2	37	83	120
2030E	25.0	2	46	163	209
2042E	33.0	2	56	200	256
2056E	47.0	2	78	269	347
2070E	60.0	2	109	411	520
2082E	75.0	2	133	439	572

Table 2.15 Drive Watt Loss (HD, Fc = Default Setting)

Model	Rated Output Current A	Carrier Frequency kHz	Interior Unit Loss W	Cooling Fin Loss W	Total Loss W
2001E	1.2	10	7	5	12
2002E	1.9	10	8	8	16
2004E	3.5	10	13	16	29
2006E	6	10	21	27	48
2010E	9.6	8	19	43	62
2012E	12.2	8	25	56	81
2021E	21	8	41	108	149
2030E	30	8	50	187	237
2042E	42	8	61	232	293
2056E	56	8	86	318	404
2070E	70	8	120	473	593
2082E	82	8	149	525	674

Table 2.16 Drive Watt Loss (ND)

Model	Rated Output Current A	Carrier Frequency kHz	Interior Unit Loss W	Cooling Fin Loss W	Total Loss W
2001E	1.2	2	8	5	13
2002E	1.9	2	12	9	21
2004E	3.5	2	15	16	31
2006E	6	2	21	25	46
2010E	9.6	2	26	51	77
2012E	12.2	2	31	61	92

Model	Rated Output Current A	Carrier Frequency kHz	Interior Unit Loss W	Cooling Fin Loss W	Total Loss W
2021E	21	2	53	111	164
2030E	30	2	64	240	304
2042E	42	2	85	307	392
2056E	56	2	110	367	477
2070E	70	2	143	534	677
2082E	82	2	161	531	692

■ Three-Phase 400 V Class

Table 2.17 Drive Watt Loss (HD, Fc = 2 kHz)

Model	Rated Output Current A	Carrier Frequency kHz	Interior Unit Loss W	Cooling Fin Loss W	Total Loss W
4001E	1.2	2	9	7	16
4002E	1.8	2	11	10	21
4004E	3.4	2	15	21	36
4005E	4.8	2	17	29	46
4007E	5.6	2	18	33	51
4009E	7.3	2	24	45	69
4012E	9.2	2	29	60	89
4018E	14.8	2	52	126	178
4023E	18	2	57	152	209
4031E	24	2	73	191	264
4038E	31	2	89	256	345
4044E	39	2	119	338	457
4060E	45	2	128	328	456

Table 2.18 Drive Watt Loss (HD, Fc = Default Setting)

Model	Rated Output Current A	Carrier Frequency kHz	Interior Unit Loss W	Cooling Fin Loss W	Total Loss W
4001E	1.2	8	10	11	21
4002E	1.8	8	12	16	28
4004E	3.4	8	17	31	48
4005E	4.8	8	20	42	62
4007E	5.6	8	20	49	69
4009E	7.3	8	28	65	93
4012E	9.2	8	34	85	119
4018E	14.8	8	59	166	225
4023E	18	8	65	200	265
4031E	24	8	84	255	339
4038E	31	8	103	338	441
4044E	39	8	137	442	579
4060E	45	8	149	446	595

Table 2.19 Drive Watt Loss (ND)

Model	Rated Output Current A	Carrier Frequency kHz	Interior Unit Loss W	Cooling Fin Loss W	Total Loss W
4001E	1.2	2	9	7	16
4002E	2.1	2	14	12	26
4004E	4.1	2	16	24	40
4005E	5.4	2	18	32	50
4007E	7.1	2	23	44	67
4009E	8.9	2	33	58	91
4012E	11.9	2	41	83	124
4018E	17.5	2	56	155	211
4023E	23.4	2	94	236	330
4031E	31	2	109	284	393
4038E	38	2	119	341	460
4044E	44	2	151	417	568
4060E	60	2	200	490	690

2.6 Removing/Reattaching Covers

DANGER! Electrical Shock Hazard. Do not examine, connect, or disconnect wiring on an energized drive. Before servicing, disconnect all power to the equipment and wait for the time specified on the warning label at a minimum. The internal capacitor stays charged after the drive is de-energized. The charge indicator LED extinguishes when the DC bus voltage decreases below 50 Vdc. When all indicators are OFF, measure for dangerous voltages to make sure that the drive is safe. If you do work on the drive when it is energized, it will cause serious injury or death from electrical shock.

◆ Remove the Front Cover

1. Use a slotted screwdriver to unlock the front cover of the drive.
Use a slotted screwdriver with a tip width of 2.5 mm (0.1 in) or less and a thickness of 0.4 mm (0.02 in) or less.

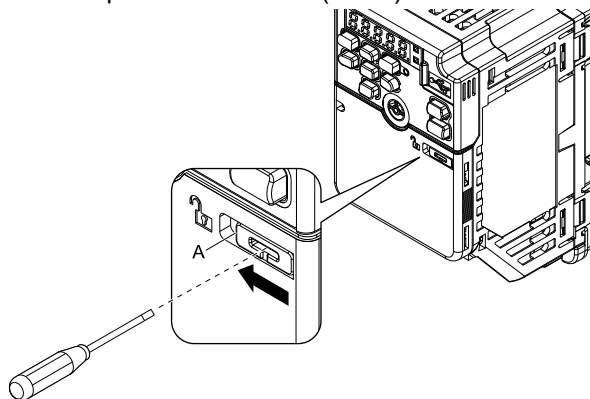

A - Front cover lock

Figure 2.7 Unlocking

2. Pull down, then pull away from the drive to remove the front cover.

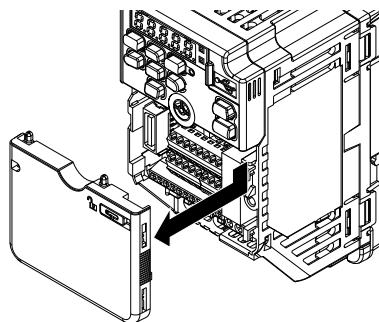

Figure 2.8 Remove the Front Cover

◆ Reattach the Front Cover

1. Reverse the steps to reattach the cover.

Note:

Make sure that you do not pinch wires or signal lines between the front cover and the drive before you reattach the cover.

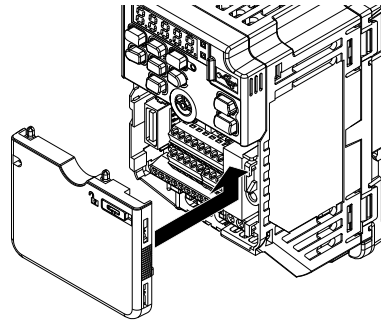
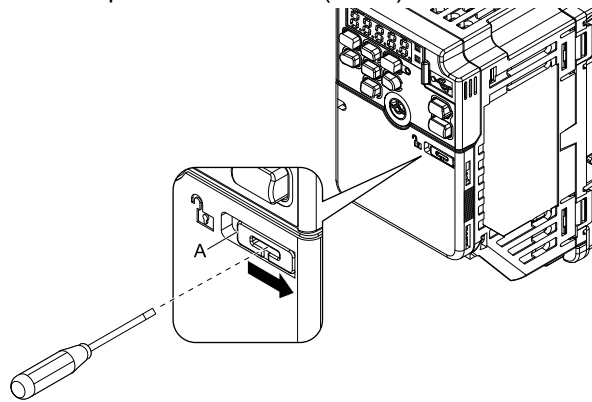

Figure 2.9 Reattach the Front Cover

2. Use a slotted screwdriver to lock the front cover of the drive.
Use a slotted screwdriver with a tip width of 2.5 mm (0.1 in) or less and a thickness of 0.4 mm (0.02 in) or less.



A - Front cover lock

Figure 2.10 Locking the Front Cover

2.7 Remove and Reattach the Keypad

◆ Remove the Keypad

Remove the front cover.

Push on the tab on the right side of the keypad, then pull the keypad forward to remove it from the drive.

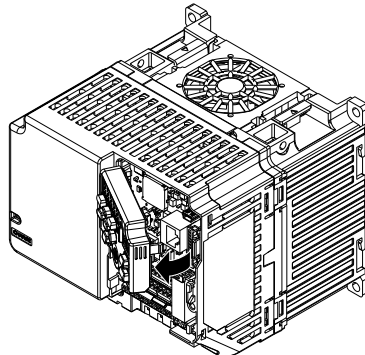

Figure 2.11 Remove the Keypad

◆ Reattach the Keypad

Push in the keypad from the front until the hooks click into place.

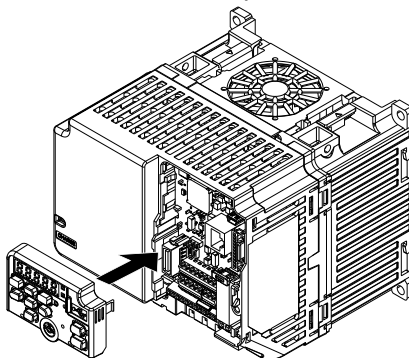

Figure 2.12 Reattach the Keypad

Attach the front cover.

2.8 Install the Keypad in a Control Panel or Another Device

◆ Operate the Keypad from a Remote Location

You can remove the keypad from the drive and connect it to a remote control extension cable 3 m (9.8 ft) long to make operation easier when you cannot access the drive. It is not necessary to open or close the panel door to operate a drive that is in a control panel. To order optional accessories, contact Yaskawa or your nearest sales representative.

Name	Option Model	Intended Use
Keypad Remote Cable	UWR0051: 1 m (3.3 ft)	To connect the keypad and drive.
	UWR0052: 3 m (9.8 ft)	This option is an RJ-45, 8-pin straight-through UTP CAT5e cable.
Installation Support Set A	900-192-933-001	To attach the keypad to the control panel. This option uses screws.
Installation Support Set B	900-192-933-002	To attach the keypad to the control panel. This option uses nut clamps. Use this option when there are weld studs in the control panel.
Keypad Panel Mounting Kit	ZPBA-GA500	To install the GA500 standard keypad to a control panel.

2.9 Installation Methods

The drive installation methods include standard installation and external heatsink installation.

◆ Standard Installation

Refer to *Drive Exterior and Mounting Dimensions on page 358* for more information about external dimensions.

◆ External Heatsink

The optional External Heatsink Installation Kit will let you install the drive with the heatsink external to the enclosure panel.

Table 2.20 shows the model number for the attachment. To order optional accessories, contact Yaskawa or your nearest sales representative.

Table 2.20 External Heatsink Installation Kit

Drive Model	Kit Model	Drive Model	Kit Model
B001	ZPSA-GA50V1-1	2056	ZPSA-GA50V6-1
B002		2070	ZPSA-GA50V7-1
B004	ZPSA-GA50V1-2	2082	
B006	ZPSA-GA50V2-2	4001	ZPSA-GA50V2-1
B010	ZPSA-GA50V2-3	4002	ZPSA-GA50V2-2
B012	ZPSA-GA50V3-1	4004	
B018	ZPSA-GA50V4-1	4005	ZPSA-GA50V2-3
2001	ZPSA-GA50V1-1	4007	
2002		4009	
2004	ZPSA-GA50V1-2	4012	ZPSA-GA50V3-1
2006	ZPSA-GA50V1-3	4018	ZPSA-GA50V5-1
2010	ZPSA-GA50V2-3	4023	
2012		ZPSA-GA50V3-1	4031
2021	ZPSA-GA50V3-1	4038	ZPSA-GA50V8-1
2030	ZPSA-GA50V5-1	4044	
2042		4060	

◆ Finless-Type Drive Installation

Refer to *Conditions on page 48* for information about the installation of finless-type drives.

2.10 Conditions

Obey the installation conditions specified in these instructions to take full advantage of the finless design of this drive.

◆ Installation Environment

The installation environment is important for the lifespan of the product and to make sure that the drive performance is correct. Make sure that the installation environment agrees with the specifications shown in [Table 2.21](#).

Table 2.21 Installation Environment

Environment	Conditions
Area of Use	Indoors
Power Supply	Overvoltage Category III (IEC60664)
Surrounding Air Temperature	-10 °C to +35 °C (14 °F to 95 °F) <ul style="list-style-type: none"> • Drive reliability is better in environments where the temperature does not increase or decrease quickly. • When you install the drive in an enclosure, use a cooling fan or air conditioner to keep the internal air temperature in the permitted range. • Do not let the drive freeze. • You can use finless-type drives at a maximum of +50 °C (122 °F) when you derate the output current. <i>*1</i>
Humidity	95%RH or less Do not let condensation form on the drive.
Storage Temperature	-20 °C to +70 °C (-4 °F to +158 °F) (short-term temperature during transportation)
Surrounding Area	Pollution degree 2 or less (IEC 60664-1) Install the drive in an area without: <ul style="list-style-type: none"> • Oil mist, corrosive or flammable gas, or dust • Metal powder, oil, water, or other unwanted materials • Radioactive or flammable materials. • Harmful gas or fluids • Salt • Direct sunlight Keep wood and other flammable materials away from the drive.
Altitude	1000 m (3281 ft) Maximum Note: Derate the output current by 1% for each 100 m (328 ft) to install the drive in altitudes between 1000 m to 4000 m (3281 ft to 13123 ft). It is not necessary to derate the rated voltage in these conditions: <ul style="list-style-type: none"> • When you install the drive at 2000 m (6562 ft) or lower • When you install the drive between 2000 m to 4000 m (6562 ft to 13123 ft) and ground the neutral point on the power supply. Contact Yaskawa or your nearest sales representative if you will not ground the neutral point.
Vibration	<ul style="list-style-type: none"> • 10 Hz to 20 Hz: 1 G (9.8 m/s², 32.15 ft/s²) • 20 Hz to 55 Hz: 0.6 G (5.9 m/s², 19.36 ft/s²)
Installation Orientation	Install the drive vertically for sufficient airflow to cool the drive.

*1 Refer to [Derating Depending on Ambient Temperature on page 55](#) for information.

NOTICE: Do not put drive peripheral devices, transformers, or other electronics near the drive. Shield the drive from electrical interference if components must be near the drive. Components near the drive can cause incorrect drive operation from electrical interference.

NOTICE: Do not let unwanted objects, for example metal shavings or wire clippings, fall into the drive during drive installation. Put a temporary cover over the drive during installation. Remove the temporary cover before start-up. Unwanted objects inside of the drive can cause damage to the drive.

◆ Heatsink Plate Temperature

CAUTION! Burn Hazard. Do not touch a hot drive heatsink or external heatsink. Yaskawa recommends that you show a high temperature warning mark or warning sign on the external heatsink. If you touch a hot drive heatsink plate or external heatsink, it can burn you.

Keep the drive heatsink plate temperature lower than the maximum temperature even when the ambient temperature is 50 °C (122 °F). Refer to [Table 2.22](#) for the maximum temperature of the heatsink plate. When you operate the drive in an ambient temperature of 35 °C (95 °F) or higher, refer to [Derating Depending on Ambient Temperature on page 55](#) and derate the drive.

Table 2.22 Maximum Temperature of the Heatsink Plate

Model	Maximum Temperature of the Heatsink Plate
B001 - B012	90 °C (194 °F)
2001 - 2021	90 °C (194 °F)
2030 - 2070	80 °C (176 °F)
4001 - 4012	90 °C (194 °F)
4018 - 4038	80 °C (176 °F)

Refer to *Single-Phase 200 V Class on page 36*, *Three-Phase 200 V Class on page 37*, and *Three-Phase 400 V Class on page 38* for the drive watt loss data.

Refer to *Monitor Heatsink Plate Temperature on page 49* to monitor drive heatsink plate temperature.

■ Monitor Heatsink Plate Temperature

- When you use the drive keypad
Set *U4-08 [Heatsink Temperature]* to show the drive heatsink temperature.



Figure 2.13 U4-08 [Heatsink Temperature] (When the heatsink plate is 89 °C)

- When you use a Multi-function Analog Monitor Output
When you use terminal AM, set the parameters as shown in [Table 2.23](#).

Table 2.23 MFAO Settings

Parameter	Name	Setting
H4-01	Terminal AM Analog Output Select	408 (<i>U4-08</i>)
H4-02	Terminal AM Analog Output Gain	100.0%
H4-03	Terminal AM Analog Output Bias	0.0%

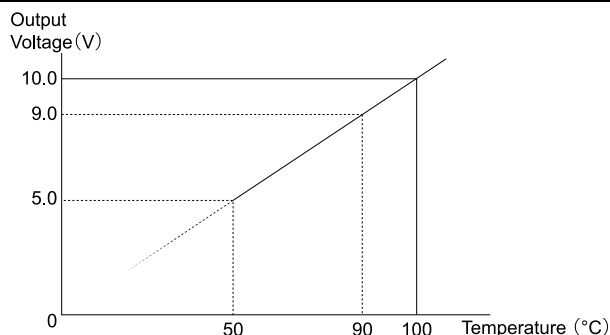

Figure 2.14 Heatsink Plate Temperature Output on MFAO

Note:

- The accuracy is ± 5 °C (41 °F) for heatsink plate temperatures between 50 °C to 100 °C (122 °F to 212 °F).
- The installation environment has an effect on the temperature.

■ Overheat Alarm Level

If the heatsink temperature is more than the temperature set in *L8-02 [Overheat Alarm Level]*, the drive detects *oH [Heatsink Overheat]*. To enable this function, set *H2-0x [MFDO Function Select]* to 20 [*Drive Overheat Pre-Alarm (oH)*].

Use *L8-03 [Overheat Alarm Level]* to set the operation when the drive detects *oH [Heatsink Overheat]*.

◆ Surface Finish of Metal Surface

Make sure that the metal surface to which you will install the drive meets these specifications:

- Flatness: ≤ 0.2 mm (0.0078 in)
- Roughness: ≤ 25 S

2.10 Conditions

Note:

A roughness of 25 S means that the average roughness "Ra" is 6.3 μm and the maximum peak "Rz" is 25 μm .

◆ Thermal Compound

The thermal compound bonds the heating and cooling elements to each other and increases thermal transfer.

Apply the thermal compound between the heatsink plate and the mating surface. The applicable thermal compound is different for different external heatsinks. When you select and apply a thermal compound, contact the thermal compound manufacturer for additional information.

Table 2.24 shows an example of thermal compound selection.

Table 2.24 Example of Thermal Compound Selection

Manufacturer	Type	Model	Application Amount (Thickness)
Shin-Etsu Chemical Co., Ltd.	Oil-based compound	X-23-7795	100 μm - 250 μm ^{*1}

*1 The thickness can change with the condition of the metal surface.

◆ Installation Position and Clearances

Use the clearances specified in Figure 2.15 to install the drive. Make sure that there is sufficient space for wiring and airflow.

Tightly push the drive heatsink plate against the metal surface (enclosure panel) for correct thermal transfer between the drive and the metal surface.

Note:

You cannot install finless-type drives side-by-side.

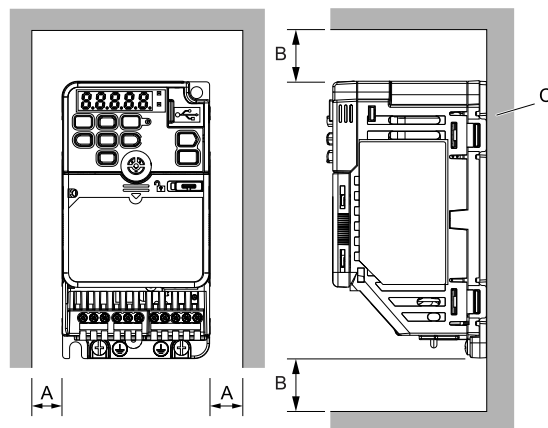

A - 30 mm (1.18 in) minimum
B - 100 mm (3.94 in) minimum

C - Metal surface (enclosure panel)

Figure 2.15 Installation Clearances

◆ Drive Watt Loss

■ Heavy Duty Rating (HD): Carrier Frequency = 2 kHz

Table 2.25 Single-Phase 200 V Class (Finless-Type Drive)

Drive Model	Rated Output Current (A)	Carrier Frequency (kHz)	Drive Watt Loss (W)		
			Interior Unit Loss	Heatsink Plate Loss (P _{Loss})	Total Loss
B001	0.8	2	7	4	11
B002	1.6	2	10	7	17
B004	3	2	13	13	26

Drive Model	Rated Output Current (A)	Carrier Frequency (kHz)	Drive Watt Loss (W)		
			Interior Unit Loss	Heatsink Plate Loss (P _{Loss})	Total Loss
B006	5	2	17	23	40
B010	8	2	30	37	67
B012	11	2	40	48	88

Table 2.26 Three-Phase 200 V Class (Finless-Type Drive)

Drive Model	Rated Output Current (A)	Carrier Frequency (kHz)	Drive Watt Loss (W)		
			Interior Unit Loss	Heatsink Plate Loss (P _{Loss})	Total Loss
2001	0.8	2	6	4	10
2002	1.6	2	7	7	14
2004	3.0	2	9	13	22
2006	5.0	2	13	22	35
2008	6.9	2	14	30	44
2010	8.0	2	17	37	54
2012	11.0	2	23	49	72
2018	14.0	2	26	61	87
2021	17.6	2	36	83	119
2030	25.0	2	46	139	185
2042	33.0	2	67	175	242
2056	47.0	2	95	284	379
2070	60.0	2	157	377	534

Table 2.27 Three-Phase 400 V Class (Finless-Type Drive)

Drive Model	Rated Output Current (A)	Carrier Frequency (kHz)	Drive Watt Loss (W)		
			Interior Unit Loss	Heatsink Plate Loss (P _{Loss})	Total Loss
4001	1.2	2	8	7	15
4002	1.8	2	10	10	20
4004	3.4	2	13	21	34
4005	4.8	2	15	29	44
4007	5.6	2	16	33	49
4009	7.3	2	21	45	66
4012	9.2	2	27	60	87
4018	14.8	2	44	105	149
4023	18	2	76	146	220
4031	24	2	62	167	229
4038	31	2	89	222	311

■ Heavy Duty Rating (HD): Carrier Frequency = Default Setting

Table 2.28 Single-Phase 200 V Class (Finless-Type Drive)

Drive Model	Rated Output Current (A)	Carrier Frequency (kHz)	Drive Watt Loss (W)		
			Interior Unit Loss	Heatsink Plate Loss (P _{Loss})	Total Loss
B001	0.8	10	8	5	13
B002	1.6	10	10	9	19
B004	3	10	14	16	30
B006	5	10	18	28	46
B010	8	8	31	42	73
B012	11	8	41	55	96

Table 2.29 Three-Phase 200 V Class (Finless-Type Drive)

Drive Model	Rated Output Current (A)	Carrier Frequency (kHz)	Drive Watt Loss (W)		
			Interior Unit Loss	Heatsink Plate Loss (P _{Loss})	Total Loss
2001	0.8	10	6	5	11
2002	1.6	10	7	8	15
2004	3.0	10	10	16	26
2006	5.0	10	14	27	41
2008	6.9	8	15	35	50
2010	8.0	8	18	43	61
2012	11.0	8	24	56	80
2018	14.0	8	30	82	112
2021	17.6	8	40	108	148
2030	25.0	8	50	163	214
2042	33.0	8	73	212	285
2056	47.0	8	108	347	455
2070	60.0	8	171	455	626

Table 2.30 Three-Phase 400 V Class (Finless-Type Drive)

Drive Model	Rated Output Current (A)	Carrier Frequency (kHz)	Drive Watt Loss (W)		
			Interior Unit Loss	Heatsink Plate Loss (P _{Loss})	Total Loss
4001	1.2	8	9	11	20
4002	1.8	8	11	16	27
4004	3.4	8	15	31	46
4005	4.8	8	18	42	60
4007	5.6	8	18	49	67
4009	7.3	8	25	65	90
4012	9.2	8	32	85	117
4018	14.8	8	52	149	201
4023	18	8	92	207	299
4031	24	8	75	240	315
4038	31	8	108	319	427

■ Normal Duty Rating (ND)

Table 2.31 Single-Phase 200 V Class (Finless-Type Drive)

Drive Model	Rated Output Current (A)	Carrier Frequency (kHz)	Drive Watt Loss (W)		
			Interior Unit Loss	Heatsink Plate Loss (P _{Loss})	Total Loss
B001	1.2	2	8	6	14
B002	1.9	2	14	11	25
B004	3.5	2	14	17	31
B006	6.0	2	17	26	43
B010	9.6	2	36	50	86
B012	12.2	2	48	60	108

Table 2.32 Three-Phase 200 V Class (Finless-Type Drive)

Drive Model	Rated Output Current (A)	Carrier Frequency (kHz)	Drive Watt Loss (W)		
			Interior Unit Loss	Heatsink Plate Loss (P _{Loss})	Total Loss
2001	1.2	2	7	5	12
2002	1.9	2	9	9	18
2004	3.5	2	11	16	27
2006	6	2	14	25	39
2008	8	2	18	37	55
2010	9.6	2	25	51	76
2012	12.2	2	30	61	91
2018	17.5	2	35	82	117
2021	21	2	52	111	163
2030	30	2	59	175	234
2042	42	2	101	250	351
2056	56	2	127	357	484
2070	70	2	202	455	657

Table 2.33 Three-Phase 400 V Class (Finless-Type Drive)

Drive Model	Rated Output Current (A)	Carrier Frequency (kHz)	Drive Watt Loss (W)		
			Interior Unit Loss	Heatsink Plate Loss (P _{Loss})	Total Loss
4001	1.2	2	8	7	15
4002	2.1	2	13	12	25
4004	4.1	2	14	24	38
4005	5.4	2	16	32	48
4007	7.1	2	20	44	64
4009	8.9	2	28	58	86
4012	11.9	2	39	83	122
4018	17.5	2	58	146	203
4023	23.4	2	81	204	286
4031	31	2	99	259	357
4038	38	2	141	319	460

◆ Screw Sizes and Tightening Torques

Table 2.34 shows the correct screw sizes and tightening torques to safety the drive to a metal surface (enclosure panel).

Table 2.34 Screw Sizes and Tightening Torques

Drive Model	Screw Size	Tightening Torque N·m (lbf·in)
B001 - B012	M5	2.0 - 2.5 (17.7 - 22.1)
2001 - 2021	M5	2.0 - 2.5 (17.7 - 22.1)
2030 - 2056	M5	2.0 - 2.5 (17.7 - 22.1)
2070	M6	4.0 - 5.0 (35.4 - 44.3)
4001 - 4012	M5	2.0 - 2.5 (17.7 - 22.1)
4018 - 4038	M5	2.0 - 2.5 (17.7 - 22.1)

NOTICE: Damage to Equipment. Tighten the screws to the specified tightening torque. Incorrect tightening torque can cause too much heat and damage to the drive.

◆ Install the Finless-Type Drive

Apply the thermal compound across the full surface of the application area on the heatsink. Tightly push the drive against the metal surface (enclosure panel).

Clean off the unwanted thermal compound from around the drive perimeter.

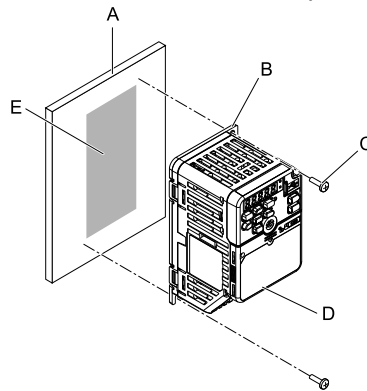

A - Metal surface (enclosure panel)
B - Heatsink Plate
C - Screws

D - Finless-type drive
E - Drive mounting area

Figure 2.16 Install the Drive

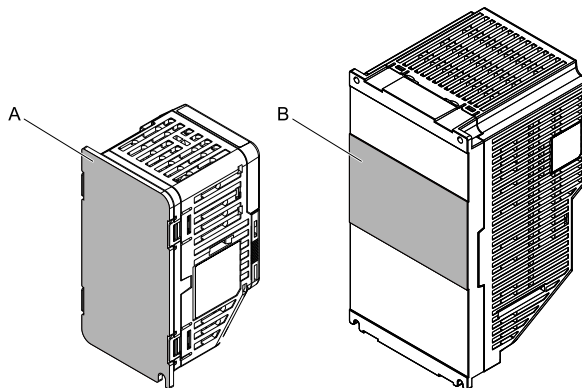

A - Application area (B001 to B012, 2001 to 2021, 4001 to 4012)

B - Application area (2030 to 2070, 4018 to 4038)

Figure 2.17 Thermal compound application area

Note:

You can mill the metal surface to be more flat and use less thermal compound. Recommended flatness is 0.05 mm (0.00197 in) or less. After you mill the metal surface, tightly push the drive against it.

◆ Derating Depending on Ambient Temperature

When you install drives in an area where ambient temperatures are higher than the rated conditions, set *L8-12 [Ambient Temperature Setting]* and *L8-35 [Installation Method Selection]*. Refer to *L8-12: Ambient Temperature Setting on page 356* and *L8-35: Installation Method Selection on page 356* for more information.

Derate the output current as specified in *Figure 2.18*.

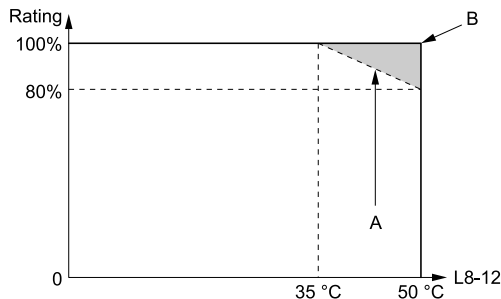

A - L8-35 = 3 [External Heatsink] (default setting)

B - L8-35 = 0 [IP20/UL Open Type] (0.5 m/s of airflow around the drive is necessary)

Figure 2.18 Derating Depending on Drive Installation Method

◆ External Heatsink Selection

This section gives information about how to select an applicable external heatsink.

■ Necessary Data for External Heatsink Selection

Symbol	Description
P_{Loss}	Drive heatsink watt loss (W) <i>*1</i>
T_{HSP_max}	Maximum heatsink plate temperature This is the temperature at the surface of the heatsink plate. Set <i>U4-08 [Heatsink Temperature]</i> to monitor the drive heatsink temperature. Maximum temperatures are different for different models. <ul style="list-style-type: none"> • B001 - B012: 90 °C (194 °F) • 2001 - 2021: 90 °C (194 °F) • 2030 - 2070: 80 °C (176 °F) • 4001 - 4012: 90 °C (194 °F) • 4018 - 4038: 80 °C (176 °F)
T_{Amb}	Ambient temperature of the external heatsink

Symbol	Description	
$R\theta_{HSP}$	Drive heatsink plate thermal resistance This value is 0.05 K/W.	
$R\theta_{HSP-EHS}$	You can use the formula to calculate thermal resistance between the drive heatsink plate and the external heatsink. $R\theta_{HSP-EHS} = \frac{d_{Comp}}{\lambda_{Comp} \cdot A_{th}}$	
	A_{th}	Heat transfer area between drive heatsink plate and external heatsink Note: Heat generation across the drive heatsink plate is not equal because of the arrangement of internal components. The effective area for thermal transfer is only 70% of the drive heatsink plate area. Use the H and W values of the drive exterior dimensions *2 to calculate the area of the drive heatsink plate.
	λ_{Comp}	Thermal conductivity of the thermal compound
	d_{Comp}	Thickness of the thermal compound (when applied)
$R\theta_{EHS}$	Thermal Resistance of the external heatsink	

*1 Refer to [Drive Watt Loss on page 50](#) for information.

*2 Refer to [Drive Exterior and Mounting Dimensions on page 358](#) for information.

External Heatsink Selection Methods

Keep the drive heatsink plate temperature lower than the maximum temperature in all ambient temperatures. Select an applicable external heatsink for your application.

Figure 2.19 shows the thermal transfer principle from the drive heatsink plate to the ambient air of the external heatsink.

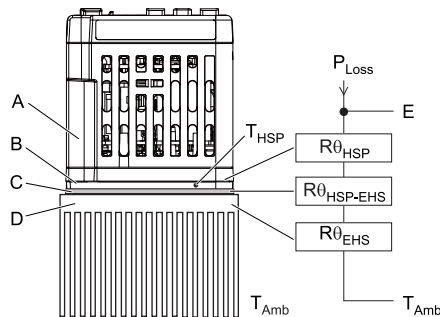

- A - Drive
- B - Heatsink Plate
- C - Thermal Compound
- D - External Heatsink
- E - Heatsink Plate Temperature

Figure 2.19 Thermal Equivalent Circuit Diagram

Select External Heatsink by Thermal Resistance

Use this formula to calculate the maximum thermal resistance $R\theta_{EHS_max}$ of the external heatsink.

$$R\theta_{EHS_max} = \left(\frac{T_{HSP_max} - T_{Amb}}{P_{Loss}} - R\theta_{HSP} - R\theta_{HSP-EHS} \right)$$

Select an external heatsink with a smaller thermal resistance than $R\theta_{EHS_max}$.

Make sure that the dimensions of the external heatsink are close to the drive dimensions (H × W). If the thermal resistance of the external heatsink is large, but the dimensions of the external heatsink are near the external dimensions of the drive, select one of these external heatsinks:

- External heatsink with more fins
- External heatsink with longer fin shape

Consider the installation environment of the drive and correct the thermal resistance $R\theta_{EHS}$ of the external heatsink. Dust and unwanted material can decrease the cooling capacity of the external heatsink.

Note:

Apply correction factors to the thermal resistance values listed in the specification of the external heatsink in these cases. For details, contact the external heatsink manufacturer.

- The heatsink height and width dimensions are much larger than the drive heatsink plate dimensions.
- You are installing multiple drives on one heatsink.

Examine Feasibility of the Selected External Heatsink

If installation conditions, for example installation space, limit your external heatsink selection, use this formula to calculate the heatsink plate temperature and examine the external heatsink:

$$T_{HSP} = P_{Loss} \cdot (R_{\theta_{HSP}} + R_{\theta_{HSP-EHS}} + R_{\theta_{EHS}}) + T_{Amb}$$

If T_{HSP} value is lower than the maximum temperature of the heatsink, you can use the selected external heatsink.

Refer to [Monitor Heatsink Plate Temperature on page 49](#) to monitor drive heatsink plate temperature.

External Heatsink Selection

These examples show an applicable heatsink selection for drive model 2006 when $C6-01 = 1$ [*Normal / Heavy Duty Selection = Normal Duty Rating*].

These are examples of calculations for the external heatsink from MIZUTANI ELECTRIC IND.CO., LTD.

- Universal Type Heat Sink EF Series, EF (98) L:150 (thermal resistance $R_{\theta_{EHS}} = 1.6$ K/W)
- Universal Type Heat Sink EK Series, EK (95) L:150 (thermal resistance $R_{\theta_{EHS}} = 1.1$ K/W)

Table 2.35 External Heatsink Selection

Symbol	Value	
P_{Loss}	25.0 W	
T_{HSP_max}	90 °C (194 °F)	
T_{Amb}	40 °C (104 °F)	
$R_{\theta_{HSP}}$	0.05 K/W	
$R_{\theta_{HSP-EHS}}$	A_{th}	H = 128 mm D = 68 mm $A_{th} = 0.7 \times 0.128 \text{ m} \times 0.068 \text{ m} = 6.1 \times 10^{-3} \text{ m}^2$
	λ_{Comp}	2.0 W/(m·K) Thermal conductivity of Oil-based compound X-23-7795 from Shin-Etsu Chemical Co., Ltd.
	d_{Comp}	100 μm Recommended compound thickness (when applied)
	$R_{\theta_{HSP-EHS}} = \frac{100 \text{ μm}}{2.0 \text{ W/(m·K)} \times 6.1 \times 10^{-3} \text{ m}^2} = 0.008 \text{ K/W}$	

Select External Heatsink by Thermal Resistance

Replace the value of [Table 2.35](#) into the formula in [Select External Heatsink by Thermal Resistance on page 56](#).

$$R_{\theta_{EHS_max}} = \left(\frac{90 \text{ °C} - 40 \text{ °C}}{25.0 \text{ W}} - 0.05 \text{ K/W} - 0.008 \text{ K/W} \right) = 1.94 \text{ K/W}$$

The thermal resistance of the external heatsink “EF(98) L: 150” is 1.6 K/W, which is sufficient. Yaskawa recommends the external heatsink “EK (95) L: 150” to prevent overheat if there is a temporary temperature increase or a decrease in the cooling capacity of the external heatsink because of dust and unwanted material.

Examine Feasibility of the Selected External Heatsink

The thermal resistance of the external heatsink “EF (98) L: 150” is 1.6 K/W. You can use the formula to calculate the heatsink plate temperature:

$$T_{HSP} = 25.0 \text{ W} \cdot (0.05 \text{ K/W} + 0.008 \text{ K/W} + 1.6 \text{ K/W}) + 40 \text{ °C} = 81.45 \text{ °C}$$

The temperature of the heatsink plate is lower than the maximum value of 90 °C, which is sufficient. Because the thermal transfer area is 70% of the drive mounting area, and the environmental conditions can change because dust and unwanted material can decrease the cooling capacity of the external heatsink, Yaskawa recommends “EK (95) L: 150” heatsink to achieve $R_{\theta_{EHS}} = 1.1$ K/W ($T_{HSP} = 68.95$ °C).

Electrical Installation

This chapter gives how to wire the control circuit terminals, motor, and power supply of the drive.

3.1	Section Safety	60
3.2	Electrical Installation	63
3.3	Main Circuit Wiring	66
3.4	Main Circuit Terminal Block Wiring Procedure	87
3.5	Control Circuit Wiring	91
3.6	Control I/O Connections	101
3.7	Connect the Drive to a PC	104
3.8	External Interlock	105
3.9	Braking Resistor Installation.....	106
3.10	Drive Wiring Protection	108
3.11	Dynamic Braking Option, Motor Protection	109
3.12	Improve the Power Factor	111
3.13	Prevent Switching Surge.....	112
3.14	Decrease Noise	113
3.15	Factory-Recommended Branch Circuit Protection for UL Listing	115
3.16	Wiring Checklist	117
3.17	Motor Application Precautions	119

3.1 Section Safety

⚠ DANGER

Electrical Shock Hazard

Do not examine, connect, or disconnect wiring on an energized drive. Before servicing, disconnect all power to the equipment and wait for the time specified on the warning label at a minimum. The internal capacitor stays charged after the drive is de-energized. The charge indicator LED extinguishes when the DC bus voltage decreases below 50 Vdc. When all indicators are OFF, measure for dangerous voltages to make sure that the drive is safe.

If you do work on the drive when it is energized, it will cause serious injury or death from electrical shock.

⚠ WARNING

Electrical Shock Hazard

Do not operate the drive when covers are missing. Replace covers and shields before you operate the drive. Use the drive only as specified by the instructions.

Some figures in this section include drives without covers or safety shields to more clearly show the inside of the drive. If covers or safety shields are missing from the drive, it can cause serious injury or death.

Ground the neutral point on the power supply of drive models BxxxE, 2xxxE, and 4xxxE to comply with the EMC Directive before you turn on the EMC filter or if there is high resistance grounding.

If you turn ON the EMC filter, but you do not ground the neutral point, it can cause serious injury or death.

Make sure that the protective ground wire complies with technical standards and local safety regulations. The EN 61800-5-1:2007 standard specifies that you must wire the power supply to automatically de-energize when the protective ground wire disconnects. If you turn on the internal EMC filter, the leakage current of the drive will be more than 3.5 mA. Use these closed-loop crimp terminals or equivalent to connect a protective ground wire that has a minimum cross-sectional area of 10 mm² (copper wire).

- 8-4NS from JST Mfg. Co., Ltd.
- R8-4S from NICHIFU Co., Ltd.
- P10-8R from PANDUIT Corp.

If you do not obey the standards and regulations, it can cause serious injury or death.

When there is a DC component in the protective earthing conductor, the drive can cause a residual current. When a residual current operated protective or monitoring device prevents direct or indirect contact, always use a type B Ground Fault Circuit Interrupter (GFCI) as specified by IEC/EN 60755.

If you do not use the correct GFCI, it can cause serious injury or death.

Do not wear loose clothing or jewelry when you do work on the drive. Tighten loose clothing and remove all metal objects, for example watches or rings.

Loose clothing can catch on the drive and jewelry can conduct electricity and cause serious injury or death.

Do not remove covers or touch circuit boards while the drive is energized.

If you touch the internal components of an energized drive, it can cause serious injury or death.

Only let approved personnel install, wire, maintain, examine, replace parts, and repair the drive.

If personnel are not approved, it can cause serious injury or death.

Do not modify the drive body or drive circuitry.

Modifications to drive body and circuitry can cause serious injury or death, will cause damage to the drive, and will void the warranty. Yaskawa is not responsible for modifications of the product made by the user.

Fire Hazard

Tighten all terminal screws to the correct tightening torque.

Connections that are too loose or too tight can cause incorrect operation and damage to the drive. Incorrect connections can also cause death or serious injury from fire.

⚠ WARNING

Tighten screws at an angle in the specified range shown in this manual.

If you tighten the screws at an angle not in the specified range, you can have loose connections that can cause damage to the terminal block or start a fire and cause serious injury or death.

Damage to Equipment

Do not apply incorrect voltage to the main circuit of the drive. Operate the drive in the specified range of the input voltage on the drive nameplate.

Voltages that are higher than the permitted nameplate tolerance can cause damage to the drive.

Fire Hazard

When you install a dynamic braking option, wire the components as specified by the wiring diagrams.

Incorrect wiring can cause damage to braking components or serious injury or death.

NOTICE

Do not let unwanted objects, for example metal shavings or wire clippings, fall into the drive during drive installation. Put a temporary cover over the drive during installation. Remove the temporary cover before start-up.

Unwanted objects inside of the drive can cause damage to the drive.

Damage to Equipment

When you touch the drive and circuit boards, make sure that you observe correct electrostatic discharge (ESD) procedures.

If you do not follow procedures, it can cause ESD damage to the drive circuitry.

Select a motor that is compatible with the load torque and speed range. When 100% continuous torque is necessary at low speed, use an inverter-duty motor or vector-duty motor. When you use a standard fan-cooled motor, decrease the motor torque in the low-speed range.

If you operate a standard fan-cooled motor at low speed and high torque, it will decrease the cooling effects and can cause heat damage.

Obey the speed range specification of the motor as specified by the manufacturer. When you must operate the motor outside of its specifications, contact the motor manufacturer.

If you continuously operate oil-lubricated motors outside of the manufacturer specifications, it can cause damage to the motor bearings.

When the input voltage is 440 V or higher or the wiring distance is longer than 100 m (328 ft), make sure that the motor insulation voltage is sufficient or use an inverter-duty motor or vector-duty motor with reinforced insulation.

Motor winding and insulation failure can occur.

Before you connect a dynamic braking option to the drive, make sure that qualified personnel read and obey the Braking Unit and Braking Resistor Unit Installation Manual (TOBPC72060001).

If you do not read and obey the manual or if personnel are not qualified, it can cause damage to the drive and braking circuit.

Make sure that all connections are correct after you install the drive and connect peripheral devices.

Incorrect connections can cause damage to the drive.

3.1 Section Safety

Note:

- Torque characteristics are different than when you operate the motor directly from line power. Make sure that you understand the load torque characteristics for the application.
- The rated input current of submersible motors is higher than the rated input current of standard motors. Carefully select the correct drive capacity. When the distance between the motor and drive is long, use a wire that can connect the motor to the drive without a reduction in motor torque.
- Do not use unshielded wire for control wiring. Use shielded, twisted-pair wires and ground the shield to the ground terminal of the drive. Unshielded wire can cause electrical interference and unsatisfactory system performance.

3.2 Electrical Installation

DANGER! *Electrical Shock Hazard. Do not examine, connect, or disconnect wiring on an energized drive. Before servicing, disconnect all power to the equipment and wait for the time specified on the warning label at a minimum. The internal capacitor stays charged after the drive is de-energized. The charge indicator LED extinguishes when the DC bus voltage decreases below 50 Vdc. When all indicators are OFF, measure for dangerous voltages to make sure that the drive is safe. If you do work on the drive when it is energized, it will cause serious injury or death from electrical shock.*

WARNING! *Electrical Shock Hazard. De-energize the drive and wait 5 minutes minimum until the Charge LED turns off. Remove the front cover and terminal cover to do work on wiring, circuit boards, and other parts. Use terminals for their correct function only. Incorrect wiring, incorrect ground connections, and incorrect repair of protective covers can cause death or serious injury.*

WARNING! *Electrical Shock Hazard. Correctly ground the drive before you turn on the EMC filter switch. If you touch electrical equipment that is not grounded, it can cause serious injury or death.*

WARNING! *Electrical Shock Hazard. Use the terminals for the drive only for their intended purpose. Refer to the technical manual for more information about the I/O terminals. Wiring and grounding incorrectly or modifying the cover may damage the equipment or cause injury.*

◆ Standard Connection Diagram

Wire the drive as specified by [Figure 3.1](#).

WARNING! *Sudden Movement Hazard. Set the MFDI parameters before you close control circuit switches. Incorrect Run/Stop circuit sequence settings can cause serious injury or death from moving equipment.*

WARNING! *Sudden Movement Hazard. Correctly wire the start/stop and safety circuits before you energize the drive. If you momentarily close a digital input terminal, it can start a drive that is programmed for 3-Wire control and cause serious injury or death from moving equipment.*

WARNING! *Sudden Movement Hazard. When you use a 3-Wire sequence, set A1-03 = 3330 [Initialize Parameters = 3-Wire Initialization] and make sure that b1-17 = 0 [Run Command at Power Up = Disregard Existing RUN Command] (default). If you do not correctly set the drive parameters for 3-Wire operation before you energize the drive, the motor can suddenly rotate when you energize the drive.*

WARNING! *Sudden Movement Hazard. Check the I/O signals and the external sequences for the drive before you set the Application Preset function. When you set the Application Preset function (A1-06 ≠ 0), it changes the I/O terminal functions for the drive and it can cause equipment to operate unusually. This can cause serious injury or death.*

NOTICE: *Fire Hazard. Install sufficient branch circuit short circuit protection as specified by applicable codes and this manual. The drive is suitable for circuits that supply not more than 31,000 RMS symmetrical amperes, 240 Vac maximum (200 V Class), 480 Vac maximum (400 V Class). Incorrect branch circuit short circuit protection can cause serious injury or death.*

NOTICE: *When the input voltage is 440 V or higher or the wiring distance is longer than 100 m (328 ft), make sure that the motor insulation voltage is sufficient or use an inverter-duty motor or vector-duty motor with reinforced insulation. Motor winding and insulation failure can occur.*

Note:

Do not connect the AC control circuit ground to the drive enclosure. Failure to obey can cause incorrect control circuit operation.

3.2 Electrical Installation

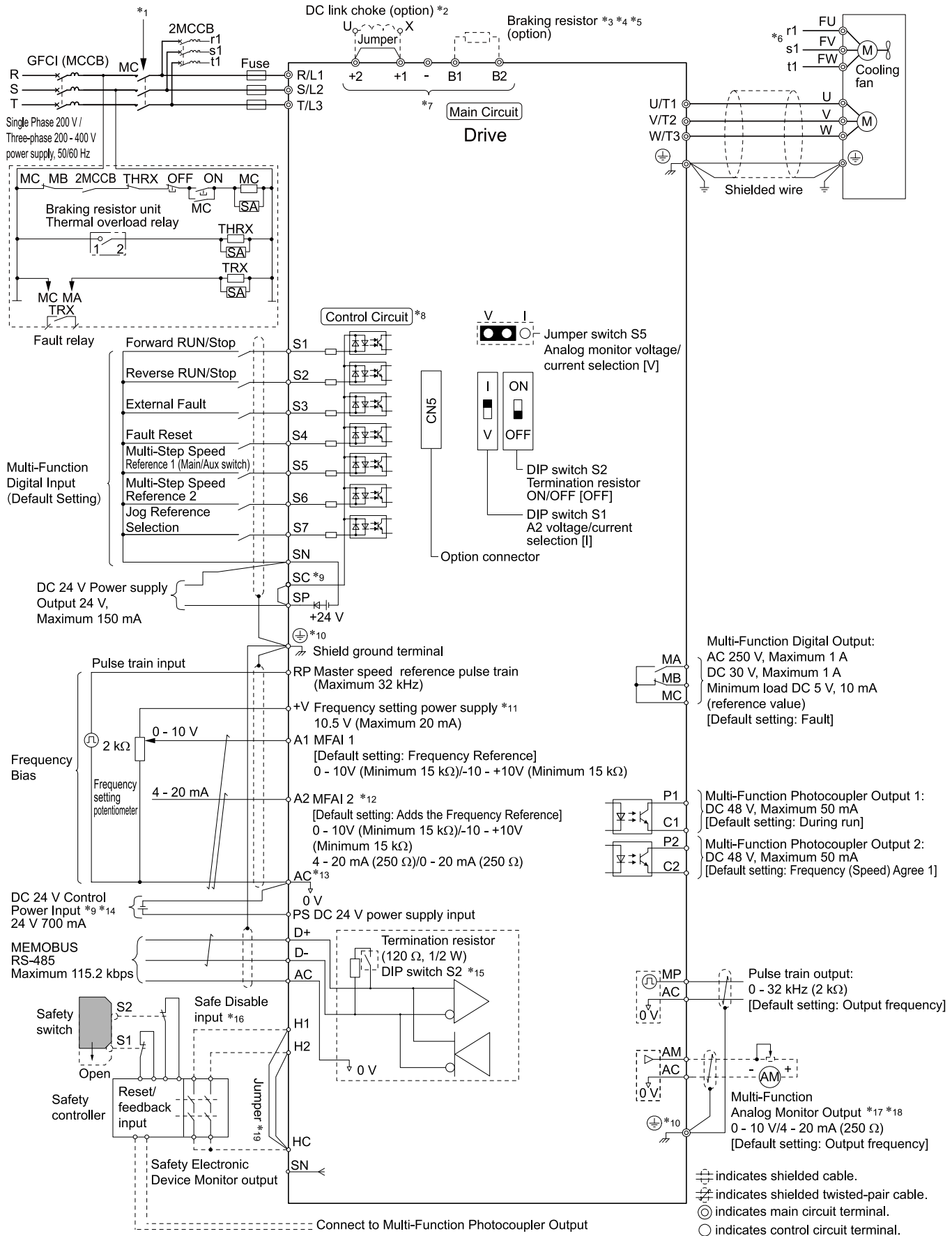

Figure 3.1 Standard Drive Connection Diagram

- *1 Set the wiring sequence to de-energize the drive with the MFDO. If the drive outputs a fault during fault restart when you use the fault restart function, set $L5-02 = 1$ [*Fault Contact at Restart Select = Always Active*] to de-energize the drive. Be careful when you use a cut-off sequence. The default setting for $L5-02$ is 0 [*Active Only when Not Restarting*].
- *2 When you install a DC link choke, you must remove the jumper between terminals +1 and +2.
- *3 When you use a regenerative converter or regenerative unit, set $L8-55 = 0$ [*Internal DB Transistor Protection = Disable*]. If $L8-55 = 1$ [*Protection Enabled*], the drive will detect rF [*Braking Resistor Fault*].
- *4 When you use a regenerative converter, regenerative unit, braking resistor, or braking resistor unit, set $L3-04 = 0$ [*Stall Prevention during Decel = Disabled*]. If $L3-04 = 1$ [*General Purpose*], the drive could possibly not stop in the specified deceleration time.
- *5 When you use an ERF-type braking resistor, set $L8-01 = 1$ [*3% ERF DB Resistor Protection = Enabled*] and set a wiring sequence to de-energize the drive with the MFDO.
- *6 Cooling fan wiring is not necessary for self-cooling motors.
- *7 Connect peripheral options to terminals -, +1, +2, B1, and B2.
- WARNING! Fire Hazard.** Only connect factory-recommended devices or circuits to drive terminals B1, B2, -, +1, and +2. Do not connect an AC power supply lines to these terminals. Incorrect wiring can cause damage to the drive and serious injury or death from fire.
- *8 Connect a 24 V power supply to terminals PS-AC to operate the control circuit while the main circuit power supply is OFF.
- *9 To set the MFDI power supply (Sinking/Sourcing Mode or internal/external power supply), install or remove a jumper between terminals SC-SP or SC-SN depending on the application.
- NOTICE: Damage to Equipment.** Do not close the circuit between terminals SP-SN. If you close the circuits between terminals SC-SP and terminals SC-SN at the same time, it will cause damage to the drive.
- Sinking Mode, Internal power supply: Install the jumper to close the circuit between terminals SC-SP.
NOTICE: Damage to Equipment. Do not close the circuit between terminals SC-SN. If you close the circuits between terminals SC-SP and terminals SC-SN at the same time, it will cause damage to the drive.
 - Sourcing Mode, Internal power supply: Install the jumper to close the circuit between terminals SC-SN.
NOTICE: Damage to Equipment. Do not close the circuit between terminals SC-SP. If you close the circuits between terminals SC-SP and terminals SC-SN at the same time, it will cause damage to the drive.
 - External power supply: Remove the jumper from the MFDI terminals. It is not necessary to close the circuit between terminals SC-SP and terminals SC-SN.
- *10 **WARNING! Electrical Shock Hazard.** When you connect the shield wire of the control circuit wiring to the protective ground terminal, do not connect the protective ground wire. If you connect the shield wire and the protective ground wire to the protective grounding terminal, it may not comply with the technical standards and local safety regulations and can cause serious injury or death.
- *11 The maximum output current capacity for terminal +V on the control circuit is 20 mA.
NOTICE: Damage to Equipment. Do not install a jumper between terminals +V and AC. A closed circuit between these terminals will cause damage to the drive.
- *12 DIP switch S1 sets terminal A2 for voltage or current input. The default setting for S1 is current input (“I” side).
- *13 Do not ground the control circuit terminals AC or connect them to the drive chassis.
NOTICE: Do not ground the AC control circuit terminals and only connect the AC terminals according to the product instructions. If you connect the AC terminals incorrectly, it can cause damage to the drive.
- *14 Connect the positive lead from an external 24 Vdc power supply to terminal PS and the negative lead to terminal AC.
NOTICE: Connect terminals PS and AC correctly for the 24 V power supply. If you connect the wires to the incorrect terminals, it will cause damage to the drive.
- *15 Set DIP switch S2 to “ON” to enable the termination resistor in the last drive in a MEMOBUS/Modbus network.
- *16 Use only Sourcing Mode for Safe Disable input.
- *17 Use multi-function analog monitor outputs with analog frequency meters, ammeters, voltmeters, and wattmeters. Do not use monitor outputs with feedback-type signal devices.
- *18 Jumper S5 sets terminal AM for voltage or current output. The default setting for S5 is voltage output (“V” side).
- *19 Disconnect the wire jumpers between H1 and HC and H2 and HC to use the Safe Disable input.

3.3 Main Circuit Wiring

This section gives information about the functions, specifications, and procedures necessary to safely and correctly wire the main circuit in the drive.

NOTICE: Damage to Equipment. Do not energize and de-energize the drive more frequently than one time each 30 minutes. If you frequently energize and de-energize the drive, it can cause drive failure.

Note:

Soldered wire connections can become loose over time and cause unsatisfactory drive performance.

◆ Motor and Main Circuit Connections

WARNING! Electrical Shock Hazard. Do not connect terminals R/L1, S/L2, T/L3, L/L1, N/L2, U/T1, V/T2, W/T3, -, +1, +2, B1, or B2 to the ground terminal. If you connect these terminals to earth ground, it can cause damage to the drive or serious injury or death.

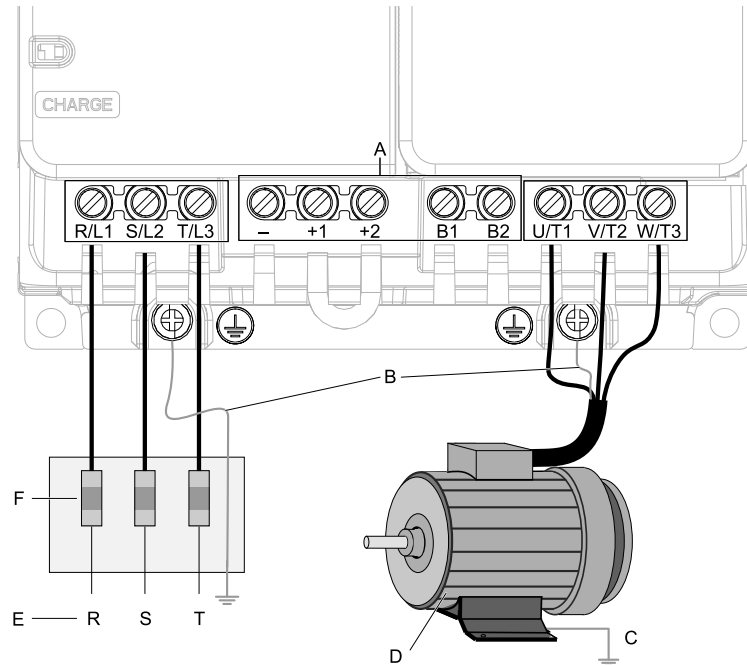

Note:

The locations of terminals are different for different drive models.

A - DC bus terminal

B - Connect to the drive ground terminal.

C - Ground the motor case.

D - Three-Phase Motor

E - Use terminals R/L1, S/L2, and T/L3 for three-phase power supply input. Use terminals L/L1 and N/L2 for single-phase power supply input.

F - Input Protection (Fuses or Circuit Breakers)

Figure 3.2 Wiring the Main Circuit and Motor

◆ Configuration of Main Circuit Terminal Block

Use [Table 3.1](#) to find the correct main circuit terminal block figure for your drive.

Table 3.1 Configuration of Main Circuit Terminal Block

Model	Figure	
	No internal EMC filter	Built-in EMC Filter
B001 - B004	Figure 3.3	Figure 3.4
2001 - 2006	Figure 3.5	Figure 3.6
B006, B010	Figure 3.7	Figure 3.8
2012, 4001 - 4009	Figure 3.9	Figure 3.10

Model	Figure	
	No internal EMC filter	Built-in EMC Filter
B012	Figure 3.11	Figure 3.12
4012	Figure 3.13	Figure 3.14
B018	Figure 3.15	-
2030, 2042, 4018, 4023	Figure 3.16	Figure 3.17
2056, 4031, 4038	Figure 3.18	Figure 3.19
2070, 2082	Figure 3.20	Figure 3.21
4044, 4060	Figure 3.22	Figure 3.23

■ Configuration of Main Circuit Terminal Block

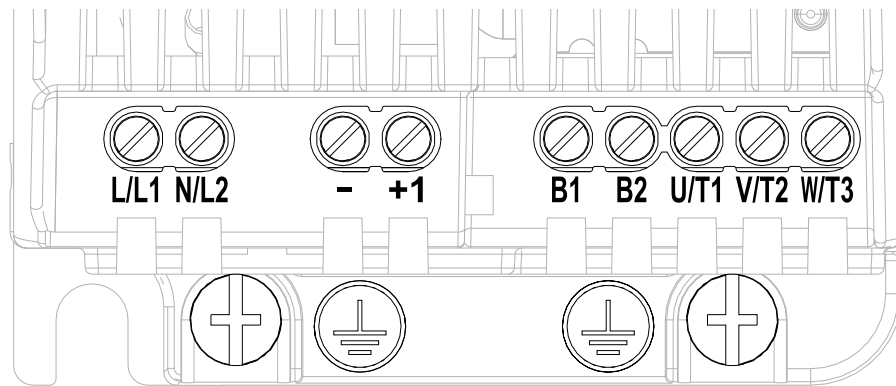

Figure 3.3 Configuration of Main Circuit Terminal Block (Single-Phase, Without a Built-in EMC Filter)

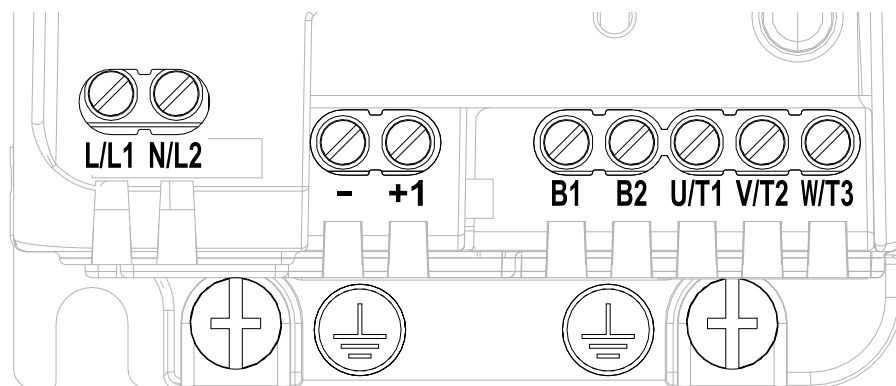

Figure 3.4 Configuration of Main Circuit Terminal Block (Single-Phase, With a Built-in EMC Filter)

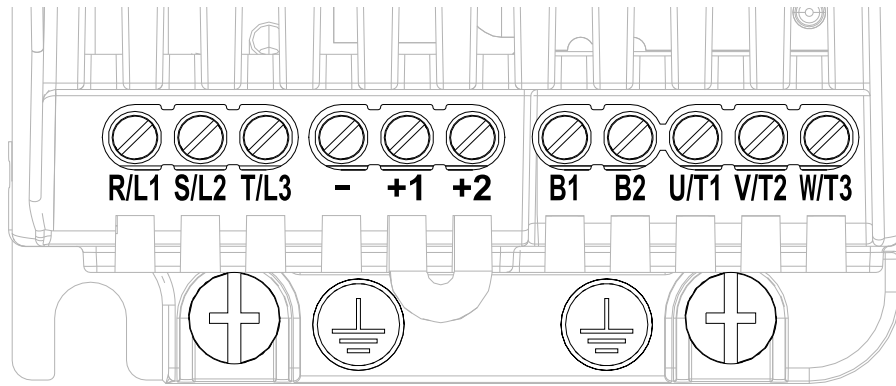

Figure 3.5 Configuration of Main Circuit Terminal Block (Three-Phase, Without a Built-in EMC Filter)

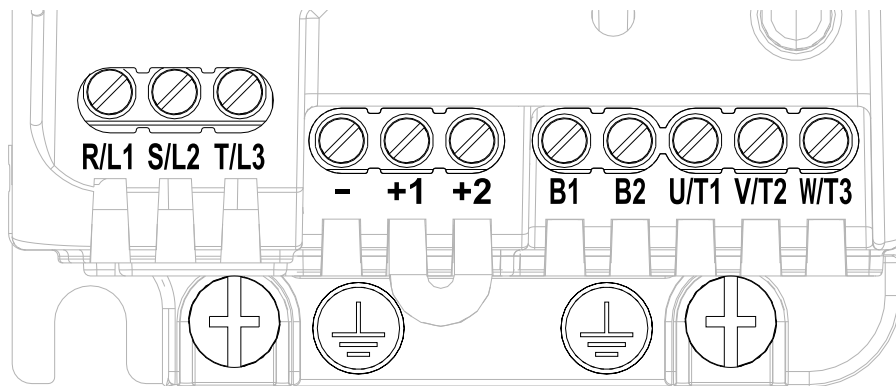

Figure 3.6 Configuration of Main Circuit Terminal Block (Three-Phase, With a Built-in EMC Filter)

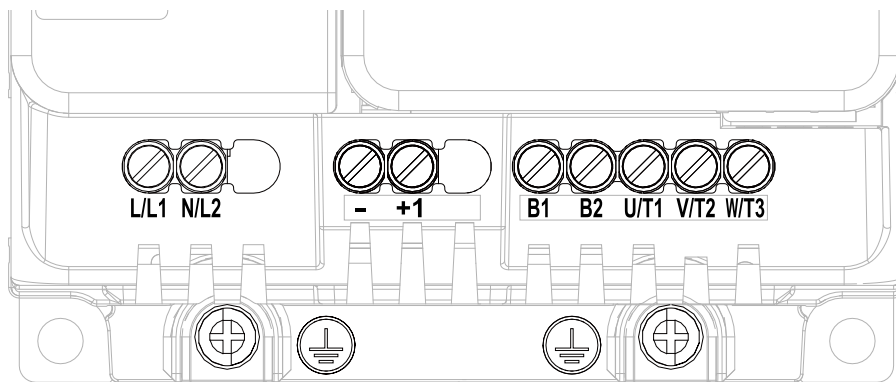

Figure 3.7 Configuration of Main Circuit Terminal Block (Single-Phase, Without a Built-in EMC Filter)

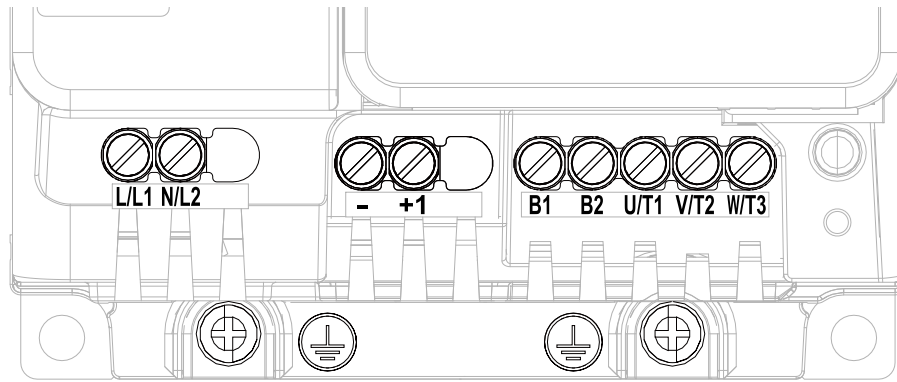

Figure 3.8 Configuration of Main Circuit Terminal Block (Single-Phase, With a Built-in EMC Filter)

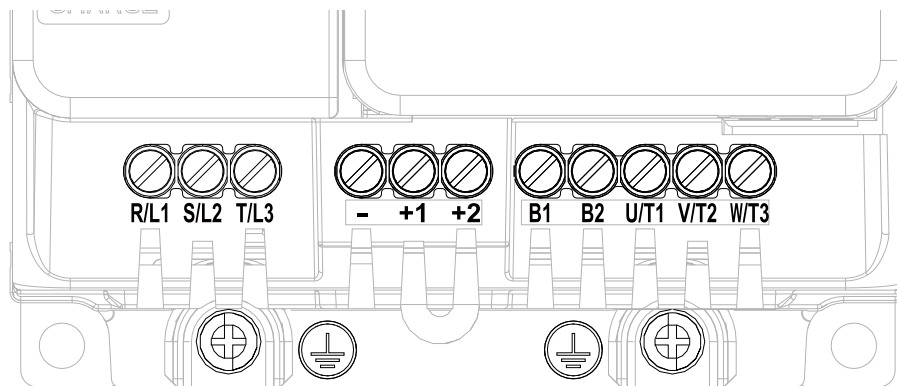

Figure 3.9 Configuration of Main Circuit Terminal Block (Three-Phase, Without a Built-in EMC Filter)

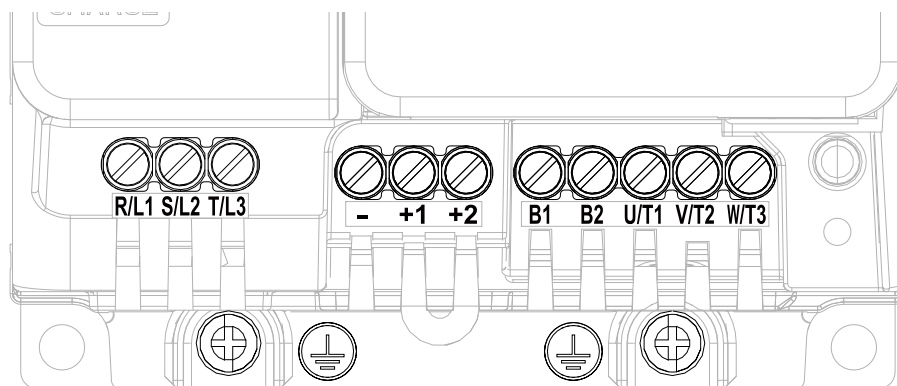

Figure 3.10 Configuration of Main Circuit Terminal Block (Three-Phase, With a Built-in EMC Filter)

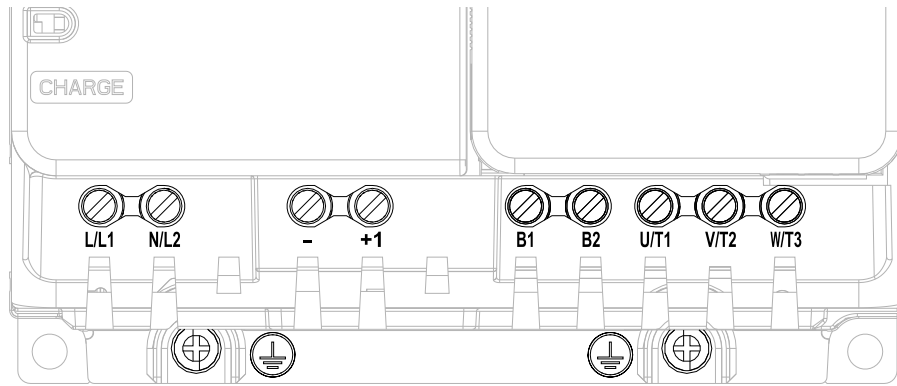

Figure 3.11 Configuration of Main Circuit Terminal Block (Single-Phase, Without a Built-in EMC Filter)

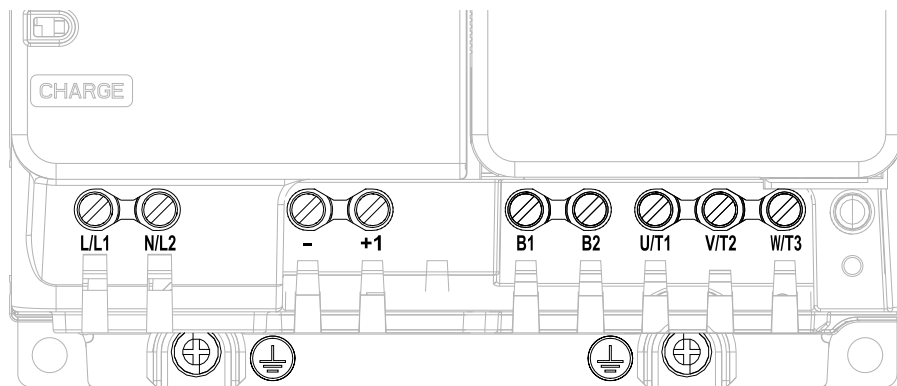

Figure 3.12 Configuration of Main Circuit Terminal Block (Single-Phase, With a Built-in EMC Filter)

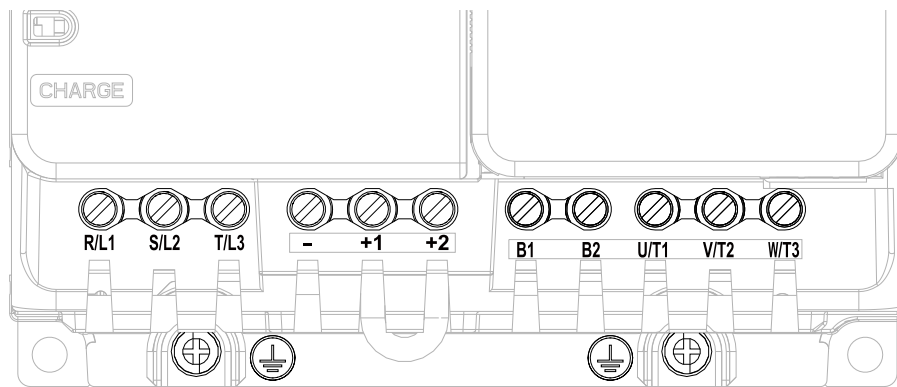

Figure 3.13 Configuration of Main Circuit Terminal Block (Three-Phase, Without a Built-in EMC Filter)

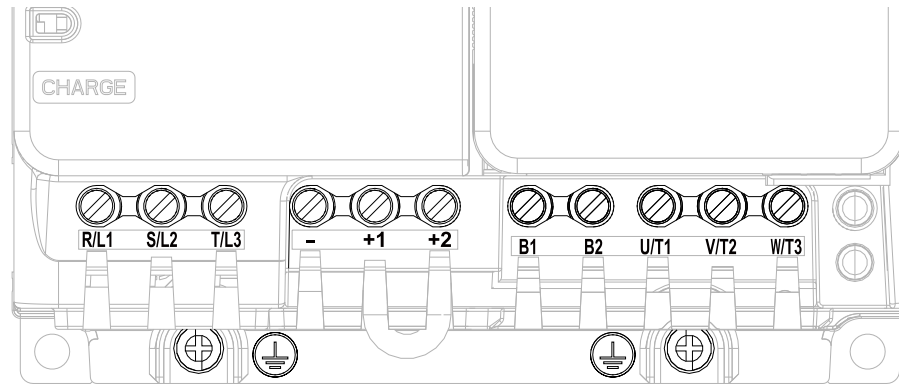

Figure 3.14 Configuration of Main Circuit Terminal Block (Three-Phase, With a Built-in EMC Filter)

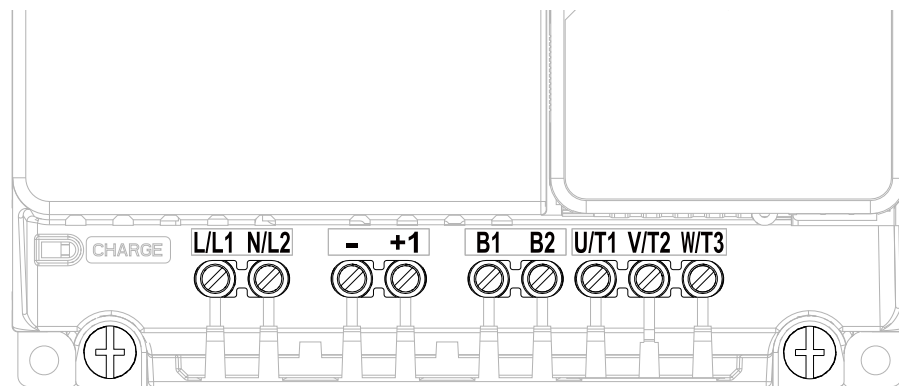

Figure 3.15 Configuration of Main Circuit Terminal Block (Single-Phase, Without a Built-in EMC Filter)

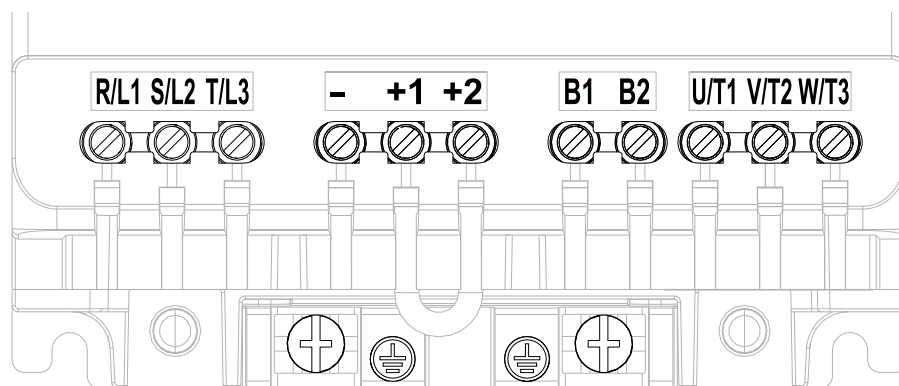

Figure 3.16 Configuration of Main Circuit Terminal Block (Three-Phase, Without a Built-in EMC Filter)

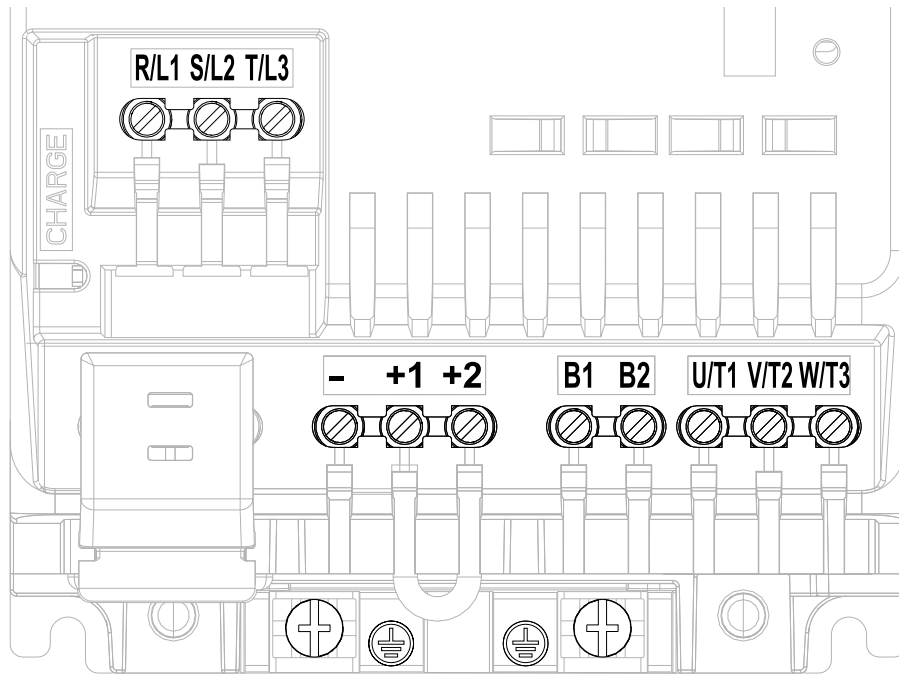

Figure 3.17 Configuration of Main Circuit Terminal Block (Three-Phase, With a Built-in EMC Filter)

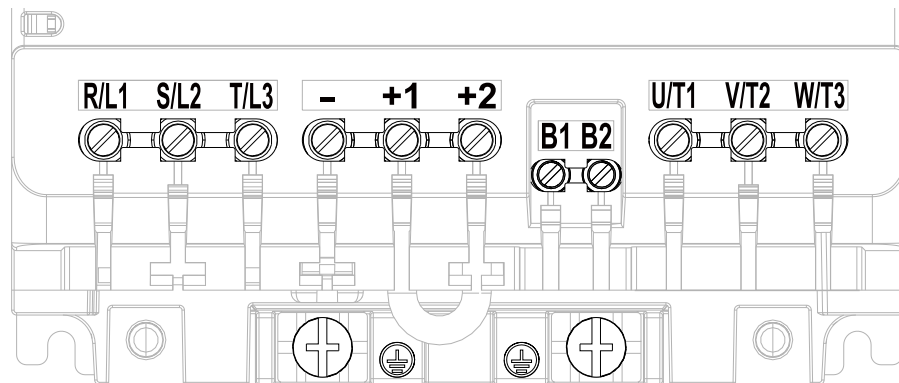

Figure 3.18 Configuration of Main Circuit Terminal Block (Three-Phase, Without a Built-in EMC Filter)

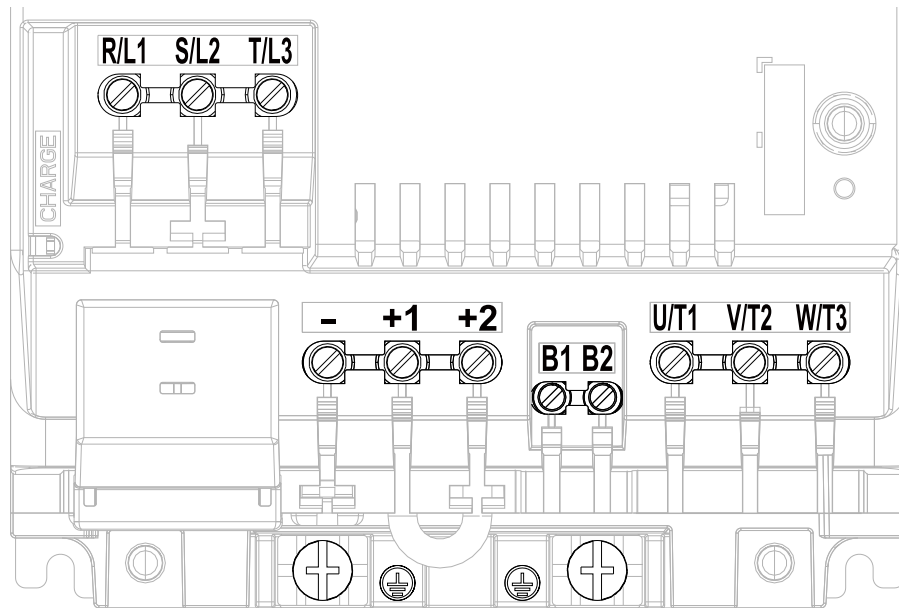

Figure 3.19 Configuration of Main Circuit Terminal Block (Three-Phase, With a Built-in EMC Filter)

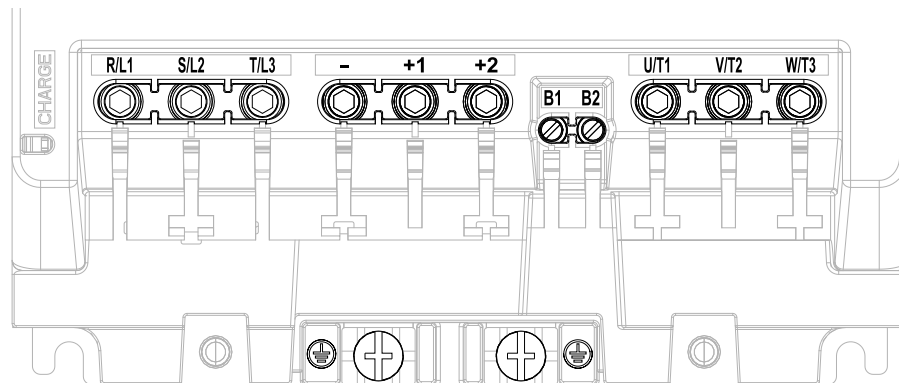

Figure 3.20 Configuration of Main Circuit Terminal Block (Three-Phase, Without a Built-in EMC Filter)

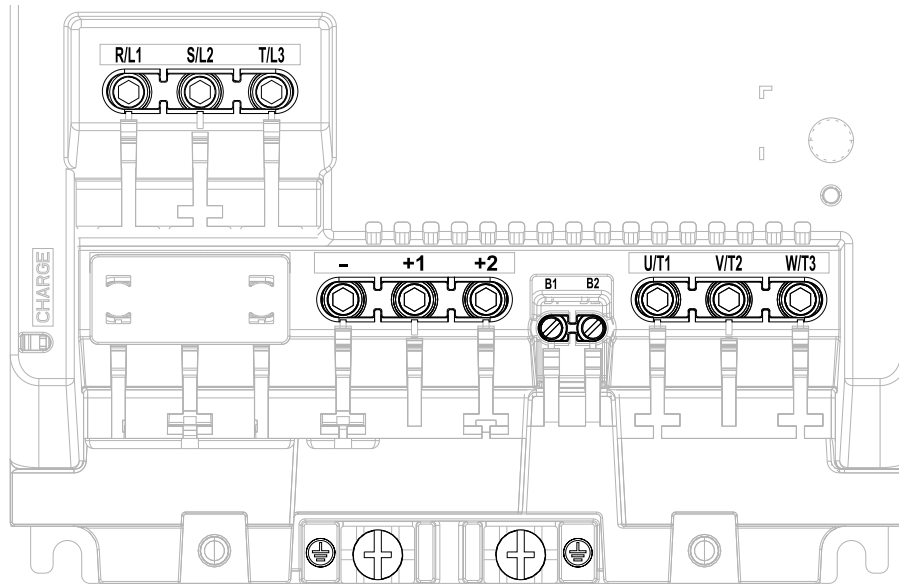

Figure 3.21 Configuration of Main Circuit Terminal Block (Three-Phase, With a Built-in EMC Filter)

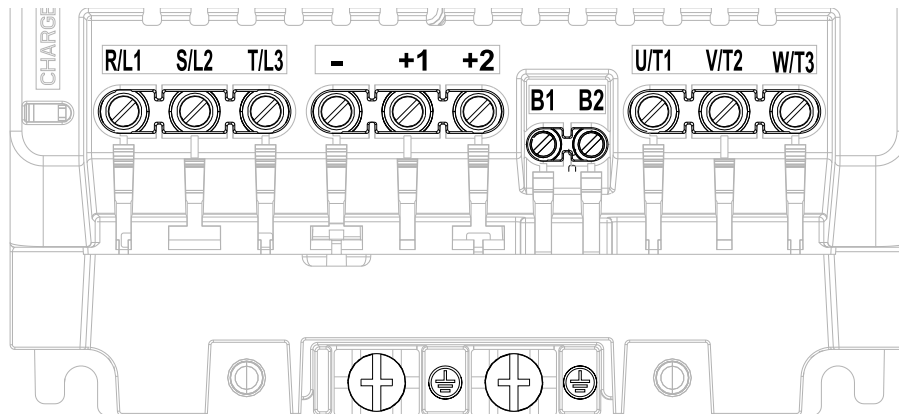

Figure 3.22 Configuration of Main Circuit Terminal Block (Three-Phase, Without a Built-in EMC Filter)

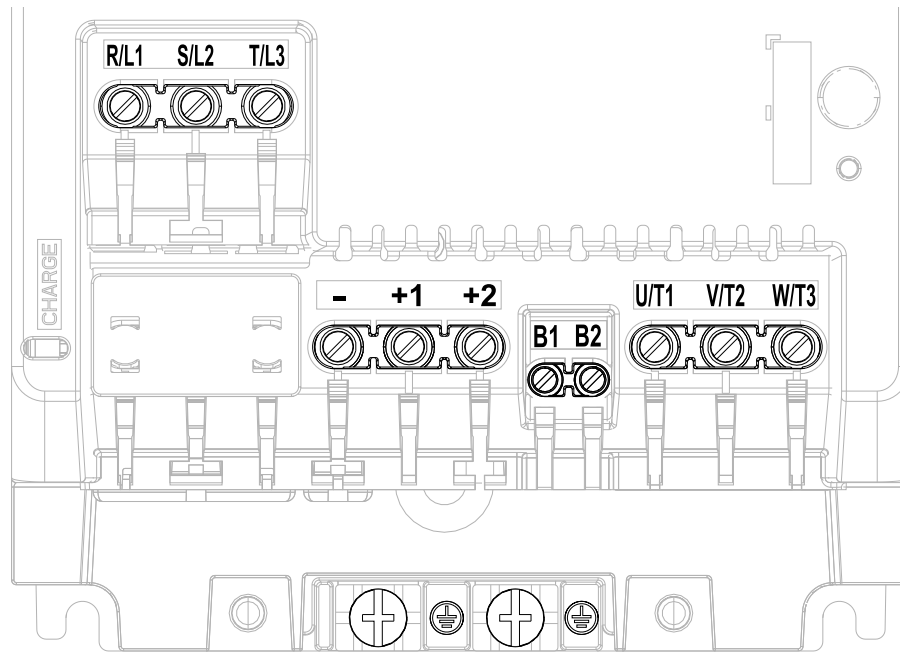

Figure 3.23 Configuration of Main Circuit Terminal Block (Three-Phase, With a Built-in EMC Filter)

◆ Main Circuit Terminal Functions

Refer to [Table 3.2](#) for the functions of drive main circuit terminals.

Table 3.2 Main Circuit Terminal Functions

Terminal	Name		Function
	Model		
	B001 - B018	2001 - 2082	
		4001 - 4060	
R/L1	-	Main circuit power supply input	To connect a commercial power supply.
S/L2			
T/L3			
L/L1	Main circuit power supply input	-	
N/L2			
U/T1	Drive output	Drive output	To connect a motor.
V/T2			
W/T3			
-	DC power input	DC power input	+1 and +2: To connect a DC link choke. Note: Remove the jumper between terminals +1 and +2 to connect a DC link choke.
+1			
+2		-	
B1	Braking resistor connection		To connect a braking resistor or braking resistor unit.
B2			
⊕	Ground Wiring		To ground the drive. • 200 V: D class grounding (ground to 100 Ω or less) • 400 V: C class grounding (ground to 10 Ω or less)

◆ Wire Selection

Select the correct wires for main circuit wiring.

3.3 Main Circuit Wiring

Refer to *Main Circuit Wire Gauges and Tightening Torques on page 170* for wire gauges and tightening torques as specified by European standards.

Refer to *Main Circuit Wire Gauges and Tightening Torques on page 190* for wire gauges and tightening torques as specified by UL standards.

■ Wire Gauge and Torque Specifications for UL Listing

WARNING! Electrical Shock Hazard.

Make sure that the protective ground wire complies with technical standards and local safety regulations. The EN 61800-5-1:2007 standard specifies that you must wire the power supply to automatically de-energize when the protective ground wire disconnects. If you turn on the internal EMC filter, the leakage current of the drive will be more than 3.5 mA. Use these closed-loop crimp terminals or equivalent to connect a protective ground wire that has a minimum cross-sectional area of 10 mm² (copper wire).

- 8-4NS from JST Mfg. Co., Ltd.
- R8-4S from NICHIFU Co., Ltd.
- P10-8R from PANDUIT Corp.

If you do not obey the standards and regulations, it can cause serious injury or death.

Note:

- The recommended wire gauges are based on drive continuous current ratings with 75 °C (167 °F) 600 V class 2 heat-resistant indoor PVC wire. Assume these conditions:
 - Ambient temperature: 40 °C (104 °F) maximum
 - Wiring distance: 100 m (3281 ft) maximum
 - Normal Duty rated current value
- Use terminals +1, +2, -, B1, and B2 to connect peripheral options, for example a DC reactor or a braking resistor. Do not connect other items to these terminals.
- Refer to the instruction manual for each device for recommended wire gauges to connect peripheral devices or options to terminals +1, +2, -, B1, and B2. Contact Yaskawa or your nearest sales representative if the recommended wire gauges for the peripheral devices or options are out of the range of the applicable gauges for the drive.
- When you use crimp ferrules on the wire ends, contact Yaskawa or your nearest sales representative.

Single-Phase 200 V Class

Model	Terminal	Recomm. Gauge AWG, kcmil	Applicable Gauge AWG, kcmil	Wire Stripping Length ^{*/} mm	Terminal Screw Size and Shape	Tightening Torque N·m (lbf·in)
B001	L/L1, N/L2	14	14	6.5	M3 ⊖	0.5 - 0.6 (4.4 - 5.3)
	U/T1, V/T2, W/T3	14	14	6.5	M3 ⊖	0.5 - 0.6 (4.4 - 5.3)
	-, +1	14	14	6.5	M3 ⊖	0.5 - 0.6 (4.4 - 5.3)
	B1, B2	14	14	6.5	M3 ⊖	0.5 - 0.6 (4.4 - 5.3)
	⊕	14 *2	14 *2	-	M3.5 ⊕	0.8 - 1.0 (7.1 - 8.9)
B002	L/L1, N/L2	14	14	6.5	M3 ⊖	0.5 - 0.6 (4.4 - 5.3)
	U/T1, V/T2, W/T3	14	14	6.5	M3 ⊖	0.5 - 0.6 (4.4 - 5.3)
	-, +1	14	14	6.5	M3 ⊖	0.5 - 0.6 (4.4 - 5.3)
	B1, B2	14	14	6.5	M3 ⊖	0.5 - 0.6 (4.4 - 5.3)
	⊕	14 *2	14 *2	-	M3.5 ⊕	0.8 - 1.0 (7.1 - 8.9)

Model	Terminal	Recomm. Gauge AWG, kcmil	Applicable Gauge AWG, kcmil	Wire Stripping Length ^{*1} mm	Terminal Screw Size and Shape	Tightening Torque N·m (lbf·in)
B004	L/L1, N/L2	14	14	6.5	M3 ⊖	0.5 - 0.6 (4.4 - 5.3)
	U/T1, V/T2, W/T3	14	14	6.5	M3 ⊖	0.5 - 0.6 (4.4 - 5.3)
	-, +1	14	14	6.5	M3 ⊖	0.5 - 0.6 (4.4 - 5.3)
	B1, B2	14	14	6.5	M3 ⊖	0.5 - 0.6 (4.4 - 5.3)
	⊕	14 *2	14 *2	-	M3.5 ⊕	0.8 - 1.0 (7.1 - 8.9)
B006	L/L1, N/L2	12	14 - 10	8	M3 ⊖	0.5 - 0.6 (4.4 - 5.3)
	U/T1, V/T2, W/T3	14	14 - 12	8	M3 ⊖	0.5 - 0.6 (4.4 - 5.3)
	-, +1	12	14 - 10	8	M3 ⊖	0.5 - 0.6 (4.4 - 5.3)
	B1, B2	14	14 - 12	8	M3 ⊖	0.5 - 0.6 (4.4 - 5.3)
	⊕	10 *2	14 - 10 *2	-	M4 ⊕	1.2 - 1.5 (10.6 - 13.3)
B010	L/L1, N/L2	10	12 - 10	8	M3 ⊖	0.5 - 0.6 (4.4 - 5.3)
	U/T1, V/T2, W/T3	14	14 - 12	8	M3 ⊖	0.5 - 0.6 (4.4 - 5.3)
	-, +1	10	12 - 10	8	M3 ⊖	0.5 - 0.6 (4.4 - 5.3)
	B1, B2	14	14 - 12	8	M3 ⊖	0.5 - 0.6 (4.4 - 5.3)
	⊕	10 *2	14 - 10 *2	-	M4 ⊕	1.2 - 1.5 (10.6 - 13.3)
B012	L/L1, N/L2	8	14 - 8	10	M4 ⊖	1.5 - 1.7 (13.5 - 15)
	U/T1, V/T2, W/T3	12	14 - 10	10	M4 ⊖	1.5 - 1.7 (13.5 - 15)
	-, +1	8	14 - 8	10	M4 ⊖	1.5 - 1.7 (13.5 - 15)
	B1, B2	14	14 - 12	10	M4 ⊖	1.5 - 1.7 (13.5 - 15)
	⊕	10 *2	14 - 10 *2	-	M4 ⊕	1.2 - 1.5 (10.6 - 13.3)
B018	L/L1, N/L2	8	12 - 6	10	M4 ⊖	1.5 - 1.7 (13.5 - 15)
	U/T1, V/T2, W/T3	10	14 - 8	10	M4 ⊖	1.5 - 1.7 (13.5 - 15)
	-, +1	8	12 - 6	10	M4 ⊖	1.5 - 1.7 (13.5 - 15)
	B1, B2	14	14 - 12	10	M4 ⊖	1.5 - 1.7 (13.5 - 15)
	⊕	8 *2	12 - 8 *2	-	M5 ⊕	2.0 - 2.5 (17.7 - 22.1)

























*1 Remove insulation from the ends of wires to expose the length of wire shown.

3.3 Main Circuit Wiring

*2 If you turn on the internal EMC filter, the leakage current of the drive will be more than 3.5 mA. Use these closed-loop crimp terminals or equivalent to connect a protective ground wire that has a minimum cross-sectional area of 10 mm² (copper wire).

- 8-4NS from JST Mfg. Co., Ltd.
- R8-4S from NICHIFU Co.,Ltd.
- P10-8R from PANDUIT Corp.

Three-Phase 200 V Class

Model	Terminal	Recomm. Gauge AWG, kcmil	Applicable Gauge AWG, kcmil	Wire Stripping Length ^{*1} mm	Terminal Screw Size and Shape	Tightening Torque N·m (lbf·in)
2001	R/L1, S/L2, T/L3	14	14	6.5	M3 	0.5 - 0.6 (4.4 - 5.3)
	U/T1, V/T2, W/T3	14	14	6.5	M3 	0.5 - 0.6 (4.4 - 5.3)
	-, +1, +2	14	14	6.5	M3 	0.5 - 0.6 (4.4 - 5.3)
	B1, B2	14	14	6.5	M3 	0.5 - 0.6 (4.4 - 5.3)
		14 *2	14 *2	-	M3.5 	0.8 - 1.0 (7.1 - 8.9)
2002	R/L1, S/L2, T/L3	14	14	6.5	M3 	0.5 - 0.6 (4.4 - 5.3)
	U/T1, V/T2, W/T3	14	14	6.5	M3 	0.5 - 0.6 (4.4 - 5.3)
	-, +1, +2	14	14	6.5	M3 	0.5 - 0.6 (4.4 - 5.3)
	B1, B2	14	14	6.5	M3 	0.5 - 0.6 (4.4 - 5.3)
		14 *2	14 *2	-	M3.5 	0.8 - 1.0 (7.1 - 8.9)
2004	R/L1, S/L2, T/L3	14	14	6.5	M3 	0.5 - 0.6 (4.4 - 5.3)
	U/T1, V/T2, W/T3	14	14	6.5	M3 	0.5 - 0.6 (4.4 - 5.3)
	-, +1, +2	14	14	6.5	M3 	0.5 - 0.6 (4.4 - 5.3)
	B1, B2	14	14	6.5	M3 	0.5 - 0.6 (4.4 - 5.3)
		14 *2	14 *2	-	M3.5 	0.8 - 1.0 (7.1 - 8.9)
2006	R/L1, S/L2, T/L3	14	14	6.5	M3 	0.5 - 0.6 (4.4 - 5.3)
	U/T1, V/T2, W/T3	14	14	6.5	M3 	0.5 - 0.6 (4.4 - 5.3)
	-, +1, +2	14	14	6.5	M3 	0.5 - 0.6 (4.4 - 5.3)
	B1, B2	14	14	6.5	M3 	0.5 - 0.6 (4.4 - 5.3)
		14 *2	14 *2	-	M3.5 	0.8 - 1.0 (7.1 - 8.9)

Model	Terminal	Recomm. Gauge AWG, kcmil	Applicable Gauge AWG, kcmil	Wire Stripping Length ^{*7} mm	Terminal Screw Size and Shape	Tightening Torque N·m (lbf·in)
2010	R/L1, S/L2, T/L3	14	14 - 12	8	M3 ⊖	0.5 - 0.6 (4.4 - 5.3)
	U/T1, V/T2, W/T3	14	14 - 12	8	M3 ⊖	0.5 - 0.6 (4.4 - 5.3)
	-, +1, +2	12	14 - 10	8	M3 ⊖	0.5 - 0.6 (4.4 - 5.3)
	B1, B2	14	14 - 12	8	M3 ⊖	0.5 - 0.6 (4.4 - 5.3)
	⊕	10 *2	14 - 10 *2	-	M4 ⊕	1.2 - 1.5 (10.6 - 13.3)
2012	R/L1, S/L2, T/L3	12	14 - 10	8	M3 ⊖	0.5 - 0.6 (4.4 - 5.3)
	U/T1, V/T2, W/T3	12	14 - 10	8	M3 ⊖	0.5 - 0.6 (4.4 - 5.3)
	-, +1, +2	10	12 - 10	8	M3 ⊖	0.5 - 0.6 (4.4 - 5.3)
	B1, B2	14	14 - 12	8	M3 ⊖	0.5 - 0.6 (4.4 - 5.3)
	⊕	10 *2	14 - 10 *2	-	M4 ⊕	1.2 - 1.5 (10.6 - 13.3)
2021	R/L1, S/L2, T/L3	8	14 - 8	10	M4 ⊖	1.5 - 1.7 (13.5 - 15)
	U/T1, V/T2, W/T3	10	14 - 8	10	M4 ⊖	1.5 - 1.7 (13.5 - 15)
	-, +1, +2	8	14 - 8	10	M4 ⊖	1.5 - 1.7 (13.5 - 15)
	B1, B2	14	14 - 10	10	M4 ⊖	1.5 - 1.7 (13.5 - 15)
	⊕	8	14 - 8	-	M4 ⊕	1.2 - 1.5 (10.6 - 13.3)
2030	R/L1, S/L2, T/L3	8	12 - 6	10	M4 ⊖	1.5 - 1.7 (13.5 - 15)
	U/T1, V/T2, W/T3	8	12 - 6	10	M4 ⊖	1.5 - 1.7 (13.5 - 15)
	-, +1, +2	6	12 - 6	10	M4 ⊖	1.5 - 1.7 (13.5 - 15)
	B1, B2	12	12 - 8	10	M4 ⊖	1.5 - 1.7 (13.5 - 15)
	⊕	8	10 - 6	-	M5 ⊕	2.0 - 2.5 (17.7 - 22.1)
2042	R/L1, S/L2, T/L3	6	12 - 6	10	M4 ⊖	1.5 - 1.7 (13.5 - 15)
	U/T1, V/T2, W/T3	6	12 - 6	10	M4 ⊖	1.5 - 1.7 (13.5 - 15)
	-, +1, +2	4	10 - 2	18	M5 ⊖	• ≤ AWG 10 2.3 - 2.5 (19.8 - 22) • AWG 8 ≤ 4.1 - 4.5 (36 - 40)
	B1, B2	10	14 - 6	10	M4 ⊖	1.5 - 1.7 (13.5 - 15)
	⊕	6	10 - 6	-	M5 ⊕	2.0 - 2.5 (17.7 - 22.1)

3.3 Main Circuit Wiring

Model	Terminal	Recomm. Gauge AWG, kcmil	Applicable Gauge AWG, kcmil	Wire Stripping Length ^{*1} mm	Terminal Screw Size and Shape	Tightening Torque N·m (lbf·in)
2056	R/L1, S/L2, T/L3	4	10 - 2	18	M5	4.1 - 4.5 (36 - 40)
	U/T1, V/T2, W/T3	4	10 - 2	18	M5	<ul style="list-style-type: none"> • ≤ AWG 10 2.3 - 2.5 (19.8 - 22) • AWG 8 ≤ 4.1 - 4.5 (36 - 40)
	-, +1, +2	2	8 - 2	18	M5	4.1 - 4.5 (36 - 40)
	B1, B2	8	12 - 6	10	M4	1.5 - 1.7 (13.5 - 15)
		6	8 - 4	-	M6	5.4 - 6.0 (47.8 - 53.1)
2070	R/L1, S/L2, T/L3	2	6 - 1	20	M6	5 - 5.5 (45 - 49)
	U/T1, V/T2, W/T3	2	8 - 1	20	M6	5 - 5.5 (45 - 49)
	-, +1, +2	1	6 - 1/0	20	M6	5 - 5.5 (45 - 49)
	B1, B2	8	12 - 6	10	M4	1.5 - 1.7 (13.5 - 15)
		4	6 - 4	-	M6	5.4 - 6.0 (47.8 - 53.1)
2082	R/L1, S/L2, T/L3	1	6 - 1/0	20	M6	5 - 5.5 (45 - 49)
	U/T1, V/T2, W/T3	2	6 - 1	20	M6	5 - 5.5 (45 - 49)
	-, +1, +2	2/0	2 - 2/0	20	M6	5 - 5.5 (45 - 49)
	B1, B2	6	10 - 6	10	M4	1.5 - 1.7 (13.5 - 15)
		4	6 - 4	-	M6	5.4 - 6.0 (47.8 - 53.1)

*1 Remove insulation from the ends of wires to expose the length of wire shown.

*2 If you turn on the internal EMC filter, the leakage current of the drive will be more than 3.5 mA. Use these closed-loop crimp terminals or equivalent to connect a protective ground wire that has a minimum cross-sectional area of 10 mm² (copper wire).

- 8-4NS from JST Mfg. Co., Ltd.
- R8-4S from NICHIFU Co., Ltd.
- P10-8R from PANDUIT Corp.

*1 Remove insulation from the ends of wires to expose the length of wire shown.

*2

Three-Phase 400 V Class

Model	Terminal	Recomm. Gauge AWG, kcmil	Applicable Gauge AWG, kcmil	Wire Stripping Length ^{*/} mm	Terminal Screw Size and Shape	Tightening Torque N·m (lbf·in)
4001	R/L1, S/L2, T/L3	14	14 - 12	8	M3 ⊖	0.5 - 0.6 (4.4 - 5.3)
	U/T1, V/T2, W/T3	14	14 - 12	8	M3 ⊖	0.5 - 0.6 (4.4 - 5.3)
	-, +1, +2	14	14 - 12	8	M3 ⊖	0.5 - 0.6 (4.4 - 5.3)
	B1, B2	14	14 - 12	8	M3 ⊖	0.5 - 0.6 (4.4 - 5.3)
	⊕	14 *2	14 - 10 *2	-	M4 ⊕	1.2 - 1.5 (10.6 - 13.3)
4002	R/L1, S/L2, T/L3	14	14 - 12	8	M3 ⊖	0.5 - 0.6 (4.4 - 5.3)
	U/T1, V/T2, W/T3	14	14 - 12	8	M3 ⊖	0.5 - 0.6 (4.4 - 5.3)
	-, +1, +2	14	14 - 12	8	M3 ⊖	0.5 - 0.6 (4.4 - 5.3)
	B1, B2	14	14 - 12	8	M3 ⊖	0.5 - 0.6 (4.4 - 5.3)
	⊕	14 *2	14 - 10 *2	-	M4 ⊕	1.2 - 1.5 (10.6 - 13.3)
4004	R/L1, S/L2, T/L3	14	14 - 12	8	M3 ⊖	0.5 - 0.6 (4.4 - 5.3)
	U/T1, V/T2, W/T3	14	14 - 12	8	M3 ⊖	0.5 - 0.6 (4.4 - 5.3)
	-, +1, +2	14	14 - 12	8	M3 ⊖	0.5 - 0.6 (4.4 - 5.3)
	B1, B2	14	14 - 12	8	M3 ⊖	0.5 - 0.6 (4.4 - 5.3)
	⊕	10 *2	14 - 10 *2	-	M4 ⊕	1.2 - 1.5 (10.6 - 13.3)
4005	R/L1, S/L2, T/L3	14	14 - 12	8	M3 ⊖	0.5 - 0.6 (4.4 - 5.3)
	U/T1, V/T2, W/T3	14	14 - 12	8	M3 ⊖	0.5 - 0.6 (4.4 - 5.3)
	-, +1, +2	14	14 - 12	8	M3 ⊖	0.5 - 0.6 (4.4 - 5.3)
	B1, B2	14	14 - 12	8	M3 ⊖	0.5 - 0.6 (4.4 - 5.3)
	⊕	10 *2	14 - 10 *2	-	M4 ⊕	1.2 - 1.5 (10.6 - 13.3)
4007	R/L1, S/L2, T/L3	14	14 - 12	8	M3 ⊖	0.5 - 0.6 (4.4 - 5.3)
	U/T1, V/T2, W/T3	14	14 - 12	8	M3 ⊖	0.5 - 0.6 (4.4 - 5.3)
	-, +1, +2	14	14 - 12	8	M3 ⊖	0.5 - 0.6 (4.4 - 5.3)
	B1, B2	14	14 - 12	8	M3 ⊖	0.5 - 0.6 (4.4 - 5.3)
	⊕	10 *2	14 - 10 *2	-	M4 ⊕	1.2 - 1.5 (10.6 - 13.3)

3.3 Main Circuit Wiring

Model	Terminal	Recomm. Gauge AWG, kcmil	Applicable Gauge AWG, kcmil	Wire Stripping Length ^{*/} mm	Terminal Screw Size and Shape	Tightening Torque N·m (lbf·in)
4009	R/L1, S/L2, T/L3	14	14 - 12	8	M3 ⊖	0.5 - 0.6 (4.4 - 5.3)
	U/T1, V/T2, W/T3	14	14 - 12	8	M3 ⊖	0.5 - 0.6 (4.4 - 5.3)
	-, +1, +2	14	14 - 12	8	M3 ⊖	0.5 - 0.6 (4.4 - 5.3)
	B1, B2	14	14 - 12	8	M3 ⊖	0.5 - 0.6 (4.4 - 5.3)
	⊕	10 *2	14 - 10 *2	-	M4 ⊕	1.2 - 1.5 (10.6 - 13.3)
4012	R/L1, S/L2, T/L3	12	14 - 10	10	M4 ⊖	1.5 - 1.7 (13.5 - 15)
	U/T1, V/T2, W/T3	14	14 - 12	10	M4 ⊖	1.5 - 1.7 (13.5 - 15)
	-, +1, +2	10	12 - 8	10	M4 ⊖	1.5 - 1.7 (13.5 - 15)
	B1, B2	14	14 - 12	10	M4 ⊖	1.5 - 1.7 (13.5 - 15)
	⊕	10 *2	14 - 10 *2	-	M4 ⊕	1.2 - 1.5 (10.6 - 13.3)
4018	R/L1, S/L2, T/L3	10	12 - 8	10	M4 ⊖	1.5 - 1.7 (13.5 - 15)
	U/T1, V/T2, W/T3	10	12 - 8	10	M4 ⊖	1.5 - 1.7 (13.5 - 15)
	-, +1, +2	10	14 - 8	10	M4 ⊖	1.5 - 1.7 (13.5 - 15)
	B1, B2	14	14 - 12	10	M4 ⊖	1.5 - 1.7 (13.5 - 15)
	⊕	10 *2	14 - 6 *2	-	M5 ⊕	2.0 - 2.5 (17.7 - 22.1)
4023	R/L1, S/L2, T/L3	8	14 - 6	10	M4 ⊖	1.5 - 1.7 (13.5 - 15)
	U/T1, V/T2, W/T3	10	14 - 8	10	M4 ⊖	1.5 - 1.7 (13.5 - 15)
	-, +1, +2	8	12 - 6	10	M4 ⊖	1.5 - 1.7 (13.5 - 15)
	B1, B2	12	14 - 10	10	M4 ⊖	1.5 - 1.7 (13.5 - 15)
	⊕	10 *2	10 - 6 *2	-	M5 ⊕	2.0 - 2.5 (17.7 - 22.1)
4031	R/L1, S/L2, T/L3	8	12 - 6	10	M4 ⊖	1.5 - 1.7 (13.5 - 15)
	U/T1, V/T2, W/T3	8	12 - 6	10	M4 ⊖	1.5 - 1.7 (13.5 - 15)
	-, +1, +2	6	12 - 4	18	M5 ⊖	• ≤ AWG 10 2.3 - 2.5 (19.8 - 22) • AWG 8 ≤ 4.1 - 4.5 (36 - 40)
	B1, B2	10	12 - 8	10	M4 ⊖	1.5 - 1.7 (13.5 - 15)
	⊕	8	10 - 6	-	M6 ⊕	5.4 - 6.0 (47.8 - 53.1)

Model	Terminal	Recomm. Gauge AWG, kcmil	Applicable Gauge AWG, kcmil	Wire Stripping Length ^{*1} mm	Terminal Screw Size and Shape	Tightening Torque N·m (lbf·in)
4038	R/L1, S/L2, T/L3	6	12 - 6	10	M4 ⊖	1.5 - 1.7 (13.5 - 15)
	U/T1, V/T2, W/T3	8	12 - 6	10	M4 ⊖	1.5 - 1.7 (13.5 - 15)
	-, +1, +2	4	10 - 2	18	M5 ⊖	<ul style="list-style-type: none"> ≤ AWG 10 2.3 - 2.5 (19.8 - 22) AWG 8 ≤ 4.1 - 4.5 (36 - 40)
	B1, B2	10	14 - 6	10	M4 ⊖	1.5 - 1.7 (13.5 - 15)
	⊕	6	10 - 6	-	M6 ⊕	5.4 - 6.0 (47.8 - 53.1)
4044	R/L1, S/L2, T/L3	4	10 - 2	18	M5 ⊖	<ul style="list-style-type: none"> ≤ AWG 10 2.3 - 2.5 (19.8 - 22) AWG 8 ≤ 4.1 - 4.5 (36 - 40)
	U/T1, V/T2, W/T3	6	12 - 4	18	M5 ⊖	<ul style="list-style-type: none"> ≤ AWG 10 2.3 - 2.5 (19.8 - 22) AWG 8 ≤ 4.1 - 4.5 (36 - 40)
	-, +1, +2	2	8 - 2	18	M5 ⊖	4.1 - 4.5 (36 - 40)
	B1, B2	8	12 - 6	10	M4 ⊖	1.5 - 1.7 (13.5 - 15)
	⊕	6	10 - 6	-	M6 ⊕	5.4 - 6.0 (47.8 - 53.1)
4060	R/L1, S/L2, T/L3	2	8 - 2	18	M5 ⊖	4.1 - 4.5 (36 - 40)
	U/T1, V/T2, W/T3	4	10 - 2	18	M5 ⊖	<ul style="list-style-type: none"> ≤ AWG 10 2.3 - 2.5 (19.8 - 22) AWG 8 ≤ 4.1 - 4.5 (36 - 40)
	-, +1, +2	2	6 - 2	18	M5 ⊖	4.1 - 4.5 (36 - 40)
	B1, B2	8	12 - 6	10	M4 ⊖	1.5 - 1.7 (13.5 - 15)
	⊕	6	10 - 6	-	M6 ⊕	5.4 - 6.0 (47.8 - 53.1)

*1 Remove insulation from the ends of wires to expose the length of wire shown.

*2 If you turn on the internal EMC filter, the leakage current of the drive will be more than 3.5 mA. Use these closed-loop crimp terminals or equivalent to connect a protective ground wire that has a minimum cross-sectional area of 10 mm² (copper wire).

- 8-4NS from JST Mfg. Co., Ltd.
- R8-4S from NICHIFU Co., Ltd.
- P10-8R from PANDUIT Corp.

◆ Main Circuit Terminal and Motor Wiring

This section outlines the various steps, precautions, and checkpoints for wiring the main circuit terminals and motor terminals.

WARNING! Fire Hazard. Do not connect main power supply wiring to drive motor terminals U/T1, V/T2, and W/T3. Connect main power supply wiring to main circuit input terminals R/L1, S/L2, and T/L3. Incorrect wiring can cause serious injury or death from fire.

3.3 Main Circuit Wiring

WARNING! Sudden Movement Hazard. Make sure that you align the phase order for the drive and motor when you connect the motor to drive output terminals U/T1, V/T2, and W/T3. If the phase order is incorrect, it can cause the motor to run in reverse. If the motor accidentally runs in reverse, it can cause serious injury or death.

NOTICE: Do not connect phase-advancing capacitors, LC/RC noise filters, or leakage breakers (GFCI) to the motor circuit. If you connect these devices to the output circuits, it can cause damage to the drive and connected equipment.

■ Cable Length Between Drive and Motor

When the wiring between the drive and the motor is too long, voltage drop along the motor cable can decrease motor torque, usually at low frequency output. If you connect motors in parallel with long motor cable, this is also a problem. Drive output current increases when the leakage current from the cable increases. An increase in leakage current can cause overcurrent and decrease the precision of the current detection.

Use the values in [Table 3.3](#) to adjust the drive carrier frequency. For systems that have 100 m (328 ft) or longer motor wiring, if you use metal conduits or isolated cables for each phase, it will increase stray capacitance.

Table 3.3 Carrier Frequency against Cable Length Between Drive and Motor

Wiring Distance Between the Drive and Motor	50 m (164 ft) Maximum	100 m (328 ft) Maximum	More than 100 m (328 ft)
Carrier Frequency	15 kHz or less	5 kHz or less	2 kHz or less

Note:

- To set the carrier frequency in a drive that is operating more than one motor, calculate the cable length as the total distance of wiring to all connected motors.
- If the length of the wire between the drive and an induction motor is longer than 100 m (328 ft), set $A1-02 = 0[V/f]$.
- The maximum cable length between the drive and a PM motor is 100 m (328 ft).
- If the cable length between the drive and the motor is too long when $A1-02 = 6 [AOLV/PM]$ or $8 [EZOLV]$, change the setting to $A1-02 = 5 [OLV/PM]$.
- When you connect to a PM motor, it can be necessary to adjust the overcurrent detection. Refer to [L8-27: Overcurrent Detection Gain on page 757](#) for more information.

■ Ground Wiring

Follow the precautions to wire the ground for one drive or a series of drives.

WARNING! Electrical Shock Hazard.

Make sure that the protective ground wire complies with technical standards and local safety regulations. The EN 61800-5-1:2007 standard specifies that you must wire the power supply to automatically de-energize when the protective ground wire disconnects. If you turn on the internal EMC filter, the leakage current of the drive will be more than 3.5 mA. Use these closed-loop crimp terminals or equivalent to connect a protective ground wire that has a minimum cross-sectional area of 10 mm² (copper wire).

- 8-4NS from JST Mfg. Co., Ltd.
- R8-4S from NICHIFU Co., Ltd.
- P10-8R from PANDUIT Corp.

If you do not obey the standards and regulations, it can cause serious injury or death.

WARNING! Electrical Shock Hazard. Ground the neutral point on the power supply of drive models BxxxE, 2xxxE, and 4xxxE to comply with the EMC Directive before you turn on the EMC filter or if there is high resistance grounding. If you turn ON the EMC filter, but you do not ground the neutral point, it can cause serious injury or death.

WARNING! Electrical Shock Hazard. Use a ground wire that complies with technical standards on electrical equipment and use the minimum length of ground wire. Incorrect equipment grounding can cause serious injury or death from dangerous electrical potentials on the equipment chassis.

WARNING! Electrical Shock Hazard.

Correctly ground the ground terminals. Obey federal and local electrical wiring codes for correct grounding methods. The maximum grounding resistance is

- 200 V class: ground to 100 Ω or less
- 400 V class: ground to 10 Ω or less

If you touch electrical equipment that is not grounded, it can cause serious injury or death.

Note:

- Only use the drive grounding wire to ground the drive. Do not share the ground wire with other devices such as welding machines or large-current electrical equipment. Incorrect equipment grounding can cause drive or equipment malfunction from electrical interference.
- To connect more than one drive to the same grounding circuit, follow the instructions in the instruction manual. Incorrect equipment grounding can cause drive or equipment malfunction from electrical interference.

When you connect more than one drive, refer to [Figure 3.24](#). Do not loop the grounding wire.

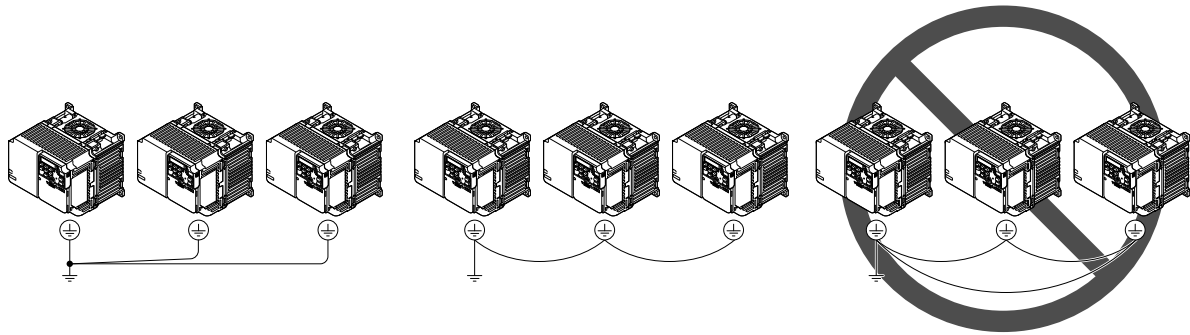

Figure 3.24 Wiring More than One Drive

■ Wiring the Main Circuit Terminal Block

WARNING! Electrical Shock Hazard. Before you wire the main circuit terminals, make sure that MCCB and MC are OFF. If you touch electrical equipment when MCCB and MC are ON, it can cause serious injury or death.

■ Main Circuit Configuration

The figures in this section show the different schematics of the drive main circuit. The connections change when the drive capacity changes. The DC power supply for the main circuit also supplies power to the control circuit.

Note:

Drive models B001A to B018A, 2001A to 2082A, and 4001A to 4060A do not have a built-in EMC filter.

WARNING! Fire Hazard. Do not connect a braking resistor to terminals +1 or -. Use terminals B1 and B2 for the braking resistor connections. If you connect a braking resistor to the incorrect terminals, it can cause damage to the drive and braking circuit and serious injury or death.

NOTICE: Do not use the negative DC bus terminal “-” as a ground terminal. This terminal is at high DC voltage potential. Incorrect wiring connections can cause damage to the drive.

Model	Figure
B001 - B004	Figure 3.25
B006 - B018	Figure 3.26
2001 - 2004, 4001 - 4004	Figure 3.27
2006 - 2082, 4005 - 4060	Figure 3.28

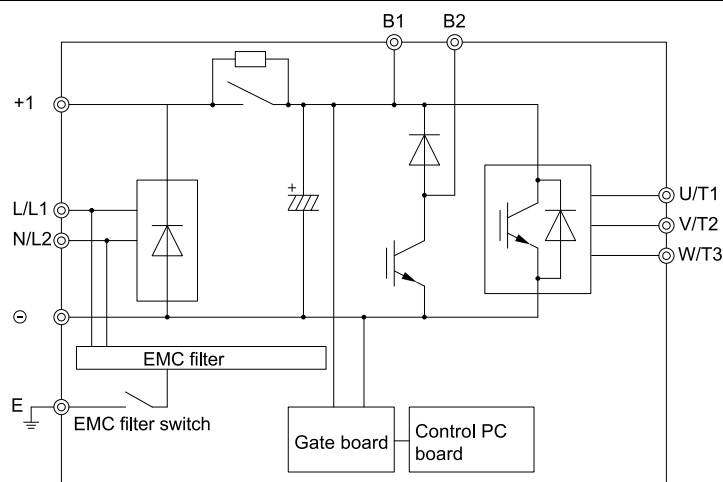

Figure 3.25 Drive Main Circuit Configuration 1

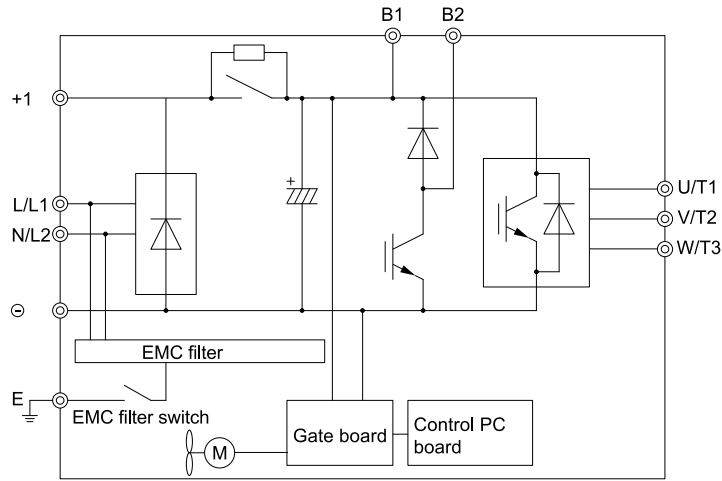

Figure 3.26 Drive Main Circuit Configuration 2

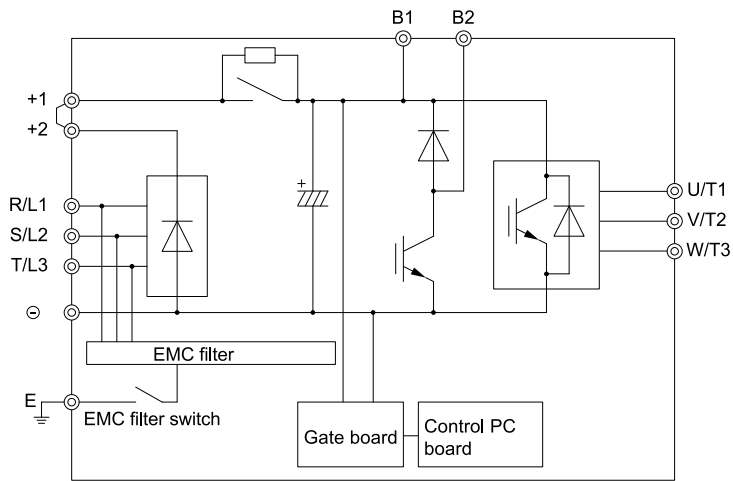

Figure 3.27 Drive Main Circuit Configuration 3

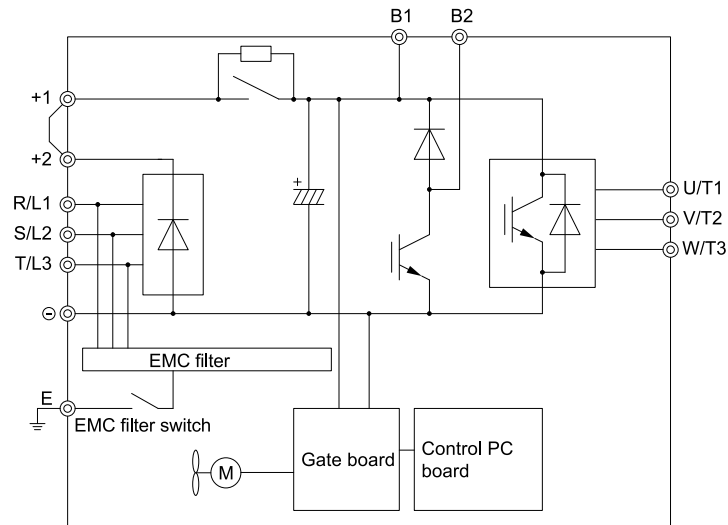

Figure 3.28 Drive Main Circuit Configuration 4

3.4 Main Circuit Terminal Block Wiring Procedure

DANGER! *Electrical Shock Hazard. Do not examine, connect, or disconnect wiring on an energized drive. Before servicing, disconnect all power to the equipment and wait for the time specified on the warning label at a minimum. The internal capacitor stays charged after the drive is de-energized. The charge indicator LED extinguishes when the DC bus voltage decreases below 50 Vdc. When all indicators are OFF, measure for dangerous voltages to make sure that the drive is safe. If you do work on the drive when it is energized, it will cause serious injury or death from electrical shock.*

◆ Wire to the Main Circuit Terminal Block

Wire to the main circuit terminal block correctly as specified by the instructions in the manual.

Read these instructions before wiring the terminal block.

■ Notes on Wiring the Main Circuit Terminal Block

Read these notes before you wire the main circuit terminal block.

WARNING! *Fire Hazard. Remove the insulation from the connection wires to the wire stripping lengths shown in the manual. If the stripping length is incorrect, the connection can cause a fire.*

WARNING! *Fire Hazard. Do not use bent or crushed wires. Remove the damaged end of the wire before you use it. Incorrect connections can cause death or serious injury from fire.*

WARNING! *Fire Hazard. If you use stranded wire, make sure that all of the wire strands are in the connection. Also, do not twist the stranded wire too much. Incorrect connections can cause death or serious injury from fire.*

NOTICE: *If you use power tools to tighten the terminal screws, use a low speed setting (300 min⁻¹ (r/min) to 400 min⁻¹ (r/min)). High speeds can cause damage to the terminal screws.*

- Use UL-Listed, vinyl-coated insulated copper wires for operation with a continuous maximum permitted temperature of 75 °C at 600 V.
- Remove all unwanted objects that are near the terminal block connections.
- Remove the insulation from the connection wires to the wire stripping lengths shown in the manual.
- Do not solder stranded wire. Soldered wire connections can become loose over time and cause unsatisfactory drive performance.
- Put the wire all the way into the terminal block. Remove the insulation from the wire to the recommended wire stripping length to fit the wire with insulation in the plastic housing.
- Use a torque driver, torque ratchet, or torque wrench for the screws. A slotted driver or a hex tool will be necessary to wire the screw clamp terminal. Use applicable tools as specified by the recommended conditions in the product manual.
- Users can purchase wiring tools from Yaskawa. Contact Yaskawa or your nearest sales representative for more information.
- Wire gauges on the drive you are replacing may not match the wire gauge ranges on your new drive. Contact Yaskawa or your nearest sales representative for more information about the connection procedures.
- Do not tighten the terminal screws at an angle of 5 degrees or more. Failure to obey can cause damage to the terminal screws.

If you damage a terminal screw, contact Yaskawa or your nearest sales representative.

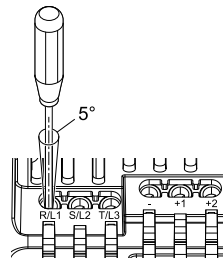

Figure 3.29 Permitted Angle

- Put the bit all the way into the hex socket to tighten the hex socket cap screw.
- When you tighten slotted screws, hold the straight-edge screwdriver perpendicularly to the screw. Make sure that you align the end of the straight-edge screwdriver with the screw groove.

3.4 Main Circuit Terminal Block Wiring Procedure

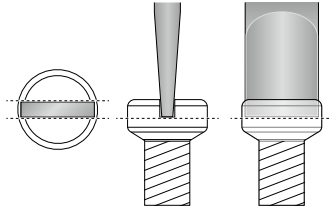
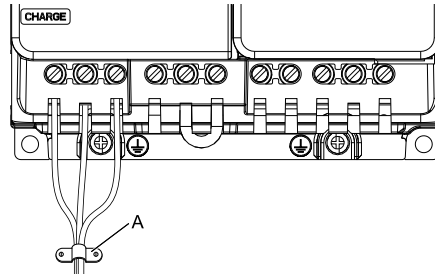

Figure 3.30 Tightening Slotted Screws

- After you connect the wires to the terminal block, lightly pull on the wires to make sure that they do not come out of the terminals.
- Do not let strain on the wiring cause damage. Use a strain relief near the wiring to release the tension. Refer to [Figure 3.31](#) for an example.



A - Cable clamp

Figure 3.31 Strain Relief Example

Table 3.4 Recommended Wiring Tools

Screw Size	Screw Shape	Wire Gauge	Adapter	Bit		Torque Driver Model (Tightening Torque)	Torque Wrench (Tightening Torque)
				Model	Manufacturer		
M3		-	Bit	SF-BIT-SL 0,5X3,0-70	PHOENIX CONTACT	TSD-M 1,2NM (0.3 - 1.2 N·m 2.7 - 10.6 lbf·in)	-
M4		-	Bit	SF-BIT-SL 1,0X4,0-70	PHOENIX CONTACT	TSD-M 3NM (1.2 - 3.0 N·m 10.6 - 26.6 lbf·in)	-
M5 *1		≤ 25 mm ² (AWG 10)	Bit	SF-BIT-SL 1,2X6,5-70	PHOENIX CONTACT	TSD-M 3NM (1.2 - 3.0 N·m 10.6 - 26.6 lbf·in)	-
		≥ 30 mm ² (AWG 8)				-	
M6	 (WAF: 5 mm)	-	Bit	SF-BIT-HEX 5-50	PHOENIX CONTACT	-	4.1 - 4.5 N·m (36.3 - 39.8 lbf·in) *2 *3
							5 - 9 N·m (44.3 - 79.7 lbf·in) *2 *3

*1 When you wire drive models 2042, 2056, 4031, 4038, 4044, and 4060, select the correct tools for the wire gauge.

*2 Use 6.35 mm (0.25 in) bit socket holder.

*3 Use a torque wrench that can apply this torque measurement range.

■ Remove IP20 Terminal Protective Cover

These drives have IP20 terminal protective covers. Remove the covers for the application.

Model	Terminal R/L1, S/L2, T/L3	Terminal -
2042 4031, 4038	-	x
2056, 2070, 2082 4044, 4060	x	x

1. Put a slotted screwdriver blade into the slit to push the hook of the IP20 terminal protective cover.

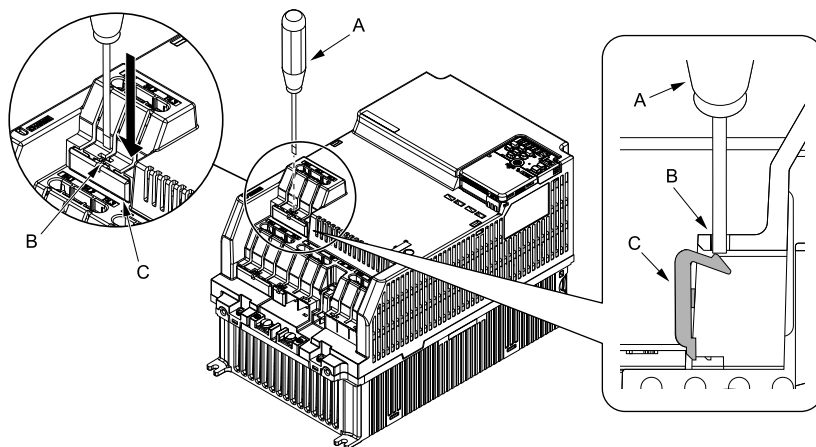

A - Slotted screwdriver
B - Slit

C - IP20 terminal protective cover

Figure 3.32 Put the Screwdriver Blade into the Slit

2. Push up the screwdriver to release the IP20 terminal protective cover.

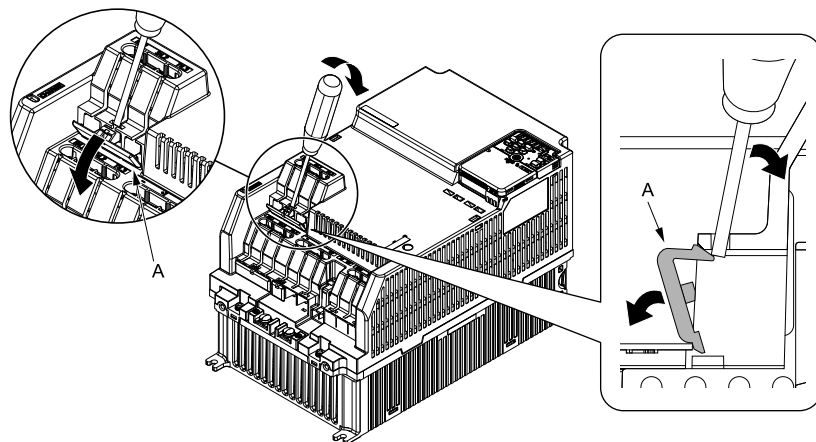

A - IP20 terminal protective cover

Figure 3.33 Release IP20 terminal protective cover

3. Remove IP20 terminal protective cover.

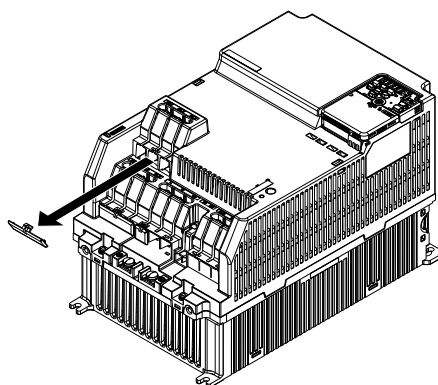

Figure 3.34 Remove IP20 Terminal Protective Cover

■ Main Circuit Terminal Block Wiring Procedure

When terminals R/L1, S/L2, T/L3, and terminal - have IP20 terminal protective covers, remove the cover on the terminal where you will wire.

3.4 Main Circuit Terminal Block Wiring Procedure

1. Put wires with prepared ends into the main circuit terminal block.

Look through the opening in the drive case to make sure that you correctly installed the wires into the terminal block.

WARNING! Fire Hazard. Remove the insulation from the connection wires to the wire stripping lengths shown in the manual. Make sure that all of the wire strands are in the connection. If wire stripping length is too short, it can pinch the covering into the terminal block. If wire stripping length is too long, it can close the circuit. Incorrect stripping lengths can cause serious injury or death from fire.

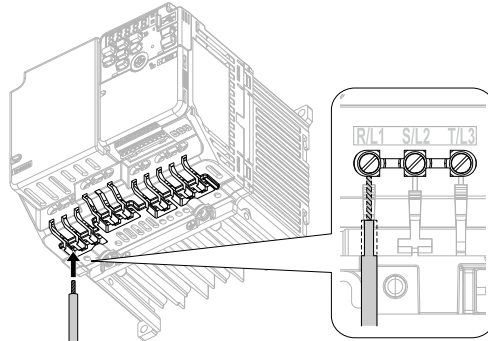

Figure 3.35 Install the Electrical Wire

Note:

There is a jumper between terminals +1 and +2. Remove the jumper, then wire to terminals +1 and +2.

2. Tighten the screws to the specified torque.

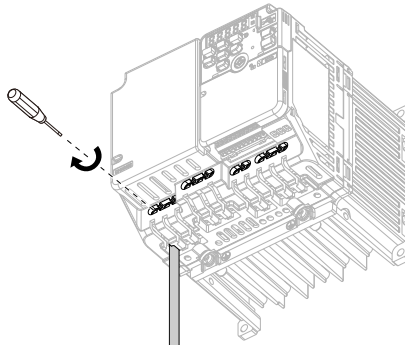

Figure 3.36 Tighten Terminal Block Screws

3.5 Control Circuit Wiring

This section gives information about how to correctly wire the control circuit.

◆ Control Circuit Connection Diagram

Wire the drive control circuit as shown in Figure 3.37.

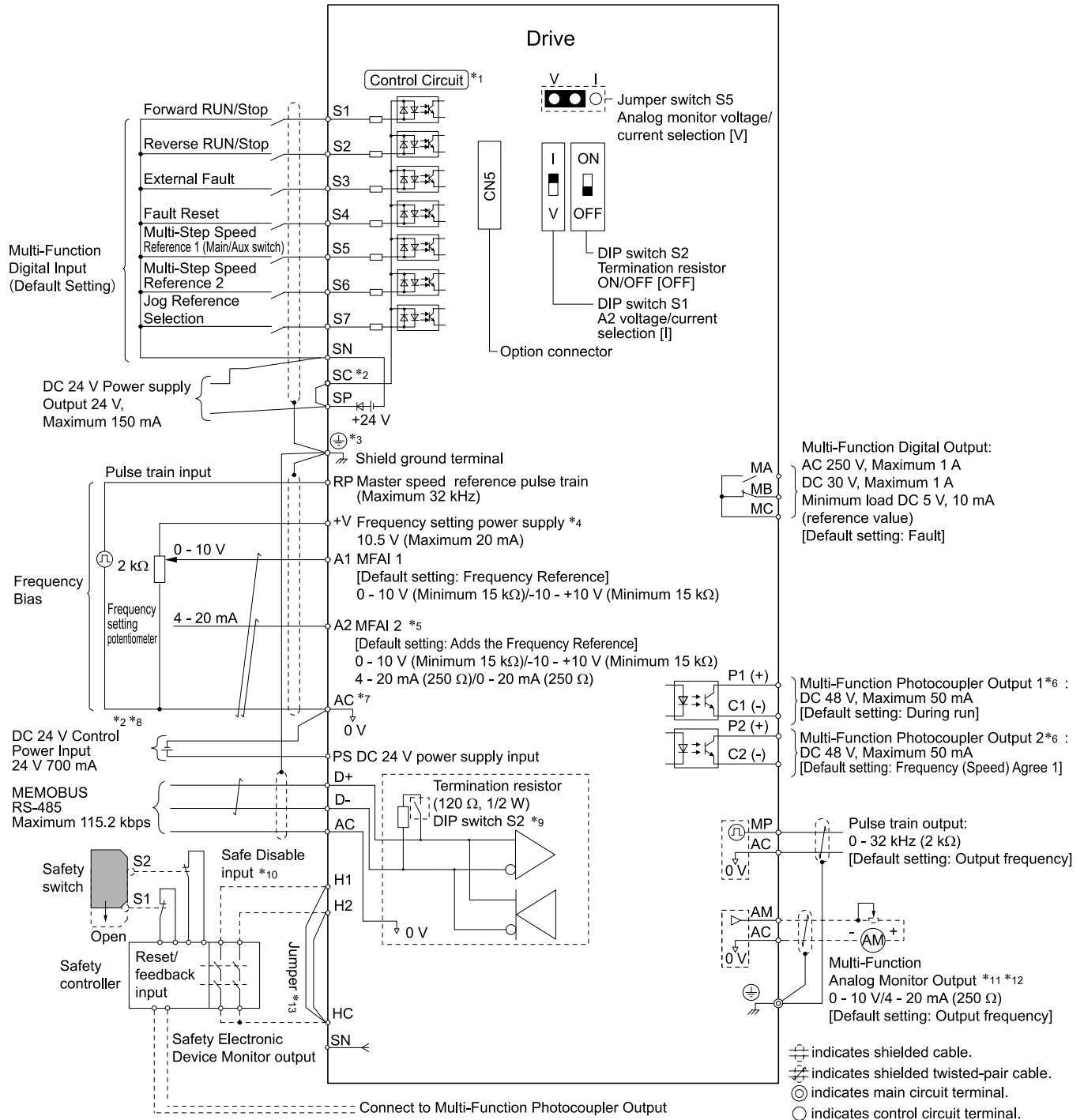

Figure 3.37 Control Circuit Connection Diagram

*1 Connect a 24 V power supply to terminals PS-AC to operate the control circuit while the main circuit power supply is OFF.

3.5 Control Circuit Wiring

- *2 To set the MFDI power supply (Sinking/Sourcing Mode or internal/external power supply), install or remove a jumper between terminals SC-SP or SC-SN depending on the application.
- NOTICE: Damage to Equipment.** Do not close the circuit between terminals SP-SN. If you close the circuits between terminals SC-SP and terminals SC-SN at the same time, it will cause damage to the drive.
- Sinking Mode, Internal power supply: Install the jumper to close the circuit between terminals SC-SP.
NOTICE: Damage to Equipment. Do not close the circuit between terminals SC-SN. If you close the circuits between terminals SC-SP and terminals SC-SN at the same time, it will cause damage to the drive.
 - Sourcing Mode, Internal power supply: Install the jumper to close the circuit between terminals SC-SN.
NOTICE: Damage to Equipment. Do not close the circuit between terminals SC-SP. If you close the circuits between terminals SC-SP and terminals SC-SN at the same time, it will cause damage to the drive.
 - External power supply: Remove the jumper from the MFDI terminals. It is not necessary to close the circuit between terminals SC-SP and terminals SC-SN.
- *3 **WARNING! Electrical Shock Hazard.** When you connect the shield wire of the control circuit wiring to the protective ground terminal, do not connect the protective ground wire. If you connect the shield wire and the protective ground wire to the protective grounding terminal, it may not comply with the technical standards and local safety regulations and can cause serious injury or death.
- *4 The maximum output current capacity for terminal +V on the control circuit is 20 mA.
- NOTICE: Damage to Equipment.** Do not install a jumper between terminals +V and AC. A closed circuit between these terminals will cause damage to the drive.
- *5 DIP switch S1 sets terminal A2 for voltage or current input. The default setting for S1 is current input ("I" side).
- *6 Do not ground the control circuit terminals AC or connect them to the drive chassis.
- NOTICE: Do not ground the AC control circuit terminals and only connect the AC terminals according to the product instructions. If you connect the AC terminals incorrectly, it can cause damage to the drive.**
- *7 Do not connect terminals PS and AC inversely. If you connect the wires to the incorrect terminals, it will cause damage to the drive.
- *8 Set DIP switch S2 to the ON position to enable the termination resistor in the last drive when you use MEMOBUS/Modbus communications.
- *9 To use the internal power supply with the Safe Disable input, use sourcing mode.
- *10 Use multi-function analog monitor outputs with analog frequency meters, ammeters, voltmeters, and wattmeters. Do not use monitor outputs with feedback-type signal devices.
- *11 Jumper S5 sets terminal AM for voltage or current output. The default setting for S5 is voltage output ("V" side).
- *12 Disconnect the wire jumpers between H1 and HC and H2 and HC to use the Safe Disable input.
-

◆ Control Circuit Terminal Block Functions

Hx-xx parameters set functions for the multi-function input and output terminals.

WARNING! Sudden Movement Hazard. Correctly wire and test all control circuits to make sure that the control circuits operate correctly. If you use a drive that has incorrect control circuit wiring or operation, it can cause death or serious injury.

WARNING! Sudden Movement Hazard. Check the I/O signals and the external sequences for the drive before you set the Application Preset function. When you set the Application Preset function ($A1-06 \neq 0$), it changes the I/O terminal functions for the drive and it can cause equipment to operate unusually. This can cause serious injury or death.

NOTICE: Damage to Equipment. Do not energize and de-energize the drive more frequently than one time each 30 minutes. If you frequently energize and de-energize the drive, it can cause drive failure.

■ Input Terminals

Refer to [Table 3.5](#) for a list of input terminals and functions.

Table 3.5 Multi-function Input Terminals

Type	Terminal	Name (Default)	Function (Signal Level)	
MFDI	S1	MFDI selection 1 (ON: Forward run, OFF: Stop)	<ul style="list-style-type: none"> Photocoupler 24 V, 6 mA <p>Note: To set the MFDI power supply (Sinking/Sourcing Mode or internal/external power supply), install or remove a jumper between terminals SC-SP or SC-SN depending on the application.</p> <ul style="list-style-type: none"> Sinking Mode, Internal power supply: Install the jumper to close the circuit between terminals SC-SP. <p>NOTICE: Damage to Equipment. Do not close the circuit between terminals SC-SN. If you close the circuits between terminals SC-SP and terminals SC-SN at the same time, it will cause damage to the drive.</p> <ul style="list-style-type: none"> Sourcing Mode, Internal power supply: Install the jumper to close the circuit between terminals SC-SN. <p>NOTICE: Damage to Equipment. Do not close the circuit between terminals SC-SP. If you close the circuits between terminals SC-SP and terminals SC-SN at the same time, it will cause damage to the drive.</p> <ul style="list-style-type: none"> External power supply: Remove the jumper from the MFDI terminals. It is not necessary to close the circuit between terminals SC-SP and terminals SC-SN. 	
	S2	MFDI selection 2 (ON: Reverse run OFF: Stop)		
	S3	MFDI selection 3 (External fault (N.O.))		
	S4	MFDI selection 4 (Fault reset)		
	S5	MFDI selection 5 (Multi-step speed reference 1)		
	S6	MFDI selection 6 (Multi-step speed reference 2)		
	S7	MFDI selection 7 (Jog command)		
	SN	MFDI power supply 0 V		MFDI power supply, 24 V (maximum 150 mA)
	SC	MFDI selection common		NOTICE: Damage to Equipment. Do not close the circuit between terminals SP-SN. If you close the circuits between terminals SC-SP and terminals SC-SN at the same time, it will cause damage to the drive.
	SP	MFDI power supply +24 Vdc		
Safe Disable Input	H1	Safe Disable input 1	Remove the jumper between terminals H1-HC and H2-HC to use the Safe Disable input. <ul style="list-style-type: none"> 24 V, 6 mA ON: Normal operation OFF: Coasting motor Internal impedance 4.7 kΩ OFF Minimum OFF time of 3 ms. 	
	H2	Safe Disable input 2		
	HC	Safe Disable function common		Safe Disable function common NOTICE: Do not close the circuit between terminals HC and SN. A closed circuit between these terminals will cause damage to the drive.
Master Frequency Reference	RP	Master frequency reference pulse train input (Master frequency reference)	<ul style="list-style-type: none"> Response frequency: 0 to 32 kHz H level duty: 30% to 70% H level voltage: 3.5 V to 13.2 V L level voltage: 0.0 V to 0.8 V Input impedance: 3 kΩ 	
	+V	Power supply for frequency setting	10.5 V (allowable current 20 mA maximum)	
	A1	MFAI1 (Master frequency reference)	Voltage input Use H3-01 [Terminal A1 Signal Level Select] to select the signal level. <ul style="list-style-type: none"> 0 V to 10 V/ 100% (input impedance: minimum 15 kΩ) -10 V to +10 V/-100% to +100% (input impedance: minimum 15 kΩ) 	
	A2	MFAI2 (Combined to terminal A1)	Voltage input or current input Use DIP switch S1 and H3-09 [Terminal A2 Signal Level Select] to select the input. <ul style="list-style-type: none"> 0 V to 10 V/ 100% (input impedance: minimum 15 kΩ) -10 V to +10 V/-100% to +100% (input impedance: minimum 15 kΩ) 4 mA to 20 mA/100%, 0 mA to 20 mA/100% (input impedance: 250 Ω) 	
	AC	Frequency reference common	0 V	

■ Output Terminals

Refer to Table 3.6 and Table 3.7 for a list of Output terminals and functions.

Table 3.6 Control Circuit Output Terminals

Type	Terminal	Name (Default)	Function (Signal Level)
Digital Outputs	MA	N.O. output (Fault)	<ul style="list-style-type: none"> Relay output 30 Vdc, 10 mA to 1 A 250 Vac, 10 mA to 1 A Minimum load: 5 V, 10 mA (Reference value)
	MB	N.C. output (Fault)	
	MC	Digital output common	
Multi-function Photocoupler Outputs	P1	Multi-function photocoupler output 1 (During RUN)	<ul style="list-style-type: none"> Photocoupler output 48 V, 2 mA to 50 mA
	C1		
	P2	Multi-function photocoupler output 2 (Speed agree 1)	
	C2		

Table 3.7 Control Circuit Monitor Output Terminals

Type	Terminal	Name (Default)	Function (Signal Level)
Monitor Output	MP	Pulse train output (Output frequency)	32 kHz (maximum) Refer to "Pulse Train Output" (page 101) for more information.
	AM	Analog monitor output (Output frequency)	Select voltage or current output. <ul style="list-style-type: none"> 0 V to 10 V/0% to 100% 4 mA to 20 mA (Receiver recommended impedance: 250 Ω) Note: Use jumper S5 and H4-07 [Terminal AM Signal Level Select] to set the signal type.
	AC	Monitor common	0 V

■ External Power Supply Input Terminals

Refer to Table 3.8 for a list of the functions of the external power supply input terminals.

Table 3.8 External Power Supply Input Terminals

Type	Terminal	Name (Default)	Function
External Power Supply Input Terminals	PS	External 24 V power supply input	Supplies backup power to the drive control circuit, keypad, and option board. 21.6 VDC to 26.4 VDC, 700 mA
	AC	External 24 V power supply ground	0 V

Alarm Display When You Use External 24 V Power Supply

When you use an external 24 V power supply, the drive detects an alarm as shown in Table 3.9 if you set o2-23 [External 24V Powerloss Detection] and o2-26 [Alarm Display at Ext. 24V Power] for the main circuit power supply. Set the alarm display as necessary.

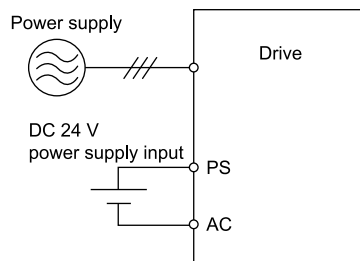

Table 3.9 Power Supply and Alarm Display

Main Circuit Power Supply	External 24 V Power Supply	o2-23 [External 24V Powerloss Detection]	o2-26 [Alarm Display at Ext. 24V Power]	Alarm Display
ON	ON	-	-	-
ON	OFF	0 [Disabled]	-	-
		1 [Enabled]	-	L24v [Loss of External Power 24 Supply]

Main Circuit Power Supply	External 24 V Power Supply	o2-23 [External 24V Powerloss Detection]	o2-26 [Alarm Display at Ext. 24V Power]	Alarm Display
OFF	ON	-	0 [Disabled]	"Ready" LED light flashes quickly
		-	1 [Enabled]	EP24v [External Power 24V Supply]

Operation When Using External 24 V Power Supply

To operate the drive, de-energize the main circuit power supply and connect an external 24 V power supply to terminals PS-AC.

Function	Operation	Solution
Keypad	The keypad operates the same as when the main circuit power supply is ON. The drive will not detect oPr [Keypad Connection Fault].	-
Data Log	The data log function operates the same as when the main circuit power supply is ON. The operation is different for different drive software versions. *1	-
Communications by Communication Option or MEMOBUS/Modbus Communication Terminals	Communication operates the same as when the main circuit power supply is ON.	-
MFAI	MFAI operates the same as when the main circuit power supply is ON.	-
MFAO	MFAO operates the same as when the main circuit power supply is ON.	-
MFDI	MFDI does not operate when the main circuit power supply of the drive is OFF.	Connect the external 24 V power supply to MFDI selection common terminal (SC). *2
MFDO Multi-Function Photocoupler Output Fault Relay Output Terminal	MFDO operates the same as when the main circuit power supply is ON. The operations of MFDO terminals and fault relay output terminals set for H2-xx = E, 10E [Fault] are different for different drive software versions. *3	-
Pulse Train Input	Pulse train input operates the same as when the main circuit power supply is ON.	-
Pulse train output	Pulse train output operates the same as when the main circuit power supply is ON.	-

*1 When you use an external 24 V power supply, the operation of the data log function is different for different drive software versions. On drives with software versions PRG: 01015 and later, you can continue the data log function.

Note:

The "PRG" column on the nameplate on the right side of the drive identifies the software version. You can also use U1-25 [SoftwareNumber FLASH] to identify the software version.

*2 When you use MFDI and a Digital Input option (DI-A3), wire the terminals as shown in [Wiring MFDI Terminals on page 95](#).

*3 When you use an external 24 V power supply, the operation of the MFDO terminals are different for different drive software versions.

Note:

The "PRG" column on the nameplate on the right side of the drive identifies the software version. You can also use U1-25 [SoftwareNumber FLASH] to identify the software version.

- Drive software versions PRG: 01013 and later
When the main circuit power supply of the drive turns off, and you remove the cause of a fault and do a fault reset from the keypad, the fault relay output terminals and the MFDO terminals set for H2-xx = E, 10E [Fault] will change status.
- Drive software versions PRG: 01012 and earlier
When the main circuit power supply of the drive turns off, remove the cause of a fault and do a fault reset from the keypad. The fault relay output terminals and the MFDO terminals set for H2-xx = E, 10E [Fault] will keep the same status as before the main circuit power supply of the drive turned off. The fault code shown on the keypad will disappear.

Wiring MFDI Terminals

If you de-energize the main circuit power supply, the MFDI terminals will not operate, even when you connect an external 24 V power supply to terminals PS-AC. When you set N.O. functions to H1-xx [MFDI Function Select], MFDI terminals always de-activate. When you set N.C. functions, MFDI terminals always activate. Connect the external 24 V power supply to the MFDI selection common terminal (SC). Refer to [Figure 3.38](#) for more information.

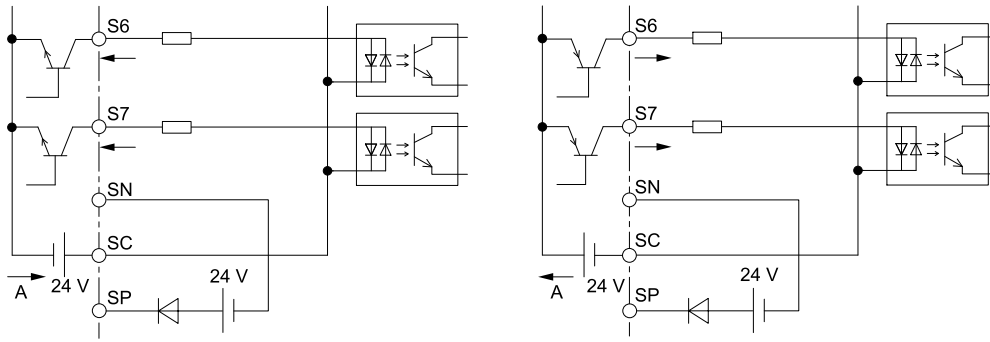

A - External power supply

Figure 3.38 Wiring MFDI Terminals

■ Serial Communication Terminals

Refer to Table 3.10 for a list of serial communication terminals and functions.

Table 3.10 Serial Communication Terminals

Type	Terminal	Terminal Name	Function (Signal Level)	
Modbus Communication	D+	Communication input/output (+)	MEMOBUS/Modbus communications Use an RS-485 cable to connect the drive.	<ul style="list-style-type: none"> • RS-485 • MEMOBUS/Modbus communication protocol • Maximum 115.2 kbps
	D-	Communication output (-)	Note: Set DIP switch S2 to ON to enable the termination resistor in the last drive in a MEMOBUS/Modbus network.	
	AC	Shield ground	0 V	

◆ Control Circuit Terminal Configuration

The control circuit terminals are in the positions shown in Figure 3.39.

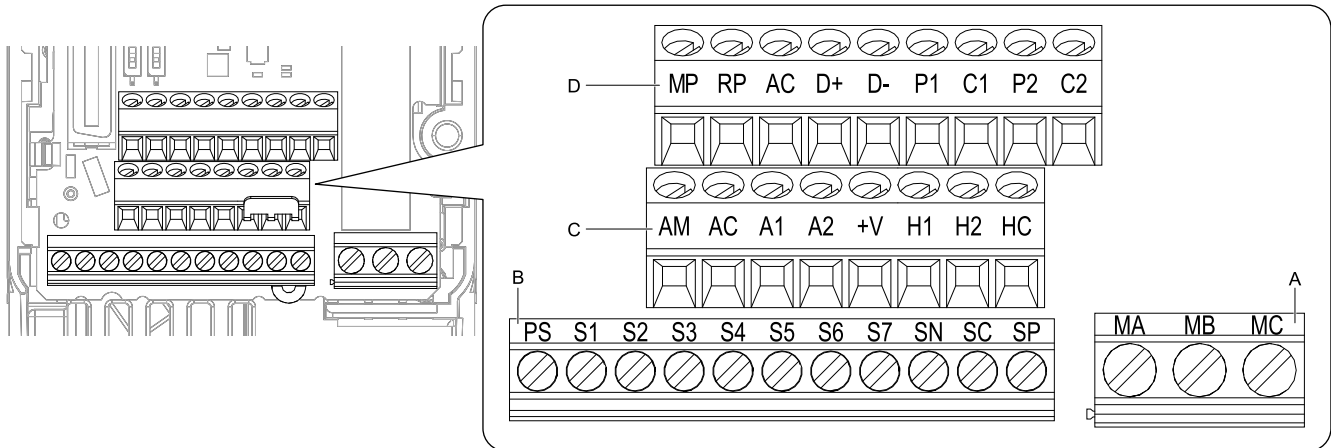

A - Terminal block (TB2)

B - Terminal block (TB1-1)

C - Terminal block (TB1-2)

D - Terminal block (TB1-3)

Figure 3.39 Control Circuit Terminal Arrangement

■ Control Circuit Wire Gauges and Tightening Torques

Use the tables in this section to select the correct wires. Use shielded wire to wire the control circuit terminal block. Use crimp ferrules on the wire ends to make the wiring procedure easier and more reliable.

Table 3.11 Control Circuit Wire Gauges and Tightening Torques

Terminal Block	Terminal	Screw Size	Tightening Torque N·m (lbf·in)	Bare Wire		Crimp Ferrule	
				Recomm. Gauge mm ² (AWG)	Applicable Gauge mm ² (AWG)	Recomm. Gauge mm ² (AWG)	Applicable Gauge mm ² (AWG)
TB1-1	PS, S1 - S7, SN, SC, SP	M2	0.22 - 0.25 (1.95 - 2.21)	0.75 (18)	<ul style="list-style-type: none"> Stranded wire 0.25 - 1.0 (24 - 17) Solid wire 0.25 - 1.5 (24 - 16) 	0.5 (20)	0.25 - 0.5 (24 - 20)
TB1-2	AM, AC, A1, A2, +V, H1, H2, HC						
TB1-3	MP, RP, AC, D+, D-, P1, C1, P2, C2						
TB2	MA, MB, MC	M3	0.5 - 0.6 (4.4 - 5.3)	0.75 (18)	<ul style="list-style-type: none"> Stranded wire 0.25 - 1.5 (24 - 16) Solid wire 0.25 - 1.5 (24 - 16) 	0.5 (20)	0.25 - 1.0 (24 - 17)

Crimp Ferrules

Attach an insulated sleeve when you use crimp ferrules. Refer to Table 3.12 for the recommended external dimensions and model numbers of crimp ferrules.

Use the CRIMPFOX 6, a crimping tool made by PHOENIX CONTACT.

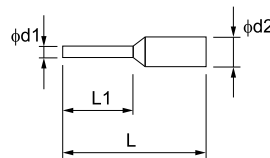

Figure 3.40 External Dimensions of Crimp Ferrules

Table 3.12 Crimp Ferrule Models and Sizes

Wire Gauge mm ² (AWG)	Model	L (mm)	L1 (mm)	φd1 (mm)	φd2 (mm)
0.25 (24)	AI 0.25-6 YE AI 0.25-6 BU	10.5	6.0	0.8	2.0
0.34 (22)	AI 0.34-6 TQ	10.5	6.0	0.8	2.0
0.5 (20)	AI 0.5-6 WH AI 0.5-6 OG	12.0	6.0	1.1	2.5
0.75 (18)	AI 0.75-6 GY AI 0.75-6 WH	12.0	6.0	1.3	2.8
1.0 (17)	AI 1-6 RD AI 1-6 YE	12.0	6.0	1.5	3.0

◆ Wiring the Control Circuit Terminal

WARNING! *Electrical Shock Hazard. Do not remove covers or touch circuit boards while the drive is energized. If you touch the internal components of an energized drive, it can cause serious injury or death.*

NOTICE: *Do not let wire shields touch other signal lines or equipment. Insulate the wire shields with electrical tape or shrink tubing. If you do not insulate the wire shields, it can cause a short circuit and damage the drive.*

Note:

- Use a Class 2 power supply to connect external power to the control terminals. If the power supply for peripheral devices is incorrect, it can cause a decrease in drive performance.
- Connect the shield of shielded cable to the applicable ground terminal. Incorrect equipment grounding can cause drive or equipment malfunction from electrical interference.
- Isolate wiring for contact output terminals MA, MB, MC, P1, C1, P2, and C2 from other control circuit wiring. Incorrect wiring procedures can cause the drive and connected equipment to malfunction and cause the drive to trip.
- Isolate control circuit wiring from main circuit wiring (terminals R/L1, S/L2, T/L3, L/L1, N/L2, B1, B2, U/T1, V/T2, W/T3, -, +1, +2) and other high-power wiring. If control circuit wiring is adjacent to main circuit wiring, it can cause incorrect operation of the drive and equipment from electrical interference.

Wire the grounding terminal and main circuit terminals, then wire the control circuit terminals.

1. Remove the front cover from the drive.
You must remove the keypad to move Jumper S5.

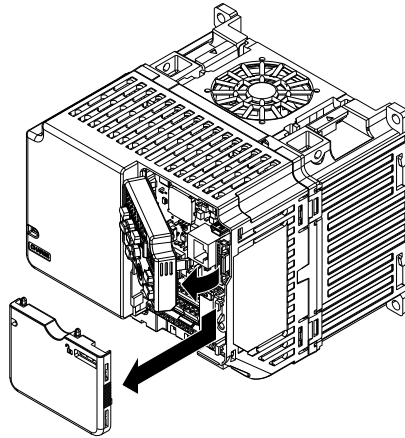

Figure 3.41 Remove the Front Cover

2. Refer to the figure and wire the control circuit.
Use a slotted screwdriver with a blade width of 2.5 mm (0.1 in) or less and thickness of 0.4 mm (0.01 in) or less.

WARNING! Fire Hazard. Tighten all terminal screws to the correct tightening torque. Connections that are too loose or too tight can cause incorrect operation and damage to the drive. Incorrect connections can also cause death or serious injury from fire.

Note:

- Use shielded, twisted-pair wires and ground the shield to the ground terminal of the drive. Incorrect equipment grounding can cause drive or equipment malfunction from electrical interference.
- Do not use control circuit wiring that is longer than 50 m (164 ft) to supply the analog frequency reference from a remote source. If the control circuit wiring is too long, it can cause unsatisfactory system performance.

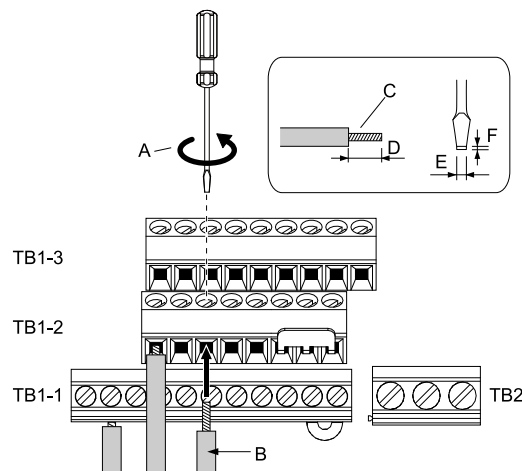

- A - Loosen the screws and put the wire into the opening on the terminal block.
- B - Wire with a crimp ferrule attached, or unsoldered wire with the core wires lightly twisted
- C - Pull back the shielding and lightly twist the end with your fingers to keep the ends from fraying.
- D - When you do not use crimp ferrules, remove approximately 5.5 mm (0.21 in) of the covering at the end of the wire.
- E - Blade width of 2.5 mm (0.1 in) or less
- F - Blade thickness of 0.4 mm (0.01 in) or less

Figure 3.42 Wiring Procedure for the Control Circuit

Note:

- It is easier to wire TB1-1 first, then TB1-2, then TB1-3.
- Do not solder the core wire. Soldered wiring connections can become loose and cause the drive to malfunction.
- Tighten all terminal screws to the correct tightening torque. Connections that are too loose or too tight can cause incorrect operation and damage to the drive. Incorrect connections can also cause death or serious injury from fire.
- Refer to [Figure 3.43](#) for information to prepare terminal ends of the shielded wire.
- Prepare the wire ends of shielded twisted-pair wires as shown in [Figure 3.43](#) to use an analog reference from an external frequency setting potentiometer to set the frequency. Connect the shield to the ground terminal (⊕) of the drive.

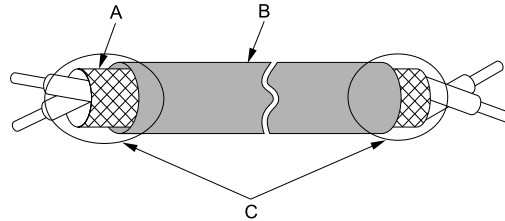

- A - Connect the shield to the ground terminal of the drive.** **C - Insulate with electrical tape or shrink tubing.**
- B - Sheath**

Figure 3.43 Prepare the Ends of Shielded Wire

3. Install the front cover.

If you moved Jumper S5, attach the keypad before you attach the front cover.

If you did not move Jumper S5, attach the front cover.

Make sure that you do not pinch wires or signal lines between the front cover and the drive before you reattach the cover.

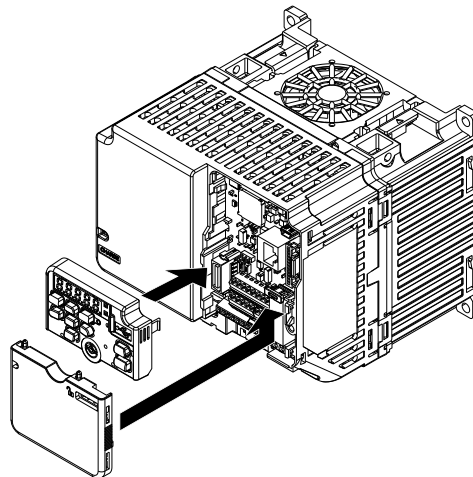

Figure 3.44 Install the Front Cover

◆ Switches and Jumpers on the Terminal Board

The terminal board has switches to adapt the drive I/Os to the external control signals as shown in [Figure 3.45](#). Set the switches to select the functions for each terminal.

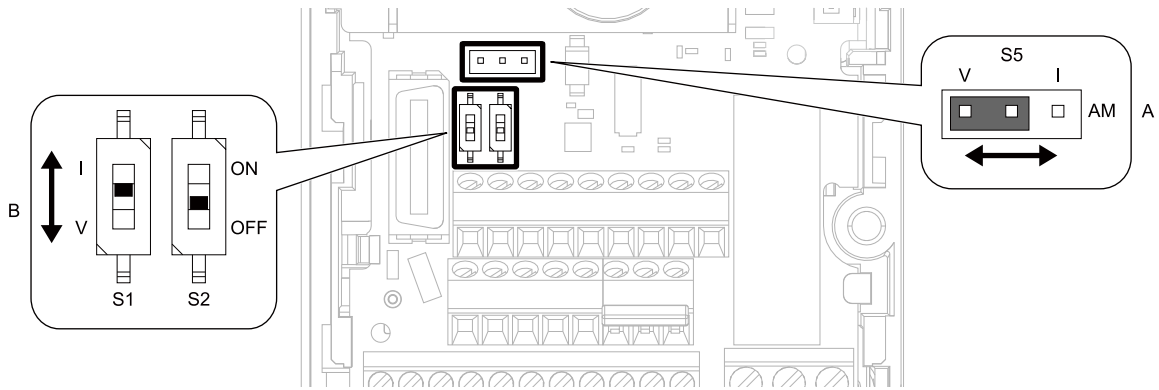

Figure 3.45 Locations of Switches

Table 3.13 I/O Terminals and Switches Functions

Position	Switch	Terminal	Function	Default
A	Jumper switch S5	AM	Sets the output method for terminal AM (voltage or current).	V (voltage output)
B	DIP switch S1	A2	Sets the input method for terminal A2 (voltage or current).	I (current input)
	DIP switch S2	-	Enables and disables the MEMOBUS/Modbus communications termination resistor.	OFF

3.6 Control I/O Connections

This section gives information about the settings for the listed control circuit I/O signals.

- MFDI (terminals S1 to S7)
- Pulse train output (terminal MP)
- MFAI (terminal A2)
- MFAO (terminal AM)
- MEMOBUS/Modbus communications (terminals D+, D-, AC)

◆ Set Sinking Mode/Sourcing Mode

Close the circuit between terminals SC-SP and SC-SN to set the sinking mode/sourcing mode and the internal/external power supply for the MFDI terminals. The default setting for the drive is internal power supply sinking mode.

NOTICE: Damage to Equipment. Do not close the circuit between terminals SP-SN. If you close the circuits between terminals SC-SP and terminals SC-SN at the same time, it will cause damage to the drive.

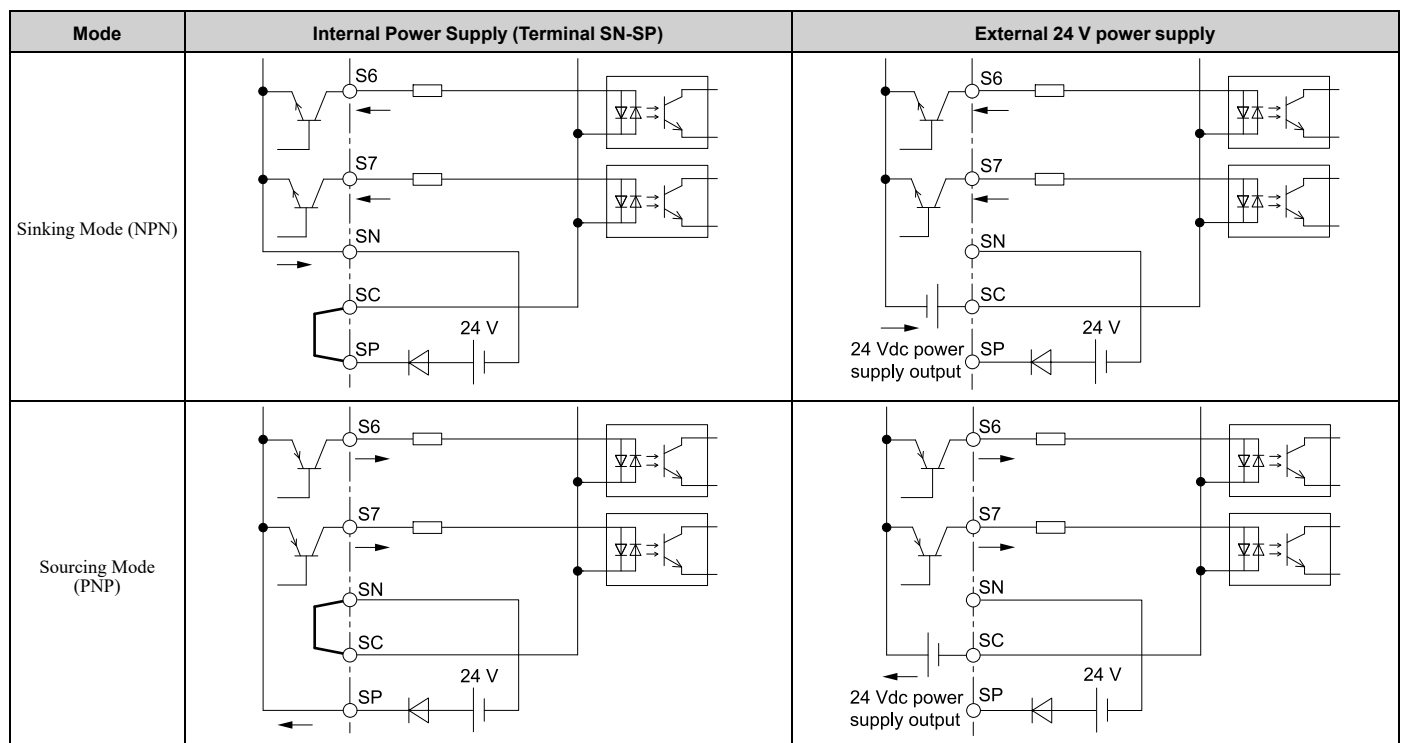

◆ Pulse Train Output

You can use pulse train monitor output terminal MP for sourcing mode or for sinking mode.

- Use for sourcing mode
The load impedance changes the voltage level of the pulse train output signal.

Load Impedance $R_L(k\Omega)$	Output Voltage $V_{MP}(V)$
1.5 k Ω or more	5 V or more
4.0 k Ω or more	8 V or more
10 k Ω or more	10 V or more

Note:

Use the formula in [Figure 3.46](#) to calculate the necessary load resistance (k Ω) to increase output voltage $V_{MP}(V)$.

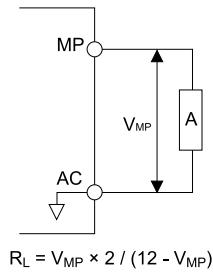

A - Load Impedance

Figure 3.46 Wiring to Use Pulse Train Output in Sourcing Mode

- Use in sinking mode

The external power supply changes the voltage level of the pulse train output signal. Keep the voltage from an external source between 10.8 Vdc to 16.5 Vdc. Adjust the load impedance to keep the current at 16 mA or lower.

External Power Supply (V)	Load Impedance (kΩ)	Sinking current (mA)
10.8 Vdc to 16.5 Vdc	1.0 kΩ or more	16 mA maximum

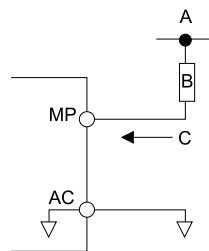

- A - External power supply
- B - Load Impedance

C - Sinking current

Figure 3.47 Wiring to Use Pulse Train Output in Sinking Mode

◆ **Set the Input Signal for the MFAI Terminal A2**

Use terminal A2 to input a voltage or a current signal. Set the signal type as shown in [Table 3.14](#).

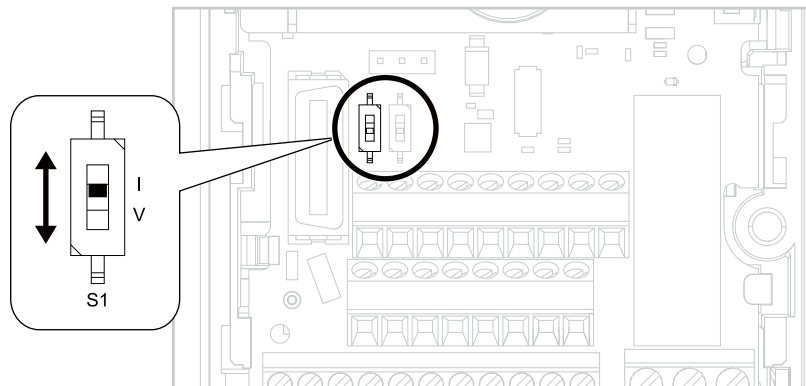

Figure 3.48 Location of DIP Switch S1

Table 3.14 MFAI Terminal A2 Signal Settings

Terminal	Input Signal	DIP Switch Settings		Parameter	
		Switch	Setting	No.	Signal Level
A2	Current input	S1	I (Default)	H3-09	2: 4 mA to 20 mA/0% to 100% (input impedance: 250 Ω) 3: 0 mA to 20 mA/0% to 100% (input impedance: 250 Ω)
	Voltage input		V		0: 0 V to 10 V/0% to 100% (with zero limit) (input impedance: minimum 15 kΩ) 4: -10 V to +10 V/-100% to 100% (input impedance: minimum 15 kΩ)

Note:

Use tweezers or a jig with a tip width of approximately 0.8 mm (0.03 in) to set DIP switches.

◆ **Set the Output Signal for the MFAO Terminal AM**

Set the signal type for terminal AM to voltage or current output. Use jumper S5 and H4-07 [Terminal AM Signal Level Select] to set the signal type.

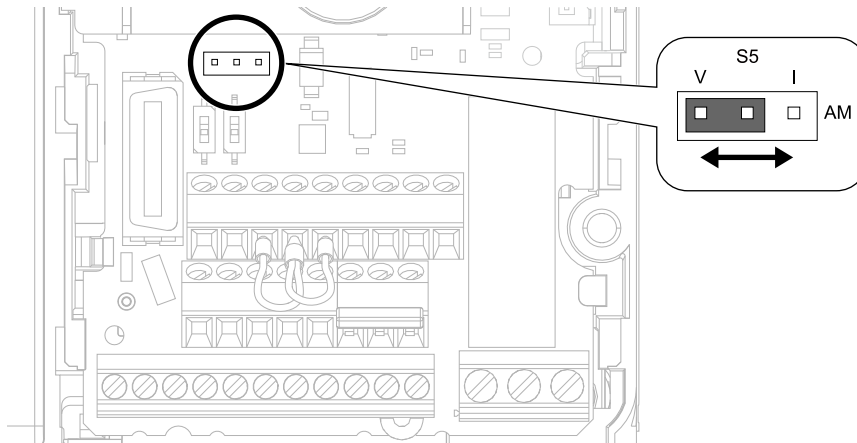
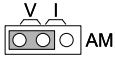
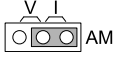

Figure 3.49 Location of Jumper Switch S5

Terminal	Types of Output Signals	Jumper S5	Parameter	
			No.	Signal Level
AM	Voltage output (Default)	 AM	H4-07	0: 0 V to 10 V
	Current output	 AM		2: 4 mA to 20 mA

◆ **Switch ON Termination Resistor for MEMOBUS/Modbus Communications**

When the drive is the last slave in a MEMOBUS/Modbus communications, set DIP switch S2 to the ON position. This drive has a built-in termination resistor for the RS-485 interface.

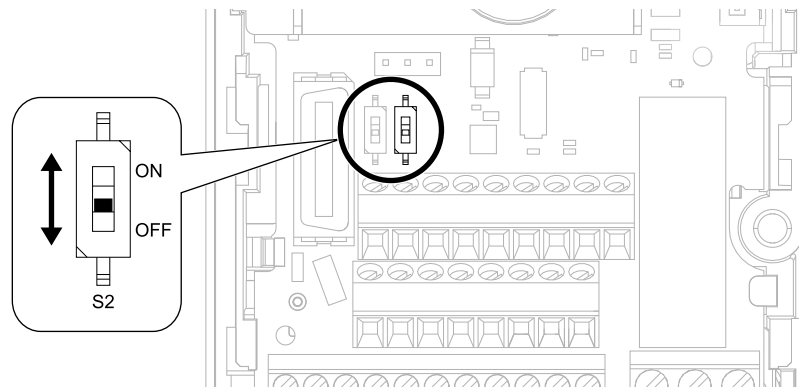

Figure 3.50 Location of DIP Switch S2

Table 3.15 MEMOBUS/Modbus Communications Termination Resistor Setting

DIP switch S2	Description
ON	The built-in termination resistor is ON.
OFF (Default)	The built-in termination resistor is OFF.

3.7 Connect the Drive to a PC

The drive has a mini-B type USB port.

You can use a USB cable (USB 2.0, type: A - mini-B) to connect the drive to a type-A USB port on a PC. After you connect the drive to the PC, you can use Yaskawa DriveWizard software to monitor drive performance and manage parameter settings.

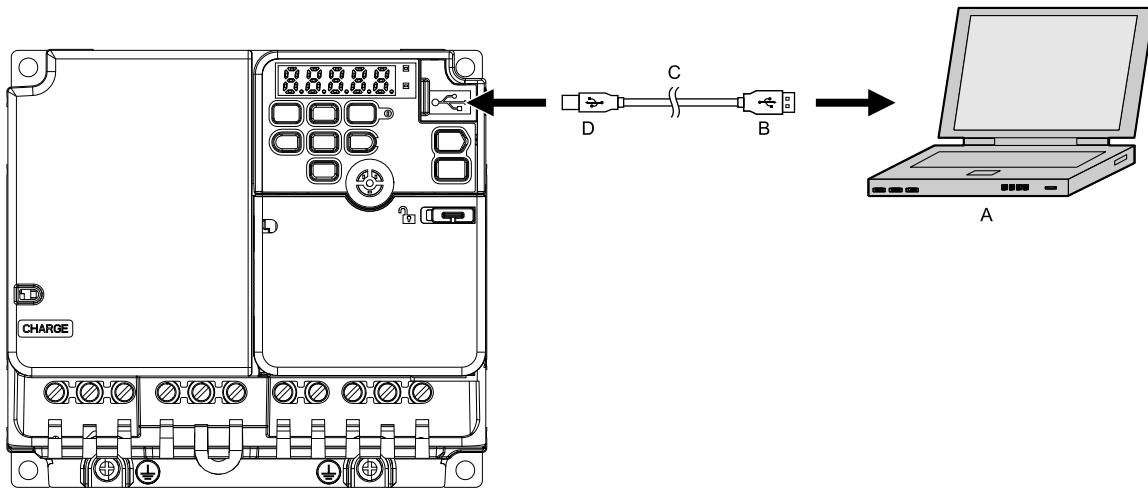

A - PC
B - Type-A connector

C - USB 2.0, type A - mini-B cable
D - Mini-B type connector

Figure 3.51 Connect to a PC (USB)

Yaskawa recommends that you use a USB cable with connectors connected with shielded wires.

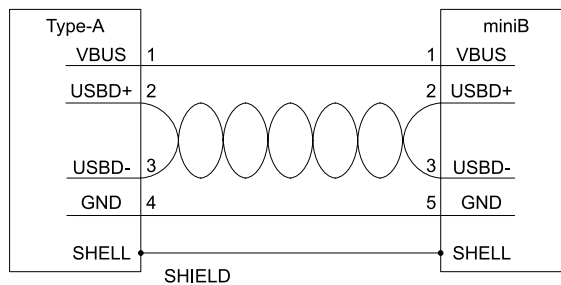

Figure 3.52 Recommended USB Cable

3.9 Braking Resistor Installation

A braking resistor or braking resistor unit (dynamic braking option) helps stop the motor quickly and smoothly when there is high load inertia. If you try to decelerate a motor in less time than usual for a coast to stop, the motor will rotate faster than the synchronous speed that aligns with the set frequency. This will cause the motor to become an induction generator. The inertia energy of the motor and regenerate to the drive and charge the drive DC bus capacitor and increase the voltage. If the voltage is more than the overvoltage level, an *ov* [Overvoltage] will occur. To prevent these overvoltage faults, a dynamic braking option is necessary.

WARNING!

Set $L3-04 = 0$ [Stall Prevention during Decel = Disabled] when you operate the drive with:

- a regenerative converter
- regenerative unit
- braking resistor
- braking resistor unit.

If you set the parameter incorrectly, the drive can decelerate for too long and cause serious injury or death.

NOTICE: Damage to Equipment. Before you connect a dynamic braking option to the drive, make sure that qualified personnel read and obey the Braking Unit and Braking Resistor Unit Installation Manual (TOBPC72060001). If you do not read and obey the manual or if personnel are not qualified, it can cause damage to the drive and braking circuit.

Note:

- Select the correct braking circuit size to dissipate the power that is necessary to decelerate the load in the correct time. Before you run the drive, make sure that the braking circuit can dissipate the energy for the set deceleration time.
- To install a dynamic braking option, set $L8-01 = 0$ [3% ERF DB Resistor Protection = Disabled].

WARNING! Fire Hazard. Do not connect a braking resistor to terminals +1 or -. Use terminals B1 and B2 for the braking resistor connections. If you connect a braking resistor to the incorrect terminals, it can cause damage to the drive and braking circuit and serious injury or death.

NOTICE: Connect braking resistors to the drive as shown in the connection diagram examples. If you wire the braking circuits incorrectly, it can cause damage to the drive or equipment.

To connect a Yaskawa ERF series braking resistor to the drive, set $L8-01 = 1$ [Enabled].

To use a non-ERF-type braking resistor, connect a thermal overload relay between the drive and the braking resistor and set a circuit to turn OFF the drive power at the trip contacts of the thermal overload relay.

◆ Install a Braking Resistor: ERF-Type

Connect the braking resistor to drive models B001 to B018, 2001 to 2021, and 4001 to 4012 as shown in [Figure 3.54](#).

When you use a braking resistor, set $L8-01 = 1$ [3% ERF DB Resistor Protection = Enabled] and set one of the MFDO parameters $H2-01$ to $H2-03 = D$ [MFDO Function Selection = Braking Resistor Fault]. Use a sequence to turn OFF the power with a MFDO.

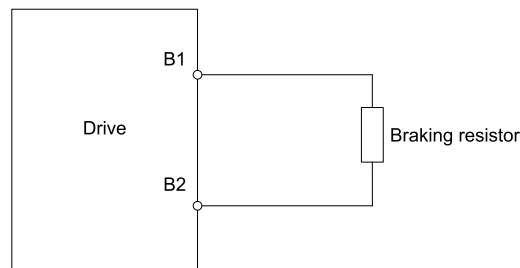

Figure 3.54 Install an ERF-Type Braking Resistor

◆ Install a Braking Resistor Unit: LKEB-Type

Connect the braking resistor unit as shown in [Figure 3.55](#). To install a braking resistor unit, set $L8-01 = 0$ [3% ERF DB Resistor Protection = Disabled].

This product has a built-in braking transistor.

To prevent overheating the braking resistor unit, set a sequence to de-energize the drive at the trip contacts of the thermal overload relay.

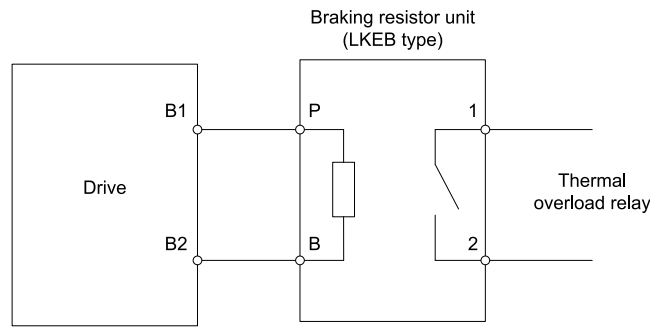

Figure 3.55 Install a Braking Resistor Unit: LKEB-Type

◆ Dynamic Braking Option Overload Protection

To prevent overheating the dynamic braking option, set a sequence to de-energize the drive at the trip contacts of the thermal overload relay.

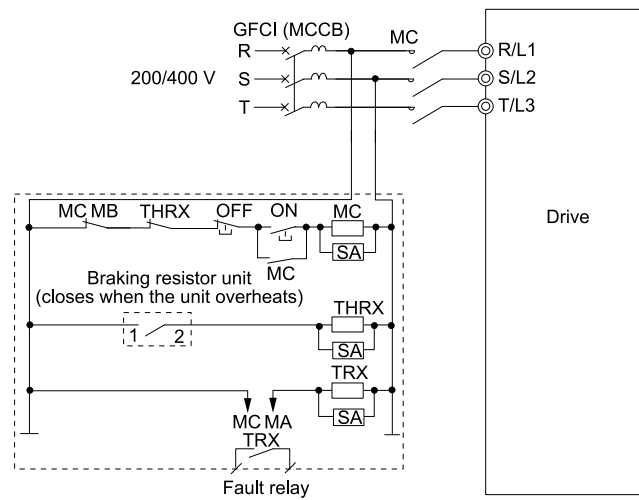

Figure 3.56 Power Supply Interrupt for Overheat Protection Example

WARNING! Fire Hazard. When you use a braking unit, use a thermal relay on the braking resistors and set a fault contact output for the braking resistor unit to disconnect drive main power through an input contactor. Incorrect braking circuit protection can cause the resistors to become too hot and cause serious injury or death.

3.10 Drive Wiring Protection

◆ Installing a Ground Fault Circuit Interrupter (GFCI)

When the drive output switches at high speeds, it causes high frequency leakage current. To prevent electrical shock and fires caused by ground fault protection that is not sufficient, install a GFCI.

Use a high frequency GFCI at the power input side of the drive and make sure that each drive has a minimum cumulative sensitivity amperage of 30 mA. The specialized breaker detects only the leakage current from frequency bands that are dangerous to humans.

If a device does not have protection against high frequencies, high frequency leakage currents can cause the device to malfunction. If you have a malfunction on a device that is not protected, decrease the carrier frequency of the drive, switch to a better breaker, or use a GFCI with a minimum cumulative sensitivity amperage of 200 mA for each drive. These conditions can have an effect on leakage current:

- Drive capacity
- Carrier frequency
- Wiring distance and types of motor cables
- EMI/RFI filter

To prevent damage and injury to personnel and drives, use a high-frequency GFCI that is rated for AC and DC power supplies.

Note:

Yaskawa recommends these GFCIs, which are designed to operate with high frequencies:

- Mitsubishi Electric Corporation, NV series
- Schneider Electric, NS series

You can use a molded-case circuit breaker (MCCB) as a replacement for a GFCI that is upstream in the power supply system.

◆ Installing a Molded-Case Circuit Breaker (MCCB) or Ground Fault Circuit Interrupter (GFCI)

Install a molded-case circuit breaker (MCCB) or a ground fault circuit interrupter (GFCI) for line protection between the power supply and main circuit power supply input terminals R/L1, S/L2, and T/L3. The MCCB or GFCI gives overload protection and also prevents damage to the main circuit and the devices that are wired to the main circuit.

Use the information in this section to select the correct MCCB or GFCI and to safely connect the device.

- The capacity of the MCCB or GFCI must be 1.5 to 2 times the rated output current of the drive. Use an MCCB or GFCI as an alternative to overheat protection (150% for one minute at the rated output current) to prevent drive faults.
- When you connect more than one drive or the drive and other device to an MCCB or GFCI, refer to [Figure 3.57](#), use a magnetic contactor (MC), and set a sequence that de-energizes the drive when it outputs errors.

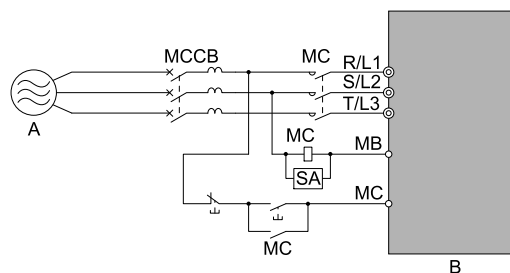

A - Power Supply

B - Drive

Figure 3.57 Connect an MCCB

WARNING! *Electrical Shock Hazard. Use an MCCB, GFCI, or Magnetic Contactor (MC) to de-energize the drive before you wire the main circuit terminal. If the main circuit terminal is energized during wiring, it will cause serious injury or death.*

3.11 Dynamic Braking Option, Motor Protection

◆ Install an Electromagnetic Contactor (MC) at the Input Side of the Drive

You can use an MC as an alternative to a molded case circuit breaker (MCCB) when:

- The protective functions of the drive have been triggered
- An emergency stop occurred, and the sequence de-energizes the drive.

If an MC on the input side of the drive (primary side) stops the drive, regenerative braking will not operate, and the drive will coast to stop.

NOTICE: *When you connect electromagnetic switches or magnetic contactors to the output motor circuits, make sure that you sequence them correctly. If the output motor circuit sequence is incorrect, it can cause damage to the drive.*

NOTICE: *Damage to Equipment. Do not energize and de-energize the drive more frequently than one time each 30 minutes. If you frequently energize and de-energize the drive, it can cause drive failure.*

Note:

- When machinery must not restart after recovery from a momentary power loss that occurred during run, install an MC at the input side of the drive and set a sequence that does not automatically set the Run command to ON after recovery of power.
- When it is necessary to stop momentary power loss, for example to maintain a circuit that has momentary power loss, use a delayed-release MC.
- Use an MC (magnetic contactor) to make sure that you can fully remove power to the drive when necessary. Wire the MC to open when a fault output terminal is triggered.

■ Protect the Braking Resistor/Braking Resistor Unit

Use an MC on the input side (primary side) to prevent damage to the braking resistor/braking resistor unit.

WARNING! *Fire Hazard. When you use a braking unit, use a thermal relay on the braking resistors and set a fault contact output for the braking resistor unit to disconnect drive main power through an input contactor. Incorrect braking circuit protection can cause the resistors to become too hot and cause serious injury or death.*

◆ Installing a Thermal Overload Relay on the Drive Output

A thermal overload relay disconnects the power line to the motor during a motor overload condition to prevent damage to the motor.

Install a thermal overload relay between the drive and motor in these conditions:

- When you operate more than one motor with one drive
- When you operate the motor directly from the power line with a power line bypass

When you operate one motor with one drive, it is not necessary to install a thermal overload relay. The drive has electronic motor overload protection in the drive software.

Note:

- When you install a thermal overload relay, set parameter $L1-01 = 0$ [*Motor Overload (oL1) Protection = Disabled*].
- Set up a sequence that will trip an external fault (coast to stop) for the contacts of the thermal overload relay.

■ General Precautions When Using Thermal Overload Relays

When you use a motor thermal overload relay on the drive output to prevent nuisance trips and overheating of the motor at low speeds, be sure to think about these application precautions:

- Operation of a low speed motor
- When you operate more than one motor with one drive
- Length of the motor cables
- Nuisance tripping because of high drive carrier frequency

Operation of a Low Speed Motor

Usually, you use thermal overload relays on general-purpose motors (standard motors). When a drive drives a general-purpose motor, the motor current is approximately 5% to 10% more than with a commercial power supply. When a motor with a shaft-driven fan operates at low speeds, the cooling capacity decreases. This can cause the motor to overheat when the load current is in the motor rated value. Enable the electronic thermal protection in the drive when possible to prevent this problem.

The electronic thermal overload function uses the relation between the speed and heat characteristics in the variable speed control range to simulate the cooling ability of general-purpose motors and forced-vented motors to prevent damage to the motor.

When You Operate More than One Motor with One Drive

To disable the overload protection function of the electronic thermal protector of the drive, set $L1-01 = 0$ [*Motor Overload (oL1) Protection = Disabled*].

Note:

If you operate more than one motor from one drive, you cannot use the electronic thermal protection of the drive.

Length of the Motor Cables

If you use long motor cables with a high carrier frequency, the increased leakage current can cause nuisance tripping of the thermal relay. To prevent this, decrease the carrier frequency or increase the tripping level of the thermal overload relay.

Nuisance Tripping Because of High Drive Carrier Frequency

High carrier frequency PWM drives make current waveforms that can increase the temperature in overload relays. It may be necessary to increase the trip level setting when encountering nuisance triggering of the relay.

WARNING! Fire Hazard. Before you increase the detection level of the thermal relay, make sure that a secondary problem is not the cause of the overload. Make sure that you know the local codes for electrical wiring, then adjust the electrothermal settings. Incorrect thermal relay adjustment and incorrect wiring can cause serious injury or death.

3.12 Improve the Power Factor

◆ Connect an AC Reactor or a DC Link Choke

AC reactors and DC link chokes decrease surges in current and improve the power factor on the input side of the drive.

Connect an AC reactor or a DC link choke the input side (primary side) in the these conditions:

- To decrease harmonic current or improve the power factor of the power supply
- When there is switching of phase advancing capacitor
- With a large capacity power supply transformer (600 kVA or more).

Note:

- You can use an AC reactor and DC link choke together.
- When you connect a thyristor converter (for example, a DC drive) to the same power supply system, use an AC reactor.
- The main circuit terminal block for the drive, and the terminal blocks for the AC reactor and DC Link Choke come in different shapes. The drive has a European-style terminal block, and the AC reactor and DC Link Choke have a circular terminal block. Correctly prepare the ends of the wiring.
- Ground the AC reactor and DC Link Choke (option) on the back of the mounting base. Remove all paint from the mounting surface of the control panel.

■ Connect an AC Reactor

Note:

When you connect an AC reactor to the output side (secondary side) of the driver, set $C6-02 = 1$ [Carrier Frequency Selection = 2.0 kHz].

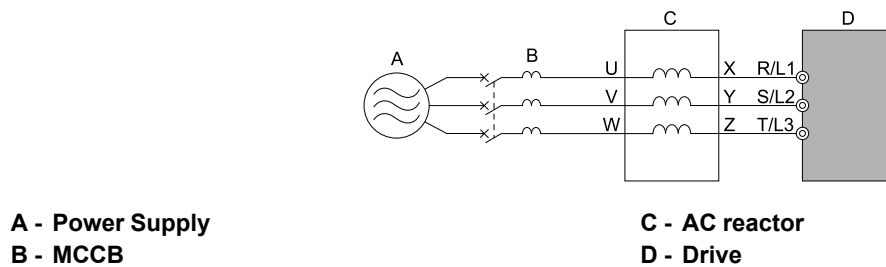

Figure 3.58 AC Reactor Connection Example

■ Connect a DC Link Choke

When you install a DC link choke, remove the jumper between terminals +1 and +2. If you will not use a DC link choke, do not remove the jumper. Refer to [Figure 3.59](#) for an example of how to wire the DC link choke.

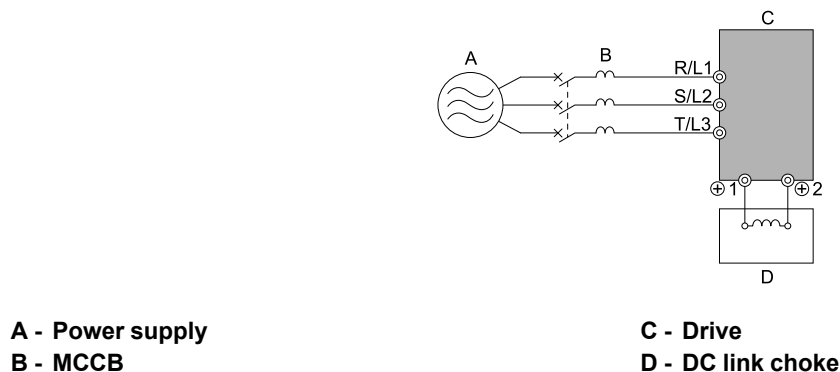

Figure 3.59 DC Link Choke Connection Example

Note:

You cannot connect a DC link choke to drive models B001 to B018.

3.13 Prevent Switching Surge

◆ Connect a Surge Protective Device

A surge protective device decreases the surge voltage generated when you switch an inductive load near the drive. Inductive loads include:

- Magnetic contactors
- Electromagnetic relays
- Magnetic valves
- Solenoids
- Magnetic brakes.

Always use a surge protective device or diode with inductive loads.

Note:

Do not connect a surge protective device to the drive output side.

3.14 Decrease Noise

Note:

The main circuit terminal block for the drive and the terminal block for the noise filter come in different shapes. The drive has a European-style terminal block and the noise filter has a circular terminal block. Correctly prepare the ends of the wiring.

◆ Connect a Noise Filter to the Input Side (Primary Side)

High-speed switching makes noise in the drive output. This noise flows from the drive to the power supply, and can have an effect on other equipment. Install a noise filter to the input side of the drive to decrease the quantity of noise that flows to the power supply. A noise filter will also stop noise from entering the drive from the power supply.

- Use a noise filter specially designed for drives.
- Install the noise filter as close as possible to the drive.

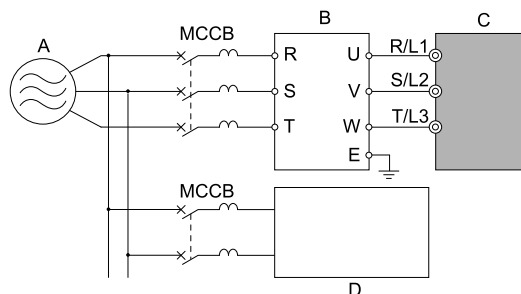

A - Power Supply

B - Input side (primary side) noise filter

C - Drive

D - Other controller

Figure 3.60 Example of Connecting the Noise Filter on the Input Side (Primary Side)

Note:

The input side (primary side) noise filter model is RTEN-5xxx.

Drive models GA50CxxxxExx have built-in input noise filters. When you use these drives, make sure that the filter specifications align with the application and applicable regulations. Refer to [European Standards on page 168](#) for more information.

◆ Connect a Noise Filter to the Output Side (Secondary Side)

A noise filter on the output side of the drive decreases inductive noise and radio frequency interference.

Figure 3.61 shows an example of noise filter wiring.

NOTICE: Do not connect phase-advancing capacitors, LC/RC noise filters, or leakage breakers (GFCI) to the motor circuit. If you connect these devices to the output circuits, it can cause damage to the drive and connected equipment.

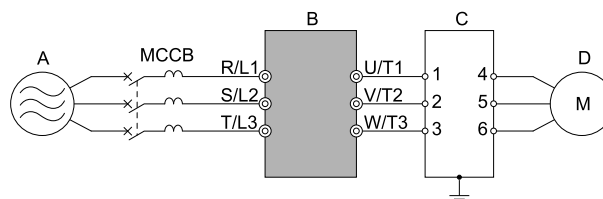

A - Power supply

B - Drive

C - Noise filter on output side (secondary side)

D - Motor

Figure 3.61 Example of Connecting the Noise Filter on the Output Side (Secondary Side)

Note:

Glossary

- Radio frequency interference: Electromagnetic waves radiated from the drive and cables make noise through the full radio bandwidth that can have an effect on nearby devices.
- Inductive noise: The noise from electromagnetic induction can have an effect on the signal line and can cause the controller to malfunction.

■ Prevent Inductive Noise

In addition to installing a noise filter, you can also run all wiring through a grounded metal conduit to decrease inductive noise occurring at the output side. Put the cables a minimum of 30 cm (11.8 in) away from the signal line to prevent induced noise. Ground the cables to metal conduits.

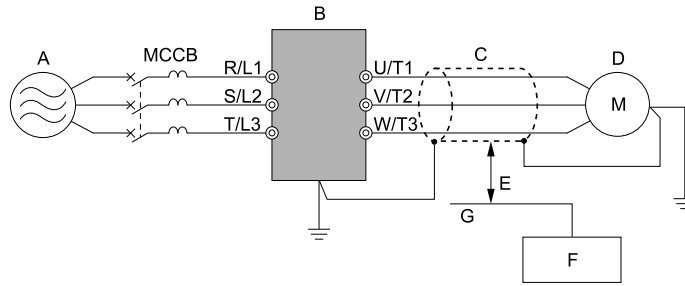

- A - Power supply
- B - Drive
- C - Shielded motor cable
- D - Motor

- E - Minimum of 30 cm (11.8 in) apart
- F - Controller
- G - Signal line

Figure 3.62 Prevent Inductive Noise

■ Decrease Radio Frequency Interference

The drive, input lines, and output lines generate radio frequency interference. Use noise filters on input and output sides and install the drive in a steel box to decrease radio frequency interference.

Note:

Keep the cable between the drive and motor as short as possible.

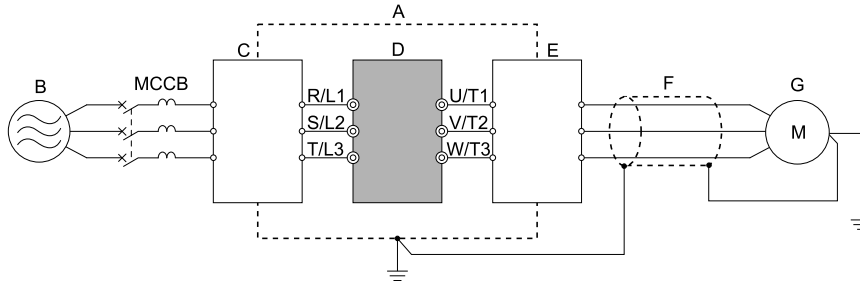

- A - Steel box
- B - Power supply
- C - Noise filter
- D - Drive

- E - Noise filter
- F - Shielded motor cable
- G - Motor

Figure 3.63 Decrease Radio Frequency Interference

3.15 Factory-Recommended Branch Circuit Protection for UL Listing

WARNING! Electrical Shock Hazard. After the input protective device trips, do not immediately energize the drive or operate peripheral devices. Wait for the time specified on the warning label at a minimum and make sure that all indicators are OFF. Then check the wiring and peripheral device ratings to find the cause of the problem. If you do not know the cause of the problem, contact Yaskawa before you energize the drive or peripheral devices. If you do not fix the problem before you operate the drive or peripheral devices, it can cause serious injury or death.

◆ UL Compliance

Install one of the types of short circuit protection devices in *Single-Phase 200 V Class on page 115*, *Three-Phase 200 V Class on page 116*, and *Three-Phase 400 V Class on page 116* to comply with UL61800-5-1. Yaskawa recommends connecting semiconductor protective type fuses, but *Single-Phase 200 V Class on page 115*, *Three-Phase 200 V Class on page 116*, and *Three-Phase 400 V Class on page 116* also show alternative short circuit protection devices.

When you use MCCBs, RK1, or RK5 fuses, you must mount the drive in a ventilated enclosure according to the minimum enclosure volume specified in *Single-Phase 200 V Class on page 115*, *Three-Phase 200 V Class on page 116*, and *Three-Phase 400 V Class on page 116*.

■ Molded Case Circuit Breaker (MCCB) Ratings

- Maximum MCCB rating is 200% of the Normal Duty drive full load output amp (FLA) rating.
- When you use MCCBs, install the drive into a ventilated enclosure with a minimum enclosure volume.

Note:

When you use MCCBs, current limiting type are recommended, but not required.

■ Non-Semiconductor Fuse Ratings

- Maximum CC, J, T, RK1 or RK5 fuse rating is 175% of the Normal Duty drive full load output amp (FLA) rating.

■ Short Circuit Current Ratings (SCCR)

The maximum SCCR provided by drive and fuse, or drive and MCCB combinations in this document, is 31,000 RMS symmetrical amps.

- 200 V Class drives: Use the protection specified in this document to prepare the drive for use on a circuit that supplies not more than 31,000 RMS and not more than 240 Vac when there is a short circuit in the power supply.
- 400 V Class drives: Use the protection specified in this document to prepare the drive for use on a circuit that supplies not more than 31,000 RMS and not more than 480 Vac when there is a short circuit in the power supply.

■ Electric Code Compliance

The user must provide short circuit protection to protect input branch circuits as specified by the National Electric Code (NEC), the Canadian Electric Code, Part 1 (CEC), and local codes.

■ Single-Phase 200 V Class

Table 3.16 Factory-Recommended Branch Circuit Protection: Single-Phase 200 V Class

Drive Model	Ventilated Protected Enclosure Not Required		Ventilated Protected Enclosure Required		
	Semiconductor Fuse Manufacturer: EATON/ Bussmann	Class J, CC, and T Fuse Maximum Amps	MCCB Maximum Amps	Class RK1 or RK5 Fuse Maximum Amps	Minimum Enclosure Volume (in ³)
B001	FWH-25A14F	3.5	15	3.5	600
B002	FWH-25A14F	6	15	6	600
B004	FWH-60B	12	15	12	600
B006	FWH-80B	20	25	20	600
B010	FWH-100B	35	40	35	960
B012	FWH-125B	40	45	40	960
B018	FWH-150B	60	70	60	960

■ Three-Phase 200 V Class

Table 3.17 Factory-Recommended Branch Circuit Protection: Three-Phase 200 V Class

Drive Model	Ventilated Protected Enclosure Not Required		Ventilated Protected Enclosure Required		
	Semiconductor Fuse Manufacturer: EATON/ Bussmann	Class J, CC, and T Fuse Maximum Amps	MCCB Maximum Amps	Class RK1 or RK5 Fuse Maximum Amps	Minimum Enclosure Volume (in ³)
2001	FWH-25A14F	2	15	2	600
2002	FWH-25A14F	3.2	15	3.2	600
2004	FWH-25A14F	6	15	6	600
2006	FWH-25A14F	10	15	10	600
2008	FWH-70B	12	15	12	600
2010	FWH-70B	15	15	15	600
2012	FWH-70B	20	20	20	600
2018	FWH-90B	30	35	30	960
2021	FWH-90B	35	40	35	960
2030	FWH-100B	50	60	50	960
2042	FWH-150B	70	80	-	960
2056	FWH-200B	90	110	-	2560
2070	FWH-200B	110	125	-	2560
2082	FWH-225B	125	150	-	2560

■ Three-Phase 400 V Class

Table 3.18 Factory-Recommended Branch Circuit Protection: Three-Phase 400 V Class

Drive Model	Ventilated Protected Enclosure Not Required		Ventilated Protected Enclosure Required		
	Semiconductor Fuse Manufacturer: EATON/ Bussmann	Class J, CC, and T Fuse Maximum Amps	MCCB Maximum Amps	Class RK1 or RK5 Fuse Maximum Amps	Minimum Enclosure Volume (in ³)
4001	FWH-40B	2	15	2	960
4002	FWH-40B	3.5	15	3.5	960
4004	FWH-50B	7	15	7	960
4005	FWH-70B	9	15	9	960
4007	FWH-70B	12	15	12	960
4009	FWH-90B	15	15	15	960
4012	FWH-90B	20	20	20	960
4018	FWH-80B	30	35	30	960
4023	FWH-100B	40	40	40	960
4031	FWH-125B	50	60	50	2560
4038	FWH-175B	60	75	-	2560
4044	FWH-200B	75	80	-	2560
4060	FWH-200B	100	110	-	2560

3.16 Wiring Checklist

Checked	No.	Item to Check
	7	Pick up all wire clippings.
	8	Make sure that none of the wires on the terminal block touch other terminals or connections.
	9	Make sure that you isolate the control circuit wiring from main circuit wiring in the control panel or in a duct.
	10	Make sure that control circuit wiring is not longer than 50 m (164 ft).
	11	Make sure that Safe Disable input wiring is not longer than 30 m (98 ft).

3.17 Motor Application Precautions

◆ Precautions for Existing Standard Motors

■ Low-Speed Range

When a drive operates a standard motor, it will lose more power compared to operating the motor with a commercial power supply. In the low speed range, the temperature of the motor increases quickly because the motor cannot decrease its temperature when the speed decreases. In these conditions, decrease the load torque of the motor in the low-speed range. Figure 3.64 shows the permitted load characteristics for a Yaskawa standard motor. When 100% continuous torque is necessary at low speeds, use a motor designed to operate with a drive.

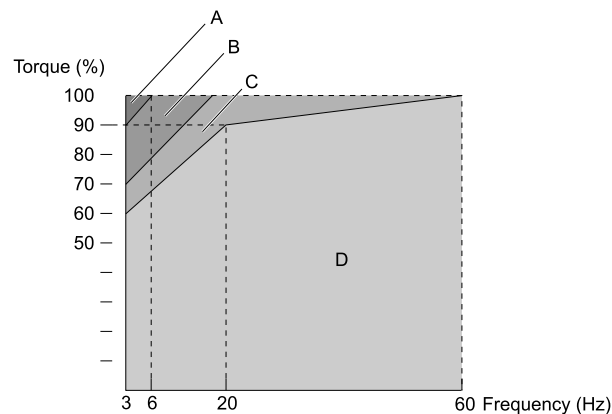

A - 25% ED (or 15 min)

B - 40% ED (or 20 min)

C - 60% ED (or 40 min)

D - Continuous operation

Figure 3.64 Permitted Load Characteristics for a Yaskawa Standard Motors

■ Insulation Withstand Voltage

Consider motor voltage tolerance levels and motor insulation in applications with an input voltage of over 440 V or particularly long wiring distances. Use an insulated drive motor.

NOTICE: Use an inverter-duty motor or vector-duty motor with reinforced insulation and windings applicable for use with an AC drive. If the motor does not have the correct insulation, it can cause a short circuit or ground fault from insulation deterioration.

■ High-Speed Operation

If you operate a motor more than its rated speed, you can have problems with the motor bearing durability and dynamic balance of the machine. Contact the motor or machine manufacturer.

■ Torque Characteristics

When you operate a motor with a drive, the torque characteristics are different than when you operate the motor directly from line power. Make sure that you know about the load torque characteristics for your application.

■ Vibration

Vibrations could occur in the these conditions:

- Resonance with the natural frequency of machinery
Use caution if you add a variable-speed drive to applications that operate the motor from line power at a constant speed. If resonance occurs, install shock-absorbing rubber around the base of the motor and enable the Jump frequency control.
- The motor is not balanced
Use caution if the motor speed is more than the rated motor speed.
- Subsynchronous resonance
Subsynchronous resonance can occur with long motor shafts and in applications such as turbines, blowers, and fans with high inertia loads.

■ Audible Noise

The audible noise of the motor changes when the carrier frequency setting changes. When you use a high carrier frequency, audible noise from the motor is equivalent to the motor noise generated when you operate from line power. If you operate at speeds that are more than the rated rotation speed, the unwanted motor noise increases.

◆ Precaution When You Use IE3 Premium Efficiency Motors

IE3 motors have different motor characteristics from IE1 and other motors. Set the parameters as specified by the motor characteristics. If you have a momentary power loss, and the drive detects *oC* [*Overcurrent*] or *ov* [*Overvoltage*] during speed search after it restores power, set these parameters:

- *b3-03* [*Speed Search Deceleration Time*] = default value × 2
 - *L2-03* [*Minimum Baseblock Time*] = default value × 2
 - *L2-04* [*Powerloss V/f Recovery Ramp Time*] = default value × 2
-

◆ Precautions for PM Motors

- Contact Yaskawa or your nearest sales representative to use a non-Yaskawa PM motor.
- You cannot operate a PM motor from a commercial power supply. If you must operate from a commercial power supply, use an induction motor.
- You cannot operate more than one PM motor from one drive. Use an induction motor and a variable-speed control drive.
- In OLV/PM, the motor can operate in the reverse direction for 1/2 turn (electrical angle) at start up.
- The quantity of generated starting torque changes when the control method and motor type change. Verify the starting torque, permitted load characteristics, impact load tolerance, and speed control range before you set up the motor with the drive. Contact Yaskawa or your nearest sales representative to use a motor that does not meet these specifications.
- In OLV/PM control, braking torque is always 125% or less when operating between 20% and 100% speed. A braking resistor unit will not change the value. Braking torque is 50% or less when operating at 20% speed or less.
- When you use a holding brake in OLV/PM control, release the brake before you start the motor. Failure to set the correct timing can cause a decrease in speed. Do not use these configurations in applications with heavy loads, for example conveyors or elevators.
- To restart a coasting motor that is rotating faster than 120 Hz, first use the Short Circuit Braking function to stop the motor. A special braking resistor unit is necessary for Short Circuit Braking. Contact Yaskawa or your nearest sales representative for more information.
To restart a coasting motor that is rotating slower than 120 Hz, use the Speed Search function.
If the motor cable is long, use Short Circuit Braking to stop the motor.

Note:

The Short Circuit Braking function uses the drive to forcefully cause a short across the motor wires to stop the motor before it has time to coast to a stop.

- You can also use EZOLV to operate synchronous reluctance motors (SynRM). Contact Yaskawa or your nearest sales representative for more information.
 - If *oC* [*Overcurrent*], *STPo* [*Motor Step-Out Detected*], or *LSo* [*Low Speed Motor Step-Out*] occur during restart, try Speed Search again and use the Short Circuit Braking function when you start to adjust the motor.
-

◆ Precautions for Specialized Motors

■ Pole Change Motors

The rated current of pole change motors is different than standard motors. Check the maximum current of the motor before you select a drive. Always stop the motor before you switch between the number of motor poles. If you change the number of poles while the motor is rotating, the overvoltage from regeneration or the overcurrent protection circuitry will make the motor coast to stop.

■ Submersible Motors

The rated current of a submersible motor is more than the rated current of a standard motor. Use a sufficiently large motor cable that will not let voltage drop decrease the maximum torque level.

■ Explosion-Proof Motors

You must test the motor and the drive together for explosion-proof certification. You must also test existing installations of explosion-proof motors. The drive is not designed for explosion-proof areas. Install the drive in a safe location.

The encoder used with pressure-resistant explosion-proof motors is intrinsically safe. When wiring between the drive and encoder, always connect through a specialized pulse coupler.

■ Geared Motors

The continuous speed range is different for different lubricating methods and manufacturers. For oil lubrication, continuous operation in the low-speed range can cause burnout. Contact the manufacturer for more information about applications where operating at more than the rated frequency is necessary.

■ Single-Phase Motors

Variable speed drives are not designed to operate with single-phase motors. The drive is for use with three-phase motors only. If you use capacitors to start the motor, it can cause a high frequency current to flow to the capacitors and can damage the capacitors. A split-phase start or a repulsion start can burn out the starter coils because the internal centrifugal switch is not activated.

■ Motors with Brakes

If you use a drive to operate a motor that has a brake connected to the output side, low voltage levels can cause the brake to possibly not release at start. Use a motor with a brake that has a dedicated source of power for the brake. Connect the brake power supply to the power supply side of the drive. Motors with built-in brakes make noise when operating at low speeds.

◆ Notes on the Power Transmission Mechanism

For power transmission machinery that uses oil to lubricate gearboxes, transmissions, or reduction gears, make sure that you use precaution if you operate the machinery continuously at low speed. Oil does not lubricate the system as well at low speeds. If you operate at frequencies higher than the rated frequency, it can cause problems with the power transmission mechanism. These problems include audible noise, decreased service life, and decreased durability.

Startup Procedure and Test Run

4.1	Section Safety	124
4.2	Overview of Keypad Components and Functions	125
4.3	Set up the Drive with General-Purpose Setup Mode.....	129
4.4	Drive Mode and Programming Mode.....	131
4.5	Start-up Procedures	136
4.6	Items to Check before Starting Up the Drive	141
4.7	Keypad Operation	142
4.8	Automatic Parameter Settings Optimized for Specific Applications (Application Presets).....	147
4.9	Auto-Tuning	148
4.10	Test Run	155
4.11	Fine Tuning during Test Runs (Adjust the Control Function).....	157
4.12	Test Run Checklist	162

4.1 Section Safety

DANGER

Electrical Shock Hazard

Do not examine, connect, or disconnect wiring on an energized drive. Before servicing, disconnect all power to the equipment and wait for the time specified on the warning label at a minimum. The internal capacitor stays charged after the drive is de-energized. The charge indicator LED extinguishes when the DC bus voltage decreases below 50 Vdc. When all indicators are OFF, measure for dangerous voltages to make sure that the drive is safe.

If you do work on the drive when it is energized, it will cause serious injury or death from electrical shock.

WARNING

Electrical Shock Hazard

Do not operate the drive when covers are missing. Replace covers and shields before you operate the drive. Use the drive only as specified by the instructions.

Some figures in this section include drives without covers or safety shields to more clearly show the inside of the drive. If covers or safety shields are missing from the drive, it can cause serious injury or death.

Do not remove covers or touch circuit boards while the drive is energized.

If you touch the internal components of an energized drive, it can cause serious injury or death.

4.2 Overview of Keypad Components and Functions

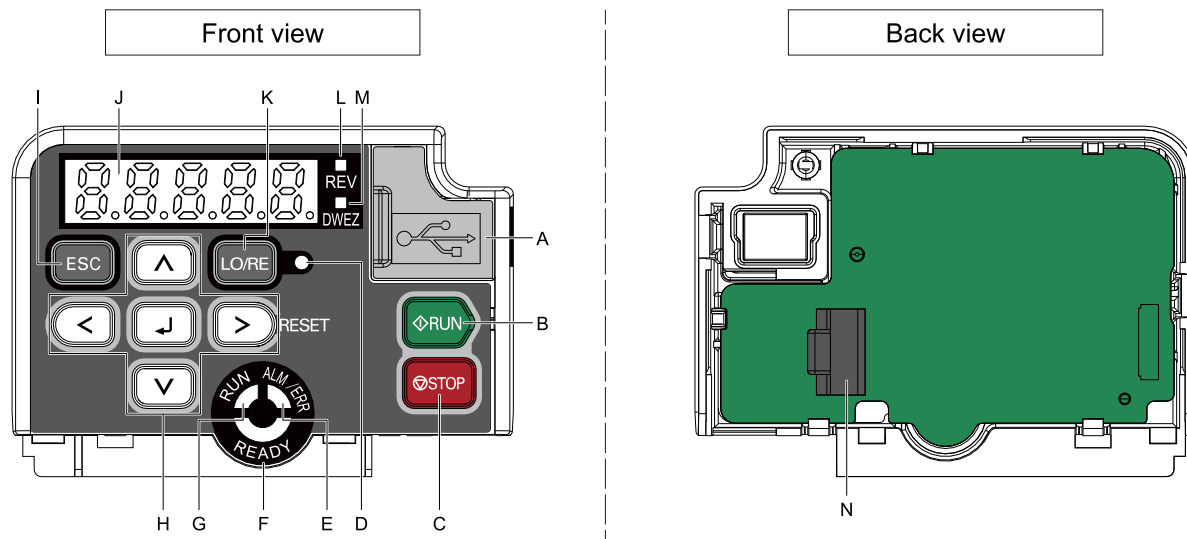





















Figure 4.1 Keypad

Table 4.1 Keypad Components and Functions

Symbol	Name	Function
A	USB Terminal Pass-through	Pass-through point to connect a USB cable to the drive to use the DriveWizard PC tool or the DriveWizard Mobile App to program the drive. Uses a USB cable (USB standard 2.0, type A - mini-B) to connect the drive to a PC, Android smartphone, or tablet.
B	RUN Key 	Starts the drive in LOCAL Mode. Starts the operation in Auto-Tuning Mode. Note: Before you use the keypad to operate the motor, push  on the keypad to set the drive to LOCAL Mode.
C	STOP Key 	Stops drive operation. Note: Uses a stop-priority circuit. Push  to stop the motor. This will also apply when a Run command (REMOTE Mode) is active at an external Run command source. To disable  priority, set $o2-02 = 0$ [<i>STOP Key Function Selection = Disabled</i>].
D	LO/RE LED 	Illuminated: The keypad controls the Run command (LOCAL Mode). OFF: The control circuit terminal or serial transmission device controls the Run command (REMOTE Mode). Note: • LOCAL: Use the keypad to operate the drive. Use the keypad to enter Run/Stop commands and the frequency reference command. • REMOTE: Use the control circuit terminal or serial transmission to operate the drive. Use the frequency reference source entered in $b1-01$ and the Run command source selected in $b1-02$.
E	ALM/ERR LED 	Illuminated: The drive detects a fault. OFF: There are no drive faults or alarms. Flashing: • Alarm • Operation Errors • An Auto-Tuning error Note: The LED will illuminate to identify a fault if the drive detects a fault and an alarm at the same time.
F	READY LED 	Illuminated: The drive is operating or is ready for operation. OFF: • The drive detects a fault. • There is no fault and the drive received a Run command, but the drive cannot run. For example, in Programming Mode. Flashing: The drive is in <i>Sto</i> [<i>Safe Torque OFF</i>] condition. Flashing quickly: The voltage of the main circuit power supply is not in the drive nameplate specifications, and the external 24 V power supply is providing the only power to the drive.

4.2 Overview of Keypad Components and Functions

Symbol	Name	Function
G	RUN LED 	<p>Illuminated: The drive is in normal operation. OFF: The drive is stopped.</p> <p>Flashing:</p> <ul style="list-style-type: none"> The drive is decelerating to stop. The drive received a Run command with a frequency reference of 0 Hz, but the drive is not set for zero speed control <p>Flashing quickly:</p> <ul style="list-style-type: none"> The drive received a Run command from the MFDI terminals while in LOCAL Mode and it switched to REMOTE Mode. The drive received a Run command from the MFDI terminals when the drive is not in Drive Mode. The drive received a Fast Stop command. The safety function shut off the drive output. <ul style="list-style-type: none"> You pushed  on the keypad while the drive is operating in REMOTE Mode. The drive is energized with an active Run command and $b1-17 = 0$ [Run Command at Power Up = Disregard Existing RUN Command].
H	Left Arrow Key 	Moves the cursor to the left.
	Up Arrow Key/Down Arrow Key 	<ul style="list-style-type: none"> Moves to a different screen. Selects parameter numbers and increments or decrements setting values.
	Right Arrow Key (RESET) 	<ul style="list-style-type: none"> Moves the cursor to the right. Resets the drive to clear a fault.
	ENTER Key 	<ul style="list-style-type: none"> Enters parameter values and settings. Selects each mode, parameter, and set value.
I	ESC Key 	<ul style="list-style-type: none"> Goes back to the previous screen. Push and hold to go back to the frequency reference screen (the initial screen).
J	LED Display	Shows parameters, errors, and other data.
K	LO/RE Selection Key 	<p>Switches drive control for the Run command and frequency reference between the keypad (LOCAL) and an external source (REMOTE).</p> <p>Note:</p> <ul style="list-style-type: none"> The LOCAL/REMOTE Selection Key continuously stays enabled after the drive stops in Drive Mode. If the application must not switch from REMOTE to LOCAL because it will have a negative effect on system performance, set $o2-01 = 0$ [LO/RE Key Function Selection = Disabled] to disable . The drive will not switch between LOCAL and REMOTE when it is receiving a Run command from an external source.
L	REV LED 	Illuminated: The drive received a Reverse run command.
M	DWEZ LED 	Illuminated: The drive is In DriveWorksEZ operation.
N	RJ-45 Connector	Connects to the drive. Use an RJ-45 8-pin straight UTP CAT5e extension cable to install the keypad in a different location than the drive.

WARNING! Sudden Movement Hazard. If you change the control source when $b1-07 = 1$ [LOCAL/REMOTE Run Selection = Accept Existing RUN Command], the drive can start suddenly. Before you change the control source, remove all personnel from the area around the drive, motor, and load. Sudden starts can cause serious injury or death.

Drive models GA50Axxxxxxx-xxxxLx ship from the factory with a blank cover instead of a keypad. To set parameters on these models, connect an optional keypad or engineering tool to one of the connection ports shown in [Figure 4.2](#).

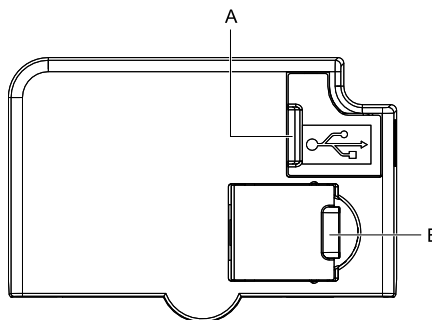

Figure 4.2 Blank Cover

Table 4.2 Blank Cover Components and Functions

Symbol	Name	Function
A	USB Terminal Pass-through	Pass-through point to connect a USB cable to the drive to use the DriveWizard PC tool or the DriveWizard Mobile App to program the drive. Uses a USB cable (USB standard 2.0, type A - mini-B) to connect the drive to a PC, Android smartphone, or tablet.
B	RJ-45 Connector Pass-through	Connects to the drive. Use an RJ-45 8-pin straight UTP CAT5e extension cable to use the keypad option to program the drive.

◆ Indicator flashing statuses

Refer to Figure 4.3 for the difference between “flashing” and “flashing quickly”.

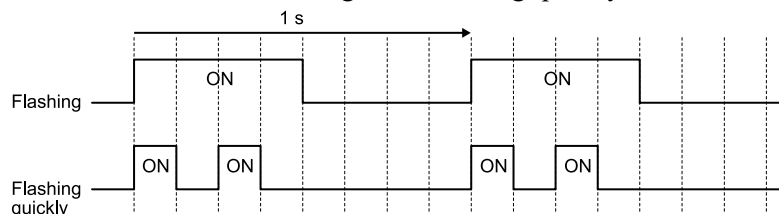

Figure 4.3 About indicator flashing statuses

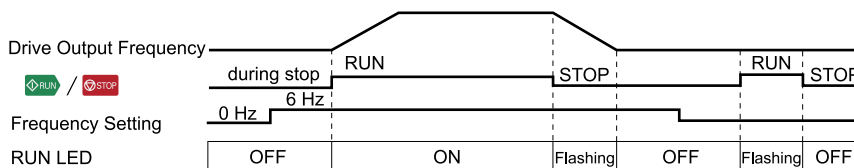

Figure 4.4 Relation between RUN indicator and Drive Operation

◆ Keypad Mode and Menu Displays

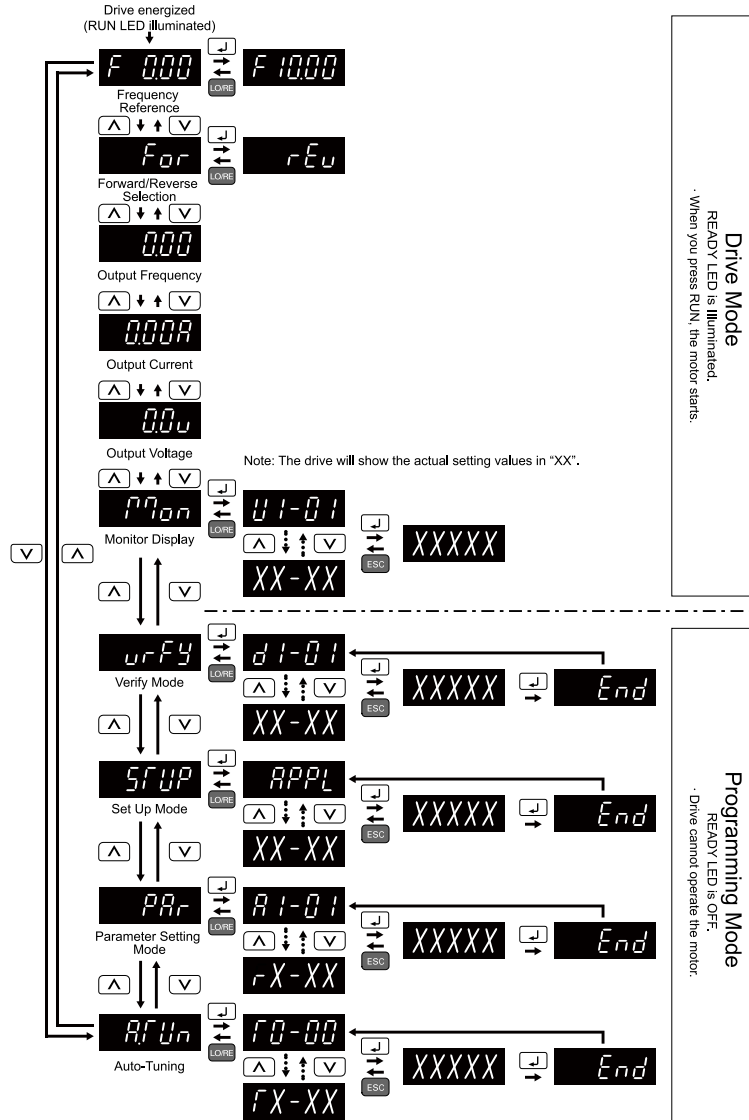

Figure 4.5 Keypad Functions and Display Levels

4.3 Set up the Drive with General-Purpose Setup Mode

Drive parameters are in letter groups from A to U. Setup Mode **SFUP** contains only the most frequently used parameters to help you set up the drive more easily.

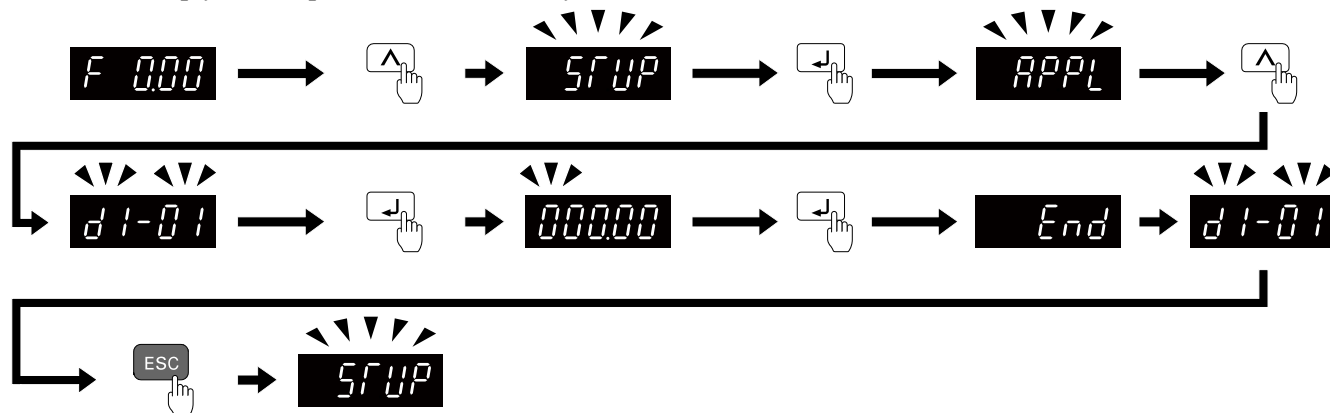

Figure 4.6 Parameters in General-Purpose Setup Mode

Table 4.3 shows the parameters available in Setup Mode. To access parameters not shown in the Setup Mode, use the **PAR** menu.

Table 4.3 Parameters in General-Purpose Setup Mode

User Parameter	Parameter	Name
A2-01	A1-02	Control Method Selection
A2-02	b1-01	Frequency Reference Selection 1
A2-03	b1-02	Run Command Selection 1
A2-04	b1-03	Stopping Method Selection
A2-05	C1-01	Acceleration Time 1
A2-06	C1-02	Deceleration Time 1
A2-07	C6-01	Normal / Heavy Duty Selection
A2-08	C6-02	Carrier Frequency Selection
A2-09	d1-01	Reference 1
A2-10	d1-02	Reference 2
A2-11	d1-03	Reference 3
A2-12	d1-04	Reference 4
A2-13	d1-17	Jog Reference
A2-14	E1-01	Input AC Supply Voltage
A2-15	E1-03	V/f Pattern Selection
A2-16	E1-04	Maximum Output Frequency
A2-17	E1-05	Maximum Output Voltage
A2-18	E1-06	Base Frequency
A2-19	E1-09	Minimum Output Frequency
A2-20	E1-13	Base Voltage
A2-21	E2-01	Motor Rated Current (FLA)
A2-22	E2-04	Motor Pole Count
A2-23	E2-11	Motor Rated Power
A2-24	H4-02	Terminal AM Analog Output Gain

4.3 Set up the Drive with General-Purpose Setup Mode

User Parameter	Parameter	Name
A2-25	L1-01	Motor Overload (oL1) Protection
A2-26	L3-04	Stall Prevention during Decel



Note:

- When you change *A1-02 [Control Mode Selection]*, the settings of some parameters automatically change.
- This manual also shows parameters that are not in Setup Mode. Use **Pr** to set the parameters not shown in the Setup Mode.
- Display parameters change when the *A1-06 [Application Preset]* setting changes.

4.4 Drive Mode and Programming Mode

The keypad display of this drive has two modes: Drive Mode and Programming Mode.

- Drive Mode
Use this mode to operate the drive. These operations are available:
 - Monitor operation statuses (for example, output frequency, output current, and output voltage)
 - Set the parameters that you can change while the drive is operating (for example, *d1-01 to d1-17*). Refer to [Parameter Details on page 499](#) for more information.
- Programming Mode
Parameter Setting Mode These operations are available:
 - Examine and set the parameters that are not at default settings (Verify Mode)
 - See and set the basic parameters necessary for the drive operation (Setup Mode)
 - See and set all parameters (Parameter Setting Mode)
 - Automatically set motor parameters (Auto-Tuning Mode)

[Table 4.4](#) gives information about the functions you can access when you push  / .

Note:

- Set *b1-08* [*Run Command Select in PRG Mode*] to accept or reject the Run command from an external source when in Programming Mode.
- Set *b1-08* = 0 [*Disregard RUN while Programming*] to reject the Run command from an external source while in Programming Mode.
 - Set *b1-08* = 1 [*Accept RUN while Programming*] to accept the Run command from an external source while in Programming Mode.
 - Set *b1-08* = 2 [*Allow Programming Only at Stop*] to prevent changes from Drive Mode to Programming Mode.

Table 4.4 Overview of the Modes

Mode	LED Display	Description	Description	Ref.
Drive Mode (Operation of the motor and monitoring of operation status)		Frequency reference display	You can set and monitor frequency references. Note: You can change what is shown on the keypad when you energize the drive. Use <i>o1-02 [Monitor Selection at Power-up]</i> to set the items. When <i>A1-02 = 6 [Control Method Selection = AOLV/PM]</i> , the display unit is %. 100% = Maximum Output Frequency	-
		Monitor display	The keypad shows <i>Ux-xx [Monitor]</i> .	-
		Output voltage display	You can monitor the output voltage reference. Set <i>o1-01 [User Monitor Selection]</i> to change the item shown on this screen.	369
		Output current display	You can monitor the output current.	-
		Output frequency display	You can monitor the frequency output from the drive.	-
		Forward/reverse selection	<i>For</i> : Motor rotates in forward direction <i>rEv</i> : Motor rotates in reverse direction Note: For applications where the motor must not rotate in reverse direction (for example, for fans and pumps), you can use <i>b1-04 [Reverse Operation Selection]</i> to prevent reverse rotation. How to set reverse operation <i>rEv</i> 	-
Programming Mode (Parameter Settings)		Auto-Tuning Mode	The drive automatically calculates and sets the motor parameters.	148 149 150
		Parameter Setting Mode	You can see and set all parameters.	134
		Setup Mode	Shows and sets basic parameters necessary for drive operation. Note: The parameters shown in the Setup Mode are different for different <i>A1-06 [Application Preset]</i> settings.	133 147
		Verify Menu	Lists all parameters that are not at their default settings.	134

◆ Drive Mode

These operations are available in Drive Mode:

- Operate and stop the drive
- Show the drive status monitors (for example, frequency reference, output frequency, output current, and output voltage)
- Show the alarm content
- Show the alarm history

Note:

To operate the drive, select Drive Mode. You can switch to other modes when the drive stops, but the drive must be in Drive Mode to start operation.

These steps show how to set the frequency reference source to LOCAL (keypad) and change the frequency reference from 0 Hz to 6 Hz.

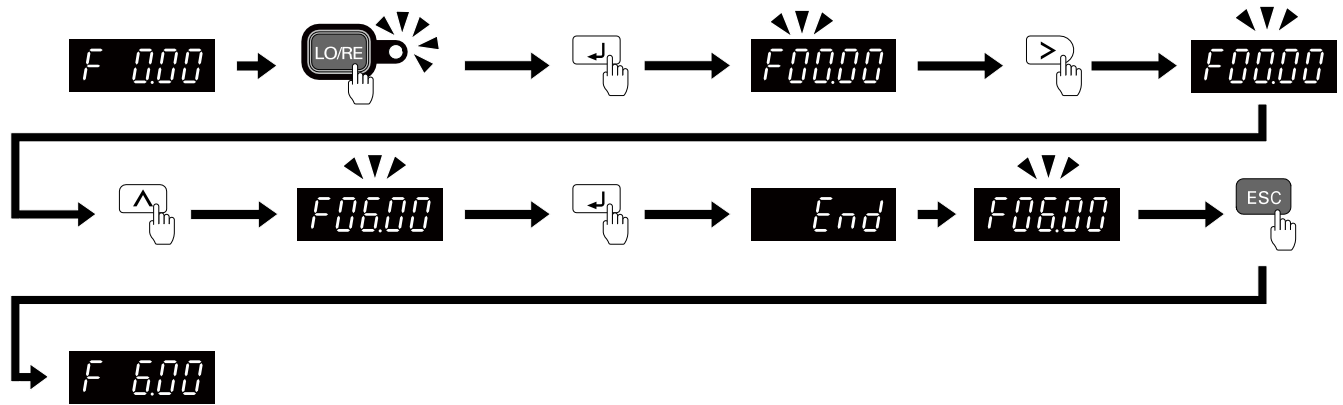

Figure 4.7 Frequency Reference Setting in Drive Mode

Note:

To prevent an incorrect setting, after you enter the frequency reference, you must push the ENTER key to change the frequency reference. Set *o2-05 = 1* [*Home Mode Freq Ref Entry Mode = Immediate / MOP-style*] to change the frequency reference value without pushing the ENTER key.

◆ Programming Mode

In Programming Mode, you can set parameters or do Auto-Tuning. This mode has 4 sub-modes for different programming requirements:

- Verify Menu: Use this mode to examine and set the parameters that are not at default settings.
- Setup Mode: Use this mode to see and set the minimum parameters necessary for drive operation. Refer to [Verify and Set the Changed Parameters \(Verify Menu\) on page 134](#) for more information.
- Parameter Setting Mode: Use this mode to see and set all parameters.
- Auto-Tuning Mode: Use this mode to automatically set the motor parameters necessary for each control method.

■ Setup Mode

In Setup Mode, you can see and set the minimum parameters necessary for drive operation. Refer to [Figure 4.8](#) for an example.

Note:

1. Refer to [Set up the Drive with General-Purpose Setup Mode on page 129](#) and [Automatic Parameter Settings Optimized for Specific Applications \(Application Presets\) on page 147](#) for more information about Setup mode parameters.
2. Push *APPL* and *J* to continue to the application selection screen. When you change the setting, it will optimize the parameter for the application. The default setting is 0 [*General-purpose*].
3. To go back to the initial screen, push *ESC*. To change another parameter in Setup Mode, push *^* or *v*.

Change *b1-01* [*Frequency Reference Selection 1*] from 1 [*Analog Input*] to 0 [*Keypad*].

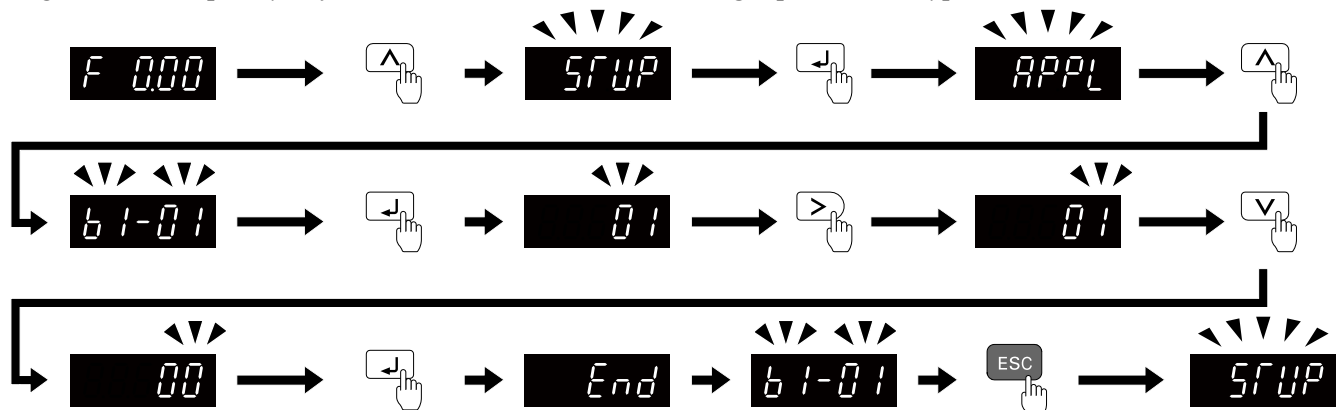

Figure 4.8 Key operation examples in Setup Mode

◆ Change Parameter Settings

Show the frequency reference screen in advance.

Note:

Push and hold **ESC** to go back to the frequency reference screen from any screen.

Use these steps to change *C1-01 [Acceleration Time 1]* from 1.0 s (default) to 2.0 s.

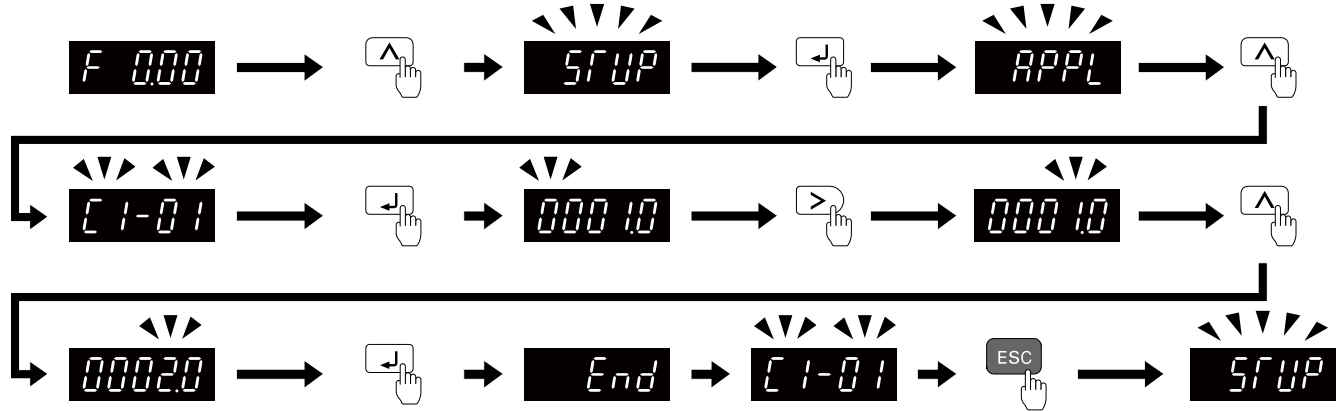

Figure 4.9 Key Operation Examples for Parameter Settings

◆ Verify and Set the Changed Parameters (Verify Menu)

Show the frequency reference screen.

Note:

Push and hold **ESC** to return to frequency reference screen from any screen.

Use Verify mode to view all parameters that are not at default settings. This is very useful when you replace a drive.

When there are no changes to parameter settings, the display shows $n\bar{0}n\bar{E}$. This lets you quickly access and re-edit changed parameters. Figure 4.10 shows the procedure.

Note:

The drive will only display *A1-02 [Control Method Selection]*, *A1-xx, A2-01 to A2-32 [User Parameter 1 to User Parameter 32]*, and *E5-01 [PM Motor Code Selection]*.

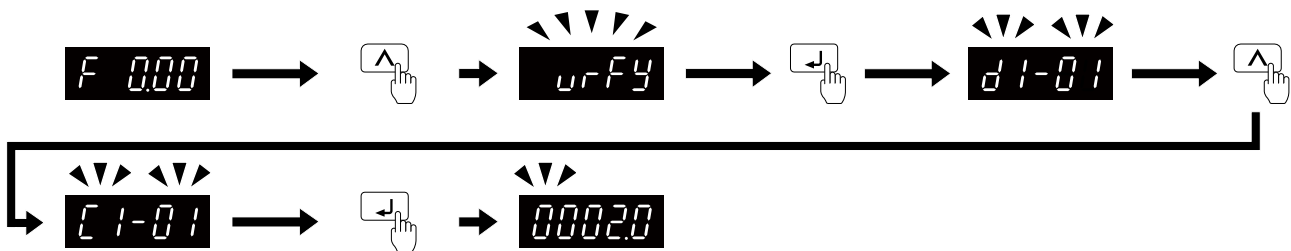

Figure 4.10 Verify and Set the Changed Parameters

◆ How to Switch between LOCAL and REMOTE

LOCAL mode lets you use the keypad to input Run commands. REMOTE mode lets you use other sources than the keypad to input Run commands.

WARNING! Sudden Movement Hazard. If you change the control source when *b1-07 = 1 [LOCAL/REMOTE Run Selection = Accept Existing RUN Command]*, the drive can start suddenly. Before you change the control source, remove all personnel from the area around the drive, motor, and load. Sudden starts can cause serious injury or death.

You can use  or MFDI functions (LOCAL/REMOTE Selection) to switch between LOCAL and REMOTE.

Note:

1.  illuminates while the drive is in LOCAL Mode.
2. While you are entering a Run command, you cannot switch between LOCAL and REMOTE.

■ Use the LO/RE Selection Key on the Keypad to Switch between LOCAL and REMOTE

Each time you push , the mode switches between LOCAL and REMOTE. The LED illuminates in LOCAL Mode.



Figure 4.11 Use the LO/RE Selection Key to Switch between LOCAL and REMOTE

■ Use MFDI Terminals (S1 to S7) to Switch between LOCAL and REMOTE

When you set $HI-xx = 1$ [*MFDI Function Selection = LOCAL/REMOTE Selection*], you can activate/deactivate the terminal to switch between LOCAL and REMOTE. Set $HI-xx = 1$ to disable the LO/RE key on the keypad. For information about the MFDI functions, refer to the list in [HI: Digital Inputs on page 643](#).

4.5 Start-up Procedures

This section gives the basic steps necessary to start up the drive.

Use the flowcharts in this section to find the most applicable start-up method for your application.

This section gives information about only the most basic settings.

Note:

Refer to the *A1-06* section to use an Application Preset to set up the drive.

◆ **Flowchart A: Connect and Run the Motor with Minimal Setting Changes**

Flowchart A shows a basic start-up sequence to connect and run a motor with a minimum of setting changes. Settings can change when the application changes.

Use the drive default parameter settings for basic applications where high precision is not necessary.

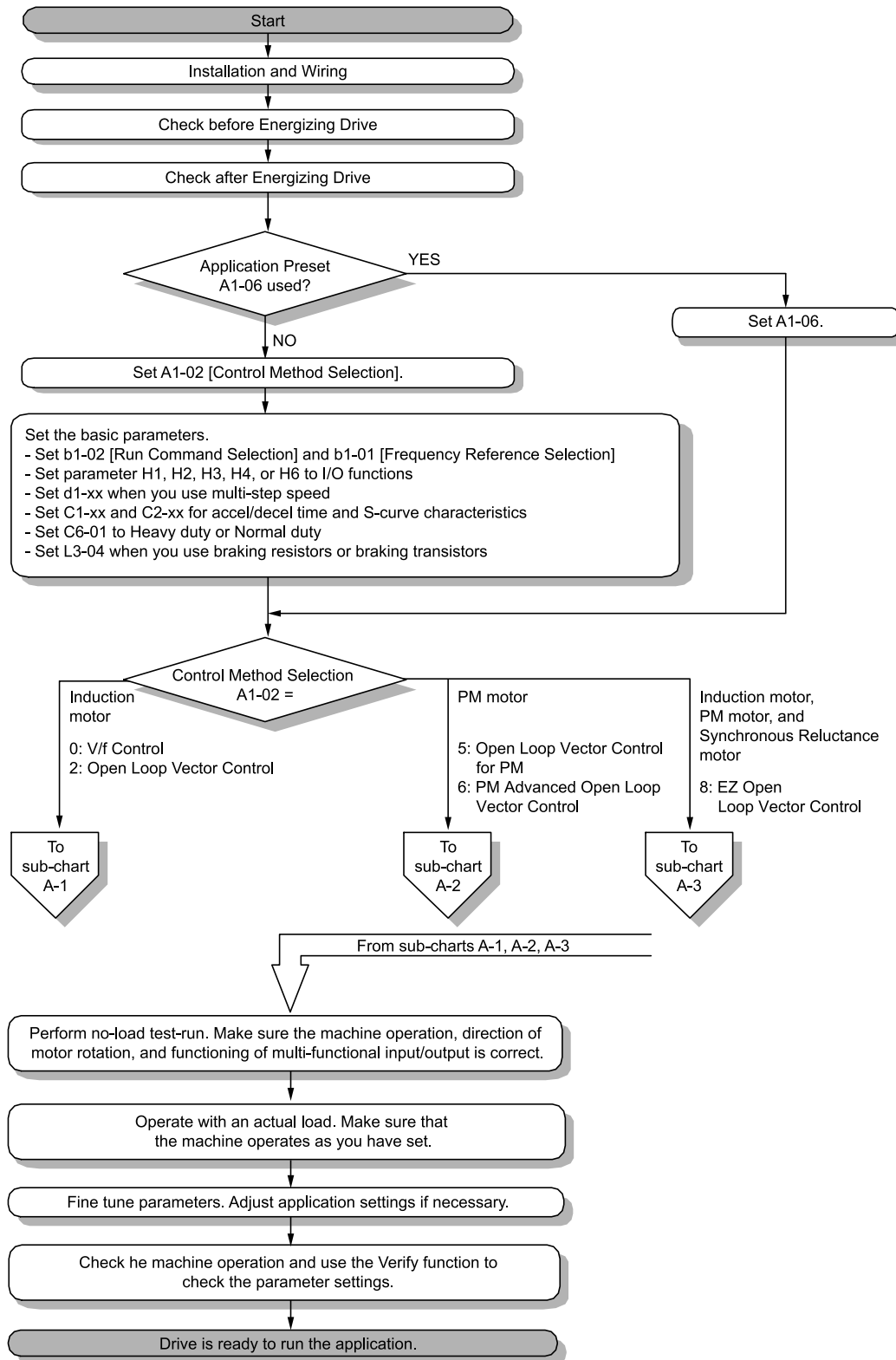

Figure 4.12 Basic Steps before Startup

◆ Sub-Chart A-1: Induction Motor Auto-Tuning and Test Run Procedure

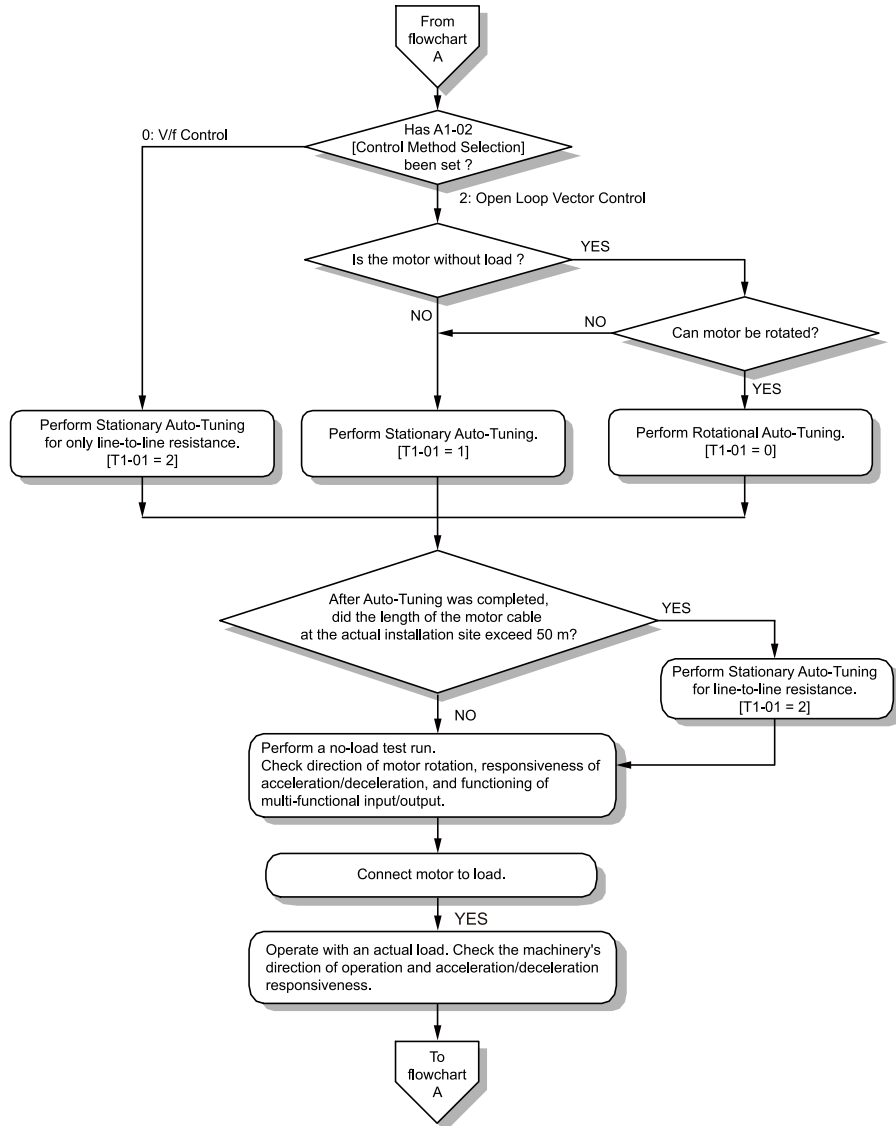

Figure 4.13 Induction Motor Auto-Tuning and Test Run Procedure

◆ Sub-Chart A-2: PM Motor Auto-Tuning and Test Run Procedure

Sub-Chart A-2 gives the basic steps to start up the drive for a PM motor.

WARNING! Crush Hazard. Test the system to make sure that the drive operates safely after you wire the drive and set parameters. If you do not test the system, it can cause damage to equipment or serious injury or death.

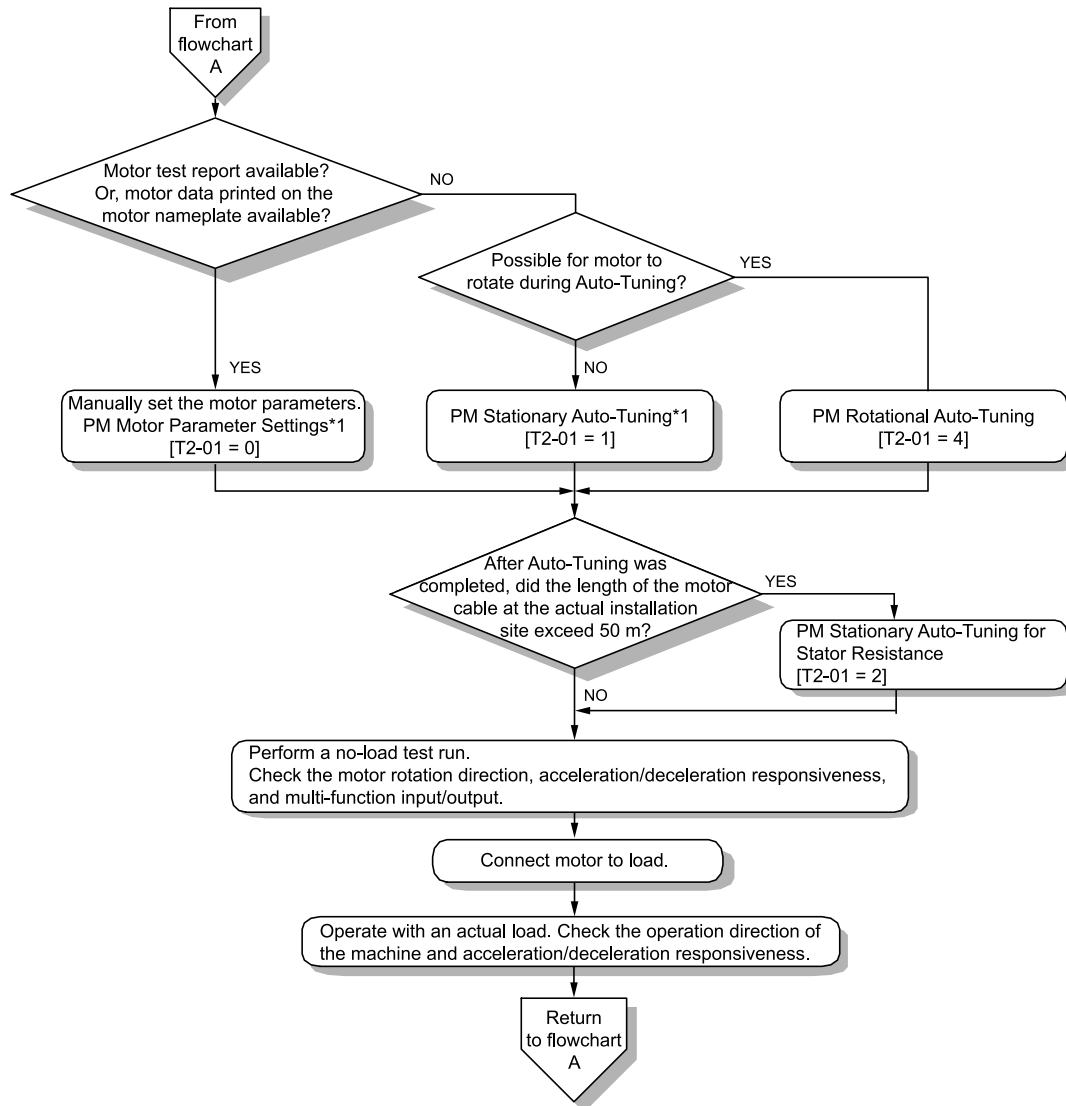

Figure 4.14 PM Motor Auto-Tuning and Test Run Procedure

*1 For Yaskawa PM motors (SMRD, SMRA-series, or SSR1-series), set *E5-01 (Motor Code)*. For PM motors from a different manufacturer, set *E5-01 = FFFF*.

◆ Subchart A-3: EZ Open Loop Vector Control Test Run Procedure

Subchart A-3 gives the setup procedure to run a PM motor in EZ Open Loop Vector Control.

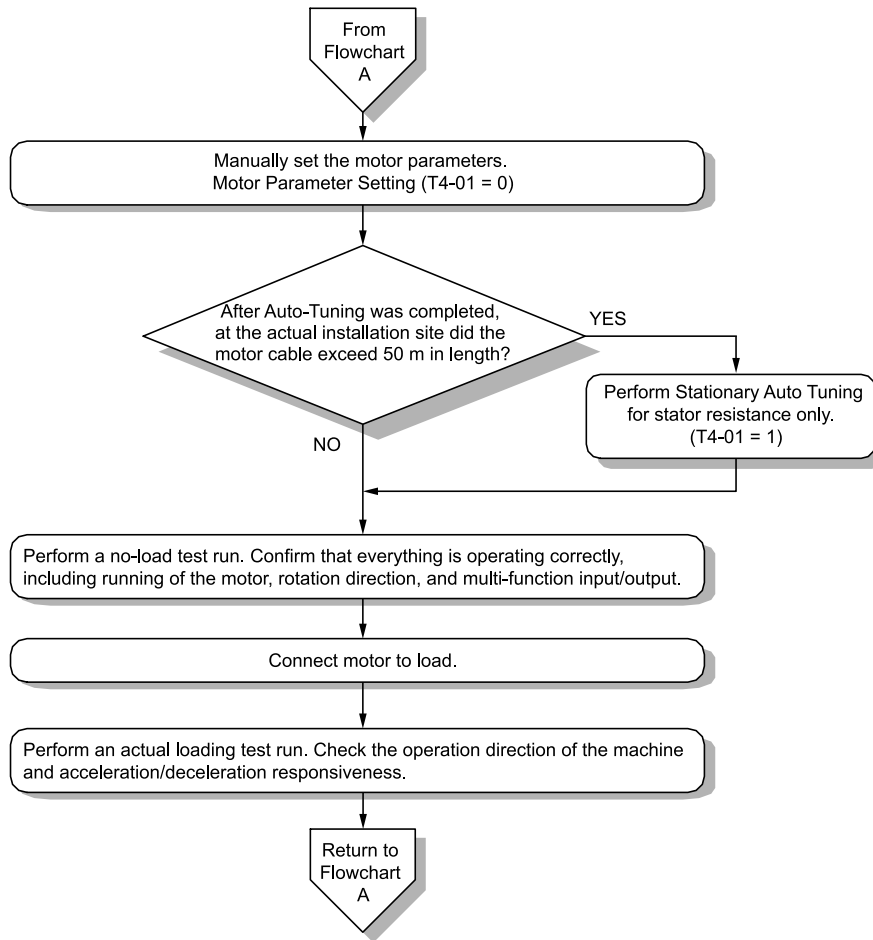

Figure 4.15 Procedure for Test Run of EZ Open Loop Vector Control Method

4.6 Items to Check before Starting Up the Drive

◆ Check before You Energize the Drive

Check the items in [Table 4.5](#) before you energize the drive.



Table 4.5 Items to Check before You Energize the Drive

Items to Check	Description
Input Power Supply Voltage	The voltage of the input power supply must be: Single-phase 200 V class: single-phase 200 Vac to 240 Vac 50/60 Hz, 270 Vdc to 340 Vdc Three-phase 200 V class: three-phase 200 Vac to 240 Vac 50/60 Hz, 270 Vdc to 340 Vdc Three-phase 400 V class: three-phase 380 Vac to 480 Vac 50/60 Hz, 513 Vdc to 679 Vdc
	Correctly wire power supply input terminals R/L1, S/L2, and T/L3, or L and N.
	Correctly ground the drive and motor.
Connection between Drive Output Terminals and Motor Terminals	Make sure that you connected drive output terminals U/T1, V/T2, and W/T3 in the correct sequence to align with motor terminals U, V, and W and tighten the screws to a correct tightening torque.
Control Circuit Terminal Wiring	Make sure that you connected the drive control circuit terminals in the correct sequence to align with devices and switches and tighten the screws to a correct tightening torque.
Control Circuit Terminal Status	Turn OFF the inputs from all devices and switches connected to the drive control circuit terminals.
Connection between Machinery and Motor	Disengage all couplings and belts that connect the motor and machinery.

◆ Check after You Energize the Drive

Check the items in [Table 4.6](#) after you energize the drive. The keypad display is different depending on drive status.

Table 4.6 Display Status after You Energize the Drive

Status	Display	Description
During Usual Operation		The LED display shows the frequency reference.
When the Drive Detects a Fault		The display is different for different faults. Refer to "Troubleshooting" to remove the cause of the fault. The ALM/ERR LED will illuminate.

4.7 Keypad Operation

Note:

Make sure that you use a keypad that has a flash number of 1004 or later. Keypads that have a flash number of 1003 or earlier will not show characters correctly.

◆ Digital character mapping table

The LED keypad shows the digital characters as shown in [Table 4.7](#)

Table 4.7 Digital character mapping table

Characters	LED Display	Characters	LED Display	Characters	LED Display	Characters	LED Display
0	0	9	9	I	i	R	r
1	1	A	A	J	j	S	s
2	2	B	b	K	k	T	t
3	3	C	c	L	l	U	u
4	4	D	d	M	m*1	V	v
5	5	E	e	N	n	W	w*1
6	6	F	f	O	o	X	No indication
7	7	G	g	P	p	Y	y
8	8	H	h	Q	q	Z	No indication

*1 Shown across two digits.

◆ Show the Monitor

Show the frequency reference screen.

Note:

Push and hold **ESC** to return to frequency reference screen from any screen.

Use these steps to monitor parameter settings.

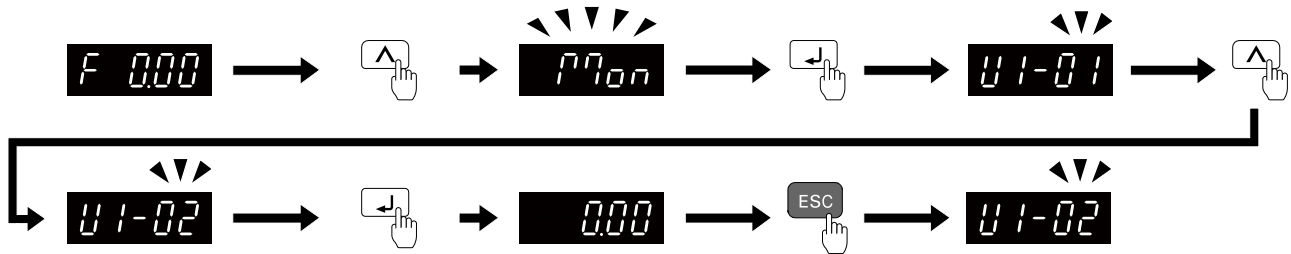

Figure 4.16 How to Monitor the Parameter Setting Values

◆ Check Modified Parameters

Show the frequency reference screen.

Note:

Push and hold **ESC** to return to frequency reference screen from any screen.

Use Verify mode to view all parameters that are not at default settings. This is very useful when you replace a drive. This lets you quickly access and re-edit changed parameters.

Note:

The drive will only display *A1-02 [Control Method Selection]*, *A1-xx*, *A2-01 to A2-32 [User Parameter 1 to User Parameter 32]*, and *E5-01 [PM Motor Code Selection]*.

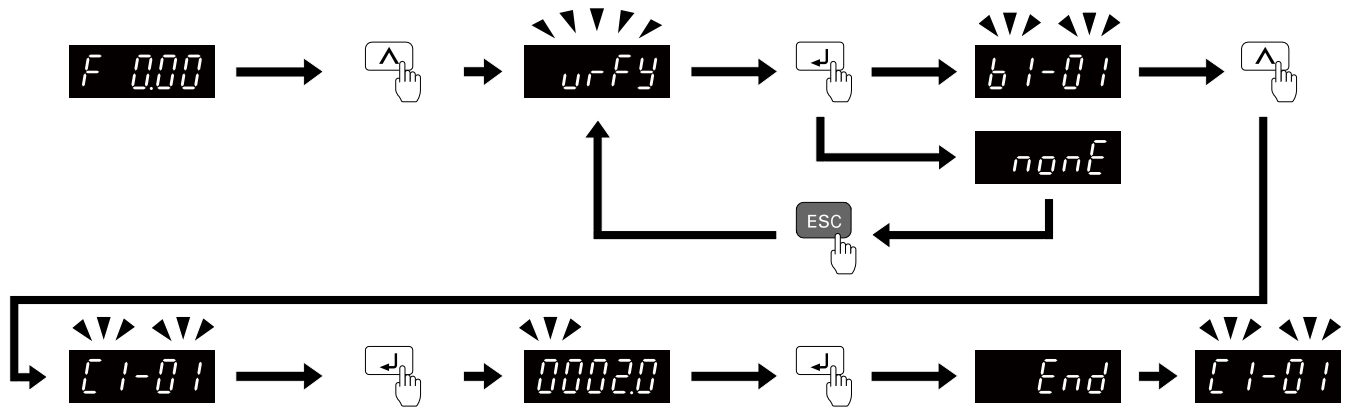

Figure 4.17 How to Examine the Changed Parameters

◆ Set and View Necessary Parameters

Show the frequency reference screen.

Note:

Push and hold **ESC** to return to frequency reference screen from any screen.

The setup mode shows the parameters set in *A2-01 to A2-32 [User Parameter 1 to User Parameter 32]*. This lets you quickly access and change these parameters.

Note:

Setup mode always shows **APPL** (*A1-06 [Application Preset]*) at the top of the list. When you change the setting, the settings for *A2-01 to A2-32* change.

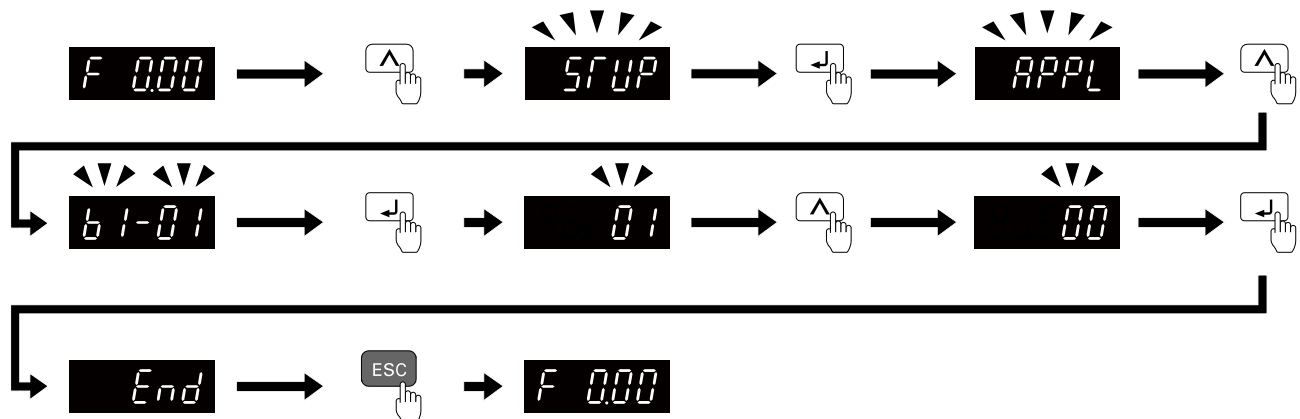

Figure 4.18 View and Set the Necessary Parameters

Continue to change the parameters or press and hold **ESC** to go back to the frequency reference screen.

◆ Change Parameter Settings

Show the frequency reference screen in advance.

Note:

Push and hold **ESC** to go back to the frequency reference screen from any screen.

This example shows how to change *C1-01 [Acceleration Time 1]*. Set the parameter to the necessary value.

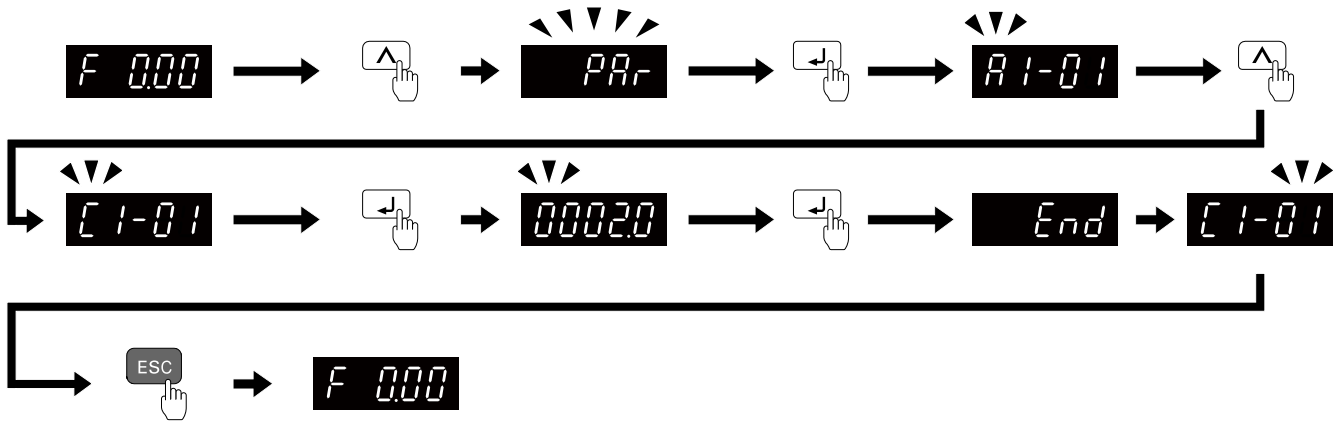

Figure 4.19 How to Change the Parameter Setting

Continue to change parameters or push and hold **ESC** to go back to the frequency reference screen.

◆ Save a Backup of Parameters

Show the frequency reference screen in advance.

Note:

Push and hold **ESC** to go back to the frequency reference screen from any screen.

Use these steps to save a backup of the drive parameters to the keypad.

Making backups of the parameter settings can save time when setting parameters after replacing a drive. If you set up more than one drive, you can copy the parameter settings from a drive that completed a test run to the other drives.

Note:

- Make sure that you stop the motor before you back up parameters.
- The drive does not accept Run commands while it is making a backup.
- Set *o3-02* = 0 [*Copy Allowed Selection = Disabled*] to protect the parameters saved in the keypad.

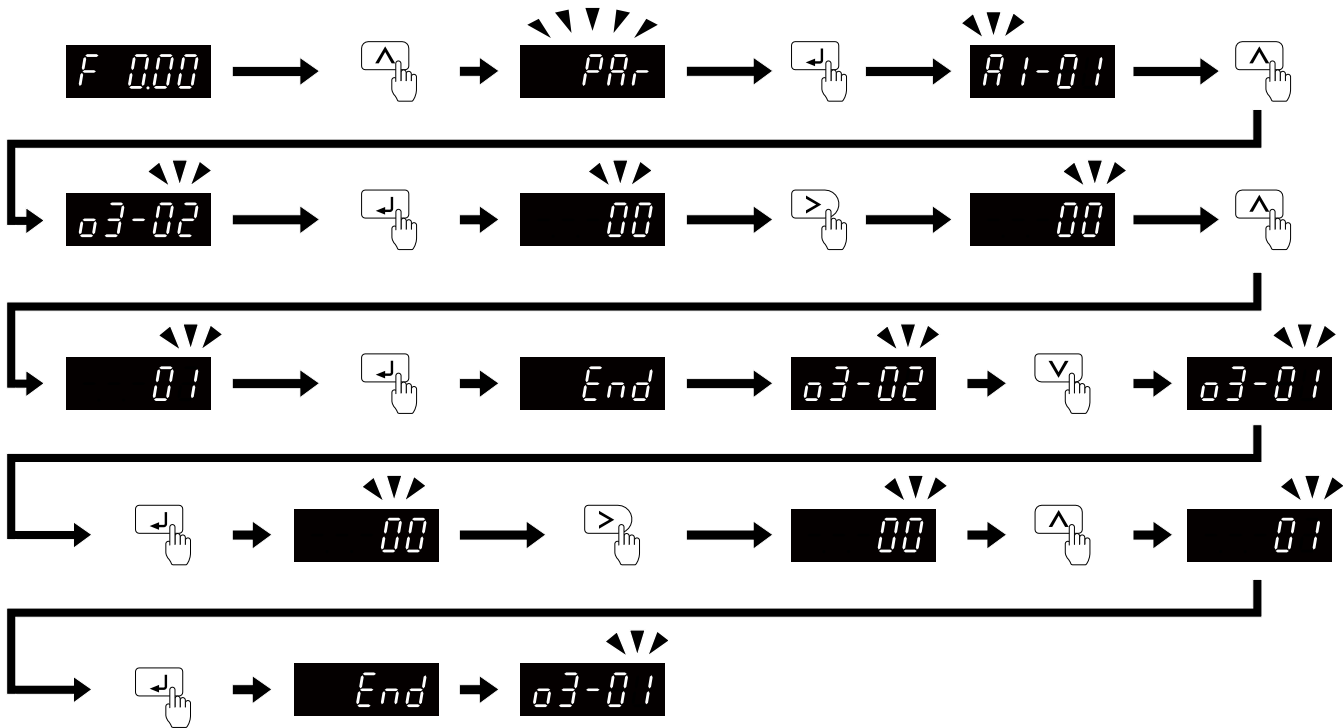

Figure 4.20 How to Save Backed-up Parameters

Push and hold **ESC** to go back to the frequency reference screen.

◆ Write Backed-up Parameters to the Drive

Show the frequency reference screen in advance.

Note:

Push and hold **ESC** to go back to the frequency reference screen from any screen.

Use these steps to write the parameters backed up in the keypad into a different drive.

Note:

- Make sure that you stop the drive before you restore the backed-up parameters.
- The drive does not accept Run commands while it is restoring parameters.

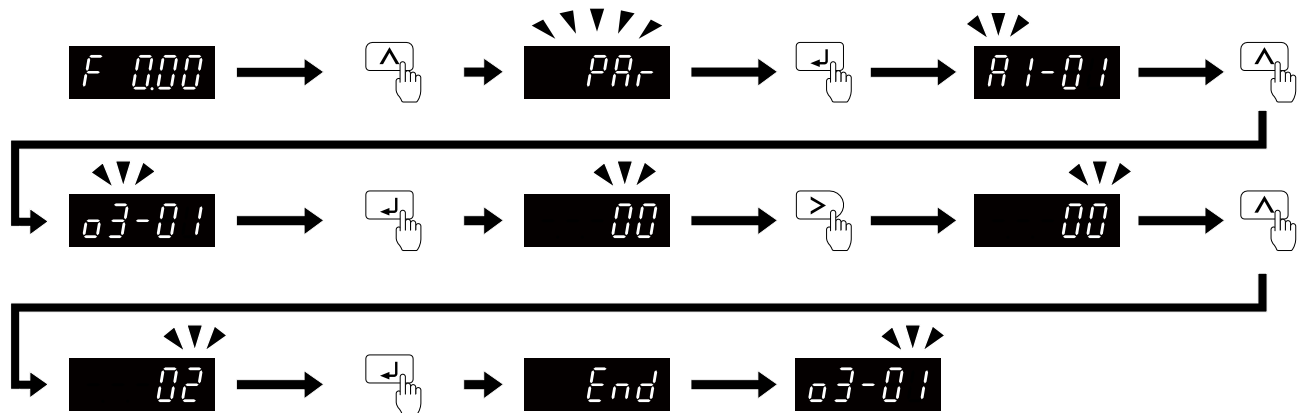

Figure 4.21 Writing backed up parameters

Push and hold **ESC** to go back to the frequency reference screen.

◆ Verify Keypad Parameters and Drive Parameters

Show the frequency reference screen in advance.

Note:

Push and hold **ESC** to go back to the frequency reference screen from any screen.

This procedure verifies that the parameter setting values that were backed up in the keypad agree with the parameter setting values in the drive.

Note:

- Make sure that you stop the drive before you examine parameters.
- The drive does not accept Run commands while it is restoring parameters.

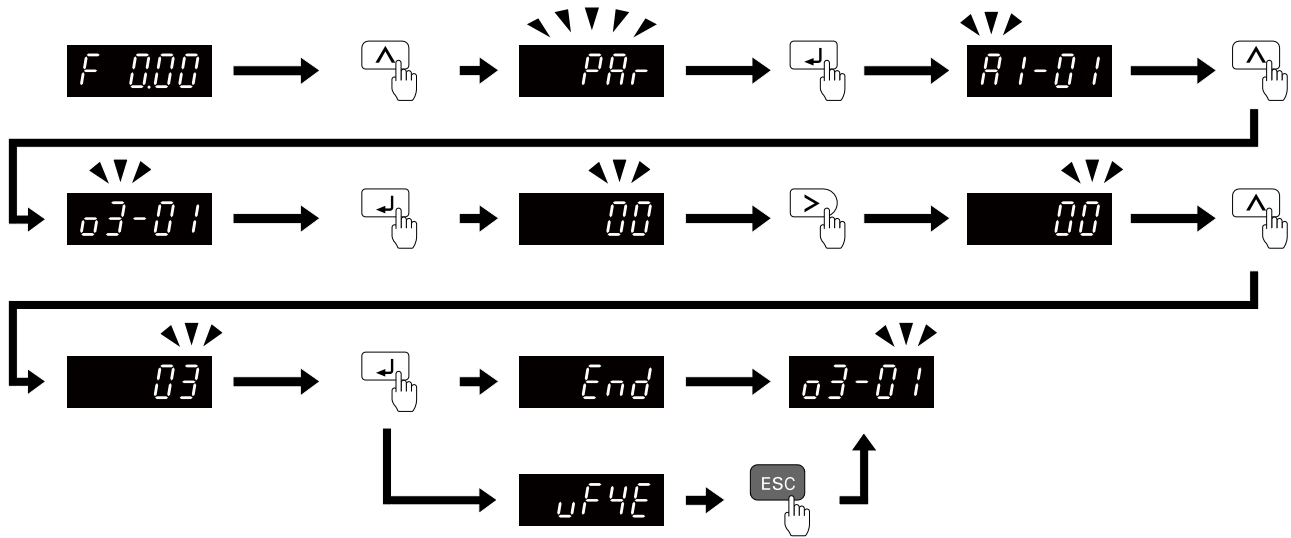

Figure 4.22 Verify Keypad Parameters and Drive Parameters

Push and hold **ESC** to go back to the frequency reference screen.

◆ Delete Parameters Backed Up to the Keypad

Show the frequency reference screen in advance.

Note:

Push and hold **ESC** to go back to the frequency reference screen from any screen.

Use these steps to erase the parameters backed up in the keypad.

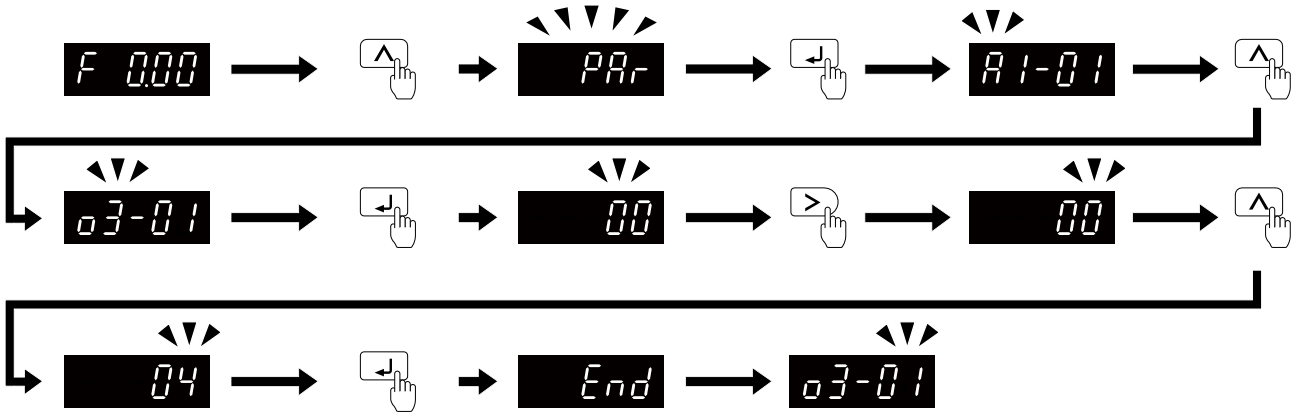

Figure 4.23 How to Erase the Backed-up Parameters

Push and hold **ESC** to go back to the frequency reference screen.

4.8 Automatic Parameter Settings Optimized for Specific Applications (Application Presets)

Show the frequency reference screen.

Note:

Press and hold **ESC** to return to the frequency reference screen from any screen.

Use this procedure to set an application preset.

The drive has application presets to set the necessary parameters for different applications to their best values. Use **ur-F4** to find parameters that were changed automatically by the application preset function in *A1-06*.

Note:

Before you set *A1-06*, make sure that you set *A1-03* = 2220, 3330 [*Initialize Parameters = 2-Wire Initialization, 3-Wire Initialization*] to initialize parameters.

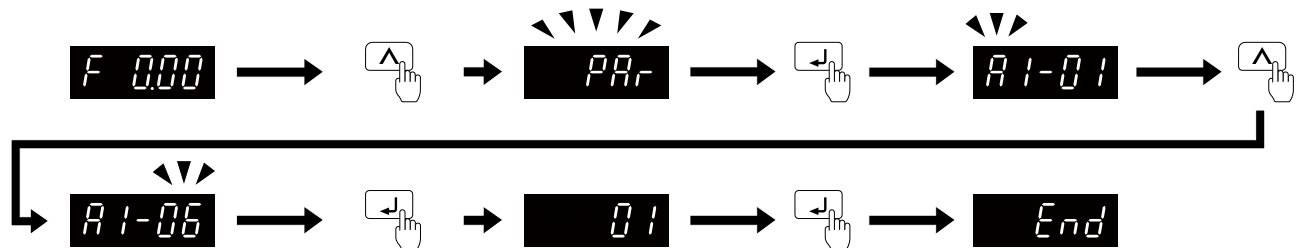

Figure 4.24 Automatic Parameter Settings

Press and hold **ESC** to go back to the frequency reference screen.

Note:

- You cannot directly set parameter *A1-06*. To set an application preset, first set *A1-03* = 2220 to initialize parameters, then set this parameter. If initializing all parameters will cause a problem, do not change the settings.
- When the drive applies the *A1-06* setting, it will also reset the parameters automatically registered to *A2-17* to *A2-32* [*User Parameters 17 to 32*] when *A2-33* = 1 [*User Parameter Auto Selection = Enabled: Auto Save Recent Params*].

4.9 Auto-Tuning

Auto-Tuning uses motor characteristics to automatically set drive parameters for vector control. Think about the type of motor, drive control method, and the motor installation environment and select the best Auto-Tuning method.

WARNING! Injury to Personnel. Rotational Auto-Tuning rotates the motor at 50% or more of the motor rated frequency. Make sure that there are no issues related to safety in the area around the drive and motor. Increased motor frequency can cause serious injury or death.

◆ Auto-Tuning for Induction Motors

This section gives information about Auto-Tuning for induction motors. Set motor parameters *E1-xx* and *E2-xx* (or, for motor 2, *E3-xx* and *E4-xx*) for Auto-Tuning.

Note:

Do Stationary Auto-Tuning if you cannot do Rotational Auto-Tuning. There can be large differences between the measured results and the motor characteristics when Auto-Tuning is complete. Examine the parameters for the measured motor characteristics after you do Stationary Auto-Tuning.

Table 4.8 Auto-Tuning Mode Selection

Method	Parameter Settings	Application Conditions and Benefits	Applicable Control Method (A1-02 Setting)	
			V/f (0)	OLV (2)
Rotational Auto-Tuning	T1-01 = 0	<ul style="list-style-type: none"> When you can decouple the motor and load the motor can rotate freely while Auto-Tuning. When operating motors that have fixed output characteristics. When it is necessary to use motors that have high-precision control. When you cannot decouple the motor and load, but the motor load is less than 30%. 	x	x
Stationary Auto-Tuning 1	T1-01 = 1	<ul style="list-style-type: none"> When you cannot decouple the motor and load. When the motor load is more than 30%. When the information from the motor test report or motor nameplate is not available. <p>With Stationary Auto-Tuning, the energized drive stays stopped for approximately 1 minute. During this time, the drive automatically measures the necessary motor parameters.</p> <ul style="list-style-type: none"> When you operate the motor with less than 30% load after Auto-Tuning. <p>Set <i>T1-12 = 1</i> [Test Mode Selection = Yes] to do a test run after Auto-Tuning.</p>	-	x
Stationary Line-Line Resistance	T1-01 = 2	<ul style="list-style-type: none"> After Auto-Tuning, the wiring distance between the drive and motor changed by 50 m or more. When the wiring distance is 50 m or more in the V/f Control mode. When the motor output and drive capacity are different. 	x	x

■ Input Data for Induction Motor Auto-Tuning

To do Auto-Tuning, input data for the items in Table 4.9 that have an "x". Before you start Auto-Tuning, prepare the motor test report or record the information from the motor nameplate as a reference.

Table 4.9 Input Data for Induction Motor Auto-Tuning

Input Data	Parameter	Unit	Auto-Tuning Mode (T1-01 Setting)		
			Rotational Auto-Tuning (0)	Stationary Auto-Tuning 1 (1)	Stationary Line-Line Resistance (2)
Motor Rated Power	T1-02	HP	x	x	x
Motor Rated Voltage	T1-03	V	x	x	-
Motor Rated Current	T1-04	A	x	x	x
Motor Base Frequency	T1-05	Hz	x	x	-
Number of Motor Poles	T1-06	-	x	x	-
Motor Base Speed	T1-07	min ⁻¹	x	x	-

Input Data	Parameter	Unit	Auto-Tuning Mode (T1-01 Setting)		
			Rotational Auto-Tuning (0)	Stationary Auto-Tuning 1 (1)	Stationary Line-Line Resistance (2)
Motor No-Load Current	T1-09	A	-	x	-
Motor Rated Slip Frequency	T1-10	Hz	-	x *1	-
Motor Iron Loss	T1-11	W	x *2	-	-
Test Mode Selection *3	T1-12	-	-	x *4	-
No-Load Voltage	T1-13	V	x *5	x *5	-

*1 Shows 0 Hz as the default value. If you do not know the Motor Rated Slip Frequency, keep the setting at 0 Hz.

*2 Input this value when $A1-02 = 0$ [Control Method Selection = V/f].

*3 If $T1-12 = 1$ [Test Mode Selection = Yes], when you run the motor in Drive Mode for the first time after Auto-Tuning, the drive will automatically set $E2-02$ [Motor Rated Slip] and $E2-03$ [Motor No-Load Current].

*4 Input this value when $T1-10$ [Motor Rated Slip Frequency] = 0 Hz.

*5 Set the same value to No-Load Voltage as $T1-03$ [Motor Rated Voltage] to get the same characteristics using Yaskawa 1000-Series drives or other legacy models.

◆ Auto-Tuning for PM Motors

This section gives information about Auto-Tuning for PM motors. Auto-Tuning sets motor parameters $E1-xx$ and $E5-xx$.

Table 4.10 Auto-Tuning for PM Motors

Mode	Parameter Settings	Application Conditions and Benefits	Applicable Control Method (A1-02 Setting)	
			OLV/PM (5)	AOLV/PM (6)
Manual Entry w/ Motor Data Sheet	T2-01 = 0	<ul style="list-style-type: none"> When the information from the motor test report or motor nameplate is available. Rotational/Stationary Auto-Tuning that energizes the motor is not done. Manually input the necessary motor parameters. 	x	x
PM Stationary Auto-Tuning	T2-01 = 1	<ul style="list-style-type: none"> When the information from the motor test report or motor nameplate is not available. <p>Note: With Stationary Auto-Tuning, the energized drive stays stopped for approximately 1 minute. During this time, the drive automatically measures the necessary motor parameters.</p>	x	x
PM Stationary Auto-Tuning for Stator Resistance	T2-01 = 2	<ul style="list-style-type: none"> After Auto-Tuning, the wiring distance between the drive and motor changed by 50 m (164 ft) or more. When the motor output and drive capacity are different. 	x	x
Rotational (Ld, Lq, R, back-EMF)	T2-01 = 4	<ul style="list-style-type: none"> When the information from the motor test report or motor nameplate is not available. When you can decouple the motor and load and the motor can rotate freely while Auto-Tuning. Values measured during Auto-Tuning are automatically set to the motor parameters. 	x	x
High Frequency Injection	T2-01 = 5	<ul style="list-style-type: none"> Automatically sets the control parameters that are necessary to set $n8-35 = 1$ [Initial Pole Detection Method = High Frequency Injection] or $n8-57 = 1$ [HFI Overlap Selection = Enabled]. Applicable to IPM motors only. Do Auto-Tuning with the motor connected to the drive. <p>Note: When you set $n8-35 = 1$ or $n8-57 = 1$, do High Frequency Injection Auto-Tuning. Set the data on the motor nameplate to the drive before you do High Frequency Injection Auto-Tuning. In High Frequency Injection Auto-Tuning, the drive energizes the stopped motor and automatically adjusts the parameters.</p>	x	x

■ Input Data for PM Motor Auto-Tuning

To do Auto-Tuning, input data for the items in Table 4.11 and Table 4.12 that have an "x". Before you start Auto-Tuning, prepare the motor test report or record the information from the motor nameplate as a reference.

Table 4.11 Input Data for PM Motor Auto-Tuning

Input Data	Parameter	Unit	Auto-Tuning Mode (T2-01 Setting)					
			Manual Entry w/ Motor Data Sheet (0)			PM Stationary Auto-Tuning (1)		PM Stationary Auto- Tuning for Stator Resistance (2)
Control Method Selection	A1-02	-	5, 6	5	6	5	6	5, 6
PM Motor Code Selection	T2-02	-	Motor code of Yaskawa motor *1	FFFF *2	FFFF *2	-	-	-
PM Motor Type	T2-03	-	-	-	-	x	x	-
PM Motor Rated Power	T2-04	kW	-	x	x	x	x	-
PM Motor Rated Voltage	T2-05	V	-	x	x	x	x	-
PM Motor Rated Current	T2-06	A	-	x	x	x	x	x
PM Motor Base Frequency	T2-07	Hz	-	x	-	x	-	-
Number of PM Motor Poles	T2-08	-	-	x	x	x	x	-
PM Motor Base Speed	T2-09	min ⁻¹	-	-	x	-	x	-
PM Motor Stator Resistance	T2-10	Ω	x	x	x	-	-	-
PM Motor d-Axis Inductance	T2-11	mH	x	x	x	-	-	-
PM Motor q-Axis Inductance	T2-12	mH	x	x	x	-	-	-
Back-EMF Units Selection	T2-13	-	x	x	x	-	-	-
Back-EMF Voltage Constant (Ke)	T2-14	*3	x	x	x	-	-	-
Pull-In Current Level	T2-15	%	-	-	-	x	x	-

*1 Set the motor code for a Yaskawa PM motor.

*2 Set the motor code to FFFF for a PM motor from a different manufacturer.

*3 Changes when the value set in T2-13 changes.

Table 4.12 Input Data for PM Motor Auto-Tuning

Input Data	Parameter	Unit	Auto-Tuning Mode (T2-01 Setting)		
			Rotational (Ld, Lq, R, back-EMF) (4)		High Frequency Injection (5)
Control Method Selection	A1-02	-	5	6	5, 6
PM Motor Code Selection	T2-02	-	-	-	-
PM Motor Type	T2-03	-	x	x	-
PM Motor Rated Power	T2-04	kW	x	x	-
PM Motor Rated Voltage	T2-05	V	x	x	-
PM Motor Rated Current	T2-06	A	x	x	-
PM Motor Base Frequency	T2-07	Hz	x	-	-
Number of PM Motor Poles	T2-08	-	x	x	-
PM Motor Base Speed	T2-09	min ⁻¹	-	x	-
Pull-In Current Level	T2-15	%	x	x	-

◆ Auto-Tuning in EZ Open Loop Vector Control Method

This section gives information about the Auto-Tuning mode for EZ Open Loop Vector Control. Auto-Tuning will set the $E\theta$ -xx parameters.

Table 4.13 EZ Tuning Mode Selection

Mode	Parameter Settings	Application Conditions and Benefits	Applicable Control Method (A1-02 Setting)
Motor Parameter Setting	T4-01 = 0	<ul style="list-style-type: none"> Applicable when driving an induction motor or a PM motor Suitable for derating torque applications, for example fans and pumps. 	EZOLV (8)
Line-to-Line Resistance	T4-01 = 1	<ul style="list-style-type: none"> After Auto-Tuning, the wiring distance between the drive and motor changed by 50 m or more. When the motor output and drive capacity are different. 	EZOLV (8)

■ Auto-Tuning Input Data in EZ Open Loop Vector Control Method

To do Auto-Tuning, input data for the items in Table 4.14 that have an "x". Before you start Auto-Tuning, prepare the motor test report or record the information from the motor nameplate as a reference.

Table 4.14 Auto-Tuning Input Data in EZ Open Loop Vector Control Method

Input Data	Parameter	Unit	Auto-Tuning Mode (T4-01 Setting)	
			Motor Parameter Setting (0)	Line-to-Line Resistance (1)
Motor Type Selection	T4-02	-	x	-
Motor Max Revolutions	T4-03	min ⁻¹	x	-
Motor Rated Revolutions	T4-04	min ⁻¹	x	-
Motor Rated Frequency	T4-05	Hz	x	-
Motor Rated Voltage	T4-06	V	x	-
Motor Rated Current (FLA)	T4-07	A	x	x
PM Motor Rated Power (kW)	T4-08	kW	x	x
Number of Motor Poles	T4-09	-	x	-

◆ ASR and Inertia Tuning

To increase drive responsiveness and prevent hunting, use Auto-Tuning to automatically adjust the control-related parameters.

These types of Auto-Tuning are available for the control system:

- Deceleration Rate Tuning
- KEB Tuning

Note:

If you do Control Tuning, you cannot set $H1-xx = 16$ [Motor 2 Selection]. Do not do Control Tuning for applications that switch between motor 1 and motor 2.

Table 4.15 Control Loop Tuning Selection

Mode	Parameter Settings	Application Conditions and Benefits	Applicable Control Methods (A1-02 Settings)				
			V/f (0)	OLV (2)	OLV/PM (5)	AOLV/PM (6)	EZOLV (8)
Deceleration Rate Tuning	T3-00 = 2	To automatically adjust the deceleration rate to prevent an <i>ov</i> [Overvoltage] fault.	x	x	x	x	x
KEB Tuning	T3-00 = 3	<ul style="list-style-type: none"> To automatically adjust parameter settings to prevent an <i>ov</i> [Overvoltage] fault with the KEB Ride-Thru function. When $L3-11 = 1$ [Overvoltage Suppression Select = Enabled]. 	x	x	x	x	x

■ Deceleration Rate Tuning

Deceleration Rate Tuning automatically sets the deceleration rate to prevent an *ov* [Overvoltage] fault during motor deceleration. Set $C1-11$ [Accel/Decel Time Switchover Freq] first to automatically set parameters $C1-02$ [Deceleration Time 1] (high speed range) and $C1-08$ [Deceleration Time 4] (low speed range).

■ KEB Tuning

KEB Tuning automatically sets parameters used for the KEB Ride-Thru function and for the overvoltage suppression function.

Control Tuning automatically sets the parameters in [Table 4.16](#) to the best values.

Table 4.16 Parameters set in Control Tuning

Parameters Automatically Set	Deceleration Rate Tuning	KEB Tuning
C1-02 [Deceleration Time 1]	x	-
C1-08 [Deceleration Time 4]	x ^{*1}	-
C1-09 [Fast Stop Time]	-	x ^{*2}
L2-06 [Kinetic Energy Backup Decel Time]	-	x ^{*3}
L3-25 [Load Inertia Ratio]	-	x

*1 The drive automatically sets C1-08 [Deceleration Time 4] only when C1-11 [Accel/Decel Time Switchover Freq] ≠ 0.

*2 When L2-29 = 0 [Kinetic Energy Backup Method = Single Drive KEB Ride-Thru 1], the drive will automatically adjust C1-09 [Fast Stop Time] and will not adjust L2-06 [Kinetic Energy Backup Decel Time]. If you must not change the Fast Stop time, do not do KEB Tuning.

*3 When L2-29 = 1, 2, or 3 [Kinetic Energy Backup Method = Single Drive KEB Ride-Thru 2, System KEB Ride-Thru 1, or System KEB Ride-Thru 2], the drive will automatically adjust L2-06 [Kinetic Energy Backup Decel Time].

◆ Precautions before Auto-Tuning

Examine the topics in this section before you start Auto-Tuning.

■ Prepare for Basic Auto-Tuning

- You must input data from the motor nameplate or motor test report to do Auto-Tuning. Make sure that this data is available before you do Auto-Tuning.
- For best performance, make sure that the drive input supply voltage is equal to or more than the motor rated voltage.

Note:

Better performance is possible when you use a motor with a rated voltage that is less than the input supply voltage (by 20 V for 200 V class models or by 40 V for 400 V class models). This is very important when you operate the motor at more than 90% of base speed, where high torque precision is necessary. If the input power supply is equal to the motor rated voltage, the drive output voltage will not be sufficient and performance will decrease.

- Push  on the keypad to cancel Auto-Tuning.
- If a Safe Disable input signal is input to the drive during Auto-Tuning, Auto-Tuning measurements will not complete successfully. If this occurs, cancel the Auto-Tuning, then do it again.
- [Table 4.17](#) shows the status of multi-function input/output terminals during Auto-Tuning.

Table 4.17 Status of Input/Output Terminals during Auto-Tuning

Auto-Tuning Type	Mode	Parameter	Multi-Function Input	Multi-Function Output ^{*1}	
Induction Motor Auto-Tuning	Rotational	Rotational Auto-Tuning	T1-01 = 0	Disabled	Functions the same as during usual operation.
	Stationary	Stationary Auto-Tuning 1	T1-01 = 1	Disabled	Keeps the status at the start of Auto-Tuning.
		Line-to-Line Resistance	T1-01 = 2	Disabled	Keeps the status at the start of Auto-Tuning.
PM Motor Auto-Tuning	Rotational	PM Rotational Auto-tuning	T2-01 = 4	Disabled	Functions the same as during usual operation.
	Stationary	PM Motor Parameter Settings	T2-01 = 0	Disabled	Keeps the status at the start of Auto-Tuning.
		PM Stationary Auto-Tuning	T2-01 = 1	Disabled	Keeps the status at the start of Auto-Tuning.
		PM Stationary Auto-Tuning for Stator Resistance	T2-01 = 2	Disabled	Keeps the status at the start of Auto-Tuning.
High Frequency Injection		T2-01 = 5	Disabled	Keeps the status at the start of Auto-Tuning.	

Auto-Tuning Type	Mode	Parameter	Multi-Function Input	Multi-Function Output */	
EZ Tuning	Stationary	Motor Parameter Setting	T4-01 = 0	Disabled	Keeps the status at the start of Auto-Tuning.
		Line-to-Line Resistance	T4-01 = 1	Disabled	Keeps the status at the start of Auto-Tuning.
ASR and Inertia Tuning	Rotational	Deceleration Rate Tuning	T3-00 = 2	Disabled	Functions the same as during usual operation.
		KEB Tuning	T3-00 = 3	Disabled	Functions the same as during usual operation.

*1 When you set a terminal to $H2-xx = E$ [MFDO Function Selection = Fault], it will function the same as during usual operation.

WARNING! Crush Hazard. Wire a sequence that will not let a multi-function output terminal open the holding brake during Stationary Auto-Tuning. If the holding brake is open during Stationary Auto-Tuning, it can cause serious injury or death.

WARNING! Sudden Movement Hazard. Before you do Rotational Auto-Tuning, disconnect the load from the motor. The load can move suddenly and cause serious injury or death.

WARNING! Injury to Personnel. Rotational Auto-Tuning rotates the motor at 50% or more of the motor rated frequency. Make sure that there are no issues related to safety in the area around the drive and motor. Increased motor frequency can cause serious injury or death.

WARNING! Electrical Shock Hazard. During Auto-Tuning, the motor will receive high voltage when the motor is stopped. Do not touch the motor until Auto-Tuning is complete. If you touch a motor that is energized, it can cause serious injury or death.

■ Precautions before Rotational Auto-Tuning

WARNING! Electrical Shock Hazard. During Auto-Tuning, the motor will receive high voltage when the motor is stopped. Do not touch the motor until Auto-Tuning is complete. If you touch a motor that is energized, it can cause serious injury or death.

- Before you do Rotational Auto-Tuning to prevent drive malfunction, uncouple the motor from the load. If you do Rotational Auto-Tuning with the motor connected to a load that is more than 30% of the motor duty rating, the drive will not correctly calculate the motor parameters and the motor can operate incorrectly.
- When the load is 30% or less of the motor duty rating, you can do Auto-Tuning with the motor connected to a load.
- Make sure that the motor magnetic brake is released.
- Make sure that external force from the machine will not cause the motor to rotate.

■ Precautions before Stationary Auto-Tuning

- Make sure that the motor magnetic brake is not open.
- Make sure that external force from the machine will not cause the motor to rotate.

WARNING! Electrical Shock Hazard. During Auto-Tuning, the motor will receive high voltage when the motor is stopped. Do not touch the motor until Auto-Tuning is complete. If you touch a motor that is energized, it can cause serious injury or death.

■ Automatically Set E2-02 [Motor Rated Slip] and E2-03 [Motor No-Load Current]

If $T1-12 = 1$ [Test Mode Selection = Yes] when selecting Stationary Auto-Tuning, the drive will automatically set motor parameters $E2-02$ [Motor Rated Slip] and $E2-03$ [Motor No-Load Current] after Auto-Tuning is complete when you use the motor for the first time in Drive Mode.

After Stationary Auto-Tuning is complete, use this procedure to do the operation in test mode:

1. Check the $E2-02$ and $E2-03$ values on the “Modified Parameters/Fault Log” screen or the “Parameters” screen.
2. Operate the motor in Drive Mode with these conditions:
 - Make sure that you connect all wiring between the drive and motor
 - Make sure that a mechanical brake on the motor shaft is not locked
 - The maximum motor load must be 30% of the rated load.
 - Keep a constant speed of 30% of $E1-06$ [Base Frequency] (default value = maximum frequency) or more for 1 second or longer.
3. After the motor stops, examine the values of $E2-02$ and $E2-03$ again in the Verify Menu or Parameter Setting Mode.
4. Make sure that the input data is correct.
When the settings in $E2-02$ and $E2-03$ are different than in step 1, the drive set the values automatically.

■ Precautions before Stationary Auto-Tuning for Line-to-Line Resistance and Stator Resistance Auto-Tuning

In V/f control, when the motor cable is 50 meters (164 feet) or longer, do Stationary Auto-Tuning for Line-to-Line Resistance.

WARNING! *Electrical Shock Hazard. During Auto-Tuning, the motor will receive high voltage when the motor is stopped. Do not touch the motor until Auto-Tuning is complete. If you touch a motor that is energized, it can cause serious injury or death.*

■ Precautions before Using Deceleration Rate Tuning and KEB Tuning

Before Deceleration Rate Tuning or KEB Tuning, check these items:

Note:

- Do not do Deceleration Rate Tuning if you use a braking resistor unit or a regenerative converter.
- Do Deceleration Rate Tuning and KEB Tuning with the load attached to the motor.
- Do not do Deceleration Rate Tuning or KEB Tuning for these applications:
In Deceleration Rate Tuning and KEB Tuning, the drive will automatically rotate the motor forward and accelerate and decelerate the motor again and again.
 - On a machine that does not let the motor rotate forward
 - In applications with a small range of operation (trolleys and other such applications that can only move linearly)
 - Applications where sudden acceleration and sudden deceleration are not applicable.
- To do KEB Tuning with the external main circuit capacitors connected to the drive, set *L3-26 [Additional DC Bus Capacitors]* then do KEB Tuning.
- Do not do KEB Tuning or Deceleration Rate Tuning if the drive is set to use *H1-xx = 16 [MFDI Function Select = Motor 2 Selection]*. Failure to obey can cause an *ov [Overvoltage]* fault.

4.10 Test Run

After you set the basic parameters and do Auto-Tuning, do a test run.

WARNING! Crush Hazard. Test the system to make sure that the drive operates safely after you wire the drive and set parameters. If you do not test the system, it can cause damage to equipment or serious injury or death.

◆ No-Load Test Run

Before connecting the motor to the machine, make sure that you check the operation status of the motor.

■ Precautions before Operation

Before rotating the motor, check these items:

- Check for safety issues near the drive, motor, and machine.
- Make sure that all emergency stop circuits and machine safety mechanisms are operating correctly.

■ Items to Check before Operation

Check these items before operation:

- Is the motor rotating in the forward direction?
- Is the motor rotating smoothly (no unusual sounds or unusual vibrations)?
- Does the motor accelerate/decelerate smoothly?

◆ Do a No-Load Test Run

Do these steps for a no-load test run:

1. Energize the drive, or push **ESC** to show the frequency reference screen.
2. Push **LO/RE** to illuminate the LOCAL/REMOTE LED.
3. Use **▲** / **▼** / **◀** / **▶** to set $d1-01 = 6.00$ [Frequency Reference 1 = 6.00 Hz], then push **↵**.
4. Push **◀RUN**.
The RUN indicator illuminates, and the motor runs at 6.00 Hz in the forward direction.
5. Make sure that the motor is rotating in the correct direction and that the drive does not show a fault.
If the drive detects a fault, remove the cause.

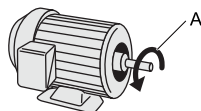

A - Forward Rotation of Motor (Counter Clockwise Direction as Seen from Load Shaft)

6. Push **▲** to increase the frequency reference value.
Change the setting value in increments of 10 Hz if necessary and examine the response.
Ex.: 6 Hz → 20 Hz → 30 Hz → 40 Hz → 50 Hz → 60 Hz
7. Each time you increase the setting value, use $U1-03$ [Output Current] to check the drive output current.
When the output current of the drive is not more than the motor rated current, the status is correct.
8. Make sure that the motor rotates correctly, then push **STOP**.
The RUN LED flashes and goes off when the motor stops completely.

◆ Actual-Load Test Run

Test the operation without a load, then connect the motor and machine to do a test run.

■ Precautions before Operation

Before rotating the motor, check these items:

- Check for safety issues near the drive, motor, and machine.
- Make sure that all emergency stop circuits and machine safety mechanisms are operating correctly.
- Make sure that the motor is fully stopped.
- Connect the motor with the machine.
Make sure that there are no loose installation screws and that the motor load shafts and machine junctions are correctly secured.
- Keep the keypad near you to push  immediately if there is unusual or incorrect operation.

■ Items to Check before Operation











- Make sure that the direction of the machine operation is correct (The motor must rotate in the correct direction).
- Make sure that the motor accelerates and decelerates smoothly.

◆ Do an Actual-Load Test Run

Note:

During a test run, make sure that *U1-03 [Output Current]* is not too high.

Connect the motor and machine, then do the test run with the same procedure that you used for the no-load test run.

1. Energize the drive, or push  to show the frequency reference screen.
2. Use  /  /  /  to set *d1-01 = 6.00 [Frequency Reference 1 = 6.00 Hz]*, then push .
3. Push  to illuminate the LOCAL/REMOTE LED.
4. Push .
The RUN indicator illuminates, and the motor runs at 6.00 Hz in the forward direction.
5. Make sure that the motor is rotating in the correct direction and that the drive does not show a fault.
If the drive detects a fault, remove the cause.
6. Push  to increase the frequency reference value.
Change the setting value in increments of 10 Hz if necessary and examine the response.
Ex.: 6 Hz → 20 Hz → 30 Hz → 40 Hz → 50 Hz → 60 Hz
7. Each time you increase the setting value, use *U1-03 [Output Current]* to check the drive output current.
When the output current of the drive is not more than the motor rated current, the status is correct.
8. Make sure that the motor rotates correctly, then push .
The RUN LED flashes and goes off when the motor stops completely.
9. Change the frequency reference and direction of motor rotation, and make sure that there are no unusual sounds or vibrations.
10. If the control function causes hunting or oscillation errors, adjust the settings to stop the errors.

4.11 Fine Tuning during Test Runs (Adjust the Control Function)

This section gives information about the adjustment procedures to stop hunting or oscillation errors caused by the control function during a test run. Adjust the applicable parameters as specified by your control method and drive status.

- [V/f Control on page 157](#)
- [Open Loop Vector Control for PM Motors on page 160](#)
- [Advanced Open Loop Vector Control Method for PM Motors on page 161](#)
- [EZ Open Loop Vector Control Method on page 161](#)

Note:

This section only lists frequently adjusted parameters. If you must adjust parameters that have a higher degree of precision, contact Yaskawa.

◆ V/f Control

Table 4.18 Parameters for Fine Tuning the Drive (A1-02 = 0 [V/f])

Issue	Parameter Number	Possible Solutions	Default	Recommended Setting
Hunting or oscillation at mid-range speeds (10 Hz to 40 Hz)	n1-02 [Hunting Prevention Gain Setting]	<ul style="list-style-type: none"> • If torque is not sufficient with heavy loads, decrease the setting value. • If hunting or oscillation occur with light loads, increase the setting value. • If hunting occurs with a low-inductance motor, for example a motor with a larger frame size or a high-frequency motor, lower the setting value. Set <i>n1-01 = 1</i> [Hunting Prevention Selection = Enabled]. 	1.00	0.10 - 2.00
<ul style="list-style-type: none"> • The volume of the motor excitation sound is too high. • Hunting or oscillation at low speeds (10 Hz or lower), or at mid-range speeds (10 Hz to 40 Hz) 	C6-02 [Carrier Frequency Selection]	<ul style="list-style-type: none"> • If the volume of the motor excitation sound is too high, increase the carrier frequency. • If hunting or oscillation occur at low or mid-range speeds, decrease the carrier frequency. 	1 (2 kHz) *1	1 to upper limit value
<ul style="list-style-type: none"> • Unsatisfactory motor torque and speed response • Hunting or oscillation 	C4-02 [Torque Compensation Delay Time]	<ul style="list-style-type: none"> • If torque or speed response are slow, decrease the setting value. • If hunting or oscillation occur, increase the setting value. 	200 ms *2	100 ms to 1000 ms
<ul style="list-style-type: none"> • Torque at low speeds (10 Hz or lower) is not sufficient. • Hunting or oscillation 	C4-01 [Torque Compensation Gain]	<ul style="list-style-type: none"> • If torque at low speeds (10 Hz or lower) is not sufficient, increase the setting value. • If hunting or oscillation occur with light loads, decrease the setting value. 	1.00	0.50 - 1.50
• If you use the drive with an IE3 high efficiency motor, the current that is more than the motor rated current will flow and trip at overload. Hunting or oscillation.	C4-01 [Torque Compensation Gain]	Decrease the setting value in these conditions: <ul style="list-style-type: none"> • Drive trips at overload. • Hunting or oscillation. 	1.00	0.00 - 1.00
<ul style="list-style-type: none"> • Torque at low speeds (10 Hz or lower) is not sufficient. • Large initial vibration at start up. 	<ul style="list-style-type: none"> • E1-08 [Mid Point A Voltage] • E1-10 [Minimum Output Voltage] 	<ul style="list-style-type: none"> • If torque at low speeds (10 Hz or lower) is not sufficient, increase the setting value. • If there is large initial vibration at start up, decrease the setting value 	<ul style="list-style-type: none"> • E1-08: 16.0 V *3 • E1-10: 12.0 V *3 	Default setting +/- 5 V *4
Speed precision is unsatisfactory.	C3-01 [Slip Compensation Gain]	Set <i>E2-01 [Motor Rated Current]</i> , <i>E2-02 [Motor Rated Slip]</i> , and <i>E2-03 [Motor No-Load Current]</i> , then adjust <i>C3-01</i> .	0.0 (no slip compensation)	0.5 - 1.5

*1 The default setting changes when the settings for *C6-01 [Normal / Heavy Duty Selection]* and *o2-04 [Drive Model (KVA) Selection]* change.

*2 The default setting changes when the settings for *A1-02 [Control Method Selection]* and *o2-04* change.

*3 The default setting changes when the settings for *A1-02* and *E1-03 [V/f Pattern Selection]* change.

*4 Recommended settings are for 200 V class drives. Multiply the voltage by 2 for 400 V class drives.

■ Precaution When You Use IE3 Premium Efficiency Motors

IE3 motors have different motor characteristics from IE1 and other motors. Set the parameters as specified by the motor characteristics. If you have a momentary power loss, and the drive detects *oC* [Overcurrent] or *ov* [Overvoltage] during speed search after it restores power, set these parameters:

- *b3-03* [Speed Search Deceleration Time] = default value × 2
- *L2-03* [Minimum Baseblock Time] = default value × 2
- *L2-04* [Powerloss V/f Recovery Ramp Time] = default value × 2

◆ Open Loop Vector Control Method

In Open Loop Vector Control, keep *C4-01* [Torque Compensation Gain] at its default setting (1.00).

If you cannot get speed precision during regeneration in Open Loop Vector Control, set *C3-04* = 1 [Slip Compensation at Regen = Enabled Above 6 Hz].

Table 4.19 Parameters for Fine Tuning the Drive (A1-02 = 2 [OLV])

Issue	Parameter Number	Possible Solutions	Default	Recommended Setting
<ul style="list-style-type: none"> • Unsatisfactory motor torque and speed response • Hunting or oscillation at mid-range speeds (10 Hz to 40 Hz) 	<i>n2-01</i> [Automatic Freq Regulator Gain]	<ul style="list-style-type: none"> • To increase the speed of torque or speed response, decrease the setting value in 0.05-unit increments. • If hunting or oscillation occur, decrease the setting value in 0.05-unit increments. 	1.00	0.50 to 2.00
	<i>n2-02</i> [Automatic Freq Regulator Time 1]	<ul style="list-style-type: none"> • To increase the speed of torque or speed response, decrease the setting value in 10 ms increments and examine the response. • If hunting or oscillation occur or if the load inertia is too much, increase the setting value in 50 ms increments and examine the response. <p>Note: Make sure that this parameter setting is: $n2-02 \leq n2-03$ [Automatic Freq Regulator Time 2]. When you adjust <i>n2-02</i>, you must also increase the <i>C4-02</i> [Torque Compensation Delay Time] value by the same ratio.</p>	50 ms	50 ms to 2000 ms
<p><i>ov</i> [Overvoltage] occurs when the drive stops accelerating, starts to decelerate, or when there are large changes in the load.</p>	<i>n2-03</i> [Automatic Freq Regulator Time 2]	<ul style="list-style-type: none"> • If <i>ov</i> occurs, increase the setting value in 50 ms increments and examine the response. • If the response is not sufficient, decrease the setting value in 10 ms increments and examine the response. <p>Note: Make sure that this parameter setting is: $n2-02$ [Automatic Freq Regulator Time 1] $\leq n2-03$. When you adjust <i>n2-03</i>, you must also increase the <i>C4-06</i> [Motor 2 Torque Comp Delay Time] value by the same ratio.</p>	750 ms	750 ms to 2000 ms
	<i>C4-06</i> [Motor 2 Torque Comp Delay Time]	<ul style="list-style-type: none"> • If <i>ov</i> occurs, increase the setting value in 10 ms increments and examine the response. • If the response is not sufficient, decrease the setting value in 2 ms increments and examine the response. <p>Note: Make sure that this parameter setting is: $C4-02$ [Torque Compensation Delay Time] $\leq C4-06$. When you adjust <i>C4-06</i>, you must also increase the <i>n2-03</i> [Automatic Freq Regulator Time 2] value by the same ratio.</p>	150 ms	150 ms to 750 ms

4.11 Fine Tuning during Test Runs (Adjust the Control Function)

Issue	Parameter Number	Possible Solutions	Default	Recommended Setting
<ul style="list-style-type: none"> Unsatisfactory motor torque and speed response Hunting or oscillation 	C4-02 [Torque Compensation Delay Time]	<ul style="list-style-type: none"> If torque or speed response are slow, decrease the setting value in 2 ms increments. If hunting or oscillation occur, increase the setting value in 10 ms increments. <p>Note: Make sure that this parameter setting is: $C4-02 \leq C4-06$ [Motor 2 Torque Comp Delay Time].</p> <p>When you adjust C4-02, you must also increase the n2-02 [Automatic Freq Regulator Time 1] value by the same ratio.</p>	20 ms *1	20 ms - 100 ms *1
<ul style="list-style-type: none"> Speed response is slow. Speed is not stable. 	C3-02 [Slip Compensation Delay Time]	<ul style="list-style-type: none"> If speed response is slow, decrease the setting value in 10 ms increments. If speed is not stable, increase the value in 10 ms increments. 	200 ms *1	100 ms to 500 ms
Speed precision is unsatisfactory.	C3-01 [Slip Compensation Gain]	<ul style="list-style-type: none"> If speed is too slow, increase the setting value in 0.1 unit increments. If speed is too fast, decrease the setting value in 0.1 unit increments. 	1.0 *2	0.5 to 1.5
<ul style="list-style-type: none"> The volume of the motor excitation sound is too high. Hunting or oscillation at low speeds (10 Hz or lower) 	C6-02 [Carrier Frequency Selection]	<ul style="list-style-type: none"> If the volume of the motor excitation sound is too high, increase the carrier frequency. If hunting or oscillation occur at low speeds, decrease the carrier frequency. 	7 (Swing PWM1) *3	0 to upper limit value
<ul style="list-style-type: none"> Torque at low speeds (10 Hz or lower) is not sufficient. speed response is slow. Speed response is slow. Large initial vibration at start up. 	<ul style="list-style-type: none"> E1-08 [Mid Point A Voltage] E1-10 [Minimum Output Voltage] 	<ul style="list-style-type: none"> If torque or speed response are slow, increase the setting value. If there is large initial vibration at start up, decrease the setting value <p>Note: If you set the value too high, the drive can output a large torque reference although the load is light.</p>	<ul style="list-style-type: none"> E1-08: 12.0 V *2 E1-10: 2.5 V *2 	Default setting +/- 2 V *4

*1 The default setting changes when the settings for A1-02 [Control Method Selection] and o2-04 [Drive Model (KVA) Selection] change.

*2 The default setting changes when the settings for A1-02 [Control Method Selection] and E1-03 [V/f Pattern Selection] change.

*3 The default setting changes when the settings for C6-01 [Normal / Heavy Duty Selection] and o2-04 change.

*4 Recommended settings are for 200 V class drives. Multiply the voltage by 2 for 400 V class drives.

■ Precaution When You Use IE3 Premium Efficiency Motors

IE3 motors have different motor characteristics from IE1 and other motors. Set the parameters as specified by the motor characteristics. If you have a momentary power loss, and the drive detects *oC* [Overcurrent] or *ov* [Overvoltage] during speed search after it restores power, set these parameters:

- $b3-03$ [Speed Search Deceleration Time] = default value $\times 2$
- $L2-03$ [Minimum Baseblock Time] = default value $\times 2$
- $L2-04$ [Powerloss V/f Recovery Ramp Time] = default value $\times 2$

◆ Open Loop Vector Control for PM Motors

Table 4.20 Parameters for Fine Tuning the Drive (A1-02 = 5 [OLV/PM])

Issue	Parameter Number	Possible Solutions	Default	Recommended Setting
Unsatisfactory motor performance	E1-xx parameters, E5-xx parameters	<ul style="list-style-type: none"> Check the settings for E1-06, E1-04 [Base Frequency, Maximum Output Frequency]. Check the E5-xx and make sure that you set all motor data correctly. <p>Note: Do not set E5-05 [PM Motor Resistance (ohms/phase)] to a line-to-line resistance value.</p> <ul style="list-style-type: none"> Do Auto-Tuning. 	-	-
Unsatisfactory motor torque and speed response	n8-55 [Motor to Load Inertia Ratio]	Adjust to align the load inertia ratio of the motor and machine.	0	Near the load inertia ratio.
	n8-45 [Speed Feedback Detection Gain]	Decrease the setting value in increments of 0.05.	0.80	-
	C4-01 [Torque Compensation Gain]	Adjust the setting value. Note: If you set this value too high, it can cause overcompensation and motor oscillation.	0.00	1.00
<ul style="list-style-type: none"> Oscillation when the motor starts. Motor stalls. 	n8-51 [Pull-in Current @ Accel/Decel]	Increase the setting value in increments of 5%.	50%	-
	<ul style="list-style-type: none"> b2-02 [DC Injection Braking Current] b2-03 [DC Inject Braking Time at Start] 	Use DC Injection Braking at start. Note: This can cause the motor to rotate in reverse for approximately 1/8 of a turn at start.	<ul style="list-style-type: none"> b2-02: 50% b2-03: 0.00 s 	<ul style="list-style-type: none"> b2-02: Adjust as necessary. b2-03: 0.5 s
	n8-55 [Motor to Load Inertia Ratio]	Increase the setting value. Note: When you operate a single motor or with a minimum quantity of inertia, if you set this value too high, it can cause motor oscillation.	0	Near the load inertia ratio.
There is too much current during deceleration.	n8-79 [Pull-in Current at Deceleration]	Set $n8-79 < n8-51$.	50% Note: When $n8-79 = 0$, the drive will apply the $n8-51$ setting to the pull-in current during deceleration.	Decrease in increments of 5%.
Stalling or oscillation occurs when you apply the load during constant speed	n8-47 [Pull-in Current Comp Filter Time]	Decrease the setting value in increments of 0.2 s.	5.0 s	-
	n8-48 [Pull-in/Light Load Id Current]	Increase the setting value in increments of 5%.	30%	-
	n8-55 [Motor to Load Inertia Ratio]	Increase the setting value. Note: When you operate a single motor or with a minimum quantity of inertia, if you set this value too high, it can cause motor oscillation.	0	Near the load inertia ratio.
Hunting or oscillation	n8-45 [Speed Feedback Detection Gain]	Increase the setting value in increments of 0.05.	0.80	-
The drive detects STPo [Motor Step-Out Detected] fault when the load is not too high.	<ul style="list-style-type: none"> E5-09 [PM Back-EMF Vpeak (mV/(rad/s))] E5-24 [PM Back-EMF L-L Vrms (mV/rpm)] 	<ul style="list-style-type: none"> Adjust the setting value. Examine the motor code on the motor nameplate or the data sheet, then set correct values for E5-09 or E5-24. 	*1	<ul style="list-style-type: none"> Yaskawa motor Set the motor code from the motor nameplate. Motor from another manufacturer Set the values from the test report.
The drive detected stalling or STPo [Motor Step-Out Detected] at high speed and maximum output voltage.	n8-62 [Output Voltage Limit Level]	Set to a value lower than the actual input voltage.	<ul style="list-style-type: none"> 200.0 V 400.0 V 	-

*1 The default setting changes when the settings for E5-01 [Motor Code Selection] and o2-04 [Drive Model (KVA) Selection] change.

◆ Advanced Open Loop Vector Control Method for PM Motors

Table 4.21 Parameters for Fine Tuning the Drive (A1-02 = 6 [AOLV/PM])

Issue	Parameter Number	Possible Solutions	Default	Recommended Setting
<ul style="list-style-type: none"> Unsatisfactory motor torque and speed response Hunting or oscillation 	<ul style="list-style-type: none"> High speed C5-01 [ASR Proportional Gain 1] Low speed C5-03 [ASR Proportional Gain 2] 	<ul style="list-style-type: none"> If torque or speed response are slow, increase the setting value in increments of 5.00. If hunting or oscillation occur, decrease the setting value. 	10.00	5.00 to 30.00 ^{*1}
	<ul style="list-style-type: none"> High speed C5-02 [ASR Integral Time 1] Low speed C5-04 [ASR Integral Time 2] 	<ul style="list-style-type: none"> If torque or speed response are slow, decrease the setting value. If hunting or oscillation occur, increase the setting value. 	0.500 s	0.300 s to 1.000 s ^{*1}
The drive cannot find ASR proportional gain or integral time for low speed or high speed.	C5-07 [ASR Gain Switchover Frequency]	Change the ASR proportional gain and ASR integral time to conform to the output frequency.	0.0%	0.0% to maximum rotation speed
Hunting or oscillation	C5-06 [ASR Delay Time]	If the rigidity of the machine is unsatisfactory and vibration is possible, increase the setting value in increments of 0.010.	0.016 s	0.016 s to 0.035 s ^{*1}
Step-out	E1-xx parameters, E5-xx parameters	Refer to the motor nameplate or test report and set E1-xx or E5-xx correctly.	-	-

*1 The best values for a no-load operation are different than the best values for actual loading operation.

◆ EZ Open Loop Vector Control Method

Table 4.22 Parameters for Fine Tuning the Drive (A1-02 = 8 [EZOLV])

Issue	Parameter Number	Possible Solutions	Default	Recommended Setting
<ul style="list-style-type: none"> Unsatisfactory motor torque and speed response Hunting or oscillation 	<ul style="list-style-type: none"> High speed C5-01 [ASR Proportional Gain 1] Low speed C5-03 [ASR Proportional Gain 2] 	<ul style="list-style-type: none"> If torque or speed response are slow, increase the setting value in increments of 5.00. If hunting or oscillation occur, decrease the setting value. 	10.00	10.00 to 50.00 ^{*1}
	<ul style="list-style-type: none"> High speed C5-02 [ASR Integral Time 1] Low speed C5-04 [ASR Integral Time 2] 	<ul style="list-style-type: none"> If torque or speed response are slow, decrease the setting value. If hunting or oscillation occur, increase the setting value. 	0.500 s	0.300 s to 1.000 s ^{*1}
The drive cannot find ASR proportional gain or integral time for low speed or high speed.	C5-07 [ASR Gain Switchover Frequency]	Change the ASR proportional gain and ASR integral time to conform to the output frequency.	0.0%	0.0% to maximum rotation speed
Hunting or oscillation	C5-06 [ASR Delay Time]	If the rigidity of the machine is unsatisfactory and vibration is possible, increase the setting value in increments of 0.010.	0.004 s	0.004 s to 0.020 s ^{*1}
Step-out	E9-xx parameters	Refer to the motor nameplate or test report and set E9-xx correctly.	-	-
Oscillation when the motor starts.	n8-51 [Accel / Decel Pull-In Current]	Increase the setting value.	80%	Increase in increments of 5%.
Motor stalls.	L7-01 to L7-04 [Torque Limit]	Increase the setting value.	200%	Increase in increments of 10%.

*1 The best values for a no-load operation are different than the best values for actual loading operation.

4.12 Test Run Checklist

Examine the items in this checklist and check each item before a test run.

Checked	No.	Description
	1	Correctly install and wire the drive as specified by this manual.
	2	Energize the drive.
	3	Set the voltage for the power supply in <i>E1-01 [Input AC Supply Voltage]</i> .

Check the applicable items as specified by your control method.

WARNING! Sudden Movement Hazard. Correctly wire the start/stop and safety circuits before you energize the drive. If you momentarily close a digital input terminal, it can start a drive that is programmed for 3-Wire control and cause serious injury or death from moving equipment.

Table 4.23 V/f [A1-02 = 0]

Checked	No.	Description
	4	Select the best V/f pattern for your application and motor characteristics. Example: For a motor with a rated frequency of 60 Hz, set <i>E1-03 = 1 [V/f Pattern Selection = Const Trq, 60Hz base, 60Hz max]</i> as a standard V/f pattern.

Table 4.24 OLV [A1-02 = 2]

Checked	No.	Description
	5	Decouple motor shafts and machines.
	6	Refer to the information on the motor nameplate and set this data correctly: <ul style="list-style-type: none"> • Motor rated power (kW) to <i>T1-02</i> • Motor rated voltage (V) to <i>T1-03</i> • Motor rated current (A) to <i>T1-04</i> • Motor base frequency (Hz) to <i>T1-05</i> • Number of motor poles to <i>T1-06</i> • Motor base speed (min^{-1}) to <i>T1-07</i>
	7	Do Rotational Auto-Tuning.

Table 4.25 OLV/PM [A1-02 = 5]

Checked	No.	Description
	8	Set <i>E5-01 to E5-24 [PM Motor Settings]</i> according to manufacturer data, or do Rotational Auto-Tuning

Table 4.26 AOLV/PM [A1-02 = 6]

Checked	No.	Description
	9	Set <i>E5-01 to E5-24 [PM Motor Settings]</i> according to manufacturer data, or do Rotational Auto-Tuning
	10	Set <i>C5-01 [ASR Proportional Gain 1]</i> and <i>C5-02 [ASR Integral Time 1]</i> .

Checked	No.	Description
	11	Make sure that the keypad shows READY LED before you start to operate the motor.
	12	To give the Run command and frequency reference from the keypad, push LORE to set to LOCAL Mode (when in LOCAL Mode, the LO/RE LED illuminates).
	13	If the motor rotates in the opposite direction during test run, switch two of the motor cables (U/T1, V/T2, W/T3).
	14	Set Heavy Duty or Normal Duty Mode with <i>C6-01 [Normal / Heavy Duty Selection]</i> to conform to the load condition.
	15	Set <i>E2-01 [Motor Rated Current (FLA)]</i> and <i>L1-01 [Motor Overload (oL1) Protection]</i> correctly for motor thermal protection.
	16	Set the drive for REMOTE Mode when the control circuit terminals supply the Run command and frequency reference (in REMOTE Mode, the LO/RE LED turns OFF).
	17	When you use terminal A1 for the frequency reference: <ul style="list-style-type: none"> • Set <i>H3-01 = 0, 4 [Terminal A1 Signal Level Select = 0 to 10 V (Lower Limit at 0), -10 to +10V (Bipolar Reference)]</i>. • Set <i>H3-02 = 0 [Terminal A1 Function Selection = Frequency Reference]</i>.

Checked	No.	Description
	18	<p>When you use terminal A2 for the frequency reference:</p> <ul style="list-style-type: none"> • Voltage input <ul style="list-style-type: none"> – Set DIP Switch S1 on the drive to "V". – Set H3-09 = 0, 4 [Terminal A2 Signal Level Select = 0-10V (Lower Limit at 0), -10 to +10V (Without Lower Limit)]. – Set H3-10 = 0 [Terminal A2 Function Selection = Frequency Reference]. • Current input <ul style="list-style-type: none"> – Set DIP Switch S1 on the drive to "I". – Set H3-09 = 2, 3 [Terminal A2 Signal Level Select = 4 to 20 mA, 0 to 20 mA]. – Set H3-10 = 0 [Terminal A2 Function Selection = Frequency Reference].
	19	<p>Make sure that the frequency reference gets to the necessary minimum and maximum values. If drive operation is incorrect, make these adjustments:</p> <ul style="list-style-type: none"> • Gain Adjustment Set the maximum voltage and current values, then adjust the analog input gain until the frequency reference is at the necessary value. <ul style="list-style-type: none"> – For terminal A1 input: H3-03 – For terminal A2 input: H3-11 • Bias adjustment Set the maximum voltage and current values, then adjust the analog input gain until the frequency reference is at the necessary value. <ul style="list-style-type: none"> – For terminal A1 input: H3-04 – For terminal A2 input: H3-12

Standards Compliance

This chapter gives information about how to make the machines and devices that use this product comply with European standards and UL standards.

5.1	Section Safety	166
5.2	European Standards.....	168
5.3	UL and CSA Standards	188
5.4	China RoHS Compliance	208
5.5	对应中国RoHS指令	209
5.6	Safe Disable Input	210
5.7	Seismic Standards	217
5.8	Australian Standard.....	219

5.1 Section Safety

DANGER

Electrical Shock Hazard

Do not examine, connect, or disconnect wiring on an energized drive. Before servicing, disconnect all power to the equipment and wait for the time specified on the warning label at a minimum. The internal capacitor stays charged after the drive is de-energized. The charge indicator LED extinguishes when the DC bus voltage decreases below 50 Vdc. When all indicators are OFF, measure for dangerous voltages to make sure that the drive is safe.

If you do work on the drive when it is energized, it will cause serious injury or death from electrical shock.

WARNING

Electrical Shock Hazard

Do not operate the drive when covers are missing. Replace covers and shields before you operate the drive. Use the drive only as specified by the instructions.

Some figures in this section include drives without covers or safety shields to more clearly show the inside of the drive. If covers or safety shields are missing from the drive, it can cause serious injury or death.

Always ground the motor-side grounding terminal.

If you do not ground the equipment correctly, it can cause serious injury or death if you touch the motor case.

Do not remove covers or touch circuit boards while the drive is energized.

If you touch the internal components of an energized drive, it can cause serious injury or death.

Only let approved personnel install, wire, maintain, examine, replace parts, and repair the drive.

If personnel are not approved, it can cause serious injury or death.

Do not wear loose clothing or jewelry when you do work on the drive. Tighten loose clothing and remove all metal objects, for example watches or rings.

Loose clothing can catch on the drive and jewelry can conduct electricity and cause serious injury or death.

Do not modify the drive body or drive circuitry.

Modifications to drive body and circuitry can cause serious injury or death, will cause damage to the drive, and will void the warranty. Yaskawa is not responsible for modifications of the product made by the user.

Fire Hazard

Tighten all terminal screws to the correct tightening torque.

Connections that are too loose or too tight can cause incorrect operation and damage to the drive. Incorrect connections can also cause death or serious injury from fire.

Tighten screws at an angle in the specified range shown in this manual.

If you tighten the screws at an angle not in the specified range, you can have loose connections that can cause damage to the terminal block or start a fire and cause serious injury or death.

Damage to Equipment

Do not apply incorrect voltage to the main circuit of the drive. Operate the drive in the specified range of the input voltage on the drive nameplate.

Voltages that are higher than the permitted nameplate tolerance can cause damage to the drive.

Fire Hazard

Do not put flammable or combustible materials on top of the drive and do not install the drive near flammable or combustible materials. Attach the drive to metal or other noncombustible material.

Flammable and combustible materials can start a fire and cause serious injury or death.

⚠ WARNING**Crush Hazard**

Wear eye protection when you do work on the drive.

If you do not use correct safety equipment, it can cause serious injury or death.

Electrical Shock Hazard

After the drive blows a fuse or trips a GFCI, do not immediately energize the drive or operate peripheral devices. Wait for the time specified on the warning label at a minimum and make sure that all indicators are OFF. Then check the wiring and peripheral device ratings to find the cause of the problem. If you do not know the cause of the problem, contact Yaskawa before you energize the drive or peripheral devices.

If you do not fix the problem before you operate the drive or peripheral devices, it can cause serious injury or death.

NOTICE**Damage to Equipment**

When you touch the drive and circuit boards, make sure that you observe correct electrostatic discharge (ESD) procedures.

If you do not follow procedures, it can cause ESD damage to the drive circuitry.

Do not break the electrical connection between the drive and the motor when the drive is outputting voltage.

Incorrect equipment sequencing can cause damage to the drive.

Before you connect a dynamic braking option to the drive, make sure that qualified personnel read and obey the Braking Unit and Braking Resistor Unit Installation Manual (TOBPC72060001).

If you do not read and obey the manual or if personnel are not qualified, it can cause damage to the drive and braking circuit.

Make sure that all connections are correct after you install the drive and connect peripheral devices.

Incorrect connections can cause damage to the drive.

Note:

Do not use unshielded cable for control wiring. Use shielded, twisted-pair wires and ground the shield to the ground terminal of the drive. Unshielded wire can cause electrical interference and unsatisfactory system performance.

5.2 European Standards



Figure 5.1 CE Mark

The CE Mark identifies that the product meets environmental and safety standards in the European Union. Products manufactured, sold, or imported in the European Union must display the CE Mark.

European Union standards include standards for electrical appliances (Low Voltage Directive), standards for electrical noise (EMC Directive), and standards for machinery (Machinery Directive).

This product displays the CE Mark in accordance with the Low Voltage Directive, the EMC Directive, and the Machinery Directive.

Table 5.1 Harmonized Standards

European Directive	Harmonized Standard
CE Low Voltage Directive Compliance 2014/35/EU	EN 61800-5-1:2007
EMC Directive 2014/30/EU	EN 61800-3:2004/A1:2012
Machinery Directive 2006/42/EC	<ul style="list-style-type: none"> • EN ISO 13849-1:2015 (PL e (Cat.III)) • EN 62061:2005/A2:2015 (SILCL3) • EN 61800-5-2:2007

The customer must display the CE Mark on the final device containing this product. Customers must verify that the final device complies with EU standards.

◆ EU Declaration of Conformity

Go to www.yaskawa.com and search for “EU Declaration of Conformity” to get an original copy of the EU Declaration of Conformity.

Yaskawa declares that this product complies with the following directives and standards at our sole responsibility.

◆ CE Low Voltage Directive Compliance

It has been confirmed that this product complies with the CE Low Voltage Directive by conducting a test according to EN 61800-5-1:2007.

The following conditions must be satisfied for machines and devices incorporating this product to comply with the CE Low Voltage Directive.

■ Area of Use

Install this product in a location with Overvoltage Category III and pollution degree 2 or less as specified in IEC/CE 60664.

■ Guarding Against Debris

When you install IP20/UL Open type drives, use an enclosure that does not let unwanted material enter the drive from above or below.

■ Electrical Installation

Refer to [Figure 5.2](#) for an example of a drive that is wired to comply with the CE Low Voltage Directive.

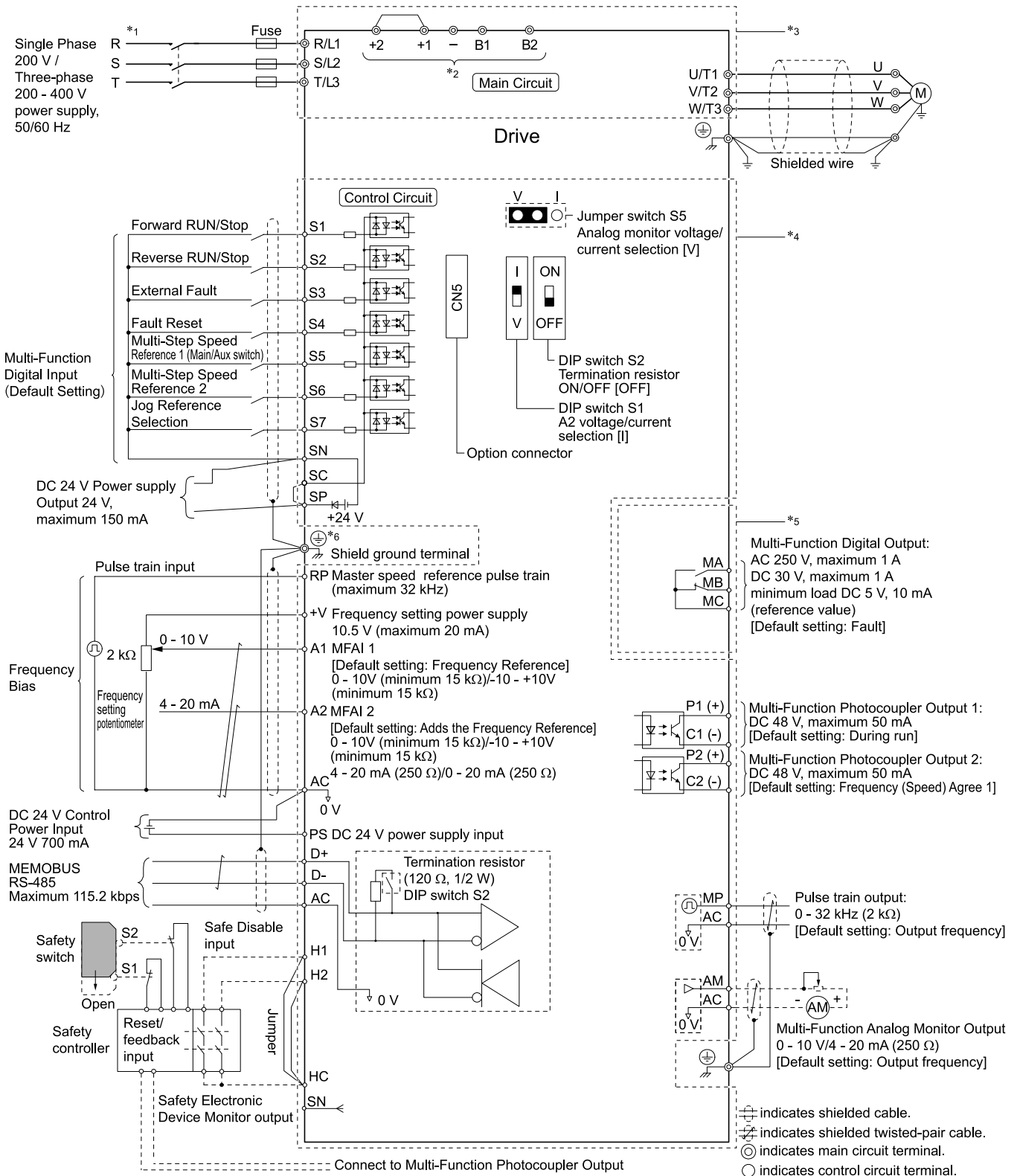

Figure 5.2 Wiring Diagram for CE Low Voltage Directive Compliance

- *1 Set L8-05 = 1 [Output Phase Loss Protect Select = Enabled] or set the wiring sequence to prevent input phase loss.
- *2 Use terminals B1, B2, -, +1, and +2 to connect options to the drive.

WARNING! Fire Hazard. Only connect factory-recommended devices or circuits to drive terminals B1, B2, -, +1, and +2. Do not connect an AC power supply lines to these terminals. Incorrect wiring can cause damage to the drive and serious injury or death from fire.

- *3 To protect the circuit, the main circuit is separate from the surface case that can touch the main circuit.

5.2 European Standards

- *4 The control circuit is a Safety Extra-Low Voltage circuit. Use reinforced insulation to separate this circuit from other circuits. Make sure that you connect the Safety Extra-Low Voltage as specified.
- *5 Reinforced insulation separates the output terminals from other circuits. You can also connect circuits that are not Safety Extra-Low Voltage circuits when the drive output is 250 Vac 1 A maximum or 30 VDC 1 A maximum.

WARNING! Electrical Shock Hazard. When you connect the shield wire of the control circuit wiring to the protective ground terminal, do not connect the protective ground wire. If you connect the shield wire and the protective ground wire to the protective grounding terminal, it may not comply with the technical standards and local safety regulations and can cause serious injury or death.

■ Main Circuit Wire Gauges and Tightening Torques

WARNING! Electrical Shock Hazard. Make sure that the protective ground wire complies with technical standards and local safety regulations. The EN 61800-5-1: 2007 standard specifies that users must wire the power supply to automatically turn off when the protective ground wire disconnects. If you turn on the internal EMC filter, the leakage current of the drive will be more than 3.5 mA. You can also connect a protective ground wire that has a minimum cross-sectional area of 10 mm² (copper wire). If you do not obey the standards and regulations, it can cause serious injury or death.

WARNING! Electrical Shock Hazard. Only connect factory-recommended devices or circuits to drive terminals B1, B2, -, +1, and +2. Do not connect AC power to these terminals. Incorrect wiring can cause damage to the drive and serious injury or death from fire.

Note:

- The recommended wire gauges are based on drive continuous current ratings with 75 °C (167 °F) 600 V class 2 heat-resistant indoor PVC wire. Assume these conditions:
 - Ambient temperature: 40 °C (104 °F) maximum
 - Wiring distance: 100 m (3281 ft) maximum
 - Normal Duty rated current value
- Refer to the instruction manual for each device for recommended wire gauges to connect peripheral devices or options to terminals +1, +2, -, B1, and B2. Contact Yaskawa or your nearest sales representative if the recommended wire gauges for the peripheral devices or options are out of the range of the applicable gauges for the drive.
- When you use crimp ferrules on the wire ends, contact Yaskawa or your nearest sales representative.

Wire Selection Precautions

WARNING! Electrical Shock Hazard.

Make sure that the protective ground wire complies with technical standards and local safety regulations. The EN 61800-5-1:2007 standard specifies that you must wire the power supply to automatically de-energize when the protective ground wire disconnects. If you turn on the internal EMC filter, the leakage current of the drive will be more than 3.5 mA. Use these closed-loop crimp terminals or equivalent to connect a protective ground wire that has a minimum cross-sectional area of 10 mm² (copper wire).

- 8-4NS from JST Mfg. Co., Ltd.
- R8-4S from NICHIFU Co., Ltd.
- P10-8R from PANDUIT Corp.

If you do not obey the standards and regulations, it can cause serious injury or death.

Think about line voltage drop before selecting wire gauges. Select wire gauges that drop the voltage by 2% or less of the rated voltage. Increase the wire gauge and the cable length when the risk of voltage drops increases. Calculate line voltage drop with this formula:

$$\text{Line voltage drop (V)} = \sqrt{3} \times \text{wire resistance } (\Omega/\text{km}) \times \text{wiring distance (m)} \times \text{motor rated current (A)} \times 10^{-3}$$

Precautions during Wiring



- Refer to “Yaskawa AC Drive Option Braking Unit, Braking Resistor Unit Instruction Manual (TOBPC72060001)” for information about wire gauges and tightening torques to connect braking resistor units.
- Use terminals +1 and - to connect a regenerative converter or regenerative unit.

WARNING! Fire Hazard. Do not connect a braking resistor to terminals +1 or -. Use terminals B1 and B2 for the braking resistor connections. If you connect a braking resistor to the incorrect terminals, it can cause damage to the drive and braking circuit and serious injury or death.

Screw Shape

These tables use icons in [Table 5.2](#) to show the shapes of the screw heads.

Table 5.2 Icons to Identify Screw Shapes

Icon	Screw Shape
	+/-
	Slotted (-)
	Hex socket cap (WAF: 5 mm)

Single-Phase 200 V Class

Model	Terminal	Recomm. Gauge mm ²	Applicable Gauge mm ²	Wire Stripping Length ^{*/} mm	Terminal Screw Size and Shape	Tightening Torque N·m (lbf·in)
B001	L/L1, N/L2	2.5	2.5	6.5	M3	0.5 - 0.6 (4.4 - 5.3)
	U/T1, V/T2, W/T3	2.5	2.5	6.5	M3	0.5 - 0.6 (4.4 - 5.3)
	-, +1	2.5	2.5	6.5	M3	0.5 - 0.6 (4.4 - 5.3)
	B1, B2	2.5	2.5	6.5	M3	0.5 - 0.6 (4.4 - 5.3)
		2.5 *2	2.5 *2	-	M3.5	0.8 - 1.0 (7.1 - 8.9)
B002	L/L1, N/L2	2.5	2.5	6.5	M3	0.5 - 0.6 (4.4 - 5.3)
	U/T1, V/T2, W/T3	2.5	2.5	6.5	M3	0.5 - 0.6 (4.4 - 5.3)
	-, +1	2.5	2.5	6.5	M3	0.5 - 0.6 (4.4 - 5.3)
	B1, B2	2.5	2.5	6.5	M3	0.5 - 0.6 (4.4 - 5.3)
		2.5 *2	2.5 *2	-	M3.5	0.8 - 1.0 (7.1 - 8.9)
B004	L/L1, N/L2	2.5	2.5	6.5	M3	0.5 - 0.6 (4.4 - 5.3)
	U/T1, V/T2, W/T3	2.5	2.5	6.5	M3	0.5 - 0.6 (4.4 - 5.3)
	-, +1	2.5	2.5	6.5	M3	0.5 - 0.6 (4.4 - 5.3)
	B1, B2	2.5	2.5	6.5	M3	0.5 - 0.6 (4.4 - 5.3)
		2.5 *2	2.5 *2	-	M3.5	0.8 - 1.0 (7.1 - 8.9)
B006	L/L1, N/L2	2.5	2.5 - 4	8	M3	0.5 - 0.6 (4.4 - 5.3)
	U/T1, V/T2, W/T3	2.5	2.5 - 4	8	M3	0.5 - 0.6 (4.4 - 5.3)
	-, +1	2.5	2.5 - 4	8	M3	0.5 - 0.6 (4.4 - 5.3)
	B1, B2	2.5	2.5 - 4	8	M3	0.5 - 0.6 (4.4 - 5.3)
		2.5 *2	2.5 - 6 *2	-	M4	1.2 - 1.5 (10.6 - 13.3)
B010	L/L1, N/L2	2.5	2.5 - 4	8	M3	0.5 - 0.6 (4.4 - 5.3)
	U/T1, V/T2, W/T3	2.5	2.5 - 4	8	M3	0.5 - 0.6 (4.4 - 5.3)
	-, +1	2.5	2.5 - 4	8	M3	0.5 - 0.6 (4.4 - 5.3)
	B1, B2	2.5	2.5 - 4	8	M3	0.5 - 0.6 (4.4 - 5.3)
		2.5 *2	2.5 - 6 *2	-	M4	1.2 - 1.5 (10.6 - 13.3)

5.2 European Standards

Model	Terminal	Recomm. Gauge mm ²	Applicable Gauge mm ²	Wire Stripping Length ^{*1/} mm	Terminal Screw Size and Shape	Tightening Torque N-m (lbf-in)
B012	L/L1, N/L2	4	2.5 - 6	10	M4 ⊖	1.5 - 1.7 (13.5 - 15)
	U/T1, V/T2, W/T3	2.5	2.5 - 4	10	M4 ⊖	1.5 - 1.7 (13.5 - 15)
	-, +1	4	2.5 - 6	10	M4 ⊖	1.5 - 1.7 (13.5 - 15)
	B1, B2	2.5	2.5 - 4	10	M4 ⊖	1.5 - 1.7 (13.5 - 15)
	⊕	4 *2	2.5 - 6 *2	-	M4 ⊕	1.2 - 1.5 (10.6 - 13.3)
B018	L/L1, N/L2	6	2.5 - 10	10	M4 ⊖	1.5 - 1.7 (13.5 - 15)
	U/T1, V/T2, W/T3	2.5	2.5 - 4	10	M4 ⊖	1.5 - 1.7 (13.5 - 15)
	-, +1	6	2.5 - 10	10	M4 ⊖	1.5 - 1.7 (13.5 - 15)
	B1, B2	2.5	2.5 - 4	10	M4 ⊖	1.5 - 1.7 (13.5 - 15)
	⊕	6 *2	4 - 10 *2	-	M5 ⊕	2.0 - 2.5 (17.7 - 22.1)

*1 Remove insulation from the ends of wires to expose the length of wire shown.

*2 If you turn on the internal EMC filter, the leakage current of the drive will be more than 3.5 mA. Use these closed-loop crimp terminals or equivalent to connect a protective ground wire that has a minimum cross-sectional area of 10 mm² (copper wire).

- 8-4NS from JST Mfg. Co., Ltd.
- R8-4S from NICHIFU Co.,Ltd.
- P10-8R from PANDUIT Corp.

Three-Phase 200 V Class

Model	Terminal	Recomm. Gauge mm ²	Applicable Gauge mm ²	Wire Stripping Length ^{*1/} mm	Terminal Screw Size and Shape	Tightening Torque N-m (lbf-in)
2001	R/L1, S/L2, T/L3	2.5	2.5	6.5	M3 ⊖	0.5 - 0.6 (4.4 - 5.3)
	U/T1, V/T2, W/T3	2.5	2.5	6.5	M3 ⊖	0.5 - 0.6 (4.4 - 5.3)
	-, +1, +2	2.5	2.5	6.5	M3 ⊖	0.5 - 0.6 (4.4 - 5.3)
	B1, B2	2.5	2.5	6.5	M3 ⊖	0.5 - 0.6 (4.4 - 5.3)
	⊕	2.5 *2	2.5 *2	-	M3.5 ⊕	0.8 - 1.0 (7.1 - 8.9)
2002	R/L1, S/L2, T/L3	2.5	2.5	6.5	M3 ⊖	0.5 - 0.6 (4.4 - 5.3)
	U/T1, V/T2, W/T3	2.5	2.5	6.5	M3 ⊖	0.5 - 0.6 (4.4 - 5.3)
	-, +1, +2	2.5	2.5	6.5	M3 ⊖	0.5 - 0.6 (4.4 - 5.3)
	B1, B2	2.5	2.5	6.5	M3 ⊖	0.5 - 0.6 (4.4 - 5.3)
	⊕	2.5 *2	2.5 *2	-	M3.5 ⊕	0.8 - 1.0 (7.1 - 8.9)

Model	Terminal	Recomm. Gauge mm ²	Applicable Gauge mm ²	Wire Stripping Length ^{*/} mm	Terminal Screw Size and Shape	Tightening Torque N·m (lbf·in)
2004	R/L1, S/L2, T/L3	2.5	2.5	6.5	M3 ⊖	0.5 - 0.6 (4.4 - 5.3)
	U/T1, V/T2, W/T3	2.5	2.5	6.5	M3 ⊖	0.5 - 0.6 (4.4 - 5.3)
	-, +1, +2	2.5	2.5	6.5	M3 ⊖	0.5 - 0.6 (4.4 - 5.3)
	B1, B2	2.5	2.5	6.5	M3 ⊖	0.5 - 0.6 (4.4 - 5.3)
	⊕	2.5 *2	2.5 *2	-	M3.5 ⊕	0.8 - 1.0 (7.1 - 8.9)
2006	R/L1, S/L2, T/L3	2.5	2.5	6.5	M3 ⊖	0.5 - 0.6 (4.4 - 5.3)
	U/T1, V/T2, W/T3	2.5	2.5	6.5	M3 ⊖	0.5 - 0.6 (4.4 - 5.3)
	-, +1, +2	2.5	2.5	6.5	M3 ⊖	0.5 - 0.6 (4.4 - 5.3)
	B1, B2	2.5	2.5	6.5	M3 ⊖	0.5 - 0.6 (4.4 - 5.3)
	⊕	2.5 *2	2.5 *2	-	M3.5 ⊕	0.8 - 1.0 (7.1 - 8.9)
2010	R/L1, S/L2, T/L3	2.5	2.5 - 4	8	M3 ⊖	0.5 - 0.6 (4.4 - 5.3)
	U/T1, V/T2, W/T3	2.5	2.5 - 4	8	M3 ⊖	0.5 - 0.6 (4.4 - 5.3)
	-, +1, +2	2.5	2.5 - 4	8	M3 ⊖	0.5 - 0.6 (4.4 - 5.3)
	B1, B2	2.5	2.5 - 4	8	M3 ⊖	0.5 - 0.6 (4.4 - 5.3)
	⊕	4 *2	2.5 - 6 *2	-	M4 ⊕	1.2 - 1.5 (10.6 - 13.3)
2012	R/L1, S/L2, T/L3	2.5	2.5 - 4	8	M3 ⊖	0.5 - 0.6 (4.4 - 5.3)
	U/T1, V/T2, W/T3	2.5	2.5 - 4	8	M3 ⊖	0.5 - 0.6 (4.4 - 5.3)
	-, +1, +2	2.5	2.5 - 4	8	M3 ⊖	0.5 - 0.6 (4.4 - 5.3)
	B1, B2	2.5	2.5 - 4	8	M3 ⊖	0.5 - 0.6 (4.4 - 5.3)
	⊕	4 *2	2.5 - 6 *2	-	M4 ⊕	1.2 - 1.5 (10.6 - 13.3)
2021	R/L1, S/L2, T/L3	4	2.5 - 6	10	M4 ⊖	1.5 - 1.7 (13.5 - 15)
	U/T1, V/T2, W/T3	2.5	2.5 - 4	10	M4 ⊖	1.5 - 1.7 (13.5 - 15)
	-, +1, +2	6	4 - 10	10	M4 ⊖	1.5 - 1.7 (13.5 - 15)
	B1, B2	2.5	2.5 - 4	10	M4 ⊖	1.5 - 1.7 (13.5 - 15)
	⊕	6 *2	2.5 - 6 *2	-	M4 ⊕	1.2 - 1.5 (10.6 - 13.3)

5.2 European Standards

Model	Terminal	Recomm. Gauge mm ²	Applicable Gauge mm ²	Wire Stripping Length ^{*1} mm	Terminal Screw Size and Shape	Tightening Torque N·m (lbf·in)
2030	R/L1, S/L2, T/L3	6	4 - 10	10	M4 ⊖	1.5 - 1.7 (13.5 - 15)
	U/T1, V/T2, W/T3	6	4 - 10	10	M4 ⊖	1.5 - 1.7 (13.5 - 15)
	-, +1, +2	10	2.5 - 16	10	M4 ⊖	1.5 - 1.7 (13.5 - 15)
	B1, B2	2.5	2.5 - 4	10	M4 ⊖	1.5 - 1.7 (13.5 - 15)
	⊕	6 *2	6 - 16	-	M5 ⊕	2.0 - 2.5 (17.7 - 22.1)
2042	R/L1, S/L2, T/L3	10	2.5 - 16	10	M4 ⊖	1.5 - 1.7 (13.5 - 15)
	U/T1, V/T2, W/T3	10	2.5 - 16	10	M4 ⊖	1.5 - 1.7 (13.5 - 15)
	-, +1, +2	16	4 - 25	18	M5 ⊖	2.3 - 2.5 (19.8 - 22)
	B1, B2	4	2.5 - 6	10	M4 ⊖	1.5 - 1.7 (13.5 - 15)
	⊕	10	6 - 16	-	M5 ⊕	2.0 - 2.5 (17.7 - 22.1)
2056	R/L1, S/L2, T/L3	16	4 - 25	18	M5 ⊖	2.3 - 2.5 (19.8 - 22)
	U/T1, V/T2, W/T3	16	4 - 25	18	M5 ⊖	2.3 - 2.5 (19.8 - 22)
	-, +1, +2	25	6 - 35	18	M5 ⊖	• ≤ 25 mm ² 2.3 - 2.5 (19.8 - 22) • 35 mm ² ≤ 4.1 - 4.5 (36 - 40)
	B1, B2	10	4 - 16	10	M4 ⊖	1.5 - 1.7 (13.5 - 15)
	⊕	10	10 - 25	-	M6 ⊕	5.4 - 6.0 (47.8 - 53.1)
2070	R/L1, S/L2, T/L3	25	6 - 35	20	M6 ⊕	5 - 5.5 (45 - 49)
	U/T1, V/T2, W/T3	16	6 - 25	20	M6 ⊕	5 - 5.5 (45 - 49)
	-, +1, +2	35	10 - 50	20	M6 ⊕	5 - 5.5 (45 - 49)
	B1, B2	10	4 - 16	10	M4 ⊖	1.5 - 1.7 (13.5 - 15)
	⊕	16	10 - 25	-	M6 ⊕	5.4 - 6.0 (47.8 - 53.1)
2082	R/L1, S/L2, T/L3	35	10 - 50	20	M6 ⊕	5 - 5.5 (45 - 49)
	U/T1, V/T2, W/T3	25	10 - 35	20	M6 ⊕	5 - 5.5 (45 - 49)
	-, +1, +2	50	16 - 70	20	M6 ⊕	5 - 5.5 (45 - 49)
	B1, B2	16	4 - 16	10	M4 ⊖	1.5 - 1.7 (13.5 - 15)
	⊕	16	10 - 25	-	M6 ⊕	5.4 - 6.0 (47.8 - 53.1)

*1 Remove insulation from the ends of wires to expose the length of wire shown.

*2 If you turn on the internal EMC filter, the leakage current of the drive will be more than 3.5 mA. Use these closed-loop crimp terminals or equivalent to connect a protective ground wire that has a minimum cross-sectional area of 10 mm² (copper wire).

- 8-4NS from JST Mfg. Co., Ltd.
- R8-4S from NICHIFU Co.,Ltd.
- P10-8R from PANDUIT Corp.

Three-Phase 400 V Class

Model	Terminal	Recomm. Gauge mm ²	Applicable Gauge mm ²	Wire Stripping Length ^{*7} mm	Terminal Screw Size and Shape	Tightening Torque N·m (lbf·in)
4001	R/L1, S/L2, T/L3	2.5	2.5 - 4	8	M3 ⊖	0.5 - 0.6 (4.4 - 5.3)
	U/T1, V/T2, W/T3	2.5	2.5 - 4	8	M3 ⊖	0.5 - 0.6 (4.4 - 5.3)
	-, +1, +2	2.5	2.5 - 4	8	M3 ⊖	0.5 - 0.6 (4.4 - 5.3)
	B1, B2	2.5	2.5 - 4	8	M3 ⊖	0.5 - 0.6 (4.4 - 5.3)
	⊕	2.5 *2	2.5 - 6 *2	-	M4 ⊕	1.2 - 1.5 (10.6 - 13.3)
4002	R/L1, S/L2, T/L3	2.5	2.5 - 4	8	M3 ⊖	0.5 - 0.6 (4.4 - 5.3)
	U/T1, V/T2, W/T3	2.5	2.5 - 4	8	M3 ⊖	0.5 - 0.6 (4.4 - 5.3)
	-, +1, +2	2.5	2.5 - 4	8	M3 ⊖	0.5 - 0.6 (4.4 - 5.3)
	B1, B2	2.5	2.5 - 4	8	M3 ⊖	0.5 - 0.6 (4.4 - 5.3)
	⊕	2.5 *2	2.5 - 6 *2	-	M4 ⊕	1.2 - 1.5 (10.6 - 13.3)
4004	R/L1, S/L2, T/L3	2.5	2.5 - 4	8	M3 ⊖	0.5 - 0.6 (4.4 - 5.3)
	U/T1, V/T2, W/T3	2.5	2.5 - 4	8	M3 ⊖	0.5 - 0.6 (4.4 - 5.3)
	-, +1, +2	2.5	2.5 - 4	8	M3 ⊖	0.5 - 0.6 (4.4 - 5.3)
	B1, B2	2.5	2.5 - 4	8	M3 ⊖	0.5 - 0.6 (4.4 - 5.3)
	⊕	4 *2	2.5 - 6 *2	-	M4 ⊕	1.2 - 1.5 (10.6 - 13.3)
4005	R/L1, S/L2, T/L3	2.5	2.5 - 4	8	M3 ⊖	0.5 - 0.6 (4.4 - 5.3)
	U/T1, V/T2, W/T3	2.5	2.5 - 4	8	M3 ⊖	0.5 - 0.6 (4.4 - 5.3)
	-, +1, +2	2.5	2.5 - 4	8	M3 ⊖	0.5 - 0.6 (4.4 - 5.3)
	B1, B2	2.5	2.5 - 4	8	M3 ⊖	0.5 - 0.6 (4.4 - 5.3)
	⊕	4 *2	2.5 - 6 *2	-	M4 ⊕	1.2 - 1.5 (10.6 - 13.3)

5.2 European Standards

Model	Terminal	Recomm. Gauge mm ²	Applicable Gauge mm ²	Wire Stripping Length ^{*/} mm	Terminal Screw Size and Shape	Tightening Torque N·m (lbf·in)
4007	R/L1, S/L2, T/L3	2.5	2.5 - 4	8	M3 ⊖	0.5 - 0.6 (4.4 - 5.3)
	U/T1, V/T2, W/T3	2.5	2.5 - 4	8	M3 ⊖	0.5 - 0.6 (4.4 - 5.3)
	-, +1, +2	2.5	2.5 - 4	8	M3 ⊖	0.5 - 0.6 (4.4 - 5.3)
	B1, B2	2.5	2.5 - 4	8	M3 ⊖	0.5 - 0.6 (4.4 - 5.3)
	⊕	4 *2	2.5 - 6 *2	-	M4 ⊕	1.2 - 1.5 (10.6 - 13.3)
4009	R/L1, S/L2, T/L3	2.5	2.5 - 4	8	M3 ⊖	0.5 - 0.6 (4.4 - 5.3)
	U/T1, V/T2, W/T3	2.5	2.5 - 4	8	M3 ⊖	0.5 - 0.6 (4.4 - 5.3)
	-, +1, +2	2.5	2.5 - 4	8	M3 ⊖	0.5 - 0.6 (4.4 - 5.3)
	B1, B2	2.5	2.5 - 4	8	M3 ⊖	0.5 - 0.6 (4.4 - 5.3)
	⊕	4 *2	2.5 - 6 *2	-	M4 ⊕	1.2 - 1.5 (10.6 - 13.3)
4012	R/L1, S/L2, T/L3	2.5	2.5 - 4	10	M4 ⊖	1.5 - 1.7 (13.5 - 15)
	U/T1, V/T2, W/T3	2.5	2.5 - 4	10	M4 ⊖	1.5 - 1.7 (13.5 - 15)
	-, +1, +2	2.5	2.5 - 4	10	M4 ⊖	1.5 - 1.7 (13.5 - 15)
	B1, B2	2.5	2.5 - 4	10	M4 ⊖	1.5 - 1.7 (13.5 - 15)
	⊕	4 *2	2.5 - 6 *2	-	M4 ⊕	1.2 - 1.5 (10.6 - 13.3)
4018	R/L1, S/L2, T/L3	2.5	2.5 - 4	10	M4 ⊖	1.5 - 1.7 (13.5 - 15)
	U/T1, V/T2, W/T3	2.5	2.5 - 4	10	M4 ⊖	1.5 - 1.7 (13.5 - 15)
	-, +1, +2	4	2.5 - 6	10	M4 ⊖	1.5 - 1.7 (13.5 - 15)
	B1, B2	2.5	2.5 - 4	10	M4 ⊖	1.5 - 1.7 (13.5 - 15)
	⊕	4 *2	2.5 - 16	-	M5 ⊕	2.0 - 2.5 (17.7 - 22.1)
4023	R/L1, S/L2, T/L3	4	2.5 - 6	10	M4 ⊖	1.5 - 1.7 (13.5 - 15)
	U/T1, V/T2, W/T3	4	2.5 - 6	10	M4 ⊖	1.5 - 1.7 (13.5 - 15)
	-, +1, +2	4	4 - 6	10	M4 ⊖	1.5 - 1.7 (13.5 - 15)
	B1, B2	2.5	2.5 - 4	10	M4 ⊖	1.5 - 1.7 (13.5 - 15)
	⊕	4 *2	4 - 16	-	M5 ⊕	2.0 - 2.5 (17.7 - 22.1)

Model	Terminal	Recomm. Gauge mm ²	Applicable Gauge mm ²	Wire Stripping Length ^{*1} mm	Terminal Screw Size and Shape	Tightening Torque N·m (lbf·in)
4031	R/L1, S/L2, T/L3	6	4 - 10	10	M4 ⊖	1.5 - 1.7 (13.5 - 15)
	U/T1, V/T2, W/T3	6	4 - 10	10	M4 ⊖	1.5 - 1.7 (13.5 - 15)
	-, +1, +2	10	2.5 - 16	18	M5 ⊖	2.3 - 2.5 (19.8 - 22)
	B1, B2	2.5	2.5 - 4	10	M4 ⊖	1.5 - 1.7 (13.5 - 15)
	⊕	6 *2	6 - 16 *2	-	M6 ⊕	5.4 - 6.0 (47.8 - 53.1)
4038	R/L1, S/L2, T/L3	10	4 - 16	10	M4 ⊖	1.5 - 1.7 (13.5 - 15)
	U/T1, V/T2, W/T3	6	2.5 - 10	10	M4 ⊖	1.5 - 1.7 (13.5 - 15)
	-, +1, +2	16	4 - 25	18	M5 ⊖	2.3 - 2.5 (19.8 - 22)
	B1, B2	4	2.5 - 6	10	M4 ⊖	1.5 - 1.7 (13.5 - 15)
	⊕	10	6 - 16	-	M6 ⊕	5.4 - 6.0 (47.8 - 53.1)
4044	R/L1, S/L2, T/L3	16	4 - 25	18	M5 ⊖	2.3 - 2.5 (19.8 - 22)
	U/T1, V/T2, W/T3	10	4 - 16	18	M5 ⊖	2.3 - 2.5 (19.8 - 22)
	-, +1, +2	16	6 - 25	18	M5 ⊖	2.3 - 2.5 (19.8 - 22)
	B1, B2	6	4 - 10	10	M4 ⊖	1.5 - 1.7 (13.5 - 15)
	⊕	10	6 - 16	-	M6 ⊕	5.4 - 6.0 (47.8 - 53.1)
4060	R/L1, S/L2, T/L3	25	6 - 35	18	M5 ⊖	• ≤ 25 mm ² 2.3 - 2.5 (19.8 - 22) • 35 mm ² ≤ 4.1 - 4.5 (36 - 40)
	U/T1, V/T2, W/T3	16	4 - 25	18	M5 ⊖	2.3 - 2.5 (19.8 - 22)
	-, +1, +2	25	6 - 35	18	M5 ⊖	• ≤ 25 mm ² 2.3 - 2.5 (19.8 - 22) • 35 mm ² ≤ 4.1 - 4.5 (36 - 40)
	B1, B2	10	2.5 - 16	10	M4 ⊖	1.5 - 1.7 (13.5 - 15)
	⊕	10	6 - 16	-	M6 ⊕	5.4 - 6.0 (47.8 - 53.1)

*1 Remove insulation from the ends of wires to expose the length of wire shown.

*2 If you turn on the internal EMC filter, the leakage current of the drive will be more than 3.5 mA. Use these closed-loop crimp terminals or equivalent to connect a protective ground wire that has a minimum cross-sectional area of 10 mm² (copper wire).

- 8-4NS from JST Mfg. Co., Ltd.
- R8-4S from NICHIFU Co., Ltd.
- P10-8R from PANDUIT Corp.

■ Connect a Fuse to the Input Side (Primary Side)

The drive circuit protection must comply with EN 61800-5-1:2007 for protection against a short circuit in the internal circuitry. Connect semiconductor fuses on the input side for branch circuit protection.

Refer to [Single-Phase 200 V Class on page 178](#), [Three-Phase 200 V Class on page 178](#), and [Three-Phase 400 V Class on page 178](#) for more information about recommended fuses.

WARNING! Electrical Shock Hazard. After the drive blows a fuse or trips a GFCI, do not immediately energize the drive or operate peripheral devices. Wait for the time specified on the warning label at a minimum and make sure that all indicators are OFF. Then check the wiring and peripheral device ratings to find the cause of the problem. If you do not know the cause of the problem, contact Yaskawa before you energize the drive or peripheral devices. If you do not fix the problem before you operate the drive or peripheral devices, it can cause serious injury or death.

Single-Phase 200 V Class

Table 5.3 Factory-Recommended Branch Circuit Protection: Single-Phase 200 V Class

Drive Model	Semiconductor Protection Fuse Rated Current Manufacturer: EATON/Bussmann	Drive Model	Semiconductor Protection Fuse Rated Current Manufacturer: EATON/Bussmann
B001	FWH-25A14F	B010	FWH-100B
B002	FWH-25A14F	B012	FWH-125B
B004	FWH-60B	B018	FWH-150B
B006	FWH-80B		

Three-Phase 200 V Class

Table 5.4 Factory-Recommended Branch Circuit Protection: Three-Phase 200 V Class

Drive Model	Semiconductor Protection Fuse Rated Current Manufacturer: EATON/Bussmann	Drive Model	Semiconductor Protection Fuse Rated Current Manufacturer: EATON/Bussmann
2001	FWH-25A14F	2021	FWH-90B
2002	FWH-25A14F	2030	FWH-100B
2004	FWH-25A14F	2042	FWH-150B
2006	FWH-25A14F	2056	FWH-200B
2010	FWH-70B	2070	FWH-200B
2012	FWH-70B	2082	FWH-225A

Three-Phase 400 V Class

Table 5.5 Factory-Recommended Branch Circuit Protection: Three-Phase 400 V Class

Drive Model	Semiconductor Protection Fuse Rated Current Manufacturer: EATON/Bussmann	Drive Model	Semiconductor Protection Fuse Rated Current Manufacturer: EATON/Bussmann
4001	FWH-40B	4018	FWH-80B
4002	FWH-40B	4023	FWH-100B
4004	FWH-50B	4031	FWH-125B
4005	FWH-70B	4038	FWH-175B
4007	FWH-70B	4044	FWH-200B
4009	FWH-90B	4060	FWH-200B
4012	FWH-90B		

■ CE Standards Compliance for DC Power Supply Input

To comply with CE Standards, install a fuse for the DC power supply input.

[Figure 5.3](#) shows a wiring example for a DC power supply that has two drives connected in parallel.

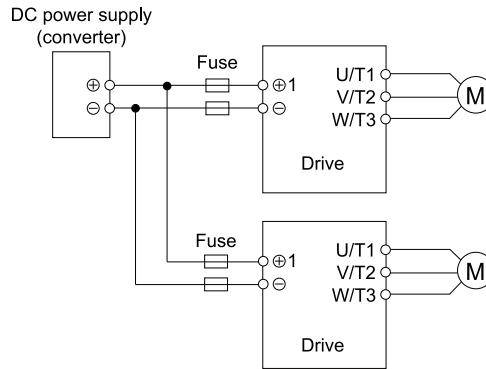

Figure 5.3 Wiring Example for DC Power Supply Input

WARNING! *Electrical Shock Hazard. Do not ground the main circuit bus. Incorrect wiring can cause serious injury or death.*

Note:

- Install a fuse for each drive when operating more than one drive. If one fuse blows, replace all fuses.
- Install the external filter (system) to comply with the EMC Directive.

Refer to [Table 5.6](#), [Table 5.7](#), and [Table 5.8](#) for the recommended fuses.

Table 5.6 Recommended Fuse: Single-Phase 200 V Class

Drive Model	Fuse Manufacturer: Bussmann	Drive Model	Fuse Manufacturer: Bussmann
	Model		Model
B001	FWH-25A14F	B010	FWH-100B
B002	FWH-25A14F	B012	FWH-125B
B004	FWH-60B	B018	FWH-150B
B006	FWH-80B		

Table 5.7 Recommended Fuse: Three-Phase 200 V Class

Drive Model	Fuse Manufacturer: Bussmann	Drive Model	Fuse Manufacturer: Bussmann
	Model		Model
2001	FWH-25A14F	2021	FWH-90B
2002	FWH-25A14F	2030	FWH-100B
2004	FWH-25A14F	2042	FWH-150B
2006	FWH-25A14F	2056	FWH-200B
2010	FWH-70B	2070	FWH-200B
2012	FWH-70B	2082	FWH-225A

Table 5.8 Recommended Fuse: Three-Phase 400 V Class

Drive Model	Fuse Manufacturer: Bussmann	Drive Model	Fuse Manufacturer: Bussmann
	Model		Model
4001	FWH-40B	4018	FWH-80B
4002	FWH-40B	4023	FWH-100B
4004	FWH-50B	4031	FWH-125B
4005	FWH-70B	4038	FWH-175B
4007	FWH-70B	4044	FWH-200B
4009	FWH-90B	4060	FWH-200B
4012	FWH-90B		

◆ EMC Directive

Use drives with built-in EMC filters or install external EMC filters to the drive input side to comply with the EMC Directive.

Drives with built-in EMC filters (models BxxxE, 2xxxE, 4xxxE) were tested in accordance with European standard EN 61800-3:2004/A1:2012, and comply with the EMC Directive.

■ Install a Drive to Conform to the EMC Directive

Install drive models BxxxE, 2xxxE, and 4xxxE with this procedure to comply with the EMC Directive when the drive is a single unit or installed in a larger device.

1. Install the drive on a grounded metal plate.
2. Wire the drive and motor.
3. Ground the wire shielding on the drive side and motor side.

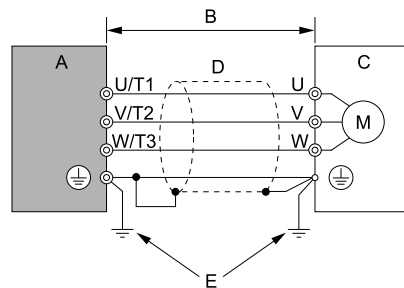

A - Drive

B - Wiring length ^{*1}

C - Motor

D - Metal conduit

E - Grounding wire

Figure 5.4 Wiring the Drive and Motor

*1 The maximum wiring length between the drive and motor is:

- BxxxE: 10 m (32.8 ft)
- 2xxxE, 4xxxE: 20 m (65.6 ft)

Note:

- Use a braided shield cable for the drive and motor wiring or put the wires through a metal conduit.
- Keep the cable between the drive and motor and the grounding wire as short as possible.

4. Use a cable clamp to ground the motor cable to the metal plate.

Note:

Make sure that the protective ground wire complies with technical specifications or local safety standards.

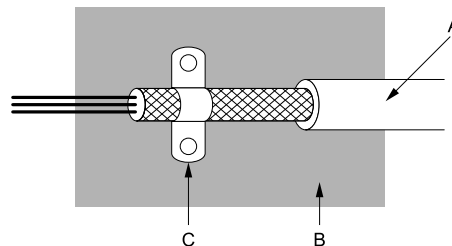

A - Braided shield cable

B - Metal plate

C - Cable clamp (conductive)

Figure 5.5 Ground the Shield

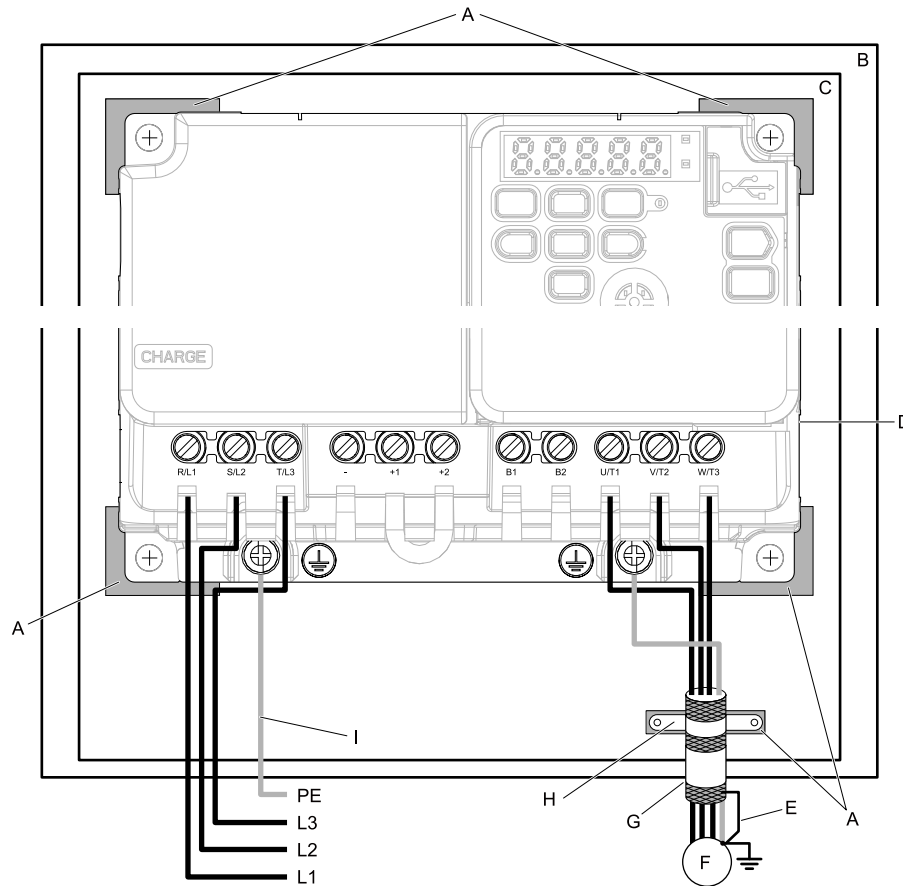

- | | |
|---|---------------------------|
| A - Grounding surface (Remove any paint or sealant.) | F - Motor |
| B - Enclosure panel | G - Motor cable |
| C - Metal plate | H - Cable clamp |
| D - Drive | I - Grounding wire |
| E - Shielded wire | |

Figure 5.6 Install a Drive with a Built-in EMC Filter

5. Connect an AC reactor or DC link choke to decrease harmonic distortion. Refer to [DC Link Chokes on page 187](#) to select a DC link choke.

Note:

- To comply with EN 61000-3-2 on drive models 2001 to 2006, and 4001 to 4004, install a DC link choke.
- The terminal block for the drive main circuit and the terminal block for the DC link choke have different shapes. The drive has a European-style terminal block, and the DC link choke has a round terminal block. Correctly prepare the ends of the wiring.

Ground Wiring

WARNING! Electrical Shock Hazard. Do not remove covers or touch circuit boards while the drive is energized. If you touch the internal components of an energized drive, it can cause serious injury or death.

WARNING! Electrical Shock Hazard. Ground the neutral point on the power supply of drive models BxxxE, 2xxxE, and 4xxxE to comply with the EMC Directive before you turn on the EMC filter or if there is high resistance grounding. If you turn ON the EMC filter, but you do not ground the neutral point, it can cause serious injury or death.

Enable the Internal EMC Filter

On drive models BxxxE, 2xxxE, and 4xxxE, move the screw or screws to turn ON and OFF (enable and disable) the EMC filter.

Make sure that the symmetric grounding network is applied, and install the screw or screws in the ON position to enable the built-in EMC filter in compliance with the EMC Directive. The EMC filter switch screw or screws are installed in the OFF position by default.

WARNING! Electrical Shock Hazard. Disconnect all power to the drive, wait for the time specified on the warning label, and check the drive for dangerous voltages before you remove covers or touch EMC filter screws. If you touch the screws when there are dangerous voltages, it will cause serious injury or death.

5.2 European Standards

WARNING! Electrical Shock Hazard. Do not remove covers or touch circuit boards while the drive is energized. If you touch the internal components of an energized drive, it can cause serious injury or death.

WARNING! Electrical Shock Hazard. Ground the neutral point on the power supply of drive models BxxxE, 2xxxE, and 4xxxE to comply with the EMC Directive before you turn on the EMC filter or if there is high resistance grounding. If you turn ON the EMC filter, but you do not ground the neutral point, it can cause serious injury or death.

WARNING! Electrical Shock Hazard. Connect the ground cable correctly. If you touch electrical equipment that is not grounded, it can cause serious injury or death.

NOTICE: To disable the internal EMC filter, move the screws from ON to OFF and then tighten to the specified torque. If you fully remove the screws or tighten the screws to an incorrect torque, it can cause drive failure.

NOTICE: Move the EMC switch screw or screws to the OFF position for networks that are not symmetrically grounded. If the screws are not in the correct position, it can cause damage to the drive.

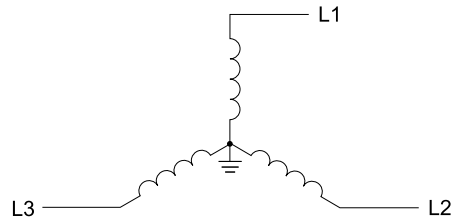

Figure 5.7 Symmetric Grounding

NOTICE: Damage to Equipment. When you use the drive with a non-grounding, high-resistance grounding, or asymmetric-grounding network, put the EMC Filter screw or screws in the OFF position to disable the built-in EMC filter. If you do not disable the built-in EMC filter, it will cause damage to the drive.

Table 5.9 shows asymmetric grounding networks.

Table 5.9 Asymmetric Grounding

Type of Grounding	Diagram
Grounded at the corner of the delta connection	<p>The diagram shows a three-phase delta (Δ) connection. One of the three corners of the delta is connected to ground. The phase lines are labeled L1, L2, and L3.</p>
Grounded at the middle of the side	<p>The diagram shows a three-phase delta (Δ) connection. The midpoint of one of the three sides of the delta is connected to ground. The phase lines are labeled L1, L2, and L3.</p>
Single-phase, grounded at the end point	<p>The diagram shows a single-phase winding connected between phase L1 and a neutral point N. The neutral point N is connected to ground.</p>
Three-phase variable transformer without solidly grounded neutral	<p>The diagram shows a three-phase variable transformer with three separate windings. Each winding is connected to a phase line (L1, L2, L3) and has a tap point. The neutral points of these windings are not connected to each other or to ground.</p>

Table 5.10 EMC Filter Switch Location

Model	Switch Location Diagram
B001E - B004E 2001E - 2006E	Figure 5.8
B006E - B012E 2010E - 2021E 4001E - 4012E	Figure 5.9
2030E - 2082E 4018E - 4060E	Figure 5.10

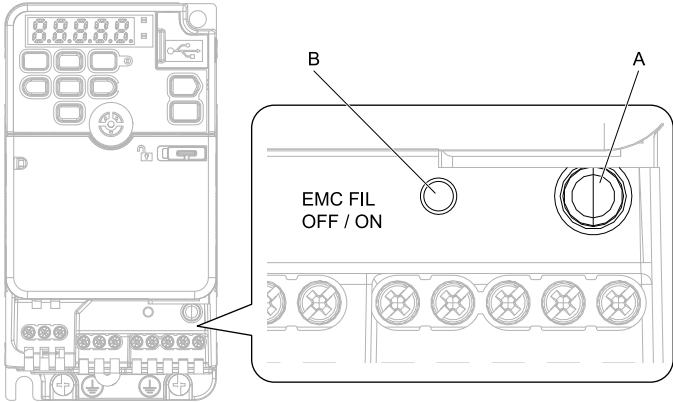

A - SW (ON)

B - SW (OFF)

Figure 5.8 EMC Filter Switch Location 1

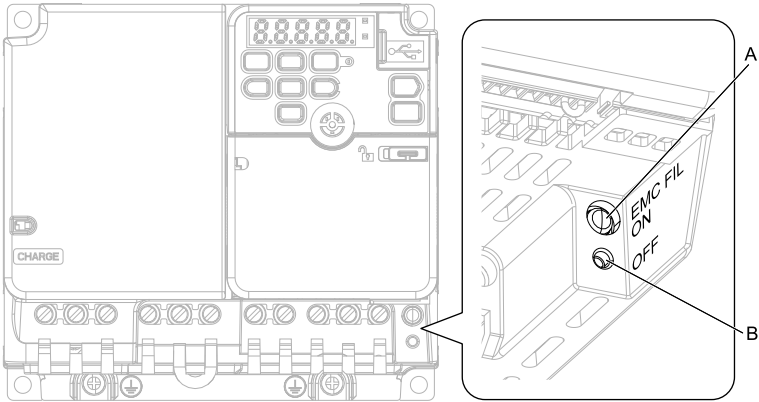

A - SW (ON)

B - SW (OFF)

Figure 5.9 EMC Filter Switch Location 2

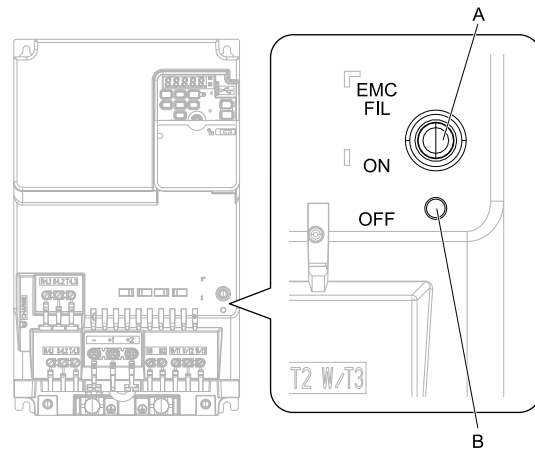

A - SW (ON)

B - SW (OFF)

Figure 5.10 EMC Filter Switch Location 3

If you lose an EMC filter switch screw, use [Table 5.11](#) to find the correct replacement screw and install the new screw with the correct tightening torque.

NOTICE: Only use the screws specified in this manual. If you use screws that are not approved, it can cause damage to the drive.

Table 5.11 Screw Sizes and Tightening Torques

Model	Screw Size	Tightening Torque N·m (lbf·in)
B001 - B004 2001 - 2006	M3 × 16	0.5 - 0.7 (4.4 - 6.2)
B006 - B012 2010 - 2021 4001 - 4012	M3 × 20	0.5 - 0.7 (4.4 - 6.2)
2030 - 2082 4018 - 4060	M4 × 20	1.0 - 1.3 (8.9 - 11.5)

■ Installing the External EMC Noise Filter

Drive models BxxxA, 2xxxA, and 4xxxA must align with the conditions in this section to comply with EN 61800-3:2004/A1:2012.

Connect an EMC noise filter that complies with European standards as specified by Yaskawa to the input side (primary side). Refer to [External EMC Noise Filter Selection on page 186](#) to select the correct EMC noise filter.

Use this procedure to install an EMC noise filter to make equipment and devices added to the drive comply with the EMC Directive.

1. Install the drive and EMC noise filter on the same grounded metal plate.
2. Wire the drive and motor.

3. Ground the wire shielding on the drive side and motor side.

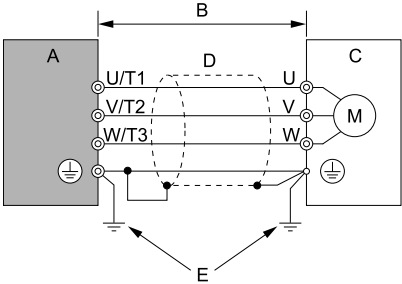

- A - Drive
- B - 10 m (32.8 ft) maximum
- C - Motor
- D - Metal conduit
- E - Grounding wire

Figure 5.11 Wiring the Drive and Motor

- Note:**
- Use a braided shield cable for the drive and motor wiring or put the wires through a metal conduit.
 - Keep the wire as short as possible. The maximum wiring length between the drive and motor is:
 - BxxxA, 2xxxA, 4xxxA: 10 m (32.8 ft)
 - Keep the grounding wire as short as possible.

4. Use a cable clamp to ground the motor cable to the metal plate.

- Note:**
Make sure that the protective ground wire complies with technical specifications or local safety standards.

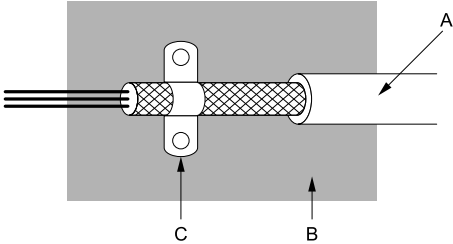

- A - Braided shield cable
- B - Metal plate
- C - Cable clamp (conductive)

Figure 5.12 Ground the Shield

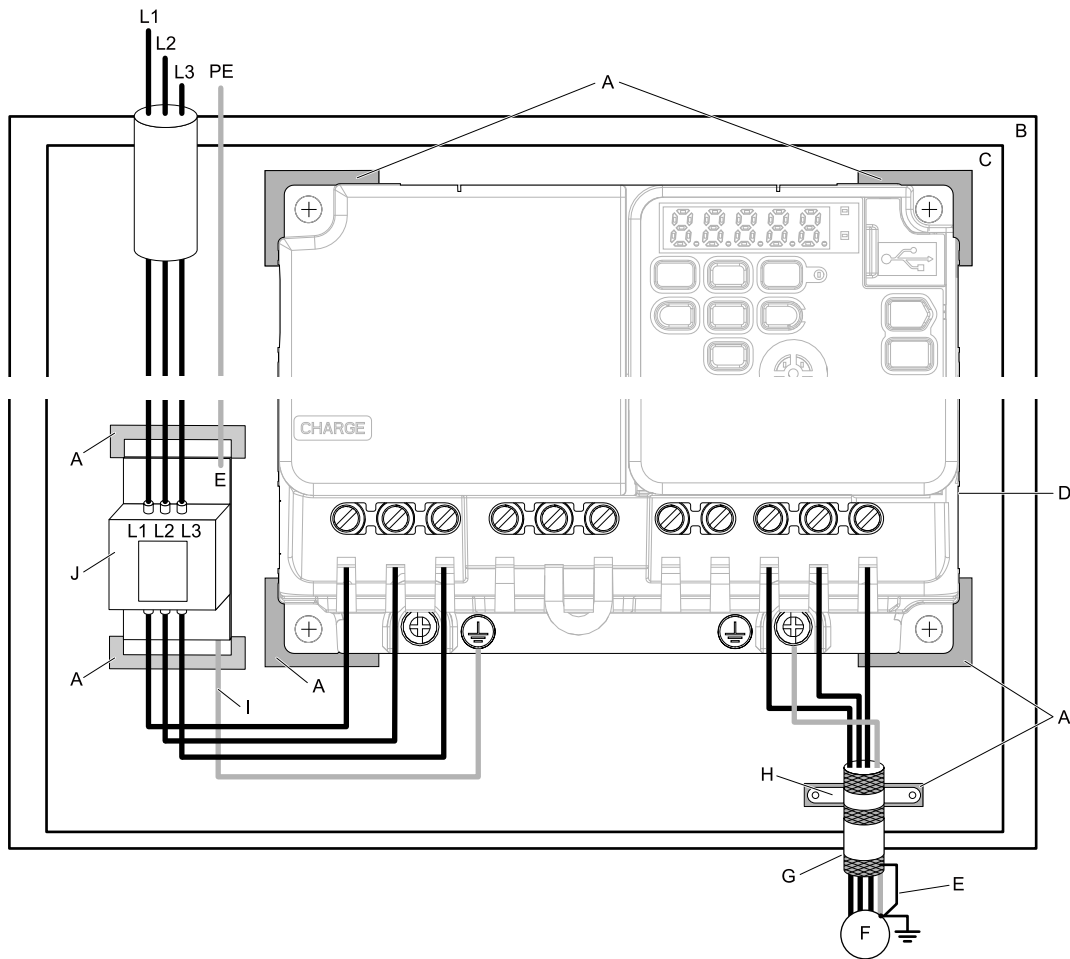

- A - Grounding surface (Remove any paint or sealant.)
- B - Enclosure panel
- C - Metal plate
- D - Drive
- E - Ground the shield.
- F - Motor
- G - Motor cable (Braided shield cable: 10 m (32.8 ft) maximum)
- H - Cable clamp
- I - Grounding wire
- J - EMC noise filter

Figure 5.13 EMC Noise Filter and Drive Installation Procedure

5. Connect the DC link choke to decrease harmonic distortion.
Refer to [DC Link Chokes on page 187](#) to select a DC link choke.

Note:

- To comply with EN 61000-3-2 on drive models 2001 to 2006, and 4001 to 4004, install a DC link choke.
- The terminal block for the drive main circuit and the terminal block for the DC link choke have different shapes. The drive has a European-style terminal block, and the DC link choke has a round terminal block. Correctly prepare the ends of the wiring.

Ground Wiring

WARNING! Electrical Shock Hazard. Do not remove covers or touch circuit boards while the drive is energized. If you touch the internal components of an energized drive, it can cause serious injury or death.

External EMC Noise Filter Selection

Table 5.12 External EMC Noise Filter (BxxxA)

Drive model	EMC Noise Filter Model	Quantity	Manufacturer
B001	FS23638-10-07	1	Schaffner
B002	FS23638-10-07	1	Schaffner
B004	FS23638-10-07	1	Schaffner
B006	FS23638-20-07	1	Schaffner

Drive model	EMC Noise Filter Model	Quantity	Manufacturer
B010	FS23638-20-07	1	Schaffner
B012	FS23638-30-07	1	Schaffner
B018	FS23638-40-07	1	Schaffner

Table 5.13 External EMC Noise Filter (2xxxA)

Drive model	EMC Noise Filter Model	Quantity	Manufacturer
2001	FS23637-8-07	1	Schaffner
2002	FS23637-8-07	1	Schaffner
2004	FS23637-8-07	1	Schaffner
2006	FS23637-8-07	1	Schaffner
2010	FS23637-14-07	1	Schaffner
2012	FS23637-14-07	1	Schaffner
2021	FS23637-24-07	1	Schaffner
2030	FS5973-35-07 <i>*1</i>	1	Schaffner
2042	FS5973-60-07 <i>*1</i>	1	Schaffner
2056	FS5973-100-07 <i>*1</i>	1	Schaffner
2070	FS5973-100-07 <i>*1</i>	1	Schaffner
2082	RTEN-5200	1	TDK

*1 When you install an external EMC noise filter, change the terminals or use the junction terminal.

Table 5.14 External EMC Noise Filter (4xxxA)

Drive model	EMC Noise Filter Model	Quantity	Manufacturer
4001	FS23639-5-07	1	Schaffner
4002	FS23639-5-07	1	Schaffner
4004	FS23639-5-07	1	Schaffner
4005	FS23639-10-07	1	Schaffner
4007	FS23639-10-07	1	Schaffner
4009	FS23639-10-07	1	Schaffner
4012	FS23639-15-07	1	Schaffner
4018	FS5972-35-07 <i>*1</i>	1	Schaffner
4023	FS5972-35-07 <i>*1</i>	1	Schaffner
4031	FS5972-60-07 <i>*1</i>	1	Schaffner
4038	FS5972-60-07 <i>*1</i>	1	Schaffner
4044	RTEN-5100	1	TDK
4060	RTEN-5100	1	TDK

*1 When you install an external EMC noise filter, change the terminals or use the junction terminal.

■ DC Link Chokes

To comply with EN 61000-3-2 drive models 2001 to 2006, and 4001 to 4004, install a DC link choke when you use an internal or external EMC filter. Refer to [Table 5.15](#) to select a DC link choke.

Table 5.15 DC Link Chokes for Harmonic Suppression

Drive Model	DC Link Choke
	Rating
2001 - 2006	5.4 A, 8 mA
4001 - 4004	3.2 A, 28 mA

5.3 UL and CSA Standards



Figure 5.14 UL/cUL Mark

The UL/cUL Mark identifies that this product conforms to rigid safety standards. This mark appears on products in the United States and Canada. It shows UL approval, which identifies that the product complies with safety standards after careful inspection and assessment. You must use UL Listed or UL Recognized parts for all primary components that are built into electrical equipment that has UL approval.

This product has been tested in accordance with UL standard UL61800-5-1, and has been verified to be in compliance with UL standards.

Machines and devices integrated with this product must satisfy the following conditions for compliance with UL standards:

◆ Area of Use

Install this product in a location with Overvoltage Category III and pollution degree 2 or less as specified in UL61800-5-1.

■ Ambient Temperature Setting

Maintain the ambient temperature within the following ranges according to the enclosure type.

- IP20/UL Type 1: -10 °C to +40 °C (14 °F to 104 °F)
- IP20/UL Open Type: -10 °C to +50 °C (14 °F to 122 °F)

◆ Wire the Main Circuit Terminal Block

Wire the main circuit terminal block correctly as specified by the instructions in the manual.

To select the correct wire gauge, refer to [Main Circuit Wire Gauges and Tightening Torques on page 190](#).

■ Notes on Wiring the Main Circuit Terminal Block

Read these notes before you wire the main circuit terminal block.

WARNING! Fire Hazard. Remove the insulation from the connection wires to the wire stripping lengths shown in the manual. If the stripping length is incorrect, the connection can cause a fire.

WARNING! Fire Hazard. Do not use bent or crushed wires. Remove the damaged end of the wire before you use it. Incorrect connections can cause death or serious injury from fire.

WARNING! Fire Hazard. If you use stranded wire, make sure that all of the wire strands are in the connection. Also, do not twist the stranded wire too much. Incorrect connections can cause death or serious injury from fire.

NOTICE: If you use power tools to tighten the terminal screws, use a low speed setting (300 min⁻¹ (r/min) to 400 min⁻¹ (r/min)). High speeds can cause damage to the terminal screws.

- Use UL-Listed, vinyl-coated insulated copper wires for operation with a continuous maximum permitted temperature of 75 °C at 600 V.
- Remove all unwanted objects that are near the terminal block connections.
- Remove the insulation from the connection wires to the wire stripping lengths shown in the manual.
- Do not solder stranded wire. Soldered wire connections can become loose over time and cause unsatisfactory drive performance.
- Put the wire all the way into the terminal block. Remove the insulation from the wire to the recommended wire stripping length to fit the wire with insulation in the plastic housing.
- Use a torque driver, torque ratchet, or torque wrench for the screws. A slotted driver or a hex tool will be necessary to wire the screw clamp terminal. Use applicable tools as specified by the recommended conditions in the product manual.

- Users can purchase wiring tools from Yaskawa. Contact Yaskawa or your nearest sales representative for more information.
 - Wire gauges on the drive you are replacing may not match the wire gauge ranges on your new drive. Contact Yaskawa or your nearest sales representative for more information about the connection procedures.
 - Do not tighten the terminal screws at an angle of 5 degrees or more. Failure to obey can cause damage to the terminal screws.
- If you damage a terminal screw, contact Yaskawa or your nearest sales representative.

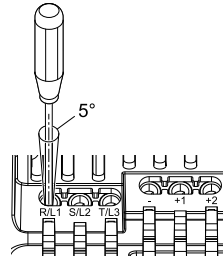

Figure 5.15 Permitted Angle

- Put the bit all the way into the hex socket to tighten the hex socket cap screw.
- When you tighten slotted screws, hold the straight-edge screwdriver perpendicularly to the screw. Make sure that you align the end of the straight-edge screwdriver with the screw groove.

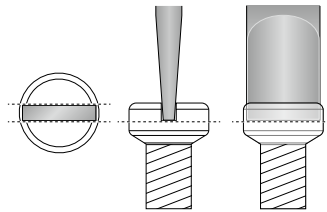
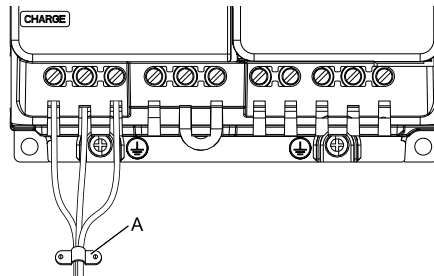

Figure 5.16 Tightening Slotted Screws

- After you connect the wires to the terminal block, lightly pull on the wires to make sure that they do not come out of the terminals.
- Do not let strain on the wiring cause damage. Use a strain relief near the wiring to release the tension. Refer to [Figure 5.17](#) for an example.





A - Cable clamp

Figure 5.17 Strain Relief Example

Table 5.16 Recommended Wiring Tools

Screw Size	Screw Shape	Wire Gauge	Adapter	Bit		Torque Driver Model (Tightening Torque)	Torque Wrench (Tightening Torque)
				Model	Manufacturer		
M3		-	Bit	SF-BIT-SL 0,5X3,0-70	PHOENIX CONTACT	TSD-M 1,2NM (0.3 - 1.2 N·m (2.7 - 10.6 lbf·in))	-
M4		-	Bit	SF-BIT-SL 1,0X4,0-70	PHOENIX CONTACT	TSD-M 3NM (1.2 - 3.0 N·m (10.6 - 26.6 lbf·in))	-

5.3 UL and CSA Standards

Screw Size	Screw Shape	Wire Gauge	Adapter	Bit		Torque Driver Model (Tightening Torque)	Torque Wrench (Tightening Torque)
				Model	Manufacturer		
M5 *1		≤ 25 mm ² (AWG 10)	Bit	SF-BIT-SL 1,2X6,5-70	PHOENIX CONTACT	TSD-M 3NM (1.2 - 3.0 N·m (10.6 - 26.6 lbf·in))	-
		≥ 30 mm ² (AWG 8)				-	4.1 - 4.5 N·m (36.3 - 39.8 lbf·in) *2 *3
M6	 (WAF: 5 mm)	-	Bit	SF-BIT-HEX 5-50	PHOENIX CONTACT	-	5 - 9 N·m (44.3 - 79.7 lbf·in) *2 *3

*1 When you wire drive models 2042, 2056, 4031, 4038, 4044, and 4060, select the correct tools for the wire gauge.

*2 Use 6.35 mm (0.25 in) bit socket holder.

*3 Use a torque wrench that can apply this torque measurement range.

■ Main Circuit Wire Gauges and Tightening Torques

Refer to [Single-Phase 200 V Class on page 191](#), [Three-Phase 200 V Class on page 193](#), and [Three-Phase 400 V Class on page 196](#) for the recommended wire gauges and tightening torques of the main circuit terminals.

Comply with local standards for correct wire gauges in the region where you will use the drive.

WARNING! Electrical Shock Hazard.

Make sure that the protective ground wire complies with technical standards and local safety regulations. The EN 61800-5-1:2007 standard specifies that you must wire the power supply to automatically de-energize when the protective ground wire disconnects. If you turn on the internal EMC filter, the leakage current of the drive will be more than 3.5 mA. Use these closed-loop crimp terminals or equivalent to connect a protective ground wire that has a minimum cross-sectional area of 10 mm² (copper wire).

- 8-4NS from JST Mfg. Co., Ltd.
- R8-4S from NICHIFU Co., Ltd.
- P10-8R from PANDUIT Corp.

If you do not obey the standards and regulations, it can cause serious injury or death.

WARNING! Electrical Shock Hazard. Only connect factory-recommended devices or circuits to drive terminals B1, B2, -, +1, and +2. Do not connect AC power to these terminals. Incorrect wiring can cause damage to the drive and serious injury or death from fire.

Note:

- The recommended wire gauges are based on drive continuous current ratings with 75 °C (167 °F) 600 V class 2 heat-resistant indoor PVC wire. Assume these conditions:
 - Ambient temperature: 40 °C (104 °F) maximum
 - Wiring distance: 100 m (3281 ft) maximum
 - Normal Duty rated current value
- Refer to the instruction manual for each device for recommended wire gauges to connect peripheral devices or options to terminals +1, +2, -, B1, and B2. Contact Yaskawa or your nearest sales representative if the recommended wire gauges for the peripheral devices or options are out of the range of the applicable gauges for the drive.
- When you use crimp ferrules on the wire ends, contact Yaskawa or your nearest sales representative.

Wire Selection Precautions

WARNING! Electrical Shock Hazard.

Make sure that the protective ground wire complies with technical standards and local safety regulations. The EN 61800-5-1:2007 standard specifies that you must wire the power supply to automatically de-energize when the protective ground wire disconnects. If you turn on the internal EMC filter, the leakage current of the drive will be more than 3.5 mA. Use these closed-loop crimp terminals or equivalent to connect a protective ground wire that has a minimum cross-sectional area of 10 mm² (copper wire).

- 8-4NS from JST Mfg. Co., Ltd.
- R8-4S from NICHIFU Co., Ltd.
- P10-8R from PANDUIT Corp.

If you do not obey the standards and regulations, it can cause serious injury or death.

Think about line voltage drop before selecting wire gauges. Select wire gauges that drop the voltage by 2% or less of the rated voltage. Increase the wire gauge and the cable length when the risk of voltage drops increases. Calculate line voltage drop with this formula:

$$\text{Line voltage drop (V)} = \sqrt{3} \times \text{wire resistance } (\Omega/\text{km}) \times \text{wiring distance (m)} \times \text{motor rated current (A)} \times 10^{-3}$$

Precautions during Wiring



- Refer to “Yaskawa AC Drive Option Braking Unit, Braking Resistor Unit Instruction Manual (TOBPC72060001)” for information about wire gauges and tightening torques to connect braking resistor units.
- Use terminals +1 and - to connect a regenerative converter or regenerative unit.

WARNING! Fire Hazard. Do not connect a braking resistor to terminals +1 or -. Use terminals B1 and B2 for the braking resistor connections. If you connect a braking resistor to the incorrect terminals, it can cause damage to the drive and braking circuit and serious injury or death.



















Screw Shape

These tables use icons in [Table 5.17](#) to show the shapes of the screw heads.

Table 5.17 Icons to Identify Screw Shapes

Icon	Screw Shape
	+/-
	Slotted (-)
	Hex socket cap (WAF: 5 mm)

Single-Phase 200 V Class

Model	Terminal	Recomm. Gauge AWG, kcmil	Applicable Gauge AWG, kcmil	Wire Stripping Length ^{*7} mm	Terminal Screw Size and Shape	Tightening Torque N·m (lbf·in)
B001	L/L1, N/L2	14	14	6.5	M3 	0.5 - 0.6 (4.4 - 5.3)
	U/T1, V/T2, W/T3	14	14	6.5	M3 	0.5 - 0.6 (4.4 - 5.3)
	-, +1	14	14	6.5	M3 	0.5 - 0.6 (4.4 - 5.3)
	B1, B2	14	14	6.5	M3 	0.5 - 0.6 (4.4 - 5.3)
		14 ^{*2}	14 ^{*2}	-	M3.5 	0.8 - 1.0 (7.1 - 8.9)
B002	L/L1, N/L2	14	14	6.5	M3 	0.5 - 0.6 (4.4 - 5.3)
	U/T1, V/T2, W/T3	14	14	6.5	M3 	0.5 - 0.6 (4.4 - 5.3)
	-, +1	14	14	6.5	M3 	0.5 - 0.6 (4.4 - 5.3)
	B1, B2	14	14	6.5	M3 	0.5 - 0.6 (4.4 - 5.3)
		14 ^{*2}	14 ^{*2}	-	M3.5 	0.8 - 1.0 (7.1 - 8.9)
B004	L/L1, N/L2	14	14	6.5	M3 	0.5 - 0.6 (4.4 - 5.3)
	U/T1, V/T2, W/T3	14	14	6.5	M3 	0.5 - 0.6 (4.4 - 5.3)
	-, +1	14	14	6.5	M3 	0.5 - 0.6 (4.4 - 5.3)
	B1, B2	14	14	6.5	M3 	0.5 - 0.6 (4.4 - 5.3)
		14 ^{*2}	14 ^{*2}	-	M3.5 	0.8 - 1.0 (7.1 - 8.9)

5.3 UL and CSA Standards































Model	Terminal	Recomm. Gauge AWG, kcmil	Applicable Gauge AWG, kcmil	Wire Stripping Length ^{*1} / mm	Terminal Screw Size and Shape	Tightening Torque N·m (lbf·in)
B006	L/L1, N/L2	12	14 - 10	8	M3 ⊖	0.5 - 0.6 (4.4 - 5.3)
	U/T1, V/T2, W/T3	14	14 - 12	8	M3 ⊖	0.5 - 0.6 (4.4 - 5.3)
	-, +1	12	14 - 10	8	M3 ⊖	0.5 - 0.6 (4.4 - 5.3)
	B1, B2	14	14 - 12	8	M3 ⊖	0.5 - 0.6 (4.4 - 5.3)
	⊕	10 ^{*2}	14 - 10 ^{*2}	-	M4 ⊕	1.2 - 1.5 (10.6 - 13.3)
B010	L/L1, N/L2	10	12 - 10	8	M3 ⊖	0.5 - 0.6 (4.4 - 5.3)
	U/T1, V/T2, W/T3	14	14 - 12	8	M3 ⊖	0.5 - 0.6 (4.4 - 5.3)
	-, +1	10	12 - 10	8	M3 ⊖	0.5 - 0.6 (4.4 - 5.3)
	B1, B2	14	14 - 12	8	M3 ⊖	0.5 - 0.6 (4.4 - 5.3)
	⊕	10 ^{*2}	14 - 10 ^{*2}	-	M4 ⊕	1.2 - 1.5 (10.6 - 13.3)
B012	L/L1, N/L2	8	14 - 8	10	M4 ⊖	1.5 - 1.7 (13.5 - 15)
	U/T1, V/T2, W/T3	12	14 - 10	10	M4 ⊖	1.5 - 1.7 (13.5 - 15)
	-, +1	8	14 - 8	10	M4 ⊖	1.5 - 1.7 (13.5 - 15)
	B1, B2	14	14 - 12	10	M4 ⊖	1.5 - 1.7 (13.5 - 15)
	⊕	10 ^{*2}	14 - 10 ^{*2}	-	M4 ⊕	1.2 - 1.5 (10.6 - 13.3)
B018	L/L1, N/L2	8	12 - 6	10	M4 ⊖	1.5 - 1.7 (13.5 - 15)
	U/T1, V/T2, W/T3	10	14 - 8	10	M4 ⊖	1.5 - 1.7 (13.5 - 15)
	-, +1	8	12 - 6	10	M4 ⊖	1.5 - 1.7 (13.5 - 15)
	B1, B2	14	14 - 12	10	M4 ⊖	1.5 - 1.7 (13.5 - 15)
	⊕	8 ^{*2}	12 - 8 ^{*2}	-	M5 ⊕	2.0 - 2.5 (17.7 - 22.1)

*1 Remove insulation from the ends of wires to expose the length of wire shown.

*2 If you turn on the internal EMC filter, the leakage current of the drive will be more than 3.5 mA. Use these closed-loop crimp terminals or equivalent to connect a protective ground wire that has a minimum cross-sectional area of 10 mm² (copper wire).

- 8-4NS from JST Mfg. Co., Ltd.
- R8-4S from NICHIFU Co., Ltd.
- P10-8R from PANDUIT Corp.

Three-Phase 200 V Class

Model	Terminal	Recomm. Gauge AWG, kcmil	Applicable Gauge AWG, kcmil	Wire Stripping Length ^{*/} mm	Terminal Screw Size and Shape	Tightening Torque N·m (lbf·in)
2001	R/L1, S/L2, T/L3	14	14	6.5	M3 	0.5 - 0.6 (4.4 - 5.3)
	U/T1, V/T2, W/T3	14	14	6.5	M3 	0.5 - 0.6 (4.4 - 5.3)
	-, +1, +2	14	14	6.5	M3 	0.5 - 0.6 (4.4 - 5.3)
	B1, B2	14	14	6.5	M3 	0.5 - 0.6 (4.4 - 5.3)
		14 *2	14 *2	-	M3.5 	0.8 - 1.0 (7.1 - 8.9)
2002	R/L1, S/L2, T/L3	14	14	6.5	M3 	0.5 - 0.6 (4.4 - 5.3)
	U/T1, V/T2, W/T3	14	14	6.5	M3 	0.5 - 0.6 (4.4 - 5.3)
	-, +1, +2	14	14	6.5	M3 	0.5 - 0.6 (4.4 - 5.3)
	B1, B2	14	14	6.5	M3 	0.5 - 0.6 (4.4 - 5.3)
		14 *2	14 *2	-	M3.5 	0.8 - 1.0 (7.1 - 8.9)
2004	R/L1, S/L2, T/L3	14	14	6.5	M3 	0.5 - 0.6 (4.4 - 5.3)
	U/T1, V/T2, W/T3	14	14	6.5	M3 	0.5 - 0.6 (4.4 - 5.3)
	-, +1, +2	14	14	6.5	M3 	0.5 - 0.6 (4.4 - 5.3)
	B1, B2	14	14	6.5	M3 	0.5 - 0.6 (4.4 - 5.3)
		14 *2	14 *2	-	M3.5 	0.8 - 1.0 (7.1 - 8.9)
2006	R/L1, S/L2, T/L3	14	14	6.5	M3 	0.5 - 0.6 (4.4 - 5.3)
	U/T1, V/T2, W/T3	14	14	6.5	M3 	0.5 - 0.6 (4.4 - 5.3)
	-, +1, +2	14	14	6.5	M3 	0.5 - 0.6 (4.4 - 5.3)
	B1, B2	14	14	6.5	M3 	0.5 - 0.6 (4.4 - 5.3)
		14 *2	14 *2	-	M3.5 	0.8 - 1.0 (7.1 - 8.9)
2010	R/L1, S/L2, T/L3	14	14 - 12	8	M3 	0.5 - 0.6 (4.4 - 5.3)
	U/T1, V/T2, W/T3	14	14 - 12	8	M3 	0.5 - 0.6 (4.4 - 5.3)
	-, +1, +2	12	14 - 10	8	M3 	0.5 - 0.6 (4.4 - 5.3)
	B1, B2	14	14 - 12	8	M3 	0.5 - 0.6 (4.4 - 5.3)
		10 *2	14 - 10 *2	-	M4 	1.2 - 1.5 (10.6 - 13.3)

5.3 UL and CSA Standards

Model	Terminal	Recomm. Gauge AWG, kcmil	Applicable Gauge AWG, kcmil	Wire Stripping Length ^{*/} mm	Terminal Screw Size and Shape	Tightening Torque N-m (lbf-in)
2012	R/L1, S/L2, T/L3	12	14 - 10	8	M3 ⊖	0.5 - 0.6 (4.4 - 5.3)
	U/T1, V/T2, W/T3	12	14 - 10	8	M3 ⊖	0.5 - 0.6 (4.4 - 5.3)
	-, +1, +2	10	12 - 10	8	M3 ⊖	0.5 - 0.6 (4.4 - 5.3)
	B1, B2	14	14 - 12	8	M3 ⊖	0.5 - 0.6 (4.4 - 5.3)
	⊕	10 *2	14 - 10 *2	-	M4 ⊕	1.2 - 1.5 (10.6 - 13.3)
2021	R/L1, S/L2, T/L3	8	14 - 8	10	M4 ⊖	1.5 - 1.7 (13.5 - 15)
	U/T1, V/T2, W/T3	10	14 - 8	10	M4 ⊖	1.5 - 1.7 (13.5 - 15)
	-, +1, +2	8	14 - 8	10	M4 ⊖	1.5 - 1.7 (13.5 - 15)
	B1, B2	14	14 - 10	10	M4 ⊖	1.5 - 1.7 (13.5 - 15)
	⊕	8	14 - 8	-	M4 ⊕	1.2 - 1.5 (10.6 - 13.3)
2030	R/L1, S/L2, T/L3	8	12 - 6	10	M4 ⊖	1.5 - 1.7 (13.5 - 15)
	U/T1, V/T2, W/T3	8	12 - 6	10	M4 ⊖	1.5 - 1.7 (13.5 - 15)
	-, +1, +2	6	12 - 6	10	M4 ⊖	1.5 - 1.7 (13.5 - 15)
	B1, B2	12	12 - 8	10	M4 ⊖	1.5 - 1.7 (13.5 - 15)
	⊕	8	10 - 6	-	M5 ⊕	2.0 - 2.5 (17.7 - 22.1)
2042	R/L1, S/L2, T/L3	6	12 - 6	10	M4 ⊖	1.5 - 1.7 (13.5 - 15)
	U/T1, V/T2, W/T3	6	12 - 6	10	M4 ⊖	1.5 - 1.7 (13.5 - 15)
	-, +1, +2	4	10 - 2	18	M5 ⊖	• ≤ AWG 10 2.3 - 2.5 (19.8 - 22) • AWG 8 ≤ 4.1 - 4.5 (36 - 40)
	B1, B2	10	14 - 6	10	M4 ⊖	1.5 - 1.7 (13.5 - 15)
	⊕	6	10 - 6	-	M5 ⊕	2.0 - 2.5 (17.7 - 22.1)

Model	Terminal	Recomm. Gauge AWG, kcmil	Applicable Gauge AWG, kcmil	Wire Stripping Length ^{*1} mm	Terminal Screw Size and Shape	Tightening Torque N·m (lbf·in)
2056	R/L1, S/L2, T/L3	4	10 - 2	18	M5	4.1 - 4.5 (36 - 40)
	U/T1, V/T2, W/T3	4	10 - 2	18	M5	<ul style="list-style-type: none"> • ≤ AWG 10 2.3 - 2.5 (19.8 - 22) • AWG 8 ≤ 4.1 - 4.5 (36 - 40)
	-, +1, +2	2	8 - 2	18	M5	4.1 - 4.5 (36 - 40)
	B1, B2	8	12 - 6	10	M4	1.5 - 1.7 (13.5 - 15)
		6	8 - 4	-	M6	5.4 - 6.0 (47.8 - 53.1)
2070	R/L1, S/L2, T/L3	2	6 - 1	20	M6	5 - 5.5 (45 - 49)
	U/T1, V/T2, W/T3	2	8 - 1	20	M6	5 - 5.5 (45 - 49)
	-, +1, +2	1	6 - 1/0	20	M6	5 - 5.5 (45 - 49)
	B1, B2	8	12 - 6	10	M4	1.5 - 1.7 (13.5 - 15)
		4	6 - 4	-	M6	5.4 - 6.0 (47.8 - 53.1)
2082	R/L1, S/L2, T/L3	1	6 - 1/0	20	M6	5 - 5.5 (45 - 49)
	U/T1, V/T2, W/T3	2	6 - 1	20	M6	5 - 5.5 (45 - 49)
	-, +1, +2	2/0	2 - 2/0	20	M6	5 - 5.5 (45 - 49)
	B1, B2	6	10 - 6	10	M4	1.5 - 1.7 (13.5 - 15)
		4	6 - 4	-	M6	5.4 - 6.0 (47.8 - 53.1)

*1 Remove insulation from the ends of wires to expose the length of wire shown.

*2 If you turn on the internal EMC filter, the leakage current of the drive will be more than 3.5 mA. Use these closed-loop crimp terminals or equivalent to connect a protective ground wire that has a minimum cross-sectional area of 10 mm² (copper wire).

- 8-4NS from JST Mfg. Co., Ltd.
- R8-4S from NICHIFU Co., Ltd.
- P10-8R from PANDUIT Corp.

*1 Remove insulation from the ends of wires to expose the length of wire shown.

5.3 UL and CSA Standards

*2

Three-Phase 400 V Class

Model	Terminal	Recomm. Gauge AWG, kcmil	Applicable Gauge AWG, kcmil	Wire Stripping Length ^{*1} mm	Terminal Screw Size and Shape	Tightening Torque N·m (lbf·in)
4001	R/L1, S/L2, T/L3	14	14 - 12	8	M3 ⊖	0.5 - 0.6 (4.4 - 5.3)
	U/T1, V/T2, W/T3	14	14 - 12	8	M3 ⊖	0.5 - 0.6 (4.4 - 5.3)
	-, +1, +2	14	14 - 12	8	M3 ⊖	0.5 - 0.6 (4.4 - 5.3)
	B1, B2	14	14 - 12	8	M3 ⊖	0.5 - 0.6 (4.4 - 5.3)
	⊕	14 *2	14 - 10 *2	-	M4 ⊕	1.2 - 1.5 (10.6 - 13.3)
4002	R/L1, S/L2, T/L3	14	14 - 12	8	M3 ⊖	0.5 - 0.6 (4.4 - 5.3)
	U/T1, V/T2, W/T3	14	14 - 12	8	M3 ⊖	0.5 - 0.6 (4.4 - 5.3)
	-, +1, +2	14	14 - 12	8	M3 ⊖	0.5 - 0.6 (4.4 - 5.3)
	B1, B2	14	14 - 12	8	M3 ⊖	0.5 - 0.6 (4.4 - 5.3)
	⊕	14 *2	14 - 10 *2	-	M4 ⊕	1.2 - 1.5 (10.6 - 13.3)
4004	R/L1, S/L2, T/L3	14	14 - 12	8	M3 ⊖	0.5 - 0.6 (4.4 - 5.3)
	U/T1, V/T2, W/T3	14	14 - 12	8	M3 ⊖	0.5 - 0.6 (4.4 - 5.3)
	-, +1, +2	14	14 - 12	8	M3 ⊖	0.5 - 0.6 (4.4 - 5.3)
	B1, B2	14	14 - 12	8	M3 ⊖	0.5 - 0.6 (4.4 - 5.3)
	⊕	10 *2	14 - 10 *2	-	M4 ⊕	1.2 - 1.5 (10.6 - 13.3)
4005	R/L1, S/L2, T/L3	14	14 - 12	8	M3 ⊖	0.5 - 0.6 (4.4 - 5.3)
	U/T1, V/T2, W/T3	14	14 - 12	8	M3 ⊖	0.5 - 0.6 (4.4 - 5.3)
	-, +1, +2	14	14 - 12	8	M3 ⊖	0.5 - 0.6 (4.4 - 5.3)
	B1, B2	14	14 - 12	8	M3 ⊖	0.5 - 0.6 (4.4 - 5.3)
	⊕	10 *2	14 - 10 *2	-	M4 ⊕	1.2 - 1.5 (10.6 - 13.3)
4007	R/L1, S/L2, T/L3	14	14 - 12	8	M3 ⊖	0.5 - 0.6 (4.4 - 5.3)
	U/T1, V/T2, W/T3	14	14 - 12	8	M3 ⊖	0.5 - 0.6 (4.4 - 5.3)
	-, +1, +2	14	14 - 12	8	M3 ⊖	0.5 - 0.6 (4.4 - 5.3)
	B1, B2	14	14 - 12	8	M3 ⊖	0.5 - 0.6 (4.4 - 5.3)
	⊕	10 *2	14 - 10 *2	-	M4 ⊕	1.2 - 1.5 (10.6 - 13.3)

Model	Terminal	Recomm. Gauge AWG, kcmil	Applicable Gauge AWG, kcmil	Wire Stripping Length ^{*7} mm	Terminal Screw Size and Shape	Tightening Torque N·m (lbf·in)
4009	R/L1, S/L2, T/L3	14	14 - 12	8	M3 ⊖	0.5 - 0.6 (4.4 - 5.3)
	U/T1, V/T2, W/T3	14	14 - 12	8	M3 ⊖	0.5 - 0.6 (4.4 - 5.3)
	-, +1, +2	14	14 - 12	8	M3 ⊖	0.5 - 0.6 (4.4 - 5.3)
	B1, B2	14	14 - 12	8	M3 ⊖	0.5 - 0.6 (4.4 - 5.3)
	⊕	10 *2	14 - 10 *2	-	M4 ⊕	1.2 - 1.5 (10.6 - 13.3)
4012	R/L1, S/L2, T/L3	12	14 - 10	10	M4 ⊖	1.5 - 1.7 (13.5 - 15)
	U/T1, V/T2, W/T3	14	14 - 12	10	M4 ⊖	1.5 - 1.7 (13.5 - 15)
	-, +1, +2	10	12 - 8	10	M4 ⊖	1.5 - 1.7 (13.5 - 15)
	B1, B2	14	14 - 12	10	M4 ⊖	1.5 - 1.7 (13.5 - 15)
	⊕	10 *2	14 - 10 *2	-	M4 ⊕	1.2 - 1.5 (10.6 - 13.3)
4018	R/L1, S/L2, T/L3	10	12 - 8	10	M4 ⊖	1.5 - 1.7 (13.5 - 15)
	U/T1, V/T2, W/T3	10	12 - 8	10	M4 ⊖	1.5 - 1.7 (13.5 - 15)
	-, +1, +2	10	14 - 8	10	M4 ⊖	1.5 - 1.7 (13.5 - 15)
	B1, B2	14	14 - 12	10	M4 ⊖	1.5 - 1.7 (13.5 - 15)
	⊕	10 *2	14 - 6 *2	-	M5 ⊕	2.0 - 2.5 (17.7 - 22.1)
4023	R/L1, S/L2, T/L3	8	14 - 6	10	M4 ⊖	1.5 - 1.7 (13.5 - 15)
	U/T1, V/T2, W/T3	10	14 - 8	10	M4 ⊖	1.5 - 1.7 (13.5 - 15)
	-, +1, +2	8	12 - 6	10	M4 ⊖	1.5 - 1.7 (13.5 - 15)
	B1, B2	12	14 - 10	10	M4 ⊖	1.5 - 1.7 (13.5 - 15)
	⊕	10 *2	10 - 6 *2	-	M5 ⊕	2.0 - 2.5 (17.7 - 22.1)
4031	R/L1, S/L2, T/L3	8	12 - 6	10	M4 ⊖	1.5 - 1.7 (13.5 - 15)
	U/T1, V/T2, W/T3	8	12 - 6	10	M4 ⊖	1.5 - 1.7 (13.5 - 15)
	-, +1, +2	6	12 - 4	18	M5 ⊖	• ≤ AWG 10 2.3 - 2.5 (19.8 - 22) • AWG 8 ≤ 4.1 - 4.5 (36 - 40)
	B1, B2	10	12 - 8	10	M4 ⊖	1.5 - 1.7 (13.5 - 15)
	⊕	8	10 - 6	-	M6 ⊕	5.4 - 6.0 (47.8 - 53.1)

5.3 UL and CSA Standards

Model	Terminal	Recomm. Gauge AWG, kcmil	Applicable Gauge AWG, kcmil	Wire Stripping Length ^{*1} mm	Terminal Screw Size and Shape	Tightening Torque N·m (lbf·in)
4038	R/L1, S/L2, T/L3	6	12 - 6	10	M4 ⊖	1.5 - 1.7 (13.5 - 15)
	U/T1, V/T2, W/T3	8	12 - 6	10	M4 ⊖	1.5 - 1.7 (13.5 - 15)
	-, +1, +2	4	10 - 2	18	M5 ⊖	<ul style="list-style-type: none"> • ≤ AWG 10 2.3 - 2.5 (19.8 - 22) • AWG 8 ≤ 4.1 - 4.5 (36 - 40)
	B1, B2	10	14 - 6	10	M4 ⊖	1.5 - 1.7 (13.5 - 15)
	⊕	6	10 - 6	-	M6 ⊕	5.4 - 6.0 (47.8 - 53.1)
4044	R/L1, S/L2, T/L3	4	10 - 2	18	M5 ⊖	<ul style="list-style-type: none"> • ≤ AWG 10 2.3 - 2.5 (19.8 - 22) • AWG 8 ≤ 4.1 - 4.5 (36 - 40)
	U/T1, V/T2, W/T3	6	12 - 4	18	M5 ⊖	<ul style="list-style-type: none"> • ≤ AWG 10 2.3 - 2.5 (19.8 - 22) • AWG 8 ≤ 4.1 - 4.5 (36 - 40)
	-, +1, +2	2	8 - 2	18	M5 ⊖	4.1 - 4.5 (36 - 40)
	B1, B2	8	12 - 6	10	M4 ⊖	1.5 - 1.7 (13.5 - 15)
	⊕	6	10 - 6	-	M6 ⊕	5.4 - 6.0 (47.8 - 53.1)
4060	R/L1, S/L2, T/L3	2	8 - 2	18	M5 ⊖	4.1 - 4.5 (36 - 40)
	U/T1, V/T2, W/T3	4	10 - 2	18	M5 ⊖	<ul style="list-style-type: none"> • ≤ AWG 10 2.3 - 2.5 (19.8 - 22) • AWG 8 ≤ 4.1 - 4.5 (36 - 40)
	-, +1, +2	2	6 - 2	18	M5 ⊖	4.1 - 4.5 (36 - 40)
	B1, B2	8	12 - 6	10	M4 ⊖	1.5 - 1.7 (13.5 - 15)
	⊕	6	10 - 6	-	M6 ⊕	5.4 - 6.0 (47.8 - 53.1)

*1 Remove insulation from the ends of wires to expose the length of wire shown.

*2 If you turn on the internal EMC filter, the leakage current of the drive will be more than 3.5 mA. Use these closed-loop crimp terminals or equivalent to connect a protective ground wire that has a minimum cross-sectional area of 10 mm² (copper wire).

- 8-4NS from JST Mfg. Co., Ltd.
- R8-4S from NICHIFU Co., Ltd.
- P10-8R from PANDUIT Corp.

■ Factory-Recommended Branch Circuit Protection for UL Listing

Install one of the types of short circuit protection devices in *Single-Phase 200 V Class on page 199*, *Three-Phase 200 V Class on page 199*, and *Three-Phase 400 V Class on page 200* to comply with UL61800-5-1. Yaskawa recommends connecting semiconductor protective type fuses, but *Single-Phase 200 V Class on page 199*, *Three-Phase 200 V Class on page 199*, and *Three-Phase 400 V Class on page 200* also show alternative short circuit protection devices.

When you use MCCBs, RK1, or RK5 fuses, you must mount the drive in a ventilated enclosure according to the minimum enclosure volume specified in *Single-Phase 200 V Class on page 199*, *Three-Phase 200 V Class on page 199*, and *Three-Phase 400 V Class on page 200*.

Molded Case Circuit Breaker (MCCB) Ratings

- Maximum MCCB rating is 200% of the Normal Duty drive full load output amp (FLA) rating.
- When you use MCCBs, install the drive into a ventilated enclosure with a minimum enclosure volume.

Note:

When you use MCCBs, current limiting type are recommended, but not required.

Non-Semiconductor Fuse Ratings

- Maximum CC, J, T, RK1 or RK5 fuse rating is 175% of the Normal Duty drive full load output amp (FLA) rating.

Short Circuit Current Ratings (SCCR)

The maximum SCCR provided by drive and fuse, or drive and MCCB combinations in this document, is 31,000 RMS symmetrical amps.

- 200 V Class drives: Use the protection specified in this document to prepare the drive for use on a circuit that supplies not more than 31,000 RMS and not more than 240 Vac when there is a short circuit in the power supply.
- 400 V Class drives: Use the protection specified in this document to prepare the drive for use on a circuit that supplies not more than 31,000 RMS and not more than 480 Vac when there is a short circuit in the power supply.

Electric Code Compliance

The user must provide short circuit protection to protect input branch circuits as specified by the National Electric Code (NEC), the Canadian Electric Code, Part 1 (CEC), and local codes.

Single-Phase 200 V Class

Table 5.18 Factory-Recommended Branch Circuit Protection: Single-Phase 200 V Class

Drive Model	Ventilated Protected Enclosure Not Required		Ventilated Protected Enclosure Required		
	Semiconductor Fuse Manufacturer: EATON/ Bussmann	Class J, CC, and T Fuse Maximum Amps	MCCB Maximum Amps	Class RK1 or RK5 Fuse Maximum Amps	Minimum Enclosure Volume (in ³)
B001	FWH-25A14F	3.5	15	3.5	600
B002	FWH-25A14F	6	15	6	600
B004	FWH-60B	12	15	12	600
B006	FWH-80B	20	25	20	600
B010	FWH-100B	35	40	35	960
B012	FWH-125B	40	45	40	960
B018	FWH-150B	60	70	60	960

Three-Phase 200 V Class

Table 5.19 Factory-Recommended Branch Circuit Protection: Three-Phase 200 V Class

Drive Model	Ventilated Protected Enclosure Not Required		Ventilated Protected Enclosure Required		
	Semiconductor Fuse Manufacturer: EATON/ Bussmann	Class J, CC, and T Fuse Maximum Amps	MCCB Maximum Amps	Class RK1 or RK5 Fuse Maximum Amps	Minimum Enclosure Volume (in ³)
2001	FWH-25A14F	2	15	2	600
2002	FWH-25A14F	3.2	15	3.2	600
2004	FWH-25A14F	6	15	6	600
2006	FWH-25A14F	10	15	10	600
2008	FWH-70B	12	15	12	600
2010	FWH-70B	15	15	15	600
2012	FWH-70B	20	20	20	600
2018	FWH-90B	30	35	30	960

Drive Model	Ventilated Protected Enclosure Not Required		Ventilated Protected Enclosure Required		
	Semiconductor Fuse Manufacturer: EATON/ Bussmann	Class J, CC, and T Fuse Maximum Amps	MCCB Maximum Amps	Class RK1 or RK5 Fuse Maximum Amps	Minimum Enclosure Volume (in ³)
2021	FWH-90B	35	40	35	960
2030	FWH-100B	50	60	50	960
2042	FWH-150B	70	80	-	960
2056	FWH-200B	90	110	-	2560
2070	FWH-200B	110	125	-	2560
2082	FWH-225B	125	150	-	2560

Three-Phase 400 V Class

Table 5.20 Factory-Recommended Branch Circuit Protection: Three-Phase 400 V Class

Drive Model	Ventilated Protected Enclosure Not Required		Ventilated Protected Enclosure Required		
	Semiconductor Fuse Manufacturer: EATON/ Bussmann	Class J, CC, and T Fuse Maximum Amps	MCCB Maximum Amps	Class RK1 or RK5 Fuse Maximum Amps	Minimum Enclosure Volume (in ³)
4001	FWH-40B	2	15	2	960
4002	FWH-40B	3.5	15	3.5	960
4004	FWH-50B	7	15	7	960
4005	FWH-70B	9	15	9	960
4007	FWH-70B	12	15	12	960
4009	FWH-90B	15	15	15	960
4012	FWH-90B	20	20	20	960
4018	FWH-80B	30	35	30	960
4023	FWH-100B	40	40	40	960
4031	FWH-125B	50	60	50	2560
4038	FWH-175B	60	75	-	2560
4044	FWH-200B	75	80	-	2560
4060	FWH-200B	100	110	-	2560

◆ Low Voltage Wiring for Control Circuit Terminals

You must provide low voltage wiring as specified by the National Electric Code (NEC), the Canadian Electric Code, Part I (CEC), and local codes. Yaskawa recommends the NEC class 1 circuit conductor. Use the UL approved class 2 power supply for external power supply.

Table 5.21 Control Circuit Terminal Power Supplies

Input/Output	Terminals	Power Supply Specifications
Digital input	S1 to S7, SN, SC, SP	Uses the LVLC power supply in the drive. Use the UL Listed class 2 power supply for external power supply.
Analog input	A1, A2, AC, +V	Uses the LVLC power supply in the drive. Use the UL Listed class 2 power supply for external power supply.
Analog output	AM, AC	Uses the LVLC power supply in the drive.
Pulse train output	MP, AC	Uses the LVLC power supply in the drive. Use the UL Listed class 2 power supply for external power supply.
Pulse train input	RP, AC	Uses the LVLC power supply in the drive. Use the UL Listed class 2 power supply for external power supply.

Input/Output	Terminals	Power Supply Specifications
Safe disable input	H1, H2, HC	Uses the LVLC power supply in the drive. Use the UL Listed class 2 power supply for external power supply.
Serial communication input/output	D+, D-, AC	Uses the LVLC power supply in the drive. Use the UL Listed class 2 power supply for external power supply.
24 V external power supply	PS, AC	Use the UL Listed class 2 power supply.

◆ CSA Standards

■ CSA for Industrial Control Equipment

This drive is CSA certified as Industrial Control Equipment Class 321116.



Figure 5.18 CSA Mark

■ CSA for Elevator Equipment

This drive is CSA certified as Elevator Equipment Class CS241101.



CSA B44.1 /
ASME A17.5

Figure 5.19 CSA B44.1-19/ASME A17.5-2019 Mark

◆ Drive Motor Overload and Overheat Protection

The drive motor overload and overheat protection function complies with the National Electric Code (NEC) and the Canadian Electric Code, Part I (CEC).

Set the Motor Rated Current and *L1-01 through L1-04 [Motor Overload Protection Select]* correctly to enable motor overload and overheat protection.

Refer to the control method and set the motor rated current with *E2-01 [Motor Rated Current (FLA)]*, *E5-03 [PM Motor Rated Current (FLA)]*, or *E9-06 [Motor Rated Current (FLA)]*.

■ E2-01: Motor Rated Current (FLA)

No. (Hex.)	Name	Description	Default (Range)
E2-01 (030E)	Motor Rated Current (FLA)	<input type="checkbox"/> V/f <input type="checkbox"/> OLV <input type="checkbox"/> OLV/PM <input type="checkbox"/> AOLV/PM <input type="checkbox"/> EZOLV Sets the motor rated current in amps.	Determined by o2-04, C6-01 (10% to 200% of the drive rated current)

Note:

- If $E2-01 < E2-03$ [Motor No-Load Current], the drive will detect $oPE02$ [Parameter Range Setting Error].
- When the drive model changes, the display units for this parameter also change.
 - 0.01 A: B001 to B018, 2001 to 2042, 4001 to 4023
 - 0.1 A: 2056 to 2082, 4031 to 4060

The value set for $E2-01$ becomes the reference value for motor protection and the torque limit. Enter the motor rated current written on the motor nameplate. Auto-Tuning the drive will automatically set $E2-01$ to the value input for $T1-04$ [Motor Rated Current].

■ E5-03: Motor Rated Current (FLA)

No. (Hex.)	Name	Description	Default (Range)
E5-03 (032B)	Motor Rated Current (FLA)	<div style="display: flex; gap: 5px;"> V/f OLV OLV/PM AOLV/PM EZOLV </div> Sets the PM motor rated current (FLA).	Determined by o2-04, C6-01 (10% to 200% of the drive rated current)

Note:

- When the drive model changes, the display units for this parameter also change.
- 0.01 A: B001 - B018, 2001 - 2042, 4001 - 4023
 - 0.1 A: 2056 - 2082, 4031 - 4060

The drive automatically sets $E5-03$ to the value input for $T2-06$ [PM Motor Rated Current] after you do these types of Auto-Tuning:

- PM Motor Parameter Settings
- PM Stationary Auto-Tuning
- PM Stationary Tuning for Stator Resistance
- PM Rotational Auto-Tuning

■ E9-06: Motor Rated Current (FLA)

No. (Hex.)	Name	Description	Default (Range)
E9-06 (11E9)	Motor Rated Current (FLA)	<div style="display: flex; gap: 5px;"> V/f OLV OLV/PM AOLV/PM EZOLV </div> Sets the motor rated current in amps.	Determined by E9-01 and o2-04 (10% to 200% of the drive rated current)

Note:

- When the drive model changes, the display units for this parameter also change.
- 0.01 A: B001 to B018, 2001 to 2042, 4001 to 4023
 - 0.1 A: 2056 to 2082, 4031 to 4060

The setting value of $E9-06$ is the reference value for motor protection. Enter the motor rated current written on the motor nameplate. Auto-Tuning the drive will automatically set $E9-06$ to the value input for $T4-07$ [Motor Rated Current].

■ L1-01: Motor Overload (oL1) Protection

No. (Hex.)	Name	Description	Default (Range)
L1-01 (0480)	Motor Overload (oL1) Protection	<div style="display: flex; gap: 5px;"> V/f OLV OLV/PM AOLV/PM EZOLV </div> Sets the motor overload protection with electronic thermal protectors.	Determined by A1-02 (0 - 6)

This parameter enables and disables the motor overload protection with electronic thermal protectors.

The cooling capability of the motor changes when the speed control range of the motor changes. Use an electronic thermal protector that aligns with the permitted load characteristics of the motor to select motor protection.

The electronic thermal protector of the drive uses these items to calculate motor overload tolerance and supply overload protection for the motor:

- Output current
- Output frequency

- Motor thermal characteristics
- Time characteristics

If the drive detects motor overload, the drive will trigger an *oL1* [Motor Overload] and stop drive output.

Set *H2-01 = 1F* [Term MA/MB-MC Function Selection = Motor Overload Alarm (oL1)] to set a motor overload alarm. If the motor overload level is more than 90% of the *oL1* detection level, the output terminal activates and triggers an overload alarm.

0 : Disabled

Disable motor protection when motor overload protection is not necessary or when the drive is operating more than one motor.

Refer to Figure 5.20 for an example of the circuit configuration to connect more than one motor to one drive.

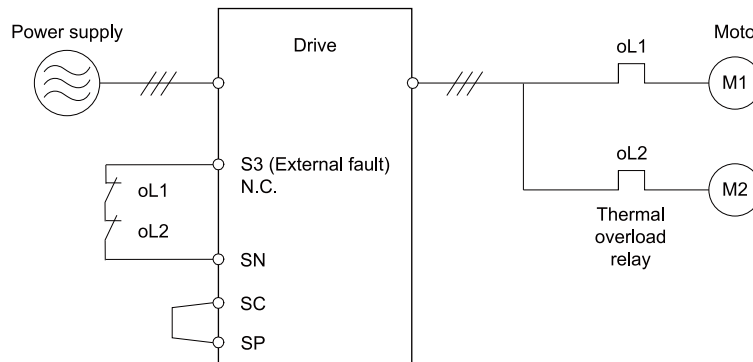

Figure 5.20 Protection Circuit Configuration to Connect More than One Motor to One Drive

NOTICE: When you connect more than one motor to one drive or when the motor amp rating is higher than the drive amp rating, set *L1-01 = 0* [Motor Overload (oL1) Protection = Disabled] and install thermal overload relays for each motor. The electronic thermal protection of the drive will not function and it can cause damage to the motor.

1 : Variable Torque

Use this setting for general-purpose motors with a 60 Hz base frequency.

The overload tolerance decreases as motor speed decreases because the cooling fan speed decreases and the ability of the motor to cool decreases in the low speed range.

The overload tolerance characteristics of the motor change the trigger point for the electronic thermal protector. This provides motor overheat protection from low speed to high speed across the full speed range.

Load Tolerance	Cooling Capability	Overload Characteristics (at 100% motor load)
	<p>This motor is designed to operate with commercial line power. Operate at a 60 Hz base frequency to maximize the motor cooling ability.</p>	<p>If the motor operates at frequencies less than 60 Hz, the drive will detect <i>oL1</i>. The drive triggers a fault relay output and the motor coasts to stop.</p>

2 : Constant Torque 10:1 Speed Range

Use this setting for drive-dedicated motors with a speed range for constant torque of 1:10.

The speed control for this motor is 10% to 100% when at 100% load. Operating slower than 10% speed at 100% load will cause motor overload.

5.3 UL and CSA Standards

Load Tolerance	Cooling Capability	Overload Characteristics (at 100% motor load)
	<p>This motor is designed to withstand increased temperatures during continuous operation in the low speed range (10% base frequency).</p>	<p>The motor operates continuously at 10% to 100% base frequency. Operating slower than 10% speed at 100% load will cause motor overload.</p>

3 : Constant Torque 100:1 SpeedRange

Use this setting for vector motors with a speed range for constant torque of 1:100.

The speed control for this motor is 1% to 100% when at 100% load. Operating slower than 1% speed at 100% load will cause motor overload.

Load Tolerance	Cooling Capability	Overload Characteristics (at 100% motor load)
	<p>This motor is designed to withstand increased temperatures during continuous operation in the low speed range (1% base frequency).</p>	<p>The motor operates continuously at 1% to 100% base frequency. Operating slower than 1% speed at 100% load will cause motor overload.</p>

4 : PM Variable Torque

Use this setting for PM motors with derated torque characteristics.

The overload tolerance decreases as motor speed decreases because the cooling fan speed decreases and the ability of the motor to cool decreases in the low speed range.

The overload tolerance characteristics of the motor change the trigger point for the electronic thermal protector. This provides motor overheat protection from low speed to high speed across the full speed range.

Load Tolerance	Cooling Capability	Overload Characteristics (at 100% motor load)
	<p>This motor is designed to withstand increased temperatures during continuous operation at rated speed and rated torque.</p>	<p>If the motor operates continuously at lower speed than rated rotation speed at more than 100% torque, the drive will detect <i>oL1</i>. The drive triggers a fault relay output and the motor coasts to stop.</p>

5 : PM Constant Torque

Use this setting with a PM motor for constant torque that has a speed range for constant torque of 1:500.

The speed control for this motor is 0.2% to 100% when at 100% load. Operating slower than 0.2% speed at 100% load will cause motor overload.

Load Tolerance	Cooling Capability	Overload Characteristics (at 100% motor load)
	<p>This motor is designed to withstand increased temperatures during continuous operation in the low speed range (0.2% base frequency).</p>	<p>The motor operates continuously at 0.2% to 100% rated speed. Operating slower than 0.2% speed at 100% load will cause motor overload.</p>

6 : Variable Torque (50Hz)

Use this setting for general-purpose motors with a 50 Hz base frequency.

The overload tolerance decreases as motor speed decreases because the cooling fan speed decreases and the ability of the motor to cool decreases in the low speed range.

The overload tolerance characteristics of the motor change the trigger point for the electronic thermal protector. This provides motor overheat protection from low speed to high speed across the full speed range.

Load Tolerance	Cooling Capability	Overload Characteristics (at 100% motor load)
	<p>This motor is designed to operate with commercial line power. Operate at a 50 Hz base frequency to maximize the motor cooling ability.</p>	<p>If the motor operates at frequencies less than commercial line power, the drive will detect <i>oLL</i>. The drive triggers a fault relay output and the motor coasts to stop.</p>

■ L1-02: Motor Overload Protection Time

No. (Hex.)	Name	Description	Default (Range)
L1-02 (0481)	Motor Overload Protection Time	<p><input type="checkbox"/> V/f <input type="checkbox"/> OLV <input type="checkbox"/> OLV/PM <input type="checkbox"/> AOLV/PM <input type="checkbox"/> EZOLV</p> <p>Sets the operation time for the electronic thermal protector of the drive to prevent damage to the motor. Usually it is not necessary to change this setting.</p>	1.0 min (0.1 - 5.0 min)

Set the overload tolerance time to the length of time that the motor can operate at 150% load from continuous operation at 100% load.

When the motor operates at 150% load continuously for 1 minute after continuous operation at 100% load (hot start), the default setting triggers the electronic thermal protector.

Figure 5.21 shows an example of the electronic thermal protector operation time. Motor overload protection operates in the range between a cold start and a hot start.

This example shows a general-purpose motor operating at the base frequency with L1-02 set to 1.0 min.

- Cold start
Shows the motor protection operation time characteristics when the overload occurs immediately after starting operation from a complete stop.
- Hot start
Shows the motor protection operation time characteristics when overload occurs from continuous operation below the motor rated current.

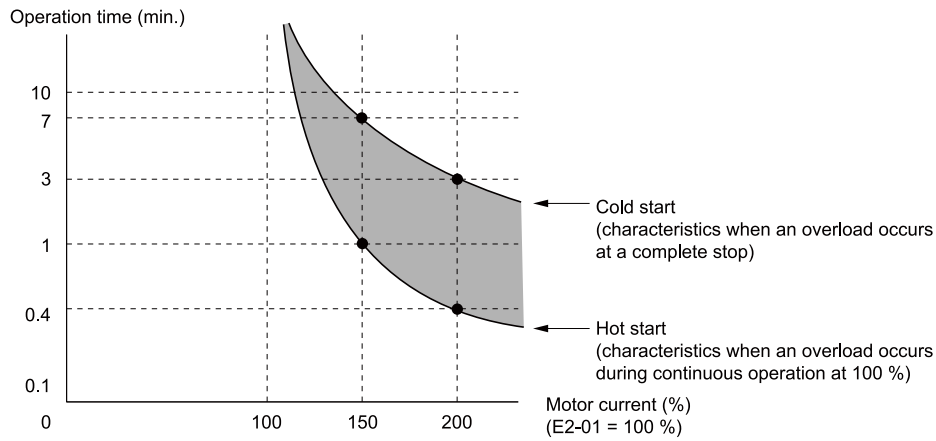

Figure 5.21 Protection Operation Time for a General-purpose Motor at Rated Output Frequency

■ **L1-03: Motor Thermistor oH Alarm Select**

No. (Hex.)	Name	Description	Default (Range)
L1-03 (0482)	Motor Thermistor oH Alarm Select	<input type="checkbox"/> V/f <input type="checkbox"/> OLV <input type="checkbox"/> OLV/PM <input type="checkbox"/> AOLV/PM <input type="checkbox"/> EZOLV Sets drive operation when the PTC input signal entered into the drive is at the oH3 [Motor Overheat Alarm] detection level.	3 (0 - 3)

0 : Ramp to Stop

The drive ramps the motor to stop in the deceleration time. The output terminal set for *Fault [H2-01 to H2-03 = E]* activates.

1 : Coast to Stop

The output turns off and the motor coasts to stop. The output terminal set for *Fault [H2-01 to H2-03 = E]* activates.

2 : Fast Stop

The drive stops the motor in the deceleration time set in *C1-09 [Fast Stop Time]*. The output terminal set for *Fault [H2-01 to H2-03 = E]* activates.

3 : Alarm Only

The keypad shows *oH3* and the drive continues operation. The output terminal set for *Alarm [H2-01 to H2-03 = 10]* activates.

■ **L1-04: Motor Thermistor oH Fault Select**

No. (Hex.)	Name	Description	Default (Range)
L1-04 (0483)	Motor Thermistor oH Fault Select	<input type="checkbox"/> V/f <input type="checkbox"/> OLV <input type="checkbox"/> OLV/PM <input type="checkbox"/> AOLV/PM <input type="checkbox"/> EZOLV Sets the drive operation when the PTC input signal to the drive is at the oH4 [Motor Overheat Fault (PTC Input)] detection level.	1 (0 - 2)

0 : Ramp to Stop

The drive ramps the motor to stop in the deceleration time. The output terminal set for *Fault [H2-01 to H2-03 = E]* activates.

1 : Coast to Stop

The output turns off and the motor coasts to stop. The output terminal set for *Fault [H2-01 to H2-03 = E]* activates.

2 : Fast Stop

The drive stops the motor in the deceleration time set in *C1-09 [Fast Stop Time]*. The output terminal set for *Fault [H2-01 to H2-03 = E]* activates.

◆ **Conditions of Acceptability**

Machines and devices integrated with finless-type drives must satisfy the following conditions for compliance with UL standards:

1. Install finless-type drives into a ventilated enclosure with a minimum enclosure volume shown in [Table 5.22](#).

Table 5.22 Minimum Enclosure Volume

Model	Minimum Volume cm ³ (in ³)
B001 - B006 2001 - 2012	9850 (600)
B010 - B012 2018 - 2042 4001 - 4023	15750 (960)
2056 - 2070 4031, 4038	42000 (2560)

2. Keep the ambient temperature lower than 35 °C (95 °F) in your application.
3. Keep the drive heatsink plate temperature lower than the maximum temperature shown in [Table 5.23](#) in your application.

Use *U4-08 [Heatsink Temperature]* to monitor the drive heatsink temperature.

Table 5.23 Maximum Temperature of the Heatsink Plate

Model	Maximum Temperature of the Heatsink Plate
B001 - B012	90 °C (194 °F)
2001 - 2021	90 °C (194 °F)
2030 - 2070	80 °C (176 °F)
4001 - 4012	90 °C (194 °F)
4018 - 4038	80 °C (176 °F)

4. Make sure that the metal surface to which you will install the drive meets these specifications:
 - Flatness: ≤ 0.2 mm (0.0078 in)
 - Roughness: ≤ 25 S
5. Make sure that there is sufficient space for wiring and airflow to cool the drive.
 - 30 mm (1.18 in) minimum from each side
 - 100 mm (3.94 in) minimum from top and bottom
6. The recommended thermal compound is X-23-7795 from Shin-Etsu Chemical Co., Ltd., or equivalent. Apply 100 μ m to 250 μ m of thermal compound over the full heatsink plate of the drive.
7. Use the correct screws to safety the drive to a metal surface (enclosure panel). [Table 5.24](#) shows the screw sizes and tightening torques.
Monitor the temperature of the external heatsink at the top center of the junction between the external heatsink and the drive.

Table 5.24 Screw Sizes and Tightening Torques

Drive Model	Screw Size	Tightening Torque N·m (lbf·in)
B001 - B012	M5	2.0 - 2.5 (17.7 - 22.1)
2001 - 2021	M5	2.0 - 2.5 (17.7 - 22.1)
2030 - 2056	M5	2.0 - 2.5 (17.7 - 22.1)
2070	M6	4.0 - 5.0 (35.4 - 44.3)
4001 - 4012	M5	2.0 - 2.5 (17.7 - 22.1)
4018 - 4038	M5	2.0 - 2.5 (17.7 - 22.1)

5.4 China RoHS Compliance



Figure 5.22 China RoHS Mark

The China RoHS mark is displayed on products containing six specified hazardous substances that are in excess of regulatory limits, based on the “Administrative Measures for the Restriction of the Use of Hazardous Substances in Electrical and Electronic Products” and “Marking for the Restricted Use of Hazardous Substances in Electronic and Electrical Products” (SJ/T 11364-2014), which were promulgated on January 26, 2016. The number displayed in the center of the mark indicates the environment-friendly use period (number of years) in which electrical and electronic products that are being produced, sold, or imported to China can be used. The date of manufacture of the electrical and electronic product is the starting date of the environment-friendly use period for the product. The six specified hazardous substances contained in the product will not leak outside of the product during normal use within this period and will have no serious impact on the environment, the human body, or property.

The environment-friendly use period for this product is 15 years. This period is not the product warranty period.

◆ Information on Hazardous Substances in This Product

Table 5.25 shows the details on hazardous substances contained in this product.

Table 5.25 Contents of Hazardous Substances in This Product

Parts Name	Hazardous Substances					
	Lead (Pb)	Mercury (Hg)	Cadmium (Cd)	Hexavalent Chromium (Cr(VI))	Polybrominated Biphenyls (PBB)	Polybrominated Diphenyl Ethers (PBDE)
Circuit Board	×	○	○	○	○	○
Electronic Parts	×	○	○	○	○	○
Brass Screw	×	○	○	○	○	○
Aluminum Die Casting	×	○	○	○	○	○

This table has been prepared in accordance with the provisions outlined in SJ/T 11364.

○: Indicates that said hazardous substance contained in all of the homogeneous materials for this part is below or equal to the limit requirement of GB/T 26572.

×: Indicates that said hazardous substance contained in at least one of the homogeneous materials used for this part is above the limit requirement of GB/T 26572.

Note:

This product complies with EU RoHS directives. In this table, "×" indicates that hazardous substances that are exempt from EU RoHS directives are contained.

5.5 对应中国RoHS指令



图 5.23 中国RoHS标志

中国RoHS标志依据2016年1月26日公布的《电器电子产品有害物质限制使用管理办法》，以及《电子电气产品有害物质限制使用标识要求》（SJ/T 11364-2014）作成。电子电气产品中特定6种有害物质的含量超过规定值时，应标识此标志。中间的数字为在中国生产销售以及进口的电子电气产品的环保使用期限（年限）。电子电气产品的环保使用期限从生产日期算起。在期限内，正常使用产品的过程中，不会有特定的6种有害物质外泄进而对环境、人和财产造成深刻影响。

本产品的环保使用期限为15年。但需要注意的是环保使用期限并非产品的质量保证期限。

◆ 本产品中含有有害物质的信息

本产品中所含有害物质的详细信息如表 5.26 所示。

表 5.26 本产品中有害物质的名称及含量

部件名称	有害物质					
	铅 (Pb)	汞 (Hg)	镉 (Cd)	六价铬 (Cr(VI))	多溴联苯 (PBB)	多溴二苯醚 (PBDE)
实装基板	×	○	○	○	○	○
电子元件	×	○	○	○	○	○
黄铜螺钉	×	○	○	○	○	○
铝压铸	×	○	○	○	○	○

本表格依据SJ/T 11364的规定编制。
 ○:表示该有害物质在该部件所有均质材料中的含量均在GB/T 26572规定的限量要求以下。
 ×:表示该有害物质至少在该部件的某一均质材料中的含量超出GB/T 26572规定的限量要求。
 (注) 本产品符合欧盟RoHS指令。上表中的“×”表示含有欧盟RoHS指令豁免的有害物质。

5.6 Safe Disable Input



Figure 5.24 TÜV Mark

The TÜV mark identifies that the product complies with the safety standards.

This section gives precautions to support the Safe Disable input. Contact Yaskawa for more information.

The safety function complies with the standards shown in [Table 5.27](#).

Table 5.27 Applied Safety Standards and Unified Standards

Safety Standards	Unified Standards
Functional Safety	IEC/EN 61508:2010 (SIL3)
	IEC 62061:2005/AMD2:2015 (SILCL3)
	EN 62061:2005/A2:2015 (SILCL3)
	IEC 61800-5-2:2016 (SIL3) EN 61800-5-2:2017 (SIL3)
Machine Safety	ISO/EN ISO 13849-1:2015 (Cat.3, PL e)
EMC	IEC 61000-6-7:2014 EN 61000-6-7:2015 IEC/EN 61326-3-1:2017
LVD	IEC 61800-5-1:2007/AMD1:2016 EN 61800-5-1:2007/A1:2017

Note:

SIL = Safety Integrity Level.

◆ Safe Disable Specifications

The Safe Disable input provides the stop function that complies with “Safe Torque Off” as specified by IEC/EN61800-5-2. The Safe Disable input meets the requirements of ISO/EN ISO 13849-1 and IEC/EN 61508. It also has a safety status monitor to detect safety circuit errors.

When you install the drive as a component in a system, you must make sure that the system complies with the applicable safety standards.

Refer to [Table 5.28](#) for safety function specifications.

Table 5.28 Safe Disable Specifications

Item	Description
Input/Output	<ul style="list-style-type: none"> Input: 2 Safe Disable input (H1, H2) Signal ON level: 18 Vdc to 28 Vdc Signal OFF level: -4 Vdc to +4 Vdc Output: 1 MFDO safety monitor output for external device monitor (EDM)
Response time from when the input opens to when the drive output stops	3 ms or less
Response time from when the H1 and H2 terminal inputs open to when the EDM signal operates	30 ms or less
Failure probability	Less frequent operation request mode
	Frequent operation request mode or continuous mode
Performance level	The Safe Disable input complies with the performance level requirements of EN ISO 13849-1.
HFT (hardware fault tolerance)	N = 1
Type of subsystem	Type B
MTTF _D	High

Item	Description
DCavg	Medium
Mission time	10 years

Note:

EDM = External Device Monitoring

PFD = Probability of Failure on Demand

PFH = Probability of Dangerous Failure per Hour

◆ Notes

DANGER! Sudden Movement Hazard. When you use the Safe Disable function in the safety system of a machine, do a full risk assessment for the system to make sure that all parts of the system comply with applicable safety standards. Incorrect application of the Safe Disable function can cause serious injury or death.

DANGER! Sudden Movement Hazard. If the output circuit of the drive is damaged and the Safe Disable function turns OFF the drive output to a permanent magnet (PM) motor, the motor can rotate 180 electrical degrees. Prevent damage to equipment and injury to personnel during this condition. Sudden motor movement can cause serious injury or death. It is possible for current to flow through the motor winding in these conditions.

DANGER! Electrical Shock Hazard. You cannot depend on the Safe Disable function to prevent electrical shock. Disconnect all power to the drive and wait for the time specified on the warning label before you remove covers. Check the drive for dangerous voltages before servicing or repair work. If you do work on the drive when it is energized and there is no cover over the electronic circuits, it can cause serious injury or death.

WARNING! Sudden Movement Hazard. Although the Safe Disable function is in operation, gravity or other external forces in the vertical axis can move the motor. Incorrect application of the Safe Disable function can cause serious injury or death.

WARNING! Sudden Movement Hazard. Do not use the drive output signals to control external holding brakes or dynamic brakes for functional safety. Use a system that conforms to the functional safety requirements. Incorrect application of the Safe Disable function can cause serious injury or death. Systems that use drive output signals (including EDM) for safety are not safe because drive output signals are not safety components.

WARNING! Sudden Movement Hazard. Connect the Safe Disable inputs to the devices as specified by the safety requirements. If you connect the Safe Disable inputs incorrectly, it can cause serious injury or death.

WARNING! Sudden Movement Hazard. To use the Safe Disable inputs, remove the jumpers between terminals H1-HC and H2-HC. If the Safe Disable circuit does not work correctly, it can cause serious injury or death.

WARNING! Sudden Movement Hazard. When you clear the Safe Disable input, make sure that the Safe Disable Monitor output operates correctly as the specification for Safe Disable function. If the Safe Disable circuit does not operate correctly, it can cause serious injury or death.

WARNING! Sudden Movement Hazard. Regularly examine the Safe Disable input and all other safety features. A system that does not operate correctly can cause serious injury or death.

WARNING! Sudden Movement Hazard. Only let approved personnel who know about the drive, instruction manual, and safety standards wire, examine, and maintain the Safe Disable input. If personnel are not approved, it can cause serious injury or death.

WARNING! Sudden Movement Hazard. Only use the Safe Disable Monitor (multi-function output terminal set to the EDM function) to monitor the Safe Disable status or to find a malfunction in the Safe Disable inputs. The monitor output is not a safety output. If you use the Safe Disable Monitor incorrectly, it can cause death or serious injury.

Note:

- When you use a drive with a built in safety function, you must replace it 10 years after first use.
- A maximum of 3 ms will elapse from when terminals H1 or H2 shut off until the drive switches to the “Safe Torque Off” status. Set the OFF status for terminals H1 and H2 to hold for at least 3 ms. The drive may not be able to switch to the “Safe Torque Off” status if terminals H1 and H2 are only open for less than 3 ms.

◆ Using the Safe Disable Function

■ Safe Disable Circuit

The Safe Disable circuit has two isolated channels (terminals H1 and H2) that stop the output transistors. The input can use the internal power supply of the drive.

Set the EDM function to one of the MFDO terminals [$H2-xx = 21$ or 121] to monitor the status of the Safe Disable function. This is the “Safe Disable monitor output function”.

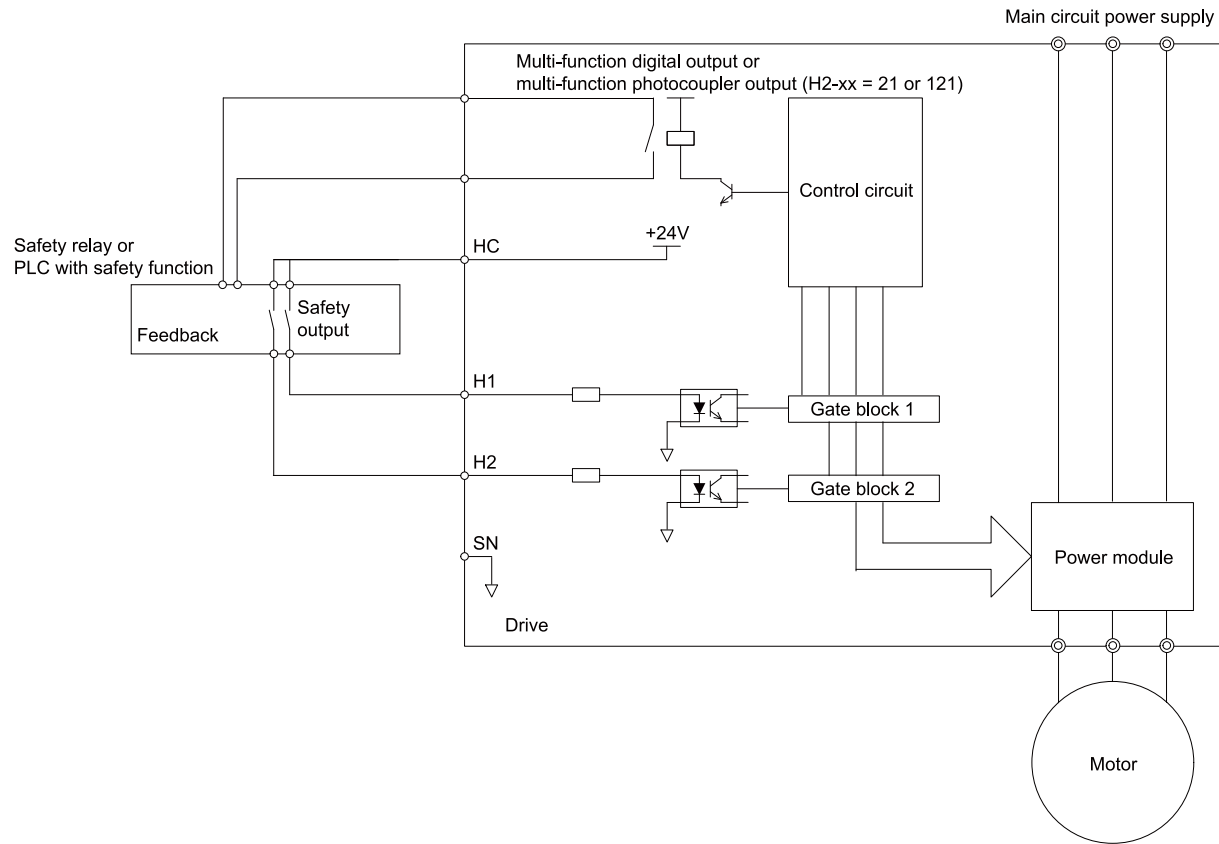

Figure 5.25 Safe Disable Function Wiring Example

■ Connect Safe Disable Input Contacts to Multiple Drives

To Use the Drive Internal Power Supply

Figure 5.26 shows an example of how to connect Safe Disable contacts.

From the terminals HC-SN of drive 1, supply the power for the Safe Disable function for the applicable drives. These conditions limit the number of units to connect:

- Internal power supply capacity
- Number of MFDIs used
- Supply current to the external sensors

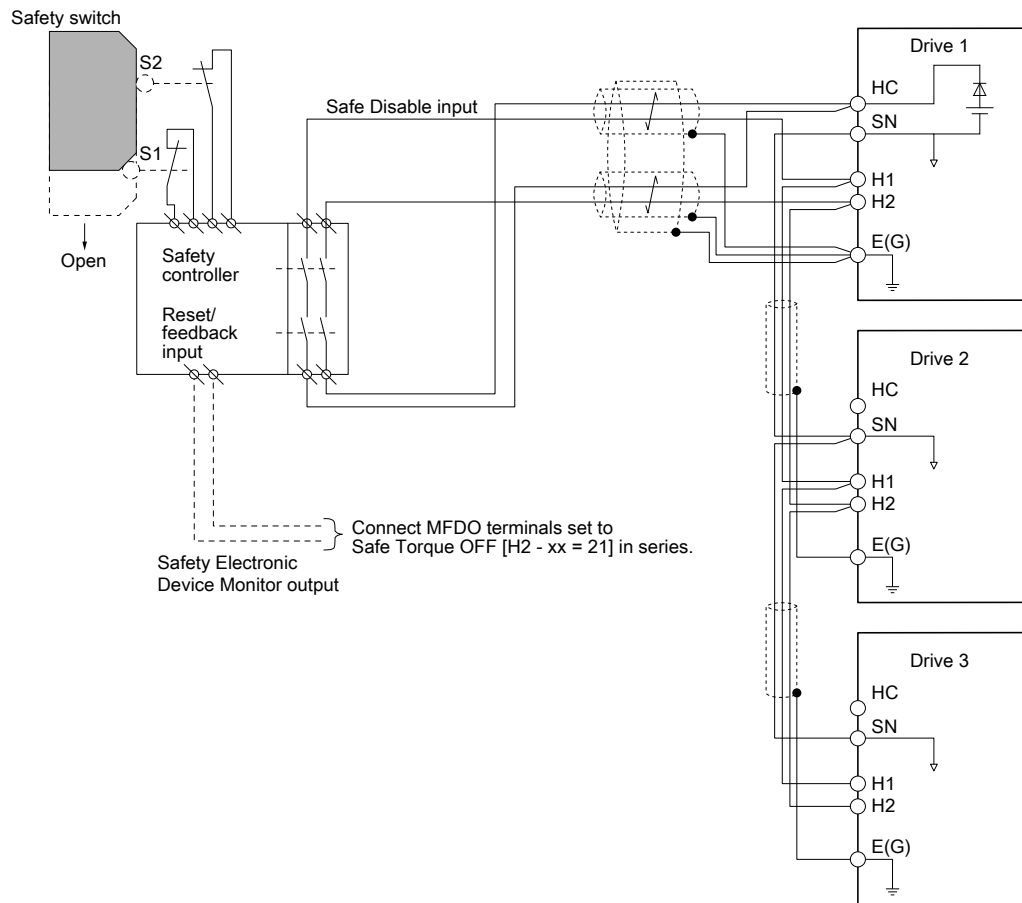

Figure 5.26 Connection Example to Use the Internal Power Supply

To Use 24 V External Power Supply

Figure 5.27 shows an example of how to connect Safe Disable contacts. These conditions limit the number of units to connect:

- External power supply capacity
- Number of MFDIs used
- Supply current to the external sensors

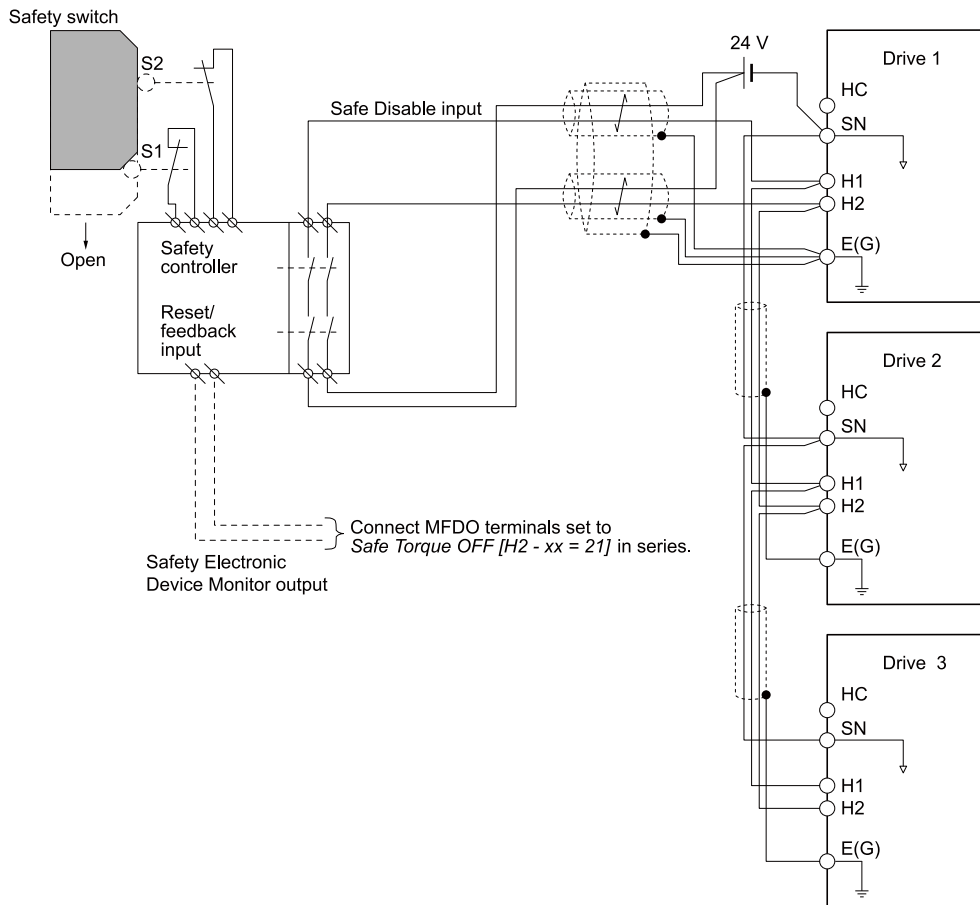

Figure 5.27 Connection Example to Use 24 V External Power Supply

Number of Possible Drives to Connect

Power Supply	Digital Inputs	24 V Output	Number of Drives
Internal power supply (Drive 1)	Yes (7-channel input)	Yes *1	1
		No	13
	No	Yes *1	4
		No	17
External power supply	-	-	Different for different external power supply capacities *2

*1 This is when you use a maximum of 150 mA.

*2 24 V, 12 mA is necessary for each drive.

Use this formula to calculate the number of units to connect:

$$n = (I_{O_{max}} - I_{MFDI} \times n_{MFDI} - I_{sensor}) / I_{safety}$$

- n: Number of units to connect
- $I_{O_{max}}$: Maximum current that the power supply can supply (234 mA for the internal power supply)
- I_{MFDI} : Current consumed per MFDI (6 mA)
- n_{MFDI} : Maximum number of MFDI that can be activated at the same time (maximum of 7-channel)
- I_{sensor} : Current externally supplied for sensor power supply (maximum of 150 mA)
- I_{safety} : Current consumed by Safe Disable terminals H1 and H2 (12 mA)

Note:

Round the values to the first decimal place.

■ Enabling and Disabling the Drive Output (“Safe Torque Off”)

Refer to [Figure 5.28](#) for an example of drive operation when the drive changes from “Safe Torque Off” status to usual operation.

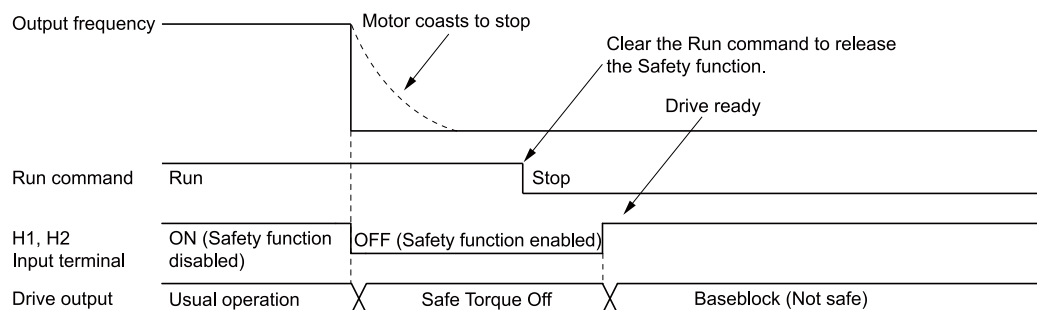

Figure 5.28 Safe Disable Operation

Switching from Usual Operation to “Safe Torque Off”

Turn OFF (open) safety input terminal H1 or H2 to enable the Safe Disable function. When the Safe Disable function is enabled while the motor is operating, the drive output and motor torque turn off and the motor always coasts to stop. The *b1-03 [Stopping Method Selection]* setting does not have an effect on the stopping method.

The “Safe Torque Off” status is only possible with the Safe Disable function. Clear the Run command to stop the drive. Turning off drive output (a baseblock condition) ≠ “Safe Torque Off”.

Note:

- When it is necessary to ramp to stop the motor, do not turn off terminals H1 and H2 until the motor fully stops. This will prevent the motor from coasting to stop during usual operation.
- A maximum of 3 ms will elapse from when terminals H1 or H2 shut off until the drive switches to the “Safe Torque Off” status. Set the OFF status for terminals H1 and H2 to hold for at least 3 ms. The drive may not be able to switch to the “Safe Torque Off” status if terminals H1 and H2 are only open for less than 3 ms.

Going from “Safe Torque Off” to Usual Operation

The safety input will only release when there is no Run command.

- During Stop
When the Safe Disable function is triggered during stop, close the circuit between terminals H1-HC and H2-HC to disable “Safe Torque Off”. Enter the Run command after the drive stops correctly.
- During Run
If you trigger the Safe Disable function during run, clear the Run command, then close the circuit between terminals H1-HC and H2-HC to disable “Safe Torque Off”. Enter the Stop command, then enter the Run command when terminals H1 and H2 are activated.

■ Safe Disable Monitor Output Function and Keypad Display

Refer to [Table 5.29](#) for information about the relation between the input channel status, Safety monitor output status, and drive output status.

Table 5.29 Safe Disable Input and External Device Monitor (EDM) Terminal Status

Input Channel Status		Safety Monitor Output Status		Drive Output Status	Keypad Display	READY LED	MEMOBUS Register 0020H	
Input 1 (H1-HC)	Input 2 (H2-HC)	MFDO Terminal (H2-xx = 21)	MFDO Terminal (H2-xx = 121)				bit C	bit D
ON (Close the circuit)	ON (Close the circuit)	OFF	ON	Baseblock (Drive ready)	Normally displayed	READY: Illuminated	0	0
OFF (Open)	ON (Close the circuit)	OFF	ON	Safety status (STo)	SToF (Flashing)	ALM/ERR: Flashing	1	0
ON (Close the circuit)	OFF (Open)	OFF	ON	Safety status (STo)	SToF (Flashing)	ALM/ERR: Flashing	1	0
OFF (Open)	OFF (Open)	ON	OFF	Safety status (STo)	STo (Flashing)	READY: Flashing	0	1

Safety Function Status Monitor

The drive Safety monitor output sends a feedback signal about the status of the Safety function. The Safety monitor output is one of the possible settings available for the MFDO terminals. If there is damage to the Safe Disable circuit, a controller (PLC or safety relay) must read this signal as an input signal to hold the “Safe Torque Off” status. This will help verify the condition of the safety circuit. Refer to the manual for the safety device for more information about the Safety function.

It is possible to switch polarity of the Safety monitor output signal with the MFDO function settings. Refer to [Table 5.29](#) for setting instructions.

Keypad Display

If the two input channels are OFF (Open), the keypad will flash *STo* [*Safe Torque OFF*].

If there is damage to the Safe disable circuit or the drive, the keypad will flash *SToF* [*Safe Torque OFF Hardware*] when one input channel is OFF (Open), and the other is ON (Short circuit). When you use the Safe disable circuit correctly, the keypad will not show *SToF*.

If there is damage to the drive, the keypad will show *SCF* [*Safety Circuit Fault*] when the drive detects a fault in the Safe disable circuit. Refer to the chapter on Troubleshooting for more information.

■ Validating the Safe Disable Function

After you replace parts or do maintenance on the drive, complete all necessary wiring to start the drive, then follow these steps to test the Safe Disable input. Keep a record of the test results.

1. When the two input channels are OFF (Open), make sure that the keypad flashes *STo* [*Safe Torque OFF*], and make sure that the motor is not running.
2. Monitor the ON/OFF status of the input channels and make sure that MFDO set to the EDM function operates as shown in [Table 5.29](#).

If one or more of these items are true, the ON/OFF status of the MFDO may not display correctly on the keypad.

- Incorrect parameter settings.
- A problem with an external device.
- The external wiring has a short circuit or is disconnected.
- There is damage to the device.

Find the cause and repair the problem to correctly display the status.

3. Make sure that the EDM signal operates during usual operation as shown in [Table 5.29](#).

5.7 Seismic Standards

The Yaskawa drives in this manual are capable of structurally and operationally withstanding the seismic response criteria as defined in the International Building Code (IBC), ASCE7, and California Department of Health Care Access and Information (HCAI).

The models in this manual were tested in compliance with AC-156 to meet the IBC seismic certification as shown on the certification labels.



Figure 5.29 Seismic Certification Label Example for Drives

◆ IBC/HCAI Seismic Mounting Requirements

Use the attachment hardware in [Table 5.30](#) to install your drive to meet the IBC/HCAI seismic mounting requirements.

◆ IP20/UL Open Type and IP20/UL Type 1 Kit Enclosure

Table 5.30 IP20/UL Open Type and IP20/UL Type 1 Kit Enclosure Methods and Hardware Specifications

Model	Attachment Method	Attachment Hardware		
		Qty	Specifications	
B001 to B018 2001 to 2056 4001 to 4038	Direct to Steel	4	Anchor Material	ASTM A307
			Anchor Diameter	3/16 in
2070, 2082 4044, 4060	Direct to Steel	4	Anchor Material	ASTM A307
			Anchor Diameter	1/4 in
	Direct to Concrete ^{*1}	4	Anchor Material	Hilti KH-EZ Screw Anchor
			Anchor Diameter	1/4 in
			Minimum Embedment	1.63 in
			Critical Edge Distance	4.0 in
CMU	1500 PSI CMU with 2000 PSI grout			

*1 Refer to [Concrete Masonry Attachment Detail on page 218](#) for Direct to Concrete installations.

◆ Concrete Masonry Attachment Detail

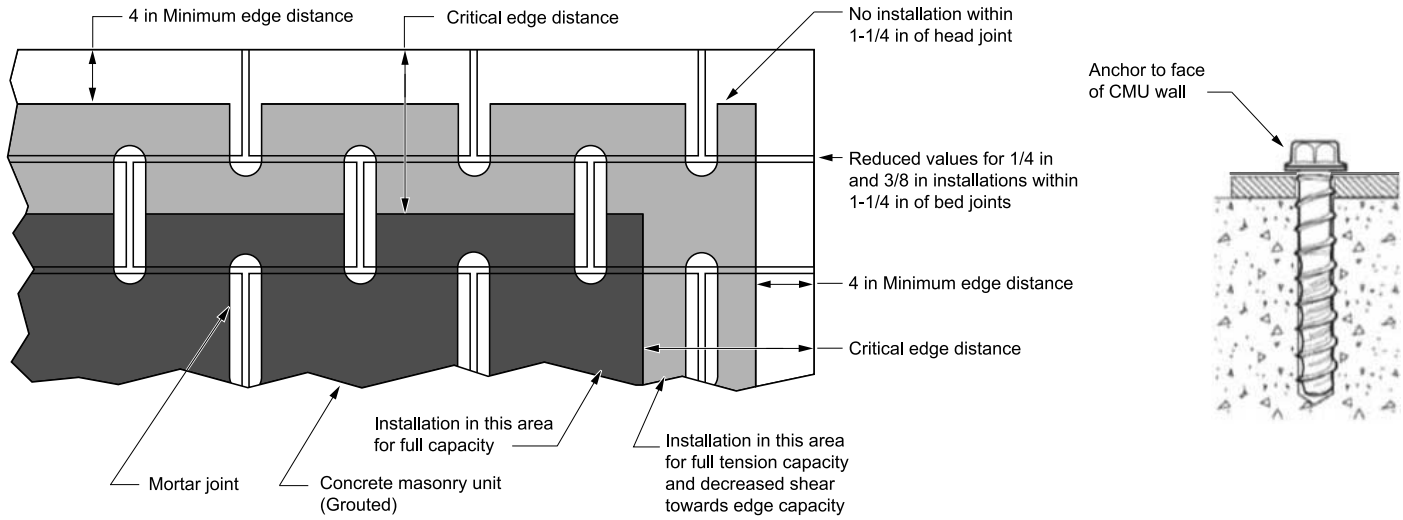

Note:

Anchorage Installation is restricted to shaded areas as per ESR 3056.

5.8 Australian Standard



Figure 5.30 Regulatory Compliance Mark

The Regulatory Compliance Mark (RCM) identifies that the product meets the requirements of the related ACMA Standards in the Radiocommunications Act of 1992 and the Telecommunications Act of 1997.

Network Communications

6.1	Section Safety	222
6.2	Field Bus Network Support.....	223
6.3	MEMOBUS/Modbus Communications	224

6.1 Section Safety

 **DANGER**

Do not ignore the safety messages in this manual.

If you ignore the safety messages in this manual, it will cause serious injury or death. The manufacturer is not responsible for injuries or damage to equipment.

6.2 Field Bus Network Support

You can use the PLC to control and monitor the drive through the network. The drive has a standard RS-485 interface (MEMOBUS/Modbus communications). Install a separately sold communication option on the drive to support other network communications.

◆ Available Communication Options

Refer to [Table 6.1](#) for the fieldbus networks that are compatible with the drive. Contact Yaskawa or your nearest sales representative to order a communication option.

Table 6.1 Available Fieldbus Network

Type of Communications	Option model	Type of Communications	Option model
CC-Link	SI-C3	EtherCAT	SI-ES3
MECHATROLINK-II	SI-T3	DeviceNet	SI-N3
MECHATROLINK-III	SI-ET3	Modbus TCP/IP	SI-EM3
PROFIBUS-DP	SI-P3	PROFINET	SI-EP3
CANopen	SI-S3	EtherNet/IP	SI-EN3

6.3 MEMOBUS/Modbus Communications

This section gives detailed information about the parameters, error codes and communication procedures for MEMOBUS/Modbus communications.

◆ Configure Master/Slave

You can use the MEMOBUS/Modbus protocol for serial communication with programmable controllers (PLC).

The MEMOBUS/Modbus communication uses one master (PLC) and a maximum of 31 slave drives. Serial communications usually starts with a signal from the master to the slave drives.

A slave drive that receives a command from the master does the specified function and then sends a response back to the master. You must set the address number for each slave drive before you start signal communications to make sure that the master uses the correct address numbers.

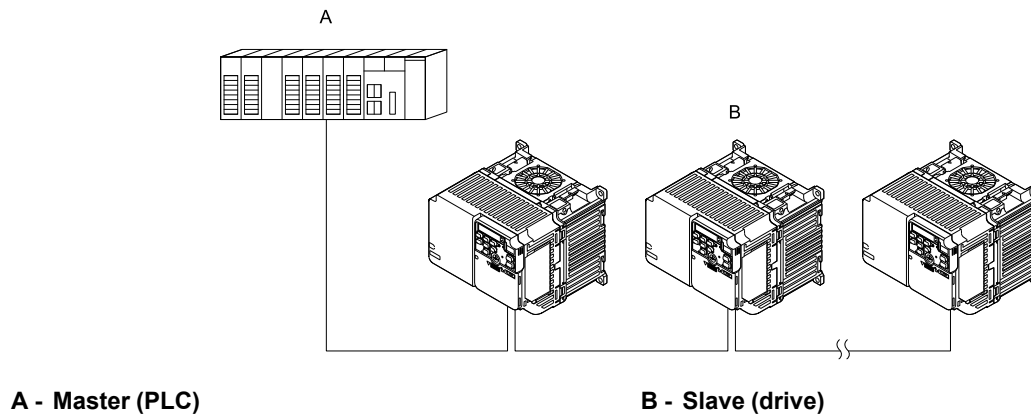

Figure 6.1 PLC and Drive Connection Example

◆ Communication Specifications

Table 6.2 lists the specifications for the MEMOBUS/Modbus communications.

Table 6.2 MEMOBUS/Modbus Specifications

Item	Specification
Interface	RS-485
Synchronization method	Asynchronous (start-stop synchronization)
Communication parameter	Communications speed: 1.2, 2.4, 4.8, 9.6, 19.2, 38.4, 57.6, 76.8, 115.2 kbps
	Data length: 8 bit (fixed)
	Parity: even, odd, none
	Stop bit 1 bit (fixed)
Communication protocol	MEMOBUS/Modbus standard (RTU mode only)
Number of possible units to connect	Maximum: 31 units

◆ Communication with the PLC

This section gives information about the settings for the termination resistor and how to connect to MEMOBUS/Modbus communications. MEMOBUS/Modbus communications uses an RS-485 interface (2-wire sequence).

■ Connect Communications Cable

Use this procedure to start communication between the PLC and drive.

1. De-energize the drive then connect the communications cable to the PLC and the drive. The drive uses terminal TB4 for MEMOBUS/Modbus communications.

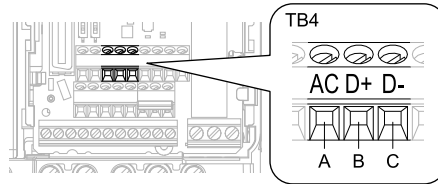

A - Terminal AC: Common ground

B - Terminal D+: Communication input/output (+)

C - Terminal D-: Communication input/output (-)

Figure 6.2 Communications Cable Connection Terminal (TB4)

Note:

Isolate the communications wiring from the main circuit wiring and other high-power wiring. Use shielded wires for the communications wiring and connect cable sheaths to the ground terminal of the drive. Incorrect wiring procedures could cause drive malfunction because of electrical interference.

2. Install the termination resistor on the network termination slave drive. Set DIP switch S2 to the ON position to enable the termination resistor on the drive.
3. Energize the drive.
4. Use the drive keypad to set the necessary communications parameters *H5-01 to H5-12*.
 - *H5-01 [Drive Node Address]*
 - *H5-02 [Communication Speed Selection]*
 - *H5-03 [Communication Parity Selection]*
 - *H5-04 [Communication Error Stop Method]*
 - *H5-05 [Comm Fault Detection Selection]*
 - *H5-06 [Drive Transmit Wait Time]*
 - *H5-09 [CE Detection Time]*
 - *H5-10 [Modbus Register 0025H Unit Sel]*
 - *H5-11 [Comm ENTER Command Mode]*
 - *H5-12 [Run Command Method Selection]*
5. De-energize the drive and wait for the keypad display to turn off.
6. Energize the drive.

The drive is prepared to start communication with the PLC.

■ Set the Termination Resistor

You must enable the termination resistor on the slave terminal of the drive to use MEMOBUS/Modbus communications. Use DIP switch S2 on the terminal block to enable and disable the built-in termination resistor. Refer to [Figure 6.3](#) for an example of how to set DIP switch S2. Use the tip of a tweezers or a jig with a tip width of 0.8 mm (0.03 in) to set the DIP switch. When you install the drive at the end of the communication line, set DIP switch S2 to ON. Set DIP switch S2 to OFF on all other drives.

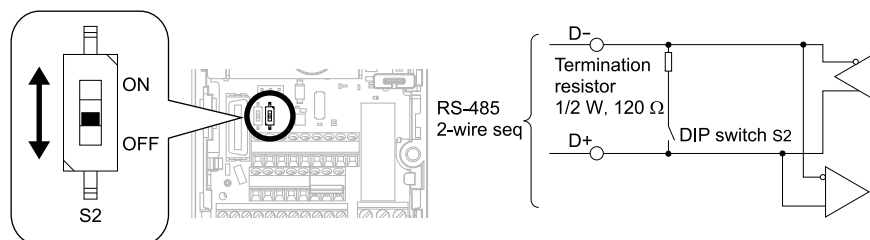

Figure 6.3 MEMOBUS/Modbus Communication Terminal and DIP Switch S2

■ Wiring Diagram for More than One Drive

[Figure 6.4](#) shows the correct wiring when you use more than one drive with MEMOBUS/Modbus communications.

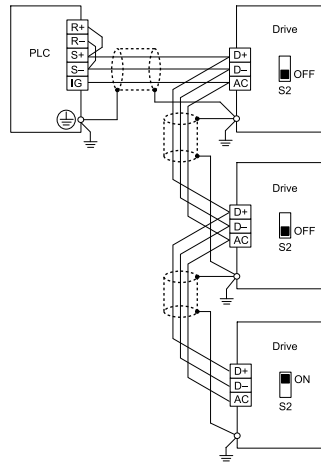

Figure 6.4 Wiring Diagram for More than One Drive

Note:

1. Set DIP switch S2 to the ON position on the last drive of the MEMOBUS/Modbus communication network to enable the termination resistor.
2. For long cable runs or multi-floor installations, connect the shield to ground at only one device on the network (at the PLC, if possible) to prevent ground loops. When you remove the shield from the ground terminal, it can increase the communication quality in some drive installation locations.

◆ MEMOBUS/Modbus Drive Operations

Drive parameters will apply to the settings when the drive is running during MEMOBUS/Modbus communications. This section gives information about the available functions and their related parameters.

■ Executable Functions

A PLC can do these operations with MEMOBUS/Modbus communications. Parameter settings (except *H5-xx*) do not have an effect on the availability of these operations.

- Monitor the drive status and operate the drive
- Set and view parameters
- Fault Reset
- Multi-function input settings

The input command from MEMOBUS/Modbus communications and MFDI terminals (S1 to S7) are linked by a logical OR operation.

■ Drive Control

Select the external command that sets the frequency references and motor run/stop with MEMOBUS/Modbus communications. Use the information in [Table 6.3](#) to set the parameters as specified by the application.

Table 6.3 Necessary Parameter Settings for Drive Control from MEMOBUS/Modbus

LOCAL Control Selected	No.	Name	Setting Value
External reference 1	b1-01	Frequency Reference Selection 1	2 [<i>Memobus/Modbus Communications</i>]
	b1-02	Run Command Selection 1	2 [<i>Memobus/Modbus Communications</i>]
External reference 2	b1-15	Frequency Reference Selection 2	2 [<i>Memobus/Modbus Communications</i>]
	b1-16	Run Command Selection 2	2 [<i>Memobus/Modbus Communications</i>]

For more information about operation mode selection, refer to *b1-01* [*Frequency Reference Selection 1*] and *b1-02* [*Run Command Selection 1*]. Refer to *H1-xx = 2* [*MFDI Function Select = External Reference 1/2 Selection*] for more information about external commands.

◆ Communications Timing

To prevent overrun of the slave side, the master cannot send a message to the same drive for a selected length of time. To prevent overrun of the master side, the slave cannot send a response message to the master for a selected length of time.

This section gives information about message timing.

■ Command Message from Master to Slave

To prevent data loss and overrun, after the master receives a message from the slave, the master cannot send the same type of command message to the same slave for a selected length of time. The minimum wait time is different for each type of message. Refer to [Table 6.4](#) to find the minimum wait times.

Table 6.4 Minimum Wait Time to Send a Message

Command Type	Example	Minimum Wait Time
1	<ul style="list-style-type: none"> Operation commands (Run command, stop command) I/O settings Reading the motor and parameter setting values 	5 ms ^{*1}
2	Writing a parameter	50 ms ^{*1}
3	Writing of modified data with the Enter command	3 to 5 s ^{*1}

*1 When the drive receives a message in the minimum wait time, it does command type 1 and sends a response message. If the drive receives command type 2 or command type 3 messages in the minimum wait time, it will trigger a communications error or the drive will ignore the command.

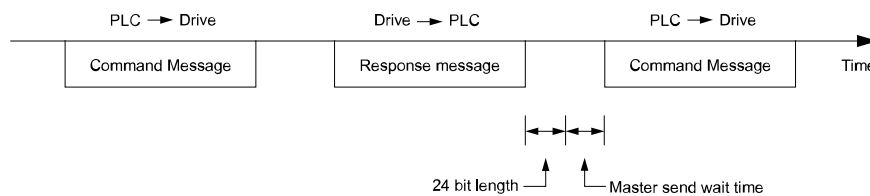

Figure 6.5 Minimum Wait Time to Send a Message

You must set the timer in the master to measure the length of time for the slave to respond to the master. If you set the timer, but the slave does not send a response message in a specified length of time, the master will send the message again.

■ Response Message from Slave

The slave receives the command message from the master then processes the data it received. The slave then waits for the time set in *H5-06 [Drive Transmit Wait Time]* then sends a response message to the master. If overrun occurs on the master, increase the wait time set in *H5-06*.

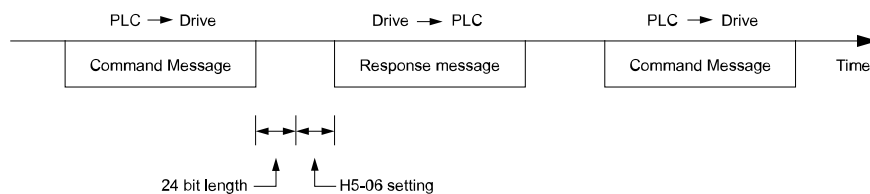

Figure 6.6 Response Wait Time

◆ Message Format

■ Communication Message Description

In MEMOBUS/Modbus communications, the master sends commands to the slave, then the slave responds. The master and slave send their messages in the configuration in [Figure 6.7](#). The length of the data changes when the description of the command (function) changes.

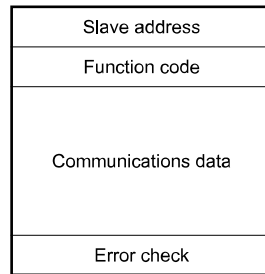

Figure 6.7 Message Format

■ Slave Address

Set the slave address of the drive to 00 to FF (Hex.). When the slave address is 00 (Hex), the master sends the command and all slaves receive the command.

The slave will not send a response message to the master.

■ Function Code

There are five function codes that set commands. Table 6.5 shows the different codes.

Table 6.5 Function Codes

Function Code (Hex.)	Subfunction Code (Hex.)	Function	Command Message		Response Message	
			Minimum Data Length (byte)	Maximum Data Length (byte)	Minimum Data Length (byte)	Maximum Data Length (byte)
03	-	Read Multiple Holding Registers	8	8	7	37
08	-	Loopback Test	8	8	8	8
10	-	Writing to Multiple Holding Registers	11	41	8	8
5A	-	Writing to Multiple Holding Registers / Reading the Register Indicated	11	41	17	17
67	010D	Reading the Contents of Non-Consecutive Holding Registers	10	248	10	248
	010E	Writing to Non-Consecutive Holding Registers	14	250	8	8

■ Communications Data

Communications data is a series of data that uses the combination of the communications register number and the data for these registers. The data length changes when the description of the command changes. For a loopback test, it switches to test code.

The communications register for the drive has a 2-byte length. Data that is written to the register for the drive is usually 2 bytes. Register data that is read from the drive is also 2 bytes.

■ Error Check

Error check uses the CRC-16 method to detect transmission errors. Use the procedure in this section to calculate CRC-16.

Command Data

When the drive receives data, it will make sure that there are no errors in the data. The drive uses the procedure below to calculate CRC-16, then the drive compares that data with the CRC-16 value in the message. If the CRC-16 values do not agree, the drive will not execute a command message.

When you calculate CRC-16 in MEMOBUS/Modbus communications, make sure that you set the start value as FFFF (Hex.). All 16 bits must be 1.

Use this procedure to calculate CRC-16:

1. Make sure that the start value is FFFF (Hex.).
2. Calculate the FFFF (Hex.) start value and the XOR of the slave address (exclusive OR).
3. Move the step 2 results one column to the right. Do this shift until the carry bit is 1.
4. When the carry bit is 1, calculate XOR via the result from the above step 3 and A001 (Hex.).
5. Do steps 3 and 4 until the 8th shift to the right.
6. Use the result of step 5 to calculate the XOR and the data of the following messages (function code, register address, data). Do steps 3 to 5 until the last data, then calculate.
7. The result of the last right shift or the value of the last XOR calculation is the result for CRC-16.

Table 6.6 lists examples of the CRC-16 calculation of slave address 02 (Hex.) and function code 03 (Hex.). The calculated results of CRC-16 for this section is D140 (Hex.).

Note:

The calculation example only gives information about some error checks with CRC-16. The drive will do the same error checks for the next data.

Table 6.6 CRC-16 Calculation Example

Description	Calculation	Overflow	Description	Calculation	Overflow
Initial value (FFFF (Hex.))	1111 1111 1111 1111	-	Function code 03 (Hex.)	0000 0011	-
Address 02 (Hex.)	0000 0010	-	XOR w result	1000 0001 0011 1101	-
XOR w initial value	1111 1111 1111 1101	-	Shift 1	0100 0000 1001 1110	1
Shift 1	0111 1111 1111 1110	1	XOR w A001 (Hex.)	1010 0000 0000 0001	-
XOR w A001 (Hex.)	1010 0000 0000 0001	-	XOR result	1110 0000 1001 1111	-
XOR result	1101 1111 1111 1111	-	Shift 2	0111 0000 0100 1111	1
Shift 2	0110 1111 1111 1111	1	XOR w A001 (Hex.)	1010 0000 0000 0001	-
XOR w A001 (Hex.)	1010 0000 0000 0001	-	XOR result	1101 0000 0100 1110	-
XOR result	1100 1111 1111 1110	-	Shift 3	0110 1000 0010 0111	0
Shift 3	0110 0111 1111 1111	0	Shift 4	0011 0100 0001 0011	1
Shift 4	0011 0011 1111 1111	1	XOR w A001 (Hex.)	1010 0000 0000 0001	-
XOR w A001 (Hex.)	1010 0000 0000 0001	-	XOR result	1001 0100 0001 0010	-
XOR result	1001 0011 1111 1110	-	Shift 5	0100 1010 0000 1001	0
Shift 5	0100 1001 1111 1111	0	Shift 6	0010 0101 0000 0100	1
Shift 6	0010 0100 1111 1111	1	XOR w A001 (Hex.)	1010 0000 0000 0001	-
XOR w A001 (Hex.)	1010 0000 0000 0001	-	XOR result	1000 0101 0000 0101	-
XOR result	1000 0100 1111 1110	-	Shift 7	0100 0010 1000 0010	1
Shift 7	0100 0010 0111 1111	0	XOR w A001 (Hex.)	1010 0000 0000 0001	-
Shift 8	0010 0001 0011 1111	1	XOR result	1110 0010 1000 0011	-
XOR w A001 (Hex.)	1010 0000 0000 0001	-	Shift 8	0111 0001 0100 0001	1
XOR result	1000 0001 0011 1110	-	XOR w A001 (Hex.)	1010 0000 0000 0001	-
Perform operations with next data (function code)			XOR result	1101 0001 0100 0000	-
			CRC-16	1101 0001 0100 0000	-
				D 1 4 0 (Lower) (Upper)	-
Continue from here with next data.					

Response Data

The drive does the CRC-16 calculation for the response message and makes sure that the data does not have errors. Make sure that the calculated value is the same value as the CRC-16 in the response message.

◆ Examples of Messages for Commands/Responses

The items in this section are examples of messages for commands/responses.

■ Read Multiple Holding Registers

Uses function code 03 (Hex.) to read the contents of a maximum of 16 holding registers.

Table 6.7 shows example messages when the drive reads status signal from the drive of slave 2, the error contents, fault contents, and frequency references.

Table 6.7 Message Example When Reading the Contents of Holding Register

Byte	Command Message		Setting Data (Hex.)	Response Message (Normal)		Setting Data (Hex.)	Response Message (Fault)		Setting Data (Hex.)
0	Slave address		02	Slave address		02	Slave address		02
1	Function code		03	Function code		03	Function code		83
2	Starting No.	Upper	00	Data Qty		08	Error code		03
3		Lower	20	First storage register	Upper	00	CRC-16	Upper	F1
4	Data Qty	Upper	00		Next storage register	Lower		65	Lower
5		Lower	04	Next storage register		Upper	00	-	
6	CRC-16	Upper	45		Next storage register	Lower	00	-	
7		Lower	F0	Next storage register		Upper	00	-	
8	-				Next storage register	Lower	00	-	
9	-			Next storage register		Upper	01	-	
10	-				CRC-16	Lower	F4	-	
11	-			CRC-16		Upper	AF	-	
12	-				Lower	82	-		

■ Loopback Test

The loopback test uses function code 08 (Hex.) and returns the command message as a response message. This test checks communication between the master and slave. The test code and data can use desired values.

Table 6.8 shows examples of messages given out when the loopback test is done with the drive of slave 1.

Table 6.8 Message Examples from the Loopback Test

Byte	Command Message		Setting Data (Hex.)	Response Message (Normal)		Setting Data (Hex.)
0	Slave address		01	Slave address		01
1	Function code		08	Function code		08
2	Test code	Upper	00	Test code	Upper	00
3		Lower	00		Lower	00
4	Data	Upper	A5	Data	Upper	A5
5		Lower	37		Lower	37
6	CRC-16	Upper	DA	CRC-16	Upper	DA
7		Lower	8D		Lower	8D

■ Writing to Multiple Holding Registers

You can write the data that you set to the number of holding registers set in function code 10 (hex). You must configure the number of the holding registers and each 8 higher bits and 8 lower bits in order in the command message for the write data. You can write to a maximum of 16 holding registers.

Table 6.9 shows example messages when you use the PLC to set Forward run in the drive of slave 1 with a 60.00 Hz frequency reference.

When you rewrite the parameter value with the write command through the *H5-11 [Comm ENTER Command Mode]* setting, you must use the Enter command to save and enable the contents of the changes. Refer to *H5-11: Comm ENTER Command Mode on page 703* and *Enter Command on page 234* for more information.

Table 6.9 Message Example When Writing to Multiple Holding Registers

Byte	Command Message		Response Message (When Normal)		Response Message (When There is a Fault)			
		Setting Data (Hex.)		Setting Data (Hex.)		Setting Data (Hex.)		
0	Slave address	01	Slave address	01	Slave address	01		
1	Function code	10	Function code	10	Function code	90		
2	Starting No.	Upper	00	Starting No.	Upper	Error code	02	
3		Lower	01		Lower			CRC-16
4	Data Quantity	Upper	00	Data Quantity	Upper	00	Lower	
5		Lower	02		Lower	02		-
6	Byte No.	04	CRC-16	Upper	10	-		
7	First data	Upper		00	Lower	08	-	
8		Lower	01	-	-	-		
9	Next data	Upper	17	-	-	-		
10		Lower	70	-	-	-		
11	CRC-16	Upper	6D	-	-	-		
12		Lower	B7	-	-	-		

Note:

The number of bytes set in the command message set the data quantity $\times 2$ during the command message. The response message uses the same formula.

■ Writing to More than One Holding Register/Reading the Indicated Register

The drive uses function code 5A (Hex.) to write to more than one register, then it reads the contents of four holding registers at the same time.

The function for writing to more than one register is the same as the function for function code 10 (Hex.). You can write to a maximum of 16 holding registers.

The four holding registers to be read from are specified in *H5-25 to H5-28 [Function 5A Register x Selection]*.

[Table 6.10](#) shows example messages when you write to more than one holding register or when you read more than one command register. [Table 6.10](#) uses this register data for the examples:

- The drive for slave 1 is set for Forward run with a frequency reference of 60.00 Hz.
- The setting in *H5-25 to H5-28* and the data in the specified holding registers are as follows.
 - *H5-25 = 0044H: U1-05 [Motor Speed] = 60.00 Hz (6000 = 1770H)*
 - *H5-26 = 0045H: U1-06 [Output Voltage Ref] = 200.0 V (2000 = 07D0H)*
 - *H5-27 = 0042H: U1-03 [Output Current] = 50% of drive rated current (100% = 8192, 50% = 4096 = 1000H)*
 - *H5-28 = 0049H: U1-10 [Input Terminal Status] = 00H*

When you rewrite the parameter value with the write command through the *H5-11 [Comm ENTER Command Mode]* setting, you must use the Enter command to save and enable the contents of the changes. Refer to *H5-11: Comm ENTER Command Mode on page 703* and *Enter Command on page 234* for more information.

Table 6.10 Message Example When Writing to More than One Holding Register/Reading the Indicated Register

Byte	Command Message		Response Message (When Normal)		Response Message (When There is a Fault)	
		Setting Data (Hex.)		Setting Data (Hex.)		Setting Data (Hex.)
0	Slave address	01	Slave address	01	Slave address	01
1	Function code	5A	Function code	5A	Function code	DA

6.3 MEMOBUS/Modbus Communications

Byte	Command Message			Response Message (When Normal)			Response Message (When There is a Fault)		
			Setting Data (Hex.)			Setting Data (Hex.)			Setting Data (Hex.)
2	Starting No.	Upper	00	Register status		0F	Register status		0F
3		Lower	01	Data in holding register 1 selected with H5-25	Upper	17	Data in holding register 1 selected with H5-25	Upper	17
4	Data Quantity	Upper	00		Data in holding register 2 selected with H5-26	Lower		70	Data in holding register 2 selected with H5-26
5		Lower	02	Data in holding register 3 selected with H5-27		Upper	07	Data in holding register 3 selected with H5-27	
6	Byte No.		04		Data in holding register 4 selected with H5-28	Lower	D0		Data in holding register 4 selected with H5-28
7	First data	Upper	00	Data in holding register 3 selected with H5-27		Upper	10	Data in holding register 3 selected with H5-27	
8		Lower	01		Data in holding register 4 selected with H5-28	Lower	00		Data in holding register 4 selected with H5-28
9	Next data	Upper	17	Data in holding register 4 selected with H5-28		Upper	00	Data in holding register 4 selected with H5-28	
10		Lower	70		Starting No.	Lower	00		Error code
11	CRC-16	Upper	4F	Starting No.		Upper	00	CRC-16	
12		Lower	43		Data Quantity	Lower	01		CRC-16
13	-			Data Quantity		Upper	00	-	
14	-				CRC-16	Lower	02	-	
15	-			CRC-16		Upper	AC	-	
16	-				CRC-16	Lower	D0	-	

Note:

The number of bytes set in the command message set the data quantity $\times 2$ during the command message.

Register status	
bit 0	Data in register 1 selected with H5-25 1: Successfully read the register 0: Register read error
bit 1	Data in register 2 selected with H5-26 1: Successfully read the register 0: Register read error
bit 2	Data in register 3 selected with H5-27 1: Successfully read the register 0: Register read error
bit 3	Data in register 4 selected with H5-28 1: Successfully read the register 0: Register read error
bit 4	Not used
bit 5	Not used
bit 6	Not used
bit 7	Not used

■ Reading the Contents of Non-Consecutive Holding Registers

The drive uses function code 67 (Hex.) and subfunction code 010D (Hex.) to read data with a maximum of 120 holding registers.

You must give the holding register number from which to read separately.

Table 6.11 shows example messages when you read the frequency reference and torque limit from the drive for slave 1. Table 6.11 uses this register data for the examples.

- 0024H: U1-01 [Frequency Reference] = 60.00 Hz (6000 = 1770H)
- 0028H: U1-09 [Torque Reference] = 100.0% (1000 = 03E8H)

Table 6.11 Message Example When Reading the Contents of Non-Consecutive Holding Registers

Byte	Command Message			Response Message (When Normal)			Response Message (When There is a Fault)		
			Setting Data (Hex.)			Setting Data (Hex.)			Setting Data (Hex.)
0	Slave address		01	Slave address		01	Slave address		01
1	Function code		67	Function code		67	Function code		E7
2	Subfunction Code	Upper	01	Subfunction Code	Upper	01	Error code		02
3		Lower	0D		Lower	0D	CRC-16	Upper	EA
4	Data Quantity	Upper	00	Byte No.	Upper	00		Lower	31
5		Lower	02		Lower	04	-		
6	Holding register 1 No.	Upper	00	Holding register 1 data	Upper	17	-		
7		Lower	24		Lower	70	-		
8	Holding register 2 No.	Upper	00	Holding register 2 data	Upper	03	-		
9		Lower	28		Lower	E8	-		
10	CRC-16	Upper	8B	CRC-16	Upper	47	-		
11		Lower	29		Lower	ED	-		

Note:

The number of bytes set in the command message set the data quantity $\times 2$ during the command message.

■ Writing to Non-Consecutive Holding Registers

The drive uses function code 67 (Hex.) and subfunction code 010E (Hex.) to write data with a maximum of 60 holding registers.

You must give the holding register number from which to write separately.

Table 6.12 shows example messages when you write the frequency reference and torque limit from the drive for slave 1. Table 6.12 uses these specified holding registers data for the examples.

- 0002H: Frequency Reference = 60.00 Hz (6000 = 1770H)
- 0004H: Torque Limit = 150.0% (1500 = 05DCH)

When you rewrite the parameter value with the write command through the H5-11 [Comm ENTER Command Mode] setting, you must use the Enter command to save and enable the contents of the changes. Refer to [H5-11: Comm ENTER Command Mode on page 703](#) and [Enter Command on page 234](#) for more information.

Table 6.12 Message Example When Writing to Non-Consecutive Holding Registers

Byte	Command Message			Response Message (When Normal)			Response Message (When There is a Fault)		
			Setting Data (Hex.)			Setting Data (Hex.)			Setting Data (Hex.)
0	Slave address		01	Slave address		01	Slave address		01
1	Function code		67	Function code		67	Function code		E7
2	Subfunction Code	Upper	01	Subfunction Code	Upper	01	Error code		02
3		Lower	0E		Lower	0E	CRC-16	Upper	EA
4	Data Quantity	Upper	00	Data Quantity	Upper	00		Lower	31
5		Lower	02		Lower	02	-		
6	Byte No.	Upper	00	CRC-16	Upper	D5	-		
7		Lower	04		Lower	FC	-		
8	Holding register 1 No.	Upper	00	-		-			
9		Lower	02	-		-			
10	Holding register 1 data	Upper	17	-		-			
11		Lower	70	-		-			

Byte	Command Message		Response Message (When Normal)		Response Message (When There is a Fault)	
		Setting Data (Hex.)		Setting Data (Hex.)		Setting Data (Hex.)
12	Holding register 2 No.	Upper	00	-	-	-
13		Lower	04	-	-	-
14	Holding register 2 data	Upper	05	-	-	-
15		Lower	DC	-	-	-
16	CRC-16	Upper	55	-	-	-
17		Lower	59	-	-	-

Note:

The number of bytes set in the command message set the data quantity $\times 2$ during the command message.

◆ Enter Command

When you use MEMOBUS/Modbus communications to write parameters from the PLC to the drive, *H5-11 [Comm ENTER Command Mode]* lets you use the Enter command to enable these parameters. This section gives information about the Enter command.

■ Types of Enter Commands

The drive supports the two Enter commands shown in [Table 6.13](#).

Write 0 to register number 0900 or 0910 (Hex.) to enable the Enter command. You can only write to these registers. If you read to these registers, it will cause an error.

Table 6.13 Types of Enter Commands

Register No. (Hex.)	Description
0900	When you write parameter data to the EEPROM, you will enable the data on the RAM at the same time. This process saves the parameter changes even if you de-energize the drive.
0910	This updates the data on the RAM, but does not write data to the EEPROM. If you de-energize the drive, you will lose the parameter changes.

Note:

- You can write the EEPROM to the drive a maximum of 100,000 times. Do not frequently execute the Enter command (0900 (Hex.)) that is written to EEPROM.
- The Enter command register is write-only. If this register is read, it will cause a Register Number Error (02 (Hex.)).
- When the command data or broadcast message is transmitted to the drive, the Enter command is not necessary.

■ Functions of the Enter Command when Replacing a Previous Generation Drive

When you replace a previous generation Yaskawa drive with this product, you must set the Enter command function for this product the same as the previous product. The Enter command function is different for Yaskawa G7, F7-series, and V7-series drives.

Use *H5-11* to set the Enter command function:

- When replacing G7 and F7 series drives, set *H5-11 = 0 [ENTER Command Required]*.
- When replacing V7 series drives, set *H5-11 = 1 [ENTER Command Not Required]*.
- When replacing 1000-series drives, set *H5-11* to the same value as the drive you replaced.

Table 6.14 Enter Command Function Differences

H5-11 Settings	H5-11 = 0	H5-11 = 1
The drive you replaced	G7, F7	V7
Time when the parameter settings are enabled	When the drive receives the Enter command from the master	When you change the parameter settings
Upper and lower limit check	Checks the upper and lower limits and considers the related parameter settings.	Checks the upper and lower limit of the changed parameter only.

H5-11 Settings	H5-11 = 0	H5-11 = 1
Default setting of related parameters	Will not change related parameter settings. You must change the parameters manually.	Automatically changes the default settings for the related parameters.
Fault detection when you set more than one parameter	Accepts and responds as usual to correct setting data if the data contains parameter setting errors. The drive discards the disabled setting data, but will not return an error message.	If there is a setting error in a parameter, the drive responds with a fault. The drive discards the data that was sent.

◆ Self-Diagnostics

The drive can use Self-Diagnostics to find the operation of the serial communications interface circuit. Self-Diagnostics connects the transmission terminal to the reception terminal on the control circuit. It then transmits the data sent by the drive and makes sure that the drive can communicate correctly.

Use this procedure to do Self-Diagnostics:

1. Energize the drive.
2. Set $H1-06 = 67$ [*Terminal S6 Function Select = Communications test mode*].
3. De-energize the drive.
4. Connect a jumper between control circuit terminals S6 and SN.

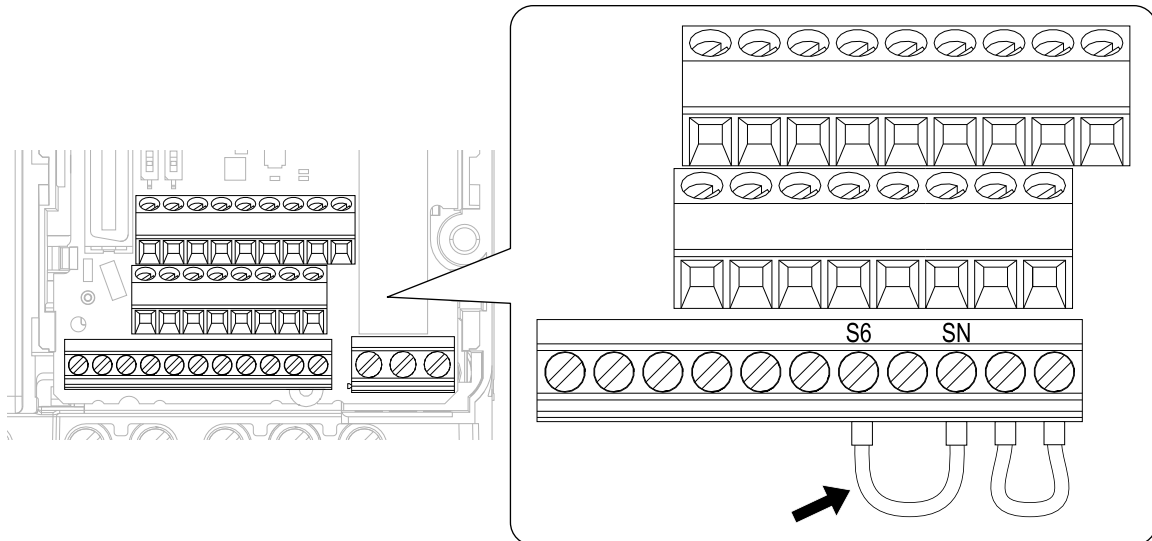

Figure 6.8 Self-Diagnostics Jumper Terminals

5. Energize the drive.
6. When normal, the keypad will show *PASS* [*MEMOBUS/Modbus Communications Test Mode Normal*]. When there is an error, the keypad will show *CE* [*MEMOBUS/Modbus Communications Error*].
7. De-energize the drive.
8. Disconnect the wire jumper between terminals S6 and SN. Set terminal S6 to its initial function.

Self-Diagnostics is complete and the drive returns to its usual function.

◆ Communications Data Table

The communication data types are command data, monitor data, and broadcast message. [Command Data on page 235](#), [Monitor Data on page 238](#), and [Broadcast Messages on page 249](#) show the communications data.

Refer to the Parameter List for parameter communications registers.

■ Command Data

You can read and write command data.

6.3 MEMOBUS/Modbus Communications

Note:

Set the reserved bit to 0. Do not write the data in the reserved register or the monitor register.

Table 6.15 MEMOBUS/Modbus Communications Command Data

Register No. (Hex.)	Description	
0000	Reserved	
0001	Run command, multi-function input command	
	bit 0	When $H5-12 = 0$, Forward run/stop 1: Forward run, 0: Stop When $H5-12 = 1$, run/stop 1: Run, 0: Stop
	bit 1	When $H5-12 = 0$, Reverse run/stop 1: Reverse run, 0: Stop When $H5-12 = 1$, Forward/Reverse run 1: Reverse, 0: Forward run
	bit 2	External fault 1: EF0 [Option Card External Fault]
	bit 3	Fault Reset 1: Reset command
	bit 4	Multi-function input 1 When the multi-function input command is $H1-01 = 40$ [Forward Run Command (2-Wire Seq)], bit 4 is "ComRef." Note: When you switch the bit ON as ComRef, the frequency reference source changes to MEMOBUS/Modbus communications. When you connect a communication option to the drive, the frequency reference source gives priority to the communications option.
	bit 5	Multi-function input 2 When the multi-function input command is $H1-02 = 41$ [Reverse Run Command (2-Wire Seq)], bit 5 is "ComCtrl." Note: When you switch the bit ON as ComCtrl, the Run Command source changes to MEMOBUS/Modbus communications. When you connect a communication option to the drive, the Run Command source gives priority to the communications option.
	bit 6	Multi-function input 3
	bit 7	Multi-function input 4
	bit 8	Multi-function input 5
	bit 9	Multi-function input 6
	bit A	Multi-function input 7
	bit B - F	Reserved
0002	Frequency Reference	$o1-03$ [Frequency Display Unit Selection] (unsigned) sets the units.
0003	Output voltage gain	Units: 0.1% Setting range: 20 (2.0%) to 2000 (200.0%), the default value at energize: 1000 (100.0%)
0004	Torque limit (0.1% signed)	
0005	Torque compensation (0.1% signed)	
0006	PID setpoint (0.01% signed)	
0007	Setting for the multi-function analog monitor output terminal AM (10 V/4000 (Hex.))	
0008	Reserved	
0009	MFDO setting	
	bit 0	MFDO (terminal MA/MB-MC) 1: ON, 0: OFF
	bit 1	Multi-function photocoupler output 1 (terminal P1-C1) 1: ON, 0: OFF
	bit 2	Multi-function photocoupler output 2 (terminal P2-C2) 1: ON, 0: OFF
	bit 3 - F	Reserved
000A	Pulse train output (Units: 1/1 Hz, setting range: 0 to 32000)	
000B - 000E	Reserved	

Register No. (Hex.)	Description	
000F	Command selection setting	
	bit 0	Reserved
	bit 1	Input for the PID setpoint 1: Enables target values from MEMOBUS/Modbus
	bit 2	Torque Limit Input 1: Enables setting values from MEMOBUS/Modbus
	bit 3	Torque Compensation Input 1: Enables setting values from MEMOBUS/Modbus
	bit 4	Reserved
	bit 5	PID feedback from the MEMOBUS/Modbus 1: Enables PID feedback (15FF (Hex.)) from MEMOBUS/Modbus
	bit 6 - B	Reserved
	bit C	Terminal S5 input of broadcast message 1: Enabled, 0: Disabled
	bit D	Terminal S6 input of broadcast message 1: Enabled, 0: Disabled
	bit E	Terminal S7 input of broadcast message 1: Enabled, 0: Disabled
	bit F	Reserved
0010 - 001F	Reserved	
15C0	bit 0	Extended multi-function input command 1
	bit 1	Extended multi-function input command 2
	bit 2	Extended multi-function input command 3
	bit 3 - F	Reserved
3004	<p>Time Setting Setting range: 0000 to 2359 (decimal), the default value at energize: 0000 Set the hour and the minute in HHMM format.</p> <ul style="list-style-type: none"> • HH: 00 to 23 (decimal) • MM: 00 to 59 (decimal) 	
3005	<p>Year and Day Setting Setting range: 1600 to 9906 (decimal), the default value at energize: 1600 Set the year and the day of the week in YYDW format.</p> <ul style="list-style-type: none"> • YY: the last two digits of the year from 16 to 99 (decimal) • DW: the day of the week <ul style="list-style-type: none"> – Sunday: 00 – Monday: 01 – Tuesday: 02 – Wednesday: 03 – Thursday: 04 – Friday: 05 – Saturday: 06 	
3006	<p>Date Setting Setting range: 101 to 1231 (decimal), the default value at energize: 101 Set the month and the date in MMDD format.</p> <ul style="list-style-type: none"> • MM: 01 to 12 (decimal) • DD: 01 to 31 (decimal) 	
3007	<p>Set the Date Information Setting range: 0 to 8 (decimal), the default value at energize: 8 Set the values specified in 3004H to 3006H as the date and time.</p> <ul style="list-style-type: none"> • Command Data: 1 • Response Data: 0 (normal), 8 (fault) 	

■ Monitor Data

You can only read monitor data.

Table 6.16 Monitor Data for MEMOBUS/Modbus Communication

Register No. (Hex.)	Description	
0020	Drive Status 1	
	bit 0	During Run 1: During run, 0: During stop
	bit 1	During Reverse 1: During reverse, 0: Forward run
	bit 2	Drive ready 1: Ready, 0: Not ready
	bit 3	Fault 1: Fault
	bit 4	Data Setting Error 1: oPExx error
	bit 5	MFDO (terminal MA/MB-MC) 1: ON, 0: OFF
	bit 6	Multi-function photocoupler output 1 (terminal P1-C1) 1: ON, 0: OFF
	bit 7	Multi-function photocoupler output 2 (terminal P2-C2) 1: ON, 0: OFF
	bit 8 - B	Reserved
	bit C	SToF [Safe Torque OFF Hardware] 1: One of Safe Disable input 1 (terminal H1-HC) and Safe Disable input 2 (terminal H2-HC) is OFF (open) and the other is ON (closed)
	bit D	STo [Safe Torque OFF] 1: Both Safe Disable input 1 (terminal H1-HC) and Safe Disable input 2 (terminal H2-HC) are OFF (open)
	bit E	ComRef status 1: Enabled
	bit F	ComCtrl status 1: Enabled
0021	Fault Description 1	
	bit 0	oC [Overcurrent], GF [Ground Fault]
	bit 1	ov [Overvoltage]
	bit 2	oL2 [Drive Overload]
	bit 3	oH1 [Heatsink Overheat], oH2 [External Overheat (H1-XX=B)]
	bit 4	rH [Braking Resistor Overheat], rr [Dynamic Braking Transistor Fault]
	bit 5	Reserved
	bit 6	FbL [PID Feedback Loss], FbH [Excessive PID Feedback]
	bit 7	EF0 [Option Card External Fault], EF1 to EF7 [External Fault]
	bit 8	CPFxx [Hardware Fault] Note: Includes oFx.
	bit 9	oL1 [Motor Overload], oL3, oL4 [Overtorque Detection 1/2], UL3, UL4 [Undertorque Detection 1/2]
	bit A	PGo [Encoder (PG) Feedback Loss], oS [Overspeed], dEv [Speed Deviation]
	bit B	During Uv [Undervoltage] detection
	bit C	Uv1 [DC Bus Undervoltage], Uv2 [Control Power Undervoltage], Uv3 [Soft Charge Answerback Fault]
	bit D	LF [Output Phase Loss], PF [Input Phase Loss]
	bit E	CE [Modbus Communication Error], bUS [Option Communication Error]
bit F	Reserved	

Register No. (Hex.)	Description	
0022	Fault Contents	
	bit 0	1: During data writing, during motor switching
	bit 1	Reserved
	bit 2	
	bit 3	1: Upper/Lower Limit Fault
	bit 4	1: Data Integrity Fault
	bit 5	1: During EEPROM writing
	bit 6	0: EEPROM writing 1: Change data only on the RAM Note: Enabled when H5-17 = 1 [ENTER Command Response @CPU BUSY = Write to RAM Only].
bit 7 - F	Reserved	
0023	U1-01 [Frequency Reference] Note: o1-03 [Frequency Display Unit Selection] sets the units.	
0024	U1-02 [Output Frequency] Note: o1-03 [Frequency Display Unit Selection] sets the units.	
0025	U1-06 [Output Voltage Ref] (units: 0.1 V) Note: Use H5-10 [Modbus Register 0025H Unit Sel] to change the setting unit.	
0026	U1-03 [Output Current] (units: 0.1 A)	
0027	U1-08 [Output Power]	
0028	U1-09 [Torque Reference]	
0029	Fault Description 2	
	bit 0	Reserved
	bit 1	GF [Ground Fault]
	bit 2	PF [Input Phase Loss]
	bit 3	LF [Output Phase Loss]
	bit 4	rH [Braking Resistor Overheat]
	bit 5	Reserved
	bit 6	oH4 [Motor Overheat Fault (PTC Input)]
bit 7 - F	Reserved	

6.3 MEMOBUS/Modbus Communications

Register No. (Hex.)	Description	
002A	Minor Fault Description 1	
	bit 0 - 1	Reserved
	bit 2	EF [FWD/REV Run Command Input Error]
	bit 3	bb [Baseblock]
	bit 4	oL3 [Overtorque 1]
	bit 5	oH [Heatsink Overheat]
	bit 6	ov [Overvoltage]
	bit 7	Uv [Undervoltage]
	bit 8	Reserved
	bit 9	CE [Modbus Communication Error]
	bit A	bUS [Option Communication Error]
	bit B	UL3/UL4 [Undertorque Detection 1/2]
	bit C	oH3 [Motor Overheat (PTC Input)]
	bit D	FbL [PID Feedback Loss], FbH [Excessive PID Feedback]
	bit E	Reserved
	bit F	CALL [Serial Comm Transmission Error]
002B	U1-10 [Input Terminal Status]	
	bit 0	I: Control circuit terminal S1 ON
	bit 1	I: Control circuit terminal S2 ON
	bit 2	I: Control circuit terminal S3 ON
	bit 3	I: Control circuit terminal S4 ON
	bit 4	I: Control circuit terminal S5 ON
	bit 5	I: Control circuit terminal S6 ON
	bit 6	I: Control circuit terminal S7 ON
	bit 7 - F	Reserved

Register No. (Hex.)	Description	
002C	Drive Status 2	
	bit 0	During Run 1: During Run
	bit 1	During zero speed 1: During zero speed
	bit 2	Speed agreement 1: During agreement
	bit 3	User-defined speed agreement 1: During agreement
	bit 4	Frequency Detection 1 1: Output frequency \leq L4-01
	bit 5	Frequency Detection 2 1: Output frequency \geq L4-01
	bit 6	Drive ready 1: Run ready
	bit 7	During low voltage detection 1: During detection
	bit 8	During Baseblock 1: Drive output during baseblock
	bit 9	Frequency reference mode 1: No communication option, 0: Communication option
	bit A	Run command mode 1: No communication option, 0: Communication option
	bit B	During overtorque/undertorque 1, 2 detection
	bit C	Frequency reference loss 1: Loss
	bit D	Executing Auto-Restart 1: Restart Enabled
	bit E	Fault 1: Fault generated
bit F	MEMOBUS/Modbus communications timeout 1: At Timeout	
002D	U1-11 [Output Terminal Status]	
	bit 0	MFDO (terminal MA/MB-MC) 1: ON, 0: OFF
	bit 1	Multi-function photocoupler output 1 (terminal P1-C1) 1: ON, 0: OFF
	bit 2	Multi-function photocoupler output 2 (terminal P2-C2) 1: ON, 0: OFF
	bit 3 - F	Reserved
002E	Reserved	
002F	Frequency reference bias (Up 2/Down 2 function) (Units: 0.1%)	
0030	Reserved	
0031	U1-07 [DC Bus Voltage] (unit: 1 V)	
0032	U1-09 [Torque Reference] (unit: 1%)	
0033	Reserved	
0034	Product Code 1 (2-character ASCII code), GA500 = "0A"	
0035	Product Code 2 (2-character ASCII code), GA500 = "50"	
0036 - 0037	Reserved	
0038	PID Feedback: Unsigned, input is equivalent to 100%/maximum output frequency (Units: 0.1%)	

6.3 MEMOBUS/Modbus Communications

Register No. (Hex.)	Description	
0039	PID Input: Signed, $\pm 100\%$ / \pm maximum output frequency (Units: 0.1%)	
003A	PID Output: Signed, $\pm 100\%$ / \pm maximum output frequency (Units: 0.1%)	
003B - 003C	Reserved	
003D	Communications error description Note: The drive saves the description of the communications error until you reset the fault.	
	bit 0	CRC Error
	bit 1	Data Length Error
	bit 2	Reserved
	bit 3	Parity Error
	bit 4	Overrun Error
	bit 5	Framing Error
	bit 6	Timeout
bit 7 - F	Reserved	
003E	Output frequency Units: min^{-1} or r/min Note: Set <i>E2-04</i> , <i>E4-04</i> , <i>E5-04</i> , <i>E9-08</i> [Motor Pole Count].	
003F	0.01% units	
0040 - 004A	Used with <i>U1-xx</i> [Operation Status Monitors]. Refer to <i>U Monitor</i> for more information.	
004B	U1-12 [Drive Status]	
	bit 0	1: During Run
	bit 1	1: During zero speed
	bit 2	1: During reverse
	bit 3	1: During reset signal input
	bit 4	1: During speed agreement
	bit 5	1: Drive operation ready
	bit 6	1: Minor Fault
	bit 7	1: Fault
	bit 8	1: oPExx [Operation Error] generation
	bit 9	1: Recovery from momentary power loss, 0: Power recovery
	bit A	1: Motor 2 Selection
	bit B	Reserved
	bit E	ComRef status/ NetRef status
bit F	ComCtrl status/ NetCtrl status	
004C - 007E	Use with <i>U1-xx</i> , <i>U4-xx</i> , <i>U5-xx</i> , <i>U6-xx</i> [Monitors]. Refer to <i>U Monitor</i> for more information.	
007F	Minor fault code (Refer to "Minor fault description" for more information about the minor fault codes.)	
0080 - 0097	Use with <i>U2-xx</i> , <i>U3-xx</i> [Monitors]. Refer to "U Monitor" for more information, and refer to "Fault Trace/Fault History Descriptions" for more information about register values.	
0098 - 0099	U4-01 [Cumulative Ope Time] Example: When <i>U4-01</i> [Cumulative Ope Time = 12345], 0098 (Hex.) = 1234 and 0099 (Hex.) = 5.	
009A - 009B	U4-03 [Cooling Fan Ope Time] Example: When <i>U4-03</i> [Cooling Fan Ope Time = 12345], 009A (Hex.) = 1234 and 009B (Hex.) = 5.	
009C - 00AA	Reserved	

Register No. (Hex.)	Description	
00AB	Drive rated current Note: The unit of display is different for different models. B001 - B018, 2001 - 2042, and 4001 - 4023: 0.01 A 2056 - 2082, 4031 - 4060: 0.1 A	
00AC	U1-05 [Motor Speed]	Units: min ⁻¹ or r/min Note: Set E2-04, E4-04, E5-04, E9-08 [Motor Pole Count].
00AD		Units: 0.01%
00AE, 00AF	Reserved	
00B0	Option codes connected to CN5	The drive stores option codes in the register. SI-C3 = 5343 (Hex.) SI-EM3 = 1005 (Hex.) SI-EN3 = 1006 (Hex.) SI-EP3 = 1007 (Hex.) SI-ES3 = 1001 (Hex.) SI-ET3 = 1004 (Hex.) SI-N3 = 534E (Hex.) SI-P3 = 5350 (Hex.) SI-S3 = 5353 (Hex.) SI-T3 = 5354 (Hex.)
00B1 - 00B4	Reserved	
00B5	U1-16 [SFS Output Frequency]	Units: min ⁻¹ or r/min Note: Set E2-04, E4-04, E5-04, E9-08 [Motor Pole Count].
00B6		Units: 0.01%
00B7	Frequency reference monitor	Units: min ⁻¹ or r/min Note: Set E2-04, E4-04, E5-04, E9-08 [Motor Pole Count].
00B8		Units: 0.01%
00B9 - 00BE	Reserved	
00BF	Operation error number xx of oPExx is displayed.	
00C0	Fault Description 3	
	bit 0	Reserved
	bit 1	Uv1 [DC Bus Undervoltage]
	bit 2	Uv2 [Control Power Undervoltage]
	bit 3	Uv3 [Soft Charge Answerback Fault]
	bit 4	SC [Short Circuit/IGBT Failure]
	bit 5	GF [Ground Fault]
	bit 6	oC [Overcurrent]
	bit 7	ov [Overvoltage]
	bit 8	oH [Heatsink Overheat]
	bit 9	oH1 [Heatsink Overheat]
	bit A	oL1 [Motor Overload]
	bit B	oL2 [Drive Overload]
	bit C	oL3 [Overtorque Detection 1]
	bit D	oL4 [Overtorque Detection 2]
	bit E	rr [Dynamic Braking Transistor Fault]
bit F	rH [Braking Resistor Overheat]	

6.3 MEMOBUS/Modbus Communications

Register No. (Hex.)	Description	
00C1	Fault Description 4	
	bit 0	EF3 [External Fault (Terminal S3)]
	bit 1	EF4 [External Fault (Terminal S4)]
	bit 2	EF5 [External Fault (Terminal S5)]
	bit 3	EF6 [External Fault (Terminal S6)]
	bit 4	EF7 [External Fault (Terminal S7)]
	bit 5 - 6	Reserved
	bit 7	oS [Overspeed]
	bit 8	dEv [Speed Deviation]
	bit 9	PGo [Encoder (PG) Feedback Loss]
	bit A	PF [Input Phase Loss]
	bit B	LF [Output Phase Loss]
	bit C	oH3 [Motor Overheat (PTC Input)]
	bit D	Reserved
	bit E	Err [EEPROM Write Error]
	bit F	oH4 [Motor Overheat Fault (PTC Input)]
00C2	Fault Description 5	
	bit 0	CE [Modbus Communication Error]
	bit 1	bUS [Option Communication Error]
	bit 2 - 3	Reserved
	bit 4	CF [Control Fault]
	bit 5	Reserved
	bit 6	EF0 [Option Card External Fault]
	bit 7	FbL [PID Feedback Loss]
	bit 8	UL3 [Undertorque Detection 1]
	bit 9	UL4 [Undertorque Detection 2]
	bit A	oL7 [High Slip Braking Overload]
	bit B - E	Reserved
	bit F	Hardware Fault (includes oFx fault)
	00C3	Fault Description 6
bit 0 - 4		Reserved
bit 5		LF2 [Output Current Imbalance]
bit 6		STPo [Motor Step-Out Detected]
bit 7		Reserved
bit 8		E5 [MECHATROLINK Watchdog Timer Err]
bit 9		Reserved
bit A		SER [Speed Search Retries Exceeded]
bit B - F	Reserved	

Register No. (Hex.)	Description	
00C4	Fault Description 7	
	bit 0	FbH [Excessive PID Feedback]
	bit 1	EF1 [External Fault (Terminal S1)]
	bit 2	EF2 [External Fault (Terminal S2)]
	bit 3	oL5 [Mechanical Weakening Detection 1]
	bit 4	UL5 [Mechanical Weakening Detection 2]
	bit 5	CoF [Current Offset Fault]
	bit 6 - 7	Reserved
	bit 8	dWFL [DriveWorksEZ Fault]
	bit 9	dWF1 [EEPROM Memory DWEZ Data Error]
	bit A	dWF2 [DriveWorksEZ Fault 2]
	bit B	dWF3 [DriveWorksEZ Fault 3]
	bit C	Reserved
	bit D	rF [Braking Resistor Fault]
	bit E	boL [Braking Transistor Overload Fault]
bit F	Reserved	
00C5	Fault Description 8	
	bit 0	LSo [Low Speed Motor Step-Out]
	bit 1	nSE [Node Setup Error]
	bit 2 - 9	Reserved
	bit A	dv7 [Polarity Judge Timeout]
bit B - F	Reserved	
00C6 - 00C7	Reserved	
00C8	Minor Fault Description 2	
	bit 0	Uv [Undervoltage]
	bit 1	ov [Overvoltage]
	bit 2	oH [Heatsink Overheat]
	bit 3	oH2 [Overheat Alarm]
	bit 4	oL3 [Overtorque 1]
	bit 5	oL4 [Overtorque 2]
	bit 6	EF [FWD/REV Run Command Input Error]
	bit 7	bb [Baseblock]
	bit 8	EF3 [External Fault (Terminal S3)]
	bit 9	EF4 [External Fault (Terminal S4)]
	bit A	EF5 [External Fault (Terminal S5)]
	bit B	EF6 [External Fault (Terminal S6)]
	bit C	EF7 [External Fault (Terminal S7)]
	bit D - E	Reserved
bit F	oS [Overspeed]	

6.3 MEMOBUS/Modbus Communications

Register No. (Hex.)	Description	
00C9	Minor Fault Description 3	
	bit 0	dEv [Speed Deviation]
	bit 1	PGo [Encoder (PG) Feedback Loss]
	bit 2	Reserved
	bit 3	CE [Modbus Communication Error]
	bit 4	bUS [Option Communication Error]
	bit 5	CALL [Serial Comm Transmission Error]
	bit 6	oL1 [Motor Overload]
	bit 7	oL2 [Drive Overload]
	bit 8	Reserved
	bit 9	EF0 [Option Card External Fault]
	bit A	rUn [Motor Switch during Run]
	bit B	Reserved
	bit C	CALL [Serial Comm Transmission Error]
	bit D	UL3 [Undertorque Detection 1]
	bit E	UL4 [Undertorque Detection 2]
	bit F	SE [Modbus Test Mode Error]
00CA	Minor Fault Description 4	
	bit 0	Reserved
	bit 1	oH3 [Motor Overheat (PTC Input)]
	bit 2 - 5	Reserved
	bit 6	FbL [PID Feedback Loss]
	bit 7	FbH [Excessive PID Feedback]
	bit 8	Reserved
	bit 9	dnE [Drive Disabled]
	bit A - F	Reserved
00CB	Minor Fault Description 5	
	bit 0	Reserved
	bit 1	AEr [Station Address Setting Error]
	bit 2	CyC [MECHATROLINK CommCycleSettingErr]
	bit 3	HCA [High Current Alarm]
	bit 4	LT-1 [Cooling Fan Maintenance Time]
	bit 5	LT-2 [Capacitor Maintenance Time]
	bit 6 - 7	Reserved
	bit 8	EF1 [External Fault (Terminal S1)]
	bit 9	EF2 [External Fault (Terminal S2)]
	bit A	SToF [Safe Torque OFF Hardware]
	bit B	Reserved
	bit C	oL5 [Mechanical Weakening Detection 1]
	bit D	UL5 [Mechanical Weakening Detection 2]
	bit E - F	Reserved

Register No. (Hex.)	Description	
00CC	Minor Fault Description 6	
	bit 0	Reserved
	bit 1	TrPC [IGBT Maintenance Time (90%)]
	bit 2	LT-3 [SoftChargeBypassRelay MainteTime]
	bit 3	LT-4 [IGBT Maintenance Time (50%)]
	bit 4	boL [Braking Transistor Overload]
	bit 5 - 7	Reserved
	bit 8	dWAL [DriveWorksEZ Alarm]
	bit 9	dWA2 [DriveWorksEZ Alarm 2]
	bit A	dWA3 [DriveWorksEZ Alarm 3]
	bit B - F	Reserved
00CD - 00CF	Reserved	
00D0	CPF Contents 1	
	bit 0 - 1	Reserved
	bit 2	CPF02 [Control Circuit Error]
	bit 3	CPF03 [Control Circuit Error]
	bit 4 - 5	Reserved
	bit 6	CPF06 [Control Circuit Error]
	bit 7	Reserved
	bit 8	CPF08 [Control Circuit Error]
	bit 9 - A	Reserved
	bit B	CPF11 [Control Circuit Error]
	bit C	CPF12 [Control Circuit Error]
	bit D	CPF13 [Control Circuit Error]
	bit E	CPF14 [Control Circuit Error]
	bit F	Reserved
00D1	CPF Contents 2	
	bit 0	CPF16 [Control Circuit Error]
	bit 1	CPF17 [Control Circuit Error]
	bit 2	CPF18 [Control Circuit Error]
	bit 3	CPF19 [Control Circuit Error]
	bit 4	CPF20 [Control Circuit Error]
	bit 5	CPF21 [Control Circuit Error]
	bit 6	CPF22 [Control Circuit Error]
	bit 7	CPF23 [Control Circuit Error]
	bit 8	CPF24 [Control Circuit Error]
	bit 9 - F	Reserved
00D2	CPF Contents 3	
	bit 0 - 5	Reserved
	bit 6	CPF38 [Control Circuit Error]
	bit 7 - F	Reserved
00D3 - 00D7	Reserved	

6.3 MEMOBUS/Modbus Communications

Register No. (Hex.)	Description	
00D8	oFA0x Description (CN5-A)	
	bit 0	oFA00 [Option Not Compatible with Port]
	bit 1	oFA01 [Option Fault/Connection Error]
	bit 2 - 4	Reserved
	bit 5	oFA05 [Option A/D Error]
	bit 6	oFA06 [Option Communication Error]
	bit 7 - F	Reserved
00D9	oFA1x Description (CN5-A)	
	bit 0	oFA10 [Option RAM Error]
	bit 1	oFA11 [Option Ope Mode Error]
	bit 2	oFA12 [Drive Receive CRC Error]
	bit 3	oFA13 [Drive Receive Frame Error]
	bit 4	oFA14 [Drive Receive Abort Error]
	bit 5	oFA15 [Option Receive CRC Error]
	bit 6	oFA16 [Option Receive Frame Error]
	bit 7	oFA17 [Option Receive Abort Error]
bit 8 - F	Reserved	
00DA	Reserved	
00DB	oFA3x Description (CN5-A)	
	bit 0	oFA30 [COM ID Error]
	bit 1	oFA31 [Type Code Error]
	bit 2	oFA32 [SUM Check Error]
	bit 3	oFA33 [Option Receive Time Over]
	bit 4	oFA34 [Memobus Time Over]
	bit 5	oFA35 [Drive Receive Time Over 1]
	bit 6	oFA36 [CI Check Error]
	bit 7	oFA37 [Drive Receive Time Over 2]
	bit 8	oFA38 [Control Reference Error]
	bit 9	oFA39 [Drive Receive Time Over 3]
	bit A	oFA40 [CtrlResSel 1Err]
	bit B	oFA41 [Drive Receive Time Over 4]
	bit C	oFA42 [CtrlResSel 2Err]
	bit D	oFA43 [Drive Receive Time Over 5]
bit E - F	Reserved	
00DC - 00E4	Reserved	

Register No. (Hex.)	Description	
00E5	Minor Fault Description 9	
	bit 0	EP24v [External Power 24V Supply]
	bit 1 - 3	Reserved
	bit 4	bAT [Keypad Battery Low Voltage]
	bit 5	Reserved
	bit 6	CP1 [Comparator 1 Limit Fault]
	bit 7	CP2 [Comparator 2 Limit Fault]
	bit 8	TiM [Keypad Time Not Set]
	bit 9	bCE [Bluetooth Communication Error]
	bit A - F	Reserved
00E6 - 00E9	Reserved	
00EA	Fault Description 11	
	bit 0	TiM [Keypad Time Not Set]
	bit 1	bAT [Keypad Battery Low Voltage]
	bit 2 - D	Reserved
	bit E	SCF [Safety Circuit Fault]
	bit F	Reserved
00EB - 00ED	Reserved	
00EE	Fault Description 12	
	bit 0 - 2	Reserved
	bit 3	CP1 [Comparator 1 Limit Fault]
	bit 4	CP2 [Comparator 2 Limit Fault]
	bit 5	bCE [Bluetooth Communication Fault]
	bit 6 - F	Reserved
00EF - 00FA	Reserved	
00FB	Output current Note: The unit of display is different for different models. B001 - B018, 2001 - 2042, and 4001 - 4023: 0.01 A 2056 - 2082, 4031 - 4060: 0.1 A	

■ Broadcast Messages

Broadcast messages are available as read-only.

The undefined bit signal in the broadcast operation signal uses the local data signal.

Table 6.17 Broadcast Messages for MEMOBUS/Modbus Communication

Register No. (Hex.)	Description	
0001	Operation signal	
	bit 0	Run command 1: Run, 0: Stop
	bit 1	Reverse run command 1: Reverse, 0: Forward run
	bit 2 - 3	Reserved
	bit 4	External fault 1: EF0 [Option Card External Fault]
	bit 5	Fault Reset 1: Reset command
	bit 6 - B	Reserved
	bit C	MFDI terminal S5 input
	bit D	MFDI terminal S6 input
	bit E	MFDI terminal S7 input
	bit F	Reserved
0002	Frequency reference	30000/100%

■ Fault Trace/Fault History Contents

Table 6.18 shows the fault codes that the commands from monitors [U2-xx, U3-xx] read.

Table 6.18 Fault Trace/Fault History Contents

Fault Code (Hex.)	Name	Fault Code (Hex.)	Name
0002	Uv1 [DC Bus Undervoltage]	001A	PGo [Encoder (PG) Feedback Loss]
0003	Uv2 [Control Power Undervoltage]	001B	PF [Input Phase Loss]
0004	Uv3 [Soft Charge Answerback Fault]	001C	LF [Output Phase Loss]
0005	SC [Short Circuit/IGBT Failure]	001D	oH3 [Motor Overheat (PTC Input)]
0006	GF [Ground Fault]	001F	Err [EEPROM Write Error]
0007	oC [Overcurrent]	0020	oH4 [Motor Overheat Fault (PTC Input)]
0008	ov [Overvoltage]	0021	CE [Modbus Communication Error]
0009	oH [Heatsink Overheat]	0022	bUS [Option Communication Error]
000A	oH1 [Heatsink Overheat]	0025	CF [Control Fault]
000B	oL1 [Motor Overload]	0027	EF0 [Option Card External Fault]
000C	oL2 [Drive Overload]	0028	FbL [PID Feedback Loss]
000D	oL3 [Overtorque Detection 1]	0029	UL3 [Undertorque Detection 1]
000E	oL4 [Overtorque Detection 2]	002A	UL4 [Undertorque Detection 2]
000F	rr [Dynamic Braking Transistor Fault]	002B	oL7 [High Slip Braking Overload]
0010	rH [Braking Resistor Overheat]	0030	Includes oFx Fault [Hardware Fault]
0011	EF3 [External Fault (Terminal S3)]	0036	LF2 [Output Current Imbalance]
0012	EF4 [External Fault (Terminal S4)]	0037	STPo [Motor Step-Out Detected]
0013	EF5 [External Fault (Terminal S5)]	003B	SEr [Speed Search Retries Exceeded]
0014	EF6 [External Fault (Terminal S6)]	0041	FbH [Excessive PID Feedback]
0015	EF7 [External Fault (Terminal S7)]	0042	EF1 [External Fault (Terminal S1)]
0018	oS [Overspeed]	0043	EF2 [External Fault (Terminal S2)]
0019	dEv [Speed Deviation]	0044	oL5 [Mechanical Weakening Detection 1]

Fault Code (Hex.)	Name	Fault Code (Hex.)	Name
0045	UL5 [Mechanical Weakening Detection 2]	0107	oFA06 [Option Communication Error]
0046	CoF [Current Offset Fault]	0111	oFA10 [Option RAM Error]
0049	dWFL [DriveWorksEZ Fault]	0112	oFA11 [Option Ope Mode Error]
004A	dWF1 [EEPROM Memory DWEZ Data Error]	0113	oFA12 [Drive Receive CRC Error]
004B	dWF2 [DriveWorksEZ Fault 2]	0114	oFA13 [Drive Receive Frame Error]
004C	dWF3 [DriveWorksEZ Fault 3]	0115	oFA14 [Drive Receive Abort Error]
004E	rF [Braking Resistor Fault]	0116	oFA15 [Option Receive CRC Error]
004F	boL [BrakingTransistor Overload Fault]	0117	oFA16 [Option Receive Frame Error]
0051	LSo [Low Speed Motor Step-Out]	0118	oFA17 [Option Receive Abort Error]
0052	nSE [Node Setup Error]	0131	oFA30 [COM ID Error]
005B	dv7 [Polarity Judge Timeout]	0132	oFA31 [Type Code Error]
0083	CPF02 [Control Circuit Error]	0133	oFA32 [SUM Check Error]
0084	CPF03 [Control Circuit Error]	0134	oFA33 [Option Receive Time Over]
0087	CPF06 [Control Circuit Error]	0135	oFA34 [Memobus Time Over]
0089	CPF08 [Control Circuit Error]	0136	oFA35 [Drive Receive Time Over 1]
008C	CPF11 [Control Circuit Error]	0137	oFA36 [CI Check Error]
008D	CPF12 [Control Circuit Error]	0138	oFA37 [Drive Receive Time Over 2]
008E	CPF13 [Control Circuit Error]	0139	oFA38 [Control Reference Error]
008F	CPF14 [Control Circuit Error]	013A	oFA39 [Drive Receive Time Over 3]
0091	CPF16 [Control Circuit Error]	013B	oFA40 [CtrlResSel 1Err]
0092	CPF17 [Control Circuit Error]	013C	oFA41 [Drive Receive Time Over 4]
0093	CPF18 [Control Circuit Error]	013D	oFA42 [CtrlResSel 2Err]
0094	CPF19 [Control Circuit Error]	013E	oFA43 [Drive Receive Time Over 5]
0095	CPF20 [Control Circuit Error]	0401	TiM [Keypad Time Not Set]
0096	CPF21 [Control Circuit Error]	0402	bAT [Keypad Battery Low Voltage]
0097	CPF22 [Control Circuit Error]	040F	SCF [Safety Circuit Fault]
0098	CPF23 [Control Circuit Error]	0414	CP1 [Comparator 1 Limit Fault]
0099	CPF24 [Control Circuit Error]	0415	CP2 [Comparator 2 Limit Fault]
00A7	CPF38 [Control Circuit Error]	0416	bCE [Bluetooth Communication Fault]
0101	oFA00 [Option Not Compatible with Port]	041A	dCE1 [Communication Error1]
0102	oFA01 [Option Fault/Connection Error]	041B	dCE2 [Communication Error2]
0106	oFA05 [Option A/D Error]	045F	oC2 [Overcurrent2]

■ Minor Fault/Alarm Contents

Table 6.19 shows the minor fault/alarm codes that communications register (007F (Hex.)) reads.

Table 6.19 Minor Fault/Alarm Contents (007 (Hex.))

Minor Fault/Alarm Code (Hex.)	Name	Minor Fault/Alarm Code (Hex.)	Name
0001	Uv [Undervoltage]	0006	oL4 [Overtorque 2]
0002	ov [Overvoltage]	0007	EF [FWD/REV Run Command Input Error]
0003	oH [Heatsink Overheat]	0008	bb [Baseblock]
0004	Overheat Alarm (oH2)	0009	EF3 [External Fault (Terminal S3)]
0005	oL3 [Overtorque 1]	000A	EF4 [External Fault (Terminal S4)]

6.3 MEMOBUS/Modbus Communications

Minor Fault/ Alarm Code (Hex.)	Name	Minor Fault/ Alarm Code (Hex.)	Name
000B	EF5 [External Fault (Terminal S5)]	0033	CyC [MECHATROLINK CommCycleSettingErr]
000C	EF6 [External Fault (Terminal S6)]	0034	HCA [High Current Alarm]
000D	EF7 [External Fault (Terminal S7)]	0035	LT-1 [Cooling Fan Maintenance Time]
0010	oS [Overspeed]	0036	LT-2 [Capacitor Maintenance Time]
0011	dEv [Speed Deviation]	0039	EF1 [External Fault (Terminal S1)]
0012	PGo [Encoder (PG) Feedback Loss]	003A	EF2 [External Fault (Terminal S2)]
0014	CE [Modbus Communication Error]	003B	SToF [Safe Torque OFF Hardware]
0015	bUS [Option Communication Error]	003D	oL5 [Mechanical Weakening Detection 1]
0016	CALL [Serial Comm Transmission Error]	003E	UL5 [Mechanical Weakening Detection 2]
0017	oL1 [Motor Overloaded]	0042	TrPC [IGBT Maintenance Time (90%)]
0018	oL2 [Drive Overloaded]	0043	LT-3 [SoftChargeBypassRelay MainteTime]
001A	EF0 [Option Card External Fault]	0044	LT-4 [IGBT Maintenance Time (50%)]
001B	rUn [Motor Switch during Run]	0045	boL [Braking Transistor Overload]
001D	CALL [Serial Comm Transmission Error]	0049	dWAL [DriveWorksEZ Alarm]
001E	UL3 [Undertorque Detection 1]	004A	dWA2 [DriveWorksEZ Alarm 2]
001F	UL4 [Undertorque Detection 2]	004B	dWA3 [DriveWorksEZ Alarm 3]
0020	SE [Modbus Test Mode Error]	0081	EP24v [External Power 24V Supply]
0021	L24v [Loss of External Power 24 Supply]	0085	bAT [Keypad Battery Low Voltage]
0022	oH3 [Motor Overheat (PTC Input)]	0087	CP1 [Comparator 1 Limit Error]
0027	FbL [PID Feedback Loss]	0088	CP2 [Comparator 2 Limit Error]
0028	FbH [Excessive PID Feedback]	0089	TiM [Keypad Time Not Set]
002A	dnE [Drive Disabled]	008A	bCE [Bluetooth Communication Error]
0032	AEr [Station Address Setting Error]		

◆ Error Codes

■ MEMOBUS/Modbus Communications Error Code List

Table 6.20 lists the MEMOBUS/Modbus communications error codes.

When an error occurs, remove the cause of the error and restart communications.

Table 6.20 MEMOBUS/Modbus Communications Error Codes

Error Code (Hex.)	Name	Cause
01	Function Code Error	The PLC set a function code that was not 03, 08, or 10 (Hex.)
02	Register Number Error	<ul style="list-style-type: none"> The register number that is trying to access is not registered. A starting number that was not 0001 or 0002 (Hex.) was set when broadcasting.
03	Bit Count Error	<ul style="list-style-type: none"> Read and write data quantities are more than the 1 to 16 range. (Command message data quantity is disabled.) The data that was read from non-consecutive holding registers contained more than 120 bytes. The data to be written to non-consecutive holding registers contained more than 60 bytes. In the write mode, the number of bytes in the message is not the number of data × 2.
21	Data Setting Error	<ul style="list-style-type: none"> Writing control data or parameters made the settings go out of the permitted setting range. A parameter setting error occurred when writing a parameter.

Error Code (Hex.)	Name	Cause
22	Write Mode Error	<ul style="list-style-type: none"> • Tried to write a disabled parameter during run. • When there was a CPF06 [Control Circuit Error], the master tried to write a parameter other than one of these: <ul style="list-style-type: none"> – A1-00 [Language Selection] – A1-01 [Access Level Selection] – A1-02 [Control Method Selection] – A1-03 [Initialize Parameters] – A1-04 [Password] – A1-05 [Password Setting] – E1-03 [V/f Pattern Selection] – o2-04 [Drive Model (KVA) Selection] • Writes the read-only data.
23	DC Bus Undervoltage Write Error	During U_v [DC Bus Undervoltage], a U_v write disabled parameter was written.
24	Error Writing Data During Parameter Processing	Tried to write a parameter from the master during parameter processing on the drive side.
25	Writing into EEPROM Disabled	Writing into EEPROM write is disabled, but EEPROM write was executed from MEMOBUS/Modbus communications. When this error occurs, the keypad shows a message and the drive continues operation.

■ No Response from Slave

The slave ignores the command message from the master and will not send a response message in these conditions:

- When a communications error (overrun, framing, parity, CRC-16) is detected in the command message.
- When the slave address in the command message and the slave address for the drive side do not agree (Use H5-01 [Drive Node Address] to set the slave address of the drive)
- When the time interval between the data of which the message is composed is longer than 24 bits
- When the data length for the command message is not accurate

Note:

- If the keypad shows CALL [Serial Comm Transmission Error], refer to “Troubleshooting” to remove the cause of the error, and try to do communications again. If the keypad does not show CALL, check U1-19 [MEMOBUS/Modbus Error Code] for the error and error type.
- If you execute the write function code when the slave address in the command message is 00 (Hex.), all of the slaves will execute the write command, but they will not send response messages to the master.

Troubleshooting

7.1	Section Safety	256
7.2	Types of Faults, Minor Faults, Alarms, and Errors	258
7.3	List of Fault, Minor Fault, Alarm, and Error Codes	259
7.4	Fault	264
7.5	Minor Faults/Alarms	286
7.6	Parameter Setting Errors.....	296
7.7	Auto-Tuning Errors	301
7.8	Backup Function Operating Mode Display and Errors.....	305
7.9	Diagnosing and Resetting Faults.....	307
7.10	Troubleshooting Without Fault Display.....	309

7.1 Section Safety

⚠ DANGER

Electrical Shock Hazard

Do not examine, connect, or disconnect wiring on an energized drive. Before servicing, disconnect all power to the equipment and wait for the time specified on the warning label at a minimum. The internal capacitor stays charged after the drive is de-energized. The charge indicator LED extinguishes when the DC bus voltage decreases below 50 Vdc. When all indicators are OFF, measure for dangerous voltages to make sure that the drive is safe.

If you do work on the drive when it is energized, it will cause serious injury or death from electrical shock.

⚠ WARNING

Electrical Shock Hazard

Do not operate the drive when covers are missing. Replace covers and shields before you operate the drive. Use the drive only as specified by the instructions.

Some figures in this section include drives without covers or safety shields to more clearly show the inside of the drive. If covers or safety shields are missing from the drive, it can cause serious injury or death.

Always ground the motor-side grounding terminal.

If you do not ground the equipment correctly, it can cause serious injury or death if you touch the motor case.

After the drive blows a fuse or trips a GFCI, do not immediately energize the drive or operate peripheral devices. Wait for the time specified on the warning label at a minimum and make sure that all indicators are OFF. Then check the wiring and peripheral device ratings to find the cause of the problem. If you do not know the cause of the problem, contact Yaskawa before you energize the drive or peripheral devices.

If you do not fix the problem before you operate the drive or peripheral devices, it can cause serious injury or death.

Only let approved personnel install, wire, maintain, examine, replace parts, and repair the drive.

If personnel are not approved, it can cause serious injury or death.

Do not wear loose clothing or jewelry when you do work on the drive. Tighten loose clothing and remove all metal objects, for example watches or rings.

Loose clothing can catch on the drive and jewelry can conduct electricity and cause serious injury or death.

Do not remove covers or touch circuit boards while the drive is energized.

If you touch the internal components of an energized drive, it can cause serious injury or death.

Do not modify the drive body or drive circuitry.

Modifications to drive body and circuitry can cause serious injury or death, will cause damage to the drive, and will void the warranty. Yaskawa is not responsible for modifications of the product made by the user.

Fire Hazard

Tighten all terminal screws to the correct tightening torque.

Connections that are too loose or too tight can cause incorrect operation and damage to the drive. Incorrect connections can also cause death or serious injury from fire.

Tighten screws at an angle in the specified range shown in this manual.

If you tighten the screws at an angle not in the specified range, you can have loose connections that can cause damage to the terminal block or start a fire and cause serious injury or death.

Damage to Equipment

Do not apply incorrect voltage to the main circuit of the drive. Operate the drive in the specified range of the input voltage on the drive nameplate.

Voltages that are higher than the permitted nameplate tolerance can cause damage to the drive.

⚠ WARNING**Fire Hazard**

Do not put flammable or combustible materials on top of the drive and do not install the drive near flammable or combustible materials. Attach the drive to metal or other noncombustible material.

Flammable and combustible materials can start a fire and cause serious injury or death.

Crush Hazard

Wear eye protection when you do work on the drive.

If you do not use correct safety equipment, it can cause serious injury or death.

Use a crane or hoist to move large drives when necessary.

If you try to move a large drive without a crane or hoist, it can cause serious injury or death.

NOTICE**Damage to Equipment**

When you touch the drive and circuit boards, make sure that you observe correct electrostatic discharge (ESD) procedures.

If you do not follow procedures, it can cause ESD damage to the drive circuitry.

Do not break the electrical connection between the drive and the motor when the drive is outputting voltage.

Incorrect equipment sequencing can cause damage to the drive.

Make sure that all connections are correct after you install the drive and connect peripheral devices.

Incorrect connections can cause damage to the drive.

Note:

Do not use unshielded wire for control wiring. Use shielded, twisted-pair wires and ground the shield to the ground terminal of the drive. Unshielded wire can cause electrical interference and unsatisfactory system performance.

7.2 Types of Faults, Minor Faults, Alarms, and Errors

If the drive or motor do not operate correctly, check the drive keypad for a code or message.

If problems occur that are not identified in this manual, contact the nearest Yaskawa representative with this information:

- Drive model
- Drive software version
- Date of purchase
- Description of the problem (for example failure conditions and modified parameters)

Table 7.1 contains descriptions of the different types of faults, minor faults, alarms, and errors that can occur during drive operation.

Contact Yaskawa if there is damage to the drive. Contact information is on the back cover of the manual.

Table 7.1 Types of Faults, Minor Faults, Alarms, and Errors

Type	Drive Response
Fault	<p>When the drive detects a fault, it will cause these conditions:</p> <ul style="list-style-type: none"> • The keypad shows the fault code, and ALM/ERR stays illuminated. • The drive shuts off output, and the motor coasts to a stop. Some faults let the user select a motor stopping method. • The terminal set to $H2-01$ to $H2-03 = E$ [MFDO Function Selection = Fault] will activate. <p>The drive will not operate until you clear the fault with a Fault Reset and the drive goes back to usual status.</p>
Minor Faults/Alarms	<p>When the drive detects a minor fault or an alarm, it will cause these conditions:</p> <ul style="list-style-type: none"> • The keypad shows the alarm code, and ALM/ERR flashes. • The drive will continue to operate the motor. Some alarms let you select a motor stopping method. • If the drive detects a minor fault, the terminal set to $H2-01$ to $H2-03 = 10$ [Alarm] will activate. If you do not set parameters $H2-01$ to $H2-03$, the drive will not trigger MFDO terminals if it detects a minor fault. • The drive will not output a minor fault signal if it detects an alarm. <p>It is not necessary to do Fault Reset.</p>
Operation Errors	<p>An error occurs when parameter settings do not agree or a parameter combination is incorrect. The drive will not operate until you set the parameters correctly.</p> <p>When the drive detects an operation error, these conditions will result:</p> <ul style="list-style-type: none"> • The keypad shows the error code. • Multi-function outputs do not output an alarm signal. <p>Find the parameters that caused the error and correct the settings.</p>
Auto-Tuning Error	<p>An error occurs during Auto-Tuning.</p> <p>When the drive detects an operation error, it will cause these conditions:</p> <ul style="list-style-type: none"> • The keypad shows the error code. • Multi-function outputs do not output an alarm signal. • The motor coasts to stop. <p>Remove the cause of the error and do Auto-Tuning again.</p>
Copy Function Error	<p>An error occurs when you use the keypad for a backup, restore, or verify operation.</p> <p>When the drive detects a copy function error, it will cause these conditions:</p> <ul style="list-style-type: none"> • The keypad shows the error code. • Multi-function outputs do not output an alarm signal. <p>Push a key on the keypad to clear the error. Remove the cause of the error and try the backup, restore, or verify operation again.</p>

7.3 List of Fault, Minor Fault, Alarm, and Error Codes

Table 7.2 shows the possible fault, minor fault, alarm, and error codes.

The display codes are in alphabetical order. Search the table for the code shown on the keypad, and identify its causes and possible solutions.

Note:

The number in parentheses adjacent to the code in the table identifies the fault code or minor fault code (hex. number) that was read during MEMOBUS/Modbus communications.

Example: AEr (0032)

Table 7.2 List of Fault, Minor Fault, Alarm, and Error Codes

Display (Hex.)	Name	ALM LED	Type	Ref.
AEr (0032)	Station Address Setting Error	Flashing	Alarm	286
bAT (0085)	Keypad Battery Low Voltage	Flashing	Alarm	286
bAT (0402)	Keypad Battery Low Voltage	Illuminated	Fault	264
bb (0008)	Baseblock	Flashing	Alarm	286
bCE (008A)	Bluetooth Communication Error	Flashing	Alarm	286
bCE (0416)	Bluetooth Communication Fault	Illuminated	Fault	264
boL (0045)	Braking Transistor Overload	Flashing	Alarm	286
boL (004F)	Braking Transistor Overload Fault	Illuminated	Fault	264
bUS (0015)	Option Communication Error	Flashing	Alarm	286
bUS (0022)	Option Communication Error	Illuminated	Fault	264
bUSy	Busy	-	Not an alarm.	287
CALL (001D)	Serial Comm Transmission Error	Flashing	Alarm	287
CE (0014)	Modbus Communication Error	Flashing	Alarm	287
CE (0021)	Modbus Communication Error	Illuminated	Fault	264
CF (0025)	Control Fault	Illuminated	Fault	265
CoF (0046)	Current Offset Fault	Illuminated	Fault	265
CP1 (0087)	Comparator 1 Limit Fault	Flashing	Alarm	287
CP1 (0414)	Comparator 1 Limit Fault	Illuminated	Fault	265
CP2 (0088)	Comparator 2 Limit Fault	Flashing	Alarm	288
CP2 (0415)	Comparator 2 Limit Fault	Illuminated	Fault	265
CPEr	Control Mode Mismatch	-	Backup Function Runtime Error	305
CPF00	Control Circuit Error	Illuminated	Fault	266
CPF01	Control Circuit Error	Illuminated	Fault	266
CPF02, CPF03 (0083, 0084)	Control Circuit Error	Illuminated	Fault	266, 266
CPF06 (0087)	Control Circuit Error (EEPROM memory Data Error)	Illuminated	Fault	266
CPF08 (0089)	Terminal Board Connection Error	Illuminated	Fault	266
CPF11 - CPF14 (008C - 008F)	Control Circuit Error	Illuminated	Fault	266 - 267
CPF16 - CPF24 (0091 - 0099)	Control Circuit Error	Illuminated	Fault	267 - 268
CPF38 (00A7)	EEPROM Memory Data Error	Illuminated	Fault	268
CPyE	Error Writing Data	-	Backup Function Runtime Error	305
CrST	Remove RUN Command to Reset	Flashing	Not an alarm.	288
CSEr	Control Mode Mismatch	-	Backup Function Runtime Error	305
CyC (0033)	MECHATROLINK CommCycleSettingErr	Flashing	Alarm	288
CyPo (0029)	Cycle Power to Accept Changes	Flashing	Alarm	288

7.3 List of Fault, Minor Fault, Alarm, and Error Codes

Display (Hex.)	Name	ALM LED	Type	Ref.
dCE1 (041A)	Communication Error1	Illuminated	Fault	268
dCE2 (041B)	Communication Error2	Illuminated	Fault	268
dEv (0011)	Speed Deviation	Flashing	Alarm	288
dEv (0019)	Speed Deviation	Illuminated	Fault	268
dFPS	Drive Model Mismatch	-	Backup Function Runtime Error	305
dnE (002A)	Drive Disabled	Flashing	Alarm	288
dv7 (005B)	Polarity Judge Timeout	Illuminated	Fault	269
dWA2 (004A)	DriveWorksEZ Alarm 2	Flashing	Alarm	288
dWA3 (004B)	DriveWorksEZ Alarm 3	Flashing	Alarm	288
dWAL (0049)	DriveWorksEZ Alarm	Flashing	Alarm	288
dWF1 (004A)	EEPROM Memory DWEZ Data Error	Illuminated	Fault	269
dWF2 (004B)	DriveWorksEZ Fault 2	Illuminated	Fault	269
dWF3 (004C)	DriveWorksEZ Fault 3	Illuminated	Fault	269
dWFL (0049)	DriveWorksEZ Fault	Illuminated	Fault	269
E5 (0031)	MECHATROLINK Watchdog Timer Err	Flashing	Alarm	289
E5 (0039)	MECHATROLINK Watchdog Timer Err	Illuminated	Fault	269
EF (0007)	FWD/REV Run Command Input Error	Flashing	Alarm	289
EF0 (001A)	Option Card External Fault	Flashing	Alarm	289
EF0 (0027)	Option Card External Fault	Illuminated	Fault	269
EF1 (0042)	External Fault (Terminal S1)	Illuminated	Fault	270
EF1 (0039)	External Fault (Terminal S1)	Flashing	Alarm	289
EF2 (003A)	External Fault (Terminal S2)	Flashing	Alarm	289
EF2 (0043)	External Fault (Terminal S2)	Illuminated	Fault	270
EF3 (0009)	External Fault (Terminal S3)	Flashing	Alarm	289
EF3 (0011)	External Fault (Terminal S3)	Illuminated	Fault	270
EF4 (000A)	External Fault (Terminal S4)	Flashing	Alarm	289
EF4 (0012)	External Fault (Terminal S4)	Illuminated	Fault	270
EF5 (000B)	External Fault (Terminal S5)	Flashing	Alarm	290
EF5 (0013)	External Fault (Terminal S5)	Illuminated	Fault	270
EF6 (000C)	External Fault (Terminal S6)	Flashing	Alarm	290
EF6 (0014)	External Fault (Terminal S6)	Illuminated	Fault	270
EF7 (000D)	External Fault (Terminal S7)	Flashing	Alarm	290
EF7 (0015)	External Fault (Terminal S7)	Illuminated	Fault	271
End1	Excessive Rated Voltage Setting	Flashing	Auto-Tuning Error	301
End2	Iron Core Saturation Coefficient	Flashing	Auto-Tuning Error	301
End3	Rated Current Setting Alarm	Flashing	Auto-Tuning Error	301
End4	Adjusted Slip Calculation Error	Flashing	Auto-Tuning Error	301
End5	Resistance Tuning Error	Flashing	Auto-Tuning Error	301
End6	Leakage Inductance Alarm	Flashing	Auto-Tuning Error	301
End7	No-Load Current Alarm	Flashing	Auto-Tuning Error	301
End8	HFI Alarm	Flashing	Auto-Tuning Error	302
End9	Initial Pole Detection Alarm	Flashing	Auto-Tuning Error	302
EP24v (0081)	External Power 24V Supply	Flashing	Alarm	290

7.3 List of Fault, Minor Fault, Alarm, and Error Codes

Display (Hex.)	Name	ALM LED	Type	Ref.
Er-01	Motor Data Error	Flashing	Auto-Tuning Error	302
Er-02	Drive in an Alarm State	Flashing	Auto-Tuning Error	302
Er-03	STOP Button was Pressed	Flashing	Auto-Tuning Error	302
Er-04	Resistance Tuning Error	Flashing	Auto-Tuning Error	303
Er-05	No-Load Current Alarm	Flashing	Auto-Tuning Error	303
Er-08	Rated Slip Error	Flashing	Auto-Tuning Error	303
Er-09	Acceleration Error	Flashing	Auto-Tuning Error	303
Er-10	Motor Direction Error	Flashing	Auto-Tuning Error	303
Er-11	Motor Speed Error	Flashing	Auto-Tuning Error	303
Er-12	Current Detection Error	Flashing	Auto-Tuning Error	304
Er-13	Leakage Inductance Alarm	Flashing	Auto-Tuning Error	304
Er-14	Motor Speed Error 2	Flashing	Auto-Tuning Error	304
Er-15	Torque Saturation Error	Flashing	Auto-Tuning Error	304
Er-16	Inertia ID Error	Flashing	Auto-Tuning Error	304
Er-17	Reverse Prohibited Error	Flashing	Auto-Tuning Error	304
Er-18	Back EMF Error	Flashing	Auto-Tuning Error	304
Er-19	PM Inductance Error	Flashing	Auto-Tuning Error	304
Er-20	Stator Resistance Error	Flashing	Auto-Tuning Error	304
Er-25	HighFreq Inject Param Tuning Err	Flashing	Auto-Tuning Error	304
Err (001F)	EEPROM Write Error	Illuminated	Fault	271
FbH (0028)	Excessive PID Feedback	Flashing	Alarm	290
FbH (0041)	Excessive PID Feedback	Illuminated	Fault	271
FbL (0027)	PID Feedback Loss	Flashing	Alarm	290
FbL (0028)	PID Feedback Loss	Illuminated	Fault	271
GF (0006)	Ground Fault	Illuminated	Fault	271
HCA (0034)	High Current Alarm	Flashing	Alarm	291
iFEr	Communication Err	-	Backup Function Runtime Error	305
L24v (0021)	Loss of External Power 24 Supply	Flashing	Alarm	291
LF (001C)	Output Phase Loss	Illuminated	Fault	272
LF2 (0036)	Output Current Imbalance	Illuminated	Fault	272
LoG	Log Com Error	Flashing	Alarm	291
LSO (0051)	Low Speed Motor Step-Out	Illuminated	Fault	272
LT-1 (0035)	Cooling Fan Maintenance Time	Flashing	Alarm	291
LT-2 (0036)	Capacitor Maintenance Time	Flashing	Alarm	291
LT-3 (0043)	SoftChargeBypassRelay MainteTime	Flashing	Alarm	291
LT-4 (0044)	IGBT Maintenance Time (50%)	Flashing	Alarm	292
ndAT	Model,VolClass,Capacity Mismatch	-	Backup Function Runtime Error	305
nSE (0052)	Node Setup Error	Illuminated	Fault	272
oC (0007)	Overcurrent	Illuminated	Fault	273
oFA00 (0101)	Option Not Compatible with Port	Illuminated	Fault	274
oFA03 - oFA06 (0104 - 0107)	Option Card Error Occurred at Option Port (CN5)	Illuminated	Fault	274 - 274
oFA10, oFA11 (0111, 0112)	Option Card Error Occurred at Option Port (CN5)	Illuminated	Fault	275, 275
oFA12 - oFA17 (0113 - 0118)	Option Card Connection Error (CN5)	Illuminated	Fault	275 - 275

7.3 List of Fault, Minor Fault, Alarm, and Error Codes

Display (Hex.)	Name	ALM LED	Type	Ref.
oFA30 - oFA43 (0131 - 013E)	Communication Option Card Connection Error (CN5)	Illuminated	Fault	276 - 277
oH (0003)	Heatsink Overheat	Flashing	Alarm	292
oH (0009)	Heatsink Overheat	Illuminated	Fault	277
oH1 (000A)	Heatsink Overheat	Illuminated	Fault	278
oH2 (0004)	External Overheat (H1-XX=B)	Flashing	Alarm	292
oH3 (001D)	Motor Overheat (PTC Input)	Illuminated	Fault	278
oH3 (0022)	Motor Overheat (PTC Input)	Flashing	Alarm	292
oH4 (0020)	Motor Overheat Fault (PTC Input)	Illuminated	Fault	278
oL1 (000B)	Motor Overload	Illuminated	Fault	278
oL2 (000C)	Drive Overload	Illuminated	Fault	279
oL3 (0005)	Overtorque 1	Flashing	Alarm	292
oL3 (000D)	Overtorque Detection 1	Illuminated	Fault	280
oL4 (0006)	Overtorque 2	Flashing	Alarm	293
oL4 (000E)	Overtorque Detection 2	Illuminated	Fault	280
oL5 (003D)	Mechanical Weakening Detection 1	Flashing	Alarm	293
oL5 (0044)	Mechanical Weakening Detection 1	Illuminated	Fault	280
oL7 (002B)	High Slip Braking Overload	Illuminated	Fault	280
oPE01	Drive Capacity Setting Fault	Flashing	Parameter Setting Error	296
oPE02	Parameter Range Setting Error	Flashing	Parameter Setting Error	296
oPE03	Multi-Function Input Setting Err	Flashing	Parameter Setting Error	296
oPE05	Run Cmd/Freq Ref Source Sel Err	Flashing	Parameter Setting Error	297
oPE07	Analog Input Selection Error	Flashing	Parameter Setting Error	298
oPE08	Parameter Selection Error	Flashing	Parameter Setting Error	298
oPE09	PID Control Selection Fault	Flashing	Parameter Setting Error	299
oPE10	V/f Data Setting Error	Flashing	Parameter Setting Error	299
oPE11	Carrier Frequency Setting Error	Flashing	Parameter Setting Error	299
oPE13	Pulse Monitor Selection Error	Flashing	Parameter Setting Error	299
oPE16	Energy Saving Constants Error	Flashing	Parameter Setting Error	299
oPE33	Digital Output Selection Error	Flashing	Parameter Setting Error	300
oPr (001E)	Keypad Connection Fault	Illuminated	Fault	280
oS (0010)	Overspeed	Flashing	Alarm	293
oS (0018)	Overspeed	Illuminated	Fault	293
ov (0002)	Overvoltage	Flashing	Alarm	293
ov (0008)	Overvoltage	Illuminated	Fault	281
ovEr	Too Many Parameters Changed	-	Not an alarm.	293
PASS	Modbus Communication Test	Flashing	Not an alarm.	293
PE1 (0047)	PLC Faults	Illuminated	Fault	282
PE2 (0048)	PLC Faults	Illuminated	Fault	282
PF (0047)	Input Phase Loss	Flashing	Alarm	293
PF (001B)	Input Phase Loss	Illuminated	Fault	282
PWEr	DWEZ Password Mismatch	-	Backup Function Runtime Error	305
rdEr	Error Reading Data	-	Backup Function Runtime Error	306
rF (004E)	Braking Resistor Fault	Illuminated	Fault	282

7.3 List of Fault, Minor Fault, Alarm, and Error Codes

Display (Hex.)	Name	ALM LED	Type	Ref.
rH (0010)	Braking Resistor Overheat	Illuminated	Fault	283
rr (000F)	Dynamic Braking Transistor Fault	Illuminated	Fault	283
rUn (001B)	Motor Switch during Run	Flashing	Alarm	294
SC (0005)	Short Circuit/ IGBT Failure	Illuminated	Fault	283
SCF (040F)	Safety Circuit Fault	Illuminated	Fault	283
SE (0020)	Modbus Test Mode Error	Flashing	Alarm	294
SEr (003B)	Speed Search Retries Exceeded	Illuminated	Fault	283
SToF (003B)	Safe Torque OFF	Flashing	Alarm	294
STPo (0037)	Motor Step-Out Detected	Illuminated	Fault	284
TiM (0089)	Keypad Time Not Set	Flashing	Alarm	294
TiM (0401)	Keypad Time Not Set	Illuminated	Fault	284
TrPC (0042)	IGBT Maintenance Time (90%)	Flashing	Alarm	294
UL3 (001E)	Undertorque Detection 1	Flashing	Alarm	295
UL3 (0029)	Undertorque Detection 1	Illuminated	Fault	284
UL4 (001F)	Undertorque Detection 2	Flashing	Alarm	295
UL4 (002A)	Undertorque Detection 2	Illuminated	Fault	284
UL5 (003E)	Mechanical Weakening Detection 2	Flashing	Alarm	295
UL5 (0045)	Mechanical Weakening Detection 2	Illuminated	Fault	284
Uv (0001)	DC Bus Undervoltage	Flashing	Alarm	295
Uv1 (0002)	DC Bus Undervoltage	Illuminated	Fault	284
Uv2 (0003)	Control Power Undervoltage	Illuminated	Fault	285
Uv3 (0004)	Soft Charge Answerback Fault	Illuminated	Fault	285
vAEr	Voltage Class, Capacity Mismatch	-	Backup Function Runtime Error	306
vFyE	Parameters do not Match	-	Backup Function Runtime Error	306

7.4 Fault

This section gives information about some of the causes and possible solutions of faults. You must use the Fault Reset operation to remove the fault before you can operate the drive. Use the information in this table to remove the cause of the fault.

Code	Name	Causes	Possible Solutions
bAT	Keypad Battery Low Voltage	The keypad battery voltage is low.	Replace the keypad battery.
Note: Use o4-24 [bAT Detection Selection] to enable/disable bAT detection.			
Code	Name	Causes	Possible Solutions
bCE	Bluetooth Communication Fault	The smartphone or tablet with DriveWizard Mobile installed is too far from the keypad.	Use the smartphone or tablet 10 m (32.8 ft) or nearer to the keypad. Note: bCE can occur when the smartphone or tablet is 10 m (32.8 ft) or nearer to the keypad depending on the specifications of the smartphone or tablet.
		Radio waves from a different device are causing interference with communications between the smartphone or tablet and keypad.	Make sure that no device around the keypad uses the same radio bandwidth (2400 MHz to 2480 MHz), and prevent radio interference.
Note: <ul style="list-style-type: none"> The drive detects this error when you use the Bluetooth LCD keypad and operate the drive with a smartphone or tablet. Do a Fault Reset to clear the fault. Set the stopping method for this fault in o2-27 [bCE Detection Selection]. 			
Code	Name	Causes	Possible Solutions
boL	BrakingTransistor Overload Fault	The duty cycle of the braking transistor is high (the regeneration power or repetition frequency is high).	<ul style="list-style-type: none"> Install a regenerative converter. Increase the deceleration time.
		You enabled the protective function for the braking transistor when you have a regenerative converter.	Set L8-55 = 0 [Internal DB TransistorProtection Selection = Disable].
		The braking transistor in the drive is broken.	Replace the drive.
Note: Do a Fault Reset to clear the fault.			
Code	Name	Causes	Possible Solutions
bUS	Option Communication Error	The drive did not receive a signal from the controller.	Correct wiring errors.
		The communications cable wiring is incorrect.	
		There is a short-circuit in the communications cable or the communications cable is not connected.	<ul style="list-style-type: none"> Repair short circuits and connect cables. Replace the defective communications cable.
		Electrical interference caused a communication data error.	<ul style="list-style-type: none"> Examine the control circuit lines, main circuit lines, and ground wiring, and decrease the effects of electrical interference. Make sure that a magnetic contactor is not the source of the electrical interference, then use a Surge Protective Device if necessary. Use only the recommended cables or other shielded line. Ground the shield on the controller side or the drive input power side. Separate the communication wiring from drive power lines, and install a noise filter to the input side of the power supply for communication. Decrease the effects of electrical interference from the controller.
		The option is incorrectly installed to the drive.	Correctly install the option to the drive.
The option is damaged.	If the fault continues and the wiring is correct, replace the option.		
Note: <ul style="list-style-type: none"> The drive detects this error if the Run command or frequency reference is assigned to the option card. Do a Fault Reset to clear the fault. If the drive detects this error, the drive will operate the motor as specified by the stopping method set in F6-01 [Communication Error Selection]. 			
Code	Name	Causes	Possible Solutions
CE	Modbus Communication Error	The communications cable wiring is incorrect.	Correct wiring errors.
		There is a short circuit in the communications cable or the communications cable is not connected.	<ul style="list-style-type: none"> Repair short circuits and connect cables. Replace the defective communications cable.

Code	Name	Causes	Possible Solutions
		Electrical interference caused a communication data error.	<ul style="list-style-type: none"> Examine the control circuit lines, main circuit lines, and ground wiring, and decrease the effects of electrical interference. Make sure that a magnetic contactor is not the source of the electrical interference, then use a Surge Protective Device if necessary. Use only the recommended cables or other shielded line. Ground the shield on the controller side or the drive input power side. Separate the communication wiring from drive power lines, and install a noise filter to the input side of the power supply for communication. Decrease the effects of electrical interference from the controller.
Note: <ul style="list-style-type: none"> The drive detects this error if it does not correctly receive control data for the <i>CE</i> detection time set to <i>H5-09 [CE Detection Time]</i>. Do a Fault Reset to clear the fault. If the drive detects this error, the drive will operate the motor as specified by the stopping method set in <i>H5-04 [Communication Error Stop Method]</i>. 			
Code	Name	Causes	Possible Solutions
CF	Control Fault	Motor parameters are set incorrectly	Correctly set the motor parameters and do Auto-Tuning again.
		The torque limit setting is too low.	Adjust <i>L7-01</i> to <i>L7-04 [Torque Limit]</i> .
		The load inertia is too large.	<ul style="list-style-type: none"> Adjust <i>C1-02</i>, <i>C1-04</i>, <i>C1-06</i>, and <i>C1-08 [Deceleration Times]</i>. Set the frequency reference to the minimum output frequency, and stop the Run command when the drive stops deceleration.
		The drive is trying to ramp to stop a machine that cannot do ramp to stop or on a machine for which deceleration is not necessary.	Correctly set <i>b1-03 [Stopping Method Selection]</i> .
		The motor and drive are connected incorrectly.	Correct wiring errors.
		Line-to-line Resistance Tuning is not done.	Do Stationary Auto-Tuning for Line-to-Line Resistance.
		The drive received a Run command while the motor was coasting.	<ul style="list-style-type: none"> Examine the sequence and input the Run command after the motor fully stops. Set <i>b3-01 = 1 [Speed Search at Start Selection = Enabled]</i>.
Note: <ul style="list-style-type: none"> The drive detects this error if the torque reference is more than the torque limit for 3 seconds or longer while the drive ramps to stop. Do a Fault Reset to clear the fault. 			
Code	Name	Causes	Possible Solutions
CoF	Current Offset Fault	The drive starts operation while the induced voltage stays in the motor (during coasting to a stop or after fast deceleration).	<ul style="list-style-type: none"> Make a sequence that does not restart operation when induced voltage stays in the motor. Set <i>b3-01 = 1 [Speed Search at Start Selection = Enabled]</i>. Use <i>Speed Search from Fmax or Fref [H1-xx = 61, 62]</i> to do a speed search through one of the external terminals. Note: When controlling the PM motor, External Speed Search commands 1 and 2 operate the same.
		A drive hardware problem occurred.	<ul style="list-style-type: none"> Do a Fault Reset to clear the fault or de-energize the drive. If the fault stays, replace the drive.
Code	Name	Causes	Possible Solutions
CP1	Comparator 1 Limit Error	The monitor value set in <i>H2-20 [Comparator 1 Monitor Selection]</i> was in the range of <i>H2-21 [Comparator 1 Lower Limit]</i> and <i>H2-22 [Comparator 1 Upper Limit]</i> .	Examine the monitor value and remove the cause of the fault.
Note: <ul style="list-style-type: none"> The drive detects this error when <i>H2-01</i> to <i>H2-03 = 66 [MFDO Function Selection = Comparator1]</i>. Do a Fault Reset to clear the fault. Set the stopping method for this fault in <i>H2-33 [Comparator1 Protection Selection]</i>. 			
Code	Name	Causes	Possible Solutions
CP2	Comparator 2 Limit Error	The monitor value set in <i>H2-26 [Comparator 2 Monitor Selection]</i> was outside the range of <i>H2-27 [Comparator 2 Lower Limit]</i> and <i>H2-28 [Comparator 2 Upper Limit]</i> .	Examine the monitor value and remove the cause of the fault.
Note: <ul style="list-style-type: none"> The drive detects this error when <i>H2-01</i> to <i>H2-03 = 67 [MFDO Function Selection = Comparator2]</i>. Do a Fault Reset to clear the fault. Set the stopping method for this fault in <i>H2-35 [Comparator2 Protection Selection]</i>. 			

7.4 Fault

Code	Name	Causes	Possible Solutions
CPF00	Control Circuit Error	A drive hardware problem occurred.	<ul style="list-style-type: none"> Re-energize the drive. If the fault stays, replace the control board or the drive. For information about replacing the control board, contact Yaskawa or your nearest sales representative.
Note: <ul style="list-style-type: none"> Do a Fault Reset to clear the fault. Fault trace is not available for these faults. 			
Code	Name	Causes	Possible Solutions
CPF01	Control Circuit Error	A drive hardware problem occurred.	<ul style="list-style-type: none"> Re-energize the drive. If the fault stays, replace the control board or the drive. For information about replacing the control board, contact Yaskawa or your nearest sales representative.
Note: <ul style="list-style-type: none"> Do a Fault Reset to clear the fault. Fault trace is not available for these faults. 			
Code	Name	Causes	Possible Solutions
CPF02	Control Circuit Error	A drive hardware problem occurred.	<ul style="list-style-type: none"> Re-energize the drive. If the fault stays, replace the control board or the drive. For information about replacing the control board, contact Yaskawa or your nearest sales representative.
Note: <ul style="list-style-type: none"> Do a Fault Reset to clear the fault. Fault trace is not available for these faults. 			
Code	Name	Causes	Possible Solutions
CPF03	Control Circuit Error	A drive hardware problem occurred.	<ul style="list-style-type: none"> Re-energize the drive. If the fault stays, replace the control board or the drive. For information about replacing the control board, contact Yaskawa or your nearest sales representative.
Note: <ul style="list-style-type: none"> Do a Fault Reset to clear the fault. Fault trace is not available for these faults. 			
Code	Name	Causes	Possible Solutions
CPF06	Control Circuit Error (EEPROM memory Data Error)	The drive power supply was de-energized while a communication option entered a parameter Write command.	Set <i>A1-03 = 2220, 3330</i> [<i>Initialize Parameters = 2-Wire Initialization, 3-Wire Initialization</i>] and initialize the drive.
		An EEPROM peripheral circuit error occurred.	<ul style="list-style-type: none"> Re-energize the drive. If the fault stays, replace the control board or the drive. For information about how to replace the control board, contact Yaskawa or your nearest sales representative.
Note: <ul style="list-style-type: none"> The drive detects this error if there is an error in the data written to the drive EEPROM. Do a Fault Reset to clear the fault. Fault trace is not available for these faults. 			
Code	Name	Causes	Possible Solutions
CPF08	Control Circuit Error	A drive hardware problem occurred.	<ul style="list-style-type: none"> Re-energize the drive. If the fault stays, replace the control board or the drive. For information about replacing the control board, contact Yaskawa or your nearest sales representative.
Note: <ul style="list-style-type: none"> Do a Fault Reset to clear the fault. Fault trace is not available for these faults. 			
Code	Name	Causes	Possible Solutions
CPF11	Control Circuit Error	A drive hardware problem occurred.	<ul style="list-style-type: none"> Re-energize the drive. If the fault stays, replace the control board or the drive. For information about replacing the control board, contact Yaskawa or your nearest sales representative.
Note: <ul style="list-style-type: none"> Do a Fault Reset to clear the fault. Fault trace is not available for these faults. 			

Code	Name	Causes	Possible Solutions
CPF12	Control Circuit Error	A drive hardware problem occurred.	<ul style="list-style-type: none"> Re-energize the drive. If the fault stays, replace the control board or the drive. For information about replacing the control board, contact Yaskawa or your nearest sales representative.
Note: <ul style="list-style-type: none"> Do a Fault Reset to clear the fault. Fault trace is not available for these faults. 			
Code	Name	Causes	Possible Solutions
CPF13	Control Circuit Error	A drive hardware problem occurred.	<ul style="list-style-type: none"> Re-energize the drive. If the fault stays, replace the control board or the drive. For information about replacing the control board, contact Yaskawa or your nearest sales representative.
Note: <ul style="list-style-type: none"> Do a Fault Reset to clear the fault. Fault trace is not available for these faults. 			
Code	Name	Causes	Possible Solutions
CPF14	Control Circuit Error	A drive hardware problem occurred.	<ul style="list-style-type: none"> Re-energize the drive. If the fault stays, replace the control board or the drive. For information about replacing the control board, contact Yaskawa or your nearest sales representative.
Note: <ul style="list-style-type: none"> Do a Fault Reset to clear the fault. Fault trace is not available for these faults. 			
Code	Name	Causes	Possible Solutions
CPF16	Control Circuit Error	A drive hardware problem occurred.	<ul style="list-style-type: none"> Re-energize the drive. If the fault stays, replace the control board or the drive. For information about replacing the control board, contact Yaskawa or your nearest sales representative.
Note: <ul style="list-style-type: none"> Do a Fault Reset to clear the fault. Fault trace is not available for these faults. 			
Code	Name	Causes	Possible Solutions
CPF17	Control Circuit Error	A drive hardware problem occurred.	<ul style="list-style-type: none"> Re-energize the drive. If the fault stays, replace the control board or the drive. For information about replacing the control board, contact Yaskawa or your nearest sales representative.
Note: <ul style="list-style-type: none"> Do a Fault Reset to clear the fault. Fault trace is not available for these faults. 			
Code	Name	Causes	Possible Solutions
CPF18	Control Circuit Error	A drive hardware problem occurred.	<ul style="list-style-type: none"> Re-energize the drive. If the fault stays, replace the control board or the drive. For information about replacing the control board, contact Yaskawa or your nearest sales representative.
Note: <ul style="list-style-type: none"> Do a Fault Reset to clear the fault. Fault trace is not available for these faults. 			
Code	Name	Causes	Possible Solutions
CPF19	Control Circuit Error	A drive hardware problem occurred.	<ul style="list-style-type: none"> Re-energize the drive. If the fault stays, replace the control board or the drive. For information about replacing the control board, contact Yaskawa or your nearest sales representative.
Note: <ul style="list-style-type: none"> Do a Fault Reset to clear the fault. Fault trace is not available for these faults. 			
Code	Name	Causes	Possible Solutions
CPF20	Control Circuit Error	A drive hardware problem occurred.	<ul style="list-style-type: none"> Re-energize the drive. If the fault stays, replace the control board or the drive. For information about replacing the control board, contact Yaskawa or your nearest sales representative.
Note: <ul style="list-style-type: none"> Do a Fault Reset to clear the fault. Fault trace is not available for these faults. 			

7.4 Fault

Code	Name	Causes	Possible Solutions
CPF21	Control Circuit Error	A drive hardware problem occurred.	<ul style="list-style-type: none"> Re-energize the drive. If the fault stays, replace the control board or the drive. For information about replacing the control board, contact Yaskawa or your nearest sales representative.
Note: <ul style="list-style-type: none"> Do a Fault Reset to clear the fault. Fault trace is not available for these faults. 			
Code	Name	Causes	Possible Solutions
CPF22	Control Circuit Error	A drive hardware problem occurred.	<ul style="list-style-type: none"> Re-energize the drive. If the fault stays, replace the control board or the drive. For information about replacing the control board, contact Yaskawa or your nearest sales representative.
Note: <ul style="list-style-type: none"> Do a Fault Reset to clear the fault. Fault trace is not available for these faults. 			
Code	Name	Causes	Possible Solutions
CPF23	Control Circuit Error	A drive hardware problem occurred.	<ul style="list-style-type: none"> Re-energize the drive. If the fault stays, replace the control board or the drive. For information about replacing the control board, contact Yaskawa or your nearest sales representative.
Note: <ul style="list-style-type: none"> Do a Fault Reset to clear the fault. Fault trace is not available for these faults. 			
Code	Name	Causes	Possible Solutions
CPF24	Control Circuit Error (Drive Unit Signal Fault)	A drive hardware problem occurred.	<ul style="list-style-type: none"> Re-energize the drive. If the fault stays, replace the control board or the drive. For information about replacing the control board, contact Yaskawa or your nearest sales representative.
Note: <ul style="list-style-type: none"> Do a Fault Reset to clear the fault. Fault trace is not available for these faults. 			
Code	Name	Causes	Possible Solutions
CPF25	Terminal Board not Connected	The terminal board is not correctly connected to the drive.	<ol style="list-style-type: none"> De-energize the drive. Correctly connect the terminal board to the drive. Re-energize the drive.
Note: Do a Fault Reset to clear the fault.			
Code	Name	Causes	Possible Solutions
CPF38	Control Circuit Error	A drive hardware problem occurred.	<ul style="list-style-type: none"> Re-energize the drive. If the fault stays, replace the control board or the drive. For information about replacing the control board, contact Yaskawa or your nearest sales representative.
Note: <ul style="list-style-type: none"> Do a Fault Reset to clear the fault. Fault trace is not available for these faults. 			
Code	Name	Causes	Possible Solutions
dCE1	Communication Error1	A drive hardware problem occurred temporarily due to noise.	<ul style="list-style-type: none"> Remove the cause of the noise. If the fault stays, replace the control board or the drive.
Note: <ul style="list-style-type: none"> Do a Fault Reset to clear the fault. Fault trace is not available for these faults. 			
Code	Name	Causes	Possible Solutions
dCE2	Communication Error2	A drive hardware problem occurred temporarily due to noise.	<ul style="list-style-type: none"> Remove the cause of the noise. If the fault stays, replace the control board or the drive.
Note: <ul style="list-style-type: none"> Do a Fault Reset to clear the fault. Fault trace is not available for these faults. 			
Code	Name	Causes	Possible Solutions
dEv	Speed Deviation	The load is too heavy.	Decrease the load.
		Acceleration and deceleration times are set too short.	Increase the values set in C1-01 to C1-08 [Acceleration/Deceleration Time].
		The dEv detection level settings are incorrect.	Adjust F1-10 [Speed Deviation Detection Level] and F1-11 [Speed Deviation Detect DelayTime].

Code	Name	Causes	Possible Solutions
		The load is locked up.	Examine the machine.
		The holding brake is stopping the motor.	Release the holding brake.
Note: <ul style="list-style-type: none"> The drive detects this error if the difference between the detected speed and the speed reference is more than the setting of <i>F1-10</i> for longer than <i>F1-11</i>. Do a Fault Reset to clear the fault. If the drive detects this error, the drive will operate the motor as specified by the stopping method set in <i>F1-04</i> [<i>Speed Deviation Detection Select</i>]. 			
Code	Name	Causes	Possible Solutions
dv7	Polarity Judge Timeout	There is a disconnection in the motor coil winding.	Measure the motor line-to-line resistance and replace the motor if a coil is disconnected.
		The screws on the drive output terminals are loose.	Tighten the terminal screws to the correct tightening torque.
Note: <ul style="list-style-type: none"> The drive detects this error if it cannot detect polarity in a pre-set length of time. Do a Fault Reset to clear the fault. 			
Code	Name	Causes	Possible Solutions
dWF1	EEPROM Memory DWEZ Data Error	There is an error in the EEPROM peripheral circuit.	<ul style="list-style-type: none"> Re-energize the drive. If the fault stays, replace the control board or the drive. For information about replacing the control board, contact Yaskawa or your nearest sales representative.
		There is a problem with the EEPROM data.	Set <i>A1-03 = 2220, 3330</i> [<i>Initialize Parameters = 2-Wire Initialization, 3-Wire Initialization</i>] to initialize the drive, then upload the DriveWorksEZ project to the drive again.
Note: <ul style="list-style-type: none"> The drive detects this error if there is an error in the DriveWorksEZ program that was saved to EEPROM. Do a Fault Reset to clear the fault. 			
Code	Name	Causes	Possible Solutions
dWF2	DriveWorksEZ Fault 2	There was a fault in the DriveWorksEZ program.	Examine the DriveWorksEZ program and remove the cause of the fault. This is not a drive fault.
Note: Do a Fault Reset to clear the fault.			
Code	Name	Causes	Possible Solutions
dWF3	DriveWorksEZ Fault 3	There was a fault in the DriveWorksEZ program.	Examine the DriveWorksEZ program and remove the cause of the fault. This is not a drive fault.
Note: Do a Fault Reset to clear the fault.			
Code	Name	Causes	Possible Solutions
dWFL	DriveWorksEZ Fault	There was a fault in the DriveWorksEZ program.	Examine the DriveWorksEZ program and remove the cause of the fault. This is not a drive fault.
Note: Do a Fault Reset to clear the fault.			
Code	Name	Causes	Possible Solutions
E5	MECHATROLINK Watchdog Timer Err	The drive detected a watchdog circuit exception while it received data from the controller.	Examine the MECHATROLINK cable connection. If this error occurs frequently, examine the wiring and decrease the effects of electrical interference as specified by these manuals: <ul style="list-style-type: none"> MECHATROLINK-II Installation Guide (MECHATROLINK Members Association, manual number MMATDEP011) MECHATROLINK-III Installation Manual (MECHATROLINK Members Association, publication number MMATDEP018)
Note: <ul style="list-style-type: none"> Do a Fault Reset to clear the fault. If the drive detects this fault, it will operate the motor as specified by the stop method set in <i>F6-25</i> [<i>MECHATROLINK Watchdog Error Sel</i>]. 			
Code	Name	Causes	Possible Solutions
EF0	Option Card External Fault	The communication option received an external fault from the controller.	<ol style="list-style-type: none"> Find the device that caused the external fault and remove the cause. Clear the external fault input from the controller.
		A programming error occurred on the controller side.	Examine the operation of the controller program.
Note: <ul style="list-style-type: none"> The drive detects this fault if the alarm function on the external device side is operating. Do a Fault Reset to clear the fault. If the drive detects this fault, it will operate the motor as specified by the stop method set in <i>F6-03</i> [<i>Comm External Fault (EF0) Select</i>]. 			

7.4 Fault

Code	Name	Causes	Possible Solutions
EF1	External Fault (Terminal S1)	MFDI terminal S1 caused an external fault through an external device.	1. Find the device that caused the external fault and remove the cause. 2. Clear the external fault input in the MFDI.
		The wiring is incorrect.	Correctly connect the signal line to MFDI terminal S1.
		<i>External Fault [HI-01 = 20 to 2B]</i> is set to MFDI terminal S1, but the terminal is not in use.	Correctly set the MFDI.
Note: Do a Fault Reset to clear the fault.			
Code	Name	Causes	Possible Solutions
EF2	External Fault (Terminal S2)	MFDI terminal S2 caused an external fault through an external device.	1. Find the device that caused the external fault and remove the cause. 2. Clear the external fault input in the MFDI.
		The wiring is incorrect.	Correctly connect the signal line to MFDI terminal S2.
		<i>External Fault [HI-02 = 20 to 2B]</i> is set to MFDI terminal S2, but the terminal is not in use.	Correctly set the MFDI.
Note: Do a Fault Reset to clear the fault.			
Code	Name	Causes	Possible Solutions
EF3	External Fault (Terminal S3)	MFDI terminal S3 caused an external fault through an external device.	1. Find the device that caused the external fault and remove the cause. 2. Clear the external fault input in the MFDI.
		The wiring is incorrect.	Correctly connect the signal line to MFDI terminal S3.
		<i>External Fault [HI-03 = 20 to 2B]</i> is set to MFDI terminal S3, but the terminal is not in use.	Correctly set the MFDI.
Note: Do a Fault Reset to clear the fault.			
Code	Name	Causes	Possible Solutions
EF4	External Fault (Terminal S4)	MFDI terminal S4 caused an external fault through an external device.	1. Find the device that caused the external fault and remove the cause. 2. Clear the external fault input in the MFDI.
		The wiring is incorrect.	Correctly connect the signal line to MFDI terminal S4.
		<i>External Fault [HI-04 = 20 to 2B]</i> is set to MFDI terminal S4, but the terminal is not in use.	Correctly set the MFDI.
Note: Do a Fault Reset to clear the fault.			
Code	Name	Causes	Possible Solutions
EF5	External Fault (Terminal S5)	MFDI terminal S5 caused an external fault through an external device.	1. Find the device that caused the external fault and remove the cause. 2. Clear the external fault input in the MFDI.
		The wiring is incorrect.	Correctly connect the signal line to MFDI terminal S5.
		<i>External Fault [HI-05 = 20 to 2B]</i> is set to MFDI terminal S5, but the terminal is not in use.	Correctly set the MFDI.
Note: Do a Fault Reset to clear the fault.			
Code	Name	Causes	Possible Solutions
EF6	External Fault (Terminal S6)	MFDI terminal S6 caused an external fault through an external device.	1. Find the device that caused the external fault and remove the cause. 2. Clear the external fault input in the MFDI.
		The wiring is incorrect.	Correctly connect the signal line to MFDI terminal S6.
		<i>External Fault [HI-06 = 20 to 2B]</i> is set to MFDI terminal S6, but the terminal is not in use.	Correctly set the MFDI.
Note: Do a Fault Reset to clear the fault.			

Code	Name	Causes	Possible Solutions
EF7	External Fault (Terminal S7)	MFDI terminal S7 caused an external fault through an external device.	<ol style="list-style-type: none"> Find the device that caused the external fault and remove the cause. Clear the external fault input in the MFDI.
		The wiring is incorrect.	Correctly connect the signal line to MFDI terminal S7.
		<i>External Fault [H1-07 = 20 to 2B]</i> is set to MFDI terminal S7, but the terminal is not in use.	Correctly set the MFDI.
Note: Do a Fault Reset to clear the fault.			
Code	Name	Causes	Possible Solutions
Err	EEPROM Write Error	There was a problem with the EEPROM hardware.	<ul style="list-style-type: none"> Re-energize the drive. If the fault stays, replace the control board or the drive. Contact Yaskawa or your nearest sales representative to replace the board.
		Electrical interference corrupted the data while it was writing to the EEPROM of the drive.	<ul style="list-style-type: none"> Push ENTER Key. Set the parameters again.
Note: Do a Fault Reset to clear the fault.			
Code	Name	Causes	Possible Solutions
FbH	Excessive PID Feedback	The <i>FbH</i> detection level is set incorrectly.	Adjust <i>b5-36 [PID High Feedback Detection Lvl]</i> and <i>b5-37 [PID High Feedback Detection Time]</i> .
		There is a problem with the PID feedback wiring.	Correct errors with the PID control wiring.
		The feedback sensor is not operating correctly.	Examine the sensors on the control device side.
		A fault occurred in the feedback input circuit of the drive.	Replace the control board or the drive. For information about replacing the control board, contact Yaskawa or your nearest sales representative.
Note: <ul style="list-style-type: none"> The drive detects this fault if the PID feedback input is more than the level set in <i>b5-36</i> for longer than <i>b5-37</i>. Do a Fault Reset to clear the fault. If the drive detects this fault, it will operate the motor as specified by the stop method set in <i>b5-12 [Feedback Loss Detection Select]</i>. 			
Code	Name	Causes	Possible Solutions
FbL	PID Feedback Loss	The <i>FbL</i> detection level is set incorrectly.	Adjust <i>b5-13 [PID Feedback Loss Detection Lvl]</i> and <i>b5-14 [PID Feedback Loss Detection Time]</i> .
		There is a problem with the PID feedback wiring.	Correct errors with the PID control wiring.
		The feedback sensor is not operating correctly.	Examine the sensors on the control device side.
		A fault occurred in the feedback input circuit of the drive.	Replace the control board or the drive. For information about replacing the control board, contact Yaskawa or your nearest sales representative.
Note: <ul style="list-style-type: none"> The drive detects this fault if the PID feedback input is more than the level set in <i>b5-13</i> for longer than <i>b5-14</i>. Do a Fault Reset to clear the fault. If the drive detects this fault, it will operate the motor as specified by the stop method set in <i>b5-12 [Feedback Loss Detection Select]</i>. 			
Code	Name	Causes	Possible Solutions
GF	Ground Fault	Overheating caused damage to the motor or the motor insulation is not satisfactory.	Measure the motor insulation resistance, and replace the motor if there is electrical conduction or unserviceable insulation.
		The motor main circuit cable is contacting ground to make a short circuit.	<ul style="list-style-type: none"> Examine the motor main circuit cable for damage, and repair short circuits. Measure the resistance between the motor main circuit cable and the ground terminal. If there is electrical conduction, replace the cable.
		An increase in the stray capacitance of the cable and the ground terminal caused an increase in the leakage current.	<ul style="list-style-type: none"> If the wiring length of the cable is more than 100 m, decrease the carrier frequency. Decrease the stray capacitance.
		There was a problem with the drive hardware.	Replace the control board or the drive. For information about replacing the control board, contact Yaskawa or your nearest sales representative.
Note: <ul style="list-style-type: none"> The drive detects this fault if a current short to ground was more than 50% of rated current on the output side of the drive. Do a Fault Reset to clear the fault. <i>L5-08 [Fault Reset Enable Select Grp2]</i> disables the Auto Restart function. 			

7.4 Fault

Code	Name	Causes	Possible Solutions
LF	Output Phase Loss	The motor main circuit cable is disconnected.	Connect motor main circuit cable wiring. Correct wiring errors in the main circuit drive input power.
		There is a disconnection in the motor coil winding.	If a coil is disconnected, measure the motor Line-to-Line Resistance and replace the motor.
		The screws on the drive output terminals are loose.	Tighten the terminal screws to the correct tightening torque.
		The rated output current of the motor is less than 5% of the drive rated current.	Examine the drive capacity or the motor output to be applied.
		You are trying to use a single-phase motor.	The drive cannot operate a single-phase motor.
		The output transistor in the drive is damaged.	<ul style="list-style-type: none"> Re-energize the drive. If the fault stays, replace the control board or the drive. For information about replacing the control board, contact Yaskawa or your nearest sales representative.
Note: <ul style="list-style-type: none"> The drive detects this fault if phase loss occurs on the output side of the drive. Do a Fault Reset to clear the fault. Set <i>L8-07 [Output Phase Loss Protection Sel]</i> to enable and disable <i>LF</i> detection. 			
Code	Name	Causes	Possible Solutions
LF2	Output Current Imbalance	Phase loss occurred in the wiring on the output side of the drive.	Examine for wiring errors or disconnected wires on the output side of the drive, and repair problems.
		The output terminal screws of the drive are loose.	Tighten the terminal screws to the correct tightening torque.
		There is not balance between the three phases of the PM motor impedance.	<ul style="list-style-type: none"> Measure the Line-to-Line Resistance for each motor phase and make sure that resistance is equal in the three phases, and that all wires are connected correctly. Replace the motor.
		The drive output circuit is broken.	<ul style="list-style-type: none"> Re-energize the drive. If the fault stays, replace the control board or the drive. For information about replacing the control board, contact Yaskawa or your nearest sales representative.
Note: <ul style="list-style-type: none"> The drive detects this fault if there is not balance between the three phases of the output current from the PM motor. Do a Fault Reset to clear the fault. 			
Code	Name	Causes	Possible Solutions
LSo	Low Speed Motor Step-Out	The motor code set incorrectly.	<ul style="list-style-type: none"> Set <i>E5-01 [PM Motor Code Selection]</i> correctly as specified by the motor. For specialized motors, refer to the motor test report and set <i>E5-xx</i> correctly.
		The load is too large.	<ul style="list-style-type: none"> Decrease the load. Replace the drive and motor with larger capacity models.
		An external force on the load side caused the motor to move at start.	Find and repair problems on the load side that cause the motor to rotate from the load side.
		The drive incorrectly detected the motor magnetic pole position.	<ul style="list-style-type: none"> Set <i>b3-01 = 1 [Speed Search at Start Selection = Enabled]</i>. If the value for <i>U6-57 [PolePolarityDeterVal]</i> is lower than 819, increase the value set in <i>n8-84 [Polarity Detection Current]</i>. Consult the motor manufacturer for information about maximum setting values.
		The setting of <i>n8-84 [Polarity Detection Current]</i> is too low.	Increase the <i>n8-84</i> setting from the default. Consult the motor manufacturer for information about maximum setting values.
		Incorrect values set in <i>L8-93 [Low Speed Pull-out DetectionTime]</i> , <i>L8-94 [Low Speed Pull-out Detect Level]</i> , and <i>L8-95 [Low Speed Pull-out Amount]</i> .	Increase the values set in <i>L8-93</i> to <i>L8-95</i> .
		The drive incorrectly detected the motor magnetic pole position.	If you are using an IPM motor, do High Frequency Injection Auto-Tuning.
Note: <ul style="list-style-type: none"> The drive detects this fault if it detects step-out while running at low speed. Do a Fault Reset to clear the fault. <i>LSo</i> is a protective function that stops the motor and stops the reverse run if a motor without a motor code incorrectly detects the initial polarity. To quickly detect motor reversal, decrease the values set in <i>L8-93</i> to <i>L8-95</i> to a range in which the drive does not malfunction. 			
Code	Name	Causes	Possible Solutions
nSE	Node Setup Error	The <i>H1-xx = 47 [Node Setup (CANopen)]</i> terminal was activated during run.	Stop the drive when the Node Setup function is in use.
		The drive received a Run command while the Node Setup function was active.	
Note: <ul style="list-style-type: none"> Do a Fault Reset to clear the fault. 			

Code	Name	Causes	Possible Solutions
oC	Overcurrent	The load is too heavy.	<ul style="list-style-type: none"> Measure the current flowing into the motor. Replace the drive with a larger capacity model if the current value is more than the drive rated current. Decrease the load or replace with a larger drive to prevent sudden changes in the current level.
		Overheating caused damage to the motor or the motor insulation is not satisfactory.	Measure the motor insulation resistance, and replace the motor if there is electrical conduction or unserviceable insulation.
		The motor main circuit cable is contacting ground to make a short circuit.	<ul style="list-style-type: none"> Examine the motor main circuit cable for damage, and repair short circuits. Measure the resistance between the motor main circuit cable and the ground terminal. If there is electrical conduction, replace the cable.
		A short circuit or ground fault on the drive output side caused damage to the output transistor of the drive.	<ul style="list-style-type: none"> Make sure that there is not a short circuit in terminal B1 and terminals U/T1, V/T2, and W/T3. Make sure that there is not a short circuit in terminals - and terminals U/T1, V/T2, and W/T3. If there is a short circuit, contact Yaskawa or your nearest sales representative.
		The acceleration time is too short.	<ul style="list-style-type: none"> Calculate the torque necessary during acceleration related to the load inertia and the specified acceleration time. Increase the values set in C1-01, C1-03, C1-05, or C1-07 [Acceleration Times] to get the necessary torque. Increase the values set in C2-01 to C2-04 [S-Curve Characteristics] to get the necessary torque. Replace the drive with a larger capacity model.
		The drive is trying to operate a specialized motor or a motor that is larger than the maximum applicable motor output of the drive.	<ul style="list-style-type: none"> Examine the motor nameplate, the motor, and the drive to make sure that the drive rated current is larger than the motor rated current. Replace the drive with a larger capacity model.
		A magnetic contactor was switched at the output.	Set the operation sequence to not turn ON or OFF the magnetic contactor while the drive is outputting voltage.
		The V/f pattern settings are incorrect.	<ul style="list-style-type: none"> Examine the ratios between the V/f pattern frequency and voltage. Decrease the voltage if it is too high compared to the frequency. Adjust E1-04 to E1-10 [V/f Pattern Parameters]. For motor 2, adjust E3-04 to E3-10.
		The torque compensation gain is too large.	Decrease the value set in C4-01 [Torque Compensation Gain] to make sure that the motor does not stall.
		Electrical interference caused a problem.	Examine the control circuit lines, main circuit lines, and ground wiring, and decrease the effects of electrical interference.
		The gain during overexcitation operation is too large.	<ul style="list-style-type: none"> Find the time when the fault occurs. If the fault occurs at the same time as overexcitation operation, decrease the value set in n3-13 [OverexcitationBraking (OEB) Gain] and consider the motor flux saturation.
		The drive received a Run command while the motor was coasting.	<ul style="list-style-type: none"> Examine the sequence and input the Run command after the motor fully stops. Set b3-01 = 1 [Speed Search at Start Selection = Enabled] or set H1-xx = 61, 62 [Speed Search from Fmax or Fref] to input speed search commands from the MFDI terminals.
		In PM Control Methods, the setting of the motor code is incorrect.	<ul style="list-style-type: none"> Enter the correct motor code to E5-01 [PM Motor Code Selection] as specified by the PM motor. For specialized motors, refer to the motor test report and set E5-xx [PM Motor Settings] correctly.
		If the drive detects the fault at start or in the low speed range (10% or less) and n8-57 = 1 [HFI Overlap Selection = Enabled] for PM Control methods, the high frequency injection gain is too high.	<ul style="list-style-type: none"> Set E5-xx [PM Motor Parameters] correctly or do Rotational Auto-Tuning. Decrease the value of n8-41 [HFI P Gain] in 0.5-unit increments. <p>Note: Set n8-41 > 0.0 for IPM motors.</p>
		The control method is set incorrectly for the motor.	Set A1-02 [Control Method Selection] correctly.
The motor main circuit cable is too long.	<ul style="list-style-type: none"> Replace the drive with a larger capacity model. Decrease C6-02 [Carrier Frequency]. Or set C6-02 = B. 		
Speed search does not complete at start when you set A1-02 = 8 [EZ Vector Control] and use an induction motor.	When E9-01 = 0 [Motor Type Selection = Induction (IM)], set b3-24 = 2 [Speed Search Method Selection = Current Detection Speed Search].		
An overcurrent occurred during overexcitation deceleration.	<ul style="list-style-type: none"> Decrease the value set in n3-13 [OverexcitationBraking (OEB) Gain]. Decrease the value set in n3-21 [HSB Current Suppression Level]. 		

7.4 Fault

Code	Name	Causes	Possible Solutions
		When you use an IE3 premium efficiency motor.	Use these values to adjust the parameters. <ul style="list-style-type: none"> • <i>b3-03 [Speed Search Deceleration Time]</i> = default value × 2 • <i>L2-03 [Minimum Baseblock Time]</i> = default value × 2 • <i>L2-04 [Powerloss V/f Recovery Ramp Time]</i> = default value × 2
Note: <ul style="list-style-type: none"> • This fault occurs if the drive sensors detect a drive output current more than the specified overcurrent detection level. • Do a Fault Reset to clear the fault. 			
Code	Name	Causes	Possible Solutions
oC2	Overcurrent2	When <i>A1-02 = 5, 6, 8 [Control Method Selection = OLV/PM, AOLV/PM, or EZOLV]</i> , the output current is more than the value set in <i>L8-27 [Overcurrent Detection Gain]</i> .	Correct the value set in <i>L8-27</i> .
Note: <ul style="list-style-type: none"> • This fault occurs if the drive sensors detect a drive output current more than the specified overcurrent detection level. • Do a Fault Reset to clear the fault. 			
Code	Name	Causes	Possible Solutions
oFA00	Option Not Compatible with Port	The option connected to connector CN5 is not compatible.	Connect a correct option.
Note: <ul style="list-style-type: none"> • Do a Fault Reset to clear the fault. • Fault trace is not available for these faults. 			
Code	Name	Causes	Possible Solutions
oFA01	Option Fault/Connection Error	You changed the option card connected to connector CN5 during operation.	<ol style="list-style-type: none"> 1. De-energize the drive. 2. Refer to the option card manual and correctly connect the option card to the connector on the drive.
Note: <ul style="list-style-type: none"> • Do a Fault Reset to clear the fault. 			
Code	Name	Causes	Possible Solutions
oFA03	Option Card Error Occurred at Option Port CN5	A fault occurred in the option card.	<ol style="list-style-type: none"> 1. De-energize the drive. 2. Make sure that the option card is correctly connected to the connector. 3. Re-energize the drive. If the problem continues, replace the option card.
Note: <ul style="list-style-type: none"> • Do a Fault Reset to clear the fault. 			
Code	Name	Causes	Possible Solutions
oFA04	Option Card Error Occurred at Option Port CN5	A fault occurred in the option card.	<ol style="list-style-type: none"> 1. De-energize the drive. 2. Make sure that the option card is correctly connected to the connector. 3. Re-energize the drive. If the problem continues, replace the option card.
Note: <ul style="list-style-type: none"> • Do a Fault Reset to clear the fault. 			
Code	Name	Causes	Possible Solutions
oFA05	Option Card Error Occurred at Option Port CN5	A fault occurred in the option card.	<ol style="list-style-type: none"> 1. De-energize the drive. 2. Make sure that the option card is correctly connected to the connector. 3. Re-energize the drive. If the problem continues, replace the option card.
Note: <ul style="list-style-type: none"> • Do a Fault Reset to clear the fault. 			
Code	Name	Causes	Possible Solutions
oFA06	Option Card Error Occurred at Option Port CN5	A fault occurred in the option card.	<ol style="list-style-type: none"> 1. De-energize the drive. 2. Make sure that the option card is correctly connected to the connector. 3. Re-energize the drive. If the problem continues, replace the option card.
Note: <ul style="list-style-type: none"> • Do a Fault Reset to clear the fault. 			

Code	Name	Causes	Possible Solutions
oFA10	Option Card Error Occurred at Option Port CN5	A fault occurred in the option card.	<ol style="list-style-type: none"> 1. De-energize the drive. 2. Make sure that the option card is correctly connected to the connector. 3. If the problem continues, replace the option card.
Note: Do a Fault Reset to clear the fault.			
Code	Name	Causes	Possible Solutions
oFA11	Option Card Error Occurred at Option Port CN5	A fault occurred in the option card.	<ol style="list-style-type: none"> 1. De-energize the drive. 2. Make sure that the option card is correctly connected to the connector. 3. If the problem continues, replace the option card.
Note: Do a Fault Reset to clear the fault.			
Code	Name	Causes	Possible Solutions
oFA12	Option Card Connection Error (CN5)	A fault occurred in the option card.	<ol style="list-style-type: none"> 1. De-energize the drive. 2. Make sure that the option card is correctly connected to the connector. 3. If the problem continues, replace the option card.
Note: Do a Fault Reset to clear the fault.			
Code	Name	Causes	Possible Solutions
oFA13	Option Card Connection Error (CN5)	A fault occurred in the option card.	<ol style="list-style-type: none"> 1. De-energize the drive. 2. Make sure that the option card is correctly connected to the connector. 3. If the problem continues, replace the option card.
Note: Do a Fault Reset to clear the fault.			
Code	Name	Causes	Possible Solutions
oFA14	Option Card Connection Error (CN5)	A fault occurred in the option card.	<ol style="list-style-type: none"> 1. De-energize the drive. 2. Make sure that the option card is correctly connected to the connector. 3. If the problem continues, replace the option card.
Note: Do a Fault Reset to clear the fault.			
Code	Name	Causes	Possible Solutions
oFA15	Option Card Connection Error (CN5)	A fault occurred in the option card.	<ol style="list-style-type: none"> 1. De-energize the drive. 2. Make sure that the option card is correctly connected to the connector. 3. If the problem continues, replace the option card.
Note: Do a Fault Reset to clear the fault.			
Code	Name	Causes	Possible Solutions
oFA16	Option Card Connection Error (CN5)	A fault occurred in the option card.	<ol style="list-style-type: none"> 1. De-energize the drive. 2. Make sure that the option card is correctly connected to the connector. 3. If the problem continues, replace the option card.
Note: Do a Fault Reset to clear the fault.			
Code	Name	Causes	Possible Solutions
oFA17	Option Card Connection Error (CN5)	A fault occurred in the option card.	<ol style="list-style-type: none"> 1. De-energize the drive. 2. Make sure that the option card is correctly connected to the connector. 3. If the problem continues, replace the option card.
Note: Do a Fault Reset to clear the fault.			

7.4 Fault

Code	Name	Causes	Possible Solutions
oFA30	Communication Option Card Connection Error (CN5)	A fault occurred in the option card.	<ol style="list-style-type: none"> 1. De-energize the drive. 2. Make sure that the option card is correctly connected to the connector. 3. If the problem continues, replace the option card.
Note: Do a Fault Reset to clear the fault.			
Code	Name	Causes	Possible Solutions
oFA31	Communication Option Card Connection Error (CN5)	A fault occurred in the option card.	<ol style="list-style-type: none"> 1. De-energize the drive. 2. Make sure that the option card is correctly connected to the connector. 3. If the problem continues, replace the option card.
Note: Do a Fault Reset to clear the fault.			
Code	Name	Causes	Possible Solutions
oFA32	Communication Option Card Connection Error (CN5)	A fault occurred in the option card.	<ol style="list-style-type: none"> 1. De-energize the drive. 2. Make sure that the option card is correctly connected to the connector. 3. If the problem continues, replace the option card.
Note: Do a Fault Reset to clear the fault.			
Code	Name	Causes	Possible Solutions
oFA33	Communication Option Card Connection Error (CN5)	A fault occurred in the option card.	<ol style="list-style-type: none"> 1. De-energize the drive. 2. Make sure that the option card is correctly connected to the connector. 3. If the problem continues, replace the option card.
Note: Do a Fault Reset to clear the fault.			
Code	Name	Causes	Possible Solutions
oFA34	Communication Option Card Connection Error (CN5)	A fault occurred in the option card.	<ol style="list-style-type: none"> 1. De-energize the drive. 2. Make sure that the option card is correctly connected to the connector. 3. If the problem continues, replace the option card.
Note: Do a Fault Reset to clear the fault.			
Code	Name	Causes	Possible Solutions
oFA35	Communication Option Card Connection Error (CN5)	A fault occurred in the option card.	<ol style="list-style-type: none"> 1. De-energize the drive. 2. Make sure that the option card is correctly connected to the connector. 3. If the problem continues, replace the option card.
Note: Do a Fault Reset to clear the fault.			
Code	Name	Causes	Possible Solutions
oFA36	Communication Option Card Connection Error (CN5)	A fault occurred in the option card.	<ol style="list-style-type: none"> 1. De-energize the drive. 2. Make sure that the option card is correctly connected to the connector. 3. If the problem continues, replace the option card.
Note: Do a Fault Reset to clear the fault.			
Code	Name	Causes	Possible Solutions
oFA37	Communication Option Card Connection Error (CN5)	A fault occurred in the option card.	<ol style="list-style-type: none"> 1. De-energize the drive. 2. Make sure that the option card is correctly connected to the connector. 3. If the problem continues, replace the option card.
Note: Do a Fault Reset to clear the fault.			

Code	Name	Causes	Possible Solutions
oFA38	Communication Option Card Connection Error (CN5)	A fault occurred in the option card.	<ol style="list-style-type: none"> 1. De-energize the drive. 2. Make sure that the option card is correctly connected to the connector. 3. If the problem continues, replace the option card.
Note: Do a Fault Reset to clear the fault.			
Code	Name	Causes	Possible Solutions
oFA39	Communication Option Card Connection Error (CN5)	A fault occurred in the option card.	<ol style="list-style-type: none"> 1. De-energize the drive. 2. Make sure that the option card is correctly connected to the connector. 3. If the problem continues, replace the option card.
Note: Do a Fault Reset to clear the fault.			
Code	Name	Causes	Possible Solutions
oFA40	Communication Option Card Connection Error (CN5)	A fault occurred in the option card.	<ol style="list-style-type: none"> 1. De-energize the drive. 2. Make sure that the option card is correctly connected to the connector. 3. If the problem continues, replace the option card.
Note: Do a Fault Reset to clear the fault.			
Code	Name	Causes	Possible Solutions
oFA41	Communication Option Card Connection Error (CN5)	A fault occurred in the option card.	<ol style="list-style-type: none"> 1. De-energize the drive. 2. Make sure that the option card is correctly connected to the connector. 3. If the problem continues, replace the option card.
Note: Do a Fault Reset to clear the fault.			
Code	Name	Causes	Possible Solutions
oFA42	Communication Option Card Connection Error (CN5)	A fault occurred in the option card.	<ol style="list-style-type: none"> 1. De-energize the drive. 2. Make sure that the option card is correctly connected to the connector. 3. If the problem continues, replace the option card.
Note: Do a Fault Reset to clear the fault.			
Code	Name	Causes	Possible Solutions
oFA43	Communication Option Card Connection Error (CN5)	A fault occurred in the option card.	<ol style="list-style-type: none"> 1. De-energize the drive. 2. Make sure that the option card is correctly connected to the connector. 3. If the problem continues, replace the option card.
Note: Do a Fault Reset to clear the fault.			
Code	Name	Causes	Possible Solutions
oH	Heatsink Overheat	The ambient temperature is high and the heatsink temperature of the drive is more than the value set in L8-02 [Overheat Alarm Level].	<ul style="list-style-type: none"> • Measure the ambient temperature. • Increase the airflow in the control panel. • Install a cooling device (cooling fan or air conditioner) to lower the ambient temperature. • Remove objects near the drive that are producing too much heat.
		The load is too heavy.	<ul style="list-style-type: none"> • Measure the output current. • Decrease the load. • Decrease the value set in C6-02 [Carrier Frequency Selection].
		The internal cooling fan of the drive stopped.	<ol style="list-style-type: none"> 1. Use the procedures in this manual to replace the cooling fan. 2. Set o4-03 = 0 [Fan Operation Time Setting = 0 h].
Note: <ul style="list-style-type: none"> • The drive detects this fault if the heatsink temperature of the drive is more than the value set in L8-02. • Do a Fault Reset to clear the fault. • If the drive detects this fault, it will operate the motor as specified by the Stopping Method set in L8-03 [Overheat Pre-Alarm Selection]. 			

7.4 Fault

Code	Name	Causes	Possible Solutions
oH1	Heatsink Overheat	The ambient temperature is high and the heatsink temperature of the drive is more than the <i>oH1</i> detection level.	<ul style="list-style-type: none"> Measure the ambient temperature. Increase the airflow in the control panel. Install a cooling device (cooling fan or air conditioner) to lower the ambient temperature. Remove objects near the drive that are producing too much heat.
		The load is too heavy.	<ul style="list-style-type: none"> Measure the output current. Decrease the load. Decrease the value set in <i>C6-02</i> [<i>Carrier Frequency Selection</i>].
<p>Note:</p> <ul style="list-style-type: none"> The drive detects this fault if the heatsink temperature of the drive is more than the <i>oH1</i> detection level. <i>o2-04</i> [<i>Drive Model (KVA) Selection</i>] determines the <i>oH1</i> detection level. Do a Fault Reset to clear the fault. <i>L5-08</i> [<i>Fault Reset Enable Select Grp2</i>] disables the Auto Restart function. 			
Code	Name	Causes	Possible Solutions
oH3	Motor Overheat (PTC Input)	The thermistor wiring that detects motor temperature is defective.	Correct wiring errors.
		A fault occurred on the machine. Example: The machine is locked.	Examine the machine and remove the cause of the fault
		The motor has overheated.	<ul style="list-style-type: none"> Check the load level, acceleration/deceleration time, and motor start/stop frequency (cycle time). Decrease the load. Increase the values set in <i>C1-01</i> to <i>C1-08</i> [<i>Acceleration/Deceleration Times</i>]. Set <i>E2-01</i> [<i>Motor Rated Current (FLA)</i>] correctly to the value specified by the motor nameplate. Make sure that the motor cooling system is operating correctly, and repair or replace it if it is damaged. Adjust <i>E1-04</i> to <i>E1-10</i> [<i>V/f Pattern Parameters</i>]. For motor 2, adjust <i>E3-04</i> to <i>E3-10</i>. Decrease the values set in <i>E1-08</i> [<i>Mid Point A Voltage</i>] and <i>E1-10</i> [<i>Minimum Output Voltage</i>]. <p>Note: If the values set in <i>E1-08</i> and <i>E1-10</i> are too low, the overload tolerance will decrease at low speeds.</p>
<p>Note:</p> <ul style="list-style-type: none"> When <i>H3-02</i> or <i>H3-10</i> = <i>E</i> [<i>MFAI Function Select = Motor Temperature (PTC Input)</i>], the drive detects this fault if the motor overheat signal input from analog input terminal A1 or A2 is more than the alarm detection level. Do a Fault Reset to clear the fault. If the drive detects this fault, it will operate the motor as specified by the Stopping Method set in <i>L1-03</i> [<i>Motor Thermistor oH Alarm Select</i>]. 			
Code	Name	Causes	Possible Solutions
oH4	Motor Overheat Fault (PTC Input)	The motor has overheated.	<ul style="list-style-type: none"> Check the load level, acceleration/deceleration time, and motor start/stop frequency (cycle time). Decrease the load. Increase the values set in <i>C1-01</i> to <i>C1-08</i> [<i>Acceleration/Deceleration Times</i>]. Set <i>E2-01</i> [<i>Motor Rated Current (FLA)</i>] correctly to the value specified by the motor nameplate. Make sure that the motor cooling system is operating correctly, and repair or replace it if it is damaged. Adjust <i>E1-04</i> to <i>E1-10</i> [<i>V/f Pattern Parameters</i>]. For motor 2, adjust <i>E3-04</i> to <i>E3-10</i>. Decrease the values set in <i>E1-08</i> [<i>Mid Point A Voltage</i>] and <i>E1-10</i> [<i>Minimum Output Voltage</i>]. <p>Note: If the values set in <i>E1-08</i> and <i>E1-10</i> are too low, the overload tolerance will decrease at low speeds.</p>
<p>Note:</p> <ul style="list-style-type: none"> The drive detects this fault if the motor overheat signal in analog input terminals A1, or A2 is more than the Fault detection level. (If <i>H3-02</i>, <i>H3-10</i> = <i>E</i> [<i>Terminal A1/A2 Function Select = Motor Temperature (PTC Input)</i>].) Do a Fault Reset to clear the fault. 			
Code	Name	Causes	Possible Solutions
oL1	Motor Overload	The load is too large.	Decrease the load. <p>Note: Reset <i>oL1</i> when <i>U4-16</i> [<i>Motor oL1 Level</i>] < 100.</p>
		The acceleration/deceleration times or cycle times are too short.	<ul style="list-style-type: none"> Examine the acceleration/deceleration times and the motor start/stop frequencies (cycle times). Increase the values set in <i>C1-01</i> to <i>C1-08</i> [<i>Acceleration/Deceleration Times</i>].

Code	Name	Causes	Possible Solutions
		Overload occurred while running at low speed.	<ul style="list-style-type: none"> Decrease the load when running at low speed. Increase the motor speed. If the motor is run frequently at low speeds, replace the motor with a larger motor or use a drive-dedicated motor. <p>Note: For general-purpose motors, overload can occur while running at low speed when operating at below the rated current.</p>
		<i>L1-01 [Motor Overload (oL1) Protection]</i> is set incorrectly.	Set <i>L1-01</i> in as specified by the motor qualities for a drive-dedicated motor.
		The V/f pattern does not fit the motor qualities.	<ul style="list-style-type: none"> Examine the ratios between the V/f pattern frequency and voltage. Decrease the voltage if it is too high compared to the frequency. Adjust <i>E1-04</i> to <i>E1-10</i> [<i>V/f Pattern Parameters</i>]. For motor 2, adjust <i>E3-04</i> to <i>E3-10</i>. Decrease the values set in <i>E1-08</i> [<i>Mid Point A Voltage</i>] and <i>E1-10</i> [<i>Minimum Output Voltage</i>]. <p>Note: If the values set in <i>E1-08</i> and <i>E1-10</i> are too low, the overload tolerance will decrease at low speeds.</p>
		<i>E1-06 [Base Frequency]</i> is set incorrectly.	Set <i>E1-06</i> to the rated frequency shown on the motor nameplate.
		One drive is operating more than one motor.	Set <i>L1-01</i> = 0 [<i>Motor Overload (oL1) Protection = Disabled</i>], connect thermal overload relay to each motor to prevent damage to the motor.
		The electronic thermal protector qualities and the motor overload properties do not match.	<ul style="list-style-type: none"> Examine the motor qualities and set <i>L1-01</i> [<i>Motor Overload (oL1) Protection</i>] correctly. Connect a thermal overload relay to the motor.
		The electronic thermal protector is operating at an incorrect level.	Set <i>E2-01</i> [<i>Motor Rated Current (FLA)</i>] correctly to the value specified by the motor nameplate.
		There is increased motor loss from overexcitation operation.	<ul style="list-style-type: none"> Lower the value set in <i>n3-13</i> [<i>OverexcitationBraking (OEB) Gain</i>]. Set <i>L3-04</i> ≠ 4 [<i>Stall Prevention during Decel ≠ Overexcitation/ High Flux</i>]. Set <i>n3-23</i> = 0 [<i>Overexcitation Braking Operation = Disabled</i>].
		The speed search-related parameters are set incorrectly.	<ul style="list-style-type: none"> Examine the settings for all speed search related parameters. Adjust <i>b3-03</i> [<i>Speed Search Deceleration Time</i>]. Set <i>b3-24</i> = 1 [<i>Speed Search Method Selection = Speed Estimation</i>] after Auto-Tuning.
		Phase loss in the input power supply is causing the output current to change.	Make sure that there is no phase loss, and repair problems.
		The motor main circuit cable is too long.	<ul style="list-style-type: none"> Replace the drive with a larger capacity model. Decrease <i>C6-02</i> [<i>Carrier Frequency</i>]. Or set <i>C6-02</i> = B.
<p>Note:</p> <ul style="list-style-type: none"> The drive detects this fault if the electronic thermal protector of the drive started the motor overload protection. Do a Fault Reset to clear the fault. <i>L5-07</i> [<i>Fault Reset Enable Select Grp1</i>] disables the Auto Restart function. 			
Code	Name	Causes	Possible Solutions
oL2	Drive Overload	The load is too large.	Decrease the load.
		The acceleration/deceleration times or cycle times are too short.	<ul style="list-style-type: none"> Examine the acceleration/deceleration times and the motor start/ stop frequencies (cycle times). Increase the values set in <i>C1-01</i> to <i>C1-08</i> [<i>Acceleration/ Deceleration Times</i>].
		The V/f pattern does not fit the motor qualities.	<ul style="list-style-type: none"> Examine the ratios between the V/f pattern frequency and voltage. Decrease the voltage if it is too high compared to the frequency. Adjust <i>E1-04</i> to <i>E1-10</i> [<i>V/f Pattern Parameters</i>]. Decrease the values set in <i>E1-08</i> [<i>Mid Point A Voltage</i>] and <i>E1-10</i> [<i>Minimum Output Voltage</i>]. For motor 2, adjust <i>E3-04</i> to <i>E3-10</i>. <p>Note: If the values set in <i>E1-08</i> and <i>E1-10</i> are too low, the overload tolerance will decrease at low speeds.</p>
		The drive capacity is too small.	Replace the drive with a larger capacity model.
		Overload occurred while running at low speed.	<ul style="list-style-type: none"> Decrease the load when running at low speed. Replace the drive with a larger capacity model. Decrease the value set in <i>C6-02</i> [<i>Carrier Frequency Selection</i>].
		The torque compensation gain is too large.	Decrease the value set in <i>C4-01</i> [<i>Torque Compensation Gain</i>] to make sure that the motor does not stall.

7.4 Fault

Code	Name	Causes	Possible Solutions
		The speed search-related parameters are set incorrectly.	<ul style="list-style-type: none"> Examine the settings for all speed search-related parameters. Adjust <i>b3-03</i> [Speed Search Deceleration Time]. Set <i>b3-24</i> = 1 [Speed Search Method Selection = Speed Estimation] after Auto-Tuning.
		Phase loss in the input power supply is causing the output current to change.	<ul style="list-style-type: none"> Correct errors with the wiring for main circuit drive input power. Make sure that there is no phase loss, and repair problems.
		Overload occurred during overexcitation deceleration.	<ul style="list-style-type: none"> Decrease the value set in <i>n3-13</i> [OverexcitationBraking (OEB) Gain]. Decrease the value set in <i>n3-21</i> [HSB Current Suppression Level].
Note: <ul style="list-style-type: none"> The drive detects this fault if the electronic thermal protector of the drive started the drive overload protection. Do a Fault Reset to clear the fault. <i>L5-07</i> [Fault Reset Enable Select Grp1] disables the Auto Restart function. 			
Code	Name	Causes	Possible Solutions
oL3	Overtorque Detection 1	A fault occurred on the machine. Example: The machine is locked.	Examine the machine and remove the cause of the fault.
		The parameters are incorrect for the load.	Adjust <i>L6-02</i> [Torque Detection Level 1] and <i>L6-03</i> [Torque Detection Time 1] settings.
Note: <ul style="list-style-type: none"> The drive detects this fault if the drive output current is more than the level set in <i>L6-02</i> for longer than <i>L6-03</i>. Do a Fault Reset to clear the fault. If the drive detects this fault, it will operate the motor as specified by the Stopping Method set in <i>L6-01</i> [Torque Detection Selection 1]. <i>L5-07</i> [Fault Reset Enable Select Grp1] disables the Auto Restart function. 			
Code	Name	Causes	Possible Solutions
oL4	Overtorque Detection 2	A fault occurred on the machine. Example: The machine is locked.	Examine the machine and remove the cause of the fault.
		The parameters are incorrect for the load.	Adjust <i>L6-05</i> [Torque Detection Level 2] and <i>L6-06</i> [Torque Detection Time 2] settings.
Note: <ul style="list-style-type: none"> The drive detects this fault if the drive output current is more than the level set in <i>L6-05</i> for longer than <i>L6-06</i>. Do a Fault Reset to clear the fault. If the drive detects this fault, it will operate the motor as specified by the Stopping Method set in <i>L6-04</i> [Torque Detection Selection 2]. <i>L5-07</i> [Fault Reset Enable Select Grp1] disables the Auto Restart function. 			
Code	Name	Causes	Possible Solutions
oL5	Mechanical Weakening Detection 1	The drive detected overtorque as specified by the conditions for mechanical weakening detection set in <i>L6-08</i> [Mechanical Fatigue Detect Select].	Do a deterioration diagnostic test on the machine side.
Note: <ul style="list-style-type: none"> Do a Fault Reset to clear the fault. If the drive detects this fault, it will operate the motor as specified by the Stopping Method set in <i>L6-08</i>. 			
Code	Name	Causes	Possible Solutions
oL7	High Slip Braking Overload	The load inertia is too large.	<ul style="list-style-type: none"> Decrease deceleration times in <i>C1-02</i>, <i>C1-04</i>, <i>C1-06</i>, and <i>C1-08</i> [Deceleration Times] for applications that do not use High Slip Braking. Use a braking resistor to decrease the deceleration time.
		An external force on the load side rotated the motor.	
		Something is preventing deceleration on the load side.	
		The value set in <i>n3-04</i> [HSB Overload Time] is too small.	<ul style="list-style-type: none"> Increase the value set in <i>n3-04</i>. Connect a thermal overload relay to the motor, and set <i>n3-04</i> = 1200 s (maximum value).
Note: <ul style="list-style-type: none"> The drive detects this fault if the output frequency is constant for longer than <i>n3-04</i>. Do a Fault Reset to clear the fault. 			
Code	Name	Causes	Possible Solutions
oPr	Keypad Connection Fault	The keypad is not securely connected to the connector on the drive.	Examine the connection between the keypad and the drive.
		The connection cable between the drive and the keypad is disconnected.	<ul style="list-style-type: none"> Remove the keypad and then reconnect it. Replace the cable if damaged.
Note: <ul style="list-style-type: none"> The drive detects this fault if these conditions are correct: <ul style="list-style-type: none"> <i>-o2-06</i> = 1 [Keypad Disconnect Detection = Enabled]. <i>-b1-02</i> = 0 [Run Command Selection 1 = Keypad], or the drive is operating in LOCAL Mode with the keypad. Do a Fault Reset to clear the fault. 			

Code	Name	Causes	Possible Solutions
oS	Overspeed	There is overshoot.	<ul style="list-style-type: none"> Decrease C5-01 [ASR Proportional Gain 1] and increase C5-02 [ASR Integral Time 1]. Use H6-02 to H6-05 [Pulse Train Input Setting Parameters] to adjust the pulse train gain.
		There is an incorrect number of PG pulses set in the drive.	Set H6-02 [Terminal RP Frequency Scaling] to the pulse train frequency during 100% reference (maximum motor rotation speed).
		The oS detection level is set incorrectly.	Adjust F1-08 [Overspeed Detection Level] and F1-09 [Overspeed Detection Delay Time].
		If the drive detects the fault at start or in the low speed range (10% or less) and n8-57 = 1 [HFI Overlap Selection = Enabled] for PM Control methods, the high frequency injection gain is too high.	<ul style="list-style-type: none"> Set E5-xx [PM Motor Parameters] correctly or do Rotational Auto-Tuning. Decrease the value of n8-41 [HFI P Gain] in 0.5 unit increments. <p>Note: Set n8-41 > 0.0 for IPM motors.</p>
<p>Note:</p> <ul style="list-style-type: none"> The drive detects this fault if the motor speed is more than the value set in F1-08 for longer than F1-09. Do a Fault Reset to clear the fault. If the drive detects this fault, it will operate the motor as specified by the Stopping Method set in F1-03 [Overspeed Detection Selection]. 			
Code	Name	Causes	Possible Solutions
ov	Overvoltage	The deceleration time is too short and too much regenerative energy is flowing back into the drive.	<ul style="list-style-type: none"> Increase the values set in C1-02, C1-04, C1-06, or C1-08 [Deceleration Times]. Connect a dynamic braking option to the drive. Perform Deceleration Rate Tuning.
		The acceleration time is too short.	<ul style="list-style-type: none"> Make sure that sudden drive acceleration does not cause the fault. Increase the values set in C1-01, C1-03, C1-05, or C1-07 [Acceleration Times]. Increase the value set in C2-02 [S-Curve Time @ End of Accel]. Set L3-11 = 1 [Overvoltage Suppression Select = Enabled].
		The braking load is too large.	Connect a dynamic braking option to the drive.
		There are surge voltages in the input power supply.	Connect a DC link choke to the drive. Note: If you turn the phase advancing capacitors ON and OFF and use thyristor converters in the same power supply system, there can be surge voltages that irregularly increase the input voltage.
		The drive output cable or motor is shorted to ground (the current short to ground is charging the main circuit capacitor of the drive through the power supply).	<ol style="list-style-type: none"> Examine the motor main circuit cable, terminals, and motor terminal box, and then remove ground faults. Re-energize the drive.
		If the drive detects ov in these conditions, the speed search-related parameters are incorrect: <ul style="list-style-type: none"> During speed search During momentary power loss recovery When the drive starts again automatically When you use an IE3 premium efficiency motor 	<ul style="list-style-type: none"> Examine the settings for all speed search related parameters. Set b3-19 ≠ 0 [Speed Search Restart Attempts ≠ 0 times]. Adjust b3-03 [Speed Search Deceleration Time]. Do Stationary Auto-Tuning for Line-to-Line Resistance and then set b3-24 = 1 [Speed Search Method Selection = Speed Estimation]. Use these values to adjust the parameters. <ul style="list-style-type: none"> b3-03 [Speed Search Deceleration Time] = default value × 2 L2-03 [Minimum Baseblock Time] = default value × 2 L2-04 [Powerloss V/f Recovery Ramp Time] = default value × 2
		The power supply voltage is too high.	Decrease the power supply voltage to match the drive rated voltage.
		The braking resistor or braking resistor unit wiring is incorrect.	Correct wiring errors in the connection to the braking resistor or braking resistor unit.
		Electrical interference caused a drive malfunction.	<ul style="list-style-type: none"> Examine the control circuit lines, main circuit lines, and ground wiring, and decrease the effects of electrical interference. Make sure that a magnetic contactor is not the source of the electrical interference, then use a Surge Protective Device if necessary.
		The load inertia is set incorrectly.	<ul style="list-style-type: none"> Examine the load inertia settings with KEB, overvoltage suppression, or stall prevention during deceleration. Adjust L3-25 [Load Inertia Ratio] to match the qualities of the machine.
The Short Circuit Braking function used in OLV/PM control method.	Connect a braking resistor to the drive.		

7.4 Fault

Code	Name	Causes	Possible Solutions
		There is motor hunting.	<ul style="list-style-type: none"> Adjust <i>n1-02</i> [<i>Hunting Prevention Gain Setting</i>]. Adjust <i>n2-02</i> [<i>Automatic Freq Regulator Time 1</i>] and <i>n2-03</i> [<i>Automatic Freq Regulator Time 2</i>]. Adjust <i>n8-45</i> [<i>Speed Feedback Detection Gain</i>] and <i>n8-47</i> [<i>Pull-in Current Comp Filter Time</i>].
		Speed search does not complete at start when you set <i>A1-02 = 8</i> [<i>EZ Vector Control</i>] and use an induction motor.	When <i>E9-01 = 0</i> [<i>Motor Type Selection = Induction (IM)</i>], set <i>b3-24 = 2</i> [<i>Speed Search Method Selection = Current Detection Speed Search</i>].
Note: <ul style="list-style-type: none"> The drive detects this error if the DC bus voltage is more than the <i>ov</i> detection level while the drive is running. Do a Fault Reset to clear the fault. For 200 V class drives, the detection level of <i>ov</i> is approximately 410 V. For 400 V class drives, the detection level is approximately 820 V. <i>L5-08</i> [<i>Fault Reset Enable Select Grp2</i>] disables the Auto Restart function. 			
Code	Name	Causes	Possible Solutions
PE1	PLC Faults	The communication option detected a fault.	Refer to the manual for the communication option card.
Note: Do a Fault Reset to clear the fault.			
Code	Name	Causes	Possible Solutions
PE2	PLC Faults	The communication option detected a fault.	Refer to the manual for the communication option card.
Note: Do a Fault Reset to clear the fault.			
Code	Name	Causes	Possible Solutions
PF	Input Phase Loss	There is a phase loss in the drive input power.	Correct errors with the wiring for main circuit drive input power.
		There is loose wiring in the drive input power terminals.	Tighten the terminal screws to the correct tightening torque.
		The drive input power voltage is changing too much.	<ul style="list-style-type: none"> Examine the input power for problems. Make the drive input power stable. If the input power supply is good, examine the magnetic contactor on the main circuit side for problems.
		There is unsatisfactory balance between voltage phases.	<ul style="list-style-type: none"> Examine the input power for problems. Make the drive input power stable. Set <i>L8-05 = 0</i> [<i>Input Phase Loss Protection Sel = Disabled</i>].
		The main circuit capacitors have become unserviceable.	<ul style="list-style-type: none"> Examine the capacitor maintenance time in monitor <i>U4-05</i> [<i>Capacitor Maintenance</i>]. If <i>U4-05</i> is more than 90%, replace the control board or the drive. For information about replacing the control board, contact Yaskawa or your nearest sales representative. If drive input power is correct and the fault stays, replace the control board or the drive. For information about replacing the control board, contact Yaskawa or your nearest sales representative.
Note: <ul style="list-style-type: none"> The drive detects this error if the DC bus voltage changes irregularly without regeneration. Do a Fault Reset to clear the fault. Use <i>L8-05</i> to enable and disable <i>PF</i> detection. 			
Code	Name	Causes	Possible Solutions
PGo	Encoder (PG) Feedback Loss	The holding brake is stopping the motor.	Release the holding brake.
Note: <ul style="list-style-type: none"> Do a Fault Reset to clear the fault. If the drive detects this error, it will operate the motor as specified by the Stopping Method set in <i>F1-02</i> [<i>PG Open Circuit Detection Select</i>]. 			
Code	Name	Causes	Possible Solutions
rF	Braking Resistor Fault	The resistance of the dynamic braking option connected to the drive is too low.	Use a dynamic braking option that fits the model and duty rating of the drive.
		A regenerative converter or regenerative unit is connected to the drive.	Set <i>L8-55 = 0</i> [<i>Internal DB Transistor Protection = Disable</i>].
Note: Do a Fault Reset to clear the fault.			

Code	Name	Causes	Possible Solutions
rH	Braking Resistor Overheat	The deceleration time is too short and excessive regenerative energy is flowing back into the drive.	<ul style="list-style-type: none"> Check the load level, deceleration time, and speed. Decrease the load. Increase the values set in <i>C1-02</i>, <i>C1-04</i>, <i>C1-06</i>, or <i>C1-08</i> [<i>Deceleration Times</i>]. Use a dynamic braking option that lets you use more power.
		The duty cycle is too high.	Examine the duty cycle. Note: When <i>L8-01</i> = 1 [<i>3% ERF DB Resistor Protection = Enabled</i>], the maximum braking duty cycle is 3%.
		The braking load is too heavy.	<ul style="list-style-type: none"> Calculate the braking load and braking power again, and decrease the braking load. Use a braking resistor that improves braking power.
		The braking resistor is not sufficient.	Use the braking resistor specifications to select a sufficient braking resistor.
Note: <ul style="list-style-type: none"> The drive detects this error if the braking resistor overheat protective function is active. The magnitude of the braking load causes the braking resistor overheat alarm, NOT the surface temperature. If the duty cycle is higher than the braking resistor rating, the drive will show the alarm. Do a Fault Reset to clear the fault. Parameter <i>L8-01</i> enables and disables <i>rH</i> detection. 			
Code	Name	Causes	Possible Solutions
rr	Dynamic Braking Transistor Fault	The drive control circuit is damaged.	<ul style="list-style-type: none"> Re-energize the drive. If the fault stays, replace the control board or the drive. For information about replacing the control board, contact Yaskawa or your nearest sales representative.
		There is a malfunction in the internal braking transistor of the drive.	
Note: Do a Fault Reset to clear the fault.			
Code	Name	Causes	Possible Solutions
SC	Short Circuit/IGBT Failure	Overheating caused damage to the motor or the motor insulation is not satisfactory.	Measure the motor insulation resistance, and replace the motor if there is electrical conduction or unserviceable insulation.
		The motor main circuit cable is contacting ground to make a short circuit.	<ul style="list-style-type: none"> Examine the motor main circuit cable for damage, and repair short circuits. Measure the resistance between the motor main circuit cable and the ground terminal. If there is electrical conduction, replace the cable.
		A short circuit or ground fault on the drive output side caused damage to the output transistor of the drive.	<ul style="list-style-type: none"> Make sure that there is not a short circuit in terminal B1 and terminals U/T1, V/T2, and W/T3. Make sure that there is not a short circuit in terminals - and terminals U/T1, V/T2, and W/T3. If there is a short circuit, contact Yaskawa or your nearest sales representative.
		When <i>A1-02</i> = 5, 6 [<i>Control Method Selection = OLV/PM or AOLV/PM</i>], the output current is more than the value set in <i>L8-27</i> [<i>Overcurrent Detection Gain</i>].	Set <i>L8-27</i> correctly.
Note: <ul style="list-style-type: none"> The drive detects this error if there is a short circuit or ground fault on the drive output side, or an IGBT failure. Do a Fault Reset to clear the fault. 			
Code	Name	Causes	Possible Solutions
SCF	Safety Circuit Fault	The safety circuit is broken.	Replace the control board or the drive. For information about replacing the control board, contact Yaskawa or your nearest sales representative.
Note: Do a Fault Reset to clear the fault.			
Code	Name	Causes	Possible Solutions
SEr	Speed Search Retries Exceeded	The speed search-related parameters are set incorrectly.	<ul style="list-style-type: none"> Decrease <i>b3-10</i> [<i>Speed Estimation Detection Gain</i>]. Increase <i>b3-17</i> [<i>Speed Est Retry Current Level</i>]. Increase <i>b3-18</i> [<i>Speed Est Retry Detection Time</i>]. Do Auto-Tuning again.
		The motor is coasting in the opposite direction of the Run command.	Set <i>b3-14</i> = 1 [<i>Bi-directional Speed Search = Enabled</i>].
Note: <ul style="list-style-type: none"> The drive detects this error if the number of speed search restarts is more than <i>b3-19</i> [<i>Speed Search Restart Attempts</i>]. Do a Fault Reset to clear the fault. 			

7.4 Fault

Code	Name	Causes	Possible Solutions
STPo	Motor Step-Out Detected	The motor code is set incorrectly for PM Control Methods.	<ul style="list-style-type: none"> Set <i>E5-01 [PM Motor Code Selection]</i> correctly as specified by the motor. For specialized motors, refer to the motor test report and set <i>E5-xx</i> correctly.
		The load is too large.	<ul style="list-style-type: none"> Increase the value set in <i>n8-55 [Motor to Load Inertia Ratio]</i>. Increase the value set in <i>n8-51 [Pull-in Current @ Acceleration]</i>. If the drive detects <i>STPo</i> during deceleration when increasing the value set in <i>n8-51</i>, set the value of <i>n8-79 [Pull-in Current @ Deceleration]</i> lower than <i>n8-51</i>. Decrease the load. Replace the drive and motor with larger capacity models.
		The load inertia is too large.	Increase the value set in <i>n8-55</i> .
		The acceleration/deceleration times are too short.	<ul style="list-style-type: none"> Increase the values set in <i>C1-01 to C1-08 [Acceleration/Deceleration Times]</i>. Increase the value set in <i>C2-01 [S-Curve Time @ Start of Accel]</i>.
		Speed response is too slow.	Increase the value set in <i>n8-55</i> .
Note: Do a Fault Reset to clear the fault.			
Code	Name	Causes	Possible Solutions
TiM	Keypad Time Not Set	There is a battery in the keypad, but the date and time are not set.	Use the keypad to set the date and time.
Note: <ul style="list-style-type: none"> Do a Fault Reset to clear the fault. Parameter <i>o4-24 [bAT Detection Selection]</i> enables and disables <i>TiM</i> detection. 			
Code	Name	Causes	Possible Solutions
UL3	Undertorque Detection 1	A fault occurred on the machine. Example: There is a broken pulley belt.	Examine the machine and remove the cause of the fault.
		The parameters are incorrect for the load.	Adjust <i>L6-02 [Torque Detection Level 1]</i> and <i>L6-03 [Torque Detection Time 1]</i> settings.
Note: <ul style="list-style-type: none"> The drive detects this error if the drive output current is less than the level set in <i>L6-02</i> for longer than <i>L6-03</i>. Do a Fault Reset to clear the fault. If the drive detects this error, it will operate the motor as specified by the Stopping Method set in <i>L6-01 [Torque Detection Selection 1]</i>. 			
Code	Name	Causes	Possible Solutions
UL4	Undertorque Detection 2	A fault occurred on the machine. Example: There is a broken pulley belt.	Examine the machine and remove the cause of the fault.
		The parameters are incorrect for the load.	Adjust <i>L6-05 [Torque Detection Level 2]</i> and <i>L6-06 [Torque Detection Time 2]</i> settings.
Note: <ul style="list-style-type: none"> The drive detects this error if the drive output current is less than the level set in <i>L6-05</i> for longer than <i>L6-06</i>. Do a Fault Reset to clear the fault. If the drive detects this error, it will operate the motor as specified by the Stopping Method set in <i>L6-04 [Torque Detection Selection 2]</i>. 			
Code	Name	Causes	Possible Solutions
UL5	Mechanical Weakening Detection 2	The drive detected undertorque as specified by the conditions for mechanical weakening detection set in <i>L6-08 [Mechanical Fatigue Detect Select]</i> .	Examine the machine for deterioration.
Note: <ul style="list-style-type: none"> Do a Fault Reset to clear the fault. If the drive detects this error, it will operate the motor as specified by the Stopping Method set in <i>L6-08</i>. 			
Code	Name	Causes	Possible Solutions
Uv1	DC Bus Undervoltage	There is a phase loss in the drive input power.	Correct errors with the wiring for main circuit drive input power.
		There is loose wiring in the drive input power terminals.	Tighten the terminal screws to the correct tightening torque.
		The drive input power voltage is changing too much.	<ul style="list-style-type: none"> Examine the input power for problems. Make the drive input power stable. If the input power supply is good, examine the magnetic contactor on the main circuit side for problems.
		There was a loss of power.	Use a better power supply.
		The main circuit capacitors have become unserviceable.	Examine the capacitor maintenance time in monitor <i>U4-05 [Capacitor Maintenance]</i> . If <i>U4-05</i> is more than 90%, replace the control board or the drive. For information about replacing the control board, contact Yaskawa or your nearest sales representative.

Code	Name	Causes	Possible Solutions
		The relay or contactor on the soft-charge bypass relay is damaged.	<i>U4-06 [PreChargeRelayMainte]</i> shows the performance life of the soft-charge bypass relay. If <i>U4-06</i> is more than 90%, replace the board or the drive. For information about replacing the board, contact Yaskawa or your nearest sales representative.
Note: <ul style="list-style-type: none"> The drive detects this error if the DC bus voltage decreases below the level set in <i>L2-05 [Undervoltage Detection Lvl (Uv1)]</i> while the drive is running. The <i>Uv1</i> detection level is approximately 190 V for a 200 V class drives. The detection level is approximately 380 V for 400 V class drives. The detection level is approximately 350 V when <i>E1-01 [Input AC Supply Voltage] < 400</i>. Do a Fault Reset to clear the fault. Fault trace is not available for this fault. <i>L5-08 [Fault Reset Enable Select Grp2]</i> disables the Auto Restart function. 			
Code	Name	Causes	Possible Solutions
Uv2	Control Power Undervoltage	The value set in <i>L2-02 [Power Loss Ride Through Time]</i> increased and the momentary power loss recovery unit is not connected to the drive.	Connect the momentary power loss recovery unit to the drive.
		There was a problem with the drive hardware.	<ul style="list-style-type: none"> Re-energize the drive. If the fault stays, replace the control board or the drive. For information about replacing the control board, contact Yaskawa or your nearest sales representative.
Note: <ul style="list-style-type: none"> The drive detects this error if the control power supply voltage decreases. Do a Fault Reset to clear the fault. Fault trace is not available for this fault. 			
Code	Name	Causes	Possible Solutions
Uv3	Soft Charge Answerback Fault	There is damage to the relay or contactor on the soft-charge bypass relay.	<ul style="list-style-type: none"> Re-energize the drive. If the fault stays, replace the control board or the drive. Monitor <i>U4-06 [PreChargeRelayMainte]</i> shows the performance life of the soft-charge bypass relay. If <i>U4-06</i> is more than 90%, replace the board or the drive. For information about replacing the control board, contact Yaskawa or your nearest sales representative.
		Air inside the drive is too hot.	Decrease the ambient temperature of the drive.
Note: <ul style="list-style-type: none"> Do a Fault Reset to clear the fault. Fault trace is not available for these faults. 			

7.5 Minor Faults/Alarms

This section gives information about the causes and possible solutions when a minor fault or alarm occurs. Use the information in this table to remove the cause of the minor fault or alarm.

Code	Name	Causes	Possible Solutions
AEr	Station Address Setting Error	The node address for the communication option is not in the permitted setting range.	<ul style="list-style-type: none"> For CC-Link communication, set F6-10 [CC-Link Node Address] correctly. For MECHATROLINK communication, set F6-20 [MECHATROLINK Station Address] correctly. For CANopen communication, set F6-35 [CANopen Node ID Selection] correctly.
Note: If the drive detects this error, the terminal set to H2-01 to H2-03 = 10 [MFDO Function Selection = Alarm] will activate.			
Code	Name	Causes	Possible Solutions
bAT	Keypad Battery Low Voltage	The keypad battery voltage is low.	Replace the keypad battery.
Note: • If the drive detects this error, the terminal set to H2-01 to H2-03 = 10 [MFDO Function Selection = Alarm] will activate. • Parameter o4-24 [bAT Detection Selection] enables and disables bAT detection.			
Code	Name	Causes	Possible Solutions
bb	Baseblock	An external baseblock command was entered through MFDI terminal S1 to S7, and the drive output stopped as shown by an external baseblock command.	Examine the external sequence and timing of the baseblock command input.
Note: The drive will not output a minor fault signal for this alarm.			
Code	Name	Causes	Possible Solutions
bCE	Bluetooth Communication Error	The smartphone or tablet with DriveWizard Mobile installed is too far from the keypad.	Use the smartphone or tablet 10 m (32.8 ft) or nearer to the keypad. Note: bCE can occur when the smartphone or tablet is 10 m or nearer to the keypad depending on the specifications of the smartphone or tablet.
		Radio waves from a different device are causing interference with the communication between the smartphone or tablet and keypad.	Make sure that no device around the keypad uses the same radio bandwidth (2400 MHz to 2480 MHz), and prevent radio interference.
Note: • The drive detects this error when you operate the drive with a smartphone or tablet with a Bluetooth LCD Keypad. • If the drive detects this error, the terminal assigned to H2-01 to H2-03 = 10 [MFDO Function Select = Alarm] will activate. • Parameter o2-27 [bCE Detection selection] enables and disables bCE detection.			
Code	Name	Causes	Possible Solutions
boL	Braking Transistor Overload	The duty cycle of the braking transistor is high (the regeneration power or repetition frequency is high).	<ul style="list-style-type: none"> Install a regenerative converter. Increase the deceleration time.
		You enabled the protective function for the braking transistor when you have a regenerative converter.	Set L8-55 = 0 [Internal DB Transistor Protection Selection = Disable].
		The braking transistor in the drive is broken.	Replace the drive.
Note: If the drive detects this error, the terminal set to H2-01 to H2-03 = 10 [MFDO Function Selection = Alarm] will activate.			
Code	Name	Causes	Possible Solutions
bUS	Option Communication Error	The communications cable wiring is incorrect.	Correct wiring errors.
		There is a short-circuit in the communications cable or the communications cable is not connected.	<ul style="list-style-type: none"> Repair short circuits and connect cables. Replace the defective communications cable.
		Electrical interference caused a communication data error.	<ul style="list-style-type: none"> Examine the control circuit lines, main circuit lines, and ground wiring, and decrease the effects of electrical interference. Make sure that a magnetic contactor is not the source of the electrical interference, then use a Surge Protective Device if necessary. Use only the recommended cables or other shielded line. Ground the shield on the controller side or the drive input power side. Separate the communication wiring from drive power lines, and install a noise filter to the input side of the power supply for communication. Decrease the effects of electrical interference from the controller.
		The option card is incorrectly installed to the drive.	Correctly install the option card to the drive.

Code	Name	Causes	Possible Solutions
		The option card is damaged.	If the alarm continues and the wiring is correct, replace the option card.
Note: <ul style="list-style-type: none"> The drive detects this error if the Run command or frequency reference is assigned to the option card. If the drive detects this error, the terminal set to H2-01 to H2-03 = 10 [MFDO Function Selection = Alarm] will activate. If the drive detects this error, it will operate the motor as specified by the stopping method set in F6-01 [Communication Error Selection]. 			
Code	Name	Causes	Possible Solutions
bUSy	Busy	You set the drive to use MEMOBUS/Modbus communications to change parameters, but you used the keypad to change parameters.	Use MEMOBUS/Modbus communications to enter the enter command, then use the keypad to change the parameter.
		You tried to change a parameter while the drive was changing setting.	Wait until the process is complete.
Code	Name	Causes	Possible Solutions
CALL	Serial Comm Transmission Error	The communications cable wiring is incorrect.	Correct wiring errors.
		There is a short-circuit in the communications cable or the communications cable is not connected.	<ul style="list-style-type: none"> Repair the short-circuited or disconnected portion of the cable. Replace the defective communications cable.
		A programming error occurred on the controller side.	Examine communications at start-up and correct programming errors.
		The communications circuitry is damaged.	<ul style="list-style-type: none"> Do a self-diagnostics check. If the problem continues, replace the control board or the drive. For information about replacing the control board, contact Yaskawa or your nearest sales representative.
		The termination resistor setting for MEMOBUS/Modbus communications is incorrect.	On the last drive in a MEMOBUS/Modbus network, set DIP switch S2 to the ON position to enable the termination resistor.
Note: <ul style="list-style-type: none"> The drive detects this error if it does not correctly receive control data from the controller when energizing the drive. If the drive detects this error, the terminal set to H2-01 to H2-03 = 10 [MFDO Function Selection = Alarm] will activate. 			
Code	Name	Causes	Possible Solutions
CE	Modbus Communication Error	The communications cable wiring is incorrect.	Correct wiring errors.
		There is a short-circuit in the communications cable or the communications cable is not connected.	<ul style="list-style-type: none"> Repair short circuits and connect cables. Replace the defective communications cable.
		Electrical interference caused a communication data error.	<ul style="list-style-type: none"> Examine the control circuit lines, main circuit lines, and ground wiring, and decrease the effects of electrical interference. Make sure that a magnetic contactor is not the source of the electrical interference, then use a Surge Protective Device if necessary. Use only the recommended cables or other shielded line. Ground the shield on the controller side or the drive input power side. Separate the communication wiring from drive power lines, and install a noise filter to the input side of the power supply for communication. Decrease the effects of electrical interference from the controller.
		The communication protocol is not compatible.	<ul style="list-style-type: none"> Examine the values set in H5-xx. Examine the settings on the controller side and correct the difference in communication conditions.
		The value set in H5-09 [CE Detection Time] is too small for the communications cycle.	<ul style="list-style-type: none"> Change the controller software settings. Increase the value set in H5-09.
		The controller software or hardware is causing a communication problem.	Examine the controller and remove the cause of the problem.
Note: <ul style="list-style-type: none"> The drive detects this error if it does not correctly receive control data for the CE detection time set to H5-09. If the drive detects this error, the terminal set to H2-01 to H2-03 = 10 [MFDO Function Selection = Alarm] will activate. If the drive detects this error, it will operate the motor as specified by the stopping method set in H5-04 [Communication Error Stop Method]. 			
Code	Name	Causes	Possible Solutions
CP1	Comparator 1 Limit Error	The monitor value set in H2-20 [Comparator 1 Monitor Selection] was in the range of H2-21 [Comparator 1 Lower Limit] and H2-22 [Comparator 1 Upper Limit].	Examine the monitor value and remove the cause of the fault.
Note: <ul style="list-style-type: none"> The drive detects this error when the terminal is assigned to H2-01 to H2-03 = 66 [MFDO Function Select = Comparator1]. If the drive detects this error, the terminal set to H2-01 to H2-03 = 10 [MFDO Function Selection = Alarm] will activate. Parameter H2-33 [Comparator1 Protection Selection] enables and disables CP1 detection. 			

7.5 Minor Faults/Alarms

Code	Name	Causes	Possible Solutions
CP2	Comparator 2 Limit Error	The monitor value set in H2-26 [Comparator 2 Monitor Selection] was outside the range of H2-27 [Comparator 2 Lower Limit] and H2-28 [Comparator 2 Upper Limit].	Examine the monitor value and remove the cause of the fault.
Note: <ul style="list-style-type: none"> The drive detects this error when the terminal is assigned to H2-01 to H2-03 = 67 [MFDO Function Select = Comparator2]. If the drive detects this error, the terminal set to H2-01 to H2-03 = 10 [MFDO Function Selection = Alarm] will activate. Parameter H2-35 [Comparator2 Protection Selection] enables and disables CP2 detection. 			
Code	Name	Causes	Possible Solutions
CrST	Cannot Reset	The drive received a fault reset command when a Run command was active.	Turn off the Run command then de-energize and re-energize the drive.
Code	Name	Causes	Possible Solutions
CyC	MECHATROLINK CommCycleSettingErr	The communications cycle setting of the controller is not in the permitted range of the MECHATROLINK interface option.	Set the communications cycle of the controller in the permitted range of the MECHATROLINK interface option.
Note: If the drive detects this error, the terminal set to H2-01 to H2-03 = 10 [MFDO Function Selection = Alarm] will activate.			
Code	Name	Causes	Possible Solutions
CyPo	Cycle Power to Accept Changes	Although F6-15 = 1 [Comm. Option Parameters Reload = Reload Now], the drive does not update the communication option parameters.	Re-energize the drive to update the communication option parameters.
Code	Name	Causes	Possible Solutions
dEv	Speed Deviation	The load is too large.	Decrease the load.
		The acceleration/deceleration times are too short.	Increase the values set in C1-01 to C1-08 [Acceleration/Deceleration Times].
		The dEv detection level settings are incorrect.	Adjust F1-10 [Speed Deviation Detection Level] and F1-11 [Speed Deviation Detect DelayTime].
		The load is locked up.	Examine the machine.
		The holding brake is stopping the motor.	Release the holding brake.
Note: <ul style="list-style-type: none"> The drive detects this error if the difference between the detected speed and the speed reference is more than the setting of F1-10 for longer than F1-11. If the drive detects this error, the terminal set to H2-01 to H2-03 = 10 [MFDO Function Selection = Alarm] will activate. If the drive detects this error, it will operate the motor as specified by the stopping method set in F1-04 [Speed Deviation Detection Select]. 			
Code	Name	Causes	Possible Solutions
dnE	Drive Disabled	A terminal set for H1-xx = 6A [Drive Enable] turned OFF.	Examine the operation sequence.
Note: If the drive detects this error, the terminal set to H2-01 to H2-03 = 10 [MFDO Function Selection = Alarm] will activate.			
Code	Name	Causes	Possible Solutions
dWA2	DriveWorksEZ Alarm 2	There was an error in the DriveWorksEZ program.	Examine the DriveWorksEZ program and remove the cause of the fault. This is not a drive fault.
Note: If the drive detects this error, the terminal set to H2-01 to H2-03 = 10 [MFDO Function Selection = Alarm] will activate.			
Code	Name	Causes	Possible Solutions
dWA3	DriveWorksEZ Alarm 3	There was an error in the DriveWorksEZ program.	Examine the DriveWorksEZ program and remove the cause of the fault. This is not a drive fault.
Note: If the drive detects this error, the terminal set to H2-01 to H2-03 = 10 [MFDO Function Selection = Alarm] will activate.			
Code	Name	Causes	Possible Solutions
dWAL	DriveWorksEZ Alarm	There was an error in the DriveWorksEZ program.	Examine the DriveWorksEZ program and remove the cause of the fault. This is not a drive fault.
Note: If the drive detects this error, the terminal set to H2-01 to H2-03 = 10 [MFDO Function Selection = Alarm] will activate.			

Code	Name	Causes	Possible Solutions
E5	MECHATROLINK Watchdog Timer Err	The drive detected a watchdog circuit exception while it received data from the controller.	Examine the MECHATROLINK cable connection. If this error occurs frequently, examine the wiring and decrease the effects of electrical interference as specified by these manuals: <ul style="list-style-type: none"> MECHATROLINK-II Installation Guide (MECHATROLINK Members Association, manual number MMATDEP011) MECHATROLINK-III Installation Manual (MECHATROLINK Members Association, publication number MMATDEP018)
Note: <ul style="list-style-type: none"> If the drive detects this error, the terminal set to $H2-01$ to $H2-03 = 10$ [MFDO Function Selection = Alarm] will activate. If the drive detects this error, it will operate the motor as specified by the stopping method set in F6-25 [MECHATROLINK Watchdog Error Sel]. 			
Code	Name	Causes	Possible Solutions
EF	FWD/REV Run Command Input Error	A forward command and a reverse command were input at the same time for longer than 0.5 s.	Examine the forward and reverse command sequence and correct the problem.
Note: <ul style="list-style-type: none"> If the drive detects EF, the motor will ramp to stop. If the drive detects this error, the terminal assigned to $H2-01$ to $H2-03 = 10$ [MFDO Function Select = Alarm] will be ON. 			
Code	Name	Causes	Possible Solutions
EF0	Option Card External Fault	The communication option card received an external fault from the controller.	<ol style="list-style-type: none"> Find the device that caused the external fault and remove the caus. Clear the external fault input from the controller.
		A programming error occurred on the controller side.	Examine the operation of the controller program.
Note: <ul style="list-style-type: none"> The drive detects this error if the alarm function on the external device side is operating. If the drive detects this error, the terminal set to $H2-01$ to $H2-03 = 10$ [MFDO Function Selection = Alarm] will activate. If the drive detects this error, it will operate the motor as specified by the stopping method set in F6-03 [Comm External Fault (EF0) Select]. 			
Code	Name	Causes	Possible Solutions
EF1	External Fault (Terminal S1)	MFDI terminal S1 caused an external fault through an external device.	<ol style="list-style-type: none"> Find the device that caused the external fault and remove the cause. Clear the external fault input in the MFDI.
		The wiring is incorrect.	Correctly connect the signal line to MFDI terminal S1.
		External Fault [H1-01 = 2C to 2F] is set to MFDI terminal S1, but the terminal is not in use.	Correctly set the MFDI.
Note: <ul style="list-style-type: none"> If the drive detects this error, the terminal assigned to $H2-01$ to $H2-03 = 10$ [MFDO Function Select = Alarm] will activate. 			
Code	Name	Causes	Possible Solutions
EF2	External Fault (Terminal S2)	MFDI terminal S2 caused an external fault through an external device.	<ol style="list-style-type: none"> Find the device that caused the external fault and remove the cause. Clear the external fault input in the MFDI.
		The wiring is incorrect.	Correctly connect the signal line to MFDI terminal S2.
		External Fault [H1-02 = 2C to 2F] is set to MFDI terminal S2, but the terminal is not in use.	Correctly set the MFDI.
Note: <ul style="list-style-type: none"> If the drive detects this error, the terminal assigned to $H2-01$ to $H2-03 = 10$ [MFDO Function Select = Alarm] will activate. 			
Code	Name	Causes	Possible Solutions
EF3	External Fault (Terminal S3)	MFDI terminal S3 caused an external fault through an external device.	<ol style="list-style-type: none"> Find the device that caused the external fault and remove the cause. Clear the external fault input in the MFDI.
		The wiring is incorrect.	Correctly connect the signal line to MFDI terminal S3.
		External Fault [H1-03 = 2C to 2F] is set to MFDI terminal S3, but the terminal is not in use.	Correctly set the MFDI.
Note: <ul style="list-style-type: none"> If the drive detects this error, the terminal assigned to $H2-01$ to $H2-03 = 10$ [MFDO Function Select = Alarm] will activate. 			
Code	Name	Causes	Possible Solutions
EF4	External Fault (Terminal S4)	MFDI terminal S4 caused an external fault through an external device.	<ol style="list-style-type: none"> Find the device that caused the external fault and remove the cause. Clear the external fault input in the MFDI.
		The wiring is incorrect.	Correctly connect the signal line to MFDI terminal S4.

7.5 Minor Faults/Alarms

Code	Name	Causes	Possible Solutions
		<i>External Fault [H1-04 = 2C to 2F]</i> is set to MFDI terminal S4, but the terminal is not in use.	Correctly set the MFDI.
Note: If the drive detects this error, the terminal assigned to <i>H2-01 to H2-03 = 10 [MFDO Function Select = Alarm]</i> will activate.			
Code	Name	Causes	Possible Solutions
EF5	External Fault (Terminal S5)	MFDI terminal S5 caused an external fault through an external device.	1. Find the device that caused the external fault and remove the cause. 2. Clear the external fault input in the MFDI.
		The wiring is incorrect.	Correctly connect the signal line to MFDI terminal S5.
		<i>External Fault [H1-05 = 2C to 2F]</i> is set to MFDI terminal S5, but the terminal is not in use.	Correctly set the MFDI.
Note: If the drive detects this error, the terminal assigned to <i>H2-01 to H2-03 = 10 [MFDO Function Select = Alarm]</i> will activate.			
Code	Name	Causes	Possible Solutions
EF6	External Fault (Terminal S6)	MFDI terminal S6 caused an external fault through an external device.	1. Find the device that caused the external fault and remove the cause. 2. Clear the external fault input in the MFDI.
		The wiring is incorrect.	Correctly connect the signal line to MFDI terminal S6.
		<i>External Fault [H1-06 = 2C to 2F]</i> is set to MFDI terminal S6, but the terminal is not in use.	Correctly set the MFDI.
Note: If the drive detects this error, the terminal assigned to <i>H2-01 to H2-03 = 10 [MFDO Function Select = Alarm]</i> will activate.			
Code	Name	Causes	Possible Solutions
EF7	External Fault (Terminal S7)	MFDI terminal S7 caused an external fault through an external device.	1. Find the device that caused the external fault and remove the cause. 2. Clear the external fault input in the MFDI.
		The wiring is incorrect.	Correctly connect the signal line to MFDI terminal S7.
		<i>External Fault [H1-07 = 2C to 2F]</i> is set to MFDI terminal S7, but the terminal is not in use.	Correctly set the MFDI.
Note: If the drive detects this error, the terminal assigned to <i>H2-01 to H2-03 = 10 [MFDO Function Select = Alarm]</i> will activate.			
Code	Name	Causes	Possible Solutions
EP24v	External Power 24V Supply	The voltage of the main circuit power supply decreased, and the 24 V power supply is supplying power to the drive.	<ul style="list-style-type: none"> Examine the main circuit power supply. Turn ON the main circuit power supply to run the drive.
Note: <ul style="list-style-type: none"> Set <i>o2-26 [Ext. Power 24V Supply Display]</i> to enable or disable <i>EP24v</i> detection. The drive will not output an alarm signal for this alarm. 			
Code	Name	Causes	Possible Solutions
FbH	Excessive PID Feedback	The <i>FbH</i> detection level is set incorrectly.	Adjust <i>b5-36 [PID High Feedback Detection Lvl]</i> and <i>b5-37 [PID High Feedback Detection Time]</i> .
		There is a problem with the PID feedback wiring.	Correct errors with the PID control wiring.
		The feedback sensor is not operating correctly.	Examine the sensors on the control device side.
		A fault occurred in the feedback input circuit of the drive.	Replace the board or the drive. For information about replacing the control board, contact Yaskawa or your nearest sales representative.
Note: <ul style="list-style-type: none"> The drive detects this error if the PID feedback input is more than the level set in <i>b5-36</i> for longer than <i>b5-37</i>. If the drive detects this error, the terminal set to <i>H2-01 to H2-03 = 10 [MFDO Function Selection = Alarm]</i> will activate. If the drive detects this error, it will operate the motor as specified by the stopping method set in <i>b5-12 [Feedback Loss Detection Select]</i>. 			
Code	Name	Causes	Possible Solutions
FbL	PID Feedback Loss	The <i>FbL</i> detection level is set incorrectly.	Adjust <i>b5-13 [PID Feedback Loss Detection Lvl]</i> and <i>b5-14 [PID Feedback Loss Detection Time]</i> .
		There is a problem with the PID feedback wiring.	Correct errors with the PID control wiring.
		The feedback sensor is not operating correctly.	Examine the sensors on the control device side.

Code	Name	Causes	Possible Solutions
		A fault occurred in the feedback input circuit of the drive.	Replace the board or the drive. For information about replacing the control board, contact Yaskawa or your nearest sales representative.
Note: <ul style="list-style-type: none"> The drive detects this error if the PID feedback input is lower than the level set in <i>b5-13</i> for longer than <i>b5-14</i>. If the drive detects this error, the terminal set to <i>H2-01</i> to <i>H2-03</i> = 10 [MFDO Function Selection = Alarm] will activate. If the drive detects this error, it will operate the motor as specified by the stopping method set in <i>b5-12</i> [Feedback Loss Detection Select]. 			
Code	Name	Causes	Possible Solutions
HCA	High Current Alarm	The load is too heavy.	<ul style="list-style-type: none"> Decrease the load for applications with repetitive starts and stops. Replace the drive with a larger capacity model.
		The acceleration time is too short.	<ul style="list-style-type: none"> Calculate the torque necessary during acceleration related to the load inertia and the specified acceleration time. Increase the values set in <i>C1-01</i>, <i>C1-03</i>, <i>C1-05</i>, or <i>C1-07</i> [Acceleration Times] until you get the necessary torque. Increase the values set in <i>C2-01</i> to <i>C2-04</i> [S-Curve Characteristics] until you get the necessary torque. Replace the drive with a larger capacity model.
		The drive is trying to operate a specialized motor or a motor that is larger than the maximum applicable motor output of the drive.	<ul style="list-style-type: none"> Examine the motor nameplate, the motor, and the drive to make sure that the drive rated current is larger than the motor rated current. Replace the drive with a larger capacity model.
		The current level temporarily increased because of speed search after a momentary power loss or while trying to Auto Restart.	If speed search or Auto Restart cause an increase in current, the drive can temporarily show this alarm. The time that the drive shows the alarm is short. No more steps are necessary to clear the alarm.
Note: <ul style="list-style-type: none"> The drive detects this error if the drive output current is more than the overcurrent alarm level (150% of the rated current). If the drive detects this error, the terminal set to <i>H2-01</i> to <i>H2-03</i> = 10 [MFDO Function Selection = Alarm] will activate. 			
Code	Name	Causes	Possible Solutions
L24v	Loss of External Power 24 Supply	The voltage of the backup 24 V power supply has decreased. The main circuit power supply is operating correctly.	<ul style="list-style-type: none"> Examine the external 24 V power supply for disconnected wires and wiring errors and repair the problems. Examine the external 24 V power supply for problems.
Note: <ul style="list-style-type: none"> Set <i>o2-23</i> [External 24V Powerloss Detection] to enable or disable <i>L24v</i> detection. The drive will not output an alarm signal for this alarm. 			
Code	Name	Causes	Possible Solutions
LoG	Log Com Error	There is not a micro SD in the keypad.	Put a micro SD card in the keypad.
		<ul style="list-style-type: none"> The drive is connected to USB. The number of log communication files is more than 1000. The micro SD card does not have available memory space. The line number data in a log communication file was changed. A communication error between the keypad and drive occurred during a log communication. 	Set <i>o5-01</i> = 0 [Log Start/Stop Selection = OFF].
Note: <p>If the drive detects this error, the terminal assigned to <i>H2-01</i> to <i>H2-03</i> = 6A [MFDO Function Select = Data Logger Error] will be ON.</p>			
Code	Name	Causes	Possible Solutions
LT-1	Cooling Fan Maintenance Time	The cooling fan is at 90% of its expected performance life.	<ol style="list-style-type: none"> Use the procedures in this manual to replace the cooling fan. Set <i>o4-03</i> = 0 [Fan Operation Time Setting = 0 h] to reset the cooling fan operation time.
Note: <p>When the estimated performance life is expired, the terminal assigned to <i>H2-01</i> to <i>H2-03</i> = 2F [MFDO Function Select = Maintenance Notification] will be ON.</p>			
Code	Name	Causes	Possible Solutions
LT-2	Capacitor Maintenance Time	The capacitors for the main circuit and control circuit are at 90% of expected performance life.	Replace the board or the drive. For information about replacing the control board, contact Yaskawa or your nearest sales representative.
Note: <p>When the estimated performance life is expired, the terminal assigned to <i>H2-01</i> to <i>H2-03</i> = 2F [MFDO Function Select = Maintenance Notification] will be ON.</p>			
Code	Name	Causes	Possible Solutions
LT-3	SoftChargeBypassRelay MainteTime	The soft charge bypass relay is at 90% of its expected performance life.	Replace the board or the drive. For information about replacing the control board, contact Yaskawa or your nearest sales representative.
Note: <p>When the estimated performance life is expired, the terminal assigned to <i>H2-01</i> to <i>H2-03</i> = 2F [MFDO Function Select = Maintenance Notification] will be ON.</p>			

7.5 Minor Faults/Alarms

Code	Name	Causes	Possible Solutions
LT-4	IGBT Maintenance Time (50%)	The IGBT is at 50% of its expected performance life.	Check the load, carrier frequency, and output frequency.
Note: When the estimated performance life is expired, the terminal assigned to H2-01 to H2-03 = 2F [MFDO Function Select = Maintenance Notification] will be ON.			
Code	Name	Causes	Possible Solutions
oH	Heatsink Overheat	The ambient temperature is high and the heatsink temperature is more than the L8-02 [Overheat Alarm Level].	<ul style="list-style-type: none"> Measure the ambient temperature. Increase the airflow around the drive. Install a cooling device (cooling fan or air conditioner) to lower the ambient temperature. Remove objects near the drive that are producing too much heat.
		There is not sufficient airflow around the drive.	<ul style="list-style-type: none"> Give the drive the correct installation space as shown in the manual. Make sure that there is sufficient circulation around the control panel. Examine the drive for dust or other unwanted materials that could clog the cooling fan. Remove unwanted materials that prevent air circulation.
		The internal cooling fan or fans have stopped.	<ol style="list-style-type: none"> Use the procedures in this manual to replace the cooling fan. Set o4-03 = 0 [Fan Operation Time Setting = 0 h].
Note: <ul style="list-style-type: none"> The drive detects this error if the heatsink temperature of the drive is more than L8-02. If the drive detects this error, the terminal set to H2-01 to H2-03 = 10 [MFDO Function Selection = Alarm] will activate. If the drive detects this error, it will operate the motor as specified by the stopping method set in L8-03 [Overheat Pre-Alarm Selection]. 			
Code	Name	Causes	Possible Solutions
oH2	External Overheat (H1-XX=B)	An external device sent an oH2.	<ol style="list-style-type: none"> Find the external device that output the overheat alarm. Remove the cause of the problem. Clear the Overheat Alarm (oH2) [H1-xx = B] set to MFDI terminals S1 to S7.
Note: If the drive detects this error, the terminal set to H2-01 to H2-03 = 10 [MFDO Function Selection = Alarm] will activate.			
Code	Name	Causes	Possible Solutions
oH3	Motor Overheat (PTC Input)	The thermistor wiring that detects motor temperature is defective.	Correct wiring errors.
		A fault occurred on the machine. Example: The machine is locked.	Examine the machine and remove the cause of the fault
		The motor has overheated.	<ul style="list-style-type: none"> Check the load level, acceleration/deceleration time, and motor start/stop frequency (cycle time). Decrease the load. Increase the values set in C1-01 to C1-08 [Acceleration/Deceleration Times]. Set E2-01 [Motor Rated Current (FLA)] correctly to the value specified by the motor nameplate. Make sure that the motor cooling system is operating correctly, and repair or replace it if it is damaged. Adjust E1-04 to E1-10 [V/f Pattern Parameters]. For motor 2, adjust E3-04 to E3-10. Decrease the values set in E1-08 [Mid Point A Voltage] and E1-10 [Minimum Output Voltage]. Note: If the values set in E1-08 and E1-10 are too low, the overload tolerance will decrease at low speeds.
Note: <ul style="list-style-type: none"> The drive detects this fault if the motor overheat signal input from analog input terminal A1 or A2 is more than the fault detection level. If the drive detects this error, the terminal set to H2-01 to H2-03 = 10 [MFDO Function Selection = Alarm] will activate. If the drive detects this error, it will operate the motor as specified by the stopping method set in L1-03 [Motor Thermistor oH Alarm Select]. 			
Code	Name	Causes	Possible Solutions
oL3	Overtorque 1	A fault occurred on the machine. Example: The machine is locked.	Examine the machine and remove the cause of the fault
		The parameters are incorrect for the load.	Adjust L6-02 [Torque Detection Level 1] and L6-03 [Torque Detection Time 1].
Note: <ul style="list-style-type: none"> The drive detects this fault if the drive output current is more than the level set in L6-02 for longer than L6-03. If the drive detects this error, the terminal set to H2-01 to H2-03 = 10 [MFDO Function Selection = Alarm] will activate. Set the conditions that trigger the minor fault using L6-01 [Torque Detection Selection 1]. 			

Code	Name	Causes	Possible Solutions
oL4	Overtorque 2	A fault occurred on the machine. Example: The machine is locked.	Examine the machine and remove the cause of the fault
		The parameters are incorrect for the load.	Adjust L6-05 [Torque Detection Level 2] and L6-06 [Torque Detection Time 2].
Note: <ul style="list-style-type: none"> The drive detects this error if the drive output current is more than the level set in L6-05 for longer than L6-06. If the drive detects this error, the terminal set to H2-01 to H2-03 = 10 [MFDO Function Selection = Alarm] will activate. Set the conditions that trigger the minor fault using L6-04 [Torque Detection Selection 2]. 			
Code	Name	Causes	Possible Solutions
oL5	Mechanical Weakening Detection 1	The drive detected overtorque as specified by the conditions for mechanical weakening detection set in L6-08 [Mechanical Fatigue Detect Select].	Do a deterioration diagnostic test on the machine side.
Note: <ul style="list-style-type: none"> If the drive detects this error, the terminal set to H2-01 to H2-03 = 10 [MFDO Function Selection = Alarm] will activate. If the drive detects this error, it will operate the motor as specified by the Stopping Method set in L6-08. 			
Code	Name	Causes	Possible Solutions
oS	Overspeed	There is overshoot.	<ul style="list-style-type: none"> Decrease C5-01 [ASR Proportional Gain 1] and increase C5-02 [ASR Integral Time 1]. Adjust the pulse train gain with H6-02 to H6-05 [Pulse Train Input Setting Parameters].
		There is an incorrect number of PG pulses set in the drive.	Set H6-02 [Terminal RP Frequency Scaling] to the pulse train frequency during 100% reference (maximum motor rotation speed).
		The oS detection level is set incorrectly.	Adjust F1-08 [Overspeed Detection Level] and F1-09 [Overspeed Detection Delay Time].
Note: <ul style="list-style-type: none"> The drive detects this error if the motor speed is more than the value set in F1-08 for longer than F1-09. If the drive detects this error, the terminal set to H2-01 to H2-03 = 10 [MFDO Function Selection = Alarm] will activate. If the drive detects this error, it will operate the motor as specified by the stopping method set in F1-03 [Overspeed Detection Selection]. 			
Code	Name	Causes	Possible Solutions
ov	Overvoltage	There are surge voltages in the input power supply.	Connect a DC link choke to the drive. Note: If you turn the phase advancing capacitors ON and OFF and use thyristor converters in the same power supply system, there can be surge voltages that irregularly increase the input voltage.
		The drive output cable or motor is shorted to ground (the current short to ground is charging the main circuit capacitor of the drive through the power supply).	<ol style="list-style-type: none"> Examine the motor main circuit cable, terminals, and motor terminal box, and then remove ground faults. Re-energize the drive.
		The power supply voltage is too high.	Decrease the power supply voltage to match the drive rated voltage.
		Electrical interference caused a drive malfunction.	<ul style="list-style-type: none"> Examine the control circuit lines, main circuit lines, and ground wiring, and decrease the effects of electrical interference. Make sure that a magnetic contactor is not the source of the electrical interference, then use a Surge Protective Device if necessary. Set L5-01 ≠ 0 [Number of Auto-Restart Attempts ≠ 0 times].
Note: <ul style="list-style-type: none"> The drive detects this error if the DC bus voltage is more than the ov detection level when the Run command has not been input (while the drive is stopped). The ov detection level is approximately 410 V with 200 V class drives. The detection level is approximately 820 V for 400 V class drives. If the drive detects this error, the terminal set to H2-01 to H2-03 = 10 [MFDO Function Selection = Alarm] will activate. 			
Code	Name	Causes	Possible Solutions
ovEr	Too Many Parameters Changed	You tried to change more than 150 parameters.	Make sure that parameters that do not have an effect on drive operation are at their default settings. Note: <ul style="list-style-type: none"> You can change 150 parameters maximum. If you change parameters that have dependencies, the drive can detect ovEr when the number of changed parameters is fewer than 150.
Code	Name	Causes	Possible Solutions
PASS	Modbus Communication Test	The MEMOBUS/Modbus communications test is complete.	The PASS display will turn off after communications test mode is cleared.
Code	Name	Causes	Possible Solutions
PF	Input Phase Loss	There is a phase loss in the drive input power.	Correct all wiring errors with the main circuit power supply.
		Loose wiring in the input power terminals.	Tighten the screws to the correct tightening torque.

7.5 Minor Faults/Alarms

Code	Name	Causes	Possible Solutions
		The drive input power voltage is changing too much.	<ul style="list-style-type: none"> Examine the supply voltage for problems. Make the drive input power stable.
		Unsatisfactory balance between voltage phases.	<ul style="list-style-type: none"> Examine the supply voltage for problems. Make the drive input power stable. If the supply voltage is good, examine the magnetic contactor on the main circuit side for problems.
		The main circuit capacitors have become unserviceable.	<ul style="list-style-type: none"> Examine the capacitor maintenance time in monitor <i>U4-05 [Capacitor Maintenance]</i>. If <i>U4-05</i> is more than 90%, replace the capacitor. Contact Yaskawa or your nearest sales representative for more information.
<p>Note:</p> <ul style="list-style-type: none"> The drive detects this error if the DC bus voltage changes irregularly without regeneration. If the drive detects this error, the terminal assigned to <i>H2-01 to H2-03 = 10 [MFDO Function Select = Alarm]</i> will be ON. Use <i>L8-05 [Input Phase Loss Protection Sel]</i> to enable and disable <i>PF</i> detection. 			
Code	Name	Causes	Possible Solutions
PGo	Encoder (PG) Feedback Loss	The encoder cable is disconnected or wired incorrectly.	Examine for wiring errors or disconnected wires in the encoder cable, and repair problems.
		The encoder is not receiving power.	Examine the encoder power supply.
		The holding brake is stopping the motor.	Release the holding brake.
<p>Note:</p> <ul style="list-style-type: none"> The drive detects this error if it does not receive the speed detection pulse signal from the encoder in the detection time set in <i>F1-14 [Encoder Open-Circuit Detect Time]</i>. If the drive detects this error, the terminal assigned to <i>H2-01 to H2-03 = 10 [MFDO Function Select = Alarm]</i> will activate. If the drive detects this error, it will operate the motor as specified by the stopping method set in <i>F1-02 [PG Open Circuit Detection Select]</i>. 			
Code	Name	Causes	Possible Solutions
rUn	Motor Switch during Run	The drive received a <i>Motor 2 Selection [H1-xx = 16]</i> during run.	Make sure that the drive receives the Motor 2 Selection while the drive is stopped.
<p>Note:</p> <p>If the drive detects this error, the terminal set to <i>H2-01 to H2-03 = 10 [MFDO Function Selection = Alarm]</i> will activate.</p>			
Code	Name	Causes	Possible Solutions
SE	Modbus Test Mode Error	MEMOBUS/Modbus communications self-diagnostics [<i>H1-xx = 67</i>] was done while the drive was running.	Stop the drive and do MEMOBUS/Modbus communications self-diagnostics.
<p>Note:</p> <p>If the drive detects this error, the terminal set to <i>H2-01 to H2-03 = 10 [MFDO Function Selection = Alarm]</i> will activate.</p>			
Code	Name	Causes	Possible Solutions
SToF	Safe Torque OFF Hardware	One of the two terminals H1-HC and H2-HC received the Safe Disable input signal.	<ul style="list-style-type: none"> Make sure that the Safe Disable signal is input from an external source to terminals H1-HC or H2-HC. When the Safe Disable function is not in use, use a jumper to connect terminals H1-HC and H2-HC.
		The Safe Disable input signal is wired incorrectly.	
		There is internal damage to one Safe Disable channel.	Replace the board or the drive. For information about replacing the control board, contact Yaskawa or your nearest sales representative.
<p>Note:</p> <p>If the drive detects this error, the terminal set to <i>H2-01 to H2-03 = 10 [MFDO Function Selection = Alarm]</i> will activate.</p>			
Code	Name	Causes	Possible Solutions
TiM	Keypad Time Not Set	There is a battery in the keypad, but the date and time are not set.	Set the date and time with the keypad.
<p>Note:</p> <ul style="list-style-type: none"> Parameter <i>o4-24 [bAT Detection Selection]</i> enables and disables <i>TiM</i> detection. If the drive detects this error, the terminal set to <i>H2-01 to H2-03 = 10 [MFDO Function Selection = Alarm]</i> will activate. 			
Code	Name	Causes	Possible Solutions
TrPC	IGBT Maintenance Time (90%)	The IGBT is at 90% of its expected performance life.	Replace the IGBT or the drive. For information about replacing the control board, contact Yaskawa or your nearest sales representative.
<p>Note:</p> <p>If the drive detects this error, the terminal set to <i>H2-01 to H2-03 = 10 [MFDO Function Selection = Alarm]</i> will activate.</p>			

Code	Name	Causes	Possible Solutions
UL3	Undertorque Detection 1	A fault occurred on the machine. Example: There is a broken pulley belt.	Examine the machine and remove the cause of the fault
		The parameters are incorrect for the load.	Adjust L6-02 [Torque Detection Level 1] and L6-03 [Torque Detection Time 1].
Note: <ul style="list-style-type: none"> The drive detects this error if the drive output current is less than the level set in L6-02 for longer than L6-03. If the drive detects this error, the terminal set to H2-01 to H2-03 = 10 [MFDO Function Selection = Alarm] will activate. Set the conditions that trigger the minor fault using L6-01 [Torque Detection Selection 1]. 			
Code	Name	Causes	Possible Solutions
UL4	Undertorque Detection 2	A fault occurred on the machine. Example: There is a broken pulley belt.	Examine the machine and remove the cause of the fault
		The parameters are incorrect for the load.	Adjust L6-05 [Torque Detection Level 2] and L6-06 [Torque Detection Time 2].
Note: <ul style="list-style-type: none"> The drive detects this error if the drive output current is less than the level set in L6-05 for longer than L6-06. If the drive detects this error, the terminal set to H2-01 to H2-03 = 10 [MFDO Function Selection = Alarm] will activate. Set the conditions that trigger the minor fault using L6-04 [Torque Detection Selection 2]. 			
Code	Name	Causes	Possible Solutions
UL5	Mechanical Weakening Detection 2	The drive detected undertorque as specified by the conditions for mechanical weakening detection set in L6-08 [Mechanical Fatigue Detect Select].	Examine the machine for deterioration.
Note: <ul style="list-style-type: none"> If the drive detects this error, the terminal set to H2-01 to H2-03 = 10 [MFDO Function Selection = Alarm] will activate. If the drive detects this error, it will operate the motor as specified by the Stopping Method set in L6-08. 			
Code	Name	Causes	Possible Solutions
Uv	DC Bus Undervoltage	The drive input power voltage is changing too much.	<ul style="list-style-type: none"> Use a better power supply voltage to align with the drive rated voltage. Make the drive input power stable. If there is not a fault with the input power supply, examine the magnetic contactor on the main circuit side for faults.
		A phase loss occurred in the drive input power.	Correct errors with the wiring for main circuit drive input power.
		There is loose wiring in the drive input power terminals.	Examine for loose screws and tighten them as specified by the tightening torque values in the manual.
		There was a loss of power.	Use a better power supply.
		The main circuit capacitors have deteriorated.	Examine the capacitor maintenance time in monitor U4-05 [Capacitor Maintenance]. If U4-05 is more than 90%, replace the control board or the drive. For information about replacing the control board, contact Yaskawa or your nearest sales representative.
		The drive input power transformer is too small and voltage drops when the power is switched on.	<ul style="list-style-type: none"> Check for an alarm when a molded-case circuit breaker, Leakage Breaker (ELCB, GFCI, or RCM/RCD) (with overcurrent protective function), or magnetic contactor is ON. Check the capacity of the drive power supply transformer.
		Air inside the drive is too hot.	Measure the ambient temperature of the drive.
		The Charge LED is broken.	Replace the board or the drive. For information about replacing the control board, contact Yaskawa or your nearest sales representative.
Note: <ul style="list-style-type: none"> The drive detects this error if one of these conditions is correct when the Run command has not been input (while the drive is stopped). <ul style="list-style-type: none"> The DC bus voltage < L2-05 [Undervoltage Detection Lvl (Uv1)]. The Contactor that prevents inrush current in the drive was opened. There is low voltage in the control drive input power. If the drive detects this error, the terminal set to H2-01 to H2-03 = 10 [MFDO Function Selection = Alarm] will activate. 			

7.6 Parameter Setting Errors

Parameter setting errors occur when multiple parameter settings do not agree, or when parameter setting values are not correct. Refer to the table in this section, examine the parameter setting that caused the error, and remove the cause of the error. You must first correct the parameter setting errors before you can operate the drive. The drive will not send notification signals for the faults and alarms when these parameter setting errors occur.

Code	Name	Causes	Possible Solutions
oPE01	Drive Capacity Setting Error	The value set in <i>o2-04 [Drive Model (KVA) Selection]</i> does not agree with the drive model.	Set <i>o2-04</i> to the correct value.
Code	Name	Causes	Possible Solutions
oPE02	Parameter Range Setting Error	Parameter settings are not in the applicable setting range.	<ol style="list-style-type: none"> 1. Push  to show <i>U1-18 [oPE Fault Parameter]</i>, and find parameters that are not in the applicable setting range. 2. Correct the parameter settings. <p>Note: If more than one error occurs at the same time, other <i>oPExx</i> errors have priority over <i>oPE02</i>.</p>
		Set $E2-01 \leq E2-03$ [<i>Motor Rated Current (FLA) ≤ Motor No-Load Current</i>].	<p>Make sure that $E2-01 > E2-03$.</p> <p>Note: If it is necessary to set $E2-01 < E2-03$, first lower the value set in <i>E2-03</i>, and then set <i>E2-01</i>.</p>
Code	Name	Causes	Possible Solutions
oPE03	Multi-Function Input Setting Err	The settings for these parameters do not agree: <ul style="list-style-type: none"> • <i>H1-01 to H1-07 [Terminals S1 to S8 Function Selection]</i> • <i>H7-01 to H7-04 [Virtual Multi-Function Inputs 1 to 4]</i> 	Correct the parameter settings.
		The settings for MFDIs overlap. Note: This does not include <i>H1-xx = 20 to 2F [MFDI Function Select = External Fault]</i> and [<i>Reserved</i>].	Set the parameters correctly to prevent MFDI function overlap.
		You did not set these pairs of MFDI functions to Digital Inputs (<i>H1-xx</i> and <i>H7-01 to H7-04</i>) at the same time: <ul style="list-style-type: none"> • Setting values <i>10 [Up Command]</i> and <i>11 [Down Command]</i> • Setting values <i>75 [Up 2 Command]</i> and <i>76 [Down 2 Command]</i> • Setting values <i>42 [Run Command (2-Wire Sequence 2)]</i> and <i>43 [FWD/REV (2-Wire Sequence 2)]</i> 	Set the MFDI pairs.
		You set a minimum of two of these MFDI combinations to Digital Inputs (<i>H1-xx</i> and <i>H7-01 to H7-04</i>) at the same time: <ul style="list-style-type: none"> • Setting values <i>10 [Up Command]</i> and <i>11 [Down Command]</i> • Setting values <i>75 [Up 2 Command]</i> and <i>76 [Down 2 Command]</i> • Setting value <i>A [Accel/Decel Ramp Hold]</i> • Setting value <i>1E [Reference Sample Hold]</i> • Setting values <i>44 to 46 [Add Offset Frequency 1 to 3 (d7-01 to d7-03)]</i> 	Remove the function settings that are not in use.

Code	Name	Causes	Possible Solutions
		<p>You set these commands in Digital Inputs (H1-xx and H7-01 to H7-04) at the same time:</p> <ul style="list-style-type: none"> Setting values 61 [Speed Search from Fmax] and 62 [Speed Search from Fref] Setting values 65, 66, 7A, 7B [KEB Ride-Thru 1 or 2 Activate] and 68 [High Slip Braking (HSB) Activate] Setting values 16 [Motor 2 Selection] and 1A [Accel/Decel Time Selection 2] Setting values 65, 66 [KEB Ride-Thru 1 Activate] and 7A, 7B [KEB Ride-Thru 2 Activate] Setting values 40, 41 [Forward RUN (2-Wire), Reverse RUN (2-Wire)] and 42, 43 [Run Command (2-Wire Sequence 2), FWD/REV (2-Wire Sequence 2)] Setting values 60 [DC Injection Braking Command] and 6A [Drive Enable] Setting values 16 [Motor 2 Selection] and 75, 76 [Up 2 Command, Down 2 Command] 	Remove the function settings that are not in use.
		<p>Settings for N.C. and N.O. input [H1-xx] for these functions were selected at the same time:</p> <ul style="list-style-type: none"> Setting value 15 [Fast Stop (N.O.)] Setting value 17 [Fast Stop (N.C.)] 	Remove one of the function settings.
		<p>You entered these settings while H1-xx = 2 [External Reference 1/2 Selection]:</p> <ul style="list-style-type: none"> b1-15 = 4 [Frequency Reference Selection 2 = Pulse Train Input] H6-01 ≠ 0 [Terminal RP Pulse Train Function ≠ Frequency Reference] 	Set H6-01 = 0.
		<p>You entered these settings while H1-xx = 2 [External Reference 1/2 Selection]:</p> <ul style="list-style-type: none"> b1-15 = 3 [Option PCB] or b1-16 = 3 [Run Command Selection 2 = Option PCB] You did not connect an option to the drive. 	Connect an input option to the drive.
		<p>You entered these settings while H1-xx = 2 [External Reference 1/2 Selection]:</p> <ul style="list-style-type: none"> b1-15 = 1 [Analog Input] H3-02 ≠ 0 [Terminal A1 Function Selection ≠ Frequency Reference] or H3-10 ≠ 0 [Terminal A2 Function Selection ≠ Frequency Reference] 	Set H3-02 = 0 or H3-10 = 0.
		<p>These parameters are set at the same time:</p> <ul style="list-style-type: none"> H1-xx ≠ 6A [Drive Enable] H2-xx = 38 [Drive Enabled] 	Correct the parameter settings.
		<p>These parameters are set at the same time:</p> <ul style="list-style-type: none"> H6-01 ≠ 3 [PG Speed Feedback (V/F Control)] H1-xx = 7E [Reverse Rotation Identifier] 	Correct the parameter settings.
		<p>These parameters are set at the same time:</p> <ul style="list-style-type: none"> H1-xx = 75/76 [Up 2 /Down 2 Command] H3-01, H3-09 = 1 [Terminal A1, A2 Signal Level Select = 0 to +10V(Without Limit)] 	Remove one of the function settings.
Code	Name	Causes	Possible Solutions
oPE05	Run Cmd/Freq Ref Source Sel Err	The setting to assign the Run command or frequency reference to an option card or the pulse train input is incorrect.	Correct the parameter settings.
		b1-01 = 3 [Frequency Reference Selection 1 = Option PCB] is set, but there is no option card connected to the drive.	Connect an option card to the drive.
		b1-02 = 3 [Run Command Selection 1 = Option PCB] is set, but there is no option card connected to the drive.	
		<p>These parameters are set at the same time:</p> <ul style="list-style-type: none"> b1-01 = 4 [Pulse Train Input] H6-01 ≠ 0 [Terminal RP Pulse Train Function ≠ Frequency Reference] 	Set H6-01 = 0.

7.6 Parameter Setting Errors

Code	Name	Causes	Possible Solutions
oPE07	Analog Input Selection Error	The settings for H3-02 and H3-10 [MFAI Function Select] and H7-30 [Virtual Analog Input Selection] overlap.	Set H3-02, H3-10, and H7-30 correctly to prevent overlap. Note: It is possible to set these functions to multiple analog input terminals at the same time: • Setting value 0 [Frequency Reference] • Setting values F and 1F [Not Used]
		These parameters are set at the same time: • H3-02, H3-10, H7-30 = B [PID Feedback] • H6-01 = 1 [Terminal RP Pulse Train Function = PID Feedback Value]	Remove the function settings that are not in use.
		These parameters are set at the same time: • H3-02, H3-10, H7-30 = C [PID Setpoint] • H6-01 = 2 [PID Setpoint Value]	
		These parameters are set at the same time: • H3-02, H3-10, H7-30 = C • b5-18 = 1 [PID Setpoint Selection = Enabled]	
		These parameters are set at the same time: • H6-01 = 2 • b5-18 = 1	
Code	Name	Causes	Possible Solutions
oPE08	Parameter Selection Error	A function was set that is not compatible with the control method selected in A1-02 [Control Method Selection].	1. Push ENTER Key to show U1-18 [oPE Fault Parameter], and find parameters that are not in the applicable setting range. 2. Correct the parameter settings. Note: If more than one error occurs at the same time, other oPExx errors have priority over oPE02.
		When A1-02 = 2 [OLV], you used these parameter settings: • n2-02 > n2-03 [Automatic Freq Regulator Time 1 > Automatic Freq Regulator Time 2] • C4-02 > C4-06 [Torque Compensation Delay Time > Motor 2 Torque Comp Delay Time]	• Set n2-02 < n2-03. • Set C4-02 < C4-06.
		When A1-02 = 0 [V/f], you used these parameter settings: • H6-01 = 3 [Terminal RP Pulse Train Function = Speed Feedback (V/F Control)] • H1-xx = 16 [MFDI Function Select = Motor 2 Selection]	Correct the parameter settings. Note: You cannot use Speed Feedback (V/F Control) with the Motor Switch function.
		When A1-02 = 5 [OLV/PM], you set E5-02 to E5-07 [PM Motor Parameters] = 0.	• Set E5-01 [PM Motor Code Selection] correctly as specified by the motor. • For specialized motors, refer to the motor test report and set E5-xx correctly.
		When A1-02 = 5, 6 [OLV/PM, AOLV/PM], you used these parameter settings: • E5-09 = 0.0 [PM Back-EMF Vpeak (mV/(rad/s)) = 0.0 mV/(rad/s)] • E5-24 = 0.0 [PM Back-EMF L-L Vrms (mV/rpm) = 0.0 mV/min ⁻¹]	Set E5-09 or E5-24 to the correct value.
		When A1-02 = 5, 6, you set E5-09 ≠ 0 and E5-24 ≠ 0.	Set E5-09 = 0 or E5-24 = 0.
		When A1-02 = 6, you set these parameters: • n8-57 = 0 [HFI Overlap Selection = Disabled] • You set E1-09 [Minimum Output Frequency] < the 5% value of E1-06.	Correct the parameter settings.
		When A1-02 = 6, you set these parameters: • n8-35 = 0 [Initial Pole Detection Method = Pull-in] • n8-57 = 1 [Enabled]	Correct the parameter settings.
		When A1-02 = 8 [EZOLV], you used these parameter settings: • E9-01 = 1, 2 [Motor Type Selection = Permanent Magnet (PM), Synchronous Reluctance (SynRM)] • b3-24 = 2 [Speed Search Method Selection = Current Detection 2]	When E9-01 = 1 or 2, set b3-24 = 1 [Speed Estimation].

Code	Name	Causes	Possible Solutions
oPE09	PID Control Selection Fault	These parameters are set at the same time: <ul style="list-style-type: none"> $b5-15 \neq 0.0$ [PID Sleep Function Start Level $\neq 0.0$ Hz] $b1-03 = 2, 3$ [Stopping Method Selection = DC Injection Braking to Stop, Coast to Stop with Timer] 	<ul style="list-style-type: none"> Set $b5-15 \neq 0.0$. Set $b1-03 = 0, 1$ [Ramp to Stop, Coast to Stop].
		These parameters are set at the same time: <ul style="list-style-type: none"> $b5-01 = 1, 2$ [Enabled (Standard), Enabled (D = Feedforward)] $d2-02 \neq 0.0$ [Frequency Reference Lower Limit $\neq 0.0\%$] 	Correct the parameter settings.
		These parameters are set at the same time: <ul style="list-style-type: none"> $b5-01 = 1, 2$ [Enabled (Standard), Enabled (D = Feedforward)] $b5-11 = 1$ [PID Output Reverse Selection = Negative Output Accepted] 	Correct the parameter settings.
		These parameters are set at the same time: <ul style="list-style-type: none"> $b5-01 = 3, 4$ [Trim (Fref+PID Out, D = Fdbk), Trim (Fref+PID Out, D = FeedFwd)] $d2-02 \neq 0.0$ has been set. 	Correct the parameter settings.
<p>Note: The drive detects this error if the PID control function selection is incorrect. (When $b5-01 = 1$ to 4 [PID Mode Setting = PID Control Enabled])</p>			
Code	Name	Causes	Possible Solutions
oPE10	V/f Data Setting Error	The parameters that set the V/f pattern do not satisfy these conditions: <ul style="list-style-type: none"> For motor 1: $E1-09 \leq E1-07 < E1-06 \leq E1-11 \leq E1-04$ [Minimum Output Frequency \leq Mid Point A Frequency $<$ Base Frequency \leq Mid Point B Frequency \leq Maximum Output Frequency] For motor 2: $E3-09 \leq E3-07 < E3-06 \leq E3-11 \leq E3-04$ [Minimum Output Frequency \leq Mid Point A Frequency $<$ Base Frequency \leq Mid Point B Frequency \leq Maximum Output Frequency] 	Set the parameters correctly to satisfy the conditions.
Code	Name	Causes	Possible Solutions
oPE11	Carrier Frequency Setting Error	These parameters are set at the same time: <ul style="list-style-type: none"> $C6-05 > 6$ [Carrier Freq Proportional Gain > 6] $C6-04 > C6-03$ [Carrier Frequency Lower Limit $>$ Carrier Frequency Upper Limit] <p>Note: When $C6-05 < 7$, $C6-04$ becomes disabled. The drive sets the carrier frequency to the value set to $C6-03$.</p>	Set $C6-02$ to $C6-05$ correctly.
		$C6-02$ to $C6-05$ settings are not in the applicable setting range.	
Code	Name	Causes	Possible Solutions
oPE13	Pulse Monitor Selection Error	$H6-06 = 101, 102, 105, \text{ or } 116$ [Terminal MP Monitor Selection = Frequency Reference, Output Frequency, Motor Speed, Output Frequency after Soft Starter] has not been set when $H6-07 = 0$ [Terminal MP Frequency Scaling = 0 Hz].	Set $H6-06$ correctly.
Code	Name	Causes	Possible Solutions
oPE16	Energy Saving Constants Error	The Energy Saving parameters are not set in the applicable setting range.	Make sure that $E5-xx$ is set correctly as specified by the motor nameplate data.

7.6 Parameter Setting Errors

Code	Name	Causes	Possible Solutions
oPE33	Digital Output Selection Error	These two parameters are set at the same time: <ul style="list-style-type: none"> • $H2-60 \neq F$ [Term MA,MB,MC Secondary Function \neq Not Used] • $H2-01 = 1xx$ [Term MA,MB,MC Function Selection = Inverse output of xx] 	Clear the $H2-01$ to $H2-03 = 1xx$ [Inverse output of xx] settings. Note: If you use the function to output logical calculation results ($H2-60$, $H2-63$, $H2-66 \neq F$), you cannot set $H2-01$ to $H2-03 = 1xx$.
		These two parameters are set at the same time: <ul style="list-style-type: none"> • $H2-63 \neq F$ [Terminal P1 Secondary Function \neq Not Used] • $H2-02 = 1xx$ [Term P1 Function Selection = Inverse output of xx] 	
		These two parameters are set at the same time: <ul style="list-style-type: none"> • $H2-66 \neq F$ [Terminal P2 Secondary Function \neq Not Used] • $H2-03 = 1xx$ [Term P2 Function Selection = Inverse output of xx] 	
		These parameter pairs are set incorrectly: <ul style="list-style-type: none"> • $H2-21$ [Comparator 1 Lower Limit] $>$ $H2-22$ [Comparator 1 Upper Limit] • $H2-27$ [Comparator 2 Lower Limit] $>$ $H2-28$ [Comparator 2 Upper Limit] 	<ul style="list-style-type: none"> • Set parameters $H2-21 \leq H2-22$. • Set parameters $H2-27 \leq H2-28$.

7.7 Auto-Tuning Errors

This table gives information about errors detected during Auto-Tuning. If the drive detects an Auto-Tuning error, the keypad will show the error and the motor will coast to stop. The drive will not send notification signals for faults and alarms when Auto-Tuning errors occur.

Two types of Auto-Tuning errors are: *Endx* and *Erx*. *Endx* identifies that Auto-Tuning has successfully completed with calculation errors. Find and repair the cause of the error and do Auto-Tuning again, or set the motor parameters manually. You can use the drive in the application if you cannot find the cause of the *Endx* error.

Erx identifies that Auto-Tuning was not successful. Find and repair the cause of the error and do Auto-Tuning again.

Code	Name	Causes	Possible Solutions
End1	Excessive Rated Voltage Setting	The torque reference was more than 20% during Auto-Tuning or the no-load current that was measured after Auto-Tuning is more than 80%.	<ul style="list-style-type: none"> Make sure that the input motor nameplate data is correct. Do Auto-Tuning again and correctly set the motor nameplate data. If you can uncouple the motor and load, remove the motor from the machine and do Rotational Auto-Tuning again. If you cannot uncouple the motor and load, use the results from Auto-Tuning.
Code	Name	Causes	Possible Solutions
End2	Iron Core Saturation Coefficient	The motor nameplate data entered during Auto-Tuning is incorrect.	<ul style="list-style-type: none"> Make sure that the input motor nameplate data is correct. Do Auto-Tuning again and correctly set the motor nameplate data.
		Auto-Tuning results were not in the applicable parameter setting range, and <i>E2-07</i> or <i>E2-08</i> [<i>Motor Saturation Coefficient 2</i>] have temporary values.	<ul style="list-style-type: none"> Examine and repair damaged motor wiring. If you can uncouple the motor and load, remove the motor from the machine and do Rotational Auto-Tuning again.
Code	Name	Causes	Possible Solutions
End3	Rated Current Setting Alarm	The rated current value is incorrect.	Do Auto-Tuning again and set the correct rated current shown on the motor nameplate.
Code	Name	Causes	Possible Solutions
End4	Adjusted Slip Calculation Error	The Auto-Tuning results were not in the applicable parameter setting range.	<ul style="list-style-type: none"> Make sure the input motor nameplate data is correct. Do Rotational Auto-Tuning again and correctly set the motor nameplate data. If you cannot uncouple the motor and load, do Stationary Auto-Tuning 2.
		The motor rated slip that was measured after Stationary Auto-Tuning was 0.2 Hz or lower.	
		The motor rated slip that was measured after compensation with <i>E2-08</i> [<i>Motor Saturation Coefficient 2</i>] is not in the applicable range.	
		The secondary resistor measurement results were not in the applicable range.	
Code	Name	Causes	Possible Solutions
End5	Resistance Tuning Error	The Auto-Tuning results of the Line-to-Line Resistance were not in the applicable range.	<ul style="list-style-type: none"> Make sure that the input motor nameplate data is correct. Examine and repair damaged motor wiring.
Code	Name	Causes	Possible Solutions
End6	Leakage Inductance Alarm	The Auto-Tuning results were not in the applicable parameter setting range.	Make sure that the input motor nameplate data is correct, and do Auto-Tuning again.
		<i>A1-02</i> [<i>Control Method Selection</i>] setting is not applicable.	<ul style="list-style-type: none"> Examine the value set in <i>A1-02</i>. Make sure that the input motor nameplate data is correct, and do Auto-Tuning again.
Code	Name	Causes	Possible Solutions
End7	No-Load Current Alarm	The Auto-Tuning results of the motor no-load current value were not in the applicable range.	Examine and repair damaged motor wiring.
		Auto-Tuning results were less than 5% of the motor rated current.	Make sure that the input motor nameplate data is correct, and do Auto-Tuning again.

7.7 Auto-Tuning Errors

Code	Name	Causes	Possible Solutions
End8	HFI Alarm	<ul style="list-style-type: none"> Inductance saliency ratio (<i>E5-07/E5-06</i>) is too small. The drive cannot find the <i>n8-36 [HFI Frequency Level for L Tuning]</i> value. 	<ul style="list-style-type: none"> Set the correct value on the motor nameplate <i>E5-xx [PM motor parameters]</i> or do Stationary/Rotational Auto-Tuning, and then do High Frequency Injection Tuning again. When it is necessary to set <i>n8-35 = 1 [Initial Pole Detection Method = High Frequency Injection]</i> or <i>n8-57 = 1 [HFI Overlap Selection = Enabled]</i>, make sure that there is no unusual noise in the low speed range (10% or less) and that the motor does not rotate in reverse at start. <p>If there is unusual noise in the low speed range (10% or less), increase <i>n8-41</i> in increments of 0.5. Set <i>n8-41 > 0.0</i> for IPM motors.</p> <p>Note: If the drive detects <i>End8</i>, it will automatically set <i>n8-35 = 0 [Pull-in]</i> and <i>n8-57 = 0 [Disabled]</i>. Do not change the settings unless necessary.</p>
End9	Initial Pole Detection Alarm	The drive cannot calculate the correct value for <i>n8-84 [Polarity Detection Current]</i> during High Frequency Injection Tuning.	<ul style="list-style-type: none"> Set the correct value on the motor nameplate <i>E5-xx [PM motor parameters]</i> or do Stationary/Rotational Auto-Tuning, and then do High Frequency Injection Tuning again. When <i>n8-35 = 1 [Initial Pole Detection Method = High Frequency Injection]</i> or <i>n8-57 = 1 [HFI Overlap Selection = Enabled]</i>, make sure that the motor does not rotate in reverse at start. <p>If there is unusual noise in the low speed range (10% or less), increase <i>n8-41</i> in increments of 0.5. Set <i>n8-41 > 0.0</i> for IPM motors.</p> <p>Note: If the drive detects <i>End9</i>, it will automatically set <i>n8-35 = 0 [Pull-in]</i> and <i>n8-57 = 0 [Disabled]</i>. Do not change the settings unless necessary.</p>
Er-01	Motor Data Error	<p>The motor nameplate data entered during Auto-Tuning is incorrect.</p> <p>The combination of the motor rated power and motor rated current do not match.</p> <p>The combination of the motor rated current that was entered during Auto-Tuning and <i>E2-03 [Motor No-Load Current]</i> do not match.</p> <p>The combination of the setting values of Motor Base Frequency and Motor Base Speed do not match.</p>	<ul style="list-style-type: none"> Make sure that the motor nameplate data is correct. Do Auto-Tuning again and correctly set the motor nameplate data. Examine the combination of drive capacity and motor output. Do Auto-Tuning again, and correctly set the motor rated power and motor rated current. Examine the motor rated current and the no-load current. Set <i>E2-03</i> correctly. Do Auto-Tuning again, and correctly set the motor rated current. <p>Do Auto-Tuning again, and correctly set the Motor Base Frequency and Motor Base Speed.</p>
Er-02	Drive in an Alarm State	<p>The motor nameplate data entered during Auto-Tuning is incorrect.</p> <p>You did Auto-Tuning while the drive had a minor fault or alarm.</p> <p>There is a defective motor cable or cable connection.</p> <p>The load is too large.</p> <p>The drive detected a minor fault during Auto-Tuning.</p>	<ul style="list-style-type: none"> Make sure that the motor nameplate data entered in Auto-Tuning is correct. Do Auto-Tuning again and correctly set the motor nameplate data. <p>Clear the minor fault or alarm and do Auto-Tuning again.</p> <p>Examine and repair motor wiring.</p> <ul style="list-style-type: none"> Decrease the load. Examine the machine area to see if, for example, the motor shaft is locked. <ol style="list-style-type: none"> Stop Auto-Tuning. Examine the minor fault code and remove the cause of the problem. Do Auto-Tuning again.
Er-03	STOP Button was Pressed	During Auto-Tuning,  was pushed.	Auto-Tuning did not complete correctly. Do Auto-Tuning again.

Code	Name	Causes	Possible Solutions
Er-04	Line-to-Line Resistance Error	The Auto-Tuning results were not in the applicable parameter setting range.	<ul style="list-style-type: none"> Examine and repair motor wiring. Disconnect the machine from the motor and do Rotational Auto-Tuning again.
		Auto-Tuning did not complete in a pre-set length of time.	
		There is a defective motor cable or cable connection.	<ul style="list-style-type: none"> Make sure that the input motor nameplate data is correct. Do Auto-Tuning again and correctly set the motor nameplate data.
		The motor nameplate data entered during Auto-Tuning is incorrect.	
Code	Name	Causes	Possible Solutions
Er-05	No-Load Current Error	The Auto-Tuning results were not in the applicable parameter setting range.	<ul style="list-style-type: none"> Examine and repair motor wiring. Disconnect the machine from the motor and do Rotational Auto-Tuning again.
		Auto-Tuning did not complete in a pre-set length of time.	
		The motor nameplate data entered during Auto-Tuning is incorrect.	<ul style="list-style-type: none"> Make sure that the input motor nameplate data is correct. Do Auto-Tuning again and correctly set the motor nameplate data.
		Rotational Auto-Tuning was done with a load that was more than 30% of the rating connected to the motor.	<ul style="list-style-type: none"> Disconnect the machine from the motor and do Rotational Auto-Tuning again. If you cannot uncouple the motor and load, make sure that the load is less than 30% of the motor rating. If a mechanical brake is installed in the motor, release the brake during Rotational Auto-Tuning.
Code	Name	Causes	Possible Solutions
Er-08	Rated Slip Error	The motor nameplate data entered during Auto-Tuning is incorrect.	<ul style="list-style-type: none"> Make sure that the input motor nameplate data is correct. Do Auto-Tuning again and correctly set the motor nameplate data.
		Auto-Tuning did not complete in a pre-set length of time.	<ul style="list-style-type: none"> Examine and repair the motor wiring. If the motor and machine are connected during Rotational Auto-Tuning, decouple the motor from the machinery.
		The Auto-Tuning results were not in the applicable parameter setting range.	
		Rotational Auto-Tuning was done with a load that was more than 30% of the rating connected to the motor.	<ul style="list-style-type: none"> Disconnect the machine from the motor and do Rotational Auto-Tuning again. If you cannot uncouple the motor and load, make sure that the load is less than 30% of the motor rating. If a mechanical brake is installed in the motor, release the brake during Rotational Auto-Tuning.
Code	Name	Causes	Possible Solutions
Er-09	Acceleration Error	The motor did not accelerate for the specified acceleration time.	<ol style="list-style-type: none"> Increase the value set in <i>CI-01 [Acceleration Time 1]</i>. Disconnect the machine from the motor and do Rotational Auto-Tuning again.
		The value of <i>L7-01</i> or <i>L7-02 [Forward/Reverse Torque Limit]</i> is small.	Increase the value set in <i>L7-01</i> or <i>L7-02</i> .
		Rotational Auto-Tuning was done with a load that was more than 30% of the rating connected to the motor.	<ul style="list-style-type: none"> Disconnect the machine from the motor and do Rotational Auto-Tuning again. If you cannot uncouple the motor and load, make sure that the load is less than 30% of the motor rating. If a mechanical brake is installed in the motor, release the brake during Rotational Auto-Tuning.
Code	Name	Causes	Possible Solutions
Er-10	Motor Direction Error	There is defective drive and motor wiring.	Examine and repair motor wiring.
		There is defective drive and encoder wiring.	Examine and repair the wiring to the encoder.
		The machine pulled the motor to rotate in the opposite direction.	Disconnect the machine from the motor and do Rotational Auto-Tuning again.
		When the torque reference is 100% or higher, the sign of the speed reference was opposite of the detected speed.	
Code	Name	Causes	Possible Solutions
Er-11	Motor Speed Error	The torque reference during acceleration is too high (100%).	<ul style="list-style-type: none"> Increase the value set in <i>CI-01 [Acceleration Time 1]</i>. Disconnect the machine from the motor and do Rotational Auto-Tuning again.

7.7 Auto-Tuning Errors

Code	Name	Causes	Possible Solutions
Er-12	Current Detection Error	There is a phase loss in the drive input power. (U/T1, V/T2, W/T3)	Examine and repair motor wiring.
		The current exceeded the current rating of the drive.	<ul style="list-style-type: none"> Check the motor wiring for any short circuits between the wires. Check and turn ON any magnetic contactors used between motors. Replace the control board or the drive. For information about replacing the control board, contact Yaskawa or your nearest sales representative.
		The output current is too low.	
		You tried Auto-Tuning without a motor connected to the drive.	Connect the motor and do Auto-Tuning.
		There was a current detection signal error.	Replace the control board or the drive. For information about replacing the control board, contact Yaskawa or your nearest sales representative.
Code	Name	Causes	Possible Solutions
Er-13	Leakage Inductance Alarm	The motor rated current value is incorrect.	Correctly set the rated current indicated on the motor nameplate and perform Auto-Tuning again.
		The drive could not complete tuning for leakage inductance in fewer than 300 seconds.	Examine and repair motor wiring.
Code	Name	Causes	Possible Solutions
Er-14	Motor Speed Error 2	The motor speed was more than two times the amplitude of speed reference during Inertia Tuning.	Decrease the value set in <i>C5-01 [ASR Proportional Gain 1]</i> .
Code	Name	Causes	Possible Solutions
Er-15	Torque Saturation Error	During Inertia Tuning, the output torque was more than the value set in <i>L7-01 to L7-04 [Torque Limit]</i> .	<ul style="list-style-type: none"> Increase the value set in <i>L7-01 to L7-04 [Torque Limit]</i> as much as possible. Decrease the values set for the frequency and amplitude of the test signals used when doing inertia tuning. First, decrease the test signal amplitude, and then do Inertia Tuning. If the error continues, decrease the test signal frequency and do Inertia Tuning again.
Code	Name	Causes	Possible Solutions
Er-16	Inertia ID Error	The inertia found by the drive was too small or too large during Inertia Tuning (10% or less, or 50000% or more).	<ul style="list-style-type: none"> Decrease the values set for the frequency and amplitude of the test signals used when doing inertia tuning. First, decrease the test signal amplitude, and then do Inertia Tuning. If the error continues, decrease the test signal frequency and do Inertia Tuning again. Correctly set the motor inertia as specified by the motor, and do Inertia Tuning again.
Code	Name	Causes	Possible Solutions
Er-17	Reverse Prohibited Error	<i>b1-04 = 1 [Reverse Operation Selection = Reverse Disabled]</i> Note: You cannot do Inertia Tuning if the drive cannot rotate the motor in reverse.	<ol style="list-style-type: none"> Enable reverse in the target machine. Set <i>b1-04 = 0 [Reverse Enabled]</i>. Do Inertia Tuning again.
Code	Name	Causes	Possible Solutions
Er-18	Back EMF Error	The result of the induced voltage tuning was not in the applicable range.	<ol style="list-style-type: none"> Make sure that the input motor nameplate data is correct. Do Auto-Tuning again and correctly set the motor nameplate data.
Code	Name	Causes	Possible Solutions
Er-19	PM Inductance Error	The Auto-Tuning results of the PM motor inductance were not in the applicable range.	<ol style="list-style-type: none"> Make sure that the input motor nameplate data is correct. Do Auto-Tuning again and correctly set the motor nameplate data.
Code	Name	Causes	Possible Solutions
Er-20	Stator Resistance Error	The Auto-Tuning results of the PM Motor Stator Resistance were not in the applicable range.	<ol style="list-style-type: none"> Make sure that the input motor nameplate data is correct. Do Auto-Tuning again and correctly set the motor nameplate data.
Code	Name	Causes	Possible Solutions
Er-25	HighFreq Inject Param Tuning Err	The motor data is incorrect.	Do Stationary Auto-Tuning again. Note: If the drive detects <i>Er-25</i> after doing Stationary Auto-Tuning, the motor may not be able to use high frequency injection control. Contact Yaskawa or your nearest sales representative for more information.

7.8 Backup Function Operating Mode Display and Errors

◆ Operating Mode Display

When you use the LCD keypad to do the backup function, the keypad shows the running operation on the LCD display. These indicators do not show that an error has occurred.

Keypad Display	Name	Display	Status
Drive and Keypad mismatch. Should the parameters be restored?	Detection of inconsistency between the drive and keypad	Normally displayed	The drive detected the connection of a keypad from a different drive. Select [Yes] to copy parameters backed up in the keypad to the connected drive.
Restore Restore from keypad	Restoring parameters	Flashing	The parameters stored in the keypad have been restored to the drive.
End	Backup/restore/verify operation ended normally	Normally displayed	The parameter backup, restore, or verify operation ended normally.
Backup Backup from Drive	Backing up parameters	Flashing	The parameters stored in the drive are being backed up to the keypad.
Verify Keypad & Drive	Verifying parameters	Flashing	The parameter settings stored in the keypad and the parameter settings in the drive match or are being compared.

◆ Backup Function Runtime Errors

When an error occurs, the keypad shows a code to identify the error.

The table in this section show the error codes. If there are errors, refer to these tables:

Note:

Push any key on the keypad to clear an error.

Code	Name	Causes	Possible Solutions
CPEr	Control Mode Mismatch	The keypad setting and drive setting for <i>A1-02 [Control Method Selection]</i> do not agree.	<ol style="list-style-type: none"> Set <i>A1-02</i> on the drive to the same value that is on the keypad. Restore the parameters.
CPyE	Error Writing Data	Parameter restore did not end correctly.	Restore the parameters.
CSEr	Control Mode Mismatch	The keypad is broken.	Replace the keypad.
dFPS	Drive Model Mismatch	You tried to restore parameters to a different drive model than the one that you backed up.	<ol style="list-style-type: none"> Examine the drive model that you used to back up the parameters. Restore the parameters.
iFEr	Keypad Communication Error	There was a communications error between the keypad and the drive.	Examine the connector or cable connection.
ndAT	Error Received Data	<p>The parameter settings for model and specifications (power supply voltage and capacity) are different between the keypad and the drive.</p> <p>The parameters are not stored in the keypad.</p>	<ol style="list-style-type: none"> Make sure that drive model and the value set in <i>o2-04 [Drive Model (KVA) Selection]</i> agree. Restore the parameters. Connect a keypad that has the correct parameters. Restore the parameters.
PWEr	DWEZ Password Mismatch	The password set in the backup operation with <i>qx-xx [DriveWorksEZ Parameters]</i> and <i>rx-xx [DriveWorksEZ Connections]</i> is incorrect.	Set the DWEZ PC software password supplied by Yaskawa for the DWEZ program user ID downloaded to the drive.
<p>Note: <i>U8-11 and U8-12 [DWEZ Versions 1 and 2]</i> show the user ID of the DWEZ program.</p>			

7.8 Backup Function Operating Mode Display and Errors

Code	Name	Causes	Possible Solutions
rdEr	Error Reading Data	You tried to back up the data when <i>o3-02 = 0 [Copy Allowed Selection = Disabled]</i> .	Set <i>o3-02 = 1 [Enabled]</i> and back up again.
Code	Name	Causes	Possible Solutions
vAEr	Voltage Class, Capacity Mismatch	The power supply specifications or drive capacity parameter settings are different between the keypad and the drive.	<ol style="list-style-type: none"> 1. Make sure that drive model and the value set in <i>o2-04 [Drive Model (KVA) Selection]</i> agree. 2. Restore the parameters.
Code	Name	Causes	Possible Solutions
vFyE	Parameters do not Match	The parameters that are backed up in the keypad and the parameters in the drive are not the same.	<ol style="list-style-type: none"> 1. Restore or backup the parameter again. 2. Verify the parameters.

7.9 Diagnosing and Resetting Faults

When a fault occurs and the drive stops, do the procedures in this section to remove the cause of the fault, then re-energize the drive.

◆ Fault and Power Loss Occur at the Same Time

WARNING! Crush Hazard. Wear eye protection when you do work on the drive. If you do not use correct safety equipment, it can cause serious injury or death.

WARNING! Electrical Shock Hazard. After the drive blows a fuse or trips a GFCI, do not immediately energize the drive or operate peripheral devices. Wait for the time specified on the warning label at a minimum and make sure that all indicators are OFF. Then check the wiring and peripheral device ratings to find the cause of the problem. If you do not know the cause of the problem, contact Yaskawa before you energize the drive or peripheral devices. If you do not fix the problem before you operate the drive or peripheral devices, it can cause serious injury or death.

1. Supply power to the control circuit from the external 24 V input.
2. Use monitor parameters $U2-xx$ [*Fault Trace*] to show the fault code and data about the operating status of the drive immediately before the fault occurred.
3. Use the information in the Troubleshooting tables to remove the fault.

Note:

1. To find the faults that were triggered, check the fault history in $U2-02$ [*Previous Fault*]. To find information about drive status (such as frequency, current, and voltage) when the faults were triggered, check $U2-03$ to $U2-20$.
2. If the fault display stays after you re-energize the drive, remove the cause of the fault and reset.

◆ Fault Occurs Without Power Loss

1. Examine the fault code shown on the keypad.
2. Use the information in the Troubleshooting tables to remove the fault.
3. Do a fault reset.

◆ Fault Reset Procedure

If a fault occurs, you must remove the cause of the fault and re-energize the drive. [Table 7.3](#) lists the different methods to reset the drive after a fault.

Table 7.3 Fault Reset Methods

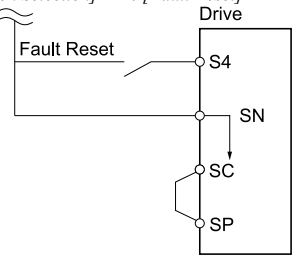
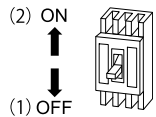
Methods	Description
Method 1	While the keypad is showing the fault or alarm code, push  on the keypad.
Method 2	<p>Switch ON the MFDI terminal set to $H1-xx = 14$ [<i>MFDI Function Select = Fault Reset</i>].</p> <p>Note: The default setting for $H1-04$ [<i>Terminal S4 Function Selection</i>] is 14 [<i>Fault Reset</i>].</p> 
Method 3	<ol style="list-style-type: none"> 1. De-energize the drive main circuit power supply. 2. Energize the drive again after the keypad display goes out. 

Note:

If the drive receives a Run command from a communication option or control circuit terminal, the drive will not reset the fault. Turn the Run command OFF to reset the fault. If you do a fault reset when the drive has a Run command, the keypad will show minor fault *CrST [Remove RUN Command to Reset]*.

7.10 Troubleshooting Without Fault Display

Note:

Make sure that you use a keypad that has a flash number of 1004 or later. Keypads that have a flash number of 1003 or earlier will not show characters correctly.

If the drive or motor operate incorrectly, but the keypad does not show a fault or error code, refer to the items this section.

- Motor hunting and oscillation
- Unsatisfactory motor torque
- Unsatisfactory speed precision
- Unsatisfactory motor torque and speed response
- Motor noise

◆ Typical Problems

Symptom	Reference
The Parameter Settings Will Not Change	309
The Motor Does Not Rotate after You Enter a Run Command	310
The Motor Rotates in the Opposite Direction from the Run Command	311
The Motor Rotates in Only One Direction	311
The Motor Is Too Hot	311
The Correct Auto-Tuning Mode Is Not Available	312
The Motor Stalls during Acceleration or Accel/Decel Time Is Too Long	312
The Drive Frequency Reference Is Different than the Controller Frequency Reference Command	313
PM Motor Speed Is Not Stable	313
There Is Too Much Motor Oscillation and the Rotation Is Irregular	313
Deceleration Takes Longer than Expected when You Enable Dynamic Braking	313
There Is Audible Noise from the Drive or Motor Cables when You Energize the Drive	314
The Ground Fault Circuit Interrupter (GFCI) Trips During Run	314
Motor Rotation Causes Unexpected Audible Noise from Connected Machinery	314
Motor Rotation Causes Oscillation or Hunting	314
PID Output Fault	315
The Starting Torque Is Not Sufficient	315
The Motor Rotates after You Shut Off Drive Output	315
The Output Frequency Is Lower Than the Frequency Reference	315
The Motor Will Not Restart after Power Loss	316







◆ The Parameter Settings Will Not Change

Causes	Possible Solutions
The drive is operating the motor (the drive is in Drive Mode).	Stop the drive and change to Programming Mode.
Parameter $A1-01 = 0$ [Access Level Selection = Operation Only].	Set $A1-01 = 2$ [Access Level Selection = Advanced Level] or $A1-01 = 3$ [Expert Level].
Parameter $H1-xx = 1B$ [MFDI Function Select = Programming Lockout].	Activate the terminals to which $H1-xx = 1B$ is set, and then change the parameters.

7.10 Troubleshooting Without Fault Display

Causes	Possible Solutions
You entered an incorrect password in A1-04 [Password].	<ul style="list-style-type: none"> Enter the correct password to A1-04 again. If you forgot the password, set the password again with A1-04 and A1-05 [Password Setting]. <p>Note: If you set the password, you cannot change these parameters until the password aligns:</p> <ul style="list-style-type: none"> A1-01 [Access Level Selection] A1-02 [Control Method Selection] A1-03 [Initialize Parameters] A1-06 [Application Preset] A1-07 [DriveWorksEZ Function Selection] A2-01 to A2-32 [User Parameter 1 to User Parameter 32]
The drive detected Uv [Undervoltage].	<ul style="list-style-type: none"> View U1-07 [DC Bus Voltage] to see the power supply voltage. Examine the main circuit wiring.

◆ The Motor Does Not Rotate after You Enter a Run Command

Causes	Possible Solutions
The drive is not in Drive Mode.	<ol style="list-style-type: none"> Make sure that the READY LED on the keypad is ON. If the READY LED is OFF, push and hold the ESC Key to go back to the frequency reference screen (the initial screen).
The drive stopped and you pushed  to transfer the Run command source to the keypad.	<p>Do one of these two:</p> <ul style="list-style-type: none"> Push . Re-energize the drive. <p>Note: When  must not change the Run command source, set o2-01 = 0 [LO/RE Key Function Selection = Disabled].</p>
Auto-Tuning completed.	<p>Push and hold the ESC Key to go back to the frequency reference screen (the initial screen).</p> <p>Note: When Auto-Tuning completes, the drive changes to Programming Mode. The drive will not accept a Run command unless the drive is in Drive Mode.</p>
The drive received a Fast Stop command.	Turn off the fast stop input signal.
The settings for the source that supplies the Run command are incorrect.	Set b1-02 [Run Command Selection 1] correctly.
The frequency reference source is not set correctly.	Set b1-01 [Frequency Reference Selection 1] correctly.
There is defective wiring in the control circuit terminals.	<ul style="list-style-type: none"> Correctly wire the drive control circuit terminals. View U1-10 [Input Terminal Status] for input terminal status.
The settings for voltage input and current input of the master frequency reference are incorrect.	<p>Examine these analog input terminal signal level settings:</p> <ul style="list-style-type: none"> Terminal A1: H3-01 [Terminal A1 Signal Level Select] Terminal A2: DIP switch S1 and H3-09 [Terminal A2 Signal Level Select]
The selection for the sinking/sourcing mode and the internal/external power supply is incorrect.	<ul style="list-style-type: none"> For sinking mode, close the circuit between terminals SC-SP with a wire jumper. For sourcing mode, close the circuit between terminals SC-SN with a wire jumper. For external power supply, remove the wire jumper.
The frequency reference is too low.	<ul style="list-style-type: none"> View U1-01 [Freq Reference]. Increase the frequency reference to a value higher than E1-09 [Minimum Output Frequency].
The MFAI setting is incorrect.	<ul style="list-style-type: none"> Make sure that the functions set to the MFAI are correct. The frequency reference is 0 when H3-02, H3-10 = 1 [MFAI Function Select = Frequency Gain] and voltage (current) is not input. Use U1-13, U1-14 [Terminal A1, A2 Input Voltage] to make sure that the analog input values set to terminals A1 and A2 are applicable.
You pushed  .	<p>Turn the Run command OFF then ON from an external input.</p> <p>Note: When you push  during operation, the drive will ramp to stop. Set o2-02 = 0 [STOP Key Function Selection = Disabled] to disable the  function.</p>
The 2-wire sequence and 3-wire sequence are not set correctly.	<ul style="list-style-type: none"> Set one of the parameters H1-03 to H1-07 [Terminals S3 to S7 Function Select] to 0 [3-Wire Sequence] to enable the 3-wire sequence. If a 2-wire sequence is necessary, make sure that H1-03 to H1-07 ≠ 0.

◆ The Motor Rotates in the Opposite Direction from the Run Command

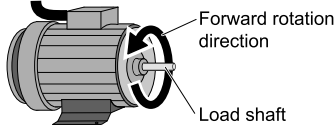
Causes	Possible Solutions
The phase wiring between the drive and motor is incorrect.	<ul style="list-style-type: none"> Examine the wiring between the drive and motor. Connect drive output terminals U/T1, V/T2, and W/T3 in the correct sequence to agree with motor terminals U, V, and W. Switch two motor cables U, V, and W to reverse motor direction.
The forward direction for the motor is set incorrectly.	<ul style="list-style-type: none"> Connect drive output terminals U/T1, V/T2, and W/T3 in the correct sequence to agree with motor terminals U, V, and W. Switch two motor cables U, V, and W to reverse motor direction.  <p style="text-align: center;">Figure 7.1 Forward Rotating Motor</p> <p>Note:</p> <ul style="list-style-type: none"> For Yaskawa motors, the forward direction is counterclockwise when looking from the motor shaft side. Refer to the motor specifications, and make sure that the forward rotation direction is correct for the application. The forward rotation direction of motors can be different for different motor manufacturers and types.
The signal connections for forward run and reverse run on the drive control circuit terminals and control panel side are incorrect.	Correctly wire the control circuit.
The motor is running at almost 0 Hz and the Speed Search estimated the speed to be in the opposite direction.	Set $b3-14 = 0$ [<i>Bi-directional Speed Search = Disabled</i>], then the drive will only do speed search in the specified direction.

◆ The Motor Rotates in Only One Direction

Causes	Possible Solutions
The drive will not let the motor rotate in reverse.	Set $b1-04 = 0$ [<i>Reverse Operation Selection = Reverse Enabled</i>].
The drive did not receive a Reverse run signal and 3-Wire sequence is selected.	Activate the terminals to which $H1-xx = 0$ [<i>3-Wire Sequence</i>] is set, and then enable reverse operation.

◆ The Motor Is Too Hot

Causes	Possible Solutions
The load is too heavy.	<ul style="list-style-type: none"> Decrease the load. Increase the acceleration and deceleration times. Examine the values set in $L1-01$ [<i>Motor Overload (oL1) Protection</i>], $L1-02$ [<i>Motor Overload Protection Time</i>], and $E2-01$ [<i>Motor Rated Current (FLA)</i>]. Use a larger motor. <p>Note: The motor also has a short-term overload rating. Examine this rating carefully before setting drive parameters.</p>
The motor is running continuously at a very low speed.	<ul style="list-style-type: none"> Change the run speed. Use a drive-dedicated motor.
The drive is operating in a vector control mode, but Auto-Tuning has not been done.	<ul style="list-style-type: none"> Do Auto-Tuning. Calculate motor parameter and set motor parameters. Set $A1-02 = 0$ [<i>Control Method Selection = V/f Control</i>].
The voltage insulation between motor phases is not sufficient.	<ul style="list-style-type: none"> Use a motor with a voltage tolerance that is higher than the maximum voltage surge. Use a drive-dedicated motor that is rated for use with AC drives for applications that use a motor on drives rated higher than 400 V class. Install an AC reactor on the output side of the drive and set $C6-02 = 1$ [<i>Carrier Frequency Selection = 2.0 kHz</i>]. <p>Note: When the motor is connected to the drive output terminals U/T1, V/T2, and W/T3, surges occur between the drive switching and the motor coils. These surges can be three times the drive input power supply voltage (600 V for a 200 V class drive, 1200 V for a 400 V class drive).</p>
The air around the motor is too hot.	<ul style="list-style-type: none"> Measure the ambient temperature. Decrease the temperature in the area until it is in the specified temperature range.
The motor fan stopped or is clogged.	<ul style="list-style-type: none"> Clean the motor fan. Make the drive environment better.

◆ The Correct Auto-Tuning Mode Is Not Available

Causes	Possible Solutions
The desired Auto-Tuning mode is not available for the selected control mode.	Change the motor control method with parameter <i>A1-02 [Control Method Selection]</i> .

◆ The Motor Stalls during Acceleration or Accel/Decel Time Is Too Long

Causes	Possible Solutions
The drive and motor system are at the torque limit or current suppression will not let the drive accelerate.	<ul style="list-style-type: none"> Decrease the load. Use a larger motor. <p>Note: Although the drive has a Stall Prevention function and a Torque Compensation Limit function, if you try to accelerate too fast or try to drive a load that is too large, it can be too much for the limits of the motor.</p>
Torque limit is set incorrectly.	Set the torque limit correctly.
The acceleration time setting is too short.	Examine the values set in <i>C1-01, C1-03, C1-05, or C1-07 [Acceleration Time]</i> and set them to applicable values.
The load is too large.	<ul style="list-style-type: none"> Increase the acceleration time. Examine the mechanical brake and make sure that it is fully releasing. Decrease the load to make sure that the output current stays less than the motor rated current. Use a larger motor. <p>Note:</p> <ul style="list-style-type: none"> In extruder and mixer applications, the load can increase as the temperature decreases. Although the drive has a Stall Prevention function and a Torque Compensation Limit function, if you try to accelerate too fast or try to drive a load that is too large, it can be too much for the limits of the motor.
The frequency reference is low.	<ul style="list-style-type: none"> Examine <i>E1-04 [Maximum Output Frequency]</i> and increase the setting if it is set too low. Examine <i>U1-01 [Frequency Reference]</i> for the correct frequency reference. Examine the multi-function input terminals to see if a frequency reference signal switch is set. When you use an MFAI, examine the low gain level set in <i>H3-03, H3-11 [Terminal A1, A2 Gain Setting]</i>.
The frequency reference is set incorrectly.	<p>When <i>H3-10 = 1 Terminal A2 Function Selection = Frequency Gain</i>, see if the drive is set for voltage (current).</p> <ul style="list-style-type: none"> Examine the value set in <i>H3-10</i>. Use <i>U1-14 [Terminal A2 Input Voltage]</i> to make sure that the analog input value set to terminal A2 is applicable.
The motor characteristics and drive parameter settings are not compatible.	<ul style="list-style-type: none"> Set the correct V/f pattern to agree with the characteristics of the motor. Examine the V/f pattern set in <i>E1-03 [V/f Pattern Selection]</i>. Do Rotational Auto-Tuning.
The drive is operating in vector control mode, but you did not complete Auto-Tuning.	<ul style="list-style-type: none"> Do Auto-Tuning. Calculate motor data and reset motor parameters. Set <i>A1-02 = 0 [Control Method Selection = V/f Control]</i>.
The Stall Prevention level during acceleration setting is too low.	<p>Increase the value set in <i>L3-02 [Stall Prevent Level during Accel]</i>.</p> <p>Note: If the <i>L3-02</i> value is too low, the acceleration time can be unsatisfactorily long.</p>
The Stall Prevention level during run setting is too low.	<p>Increase the value set in <i>L3-06 [Stall Prevent Level during Run]</i>.</p> <p>Note: If the <i>L3-06</i> value is too low, speed will decrease before the drive outputs torque.</p>
The drive is at the limit of the V/f motor control method.	<ul style="list-style-type: none"> When the motor cable is longer than 50 m (164 ft), do Auto-Tuning for line-to-line resistance. Set the V/f pattern to "High Starting Torque". Use a Vector Control method. <p>Note: V/f control method does not supply high torque at low speeds.</p>

◆ The Drive Frequency Reference Is Different than the Controller Frequency Reference Command

Causes	Possible Solutions
The analog input gain and bias for the frequency reference input are set incorrectly.	Examine the gain and bias settings for the analog inputs that set the frequency reference. <ul style="list-style-type: none"> Terminal A1: H3-03 [Terminal A1 Gain Setting], H3-04 [Terminal A1 Bias Setting] Terminal A2: H3-11 [Terminal A2 Gain Setting], H3-12 [Terminal A2 Bias Setting]
The drive is receiving frequency bias signals from analog input terminals A1 and A2 and the sum of all signals makes the frequency reference.	<ul style="list-style-type: none"> Examine parameters H3-02, H3-10 [MFAI Function Select]. If both of these parameters = 0, change the settings. Use U1-13, U1-14 [Terminal A1, A2 Input Voltage] to make sure that the analog input values set to terminals A1 and A2 are applicable.
PID control is enabled.	If PID control is not necessary, set b5-01 = 0 [PID Mode Setting = Disabled]. <p>Note: When PID control is enabled, the drive adjusts the output frequency as specified by the target value. The drive will only accelerate to the maximum output frequency set in E1-04 [Maximum Output Frequency] while PID control is active.</p>

◆ The Motor Speed Is Not Stable When Using a PM Motor

Causes	Possible Solutions
E5-01 [PM Motor Code Selection] is set incorrectly.	Refer to "Motor Performance Fine-Tuning" in the technical manual.
The drive is operating the motor at more than the specified speed control range.	Examine the speed control range and adjust the speed.
The motor is hunting.	Adjust these parameters to have the largest effect: <ul style="list-style-type: none"> n8-55 [Motor to Load Inertia Ratio] n8-45 [Speed Feedback Detection Gain] C4-02 [Torque Compensation Delay Time]
Hunting occurs at start.	Increase the value set in C2-01 [S-Curve Time @ Start of Accel].
Too much current is flowing through the drive.	Set E5-01 [PM Motor Code Selection] correctly as specified by the motor. For special-purpose motors, enter the correct value to E5-xx as specified by the motor test report.
Operation is not stable when n8-57 = 1 [HFI Overlap Selection = Enabled].	<ul style="list-style-type: none"> Do High Frequency Injection Auto-Tuning. Decrease the value set in n8-41 [HFI P Gain] in increments of 0.5. <p>Note: Set n8-41 > 0.0 for IPM motors.</p>

◆ There Is Too Much Motor Oscillation and the Rotation Is Irregular

Causes	Possible Solutions
Unsatisfactory balance of motor phases.	<ul style="list-style-type: none"> Make sure that the drive input power voltage supplies stable power. Set L8-05 = 0 [Input Phase Loss Protect Select = Disabled].
The motor is hunting.	<ul style="list-style-type: none"> Set n1-01 = 1 [Hunting Prevention Selection = Enabled]. Increase the value of n2-01 [SpdFeedbackDetectCtr (AFR) Gain] or n2-02 [SpdFeedbackDetCtr (AFR)TimeConst1].

◆ Deceleration Takes Longer Than Expected When Dynamic Braking Is Enabled

Causes	Possible Solutions
The stall prevention during deceleration setting is incorrect.	<ul style="list-style-type: none"> Examine the setting for L3-04 [Decel Stall Prevention Selection]. When the drive has a dynamic braking option installed, set L3-04 = 0 [Disabled]. If the drive detects ov [Overvoltage], set L3-04 = 3 [General Purpose w/ DB resistor].
The deceleration time setting is too long.	Set C1-02, C1-04, C1-06, or C1-08 [Deceleration Times] to applicable values.
The motor torque is not sufficient.	Use a larger motor. <p>Note: If these items are correct, the demand on the motor is more than the motor capacity:</p> <ul style="list-style-type: none"> Parameter settings are correct. The drive does not detect ov [Overvoltage].

7.10 Troubleshooting Without Fault Display

Causes	Possible Solutions
The drive and motor system reached the torque limit.	<ul style="list-style-type: none"> Examine the values set in L7-01 to L7-04 [Torque Limit] and increase them if necessary. <p>Note: If the torque limit is enabled, deceleration time can increase because the drive cannot output more torque than the limit.</p> <ul style="list-style-type: none"> If H3-02, H3-10 = 10, 11, 12, 15 [MFAI Function Select = Torque Limit], examine the settings for the MFAIs. <ul style="list-style-type: none"> Examine the values set in H3-02 and H3-10. Use U1-13, U1-14 [Terminal A1, A2 Input Voltage] to make sure that the analog input values set to terminals A1 and A2 are applicable.
The load is more than the internal torque limit as specified by the drive rated current.	Replace the drive with a larger capacity model.

◆ There Is Audible Noise from the Drive or Motor Cables when You Energize the Drive

Causes	Possible Solutions
The relay switching in the drive is making too much noise.	<ul style="list-style-type: none"> Use C6-02 [Carrier Frequency Selection] to decrease the carrier frequency. Connect a noise filter to the input side of the drive power supply. Connect a noise filter to the output side of the drive. Isolate the control circuit wiring from the main circuit wiring. Use a metal cable gland to wire the drive. Shield the periphery of the drive with metal. Make sure that the drive and motor are grounded correctly. Make sure that ground faults have not occurred in the wiring or motor.

◆ The Ground Fault Circuit Interrupter (GFCI) Trips During Run

Causes	Possible Solutions
There is too much leakage current from the drive.	<ul style="list-style-type: none"> Increase the GFCI sensitivity or use GFCI with a higher threshold. Use C6-02 [Carrier Frequency Selection] to decrease the carrier frequency. Decrease the length of the cable used between the drive and the motor. Install a noise filter or AC reactor on the output side of the drive. Set C6-02 = 1 [2.0 kHz] when connecting an AC reactor. Disable the internal EMC filter.

◆ Motor Rotation Causes Unexpected Audible Noise from Connected Machinery

Causes	Possible Solutions
The carrier frequency and the resonant frequency of the connected machinery are the same.	<ul style="list-style-type: none"> Adjust C6-02 to C6-05 [Carrier Frequency]. Set C6-02 = 1 to 6 [Carrier Frequency Selection = Frequency other than Swing PWM]. <p>Note: If C6-02 = 7 to A [Carrier Frequency Selection = Swing PWM], the drive will not know if the noise comes from the drive or the machine.</p>
The drive output frequency and the resonant frequency of the connected machinery are the same.	<ul style="list-style-type: none"> Adjust d3-01 to d3-04 [Jump Frequency]. Put the motor on a rubber pad to decrease vibration.

◆ Motor Rotation Causes Oscillation or Hunting

Causes	Possible Solutions
The frequency reference is assigned to an external source, and there is electrical interference in the signal.	<p>Make sure that electrical interference does not have an effect on the signal lines.</p> <ul style="list-style-type: none"> Isolate control circuit wiring from main circuit wiring. Use twisted-pair cables or shielded wiring for the control circuit. Increase the value of H3-13 [Analog Input Filter Time Constant].
The cable between the drive and motor is too long.	<ul style="list-style-type: none"> Do Auto-Tuning. Make the wiring as short as possible.
The PID parameters are not sufficiently adjusted.	Adjust b5-xx [PID control].

◆ PID Output Fault

Causes	Possible Solutions
There is no PID feedback input.	<ul style="list-style-type: none"> Examine the MFAI terminal settings. Make sure that $H3-02, H3-10 = B$ [MFAI Function Select = PID Feedback]. Make sure that the MFAI terminal settings agree with the signal inputs. Examine the connection of the feedback signal. Make sure that you set $b5-xx$ [PID Control] correctly. <p>Note: If there is no PID feedback input to the terminal, the detected value is 0, which causes a PID fault and also causes the drive to operate at maximum frequency.</p>
The detection level and the target value do not align.	<p>Use $H3-03, H3-11$ [Terminal A1 and A2 Gain Setting] to adjust PID target and feedback signal scaling.</p> <p>Note: PID control keeps the difference between the target value and detection value at 0. Set the input level for the values relative to each other.</p>
Reverse drive output frequency and speed detection. When output frequency increases, the sensor detects a speed decrease.	Set $b5-09 = 1$ [PID Output Level Selection = Reverse output (reverse acting)].

◆ The Starting Torque Is Not Sufficient

Causes	Possible Solutions
Auto-Tuning has not been done in vector control method.	Do Auto-Tuning.
The control method was changed after doing Auto-Tuning.	Do Auto-Tuning again.
Stationary Auto-Tuning for Line-to-Line Resistance was done.	Do Rotational Auto-Tuning.

◆ The Motor Rotates after the Drive Output Is Shut Off

Causes	Possible Solutions
DC Injection Braking is too low and the drive cannot decelerate correctly.	<ul style="list-style-type: none"> Increase the value set in $b2-02$ [DC Injection Braking Current]. Increase the value set in $b2-04$ [DC Inject Braking Time at Stop].
The stopping method makes the drive coast to stop.	Set $b1-03 = 0$ or 2 [Stopping Method Selection = Ramp to Stop, DC Injection Braking to Stop].

◆ The Output Frequency Is Lower Than the Frequency Reference

Causes	Possible Solutions
The frequency reference is in the Jump frequency range.	<p>Adjust $d3-01$ to $d3-03$ [Jump Frequency 1 to 3] and $d3-04$ [Jump Frequency Width].</p> <p>Note: Enabling the Jump frequency prevents the drive from outputting the frequencies specified in the Jump range.</p>
The upper limit for the frequency reference has been exceeded.	<p>Set $E1-04$ [Maximum Output Frequency] and $d2-01$ [Frequency Reference Upper Limit] to the best values for the application.</p> <p>Note: This calculation supplies the upper value for the output frequency: $E1-04 \times d2-01 / 100$</p>
A large load triggered Stall Prevention function during acceleration.	<ul style="list-style-type: none"> Decrease the load. Adjust $L3-02$ [Stall Prevent Level during Accel].
$L3-01 = 3$ [Stall Prevent Select during Accel = ILim Mode] has been set.	<ol style="list-style-type: none"> Check whether the V/f pattern and motor parameter settings are appropriate, and set them correctly. If this does not solve the problem, and it is not necessary to limit the current level of stall during acceleration, adjust $L3-02$. If this does not solve the problem, set $L3-01 = 1$ [Enabled].
The motor is rotating at this speed: $b2-01$ [DC Injection/Zero SpeedThreshold] \leq Motor Speed $< E1-09$ [Minimum Output Frequency]	Set $E1-09 < b2-01$.

◆ The Motor Will Not Restart after a Loss of Power

Causes	Possible Solutions
The drive did not receive a Run command after applying power.	<ul style="list-style-type: none">• Examine the sequence and wiring that enters the Run command.• Set up a relay to make sure that the Run command stays enabled during a loss of power.
For applications that use 3-wire sequence, the momentary power loss continued for a long time, and the relay that keeps the Run command has been switched off.	Examine the wiring and circuitry for the relay that keeps the Run command enabled during the momentary power loss ride-thru time.

Periodic Inspection and Maintenance

This chapter gives information about how to examine and maintain drives in use, how to replace cooling fans and other parts, and how to store drives.

8.1	Section Safety	318
8.2	Inspection.....	320
8.3	Maintenance	323
8.4	Replace Cooling Fans	325
8.5	Replace the Drive	331
8.6	Storage Guidelines	335

8.1 Section Safety

DANGER

Electrical Shock Hazard

Do not examine, connect, or disconnect wiring on an energized drive. Before servicing, disconnect all power to the equipment and wait for the time specified on the warning label at a minimum. The internal capacitor stays charged after the drive is de-energized. The charge indicator LED extinguishes when the DC bus voltage decreases below 50 Vdc. When all indicators are OFF, measure for dangerous voltages to make sure that the drive is safe.

If you do work on the drive when it is energized, it will cause serious injury or death from electrical shock.

Disconnect all power to the drive and wait for the time specified on the warning label before you remove covers. Check the drive for dangerous voltages before servicing or repair work.

If you do work on the drive when it is energized and there is no cover over the electronic circuits, it will cause serious injury or death from electrical shock. The drive has internal capacitors that stay charged after you de-energize the drive.

WARNING

Electrical Shock Hazard

The motor will run after you de-energize the drive. PM motors can generate induced voltage to the terminal of the motor after you de-energize the drive.

If you touch a motor that is moving or energized, it can cause serious injury or death.

Do not operate the drive when covers are missing. Replace covers and shields before you operate the drive. Use the drive only as specified by the instructions.

Some figures in this section include drives without covers or safety shields to more clearly show the inside of the drive. If covers or safety shields are missing from the drive, it can cause serious injury or death.

Always ground the motor-side grounding terminal.

If you do not ground the equipment correctly, it can cause serious injury or death if you touch the motor case.

Only let approved personnel install, wire, maintain, examine, replace parts, and repair the drive.

If personnel are not approved, it can cause serious injury or death.

Do not wear loose clothing or jewelry when you do work on the drive. Tighten loose clothing and remove all metal objects, for example watches or rings.

Loose clothing can catch on the drive and jewelry can conduct electricity and cause serious injury or death.

Fire Hazard

Tighten all terminal screws to the correct tightening torque.

Connections that are too loose or too tight can cause incorrect operation and damage to the drive. Incorrect connections can also cause death or serious injury from fire.

Damage to Equipment

Do not apply incorrect voltage to the main circuit of the drive. Operate the drive in the specified range of the input voltage on the drive nameplate.

Voltages that are higher than the permitted nameplate tolerance can cause damage to the drive.

Fire Hazard

Do not put flammable or combustible materials on top of the drive and do not install the drive near flammable or combustible materials. Attach the drive to metal or other noncombustible material.

Flammable and combustible materials can start a fire and cause serious injury or death.

⚠ WARNING**Electrical Shock Hazard**

Do not modify the drive body or drive circuitry.

Modifications to drive body and circuitry can cause serious injury or death, will cause damage to the drive, and will void the warranty. Yaskawa is not responsible for modifications of the product made by the user.

Sudden Movement Hazard

Make sure that you align the phase order for the drive and motor when you connect the motor to drive output terminals U/T1, V/T2, and W/T3.

If the phase order is incorrect, it can cause the motor to run in reverse. If the motor accidentally runs in reverse, it can cause serious injury or death.

⚠ CAUTION**Burn Hazard**

Do not touch a hot drive heatsink. De-energize the drive, wait for a minimum of 15 minutes, then make sure that the heatsink is cool before you replace the cooling fans.

If you touch a hot drive heatsink, it can burn you.

NOTICE**Damage to Equipment**

When you touch the drive and circuit boards, make sure that you observe correct electrostatic discharge (ESD) procedures.

If you do not follow procedures, it can cause ESD damage to the drive circuitry.

Use the instructions in this manual to replace the cooling fans. When you do maintenance on the fans, replace all the fans to increase product life.

If you install the fans incorrectly, it can cause damage to the drive.

Make sure that all connections are correct after you install the drive and connect peripheral devices.

Incorrect connections can cause damage to the drive.

Do not energize and de-energize the drive more frequently than one time each 30 minutes.

If you frequently energize and de-energize the drive, it can cause drive failure.

Do not operate a drive or connected equipment that has damaged or missing parts.

You can cause damage to the drive and connected equipment.

Note:

Do not use unshielded cable for control wiring. Use shielded, twisted-pair wires and ground the shield to the ground terminal of the drive. Unshielded wire can cause electrical interference and unsatisfactory system performance.

8.2 Inspection

Power electronics have limited life and can show changes in performance and deterioration of performance after years of use in usual conditions. To help prevent these problems, it is important to do preventive maintenance and regular inspection, and replace parts on the drive.

Drives contain different types of power electronics, for example power transistors, semiconductors, capacitors, resistors, fans, and relays. The electronics in the drive are necessary for correct motor control.

Follow the inspection lists in this chapter as a part of a regular maintenance program.

Note:

Examine the drive one time each year at a minimum.

The operating conditions, environmental conditions, and use conditions will have an effect on the examination frequency for connected equipment.

Examine the drive more frequently if you use the drive in bad conditions or in these conditions:

- High ambient temperatures
- Frequent starting and stopping
- Changes in the AC power supply or load
- Too much vibration or shock loading
- Dust, metal dust, salt, sulfuric acid, or chlorine atmospheres
- Unsatisfactory storage conditions.

◆ Recommended Daily Inspection

Table 8.1 gives information about the recommended daily inspection for Yaskawa drives. Examine the items in Table 8.1 each day to make sure that the components do not wear out or fail. Make a copy of this checklist and put a check mark in the “Checked” column after each inspection.

Table 8.1 Daily Inspection Checklist

Inspection Area	Inspection Points	Corrective Action	Checked
Motor	Examine for unusual oscillation or noise coming from the motor.	<ul style="list-style-type: none"> • Check the load coupling. • Measure motor vibration. • Tighten all loose components. 	
Cooling System	Examine for unusual heat from the drive or motor and visible discoloration.	<ul style="list-style-type: none"> • Check for a load that is too heavy. • Tighten loose screws. • Check for a dirty heatsink or motor. • Measure the ambient temperature. 	
	Examine the cooling fans.	<ul style="list-style-type: none"> • Check for a clogged or dirty fan. • Use the performance life monitor to check for correct fan operation. 	
Surrounding Environment	Make sure that the installation environment is applicable.	Remove the source of contamination or correct unsatisfactory environment.	
Load	Make sure that the drive output current is not more than the motor or drive rating for an extended period of time.	<ul style="list-style-type: none"> • Check for a load that is too heavy. • Check the correct motor parameter settings. 	
Power Supply Voltage	Examine main power supply and control voltages.	<ul style="list-style-type: none"> • Correct the voltage or power supply to agree with nameplate specifications. • Verify all main circuit phases. 	

◆ Recommended Periodic Inspection

Table 8.2 to Table 8.6 give information about the recommended periodic inspections for Yaskawa drives. Examine the drive one time each year at a minimum. The operating conditions, environmental conditions, and use conditions will have an effect on the examination frequency for connected equipment. You must use your experience with the application to select the correct inspection frequency for each drive installation. Periodic inspections will help to prevent performance deterioration and product failure. Make a copy of this checklist and put a check mark in the “Checked” column after each inspection.

DANGER! Electrical Shock Hazard. Do not examine, connect, or disconnect wiring on an energized drive. Before servicing, disconnect all power to the equipment and wait for the time specified on the warning label at a minimum. The internal capacitor stays charged after the drive is de-energized. The charge indicator LED extinguishes when the DC bus voltage decreases below 50 Vdc. When all indicators are OFF, measure for dangerous voltages to make sure that the drive is safe. If you do work on the drive when it is energized, it will cause serious injury or death from electrical shock.

Table 8.2 Main Circuit Periodic Inspection Checklist

Inspection Area	Inspection Points	Corrective Action	Checked
General	<ul style="list-style-type: none"> Examine equipment for discoloration from too much heat or deterioration. Examine for damaged parts. 	<ul style="list-style-type: none"> Replace damaged components as necessary. The drive does not have many serviceable parts and it could be necessary to replace the drive. 	
	Examine for dirt, unwanted particles, or dust on components.	<ul style="list-style-type: none"> Examine enclosure door seal. Use a vacuum cleaner to remove unwanted particles and dust without touching the components. If you cannot remove unwanted particles and dust with a vacuum cleaner, replace the components. 	
Conductors and Wiring	<ul style="list-style-type: none"> Examine wiring and connections for discoloration or damage. Examine wiring and connections for discoloration from too much heat. Examine wire insulation and shielding for discoloration and wear. 	Repair or replace damaged wiring.	
Terminal Block	Examine terminals for stripped, damaged, or loose connections.	<ul style="list-style-type: none"> Tighten loose screws. Replace damaged screws. 	
Electromagnetic Contactors and Relays	<ul style="list-style-type: none"> Examine contactors and relays for too much noise during operation. Examine coils for signs of too much heat, such as melted or broken insulation. 	<ul style="list-style-type: none"> Check coil voltage for overvoltage or undervoltage conditions. Replace broken relays, contactors, or circuit boards that you can remove. 	
Dynamic Braking Option	Examine the insulation for discoloration from too much heat.	If there is discoloration in the option, check to make sure that there is not damage to the wiring. A small quantity of discoloration is not a problem.	
Electrolytic capacitor	<ul style="list-style-type: none"> Examine for leaks, discoloration, or cracks. Examine if the cap has come off, if there is swelling, or if there are leaks from broken sides. 	The drive does not have many serviceable parts and it could be necessary to replace the drive.	
Diodes, IGBT (Power Transistor)	Examine for dust or other unwanted material collected on the surface.	Use a vacuum cleaner to remove unwanted particles and dust without touching the components.	

Table 8.3 Motor Periodic Inspection Checklist

Inspection Area	Inspection Points	Corrective Action	Checked
Operation Check	Check for increased vibration or unusual noise.	Stop the motor and contact approved maintenance personnel as necessary.	

Table 8.4 Control Circuit Periodic Inspection Checklist

Inspection Area	Inspection Points	Corrective Action	Checked
General	<ul style="list-style-type: none"> Examine terminals for stripped, damaged, or loose connections. Make sure that all terminals have been correctly tightened. 	<ul style="list-style-type: none"> Tighten loose screws. Replace damaged screws or terminals. If terminals are integral to a circuit board, it could be necessary to replace the control board or the drive. 	
Circuit Boards	<ul style="list-style-type: none"> Check for odor, discoloration, or rust. Make sure that all connections are correctly fastened. Make sure that the surface of the circuit board does not have dust or oil mist. 	<ul style="list-style-type: none"> Tighten loose connections. Use a vacuum cleaner to remove unwanted particles and dust without touching the components. If you cannot remove unwanted particles and dust with a vacuum cleaner, replace the components. Do not use solvents to clean the board. The drive does not have many serviceable parts and it could be necessary to replace the drive. 	

Table 8.5 Cooling System Periodic Inspection Checklist

Inspection Area	Inspection Points	Corrective Action	Checked
Cooling fans	<ul style="list-style-type: none"> Check for unusual oscillation or unusual noise. Check for damaged or missing fan blades. 	Clean or replace the fans as necessary.	
Heatsink	<ul style="list-style-type: none"> Examine for dust or other unwanted material collected on the surface. Examine for dirt. 	Use a vacuum cleaner to remove unwanted particles and dust without touching the components.	
Air Duct	Examine air intake, exhaust openings and make sure that there are no unwanted materials on the surface.	Clear blockages and clean air duct as necessary.	

Table 8.6 Keypad Periodic Inspection Checklist

Inspection Area	Inspection Points	Corrective Action	Checked
General	<ul style="list-style-type: none"> • Make sure that the keypad shows the data correctly. • Examine for dust or other unwanted material that collected on components in the area. 	<ul style="list-style-type: none"> • If you have problems with the display or the keys, contact Yaskawa or your nearest sales representative. • Clean the keypad. 	

8.3 Maintenance

The drive Maintenance Monitors keep track of component wear and tell the user when the end of the estimated performance life is approaching. The Maintenance Monitors prevent the need to shut down the full system for unexpected problems. Users can set alarm notifications for the maintenance periods for these drive components:

- Cooling fan
- Electrolytic capacitor
- Soft charge bypass relay
- IGBT

Contact Yaskawa or your nearest sales representative for more information about part replacement.

◆ Replaceable Parts

You can replace these parts of the drive:

- Cooling fan

If there is a failure in the main circuit, replace the drive.

You can remove the control circuit board of the drive. When you remove the control circuit terminal block of the drive and install a new terminal block, you can easily replace the control circuit terminal block. Refer to [Replace the Drive on page 331](#) for more information.

If the drive is in the warranty period, contact Yaskawa or your nearest sales representative before you replace parts. Yaskawa reserves the right to replace or repair the drive as specified by the Yaskawa warranty policy.

DANGER! Electrical Shock Hazard. Do not examine, connect, or disconnect wiring on an energized drive. Before servicing, disconnect all power to the equipment and wait for the time specified on the warning label at a minimum. The internal capacitor stays charged after the drive is de-energized. The charge indicator LED extinguishes when the DC bus voltage decreases below 50 Vdc. When all indicators are OFF, measure for dangerous voltages to make sure that the drive is safe. If you do work on the drive when it is energized, it will cause serious injury or death from electrical shock.

◆ Part Replacement Guidelines

[Table 8.7](#) shows the standard replacement period for replacement parts. When you replace these parts, make sure that you use Yaskawa replacement parts for the applicable model and design revision number of your drive.

Table 8.7 Standard Replacement Period

Parts	Standard Replacement Period
Cooling fan	10 years
Electrolytic capacitor ^{*1}	10 years

*1 If there is damage to parts that you cannot repair or replace, replace the drive.

Note:

Performance life estimate is based on these use conditions. These conditions are provided for the purpose of replacing parts to maintain performance. Some parts may require more frequent replacement due to poor environments or rigorous use. Operating conditions for performance life estimate: Ambient temperature: Yearly average of 40 °C (IP20/UL Open Type), Load factor: 80%, Operating rate: 24 hours a day

◆ Monitors that Display the Lifespan of Drive Components

The drive keypad shows percentage values for the replacement parts to help you know when you must replace those components. Use the monitors in [Table 8.8](#) to check replacement periods. When the monitor value is 100%, the component is at the end of its useful life and there is an increased risk of drive malfunction. Yaskawa recommends that you check the maintenance period regularly to make sure that you get the maximum performance life.

Table 8.8 Performance Life Monitors

Monitor No.	Parts	Description
U4-03	Cooling fan	Shows the total operation time of fans as 0 to 99999 hours. After this value is 99999, the drive automatically resets it to 0.
U4-04		Shows the total fan operation time as a percentage of the specified maintenance period.
U4-05	Electrolytic capacitor	Shows the total capacitor usage time as a percentage of the specified maintenance period.
U4-06	Soft charge bypass relay	Shows the number of times the drive is energized as a percentage of the performance life of the inrush circuit.
U4-07	IGBT	Shows the percentage of the maintenance period for the IGBTs.

◆ Alarm Outputs for Maintenance Monitors

You can use *H2-xx* [MFDO Function Selection] to send a message that tells you when a specified component is near the end of its performance life estimate. Set the applicable value to *H2-xx* as shown in Table 8.9 for your component. When the specified component is near the end of its performance life estimate, the MFDO terminals set for *H2-xx* = 2F [Maintenance Notification] will turn ON, and the keypad will show an alarm that identifies the component to replace.

Table 8.9 Maintenance Period Alarms

Display	Alarm Name	Cause	Possible Solutions	MFDO (Setting Value in H2-xx)
LT-1	Cooling Fan Maintenance Time	The cooling fan is at 90% of its expected performance life.	Replace the cooling fan, then set <i>o4-03</i> = 0 [Fan Operation Time Setting = 0 h] to reset the cooling fan operation time.	2F
LT-2	Capacitor Maintenance Time	The capacitors for the main circuit and control circuit are at 90% of expected performance life.	Replace the board or the drive. Contact Yaskawa or your nearest sales representative to replace the board.	
LT-3	SoftChargeBypassRelay Maintenance Time	The soft charge bypass relay is at 90% of its performance life estimate.	Replace the board or the drive. Contact Yaskawa or your nearest sales representative to replace the board.	
LT-4	IGBT Maintenance Time (50%)	The IGBT is at 50% of its expected performance life.	Check the load, carrier frequency, and output frequency.	
TrPC	IGBT Maintenance Time (90%)	The IGBT is at 90% of its expected performance life.	Replace the IGBT or the drive.	10

◆ Related Parameters

Replace the component, then set *o4-03*, *o4-05*, *o4-07*, and *o4-09* [Maintenance Setting] = 0 to reset the Maintenance Monitor. If these parameters are not reset after the corresponding parts have been replaced, the Maintenance Monitor function will continue to count down the performance life from the value that was reached with the old part. If the Maintenance Monitor is not reset, the drive will not have the correct value of the performance life for the new component.

Note:

The maintenance period changes for different operating environments.

Table 8.10 Maintenance Setting Parameters

No.	Name	Function
o4-03	Fan Operation Time Setting	Sets the value from which to start the cumulative drive cooling fan operation time in 10-hour units. Note: When <i>o4-03</i> = 30 has been set, the drive will count the operation time for the cooling fan from 300 hours and <i>U4-03</i> [Cooling Fan Operation Time] will show 300 h.
o4-05	Capacitor Maintenance Setting	Sets the value from which to start the count for the main circuit capacitor maintenance period as a percentage.
o4-07	Softcharge Relay Maintenance Set	Sets as a percentage the value from which to start the count for the soft charge bypass relay maintenance time.
o4-09	IGBT Maintenance Setting	Sets the value from which to start the count for the IGBT maintenance period as a percentage.

8.4 Replace Cooling Fans

NOTICE: Use the instructions in this manual to replace the cooling fans. When you do maintenance on the fans, replace all the fans to increase product life. If you install the fans incorrectly, it can cause damage to the drive.

To replace a cooling fan, contact Yaskawa or your nearest sales representative.

◆ Number of Cooling Fans

Table 8.11 Single-Phase 200 V Class

Model	Cooling Fans	Replacement Procedure	Ref.
B001 - B006	-	-	-
B010, B012	1	A	325
B018	2	B	

Table 8.12 Three-Phase 200 V Class

Model	Cooling Fans	Replacement Procedure	Ref.
2001-2004	-	-	-
2006 - 2021	1	A	325
2030	1	B	328
2042 - 2082	2	A	325

Table 8.13 Three-Phase 400 V Class

Model	Cooling Fans	Replacement Procedure	Ref.
4001 - 4004	-	-	-
4005 - 4012	1	A	325
4018, 4023	1	B	328
4031 - 4060	2	A	325

◆ Replace the Cooling Fan (Procedure A)

DANGER! Electrical Shock Hazard. Do not examine, connect, or disconnect wiring on an energized drive. Before servicing, disconnect all power to the equipment and wait for the time specified on the warning label at a minimum. The internal capacitor stays charged after the drive is de-energized. The charge indicator LED extinguishes when the DC bus voltage decreases below 50 Vdc. When all indicators are OFF, measure for dangerous voltages to make sure that the drive is safe. If you do work on the drive when it is energized, it will cause serious injury or death from electrical shock.

CAUTION! Burn Hazard. Do not touch a hot drive heatsink. De-energize the drive, wait for a minimum of 15 minutes, then make sure that the heatsink is cool before you replace the cooling fans. If you touch a hot drive heatsink, it can burn you.

NOTICE: Use the instructions in this manual to replace the cooling fans. When you do maintenance on the fans, replace all the fans to increase product life. If you install the fans incorrectly, it can cause damage to the drive.

■ Remove a Fan

1. To remove the fan finger guard from the drive, push the hooks on the left and right sides of it and pull up.

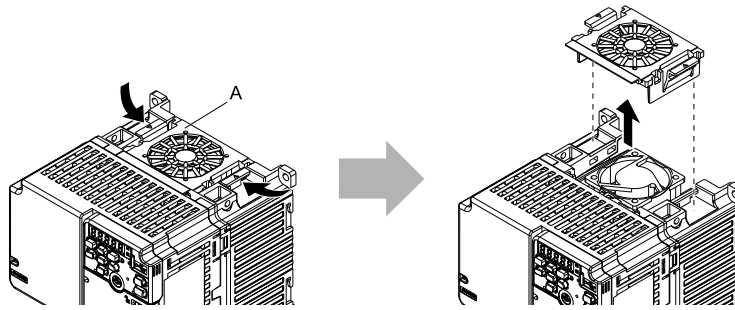

A - Fan finger guard

Figure 8.1 Remove the Fan Finger Guard

2. Pull the cooling fan straight up from the drive. Disconnect the power supply connector and remove the fan from the drive.

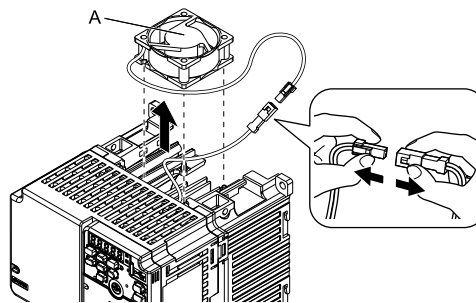

A - Cooling fan

Figure 8.2 Remove the Cooling Fan

■ Install a Fan

Reverse the removal procedure to install a cooling fan.

1. Connect the power supply connector between the drive and cooling fan.

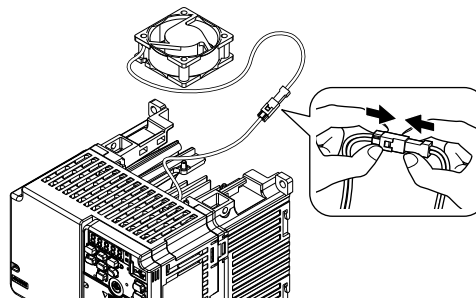
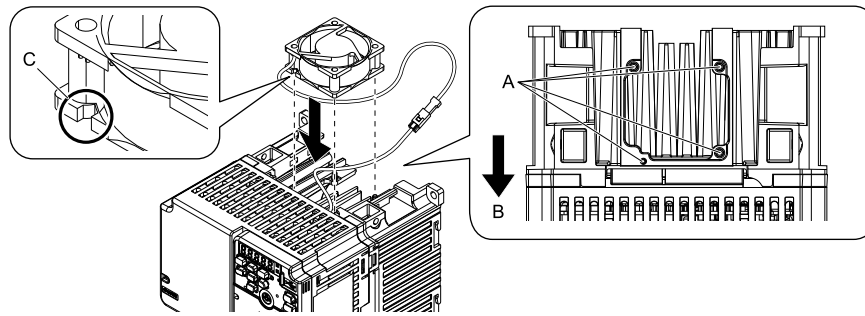

Figure 8.3 Connect the Power Supply Connector

2. Align the notches on the fan with the pins on the drive and install the cooling fans in the drive.



A - Alignment pins on drive
B - Front of drive

C - Notch on fan

Figure 8.4 Install the Cooling Fan

Note:

When you install the cooling fan, make sure that you do not pinch cables between the cooling fan and the drive.

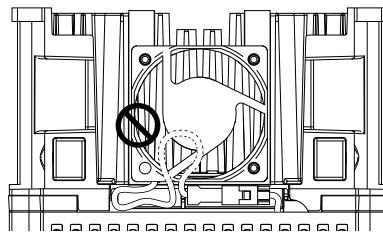

3. Put the cable and connector in the recess of the drive.

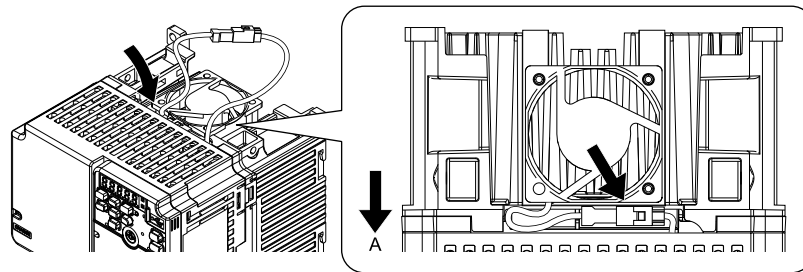

A - Front of drive

Figure 8.5 Put the Cable and Connector in the Drive Recess

Note:

The connector installation position is different for different models.

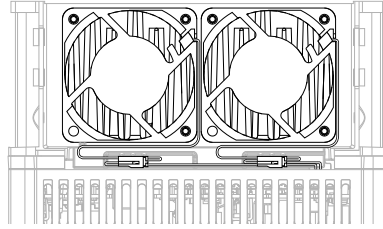

Figure 8.6 Put the Connector in the Recess

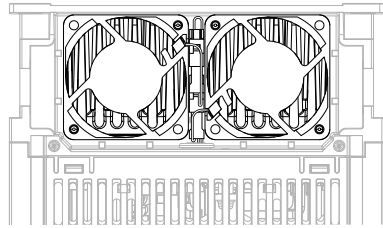

Figure 8.7 Put the Connector in Between the Fans

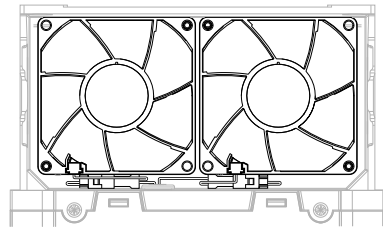

Figure 8.8 Put the Connector in Between the Drive and Fan

4. Insert the fan cover straight until the hook clicks into place.

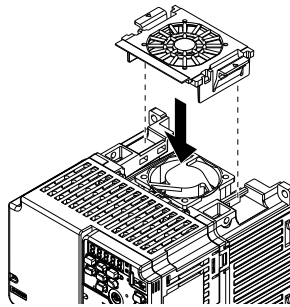

Figure 8.9 Reattach the Fan Finger Guard

5. Energize the drive and set $\alpha 4-03 = 0$ [Fan Operation Time Setting = 0 h] to reset the cooling fan operation time.

◆ Replace the Cooling Fan (Procedure B)

DANGER! Electrical Shock Hazard. Do not examine, connect, or disconnect wiring on an energized drive. Before servicing, disconnect all power to the equipment and wait for the time specified on the warning label at a minimum. The internal capacitor stays charged after the drive is de-energized. The charge indicator LED extinguishes when the DC bus voltage decreases below 50 Vdc. When all indicators are OFF, measure for dangerous voltages to make sure that the drive is safe. If you do work on the drive when it is energized, it will cause serious injury or death from electrical shock.

CAUTION! Burn Hazard. Do not touch a hot drive heatsink. De-energize the drive, wait for a minimum of 15 minutes, then make sure that the heatsink is cool before you replace the cooling fans. If you touch a hot drive heatsink, it can burn you.

NOTICE: Use the instructions in this manual to replace the cooling fans. When you do maintenance on the fans, replace all the fans to increase product life. If you install the fans incorrectly, it can cause damage to the drive.

■ Remove a Fan

1. Push the tabs toward the back of the drive and pull up to remove the fan finger guard from the drive.

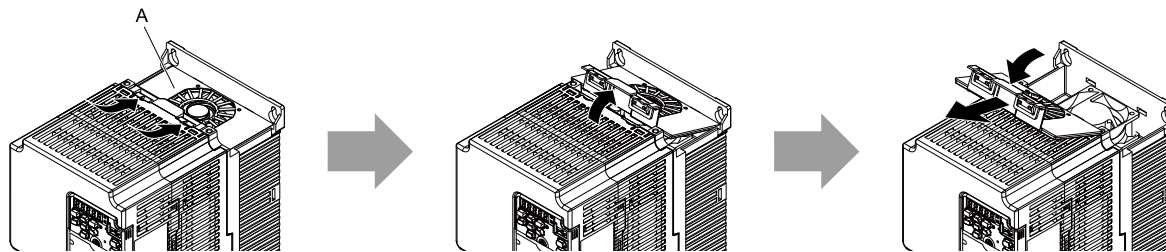

A - Fan finger guard

Figure 8.10 Remove the Fan Finger Guard

2. Pull the cooling fan straight up from the drive. Disconnect the power supply connector and remove the fan from the drive.

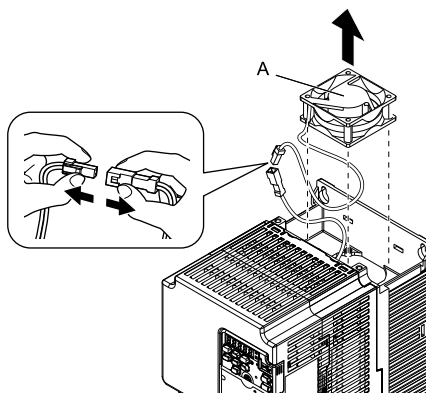

A - Cooling fan

Figure 8.11 Remove the Cooling Fan

■ Install the Cooling Fans

Reverse the removal procedure to install a cooling fan.

1. Connect the power supply connector between the drive and cooling fan.

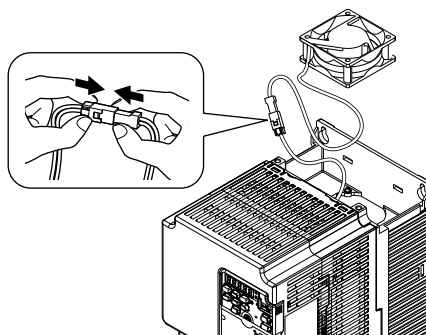
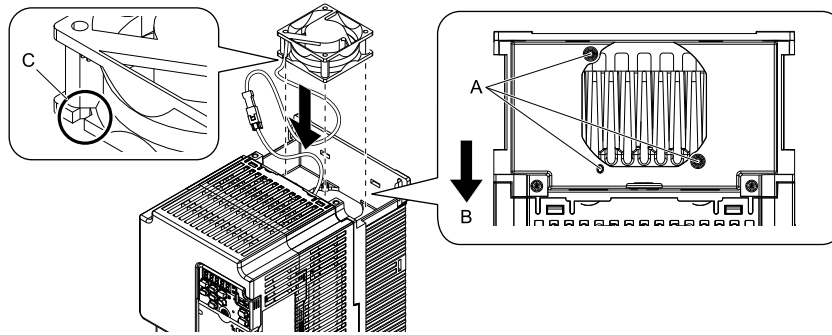

Figure 8.12 Connecting the power supply connector

2. Install the cooling fans so that they align with the pins on the drive.



A - Alignment pins on drive
B - Front of drive

C - Notches

Figure 8.13 Installing the cooling fans

Note:

When you install the cooling fan, make sure that you do not pinch cables between the cooling fan and the drive.

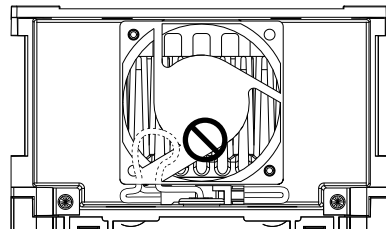

3. Put the cable and connector in the recess of the drive.

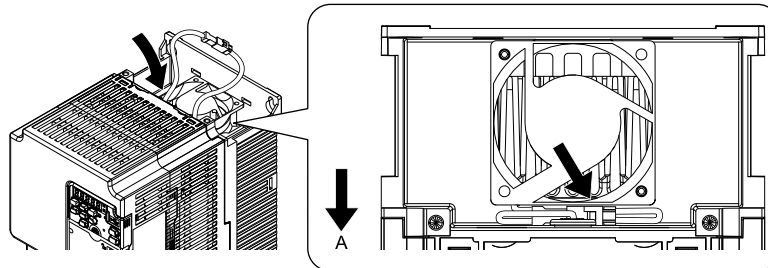

A - Front of drive

Figure 8.14 Putting the cable and connector in the recess

4. Insert the tabs of the fan cover into the holes in the drive and press in the fan cover until the hook clicks into place.

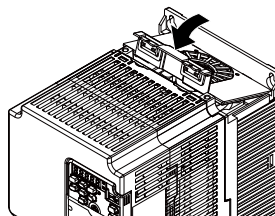

Figure 8.15 Reattach the Fan Finger Guard

5. Energize the drive and set $\alpha 4-03 = 0$ [Fan Operation Time Setting = 0 h] to reset the cooling fan operation time.

8.5 Replace the Drive

◆ About the Control Circuit Board

You can remove the control circuit board of the drive and install a new board. If there is a failure in the drive, you can use this feature to easily replace the control circuit board.

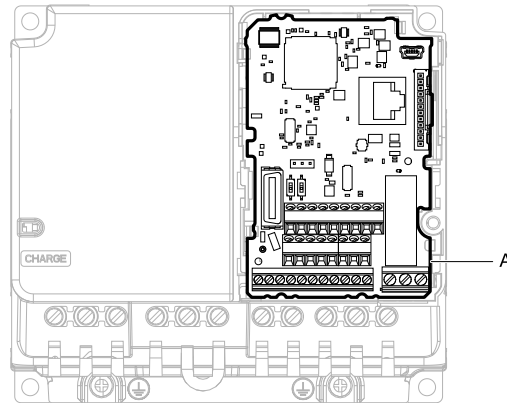

A - Control circuit board

Figure 8.16 Control Circuit Terminal Block

◆ Replace the Drive

DANGER! Electrical Shock Hazard. Disconnect all power to the drive and wait for the time specified on the warning label before you remove covers. Check the drive for dangerous voltages before servicing or repair work. If you do work on the drive when it is energized and there is no cover over the electronic circuits, it will cause serious injury or death from electrical shock. The drive has internal capacitors that stay charged after you de-energize the drive.

DANGER! Electrical Shock Hazard. Do not examine, connect, or disconnect wiring on an energized drive. Before servicing, disconnect all power to the equipment and wait for the time specified on the warning label at a minimum. The internal capacitor stays charged after the drive is de-energized. The charge indicator LED extinguishes when the DC bus voltage decreases below 50 Vdc. When all indicators are OFF, measure for dangerous voltages to make sure that the drive is safe. If you do work on the drive when it is energized, it will cause serious injury or death from electrical shock.

WARNING! Electrical Shock Hazard. Only let approved personnel install, wire, maintain, examine, replace parts, and repair the drive. If personnel are not approved, it can cause serious injury or death.

NOTICE: Damage to Equipment. When you touch the drive and circuit boards, make sure that you observe correct electrostatic discharge (ESD) procedures. If you do not follow procedures, it can cause ESD damage to the drive circuitry.

■ Notes on Wiring the Main Circuit Terminal Block

Read these notes before you wire the main circuit terminal block.

WARNING! Fire Hazard. Remove the insulation from the connection wires to the wire stripping lengths shown in the manual. If the stripping length is incorrect, the connection can cause a fire.

WARNING! Fire Hazard. Do not use bent or crushed wires. Remove the damaged end of the wire before you use it. Incorrect connections can cause death or serious injury from fire.

WARNING! Fire Hazard. If you use stranded wire, make sure that all of the wire strands are in the connection. Also, do not twist the stranded wire too much. Incorrect connections can cause death or serious injury from fire.

NOTICE: If you use power tools to tighten the terminal screws, use a low speed setting (300 min^{-1} (r/min) to 400 min^{-1} (r/min)). High speeds can cause damage to the terminal screws.

- Use UL-Listed, vinyl-coated insulated copper wires for operation with a continuous maximum permitted temperature of $75 \text{ }^{\circ}\text{C}$ at 600 V.
- Remove all unwanted objects that are near the terminal block connections.
- Remove the insulation from the connection wires to the wire stripping lengths shown in the manual.
- Do not solder stranded wire. Soldered wire connections can become loose over time and cause unsatisfactory drive performance.
- Put the wire all the way into the terminal block. Remove the insulation from the wire to the recommended wire stripping length to fit the wire with insulation in the plastic housing.

8.5 Replace the Drive

- Use a torque driver, torque ratchet, or torque wrench for the screws. A slotted driver or a hex tool will be necessary to wire the screw clamp terminal. Use applicable tools as specified by the recommended conditions in the product manual.
 - Users can purchase wiring tools from Yaskawa. Contact Yaskawa or your nearest sales representative for more information.
 - Wire gauges on the drive you are replacing may not match the wire gauge ranges on your new drive. Contact Yaskawa or your nearest sales representative for more information about the connection procedures.
 - Do not tighten the terminal screws at an angle of 5 degrees or more. Failure to obey can cause damage to the terminal screws.
- If you damage a terminal screw, contact Yaskawa or your nearest sales representative.

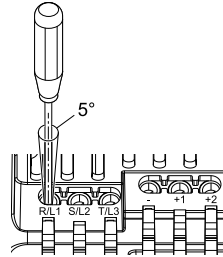

Figure 8.17 Permitted Angle

- Put the bit all the way into the hex socket to tighten the hex socket cap screw.
- When you tighten slotted screws, hold the straight-edge screwdriver perpendicularly to the screw. Make sure that you align the end of the straight-edge screwdriver with the screw groove.

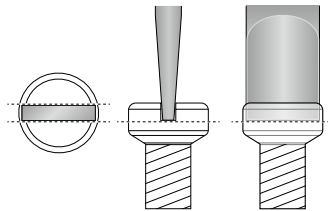
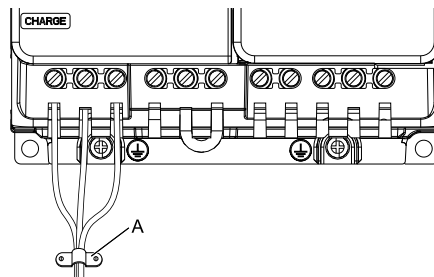

Figure 8.18 Tightening Slotted Screws

- After you connect the wires to the terminal block, lightly pull on the wires to make sure that they do not come out of the terminals.
- Do not let strain on the wiring cause damage. Use a strain relief near the wiring to release the tension. Refer to [Figure 8.19](#) for an example.





A - Cable clamp

Figure 8.19 Strain Relief Example

Table 8.14 Recommended Wiring Tools

Screw Size	Screw Shape	Wire Gauge	Adapter	Bit		Torque Driver Model (Tightening Torque)	Torque Wrench (Tightening Torque)
				Model	Manufacturer		
M3	⊖	-	Bit	SF-BIT-SL 0,5X3,0-70	PHOENIX CONTACT	TSD-M 1,2NM (0.3 - 1.2 N·m (2.7 - 10.6 lbf·in))	-
M4	⊖	-	Bit	SF-BIT-SL 1,0X4,0-70	PHOENIX CONTACT	TSD-M 3NM (1.2 - 3.0 N·m (10.6 - 26.6 lbf·in))	-

Screw Size	Screw Shape	Wire Gauge	Adapter	Bit		Torque Driver Model (Tightening Torque)	Torque Wrench (Tightening Torque)
				Model	Manufacturer		
M5 ^{*1}		≤ 25 mm ² (AWG 10)	Bit	SF-BIT-SL 1,2X6,5-70	PHOENIX CONTACT	TSD-M 3NM (1.2 - 3.0 N·m (10.6 - 26.6 lbf·in))	-
		≥ 30 mm ² (AWG 8)				-	4.1 - 4.5 N·m (36.3 - 39.8 lbf·in) ^{*2 *3}
M6	 (WAF: 5 mm)	-	Bit	SF-BIT-HEX 5-50	PHOENIX CONTACT	-	5 - 9 N·m (44.3 - 79.7 lbf·in) ^{*2 *3}

*1 When you wire drive models 2042, 2056, 4031, 4038, 4044, and 4060, select the correct tools for the wire gauge.

*2 Use 6.35 mm (0.25 in) bit socket holder.

*3 Use a torque wrench that can apply this torque measurement range.

■ Remove the Control Circuit Board

Remove the front cover and keypad from the drive.

1. Push the tabs to the left that hold the control board to the drive.

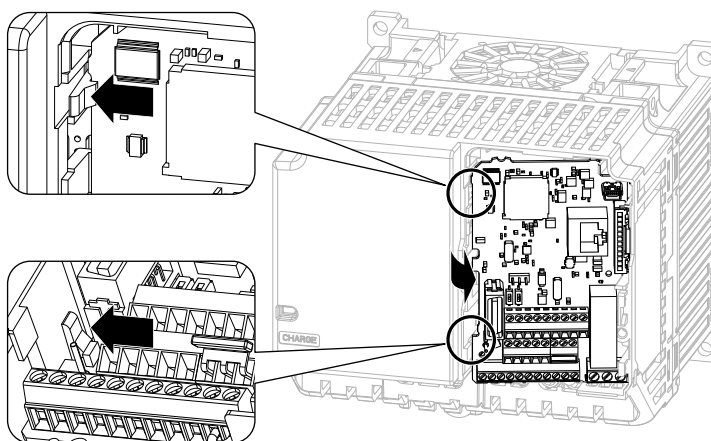

Figure 8.20 Unhook the Tabs

2. Pull the left side of the control circuit board out first.

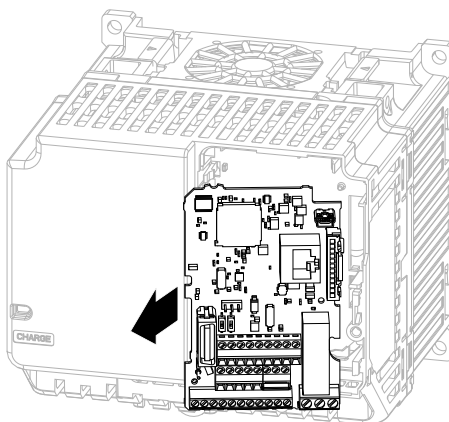

Figure 8.21 Remove the Control Circuit Board

■ Put the Control Circuit Board in a New Drive

Remove the keypad, front cover, and control circuit board of the new drive.

Wire the main circuit terminals of the new drive, then attach the wired control circuit board.

8.5 Replace the Drive

1. Wire the main circuit terminals.

Note:

To wire terminals +1 and +2, remove the jumper between terminals +1 and +2.

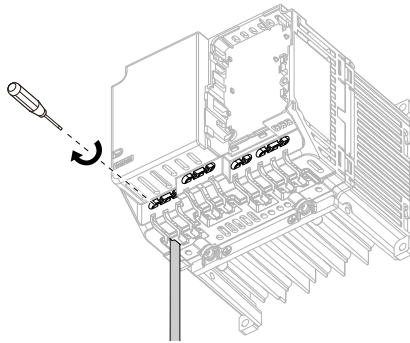

Figure 8.22 Wire the Main Circuit Terminals

2. Attach the wired control circuit board to the drive.
Push the control circuit board until the hooks click into place on the drive.

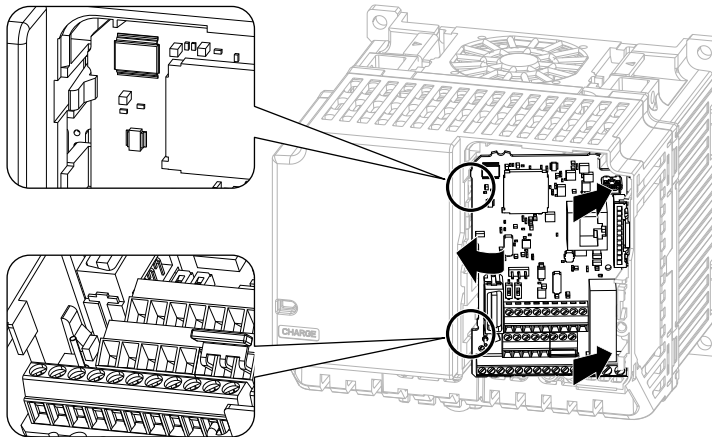

Figure 8.23 Attach the Control Circuit Board

3. Attach the keypad and front cover to the new drive.
4. Energize the drive and set these parameters:
 - o2-04 [Drive Model (KVA) Selection]: Set this parameter to the model number of the new drive.
 - o4-01 to o4-13 [Maintenance Period]: Reset the performance life monitors for the components.

8.6 Storage Guidelines

The chemicals in the electrolytic capacitors and other electronic parts of the drive change over time. When you store the drive for long periods of time, use the information in this section to help keep the performance life estimates.

◆ Storage Location

- Temperature and Humidity

When you store the drive for approximately one month, for example during shipping, you can put the drive in a location where the temperature is $-20\text{ }^{\circ}\text{C}$ to $+70\text{ }^{\circ}\text{C}$ ($-4\text{ }^{\circ}\text{F}$ to $+158\text{ }^{\circ}\text{F}$). Correctly package and store the drive during shipping to prevent vibration and impact damage.

Do not put the drive in direct sunlight or where there will be condensation or ice. Put the drive in a location where the relative humidity is 95% or less.

- Dust and Oil Mist

Do not keep the drive locations with dust or oil mist. For example, cement factories and cotton mills.

- Corrosive Gas

Do not keep the drive in locations with corrosive gas. For example, chemical plants, refineries, and sewage plants.

- Salt Damage

Do not keep the drive in salty locations. For example, locations near the ocean, and salt damage-designated locations.

Do not keep the drive in unsatisfactory locations. Keep all drives in storage rooms that are safe from unsatisfactory elements.

◆ Regular Application of Power

To prevent deterioration of the capacitors, Yaskawa recommends that you apply power to the drive a minimum of one time each year for a minimum of 30 minutes.

If you store the drive for longer than two years and do not apply power, Yaskawa recommends that you use a variable power source and gradually increase the power from 0 V to the rated drive voltage over a period of 2 to 3 minutes. Apply power for a minimum of 1 hour with no load to reform the main circuit electrolytic capacitor. When you operate the drive after you apply power, wire the drive correctly and check for drive faults, overcurrents, motor vibration, motor speed differences, and other defects during operation.

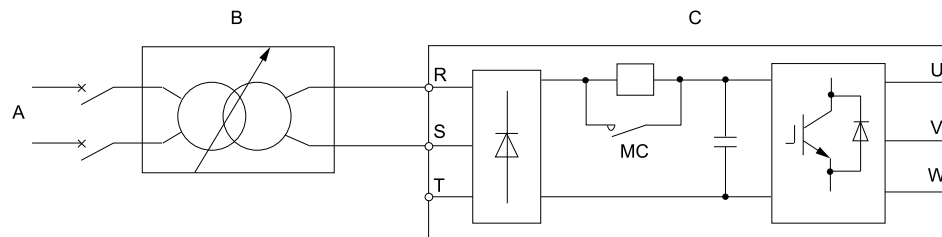

A - AC power supply

B - Variable power source

C - Drive

Figure 8.24 Power Distribution Method

Disposal

9.1	Section Safety	338
9.2	Disposal Instructions	339
9.3	WEEE Directive	340

9.1 Section Safety

WARNING

Electrical Shock Hazard

De-energize the drive and wait 5 minutes minimum until the Charge LED turns off. Remove the front cover and terminal cover to do work on wiring, circuit boards, and other parts. Use terminals for their correct function only.

Incorrect wiring, incorrect ground connections, and incorrect repair of protective covers can cause death or serious injury.

Only let approved personnel install, wire, maintain, examine, replace parts, and repair the drive.

If personnel are not approved, it can cause serious injury or death.

Do not wear loose clothing or jewelry when you do work on the drive. Tighten loose clothing and remove all metal objects, for example watches or rings.

Loose clothing can catch on the drive and jewelry can conduct electricity and cause serious injury or death.

Crush Hazard

Wear eye protection when you do work on the drive.

If you do not use correct safety equipment, it can cause serious injury or death.

CAUTION

Crush Hazard

Tighten terminal cover screws and hold the case safely when you move the drive.

If the drive or covers fall, it can cause moderate injury.

9.2 Disposal Instructions

Correctly dispose of the product and packing material as specified by applicable regional, local, and municipal laws and regulations.

9.3 WEEE Directive



The wheelee bin symbol on this product, its manual, or its packaging identifies that you must recycle it at the end of its product life.

You must discard the product at an applicable collection point for electrical and electronic equipment (EEE). Do not discard the product with usual waste.

Specifications

10.1	Section Safety	342
10.2	Drive Duty Modes	343
10.3	Model-Specific Specifications (Single-Phase 200 V Class).....	344
10.4	Model Specifications (Three-Phase 200 V Class)	345
10.5	Model Specifications (Three-Phase 400 V Class)	348
10.6	Drive Specifications.....	350
10.7	Drive Derating	353
10.8	Drive Exterior and Mounting Dimensions.....	358
10.9	Peripheral Devices and Options.....	367

10.1 Section Safety

 **DANGER**

Do not ignore the safety messages in this manual.

If you ignore the safety messages in this manual, it will cause serious injury or death. The manufacturer is not responsible for injuries or damage to equipment.

10.2 Drive Duty Modes

The drive has two duty modes from which to select for the application: Heavy Duty (HD) and Normal Duty (ND). Refer to [Table 10.1](#) for information about the differences between HD and ND ratings.

Table 10.1 Drive Duty Modes

Duty Rating	C6-01 Setting	Application	Default Carrier Frequency	Overload Tolerance (oL2 [Drive Overload])
Heavy Duty Rating (HD)	0	<ul style="list-style-type: none"> • Extruder • Conveyor • Cranes • Constant torque or high overload capacity 	Determined by o2-04, A1-02	150% of the rated output current for 60 seconds The permitted frequency of overload is one time each 10 minutes.
Normal Duty Rating (ND)	1	<ul style="list-style-type: none"> • Fan • Pump • Blower • Variable speed control 	Determined by o2-04, A1-02	110% of the rated output current for 60 seconds The permitted frequency of overload is one time each 10 minutes.

10.3 Model-Specific Specifications (Single-Phase 200 V Class)

Table 10.2 Ratings (Single-Phase 200 V Class)

Model		B001	B002	B004	B006	B010	B012	B018	
Maximum Applicable Motor Output (kW)	HD *1	0.1	0.2	0.4	0.75	1.5	2.2	3.7	
	ND *2	0.2	0.4	0.75	1.1	2.2	3.0	-	
Maximum Applicable Motor Output (HP)	HD *1	1/6	1/4	1/2	1	2	3	5	
	ND *2	1/6	1/4	3/4	1.5	3	3	-	
Input	Rated Input Current (A)	HD (AC)	1.4	2.8	5.5	11	14.1	20.6	35.0
		HD (DC)	1.4	2.8	5.5	11	14.1	20.6	35.0
		ND (AC)	2.0	5.0	7.3	13.8	20.2	24.0	-
		ND (DC)	2.0	5.0	7.3	13.8	20.2	24.0	-
Output	Rated Output Capacity (kVA) *3	HD	0.3	0.6	1.1	1.9	3	4.2	6.7
		ND	0.5	0.7	1.3	2.3	3.7	4.6	-
	Rated Output Current (A)	HD	0.8	1.6	3	5	8	11	17.6
		ND	1.2	1.9	3.5	6	9.6	12.2	-
	Overload Tolerance	<ul style="list-style-type: none"> HD: 150% of the rated output current for 60 seconds. The permitted frequency of overload is one time each 10 minutes. ND: 110% of the rated output current for 60 seconds. The permitted frequency of overload is one time each 10 minutes. Note: Derating can be necessary for applications that start and stop frequently.							
	Carrier Frequency	HD: 10 kHz without derating the drive capacity. ND: 2 kHz without derating the drive capacity. Derate the drive capacity to use values to 15 kHz maximum.				HD: 8 kHz without derating the drive capacity. ND: 2 kHz without derating the drive capacity. Derate the drive capacity to use values to 15 kHz maximum.			
	Maximum Output Voltage	Three-phase 200 V to 240 V Note: The maximum output voltage is proportional to the input voltage.							
	Maximum Output Frequency	<ul style="list-style-type: none"> V/f, OLV, OLV/PM: 590 Hz AOLV/PM: 270 Hz EZOLV: 120 Hz 							
Measures for Harmonics	AC reactor	External options							
Braking Device	Braking Transistor	Standard internal characteristics							
EMC Filter	EMC Filter IEC61800-3	Factory option Models BxxxE: Category C1 (Conducted emission)						External options	
Power Supply	Rated Voltage/Rated Frequency	<ul style="list-style-type: none"> Single-phase AC power supply 200 V to 240 V at 50/60 Hz DC power supply 270 V to 340 V 							
	Permitted Voltage Fluctuation	-15% to +10%							
	Permitted Frequency Fluctuation	±5%							
	Input Power (kVA)	HD	0.4	0.7	1.5	2.9	3.7	5.4	9.2
ND		0.5	1.3	1.9	3.6	5.3	6.3	-	

*1 The maximum applicable motor output complies with 208 V motor ratings as specified in NEC Table 430.250. The rated output current of the drive output amps must be equal to or more than the motor rated current.

*2 The maximum applicable motor output is based on 4-pole, general-purpose 220 V motor ratings. The rated output current of the drive output amps must be equal to or more than the motor rated current.

*3 The rated output capacity is calculated with a rated output voltage of 220 V.

10.4 Model Specifications (Three-Phase 200 V Class)

Table 10.3 Ratings (Three-Phase 200 V Class)

Model		2001	2002	2004	2006	
Maximum Applicable Motor Output (kW)	HD *1	0.1	0.2	0.2	0.75	
	ND *2	0.2	0.4	0.75	1.1	
Maximum Applicable Motor Output (HP)	HD *1	1/6	1/4	1/2	1	
	ND *2	1/6	1/4	3/4	1.5	
Input	Rated Input Current (A)	HD (AC)	0.7	1.5	2.9	5.8
		HD (DC)	0.9	1.8	3.6	7.1
		ND (AC)	1.1	1.9	3.9	7.3
		ND (DC)	1.3	2.3	4.8	8.9
Output	Rated Output Capacity (kVA) *3	HD	0.3	0.6	1.1	1.9
		ND	0.5	0.7	1.3	2.3
	Rated Output Current (A)	HD	0.8	1.6	3.0	5.0
		ND	1.2	1.9	3.5	6
	Overload Tolerance	<ul style="list-style-type: none"> HD: 150% of the rated output current for 60 seconds. The permitted frequency of overload is one time each 10 minutes. ND: 110% of the rated output current for 60 seconds. The permitted frequency of overload is one time each 10 minutes. <p>Note: Derating can be necessary for applications that start and stop frequently.</p>				
	Carrier Frequency	HD: 10 kHz without derating the drive capacity. ND: 2 kHz without derating the drive capacity. Derate the drive capacity to use values to 15 kHz maximum.				
	Maximum Output Voltage	Three-phase 200 V to 240 V Note: The maximum output voltage is proportional to the input voltage.				
Maximum Output Frequency	<ul style="list-style-type: none"> EZOLV: 120 Hz AOLV/PM: 270 Hz V/f, OLV, OLV/PM: 590 Hz 					
Measures for Harmonics	DC reactor	External options				
Braking Device	Braking Transistor	Standard internal characteristics				
EMC Filter	EMC Filter IEC61800-3	Factory option Models 2xxxE: Category C3 (Conducted emission)				
Power Supply	Rated Voltage/Rated Frequency		<ul style="list-style-type: none"> Three-phase AC power supply 200 V to 240 V at 50/60 Hz DC power supply 270 V to 340 V 			
	Permitted Voltage Fluctuation		-15% to +10%			
	Permitted Frequency Fluctuation		±5%			
	Input Power (kVA)	HD	0.3	0.7	1.3	2.7
ND		0.5	1.2	1.8	3.3	

*1 The maximum applicable motor output complies with 208 V motor ratings as specified in NEC Table 430.250. The rated output current of the drive output amps must be equal to or more than the motor rated current.

*2 The maximum applicable motor output is based on 4-pole, general-purpose 220 V motor ratings. The rated output current of the drive output amps must be equal to or more than the motor rated current.

*3 The rated output capacity is calculated with a rated output voltage of 220 V.

10.4 Model Specifications (Three-Phase 200 V Class)

Table 10.4 Ratings (Three-Phase 200 V Class)

Model		2010	2012	2021	2030	
Maximum Applicable Motor Output (kW)	HD ^{*1}	1.5	2.2	3.7	5.5	
	ND ^{*2}	2.2	3	5.5	7.5	
Maximum Applicable Motor Output (HP)	HD ^{*1}	2	3	5	7.5	
	ND ^{*2}	3	4	7.5	10	
Input	Rated Input Current (A)	HD (AC)	7.5	11	18.9	24
		HD (DC)	9.2	13.5	23.1	29.4
		ND (AC)	10.8	13.9	24	37
		ND (DC)	13.2	17	29.4	45.3
Output	Rated Output Capacity (kVA) ^{*3}	HD	3	4.2	6.7	9.5
		ND	3.7	4.6	8	11.4
	Rated Output Current (A)	HD	8.0	11.0	17.6	25.0
		ND	9.6	12.2	21	30
	Overload Tolerance	<ul style="list-style-type: none"> HD: 150% of the rated output current for 60 seconds. The permitted frequency of overload is one time each 10 minutes. ND: 110% of the rated output current for 60 seconds. The permitted frequency of overload is one time each 10 minutes. Note: Derating can be necessary for applications that start and stop frequently.				
	Carrier Frequency	HD: 8 kHz without derating the drive capacity. ND: 2 kHz without derating the drive capacity. Derate the drive capacity to use values to 15 kHz maximum.				
Maximum Output Voltage	Three-phase 200 V to 240 V Note: The maximum output voltage is proportional to the input voltage.					
Maximum Output Frequency	<ul style="list-style-type: none"> V/f, OLV, OLV/PM: 590 Hz AOLV/PM: 270 Hz EZOLV: 120 Hz 					
Measures for Harmonics	DC Link Choke	External options				
Braking Device	Braking Transistor	Standard internal characteristics				
EMC Filter	EMC Filter IEC61800-3	Factory option Models 2xxxE: Category C3 (Conducted emission)				
Power Supply	Rated Voltage/Rated Frequency		<ul style="list-style-type: none"> Three-phase AC power supply 200 V to 240 V at 50/60 Hz DC power supply 270 V to 340 V 			
	Permitted Voltage Fluctuation		-15% to +10%			
	Permitted Frequency Fluctuation		±5%			
	Input Power (kVA)	HD	3.4	5.0	8.7	11.0
ND		4.9	6.4	11	17.0	

*1 The maximum applicable motor output complies with 208 V motor ratings as specified in NEC Table 430.250. The rated output current of the drive output amps must be equal to or more than the motor rated current.

*2 The maximum applicable motor output is based on 4-pole, general-purpose 220 V motor ratings. The rated output current of the drive output amps must be equal to or more than the motor rated current.

*3 The rated output capacity is calculated with a rated output voltage of 220 V.

Table 10.5 Ratings (Three-Phase 200 V Class)

Model		2042	2056	2070	2082
Maximum Applicable Motor Output (kW)	HD ^{*1}	7.5	11	15	18.5
	ND ^{*2}	11	15	18.5	22
Maximum Applicable Motor Output (HP)	HD ^{*1}	10	15	20	25
	ND ^{*2}	10	20	25	30

10.4 Model Specifications (Three-Phase 200 V Class)

Model		2042	2056	2070	2082	
Input	Rated Input Current (A)	HD (AC)	37	52	68	96
		HD (DC)	45.3	63.7	83.3	117.6
		ND (AC)	52	68	80	114
		ND (DC)	63.7	83.3	98	139.6
Output	Rated Output Capacity (kVA) *3	HD	12.6	17.9	22.9	28.6
		ND	16	21.3	26.7	31.2
	Rated Output Current (A)	HD	33.0	47.0	60.0	75.0
		ND	42	56	70	82
	Overload Tolerance	<ul style="list-style-type: none"> HD: 150% of the rated output current for 60 seconds. The permitted frequency of overload is one time each 10 minutes. ND: 110% of the rated output current for 60 seconds. The permitted frequency of overload is one time each 10 minutes. <p>Note: Derating can be necessary for applications that start and stop frequently.</p>				
	Carrier Frequency	HD: 8 kHz without derating the drive capacity. ND: 2 kHz without derating the drive capacity. Derate the drive capacity to use values to 15 kHz maximum.				
	Maximum Output Voltage	Three-phase 200 V to 240 V Note: The maximum output voltage is proportional to the input voltage.				
	Maximum Output Frequency	<ul style="list-style-type: none"> V/f, OLV, OLV/PM: 590 Hz AOLV/PM: 270 Hz EZOLV: 120 Hz 				
Measures for Harmonics	DC Link Choke	External options				
Braking Device	Braking Transistor	Standard internal characteristics				
EMC Filter	EMC Filter IEC61800-3	Factory option Models 2xxxE: Category C3 (Conducted emission)				
Power Supply	Rated Voltage/Rated Frequency		<ul style="list-style-type: none"> Three-phase AC power supply 200 V to 240 V at 50/60 Hz DC power supply 270 V to 340 V 			
	Permitted Voltage Fluctuation		-15% to +10%			
	Permitted Frequency Fluctuation		±5%			
	Input Power (kVA)	HD	17.0	24.0	31.0	44.0
ND		24.0	31.0	37.0	52.0	

*1 The maximum applicable motor output complies with 208 V motor ratings as specified in NEC Table 430.250. The rated output current of the drive output amps must be equal to or more than the motor rated current.

*2 The maximum applicable motor output is based on 4-pole, general-purpose 220 V motor ratings. The rated output current of the drive output amps must be equal to or more than the motor rated current.

*3 The rated output capacity is calculated with a rated output voltage of 220 V.

10.5 Model Specifications (Three-Phase 400 V Class)

Table 10.6 Ratings (Three-Phase 400 V Class)

Model		Duty Rating	4001	4002	4004	4005	4007	4009	4012
Maximum Applicable Motor Output *1 (kW)		HD	0.2	0.4	0.75	1.5	2.2	3.0	3.7
		ND	0.4	0.75	1.5	2.2	3.0	3.7	5.5
Maximum Applicable Motor Output *1 (HP)		HD	1/2	3/4	2	3	3	4	5
		ND	1/2	1	2	3	4	5	7.5
Input	Rated Input Current (A)	HD (AC)	1.2	1.8	3.2	4.4	6.0	8.2	10.4
		HD (DC)	1.5	2.2	3.9	5.4	7.3	10	12.7
		ND (AC)	1.2	2.1	4.3	5.9	8.1	9.4	14
		ND (DC)	1.5	2.6	5.3	7.2	9.9	11.5	17.1
Rated Output Capacity *2 (kVA)		HD	0.9	1.4	2.6	3.7	4.3	5.6	7
		ND	0.9	1.6	3.1	4.1	5.4	6.8	9.1
Rated Output Current (A)		HD	1.2	1.8	3.4	4.8	5.6	7.3	9.2
		ND	1.2	2.1	4.1	5.4	7.1	8.9	11.9
Output		Overload Tolerance	<ul style="list-style-type: none"> HD: 150% of the rated output current for 60 seconds. The permitted frequency of overload is one time each 10 minutes. ND: 110% of the rated output current for 60 seconds. The permitted frequency of overload is one time each 10 minutes. Note: Derating can be necessary for applications that start and stop frequently.						
		Carrier Frequency	HD: 8 kHz without derating the drive capacity. ND: 2 kHz without derating the drive capacity. Derate the drive capacity to use values to 15 kHz maximum.						
		Maximum Output Voltage	Three-phase 380 V to 480 V Note: The maximum output voltage is proportional to the input voltage.						
		Maximum Output Frequency	<ul style="list-style-type: none"> V/f, OLV, OLV/PM: 590 Hz AOLV/PM: 270 Hz EZOLV: 120 Hz 						
Measures for Harmonics	DC reactor	External options							
Braking Device	Braking Transistor	Standard internal characteristics							
EMC Filter	EMC Filter IEC61800-3	Factory option Models 4xxxE: Category C2 (Conducted emission)							
Power Supply		Rated Voltage/Rated Frequency	Three-phase AC power supply 380 V to 480 V at 50/60 Hz						
		Permitted Voltage Fluctuation	-15% to +10%						
		Permitted Frequency Fluctuation	±5%						
		Input Power (kVA)	HD	1.1	1.6	2.9	4	5.5	7.5
ND	1.1		1.9	3.9	5.4	7.4	8.6	13	

*1 The maximum applicable motor output complies with 380 V motor ratings as specified in Annex G of IEC 60947-4-1. The rated output current of the drive output amps must be equal to or more than the motor rated current.

*2 The rated output capacity is calculated with a rated output voltage of 440 V.

Table 10.7 Ratings (Three-Phase 400 V Class)

Model		Duty Rating	4018	4023	4031	4038	4044	4060
Maximum Applicable Motor Output *1 (kW)		HD	5.5	7.5	11.0	15.0	18.5	22.0
		ND	7.5	11.0	15.0	18.5	22.0	30.0
Maximum Applicable Motor Output *1 (HP)		HD	10	10	15	20	25	30
		ND	10	15	20	25	30	40

10.5 Model Specifications (Three-Phase 400 V Class)

Model		Duty Rating	4018	4023	4031	4038	4044	4060
Input	Rated Input Current (A)	HD (AC)	15	20	29	39	50.5	59.7
		HD (DC)	18.4	24.5	35.5	47.8	61.8	73.1
		ND (AC)	20	24	38	44	59.7	80.7
		ND (DC)	24.5	29.4	46.5	53.9	73.1	98.8
Output	Rated Output Capacity ^{*2} (kVA)	HD	11.3	13.7	18.3	23.6	29.7	34.3
		ND	13.3	17.8	23.6	29	33.5	45.7
	Rated Output Current (A)	HD	14.8	18.0	24.0	31.0	39.0	45.0
		ND	17.5	23.4	31.0	38.0	44.0	60
	Overload Tolerance	<ul style="list-style-type: none"> • HD: 150% of the rated output current for 60 seconds. The permitted frequency of overload is one time each 10 minutes. • ND: 110% of the rated output current for 60 seconds. The permitted frequency of overload is one time each 10 minutes. <p>Note: Derating can be necessary for applications that start and stop frequently.</p>						
	Carrier Frequency	HD: 8 kHz without derating the drive capacity. ND: 2 kHz without derating the drive capacity. Derate the drive capacity to use values to 15 kHz maximum.						
	Maximum Output Voltage	Three-phase 380 V to 480 V Note: The maximum output voltage is proportional to the input voltage.						
	Maximum Output Frequency	<ul style="list-style-type: none"> • V/f, OLV, OLV/PM: 590 Hz • AOLV/PM: 270 Hz • EZOLV: 120 Hz 						
Measures for Harmonics	DC reactor	External options						
Braking Device	Braking Transistor	Standard internal characteristics						
EMC Filter	EMC Filter IEC61800-3	Factory option Models 4xxxE: Category C2 (Conducted emission)						
Power Supply	Rated Voltage/Rated Frequency		Three-phase AC power supply 380 V to 480 V at 50/60 Hz					
	Permitted Voltage Fluctuation		-15% to +10%					
	Permitted Frequency Fluctuation		±5%					
	Input Power (kVA)	HD	14	18	27	36	47	55
ND		18	22	35	40	55	74	

*1 The maximum applicable motor output complies with 380 V motor ratings as specified in Annex G of IEC 60947-4-1. The rated output current of the drive output amps must be equal to or more than the motor rated current.

*2 The rated output capacity is calculated with a rated output voltage of 440 V.

10.6 Drive Specifications

Note:

- To get the OLV specifications, do Rotational Auto-Tuning.
- To get the longest product life, install the drive in an environment that meets the necessary specifications.

Table 10.8 Control Characteristics

Item	Specification
Control Methods	<ul style="list-style-type: none"> • V/f Control • Open Loop Vector • PM Open Loop Vector • PM Advanced Open Loop Vector • EZ Vector Control
Frequency Control Range	<ul style="list-style-type: none"> • V/f, OLV, and OLV/PM: 0.01 Hz to 590 Hz • AOLV/PM: 0.01 Hz to 270 Hz • EZOLV: 0.01 Hz to 120 Hz
Frequency Accuracy (Temperature Fluctuation)	Digital inputs: $\pm 0.01\%$ of the maximum output frequency (-10 °C to +40 °C (14 °F to 104 °F)) Analog inputs: In $\pm 0.1\%$ of the maximum output frequency (25 °C ± 10 °C (77 °F ± 18 °F))
Frequency Setting Resolution	Digital inputs: 0.01 Hz Analog inputs: 1/2048 of the maximum output frequency (11-bit)
Output Frequency Resolution	0.001 Hz
Frequency Setting Signal	Main speed frequency reference: -10 Vdc to +10 Vdc (minimum 15 k Ω), 0 Vdc to 10 Vdc (minimum 15 k Ω), 4 mA to 20 mA (250 Ω), 0 mA to 20 mA (250 Ω) Main speed reference: Pulse train input (maximum 32 kHz)
Starting Torque	<ul style="list-style-type: none"> • V/f: 150%/3 Hz • OLV: 150%/1 Hz • OLV/PM: 100%/5% speed • AOLV/PM: 100%/0 min⁻¹ (when high frequency injection is enabled) • EZOLV: 100%/10% speed <p>Note: Correctly select the drive and motor capacity for this starting torque in these control methods:</p> <ul style="list-style-type: none"> • OLV • AOLV/PM
Speed Control Range	<ul style="list-style-type: none"> • V/f: 1:40 • OLV: 1:100 • OLV/PM: 1:10 • AOLV/PM: 1:100 (when high frequency injection is enabled) • EZOLV: 1:10
Zero Speed Control	Possible in AOLV/PM control methods.
Torque Limits	You can use parameter settings for different limits in four quadrants in these control methods: <ul style="list-style-type: none"> • OLV • AOLV/PM • EZOLV
Acceleration and Deceleration Times	0.0 s to 6000.0 s The drive can set four pairs of different acceleration and deceleration times.
Braking Torque	<p>Approximately 20% without a resistor Approximately 125% with a dynamic braking option</p> <ul style="list-style-type: none"> • Short-time average deceleration torque Motor output 0.1/0.2 kW: over 150% Motor output 0.4/0.75 kW: over 100% Motor output 1.5 kW: over 50% Motor output 2.2 kW and larger: over 20%. Overexcitation Braking/High Slip Braking allow for approximately 40% <p>WARNING! Set L3-04 = 0 [Stall Prevention during Decel = Disabled] when you operate the drive with:</p> <ul style="list-style-type: none"> • a regenerative converter • regenerative unit • braking resistor • braking resistor unit. <p><i>If you set the parameter incorrectly, the drive can decelerate for too long and cause serious injury or death.</i></p> <p>Note:</p> <ul style="list-style-type: none"> • Short-time average deceleration torque refers to the necessary torque to decelerate the motor (uncoupled from the load) from the rated speed to zero. Motor characteristics can change the actual specifications. • Motor characteristics change the continuous regenerative torque and short-time average deceleration torque for motors 2.2 kW and larger.

Item	Specification
V/f Characteristics	Select from 15 pre-defined V/f patterns, or a user-set V/f pattern.
Main Control Functions	Feed Forward Control, Restart After Momentary Power Loss, Speed Search, Overtorque Detection, Torque Limit, 17 Step Speed (max.), Accel/Decel Switch, S-curve Acceleration/Deceleration, 3-wire Sequence, Auto-Tuning (Rotational and Stationary), Dwell Function, Cooling Fan ON/OFF Switch, Slip Compensation, Torque Compensation, Frequency Jump, Upper/Lower Limits for Frequency Reference, DC Injection Braking at Start and Stop, Overexcitation Braking, High Slip Braking, PID Control (with Sleep Function), Energy Saving Control, MEMOBUS/Modbus Communications (RS-485 max, 115.2 kbps), Auto Restart, Application Presets, DriveWorksEZ (customized functions), Parameter Backup Function, Online Tuning, KEB, Overexcitation Deceleration, Overvoltage Suppression, High Frequency Injection, etc.

Table 10.9 Protection Functions

Item	Specification
Motor Protection	Electronic thermal overload protection
Momentary Overcurrent Protection	Drive stops when the output current is more than 200% of the HD output current.
Overload Protection	Drive stops when the output current is more than these overload tolerances: <ul style="list-style-type: none"> • HD: 150% of the rated output current for 60 seconds. • ND: 110% of the rated output current for 60 seconds. Note: If output frequency < 6 Hz, the drive can trigger the overload protection function when the output current is in the overload tolerance range.
Overvoltage Protection	200 V Class: Stops when the DC bus voltage is more than approximately 410 V 400 V Class: Stops when the DC bus voltage is more than approximately 820 V
Undervoltage Protection	Single-phase 200 V class: Stops when the DC bus voltage decreases to less than approximately 160 V Three-phase 200 V class: Stops when the DC bus voltage decreases to less than approximately 190 V Three-phase 400 V class: Stops when the DC bus voltage decreases to less than approximately 380 V
Momentary Power Loss Ride-thru	Stops when power loss is longer than 15 ms and continues operation if power loss is shorter than 2 s (depending on parameter settings). Note: <ul style="list-style-type: none"> • Load size and motor speed can cause the stop time to be shorter. • Drive capacity will change the continuous operation time. A Momentary Power Loss Recovery Unit is necessary to continue operation through a 2 s power loss on models 2001 to 2042 and 4001 to 4023.
Heatsink Overheat Protection	The drive stops when the thermistor detects an IGBT temperature more than approximately 100°C (212°F). The trip temperature level is different for different drive models.
Braking Resistor Overheat Protection	Overheat detection for braking resistor (optional ERF-type, 3% ED)
Stall Prevention	Stall prevention is available during acceleration, deceleration, and during run.
Ground Fault Protection	Electronic circuit protection Note: This protection detects ground faults during run. The drive will not provide protection when: <ul style="list-style-type: none"> • There is a low-resistance ground fault for the motor cable or terminal block • There is a ground fault and you energize the drive
DC Bus Charge LED	Charge LED illuminates when DC bus voltage is more than 50 V.

Table 10.10 Environment

Item	Specification
Area of Use	Indoors
Power Supply	Overvoltage Category III
Ambient Temperature	IP20/UL Open Type: -10 °C to +50 °C (14 °F to 122 °F) IP20/UL Type 1: -10 °C to +40 °C (14 °F to 104 °F) <ul style="list-style-type: none"> • When you install the drive in an enclosure, use a cooling fan or air conditioner to keep the internal air temperature in the permitted range. • Do not let the drive freeze.
Humidity	95% RH or less Do not let condensation form on the drive.
Storage Temperature	-20 °C to +70 °C (-4 °F to +158 °F) (short-term temperature during transportation)
Surrounding Area	Pollution degree 2 or less Install the drive in an area without: <ul style="list-style-type: none"> • Oil mist, corrosive or flammable gas, or dust • Metal powder, oil, water, or other unwanted materials • Radioactive materials or flammable materials, including wood • Harmful gas or fluids • Salt • Direct sunlight

10.6 Drive Specifications

Item	Specification
Altitude	<p>1000 m (3281 ft) Maximum</p> <p>Note: Derate the output current by 1% for each 100 m (328 ft) to install the drive in altitudes between 1000 m to 4000 m (3281 ft to 13123 ft). It is not necessary to derate the rated voltage in these conditions:</p> <ul style="list-style-type: none"> • Installing the drive at 2000 m (6562 ft) or lower • Installing the drive between 2000 m to 4000 m (6562 ft to 13123 ft) and grounding the neutral point on the power supply. Contact Yaskawa or your nearest sales representative if you will not ground the neutral point.
Vibration	<ul style="list-style-type: none"> • 10 Hz to 20 Hz: 1 G (9.8 m/s², 32.15 ft/s²) • 20 Hz to 55 Hz: 0.6 G (5.9 m/s², 19.36 ft/s²)
Installation Orientation	Install the drive vertically for sufficient airflow to cool the drive.

Table 10.11 Standard

Item	Specification
Harmonized Standard	<ul style="list-style-type: none"> • UL 61800-5-1 • EN 61800-3 • EN 61800-5-1 • Two Safe Disable inputs and one EDM output according to EN ISO 13849-1 (Cat.3, PL e), EN 61800-5-2 SIL3
Enclosure Protection Design	<p>IP20/UL Open Type IP20/UL Type 1</p> <p>Note: Install a UL Type 1 kit (optional) on an IP20/UL Open Type drive to change the drive to an IP20/UL Type 1 enclosure.</p>

10.7 Drive Derating

You must derate the drive capacity to operate the drive above the rated temperature, altitude, and default carrier frequency.

◆ Carrier Frequency Settings and Rated Current Values

The tables in this section show how the drive rated output current changes when the *C6-02 [Carrier Frequency Selection]* value changes. The output current value changes linearly as the carrier frequency changes. You can use the values from the tables to calculate a frequency that is not shown.

■ Single-Phase 200 V Class

Table 10.12 Carrier Frequency and Rated Current Derating (Single-Phase 200 V)

Model	Rated Current (A)											
	Heavy Duty Rating (HD) [C6-01 = 0]						Normal Duty Rating (ND) [C6-01 = 1]					
	2 kHz	5 kHz	8 kHz	10 kHz	12.5 kHz	15 kHz	2 kHz	5 kHz	8 kHz	10 kHz	12.5 kHz	15 kHz
B001	0.8	0.8	0.8	0.8	0.7	0.6	1.2	1.1	1.0	0.9	0.8	0.6
B002	1.6	1.6	1.6	1.6	1.4	1.3	1.9	1.9	1.7	1.6	1.4	1.3
B004	3.0	3.0	3.0	3.0	2.7	2.4	3.5	3.5	3.2	3.0	2.7	2.4
B006	5.0	5.0	5.0	5.0	4.5	4.0	6.0	6.0	5.4	5.0	4.5	4.0
B010	8.0	8.0	8.0	7.5	7.0	6.4	9.6	9.1	8.3	7.7	7.1	6.4
B012	11.0	11.0	11.0	10.4	9.6	8.8	12.2	11.9	11.0	10.4	9.6	8.8
B018	17.6	17.6	17.6	16.6	15.3	14.1	21.0	19.8	18.1	17.0	15.5	14.1

Table 10.13 AOLV/PM Carrier Frequency and Rated Current Derating (Single-Phase 200 V)

Model	Rated Current (A)											
	Heavy Duty Rating (HD) [C6-01 = 0]						Normal Duty Rating (ND) [C6-01 = 1]					
	2 kHz	4 kHz	6 kHz	8 kHz	10 kHz	12 kHz	2 kHz	4 kHz	6 kHz	8 kHz	10 kHz	12 kHz
B001	0.8	0.8	0.8	0.7	0.6	0.5	1.2	1.1	0.9	0.8	0.6	0.5
B002	1.6	1.6	1.6	1.5	1.3	1.1	1.9	1.9	1.7	1.5	1.3	1.1
B004	3.0	3.0	3.0	2.8	2.4	2.0	3.5	3.5	3.1	2.8	2.4	2.0
B006	5.0	5.0	5.0	4.6	4.0	3.4	6.0	5.8	5.2	4.6	4.0	3.4
B010	8.0	8.0	7.8	7.1	6.4	5.7	9.6	8.8	8.0	7.2	6.4	5.6
B012	11.0	11.0	10.7	9.7	8.8	7.9	12.2	11.6	10.7	9.7	8.8	7.9
B018	17.6	17.6	17.1	15.6	14.1	12.6	21.0	19.3	17.5	15.8	14.1	12.3

■ Three-Phase 200 V Class

Table 10.14 Carrier Frequency and Rated Current Derating (Three-Phase 200 V)

Model	Rated Current (A)											
	Heavy Duty Rating (HD) [C6-01 = 0]						Normal Duty Rating (ND) [C6-01 = 1]					
	2 kHz	5 kHz	8 kHz	10 kHz	12.5 kHz	15 kHz	2 kHz	5 kHz	8 kHz	10 kHz	12.5 kHz	15 kHz
2001	0.8	0.8	0.8	0.8	0.7	0.6	1.2	1.1	1.0	0.9	0.8	0.6
2002	1.6	1.6	1.6	1.6	1.4	1.3	1.9	1.9	1.7	1.6	1.4	1.3
2004	3.0	3.0	3.0	3.0	2.7	2.4	3.5	3.5	3.2	3.0	2.7	2.4
2006	5.0	5.0	5.0	5.0	4.5	4	6.0	6.0	5.4	5.0	4.5	4

10.7 Drive Derating

Model	Rated Current (A)											
	Heavy Duty Rating (HD) [C6-01 = 0]						Normal Duty Rating (ND) [C6-01 = 1]					
	2 kHz	5 kHz	8 kHz	10 kHz	12.5 kHz	15 kHz	2 kHz	5 kHz	8 kHz	10 kHz	12.5 kHz	15 kHz
2010	8.0	8.0	8.0	7.5	7.0	6.4	9.6	9.1	8.3	7.7	7.1	6.4
2012	11.0	11.0	11.0	10.4	9.6	8.8	12.2	11.9	11.0	10.4	9.6	8.8
2021	17.6	17.6	17.6	16.6	15.3	14.1	21.0	19.8	18.1	17.0	15.5	14.1
2030	25.0	25.0	25.0	23.6	21.8	20	30.0	28.3	25.8	24.2	22.1	20
2042	33.0	33.0	33.0	31.1	28.8	26	42.0	39.4	35.5	32.9	29.7	26
2056	47.0	47.0	47.0	44.3	41.0	38	56.0	52.9	48.3	45.3	41.4	38
2070	60.0	60.0	60.0	56.6	52.3	48	70.0	66.3	60.8	57.2	52.6	48
2082	75.0	75.0	75.0	70.7	65.4	60	82.0	81.4	75.0	70.7	65.4	60

Table 10.15 AOLV/PM Carrier Frequency and Rated Current Derating (Three-Phase 200 V)

Model	Rated Current (A)											
	Heavy Duty Rating (HD) [C6-01 = 0]						Normal Duty Rating (ND) [C6-01 = 1]					
	2 kHz	4 kHz	6 kHz	8 kHz	10 kHz	12 kHz	2 kHz	4 kHz	6 kHz	8 kHz	10 kHz	12 kHz
2001	0.8	0.8	0.8	0.7	0.6	0.5	1.2	1.1	0.9	0.8	0.6	0.5
2002	1.6	1.6	1.6	1.5	1.3	1.1	1.9	1.9	1.7	1.5	1.3	1.1
2004	3.0	3.0	3.0	2.8	2.4	2.0	3.5	3.5	3.1	2.8	2.4	2.0
2006	5.0	5.0	5.0	4.6	4.0	3.4	6.0	5.8	5.2	4.6	4.0	3.4
2010	8.0	8.0	7.8	7.1	6.4	5.7	9.6	8.8	8.0	7.2	6.4	5.6
2012	11.0	11.0	10.7	9.7	8.8	7.9	12.2	11.6	10.7	9.7	8.8	7.9
2021	17.6	17.6	17.1	15.6	14.1	12.6	21.0	19.3	17.5	15.8	14.1	12.4
2030	25.0	25.0	24.3	22.1	20.0	17.9	30.0	27.5	25.0	22.5	20.0	17.5
2042	33.0	33.0	32.1	29.2	26.4	23.6	42.0	38.1	34.2	30.3	26.4	22.5
2056	47.0	47.0	45.7	41.6	37.6	33.6	56.0	51.4	46.8	42.2	37.6	33.0
2070	60.0	60.0	58.3	53.1	48.0	42.9	70.0	64.5	59.0	53.5	48.0	42.5
2082	75.0	75.0	72.9	66.4	60.0	53.6	82.0	79.3	72.9	66.4	60.0	53.6

■ Three-Phase 400 V Class

Table 10.16 Carrier Frequency and Rated Current Derating (Three-Phase 400 V)

Model	Rated Current (A)											
	Heavy Duty Rating (HD) [C6-01 = 0]						Normal Duty Rating (ND) [C6-01 = 1]					
	2 kHz	5 kHz	8 kHz	10 kHz	12.5 kHz	15 kHz	2 kHz	5 kHz	8 kHz	10 kHz	12.5 kHz	15 kHz
4001	1.2	1.2	1.2	1.1	0.9	0.7	1.2	1.2	1.2	1.1	0.9	0.7
4002	1.8	1.8	1.8	1.6	1.3	1.1	2.1	2.1	1.8	1.6	1.3	1.1
4004	3.4	3.4	3.4	3.0	2.5	2.0	4.1	4.0	3.4	3.0	2.5	2.0
4005	4.8	4.8	4.8	4.3	3.6	2.9	5.4	5.4	4.8	4.2	3.6	2.9
4007	5.5	5.5	5.5	4.9	4.1	3.3	7.1	6.5	5.5	4.9	4.1	3.3
4009	7.3	7.3	7.3	6.5	5.4	4.4	8.9	8.6	7.3	6.5	5.4	4.4
4012	9.2	9.2	9.2	8.1	6.8	5.5	11.9	10.8	9.2	8.2	6.8	5.5
4018	14.8	14.8	14.8	13.1	11.0	8.9	17.5	17.0	14.5	12.8	10.8	8.7
4023	18.0	18.0	18.0	15.9	13.4	10.8	23.4	21.3	18.2	16.1	13.4	10.8

Model	Rated Current (A)											
	Heavy Duty Rating (HD) [C6-01 = 0]						Normal Duty Rating (ND) [C6-01 = 1]					
	2 kHz	5 kHz	8 kHz	10 kHz	12.5 kHz	15 kHz	2 kHz	5 kHz	8 kHz	10 kHz	12.5 kHz	15 kHz
4031	24.0	24.0	24.0	21.3	17.8	14.4	31.0	28.2	24.1	21.3	17.9	14.4
4038	31.0	31.0	31.0	27.5	23.0	18.6	38.0	36.3	31.0	27.5	23.0	18.6
4044	39.0	39.0	39.0	34.5	29.0	23.4	44.0	44.0	39.0	34.5	29.0	23.4
4060	45.0	45.0	45.0	39.9	33.4	27.0	60.0	54.5	46.3	40.8	33.9	27.0

Table 10.17 AOLV/PM Carrier Frequency and Rated Current Derating (Three-Phase 400 V)

Model	Rated Current (A)											
	Heavy Duty Rating (HD) [C6-01 = 0]						Normal Duty Rating (ND) [C6-01 = 1]					
	2 kHz	4 kHz	6 kHz	8 kHz	10 kHz	12 kHz	2 kHz	4 kHz	6 kHz	8 kHz	10 kHz	12 kHz
4001	1.2	1.2	1.1	0.9	0.7	0.5	1.2	1.2	1.1	0.9	0.7	0.5
4002	1.8	1.8	1.7	1.4	1.1	0.8	2.1	2.0	1.7	1.4	1.1	0.8
4004	3.4	3.4	3.2	2.6	2.0	1.5	4.1	3.8	3.2	2.6	2.0	1.5
4005	4.8	4.8	4.5	3.7	2.9	2.1	5.4	5.3	4.5	3.7	2.9	2.1
4007	5.5	5.5	5.2	4.2	3.3	2.4	7.1	6.2	5.2	4.3	3.3	2.4
4009	7.3	7.3	6.9	5.6	4.4	3.1	8.9	8.1	6.9	5.6	4.4	3.1
4012	9.2	9.2	8.7	7.1	5.5	3.9	11.9	10.3	8.7	7.1	5.5	3.9
4018	14.8	14.8	14.0	11.4	8.9	6.3	17.5	16.2	13.7	11.2	8.7	6.2
4023	18.0	18.0	17.0	13.9	10.8	7.7	23.4	20.3	17.1	14.0	10.8	7.7
4031	24.0	24.0	22.6	18.5	14.4	10.3	31.0	26.9	22.7	18.6	14.4	10.3
4038	31.0	31.0	29.2	23.9	18.6	13.3	38.0	34.5	29.2	23.9	18.6	13.3
4044	39.0	39.0	36.8	30.1	23.4	16.7	44.0	43.5	36.8	30.1	23.4	16.7
4060	45.0	45.0	42.4	34.7	27.0	19.3	60.0	51.8	43.5	35.3	27.0	18.8

◆ Derating Depending on Ambient Temperature

When you install drives in these conditions, set L8-12 [Ambient Temperature Setting] and L8-35 [Installation Method Selection].

- Surrounding air temperatures are higher than the rated conditions
- Install drives side-by-side in the enclosure panel

Derate the output current as specified in Figure 10.1.

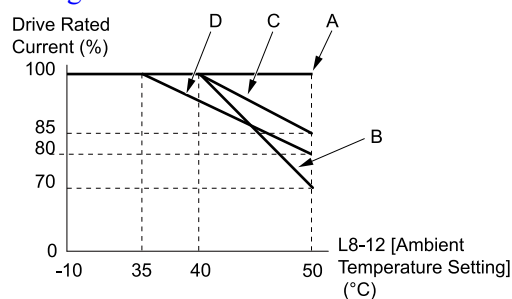

A - L8-35 = 0 [IP20/UL Open Type] (0.5 m/s of airflow around the drive is necessary)

B - L8-35 = 1 [Side-by-Side Mounting]

C - L8-35 = 2 [IP20/UL Type 1]

D - L8-35 = 3 [External Heatsink/Finless]

Figure 10.1 Derating Depending on Drive Installation Method

■ L8-12: Ambient Temperature Setting

No. (Hex.)	Name	Description	Default (Range)
L8-12 (04B8)	Ambient Temperature Setting	<div style="display: flex; gap: 5px;"> V/f OLV OLV/PM AOLV/PM EZOLV </div> Sets the ambient temperature of the drive installation area.	40 °C (-10 °C - +60 °C)

Note:

The setting range changes when the L8-35 [Installation Method Selection] value changes:

- 0 [IP20/UL Open Type]: -10 °C to +60 °C
- 1 [Side-by-Side Mounting]: -10 °C to +50 °C
- 2 [IP20/UL Type 1]: -10 °C to +50 °C
- 3 [External Heatsink/Finless]: -10 °C to +50 °C

The drive automatically adjusts the drive rated current to the best value as specified by the set temperature. Set the ambient temperature of the area where you install the drive to a value that is more than the drive rating.

Refer to [Derating Depending on Ambient Temperature on page 355](#) for information about derating as specified by ambient temperature.

■ L8-35: Installation Method Selection

No. (Hex.)	Name	Description	Default (Range)
L8-35 (04EC)	Installation Method Selection	<div style="display: flex; gap: 5px;"> V/f OLV OLV/PM AOLV/PM EZOLV </div> Sets the type of drive installation.	0, 3 (0 - 3)

Note:

- Parameter A1-03 [Initialize Parameters] does not initialize this parameter.
- This parameter is set to the correct value when the drive is shipped. Change the value only in these conditions:
 - Side-by-Side installation
 - When you install a UL Type 1 kit on an IP20/UL Open Type drive to convert the drive to an IP20/UL Type 1 drive.
 - Mounting a standard drive with the heatsink outside the enclosure panel.
- Do not change the settings for finless-type drives.

The drive automatically adjusts the overload protection detection level to the best value for each setting value. Refer to [Derating Depending on Ambient Temperature on page 355](#) for information about derating as specified by ambient temperature.

0 : IP20/UL Open Type

Use this setting to install IP20/UL Open Type drives.

Make sure that there is 30 mm (1.18 in) minimum of space between drives or between the drive and side of the enclosure panel.

1 : Side-by-Side Mounting

Use this setting to install more than one drive side-by-side.

Note:

You cannot install finless-type drives side-by-side.

2 : IP20/UL Type1

Use this setting to install IP20/UL Type 1 drives.

Note:

You cannot install an IP20/UL Type 1 Kit (optional) on a finless-type drive.

3 : External Heatsink/Finless

Use this setting when the heatsink (cooling fin) is outside the enclosure panel or when you install a finless-type drive.

◆ Altitude Derating

Install the drive in a location that has an altitude of 1000 m (3281 ft) or lower.

Derate the output current by 1% for each 100 m (328 ft) to install the drive in altitudes between 1000 to 4000 m (3281 to 13123 ft).

It is not necessary to derate the rated voltage in these conditions:

- Installing the drive at 2000 m (6562 ft) or lower
- Installing the drive between 2000 to 4000 m (6562 to 13123 ft) and grounding the neutral point on the power supply.

If you do not ground the drive with a neutral network, contact Yaskawa or your nearest sales representative.

10.8 Drive Exterior and Mounting Dimensions

◆ Drive Models and Exterior and Mounting Dimensions

Table 10.18 Single-Phase 200 V Class

Model	IP20/UL Open Type	Finless-Type Drive
B001 - B004	358	363
B006 - B018 *1	360	364

*1 There is not a finless-type B018 model.

Table 10.19 Three-Phase 200 V Class

Model	IP20/UL Open Type	Finless-Type Drive
2001 - 2006	358	363
2010 - 2021	360	364
2030 - 2082 *1	362	365

*1 There is not a finless-type 2082 model.

Table 10.20 Three-Phase 400 V Class

Model	IP20/UL Open Type	Finless-Type Drive
4001 - 4012	360	364
4018 - 4060 *1	362	365

*1 There are not finless-type 4044 or 4060 models.

◆ IP20/UL Open Type

■ B001 to B004, 2001 to 2006

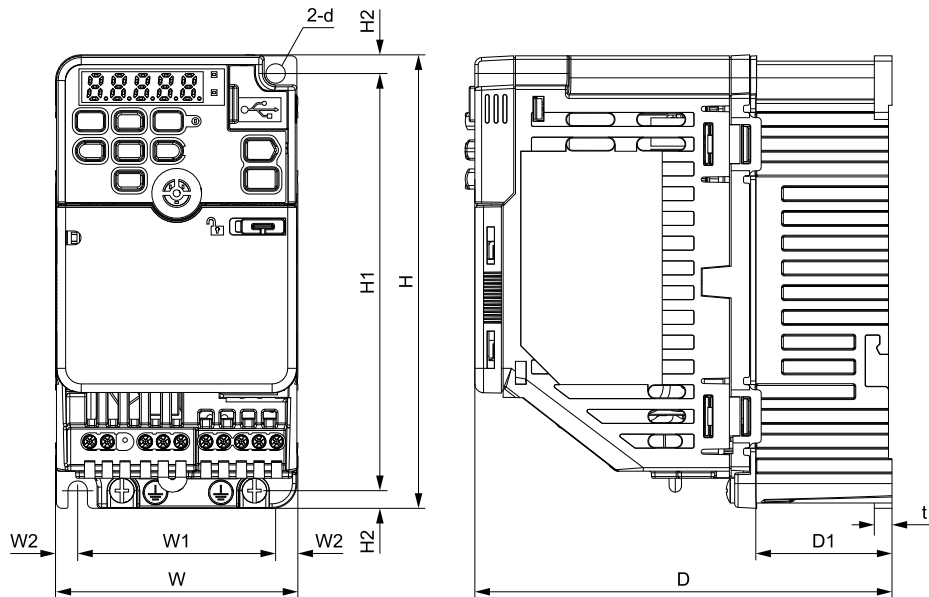

Figure 10.2 Exterior and Mounting Dimensions

Table 10.21 Single-Phase 200 V Class (IP20/UL Open Type, without Built-in EMC Filter)

Model	Dimensions mm (in)										Est. Weight kg (lb)
	W	H	D	W1	W2	H1	H2	D1	t1	d	
B001A	68 (2.68)	128 (5.04)	76 (2.99)	56 (2.20)	6 (0.24)	118 (4.65)	5 (0.20)	6.5 (0.26)	3 (0.12)	M5	0.5 (1.1)
B002A	68 (2.68)	128 (5.04)	76 (2.99)	56 (2.20)	6 (0.24)	118 (4.65)	5 (0.20)	6.5 (0.26)	3 (0.12)	M5	0.5 (1.1)
B004A	68 (2.68)	128 (5.04)	118 (4.65)	56 (2.20)	6 (0.24)	118 (4.65)	5 (0.20)	38.5 (1.52)	5 (0.20)	M5	0.8 (1.8)

Table 10.22 Single-Phase 200 V Class (IP20/UL Open Type, with Built-in EMC Filter)

Model	Dimensions mm (in)										Est. Weight kg (lb)
	W	H	D	W1	W2	H1	H2	D1	t1	d	
B001E	68 (2.68)	128 (5.04)	116 (4.57)	56 (2.20)	6 (0.24)	118 (4.65)	5 (0.20)	6.5 (0.26)	3 (0.12)	M5	0.7 (1.6)
B002E	68 (2.68)	128 (5.04)	116 (4.57)	56 (2.20)	6 (0.24)	118 (4.65)	5 (0.20)	6.5 (0.26)	3 (0.12)	M5	0.7 (1.6)
B004E	68 (2.68)	128 (5.04)	158 (6.22)	56 (2.20)	6 (0.24)	118 (4.65)	5 (0.20)	38.5 (1.52)	5 (0.20)	M5	1.0 (2.2)

Table 10.23 Three-Phase 200 V Class (IP20/UL Open Type, without Built-in EMC Filter)

Model	Dimensions mm (in)										Est. Weight kg (lb)
	W	H	D	W1	W2	H1	H2	D1	t1	d	
2001A	68 (2.68)	128 (5.04)	76 (2.99)	56 (2.20)	6 (0.24)	118 (4.65)	5 (0.20)	6.5 (0.26)	3 (0.12)	M5	0.5 (1.1)
2002A	68 (2.68)	128 (5.04)	76 (2.99)	56 (2.20)	6 (0.24)	118 (4.65)	5 (0.20)	6.5 (0.26)	3 (0.12)	M5	0.5 (1.1)
2004A	68 (2.68)	128 (5.04)	108 (4.25)	56 (2.20)	6 (0.24)	118 (4.65)	5 (0.20)	38.5 (1.52)	5 (0.20)	M5	0.8 (1.8)
2006A	68 (2.68)	128 (5.04)	128 (5.04)	56 (2.20)	6 (0.24)	118 (4.65)	5 (0.20)	58.5 (2.30)	5 (0.20)	M5	0.9 (2.0)

Table 10.24 Three-Phase 200 V Class (IP20/UL Open Type, with Built-in EMC Filter)

Model	Dimensions mm (in)										Est. Weight kg (lb)
	W	H	D	W1	W2	H1	H2	D1	t1	d	
2001E	68 (2.68)	128 (5.04)	116 (4.57)	56 (2.20)	6 (0.24)	118 (4.65)	5 (0.20)	6.5 (0.26)	3 (0.12)	M5	0.6 (1.3)
2002E	68 (2.68)	128 (5.04)	116 (4.57)	56 (2.20)	6 (0.24)	118 (4.65)	5 (0.20)	6.5 (0.26)	3 (0.12)	M5	0.6 (1.3)
2004E	68 (2.68)	128 (5.04)	148 (5.83)	56 (2.20)	6 (0.24)	118 (4.65)	5 (0.20)	38.5 (1.52)	5 (0.20)	M5	0.9 (2.0)
2006E	68 (2.68)	128 (5.04)	168 (6.61)	56 (2.20)	6 (0.24)	118 (4.65)	5 (0.20)	58.5 (2.30)	5 (0.20)	M5	1.1 (2.4)

■ B006 to B018, 2010 to 2021, 4001 to 4012

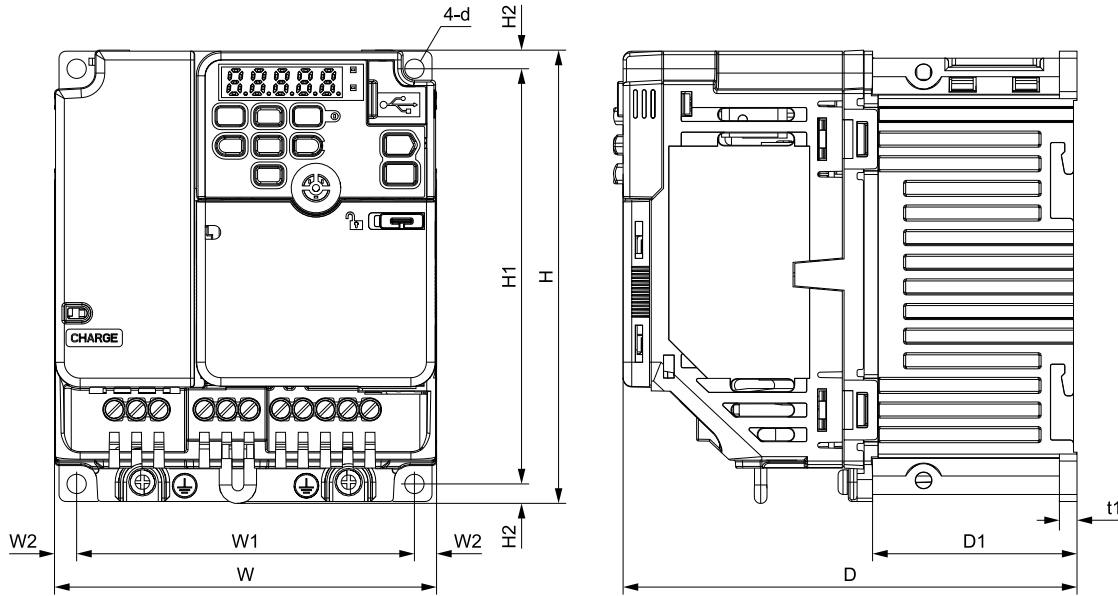

Figure 10.3 Exterior and Mounting Dimensions

Table 10.25 Single-Phase 200 V Class (IP20/UL Open Type, without Built-in EMC Filter)

Model	Dimensions mm (in)										Est. Weight kg (lb)
	W	H	D	W1	W2	H1	H2	D1	t1	d	
B006A	108 (4.25)	128 (5.04)	137.5 (5.41)	96 (3.78)	6 (0.24)	118 (4.65)	5 (0.20)	56.5 (2.22)	5 (0.20)	M5	1.5 (3.3)
B010A	108 (4.25)	128 (5.04)	154 (6.06)	96 (3.78)	6 (0.24)	118 (4.65)	5 (0.20)	56.5 (2.22)	5 (0.20)	M5	1.5 (3.3)
B012A	140 (5.51)	128 (5.04)	163 (6.42)	128 (5.04)	6 (0.24)	118 (4.65)	5 (0.20)	65 (2.56)	5 (0.20)	M5	2.1 (4.6)
B018A	170 (6.69)	128 (5.04)	180 (7.09)	158 (6.22)	6 (0.24)	118 (4.65)	5 (0.20)	65 (2.56)	5 (0.20)	M5	2.9 (6.4)

Table 10.26 Single-Phase 200 V Class (IP20/UL Open Type, with Built-in EMC Filter)

Model	Dimensions mm (in)										Est. Weight kg (lb)
	W	H	D	W1	W2	H1	H2	D1	t1	d	
B006E	108 (4.25)	128 (5.04)	182.5 (7.19)	96 (3.78)	6 (0.24)	118 (4.65)	5 (0.20)	56.5 (2.22)	5 (0.20)	M5	1.8 (4.0)
B010E	108 (4.25)	128 (5.04)	199 (7.83)	96 (3.78)	6 (0.24)	118 (4.65)	5 (0.20)	56.5 (2.22)	5 (0.20)	M5	1.8 (4.0)
B012E	140 (5.51)	128 (5.04)	203 (7.99)	128 (5.04)	6 (0.24)	118 (4.65)	5 (0.20)	65 (2.56)	5 (0.20)	M5	2.7 (6.0)

Table 10.27 Three-Phase 200 V Class (IP20/UL Open Type, without Built-in EMC Filter)

Model	Dimensions mm (in)										Est. Weight kg (lb)
	W	H	D	W1	W2	H1	H2	D1	t1	d	
2010A	108 (4.25)	128 (5.04)	129 (5.08)	96 (3.78)	6 (0.24)	118 (4.65)	5 (0.20)	56.5 (2.22)	5 (0.20)	M5	1.5 (3.3)
2012A	108 (4.25)	128 (5.04)	137.5 (5.41)	96 (3.78)	6 (0.24)	118 (4.65)	5 (0.20)	56.5 (2.22)	5 (0.20)	M5	1.5 (3.3)
2021A	140 (5.51)	128 (5.04)	143 (5.63)	128 (5.04)	6 (0.24)	118 (4.65)	5 (0.20)	65 (2.56)	5 (0.20)	M5	2.0 (4.4)

Table 10.28 Three-Phase 200 V Class (IP20/UL Open Type, with Built-in EMC Filter)

Model	Dimensions mm (in)										Est. Weight kg (lb)
	W	H	D	W1	W2	H1	H2	D1	t1	d	
2010E	108 (4.25)	128 (5.04)	174 (6.85)	96 (3.78)	6 (0.24)	118 (4.65)	5 (0.20)	56.5 (2.22)	5 (0.20)	M5	1.6 (3.5)
2012E	108 (4.25)	128 (5.04)	182.5 (7.19)	96 (3.78)	6 (0.24)	118 (4.65)	5 (0.20)	56.5 (2.22)	5 (0.20)	M5	1.6 (3.5)
2021E	140 (5.51)	128 (5.04)	193 (7.60)	128 (5.04)	6 (0.24)	118 (4.65)	5 (0.20)	65 (2.56)	5 (0.20)	M5	2.4 (5.3)

Table 10.29 Three-Phase 400 V Class (IP20/UL Open Type, without Built-in EMC Filter)

Model	Dimensions mm (in)										Est. Weight kg (lb)
	W	H	D	W1	W2	H1	H2	D1	t1	d	
4001A	108 (4.25)	128 (5.04)	81 (3.19)	96 (3.78)	6 (0.24)	118 (4.65)	5 (0.20)	8.5 (0.33)	5 (0.20)	M5	0.8 (1.8)
4002A	108 (4.25)	128 (5.04)	99 (3.90)	96 (3.78)	6 (0.24)	118 (4.65)	5 (0.20)	26.5 (1.04)	5 (0.20)	M5	0.9 (2.0)
4004A	108 (4.25)	128 (5.04)	137.5 (5.41)	96 (3.78)	6 (0.24)	118 (4.65)	5 (0.20)	56.5 (2.22)	5 (0.20)	M5	1.5 (3.3)
4005A	108 (4.25)	128 (5.04)	154 (6.06)	96 (3.78)	6 (0.24)	118 (4.65)	5 (0.20)	56.5 (2.22)	5 (0.20)	M5	1.5 (3.3)
4007A	108 (4.25)	128 (5.04)	154 (6.06)	96 (3.78)	6 (0.24)	118 (4.65)	5 (0.20)	56.5 (2.22)	5 (0.20)	M5	1.5 (3.3)
4009A	108 (4.25)	128 (5.04)	154 (6.06)	96 (3.78)	6 (0.24)	118 (4.65)	5 (0.20)	56.5 (2.22)	5 (0.20)	M5	1.5 (3.3)
4012A	140 (5.51)	128 (5.04)	143 (5.63)	128 (5.04)	6 (0.24)	118 (4.65)	5 (0.20)	65 (2.56)	5 (0.20)	M5	2.0 (4.4)

Table 10.30 Three-Phase 400 V Class (IP20/UL Open Type, with Built-in EMC Filter)

Model	Dimensions mm (in)										Est. Weight kg (lb)
	W	H	D	W1	W2	H1	H2	D1	t1	d	
4001E	108 (4.25)	128 (5.04)	126 (4.96)	96 (3.78)	6 (0.24)	118 (4.65)	5 (0.20)	8.5 (0.33)	5 (0.20)	M5	1.4 (3.1)
4002E	108 (4.25)	128 (5.04)	144 (5.67)	96 (3.78)	6 (0.24)	118 (4.65)	5 (0.20)	26.5 (1.04)	5 (0.20)	M5	1.5 (3.3)
4004E	108 (4.25)	128 (5.04)	182.5 (7.19)	96 (3.78)	6 (0.24)	118 (4.65)	5 (0.20)	56.5 (2.22)	5 (0.20)	M5	1.9 (4.2)
4005E	108 (4.25)	128 (5.04)	199 (7.83)	96 (3.78)	6 (0.24)	118 (4.65)	5 (0.20)	56.5 (2.22)	5 (0.20)	M5	1.9 (4.2)
4007E	108 (4.25)	128 (5.04)	199 (7.83)	96 (3.78)	6 (0.24)	118 (4.65)	5 (0.20)	56.5 (2.22)	5 (0.20)	M5	1.9 (4.2)
4009E	108 (4.25)	128 (5.04)	199 (7.83)	96 (3.78)	6 (0.24)	118 (4.65)	5 (0.20)	56.5 (2.22)	5 (0.20)	M5	1.9 (4.2)
4012E	140 (5.51)	128 (5.04)	193 (7.60)	128 (5.04)	6 (0.24)	118 (4.65)	5 (0.20)	65 (2.56)	5 (0.20)	M5	2.6 (5.7)

■ 2030 to 2082, 4018 to 4060

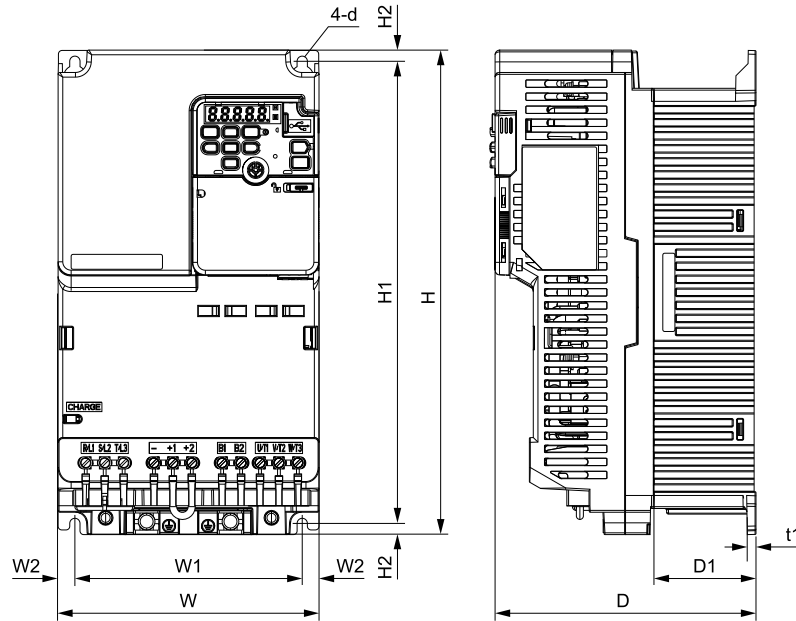

Figure 10.4 Exterior and Mounting Dimensions

Table 10.31 Three-Phase 200 V Class (IP20/UL Open Type, without Built-in EMC Filter)

Model	Dimensions mm (in)										Est. Weight kg (lb)
	W	H	D	W1	W2	H1	H2	D1	t1	d	
2030A	140 (5.51)	260 (10.24)	140 (5.51)	122 (4.80)	9 (0.35)	248 (9.76)	6 (0.24)	55 (2.17)	5 (0.20)	M5	3.4 (7.5)
2042A	140 (5.51)	260 (10.24)	140 (5.51)	122 (4.80)	9 (0.35)	248 (9.76)	6 (0.24)	55 (2.17)	5 (0.20)	M5	3.6 (7.9)
2056A	180 (7.09)	300 (11.81)	143 (5.63)	160 (6.30)	10 (0.39)	284 (11.18)	8 (0.31)	55 (2.17)	5 (0.20)	M5	5.5 (12.1)
2070A	220 (8.66)	350 (13.78)	187 (7.36)	192 (7.56)	14 (0.55)	336 (13.23)	7 (0.28)	78 (3.07)	5 (0.20)	M6	7.5 (16.5)
2082A	220 (8.66)	350 (13.78)	187 (7.36)	192 (7.56)	14 (0.55)	336 (13.23)	7 (0.28)	78 (3.07)	5 (0.20)	M6	8.0 (17.6)

Table 10.32 Three-Phase 200 V Class (IP20/UL Open Type, with Built-in EMC Filter)

Model	Dimensions mm (in)										Est. Weight kg (lb)
	W	H	D	W1	W2	H1	H2	D1	t1	d	
2030E	140 (5.51)	260 (10.24)	196 (7.72)	122 (4.80)	9 (0.35)	248 (9.76)	6 (0.24)	55 (2.17)	5 (0.20)	M5	3.9 (8.6)
2042E	140 (5.51)	260 (10.24)	196 (7.72)	122 (4.80)	9 (0.35)	248 (9.76)	6 (0.24)	55 (2.17)	5 (0.20)	M5	4.1 (9.0)
2056E	180 (7.09)	300 (11.81)	196 (7.72)	160 (6.30)	10 (0.39)	284 (11.18)	8 (0.31)	55 (2.17)	5 (0.20)	M5	6.0 (13.2)
2070E	220 (8.66)	350 (13.78)	216 (8.50)	192 (7.56)	14 (0.55)	336 (13.23)	7 (0.28)	78 (3.07)	5 (0.20)	M6	8.5 (18.7)
2082E	220 (8.66)	350 (13.78)	216 (8.50)	192 (7.56)	14 (0.55)	336 (13.23)	7 (0.28)	78 (3.07)	5 (0.20)	M6	9.0 (19.9)

Table 10.33 Three-Phase 400 V Class (IP20/UL Open Type, without Built-in EMC Filter)

Model	Dimensions mm (in)										Est. Weight kg (lb)
	W	H	D	W1	W2	H1	H2	D1	t1	d	
4018A	140 (5.51)	260 (10.24)	140 (5.51)	122 (4.80)	9 (0.35)	248 (9.76)	6 (0.24)	55 (2.17)	5 (0.20)	M5	3.0 (6.6)
4023A	140 (5.51)	260 (10.24)	140 (5.51)	122 (4.80)	9 (0.35)	248 (9.76)	6 (0.24)	55 (2.17)	5 (0.20)	M5	3.2 (7.1)
4031A	180 (7.09)	300 (11.81)	143 (5.63)	160 (6.30)	10 (0.39)	284 (11.18)	8 (0.31)	55 (2.17)	5 (0.20)	M5	4.6 (10.2)
4038A	180 (7.09)	300 (11.81)	143 (5.63)	160 (6.30)	10 (0.39)	284 (11.18)	8 (0.31)	55 (2.17)	5 (0.20)	M5	4.8 (10.6)
4044A	190 (7.48)	350 (13.78)	204 (8.03)	160 (6.30)	15 (0.59)	336 (13.23)	7 (0.28)	94 (3.70)	5 (0.20)	M6	6.5 (14.3)
4060A	190 (7.48)	350 (13.78)	204 (8.03)	160 (6.30)	15 (0.59)	336 (13.23)	7 (0.28)	94 (3.70)	5 (0.20)	M6	6.5 (14.3)

Table 10.34 Three-Phase 400 V Class (IP20/UL Open Type, with Built-in EMC Filter)

Model	Dimensions mm (in)										Est. Weight kg (lb)
	W	H	D	W1	W2	H1	H2	D1	t1	d	
4018E	140 (5.51)	260 (10.24)	196 (7.72)	122 (4.80)	9 (0.35)	248 (9.76)	6 (0.24)	55 (2.17)	5 (0.20)	M5	3.9 (8.6)
4023E	140 (5.51)	260 (10.24)	196 (7.72)	122 (4.80)	9 (0.35)	248 (9.76)	6 (0.24)	55 (2.17)	5 (0.20)	M5	3.9 (8.6)
4031E	180 (7.09)	300 (11.81)	196 (7.72)	160 (6.30)	10 (0.39)	284 (11.18)	8 (0.31)	55 (2.17)	5 (0.20)	M5	5.5 (12.1)
4038E	180 (7.09)	300 (11.81)	196 (7.72)	160 (6.30)	10 (0.39)	284 (11.18)	8 (0.31)	55 (2.17)	5 (0.20)	M5	5.5 (12.1)
4044E	190 (7.48)	350 (13.78)	251 (9.88)	160 (6.30)	15 (0.59)	336 (13.23)	7 (0.28)	94 (3.70)	5 (0.20)	M6	8.0 (17.6)
4060E	190 (7.48)	350 (13.78)	251 (9.88)	160 (6.30)	15 (0.59)	336 (13.23)	7 (0.28)	94 (3.70)	5 (0.20)	M6	8.5 (18.7)

◆ **Finless-Type Drive**

■ **B001 to B004, 2001 to 2006**

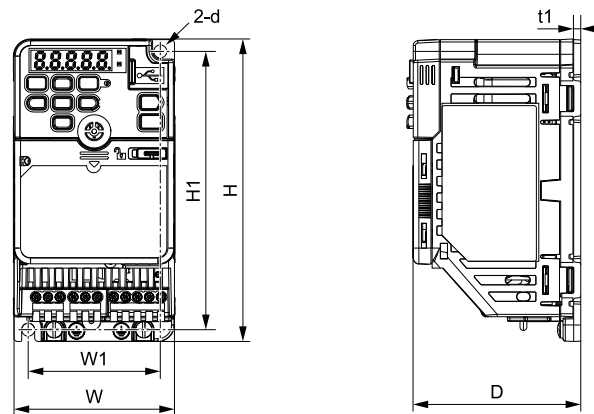

Figure 10.5 Exterior and Mounting Dimensions

Table 10.35 Single-Phase 200 V Class (Finless-Type Drive)

Model	Dimensions mm (in)							Est. Weight kg (lb)
	W	H	D	W1	H1	t1	d	
B001	68 (2.68)	128 (5.04)	71 (2.80)	56 (2.20)	118 (4.65)	3 (0.12)	M5	0.6 (1.32)
B002	68 (2.68)	128 (5.04)	71 (2.80)	56 (2.20)	118 (4.65)	3 (0.12)	M5	0.6 (1.32)
B004	68 (2.68)	128 (5.04)	81 (3.19)	56 (2.20)	118 (4.65)	3 (0.12)	M5	0.6 (1.32)

Table 10.36 Three-Phase 200 V Class (Finless-Type Drive)

Model	Dimensions mm (in)							Est. Weight kg (lb)
	W	H	D	W1	H1	t1	d	
2001	68 (2.68)	128 (5.04)	71 (2.80)	56 (2.20)	118 (4.65)	3 (0.12)	M5	0.6 (1.32)
2002	68 (2.68)	128 (5.04)	71 (2.80)	56 (2.20)	118 (4.65)	3 (0.12)	M5	0.6 (1.32)
2004	68 (2.68)	128 (5.04)	71 (2.80)	56 (2.20)	118 (4.65)	3 (0.12)	M5	0.6 (1.32)
2006	68 (2.68)	128 (5.04)	71 (2.80)	56 (2.20)	118 (4.65)	3 (0.12)	M5	0.6 (1.32)

■ B006 to B012, 2010 to 2021, 4001 to 4012

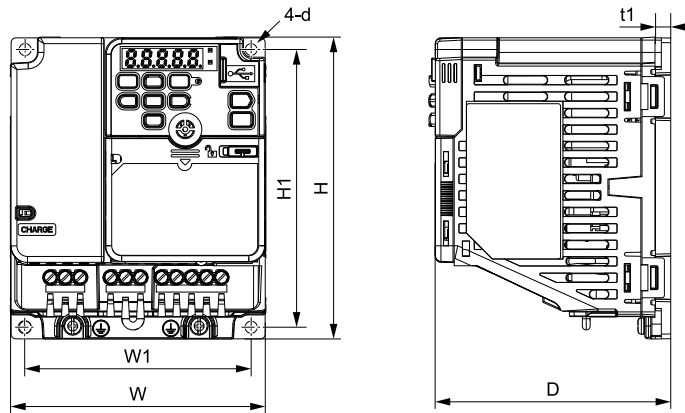

Figure 10.6 Exterior and Mounting Dimensions

Table 10.37 Single-Phase 200 V Class (Finless-Type Drive)

Model	Dimensions mm (in)							Est. Weight kg (lb)
	W	H	D	W1	H1	t1	d	
B006	108 (4.25)	128 (5.04)	81 (3.19)	96 (3.78)	118 (4.65)	4 (0.16)	M5	0.9 (1.98)
B010	108 (4.25)	128 (5.04)	92.5 (3.64)	96 (3.78)	118 (4.65)	4 (0.16)	M5	1.0 (2.20)
B012	140 (5.51)	128 (5.04)	98 (3.86)	128 (5.04)	118 (4.65)	4 (0.16)	M5	1.2 (2.65)

Table 10.38 Three-Phase 200 V Class (Finless-Type Drive)

Model	Dimensions mm (in)							Est. Weight kg (lb)
	W	H	D	W1	H1	t1	d	
2010	108 (4.25)	128 (5.04)	72.5 (2.85)	96 (3.78)	118 (4.65)	4 (0.16)	M5	0.8 (1.76)
2012	108 (4.25)	128 (5.04)	81 (3.19)	96 (3.78)	118 (4.65)	4 (0.16)	M5	0.9 (1.98)
2021	140 (5.51)	128 (5.04)	78 (3.07)	128 (5.04)	118 (4.65)	4 (0.16)	M5	1.2 (2.65)

Table 10.39 Three-Phase 400 V Class (Finless-Type Drive)

Model	Dimensions mm (in)							Est. Weight kg (lb)
	W	H	D	W1	H1	t1	d	
4001	108 (4.25)	128 (5.04)	75 (2.95)	96 (3.78)	118 (4.65)	4 (0.16)	M5	0.8 (1.76)
4002	108 (4.25)	128 (5.04)	75 (2.95)	96 (3.78)	118 (4.65)	4 (0.16)	M5	0.8 (1.76)
4004	108 (4.25)	128 (5.04)	83.5 (3.29)	96 (3.78)	118 (4.65)	4 (0.16)	M5	0.9 (1.98)
4005	108 (4.25)	128 (5.04)	100 (3.94)	96 (3.78)	118 (4.65)	4 (0.16)	M5	1.0 (2.20)
4007	108 (4.25)	128 (5.04)	100 (3.94)	96 (3.78)	118 (4.65)	4 (0.16)	M5	1.0 (2.20)
4009	108 (4.25)	128 (5.04)	100 (3.94)	96 (3.78)	118 (4.65)	4 (0.16)	M5	1.0 (2.20)
4012	140 (5.51)	128 (5.04)	78 (3.07)	128 (5.04)	118 (4.65)	4 (0.16)	M5	1.2 (2.65)

■ 2030 - 2070, 4018 - 4038

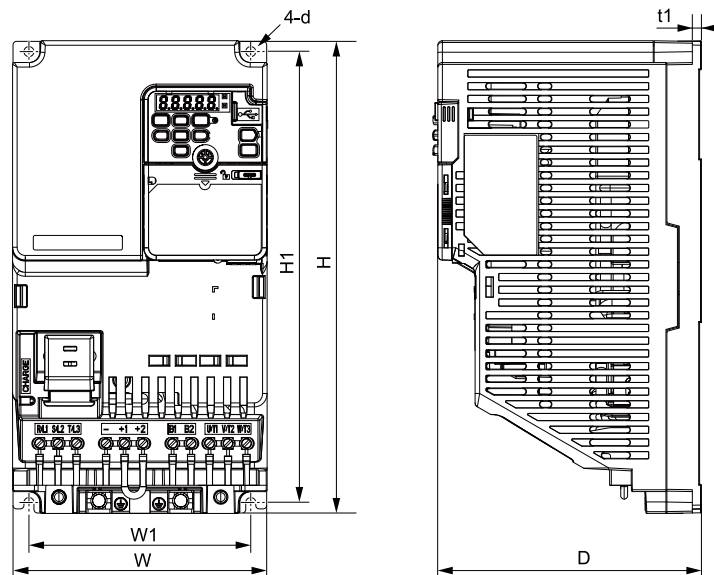

Figure 10.7 Exterior and Mounting Dimensions

10.8 Drive Exterior and Mounting Dimensions

Table 10.40 Three-Phase 200 V Class (Finless-Type Drive)

Model	Dimensions mm (in)							Est. Weight kg (lb)
	W	H	D	W1	H1	t1	d	
2030	140 (5.51)	260 (10.24)	145 (5.71)	122 (4.80)	248 (9.76)	5 (0.20)	M5	2.9 (6.39)
2042	140 (5.51)	260 (10.24)	145 (5.71)	122 (4.80)	248 (9.76)	5 (0.20)	M5	3.1 (6.83)
2056	180 (7.09)	300 (11.81)	147 (5.79)	160 (6.30)	284 (11.18)	5 (0.20)	M5	4.5 (9.92)
2070	220 (8.66)	350 (13.78)	152 (5.98)	192 (7.56)	336 (13.23)	5 (0.20)	M6	6.0 (13.23)

Table 10.41 Three-Phase 400 V Class (Finless-Type Drive)

Model	Dimensions mm (in)							Est. Weight kg (lb)
	W	H	D	W1	H1	t1	d	
4018	140 (5.51)	260 (10.24)	145 (5.71)	122 (4.80)	248 (9.76)	5 (0.20)	M5	2.6 (5.73)
4023	140 (5.51)	260 (10.24)	145 (5.71)	122 (4.80)	248 (9.76)	5 (0.20)	M5	2.8 (6.17)
4031	180 (7.09)	300 (11.81)	147 (5.79)	160 (6.30)	284 (11.18)	5 (0.20)	M5	4.1 (9.04)
4038	180 (7.09)	300 (11.81)	147 (5.79)	160 (6.30)	284 (11.18)	5 (0.20)	M5	4.3 (9.48)

10.9 Peripheral Devices and Options

Table 10.42 to Table 10.46 show the available peripheral devices and options for the drive. Contact Yaskawa or your nearest sales representative to make an order.

- Selection: Refer to the drive catalog for information about available products.
- Installation and wiring: Refer to the instruction manual for each option.

Table 10.42 Main Circuit Options

Name	Intended Use
DC Link Choke	To improve the drive input power factor. <ul style="list-style-type: none"> • To prevent damage to the drive when the power supply capacity is large. You must only use this option when the power supply capacity is more than 600 kVA. • To decrease harmonic current. • To improve the power supply total power factor.
AC reactor	To improve the drive input power factor. <ul style="list-style-type: none"> • To prevent damage to the drive when the power supply capacity is large. You must only use this option when the power supply capacity is more than 600 kVA. • To decrease harmonic current. • To improve the power supply total power factor.

Table 10.43 Keypad

Name	Model	Intended Use
LCD Keypad	JVOP-KPLCA04xxx	A replacement keypad that has an LCD display. Use connection cables that are 3 m (9.8 ft) long maximum to connect this keypad for remote operation.
LED Keypad	JVOP-KPLEA04xxx	A replacement keypad that has an LED display. Use connection cables that are 3 m (9.8 ft) long maximum to connect this keypad for remote operation.
Bluetooth LCD Keypad	JVOP-KPLCC04xxx	A replacement LCD keypad that can connect to the drive with Bluetooth communications and DriveWizard Mobile.
Blank Cover	JVOPKPBCH04AAA	To keep the protection performance when you install the keypad outside of the control panel.
Keypad Panel Mounting Kit	ZPBA-GA500	To install the GA500 standard keypad to a control panel.
	900-192-933-001	To use screws to install an optional keypad to a control panel.
	900-192-933-002	To use nut clamps to install an optional keypad to a control panel.
Remote Control Extension Cable	1 m: WV001	To connect the keypad and drive.
	3 m: WV003	This option is an RJ-45, 8-pin straight-through UTP CAT5e cable.

Table 10.44 Attachments

Name	Model	Intended Use
Heatsink External Mounting Kit	ZPSA-GA50Vx-x	Use this option to install the heatsink outside of the control panel.
UL Type 1 Kit	ZBAA-GA50Vx-x	To change an IP20/UL Open Type drive to an IP20/UL Type 1 drive.
DIN Rail Attachment	ZPZ-GA50Vx	To use a DIN rail to install the drive.
Communication Option Case	JOHB-GA50	To install a communication option on a drive.

Table 10.45 Engineering Tools

Name	Model	Intended Use
DriveWizard	-	To use a PC to program drives and manage parameters.
DriveWorksEZ	-	To use a PC to do advanced drive programming.

Table 10.46 Communication option

Name	Model	Intended Use	Document No.
CANopen	SI-S3	This option uses the host controller over CANopen communication to: <ul style="list-style-type: none"> Operate and stop the drive Set and view parameters Monitor output frequency, output current, and other statuses 	TOBPC73060085 SIJPC73060085
PROFIBUS-DP	SI-P3	This option uses the host controller over PROFIBUS-DP communication to: <ul style="list-style-type: none"> Operate and stop the drive Set and view parameters Monitor output frequency, output current, and other statuses 	TOBPC73060082 SIJPC73060082
CC-Link	SI-C3	This option uses the host controller over CC-Link communication to: <ul style="list-style-type: none"> Operate and stop the drive Set and view parameters Monitor output frequency, output current, and other statuses 	TOBPC73060083 SIJPC73060083
EtherNet/IP	SI-EN3	This option uses the host controller over EtherNet/IP communication to: <ul style="list-style-type: none"> Operate and stop the drive Set and view parameters Monitor output frequency, output current, and other statuses 	TOBPC73060092 SIJPC73060092
PROFINET	SI-EP3	This option uses the host controller over PROFINET communication to: <ul style="list-style-type: none"> Operate and stop the drive Set and view parameters Monitor output frequency, output current, and other statuses 	TOBPC73060089 SIJPC73060089
DeviceNet	SI-N3	This option uses the host controller over DeviceNet communication to: <ul style="list-style-type: none"> Operate and stop the drive Set and view parameters Monitor output frequency, output current, and other statuses <p>Note: The drive is compatible with option software versions 1114 and later.</p>	TOBPC73060084 SIJPC73060084
Modbus TCP/IP	SI-EM3	This option uses the host controller over Modbus TCP/IP communication to: <ul style="list-style-type: none"> Operate and stop the drive Set and view parameters Monitor output frequency, output current, and other statuses 	TOBPC73060091 SIJPC73060091
MECHATROLINK-II	SI-T3	This option uses the host controller over MECHATROLINK-II communication to: <ul style="list-style-type: none"> Operate and stop the drive Set and view parameters Monitor output frequency, output current, and other statuses <p>Note: The drive is compatible with option software versions 6108 and later.</p>	TOBPC73060086 SIJPC73060086
MECHATROLINK-III	SI-ET3	This option uses the host controller over MECHATROLINK-III communication to: <ul style="list-style-type: none"> Operate and stop the drive Set and view parameters Monitor output frequency, output current, and other statuses <p>Note: The drive is compatible with option software versions 6202 and later.</p>	TOBPC73060088 SIJPC73060088

Parameter List

11.1	Section Safety	370
11.2	How to Read the Parameter List	371
11.3	Parameter Groups	372
11.4	A: Initialization Parameters.....	373
11.5	b: Application	376
11.6	C: Tuning	386
11.7	d: Reference Settings.....	391
11.8	E: Motor Parameters.....	395
11.9	F: Options.....	400
11.10	H: Terminal Functions	410
11.11	L: Protection Functions	436
11.12	n: Special Adjustment.....	446
11.13	o: Keypad-Related Settings	453
11.14	q: DriveWorksEZ Parameters.....	459
11.15	r: DWEZ Connection 1-20	460
11.16	T: Motor Tuning	461
11.17	U: Monitors.....	464
11.18	Parameters that Change from the Default Settings with A1-02 [Control Method Selection]	479
11.19	Parameters that Change from the Default Settings with E3-01 [Motor 2 Control Mode Selection]	483
11.20	Parameters Changed by E1-03 [V/f Pattern Selection]	484
11.21	Defaults by Drive Model and Duty Rating ND/HD.....	485

11.1 Section Safety





 **DANGER**

Do not ignore the safety messages in this manual.

If you ignore the safety messages in this manual, it will cause serious injury or death. The manufacturer is not responsible for injuries or damage to equipment.

11.2 How to Read the Parameter List

◆ Icons and Terms that Identify Parameters and Control Modes

Icon	Description
	The parameter is available when operating the drive with V/f Control.
	The parameter is available when operating the drive with Open Loop Vector Control.
	The parameter is available when operating the drive with Open Loop Vector Control for PM.
	The parameter is available when operating the drive with Advanced Open Loop Vector Control for PM.
	The parameter is available when operating the drive with EZ Open Loop Vector Control.
Hex.	Hexadecimal numbers that represent MEMOBUS addresses to change parameters over network communication.
RUN	The parameter can be changed settings during run.
Expert	The parameter that is available in Expert Mode only. <i>*1</i>

*1 Set $A1-01 = 3$ [*Access Level Selection = Expert Level*] to display and set Expert Mode parameters on the keypad.

Note:

Gray icons identify parameters that are not available in the specified control method.

11.3 Parameter Groups

Represents the type of product parameters.

Parameter	Name
A1	Initialization
A2	User Parameters
b1	Operation Mode Selection
b2	DC Injection Braking and Short Circuit Braking
b3	Speed Search
b4	Timer Function
b5	PID control
b6	Dwell Function
b8	Energy Saving
C1	Accel & Decel Time
C2	S-Curve Characteristics
C3	Slip Compensation
C4	Torque Compensation
C5	Automatic Speed Regulator (ASR: Automatic Speed Regulator)
C6	Carrier Frequency
d1	Frequency Reference
d2	Reference Limits
d3	Jump Frequency
d4	Frequency Ref Up/Down & Hold
d6	Field Weakening /Forcing
d7	Offset Frequency
E1	V/f Pattern for Motor 1
E2	Motor Parameters
E3	V/f Pattern for Motor 2
E4	Motor 2 Parameters
E5	PM Motor Settings
E9	Motor Setting
F1	Fault Detection during PG Speed Control
F6	Communication Options
F7	Communication Options
H1	Digital Inputs
H2	Digital Outputs
H3	Analog Inputs
H4	Analog Outputs
H5	Modbus Communication
H6	Pulse Train Input/Output

Parameter	Name
H7	Virtual MFIO selection
L1	Motor Protection
L2	Power Loss Ride Through
L3	Stall Prevention
L4	Speed Detection
L5	Fault Restart
L6	Torque Detection
L7	Torque Limit
L8	Drive Protection
n1	Hunting Prevention
n2	Auto Freq Regulator (AFR)
n3	High Slip/Overexcite Braking
n5	Feed Forward Control
n6	Online Tuning
n7	EZ Drive
n8	PM Motor Control Tuning
nA	PM Motor Control Tuning
o1	Keypad Display
o2	Keypad Operation
o3	Copy Keypad Function
o4	Maintenance Monitors
o5	Log Function
q	DriveWorksEZ Parameters
r	DWEZ Connection 1-20
T0	Tuning Mode Selection
T1	Induction Motor Auto-Tuning
T2	PM Motor Auto-Tuning
T3	ASR and Inertia Tuning
T4	EZ Tuning
U1	Operation Status Monitors
U2	Fault Trace
U3	Fault History
U4	Maintenance Monitors
U5	PID Monitors
U6	Operation Status Monitors
U8	DriveWorksEZ Monitors

11.4 A: Initialization Parameters

◆ A1: Initialization

No. (Hex.)	Name	Description	Default (Range)	Ref.
A1-00 (0100) RUN	Language Selection	<p>V/f OLV OLV/PM AOLV/PM EZOLV</p> <p>Sets the language for the LCD keypad.</p> <p>Note: When you use <i>A1-03 [Initialize Parameters]</i> to initialize the drive, the drive will not reset this parameter.</p> <p>0 : English 1 : Japanese 2 : German 3 : French 4 : Italian 5 : Spanish 6 : Portuguese 7 : Chinese 8 : Czech 9 : Russian 10 : Turkish 11 : Polish 12 : Greek</p>	0 (0 - 12)	501
A1-01 (0101) RUN	Access Level Selection	<p>V/f OLV OLV/PM AOLV/PM EZOLV</p> <p>Sets user access to parameters. The access level controls which parameters the keypad will display, and which parameters the user can set.</p> <p>0 : Operation Only 1 : User Parameters 2 : Advanced Level 3 : Expert Level</p>	2 (0 - 3)	501
A1-02 (0102)	Control Method Selection	<p>V/f OLV OLV/PM AOLV/PM EZOLV</p> <p>Sets the control method for the drive application and the motor.</p> <p>0 : V/f Control 2 : Open Loop Vector 5 : PM Open Loop Vector 6 : PM Advanced Open Loop Vector 8 : EZ Vector Control</p>	2 (0, 2, 5, 6, 8)	502
A1-03 (0103)	Initialize Parameters	<p>V/f OLV OLV/PM AOLV/PM EZOLV</p> <p>Sets parameters to default values.</p> <p>0 : No Initialization 1110 : User Initialization 2220 : 2-Wire Initialization 3330 : 3-Wire Initialization</p>	0 (0 - 3330)	503
A1-04 (0104)	Password	<p>V/f OLV OLV/PM AOLV/PM EZOLV</p> <p>Entry point for the password set in <i>A1-05 [Password Setting]</i>. The user can view the settings of parameters that are locked without entering the password. Enter the correct password in this parameter to change parameter settings.</p>	0000 (0000 - 9999)	504
A1-05 (0105)	Password Setting	<p>V/f OLV OLV/PM AOLV/PM EZOLV</p> <p>Set the password to lock parameters and prevent changes to parameter settings. Enter the correct password in <i>A1-04 [Password]</i> to unlock parameters and accept changes.</p>	0000 (0000 - 9999)	505
A1-06 (0127)	Application Preset	<p>V/f OLV OLV/PM AOLV/PM EZOLV</p> <p>Sets the drive to operate in selected application conditions.</p> <p>0 : General-purpose 1 : Water Supply Pump 2 2 : Conveyor 3 : Exhaust Fan 4 : HVAC Fan 5 : Air Compressor 8 : Conveyor 2</p>	0 (0 - 5, 8)	505

11.4 A: Initialization Parameters

No. (Hex.)	Name	Description	Default (Range)	Ref.
A1-07 (0128)	DriveWorksEZ Function Selection	<p>V/f OLV OLV/PM AOLV/PM EZOLV</p> <p>Sets the drive to operate with DriveWorksEZ. 0 : DWEZ Disabled 1 : DWEZ Enabled 2 : Enabled/Disabled wDigital Input</p>	0 (0 - 2)	510
A1-11 (111D) Expert	Firmware Update Lock	<p>V/f OLV OLV/PM AOLV/PM EZOLV</p> <p>Protects the drive firmware. When you enable the protection, you cannot update the drive firmware. 0 : Disabled 1 : Enabled</p>	0 (0, 1)	511
A1-12 (1564)	Bluetooth ID	<p>V/f OLV OLV/PM AOLV/PM EZOLV</p> <p>Sets the password necessary to use Bluetooth to control the drive with a smartphone or tablet.</p>	- (0000 - 9999)	511

◆ A2: User Parameters

No. (Hex.)	Name	Description	Default (Setting Range)	Ref.
A2-01 (0106)	User Parameter 1	<p>V/f OLV OLV/PM AOLV/PM EZOLV</p> <p>Sets the parameter number to show on the first line in Setup Mode. You can select a maximum of 32 parameters for the drive and set them to parameters <i>A2-01</i> to <i>A2-32</i>.</p>	A1-02 (Determined by A1-06)	511
A2-02 (0107)	User Parameter 2	<p>V/f OLV OLV/PM AOLV/PM EZOLV</p> <p>Sets the parameter number to show on the second line in Setup Mode. You can select a maximum of 32 parameters for the drive and set them to parameters <i>A2-01</i> to <i>A2-32</i>.</p>	b1-01 (Determined by A1-06)	511
A2-03 (0108)	User Parameter 3	<p>V/f OLV OLV/PM AOLV/PM EZOLV</p> <p>Sets the parameter number to show on the third line in Setup Mode. You can select a maximum of 32 parameters for the drive and set them to parameters <i>A2-01</i> to <i>A2-32</i>.</p>	b1-02 (Determined by A1-06)	511
A2-04 (0109)	User Parameter 4	<p>V/f OLV OLV/PM AOLV/PM EZOLV</p> <p>Sets the parameter number to show on the fourth line in Setup Mode. You can select a maximum of 32 parameters for the drive and set them to parameters <i>A2-01</i> to <i>A2-32</i>.</p>	b1-03 (Determined by A1-06)	511
A2-05 (010A)	User Parameter 5	<p>V/f OLV OLV/PM AOLV/PM EZOLV</p> <p>Sets the parameter number to show on the fifth line in Setup Mode. You can select a maximum of 32 parameters for the drive and set them to parameters <i>A2-01</i> to <i>A2-32</i>.</p>	C1-01 (Determined by A1-06)	511
A2-06 (010B)	User Parameter 6	<p>V/f OLV OLV/PM AOLV/PM EZOLV</p> <p>Sets the parameter number to show on the sixth line in Setup Mode. You can select a maximum of 32 parameters for the drive and set them to parameters <i>A2-01</i> to <i>A2-32</i>.</p>	C1-02 (Determined by A1-06)	511
A2-07 (010C)	User Parameter 7	<p>V/f OLV OLV/PM AOLV/PM EZOLV</p> <p>Sets the parameter number to show on the seventh line in Setup Mode. You can select a maximum of 32 parameters for the drive and set them to parameters <i>A2-01</i> to <i>A2-32</i>.</p>	C6-01 (Determined by A1-06)	511
A2-08 (010D)	User Parameter 8	<p>V/f OLV OLV/PM AOLV/PM EZOLV</p> <p>Sets the parameter number to show on the eighth line in Setup Mode. You can select a maximum of 32 parameters for the drive and set them to parameters <i>A2-01</i> to <i>A2-32</i>.</p>	C6-02 (Determined by A1-06)	511
A2-09 (010E)	User Parameter 9	<p>V/f OLV OLV/PM AOLV/PM EZOLV</p> <p>Sets the parameter number to show on the ninth line in Setup Mode. You can select a maximum of 32 parameters for the drive and set them to parameters <i>A2-01</i> to <i>A2-32</i>.</p>	d1-01 (Determined by A1-06)	511
A2-10 (010F)	User Parameter 10	<p>V/f OLV OLV/PM AOLV/PM EZOLV</p> <p>Sets the parameter number to show on the 10th line in Setup Mode. You can select a maximum of 32 parameters for the drive and set them to parameters <i>A2-01</i> to <i>A2-32</i>.</p>	d1-02 (Determined by A1-06)	511
A2-11 (0110)	User Parameter 11	<p>V/f OLV OLV/PM AOLV/PM EZOLV</p> <p>Sets the parameter number to show on the 11th line in Setup Mode. You can select a maximum of 32 parameters for the drive and set them to parameters <i>A2-01</i> to <i>A2-32</i>.</p>	d1-03 (Determined by A1-06)	511
A2-12 (0111)	User Parameter 12	<p>V/f OLV OLV/PM AOLV/PM EZOLV</p> <p>Sets the parameter number to show on the 12th line in Setup Mode. You can select a maximum of 32 parameters for the drive and set them to parameters <i>A2-01</i> to <i>A2-32</i>.</p>	d1-04 (Determined by A1-06)	511
A2-13 (0112)	User Parameter 13	<p>V/f OLV OLV/PM AOLV/PM EZOLV</p> <p>Sets the parameter number to show on the 13th line in Setup Mode. You can select a maximum of 32 parameters for the drive and set them to parameters <i>A2-01</i> to <i>A2-32</i>.</p>	d1-17 (Determined by A1-06)	511
A2-14 (0113)	User Parameter 14	<p>V/f OLV OLV/PM AOLV/PM EZOLV</p> <p>Sets the parameter number to show on the 14th line in Setup Mode. You can select a maximum of 32 parameters for the drive and set them to parameters <i>A2-01</i> to <i>A2-32</i>.</p>	E1-01 (Determined by A1-06)	511

No. (Hex.)	Name	Description	Default (Setting Range)	Ref.
A2-15 (0114)	User Parameter 15	V/f OLV OLV/PM AOLV/PM EZOLV Sets the parameter number to show on the 15th line in Setup Mode. You can select a maximum of 32 parameters for the drive and set them to parameters <i>A2-01</i> to <i>A2-32</i> .	E1-03 (Determined by A1-06)	511
A2-16 (0115)	User Parameter 16	V/f OLV OLV/PM AOLV/PM EZOLV Sets the parameter number to show on the 16th line in Setup Mode. You can select a maximum of 32 parameters for the drive and set them to parameters <i>A2-01</i> to <i>A2-32</i> .	E1-04 (Determined by A1-06)	511
A2-17 (0116)	User Parameter 17	V/f OLV OLV/PM AOLV/PM EZOLV Sets the parameter number to show on the 17th line in Setup Mode. You can select a maximum of 32 parameters for the drive and set them to parameters <i>A2-01</i> to <i>A2-32</i> .	E1-05 (Determined by A1-06)	511
A2-18 (0117)	User Parameter 18	V/f OLV OLV/PM AOLV/PM EZOLV Sets the parameter number to show on the 18th line in Setup Mode. You can select a maximum of 32 parameters for the drive and set them to parameters <i>A2-01</i> to <i>A2-32</i> .	E1-06 (Determined by A1-06)	511
A2-19 (0118)	User Parameter 19	V/f OLV OLV/PM AOLV/PM EZOLV Sets the parameter number to show on the 19th line in Setup Mode. You can select a maximum of 32 parameters for the drive and set them to parameters <i>A2-01</i> to <i>A2-32</i> .	E1-09 (Determined by A1-06)	511
A2-20 (0119)	User Parameter 20	V/f OLV OLV/PM AOLV/PM EZOLV Sets the parameter number to show on the 20th line in Setup Mode. You can select a maximum of 32 parameters for the drive and set them to parameters <i>A2-01</i> to <i>A2-32</i> .	E1-13 (Determined by A1-06)	511
A2-21 (011A)	User Parameter 21	V/f OLV OLV/PM AOLV/PM EZOLV Sets the parameter number to show on the 21st line in Setup Mode. You can select a maximum of 32 parameters for the drive and set them to parameters <i>A2-01</i> to <i>A2-32</i> .	E2-01 (Determined by A1-06)	511
A2-22 (011B)	User Parameter 22	V/f OLV OLV/PM AOLV/PM EZOLV Sets the parameter number to show on the 22nd line in Setup Mode. You can select a maximum of 32 parameters for the drive and set them to parameters <i>A2-01</i> to <i>A2-32</i> .	E2-04 (Determined by A1-06)	511
A2-23 (011C)	User Parameter 23	V/f OLV OLV/PM AOLV/PM EZOLV Sets the parameter number to show on the 23rd line in Setup Mode. You can select a maximum of 32 parameters for the drive and set them to parameters <i>A2-01</i> to <i>A2-32</i> .	E2-11 (Determined by A1-06)	511
A2-24 (011D)	User Parameter 24	V/f OLV OLV/PM AOLV/PM EZOLV Sets the parameter number to show on the 24th line in Setup Mode. You can select a maximum of 32 parameters for the drive and set them to parameters <i>A2-01</i> to <i>A2-32</i> .	H4-02 (Determined by A1-06)	511
A2-25 (011E)	User Parameter 25	V/f OLV OLV/PM AOLV/PM EZOLV Sets the parameter number to show on the 25th line in Setup Mode. You can select a maximum of 32 parameters for the drive and set them to parameters <i>A2-01</i> to <i>A2-32</i> .	L1-01 (Determined by A1-06)	511
A2-26 (011F)	User Parameter 26	V/f OLV OLV/PM AOLV/PM EZOLV Sets the parameter number to show on the 26th line in Setup Mode. You can select a maximum of 32 parameters for the drive and set them to parameters <i>A2-01</i> to <i>A2-32</i> .	L3-04 (Determined by A1-06)	511
A2-27 (0120)	User Parameter 27	V/f OLV OLV/PM AOLV/PM EZOLV Sets the parameter number to show on the 27th line in Setup Mode. You can select a maximum of 32 parameters for the drive and set them to parameters <i>A2-01</i> to <i>A2-32</i> .	- (Determined by A1-06)	511
A2-28 (0121)	User Parameter 28	V/f OLV OLV/PM AOLV/PM EZOLV Sets the parameter number to show on the 28th line in Setup Mode. You can select a maximum of 32 parameters for the drive and set them to parameters <i>A2-01</i> to <i>A2-32</i> .	- (Determined by A1-06)	511
A2-29 (0122)	User Parameter 29	V/f OLV OLV/PM AOLV/PM EZOLV Sets the parameter number to show on the 29th line in Setup Mode. You can select a maximum of 32 parameters for the drive and set them to parameters <i>A2-01</i> to <i>A2-32</i> .	- (Determined by A1-06)	511
A2-30 (0123)	User Parameter 30	V/f OLV OLV/PM AOLV/PM EZOLV Sets the parameter number to show on the 30th line in Setup Mode. You can select a maximum of 32 parameters for the drive and set them to parameters <i>A2-01</i> to <i>A2-32</i> .	- (Determined by A1-06)	511
A2-31 (0124)	User Parameter 31	V/f OLV OLV/PM AOLV/PM EZOLV Sets the parameter number to show on the 31st line in Setup Mode. You can select a maximum of 32 parameters for the drive and set them to parameters <i>A2-01</i> to <i>A2-32</i> .	- (Determined by A1-06)	511
A2-32 (0125)	User Parameter 32	V/f OLV OLV/PM AOLV/PM EZOLV Sets the parameter number to show on the 32nd line in Setup Mode. You can select a maximum of 32 parameters for the drive and set them to parameters <i>A2-01</i> to <i>A2-32</i> .	- (Determined by A1-06)	511
A2-33 (0126)	User Parameter Auto Selection	V/f OLV OLV/PM AOLV/PM EZOLV Sets the automatic save feature for changes to parameters <i>A2-17</i> to <i>A2-32</i> [<i>User Parameters 17 to 32</i>]. 0 : Disabled: Manual Entry Required 1 : Enabled: Auto Save Recent Parms	Determined by A1-06 (0, 1)	511

11.5 b: Application

◆ b1: Operation Mode Selection

No. (Hex.)	Name	Description	Default (Setting Range)	Ref.
b1-01 (0180)	Frequency Reference Selection 1	<p>V/f OLV OLV/PM AOLV/PM EZOLV</p> <p>Sets the input method for the frequency reference.</p> <p>0 : Keypad 1 : Analog Input 2 : Memobus/Modbus Communications 3 : Option PCB 4 : Pulse Train Input</p>	1 (0 - 4)	513
b1-02 (0181)	Run Command Selection 1	<p>V/f OLV OLV/PM AOLV/PM EZOLV</p> <p>Sets the input method for the Run command.</p> <p>0 : Keypad 1 : Digital Input 2 : Memobus/Modbus Communications 3 : Option PCB</p>	1 (0 - 3)	515
b1-03 (0182)	Stopping Method Selection	<p>V/f OLV OLV/PM AOLV/PM EZOLV</p> <p>Sets the method to stop the motor after removing a Run command or entering a Stop command.</p> <p>Note: When A1-02 = 5, 6, 8 [Control Method Selection = OLV/PM, AOLV/PM, EZOLV], the setting range is 0, 1, 3.</p> <p>0 : Ramp to Stop 1 : Coast to Stop 2 : DC Injection Braking to Stop 3 : Coast to Stop with Timer</p>	0 (0 - 3)	515
b1-04 (0183)	Reverse Operation Selection	<p>V/f OLV OLV/PM AOLV/PM EZOLV</p> <p>Sets the reverse operation function. Disable reverse operation in fan or pump applications where reverse rotation is dangerous.</p> <p>0 : Reverse Enabled 1 : Reverse Disabled</p>	0 (0, 1)	518
b1-06 (0185)	Digital Input Reading	<p>V/f OLV OLV/PM AOLV/PM EZOLV</p> <p>Sets the number of times that the drive reads the sequence input command to prevent malfunction because of electrical interference.</p> <p>0 : Single Scan 1 : Double Scan</p>	1 (0, 1)	518
b1-07 (0186)	LOCAL/REMOTE Run Selection	<p>V/f OLV OLV/PM AOLV/PM EZOLV</p> <p>Sets drive response to an existing Run command when the drive receives a second Run command from a different location.</p> <p>0 : Disregard Existing RUN Command 1 : Accept Existing RUN Command</p>	0 (0, 1)	519
b1-08 (0187)	Run Command Select in PRG Mode	<p>V/f OLV OLV/PM AOLV/PM EZOLV</p> <p>Sets the conditions for the drive to accept a Run command entered from an external source when using the keypad to set parameters.</p> <p>0 : Disregard RUN while Programming 1 : Accept RUN while Programming 2 : Allow Programming Only at Stop</p>	0 (0 - 2)	519
b1-14 (01C3)	Phase Order Selection	<p>V/f OLV OLV/PM AOLV/PM EZOLV</p> <p>Sets the phase order for output terminals U/T1, V/T2, and W/T3. This parameter can align the Forward Run command from the drive and the forward direction of the motor without changing wiring.</p> <p>0 : Standard 1 : Switch Phase Order</p>	0 (0, 1)	520
b1-15 (01C4)	Frequency Reference Selection 2	<p>V/f OLV OLV/PM AOLV/PM EZOLV</p> <p>Sets the input method for frequency reference 2.</p> <p>0 : Keypad 1 : Analog Input 2 : Memobus/Modbus Communications 3 : Option PCB 4 : Pulse Train Input</p>	0 (0 - 4)	520

No. (Hex.)	Name	Description	Default (Setting Range)	Ref.
b1-16 (01C5)	Run Command Selection 2	<p>V/f OLV OLV/PM AOLV/PM EZOLV</p> <p>Sets the input method for Run Command 2 when the user switches the control circuit terminals ON/OFF to change the Run command source.</p> <p>0 : Keypad 1 : Digital Input 2 : Memobus/Modbus Communications 3 : Option PCB</p>	0 (0 - 3)	522
b1-17 (01C6)	Run Command at Power Up	<p>V/f OLV OLV/PM AOLV/PM EZOLV</p> <p>Sets drive response when the CPU changes from de-energized to energized and there is an active Run command. Set this parameter in applications where energizing or de-energizing the drive enables the Run command. When the CPU stays energized during loss of power, L2-01 [Power Loss Ride Through Select] sets operation.</p> <p>0 : Disregard Existing RUN Command 1 : Accept Existing RUN Command</p>	0 (0, 1)	522
b1-35 (1117) Expert	Digital Input Deadband Time	<p>V/f OLV OLV/PM AOLV/PM EZOLV</p> <p>Sets the deadband time for MFDIs.</p>	0.0 ms (0.0 to 100.0 ms)	523

◆ b2: DC Injection Braking and Short Circuit Braking

No. (Hex.)	Name	Description	Default (Range)	Ref.
b2-01 (0189)	DC Injection/Zero SpeedThreshold	<p>V/f OLV OLV/PM AOLV/PM EZOLV</p> <p>Sets the frequency to start DC Injection Braking or Short Circuit Braking near the end of a stop ramp.</p> <p>Note: This parameter is available when b1-03 = 0 [Stopping Method Selection = Ramp to Stop].</p>	Determined by A1-02 (0.0 - 10.0 Hz)	523
b2-02 (018A)	DC Injection Braking Current	<p>V/f OLV OLV/PM AOLV/PM EZOLV</p> <p>Sets the DC Injection Braking current as a percentage of the drive rated current.</p>	50% (0 - 75%)	524
b2-03 (018B)	DC Inject Braking Time at Start	<p>V/f OLV OLV/PM AOLV/PM EZOLV</p> <p>Sets the DC Injection Braking Time at stop.</p>	0.00 s (0.00 - 10.00 s)	524
b2-04 (018C)	DC Inject Braking Time at Stop	<p>V/f OLV OLV/PM AOLV/PM EZOLV</p> <p>Sets the DC Injection Braking Time at stop.</p>	Determined by A1-02 (0.00 - 10.00 s)	524
b2-08 (0190)	Magnetic Flux Compensation Value	<p>V/f OLV OLV/PM AOLV/PM EZOLV</p> <p>Sets how much current the drive injects when DC Injection Braking at Start starts (Initial Excitation) as a percentage of E2-03 [Motor No-Load Current].</p>	0% (0 - 1000%)	525
b2-12 (01BA)	Short Circuit Brake Time @ Start	<p>V/f OLV OLV/PM AOLV/PM EZOLV</p> <p>Sets the Short Circuit Braking time at start.</p>	0.00 s (0.00 - 25.50 s)	525
b2-13 (01BB)	Short Circuit Brake Time @ Stop	<p>V/f OLV OLV/PM AOLV/PM EZOLV</p> <p>Sets the Short Circuit Braking time at stop.</p>	A1-02 = 8: 0.00 s Other than A1-02 = 8: 0.50 s (0.00 - 25.50 s)	525
b2-18 (0177)	Short Circuit Braking Current	<p>V/f OLV OLV/PM AOLV/PM EZOLV</p> <p>Sets the Short Circuit Braking Current as a percentage of the motor rated current.</p> <p>Note: Parameter A1-02 [Control Method Selection] selects which parameter is the motor rated current. • A1-02 = 5, 6 [OLV/PM, AOLV/PM]: E5-03 [PM Motor Rated Current (FLA)] • A1-02 = 8 [EZOLV]: E9-06 [Motor Rated Current (FLA)]</p>	100.0% (0.0 - 200.0%)	526

◆ b3: Speed Search

No. (Hex.)	Name	Description	Default (Range)	Ref.
b3-01 (0191)	Speed Search at Start Selection	<p>V/f OLV OLV/PM AOLV/PM EZOLV</p> <p>Sets the Speed Search at Start function so the drive will do Speed Search with each Run command.</p> <p>0 : Disable 1 : Enabled</p>	Determined by A1-02 (0, 1)	529
b3-02 (0192)	SpeedSearch Deactivation Current	<p>V/f OLV OLV/PM AOLV/PM EZOLV</p> <p>Sets the current level that stops Speed Search as a percentage of the drive rated output current. Usually it is not necessary to change this setting.</p>	Determined by A1-02 (0 - 200%)	530
b3-03 (0193)	Speed Search Deceleration Time	<p>V/f OLV OLV/PM AOLV/PM EZOLV</p> <p>Sets the deceleration time during Speed Search operation. Set the length of time to decelerate from the maximum output frequency to the minimum output frequency.</p> <p>Note: When A1-02 = 8 [Control Method Selection = EZOLV], this parameter takes effect only in Expert Mode.</p>	2.0 s (0.1 - 10.0 s)	530
b3-04 (0194)	V/f Gain during Speed Search	<p>V/f OLV OLV/PM AOLV/PM EZOLV</p> <p>Sets the ratio used to reduce the V/f during searches to reduce the output current during speed searches.</p>	Determined by o2-04 (10 - 100)	530
b3-05 (0195)	Speed Search Delay Time	<p>V/f OLV OLV/PM AOLV/PM EZOLV</p> <p>Sets the Speed Search delay time to activate a magnetic contactor installed between the drive and motor.</p>	0.2 s (0.0 - 100.0 s)	530
b3-06 (0196) Expert	Speed Estimation Current Level 1	<p>V/f OLV OLV/PM AOLV/PM EZOLV</p> <p>Sets the level of current that flows to the motor during Speed Estimation Speed Search as a coefficient of the motor rated current. Usually it is not necessary to change this setting.</p>	Determined by o2-04 (0.0 - 2.0)	530
b3-07 (0197) Expert	Speed Estimation Current Level 2	<p>V/f OLV OLV/PM AOLV/PM EZOLV</p> <p>Sets the level of current that flows to the motor during Speed Estimation Speed Search as a coefficient of E2-03 [Motor No-Load Current] or E4-03 [Motor 2 Rated No-Load Current]. Usually it is not necessary to change this setting.</p>	1.0 (0.0 - 3.0)	531
b3-08 (0198)	Speed Estimation ACR P Gain	<p>V/f OLV OLV/PM AOLV/PM EZOLV</p> <p>Sets the proportional gain for the automatic current regulator during Speed Estimation Speed Search. Also adjusts speed search responsiveness. Usually it is not necessary to change this setting.</p>	Determined by A1-02 and o2-04 (0.00 - 6.00)	531
b3-09 (0199)	Speed Estimation ACR I Time	<p>V/f OLV OLV/PM AOLV/PM EZOLV</p> <p>Sets the integral time for the automatic current regulator during Speed Estimation Speed Search. Also adjusts speed search responsiveness. Usually it is not necessary to change this setting.</p>	Determined by A1-02 when A1-02 ≠ 5 20.0 when A1-02 = 5 (0.0 - 1000.0 ms)	531
b3-10 (019A) Expert	Speed Estimation Detection Gain	<p>V/f OLV OLV/PM AOLV/PM EZOLV</p> <p>Sets the gain to correct estimated frequencies from Speed Estimation Speed Search.</p>	1.05 (1.00 - 1.20)	531
b3-14 (019E)	Bi-directional Speed Search	<p>V/f OLV OLV/PM AOLV/PM EZOLV</p> <p>Sets the direction of Speed Search to the direction of the frequency reference or in the motor rotation direction as detected by the drive.</p> <p>0 : Disabled 1 : Enabled</p> <p>Note:</p> <ul style="list-style-type: none"> When E9-01 = 0 [Motor Type Selection = Induction (IM)] and A1-02 = 0, 2, or 8 [Control Method Selection = V/f, OLV, or EZOLV], the default settings change when the setting of b3-24 [Speed Search Method Selection] changes. <ul style="list-style-type: none"> -b3-24 = 1 [Speed Estimation]: Refer to 479. -b3-24 = 2 [Current Detection 2]: 0 When E9-01 = 1 or 2 [Permanent Magnet (PM), Synchronous Reluctance (SynRM)] and A1-02 = 0 or 8 [V/f, EZOLV], refer to 479. <p>When you set A1-02, b3-24, and E9-01, set b3-14.</p>	Determined by A1-02 and b3-24 (0, 1)	531
b3-17 (01F0) Expert	Speed Est Retry Current Level	<p>V/f OLV OLV/PM AOLV/PM EZOLV</p> <p>Sets the current level for the search retry function in Speed Estimation Speed Search as a percentage where drive rated current is a setting value of 100%.</p>	150% (0 - 200%)	532
b3-18 (01F1) Expert	Speed Est Retry Detection Time	<p>V/f OLV OLV/PM AOLV/PM EZOLV</p> <p>Sets the length of time that the drive will wait to retry Speed Estimation Speed Search when too much current flow stopped the Speed Search.</p>	0.10 s (0.00 - 1.00 s)	532
b3-19 (01F2)	Speed Search Restart Attempts	<p>V/f OLV OLV/PM AOLV/PM EZOLV</p> <p>Sets the number of times to restart Speed Search if Speed Search does not complete.</p>	3 times (0 - 10 times)	532

No. (Hex.)	Name	Description	Default (Range)	Ref.
b3-24 (01C0)	Speed Search Method Selection	<p><input checked="" type="checkbox"/> V/f <input checked="" type="checkbox"/> OLV <input type="checkbox"/> OLV/PM <input type="checkbox"/> AOLV/PM <input type="checkbox"/> EZOLV</p> <p>Sets the Speed Search method when you start the motor or when you restore power after a momentary power loss.</p> <p>Note:</p> <ul style="list-style-type: none"> When $A1-02 = 8$ [Control Method Selection = EZOLV], the default setting changes when the setting for $E9-01$ [Motor Type Selection] changes. <ul style="list-style-type: none"> $E9-01 = 0$ [Induction (IM)]: 2 $E9-01 = 1, 2$ [Permanent Magnet (PM), Synchronous Reluctance (SynRM)]: 1 When you set $A1-02 = 8$ and $E9-01 = 1$ or 2, set $b3-24 = 1$. If $b3-24 = 2$, the drive will detect $oPE08$ [Parameter Selection Error]. When you set $b3-24$, it will trigger the drive to initialize $b3-14$ [Bi-directional Speed Search]. After you set $b3-24$, set $b3-14$. <p>1 : Speed Estimation 2 : Current Detection 2</p>	2 (1, 2)	532
b3-25 (01C8) Expert	Speed Search Wait Time	<p><input checked="" type="checkbox"/> V/f <input checked="" type="checkbox"/> OLV <input type="checkbox"/> OLV/PM <input type="checkbox"/> AOLV/PM <input type="checkbox"/> EZOLV</p> <p>Sets the length of time the drive will wait to start the Speed Search Retry function.</p>	0.5 s (0.0 - 30.0 s)	533
b3-26 (01C7) Expert	Direction Determination Level	<p><input checked="" type="checkbox"/> V/f <input checked="" type="checkbox"/> OLV <input type="checkbox"/> OLV/PM <input type="checkbox"/> AOLV/PM <input type="checkbox"/> EZOLV</p> <p>Sets the level to find the motor rotation direction. Increase the value if the drive cannot find the direction.</p>	1000 (40 to 60000)	533
b3-29 (077C) Expert	Speed Search Back-EMF Threshold	<p><input checked="" type="checkbox"/> V/f <input checked="" type="checkbox"/> OLV <input type="checkbox"/> OLV/PM <input type="checkbox"/> AOLV/PM <input type="checkbox"/> EZOLV</p> <p>Sets the induced voltage for motors that use Speed Search. The drive will start Speed Search when the motor induced voltage level is the same as the setting value. Usually it is not necessary to change this setting.</p>	10% (0 - 10%)	533
b3-31 (0BC0) Expert	Spd Search Current Reference Lvl	<p><input checked="" type="checkbox"/> V/f <input checked="" type="checkbox"/> OLV <input type="checkbox"/> OLV/PM <input type="checkbox"/> AOLV/PM <input type="checkbox"/> EZOLV</p> <p>Sets the current level that decreases the output current during Current Detection Speed Search.</p>	1.50 (1.50 - 3.50)	533
b3-32 (0BC1) Expert	Spd Search Current Complete Lvl	<p><input checked="" type="checkbox"/> V/f <input checked="" type="checkbox"/> OLV <input type="checkbox"/> OLV/PM <input type="checkbox"/> AOLV/PM <input type="checkbox"/> EZOLV</p> <p>Sets the current level that completes Speed Search.</p>	1.20 (0.00 - 1.49)	533
b3-33 (0B3F) Expert	Speed Search during Uv Selection	<p><input checked="" type="checkbox"/> V/f <input checked="" type="checkbox"/> OLV <input type="checkbox"/> OLV/PM <input type="checkbox"/> AOLV/PM <input type="checkbox"/> EZOLV</p> <p>Sets the function that starts Speed Search at start-up if the drive detects a Uv [Undervoltage] when it receives a Run command.</p> <p>0 : Disabled 1 : Enabled</p>	1 (0, 1)	534
b3-39 (1B8F) Expert	Regen Judgment Lv of Spd Search	<p><input checked="" type="checkbox"/> V/f <input checked="" type="checkbox"/> OLV <input type="checkbox"/> OLV/PM <input type="checkbox"/> AOLV/PM <input type="checkbox"/> EZOLV</p> <p>Sets the level to determine the regenerative state during speed search. Usually it is not necessary to change this setting.</p>	15% (0 - 50%)	534
b3-54 (3123)	Search Time	<p><input checked="" type="checkbox"/> V/f <input checked="" type="checkbox"/> OLV <input type="checkbox"/> OLV/PM <input type="checkbox"/> AOLV/PM <input type="checkbox"/> EZOLV</p> <p>Sets the length of time that the drive will run Speed Search.</p>	400 ms (10 - 2000 ms)	534
b3-55 (3124) Expert	Current Increment Time	<p><input checked="" type="checkbox"/> V/f <input checked="" type="checkbox"/> OLV <input type="checkbox"/> OLV/PM <input type="checkbox"/> AOLV/PM <input type="checkbox"/> EZOLV</p> <p>Sets the length of time that the drive will increase the current from zero current to the setting value of $b3-06$ [Speed Estimation Current Level 1].</p>	10 ms (10 - 2000 ms)	534
b3-56 (3126)	InverseRotationSearch WaitTime	<p><input checked="" type="checkbox"/> V/f <input checked="" type="checkbox"/> OLV <input type="checkbox"/> OLV/PM <input type="checkbox"/> AOLV/PM <input type="checkbox"/> EZOLV</p> <p>Sets the wait time until the drive starts inverse rotation search after it completes forward search when you do inverse rotation search during Current Detection Speed Search.</p>	Determined by o2-04 (0.1 - 5.0 s)	535
b3-61 (1B96) Expert	Initial Pole Detection Response Gain	<p><input checked="" type="checkbox"/> V/f <input checked="" type="checkbox"/> OLV <input type="checkbox"/> OLV/PM <input type="checkbox"/> AOLV/PM <input type="checkbox"/> EZOLV</p> <p>Sets the responsiveness for initial motor magnetic pole calculation when $A1-02 = 6$ [Control Method Selection = AOLV/PM]. Set $b3-61 > 0.0$ for an ordinary IPM motor. It is automatically set if High Frequency Injection Tuning is used.</p> <p>Note:</p> <ul style="list-style-type: none"> Set $n8-35 = 1$ [Initial Pole Calculation Method = High Frequency Injection] to enable this parameter. Set $n8-41$ [HFI P Gain] to adjust the responsiveness for initial motor magnetic pole calculation when $A1-02 = 5$ [OLV/PM]. 	5.0 (-20.0 - +20.0)	535

◆ b4: Timer Function

No. (Hex.)	Name	Description	Default (Range)	Ref.
b4-01 (01A3)	Timer Function ON-Delay Time	V/f OLV OLV/PM AOLV/PM EZOLV Sets the ON-delay time for the timer input.	0.0 s (0.0 - 3000.0 s)	536
b4-02 (01A4)	Timer Function OFF-Delay Time	V/f OLV OLV/PM AOLV/PM EZOLV Sets the OFF-delay time for the timer input.	0.0 s (0.0 - 3000.0 s)	536
b4-03 (0B30) Expert	Terminal M1-M2 ON-Delay Time	V/f OLV OLV/PM AOLV/PM EZOLV Sets the delay time to activate the contact after the function set in <i>H2-01</i> activates.	0 ms (0 - 65000 ms)	536
b4-04 (0B31) Expert	Terminal M1-M2 OFF-Delay Time	V/f OLV OLV/PM AOLV/PM EZOLV Sets the delay time to deactivate the contact after the function set in <i>H2-01</i> deactivates.	0 ms (0 - 65000 ms)	536
b4-05 (0B32) Expert	Terminal M3-M4 ON-Delay Time	V/f OLV OLV/PM AOLV/PM EZOLV Sets the delay time to activate the contact after the function set in <i>H2-02</i> activates.	0 ms (0 - 65000 ms)	536
b4-06 (0B33) Expert	Terminal M3-M4 OFF-Delay Time	V/f OLV OLV/PM AOLV/PM EZOLV Sets the delay time to deactivate the contact after the function set in <i>H2-02</i> deactivates.	0 ms (0 - 65000 ms)	536
b4-07 (0B34) Expert	Terminal P2 ON-Delay Time	V/f OLV OLV/PM AOLV/PM EZOLV Sets the delay time until the contact is turned ON after the function set with <i>H2-03</i> turns ON.	0 ms (0 - 65000 ms)	537
b4-08 (0B35) Expert	Terminal P2 OFF-Delay Time	V/f OLV OLV/PM AOLV/PM EZOLV Sets the delay time to deactivate the contact after the function set in <i>H2-03</i> deactivates.	0 ms (0 - 65000 ms)	537

◆ b5: PID control

No. (Hex.)	Name	Description	Default (Range)	Ref.
b5-01 (01A5)	PID Mode Setting	V/f OLV OLV/PM AOLV/PM EZOLV Sets the type of PID control. 0 : Disabled 1 : Standard 2 : Standard (D on feedback) 3 : Fref + PID Trim 4 : Fref + PID Trim (D on feedback) 5 : Same as 7series & prior, b5-01=1 6 : Same as 7series & prior, b5-01=2 7 : Same as 7series & prior, b5-01=3 8 : Same as 7series & prior, b5-01=4 Note: Use settings 5 to 8 instead of settings 1 to 4 when the drive is a replacement for Varispeed F7.	0 (0 - 8)	542
b5-02 (01A6) RUN	Proportional Gain (P)	V/f OLV OLV/PM AOLV/PM EZOLV Sets the proportional gain (P) that is applied to PID input.	1.00 (0.00 - 25.00)	543
b5-03 (01A7) RUN	Integral Time (I)	V/f OLV OLV/PM AOLV/PM EZOLV Sets the integral time (I) that is applied to PID input.	1.0 s (0.0 - 360.0 s)	543
b5-04 (01A8) RUN	Integral Limit	V/f OLV OLV/PM AOLV/PM EZOLV Sets the upper limit for integral control (I) as a percentage of the Maximum Output Frequency. Note: Parameter <i>A1-02</i> [Control Method Selection] selects which parameter is the maximum output frequency. • <i>A1-02</i> ≠ 8 [EZOLV]: <i>E1-04</i> [Maximum Output Frequency] • <i>A1-02</i> = 8: <i>E9-02</i> [Maximum Speed]	100.0% (0.0 - 100.0%)	543
b5-05 (01A9) RUN	Derivative Time (D)	V/f OLV OLV/PM AOLV/PM EZOLV Sets the derivative time (D) for PID control. This parameter adjusts system responsiveness.	0.00 s (0.00 - 10.00 s)	544

No. (Hex.)	Name	Description	Default (Range)	Ref.
b5-06 (01AA) RUN	PID Output Limit	V/f OLV OLV/PM AOLV/PM EZOLV Sets the maximum possible output from the PID controller as a percentage of the Maximum Output Frequency. Note: Parameter <i>A1-02</i> [Control Method Selection] selects which parameter is the maximum output frequency. • <i>A1-02</i> ≠ 8 [EZOLV]: <i>E1-04</i> [Maximum Output Frequency] • <i>A1-02</i> = 8: <i>E9-02</i> [Maximum Speed]	100.0% (0.0 - 100.0%)	544
b5-07 (01AB) RUN	PID Offset Adjustment	V/f OLV OLV/PM AOLV/PM EZOLV Sets the offset for the PID control output as a percentage of the Maximum Output Frequency. Note: Parameter <i>A1-02</i> [Control Method Selection] selects which parameter is the maximum output frequency. • <i>A1-02</i> ≠ 8 [EZOLV]: <i>E1-04</i> [Maximum Output Frequency] • <i>A1-02</i> = 8: <i>E9-02</i> [Maximum Speed]	0.0% (-100.0 - +100.0%)	544
b5-08 (01AC) RUN Expert	PID Primary Delay Time Constant	V/f OLV OLV/PM AOLV/PM EZOLV Sets the primary delay time constant for the PID control output. Usually it is not necessary to change this setting.	0.00 s (0.00 - 10.00 s)	544
b5-09 (01AD)	PID Output Level Selection	V/f OLV OLV/PM AOLV/PM EZOLV Sets the polarity of the PID output. 0 : Normal Output (Direct Acting) 1 : Reverse Output (Reverse Acting)	0 (0, 1)	544
b5-10 (01AE) RUN	PID Output Gain Setting	V/f OLV OLV/PM AOLV/PM EZOLV Sets the amount of gain to apply to the PID output.	1.00 (0.00 - 25.00)	544
b5-11 (01AF)	PID Output Reverse Selection	V/f OLV OLV/PM AOLV/PM EZOLV Sets the function that enables and disables reverse motor rotation for negative PID control output. 0 : Lower Limit is Zero 1 : Negative Output Accepted	0 (0, 1)	545
b5-12 (01B0)	Feedback Loss Detection Select	V/f OLV OLV/PM AOLV/PM EZOLV Sets the drive response to PID feedback loss/excess. Sets drive operation after the drive detects PID feedback loss/excess. 0 : Digital Out Only, Always Detect 1 : Alarm + Digital Out, Always Det 2 : Fault + Digital Out, Always Det 3 : Digital Out Only, @ PID Enable 4 : Alarm + Digital Out, @PID Enable 5 : Fault + Digital Out, @PID Enable	0 (0 - 5)	545
b5-13 (01B1)	PID Feedback Loss Detection Lvl	V/f OLV OLV/PM AOLV/PM EZOLV Sets the level that triggers <i>PID Feedback Loss [FbL]</i> detection as a percentage of the Maximum Output Frequency. Note: Parameter <i>A1-02</i> [Control Method Selection] selects which parameter is the maximum output frequency. • <i>A1-02</i> ≠ 8 [EZOLV]: <i>E1-04</i> [Maximum Output Frequency] • <i>A1-02</i> = 8: <i>E9-02</i> [Maximum Speed]	0% (0 - 100%)	546
b5-14 (01B2)	PID Feedback Loss Detection Time	V/f OLV OLV/PM AOLV/PM EZOLV Sets the length of time that PID Feedback must be less than <i>b5-13</i> [PID Feedback Loss Detection Lvl] to detect <i>PID Feedback Loss [FbL]</i> .	1.0 s (0.0 - 25.5 s)	546
b5-15 (01B3)	PID Sleep Function Start Level	V/f OLV OLV/PM AOLV/PM EZOLV Sets the output level that triggers the PID Sleep function.	Determined by A1-02 (0.0 - 590.0)	546
b5-16 (01B4)	PID Sleep Delay Time	V/f OLV OLV/PM AOLV/PM EZOLV Sets a delay time to start or stop the PID Sleep function.	0.0 s (0.0 - 25.5 s)	546
b5-17 (01B5) RUN	PID Accel/Decel Time	V/f OLV OLV/PM AOLV/PM EZOLV Raises or lowers the PID setpoint using the acceleration and deceleration times set to the drive. This is a soft-starter for the PID setpoint.	0.0 s (0.0 - 6000.0 s)	546
b5-18 (01DC)	b5-19 PID Setpoint Selection	V/f OLV OLV/PM AOLV/PM EZOLV Sets the function that enables and disables <i>b5-19</i> [PID Setpoint Value]. 0 : Disabled 1 : Enabled	0 (0, 1)	547

11.5 b: Application

No. (Hex.)	Name	Description	Default (Range)	Ref.
b5-19 (01DD) RUN	PID Setpoint Value	V/f OLV OLV/PM AOLV/PM EZOLV Sets the PID setpoint when <i>b5-18 = 1</i> [<i>b5-19 PID Setpoint Selection = Enabled</i>].	0.00% (0.00 - 100.00%)	547
b5-20 (01E2)	PID Unit Selection	V/f OLV OLV/PM AOLV/PM EZOLV Sets the number of digits to set and show the PID setpoint. 0 : 0.01Hz units 1 : 0.01% units 2 : rev/min 3 : User Units	1 (0 - 3)	547
b5-34 (019F) RUN	PID Output Lower Limit Level	V/f OLV OLV/PM AOLV/PM EZOLV Sets the lower limit level for the PID control as a percentage of <i>E1-04</i> [<i>Maximum Output Frequency</i>]. When you use <i>b5-34</i> , set <i>b5-91 = 0</i> [<i>EZ Sleep Minimum Speed = 0 (Disabled)</i>]. When you set the output lower limit level as Hz units or min ⁻¹ (r/min) units, refer to page 552. Note: Parameter <i>A1-02</i> [<i>Control Method Selection</i>] selects which parameter is the maximum output frequency. • <i>A1-02 ≠ 8</i> [<i>EZOLV</i>]: <i>E1-04</i> [<i>Maximum Output Frequency</i>] • <i>A1-02 = 8</i> : <i>E9-02</i> [<i>Maximum Speed</i>]	0.0% (-100.0 - +100.0%)	547
b5-35 (01A0) RUN	PID Input Limit Level	V/f OLV OLV/PM AOLV/PM EZOLV Sets the output upper limit for the PID control as a percentage of the Maximum Output Frequency. Note: Parameter <i>A1-02</i> [<i>Control Method Selection</i>] selects which parameter is the maximum output frequency. • <i>A1-02 ≠ 8</i> [<i>EZOLV</i>]: <i>E1-04</i> [<i>Maximum Output Frequency</i>] • <i>A1-02 = 8</i> : <i>E9-02</i> [<i>Maximum Speed</i>]	1000.0% (0.0 - 1000.0%)	548
b5-36 (01A1)	PID High Feedback Detection Lvl	V/f OLV OLV/PM AOLV/PM EZOLV Sets the level that triggers <i>Excessive PID Feedback [FbH]</i> as a percentage of the Maximum Output Frequency. Note: Parameter <i>A1-02</i> [<i>Control Method Selection</i>] selects which parameter is the maximum output frequency. • <i>A1-02 ≠ 8</i> [<i>EZOLV</i>]: <i>E1-04</i> [<i>Maximum Output Frequency</i>] • <i>A1-02 = 8</i> : <i>E9-02</i> [<i>Maximum Speed</i>]	100% (0 - 100%)	548
b5-37 (01A2)	PID High Feedback Detection Time	V/f OLV OLV/PM AOLV/PM EZOLV Sets the length of time that the PID feedback signal must be more than the level set in <i>b5-36</i> [<i>PID Feedback High Detection Lvl</i>] to cause <i>Excessive PID Feedback [FbH]</i> .	1.0 s (0.0 - 25.5 s)	548
b5-38 (01FE)	PID User Unit Display Scaling	V/f OLV OLV/PM AOLV/PM EZOLV Sets the value that the drive sets or shows as the PID setpoint when at the maximum output frequency.	Determined by <i>b5-20</i> (1 - 60000)	548
b5-39 (01FF)	PID User Unit Display Digits	V/f OLV OLV/PM AOLV/PM EZOLV Sets the number of digits to set and show the PID setpoint. 0 : No Decimal Places (XXXXX) 1 : One Decimal Places (XXXX.X) 2 : Two Decimal Places (XXX.XX) 3 : Three Decimal Places (XX.XXX)	Determined by <i>b5-20</i> (0 - 3)	548
b5-40 (017F)	Frequency Reference Monitor @PID	V/f OLV OLV/PM AOLV/PM EZOLV Sets the contents for monitor <i>U1-01</i> [<i>Frequency Reference</i>] in PID control. 0 : <i>U1-01</i> Includes PID Output 1 : <i>U1-01</i> Excludes PID Output	0 (0, 1)	549
b5-47 (017D)	PID Trim Mode Output Reverse Sel	V/f OLV OLV/PM AOLV/PM EZOLV Sets reverse motor rotation when the PID control output is negative. 0 : Lower Limit is Zero 1 : Negative Output Accepted	1 (0, 1)	549
b5-53 (0B8F) RUN	PID Integrator Ramp Limit	V/f OLV OLV/PM AOLV/PM EZOLV Sets the responsiveness of PID control when the PID feedback changes quickly.	0.0 Hz (0.0 - 10.0 Hz)	549
b5-55 (0BE1)	PID Feedback Monitor Selection	V/f OLV OLV/PM AOLV/PM EZOLV Sets the monitor (<i>Ux-xx</i>) used as the PID Feedback. Set the <i>x-xx</i> part of the <i>Ux-xx</i> [<i>Monitor</i>].	000 (000 - 999)	550
b5-56 (0BE2)	PID Feedback Monitor Gain	V/f OLV OLV/PM AOLV/PM EZOLV Sets the gain for the monitor set in <i>b5-55</i> [<i>PID Feedback Monitor Selection</i>].	1.00 (0.00 - 10.00)	550

No. (Hex.)	Name	Description	Default (Range)	Ref.
b5-57 (11DD)	PID Feedback Monitor Bias	V/f OLV OLV/PM AOLV/PM EZOLV Sets the bias for the monitor specified in b5-55 [PID Feedback Monitor Selection].	0.00 (-10.00 - +10.00)	550
b5-58 (1182) RUN	PID Setpoints 2	V/f OLV OLV/PM AOLV/PM EZOLV Sets the PID setpoint when H1-xx = 3E or 3F [MFDI Function Select = PID Setpoint Selection 1/2]. This value is a percentage of the maximum output frequency. Note: Parameter A1-02 [Control Method Selection] selects which parameter is the maximum output frequency. • A1-02 ≠ 8 [EZOLV]: E1-04 [Maximum Output Frequency] • A1-02 = 8: E9-02 [Maximum Speed]	0.00% (0.00 - 100.00%)	550
b5-59 (1183) RUN	PID Setpoints 3	V/f OLV OLV/PM AOLV/PM EZOLV Sets the PID setpoint when H1-xx = 3E or 3F [MFDI Function Select = PID Setpoint Selection 1/2]. This value is a percentage of the maximum output frequency. Note: Parameter A1-02 [Control Method Selection] selects which parameter is the maximum output frequency. • A1-02 ≠ 8 [EZOLV]: E1-04 [Maximum Output Frequency] • A1-02 = 8: E9-02 [Maximum Speed]	0.00% (0.00 - 100.00%)	550
b5-60 (1184) RUN	PID Setpoints 4	V/f OLV OLV/PM AOLV/PM EZOLV Sets the PID setpoint when H1-xx = 3E or 3F [MFDI Function Select = PID Setpoint Selection 1/2]. This value is a percentage of the maximum output frequency. Note: Parameter A1-02 [Control Method Selection] selects which parameter is the maximum output frequency. • A1-02 ≠ 8 [EZOLV]: E1-04 [Maximum Output Frequency] • A1-02 = 8: E9-02 [Maximum Speed]	0.00% (0.00 - 100.00%)	550
b5-61 (119A)	PID Trim Mode Lower Limit Sel	V/f OLV OLV/PM AOLV/PM EZOLV Sets the function that adjusts the PID output in relation to the frequency reference. 0 : Disabled 1 : Enabled	0 (0, 1)	550
b5-62 (119B)	PID Trim Mode Lower Limit Value	V/f OLV OLV/PM AOLV/PM EZOLV Sets the PID Trim Mode Lower Limit Value as a percentage of the maximum output frequency. Note: Parameter A1-02 [Control Method Selection] selects which parameter is the maximum output frequency. • A1-02 ≠ 8 [EZOLV]: E1-04 [Maximum Output Frequency] • A1-02 = 8: E9-02 [Maximum Speed]	0.00% (0.00 - 100.00%)	551
b5-63 (119C)	PID Differential FB Monitor Sel	V/f OLV OLV/PM AOLV/PM EZOLV Selects the monitor (Ux-xx) used as the PID Differential Feedback. Set the x-xx part of the Ux-xx [Monitor].	000 (000 - 999)	551
b5-64 (119D)	PID Differential FB Monitor Gain	V/f OLV OLV/PM AOLV/PM EZOLV Sets the gain for the monitor specified in b5-63 [PID Differential FB Monitor Sel].	1.00 (0.00 - 10.00)	551
b5-65 (119F)	PID Differential FB Monitor Bias	V/f OLV OLV/PM AOLV/PM EZOLV Sets the bias for the monitor specified in b5-63 [PID Differential FB Monitor Sel].	0.00 (-10.00 - +10.00)	551
b5-66 (11DE)	PID Feedback Monitor Level	V/f OLV OLV/PM AOLV/PM EZOLV Sets the signal level for the monitor specified in b5-55 [PID Feedback Monitor Selection]. 0 : Absolute 1 : Bi-directional (+/-)	0 (0, 1)	551
b5-67 (11DF)	PID Differential FB Monitor Lvl	V/f OLV OLV/PM AOLV/PM EZOLV Sets the signal level for the monitor specified in b5-63 [PID Differential FB Monitor Sel]. 0 : Absolute 1 : Bi-directional (+/-)	0 (0, 1)	551
b5-89 (0B89) RUN	Sleep Method Selection	V/f OLV OLV/PM AOLV/PM EZOLV Sets sleep and wake up operation when using PID. 0 : Standard 1 : EZ Sleep/Wake-up	0 (0, 1)	552
b5-90 (0B90)	EZ Sleep Unit	V/f OLV OLV/PM AOLV/PM EZOLV Sets the measurement units for b5-91 [EZ Sleep Minimum Speed] and b5-92 [EZ Sleep Level]. 0 : 0.1Hz units 1 : rev/min	0 (0, 1)	552

11.5 b: Application

No. (Hex.)	Name	Description	Default (Range)	Ref.
b5-91 (0B91) RUN	EZ Sleep Minimum Speed	V/f OLV OLV/PM AOLV/PM EZOLV Sets the output lower limit level for the PID control as Hz units or min ⁻¹ (r/min) units. When you use b5-91, set b5-34 = 0.0 [PID Output Lower Limit Level = 0.0 (disabled)]. When you set the output lower limit for PID output as a percentage of the Maximum Output Frequency, refer to page 547.	0.0 Hz or 0 min ⁻¹ (r/min) (0.0 to 590.0 Hz or 0 to 35400 min ⁻¹ (r/min))	552
b5-92 (0B92) RUN	EZ Sleep Level	V/f OLV OLV/PM AOLV/PM EZOLV Sets the value that the output frequency or motor speed must be less than for longer than b5-93 [EZ Sleep Time] to enter Sleep Mode.	0.0 Hz or 0 min ⁻¹ (r/min) (0.0 to 590.0 Hz or 0 to 35400 min ⁻¹ (r/min))	552
b5-93 (0B93) RUN	EZ Sleep Time	V/f OLV OLV/PM AOLV/PM EZOLV Sets the length of time that the output frequency or motor speed must be less than b5-92 [EZ Sleep Level] to enter Sleep Mode.	5.0 s (0.0 - 1000.0 s)	552
b5-94 (0B94) RUN	EZ Sleep Wake-up Level	V/f OLV OLV/PM AOLV/PM EZOLV Sets the level at which the drive resumes operation when exiting Sleep Mode.	0.00% (0.00 - 600.00%)	553
b5-95 (0B95)	EZ Sleep Wake-up Mode	V/f OLV OLV/PM AOLV/PM EZOLV Sets the wake-up mode to use when exiting Sleep Mode. 0 : Absolute 1 : Setpoint Delta	0 (0, 1)	553
b5-96 (0B96) RUN	EZ Sleep Wake-up Time	V/f OLV OLV/PM AOLV/PM EZOLV Sets the EZ Wake-up time.	1.0 s (0.0 - 1000.0 s)	553

◆ b6: Dwell Function

No. (Hex.)	Name	Description	Default (Range)	Ref.
b6-01 (01B6)	Dwell Reference at Start	V/f OLV OLV/PM AOLV/PM EZOLV Sets the output frequency that the drive will hold momentarily when the motor starts.	0.0 (Determined by A1-02)	554
b6-02 (01B7)	Dwell Time at Start	V/f OLV OLV/PM AOLV/PM EZOLV Sets the length of time that the drive will hold the output frequency when the motor starts.	0.0 s (0.0 - 10.0 s)	554
b6-03 (01B8)	Dwell Reference at Stop	V/f OLV OLV/PM AOLV/PM EZOLV Sets the output frequency that the drive will hold momentarily when ramping to stop the motor.	0.0 (Determined by A1-02)	554
b6-04 (01B9)	Dwell Time at Stop	V/f OLV OLV/PM AOLV/PM EZOLV Sets the length of time for the drive to hold the output frequency when ramping to stop the motor.	0.0 s (0.0 - 10.0 s)	554

◆ b8: Energy Saving

No. (Hex.)	Name	Description	Default (Range)	Ref.
b8-01 (01CC)	Energy Saving Control Selection	V/f OLV OLV/PM AOLV/PM EZOLV Sets the Energy-saving control function. 0 : Disabled 1 : Enabled 2 : Automatic Optimization Note: When A1-02 = 6 [Control Method Selection = AOLV/PM], you can only select setting 2 in Expert Mode.	0 (0 - 2)	555
b8-02 (01CD) RUN Expert	Energy Saving Gain	V/f OLV OLV/PM AOLV/PM EZOLV Sets the gain for Energy-saving control.	Determined by A1-02 (0.0 - 10.0)	555
b8-03 (01CE) RUN Expert	Energy Saving Filter Time	V/f OLV OLV/PM AOLV/PM EZOLV Sets the responsiveness for Energy-saving control.	Determined by A1-02 , C6-01 and o2-04 (0.00 - 10.00 s)	555

No. (Hex.)	Name	Description	Default (Range)	Ref.
b8-04 (01CF) Expert	Energy Saving Coefficient Value	<input checked="" type="checkbox"/> V/f <input type="checkbox"/> OLV <input type="checkbox"/> OLV/PM <input type="checkbox"/> AOLV/PM <input type="checkbox"/> EZOLV Sets the Energy-saving control coefficient to maintain maximum motor efficiency. The default setting is for Yaskawa motors.	Determined by C6-01, E2-11, and o2-04 (0.00 - 655.00)	555
b8-05 (01D0) Expert	Power Detection Filter Time	<input checked="" type="checkbox"/> V/f <input type="checkbox"/> OLV <input type="checkbox"/> OLV/PM <input type="checkbox"/> AOLV/PM <input type="checkbox"/> EZOLV Sets the time constant to measure output power.	20 ms (0 - 2000 ms)	555
b8-06 (01D1) Expert	Search Operation Voltage Limit	<input checked="" type="checkbox"/> V/f <input type="checkbox"/> OLV <input type="checkbox"/> OLV/PM <input type="checkbox"/> AOLV/PM <input type="checkbox"/> EZOLV Sets the voltage limit for Search Operation as a percentage of the motor rated voltage.	0% (0 - 100%)	556
b8-16 (01F8) Expert	PM E-Save Coefficient Ki	<input type="checkbox"/> V/f <input type="checkbox"/> OLV <input type="checkbox"/> OLV/PM <input checked="" type="checkbox"/> AOLV/PM <input type="checkbox"/> EZOLV Sets torque linearity. This parameter uses the Ki value from the motor nameplate. Usually it is not necessary to change this setting.	1.00 (0.00 - 3.00)	556
b8-17 (01F9) Expert	PM E-Save Coefficient Kt	<input type="checkbox"/> V/f <input type="checkbox"/> OLV <input type="checkbox"/> OLV/PM <input checked="" type="checkbox"/> AOLV/PM <input type="checkbox"/> EZOLV Sets torque linearity. This parameter uses the Kt value from the motor nameplate. Usually it is not necessary to change this setting.	1.00 (0.00 - 3.00)	556
b8-18 (01FA) Expert	E-Save d-axis Current FilterTime	<input type="checkbox"/> V/f <input type="checkbox"/> OLV <input type="checkbox"/> OLV/PM <input checked="" type="checkbox"/> AOLV/PM <input type="checkbox"/> EZOLV Sets the d-axis current reference filter time constant.	0.100 s (0.000 - 5.000 s)	556
b8-19 (0B40) Expert	E-Save Search Frequency	<input type="checkbox"/> V/f <input type="checkbox"/> OLV <input type="checkbox"/> OLV/PM <input checked="" type="checkbox"/> AOLV/PM <input type="checkbox"/> EZOLV Sets the frequency of Energy-saving control search operations. Usually it is not necessary to change this setting.	Determined by A1-02 (10 - 300 Hz)	556
b8-20 (0B41) Expert	E-Save Search Width	<input type="checkbox"/> V/f <input type="checkbox"/> OLV <input type="checkbox"/> OLV/PM <input checked="" type="checkbox"/> AOLV/PM <input type="checkbox"/> EZOLV Sets the amplitude of Energy-saving control search operations.	1.0 degrees (0.1 - 5.0 degrees)	557
b8-21 (0B42) Expert	PM E-Save Search Gain	<input type="checkbox"/> V/f <input type="checkbox"/> OLV <input type="checkbox"/> OLV/PM <input checked="" type="checkbox"/> AOLV/PM <input type="checkbox"/> EZOLV Sets the gain of Energy-saving control search operations.	0.3Hz (0.1 - 20.0 Hz)	557
b8-22 (0B43) Expert	PM E-Save Search LPF Cutoff Freq	<input type="checkbox"/> V/f <input type="checkbox"/> OLV <input type="checkbox"/> OLV/PM <input checked="" type="checkbox"/> AOLV/PM <input type="checkbox"/> EZOLV Sets the frequency of the filter used to extract the high-efficiency phase from search operations. Usually it is not necessary to change this setting.	10.0 Hz (1.0 - 30.0 Hz)	557
b8-23 (0B44) Expert	PM E-Save Search Limit	<input type="checkbox"/> V/f <input type="checkbox"/> OLV <input type="checkbox"/> OLV/PM <input checked="" type="checkbox"/> AOLV/PM <input type="checkbox"/> EZOLV Sets the search operations output limit. Usually it is not necessary to change this setting.	15.0 degrees (0.0 - 30.0 degrees)	557
b8-24 (0B45) Expert	PM E-Save High Freq ACR Gain	<input type="checkbox"/> V/f <input type="checkbox"/> OLV <input type="checkbox"/> OLV/PM <input checked="" type="checkbox"/> AOLV/PM <input type="checkbox"/> EZOLV Sets the gain for high-frequency current control.	200.0 Hz (100.0 - 1000.0 Hz)	557
b8-25 (0B46) Expert	PM E-Save Search Start Level	<input type="checkbox"/> V/f <input type="checkbox"/> OLV <input type="checkbox"/> OLV/PM <input checked="" type="checkbox"/> AOLV/PM <input type="checkbox"/> EZOLV Sets the start level for search operations.	10.0% (0.0 - 100.0%)	558
b8-26 (0B47) Expert	PM E-Save Power Setpoint	<input type="checkbox"/> V/f <input type="checkbox"/> OLV <input type="checkbox"/> OLV/PM <input checked="" type="checkbox"/> AOLV/PM <input type="checkbox"/> EZOLV Sets a value to increase torque accuracy.	0.0% (-10.0 - +10.0%)	558
b8-28 (0B8B) Expert	Over Excitation Action Selection	<input type="checkbox"/> V/f <input type="checkbox"/> OLV <input type="checkbox"/> OLV/PM <input type="checkbox"/> AOLV/PM <input checked="" type="checkbox"/> EZOLV Sets the function for excitation operation. 0 : Disabled 1 : Enabled	0 (0, 1)	558
b8-29 (0B8C)	Energy Saving Priority Selection	<input type="checkbox"/> V/f <input type="checkbox"/> OLV <input type="checkbox"/> OLV/PM <input type="checkbox"/> AOLV/PM <input checked="" type="checkbox"/> EZOLV Sets the priority of drive response between changes to the load or Energy-saving control. Enable this to prioritize energy-saving control. Disable this to prioritize tracking related fast load changes, and prevent motor stall. 0 : Priority: Drive Response 1 : Priority: Energy Savings	0 (0, 1)	558

11.6 C: Tuning

◆ C1: Accel & Decel Time

No. (Hex.)	Name	Description	Default (Range)	Ref.
C1-01 (0200) RUN	Acceleration Time 1	V/f OLV OLV/PM AOLV/PM EZOLV Sets the length of time to accelerate from zero to maximum output frequency.	10.0 s (0.0 - 6000.0 s)	561
C1-02 (0201) RUN	Deceleration Time 1	V/f OLV OLV/PM AOLV/PM EZOLV Sets the length of time to decelerate from maximum output frequency to zero.	10.0 s (0.0 - 6000.0 s)	561
C1-03 (0202) RUN	Acceleration Time 2	V/f OLV OLV/PM AOLV/PM EZOLV Sets the length of time to accelerate from zero to maximum output frequency.	10.0 s (0.0 - 6000.0 s)	561
C1-04 (0203) RUN	Deceleration Time 2	V/f OLV OLV/PM AOLV/PM EZOLV Sets the length of time to decelerate from maximum output frequency to zero.	10.0 s (0.0 - 6000.0 s)	561
C1-05 (0204) RUN	Acceleration Time 3	V/f OLV OLV/PM AOLV/PM EZOLV Sets the length of time to accelerate from zero to maximum output frequency.	10.0 s (0.0 - 6000.0 s)	561
C1-06 (0205) RUN	Deceleration Time 3	V/f OLV OLV/PM AOLV/PM EZOLV Sets the length of time to decelerate from maximum output frequency to zero.	10.0 s (0.0 - 6000.0 s)	561
C1-07 (0206) RUN	Acceleration Time 4	V/f OLV OLV/PM AOLV/PM EZOLV Sets the length of time to accelerate from zero to maximum output frequency.	10.0 s (0.0 - 6000.0 s)	562
C1-08 (0207) RUN	Deceleration Time 4	V/f OLV OLV/PM AOLV/PM EZOLV Sets the length of time to decelerate from maximum output frequency to zero.	10.0 s (0.0 - 6000.0 s)	562
C1-09 (0208) RUN	Fast Stop Time	V/f OLV OLV/PM AOLV/PM EZOLV Sets the length of time that the drive will decelerate to zero for a Fast Stop. Note: • Decelerating too quickly can cause an <i>ov</i> [Overvoltage] fault that shuts off the drive while the motor to coasts to a stop. Set a Fast Stop time in C1-09 that prevents motor coasting and makes sure that the motor stops quickly and safely. • When L2-29 = 0 [Kinetic Energy Backup Method = Single Drive KEB Ride-Thru 1] and you do KEB Auto-Tuning, the drive will automatically set C1-09. If you must not change the Fast Stop time, do not do KEB Tuning.	10.0 s (0.0 - 6000.0 s)	562
C1-10 (0209)	Accel/Decel Time Setting Units	V/f OLV OLV/PM AOLV/PM EZOLV Sets the setting units for C1-01 to C1-08 [Accel/Decel Times 1 to 4], C1-09 [Fast Stop Time], L2-06 [Kinetic Energy Backup Decel Time], and L2-07 [Kinetic Energy Backup Accel Time]. 0 : 0.01 s (0.00 to 600.00 s) 1 : 0.1 s (0.0 to 6000.0 s)	1 (0, 1)	562
C1-11 (020A)	Accel/Decel Time Switching Frequency	V/f OLV OLV/PM AOLV/PM EZOLV Sets the frequency at which the drive will automatically change acceleration and deceleration times.	Determined by A1-02 (0.0 - 590.0 Hz)	563
C1-14 (0264) RUN	Accel/Decel Rate Frequency	V/f OLV OLV/PM AOLV/PM EZOLV Sets the base frequency used to calculate acceleration and deceleration rates.	0.0 Hz (0.0 - 590.0 Hz)	563

◆ C2: S-Curve Characteristics

No. (Hex.)	Name	Description	Default (Range)	Ref.
C2-01 (020B)	S-Curve Time @ Start of Accel	V/f OLV OLV/PM AOLV/PM EZOLV Sets the S-curve acceleration time at start.	Determined by A1-02 (0.00 - 10.00 s)	565
C2-02 (020C)	S-Curve Time @ End of Accel	V/f OLV OLV/PM AOLV/PM EZOLV Sets the S-curve acceleration time at completion.	0.20 s (0.00 - 10.00 s)	565

No. (Hex.)	Name	Description	Default (Range)	Ref.
C2-03 (020D)	S-Curve Time @ Start of Decel	<input type="checkbox"/> V/f <input type="checkbox"/> OLV <input type="checkbox"/> OLV/PM <input type="checkbox"/> AOLV/PM <input type="checkbox"/> EZOLV Sets the S-curve deceleration time at start.	0.20 s (0.00 - 10.00 s)	565
C2-04 (020E)	S-Curve Time @ End of Decel	<input type="checkbox"/> V/f <input type="checkbox"/> OLV <input type="checkbox"/> OLV/PM <input type="checkbox"/> AOLV/PM <input type="checkbox"/> EZOLV Sets the S-curve deceleration time at completion.	0.00 s (0.00 - 10.00 s)	565

◆ C3: Slip Compensation

No. (Hex.)	Name	Description	Default (Range)	Ref.
C3-01 (020F) RUN	Slip Compensation Gain	<input type="checkbox"/> V/f <input type="checkbox"/> OLV <input type="checkbox"/> OLV/PM <input type="checkbox"/> AOLV/PM <input type="checkbox"/> EZOLV Sets the gain for the slip compensation function. Usually it is not necessary to change this setting. Note: Correctly set these parameters before changing the slip compensation gain: • E2-01 [Motor Rated Current (FLA)] • E2-02 [Motor Rated Slip] • E2-03 [Motor No-Load Current]	Determined by A1-02 (0.0 - 2.5)	566
C3-02 (0210) RUN	Slip Compensation Delay Time	<input type="checkbox"/> V/f <input type="checkbox"/> OLV <input type="checkbox"/> OLV/PM <input type="checkbox"/> AOLV/PM <input type="checkbox"/> EZOLV Sets the slip compensation delay time when speed is unstable or when the slip compensation response is too slow. Usually it is not necessary to change this setting.	Determined by A1-02 (0 - 10000 ms)	566
C3-03 (0211)	Slip Compensation Limit	<input type="checkbox"/> V/f <input type="checkbox"/> OLV <input type="checkbox"/> OLV/PM <input type="checkbox"/> AOLV/PM <input type="checkbox"/> EZOLV Sets the upper limit for the slip compensation function as a percentage of the motor rated slip.	200% (0 - 250%)	566
C3-04 (0212)	Slip Compensation at Regen	<input type="checkbox"/> V/f <input type="checkbox"/> OLV <input type="checkbox"/> OLV/PM <input type="checkbox"/> AOLV/PM <input type="checkbox"/> EZOLV Sets the slip compensation function during regeneration. 0 : Disabled 1 : Enabled Above 6Hz 2 : Enabled Above Defined Range	0 (0 - 2)	567
C3-05 (0213)	Output Voltage Limit Selection	<input type="checkbox"/> V/f <input type="checkbox"/> OLV <input type="checkbox"/> OLV/PM <input type="checkbox"/> AOLV/PM <input type="checkbox"/> EZOLV Sets the automatic reduction of motor magnetic flux when the output voltage is saturated. 0 : Disabled 1 : Enabled	0 (0, 1)	567
C3-16 (0261) Expert	Vout Modulation Limit Start Lvl	<input type="checkbox"/> V/f <input type="checkbox"/> OLV <input type="checkbox"/> OLV/PM <input type="checkbox"/> AOLV/PM <input type="checkbox"/> EZOLV Sets the modulation factor that starts the output voltage limit operation when C3-05 = 1 [Output Voltage Limit Selection = Enabled].	90.0% (70.0 - 90.0%)	567
C3-17 (0262) Expert	Vout Modulation Limit Max Level	<input type="checkbox"/> V/f <input type="checkbox"/> OLV <input type="checkbox"/> OLV/PM <input type="checkbox"/> AOLV/PM <input type="checkbox"/> EZOLV Sets the modulation factor used with C3-18 [Output Voltage Limit Level] for the output voltage limit operation when C3-05 = 1 [Output Voltage Limit Selection = Enabled].	100.0% (85.0 - 100.0%)	568
C3-18 (0263) Expert	Output Voltage Limit Level	<input type="checkbox"/> V/f <input type="checkbox"/> OLV <input type="checkbox"/> OLV/PM <input type="checkbox"/> AOLV/PM <input type="checkbox"/> EZOLV Sets the maximum drop width of the voltage reference when C3-05 = 1 [Output Voltage Limit Selection = Enabled].	90.0% (50.0 - 100.0%)	568
C3-21 (033E) RUN	Motor 2 Slip Compensation Gain	<input type="checkbox"/> V/f <input type="checkbox"/> OLV <input type="checkbox"/> OLV/PM <input type="checkbox"/> AOLV/PM <input type="checkbox"/> EZOLV Sets the gain for the motor 2 slip compensation function. Usually it is not necessary to change this setting. Note: Correctly set these parameters before changing the slip compensation gain: • E4-01 [Motor 2 Rated Current] • E4-02 [Motor 2 Rated Slip] • E4-03 [Motor 2 Rated No-Load Current]	Determined by E3-01 (0.0 - 2.5)	568
C3-22 (0241) RUN	Motor 2 Slip Comp Delay Time	<input type="checkbox"/> V/f <input type="checkbox"/> OLV <input type="checkbox"/> OLV/PM <input type="checkbox"/> AOLV/PM <input type="checkbox"/> EZOLV Sets the slip compensation delay time for motor 2 when speed is unstable or when the slip compensation response is too slow. Usually it is not necessary to change this setting.	Determined by E3-01 (0 - 10000 ms)	568
C3-23 (0242)	Motor 2 Slip Compensation Limit	<input type="checkbox"/> V/f <input type="checkbox"/> OLV <input type="checkbox"/> OLV/PM <input type="checkbox"/> AOLV/PM <input type="checkbox"/> EZOLV Sets the upper limit for the slip compensation function as a percentage of the motor 2 rated slip.	200% (0 - 250%)	568

11.6 C: Tuning

No. (Hex.)	Name	Description	Default (Range)	Ref.
C3-24 (0243)	Motor 2 Slip Comp during Regen	<p><input type="checkbox"/> V/f <input checked="" type="checkbox"/> OLV <input type="checkbox"/> OLV/PM <input type="checkbox"/> AOLV/PM <input type="checkbox"/> EZOLV</p> <p>Sets the slip compensation during regenerative operation function for motor 2.</p> <p>0 : Disabled 1 : Enabled Above 6Hz 2 : Enabled Above Defined Range</p>	0 (0 - 2)	569
C3-29 (1B5D) Expert	Slip Compensation Gain @ Low Spd	<p><input type="checkbox"/> V/f <input type="checkbox"/> OLV <input type="checkbox"/> OLV/PM <input type="checkbox"/> AOLV/PM <input checked="" type="checkbox"/> EZOLV</p> <p>Sets the gain for the slip compensation function in the low speed range. Usually it is not necessary to change this setting.</p>	0.0 (0.0 - 2.5)	569

◆ C4: Torque Compensation

No. (Hex.)	Name	Description	Default (Range)	Ref.
C4-01 (0215) RUN	Torque Compensation Gain	<p><input type="checkbox"/> V/f <input checked="" type="checkbox"/> OLV <input type="checkbox"/> OLV/PM <input type="checkbox"/> AOLV/PM <input type="checkbox"/> EZOLV</p> <p>Sets the gain for the torque compensation function. Use this parameter value for motor 1 when operating multiple motors.</p> <p>Note: When A1-02 = 8 [Control Method Selection = EZOLV], you cannot change this parameter during drive run.</p>	Determined by A1-02 (0.00 - 2.50)	570
C4-02 (0216) RUN	Torque Compensation Delay Time	<p><input type="checkbox"/> V/f <input type="checkbox"/> OLV <input type="checkbox"/> OLV/PM <input type="checkbox"/> AOLV/PM <input type="checkbox"/> EZOLV</p> <p>Sets the torque compensation delay time. Usually it is not necessary to change this setting.</p> <p>Note: When A1-02 = 5, 8 [Control Method Selection = OLV/PM, EZOLV], you cannot change the setting while the drive is running.</p>	Determined by A1-02 (0 - 60000 ms)	570
C4-03 (0217)	Torque Compensation @ FWD Start	<p><input type="checkbox"/> V/f <input checked="" type="checkbox"/> OLV <input type="checkbox"/> OLV/PM <input type="checkbox"/> AOLV/PM <input type="checkbox"/> EZOLV</p> <p>Set the amount of torque reference for forward start as a percentage of the motor rated torque.</p>	0.0% (0.0 - 200.0%)	570
C4-04 (0218)	Torque Compensation @ REV Start	<p><input type="checkbox"/> V/f <input checked="" type="checkbox"/> OLV <input type="checkbox"/> OLV/PM <input type="checkbox"/> AOLV/PM <input type="checkbox"/> EZOLV</p> <p>Sets the amount of torque reference for reverse start as a percentage of the motor rated torque.</p>	0.0% (-200.0 - 0.0%)	570
C4-05 (0219)	Torque Compensation Time	<p><input type="checkbox"/> V/f <input checked="" type="checkbox"/> OLV <input type="checkbox"/> OLV/PM <input type="checkbox"/> AOLV/PM <input type="checkbox"/> EZOLV</p> <p>Sets the starting torque constant to use with C4-03 and C4-04 [Torque Compensation @ FWD/REV Start].</p>	10 ms (0 - 200 ms)	571
C4-06 (021A)	Motor 2 Torque Comp Delay Time	<p><input type="checkbox"/> V/f <input checked="" type="checkbox"/> OLV <input type="checkbox"/> OLV/PM <input type="checkbox"/> AOLV/PM <input type="checkbox"/> EZOLV</p> <p>Sets the value if <i>ov</i> [Overvoltage] occurs with sudden changes in the load, at the end of acceleration, or at the start of deceleration.</p>	150 ms (0 - 10000 ms)	571
C4-07 (0341) RUN	Motor 2 Torque Compensation Gain	<p><input type="checkbox"/> V/f <input checked="" type="checkbox"/> OLV <input type="checkbox"/> OLV/PM <input type="checkbox"/> AOLV/PM <input type="checkbox"/> EZOLV</p> <p>Sets the gain for motor 2 torque compensation function when using the Motor Switch function.</p>	1.00 (0.00 - 2.50)	571
C4-23 (1583) Expert	Current Control Gain	<p><input type="checkbox"/> V/f <input type="checkbox"/> OLV <input type="checkbox"/> OLV/PM <input type="checkbox"/> AOLV/PM <input checked="" type="checkbox"/> EZOLV</p> <p>Sets the Current control gain. Usually it is not necessary to change this parameter.</p>	1.00 (0.50 - 2.50)	571

◆ C5: Automatic Speed Regulator (ASR: Automatic Speed Regulator)

No. (Hex.)	Name	Description	Default (Range)	Ref.
C5-01 (021B) RUN	ASR Proportional Gain 1	<p><input type="checkbox"/> V/f <input type="checkbox"/> OLV <input type="checkbox"/> OLV/PM <input type="checkbox"/> AOLV/PM <input checked="" type="checkbox"/> EZOLV</p> <p>Sets the gain to adjust ASR response.</p> <p>Note: When A1-02 = 0 [Control Method Selection = V/f], set H6-01 = 3 [Terminal RP Pulse Train Function = Speed Feedback (V/F Control)] to enable this parameter.</p>	Determined by A1-02 (0.00 - 300.00)	574
C5-02 (021C) RUN	ASR Integral Time 1	<p><input type="checkbox"/> V/f <input type="checkbox"/> OLV <input type="checkbox"/> OLV/PM <input type="checkbox"/> AOLV/PM <input checked="" type="checkbox"/> EZOLV</p> <p>Sets the ASR integral time.</p> <p>Note: When A1-02 = 0 [Control Method Selection = V/f], set H6-01 = 3 [Terminal RP Pulse Train Function = Speed Feedback (V/F Control)] to enable this parameter.</p>	Determined by A1-02 (0.000 - 60.000 s)	574

No. (Hex.)	Name	Description	Default (Range)	Ref.
C5-03 (021D) RUN	ASR Proportional Gain 2	<p>V/f OLV OLV/PM AOLV/PM EZOLV</p> <p>Sets the gain to adjust ASR response.</p> <p>Note: When A1-02 = 0 [Control Method Selection = V/f], set H6-01 = 3 [Terminal RP Pulse Train Function = Speed Feedback (V/F Control)] to enable this parameter.</p>	Determined by A1-02 (0.00 - 300.00)	574
C5-04 (021E) RUN	ASR Integral Time 2	<p>V/f OLV OLV/PM AOLV/PM EZOLV</p> <p>Sets the ASR integral time.</p> <p>Note: When A1-02 = 0 [Control Method Selection = V/f], set H6-01 = 3 [Terminal RP Pulse Train Function = Speed Feedback (V/F Control)] to enable this parameter.</p>	Determined by A1-02 (0.000 - 60.000 s)	575
C5-05 (021F)	ASR Limit	<p>V/f OLV OLV/PM AOLV/PM EZOLV</p> <p>Sets the ASR output limit where E1-04 [Maximum Output Frequency] is 100%.</p> <p>Note: When A1-02 = 0 [Control Method Selection = V/f], set H6-01 = 3 [Terminal RP Pulse Train Function = Speed Feedback (V/F Control)] to enable this parameter.</p>	5.0% (0.0 - 20.0%)	575
C5-06 (0220)	ASR Delay Time	<p>V/f OLV OLV/PM AOLV/PM EZOLV</p> <p>Sets the filter time constant of the torque reference output from the speed loop. Usually it is not necessary to change this setting.</p>	Determined by A1-02 (0.000 - 0.500 s)	575
C5-07 (0221)	ASR Gain Switchover Frequency	<p>V/f OLV OLV/PM AOLV/PM EZOLV</p> <p>Sets the frequency where the drive will switch between these parameters: C5-01 and C5-03 [ASR Proportional Gain 1/2] C5-02 and C5-04 [ASR Integral Time 1/2]</p>	Determined by A1-02 (Determined by A1-02)	575
C5-08 (0222)	ASR Integral Limit	<p>V/f OLV OLV/PM AOLV/PM EZOLV</p> <p>Set the upper limit of the ASR integral amount as a percentage of the rated load.</p>	400% (0 - 400%)	575
C5-12 (0386)	Integral Operation @ Accel/Decel	<p>V/f OLV OLV/PM AOLV/PM EZOLV</p> <p>Sets ASR integral operation during acceleration and deceleration. 0 : No 1 : Yes</p> <p>Note: When A1-02 = 0 [Control Method Selection = V/f], set H6-01 = 3 [Terminal RP Pulse Train Function = Speed Feedback (V/F Control)] to enable this parameter.</p>	0 (0, 1)	576
C5-29 (0B18) Expert	Speed Control Response	<p>V/f OLV OLV/PM AOLV/PM EZOLV</p> <p>Sets the level of speed control responsiveness. Usually it is not necessary to change this setting. 0 : Standard 1 : High Performance 1</p>	1 (0, 1)	576
C5-39 (030D)	ASR Primary Delay Time Const 2	<p>V/f OLV OLV/PM AOLV/PM EZOLV</p> <p>Sets the filter time constant used when the torque reference is output from ASR. Usually it is not necessary to change this parameter.</p>	0.000 s (0.000 - 0.500 s)	576

◆ C6: Duty & Carrier Frequency

No. (Hex.)	Name	Description	Default (Range)	Ref.
C6-01 (0223)	Normal / Heavy Duty Selection	<p><input type="radio"/> V/f <input type="radio"/> OLV <input type="radio"/> OLV/PM <input type="radio"/> AOLV/PM <input type="radio"/> EZOLV</p> <p>Sets the drive duty rating. 0 : Heavy Duty Rating 1 : Normal Duty Rating</p>	1 (0, 1)	576
C6-02 (0224)	Carrier Frequency Selection	<p><input type="radio"/> V/f <input type="radio"/> OLV <input type="radio"/> OLV/PM <input type="radio"/> AOLV/PM <input type="radio"/> EZOLV</p> <p>Sets the carrier frequency for the transistors in the drive. 1 : 2.0 kHz 2 : 5.0 kHz (AOLV/PM: 4.0 kHz) 3 : 8.0 kHz (AOLV/PM: 6.0 kHz) 4 : 10.0 kHz (AOLV/PM: 8.0 kHz) 5 : 12.5 kHz (AOLV/PM: 10.0 kHz) 6 : 15.0 kHz (AOLV/PM: 12.0 kHz) 7 : Swing PWM4 (Audible Sound 1) 8 : Swing PWM4 (Audible Sound 2) 9 : Swing PWM4 (Audible Sound 3) A : Swing PWM4 (Audible Sound 4) B : Leakage Current Rejection PWM F : User Defined (C6-03 to C6-05)</p> <p>Note:</p> <ul style="list-style-type: none"> The setting range changes when the A1-02 [Control Method Selection] value changes: -5, 8 [OLV/PM, EZOLV]: You can set C6-02 = 1 to 6, B, and F. -6 [AOLV/PM]: You can set C6-02 = 1 to 6. The carrier frequency for Swing PWM 1 is equivalent to 2.0 kHz. Swing PWM applies a special PWM pattern to decrease the audible noise. 	Determined by A1-02, C6-01, and o2-04 (Determined by A1-02)	577
C6-03 (0225)	Carrier Frequency Upper Limit	<p><input type="radio"/> V/f <input type="radio"/> OLV <input type="radio"/> OLV/PM <input type="radio"/> AOLV/PM <input type="radio"/> EZOLV</p> <p>Sets the upper limit of the carrier frequency. Set C6-02 = F [Carrier Frequency Selection = User Defined (C6-03 to C6-05)] to set this parameter.</p>	Determined by C6-02 (1.0 - 15.0 kHz)	578
C6-04 (0226)	Carrier Frequency Lower Limit	<p><input type="radio"/> V/f <input type="radio"/> OLV <input type="radio"/> OLV/PM <input type="radio"/> AOLV/PM <input type="radio"/> EZOLV</p> <p>Sets the lower limit of the carrier frequency. Set C6-02 = F [Carrier Frequency Selection = User Defined (C6-03 to C6-05)] to set this parameter.</p>	Determined by C6-02 (1.0 - 15.0 kHz)	579
C6-05 (0227)	Carrier Freq Proportional Gain	<p><input type="radio"/> V/f <input type="radio"/> OLV <input type="radio"/> OLV/PM <input type="radio"/> AOLV/PM <input type="radio"/> EZOLV</p> <p>Sets the proportional gain for the carrier frequency. Set C6-02 = F [Carrier Frequency Selection = User Defined (C6-03 to C6-05)] to set this parameter.</p>	Determined by C6-02 (0 - 99)	579
C6-09 (022B)	Carrier Freq at Rotational Tune	<p><input type="radio"/> V/f <input type="radio"/> OLV <input type="radio"/> OLV/PM <input type="radio"/> AOLV/PM <input type="radio"/> EZOLV</p> <p>Sets the Auto-Tuning carrier frequency. Usually it is not necessary to change this setting. 0 : 5 kHz 1 : Use C6-03</p>	0 (0, 1)	579

11.7 d: Reference Settings

◆ d1: Frequency Reference

No. (Hex.)	Name	Description	Default (Range)	Ref.
d1-01 (0280) RUN	Reference 1	<p>V/f OLV OLV/PM AOLV/PM EZOLV</p> <p>Sets the frequency reference in the units from o1-03 [Frequency Display Unit Selection].</p> <p>Note: When A1-02 = 6 [Control Method Selection = AOLV/PM], the default setting is o1-03 = 1 [0.01% (100% = E1-04)].</p>	0.00 Hz (0.00 - 590.00 Hz)	583
d1-02 (0281) RUN	Reference 2	<p>V/f OLV OLV/PM AOLV/PM EZOLV</p> <p>Sets the frequency reference in the units from o1-03 [Frequency Display Unit Selection].</p> <p>Note: When A1-02 = 6 [Control Method Selection = AOLV/PM], the default setting is o1-03 = 1 [0.01% (100% = E1-04)].</p>	0.00 Hz (0.00 - 590.00 Hz)	584
d1-03 (0282) RUN	Reference 3	<p>V/f OLV OLV/PM AOLV/PM EZOLV</p> <p>Sets the frequency reference in the units from o1-03 [Frequency Display Unit Selection].</p> <p>Note: When A1-02 = 6 [Control Method Selection = AOLV/PM], the default setting is o1-03 = 1 [0.01% (100% = E1-04)].</p>	0.00 Hz (0.00 - 590.00 Hz)	584
d1-04 (0283) RUN	Reference 4	<p>V/f OLV OLV/PM AOLV/PM EZOLV</p> <p>Sets the frequency reference in the units from o1-03 [Frequency Display Unit Selection].</p> <p>Note: When A1-02 = 6 [Control Method Selection = AOLV/PM], the default setting is o1-03 = 1 [0.01% (100% = E1-04)].</p>	0.00 Hz (0.00 - 590.00 Hz)	584
d1-05 (0284) RUN	Reference 5	<p>V/f OLV OLV/PM AOLV/PM EZOLV</p> <p>Sets the frequency reference in the units from o1-03 [Frequency Display Unit Selection].</p> <p>Note: When A1-02 = 6 [Control Method Selection = AOLV/PM], the default setting is o1-03 = 1 [0.01% (100% = E1-04)].</p>	0.00 Hz (0.00 - 590.00 Hz)	584
d1-06 (0285) RUN	Reference 6	<p>V/f OLV OLV/PM AOLV/PM EZOLV</p> <p>Sets the frequency reference in the units from o1-03 [Frequency Display Unit Selection].</p> <p>Note: When A1-02 = 6 [Control Method Selection = AOLV/PM], the default setting is o1-03 = 1 [0.01% (100% = E1-04)].</p>	0.00 Hz (0.00 - 590.00 Hz)	584
d1-07 (0286) RUN	Reference 7	<p>V/f OLV OLV/PM AOLV/PM EZOLV</p> <p>Sets the frequency reference in the units from o1-03 [Frequency Display Unit Selection].</p> <p>Note: When A1-02 = 6 [Control Method Selection = AOLV/PM], the default setting is o1-03 = 1 [0.01% (100% = E1-04)].</p>	0.00 Hz (0.00 - 590.00 Hz)	585
d1-08 (0287) RUN	Reference 8	<p>V/f OLV OLV/PM AOLV/PM EZOLV</p> <p>Sets the frequency reference in the units from o1-03 [Frequency Display Unit Selection].</p> <p>Note: When A1-02 = 6 [Control Method Selection = AOLV/PM], the default setting is o1-03 = 1 [0.01% (100% = E1-04)].</p>	0.00 Hz (0.00 - 590.00 Hz)	585
d1-09 (0288) RUN	Reference 9	<p>V/f OLV OLV/PM AOLV/PM EZOLV</p> <p>Sets the frequency reference in the units from o1-03 [Frequency Display Unit Selection].</p> <p>Note: When A1-02 = 6 [Control Method Selection = AOLV/PM], the default setting is o1-03 = 1 [0.01% (100% = E1-04)].</p>	0.00 Hz (0.00 - 590.00 Hz)	585
d1-10 (028B) RUN	Reference 10	<p>V/f OLV OLV/PM AOLV/PM EZOLV</p> <p>Sets the frequency reference in the units from o1-03 [Frequency Display Unit Selection].</p> <p>Note: When A1-02 = 6 [Control Method Selection = AOLV/PM], the default setting is o1-03 = 1 [0.01% (100% = E1-04)].</p>	0.00 Hz (0.00 - 590.00 Hz)	585
d1-11 (028C) RUN	Reference 11	<p>V/f OLV OLV/PM AOLV/PM EZOLV</p> <p>Sets the frequency reference in the units from o1-03 [Frequency Display Unit Selection].</p> <p>Note: When A1-02 = 6 [Control Method Selection = AOLV/PM], the default setting is o1-03 = 1 [0.01% (100% = E1-04)].</p>	0.00 Hz (0.00 - 590.00 Hz)	586

11.7 d: Reference Settings

No. (Hex.)	Name	Description	Default (Range)	Ref.
d1-12 (028D) RUN	Reference 12	<p>V/f OLV OLV/PM AOLV/PM EZOLV</p> <p>Sets the frequency reference in the units from o1-03 [Frequency Display Unit Selection].</p> <p>Note: When A1-02 = 6 [Control Method Selection = AOLV/PM], the default setting is o1-03 = 1 [0.01% (100% = E1-04)].</p>	0.00 Hz (0.00 - 590.00 Hz)	586
d1-13 (028E) RUN	Reference 13	<p>V/f OLV OLV/PM AOLV/PM EZOLV</p> <p>Sets the frequency reference in the units from o1-03 [Frequency Display Unit Selection].</p> <p>Note: When A1-02 = 6 [Control Method Selection = AOLV/PM], the default setting is o1-03 = 1 [0.01% (100% = E1-04)].</p>	0.00 Hz (0.00 - 590.00 Hz)	586
d1-14 (028F) RUN	Reference 14	<p>V/f OLV OLV/PM AOLV/PM EZOLV</p> <p>Sets the frequency reference in the units from o1-03 [Frequency Display Unit Selection].</p> <p>Note: When A1-02 = 6 [Control Method Selection = AOLV/PM], the default setting is o1-03 = 1 [0.01% (100% = E1-04)].</p>	0.00 Hz (0.00 - 590.00 Hz)	586
d1-15 (0290) RUN	Reference 15	<p>V/f OLV OLV/PM AOLV/PM EZOLV</p> <p>Sets the frequency reference in the units from o1-03 [Frequency Display Unit Selection].</p> <p>Note: When A1-02 = 6 [Control Method Selection = AOLV/PM], the default setting is o1-03 = 1 [0.01% (100% = E1-04)].</p>	0.00 Hz (0.00 - 590.00 Hz)	586
d1-16 (0291) RUN	Reference 16	<p>V/f OLV OLV/PM AOLV/PM EZOLV</p> <p>Sets the frequency reference in the units from o1-03 [Frequency Display Unit Selection].</p> <p>Note: When A1-02 = 6 [Control Method Selection = AOLV/PM], the default setting is o1-03 = 1 [0.01% (100% = E1-04)].</p>	0.00 Hz (0.00 - 590.00 Hz)	587
d1-17 (0292) RUN	Jog Reference	<p>V/f OLV OLV/PM AOLV/PM EZOLV</p> <p>Sets the Jog frequency reference in the units from o1-03 [Frequency Display Unit Selection]. Set H1-xx = 6 [MFDI Function Select = Jog Reference Selection] to use the Jog frequency reference.</p> <p>Note: When A1-02 = 6 [Control Method Selection = AOLV/PM], the default setting is o1-03 = 1 [0.01% (100% = E1-04)].</p>	6.00 Hz (0.00 - 590.00 Hz)	587

◆ d2: Reference Limits

No. (Hex.)	Name	Description	Default (Range)	Ref.
d2-01 (0289)	Frequency Reference Upper Limit	<p>V/f OLV OLV/PM AOLV/PM EZOLV</p> <p>Sets maximum limit for all frequency references. The maximum output frequency is 100%.</p> <p>Note: Parameter A1-02 [Control Method Selection] selects which parameter is the maximum output frequency. • A1-02 ≠ 8 [EZOLV]: E1-04 [Maximum Output Frequency] • A1-02 = 8: E9-02 [Motor Max Revolutions]</p>	100.0% (0.0 - 110.0%)	587
d2-02 (028A)	Frequency Reference Lower Limit	<p>V/f OLV OLV/PM AOLV/PM EZOLV</p> <p>Sets minimum limit for all frequency references. The maximum output frequency is 100%.</p> <p>Note: Parameter A1-02 [Control Method Selection] selects which parameter is the maximum output frequency. • A1-02 ≠ 8 [EZOLV]: E1-04 [Maximum Output Frequency] • A1-02 = 8: E9-02 [Motor Max Revolutions]</p>	0.0% (0.0 - 110.0%)	588
d2-03 (0293)	Analog Frequency Ref Lower Limit	<p>V/f OLV OLV/PM AOLV/PM EZOLV</p> <p>Sets the lower limit for the master frequency reference (the first frequency of the multi-step speed reference) as a percentage. The maximum output frequency is 100%.</p> <p>Note: Parameter A1-02 [Control Method Selection] selects which parameter is the maximum output frequency. • A1-02 ≠ 8: E1-04 [Maximum Output Frequency] • A1-02 = 8: E9-02 [Maximum Speed]</p>	0.0% (0.0 - 110.0%)	588

◆ d3: Jump Frequency

No. (Hex.)	Name	Description	Default (Range)	Ref.
d3-01 (0294)	Jump Frequency 1	V/f OLV OLV/PM AOLV/PM EZOLV Sets the median value of the frequency band that the drive will avoid.	0.0 Hz (Determined by A1-02)	589
d3-02 (0295)	Jump Frequency 2	V/f OLV OLV/PM AOLV/PM EZOLV Sets the median value of the frequency band that the drive will avoid.	0.0 Hz (Determined by A1-02)	589
d3-03 (0296)	Jump Frequency 3	V/f OLV OLV/PM AOLV/PM EZOLV Sets the median value of the frequency band that the drive will avoid.	0.0 Hz (Determined by A1-02)	589
d3-04 (0297)	Jump Frequency Width	V/f OLV OLV/PM AOLV/PM EZOLV Sets the width of the frequency band that the drive will avoid.	1.0 Hz (Determined by A1-02)	589

◆ d4: Frequency Ref Up/Down & Hold

No. (Hex.)	Name	Description	Default (Range)	Ref.
d4-01 (0298)	Freq Reference Hold Selection	V/f OLV OLV/PM AOLV/PM EZOLV Sets the function that saves the frequency reference or the frequency bias (Up/Down 2) after a Stop command or when de-energizing the drive. Set <i>H1-xx</i> [<i>MFDI Function Selection</i>] to one of these values to enable this parameter: <ul style="list-style-type: none"> <i>A</i> [<i>Accel/Decel Ramp Hold</i>] <i>10/11</i> [<i>Up/Down Command</i>] <i>75/76</i> [<i>Up/Down 2 Command</i>] 0 : Disabled 1 : Enabled	0 (0, 1)	589
d4-03 (02AA) RUN	Up/Down 2 Bias Step Frequency	V/f OLV OLV/PM AOLV/PM EZOLV Sets the bias that the Up/Down 2 function adds to or subtracts from the frequency reference.	0.00 Hz (0.00 - 99.99 Hz)	591
d4-04 (02AB) RUN	Up/Down 2 Ramp Selection	V/f OLV OLV/PM AOLV/PM EZOLV Sets the acceleration and deceleration times for the Up/Down 2 function to apply the bias to the frequency reference. 0 : Use Selected Accel/Decel Time 1 : Use Accel/Decel Time 4	0 (0, 1)	592
d4-05 (02AC) RUN	Up/Down 2 Bias Mode Selection	V/f OLV OLV/PM AOLV/PM EZOLV Sets the function that saves the bias value to the drive when you open or close the two <i>Up/Down 2 Commands</i> [<i>H1-xx = 75, 76</i>]. Set <i>d4-03</i> [<i>Up/Down 2 Bias Step Frequency</i>] = 0.00 before you set this parameter. 0 : Hold when Neither Up/Down Closed 1 : Reset when Neither / Both Closed	0 (0, 1)	592
d4-06 (02AD)	Frequency Ref Bias (Up/Down 2)	V/f OLV OLV/PM AOLV/PM EZOLV Saves the bias value from the Up/Down 2 Command where the Maximum Output Frequency is 100%. Note: Parameter <i>A1-02</i> [<i>Control Method Selection</i>] selects which parameter is the maximum output frequency. <ul style="list-style-type: none"> <i>A1-02</i> ≠ 8 [<i>EZOLV</i>]: <i>E1-04</i> [<i>Maximum Output Frequency</i>] <i>A1-02</i> = 8: <i>E9-02</i> [<i>Maximum Speed</i>] 	0.0% (-99.9 - +100.0%)	593
d4-07 (02AE) RUN	Analog Freq Ref Fluctuate Limit	V/f OLV OLV/PM AOLV/PM EZOLV If the frequency reference changes for more than the level set to this parameter, then the bias value will be held. The value is set as a percentage of the Maximum Output Frequency. Note: Parameter <i>A1-02</i> [<i>Control Method Selection</i>] selects which parameter is the maximum output frequency. <ul style="list-style-type: none"> <i>A1-02</i> ≠ 8 [<i>EZOLV</i>]: <i>E1-04</i> [<i>Maximum Output Frequency</i>] <i>A1-02</i> = 8: <i>E9-02</i> [<i>Maximum Speed</i>] 	1.0% (0.1 - 100.0%)	593
d4-08 (02AF) RUN	Up/Down 2 Bias Upper Limit	V/f OLV OLV/PM AOLV/PM EZOLV Sets the upper limit of the Up/Down 2 bias as a percentage of the Maximum Output Frequency. Note: Parameter <i>A1-02</i> [<i>Control Method Selection</i>] selects which parameter is the maximum output frequency. <ul style="list-style-type: none"> <i>A1-02</i> ≠ 8 [<i>EZOLV</i>]: <i>E1-04</i> [<i>Maximum Output Frequency</i>] <i>A1-02</i> = 8: <i>E9-02</i> [<i>Maximum Speed</i>] 	100.0% (0.0 - 100.0%)	593

11.7 d: Reference Settings

No. (Hex.)	Name	Description	Default (Range)	Ref.
d4-09 (02B0) RUN	Up/Down 2 Bias Lower Limit	<p>V/f OLV OLV/PM AOLV/PM EZOLV</p> <p>Sets the lower limit of the Up/Down 2 bias as a percentage of the Maximum Output Frequency.</p> <p>Note: Parameter <i>A1-02</i> [Control Method Selection] selects which parameter is the maximum output frequency. • <i>A1-02</i> ≠ 8 [EZOLV]: <i>E1-04</i> [Maximum Output Frequency] • <i>A1-02</i> = 8: <i>E9-02</i> [Maximum Speed]</p>	0.0% (-99.9 - 0.0%)	594
d4-10 (02B6)	Up/Down Freq Lower Limit Select	<p>V/f OLV OLV/PM AOLV/PM EZOLV</p> <p>Sets the lower frequency limit for the Up/Down function.</p> <p>0 : Greater of d2-02 or Analog 1 : d2-02</p>	0 (0, 1)	594

◆ d6: Field Weakening /Forcing

No. (Hex.)	Name	Description	Default (Range)	Ref.
d6-01 (02A0)	Field Weakening Level	<p>V/f OLV OLV/PM AOLV/PM EZOLV</p> <p>Sets the drive output voltage as a percentage of <i>E1-05</i> [Maximum Output Voltage] when <i>H1-xx</i> = 63 [Field Weakening] is activated.</p>	80% (0 - 100%)	595
d6-02 (02A1)	Field Weakening Frequency Limit	<p>V/f OLV OLV/PM AOLV/PM EZOLV</p> <p>Sets the minimum output frequency to start field weakening.</p>	0.0 Hz (0.0 - 590.0 Hz)	595
d6-03 (02A2)	Field Forcing Selection	<p>V/f OLV OLV/PM AOLV/PM EZOLV</p> <p>Sets the field forcing function.</p> <p>0 : Disabled 1 : Enabled</p>	0 (0, 1)	595
d6-06 (02A5)	Field Forcing Limit	<p>V/f OLV OLV/PM AOLV/PM EZOLV</p> <p>Sets the limit value for field forcing to increase the motor excitation current reference as a percentage of <i>E2-03</i> [Motor No-Load Current]. Usually it is not necessary to change this setting.</p>	400% (100 - 400%)	595

◆ d7: Offset Frequency

No. (Hex.)	Name	Description	Default (Range)	Ref.
d7-01 (02B2) RUN	Offset Frequency 1	<p>V/f OLV OLV/PM AOLV/PM EZOLV</p> <p>Uses <i>H1-xx</i> = 44 [MFDI Function Select = Add Offset Frequency 1 (d7-01)] as a percentage of the Maximum Output Frequency to add or subtract the set frequency to/from the frequency reference.</p> <p>Note: Parameter <i>A1-02</i> [Control Method Selection] selects which parameter is the maximum output frequency. • <i>A1-02</i> ≠ 8 [EZOLV]: <i>E1-04</i> [Maximum Output Frequency] • <i>A1-02</i> = 8: <i>E9-02</i> [Maximum Speed]</p>	0.0% (-100.0 - +100.0%)	596
d7-02 (02B3) RUN	Offset Frequency 2	<p>V/f OLV OLV/PM AOLV/PM EZOLV</p> <p>Uses <i>H1-xx</i> = 45 [MFDI Function Select = Add Offset Frequency 2 (d7-02)] as a percentage of the Maximum Output Frequency to add or subtract the set frequency to/from the frequency reference.</p> <p>Note: Parameter <i>A1-02</i> [Control Method Selection] selects which parameter is the maximum output frequency. • <i>A1-02</i> ≠ 8 [EZOLV]: <i>E1-04</i> [Maximum Output Frequency] • <i>A1-02</i> = 8: <i>E9-02</i> [Maximum Speed]</p>	0.0% (-100.0 - +100.0%)	596
d7-03 (02B4) RUN	Offset Frequency 3	<p>V/f OLV OLV/PM AOLV/PM EZOLV</p> <p>Uses <i>H1-xx</i> = 46 [MFDI Function Select = Add Offset Frequency 3 (d7-03)] as a percentage of the Maximum Output Frequency to add or subtract the set frequency to/from the frequency reference.</p> <p>Note: Parameter <i>A1-02</i> [Control Method Selection] selects which parameter is the maximum output frequency. • <i>A1-02</i> ≠ 8 [EZOLV]: <i>E1-04</i> [Maximum Output Frequency] • <i>A1-02</i> = 8: <i>E9-02</i> [Maximum Speed]</p>	0.0% (-100.0 - +100.0%)	596

11.8 E: Motor Parameters

◆ E1: V/f Pattern for Motor 1

No. (Hex.)	Name	Description	Default (Range)	Ref.
E1-01 (0300)	Input AC Supply Voltage	<p>V/f OLV OLV/PM AOLV/PM EZOLV</p> <p>Sets the drive input voltage.</p> <p>NOTICE: Damage to Equipment. Set E1-01 [Input AC Supply Voltage] to align with the drive input voltage (not motor voltage). If this parameter is incorrect, the protective functions of the drive will not operate correctly and it can cause damage to the drive.</p>	200 V Class: 240 V, 400 V Class: 480 V (200 V Class: 155 to 255 V, 400 V Class: 310 to 510 V)	598
E1-03 (0302)	V/f Pattern Selection	<p>V/f OLV OLV/PM AOLV/PM EZOLV</p> <p>Sets the V/f pattern for the drive and motor. You can use one of the preset patterns or you can make a custom pattern.</p> <p>0 : Const Trq, 50Hz base, 50Hz max 1 : Const Trq, 60Hz base, 60Hz max 2 : Const Trq, 50Hz base, 60Hz max 3 : Const Trq, 60 Hz base, 72 Hz max 4 : VT, 50Hz, 65% Vmid reduction 5 : VT, 50Hz, 50% Vmid reduction 6 : VT, 60 Hz, 65% Vmid reduction 7 : VT, 60 Hz, 50% Vmid reduction 8 : High Trq, 50Hz, 25% Vmin Boost 9 : High Trq, 50Hz, 65% Vmin Boost A : High Trq, 60 Hz, 25% Vmin Boost B : High Trq, 60 Hz, 65% Vmin Boost C : Const Trq, 60 Hz base, 90 Hz max D : Const Trq, 60 Hz base, 120 Hz max E : Const Trq, 60 Hz base, 180 Hz max F : V/f Pattern Selection</p> <p>Note:</p> <ul style="list-style-type: none"> When A1-02 = 2 [Control Method Selection = OLV], settings 0 to E are not available. Set the correct V/f pattern for the application and operation area. An incorrect V/f pattern can decrease motor torque and increase current from overexcitation. 	F (Determined by A1-02)	598
E1-04 (0303)	Maximum Output Frequency	<p>V/f OLV OLV/PM AOLV/PM EZOLV</p> <p>Sets the maximum output frequency for the V/f pattern.</p>	Determined by A1-02 and E5-01 (Determined by A1-02 and E5-01)	603
E1-05 (0304)	Maximum Output Voltage	<p>V/f OLV OLV/PM AOLV/PM EZOLV</p> <p>Sets the maximum output voltage for the V/f pattern.</p>	200 V Class: 230.0 V, 400 V: 460.0 V (200 V Class: 0.0 - 255.0 V, 400 V Class: 0.0 - 510.0 V)	604
E1-06 (0305)	Base Frequency	<p>V/f OLV OLV/PM AOLV/PM EZOLV</p> <p>Sets the base frequency for the V/f pattern.</p>	Determined by A1-02 and E5-01 (0.0 - E1-04)	604
E1-07 (0306)	Mid Point A Frequency	<p>V/f OLV OLV/PM AOLV/PM EZOLV</p> <p>Sets a middle output frequency for the V/f pattern.</p>	Determined by A1-02 (0.0 - E1-04)	604
E1-08 (0307)	Mid Point A Voltage	<p>V/f OLV OLV/PM AOLV/PM EZOLV</p> <p>Sets a middle output voltage for the V/f pattern.</p>	Determined by A1-02, C6-01 and o2-04 (200 V Class: 0.0 - 255.0 V, 400 V Class: 0.0 - 510.0 V)	604
E1-09 (0308)	Minimum Output Frequency	<p>V/f OLV OLV/PM AOLV/PM EZOLV</p> <p>Sets the minimum output frequency for the V/f pattern.</p>	Determined by A1-02 and E5-01 (Determined by A1-02, E1-04, and E5-01)	604
E1-10 (0309)	Minimum Output Voltage	<p>V/f OLV OLV/PM AOLV/PM EZOLV</p> <p>Sets the minimum output voltage for the V/f pattern.</p>	Determined by A1-02 (200 V Class: 0.0 to 255.0 V, 400 V Class: 0.0 to 510.0 V)	604
E1-11 (030A) Expert	Mid Point B Frequency	<p>V/f OLV OLV/PM AOLV/PM EZOLV</p> <p>Sets a middle output frequency for the V/f pattern.</p>	0.0 Hz (0.0 - E1-04)	604

11.8 E: Motor Parameters

No. (Hex.)	Name	Description	Default (Range)	Ref.
E1-12 (030B) Expert	Mid Point B Voltage	<input type="checkbox"/> V/f <input checked="" type="checkbox"/> OLV <input type="checkbox"/> OLV/PM <input type="checkbox"/> AOLV/PM <input type="checkbox"/> EZOLV Sets a middle point voltage for the V/f pattern.	0.0 V (200 V Class: 0.0 to 255.0 V, 400 V Class: 0.0 to 510.0 V)	605
E1-13 (030C) Expert	Base Voltage	<input type="checkbox"/> V/f <input checked="" type="checkbox"/> OLV <input type="checkbox"/> OLV/PM <input type="checkbox"/> AOLV/PM <input type="checkbox"/> EZOLV Sets the base voltage for the V/f pattern.	0.0 V (200 V Class: 0.0 - 255.0 V, 400 V Class: 0.0 - 510.0 V)	605

◆ E2: Motor Parameters

No. (Hex.)	Name	Description	Default (Range)	Ref.
E2-01 (030E)	Motor Rated Current (FLA)	<input type="checkbox"/> V/f <input checked="" type="checkbox"/> OLV <input type="checkbox"/> OLV/PM <input type="checkbox"/> AOLV/PM <input type="checkbox"/> EZOLV Sets the motor rated current in amps.	Determined by o2-04, C6-01 (10% to 200% of the drive rated current)	605
E2-02 (030F)	Motor Rated Slip	<input type="checkbox"/> V/f <input checked="" type="checkbox"/> OLV <input type="checkbox"/> OLV/PM <input type="checkbox"/> AOLV/PM <input type="checkbox"/> EZOLV Sets motor rated slip.	Determined by o2-04, C6-01 (0.000 - 20.000 Hz)	606
E2-03 (0310)	Motor No-Load Current	<input type="checkbox"/> V/f <input checked="" type="checkbox"/> OLV <input type="checkbox"/> OLV/PM <input type="checkbox"/> AOLV/PM <input type="checkbox"/> EZOLV Sets the no-load current for the motor in amps when operating at the rated frequency and the no-load voltage.	Determined by o2-04, C6-01 (0 to E2-01)	606
E2-04 (0311)	Motor Pole Count	<input type="checkbox"/> V/f <input checked="" type="checkbox"/> OLV <input type="checkbox"/> OLV/PM <input type="checkbox"/> AOLV/PM <input type="checkbox"/> EZOLV Sets the number of motor poles. Note: • When A1-02 = 0 [Control Method Selection = V/f], the maximum value is 120. • When A1-02 = 2 [OLV], the maximum value is 48.	4 (2 - 120)	606
E2-05 (0312)	Motor Line-to-Line Resistance	<input type="checkbox"/> V/f <input checked="" type="checkbox"/> OLV <input type="checkbox"/> OLV/PM <input type="checkbox"/> AOLV/PM <input type="checkbox"/> EZOLV Sets the line-to-line resistance for the motor stator windings.	Determined by o2-04, C6-01 (0.000 - 65.000 Ω)	606
E2-06 (0313)	Motor Leakage Inductance	<input type="checkbox"/> V/f <input checked="" type="checkbox"/> OLV <input type="checkbox"/> OLV/PM <input type="checkbox"/> AOLV/PM <input type="checkbox"/> EZOLV Sets the voltage drop from motor leakage inductance when the motor is operating at the rated frequency and rated current. This value is a percentage of Motor Rated Voltage.	Determined by o2-04, C6-01 (0.0 - 60.0%)	607
E2-07 (0314)	Motor Saturation Coefficient 1	<input type="checkbox"/> V/f <input checked="" type="checkbox"/> OLV <input type="checkbox"/> OLV/PM <input type="checkbox"/> AOLV/PM <input type="checkbox"/> EZOLV Sets the motor iron-core saturation coefficient at 50% of the magnetic flux.	0.50 (0.00 - 0.50)	607
E2-08 (0315)	Motor Saturation Coefficient 2	<input type="checkbox"/> V/f <input checked="" type="checkbox"/> OLV <input type="checkbox"/> OLV/PM <input type="checkbox"/> AOLV/PM <input type="checkbox"/> EZOLV Sets the motor iron-core saturation coefficient at 75% of the magnetic flux.	0.75 (E2-07 - 0.75)	607
E2-09 (0316) Expert	Motor Mechanical Loss	<input type="checkbox"/> V/f <input checked="" type="checkbox"/> OLV <input type="checkbox"/> OLV/PM <input type="checkbox"/> AOLV/PM <input type="checkbox"/> EZOLV Sets the mechanical loss of the motor. It is set as a percentage of E2-11 [Motor Rated Power]. Usually it is not necessary to change this setting.	0.0% (0.0 - 10.0%)	607
E2-10 (0317)	Motor Iron Loss	<input type="checkbox"/> V/f <input checked="" type="checkbox"/> OLV <input type="checkbox"/> OLV/PM <input type="checkbox"/> AOLV/PM <input type="checkbox"/> EZOLV Sets the motor iron loss.	Determined by o2-04, C6-01 (0 - 65535 W)	607
E2-11 (0318)	Motor Rated Power	<input type="checkbox"/> V/f <input checked="" type="checkbox"/> OLV <input type="checkbox"/> OLV/PM <input type="checkbox"/> AOLV/PM <input type="checkbox"/> EZOLV Sets the motor rated output in the units from o1-58 [Motor Power Unit Selection].	Determined by o2-04, C6-01 (0.00 - 650.00)	608

◆ E3: V/f Pattern for Motor 2

No. (Hex.)	Name	Description	Default (Range)	Ref.
E3-01 (0319)	Motor 2 Control Mode Selection	<input type="checkbox"/> V/f <input checked="" type="checkbox"/> OLV <input type="checkbox"/> OLV/PM <input type="checkbox"/> AOLV/PM <input type="checkbox"/> EZOLV Sets the control method for motor 2. Note: When you change this setting, the drive will set all parameters that are dependent on this parameter to their default settings. 0 : V/f Control 2 : Open Loop Vector	0 (0, 2)	608
E3-04 (031A)	Motor 2 Maximum Output Frequency	<input type="checkbox"/> V/f <input checked="" type="checkbox"/> OLV <input type="checkbox"/> OLV/PM <input type="checkbox"/> AOLV/PM <input type="checkbox"/> EZOLV Set the maximum output frequency for the motor 2 V/f pattern.	Determined by E3-01 (40.0 - 590.0 Hz)	609

No. (Hex.)	Name	Description	Default (Range)	Ref.
E3-05 (031B)	Motor 2 Maximum Output Voltage	<input type="checkbox"/> V/f <input checked="" type="checkbox"/> OLV <input type="checkbox"/> OLV/PM <input type="checkbox"/> AOLV/PM <input type="checkbox"/> EZOLV Sets the maximum output voltage for the motor 2 V/f pattern.	Determined by E3-01 (200 V Class: 0.0 - 255.0 V, 400 V Class: 0.0 - 510.0 V)	609
E3-06 (031C)	Motor 2 Base Frequency	<input type="checkbox"/> V/f <input checked="" type="checkbox"/> OLV <input type="checkbox"/> OLV/PM <input type="checkbox"/> AOLV/PM <input type="checkbox"/> EZOLV Sets the base frequency for the motor 2 V/f pattern.	Determined by E3-01 (0.0 - E3-04)	609
E3-07 (031D)	Motor 2 Mid Point A Frequency	<input type="checkbox"/> V/f <input checked="" type="checkbox"/> OLV <input type="checkbox"/> OLV/PM <input type="checkbox"/> AOLV/PM <input type="checkbox"/> EZOLV Sets a middle output frequency for the motor 2 V/f pattern.	Determined by E3-01 (0.0 - E3-04)	609
E3-08 (031E)	Motor 2 Mid Point A Voltage	<input type="checkbox"/> V/f <input checked="" type="checkbox"/> OLV <input type="checkbox"/> OLV/PM <input type="checkbox"/> AOLV/PM <input type="checkbox"/> EZOLV Sets a middle output voltage for the motor 2 V/f pattern.	Determined by E3-01 (200 V Class: 0.0 - 255.0 V, 400 V Class: 0.0 - 510.0 V)	609
E3-09 (031F)	Motor 2 Minimum Output Frequency	<input type="checkbox"/> V/f <input checked="" type="checkbox"/> OLV <input type="checkbox"/> OLV/PM <input type="checkbox"/> AOLV/PM <input type="checkbox"/> EZOLV Sets the minimum output frequency for the motor 2 V/f pattern.	Determined by E3-01 (0.0 - E3-04)	609
E3-10 (0320)	Motor 2 Minimum Output Voltage	<input type="checkbox"/> V/f <input checked="" type="checkbox"/> OLV <input type="checkbox"/> OLV/PM <input type="checkbox"/> AOLV/PM <input type="checkbox"/> EZOLV Sets the minimum output voltage for the motor 2 V/f pattern.	Determined by E3-01 (200 V Class: 0.0 - 255.0 V, 400 V Class: 0.0 - 510.0 V)	609
E3-11 (0345) Expert	Motor 2 Mid Point B Frequency	<input type="checkbox"/> V/f <input checked="" type="checkbox"/> OLV <input type="checkbox"/> OLV/PM <input type="checkbox"/> AOLV/PM <input type="checkbox"/> EZOLV Sets a middle output frequency for the motor 2 V/f pattern. Set this parameter to adjust the V/f pattern for the constant output range. Usually it is not necessary to change this parameter.	0.0 Hz (0.0 - E3-04)	609
E3-12 (0346) Expert	Motor 2 Mid Point B Voltage	<input type="checkbox"/> V/f <input checked="" type="checkbox"/> OLV <input type="checkbox"/> OLV/PM <input type="checkbox"/> AOLV/PM <input type="checkbox"/> EZOLV Sets a middle output voltage for the motor 2 V/f pattern. Set this parameter to adjust the V/f pattern for the constant output range. Usually it is not necessary to change this parameter.	0.0 V (200 V Class: 0.0 to 255.0 V, 400 V Class: 0.0 to 510.0 V)	610
E3-13 (0347) Expert	Motor 2 Base Voltage	<input type="checkbox"/> V/f <input checked="" type="checkbox"/> OLV <input type="checkbox"/> OLV/PM <input type="checkbox"/> AOLV/PM <input type="checkbox"/> EZOLV Sets the base voltage for the motor 2 V/f pattern. Set this parameter to adjust the V/f pattern for the constant output range. Usually it is not necessary to change this parameter.	0.0 V (200 V Class: 0.0 to 255.0 V, 400 V Class: 0.0 to 510.0 V)	610

◆ E4: Motor 2 Parameters

No. (Hex.)	Name	Description	Default (Range)	Ref.
E4-01 (0321)	Motor 2 Rated Current	<input type="checkbox"/> V/f <input checked="" type="checkbox"/> OLV <input type="checkbox"/> OLV/PM <input type="checkbox"/> AOLV/PM <input type="checkbox"/> EZOLV Sets the motor rated current for motor 2 in amps.	Determined by o2-04, C6-01 (10% to 200% of the drive rated current)	610
E4-02 (0322)	Motor 2 Rated Slip	<input type="checkbox"/> V/f <input checked="" type="checkbox"/> OLV <input type="checkbox"/> OLV/PM <input type="checkbox"/> AOLV/PM <input type="checkbox"/> EZOLV Sets the motor rated slip for motor 2.	Determined by o2-04, C6-01 (0.000 - 20.000 Hz)	610
E4-03 (0323)	Motor 2 Rated No-Load Current	<input type="checkbox"/> V/f <input checked="" type="checkbox"/> OLV <input type="checkbox"/> OLV/PM <input type="checkbox"/> AOLV/PM <input type="checkbox"/> EZOLV Sets the no-load current for motor 2 in amps when operating at the rated frequency and the no-load voltage.	Determined by o2-04, C6-01 (0 to E4-01)	611
E4-04 (0324)	Motor 2 Motor Poles	<input type="checkbox"/> V/f <input checked="" type="checkbox"/> OLV <input type="checkbox"/> OLV/PM <input type="checkbox"/> AOLV/PM <input type="checkbox"/> EZOLV Sets the number of poles for motor 2.	4 (2 - 120)	611
E4-05 (0325)	Motor 2 Line-to-Line Resistance	<input type="checkbox"/> V/f <input checked="" type="checkbox"/> OLV <input type="checkbox"/> OLV/PM <input type="checkbox"/> AOLV/PM <input type="checkbox"/> EZOLV Sets the line-to-line resistance for the motor 2 stator windings.	Determined by o2-04, C6-01 (0.000 - 65.000 Ω)	611
E4-06 (0326)	Motor 2 Leakage Inductance	<input type="checkbox"/> V/f <input checked="" type="checkbox"/> OLV <input type="checkbox"/> OLV/PM <input type="checkbox"/> AOLV/PM <input type="checkbox"/> EZOLV Sets the voltage drop from motor 2 leakage inductance as a percentage of Motor Rated Voltage when motor 2 operates at the rated frequency and rated current.	Determined by o2-04, C6-01 (0.0 - 60.0%)	611
E4-07 (0343)	Motor 2 Saturation Coefficient 1	<input type="checkbox"/> V/f <input checked="" type="checkbox"/> OLV <input type="checkbox"/> OLV/PM <input type="checkbox"/> AOLV/PM <input type="checkbox"/> EZOLV Sets the motor 2 iron-core saturation coefficient at 50% of the magnetic flux.	0.50 (0.00 - 0.50)	612
E4-08 (0344)	Motor 2 Saturation Coefficient 2	<input type="checkbox"/> V/f <input checked="" type="checkbox"/> OLV <input type="checkbox"/> OLV/PM <input type="checkbox"/> AOLV/PM <input type="checkbox"/> EZOLV Sets the motor 2 iron-core saturation coefficient at 75% of the magnetic flux.	0.75 (E4-07 - 0.75)	612
E4-09 (033F) Expert	Motor 2 Mechanical Loss	<input type="checkbox"/> V/f <input checked="" type="checkbox"/> OLV <input type="checkbox"/> OLV/PM <input type="checkbox"/> AOLV/PM <input type="checkbox"/> EZOLV Sets the mechanical loss of motor 2. It is set as a percentage of E4-11 [Motor 2 Rated Power]. Usually it is not necessary to change this setting.	0.0% (0.0 - 10.0%)	612

11.8 E: Motor Parameters

No. (Hex.)	Name	Description	Default (Range)	Ref.
E4-10 (0340)	Motor 2 Iron Loss	<input type="checkbox"/> V/f <input type="checkbox"/> OLV <input checked="" type="checkbox"/> OLV/PM <input type="checkbox"/> AOLV/PM <input type="checkbox"/> EZOLV Sets the motor iron loss for motor 2.	Determined by o2-04, C6-01 (0 - 65535 W)	612
E4-11 (0327)	Motor 2 Rated Power	<input type="checkbox"/> V/f <input type="checkbox"/> OLV <input checked="" type="checkbox"/> OLV/PM <input type="checkbox"/> AOLV/PM <input type="checkbox"/> EZOLV Sets the motor rated power in the units from o1-58 [Motor Power Unit Selection].	Determined by o2-04, C6-01 (0.00 - 650.00 HP)	612

◆ E5: PM Motor Settings

No. (Hex.)	Name	Description	Default (Range)	Ref.
E5-01 (0329)	PM Motor Code Selection	<input type="checkbox"/> V/f <input type="checkbox"/> OLV <input checked="" type="checkbox"/> OLV/PM <input type="checkbox"/> AOLV/PM <input type="checkbox"/> EZOLV Sets the motor code for Yaskawa PM motors. The drive uses the motor code to automatically set some parameters to their correct settings.	FFFF (0000 - FFFF)	613
E5-02 (032A)	PM Motor Rated Power	<input type="checkbox"/> V/f <input type="checkbox"/> OLV <input checked="" type="checkbox"/> OLV/PM <input type="checkbox"/> AOLV/PM <input type="checkbox"/> EZOLV Sets the PM motor rated output in the units from o1-58 [Motor Power Unit Selection].	Determined by o2-04, C6-01 (0.10 - 30.00 kW)	613
E5-03 (032B)	Motor Rated Current (FLA)	<input type="checkbox"/> V/f <input type="checkbox"/> OLV <input checked="" type="checkbox"/> OLV/PM <input type="checkbox"/> AOLV/PM <input type="checkbox"/> EZOLV Sets the PM motor rated current (FLA).	Determined by o2-04, C6-01 (10% to 200% of the drive rated current)	613
E5-04 (032C)	PM Motor Pole Count	<input type="checkbox"/> V/f <input type="checkbox"/> OLV <input checked="" type="checkbox"/> OLV/PM <input type="checkbox"/> AOLV/PM <input type="checkbox"/> EZOLV Sets the number of PM motor poles.	4 (2 - 120)	613
E5-05 (032D)	PM Motor Resistance (ohms/phase)	<input type="checkbox"/> V/f <input type="checkbox"/> OLV <input checked="" type="checkbox"/> OLV/PM <input type="checkbox"/> AOLV/PM <input type="checkbox"/> EZOLV Sets the resistance per phase of a PM motor. Set 50% of the line-to-line resistance.	0.100 Ω (0.000 - 65.000 Ω)	614
E5-06 (032E)	PM d-axis Inductance (mH/phase)	<input type="checkbox"/> V/f <input type="checkbox"/> OLV <input checked="" type="checkbox"/> OLV/PM <input type="checkbox"/> AOLV/PM <input type="checkbox"/> EZOLV Sets the PM motor d-axis inductance.	1.00 mH (0.00 - 300.00 mH)	614
E5-07 (032F)	PM q-axis Inductance (mH/phase)	<input type="checkbox"/> V/f <input type="checkbox"/> OLV <input checked="" type="checkbox"/> OLV/PM <input type="checkbox"/> AOLV/PM <input type="checkbox"/> EZOLV Sets the PM motor q-axis inductance.	1.00 mH (0.00 - 600.00 mH)	614
E5-09 (0331)	PM Back-EMF Vpeak (mV/(rad/s))	<input type="checkbox"/> V/f <input type="checkbox"/> OLV <input checked="" type="checkbox"/> OLV/PM <input type="checkbox"/> AOLV/PM <input type="checkbox"/> EZOLV Sets the peak value of PM motor induced voltage.	0.0 mV/(rad/sec) (0.0 - 2000.0 mV/(rad/s))	614
E5-24 (0353)	PM Back-EMF L-L Vrms (mV/rpm)	<input type="checkbox"/> V/f <input type="checkbox"/> OLV <input checked="" type="checkbox"/> OLV/PM <input type="checkbox"/> AOLV/PM <input type="checkbox"/> EZOLV Sets the RMS value for PM motor line voltage.	200 V Class: 100.0 mV/min ⁻¹ 400 V Class: 200.0 mV/min ⁻¹ (0.0 - 6500.0 mV/min ⁻¹)	615
E5-25 (035E) Expert	Polarity Estimation Timeout	<input type="checkbox"/> V/f <input type="checkbox"/> OLV <input checked="" type="checkbox"/> OLV/PM <input type="checkbox"/> AOLV/PM <input type="checkbox"/> EZOLV Sets the function that switches polarity for initial polarity estimation. Usually it is not necessary to change this setting. 0 : Disabled 1 : Enabled	0 (0, 1)	615

◆ E9: Motor Setting

No. (Hex.)	Name	Description	Default (Range)	Ref.
E9-01 (11E4)	Motor Type Selection	<input type="checkbox"/> V/f <input type="checkbox"/> OLV <input type="checkbox"/> OLV/PM <input type="checkbox"/> AOLV/PM <input checked="" type="checkbox"/> EZOLV Sets the type of motor. 0 : Induction (IM) 1 : Permanent Magnet (PM) 2 : Synchronous Reluctance (SynRM)	0 (0 - 2)	615
E9-02 (11E5)	Maximum Speed	<input type="checkbox"/> V/f <input type="checkbox"/> OLV <input type="checkbox"/> OLV/PM <input type="checkbox"/> AOLV/PM <input checked="" type="checkbox"/> EZOLV Sets the maximum speed of the motor.	Determined by E9-01 (40.0 - 120.0 Hz)	615
E9-03 (11E6)	Rated Speed	<input type="checkbox"/> V/f <input type="checkbox"/> OLV <input type="checkbox"/> OLV/PM <input type="checkbox"/> AOLV/PM <input checked="" type="checkbox"/> EZOLV Sets the rated rotation speed of the motor.	Determined by E9-01 (100 - 7200 min ⁻¹)	616
E9-04 (11E7)	Base Frequency	<input type="checkbox"/> V/f <input type="checkbox"/> OLV <input type="checkbox"/> OLV/PM <input type="checkbox"/> AOLV/PM <input checked="" type="checkbox"/> EZOLV Sets the rated frequency of the motor.	Determined by E9-01 (40.0 - 120.0 Hz)	616

No. (Hex.)	Name	Description	Default (Range)	Ref.
E9-05 (11E8)	Motor Rated Voltage	<input type="checkbox"/> V/f <input type="checkbox"/> OLV <input type="checkbox"/> OLV/PM <input type="checkbox"/> AOLV/PM <input checked="" type="checkbox"/> EZOLV Sets the rated voltage of the motor.	200 V Class: 230.0 V, 400 V Class: 460.0 V (200 V Class: 0.0 - 255.0 V, 400 V Class: 0.0 - 510.0 V)	616
E9-06 (11E9)	Motor Rated Current (FLA)	<input type="checkbox"/> V/f <input type="checkbox"/> OLV <input type="checkbox"/> OLV/PM <input type="checkbox"/> AOLV/PM <input checked="" type="checkbox"/> EZOLV Sets the motor rated current in amps.	Determined by E9-01 and o2-04 (10% to 200% of the drive rated current)	616
E9-07 (11EA)	Motor Rated Power	<input type="checkbox"/> V/f <input type="checkbox"/> OLV <input type="checkbox"/> OLV/PM <input type="checkbox"/> AOLV/PM <input checked="" type="checkbox"/> EZOLV Sets the motor rated output in the units from o1-58 [Motor Power Unit Selection].	Determined by E9-02 and o2-04 (0.00 - 650.00 kW)	616
E9-08 (11EB)	Motor Pole Count	<input type="checkbox"/> V/f <input type="checkbox"/> OLV <input type="checkbox"/> OLV/PM <input type="checkbox"/> AOLV/PM <input checked="" type="checkbox"/> EZOLV Sets the number of motor poles.	4 (2 to 120)	617
E9-09 (11EC)	Motor Rated Slip	<input type="checkbox"/> V/f <input type="checkbox"/> OLV <input type="checkbox"/> OLV/PM <input type="checkbox"/> AOLV/PM <input checked="" type="checkbox"/> EZOLV Sets the motor rated slip.	0.000 Hz (0.000 - 20.000 Hz)	617
E9-10 (11ED)	Motor Line-to-Line Resistance	<input type="checkbox"/> V/f <input type="checkbox"/> OLV <input type="checkbox"/> OLV/PM <input type="checkbox"/> AOLV/PM <input checked="" type="checkbox"/> EZOLV Sets the line-to-line resistance for the motor stator windings.	Determined by o2-04 (0.000 - 65.000 Ω)	617

11.9 F: Options

◆ F1: Fault Detection in PG Speed Control

No. (Hex.)	Name	Description	Default (Range)	Ref.
F1-02 (0381)	Encoder Signal Loss Detect Sel	<p>V/f OLV OLV/PM AOLV/PM EZOLV</p> <p>Sets the method to stop the motor or let the motor continue operating when the drive detects <i>PGo</i> [<i>Encoder (PG) Feedback Loss</i>].</p> <p>0 : Ramp to Stop 1 : Coast to Stop 2 : Fast Stop (Use C1-09) 3 : Alarm Only 4 : No Alarm Display</p> <p>Note: When <i>A1-02</i> = 0 [<i>Control Method Selection = V/f</i>], set <i>H6-01</i> = 3 [<i>Terminal RP Pulse Train Function = Speed Feedback (V/F Control)</i>] to enable this parameter.</p>	1 (0 - 4)	618
F1-03 (0382)	Overspeed Detection Selection	<p>V/f OLV OLV/PM AOLV/PM EZOLV</p> <p>Sets the method to stop the motor or let the motor continue to operate when the drive detects <i>oS</i> [<i>Overspeed</i>].</p> <p>0 : Ramp to Stop 1 : Coast to Stop 2 : Fast Stop (Use C1-09) 3 : Alarm Only</p> <p>Note: When <i>A1-02</i> = 0 [<i>Control Method Selection = V/f</i>], set <i>H6-01</i> = 3 [<i>Terminal RP Pulse Train Function = Speed Feedback (V/F Control)</i>] to enable this parameter.</p>	1 (0 - 3)	618
F1-04 (0383)	Speed Deviation Detection Select	<p>V/f OLV OLV/PM AOLV/PM EZOLV</p> <p>Sets the method to stop the motor or let the motor continue to operate when the drive detects <i>dEv</i> [<i>Speed Deviation</i>].</p> <p>0 : Ramp to Stop 1 : Coast to Stop 2 : Fast Stop (Use C1-09) 3 : Alarm Only</p> <p>Note: When <i>A1-02</i> = 0 [<i>Control Method Selection = V/f</i>], set <i>H6-01</i> = 3 [<i>Terminal RP Pulse Train Function = Speed Feedback (V/F Control)</i>] to enable this parameter.</p>	3 (0 - 3)	619
F1-08 (0387)	Overspeed Detection Level	<p>V/f OLV OLV/PM AOLV/PM EZOLV</p> <p>Sets the detection level of <i>oS</i> [<i>Overspeed</i>] as a percentage when the maximum output frequency is 100%.</p> <p>Note:</p> <ul style="list-style-type: none"> Parameter <i>A1-02</i> [<i>Control Method Selection</i>] selects which parameter is the maximum output frequency. <ul style="list-style-type: none"> –<i>A1-02</i> ≠ 8 [<i>EZOLV</i>]: <i>E1-04</i> [<i>Maximum Output Frequency</i>] –<i>A1-02</i> = 8: <i>E9-02</i> [<i>Motor Max Revolutions</i>] When <i>A1-02</i> = 0 [<i>Control Method Selection = V/f</i>], set <i>H6-01</i> = 3 [<i>Terminal RP Pulse Train Function = Speed Feedback (V/F Control)</i>] to enable this parameter. 	115% (0 - 120%)	619
F1-09 (0388)	Overspeed Detection Delay Time	<p>V/f OLV OLV/PM AOLV/PM EZOLV</p> <p>Sets the length of time that the speed feedback must be more than the <i>F1-08</i> level to cause <i>oS</i> [<i>Overspeed</i>].</p> <p>Note: When <i>A1-02</i> = 0 [<i>Control Method Selection = V/f</i>], set <i>H6-01</i> = 3 [<i>Terminal RP Pulse Train Function = Speed Feedback (V/F Control)</i>] to enable this parameter.</p>	Determined by A1-02 (0.0 - 2.0 s)	620
F1-10 (0389)	Speed Deviation Detection Level	<p>V/f OLV OLV/PM AOLV/PM EZOLV</p> <p>Sets the detection level of <i>dEv</i> [<i>Speed Deviation</i>] as a percentage when the maximum output frequency is 100%.</p> <p>Note:</p> <ul style="list-style-type: none"> Parameter <i>A1-02</i> [<i>Control Method Selection</i>] selects which parameter is the maximum output frequency. <ul style="list-style-type: none"> –<i>A1-02</i> ≠ 8 [<i>EZOLV</i>]: <i>E1-04</i> [<i>Maximum Output Frequency</i>] –<i>A1-02</i> = 8: <i>E9-02</i> [<i>Maximum Speed</i>] When <i>A1-02</i> = 0 [<i>Control Method Selection = V/f</i>], set <i>H6-01</i> = 3 [<i>Terminal RP Pulse Train Function = Speed Feedback (V/F Control)</i>] to enable this parameter. 	10% (0 - 50%)	620

No. (Hex.)	Name	Description	Default (Range)	Ref.
F1-11 (038A)	Speed Deviation Detect DelayTime	<p>V/f OLV OLV/PM AOLV/PM EZOLV</p> <p>Sets the length of time that the difference between the frequency reference and speed feedback must be more than the level in <i>F1-10</i> to cause <i>dEv</i> [Speed Deviation].</p> <p>Note: When <i>A1-02</i> = 0 [Control Method Selection = V/f], set <i>H6-01</i> = 3 [Terminal RP Pulse Train Function = Speed Feedback (V/F Control)] to enable this parameter.</p>	0.5 s (0.0 - 10.0 s)	620
F1-14 (038D)	Encoder Open-Circuit Detect Time	<p>V/f OLV OLV/PM AOLV/PM EZOLV</p> <p>Sets the length of time that the drive must not receive a pulse signal to cause <i>PGO</i> [Encoder (PG) Feedback Loss].</p> <p>Note: Motor speed and load conditions can cause <i>ov</i> [Overvoltage] and <i>oC</i> [Overcurrent] faults. When <i>A1-02</i> = 0 [Control Method Selection = V/f], set <i>H6-01</i> = 3 [Terminal RP Pulse Train Function = Speed Feedback (V/F Control)] to enable this parameter.</p>	2.0 s (0.0 - 10.0 s)	620

◆ F6: Communication Options

No. (Hex.)	Name	Description	Default (Range)	Ref.
F6-01 (03A2)	Communication Error Selection	<p>V/f OLV OLV/PM AOLV/PM EZOLV</p> <p>Sets the method to stop the motor or let the motor continue operating when the drive detects <i>bUS</i> [Option Communication Error].</p> <p>0 : Ramp to Stop 1 : Coast to Stop 2 : Fast Stop (Use C1-09) 3 : Alarm Only 4 : Alarm (Run at d1-04) 5 : Alarm - Ramp Stop</p>	1 (0 - 5)	626
F6-02 (03A3)	Comm External Fault (EF0) Detect	<p>V/f OLV OLV/PM AOLV/PM EZOLV</p> <p>Sets the conditions at which <i>EF0</i> [Option Card External Fault] is detected.</p> <p>0 : Always Detected 1 : Detected during RUN Only</p>	0 (0, 1)	627
F6-03 (03A4)	Comm External Fault (EF0) Select	<p>V/f OLV OLV/PM AOLV/PM EZOLV</p> <p>Sets the method to stop the motor or let the motor continue operating when the drive detects <i>EF0</i> [Option Card External Fault].</p> <p>0 : Ramp to Stop 1 : Coast to Stop 2 : Fast Stop (Use C1-09) 3 : Alarm Only</p>	1 (0 - 3)	627
F6-04 (03A5)	bUS Error Detection Time	<p>V/f OLV OLV/PM AOLV/PM EZOLV</p> <p>Sets the delay time for the drive to detect <i>bUS</i> [Option Communication Error].</p> <p>Note: When you install a CC-Link option (SI-C3) to the drive, the setting value changes to 0.0 s.</p>	2.0 s (0.0 - 12.0 s)	627
F6-06 (03A7)	Torque Reference/Limit by Comm	<p>V/f OLV OLV/PM AOLV/PM EZOLV</p> <p>Sets the function that enables and disables the torque reference and torque limit received from the communication option.</p> <p>0 : Disabled 1 : Enabled</p>	0 (0, 1)	627
F6-07 (03A8)	Multi-Step Ref @ NetRef/ComRef	<p>V/f OLV OLV/PM AOLV/PM EZOLV</p> <p>Sets the function that enables and disables the multi-step speed reference when the frequency reference source is NetRef or ComRef (communication option card or MEMOBUS/Modbus communications).</p> <p>0 : Disable Multi-Step References 1 : Enable Multi-Step References</p>	1 (0, 1)	628
F6-08 (036A)	Comm Parameter Reset @Initialize	<p>V/f OLV OLV/PM AOLV/PM EZOLV</p> <p>Sets the function to initialize <i>F6-xx</i> and <i>F7-xx</i> parameters when the drive is initialized with <i>A1-03</i> [Initialize Parameters].</p> <p>0 : No Reset - Parameters Retained 1 : Reset Back to Factory Default</p>	0 (0, 1)	628

11.9 F: Options

No. (Hex.)	Name	Description	Default (Range)	Ref.
F6-10 (03B6)	CC-Link Node Address	<p>V/f OLV OLV/PM AOLV/PM EZOLV</p> <p>Sets the node address for CC-Link communication. Restart the drive after you change the parameter setting.</p> <p>Note: Be sure to set a node address that is different than all other node addresses. Do not set this parameter to 0. Incorrect parameter settings will cause <i>AEr</i> [Station Address Setting Error] errors and the L.ERR LED on the option will come on.</p>	0 (0 - 64)	628
F6-11 (03B7)	CC-Link Communication Speed	<p>V/f OLV OLV/PM AOLV/PM EZOLV</p> <p>Sets the communication speed for CC-Link communication. Restart the drive after you change the parameter setting.</p> <p>0 : 156 kbps 1 : 625 kbps 2 : 2.5 Mbps 3 : 5 Mbps 4 : 10 Mbps</p>	0 (0 - 4)	628
F6-14 (03BB)	BUS Error Auto Reset	<p>V/f OLV OLV/PM AOLV/PM EZOLV</p> <p>Sets the automatic reset function for <i>bUS</i> [Option Communication Errors].</p> <p>0 : Disable 1 : Enabled</p>	0 (0, 1)	629
F6-15 (0B5B)	Comm. Option Parameters Reload	<p>V/f OLV OLV/PM AOLV/PM EZOLV</p> <p>Sets the update method when you change <i>F6-xx</i>, <i>F7-xx</i> [Communication Options].</p> <p>0 : Reload at Next Power Cycle 1 : Reload Now 2 : Cancel Reload Request</p>	0 (0 - 2)	629
F6-16 (0B8A)	Gateway Mode	<p>V/f OLV OLV/PM AOLV/PM EZOLV</p> <p>Sets the gateway mode operation and the number of connected slave drives.</p> <p>0 : Disabled 1 : Enabled: 1 Slave Drives 2 : Enabled: 2 Slave Drives 3 : Enabled: 3 Slave Drives 4 : Enabled: 4 Slave Drives</p>	0 (0 to 4)	629
F6-20 (036B)	MECHATROLINK Station Address	<p>V/f OLV OLV/PM AOLV/PM EZOLV</p> <p>Sets the station address for MECHATROLINK communication. Change the parameter then cycle power on the drive.</p> <p>Note:</p> <ul style="list-style-type: none"> The setting range changes if using MECHATROLINK-II or MECHATROLINK-III: –MECHATROLINK-II (SI-T3) range: 20 - 3F –MECHATROLINK-III (SI-ET3) range: 03 - EF Be sure to set a node address that is different than all other node addresses. Incorrect parameter settings will cause <i>AEr</i> [Station Address Setting Error] errors and the L.ERR LED on the option will come on. The drive detects <i>AEr</i> errors when the station address is 20 or 3F. 	0021h (MECHATROLINK-II: 0020h - 003Fh, MECHATROLINK-III: 0003h - 00EFh)	629
F6-21 (036C)	MECHATROLINK Frame Size	<p>V/f OLV OLV/PM AOLV/PM EZOLV</p> <p>Sets the frame size for MECHATROLINK communication. Restart the drive after you change the parameter setting.</p> <p>0 : 32byte (M-2) / 64byte (M-3) 1 : 17byte (M-2) / 32byte (M-3)</p>	0 (0, 1)	630
F6-22 (036D)	MECHATROLINK Link Speed	<p>V/f OLV OLV/PM AOLV/PM EZOLV</p> <p>Sets the communications speed for MECHATROLINK-II. Restart the drive after you change the parameter setting.</p> <p>Note: This parameter is only available with the MECHATROLINK-II option.</p> <p>0 : 10 Mbps 1 : 4 Mbps</p>	0 (0, 1)	630
F6-23 (036E)	MECHATROLINK Monitor Select (E)	<p>V/f OLV OLV/PM AOLV/PM EZOLV</p> <p>Sets the MEMOBUS register used for the monitor functions of INV_CTL (drive operation control command) and INV_I/O (drive I/O control command). Restart the drive after you change the parameter setting.</p>	0000h (0000h - FFFFh)	630
F6-24 (036F)	MECHATROLINK Monitor Select (F)	<p>V/f OLV OLV/PM AOLV/PM EZOLV</p> <p>Sets the MEMOBUS register used for the monitor functions of INV_CTL (drive operation control command) and INV_I/O (drive I/O control command). Restart the drive after you change the parameter setting.</p>	0000h (0000h - FFFFh)	630

No. (Hex.)	Name	Description	Default (Range)	Ref.
F6-25 (03C9)	MECHATROLINK Watchdog Error Sel	<p>V/f OLV OLV/PM AOLV/PM EZOLV</p> <p>Sets the method to stop the motor or let the motor continue operating when the drive detects <i>E5</i> [<i>MECHATROLINK Watchdog Timer Err</i>].</p> <p>0 : Ramp to Stop 1 : Coast to Stop 2 : Fast Stop (Use C1-09) 3 : Alarm Only</p>	1 (0 - 3)	630
F6-26 (03CA)	MECHATROLINK Allowable No of Err	<p>V/f OLV OLV/PM AOLV/PM EZOLV</p> <p>Sets the number of times that the option must detect a <i>bUS</i> alarm to cause a <i>bUS</i> [<i>Option Communication Error</i>].</p>	2 (2 - 10 times)	631
F6-30 (03CB)	PROFIBUS-DP Node Address	<p>V/f OLV OLV/PM AOLV/PM EZOLV</p> <p>Sets the node address for PROFIBUS-DP communication. Restart the drive after you change the parameter setting.</p> <p>Note: Be sure to set an address that is different than all other node addresses. Do not set this parameter to 0.</p>	0 (0 - 125)	631
F6-31 (03CC)	PROFIBUS-DP Clear Mode Selection	<p>V/f OLV OLV/PM AOLV/PM EZOLV</p> <p>Sets what the drive will do after it receives the Clear Mode command.</p> <p>0 : Reset 1 : Hold Previous State</p>	0 (0, 1)	631
F6-32 (03CD)	PROFIBUS-DP Data Format Select	<p>V/f OLV OLV/PM AOLV/PM EZOLV</p> <p>Sets the data format of PROFIBUS-DP communication. Restart the drive after you change the parameter setting.</p> <p>0 : PPO Type 1 : Conventional 2 : PPO (bit0) 3 : PPO (Enter) 4 : Conventional (Enter) 5 : PPO (bit0, Enter)</p>	0 (0 - 5)	631
F6-35 (03D0)	CANopen Node ID Selection	<p>V/f OLV OLV/PM AOLV/PM EZOLV</p> <p>Sets the node address for CANopen communication. Restart the drive after you change the parameter setting.</p> <p>Note: Be sure to set an address that is different than all other node addresses. Do not set this parameter to 0. Incorrect parameter settings will cause <i>AEr</i> [<i>Station Address Setting Error</i>] errors and the L.ERR LED on the option will come on.</p>	0 (0 - 126)	632
F6-36 (03D1)	CANopen Communication Speed	<p>V/f OLV OLV/PM AOLV/PM EZOLV</p> <p>Sets the CANopen communications speed. Restart the drive after you change the parameter setting.</p> <p>0 : Auto-detection 1 : 10 kbps 2 : 20 kbps 3 : 50 kbps 4 : 125 kbps 5 : 250 kbps 6 : 500 kbps 7 : 800 kbps 8 : 1 Mbps</p>	6 (0 - 8)	632
F6-50 (03C1)	DeviceNet MAC Address	<p>V/f OLV OLV/PM AOLV/PM EZOLV</p> <p>Sets the MAC address for DeviceNet communication. Restart the drive after you change the parameter setting.</p> <p>Note: Be sure to set a MAC address that is different than all other node addresses. Do not set this parameter to 0. Incorrect parameter settings will cause <i>AEr</i> [<i>Station Address Setting Error</i>] errors and the MS LED on the option will flash.</p>	64 (0 - 64)	632
F6-51 (03C2)	DeviceNet Baud Rate	<p>V/f OLV OLV/PM AOLV/PM EZOLV</p> <p>Sets the DeviceNet communications speed. Restart the drive after you change the parameter setting.</p> <p>0 : 125 kbps 1 : 250 kbps 2 : 500 kbps 3 : Adjustable from Network 4 : Detect Automatically</p>	4 (0 - 4)	632
F6-52 (03C3)	DeviceNet PCA Setting	<p>V/f OLV OLV/PM AOLV/PM EZOLV</p> <p>Sets the format of data that the DeviceNet communication master sends to the drive.</p>	21 (0 - 255)	633

11.9 F: Options

No. (Hex.)	Name	Description	Default (Range)	Ref.
F6-53 (03C4)	DeviceNet PPA Setting	V/f OLV OLV/PM AOLV/PM EZOLV Sets the format of data that the drive sends to the DeviceNet communication master.	71 (0 - 255)	633
F6-54 (03C5)	DeviceNet Idle Fault Detection	V/f OLV OLV/PM AOLV/PM EZOLV Sets the function to detect <i>EF0 [Option Card External Fault]</i> when the drive does not receive data from the DeviceNet master. 0 : Enabled 1 : Disabled, No Fault Detection 2 : Vendor Specific 3 : RUN Forward 4 : RUN Reverse	0 (0 - 4)	633
F6-55 (03C6)	DeviceNet Baud Rate Monitor	V/f OLV OLV/PM AOLV/PM EZOLV Sets the function to see the actual DeviceNet communications speed using the keypad. This parameter functions as a monitor only. 0 : 125 kbps 1 : 250 kbps 2 : 500 kbps	0 (0 - 2)	633
F6-56 (03D7)	DeviceNet Speed Scaling	V/f OLV OLV/PM AOLV/PM EZOLV Sets the speed scale for DeviceNet communication.	0 (-15 - +15)	633
F6-57 (03D8)	DeviceNet Current Scaling	V/f OLV OLV/PM AOLV/PM EZOLV Sets the current scale of the DeviceNet communication master.	0 (-15 - +15)	634
F6-58 (03D9)	DeviceNet Torque Scaling	V/f OLV OLV/PM AOLV/PM EZOLV Sets the torque scale of the DeviceNet communication master.	0 (-15 - +15)	634
F6-59 (03DA)	DeviceNet Power Scaling	V/f OLV OLV/PM AOLV/PM EZOLV Sets the power scale of the DeviceNet communication master.	0 (-15 - +15)	634
F6-60 (03DB)	DeviceNet Voltage Scaling	V/f OLV OLV/PM AOLV/PM EZOLV Sets the voltage scale of the DeviceNet communication master.	0 (-15 - +15)	634
F6-61 (03DC)	DeviceNet Time Scaling	V/f OLV OLV/PM AOLV/PM EZOLV Sets the time scale of the DeviceNet communication master.	0 (-15 - +15)	634
F6-62 (03DD)	DeviceNet Heartbeat Interval	V/f OLV OLV/PM AOLV/PM EZOLV Sets the heartbeat for DeviceNet communication. Set this parameter to 0 to disable the heartbeat function.	0 (0 - 10)	634
F6-63 (03DE)	DeviceNet Network MAC ID	V/f OLV OLV/PM AOLV/PM EZOLV Sets the function to see the actual DeviceNet MAC address using the keypad. This parameter functions as a monitor only.	63 (0 - 63)	634
F6-64 (03DF)	Dynamic Out Assembly 109 Param1	V/f OLV OLV/PM AOLV/PM EZOLV Sets Configurable Output 1 written to the MEMOBUS register.	0000H (0000H - FFFFH)	634
F6-65 (03E0)	Dynamic Out Assembly 109 Param2	V/f OLV OLV/PM AOLV/PM EZOLV Sets Configurable Output 2 written to the MEMOBUS register.	0000H (0000H - FFFFH)	634
F6-66 (03E1)	Dynamic Out Assembly 109 Param3	V/f OLV OLV/PM AOLV/PM EZOLV Sets Configurable Output 3 written to the MEMOBUS register.	0000H (0000H - FFFFH)	634
F6-67 (03E2)	Dynamic Out Assembly 109 Param4	V/f OLV OLV/PM AOLV/PM EZOLV Sets Configurable Output 4 written to the MEMOBUS register.	0000H (0000H - FFFFH)	634
F6-68 (03E3)	Dynamic In Assembly 159 Param 1	V/f OLV OLV/PM AOLV/PM EZOLV Sets Configurable Input 1 read from the MEMOBUS register.	0000H (0000H - FFFFH)	635
F6-69 (03E4)	Dynamic In Assembly 159 Param 2	V/f OLV OLV/PM AOLV/PM EZOLV Sets Configurable Input 2 read from the MEMOBUS register.	0000H (0000H - FFFFH)	635
F6-70 (03C7)	Dynamic In Assembly 159 Param 3	V/f OLV OLV/PM AOLV/PM EZOLV Sets Configurable Input 3 read from the MEMOBUS register.	0000H (0000H - FFFFH)	635
F6-71 (03C8)	Dynamic In Assembly 159 Param 4	V/f OLV OLV/PM AOLV/PM EZOLV Sets Configurable Input 4 read from the MEMOBUS register.	0000H (0000H - FFFFH)	635
F6-72 (081B)	PowerLink Node Address	V/f OLV OLV/PM AOLV/PM EZOLV Sets the node ID for PowerLink communication. Note: Be sure to set an address that is different than all other node addresses. Do not set this parameter to 0.	0 (0 - 255)	635

◆ F7: Communication Options

No. (Hex.)	Name	Description	Default (Range)	Ref.
F7-01 (03E5)	IP Address 1	<p>V/f OLV OLV/PM AOLV/PM EZOLV</p> <p>Sets the first octet of the IP Address for the device that is connecting to the network. Restart the drive after you change this parameter.</p> <p>Note: When $F7-13 = 0$ [Address Mode at Startup = Static]:</p> <ul style="list-style-type: none"> • Use parameters $F7-01$ to $F7-04$ [IP Address 1 to 4] to set the IP Address. Be sure to set a different IP address for each drive on the network. • Also set parameters $F7-05$ to $F7-12$ [Subnet Mask 1 to 4, Gateway Address 1 to 4]. 	192 (0 - 255)	635
F7-02 (03E6)	IP Address 2	<p>V/f OLV OLV/PM AOLV/PM EZOLV</p> <p>Sets the second octet of the IP Address for the device that is connecting to the network. Restart the drive after you change this parameter.</p> <p>Note: When $F7-13 = 0$ [Address Mode at Startup = Static]:</p> <ul style="list-style-type: none"> • Use parameters $F7-01$ to $F7-04$ [IP Address 1 to 4] to set the IP Address. Be sure to set a different IP address for each drive on the network. • Also set parameters $F7-05$ to $F7-12$ [Subnet Mask 1 to 4, Gateway Address 1 to 4]. 	168 (0 - 255)	635
F7-03 (03E7)	IP Address 3	<p>V/f OLV OLV/PM AOLV/PM EZOLV</p> <p>Sets the third octet of the IP Address for the device that is connecting to the network. Restart the drive after you change this parameter.</p> <p>Note: When $F7-13 = 0$ [Address Mode at Startup = Static]:</p> <ul style="list-style-type: none"> • Use parameters $F7-01$ to $F7-04$ [IP Address 1 to 4] to set the IP Address. Be sure to set a different IP address for each drive on the network. • Also set parameters $F7-05$ to $F7-12$ [Subnet Mask 1 to 4, Gateway Address 1 to 4]. 	1 (0 - 255)	635
F7-04 (03E8)	IP Address 4	<p>V/f OLV OLV/PM AOLV/PM EZOLV</p> <p>Sets the fourth octet of the IP Address for the device that is connecting to the network. Restart the drive after you change this parameter.</p> <p>Note: When $F7-13 = 0$ [Address Mode at Startup = Static]:</p> <ul style="list-style-type: none"> • Use parameters $F7-01$ to $F7-04$ [IP Address 1 to 4] to set the IP Address. Be sure to set a different IP address for each drive on the network. • Also set parameters $F7-05$ to $F7-12$ [Subnet Mask 1 to 4, Gateway Address 1 to 4]. 	20 (0 - 255)	635
F7-05 (03E9)	Subnet Mask 1	<p>V/f OLV OLV/PM AOLV/PM EZOLV</p> <p>Sets the first octet of the subnet mask of the connected network.</p> <p>Note: Set this parameter when $F7-13 = 0$ [Address Mode at Startup = Static].</p>	255 (0 - 255)	636
F7-06 (03EA)	Subnet Mask 2	<p>V/f OLV OLV/PM AOLV/PM EZOLV</p> <p>Sets the second octet of the subnet mask of the connected network.</p> <p>Note: Set this parameter when $F7-13 = 0$ [Address Mode at Startup = Static].</p>	255 (0 - 255)	636
F7-07 (03EB)	Subnet Mask 3	<p>V/f OLV OLV/PM AOLV/PM EZOLV</p> <p>Sets the third octet of the subnet mask of the connected network.</p> <p>Note: Set this parameter when $F7-13 = 0$ [Address Mode at Startup = Static].</p>	255 (0 - 255)	636
F7-08 (03EC)	Subnet Mask 4	<p>V/f OLV OLV/PM AOLV/PM EZOLV</p> <p>Sets the fourth octet of the subnet mask of the connected network.</p> <p>Note: Set this parameter when $F7-13 = 0$ [Address Mode at Startup = Static].</p>	0 (0 - 255)	636
F7-09 (03ED)	Gateway Address 1	<p>V/f OLV OLV/PM AOLV/PM EZOLV</p> <p>Sets the first octet of the gateway address of the connected network.</p> <p>Note: Set this parameter when $F7-13 = 0$ [Address Mode at Startup = Static].</p>	192 (0 - 255)	636
F7-10 (03EE)	Gateway Address 2	<p>V/f OLV OLV/PM AOLV/PM EZOLV</p> <p>Sets the second octet of the gateway address of the connected network.</p> <p>Note: Set this parameter when $F7-13 = 0$ [Address Mode at Startup = Static].</p>	168 (0 - 255)	636
F7-11 (03EF)	Gateway Address 3	<p>V/f OLV OLV/PM AOLV/PM EZOLV</p> <p>Sets the third octet of the gateway address of the connected network.</p> <p>Note: Set this parameter when $F7-13 = 0$ [Address Mode at Startup = Static].</p>	1 (0 - 255)	637

11.9 F: Options

No. (Hex.)	Name	Description	Default (Range)	Ref.
F7-12 (03F0)	Gateway Address 4	<p><input type="checkbox"/> V/f <input type="checkbox"/> OLV <input type="checkbox"/> OLV/PM <input type="checkbox"/> AOLV/PM <input type="checkbox"/> EZOLV</p> <p>Sets the fourth octet of the gateway address of the connected network.</p> <p>Note: Set this parameter when $F7-13 = 0$ [Address Mode at Startup = Static].</p>	1 (0 - 255)	637
F7-13 (03F1)	Address Mode at Startup	<p><input type="checkbox"/> V/f <input type="checkbox"/> OLV <input type="checkbox"/> OLV/PM <input type="checkbox"/> AOLV/PM <input type="checkbox"/> EZOLV</p> <p>Sets the method to set option card IP addresses.</p> <p>0 : Static 1 : BOOTP 2 : DHCP</p> <p>Note:</p> <ul style="list-style-type: none"> The following setting values are available when using the PROFINET communication option card (SI-EP3). -0: Static -2: DHCP When $F7-13 = 0$, set parameters $F7-01$ to $F7-12$ [IP Address 1 to Gateway Address 4] to set the IP Address. Be sure to set a different IP address for each drive on the network. 	2 (0 - 2)	637
F7-14 (03F2)	Duplex Mode Selection	<p><input type="checkbox"/> V/f <input type="checkbox"/> OLV <input type="checkbox"/> OLV/PM <input type="checkbox"/> AOLV/PM <input type="checkbox"/> EZOLV</p> <p>Sets the duplex mode setting method.</p> <p>0 : Half/Half 1 : Auto/Auto 2 : Full/Full 3 : Half/Auto 4 : Half/Full 5 : Auto/Half 6 : Auto/Full 7 : Full/Half 8 : Full/Auto</p>	1 (0 - 8)	637
F7-15 (03F3)	Communication Speed Selection	<p><input type="checkbox"/> V/f <input type="checkbox"/> OLV <input type="checkbox"/> OLV/PM <input type="checkbox"/> AOLV/PM <input type="checkbox"/> EZOLV</p> <p>Sets the communications speed.</p> <p>10 : 10/10 Mbps 100 : 100/100 Mbps 101 : 10/100 Mbps 102 : 100/10 Mbps</p>	10 (10, 100 - 102)	638
F7-16 (03F4)	Timeout Value	<p><input type="checkbox"/> V/f <input type="checkbox"/> OLV <input type="checkbox"/> OLV/PM <input type="checkbox"/> AOLV/PM <input type="checkbox"/> EZOLV</p> <p>Sets the detection time for a communications timeout.</p> <p>Note: Set this parameter to 0.0 to disable the connection timeout function.</p>	0.0 s (0.0 - 30.0 s)	638
F7-17 (03F5)	EtherNet/IP Speed Scaling Factor	<p><input type="checkbox"/> V/f <input type="checkbox"/> OLV <input type="checkbox"/> OLV/PM <input type="checkbox"/> AOLV/PM <input type="checkbox"/> EZOLV</p> <p>Sets the scaling factor for the speed monitor in the EtherNet/IP Class ID 2AH Object.</p>	0 (-15 - +15)	638
F7-18 (03F6)	EtherNet/IP Current Scale Factor	<p><input type="checkbox"/> V/f <input type="checkbox"/> OLV <input type="checkbox"/> OLV/PM <input type="checkbox"/> AOLV/PM <input type="checkbox"/> EZOLV</p> <p>Sets the scaling factor for the output current monitor in the EtherNet/IP Class ID 2AH Object.</p>	0 (-15 - +15)	638
F7-19 (03F7)	EtherNet/IP Torque Scale Factor	<p><input type="checkbox"/> V/f <input type="checkbox"/> OLV <input type="checkbox"/> OLV/PM <input type="checkbox"/> AOLV/PM <input type="checkbox"/> EZOLV</p> <p>Sets the scaling factor for the torque monitor in the EtherNet/IP Class ID 2AH Object.</p>	0 (-15 - +15)	638
F7-20 (03F8)	EtherNet/IP Power Scaling Factor	<p><input type="checkbox"/> V/f <input type="checkbox"/> OLV <input type="checkbox"/> OLV/PM <input type="checkbox"/> AOLV/PM <input type="checkbox"/> EZOLV</p> <p>Sets the scaling factor for the power monitor in the EtherNet/IP Class ID 2AH Object.</p>	0 (-15 - +15)	638
F7-21 (03F9)	EtherNet/IP Voltage Scale Factor	<p><input type="checkbox"/> V/f <input type="checkbox"/> OLV <input type="checkbox"/> OLV/PM <input type="checkbox"/> AOLV/PM <input type="checkbox"/> EZOLV</p> <p>Sets the scaling factor for the voltage monitor in the EtherNet/IP Class ID 2AH Object.</p>	0 (-15 - +15)	638
F7-22 (03FA)	EtherNet/IP Time Scaling	<p><input type="checkbox"/> V/f <input type="checkbox"/> OLV <input type="checkbox"/> OLV/PM <input type="checkbox"/> AOLV/PM <input type="checkbox"/> EZOLV</p> <p>Sets the scaling factor for the time monitor in the EtherNet/IP Class ID 2AH Object.</p>	0 (-15 - +15)	639
F7-23 (03FB)	Dynamic Out Param 1 for CommCard	<p><input type="checkbox"/> V/f <input type="checkbox"/> OLV <input type="checkbox"/> OLV/PM <input type="checkbox"/> AOLV/PM <input type="checkbox"/> EZOLV</p> <p>When you use an Ethernet/IP option, sets Output Assembly 116. The drive writes the values from Output Assembly 116 to the MEMOBUS/Modbus address register that is stored for each parameter. The drive will not write the values from Output Assembly 116 to the registers when the MEMOBUS/Modbus address is 0. When you use a PROFINET option, set this parameter to set to configurable output 1.</p>	0	639
F7-24 (03FC)	Dynamic Out Param 2 for CommCard	<p><input type="checkbox"/> V/f <input type="checkbox"/> OLV <input type="checkbox"/> OLV/PM <input type="checkbox"/> AOLV/PM <input type="checkbox"/> EZOLV</p> <p>When you use an Ethernet/IP option, sets Output Assembly 116. The drive writes the values from Output Assembly 116 to the MEMOBUS/Modbus address register that is stored for each parameter. The drive will not write the values from Output Assembly 116 to the registers when the MEMOBUS/Modbus address is 0. When you use a PROFINET option, set this parameter to set to configurable output 2.</p>	0	639

No. (Hex.)	Name	Description	Default (Range)	Ref.
F7-25 (03FD)	Dynamic Out Param 3 for CommCard	V/f OLV OLV/PM AOLV/PM EZOLV When you use an Ethernet/IP option, sets Output Assembly 116. The drive writes the values from Output Assembly 116 to the MEMOBUS/Modbus address register that is stored for each parameter. The drive will not write the values from Output Assembly 116 to the registers when the MEMOBUS/Modbus address is 0. When you use a PROFINET option, set this parameter to set to configurable output 3.	0	639
F7-26 (03FE)	Dynamic Out Param 4 for CommCard	V/f OLV OLV/PM AOLV/PM EZOLV Sets Output Assembly 116 when you use an Ethernet/IP option. The drive writes the values from Output Assembly 116 to the MEMOBUS/Modbus address register that is stored for each parameter. The drive will not write the values from Output Assembly 116 to the registers when the MEMOBUS/Modbus address is 0. When you use a ProfiNet option, set this parameter to set to configurable output 4.	0	639
F7-27 (03FF)	Dynamic Out Param 5 for CommCard	V/f OLV OLV/PM AOLV/PM EZOLV When you use an Ethernet/IP option, sets Output Assembly 116. The drive writes the values from Output Assembly 116 to the MEMOBUS/Modbus address register that is stored for each parameter. The drive will not write the values from Output Assembly 116 to the registers when the MEMOBUS/Modbus address is 0. When you use a PROFINET option, set this parameter to set to configurable output 5.	0	639
F7-28 (0370)	Dynamic Out Param 6 for CommCard	V/f OLV OLV/PM AOLV/PM EZOLV When you use an Ethernet/IP option, sets Output Assembly 116. The drive writes the values from Output Assembly 116 to the MEMOBUS/Modbus address register that is stored for each parameter. The drive will not write the values from Output Assembly 116 to the registers when the MEMOBUS/Modbus address is 0.	0	639
F7-29 (0371)	Dynamic Out Param 7 for CommCard	V/f OLV OLV/PM AOLV/PM EZOLV When you use an Ethernet/IP option, sets Output Assembly 116. The drive writes the values from Output Assembly 116 to the MEMOBUS/Modbus address register that is stored for each parameter. The drive will not write the values from Output Assembly 116 to the registers when the MEMOBUS/Modbus address is 0.	0	639
F7-30 (0372)	Dynamic Out Param 8 for CommCard	V/f OLV OLV/PM AOLV/PM EZOLV When you use an Ethernet/IP option, sets Output Assembly 116. The drive writes the values from Output Assembly 116 to the MEMOBUS/Modbus address register that is stored for each parameter. The drive will not write the values from Output Assembly 116 to the registers when the MEMOBUS/Modbus address is 0.	0	639
F7-31 (0373)	Dynamic Out Param 9 for CommCard	V/f OLV OLV/PM AOLV/PM EZOLV When you use an Ethernet/IP option, sets Output Assembly 116. The drive writes the values from Output Assembly 116 to the MEMOBUS/Modbus address register that is stored for each parameter. The drive will not write the values from Output Assembly 116 to the registers when the MEMOBUS/Modbus address is 0.	0	639
F7-32 (0374)	Dynamic Out Param 10 for CommCard	V/f OLV OLV/PM AOLV/PM EZOLV When you use an Ethernet/IP option, sets Output Assembly 116. The drive writes the values from Output Assembly 116 to the MEMOBUS/Modbus address register that is stored for each parameter. The drive will not write the values from Output Assembly 116 to the registers when the MEMOBUS/Modbus address is 0.	0	639
F7-33 (0375)	Dynamic In Param 1 for CommCard	V/f OLV OLV/PM AOLV/PM EZOLV Sets Input Assembly 166 when you use an Ethernet/IP option. The drive sends the values from the MEMOBUS/Modbus address registers stored for each parameter to Input Assembly 166. The drive returns the default register value for the option card when the MEMOBUS/Modbus address is 0 and the value sent to Input Assembly 166 is not defined. When you use a ProfiNet option, set this parameter to set to configurable input 1.	0	639
F7-34 (0376)	Dynamic In Param 2 for CommCard	V/f OLV OLV/PM AOLV/PM EZOLV Sets Input Assembly 166 when you use an Ethernet/IP option. The drive sends the values from the MEMOBUS/Modbus address registers stored for each parameter to Input Assembly 166. The drive returns the default register value for the option card when the MEMOBUS/Modbus address is 0 and the value sent to Input Assembly 166 is not defined. When you use a ProfiNet option, set this parameter to set to configurable input 2.	0	639
F7-35 (0377)	Dynamic In Param 3 for CommCard	V/f OLV OLV/PM AOLV/PM EZOLV Sets Input Assembly 166 when you use an Ethernet/IP option. The drive sends the values from the MEMOBUS/Modbus address registers stored for each parameter to Input Assembly 166. The drive returns the default register value for the option card when the MEMOBUS/Modbus address is 0 and the value sent to Input Assembly 166 is not defined. When you use a ProfiNet option, set this parameter to set to configurable input 3.	0	639
F7-36 (0378)	Dynamic In Param 4 for CommCard	V/f OLV OLV/PM AOLV/PM EZOLV Sets Input Assembly 166 when you use an Ethernet/IP option. The drive sends the values from the MEMOBUS/Modbus address registers stored for each parameter to Input Assembly 166. The drive returns the default register value for the option card when the MEMOBUS/Modbus address is 0 and the value sent to Input Assembly 166 is not defined. When you use a ProfiNet option, set this parameter to set to configurable input 4.	0	639
F7-37 (0379)	Dynamic In Param 5 for CommCard	V/f OLV OLV/PM AOLV/PM EZOLV Sets Input Assembly 166 when you use an Ethernet/IP option. The drive sends the values from the MEMOBUS/Modbus address registers stored for each parameter to Input Assembly 166. The drive returns the default register value for the option card when the MEMOBUS/Modbus address is 0 and the value sent to Input Assembly 166 is not defined. When you use a ProfiNet option, set this parameter to set to configurable input 5.	0	639

11.9 F: Options

No. (Hex.)	Name	Description	Default (Range)	Ref.
F7-38 (037A)	Dynamic In Param 6 for CommCard	V/f OLV OLV/PM AOLV/PM EZOLV Sets Input Assembly 166 when you use an Ethernet/IP option. The drive sends the values from the MEMOBUS/Modbus address registers stored for each parameter to Input Assembly 166. The drive returns the default register value for the option card when the MEMOBUS/Modbus address is 0 and the value sent to Input Assembly 166 is not defined.	0	639
F7-39 (037B)	Dynamic In Param 7 for CommCard	V/f OLV OLV/PM AOLV/PM EZOLV Sets Input Assembly 166 when you use an Ethernet/IP option. The drive sends the values from the MEMOBUS/Modbus address registers stored for each parameter to Input Assembly 166. The drive returns the default register value for the option card when the MEMOBUS/Modbus address is 0 and the value sent to Input Assembly 166 is not defined.	0	639
F7-40 (037C)	Dynamic In Param 8 for CommCard	V/f OLV OLV/PM AOLV/PM EZOLV Sets Input Assembly 166 when you use an Ethernet/IP option. The drive sends the values from the MEMOBUS/Modbus address registers stored for each parameter to Input Assembly 166. The drive returns the default register value for the option card when the MEMOBUS/Modbus address is 0 and the value sent to Input Assembly 166 is not defined.	0	639
F7-41 (037D)	Dynamic In Param 9 for CommCard	V/f OLV OLV/PM AOLV/PM EZOLV Sets Input Assembly 166 when you use an Ethernet/IP option. The drive sends the values from the MEMOBUS/Modbus address registers stored for each parameter to Input Assembly 166. The drive returns the default register value for the option card when the MEMOBUS/Modbus address is 0 and the value sent to Input Assembly 166 is not defined.	0	639
F7-42 (037E)	Dynamic In Param 10 for CommCard	V/f OLV OLV/PM AOLV/PM EZOLV Sets Input Assembly 166 when you use an Ethernet/IP option. The drive sends the values from the MEMOBUS/Modbus address registers stored for each parameter to Input Assembly 166. The drive returns the default register value for the option card when the MEMOBUS/Modbus address is 0 and the value sent to Input Assembly 166 is not defined.	0	639
F7-60 (0780)	PZD1 Write (Control Word)	V/f OLV OLV/PM AOLV/PM EZOLV When you use a Profibus option, set the MEMOBUS/Modbus address for PZD1 (PPO output). PZD1 (PPO output) functions as the STW when <i>F7-60 = 0 to 2</i> .	0	639
F7-61 (0781)	PZD2 Write (Frequency Reference)	V/f OLV OLV/PM AOLV/PM EZOLV When you use a Profibus option, sets the MEMOBUS/Modbus address for PZD2 (PPO output). PZD2 (PPO output) functions as the HSW when <i>F7-61 = 0 to 2</i> .	0	639
F7-62 (0782)	PZD3 Write	V/f OLV OLV/PM AOLV/PM EZOLV When you use a Profibus option, sets the MEMOBUS/Modbus address for PZD3 (PPO output). A value of 0, 1, or 2 will disable the PZD3 (PPO output) write operation to the MEMOBUS/Modbus register.	0	639
F7-63 (0783)	PZD4 Write	V/f OLV OLV/PM AOLV/PM EZOLV When you use a Profibus option, sets the MEMOBUS/Modbus address for PZD4 (PPO output). A value of 0, 1, or 2 will disable the PZD4 (PPO output) write operation to the MEMOBUS/Modbus register.	0	639
F7-64 (0784)	PZD5 Write	V/f OLV OLV/PM AOLV/PM EZOLV When you use a Profibus option, sets the MEMOBUS/Modbus address for PZD5 (PPO output). A value of 0, 1, or 2 will disable the PZD5 (PPO output) write operation to the MEMOBUS/Modbus register.	0	640
F7-65 (0785)	PZD6 Write	V/f OLV OLV/PM AOLV/PM EZOLV When you use a Profibus option, sets the MEMOBUS/Modbus address for PZD6 (PPO output). A value of 0, 1, or 2 will disable the PZD6 (PPO output) write operation to the MEMOBUS/Modbus register.	0	640
F7-66 (0786)	PZD7 Write	V/f OLV OLV/PM AOLV/PM EZOLV When you use a Profibus option, sets the MEMOBUS/Modbus address for PZD7 (PPO output). A value of 0, 1, or 2 will disable the PZD7 (PPO output) write operation to the MEMOBUS/Modbus register.	0	640
F7-67 (0787)	PZD8 Write	V/f OLV OLV/PM AOLV/PM EZOLV When you use a Profibus option, sets the MEMOBUS/Modbus address for PZD8 (PPO output). A value of 0, 1, or 2 will disable the PZD8 (PPO output) write operation to the MEMOBUS/Modbus register.	0	640
F7-68 (0788)	PZD9 Write	V/f OLV OLV/PM AOLV/PM EZOLV When you use a Profibus option, sets the MEMOBUS/Modbus address for PZD9 (PPO output). A value of 0, 1, or 2 will disable the PZD9 (PPO output) write operation to the MEMOBUS/Modbus register.	0	640
F7-69 (0789)	PZD10 Write	V/f OLV OLV/PM AOLV/PM EZOLV When you use a Profibus option, sets the MEMOBUS/Modbus address for PZD10 (PPO output). A value of 0, 1, or 2 will disable the PZD10 (PPO output) write operation to the MEMOBUS/Modbus register.	0	640
F7-70 (078A)	PZD1 Read (Status Word)	V/f OLV OLV/PM AOLV/PM EZOLV When you use a Profibus option, sets the MEMOBUS/Modbus address for PZD1 (PPO input). PZD1 (PPO input) functions as the ZSW when <i>F7-70 = 0</i> .	0	640
F7-71 (078B)	PZD2 Read (Output Frequency)	V/f OLV OLV/PM AOLV/PM EZOLV When you use a Profibus option, sets the MEMOBUS/Modbus address for PZD2 (PPO input). PZD2 (PPO input) functions as the HIW when <i>F7-71 = 0</i> .	0	641

No. (Hex.)	Name	Description	Default (Range)	Ref.
F7-72 (078C)	PZD3 Read	V/f OLV OLV/PM AOLV/PM EZOLV When you use a Profibus option, sets the MEMOBUS/Modbus address for PZD3 (PPO input). A value of 0 will disable the PZD3 (PPO input) load operation from the MEMOBUS/Modbus register.	0	641
F7-73 (078D)	PZD4 Read	V/f OLV OLV/PM AOLV/PM EZOLV When you use a Profibus option, sets the MEMOBUS/Modbus address for PZD4 (PPO input). A value of 0 will disable the PZD4 (PPO input) load operation from the MEMOBUS/Modbus register.	0	641
F7-74 (078E)	PZD5 Read	V/f OLV OLV/PM AOLV/PM EZOLV When you use a Profibus option, sets the MEMOBUS/Modbus address for PZD5 (PPO input). A value of 0 will disable the PZD5 (PPO input) load operation from the MEMOBUS/Modbus register.	0	641
F7-75 (078F)	PZD6 Read	V/f OLV OLV/PM AOLV/PM EZOLV When you use a Profibus option, sets the MEMOBUS/Modbus address for PZD6 (PPO input). A value of 0 will disable the PZD6 (PPO input) load operation from the MEMOBUS/Modbus register.	0	641
F7-76 (0790)	PZD7 Read	V/f OLV OLV/PM AOLV/PM EZOLV When you use a Profibus option, sets the MEMOBUS/Modbus address for PZD7 (PPO input). A value of 0 will disable the PZD7 (PPO input) load operation from the MEMOBUS/Modbus register.	0	641
F7-77 (0791)	PZD8 Read	V/f OLV OLV/PM AOLV/PM EZOLV When you use a Profibus option, sets the MEMOBUS/Modbus address for PZD8 (PPO input). A value of 0 will disable the PZD8 (PPO input) load operation from the MEMOBUS/Modbus register.	0	641
F7-78 (0792)	PZD9 Read	V/f OLV OLV/PM AOLV/PM EZOLV When you use a Profibus option, sets the MEMOBUS/Modbus address for PZD9 (PPO input). A value of 0 will disable the PZD9 (PPO input) load operation from the MEMOBUS/Modbus register.	0	641
F7-79 (0793)	PZD10 Read	V/f OLV OLV/PM AOLV/PM EZOLV When you use a Profibus option, sets the MEMOBUS/Modbus address for PZD10 (PPO input). A value of 0 will disable the PZD10 (PPO input) load operation from the MEMOBUS/Modbus register.	0	642

11.10 H: Terminal Functions

◆ H1: Digital Inputs

No. (Hex.)	Name	Description	Default (Range)	Ref.
H1-01 (0438)	Terminal S1 Function Selection	<p>V/f OLV OLV/PM AOLV/PM EZOLV</p> <p>Sets the function for MFDI terminal S1.</p> <p>Note: The default setting is <i>F</i> when you initialize the drive for <i>3-Wire Initialization [A1-03 = 3330]</i>.</p>	40 (1 - 1FF)	644
H1-02 (0439)	Terminal S2 Function Selection	<p>V/f OLV OLV/PM AOLV/PM EZOLV</p> <p>Sets the function for MFDI terminal S2.</p> <p>Note: The default setting is <i>F</i> when you initialize the drive for <i>3-Wire Initialization [A1-03 = 3330]</i>.</p>	41 (1 - 1FF)	644
H1-03 (0400)	Terminal S3 Function Selection	<p>V/f OLV OLV/PM AOLV/PM EZOLV</p> <p>Sets the function for MFDI terminal S3.</p>	24 (0 - 1FF)	644
H1-04 (0401)	Terminal S4 Function Selection	<p>V/f OLV OLV/PM AOLV/PM EZOLV</p> <p>Sets the function for MFDI terminal S4.</p>	14 (0 - 1FF)	644
H1-05 (0402)	Terminal S5 Function Selection	<p>V/f OLV OLV/PM AOLV/PM EZOLV</p> <p>Sets the function for MFDI terminal S5.</p> <p>Note: The default setting is <i>0</i> when the drive is initialized for <i>3-Wire Initialization [A1-03 = 3330]</i>.</p>	3 (0 - 1FF)	644
H1-06 (0403)	Terminal S6 Function Selection	<p>V/f OLV OLV/PM AOLV/PM EZOLV</p> <p>Sets the function for MFDI terminal S6.</p> <p>Note: The default setting is <i>3</i> when the drive is initialized for <i>3-Wire Initialization [A1-03 = 3330]</i>.</p>	4 (0 - 1FF)	645
H1-07 (0404)	Terminal S7 Function Selection	<p>V/f OLV OLV/PM AOLV/PM EZOLV</p> <p>Sets the function for MFDI terminal S7.</p> <p>Note: The default setting is <i>4</i> when the drive is initialized for <i>3-Wire Initialization [A1-03 = 3330]</i>.</p>	6 (0 - 1FF)	645
H1-21 (0B70)	Terminal S1 Function Selection 2	<p>V/f OLV OLV/PM AOLV/PM EZOLV</p> <p>Sets the second function for MFDI terminal S1.</p>	F (1 - 19F)	645
H1-22 (0B71)	Terminal S2 Function Select 2	<p>V/f OLV OLV/PM AOLV/PM EZOLV</p> <p>Sets the second function for MFDI terminal S2.</p>	F (1 - 19F)	645
H1-23 (0B72)	Terminal S3 Function Selection 2	<p>V/f OLV OLV/PM AOLV/PM EZOLV</p> <p>Sets the second function for MFDI terminal S3.</p>	F (1 - 19F)	645
H1-24 (0B73)	Terminal S4 Function Selection 2	<p>V/f OLV OLV/PM AOLV/PM EZOLV</p> <p>Sets the second function for MFDI terminal S4.</p>	F (1 - 19F)	645
H1-25 (0B74)	Terminal S5 Function Selection 2	<p>V/f OLV OLV/PM AOLV/PM EZOLV</p> <p>Sets the second function for MFDI terminal S5.</p>	F (1 - 19F)	646
H1-26 (0B75)	Terminal S6 Function Selection 2	<p>V/f OLV OLV/PM AOLV/PM EZOLV</p> <p>Sets the second function for MFDI terminal S6.</p>	F (1 - 19F)	646
H1-27 (0B76)	Terminal S7 Function Selection 2	<p>V/f OLV OLV/PM AOLV/PM EZOLV</p> <p>Sets the second function for MFDI terminal S7.</p>	F (1 - 19F)	646
H1-40 (0B54)	Mbus Reg 15C0h bit0 Input Func	<p>V/f OLV OLV/PM AOLV/PM EZOLV</p> <p>Sets MFDI function to set to <i>bit 0</i> of the MEMOBUS register <i>15C0 (Hex.)</i>.</p>	F (1 - 19F)	646
H1-41 (0B55)	Mbus Reg 15C0h bit1 Input Func	<p>V/f OLV OLV/PM AOLV/PM EZOLV</p> <p>Sets MFDI function to set to <i>bit 1</i> of the MEMOBUS register <i>15C0 (Hex.)</i>.</p>	F (1 - 19F)	646
H1-42 (0B56)	Mbus Reg 15C0h bit2 Input Func	<p>V/f OLV OLV/PM AOLV/PM EZOLV</p> <p>Sets MFDI function to set to <i>bit 2</i> of the MEMOBUS register <i>15C0 (Hex.)</i>.</p>	F (1 - 19F)	647

■ H1-xx: MFDI Setting Values

Setting Value	Function	Description	Ref.
0	3-Wire Sequence	<input type="checkbox"/> V/f <input type="checkbox"/> OLV <input type="checkbox"/> OLV/PM <input type="checkbox"/> AOLV/PM <input type="checkbox"/> EZOLV Sets the direction of motor rotation for 3-wire sequence.	647
1	LOCAL/REMOTE Selection	<input type="checkbox"/> V/f <input type="checkbox"/> OLV <input type="checkbox"/> OLV/PM <input type="checkbox"/> AOLV/PM <input type="checkbox"/> EZOLV Sets drive control for the keypad (LOCAL) or an external source (REMOTE). ON : LOCAL OFF : REMOTE	648
2	External Reference 1/2 Selection	<input type="checkbox"/> V/f <input type="checkbox"/> OLV <input type="checkbox"/> OLV/PM <input type="checkbox"/> AOLV/PM <input type="checkbox"/> EZOLV Sets the drive to use Run command source 1/2 or Reference command source 1/2 when in REMOTE Mode. ON : b1-15 [Frequency Reference Selection 2], b1-16 [Run Command Selection 2] OFF : b1-01 [Frequency Reference Selection 1], b1-02 [Run Command Selection 1]	648
3	Multi-Step Speed Reference 1	<input type="checkbox"/> V/f <input type="checkbox"/> OLV <input type="checkbox"/> OLV/PM <input type="checkbox"/> AOLV/PM <input type="checkbox"/> EZOLV Uses speed references d1-01 to d1-16 to set a multi-step speed reference.	648
4	Multi-Step Speed Reference 2	<input type="checkbox"/> V/f <input type="checkbox"/> OLV <input type="checkbox"/> OLV/PM <input type="checkbox"/> AOLV/PM <input type="checkbox"/> EZOLV Uses speed references d1-01 to d1-16 to set a multi-step speed reference.	648
5	Multi-Step Speed Reference 3	<input type="checkbox"/> V/f <input type="checkbox"/> OLV <input type="checkbox"/> OLV/PM <input type="checkbox"/> AOLV/PM <input type="checkbox"/> EZOLV Uses speed references d1-01 to d1-16 to set a multi-step speed reference.	649
6	Jog Reference Selection	<input type="checkbox"/> V/f <input type="checkbox"/> OLV <input type="checkbox"/> OLV/PM <input type="checkbox"/> AOLV/PM <input type="checkbox"/> EZOLV Sets the drive to use the JOG Frequency Reference (JOG command) set in d1-17. The JOG Frequency Reference (JOG command) overrides Frequency References 1 to 16 (d1-01 to d1-16).	649
7	Accel/Decel Time Selection 1	<input type="checkbox"/> V/f <input type="checkbox"/> OLV <input type="checkbox"/> OLV/PM <input type="checkbox"/> AOLV/PM <input type="checkbox"/> EZOLV Sets the drive to use Acceleration/Deceleration Time 1 [C1-01, C1-02] or Acceleration/Deceleration Time 2 [C1-03, C1-04].	649
8	Baseblock Command (N. O.)	<input type="checkbox"/> V/f <input type="checkbox"/> OLV <input type="checkbox"/> OLV/PM <input type="checkbox"/> AOLV/PM <input type="checkbox"/> EZOLV Sets the command that stops drive output and coasts the motor to stop when the input is ON. ON : Baseblock (drive output stop) OFF : Normal operation	649
9	Baseblock Command (N. C.)	<input type="checkbox"/> V/f <input type="checkbox"/> OLV <input type="checkbox"/> OLV/PM <input type="checkbox"/> AOLV/PM <input type="checkbox"/> EZOLV Sets the command that stops drive output and coasts the motor to stop when the input terminal is OFF. ON : Normal operation OFF : Baseblock (drive output stop)	649
A	Accel/Decel Ramp Hold	<input type="checkbox"/> V/f <input type="checkbox"/> OLV <input type="checkbox"/> OLV/PM <input type="checkbox"/> AOLV/PM <input type="checkbox"/> EZOLV Momentarily pauses motor acceleration and deceleration when the terminal is turned ON, retains the output frequency that was stored in the drive at the time of the pause, and restarts motor operation.	650
B	Overheat Alarm (oH2)	<input type="checkbox"/> V/f <input type="checkbox"/> OLV <input type="checkbox"/> OLV/PM <input type="checkbox"/> AOLV/PM <input type="checkbox"/> EZOLV Sets the drive to show an oH2 [External Overheat (H1-XX=B)] alarm when the input terminal is ON. The alarm does not have an effect on drive operation.	650
C	Analog Terminal Enable Selection	<input type="checkbox"/> V/f <input type="checkbox"/> OLV <input type="checkbox"/> OLV/PM <input type="checkbox"/> AOLV/PM <input type="checkbox"/> EZOLV Sets the command that enables or disables the terminals selected in H3-14 [Analog Input Terminal Enable Sel]. ON : Input to the terminal selected with H3-14 is enabled OFF : Input to the terminal selected with H3-14 is disabled	650
E	ASR Integral Reset	<input type="checkbox"/> V/f <input type="checkbox"/> OLV <input type="checkbox"/> OLV/PM <input type="checkbox"/> AOLV/PM <input type="checkbox"/> EZOLV Sets the command to reset the integral value and use PI control or P control for the speed control loop. ON : P control OFF : PI control	650
F	Not Used	<input type="checkbox"/> V/f <input type="checkbox"/> OLV <input type="checkbox"/> OLV/PM <input type="checkbox"/> AOLV/PM <input type="checkbox"/> EZOLV Use this setting for unused terminals or to use terminals in through mode.	650
10	Up Command	<input type="checkbox"/> V/f <input type="checkbox"/> OLV <input type="checkbox"/> OLV/PM <input type="checkbox"/> AOLV/PM <input type="checkbox"/> EZOLV Sets the command to use a push button switch to increase the drive frequency reference. You must also set Setting 11 [Down Command]. ON : Increases the frequency reference. OFF : Holds the current frequency reference.	650
11	Down Command	<input type="checkbox"/> V/f <input type="checkbox"/> OLV <input type="checkbox"/> OLV/PM <input type="checkbox"/> AOLV/PM <input type="checkbox"/> EZOLV Sets the command to use a push button switch to decrease the drive frequency reference. You must also set Setting 10 [Up Command]. ON : Decreases the frequency reference. OFF : Holds the current frequency reference.	652
12	Forward Jog	<input type="checkbox"/> V/f <input type="checkbox"/> OLV <input type="checkbox"/> OLV/PM <input type="checkbox"/> AOLV/PM <input type="checkbox"/> EZOLV Sets the command to operate the motor in the forward direction at the Jog Frequency set in d1-17 [Jog Reference].	653

11.10 H: Terminal Functions

Setting Value	Function	Description	Ref.
13	Reverse Jog	V/f OLV OLV/PM AOLV/PM EZOLV Sets the command to operate the motor in the reverse direction at the Jog Frequency set in <i>d1-17 [Jog Reference]</i> .	653
14	Fault Reset	V/f OLV OLV/PM AOLV/PM EZOLV Sets the command to reset the current fault when the Run command is inactive. Note: The drive ignores the fault reset command when the Run command is active. Remove the Run command before trying to reset a fault.	653
15	Fast Stop (N.O.)	V/f OLV OLV/PM AOLV/PM EZOLV Sets the command to ramp to stop in the deceleration time set in <i>C1-09 [Fast Stop Time]</i> when the input terminal is ON while the drive is operating.	653
16	Motor 2 Selection	V/f OLV OLV/PM AOLV/PM EZOLV Sets the command for the drive to operate motor 1 or motor 2. Stop the motors before switching. ON : Operate motor 2 OFF : Operate motor 1	654
17	Fast Stop (N.C.)	V/f OLV OLV/PM AOLV/PM EZOLV Sets the command to ramp to stop in the deceleration time set in <i>C1-09 [Fast Stop Time]</i> when the input terminal is ON while the drive is operating.	654
18	Timer Function	V/f OLV OLV/PM AOLV/PM EZOLV Sets the command to start the timer function. Use this setting with <i>Timer Output [H2-xx = 12]</i> .	655
19	PID Disable	V/f OLV OLV/PM AOLV/PM EZOLV Sets the command to disable PID control when <i>b5-01 = 1 to 8 [PID Mode Setting = Enabled]</i> . ON : PID control disabled OFF : PID control enabled	655
1 A	Accel/Decel Time Selection 2	V/f OLV OLV/PM AOLV/PM EZOLV Set this function and <i>H1-xx = 7 [Accel/Decel Time Selection 1]</i> together. Sets the drive to use <i>Acceleration/Deceleration Time 3 [C1-05, C1-06]</i> or <i>Acceleration/Deceleration Time 4 [C1-07, C1-08]</i> .	655
1B	Programming Lockout	V/f OLV OLV/PM AOLV/PM EZOLV Sets the command to prevent parameter changes when the terminal is OFF. ON : Programming Lockout OFF : Parameter Write Prohibit	655
1E	Reference Sample Hold	V/f OLV OLV/PM AOLV/PM EZOLV Sets the command to sample the frequency reference at terminal A1 or A2, and hold the frequency reference at that frequency.	655
20	External Fault (NO-Always-Ramp)	V/f OLV OLV/PM AOLV/PM EZOLV When the terminal activates, the drive ramps to stop in the selected deceleration time. Fault relay output terminal MA-MC will turn ON, and MB-MC will turn OFF. The drive always detects external faults whether the drive is stopped or running.	656
21	External Fault (NC-Always-Ramp)	V/f OLV OLV/PM AOLV/PM EZOLV When the terminal deactivates, the drive ramps to stop in the selected deceleration time. Fault relay output terminal MA-MC will turn ON, and MB-MC will turn OFF. The drive always detects external faults whether the drive is stopped or running.	656
22	External Fault (NO-@Run-Ramp)	V/f OLV OLV/PM AOLV/PM EZOLV When the terminal activates during run, the drive ramps to stop in the selected deceleration time. Fault relay output terminal MA-MC will turn ON, and MB-MC will turn OFF. The drive does not detect external faults while the drive is stopped.	656
23	External Fault (NC-@Run-Ramp)	V/f OLV OLV/PM AOLV/PM EZOLV When the terminal deactivates during run, the drive ramps to stop in the selected deceleration time. Fault relay output terminal MA-MC will turn ON, and MB-MC will turn OFF. The drive does not detect external faults while the drive is stopped.	656
24	External Fault (NO-Always-Coast)	V/f OLV OLV/PM AOLV/PM EZOLV When the terminal activates, the drive shuts off the output and the motor coasts to stop. Fault relay output terminal MA-MC will turn ON, and MB-MC will turn OFF. The drive always detects external faults whether the drive is stopped or running.	656
25	External Fault (NC-Always-Coast)	V/f OLV OLV/PM AOLV/PM EZOLV When the terminal deactivates, the drive shuts off the output and the motor coasts to stop. Fault relay output terminal MA-MC will turn ON, and MB-MC will turn OFF. The drive always detects external faults whether the drive is stopped or running.	656
26	External Fault (NO-@Run-Coast)	V/f OLV OLV/PM AOLV/PM EZOLV When the terminal activates during run, the drive shuts off the output and the motor coasts to stop. Fault relay output terminal MA-MC will turn ON, and MB-MC will turn OFF. The drive does not detect external faults while the drive is stopped.	656
27	External Fault (NC-@Run-Coast)	V/f OLV OLV/PM AOLV/PM EZOLV When the terminal deactivates during run, the drive shuts off the output and the motor coasts to stop. Fault relay output terminal MA-MC will turn ON, and MB-MC will turn OFF. The drive does not detect external faults while the drive is stopped.	656

Setting Value	Function	Description	Ref.
28	External Fault (NO-Always-FStop)	V/f OLV OLV/PM AOLV/PM EZOLV When the terminal activates, the drive stops the motor in the deceleration time set to <i>CI-09 [Fast Stop Time]</i> . Fault relay output terminal MA-MC turns ON, and MB-MC turns OFF. Stopped drives and running drives will detect external faults.	656
29	External Fault (NC-Always-FStop)	V/f OLV OLV/PM AOLV/PM EZOLV When the terminal deactivates, the drive stops the motor in the deceleration time set to <i>CI-09 [Fast Stop Time]</i> . Fault relay output terminal MA-MC turns ON, and MB-MC turns OFF. Stopped drives and running drives will detect external faults.	656
2A	External Fault (NO-@Run-FStop)	V/f OLV OLV/PM AOLV/PM EZOLV When the terminal activates during run, the drive stops the motor in the deceleration time set to <i>CI-09 [Fast Stop Time]</i> . Fault relay output terminal MA-MC turns ON, and MB-MC turns OFF. Stopped drives will not detect external faults.	656
2B	External Fault (NC-@Run-FStop)	V/f OLV OLV/PM AOLV/PM EZOLV When the terminal deactivates during run, the drive stops the motor in the deceleration time set to <i>CI-09 [Fast Stop Time]</i> . Fault relay output terminal MA-MC turns ON, and MB-MC turns OFF. Stopped drives will not detect external faults.	656
2C	External Fault (NO-Always-Alarm)	V/f OLV OLV/PM AOLV/PM EZOLV When the terminal activates, the keypad shows <i>EFx [External Fault (Input Terminal Sx)]</i> and the output terminal set for Alarm [<i>H2-01 to H2-03 = 10</i>] activates. The drive continues operation. Stopped drives and running drives will detect external faults.	656
2D	External Fault (NC-Always-Alarm)	V/f OLV OLV/PM AOLV/PM EZOLV When the terminal deactivates, the keypad shows <i>EFx [External Fault (Input Terminal Sx)]</i> and the output terminal set for Alarm [<i>H2-01 to H2-03 = 10</i>] activates. The drive continues operation. Stopped drives and running drives will detect external faults.	657
2E	External Fault (NO-@Run-Alarm)	V/f OLV OLV/PM AOLV/PM EZOLV When the terminal activates during run, the keypad shows <i>EFx [External Fault (Input Terminal Sx)]</i> and the output terminal set for Alarm [<i>H2-01 to H2-03 = 10</i>] activates. The drive continues operation. Stopped drives will not detect external faults.	657
2F	External Fault (NC-@Run-Alarm)	V/f OLV OLV/PM AOLV/PM EZOLV When the terminal deactivates during run, the keypad shows <i>EFx [External Fault (Input Terminal Sx)]</i> and the output terminal set for Alarm [<i>H2-01 to H2-03 = 10</i>] activates. The drive continues operation. Stopped drives will not detect external faults.	657
30	PID Integrator Reset	V/f OLV OLV/PM AOLV/PM EZOLV Sets the command to reset and hold the PID control integral to 0 when the terminal is ON.	657
31	PID Integrator Hold	V/f OLV OLV/PM AOLV/PM EZOLV Sets the command to hold the integral value of the PID control while the terminal is activated.	657
32	Multi-Step Speed Reference 4	V/f OLV OLV/PM AOLV/PM EZOLV Uses speed references <i>d1-01 to d1-16</i> to set a multi-step speed reference.	657
34	PID Soft Starter Disable	V/f OLV OLV/PM AOLV/PM EZOLV Sets the PID soft starter function. ON : Disable OFF : Enabled	657
35	PID Input (Error) Invert	V/f OLV OLV/PM AOLV/PM EZOLV Sets the command to turn the terminal ON and OFF to switch the PID input level (polarity).	658
3E	PID Setpoint Selection 1	V/f OLV OLV/PM AOLV/PM EZOLV Set this function and <i>H1-xx = 3F [PID Setpoint Selection 2]</i> together. Sets the function to switch the PID setpoint to <i>b5-58 to b5-60 [PID Setpoint 2 to 4]</i> .	658
3F	PID Setpoint Selection 2	V/f OLV OLV/PM AOLV/PM EZOLV Set this function and <i>H1-xx = 3E [PID Setpoint Selection 1]</i> at the same time. Sets the function to switch the PID setpoint to <i>b5-58 to b5-60 [PID Setpoint 2 to 4]</i> .	658
40	Forward RUN (2-Wire)	V/f OLV OLV/PM AOLV/PM EZOLV Sets the Forward Run command for 2-wire sequence 1. Set this function and <i>H1-xx = 41 [Reverse RUN (2-Wire)]</i> together. ON : Forward Run OFF : Stop Note: • If you turn ON the Forward Run command terminal and the Reverse Run command terminal, it will cause an <i>EF [FWD/REV Run Command Input Error]</i> alarm and the motor will ramp to stop. • Initialize the drive with a 2-wire sequence to set the Forward Run command to terminal S1. • This function will not operate at the same time as <i>H1-xx = 42, 43 [Run Command (2-Wire Sequence 2), FWD/REV (2-Wire Sequence 2)]</i> .	658

11.10 H: Terminal Functions

Setting Value	Function	Description	Ref.
41	Reverse RUN (2-Wire)	<p>V/f OLV OLV/PM AOLV/PM EZOLV</p> <p>Sets the Forward Run command for 2-wire sequence 1. Set this function and $H1-xx = 40$ [Forward RUN (2-Wire)] together. ON : Reverse Run OFF : Stop</p> <p>Note:</p> <ul style="list-style-type: none"> If you turn ON the Forward Run command terminal and the Reverse Run command terminal, it will cause an <i>EF [FWD/REV Run Command Input Error]</i> alarm and the motor will ramp to stop. Initialize the drive with a 2-wire sequence to set the Reverse Run command to terminal S2. This function will not operate at the same time as $H1-xx = 42, 43$ [Run Command (2-Wire Sequence 2), FWD/REV (2-Wire Sequence 2)]. 	658
42	Run Command (2-Wire Sequence 2)	<p>V/f OLV OLV/PM AOLV/PM EZOLV</p> <p>Sets the Run command for 2-wire sequence 2. Set this function and $H1-xx = 43$ [FWD/REV (2-Wire Sequence 2)] together. ON : Run OFF : Stop</p> <p>Note:</p> <p>This function will not operate at the same time as $H1-xx = 40, 41$ [Forward RUN (2-Wire), Reverse RUN (2-Wire)].</p>	659
43	FWD/REV (2-Wire Sequence 2)	<p>V/f OLV OLV/PM AOLV/PM EZOLV</p> <p>Sets the direction of motor rotation for 2-wire sequence 2. Set this function and $H1-xx = 42$ [Run Command (2-Wire Sequence 2)] together. ON : Reverse Run OFF : Forward Run</p> <p>Note:</p> <ul style="list-style-type: none"> You must input the Run command to rotate the motor. This function will not operate at the same time as $H1-xx = 40, 41$ [Forward RUN (2-Wire), Reverse RUN (2-Wire)]. 	659
44	Add Offset Frequency 1 (d7-01)	<p>V/f OLV OLV/PM AOLV/PM EZOLV</p> <p>Sets the function to add the offset frequency set in $d7-01$ [Offset Frequency 1] to the frequency reference when the terminal activates.</p>	659
45	Add Offset Frequency 2 (d7-02)	<p>V/f OLV OLV/PM AOLV/PM EZOLV</p> <p>Sets the function to add the offset frequency set in $d7-02$ [Offset Frequency 2] to the frequency reference when the terminal activates.</p>	659
46	Add Offset Frequency 3 (d7-03)	<p>V/f OLV OLV/PM AOLV/PM EZOLV</p> <p>Sets the function to add the offset frequency set in $d7-03$ [Offset Frequency 3] to the frequency reference when the terminal activates.</p>	659
47	Node Setup (CANopen)	<p>V/f OLV OLV/PM AOLV/PM EZOLV</p> <p>Sets the function in CANopen communications to start the Node Setup function to set the drive node address from the host controller.</p>	660
60	DC Injection Braking Command	<p>V/f OLV OLV/PM AOLV/PM EZOLV</p> <p>Sets the command to use DC Injection Braking to stop the motor.</p> <p>Note:</p> <p>When $A1-02 = 8$ [Control Method Selection = EZOLV], this function is available with a PM motor.</p>	660
61	Speed Search from Fmax	<p>V/f OLV OLV/PM AOLV/PM EZOLV</p> <p>Sets the function to use an external reference to start speed search although $b3-01 = 0$ [Speed Search Selection at Start = Disabled] to not allow speed search at start.</p> <p>Note:</p> <p>The drive will detect <i>oPE03 [Multi-Function Input Setting Err]</i> when $H1-xx = 61$ [Speed Search from Fmax] and $H1-xx = 62$ [Speed Search from Fref] are set at the same time.</p>	660
62	Speed Search from Fref	<p>V/f OLV OLV/PM AOLV/PM EZOLV</p> <p>Sets the function to use an external reference to start speed search although $b3-01 = 0$ [Speed Search Selection at Start = Disabled] to not allow speed search at start.</p> <p>Note:</p> <p>The drive will detect <i>oPE03 [Multi-Function Input Setting Err]</i> when $H1-xx = 61$ [Speed Search from Fmax] and $H1-xx = 62$ [Speed Search from Fref] are set at the same time.</p>	660
63	Field Weakening	<p>V/f OLV OLV/PM AOLV/PM EZOLV</p> <p>Sets the function to send the Field Weakening Level and Field Weakening Frequency Limit commands set in $d6-01$ [Field Weakening Level] and $d6-02$ [Field Weakening Frequency Limit] when the input terminal is activated.</p>	661
65	KEB Ride-Thru 1 Activate (N.C.)	<p>V/f OLV OLV/PM AOLV/PM EZOLV</p> <p>Sets operation of the KEB1 function through the KEB Ride-Thru 1 (N.C.). ON : Normal operation OFF : Deceleration during momentary power loss</p>	661

Setting Value	Function	Description	Ref.
66	KEB Ride-Thru 1 Activate (N.O.)	V/f OLV OLV/PM AOLV/PM EZOLV Sets operation of the KEB1 function through the KEB Ride-Thru 1 (N.O.). ON : Deceleration during momentary power loss OFF : Normal operation	661
67	Communications Test Mode	V/f OLV OLV/PM AOLV/PM EZOLV Set the function for the drive to self-test RS-485 serial communications operation.	661
68	High Slip Braking (HSB) Activate	V/f OLV OLV/PM AOLV/PM EZOLV Sets the command to use high-slip braking to stop the motor.	661
6 A	Drive Enable	V/f OLV OLV/PM AOLV/PM EZOLV Sets the function to show <i>dnE</i> [<i>Drive Disabled</i>] on the keypad and ignore Run commands when the terminal is OFF.	662
75	Up 2 Command	V/f OLV OLV/PM AOLV/PM EZOLV Sets the function to increase the frequency reference bias value to accelerate the motor when the terminal is activated. Set this function and <i>H1-xx = 76</i> [<i>Down 2 Command</i>] together. Note: When you use this function, set the optimal bias limit values with <i>d4-08</i> and <i>d4-09</i> [<i>Up/Down 2 Bias Upper Limit/Lower Limit</i>].	662
76	Down 2 Command	V/f OLV OLV/PM AOLV/PM EZOLV Sets the function to decrease the frequency reference bias value to decelerate the motor when the terminal is activated. Set this function and <i>H1-xx = 75</i> [<i>Up 2 Command</i>] together. Note: When you use this function, set the optimal bias limit values with <i>d4-08</i> and <i>d4-09</i> [<i>Up/Down 2 Bias Upper Limit/Lower Limit</i>].	663
77	ASR Gain (C5-03) Select	V/f OLV OLV/PM AOLV/PM EZOLV Sets the function to switch the ASR proportional gain to <i>C5-01</i> [<i>ASR Proportional Gain 1</i>] or <i>C5-03</i> [<i>ASR Proportional Gain 2</i>]. ON : C5-03 OFF : C5-01	663
78	Analog TorqueRef Polarity Invert	V/f OLV OLV/PM AOLV/PM EZOLV Sets the rotation direction of the external torque reference. ON : External torque reference reverse direction OFF : External torque reference forward direction	663
7A	KEB Ride-Thru 2 Activate (N.C.)	V/f OLV OLV/PM AOLV/PM EZOLV Sets operation of the KEB2 function through the KEB Ride-Thru 2 (N.C.). ON : Normal operation OFF : Deceleration during momentary power loss	664
7B	KEB Ride-Thru 2 Activate (N.O.)	V/f OLV OLV/PM AOLV/PM EZOLV Sets operation of the KEB2 function through the KEB Ride-Thru 2 (N.O.). ON : Deceleration during momentary power loss OFF : Normal operation	664
7C	Short Circuit Braking (N.O.)	V/f OLV OLV/PM AOLV/PM EZOLV Sets operation of Short Circuit Braking (N.O.). ON : Short Circuit Braking is enabled. OFF : Normal operation Note: When <i>A1-02 = 8</i> [<i>Control Method Selection = EZOLV</i>], this function is available only when you use a PM motor.	664
7D	Short Circuit Braking (N.C.)	V/f OLV OLV/PM AOLV/PM EZOLV Sets operation of Short Circuit Braking (N.C.). ON : Normal operation OFF : Short Circuit Braking is enabled. Note: When <i>A1-02 = 8</i> [<i>Control Method Selection = EZOLV</i>], this function is available only when you use a PM motor.	664
7E	Reverse Rotation Identifier	V/f OLV OLV/PM AOLV/PM EZOLV Sets the motor rotation direction when you use Simple Closed Loop V/f Control method. ON : Reverse run OFF : Forward run	665
90	DWEZ Digital Input 1	V/f OLV OLV/PM AOLV/PM EZOLV Sets the DriveWorksEZ digital input 1. Refer to the DriveWorksEZ online manual for more information.	665
91	DWEZ Digital Input 2	V/f OLV OLV/PM AOLV/PM EZOLV Sets the DriveWorksEZ digital input 2. Refer to the DriveWorksEZ online manual for more information.	665
92	DWEZ Digital Input 3	V/f OLV OLV/PM AOLV/PM EZOLV Sets the DriveWorksEZ digital input 3. Refer to the DriveWorksEZ online manual for more information.	665

11.10 H: Terminal Functions

Setting Value	Function	Description	Ref.
93	DWEZ Digital Input 4	V/f OLV OLV/PM AOLV/PM EZOLV Sets the DriveWorksEZ digital input 4. Refer to the DriveWorksEZ online manual for more information.	665
94	DWEZ Digital Input 5	V/f OLV OLV/PM AOLV/PM EZOLV Sets the DriveWorksEZ digital input 5. Refer to the DriveWorksEZ online manual for more information.	665
95	DWEZ Digital Input 6	V/f OLV OLV/PM AOLV/PM EZOLV Sets the DriveWorksEZ digital input 6. Refer to the DriveWorksEZ online manual for more information.	665
96	DWEZ Digital Input 7	V/f OLV OLV/PM AOLV/PM EZOLV Sets the DriveWorksEZ digital input 7. Refer to the DriveWorksEZ online manual for more information.	665
9F	DWEZ Disable	V/f OLV OLV/PM AOLV/PM EZOLV Sets operation of the DriveWorksEZ program saved in the drive. ON : Disabled OFF : Enabled Note: Set <i>A1-07 = 2</i> [<i>DriveWorksEZ Function Selection = Enabled/Disabled wDigital Input</i>] to use this function.	665
101	!LOCAL/REMOTE Selection	V/f OLV OLV/PM AOLV/PM EZOLV Sets drive control for the keypad (LOCAL) or an external source (REMOTE). ON : REMOTE OFF : LOCAL	665
102	!External Reference 1/2 Selection	V/f OLV OLV/PM AOLV/PM EZOLV Sets the drive to use Run command source 1/2 or Reference command source 1/2 when in REMOTE Mode. ON : <i>b1-01 = [Frequency Reference Selection 1], b1-02 [Run Command Selection 1]</i> OFF : <i>b1-15 = [Frequency Reference Selection 2], b1-16 [Run Command Selection 2]</i>	665
103	!Multi-Step Speed Reference 1	V/f OLV OLV/PM AOLV/PM EZOLV Uses a combination of multi-step speed references 1, 2, 3, and 4 (N.C.) to switch <i>d1-01</i> to <i>d1-16</i> [<i>Reference 1 to 16</i>].	665
104	!Multi-Step Speed Reference 2	V/f OLV OLV/PM AOLV/PM EZOLV Uses a combination of multi-step speed references 1, 2, 3, and 4 (N.C.) to switch <i>d1-01</i> to <i>d1-16</i> [<i>Reference 1 to 16</i>].	665
105	!Multi-Step Speed Reference 3	V/f OLV OLV/PM AOLV/PM EZOLV Uses a combination of multi-step speed references 1, 2, 3, and 4 (N.C.) to switch <i>d1-01</i> to <i>d1-16</i> [<i>Reference 1 to 16</i>].	665
106	!Jog Reference Selection	V/f OLV OLV/PM AOLV/PM EZOLV Sets the drive to use the JOG Frequency Reference (JOG command) set in <i>d1-17</i> [<i>Jog Reference</i>]. The JOG Frequency Reference (JOG command) overrides the <i>d1-01</i> to <i>d1-16</i> [<i>References 1 to 16</i>].	665
107	!Accel/Decel Time Selection 1	V/f OLV OLV/PM AOLV/PM EZOLV Sets the drive to use <i>C1-01, C1-02</i> [<i>Acceleration/Deceleration Time 1</i>] or <i>C1-03, C1-04</i> [<i>Acceleration/Deceleration Time 2</i>].	665
10 A	!Accel/Decel Ramp Hold	V/f OLV OLV/PM AOLV/PM EZOLV Momentarily pauses motor acceleration and deceleration when the terminal deactivates, retains the output frequency that was stored in the drive at the time of the pause, and restarts motor operation.	665
10B	!Overheat Alarm (oH2)	V/f OLV OLV/PM AOLV/PM EZOLV Sets the drive to display an <i>oH2</i> [<i>Drive Overheat Warning</i>] alarm when the input terminal deactivates. The alarm does not have an effect on drive operation.	665
10C	!Analog Terminal Enable Selection	V/f OLV OLV/PM AOLV/PM EZOLV Enables and disables the terminal selected with the <i>H3-14</i> [<i>Analog Input Term Enable Select</i>] function. ON : Input to the terminal selected with <i>H3-14</i> is disabled OFF : Input to the terminal selected with <i>H3-14</i> is enabled	665
10E	!ASR Integral Reset	V/f OLV OLV/PM AOLV/PM EZOLV Sets the command to reset the integral value and use PI control or P control for the speed control loop. ON : PI control OFF : P control	665
110	!Up Command	V/f OLV OLV/PM AOLV/PM EZOLV Set this function and <i>I11</i> [<i>!Down Command</i>] together. Sets the Up command and Down command to use the two push button switches to increase and decrease the drive frequency reference. ON : Holds the current frequency reference. OFF : Increases the frequency reference.	665
111	!Down Command	V/f OLV OLV/PM AOLV/PM EZOLV Set this function and <i>I10</i> [<i>!Up Command</i>] together. Sets the Up command and Down command to use the two push button switches to increase and decrease the drive frequency reference. ON : Holds the current frequency reference. OFF : Decreases the frequency reference.	665

Setting Value	Function	Description	Ref.
114	!Fault Reset	<p>V/f OLV OLV/PM AOLV/PM EZOLV</p> <p>Sets the command to reset the current fault when the Run command is not active.</p> <p>Note: The drive ignores the fault reset command when the Run command is active. Remove the Run command before you try to reset a fault.</p>	665
116	!Motor 2 Selection	<p>V/f OLV OLV/PM AOLV/PM EZOLV</p> <p>Sets the command for the drive to operate motor 1 or motor 2. Stop the motors before switching.</p> <p>ON : Operate motor 1 OFF : Operate motor 2</p>	665
118	!Timer Function	<p>V/f OLV OLV/PM AOLV/PM EZOLV</p> <p>Sets the command to start the timer function. Use this setting with $H2-xx = 112$ [!Timer Output].</p>	665
119	!PID Disable	<p>V/f OLV OLV/PM AOLV/PM EZOLV</p> <p>Sets the command to disable PID control with an external input when $b5-01 = 1$ to 8 [PID Function Setting = Enabled].</p> <p>ON : PID control enabled OFF : PID control disabled</p>	665
11 A	!Accel/Decel Time Selection 2	<p>V/f OLV OLV/PM AOLV/PM EZOLV</p> <p>Set this function and $H1-xx = 107$ [!Accel/Decel Time Selection 1] together. Sets the drive to use $C1-01$ to $C1-08$ [Acceleration/Deceleration Times 1 to 4].</p>	665
11B	!Programming Lockout	<p>V/f OLV OLV/PM AOLV/PM EZOLV</p> <p>Sets the command to prevent parameter changes when the terminal is OFF. You can continue to view parameter setting values when the terminal is ON [Parameter Write Prohibit].</p> <p>ON : Parameter Write Prohibit OFF : Programming Lockout</p>	665
11E	!Reference Sample Hold	<p>V/f OLV OLV/PM AOLV/PM EZOLV</p> <p>Sets the command to sample the frequency reference at terminal A1 or A2, and hold the frequency reference at that frequency.</p>	665
130	!PID Integrator Reset	<p>V/f OLV OLV/PM AOLV/PM EZOLV</p> <p>Sets the command to reset and hold the PID control integral to 0 when the terminal deactivates.</p>	665
131	!PID Integrator Hold	<p>V/f OLV OLV/PM AOLV/PM EZOLV</p> <p>Sets the command to hold the integral value of the PID control while the terminal deactivates.</p>	665
132	!Multi-Step Speed Reference 4	<p>V/f OLV OLV/PM AOLV/PM EZOLV</p> <p>Uses a combination of multi-step speed references 1, 2, 3, and 4 (N.C.) to switch $d1-01$ to $d1-16$ [Reference 1 to 16].</p>	665
134	!PID Soft Starter Disable	<p>V/f OLV OLV/PM AOLV/PM EZOLV</p> <p>Sets the PID soft starter function.</p> <p>ON : Enabled OFF : Disable</p>	665
135	!PID Input (Error) Invert	<p>V/f OLV OLV/PM AOLV/PM EZOLV</p> <p>Sets the command to turn the terminal ON and OFF to switch the PID input level (polarity).</p>	665
13E	!PID Setpoint Selection 1	<p>V/f OLV OLV/PM AOLV/PM EZOLV</p> <p>Set this function and $H1-xx = 13F$ [!PID Setpoint Selection 2] together. Sets the function to use the PID setpoint set in $b5-58$ to $b5-60$ [PID setpoint2 to 4].</p>	665
13F	!PID Setpoint Selection 2	<p>V/f OLV OLV/PM AOLV/PM EZOLV</p> <p>Set this function and $H1-xx = 13E$ [!PID Setpoint Selection 1] together. Sets the function to use the PID setpoint set in $b5-58$ to $b5-60$ [PID setpoint2 to 4].</p>	665
144	!Add Offset Frequency 1 (d7-01)	<p>V/f OLV OLV/PM AOLV/PM EZOLV</p> <p>Sets the function to add the offset frequency set in $d7-01$ to the frequency reference when the terminal deactivates.</p>	665
145	!Add Offset Frequency 2 (d7-02)	<p>V/f OLV OLV/PM AOLV/PM EZOLV</p> <p>Sets the function to add the offset frequency set in $d7-02$ to the frequency reference when the terminal deactivates.</p>	665
146	!Add Offset Frequency 3 (d7-03)	<p>V/f OLV OLV/PM AOLV/PM EZOLV</p> <p>Sets the function to add the offset frequency set in $d7-03$ to the frequency reference when the terminal deactivates.</p>	665
147	!Node Setup (CANopen)	<p>V/f OLV OLV/PM AOLV/PM EZOLV</p> <p>Sets the function in CANopen communications to start the Node Setup function to set the drive node address from the host controller.</p>	665
160	!DC Injection Braking Command	<p>V/f OLV OLV/PM AOLV/PM EZOLV</p> <p>Sets the command to use DC Injection Braking to stop the motor.</p> <p>Note: When $A1-02 = 8$ [Control Method Selection = EZ Vector Control], this function is available if you use a PM motor.</p>	665

11.10 H: Terminal Functions

Setting Value	Function	Description	Ref.
161	!Speed Search from Fmax	<p><input type="checkbox"/> V/f <input type="checkbox"/> OLV <input type="checkbox"/> OLV/PM <input type="checkbox"/> AOLV/PM <input type="checkbox"/> EZOLV</p> <p>Sets the function to use an external reference to start speed search although <i>b3-01 = 0 [Speed Search Selection at Start = Disabled]</i> to not allow speed search at start.</p> <p>Note: The drive will detect <i>oPE03 [Multi-Function Input Setting Err]</i> when <i>H1-xx = 161 [!Speed Search from Fmax]</i> and <i>H1-xx = 162 [!Speed Search from Fref]</i> are set at the same time.</p>	665
162	!Speed Search from Fref	<p><input type="checkbox"/> V/f <input type="checkbox"/> OLV <input type="checkbox"/> OLV/PM <input type="checkbox"/> AOLV/PM <input type="checkbox"/> EZOLV</p> <p>Sets the function to use an external reference to start speed search although <i>b3-01 = 0 [Speed Search Selection at Start = Disabled]</i> to not allow speed search at start.</p> <p>Note: The drive will detect <i>oPE03 [Multi-Function Input Setting Err]</i> when <i>H1-xx = 161 [!Speed Search from Fmax]</i> and <i>H1-xx = 162 [!Speed Search from Fref]</i> are set at the same time.</p>	665
163	!Field Weakening	<p><input type="checkbox"/> V/f <input type="checkbox"/> OLV <input type="checkbox"/> OLV/PM <input type="checkbox"/> AOLV/PM <input type="checkbox"/> EZOLV</p> <p>Sets the function to send the Field Weakening Level and Field Weakening Frequency Limit commands set in <i>d6-01</i> and <i>d6-02</i> when the input terminal deactivates.</p>	665
167	!Communications Test Mode	<p><input type="checkbox"/> V/f <input type="checkbox"/> OLV <input type="checkbox"/> OLV/PM <input type="checkbox"/> AOLV/PM <input type="checkbox"/> EZOLV</p> <p>Set the function for the drive to self-test RS-485 serial communications operation.</p>	665
168	!High Slip Braking (HSB) Activate	<p><input type="checkbox"/> V/f <input type="checkbox"/> OLV <input type="checkbox"/> OLV/PM <input type="checkbox"/> AOLV/PM <input type="checkbox"/> EZOLV</p> <p>Sets the command to use high-slip braking to stop the motor.</p>	665
16 A	!Drive Enable	<p><input type="checkbox"/> V/f <input type="checkbox"/> OLV <input type="checkbox"/> OLV/PM <input type="checkbox"/> AOLV/PM <input type="checkbox"/> EZOLV</p> <p>Sets the function to show <i>dnE [Drive Enabled]</i> on the keypad and ignore Run commands when the terminal activates.</p>	665
175	!Up 2 Command	<p><input type="checkbox"/> V/f <input type="checkbox"/> OLV <input type="checkbox"/> OLV/PM <input type="checkbox"/> AOLV/PM <input type="checkbox"/> EZOLV</p> <p>When the terminal deactivates, the motor accelerates by increasing the frequency reference bias value. Set !Up 2 Command and !Down 2 Command together.</p> <p>Note: When you use the functions, set the optimal bias limit values with <i>d4-08</i> and <i>d4-09 [Up/Down 2 Bias Upper Limit/Lower Limit (Up/Down 2)]</i>.</p>	665
176	!Down 2 Command	<p><input type="checkbox"/> V/f <input type="checkbox"/> OLV <input type="checkbox"/> OLV/PM <input type="checkbox"/> AOLV/PM <input type="checkbox"/> EZOLV</p> <p>When the terminal deactivates, the motor decelerates by decreasing the frequency reference bias value. Set !Up 2 Command and !Down 2 Command together.</p> <p>Note: When you use the functions, set the optimal bias limit values with <i>d4-08</i> and <i>d4-09 [Up/Down 2 Bias Upper Limit/Lower Limit (Up/Down 2)]</i>.</p>	665
177	!ASR Gain (C5-03) Select	<p><input type="checkbox"/> V/f <input type="checkbox"/> OLV <input type="checkbox"/> OLV/PM <input type="checkbox"/> AOLV/PM <input type="checkbox"/> EZOLV</p> <p>Sets the function to switch the ASR proportional gain to <i>C5-01 [ASR Proportional Gain 1]</i> or <i>C5-03 [ASR Proportional Gain 2]</i>.</p> <p>ON : C5-01 OFF : C5-03</p>	665
178	!Analog TorqueRef Polarity Invert	<p><input type="checkbox"/> V/f <input type="checkbox"/> OLV <input type="checkbox"/> OLV/PM <input type="checkbox"/> AOLV/PM <input type="checkbox"/> EZOLV</p> <p>Sets the rotation direction of the external torque reference.</p> <p>ON : External torque reference forward direction OFF : External torque reference reverse direction</p>	665
17E	!Reverse Rotation Identifier	<p><input type="checkbox"/> V/f <input type="checkbox"/> OLV <input type="checkbox"/> OLV/PM <input type="checkbox"/> AOLV/PM <input type="checkbox"/> EZOLV</p> <p>Sets the motor rotation direction when you use Simple Closed Loop V/f Control method.</p> <p>ON : Forward run OFF : Reverse run</p>	665
17F	!PID Bi-Directional Enable	<p><input type="checkbox"/> V/f <input type="checkbox"/> OLV <input type="checkbox"/> OLV/PM <input type="checkbox"/> AOLV/PM <input type="checkbox"/> EZOLV</p> <p>Switches the PID Bi-Directional output to enable or disable.</p> <p>ON : Disable OFF : Enabled</p>	665
19F	!DWEZ Disable	<p><input type="checkbox"/> V/f <input type="checkbox"/> OLV <input type="checkbox"/> OLV/PM <input type="checkbox"/> AOLV/PM <input type="checkbox"/> EZOLV</p> <p>Switches the DriveWorksEZ program saved in the drive to enable or disable.</p> <p>ON : Enabled OFF : Disable</p> <p>Note: Set <i>A1-07 = 2 [DriveWorksEZ Function Selection = Digital input]</i> to use this function.</p>	665

◆ H2: Digital Outputs

No. (Hex.)	Name	Description	Default (Range)	Ref.
H2-01 (040B)	Term MA/MB-MC Function Selection	<p>V/f OLV OLV/PM AOLV/PM EZOLV</p> <p>Sets the function set for MFDO terminal MA-MC or MB-MC.</p> <p>Note: Set this parameter to <i>F</i> when the terminal is not being used or to use the terminal in through mode.</p>	E (0 - 1FF)	668
H2-02 (040C)	Term P1-C1 Function Selection	<p>V/f OLV OLV/PM AOLV/PM EZOLV</p> <p>Sets the function for MFDO terminal P1-C1.</p> <p>Note: Set this parameter to <i>F</i> when the terminal is not being used or to use the terminal in through mode.</p>	0 (0 - 1FF)	668
H2-03 (040D)	Term P2-C2 Function Selection	<p>V/f OLV OLV/PM AOLV/PM EZOLV</p> <p>Sets the function for MFDO terminal P2-C2.</p> <p>Note: Set this parameter to <i>F</i> when the terminal is not being used or to use the terminal in through mode.</p>	2 (0 - 1FF)	668
H2-06 (0437)	Watt Hour Output Unit Selection	<p>V/f OLV OLV/PM AOLV/PM EZOLV</p> <p>Sets the unit for the output signal when <i>H2-01 to H2-03 = 39</i> [MFDO Function Selection = Watt Hour Pulse Output].</p> <p>0 : 0.1 kWh units 1 : 1 kWh units 2 : 10 kWh units 3 : 100 kWh units 4 : 1000 kWh units</p>	0 (0 - 4)	668
H2-07 (0B3A)	Modbus Register 1 Address Select	<p>V/f OLV OLV/PM AOLV/PM EZOLV</p> <p>Sets the address of the MEMOBUS/Modbus register output to the MFDO terminal.</p>	0001 (0001 - 1FFF)	669
H2-08 (0B3B)	Modbus Register 1 Bit Select	<p>V/f OLV OLV/PM AOLV/PM EZOLV</p> <p>Sets the bit of the MEMOBUS/Modbus register output to the MFDO terminal.</p>	0000 (0000 - FFFF)	669
H2-09 (0B3C)	Modbus Register 2 Address Select	<p>V/f OLV OLV/PM AOLV/PM EZOLV</p> <p>Sets the address of the MEMOBUS/Modbus register output to the MFDO terminal.</p>	0001 (0001 - 1FFF)	669
H2-10 (0B3D)	Modbus Register 2 Bit Select	<p>V/f OLV OLV/PM AOLV/PM EZOLV</p> <p>Sets the bit of the MEMOBUS/Modbus register output to the MFDO terminal.</p>	0000 (0000 - FFFF)	669
H2-20 (1540)	Comparator 1 Monitor Selection	<p>V/f OLV OLV/PM AOLV/PM EZOLV</p> <p>Sets the monitor number for comparator 1. Set the <i>x-xx</i> part of the <i>Ux-xx</i> [Monitor]. For example, set <i>H2-20 = 102</i> to monitor <i>U1-02</i> [Output Frequency].</p>	102 (000 - 999)	669
H2-21 (1541)	Comparator 1 Lower Limit	<p>V/f OLV OLV/PM AOLV/PM EZOLV</p> <p>Sets the lower limit detection level for comparator 1 when the full scale analog output for the monitor selected in <i>H2-20</i> [Comparator 1 Monitor Selection] is the 100% value.</p>	0.0% (0.0 - 300.0%)	669
H2-22 (1542)	Comparator 1 Upper Limit	<p>V/f OLV OLV/PM AOLV/PM EZOLV</p> <p>Sets the upper limit detection level for comparator 1 when the full scale analog output for the monitor selected in <i>H2-20</i> [Comparator 1 Monitor Selection] is the 100% value.</p>	0.0% (0.0 - 300.0%)	670
H2-23 (1543)	Comparator 1 Hysteresis	<p>V/f OLV OLV/PM AOLV/PM EZOLV</p> <p>Sets the hysteresis level for comparator 1 as a percentage of the full scale analog output for the monitor selected in <i>H2-20</i> [Comparator 1 Monitor Selection].</p>	0.0% (0.0 - 10.0%)	670
H2-24 (1544)	Comparator 1 On-Delay Time	<p>V/f OLV OLV/PM AOLV/PM EZOLV</p> <p>Sets the on-delay time for comparator 1.</p>	0.0 s (0.0 - 600.0 s)	670
H2-25 (1545)	Comparator 1 Off-Delay Time	<p>V/f OLV OLV/PM AOLV/PM EZOLV</p> <p>Sets the off-delay time for comparator 1.</p>	0.0 s (0.0 - 600.0 s)	670
H2-26 (1546)	Comparator 2 Monitor Selection	<p>V/f OLV OLV/PM AOLV/PM EZOLV</p> <p>Sets the monitor number for comparator 2. Set the <i>x-xx</i> part of the <i>Ux-xx</i> [Monitor]. For example, set <i>H2-26 = 103</i> to monitor <i>U1-03</i> [Output Current].</p>	103 (000 - 999)	670
H2-27 (1547)	Comparator 2 Lower Limit	<p>V/f OLV OLV/PM AOLV/PM EZOLV</p> <p>Sets the lower limit detection level for comparator 2 as a percentage of the full scale analog output for the monitor selected in <i>H2-26</i> [Comparator 2 Monitor Selection].</p>	0.0% (0.0 - 300.0%)	670
H2-28 (1548)	Comparator 2 Upper Limit	<p>V/f OLV OLV/PM AOLV/PM EZOLV</p> <p>Sets the upper limit detection level for comparator 2 as a percentage of the full scale analog output for the monitor selected in <i>H2-26</i> [Comparator 2 Monitor Selection].</p>	0.0% (0.0 - 300.0%)	671
H2-29 (1549)	Comparator 2 Hysteresis	<p>V/f OLV OLV/PM AOLV/PM EZOLV</p> <p>Sets the hysteresis level for comparator 2 as a percentage of the full scale analog output for the monitor selected in <i>H2-26</i> [Comparator 2 Monitor Selection].</p>	0.0% (0.0 - 10.0%)	671

11.10 H: Terminal Functions

No. (Hex.)	Name	Description	Default (Range)	Ref.
H2-30 (154A)	Comparator 2 On-Delay Time	V/f OLV OLV/PM AOLV/PM EZOLV Sets the on-delay time for comparator 2.	0.0 s (0.0 - 600.0 s)	671
H2-31 (154B)	Comparator 2 Off-Delay Time	V/f OLV OLV/PM AOLV/PM EZOLV Sets the off-delay time for comparator 2.	0.0 s (0.0 - 600.0 s)	671
H2-32 (159A)	Comparator 1 Filter Time	V/f OLV OLV/PM AOLV/PM EZOLV Sets the time constant that is applied to the primary delay filter used for the analog output of the monitor selected with H2-20 [Comparator 1 Monitor Selection].	0.0s (0.0 - 10.0 s)	671
H2-33 (159B)	Comparator1 Protection Selection	V/f OLV OLV/PM AOLV/PM EZOLV Sets drive operation when it detects CP1 [Comparator1 Limit Fault]. 0 : Ramp to Stop 1 : Coast to Stop 2 : Fast Stop (Use C1-09) 3 : Alarm Only 4 : Digital Output Only	4 (0 - 4)	671
H2-34 (159C)	Comparator 2 Filter Time	V/f OLV OLV/PM AOLV/PM EZOLV Sets the time constant that is applied to the primary delay filter used for the analog output of the monitor selected with H2-26 [Comparator 2 Monitor Selection].	0.0s (0.0 - 10.0 s)	672
H2-35 (159D)	Comparator2 Protection Selection	V/f OLV OLV/PM AOLV/PM EZOLV Sets drive operation when it detects CP2 [Comparator2 Limit Fault]. 0 : Ramp to Stop 1 : Coast to Stop 2 : Fast Stop (Use C1-09) 3 : Alarm Only 4 : Digital Output Only	4 (0 - 4)	672
H2-36 (159E)	Comparator 1 Ineffective Time	V/f OLV OLV/PM AOLV/PM EZOLV Sets the length of time that CP1 [Comparator1 Limit Fault] is disabled.	0.0 s (0.0 - 1000.0 s)	672
H2-37 (159F)	Comparator 2 Ineffective Time	V/f OLV OLV/PM AOLV/PM EZOLV Sets the length of time that CP2 [Comparator2 Limit Fault] is disabled.	0.0 s (0.0 - 1000.0 s)	673
H2-40 (0B58)	Mbus Reg 15E0h bit0 Output Func	V/f OLV OLV/PM AOLV/PM EZOLV Sets the MFDO for bit 0 of MEMOBUS register 15E0 (Hex.).	F (0 - 1FF)	673
H2-41 (0B59)	Mbus Reg 15E0h bit1 Output Func	V/f OLV OLV/PM AOLV/PM EZOLV Sets the MFDO for bit 1 of MEMOBUS register 15E0 (Hex.).	F (0 - 1FF)	673
H2-42 (0B5A)	Mbus Reg 15E0h bit2 Output Func	V/f OLV OLV/PM AOLV/PM EZOLV Sets the MFDO for bit 2 of MEMOBUS register 15E0 (Hex.).	F (0 - 1FF)	673
H2-60 (1B46) Expert	Term MA,MB,MC Secondary Function	V/f OLV OLV/PM AOLV/PM EZOLV Sets the second function for terminal MA/MB-MC. Outputs the logical calculation results of the terminals set to functions by H2-01 [Term MA,MB,MC Function Selection].	F (0 - FF)	673
H2-61 (1B47) Expert	Term MA,MB,MC Logical Operation	V/f OLV OLV/PM AOLV/PM EZOLV Sets the logical operation for the functions set in H2-01 [Term MA,MB,MC Function Selection] and H2-60 [Term MA,MB,MC Secondary Function].	0 (0 - 8)	673
H2-62 (1B48) Expert	Term MA,MB,MC Minimum ON Time	V/f OLV OLV/PM AOLV/PM EZOLV Sets the minimum ON time that the drive uses to output the logical calculation results from terminal MA/MB-MC.	0.1 s (0.0 - 25.0 s)	673
H2-63 (1B49) Expert	Terminal P1 Secondary Function	V/f OLV OLV/PM AOLV/PM EZOLV Sets the second function for terminal P1-C1. Outputs the logical calculation results of the terminals set to functions by H2-02 [Term P1 Function Selection].	F (0 - FF)	674
H2-64 (1B4A) Expert	Terminal P1 Logical Operation	V/f OLV OLV/PM AOLV/PM EZOLV Sets the logical operation for the functions set in H2-02 [Term P1 Function Selection] and H2-63 [Terminal P1 Secondary Function].	0 (0 - 8)	674
H2-65 (1B4B) Expert	Terminal P1 Minimum ON Time	V/f OLV OLV/PM AOLV/PM EZOLV Sets the minimum ON time used to output the logical calculation results from terminal P1-C1.	0.1 s (0.0 - 25.0 s)	674
H2-66 (1B4C) Expert	Terminal P2 Secondary Function	V/f OLV OLV/PM AOLV/PM EZOLV Sets the second function for terminal P2-C2. Outputs the logical calculation results of the terminals assigned to functions by H2-03 [Term P2 Function Selection].	F (0 - FF)	674

No. (Hex.)	Name	Description	Default (Range)	Ref.
H2-67 (1B4D) Expert	Terminal P2 Logical Operation	V/f OLV OLV/PM AOLV/PM EZOLV Sets the logical operation for the functions set in H2-03 [Term P2 Function Selection] and H2-66 [Terminal P2 Secondary Function].	0 (0 - 8)	674
H2-68 (1B4E) Expert	Terminal P2 Minimum ON Time	V/f OLV OLV/PM AOLV/PM EZOLV Sets the minimum ON time used to output the logical calculation results from terminal P2-C2.	0.1 s (0.0 - 25.0 s)	674

■ H2-xx: MFDO Setting Values

Setting Value	Function	Description	Ref.																		
0	During Run	V/f OLV OLV/PM AOLV/PM EZOLV The terminal activates when you input a Run command and when the drive is outputting voltage. ON : Drive is running OFF : Drive is stopping	675																		
1	Zero Speed	V/f OLV OLV/PM AOLV/PM EZOLV The terminal activates when the output frequency is less than E1-09 [Minimum Output Frequency] or b2-01 [DC Injection/Zero SpeedThreshold]. Note: Parameter A1-02 [Control Method Selection] selects which parameter is the reference. <table border="1" style="width: 100%; border-collapse: collapse;"> <thead> <tr> <th>A1-02 Setting</th> <th>Control Method Selection</th> <th>Parameter Used as the Reference</th> </tr> </thead> <tbody> <tr> <td>0</td> <td>V/f</td> <td>E1-09</td> </tr> <tr> <td>2</td> <td>OLV</td> <td>b2-01</td> </tr> <tr> <td>5</td> <td>OLV/PM</td> <td>E1-09</td> </tr> <tr> <td>6</td> <td>AOLV/PM</td> <td>E1-09</td> </tr> <tr> <td>8</td> <td>EZOLV</td> <td>E1-09</td> </tr> </tbody> </table> ON : Output frequency < value of E1-09 or b2-01. OFF : Output frequency ≥ E1-09 or b2-01.	A1-02 Setting	Control Method Selection	Parameter Used as the Reference	0	V/f	E1-09	2	OLV	b2-01	5	OLV/PM	E1-09	6	AOLV/PM	E1-09	8	EZOLV	E1-09	675
A1-02 Setting	Control Method Selection	Parameter Used as the Reference																			
0	V/f	E1-09																			
2	OLV	b2-01																			
5	OLV/PM	E1-09																			
6	AOLV/PM	E1-09																			
8	EZOLV	E1-09																			
2	Speed Agree 1	V/f OLV OLV/PM AOLV/PM EZOLV The terminal activates when the output frequency is in the range of the frequency reference ± L4-02 [Speed Agree Detection Width]. ON : The output frequency is in the range of "frequency reference ± L4-02". OFF : The output frequency does not align with the frequency reference although the drive is running.	675																		
3	User-Set Speed Agree 1	V/f OLV OLV/PM AOLV/PM EZOLV The terminal activates when the output frequency is in the range of L4-01 [Speed Agree Detection Level] ± L4-02 [Speed Agree Detection Width] and in the range of the frequency reference ± L4-02. Note: The detection function operates in the two motor rotation directions. The drive uses the L4-01 value as the forward/reverse detection level. ON : The output frequency is in the range as defined by the result of "L4-01 ± L4-02" and the range of frequency reference ± L4-02. OFF : The output frequency is not in the range of "L4-01 ± L4-02" nor the range of frequency reference ± L4-02.	676																		
4	Frequency Detection 1	V/f OLV OLV/PM AOLV/PM EZOLV The terminal deactivates when the output frequency is higher than the value of L4-01 [Speed Agree Detection Level] + L4-02 [Speed Agree Detection Width]. After the terminal deactivates, the terminal stays deactivated until the output frequency = L4-01. Note: The detection function operates in the two motor rotation directions. The drive uses the L4-01 value as the forward/reverse detection level. ON : The output frequency is less than L4-01 or is not more than L4-01 + L4-02. OFF : The output frequency is more than L4-01 + L4-02.	676																		
5	Frequency Detection 2	V/f OLV OLV/PM AOLV/PM EZOLV The terminal activates when the output frequency is higher than the value of L4-01 [Speed Agree Detection Level]. After the terminal activates, the terminal stays activated until the output frequency is at the value of L4-01 - L4-02. Note: The detection function operates in the two motor rotation directions. The drive uses the L4-01 value as the forward/reverse detection level. ON : The output frequency is more than L4-01. OFF : The output frequency is less than "L4-01 - L4-02," or it is not more than L4-01.	677																		
6	Drive Ready	V/f OLV OLV/PM AOLV/PM EZOLV The terminal activates when the drive is ready and running.	677																		

11.10 H: Terminal Functions

Setting Value	Function	Description	Ref.
7	DC Bus Undervoltage	<p>V/f OLV OLV/PM AOLV/PM EZOLV</p> <p>The terminal activates when the DC bus voltage or control circuit power supply is at the voltage set in L2-05 [Undervoltage Detection Lvl (Uv1)] or less. The terminal also activates when there is a fault with the DC bus voltage. ON : The DC bus voltage \leq L2-05 OFF : The DC bus voltage $>$ L2-05</p>	678
8	During Baseblock (N.O.)	<p>V/f OLV OLV/PM AOLV/PM EZOLV</p> <p>The terminal activates during baseblock. When the drive is in baseblock, the drive output transistor stops switching and does not make DC bus voltage. ON : During baseblock OFF : The drive is not in baseblock.</p>	678
9	Frequency Reference from Keypad	<p>V/f OLV OLV/PM AOLV/PM EZOLV</p> <p>Shows the selected frequency reference source. ON : The keypad is the frequency reference source. OFF : Parameter b1-01 or b1-15 [Frequency Reference Selection 1 or 2] is the frequency reference source.</p>	678
A	Run Command Source	<p>V/f OLV OLV/PM AOLV/PM EZOLV</p> <p>Shows the selected Run command source. ON : The keypad is the Run command source. OFF : Parameter b1-02 or b1-16 [Run Command Selection 1 or 2] is the Run command source.</p>	678
B	Torque Detection 1 (N.O.)	<p>V/f OLV OLV/PM AOLV/PM EZOLV</p> <p>The terminal activates when the drive detects overtorque or undertorque. ON : The output current/torque $>$ L6-02 [Torque Detection Level 1], or the output current/torque $<$ L6-02 for longer than the time set in L6-03 [Torque Detection Time 1].</p>	678
C	Frequency Reference Loss	<p>V/f OLV OLV/PM AOLV/PM EZOLV</p> <p>The terminal activates when the drive detects a loss of frequency reference.</p>	678
D	Braking Resistor Fault	<p>V/f OLV OLV/PM AOLV/PM EZOLV</p> <p>The terminal activates when the mounting-type braking resistor is overheating or when there is a braking transistor fault.</p>	679
E	Fault	<p>V/f OLV OLV/PM AOLV/PM EZOLV</p> <p>The terminal activates when the drive detects a fault. Note: The terminal will not activate for CPF00 and CPF01 [Control Circuit Error] faults.</p>	679
F	Not Used	<p>V/f OLV OLV/PM AOLV/PM EZOLV</p> <p>Use this setting for unused terminals or to use terminals in through mode. Also use this setting as the PLC contact output via MEMOBUS/Modbus or the communication option. This signal does not function if you do not configure signals from the PLC.</p>	679
10	Alarm	<p>V/f OLV OLV/PM AOLV/PM EZOLV</p> <p>The terminal activates when the drive detects a minor fault.</p>	679
11	Fault Reset Command Active	<p>V/f OLV OLV/PM AOLV/PM EZOLV</p> <p>The terminal activates when the drive receives the Reset command from the control circuit terminal, serial communications, or the communication option.</p>	679
12	Timer Output	<p>V/f OLV OLV/PM AOLV/PM EZOLV</p> <p>Sets the terminal as the timer output. Use this setting with the timer input set in H1-xx = 18 [MFDI Function Selection = Timer Function].</p>	679
13	Speed Agree 2	<p>V/f OLV OLV/PM AOLV/PM EZOLV</p> <p>The terminal activates when the output frequency is in the range of the frequency reference \pm L4-04 [Speed Agree Detection Width(+/-)]. Note: The detection function operates in the two motor rotation directions. ON : The output frequency is in the range of "frequency reference \pm L4-04". OFF : The output frequency is not in the range of "frequency reference \pm L4-04".</p>	679
14	User-Set Speed Agree 2	<p>V/f OLV OLV/PM AOLV/PM EZOLV</p> <p>The terminal activates when the output frequency is in the range of L4-03 [Speed Agree Detection Level(+/-)] \pm L4-04 [Speed Agree Detection Width(+/-)] and in the range of the frequency reference \pm L4-04. Note: The detection level set in L4-03 is a signed value. The drive will only detect in one direction. ON : The output frequency is in the range as defined by the result of "L4-03 \pm L4-04" and the range of frequency reference \pm L4-04. OFF : The output frequency is not in the range of "L4-03 \pm L4-04" nor the range of frequency reference \pm L4-04.</p>	680

Setting Value	Function	Description	Ref.
15	Frequency Detection 3	<p>V/f OLV OLV/PM AOLV/PM EZOLV</p> <p>The terminal deactivates when the output frequency is more than "$L4-03$ [<i>Speed Agree Detection Level(+/-)</i>] + $L4-04$ [<i>Speed Agree Detection Width(+/-)</i>]". After the terminal deactivates, the terminal stays deactivated until the output frequency is at the value of $L4-03$.</p> <p>Note: The detection level set in $L4-03$ is a signed value. The drive will only detect in one direction. ON : The output frequency is less than $L4-03$ or is not more than $L4-03 + L4-04$. OFF : The output frequency is higher than $L4-03 + L4-04$.</p>	680
16	Frequency Detection 4	<p>V/f OLV OLV/PM AOLV/PM EZOLV</p> <p>The terminal activates when the output frequency is higher than the value of $L4-03$ [<i>Speed Agree Detection Level(+/-)</i>]. After the terminal activates, the terminal stays activated until the output frequency = $L4-03 - L4-04$.</p> <p>Note: The detection level set in $L4-03$ is a signed value. The drive will only detect in one direction. ON : The output frequency is more than $L4-03$. OFF : The output frequency is less than "$L4-03 - L4-04$," or it is not more than $L4-03$.</p>	681
17	Torque Detection 1 (N.C.)	<p>V/f OLV OLV/PM AOLV/PM EZOLV</p> <p>The terminal deactivates when the drive detects overtorque or undertorque. OFF : The output current/torque > $L6-02$ [<i>Torque Detection Level 1</i>], or the output current/torque < $L6-02$ for longer than the time set in $L6-03$ [<i>Torque Detection Time 1</i>].</p>	681
18	Torque Detection 2 (N.O.)	<p>V/f OLV OLV/PM AOLV/PM EZOLV</p> <p>The terminal activates when the drive detects overtorque or undertorque. ON : The output current/torque > $L6-05$ [<i>Torque Detection Level 2</i>], or the output current/torque < $L6-05$ for longer than the time set in $L6-06$ [<i>Torque Detection Time 2</i>].</p>	681
19	Torque Detection 2 (N.C.)	<p>V/f OLV OLV/PM AOLV/PM EZOLV</p> <p>The terminal deactivates when the drive detects overtorque or undertorque. OFF : The output current/torque > $L6-05$ [<i>Torque Detection Level 2</i>], or the output current/torque < $L6-05$ for longer than the time set in $L6-06$ [<i>Torque Detection Time 2</i>].</p>	682
1A	During Reverse	<p>V/f OLV OLV/PM AOLV/PM EZOLV</p> <p>The terminal activates when the motor operates in the reverse direction. ON : The motor is operating in the reverse direction. OFF : The motor is operating in the forward direction or the motor stopped.</p>	682
1B	During Baseblock (N.C.)	<p>V/f OLV OLV/PM AOLV/PM EZOLV</p> <p>The terminal deactivates during baseblock. When the drive is in baseblock, the drive output transistor stops switching and does not make DC bus voltage. ON : The drive is not in baseblock. OFF : During baseblock</p>	682
1C	Motor 2 Selected	<p>V/f OLV OLV/PM AOLV/PM EZOLV</p> <p>The terminal activates when you select motor 2. ON : Motor 2 Selected OFF : Motor 1 Selected</p>	682
1E	Executing Auto-Restart	<p>V/f OLV OLV/PM AOLV/PM EZOLV</p> <p>The terminal activates when the Auto Restart function is trying to restart after a fault.</p>	683
1F	Motor Overload Alarm (oL1)	<p>V/f OLV OLV/PM AOLV/PM EZOLV</p> <p>The terminal activates when the electronic thermal protection value of the motor overload protective function is a minimum of 90% of the detection level.</p>	683
20	Drive Overheat Pre-Alarm (oH)	<p>V/f OLV OLV/PM AOLV/PM EZOLV</p> <p>The terminal activates when the drive heatsink temperature is at the level set with $L8-02$ [<i>Overheat Alarm Level</i>].</p>	683
21	Safe Torque OFF	<p>V/f OLV OLV/PM AOLV/PM EZOLV</p> <p>The terminal activates (safety stop state) when the safety circuit and safety diagnosis circuit are operating correctly and when terminals H1-HC and H2-HC are OFF (Open). ON : Safety stop state OFF : Safety circuit fault or RUN/READY</p>	683
22	Mechanical Weakening Detection	<p>V/f OLV OLV/PM AOLV/PM EZOLV</p> <p>The terminal activates when the drive detects mechanical weakening.</p>	683
2F	Maintenance Notification	<p>V/f OLV OLV/PM AOLV/PM EZOLV</p> <p>The terminal activates when drive components are at their estimated maintenance period. Tells you about the maintenance period for these items:</p> <ul style="list-style-type: none"> • IGBT • Cooling Fan • Capacitor • Soft charge bypass relay 	683
30	During Torque Limit	<p>V/f OLV OLV/PM AOLV/PM EZOLV</p> <p>The terminal activates when the torque reference is the torque limit set with $L7$ parameters or $H3-02$ or $H3-10$ [<i>MFAI Function Selection</i>].</p>	684

11.10 H: Terminal Functions

Setting Value	Function	Description	Ref.
37	During Frequency Output	<p>V/f OLV OLV/PM AOLV/PM EZOLV</p> <p>The terminal activates when the drive outputs frequency. ON : The drive is outputting frequency. OFF : The drive is not outputting frequency.</p>	684
38	Drive Enabled	<p>V/f OLV OLV/PM AOLV/PM EZOLV</p> <p>This terminal activates when the $H1-xx = 6A$ [Drive Enable] terminal activates.</p>	684
39	Watt Hour Pulse Output	<p>V/f OLV OLV/PM AOLV/PM EZOLV</p> <p>Outputs the pulse that shows the watt hours.</p>	684
3C	LOCAL Control Selected	<p>V/f OLV OLV/PM AOLV/PM EZOLV</p> <p>The terminal activates when the Run command source or frequency reference source is LOCAL. ON : LOCAL OFF : REMOTE</p>	685
3D	During Speed Search	<p>V/f OLV OLV/PM AOLV/PM EZOLV</p> <p>The terminal activates when the drive is doing speed search.</p>	685
3E	PID Feedback Low	<p>V/f OLV OLV/PM AOLV/PM EZOLV</p> <p>The terminal activates when the drive detects FbL [PID Feedback Loss].</p>	685
3F	PID Feedback High	<p>V/f OLV OLV/PM AOLV/PM EZOLV</p> <p>The terminal activates when the drive detects FbH [Excessive PID Feedback].</p>	685
4 A	During KEB Ride-Thru	<p>V/f OLV OLV/PM AOLV/PM EZOLV</p> <p>The activates during KEB Ride-Thru.</p>	685
4B	During Short Circuit Braking	<p>V/f OLV OLV/PM AOLV/PM EZOLV</p> <p>The terminal activates during Short Circuit Braking. Note: When $A1-02 = 8$ [Control Method Selection = EZOLV], this function is available only when you use a PM motor.</p>	685
4C	During Fast Stop	<p>V/f OLV OLV/PM AOLV/PM EZOLV</p> <p>The terminal activates when the fast stop is in operation.</p>	686
4D	oH Pre-Alarm Time Limit	<p>V/f OLV OLV/PM AOLV/PM EZOLV</p> <p>The terminal activates when $L8-03 = 4$ [Overheat Pre-Alarm Selection = Operate at Reduced Speed (L8-19)] and oH [Heatsink Overheat] does not clear after the drive decreases the frequency for 10 cycles.</p>	686
4E	Braking Transistor Fault (rr)	<p>V/f OLV OLV/PM AOLV/PM EZOLV</p> <p>The terminal activates when the internal braking transistor overheats and the drive detects an rr [Dynamic Braking Transistor Fault] fault.</p>	686
4F	Braking Resistor Overheat (rH)	<p>V/f OLV OLV/PM AOLV/PM EZOLV</p> <p>The terminal activates when the braking resistor overheats and the drive detects an rH [Braking Resistor Overheat] fault.</p>	686
61	Pole Position Detection Complete	<p>V/f OLV OLV/PM AOLV/PM EZOLV</p> <p>The terminal activates when drive receives a Run command and the drive detects the motor magnetic pole position of the PM motor.</p>	686
62	Modbus Reg 1 Status Satisfied	<p>V/f OLV OLV/PM AOLV/PM EZOLV</p> <p>The terminal activates when the bit specified by $H2-08$ [Modbus Register 1 Bit Select] for the MEMOBUS register address set with $H2-07$ [Modbus Register 1 Address Select] activates.</p>	686
63	Modbus Reg 2 Status Satisfied	<p>V/f OLV OLV/PM AOLV/PM EZOLV</p> <p>The terminal activates when the bit specified by $H2-10$ [Modbus Register 2 Bit Select] for the MEMOBUS register address set with $H2-09$ [Modbus Register 2 Address Select] activates.</p>	686
66	Comparator1	<p>V/f OLV OLV/PM AOLV/PM EZOLV</p> <p>The terminal activates if the monitor value set with $H2-20$ [Comparator 1 Monitor Selection] is in range of the values of $H2-21$ [Comparator 1 Lower Limit] and $H2-22$ [Comparator 1 Upper Limit] for the time set in $H2-24$ [Comparator 1 On-Delay Time].</p>	686
67	Comparator2	<p>V/f OLV OLV/PM AOLV/PM EZOLV</p> <p>The terminal activates if the monitor value set with $H2-26$ [Comparator 2 Monitor Selection] is not in the range of the values of $H2-27$ [Comparator 2 Lower Limit] and $H2-28$ [Comparator 2 Upper Limit] for the time set in $H2-30$ [Comparator 2 On-Delay Time].</p>	687
69	External Power 24V Supply	<p>V/f OLV OLV/PM AOLV/PM EZOLV</p> <p>The terminal activates when there is an external 24V power supply between terminals PS-AC. ON : The external 24V power supply is supplying power. OFF : The external 24V power supply is not supplying power.</p>	687
6 A	Data Logger Error	<p>V/f OLV OLV/PM AOLV/PM EZOLV</p> <p>The terminal activates when the drive detects a LoG [Com Error / Abnormal SD card].</p>	688
90	DWEZ Digital Output 1	<p>V/f OLV OLV/PM AOLV/PM EZOLV</p> <p>Sets the DriveWorksEZ digital output 1. Refer to the DriveWorksEZ online manual for more information.</p>	688

Setting Value	Function	Description	Ref.																		
91	DWEZ Digital Output 2	V/f OLV OLV/PM AOLV/PM EZOLV Sets the DriveWorksEZ digital output 2. Refer to the DriveWorksEZ online manual for more information.	688																		
92	DWEZ Digital Output 3	V/f OLV OLV/PM AOLV/PM EZOLV Sets the DriveWorksEZ digital output 3. Refer to the DriveWorksEZ online manual for more information.	688																		
100	!During Run	V/f OLV OLV/PM AOLV/PM EZOLV The terminal deactivates when you input a Run command and when the drive is outputting voltage. ON : Drive is stopping OFF : Drive is running	688																		
101	!Zero Speed	V/f OLV OLV/PM AOLV/PM EZOLV The terminal deactivates when the output frequency is less than $E1-09$ [Minimum Output Frequency] or $b2-01$ [DC Injection/Zero SpeedThreshold]. Note: Parameter $A1-02$ [Control Method Selection] selects which parameter is the reference. <table border="1" style="margin-left: 20px;"> <thead> <tr> <th>A1-02 Setting</th> <th>Control Method Selection</th> <th>Parameter Used as the Reference</th> </tr> </thead> <tbody> <tr> <td>0</td> <td>V/f</td> <td>$E1-09$</td> </tr> <tr> <td>2</td> <td>OLV</td> <td>$b2-01$</td> </tr> <tr> <td>5</td> <td>OLV/PM</td> <td>$E1-09$</td> </tr> <tr> <td>6</td> <td>AOLV/PM</td> <td>$E1-09$</td> </tr> <tr> <td>8</td> <td>EZOLV</td> <td>$E1-09$</td> </tr> </tbody> </table> ON : Output frequency $\geq E1-09$ or $b2-01$. OFF : Output frequency < value of $E1-09$ or $b2-01$.	A1-02 Setting	Control Method Selection	Parameter Used as the Reference	0	V/f	$E1-09$	2	OLV	$b2-01$	5	OLV/PM	$E1-09$	6	AOLV/PM	$E1-09$	8	EZOLV	$E1-09$	688
A1-02 Setting	Control Method Selection	Parameter Used as the Reference																			
0	V/f	$E1-09$																			
2	OLV	$b2-01$																			
5	OLV/PM	$E1-09$																			
6	AOLV/PM	$E1-09$																			
8	EZOLV	$E1-09$																			
102	!Speed Agree 1	V/f OLV OLV/PM AOLV/PM EZOLV The terminal deactivates when the output frequency is in the range of the frequency reference $\pm L4-02$ [Speed Agree Detection Width]. ON : The output frequency does not align with the frequency reference although the drive is running. OFF : The output frequency is in the range of "frequency reference $\pm L4-02$ ".	688																		
103	!User-Set Speed Agree 1	V/f OLV OLV/PM AOLV/PM EZOLV The terminal deactivates when the output frequency is in the range of $L4-01$ [Speed Agree Detection Level] $\pm L4-02$ [Speed Agree Detection Width] and in the range of the frequency reference $\pm L4-02$. Note: The detection function operates in the two motor rotation directions. The drive uses the $L4-01$ value as the forward/reverse detection level. ON : The output frequency is not in the range of " $L4-01 \pm L4-02$ " nor the range of frequency reference $\pm L4-02$. OFF : The output frequency is in the range as defined by the result of " $L4-01 \pm L4-02$ " and the range of frequency reference $\pm L4-02$.	688																		
104	!Frequency Detection 1	V/f OLV OLV/PM AOLV/PM EZOLV The terminal activates when the output frequency is higher than the value of $L4-01$ [Speed Agree Detection Level] + $L4-02$ [Speed Agree Detection Width]. When the terminal activates, it stays activated until the output frequency = $L4-01$. Note: The detection function operates in the two motor rotation directions. The drive uses the $L4-01$ value as the forward/reverse detection level. ON : The output frequency is higher than $L4-01 + L4-02$. OFF : The output frequency is less than $L4-01$ or is not more than $L4-01 + L4-02$.	688																		
105	!Frequency Detection 2	V/f OLV OLV/PM AOLV/PM EZOLV The terminal deactivates when the output frequency is higher than the value of $L4-01$ [Speed Agree Detection Level]. After the terminal activates, the terminal stays on until the output frequency = $L4-01 - L4-02$. Note: The detection function operates in the two motor rotation directions. The drive uses the $L4-01$ value as the forward/reverse detection level. ON : The output frequency is less than " $L4-01 - L4-02$," or it is not more than $L4-01$. OFF : The output frequency is more than $L4-01$.	688																		
106	!Drive Ready	V/f OLV OLV/PM AOLV/PM EZOLV The terminal deactivates when the drive is ready and running.	688																		
107	!DC Bus Undervoltage	V/f OLV OLV/PM AOLV/PM EZOLV The terminal deactivates when the DC bus voltage or control circuit power supply is at or below the voltage set in $L2-05$ [Undervoltage Detection Lvl (Uv1)]. The terminal also deactivates when there is a fault with the DC bus voltage. ON : The DC bus voltage is more than the setting value of $L2-05$. OFF : The DC bus voltage is less than the setting value of $L2-05$.	688																		

11.10 H: Terminal Functions

Setting Value	Function	Description	Ref.
108	During Baseblock (N.C.)	<p>V/f OLV OLV/PM AOLV/PM EZOLV</p> <p>The terminal deactivates during baseblock. When the drive is in baseblock, the drive output transistor stops switching and does not make DC bus voltage. ON : The drive is not in baseblock. OFF : During baseblock</p>	688
109	!Frequency Reference from Keypad	<p>V/f OLV OLV/PM AOLV/PM EZOLV</p> <p>Shows the selected frequency reference source. ON : b1-01 [Frequency Reference Selection 1] or b1-15 [Frequency Reference Selection 2] is the frequency reference source. OFF : The keypad is the frequency reference source.</p>	688
10A	!Run Command from Keypad	<p>V/f OLV OLV/PM AOLV/PM EZOLV</p> <p>Shows the selected Run command source. ON : b1-02 [Run Command Selection 1] or b1-16 [Run Command Selection 2] is the Run command source. OFF : The keypad is the Run command source.</p>	688
10B	Torque Detection 1 (N.C.)	<p>V/f OLV OLV/PM AOLV/PM EZOLV</p> <p>The terminal deactivates when the drive detects overtorque or undertorque. OFF : The output current/torque exceeds the torque value set with L6-02 [Torque Detection Level 1], or the level has dropped and remained in this state longer than the time set with L6-03 [Torque Detection Time 1].</p>	688
10C	!Frequency Reference Loss	<p>V/f OLV OLV/PM AOLV/PM EZOLV</p> <p>The terminal deactivates when the drive detects a loss of frequency reference.</p>	688
10D	!Braking Resistor Fault	<p>V/f OLV OLV/PM AOLV/PM EZOLV</p> <p>The terminal deactivates when the mounting-type braking resistor is overheating or when there is a braking transistor fault.</p>	688
10E	!Fault	<p>V/f OLV OLV/PM AOLV/PM EZOLV</p> <p>The terminal deactivates when the drive detects a fault. Note: Faults CPF00 and CPF01 [Control Circuit Error] are excluded.</p>	688
110	!Alarm	<p>V/f OLV OLV/PM AOLV/PM EZOLV</p> <p>The terminal deactivates when the drive detects a minor fault.</p>	688
111	!Fault Reset Command Active	<p>V/f OLV OLV/PM AOLV/PM EZOLV</p> <p>The terminal deactivates when the drive receives the Reset command from the control circuit terminal, serial communications, or the communication option.</p>	688
112	!Timer Output	<p>V/f OLV OLV/PM AOLV/PM EZOLV</p> <p>Sets the terminal as the timer output. Use this setting with the timer input set in H1-xx = 118 [MFDI Function Selection = !Timer Function].</p>	688
113	!Speed Agree 2	<p>V/f OLV OLV/PM AOLV/PM EZOLV</p> <p>The terminal deactivates when the output frequency is in the range of the frequency reference $\pm L4-04$ [Speed Agree Detection Width(+/-)]. Note: The detection function operates in the two motor rotation directions. ON : The output frequency is not in the range of "frequency reference $\pm L4-04$". OFF : The output frequency is in the range of "frequency reference $\pm L4-04$".</p>	688
114	!User-Set Speed Agree 2	<p>V/f OLV OLV/PM AOLV/PM EZOLV</p> <p>The terminal deactivates when the output frequency is in the range of L4-03 [Speed Agree Detection Level(+/-)] $\pm L4-04$ [Speed Agree Detection Width(+/-)] and in the range of the frequency reference $\pm L4-04$. Note: The detection level set in L4-03 is a signed value. The drive will only detect in one direction. ON : The output frequency is not in the range of "L4-03 $\pm L4-04$" nor the range of frequency reference $\pm L4-04$. OFF : The output frequency is in the range of "L4-03 $\pm L4-04$" and the range of frequency reference $\pm L4-04$.</p>	688
115	!Frequency Detection 3	<p>V/f OLV OLV/PM AOLV/PM EZOLV</p> <p>The terminal activates when the output frequency is higher than "L4-03 [Speed Agree Detection Level(+/-)] + L4-04 [Speed Agree Detection Width(+/-)]". After the terminal deactivates, the terminal stays deactivated until the output frequency = L4-03. Note: The detection level set in L4-03 is a signed value. The drive will only detect in one direction. ON : The output frequency is higher than L4-03 + L4-04. OFF : The output frequency is less than L4-03 or is not more than L4-03 + L4-04.</p>	688
116	!Frequency Detection 4	<p>V/f OLV OLV/PM AOLV/PM EZOLV</p> <p>The terminal deactivates when the output frequency is higher than the value of L4-03 [Speed Agree Detection Level(+/-)]. After the terminal deactivates, the terminal stays deactivated until the output frequency = L4-03 - L4-04. Note: The detection level set in L4-03 is a signed value. The drive will only detect in one direction. ON : The output frequency is less than "L4-03 - L4-04," or it is not more than L4-03. OFF : The output frequency is more than L4-03.</p>	688

Setting Value	Function	Description	Ref.
117	Torque Detection 1 (N.O.)	V/f OLV OLV/PM AOLV/PM EZOLV The terminal activates when the drive detects overtorque or undertorque. ON : The output current/torque exceeds the torque value set with L6-02 [Torque Detection Level 1], or the level has dropped and remained in this state longer than the time set with L6-03 [Torque Detection Time 1].	688
118	Torque Detection 2 (N.C.)	V/f OLV OLV/PM AOLV/PM EZOLV The terminal deactivates when the drive detects overtorque or undertorque. OFF : The output current/torque exceeds the torque value set with L6-05 [Torque Detection Level 2], or the level has dropped and remained in this state longer than the time set with L6-06 [Torque Detection Time 2].	688
119	Torque Detection 2 (N.O.)	V/f OLV OLV/PM AOLV/PM EZOLV The terminal activates when the drive detects overtorque or undertorque. ON : The output current/torque exceeds the torque value set with L6-05 [Torque Detection Level 2], or the level has dropped and remained in this state longer than the time set with L6-06 [Torque Detection Time 2].	688
11A	!During Reverse	V/f OLV OLV/PM AOLV/PM EZOLV The terminal deactivates when the motor operates in the reverse direction. ON : The motor is operating in the forward direction or the motor stopped. OFF : The motor is operating in the reverse direction.	688
11B	During Baseblock (N.O.)	V/f OLV OLV/PM AOLV/PM EZOLV The terminal activates during baseblock. When the drive is in baseblock, the drive output transistor stops switching and does not make DC bus voltage. ON : During baseblock OFF : The drive is not in baseblock.	688
11C	!Motor 2 Selected	V/f OLV OLV/PM AOLV/PM EZOLV The terminal deactivates when motor 2 is selected. ON : Motor 1 Selection OFF : Motor 2 Selection	688
11E	!Executing Auto-Restart	V/f OLV OLV/PM AOLV/PM EZOLV The terminal deactivates when the Auto Restart function is trying to restart after a fault.	688
11F	!Motor Overload Alarm (oL1)	V/f OLV OLV/PM AOLV/PM EZOLV The terminal deactivates when the electronic thermal protection value of the motor overload protective function is a minimum of 90% of the detection level.	688
120	!Drive Overheat Pre-Alarm (oH)	V/f OLV OLV/PM AOLV/PM EZOLV The terminal deactivates when the drive heatsink temperature is at the level set with L8-02 [Overheat Alarm Level].	688
121	!Safe Torque OFF	V/f OLV OLV/PM AOLV/PM EZOLV The terminal deactivates (safety stop state) when the safety circuit and safety diagnosis circuit are operating correctly and when terminals H1-HC and H2-HC are OFF (Open). ON : Safety circuit fault or RUN/READY OFF : Safety stop state	688
122	!Mechanical Weakening Detection	V/f OLV OLV/PM AOLV/PM EZOLV The terminal deactivates when the drive detects mechanical weakening.	688
12F	!Maintenance Notification	V/f OLV OLV/PM AOLV/PM EZOLV The terminal deactivates when drive components are at their estimated maintenance period. Tells you about the maintenance period for these items: • IGBT • Cooling Fan • Capacitor • Soft charge bypass relay	688
130	!During Torque Limit	V/f OLV OLV/PM AOLV/PM EZOLV The terminal deactivates when the torque reference is the torque limit set with L7 parameters or H3-02 or H3-10 [MFAl Function Selection].	688
137	!During Frequency Output	V/f OLV OLV/PM AOLV/PM EZOLV The terminal deactivates when the drive outputs frequency. ON : The drive is not outputting frequency. OFF : The drive is outputting frequency.	688
138	!Drive Enabled	V/f OLV OLV/PM AOLV/PM EZOLV This terminal deactivates when the H1-xx = 16A [Drive Enable] terminal deactivates.	688
139	!Watt Hour Pulse Output	V/f OLV OLV/PM AOLV/PM EZOLV Outputs the pulse that shows the watt hours.	688
13C	!LOCAL Control Selected	V/f OLV OLV/PM AOLV/PM EZOLV The terminal deactivates when the Run command source or frequency reference source is LOCAL. ON : REMOTE OFF : LOCAL	688

11.10 H: Terminal Functions

Setting Value	Function	Description	Ref.
13D	!During Speed Search	V/f OLV OLV/PM AOLV/PM EZOLV The terminal deactivates when the drive does speed search.	688
13E	!PID Feedback Low	V/f OLV OLV/PM AOLV/PM EZOLV The terminal deactivates when the drive detects <i>FbL</i> [PID Feedback Loss].	688
13F	!PID Feedback High	V/f OLV OLV/PM AOLV/PM EZOLV The terminal deactivates when the drive detects <i>FbH</i> [Excessive PID Feedback].	688
14A	!During KEB Ride-Thru	V/f OLV OLV/PM AOLV/PM EZOLV The terminal deactivates when the drive executes the KEB Ride-Thru function.	688
14B	!During Short Circuit Braking	V/f OLV OLV/PM AOLV/PM EZOLV The terminal deactivates during Short Circuit Braking. Note: When <i>A1-02</i> = 8 [Control Method Selection = EZ Vector Control], this function is available when you use a PM motor.	688
14C	!During Fast Stop	V/f OLV OLV/PM AOLV/PM EZOLV The terminal deactivates when the fast stop is in operation.	688
14D	!oH Pre-Alarm Reduction Limit	V/f OLV OLV/PM AOLV/PM EZOLV The terminal deactivates when <i>L8-03</i> = 4 [Overheat Pre-Alarm Selection = Operate at Reduced Speed (L8-19)] and <i>oH</i> [Heatsink Overheat] does not clear after the drive decreases the frequency for 10 cycles.	688
14E	!Braking Transistor Fault (rr)	V/f OLV OLV/PM AOLV/PM EZOLV The terminal deactivates when the internal braking transistor overheats and the drive detects an <i>rr</i> [Dynamic Braking Transistor Fault] fault.	688
14F	!Braking Resistor Overheat (rH)	V/f OLV OLV/PM AOLV/PM EZOLV The terminal deactivates when the braking resistor overheats and the drive detects an <i>rH</i> [Braking Resistor Overheat] fault.	688
161	!RotorPositionDetection Complete	V/f OLV OLV/PM AOLV/PM EZOLV The terminal deactivates when drive receives a Run command and the drive detects the motor magnetic pole position of the PM motor.	688
162	!Modbus Reg 1 Status Satisfied	V/f OLV OLV/PM AOLV/PM EZOLV The terminal deactivates when the bit specified by <i>H2-07</i> turns on regarding the MEMOBUS register address configured with <i>H2-08</i> .	688
163	!Modbus Reg 2 Status Satisfied	V/f OLV OLV/PM AOLV/PM EZOLV The terminal deactivates when the bit specified by <i>H2-10</i> turns on regarding the MEMOBUS register address configured with <i>H2-09</i> .	688
166	!Comparator 1	V/f OLV OLV/PM AOLV/PM EZOLV The terminal deactivates when the monitor value set with <i>H2-20</i> is within range of <i>H2-21</i> and <i>H2-22</i> for the time set in <i>H2-24</i> .	688
167	!Comparator 2	V/f OLV OLV/PM AOLV/PM EZOLV The terminal deactivates when the when the monitor value set with <i>H2-26</i> is outside the range of <i>H2-27</i> and <i>H2-28</i> for the time set in <i>H2-30</i> .	688
169	!External Power 24V Supply	V/f OLV OLV/PM AOLV/PM EZOLV The terminal deactivates when there is an external 24V power supply between terminals PS-AC. ON : The external 24V power supply is not supplying power. OFF : The external 24V power supply is supplying power.	688
16A	!Data Logger Error	V/f OLV OLV/PM AOLV/PM EZOLV The terminal deactivates when the drive detects a <i>LoG</i> [Com Error / Abnormal SD card].	688
190	!DWEZ Digital Output 1	V/f OLV OLV/PM AOLV/PM EZOLV Sets the DriveWorksEZ digital output 1. Refer to the DriveWorksEZ online manual for more information.	688
191	!DWEZ Digital Output 2	V/f OLV OLV/PM AOLV/PM EZOLV Sets the DriveWorksEZ digital output 2. Refer to the DriveWorksEZ online manual for more information.	688
192	!DWEZ Digital Output 3	V/f OLV OLV/PM AOLV/PM EZOLV Sets the DriveWorksEZ digital output 3. Refer to the DriveWorksEZ online manual for more information.	688

◆ H3: Analog Inputs

No. (Hex.)	Name	Description	Default (Range)	Ref.
H3-01 (0410)	Terminal A1 Signal Level Select	V/f OLV OLV/PM AOLV/PM EZOLV Sets the input signal level for MFAI terminal A1. 0 : 0 to 10V (Lower Limit at 0) 4 : -10 to +10V (Bipolar Reference)	0 (0, 4)	690
H3-02 (0434)	Terminal A1 Function Selection	V/f OLV OLV/PM AOLV/PM EZOLV Sets the function for MFAI terminal A1.	0 (0 - 32)	690
H3-03 (0411) RUN	Terminal A1 Gain Setting	V/f OLV OLV/PM AOLV/PM EZOLV Sets the gain of the analog signal input to MFAI terminal A1.	100.0% (-999.9 - +999.9%)	690
H3-04 (0412) RUN	Terminal A1 Bias Setting	V/f OLV OLV/PM AOLV/PM EZOLV Sets the bias of the analog signal input to MFAI terminal A1.	0.0% (-999.9 - +999.9%)	690
H3-09 (0417)	Terminal A2 Signal Level Select	V/f OLV OLV/PM AOLV/PM EZOLV Sets the input signal level for MFAI terminal A2. 0 : 0-10V (LowLim=0) 2 : 4 to 20 mA 3 : 0 to 20 mA 4 : -10 to +10V (Bipolar Reference)	2 (0, 2 - 4)	691
H3-10 (0418)	Terminal A2 Function Selection	V/f OLV OLV/PM AOLV/PM EZOLV Sets the function for MFAI terminal A2.	0 (0 - 32)	691
H3-11 (0419) RUN	Terminal A2 Gain Setting	V/f OLV OLV/PM AOLV/PM EZOLV Sets the gain of the analog signal input to MFAI terminal A2.	100.0% (-999.9 - +999.9%)	691
H3-12 (041A) RUN	Terminal A2 Bias Setting	V/f OLV OLV/PM AOLV/PM EZOLV Sets the bias of the analog signal input to MFAI terminal A2.	0.0% (-999.9 - +999.9%)	691
H3-13 (041B)	Analog Input FilterTime Constant	V/f OLV OLV/PM AOLV/PM EZOLV Sets the time constant for primary delay filters on MFAI terminals.	0.03 s (0.00 - 2.00 s)	692
H3-14 (041C)	Analog Input Terminal Enable Sel	V/f OLV OLV/PM AOLV/PM EZOLV Sets the enabled terminal or terminals when $H1-xx = C$ [<i>MFDI Function Select = Analog Terminal Enable Selection</i>] is ON. 1 : Terminal A1 only 2 : Terminal A2 only 7 : Terminals A1 and A2	7 (1, 2, 7)	692
H3-16 (02F0)	Terminal A1 Offset	V/f OLV OLV/PM AOLV/PM EZOLV Sets the offset level for analog signals input to terminal A1. Usually it is not necessary to change this setting.	0 (-500 - +500)	692
H3-17 (02F1)	Terminal A2 Offset	V/f OLV OLV/PM AOLV/PM EZOLV Sets the offset level for analog signals input to terminal A2. Usually it is not necessary to change this setting.	0 (-500 - +500)	692
H3-40 (0B5C)	Mbus Reg 15C1h Input Function	V/f OLV OLV/PM AOLV/PM EZOLV Sets the MEMOBUS AI1 function.	F (4 - 2F)	692
H3-41 (0B5F)	Mbus Reg 15C2h Input Function	V/f OLV OLV/PM AOLV/PM EZOLV Sets the MEMOBUS AI2 function.	F (4 - 2F)	693
H3-42 (0B62)	Mbus Reg 15C3h Input Function	V/f OLV OLV/PM AOLV/PM EZOLV Sets the MEMOBUS AI3 function.	F (4 - 2F)	693
H3-43 (117F)	Mbus Reg Inputs FilterTime Const	V/f OLV OLV/PM AOLV/PM EZOLV Sets the time constant to apply a primary delay filter to the MEMOBUS analog input register values.	0.00 s (0.00 - 2.00 s)	693

■ H3-xx: MFAI Setting Values

Setting Value	Function	Description	Ref.
0	Frequency Reference	V/f OLV OLV/PM AOLV/PM EZOLV The input value from the MFAI terminal set with this function becomes the master frequency reference.	693
1	Frequency Gain	V/f OLV OLV/PM AOLV/PM EZOLV The drive multiplies the analog frequency reference with the input value from the MFAI set with this function.	693
2	Auxiliary Frequency Reference 1	V/f OLV OLV/PM AOLV/PM EZOLV Sets Reference 2 through multi-step speed reference to enable the command reference (Auxiliary Frequency Reference 1) from the analog input terminal set here. This value is a percentage where the Maximum Output Frequency setting is a setting value of 100%. Note: Parameter A1-02 [Control Method Selection] selects which parameter is the maximum output frequency. • A1-02 ≠ 8 [EZOLV]: E1-04 [Maximum Output Frequency] • A1-02 = 8: E9-02 [Maximum Speed]	694
3	Auxiliary Frequency Reference 2	V/f OLV OLV/PM AOLV/PM EZOLV Sets Reference 3 through multi-step speed reference to enable the command reference (Auxiliary Frequency Reference 2) from the analog input terminal set here. This value is a percentage where the Maximum Output Frequency setting is a setting value of 100%. Note: Parameter A1-02 [Control Method Selection] selects which parameter is the maximum output frequency. • A1-02 ≠ 8 [EZOLV]: E1-04 [Maximum Output Frequency] • A1-02 = 8: E9-02 [Maximum Speed]	694
4	Output Voltage Bias	V/f OLV OLV/PM AOLV/PM EZOLV Set this parameter to input a bias signal to amplify the output voltage.	694
5	Accel/Decel Time Gain	V/f OLV OLV/PM AOLV/PM EZOLV Enters a signal to adjust the gain used for C1-01 to C1-08 [Acceleration/Deceleration Times 1 to 4] and C1-09 [Fast Stop Time] when the full scale analog signal (10 V or 20 mA) is 100%.	694
6	DC Injection Braking Current	V/f OLV OLV/PM AOLV/PM EZOLV Enters a signal to adjust the current level used for DC Injection Braking when the drive rated output current is 100%.	695
7	Torque Detection Level	V/f OLV OLV/PM AOLV/PM EZOLV Enters a signal to adjust the overtorque/undertorque detection level. Note: Use this function with L6-01 [Torque Detection Selection 1]. This parameter functions as an alternative to L6-02 [Torque Detection Level 1].	695
8	Stall Prevent Level during Run	V/f OLV OLV/PM AOLV/PM EZOLV Enters a signal to adjust the stall prevention level during run if the drive rated current is 100%.	695
9	Output Frequency Lower Limit	V/f OLV OLV/PM AOLV/PM EZOLV Enters a signal to adjust the output frequency lower limit level as a percentage of the maximum output frequency. Note: Parameter A1-02 [Control Method Selection] selects which parameter is the maximum output frequency. • A1-02 ≠ 8 [EZOLV]: E1-04 [Maximum Output Frequency] • A1-02 = 8: E9-02 [Maximum Speed]	695
B	PID Feedback	V/f OLV OLV/PM AOLV/PM EZOLV Enter the PID feedback value as a percentage of the maximum output frequency. Note: Parameter A1-02 [Control Method Selection] selects which parameter is the maximum output frequency. • A1-02 ≠ 8 [EZOLV]: E1-04 [Maximum Output Frequency] • A1-02 = 8: E9-02 [Maximum Speed]	696
C	PID Setpoint	V/f OLV OLV/PM AOLV/PM EZOLV Enters the PID setpoint as a percentage of the maximum output frequency. Note: Parameter A1-02 [Control Method Selection] selects which parameter is the maximum output frequency. • A1-02 ≠ 8 [EZOLV]: E1-04 [Maximum Output Frequency] • A1-02 = 8: E9-02 [Maximum Speed]	696
D	Frequency Bias	V/f OLV OLV/PM AOLV/PM EZOLV Enters the bias value added to the frequency reference as a percentage of the maximum output frequency. Note: Parameter A1-02 [Control Method Selection] selects which parameter is the maximum output frequency. • A1-02 ≠ 8 [EZOLV]: E1-04 [Maximum Output Frequency] • A1-02 = 8: E9-02 [Maximum Speed]	696
E	Motor Temperature (PTC Input)	V/f OLV OLV/PM AOLV/PM EZOLV Uses the motor Positive Temperature Coefficient (PTC) thermistor to prevent heat damage to the motor as a percentage of the current value when the 10 V analog signal is input.	696

Setting Value	Function	Description	Ref.
F	Not Used	V/f OLV OLV/PM AOLV/PM EZOLV Use this setting for unused terminals or to use terminals in through mode.	696
10	Forward Torque Limit	V/f OLV OLV/PM AOLV/PM EZOLV Enters the forward torque limit if the motor rated torque is 100%.	696
11	Reverse Torque Limit	V/f OLV OLV/PM AOLV/PM EZOLV Enters the load torque limit if the motor rated torque is 100%.	698
12	Regenerative Torque Limit	V/f OLV OLV/PM AOLV/PM EZOLV Enters the regenerative torque limit if the motor rated torque is 100%.	698
13	Torque Reference / Torque Limit	V/f OLV OLV/PM AOLV/PM EZOLV Enters the torque reference if the motor rated torque is 100%. This setting is the torque limit for speed control.	698
14	Torque Compensation	V/f OLV OLV/PM AOLV/PM EZOLV Enters the torque compensation value if the motor rated torque is 100%.	698
15	General Torque Limit	V/f OLV OLV/PM AOLV/PM EZOLV Enters the torque limit that is the same for all quadrants for forward, reverse, and regenerative operation if the motor rated torque is 100%.	698
16	Differential PID Feedback	V/f OLV OLV/PM AOLV/PM EZOLV Enters the PID differential feedback value if the full scale analog signal (10 V or 20 mA) is 100%.	698
1F	Not Used	V/f OLV OLV/PM AOLV/PM EZOLV Use this setting for unused terminals or to use terminals in through mode.	698
30	DWEZ Analog Input 1	V/f OLV OLV/PM AOLV/PM EZOLV Use with DriveWorksEZ. Refer to the DriveWorksEZ online manual for more information.	699
31	DWEZ Analog Input 2	V/f OLV OLV/PM AOLV/PM EZOLV Use with DriveWorksEZ. Refer to the DriveWorksEZ online manual for more information.	699

◆ H4: Analog Outputs

No. (Hex.)	Name	Description	Default (Range)	Ref.
H4-01 (041D)	Terminal AM Analog Output Select	V/f OLV OLV/PM AOLV/PM EZOLV Sets the monitoring number to be output from the MFAO terminal AM. Set the x-xx part of the Ux-xx [Monitor]. For example, set H4-01 = 102 to monitor U1-02 [Output Frequency].	102 (000 - 999)	700
H4-02 (041E) RUN	Terminal AM Analog Output Gain	V/f OLV OLV/PM AOLV/PM EZOLV Sets the gain of the monitor signal that is sent from MFAO terminal AM. Sets the analog signal output level from the terminal AM at 10 V or 20 mA as 100% when an output for monitoring items is 100%.	100.0% (-999.9 - +999.9%)	700
H4-03 (041F) RUN	Terminal AM Analog Output Bias	V/f OLV OLV/PM AOLV/PM EZOLV Sets the bias of the monitor signal that is sent from MFAO terminal AM. When an output for monitoring items is 0%, this parameter sets the analog signal output level from the AM terminal at 10 V or 20 mA as 0%.	0.0% (-999.9 - +999.9%)	700
H4-07 (0423)	Terminal AM Signal Level Select	V/f OLV OLV/PM AOLV/PM EZOLV Sets the MFAO terminal AM output signal level. Note: Make sure that you set jumper S5 on the control circuit terminal board when you change these parameters. 0 : 0-10V 2 : 4 to 20 mA	0 (0, 2)	701
H4-20 (0B53)	Analog Power Monitor 100% Level	V/f OLV OLV/PM AOLV/PM EZOLV Sets the level at 10 V when U1-08 [Output Power] is set for analog output.	0.00 kW (0.00 - 650.00 kW)	701

◆ H5: Modbus Communication

No. (Hex.)	Name	Description	Default (Range)	Ref.
H5-01 (0425)	Drive Node Address	<p>V/f OLV OLV/PM AOLV/PM EZOLV</p> <p>Sets the communication slave address for drives.</p> <p>Note:</p> <ul style="list-style-type: none"> Re-energize the drive or set $H5-20 = 1$ [<i>Communication Parameters Reload = Reload Now</i>] after you change the parameter setting. Setting 0 will not let the drive respond to MEMOBUS/Modbus communications. 	1FH (0 - FFH)	701
H5-02 (0426)	Communication Speed Selection	<p>V/f OLV OLV/PM AOLV/PM EZOLV</p> <p>Sets the communications speed for MEMOBUS/Modbus communications.</p> <p>Note:</p> <p>Re-energize the drive or set $H5-20 = 1$ [<i>Communication Parameters Reload = Reload Now</i>] after you change the parameter setting.</p> <p>0 : 1200 bps 1 : 2400 bps 2 : 4800 bps 3 : 9600 bps 4 : 19.2 kbps 5 : 38.4 kbps 6 : 57.6 kbps 7 : 76.8 kbps 8 : 115.2 kbps</p>	3 (0 - 8)	701
H5-03 (0427)	Communication Parity Selection	<p>V/f OLV OLV/PM AOLV/PM EZOLV</p> <p>Sets the communications parity used for MEMOBUS/Modbus communications.</p> <p>Note:</p> <p>Re-energize the drive or set $H5-20 = 1$ [<i>Communication Parameters Reload = Reload Now</i>] after you change the parameter setting.</p> <p>0 : No parity 1 : Even parity 2 : Odd parity</p>	0 (0 - 2)	702
H5-04 (0428)	Communication Error Stop Method	<p>V/f OLV OLV/PM AOLV/PM EZOLV</p> <p>Sets the motor Stopping Method when the drive detects <i>CE</i> [<i>MEMOBUS/Modbus Communication Err</i>] issues.</p> <p>0 : Ramp to Stop 1 : Coast to Stop 2 : Fast Stop (Use C1-09) 3 : Alarm Only</p>	3 (0 - 3)	702
H5-05 (0429)	Comm Fault Detection Selection	<p>V/f OLV OLV/PM AOLV/PM EZOLV</p> <p>Sets the function that detects <i>CE</i> [<i>Modbus Communication Error</i>] issues during MEMOBUS/Modbus communications.</p> <p>0 : Disabled 1 : Enabled</p>	1 (0, 1)	702
H5-06 (042A)	Drive Transmit Wait Time	<p>V/f OLV OLV/PM AOLV/PM EZOLV</p> <p>Sets the time to wait to send a response message after the drive receives a command message from the master.</p> <p>Note:</p> <p>Restart the drive after changing the parameter setting.</p>	5 ms (0 - 65 ms)	703
H5-09 (0435)	CE Detection Time	<p>V/f OLV OLV/PM AOLV/PM EZOLV</p> <p>Sets the detection time for <i>CE</i> [<i>Modbus Communication Error</i>] issues when communication stops.</p>	2.0 s (0.0 - 25.0 s)	703
H5-10 (0436)	Modbus Register 0025H Unit Sel	<p>V/f OLV OLV/PM AOLV/PM EZOLV</p> <p>Sets the unit of measure used for the MEMOBUS/Modbus communications monitor register 0025H (output voltage reference monitor).</p> <p>0 : 0.1 V units 1 : 1 V units</p>	0 (0, 1)	703
H5-11 (043C) RUN	Comm ENTER Command Mode	<p>V/f OLV OLV/PM AOLV/PM EZOLV</p> <p>Sets the function to make the Enter command necessary to change parameters through MEMOBUS/Modbus communications.</p> <p>0 : ENTER Command Required 1 : ENTER Command Not Required</p>	1 (0, 1)	703

No. (Hex.)	Name	Description	Default (Range)	Ref.
H5-12 (043D)	Run Command Method Selection	V/f OLV OLV/PM AOLV/PM EZOLV Sets the input method for the Run command when $b1-02 = 2$ [Run Command Selection 1 = Memobus/Modbus Communications] or $b1-16 = 2$ [Run Command Selection 2 = Memobus/Modbus Communications]. 0 : FWD/Stop, REV/Stop 1 : Run/Stop, FWD/REV	0 (0, 1)	703
H5-17 (11A1) Expert	ENTER command response @CPU BUSY	V/f OLV OLV/PM AOLV/PM EZOLV Sets operation when the EEPROM write command is sent without EEPROM write available. Usually it is not necessary to change this setting. 0 : Ignore Command(No ROM/RAM Write) 1 : Write to RAM Only	0 (0, 1)	704
H5-18 (11A2)	Motor Speed Filter over Comms	V/f OLV OLV/PM AOLV/PM EZOLV Sets the filter time constant used when monitoring motor speed during MEMOBUS/Modbus communications or with a communication option.	0 ms (0 - 100 ms)	704
H5-20 (0B57)	Communication Parameters Reload	V/f OLV OLV/PM AOLV/PM EZOLV Sets the function to immediately enable updated MEMOBUS/Modbus communications parameters. 0 : Reload at Next Power Cycle 1 : Reload Now	0 (0, 1)	704
H5-22 (11CF)	Speed Search from MODBUS	V/f OLV OLV/PM AOLV/PM EZOLV Enables the MEMOBUS/Modbus communication register Speed Search function (bit0 of 15DFH). 0 : Disabled 1 : Enabled	0 (0, 1)	704
H5-25 (1589) RUN	Function 5A Register 1 Selection	V/f OLV OLV/PM AOLV/PM EZOLV Returns the contents of the specified MEMOBUS/Modbus communications register when responding to the master device.	0044H (U1-05) (0000H - FFFFH)	705
H5-26 (158A) RUN	Function 5A Register 2 Selection	V/f OLV OLV/PM AOLV/PM EZOLV Returns the contents of the specified MEMOBUS/Modbus communications register when responding to the master device.	0045H (U1-06) (0000H - FFFFH)	705
H5-27 (158B) RUN	Function 5A Register 3 Selection	V/f OLV OLV/PM AOLV/PM EZOLV Returns the contents of the specified MEMOBUS/Modbus communications register when responding to the master device.	0042H (U1-03) (0000H - FFFFH)	705
H5-28 (158C) RUN	Function 5A Register 4 Selection	V/f OLV OLV/PM AOLV/PM EZOLV Returns the contents of the specified MEMOBUS/Modbus communications register when responding to the master device.	0049H (U1-10) (0000H - FFFFH)	705

◆ H6: Pulse Train Input/Output

No. (Hex.)	Name	Description	Default (Range)	Ref.
H6-01 (042C)	Terminal RP Pulse Train Function	V/f OLV OLV/PM AOLV/PM EZOLV Sets the function for pulse train input terminal RP. 0 : Frequency Reference 1 : PID Feedback Value 2 : PID Setpoint Value 3 : Speed Feedback (V/F Control)	0 (0 - 3)	706
H6-02 (042D) RUN	Terminal RP Frequency Scaling	V/f OLV OLV/PM AOLV/PM EZOLV Sets the frequency of the pulse train input signal used when the item selected with H6-01 [Terminal RP Pulse Train Function] is input at 100%.	1440 Hz (100 - 32000 Hz)	707
H6-03 (042E) RUN	Terminal RP Function Gain	V/f OLV OLV/PM AOLV/PM EZOLV Sets the gain used when the function in H6-01 [Terminal RP Pulse Train Function] is input to terminal RP.	100.0% (0.0 - 1000.0%)	707
H6-04 (042F) RUN	Terminal RP Function Bias	V/f OLV OLV/PM AOLV/PM EZOLV Sets the bias used when the function in H6-01 [Terminal RP Pulse Train Function] is input to terminal RP. Sets a value at the time when the pulse train is 0 Hz.	0.0% (-100.0 - 100.0%)	707
H6-05 (0430) RUN	Terminal RP Filter Time	V/f OLV OLV/PM AOLV/PM EZOLV Sets the time constant for the pulse train input primary delay filters.	0.10 s (0.00 - 2.00 s)	708

11.10 H: Terminal Functions

No. (Hex.)	Name	Description	Default (Range)	Ref.
H6-06 (0431) RUN	Terminal MP Monitor Selection	V/f OLV OLV/PM AOLV/PM EZOLV Sets a function for pulse train monitor output terminal MP. Sets the "x-xx" part of the <i>Ux-xx</i> monitor.	102 (000, 031, 101, 102, 105, 116, 501, 502, 801 - 809, 821 - 825, 831 - 839, 851 - 855)	708
H6-07 (0432) RUN	Terminal MP Frequency Scaling	V/f OLV OLV/PM AOLV/PM EZOLV Sets the frequency of the pulse train output signal used when the monitor set with <i>H6-06</i> [Terminal MP Monitor Selection] is 100%.	1440 Hz (0 - 32000 Hz)	709
H6-08 (043F)	Terminal RP Minimum Frequency	V/f OLV OLV/PM AOLV/PM EZOLV Sets the minimum frequency of the pulse train signal that terminal RP can detect.	0.5 Hz (0.1 - 1000.0 Hz)	709

◆ H7: Virtual MFIO selection

No. (Hex.)	Name	Description	Default (Range)	Ref.
H7-00 (116F) Expert	Virtual MFIO selection	V/f OLV OLV/PM AOLV/PM EZOLV Sets the function to enable and disable the virtual I/O function. Set this parameter to 1 to operate the virtual I/O function. 0 : Disabled 1 : Enabled	0 (0, 1)	710
H7-01 (1185) Expert	Virtual Multi-Function Input 1	V/f OLV OLV/PM AOLV/PM EZOLV Sets the function that enters the virtual input set in <i>H7-10</i> [Virtual Multi-Function Output 1]. Note: <i>1B</i> [Programming Lockout] and <i>11B</i> [Inverse Input of 1B] are not available.	F (1 - 19F)	710
H7-02 (1186) Expert	Virtual Multi-Function Input 2	V/f OLV OLV/PM AOLV/PM EZOLV Sets the function that enters the virtual input set in <i>H7-12</i> [Virtual Multi-Function Output 2]. Note: <i>1B</i> [Programming Lockout] and <i>11B</i> [Inverse Input of 1B] are not available.	F (1 - 19F)	710
H7-03 (1187) Expert	Virtual Multi-Function Input 3	V/f OLV OLV/PM AOLV/PM EZOLV Sets the function that enters the virtual input set in <i>H7-14</i> [Virtual Multi-Function Output 3]. Note: <i>1B</i> [Programming Lockout] and <i>11B</i> [Inverse Input of 1B] are not available.	F (1 - 19F)	710
H7-04 (1188) Expert	Virtual Multi-Function Input 4	V/f OLV OLV/PM AOLV/PM EZOLV Sets the function that enters the virtual input set in <i>H7-16</i> [Virtual Multi-Function Output 4]. Note: <i>1B</i> [Programming Lockout] and <i>11B</i> [Inverse Input of 1B] are not available.	F (1 - 19F)	710
H7-10 (11A4) Expert	Virtual Multi-Function Output 1	V/f OLV OLV/PM AOLV/PM EZOLV Sets the function for virtual digital output 1.	F (0 - 1A7)	710
H7-11 (11A5) Expert	Virtual Output 1 Delay Time	V/f OLV OLV/PM AOLV/PM EZOLV Sets the minimum ON time for virtual digital output 1.	0.1 s (0.0 - 25.0 s)	711
H7-12 (11A6) Expert	Virtual Multi-Function Output 2	V/f OLV OLV/PM AOLV/PM EZOLV Sets the function for virtual digital output 2.	F (0 - 1A7)	711
H7-13 (11A7) Expert	Virtual Output 2 Delay Time	V/f OLV OLV/PM AOLV/PM EZOLV Sets the minimum ON time for virtual digital output 2.	0.1 s (0.0 - 25.0 s)	711
H7-14 (11A8) Expert	Virtual Multi-Function Output 3	V/f OLV OLV/PM AOLV/PM EZOLV Sets the function for virtual digital output 3.	F (0 - 1A7)	711
H7-15 (11A9) Expert	Virtual Output 3 Delay Time	V/f OLV OLV/PM AOLV/PM EZOLV Sets the minimum ON time for virtual digital output 3.	0.1 s (0.0 - 25.0 s)	711
H7-16 (11AA) Expert	Virtual Multi-Function Output 4	V/f OLV OLV/PM AOLV/PM EZOLV Sets the function for virtual digital output 4.	F (0 - 1A7)	711

No. (Hex.)	Name	Description	Default (Range)	Ref.
H7-17 (11AB) Expert	Virtual Output 4 Delay Time	V/f OLV OLV/PM AOLV/PM EZOLV Sets the minimum ON time for virtual digital output 4.	0.1 s (0.0 - 25.0 s)	711
H7-30 (1177) Expert	Virtual Analog Input Selection	V/f OLV OLV/PM AOLV/PM EZOLV Sets the virtual analog input function.	F (0 - 32)	712
H7-31 (1178) RUN Expert	Virtual Analog Input Gain	V/f OLV OLV/PM AOLV/PM EZOLV Sets the virtual analog input gain.	100.0% (-999.9 - 999.9%)	712
H7-32 (1179) RUN Expert	Virtual Analog Input Bias	V/f OLV OLV/PM AOLV/PM EZOLV Sets the virtual analog input bias.	0.0% (-999.9 - 999.9%)	712
H7-40 (1163)	Virtual Analog Out Signal Select	V/f OLV OLV/PM AOLV/PM EZOLV Sets the signal level of the virtual analog output. 0 : 0 to 100% (Absolute Value) 1 : -100 to 100% 2 : 0 to 100% (Lower Limit at 0)	0 (0 - 2)	712
H7-41 (1164)	Virtual Analog Output Function	V/f OLV OLV/PM AOLV/PM EZOLV Sets the monitor to be output from the virtual analog output. Set the x-xx part of the <i>Ux-xx [Monitor]</i> . For example, set H7-41 = 102 to monitor U1-02 [Output Frequency].	102 (0 - 999)	712
H7-42 (1165)	Virtual Analog Output FilterTime	V/f OLV OLV/PM AOLV/PM EZOLV Sets the time constant for a primary filter of the virtual analog output.	0.00 s (0.00 - 2.00 s)	712

11.11 L: Protection Functions

◆ L1: Motor Protection

No. (Hex.)	Name	Description	Default (Range)	Ref.
L1-01 (0480)	Motor Overload (oL1) Protection	<p>V/f OLV OLV/PM AOLV/PM EZOLV</p> <p>Sets the motor overload protection with electronic thermal protectors.</p> <p>0 : No 1 : Variable Torque 2 : Constant Torque 10:1 Speed Range 3 : Constant Torque 100:1 SpeedRange 4 : PM Variable Torque 5 : PM Constant Torque 6 : Variable Torque (50Hz)</p> <p>Note: When only one motor is connected to a drive, set <i>L1-01 = 1 to 6 [Enabled]</i>. External thermal relays are not necessary in these conditions.</p>	Determined by A1-02 (0 - 6)	202
L1-02 (0481)	Motor Overload Protection Time	<p>V/f OLV OLV/PM AOLV/PM EZOLV</p> <p>Sets the operation time for the electronic thermal protector of the drive to prevent damage to the motor. Usually it is not necessary to change this setting.</p>	1.0 min (0.1 - 5.0 min)	205
L1-03 (0482)	Motor Thermistor oH Alarm Select	<p>V/f OLV OLV/PM AOLV/PM EZOLV</p> <p>Sets drive operation when the PTC input signal entered into the drive is at the <i>oH3 [Motor Overheat Alarm]</i> detection level.</p> <p>0 : Ramp to Stop 1 : Coast to Stop 2 : Fast Stop 3 : Alarm Only</p>	3 (0 - 3)	206
L1-04 (0483)	Motor Thermistor oH Fault Select	<p>V/f OLV OLV/PM AOLV/PM EZOLV</p> <p>Sets the drive operation when the PTC input signal to the drive is at the <i>oH4 [Motor Overheat Fault (PTC Input)]</i> detection level.</p> <p>0 : Ramp to Stop 1 : Coast to Stop 2 : Fast Stop</p>	1 (0 - 2)	206
L1-05 (0484)	Motor Thermistor Filter Time	<p>V/f OLV OLV/PM AOLV/PM EZOLV</p> <p>Sets the primary delay time constant for the PTC input signal entered to the drive. This parameter prevents accidental motor overheat faults.</p>	0.20 s (0.00 - 10.00 s)	719
L1-08 (1103)	oL1 Current Level	<p>V/f OLV OLV/PM AOLV/PM EZOLV</p> <p>Sets the reference current for the motor 1 thermal overload detection. When the current level > 0.0 A, you cannot set this value < 10% of drive rated current.</p>	0.0 A (0.0 A or 10% to 150% of the drive rated current)	719
L1-09 (1104)	oL1 Current Level for Motor 2	<p>V/f OLV OLV/PM AOLV/PM EZOLV</p> <p>Sets the reference current for the motor 2 thermal overload detection. When the current level > 0.0 A, you cannot set this value < 10% of drive rated current.</p>	0.0 A (0.0 A or 10 to 150% of the drive rated current)	719
L1-13 (046D)	Motor Overload Memory Selection	<p>V/f OLV OLV/PM AOLV/PM EZOLV</p> <p>Sets the function that keeps the current electronic thermal protector value when the drive stops receiving power.</p> <p>0 : Disabled 1 : Enabled</p>	1 (0, 1)	719
L1-22 (0768) RUN	Leakage Current Filter Time1	<p>V/f OLV OLV/PM AOLV/PM EZOLV</p> <p>Sets the leakage current detection reduction filter time constant during constant speed run.</p> <p>Note: You can set this parameter when <i>C6-02 = B [Carrier Frequency Selection = Leakage Current Detection Reduction Rate PWM]</i>.</p>	Determined by C6-02 (0.0 - 60.0 s)	719
L1-23 (0769) RUN	Leakage Current Filter Time2	<p>V/f OLV OLV/PM AOLV/PM EZOLV</p> <p>Sets the leakage current detection reduction filter time constant during acceleration/ deceleration.</p> <p>Note:</p> <ul style="list-style-type: none"> You can set this parameter when <i>C6-02 = B [Carrier Frequency Selection = Leakage Current Detection Reduction Rate PWM]</i>. When the setting value increases, the current monitor also starts up slowly. Examine the relevant sequence for problems. 	Determined by C6-02 (0.0 - 60.0 s)	720

◆ L2: Power Loss Ride Through

No. (Hex.)	Name	Description	Default (Range)	Ref.
L2-01 (0485)	Power Loss Ride Through Select	<p>V/f OLV OLV/PM AOLV/PM EZOLV</p> <p>Sets the drive operation after a momentary power loss.</p> <p>0 : Disabled 1 : Enabled for L2-02 Time 2 : Enabled while CPU Power Active 3 : Kinetic Energy Backup: L2-02 4 : Kinetic Energy Backup: CPU Power 5 : Kinetic Energy Backup: DecelStop</p>	0 (0 - 5)	725
L2-02 (0486)	Power Loss Ride Through Time	<p>V/f OLV OLV/PM AOLV/PM EZOLV</p> <p>Sets the length of time that the drive will wait before it tries to restart if the DC bus voltage is less than L2-05 [<i>Undervoltage Detection Lvl (Uv1)</i>] after a momentary power loss.</p>	Determined by o2-04, C6-01 (0.0 - 25.5 s)	726
L2-03 (0487)	Minimum Baseblock Time	<p>V/f OLV OLV/PM AOLV/PM EZOLV</p> <p>Sets the minimum time to continue the drive output block (baseblock) after a baseblock.</p>	Determined by o2-04, C6-01 (0.1 - 5.0 s)	727
L2-04 (0488)	Powerloss V/f Recovery Ramp Time	<p>V/f OLV OLV/PM AOLV/PM EZOLV</p> <p>Sets the time for the drive output voltage to go back to correct voltage after completing speed searches.</p>	Determined by o2-04, C6-01 (0.0 - 5.0 s)	727
L2-05 (0489)	Undervoltage Detection Lvl (Uv1)	<p>V/f OLV OLV/PM AOLV/PM EZOLV</p> <p>Sets the voltage at which a <i>Uv1</i> [<i>DC Bus Undervoltage</i>] fault is triggered or at which the KEB function is activated. Usually it is not necessary to change this setting.</p> <p>NOTICE: Damage to Equipment. When you set this parameter to a value lower than the default, you must install an AC reactor on the input side of the power supply. If you do not install an AC reactor, it will cause damage to the drive circuitry.</p>	Determined by o2-04 and E1-01 (200 V Class: 150 - 210 V, 400 V Class: 300 - 420 V)	727
L2-06 (048A) Expert	Kinetic Energy Backup Decel Time	<p>V/f OLV OLV/PM AOLV/PM EZOLV</p> <p>Sets the deceleration time during KEB operation used to decrease the maximum output frequency to 0.</p> <p>Note: When L2-29 = 1, 2, or 3 [<i>Kinetic Energy Backup Method = Single Drive KEB Ride-Thru 2, System KEB Ride-Thru 1, or System KEB Ride-Thru 2</i>] and you do KEB Auto-Tuning, the drive will automatically set this value.</p>	0.0 s (0.0 - 6000.0 s)	727
L2-07 (048B) Expert	Kinetic Energy Backup Accel Time	<p>V/f OLV OLV/PM AOLV/PM EZOLV</p> <p>Sets the acceleration time to return the frequency to the frequency reference before a power loss after canceling KEB operation.</p>	0.0 s (0.0 - 6000.0 s)	728
L2-08 (048C) Expert	Frequency Gain at KEB Start	<p>V/f OLV OLV/PM AOLV/PM EZOLV</p> <p>Sets the quantity of output frequency reduction used when KEB operation starts as a percentage of the motor rated slip before starting KEB operation.</p>	100% (0 - 300%)	728
L2-09 (048D) Expert	KEB Minimum Frequency Level	<p>V/f OLV OLV/PM AOLV/PM EZOLV</p> <p>Sets the quantity of output frequency reduction used as a percentage of E2-02 [<i>Motor Rated Slip</i>] when KEB operation starts.</p>	20% (0 - 100%)	728
L2-10 (048E) Expert	Minimum KEB Time	<p>V/f OLV OLV/PM AOLV/PM EZOLV</p> <p>Sets the minimum length of time to operate the KEB after the drive detects a momentary power loss.</p>	50 ms (0 - 25500 ms)	728
L2-11 (0461) Expert	KEB DC Bus Voltage Setpoint	<p>V/f OLV OLV/PM AOLV/PM EZOLV</p> <p>Sets the target value that controls the DC bus voltage to a constant level in Single Drive KEB Ride-Thru 2. Sets the DC bus voltage level that completes the KEB operation for all other KEB methods.</p>	Determined by E1-01 (Determined by E1-01)	729
L2-29 (0475) Expert	Kinetic Energy Backup Method	<p>V/f OLV OLV/PM AOLV/PM EZOLV</p> <p>Sets the KEB function operation mode.</p> <p>0 : Single Drive KEB Ride-Thru 1 1 : Single Drive KEB Ride-Thru 2 2 : System KEB Ride-Thru 1 3 : System KEB Ride-Thru 2</p>	0 (0 - 3)	729

11.11 L: Protection Functions

No. (Hex.)	Name	Description	Default (Range)	Ref.
L2-30 (045E) Expert	KEB Zero Speed Operation	<p>V/f OLV OLV/PM AOLV/PM EZOLV</p> <p>Sets the operation when the output frequency decreases below the zero level (DC braking injection starting frequency) during KEB deceleration when L2-01 = 3 to 5 [Power Loss Ride Through Select = Kinetic Energy Backup: L2-02, Kinetic Energy Backup: CPU Power, or Kinetic Energy Backup: DecelStop].</p> <p>0 : Baseblock 1 : DC/SC Braking</p>	0 (0, 1)	730
L2-31 (045D) Expert	KEB Start Voltage Offset Level	<p>V/f OLV OLV/PM AOLV/PM EZOLV</p> <p>Sets the KEB start voltage offset.</p>	Determined by A1-02 (200 V Class: 0 - 100 V, 400 V Class: 0 - 200 V)	730

◆ L3: Stall Prevention

No. (Hex.)	Name	Description	Default (Range)	Ref.
L3-01 (048F)	Stall Prevention during Accel	<p>V/f OLV OLV/PM AOLV/PM EZOLV</p> <p>Sets the method of the Stall Prevention During Acceleration.</p> <p>0 : Disable 1 : Enabled 2 : Intelligent (Ignore Accel Ramp) 3 : Current Limit Acceleration</p>	1 (0 - 3)	731
L3-02 (0490)	Stall Prevent Level during Accel	<p>V/f OLV OLV/PM AOLV/PM EZOLV</p> <p>Sets the output current level at which the Stall Prevention function operates during acceleration where the drive rated output current is 100%.</p> <p>Note: The upper limit to the setting range changes when the setting for C6-01 [Normal / Heavy Duty Selection] changes.</p> <ul style="list-style-type: none"> • 150% when C6-01 = 0 [Heavy Duty Rating] • 120% when C6-01 = 1 [Normal Duty Rating] 	Determined by C6-01 (0 - 150%)	732
L3-03 (0491)	Stall Prevent Limit during Accel	<p>V/f OLV OLV/PM AOLV/PM EZOLV</p> <p>Sets the lower limit for the stall prevention level used in the constant output range as a percentage of the drive rated output current.</p>	50% (0 - 100%)	732
L3-04 (0492)	Stall Prevention during Decel	<p>V/f OLV OLV/PM AOLV/PM EZOLV</p> <p>Sets the method that the drive will use to prevent overvoltage faults when decelerating.</p> <p>Note:</p> <ol style="list-style-type: none"> To connect a dynamic braking option (braking resistor or braking resistor unit) to the drive, set this parameter to 0 or 3. Parameter settings 1, 2, 4, 5, and 7 will enable Stall Prevention function during deceleration, and the dynamic braking option will not function. The setting range changes when the A1-02 [Control Method Selection] value changes: <ul style="list-style-type: none"> • When A1-02 = 5 [OLV/PM], the setting range is 0 to 2. • When A1-02 = 6 or 8 [AOLV/PM or EZOLV], the setting range is 0 or 1. <p>0 : No 1 : General Purpose 2 : Intelligent (Ignore Decel Ramp) 3 : General Purpose w/ DB resistor 4 : Overexcitation/High Flux 5 : Overexcitation/High Flux 2 7 : Overexcitation/High Flux 3</p>	1 (Determined by A1-02)	733
L3-05 (0493)	Stall Prevention during RUN	<p>V/f OLV OLV/PM AOLV/PM EZOLV</p> <p>Sets the function to enable and disable Stall Prevention During Run.</p> <p>Note:</p> <ul style="list-style-type: none"> • An output frequency less than 6 Hz disables Stall Prevention during Run. The setting values of L3-05 and L3-06 [Stall Prevent Level during Run] do not have an effect. • The setting range changes when the A1-02 [Control Method Selection] value changes: <ul style="list-style-type: none"> - A1-02 = 0, 5 [V/f, OLV/PM] : 0 to 2 - A1-02 = 8 [EZOLV] : 0, 3 <p>0 : No 1 : Deceleration Time 1 (C1-02) 2 : Deceleration Time 2 (C1-04) 3 : Intelligent (Ignore Decel Ramp)</p>	2 (0 - Determined by A1-02)	735

No. (Hex.)	Name	Description	Default (Range)	Ref.
L3-06 (0494)	Stall Prevent Level during Run	<p>V/f OLV OLV/PM AOLV/PM EZOLV</p> <p>Sets the output current level at which the Stall Prevention function is enabled during run when the drive rated output current is 100%.</p> <p>Note:</p> <ul style="list-style-type: none"> This parameter is applicable when L3-05 = 1, 2 [Stall Prevention during RUN = Deceleration Time 1 (C1-02), Deceleration Time 2 (C1-04)]. The upper limit to the setting range changes when the setting for C6-01 [Normal / Heavy Duty Selection] changes. <ul style="list-style-type: none"> -150% when C6-01 = 0 [Heavy Duty Rating] -120% when C6-01 = 1 [Normal Duty Rating] 	Determined by C6-01 (5 - 150%)	735
L3-11 (04C7)	Overvoltage Suppression Select	<p>V/f OLV OLV/PM AOLV/PM EZOLV</p> <p>Sets the overvoltage suppression function.</p> <p>0 : Disabled 1 : Enabled</p>	0 (0, 1)	736
L3-17 (0462)	DC Bus Regulation Level	<p>V/f OLV OLV/PM AOLV/PM EZOLV</p> <p>Sets the target value for the DC bus voltage when the overvoltage suppression function and the Decel Stall Prevention function (Intelligent Stall Prevention) are active.</p>	200 V Class: 375 V, 400 V Class: 750 V (200 V Class: 150 to 400 V, 400 V Class: 300 to 800 V)	736
L3-20 (0465) Expert	DC Bus Voltage Adjustment Gain	<p>V/f OLV OLV/PM AOLV/PM EZOLV</p> <p>Sets the proportional gain used to control the DC bus voltage.</p>	Determined by A1-02 (0.00 - 5.00)	736
L3-21 (0466) Expert	OVSuppression Accel/Decel P Gain	<p>V/f OLV OLV/PM AOLV/PM EZOLV</p> <p>Sets the proportional gain to calculate acceleration and deceleration rates.</p>	Determined by A1-02 (0.10 - 10.00)	737
L3-22 (04F9)	PM Stall Prevention Decel Time	<p>V/f OLV OLV/PM AOLV/PM EZOLV</p> <p>Sets the momentary deceleration time that the drive will use when it tries to accelerate a PM motor and detected motor stalls. This function is applicable when L3-01 = 1 [Stall Prevention during Accel = Enabled].</p>	0.0 s (0.0 - 6000.0 s)	737
L3-23 (04FD)	Stall P Reduction at Constant HP	<p>V/f OLV OLV/PM AOLV/PM EZOLV</p> <p>Sets the function to automatically decrease the Stall Prevention Level during Run for constant output ranges.</p> <p>0 : Use L3-06 for Entire Speed Range 1 : Automatic Reduction @ CHP Region</p>	0 (0, 1)	737
L3-24 (046E) Expert	Motor Accel Time @ Rated Torque	<p>V/f OLV OLV/PM AOLV/PM EZOLV</p> <p>Sets the motor acceleration time to reach the maximum frequency at the motor rated torque for stopped single-drive motors.</p>	Determined by o2-04, C6-01, E2-11, and E5-01 (0.001 - 10.000 s)	737
L3-25 (046F) Expert	Load Inertia Ratio	<p>V/f OLV OLV/PM AOLV/PM EZOLV</p> <p>Sets the ratio between motor inertia and machine inertia.</p>	1.0 (0.1 - 1000.0)	738
L3-26 (0455) Expert	Additional DC Bus Capacitors	<p>V/f OLV OLV/PM AOLV/PM EZOLV</p> <p>Sets the capacity for external main circuit capacitors. Usually it is not necessary to change this setting. Sets this parameter when you use the KEB Ride-Thru function.</p>	0 μF (0 to 65000 μF)	738
L3-27 (0456)	Stall Prevention Detection Time	<p>V/f OLV OLV/PM AOLV/PM EZOLV</p> <p>Sets a delay time between reaching the Stall Prevention level and starting the Stall Prevention function.</p>	60 ms (0 - 5000 ms)	738
L3-34 (016F) Expert	Torque Limit Delay Time	<p>V/f OLV OLV/PM AOLV/PM EZOLV</p> <p>Sets the filter time constant that returns the torque limit to its initial value when KEB operation operates in Single Drive KEB Ride-Thru mode.</p>	Determined by A1-02 (0.000 - 1.000 s)	738
L3-35 (0747) Expert	Speed Agree Width for Auto Decel	<p>V/f OLV OLV/PM AOLV/PM EZOLV</p> <p>Sets the width for speed agreement when L3-04 = 2 [Stall Prevention during Decel = Intelligent (Ignore Decel Ramp)]. Usually it is not necessary to change this setting.</p>	0.00 Hz (0.00 - 1.00 Hz)	739
L3-36 (11D0)	Current Suppression Gain@Accel	<p>V/f OLV OLV/PM AOLV/PM EZOLV</p> <p>Sets the gain to suppress current and motor speed hunting during operation when L3-01 = 3 [Stall Prevention during Accel = Current Limit Method]. Usually it is not necessary to change this setting.</p>	Determined by A1-02 (0.0 - 100.0)	739
L3-37 (11D1) Expert	Current Limit P Gain @Accel	<p>V/f OLV OLV/PM AOLV/PM EZOLV</p> <p>Suppresses current hunting during acceleration. Usually it is not necessary to change this setting.</p>	5 ms (0 - 100 ms)	739
L3-38 (11D2) Expert	Current Limit I Time @ Accel	<p>V/f OLV OLV/PM AOLV/PM EZOLV</p> <p>Suppresses current hunting and overshooting that occurs when the drive stalls during acceleration. Usually it is not necessary to change this setting.</p>	10.0 (0.0 - 100.0)	739

11.11 L: Protection Functions

No. (Hex.)	Name	Description	Default (Range)	Ref.
L3-39 (11D3)	Current Limit Filter Time@Accel	<input type="checkbox"/> V/f <input type="checkbox"/> OLV <input type="checkbox"/> OLV/PM <input type="checkbox"/> AOLV/PM <input type="checkbox"/> EZOLV Sets the time constant to adjust the acceleration rate when $L3-01 = 3$ [Stall Prevention during Accel = Current Limit Acceleration]. Usually it is not necessary to change this setting.	100.0 ms (1.0 - 1000.0 ms)	739
L3-40 (11D4)	Current Limit S-Curve @ Acc/Dec	<input type="checkbox"/> V/f <input type="checkbox"/> OLV <input type="checkbox"/> OLV/PM <input type="checkbox"/> AOLV/PM <input type="checkbox"/> EZOLV Sets the function to enable and disable the best S-curve characteristic used for current-limited acceleration. 0 : Disable 1 : Enabled	0 (0, 1)	739

◆ L4: Speed Detection

No. (Hex.)	Name	Description	Default (Range)	Ref.
L4-01 (0499)	Speed Agree Detection Level	<input type="checkbox"/> V/f <input type="checkbox"/> OLV <input type="checkbox"/> OLV/PM <input type="checkbox"/> AOLV/PM <input type="checkbox"/> EZOLV Sets the level to detect speed agree or motor speed. Sets the level to detect speed agree or motor speed when $H2-01$ to $H2-03 = 2, 3, 4, 5$ [MFDO Function Selection = Speed Agree 1, User-set Speed Agree 1, Frequency Detection 1, Frequency Detection 2].	Determined by A1-02 (Determined by A1-02)	740
L4-02 (049A)	Speed Agree Detection Width	<input type="checkbox"/> V/f <input type="checkbox"/> OLV <input type="checkbox"/> OLV/PM <input type="checkbox"/> AOLV/PM <input type="checkbox"/> EZOLV Sets the width to detect speed agree or motor speed. Sets the width to detect speed agree or motor speed when $H2-01$ to $H2-03 = 2, 3, 4, 5$ [MFDO Function Selection = Speed Agree 1, User-set Speed Agree 1, Frequency Detection 1, Frequency Detection 2].	Determined by A1-02 (Determined by A1-02)	740
L4-03 (049B)	Speed Agree Detection Level(+/-)	<input type="checkbox"/> V/f <input type="checkbox"/> OLV <input type="checkbox"/> OLV/PM <input type="checkbox"/> AOLV/PM <input type="checkbox"/> EZOLV Sets the level to detect speed agree or motor speed. Sets the level to detect speed agree or motor speed when $H2-01$ to $H2-03 = 13, 14, 15, 16$ [MFDO Function Selection = Speed Agree 2, User-set Speed Agree 2, Frequency Detection 3, Frequency Detection 4].	Determined by A1-02 (Determined by A1-02)	740
L4-04 (049C)	Speed Agree Detection Width(+/-)	<input type="checkbox"/> V/f <input type="checkbox"/> OLV <input type="checkbox"/> OLV/PM <input type="checkbox"/> AOLV/PM <input type="checkbox"/> EZOLV Sets the width to detect speed agree or motor speed. Sets the width to detect speed agree or motor speed when $H2-01$ to $H2-03 = 13, 14, 15, 16$ [MFDO Function Selection = Speed Agree 2, User-set Speed Agree 2, Frequency Detection 3, Frequency Detection 4].	Determined by A1-02 (Determined by A1-02)	740
L4-05 (049D)	Fref Loss Detection Selection	<input type="checkbox"/> V/f <input type="checkbox"/> OLV <input type="checkbox"/> OLV/PM <input type="checkbox"/> AOLV/PM <input type="checkbox"/> EZOLV Sets the operation when the drive detects a loss of frequency reference. 0 : Stop 1 : Run at (L4-06 x Last Reference)	0 (0, 1)	740
L4-06 (04C2)	Frequency Reference @Loss of Ref	<input type="checkbox"/> V/f <input type="checkbox"/> OLV <input type="checkbox"/> OLV/PM <input type="checkbox"/> AOLV/PM <input type="checkbox"/> EZOLV Sets the frequency reference as a percentage to continue drive operation after it detects a frequency reference loss. The value is a percentage of the frequency reference before the drive detected the loss.	80.0% (0.0 - 100.0%)	741
L4-07 (0470)	Speed Agree Detection Selection	<input type="checkbox"/> V/f <input type="checkbox"/> OLV <input type="checkbox"/> OLV/PM <input type="checkbox"/> AOLV/PM <input type="checkbox"/> EZOLV Sets the condition that activates speed detection. 0 : No Detection during Baseblock 1 : Detection Always Enabled	0 (0, 1)	741
L4-08 (047F)	Speed Agree Source Selection	<input type="checkbox"/> V/f <input type="checkbox"/> OLV <input type="checkbox"/> OLV/PM <input type="checkbox"/> AOLV/PM <input type="checkbox"/> EZOLV Sets the drive to use the soft starter output frequency or the motor speed (estimation value) for speed detection. 0 : Softstarter Output (Reference) 1 : Motor Speed (Actual Speed)	0 (0, 1)	741

◆ L5: Fault Restart

No. (Hex.)	Name	Description	Default (Range)	Ref.
L5-01 (049E)	Number of Auto-Restart Attempts	<input type="checkbox"/> V/f <input type="checkbox"/> OLV <input type="checkbox"/> OLV/PM <input type="checkbox"/> AOLV/PM <input type="checkbox"/> EZOLV Sets the number of times that the drive will try to restart.	0 (0 - 10 times)	743
L5-02 (049F)	Fault Contact at Restart Select	<input type="checkbox"/> V/f <input type="checkbox"/> OLV <input type="checkbox"/> OLV/PM <input type="checkbox"/> AOLV/PM <input type="checkbox"/> EZOLV Sets the function that sends signals to the MFDO terminal set for Fault [$H2-xx = E$] while the drive is automatically restarting. 0 : Active Only when Not Restarting 1 : Always Active	0 (0, 1)	743

No. (Hex.)	Name	Description	Default (Range)	Ref.
L5-04 (046C)	Interval Method Restart Time	<p>V/f OLV OLV/PM AOLV/PM EZOLV</p> <p>Sets the time interval between each Auto Restart attempt. This function is enabled when $L5-05 = 1$ [Auto Restart Operation Selection = Use L5-04 Time].</p>	10.0 s (0.5 - 600.0 s)	743
L5-05 (0467)	Auto-Restart Method	<p>V/f OLV OLV/PM AOLV/PM EZOLV</p> <p>Sets the count method for the Auto Restart operation. 0 : Continuous/Immediate Attempts 1 : Interval/Attempt after L5-04 sec</p>	0 (0, 1)	743
L5-07 (0B2A)	Fault Reset Enable Select Grp1	<p>V/f OLV OLV/PM AOLV/PM EZOLV</p> <p>Use these 4 digits to set the Auto Restart function for $oL1$ to $oL4$. From left to right, the digits set $oL1$, $oL2$, $oL3$, and $oL4$, in order.</p> <p>0000 : Disabled 0001 : Enabled (—/—/—/ $oL4$) 0010 : Enabled (—/—/ $oL3$/—) 0011 : Enabled (—/—/ $oL3$/$oL4$) 0100 : Enabled (—/ $oL2$/—/—) 0101 : Enabled (—/ $oL2$/—/ $oL4$) 0110 : Enabled (—/ $oL2$/$oL3$/—) 0111 : Enabled (—/ $oL2$/$oL3$/$oL4$) 1000 : Enabled ($oL1$/—/—/—) 1001 : Enabled ($oL1$/—/—/ $oL4$) 1010 : Enabled ($oL1$/—/ $oL3$/—) 1011 : Enabled ($oL1$/—/ $oL3$/$oL4$) 1100 : Enabled ($oL1$/$oL2$/—/—) 1101 : Enabled ($oL1$/$oL2$/—/ $oL4$) 1110 : Enabled ($oL1$/$oL2$/$oL3$/—) 1111 : Enabled ($oL1$/$oL2$/$oL3$/$oL4$)</p>	1111 (0000 - 1111)	743
L5-08 (0B2B)	Fault Reset Enable Select Grp2	<p>V/f OLV OLV/PM AOLV/PM EZOLV</p> <p>Use these 4 digits to set the Auto Restart function for $Uv1$, ov, $oH1$, and GF. From left to right, the digits set $Uv1$, ov, $oH1$, and GF, in order.</p> <p>0000 : Disabled 0001 : Enabled (—/—/—/ GF) 0010 : Enabled (—/—/ $oH1$/—) 0011 : Enabled (—/—/ $oH1$/GF) 0100 : Enabled (—/ ov/—/—) 0101 : Enabled (—/ ov/—/ GF) 0110 : Enabled (—/ ov/$oH1$/—) 0111 : Enabled (—/ ov/$oH1$/GF) 1000 : Enabled ($Uv1$/—/—/—) 1001 : Enabled ($Uv1$/—/—/ GF) 1010 : Enabled ($Uv1$/—/ $oH1$/—) 1011 : Enabled ($Uv1$/—/ $oH1$/GF) 1100 : Enabled ($Uv1$/ov/—/—) 1101 : Enabled ($Uv1$/ov/—/ GF) 1110 : Enabled ($Uv1$/ov/$oH1$/—) 1111 : Enabled ($Uv1$/ov/$oH1$/GF)</p>	1111 (0000 - 1111)	744

◆ L6: Torque Detection

No. (Hex.)	Name	Description	Default (Range)	Ref.
L6-01 (04A1)	Torque Detection Selection 1	<p>V/f OLV OLV/PM AOLV/PM EZOLV</p> <p>Sets torque detection conditions that will trigger an overtorque or undertorque response from the drive.</p> <p>0 : Disabled 1 : oL @ Speed Agree - Alarm only 2 : oL @ RUN - Alarm only 3 : oL @ Speed Agree - Fault 4 : oL @ RUN - Fault 5 : UL @ Speed Agree - Alarm only 6 : UL @ RUN - Alarm only 7 : UL @ Speed Agree - Fault 8 : UL @ RUN - Fault</p>	0 (0 - 8)	747
L6-02 (04A2)	Torque Detection Level 1	<p>V/f OLV OLV/PM AOLV/PM EZOLV</p> <p>Sets the detection level for Overtorque/Undertorque Detection 1. In V/f control, drive rated output current = 100% value. In vector control, motor rated torque = 100% value.</p>	150% (0 - 300%)	748
L6-03 (04A3)	Torque Detection Time 1	<p>V/f OLV OLV/PM AOLV/PM EZOLV</p> <p>Sets the detection time for Overtorque/Undertorque Detection 1.</p>	0.1 s (0.0 - 10.0 s)	748
L6-04 (04A4)	Torque Detection Selection 2	<p>V/f OLV OLV/PM AOLV/PM EZOLV</p> <p>Sets the speed range that detects overtorque and undertorque and the operation of drives (operation status) after detection.</p> <p>0 : Disabled 1 : oL @ Speed Agree - Alarm only 2 : oL @ RUN - Alarm only 3 : oL @ Speed Agree - Fault 4 : oL @ RUN - Fault 5 : UL @ Speed Agree - Alarm only 6 : UL @ RUN - Alarm only 7 : UL @ Speed Agree - Fault 8 : UL @ RUN - Fault</p>	0 (0 - 8)	748
L6-05 (04A5)	Torque Detection Level 2	<p>V/f OLV OLV/PM AOLV/PM EZOLV</p> <p>Sets the detection level for Overtorque/Undertorque Detection 2. In V/f control, drive rated output current = 100% value. In vector control, motor rated torque = 100% value.</p>	150% (0 - 300%)	749
L6-06 (04A6)	Torque Detection Time 2	<p>V/f OLV OLV/PM AOLV/PM EZOLV</p> <p>Sets the detection time for Overtorque/Undertorque Detection 2.</p>	0.1 s (0.0 - 10.0 s)	749
L6-07 (04E5)	Torque Detection Filter Time	<p>V/f OLV OLV/PM AOLV/PM EZOLV</p> <p>Sets the time constant for a primary filter to the torque reference or to the output current used to detect overtorque/undertorque.</p>	0 ms (0 - 1000 ms)	749
L6-08 (0468)	Mechanical Fatigue Detect Select	<p>V/f OLV OLV/PM AOLV/PM EZOLV</p> <p>Sets the speed where the drive detects mechanical deterioration and how the drive operates (operation status) after detection.</p> <p>0 : Disabled 1 : oL5 @ Speed > L6-09 - Alarm 2 : oL5 @ Speed > L6-09 - Alarm 3 : oL5 @ Speed > L6-09 - Fault 4 : oL5 @ Speed > L6-09 - Fault 5 : UL5 @ Speed < L6-09 - Alarm 6 : UL5 @ Speed < L6-09 - Alarm 7 : UL5 @ Speed < L6-09 - Fault 8 : UL5 @ Speed < L6-09 - Fault</p>	0 (0 - 8)	749
L6-09 (0469)	Mech Fatigue Detect Speed Level	<p>V/f OLV OLV/PM AOLV/PM EZOLV</p> <p>Sets the speed level where the drive will operate the mechanical deterioration detection function, as a percentage of the Maximum Output Frequency.</p> <p>Note: Parameter A1-02 [Control Method Selection] selects which parameter is the maximum output frequency. • A1-02 ≠ 8 [EZOLV]: E1-04 [Maximum Output Frequency] • A1-02 = 8: E9-02 [Maximum Speed]</p>	110.0% (-110.0 - 110.0%)	750

No. (Hex.)	Name	Description	Default (Range)	Ref.
L6-10 (046A)	Mech Fatigue Detect Delay Time	<input type="checkbox"/> V/f <input checked="" type="checkbox"/> OLV <input checked="" type="checkbox"/> OLV/PM <input checked="" type="checkbox"/> AOLV/PM <input checked="" type="checkbox"/> EZOLV Sets the time for mechanical deterioration detection.	0.1 s (0.0 - 10.0 s)	750
L6-11 (046B)	Mech Fatigue Hold Off Time	<input type="checkbox"/> V/f <input checked="" type="checkbox"/> OLV <input checked="" type="checkbox"/> OLV/PM <input checked="" type="checkbox"/> AOLV/PM <input checked="" type="checkbox"/> EZOLV Sets the time that the drive will start mechanical deterioration detection triggered by the cumulative operation time of the drive.	0 h (0 - 65535 h)	750

◆ L7: Torque Limit

No. (Hex.)	Name	Description	Default (Range)	Ref.
L7-01 (04A7) RUN	Forward Torque Limit	<input type="checkbox"/> V/f <input checked="" type="checkbox"/> OLV <input checked="" type="checkbox"/> OLV/PM <input checked="" type="checkbox"/> AOLV/PM <input checked="" type="checkbox"/> EZOLV Sets the torque limit value for forward motoring as a percentage, where motor rated torque is the 100% value.	200% (0 - 300%)	751
L7-02 (04A8) RUN	Reverse Torque Limit	<input type="checkbox"/> V/f <input checked="" type="checkbox"/> OLV <input checked="" type="checkbox"/> OLV/PM <input checked="" type="checkbox"/> AOLV/PM <input checked="" type="checkbox"/> EZOLV Sets the torque limit value for reversed motoring as a percentage, where motor rated torque is the 100% value.	200% (0 - 300%)	751
L7-03 (04A9) RUN	Forward Regenerative Trq Limit	<input type="checkbox"/> V/f <input checked="" type="checkbox"/> OLV <input checked="" type="checkbox"/> OLV/PM <input checked="" type="checkbox"/> AOLV/PM <input checked="" type="checkbox"/> EZOLV Sets the torque limit value for forward regenerative conditions as a percentage of the motor rated torque.	200% (0 - 300%)	752
L7-04 (04AA) RUN	Reverse Regenerative Trq Limit	<input type="checkbox"/> V/f <input checked="" type="checkbox"/> OLV <input checked="" type="checkbox"/> OLV/PM <input checked="" type="checkbox"/> AOLV/PM <input checked="" type="checkbox"/> EZOLV Sets the torque limit value for reversed regenerative conditions as a percentage of the motor rated torque.	200% (0 - 300%)	752
L7-06 (04AC)	Torque Limit Integral Time	<input type="checkbox"/> V/f <input checked="" type="checkbox"/> OLV <input checked="" type="checkbox"/> OLV/PM <input checked="" type="checkbox"/> AOLV/PM <input checked="" type="checkbox"/> EZOLV Sets the integral time constant for the torque limit function.	200 ms (5 - 10000 ms)	752
L7-07 (04C9)	Torque Limit during Accel/Decel	<input type="checkbox"/> V/f <input checked="" type="checkbox"/> OLV <input checked="" type="checkbox"/> OLV/PM <input checked="" type="checkbox"/> AOLV/PM <input checked="" type="checkbox"/> EZOLV Sets the torque limit function during acceleration and deceleration. 0 : Proportional only 1 : Proportional & Integral control	0 (0, 1)	752
L7-16 (044D)	Torque Limit Process at Start	<input type="checkbox"/> V/f <input checked="" type="checkbox"/> OLV <input checked="" type="checkbox"/> OLV/PM <input checked="" type="checkbox"/> AOLV/PM <input checked="" type="checkbox"/> EZOLV Assigns a time filter to allow the torque limit to build at start. 0 : Disabled 1 : Enabled	1 (0, 1)	753

◆ L8: Drive Protection

No. (Hex.)	Name	Description	Default (Range)	Ref.
L8-01 (04AD)	3% ERF DB Resistor Protection	<input type="checkbox"/> V/f <input checked="" type="checkbox"/> OLV <input checked="" type="checkbox"/> OLV/PM <input checked="" type="checkbox"/> AOLV/PM <input checked="" type="checkbox"/> EZOLV Sets the function to enable braking resistor protection with a Yaskawa ERF series braking resistor (3% ED) installed on the heatsink. 0 : No 1 : Yes	0 (0, 1)	753
L8-02 (04AE)	Overheat Alarm Level	<input type="checkbox"/> V/f <input checked="" type="checkbox"/> OLV <input checked="" type="checkbox"/> OLV/PM <input checked="" type="checkbox"/> AOLV/PM <input checked="" type="checkbox"/> EZOLV Sets the <i>oH</i> detection level in temperature.	Determined by o2-04, C6-01 (50 - 150 °C)	753
L8-03 (04AF)	Overheat Pre-Alarm Selection	<input type="checkbox"/> V/f <input checked="" type="checkbox"/> OLV <input checked="" type="checkbox"/> OLV/PM <input checked="" type="checkbox"/> AOLV/PM <input checked="" type="checkbox"/> EZOLV Sets operation after the drive detects an <i>oH</i> alarm. 0 : Ramp to Stop 1 : Coast to Stop 2 : Fast Stop (Use C1-09) 3 : Alarm Only 4 : Operate at Reduced Speed (L8-19)	3 (0 - 4)	753
L8-05 (04B1)	Input Phase Loss Protection Sel	<input type="checkbox"/> V/f <input checked="" type="checkbox"/> OLV <input checked="" type="checkbox"/> OLV/PM <input checked="" type="checkbox"/> AOLV/PM <input checked="" type="checkbox"/> EZOLV Sets the function to enable and disable input phase loss detection. 0 : Disabled 1 : Enabled	Determined by o2-04 (Determined by o2-04)	754

11.11 L: Protection Functions

No. (Hex.)	Name	Description	Default (Range)	Ref.
L8-07 (04B3)	Output Phase Loss Protection Sel	<p><input checked="" type="checkbox"/> V/f <input checked="" type="checkbox"/> OLV <input checked="" type="checkbox"/> OLV/PM <input checked="" type="checkbox"/> AOLV/PM <input checked="" type="checkbox"/> EZOLV</p> <p>Sets the function to enable and disable output phase loss detection. The drive starts output phase loss detection when the output current decreases to less than 5% of the drive rated current.</p> <p>Note: The drive can incorrectly start output phase loss detection in these conditions:</p> <ul style="list-style-type: none"> • The motor rated current is very small compared to the drive rating. • The drive is operating a PM motor with a small load. <p>0 : Disabled 1 : Fault when one phase is lost 2 : Fault when two phases are lost</p>	1 (0 - 2)	755
L8-09 (04B5)	Output Ground Fault Detection	<p><input checked="" type="checkbox"/> V/f <input checked="" type="checkbox"/> OLV <input checked="" type="checkbox"/> OLV/PM <input checked="" type="checkbox"/> AOLV/PM <input checked="" type="checkbox"/> EZOLV</p> <p>Sets the function to enable and disable ground fault protection.</p> <p>0 : Disabled 1 : Enabled</p>	Determined by o2-04 (0, 1)	755
L8-10 (04B6)	Heatsink Fan Operation Selection	<p><input checked="" type="checkbox"/> V/f <input checked="" type="checkbox"/> OLV <input checked="" type="checkbox"/> OLV/PM <input checked="" type="checkbox"/> AOLV/PM <input checked="" type="checkbox"/> EZOLV</p> <p>Sets operation of the heatsink cooling fan.</p> <p>0 : During Run, w/ L8-11 Off-Delay 1 : Always On 2 : Temperature-Dependent Fan Ctrl.</p>	0 (0 - 2)	755
L8-11 (04B7)	Heatsink Fan Off-Delay Time	<p><input checked="" type="checkbox"/> V/f <input checked="" type="checkbox"/> OLV <input checked="" type="checkbox"/> OLV/PM <input checked="" type="checkbox"/> AOLV/PM <input checked="" type="checkbox"/> EZOLV</p> <p>Sets the length of time that the drive will wait before it stops the cooling fan after it cancels the Run command when L8-10 = 0 [Heatsink Fan Operation Selection = During Run, w/ L8-11 Off-Delay].</p>	60 s (0 - 300 s)	756
L8-12 (04B8)	Ambient Temperature Setting	<p><input checked="" type="checkbox"/> V/f <input checked="" type="checkbox"/> OLV <input checked="" type="checkbox"/> OLV/PM <input checked="" type="checkbox"/> AOLV/PM <input checked="" type="checkbox"/> EZOLV</p> <p>Sets the ambient temperature of the drive installation area.</p> <p>Note: The setting range changes when the L8-35 [Installation Method Selection] value changes:</p> <ul style="list-style-type: none"> • 0 [IP20/UL Open Type]: -10 °C to +60 °C • 1 [Side-by-Side Mounting]: -10 °C to +50 °C • 2 [IP20/UL Type 1]: -10 °C to +50 °C • 3 [External Heatsink/Finless]: -10 °C to +50 °C 	40 °C (-10 °C - +60 °C)	356
L8-15 (04BB)	Drive oL2 @ Low Speed Protection	<p><input checked="" type="checkbox"/> V/f <input checked="" type="checkbox"/> OLV <input checked="" type="checkbox"/> OLV/PM <input checked="" type="checkbox"/> AOLV/PM <input checked="" type="checkbox"/> EZOLV</p> <p>Sets the function to decrease the drive overload level at which the drive will trigger oL2 [Drive Overload] during low speed operation (6 Hz or slower) to prevent damage to the main circuit transistors.</p> <p>Note: Contact Yaskawa or your nearest sales representative before disabling this function at low speeds. If you frequently operate drives with high output current in low speed ranges, it can cause heat stress and decrease the life span of drive IGBTs.</p> <p>0 : Disabled (No Additional Derate) 1 : Enabled (Reduced oL2 Level)</p>	1 (0, 1)	756
L8-18 (04BE)	Software Current Limit Selection	<p><input checked="" type="checkbox"/> V/f <input checked="" type="checkbox"/> OLV <input checked="" type="checkbox"/> OLV/PM <input checked="" type="checkbox"/> AOLV/PM <input checked="" type="checkbox"/> EZOLV</p> <p>Set the software current limit selection function to prevent damage to the main circuit transistor caused by too much current.</p> <p>0 : Disabled 1 : Enabled</p>	0 (0, 1)	756
L8-19 (04BF)	Freq Reduction @ oH Pre-Alarm	<p><input checked="" type="checkbox"/> V/f <input checked="" type="checkbox"/> OLV <input checked="" type="checkbox"/> OLV/PM <input checked="" type="checkbox"/> AOLV/PM <input checked="" type="checkbox"/> EZOLV</p> <p>Sets the ratio at which the drive derates the frequency reference during an oH alarm.</p>	0.8 (0.1 - 0.9)	757
L8-27 (04DD)	Overcurrent Detection Gain	<p><input checked="" type="checkbox"/> V/f <input checked="" type="checkbox"/> OLV <input checked="" type="checkbox"/> OLV/PM <input checked="" type="checkbox"/> AOLV/PM <input checked="" type="checkbox"/> EZOLV</p> <p>Sets the PM motor overcurrent detection level as a percentage of the motor rated current value.</p> <p>Note: Parameter A1-02 [Control Method Selection] selects which parameter is the motor rated current.</p> <ul style="list-style-type: none"> • A1-02 ≠ 8 [EZOLV]: E5-03 [PM Motor Rated Current (FLA)] • A1-02 = 8: E9-06 [Motor Rated Current (FLA)] 	300.0% (0.0 - 1000.0%)	757
L8-29 (04DF)	Output Unbalance Detection Sel	<p><input checked="" type="checkbox"/> V/f <input checked="" type="checkbox"/> OLV <input checked="" type="checkbox"/> OLV/PM <input checked="" type="checkbox"/> AOLV/PM <input checked="" type="checkbox"/> EZOLV</p> <p>Sets the function to detect LF2 [Output Current Imbalance].</p> <p>0 : Disabled 1 : Enabled</p>	1 (0, 1)	757
L8-31 (04E1)	LF2 Detection Time	<p><input checked="" type="checkbox"/> V/f <input checked="" type="checkbox"/> OLV <input checked="" type="checkbox"/> OLV/PM <input checked="" type="checkbox"/> AOLV/PM <input checked="" type="checkbox"/> EZOLV</p> <p>Sets the LF2 [Output Current Imbalance] detection time.</p>	3 (1 - 100)	757

No. (Hex.)	Name	Description	Default (Range)	Ref.
L8-35 (04EC)	Installation Method Selection	<p><input type="checkbox"/> V/f <input type="checkbox"/> OLV <input type="checkbox"/> OLV/PM <input type="checkbox"/> AOLV/PM <input type="checkbox"/> EZOLV</p> <p>Sets the type of drive installation.</p> <p>Note: This parameter is set to the correct value when the drive is shipped. 0 : IP20/UL Open Type 1 : Side-by-Side Mounting 2 : IP20/UL Type1 3 : External Heatsink/Finless</p>	0, 3 (0 - 3)	356
L8-40 (04F1)	Carrier Freq Reduction Off-Delay	<p><input type="checkbox"/> V/f <input type="checkbox"/> OLV <input type="checkbox"/> OLV/PM <input type="checkbox"/> AOLV/PM <input type="checkbox"/> EZOLV</p> <p>Sets the length of time until the automatically reduced carrier frequency returns to the condition before the reduction.</p>	Determined by A1-02 (0.00 - 2.00 s)	758
L8-41 (04F2)	High Current Alarm Selection	<p><input type="checkbox"/> V/f <input type="checkbox"/> OLV <input type="checkbox"/> OLV/PM <input type="checkbox"/> AOLV/PM <input type="checkbox"/> EZOLV</p> <p>Sets the function to cause an HCA [Current Alarm] when the output current is more than 150% of the drive rated current. 0 : No 1 : Yes</p>	0 (0, 1)	758
L8-51 (0471) Expert	STPo I Detection Level	<p><input type="checkbox"/> V/f <input type="checkbox"/> OLV <input type="checkbox"/> OLV/PM <input type="checkbox"/> AOLV/PM <input type="checkbox"/> EZOLV</p> <p>Sets the STPo [Motor Step-Out Detected] detection level as a percentage of the motor rated current.</p> <p>Note: Parameter A1-02 [Control Method Selection] selects which parameter is the motor rated current. • A1-02 = 5 [OLV/PM]: E5-03 [PM Motor Rated Current (FLA)] • A1-02 = 8 [EZOLV]: E9-06 [Motor Rated Current (FLA)]</p>	0.0% (0.0 - 300.0%)	759
L8-52 (0472) Expert	STPo Integration Level	<p><input type="checkbox"/> V/f <input type="checkbox"/> OLV <input type="checkbox"/> OLV/PM <input type="checkbox"/> AOLV/PM <input type="checkbox"/> EZOLV</p> <p>Sets the detection level for STPo [Motor Step-Out Detected] related to the ACR integral value.</p>	1.0 (0.1 - 2.0)	759
L8-53 (0473) Expert	STPo Integration Time	<p><input type="checkbox"/> V/f <input type="checkbox"/> OLV <input type="checkbox"/> OLV/PM <input type="checkbox"/> AOLV/PM <input type="checkbox"/> EZOLV</p> <p>Sets the length of time until the drive detects STPo after it is more than the value of L8-51 [STPo I Detection Level].</p>	1.0 s (1.0 - 10.0 s)	759
L8-54 (0474) Expert	STPo Id Diff Detection	<p><input type="checkbox"/> V/f <input type="checkbox"/> OLV <input type="checkbox"/> OLV/PM <input type="checkbox"/> AOLV/PM <input type="checkbox"/> EZOLV</p> <p>Sets the Id deviation detection function for STPo [Motor Step-Out Detected]. 0 : Disabled 1 : Enabled</p>	1 (0, 1)	759
L8-55 (045F)	Internal DB TransistorProtection	<p><input type="checkbox"/> V/f <input type="checkbox"/> OLV <input type="checkbox"/> OLV/PM <input type="checkbox"/> AOLV/PM <input type="checkbox"/> EZOLV</p> <p>Sets the protection function for the internal braking transistor. 0 : Disable 1 : Protection Enabled</p>	1 (0, 1)	759
L8-56 (047D) Expert	Stall P @ Accel Activation Time	<p><input type="checkbox"/> V/f <input type="checkbox"/> OLV <input type="checkbox"/> OLV/PM <input type="checkbox"/> AOLV/PM <input type="checkbox"/> EZOLV</p> <p>Sets the length time that the acceleration stall prevention function can continue to operate before the drive detects an STPo [Motor Step-Out Detected].</p>	5000 ms (100 - 5000 ms)	760
L8-57 (047E) Expert	Stall Prevention Retry Counts	<p><input type="checkbox"/> V/f <input type="checkbox"/> OLV <input type="checkbox"/> OLV/PM <input type="checkbox"/> AOLV/PM <input type="checkbox"/> EZOLV</p> <p>Sets the number of times the acceleration stall prevention function can operate until speeds agree before the drive detects an STPo [Motor Step-Out Detected].</p>	10 (1 - 10 times)	760
L8-90 (0175) Expert	STPo Detection Level (Low Speed)	<p><input type="checkbox"/> V/f <input type="checkbox"/> OLV <input type="checkbox"/> OLV/PM <input type="checkbox"/> AOLV/PM <input type="checkbox"/> EZOLV</p> <p>Sets the detection level that the control fault must be equal to or more than to cause an STPo [Motor Step-Out Detected].</p>	Determined by A1-02 (0 - 5000 times)	760
L8-93 (073C) Expert	Low Speed Pull-out DetectionTime	<p><input type="checkbox"/> V/f <input type="checkbox"/> OLV <input type="checkbox"/> OLV/PM <input type="checkbox"/> AOLV/PM <input type="checkbox"/> EZOLV</p> <p>Sets the length of time the drive will wait to start baseblock after detecting LSo [Low Speed Motor Step-Out].</p>	1.0 s (0.0 - 10.0 s)	760
L8-94 (073D) Expert	Low Speed Pull-out Detect Level	<p><input type="checkbox"/> V/f <input type="checkbox"/> OLV <input type="checkbox"/> OLV/PM <input type="checkbox"/> AOLV/PM <input type="checkbox"/> EZOLV</p> <p>Sets the detection level for LSo [Low Speed Motor Step-Out] as a percentage of E1-04 [Maximum Output Frequency].</p>	3% (0 - 10%)	760
L8-95 (077F) Expert	Low Speed Pull-out Amount	<p><input type="checkbox"/> V/f <input type="checkbox"/> OLV <input type="checkbox"/> OLV/PM <input type="checkbox"/> AOLV/PM <input type="checkbox"/> EZOLV</p> <p>Sets the average count of LSo [Low Speed Motor Step-Out] detections.</p>	10 (1 - 50 times)	760

11.12 n: Special Adjustment

◆ n1: Hunting Prevention

No. (Hex.)	Name	Description	Default (Range)	Ref.
n1-01 (0580)	Hunting Prevention Selection	<p><input type="checkbox"/> V/f <input type="checkbox"/> OLV <input type="checkbox"/> OLV/PM <input type="checkbox"/> AOLV/PM <input type="checkbox"/> EZOLV</p> <p>Sets the function to prevent hunting.</p> <p>Note: When you replace a V1000-series drive with a GA500 drive, set $n1-01 = 1$ [<i>Hunting Prevention Selection = Enabled</i>].</p> <p>0 : Disable 1 : Enabled</p>	0 (0, 1)	761
n1-02 (0581) Expert	Hunting Prevention Gain Setting	<p><input type="checkbox"/> V/f <input type="checkbox"/> OLV <input type="checkbox"/> OLV/PM <input type="checkbox"/> AOLV/PM <input type="checkbox"/> EZOLV</p> <p>Sets the performance of the hunting prevention function. Usually it is not necessary to change this parameter.</p>	1.00 (0.00 - 2.50)	761
n1-03 (0582) Expert	Hunting Prevention Time Constant	<p><input type="checkbox"/> V/f <input type="checkbox"/> OLV <input type="checkbox"/> OLV/PM <input type="checkbox"/> AOLV/PM <input type="checkbox"/> EZOLV</p> <p>Sets the primary delay time constant of the hunting prevention function. Usually it is not necessary to change this parameter.</p>	Determined by o2-04 (0 - 500 ms)	761
n1-05 (0530) Expert	Hunting Prevent Gain in Reverse	<p><input type="checkbox"/> V/f <input type="checkbox"/> OLV <input type="checkbox"/> OLV/PM <input type="checkbox"/> AOLV/PM <input type="checkbox"/> EZOLV</p> <p>Sets the performance of the hunting prevention function. This parameter adjusts Reverse run. Usually it is not necessary to change this parameter.</p>	0.00 (0.00 - 2.50)	761
n1-13 (1B59) Expert	DC Bus Stabilization Control	<p><input type="checkbox"/> V/f <input type="checkbox"/> OLV <input type="checkbox"/> OLV/PM <input type="checkbox"/> AOLV/PM <input type="checkbox"/> EZOLV</p> <p>Sets the oscillation suppression function for the DC bus voltage.</p> <p>0 : Disabled 1 : Enabled</p>	0 (0, 1)	762
n1-14 (1B5A) Expert	DC Bus Stabilization Time	<p><input type="checkbox"/> V/f <input type="checkbox"/> OLV <input type="checkbox"/> OLV/PM <input type="checkbox"/> AOLV/PM <input type="checkbox"/> EZOLV</p> <p>Adjusts the responsiveness of the oscillation suppression function for the DC bus voltage. Set $n1-13 = 1$ [<i>DC Bus Stabilization Control = Enabled</i>] to enable this parameter.</p>	100.0 ms (50.0 - 500.0 ms)	762

◆ n2: Auto Freq Regulator (AFR)

No. (Hex.)	Name	Description	Default (Range)	Ref.
n2-01 (0584)	Automatic Freq Regulator Gain	<p><input type="checkbox"/> V/f <input checked="" type="checkbox"/> OLV <input type="checkbox"/> OLV/PM <input type="checkbox"/> AOLV/PM <input type="checkbox"/> EZOLV</p> <p>Sets the gain of the AFR function as a magnification value. Usually it is not necessary to change this setting.</p>	1.00 (0.00 - 10.00)	762
n2-02 (0585)	Automatic Freq Regulator Time 1	<p><input type="checkbox"/> V/f <input checked="" type="checkbox"/> OLV <input type="checkbox"/> OLV/PM <input type="checkbox"/> AOLV/PM <input type="checkbox"/> EZOLV</p> <p>Sets the time constant that sets the rate of change for the AFR function. Usually it is not necessary to change this setting.</p>	50 ms (0 - 2000 ms)	763
n2-03 (0586)	Automatic Freq Regulator Time 2	<p><input type="checkbox"/> V/f <input checked="" type="checkbox"/> OLV <input type="checkbox"/> OLV/PM <input type="checkbox"/> AOLV/PM <input type="checkbox"/> EZOLV</p> <p>Sets the time constant that sets the speed difference of the AFR function. Use this parameter for speed searches or regeneration. Usually it is not necessary to change this setting.</p>	750 ms (0 - 2000 ms)	763

◆ n3: High Slip/Overexcite Braking

No. (Hex.)	Name	Description	Default (Range)	Ref.
n3-01 (0588) Expert	HSB Deceleration Frequency Width	<p><input type="checkbox"/> V/f <input type="checkbox"/> OLV <input type="checkbox"/> OLV/PM <input type="checkbox"/> AOLV/PM <input type="checkbox"/> EZOLV</p> <p>Sets the amount by which the output frequency is to be lowered during high-slip braking, as a percentage of $E1-04$ [<i>Maximum Output Frequency</i>], which represents the 100% value.</p>	5% (1 - 20%)	765
n3-02 (0589) Expert	HSB Current Limit Level	<p><input type="checkbox"/> V/f <input type="checkbox"/> OLV <input type="checkbox"/> OLV/PM <input type="checkbox"/> AOLV/PM <input type="checkbox"/> EZOLV</p> <p>Sets the maximum current output during high-slip braking as a percentage, where $E2-01$ [<i>Motor Rated Current (FLA)</i>] is 100%. Also set the current suppression to prevent exceeding drive overload tolerance.</p> <p>Note: The upper limit to the setting range changes when the setting for $C6-01$ [<i>Normal / Heavy Duty Selection</i>] changes.</p> <ul style="list-style-type: none"> • 150% when $C6-01 = 0$ [<i>Heavy Duty Rating</i>] • 120% when $C6-01 = 1$ [<i>Normal Duty Rating</i>] 	Determined by C6-01 (0 - 150%)	765

No. (Hex.)	Name	Description	Default (Range)	Ref.
n3-03 (058A) Expert	HSB Dwell Time at Stop	<input checked="" type="checkbox"/> V/f <input type="checkbox"/> OLV <input type="checkbox"/> OLV/PM <input type="checkbox"/> AOLV/PM <input type="checkbox"/> EZOLV Sets the dwell time, a length of time when high-slip braking is ending and during which the motor speed decreases and runs at a stable speed. For a set length of time, the drive will hold the actual output frequency at the minimum output frequency set in <i>E1-09</i> .	1.0 s (0.0 - 10.0 s)	765
n3-04 (058B) Expert	HSB Overload Time	<input checked="" type="checkbox"/> V/f <input type="checkbox"/> OLV <input type="checkbox"/> OLV/PM <input type="checkbox"/> AOLV/PM <input type="checkbox"/> EZOLV Sets the time used to detect <i>oL7 [High Slip Braking Overload]</i> , which occurs when the output frequency does not change during high-slip braking. Usually it is not necessary to change this parameter.	40 s (30 - 1200 s)	765
n3-13 (0531)	OverexcitationBraking (OEB) Gain	<input checked="" type="checkbox"/> V/f <input type="checkbox"/> OLV <input type="checkbox"/> OLV/PM <input type="checkbox"/> AOLV/PM <input type="checkbox"/> EZOLV Sets the gain value that the drive multiplies by the V/f pattern output value during overexcitation deceleration to calculate the overexcitation level.	1.10 (1.00 - 1.40)	766
n3-14 (0532) Expert	OEB High Frequency Injection	<input checked="" type="checkbox"/> V/f <input type="checkbox"/> OLV <input type="checkbox"/> OLV/PM <input type="checkbox"/> AOLV/PM <input type="checkbox"/> EZOLV Sets the function that injects harmonic signals during overexcitation deceleration. 0 : Disabled 1 : Enabled	0 (0, 1)	766
n3-21 (0579)	HSB Current Suppression Level	<input checked="" type="checkbox"/> V/f <input type="checkbox"/> OLV <input type="checkbox"/> OLV/PM <input type="checkbox"/> AOLV/PM <input type="checkbox"/> EZOLV Sets the upper limit of the current that is suppressed at the time of overexcitation deceleration as a percentage of the drive rated current.	100% (0 - 150%)	766
n3-23 (057B)	Overexcitation Braking Operation	<input checked="" type="checkbox"/> V/f <input type="checkbox"/> OLV <input type="checkbox"/> OLV/PM <input type="checkbox"/> AOLV/PM <input type="checkbox"/> EZOLV Sets the direction of motor rotation where the drive will enable overexcitation. 0 : Disabled 1 : Enabled Only when Rotating FWD 2 : Enabled Only when Rotating REV	0 (0 - 2)	766

◆ n5: Feed Forward Control

No. (Hex.)	Name	Description	Default (Range)	Ref.
n5-01 (05B0)	Feed Forward Control Selection	<input checked="" type="checkbox"/> V/f <input type="checkbox"/> OLV <input type="checkbox"/> OLV/PM <input type="checkbox"/> AOLV/PM <input type="checkbox"/> EZOLV Sets the feed forward function. 0 : Disabled 1 : Enabled	0 (0, 1)	767
n5-02 (05B1)	Motor Inertia Acceleration Time	<input checked="" type="checkbox"/> V/f <input type="checkbox"/> OLV <input type="checkbox"/> OLV/PM <input type="checkbox"/> AOLV/PM <input type="checkbox"/> EZOLV Sets the length of time for the motor to accelerate from the stopped to the maximum frequency with a single motor at the rated torque. Inertia Tuning automatically sets the motor acceleration time.	Determined by C6-01, E5-01, and o2-04 (0.001 - 10.000 s)	768
n5-03 (05B2)	Feed Forward Control Gain	<input checked="" type="checkbox"/> V/f <input type="checkbox"/> OLV <input type="checkbox"/> OLV/PM <input type="checkbox"/> AOLV/PM <input type="checkbox"/> EZOLV Sets the ratio between load inertia and motor inertia. Inertia Tuning automatically sets the Feedforward Control Gain value.	1.00 (0.00 - 100.00)	768
n5-04 (05B3) RUN Expert	Speed Response Frequency	<input checked="" type="checkbox"/> V/f <input type="checkbox"/> OLV <input type="checkbox"/> OLV/PM <input type="checkbox"/> AOLV/PM <input type="checkbox"/> EZOLV Sets the response frequency for the speed reference. Usually it is not necessary to change this parameter.	Determined by A1-02 (0.00 - 500.00 Hz)	769

◆ n6: Online Tuning

No. (Hex.)	Name	Description	Default (Range)	Ref.
n6-01 (0570)	Online Tuning Selection	<input checked="" type="checkbox"/> V/f <input type="checkbox"/> OLV <input type="checkbox"/> OLV/PM <input type="checkbox"/> AOLV/PM <input type="checkbox"/> EZOLV Sets the type of motor data that Online Tuning uses for OLV control. 0 : Disabled 1 : Line-to-Line Resistance Tuning 2 : Voltage Correction Tuning	0 (0 - 2)	769
n6-05 (05C7) Expert	Online Tuning Gain	<input checked="" type="checkbox"/> V/f <input type="checkbox"/> OLV <input type="checkbox"/> OLV/PM <input type="checkbox"/> AOLV/PM <input type="checkbox"/> EZOLV Sets the compensation gain when <i>n6-01 = 2 [Online Tuning Selection = Voltage Correction Tuning]</i> . Usually it is not necessary to change this parameter.	1.0 (0.1 - 50.0)	770

◆ n7: EZ Drive

No. (Hex.)	Name	Description	Default (Range)	Ref.
n7-01 (3111) Expert	Damping Gain for Low Frequency	<input type="checkbox"/> V/f <input type="checkbox"/> OLV <input type="checkbox"/> OLV/PM <input type="checkbox"/> AOLV/PM <input checked="" type="checkbox"/> EZOLV Sets the oscillation suppression gain for the low speed range.	1.0 (0.1 - 10.0)	770
n7-05 (3115) Expert	Response Gain for Load Changes	<input type="checkbox"/> V/f <input type="checkbox"/> OLV <input type="checkbox"/> OLV/PM <input type="checkbox"/> AOLV/PM <input checked="" type="checkbox"/> EZOLV Sets the response gain related to changes in the load.	50 (10 - 1000)	770
n7-07 (3117) Expert	Speed Calculation Gain1	<input type="checkbox"/> V/f <input type="checkbox"/> OLV <input type="checkbox"/> OLV/PM <input type="checkbox"/> AOLV/PM <input checked="" type="checkbox"/> EZOLV Sets the speed calculation gain during usual operation. Usually it is not necessary to change this setting.	15.0 (1.0 - 50.0)	770
n7-08 (3118) Expert	Speed Calculation Gain2	<input type="checkbox"/> V/f <input type="checkbox"/> OLV <input type="checkbox"/> OLV/PM <input type="checkbox"/> AOLV/PM <input checked="" type="checkbox"/> EZOLV Sets the speed calculation gain during a speed search.	25.0 (1.0 - 50.0)	770
n7-10 (311A) Expert	Pull-in Current Switching Speed	<input type="checkbox"/> V/f <input type="checkbox"/> OLV <input type="checkbox"/> OLV/PM <input type="checkbox"/> AOLV/PM <input checked="" type="checkbox"/> EZOLV Sets the speed range to operate with the pull-in current command. Drive rated frequency = 100% value. If there is a large quantity of oscillation when you operate in the low speed range, increase the setting value.	10.0% (0.0 - 100.0%)	771
n7-17 (3122)	Resistance TemperatureCorrection	<input type="checkbox"/> V/f <input type="checkbox"/> OLV <input type="checkbox"/> OLV/PM <input type="checkbox"/> AOLV/PM <input checked="" type="checkbox"/> EZOLV Sets the function to adjust for changes in the motor resistance value caused by changes in the temperature. 0 : Invalid 1 : Valid (Only 1 time) 2 : Valid (Every time)	1 (0 to 2)	771
n7-19 (3128) Expert	Flux Error Compensation Gain	<input type="checkbox"/> V/f <input type="checkbox"/> OLV <input type="checkbox"/> OLV/PM <input type="checkbox"/> AOLV/PM <input checked="" type="checkbox"/> EZOLV Sets the gain for magnetic flux compensation. Usually it is not necessary to change this setting.	5000% (0 - 50000%)	771

◆ n8: PM Motor Control Tuning

No. (Hex.)	Name	Description	Default (Range)	Ref.
n8-01 (0540)	Pole Position Detection Current	<input type="checkbox"/> V/f <input type="checkbox"/> OLV <input checked="" type="checkbox"/> OLV/PM <input type="checkbox"/> AOLV/PM <input type="checkbox"/> EZOLV Sets the Initial Rotor Position Estimated Current as a percentage where E5-03 [PM Motor Rated Current (FLA)] = 100%. Usually it is not necessary to change this setting.	50% (0 - 100%)	771
n8-02 (0541)	Pole Alignment Current Level	<input type="checkbox"/> V/f <input type="checkbox"/> OLV <input type="checkbox"/> OLV/PM <input type="checkbox"/> AOLV/PM <input checked="" type="checkbox"/> EZOLV Sets the current at the time of polar attraction as a percentage where E5-03 [motor rated current] is 100%. Usually it is not necessary to change this setting.	80% (0 - 150%)	772
n8-11 (054A) Expert	Observer Calculation Gain 2	<input type="checkbox"/> V/f <input type="checkbox"/> OLV <input type="checkbox"/> OLV/PM <input checked="" type="checkbox"/> AOLV/PM <input type="checkbox"/> EZOLV Sets the gain for speed estimation. Usually it is not necessary to change this setting.	Determined by n8-72 (0.0 - 1000.0)	772
n8-14 (054D) Expert	Polarity Compensation Gain 3	<input type="checkbox"/> V/f <input type="checkbox"/> OLV <input type="checkbox"/> OLV/PM <input type="checkbox"/> AOLV/PM <input checked="" type="checkbox"/> EZOLV Sets the gain for speed estimation. Usually it is not necessary to change this setting.	1.000 (0.000 - 10.000)	772
n8-15 (054E) Expert	Polarity Compensation Gain 4	<input type="checkbox"/> V/f <input type="checkbox"/> OLV <input type="checkbox"/> OLV/PM <input type="checkbox"/> AOLV/PM <input checked="" type="checkbox"/> EZOLV Sets the gain for speed estimation. Usually it is not necessary to change this setting.	0.500 (0.000 - 10.000)	772
n8-21 (0554) Expert	Motor Back-EMF (Ke) Gain	<input type="checkbox"/> V/f <input type="checkbox"/> OLV <input type="checkbox"/> OLV/PM <input type="checkbox"/> AOLV/PM <input checked="" type="checkbox"/> EZOLV Sets the gain for speed estimation. Usually it is not necessary to change this setting.	0.90 (0.80 - 1.00)	772
n8-23 (0556) Expert	ACR q Gain @PoleEst	<input type="checkbox"/> V/f <input type="checkbox"/> OLV <input checked="" type="checkbox"/> OLV/PM <input type="checkbox"/> AOLV/PM <input type="checkbox"/> EZOLV Sets the proportional gain for current regulator q-axis control when the drive estimates the initial pole. Usually it is not necessary to change this setting.	0 (0 - 2000)	772
n8-24 (0557) Expert	ACR q Integral Time @PoleEst	<input type="checkbox"/> V/f <input type="checkbox"/> OLV <input checked="" type="checkbox"/> OLV/PM <input type="checkbox"/> AOLV/PM <input type="checkbox"/> EZOLV Sets the integral time for current regulator q-axis control when the drive estimates the initial pole. Usually it is not necessary to change this setting.	0.0 ms (0.0 - 100.0 ms)	773
n8-25 (0558) Expert	ACR q Limit @PoleEst	<input type="checkbox"/> V/f <input type="checkbox"/> OLV <input checked="" type="checkbox"/> OLV/PM <input type="checkbox"/> AOLV/PM <input type="checkbox"/> EZOLV Sets the q-axis limit of the current regulator when the drive estimates the initial pole. Usually it is not necessary to change this setting.	0% (0 - 150%)	773

No. (Hex.)	Name	Description	Default (Range)	Ref.
n8-26 (0559) Expert	ACR d Gain @PoleEst	<input type="checkbox"/> V/f <input type="checkbox"/> OLV <input checked="" type="checkbox"/> OLV/PM <input type="checkbox"/> AOLV/PM <input type="checkbox"/> EZOLV Sets the proportional gain for current regulator d-axis control when the drive estimates the initial pole. Usually it is not necessary to change this setting.	500 (0 - 2000)	773
n8-27 (055A) Expert	ACR d Integral Time @PoleEst	<input type="checkbox"/> V/f <input type="checkbox"/> OLV <input checked="" type="checkbox"/> OLV/PM <input type="checkbox"/> AOLV/PM <input type="checkbox"/> EZOLV Sets the integral time for current regulator d-axis control when the drive estimates the initial pole. Usually it is not necessary to change this setting.	0.0 ms (0.0 - 100.0 ms)	773
n8-28 (055B) Expert	ACR d Lim @PoleEst	<input type="checkbox"/> V/f <input type="checkbox"/> OLV <input checked="" type="checkbox"/> OLV/PM <input type="checkbox"/> AOLV/PM <input type="checkbox"/> EZOLV Sets the d-axis limit of the current regulator when the drive estimates the initial pole. Usually it is not necessary to change this setting.	100% (0 - 150%)	773
n8-35 (0562)	Initial Pole Detection Method	<input type="checkbox"/> V/f <input type="checkbox"/> OLV <input checked="" type="checkbox"/> OLV/PM <input type="checkbox"/> AOLV/PM <input type="checkbox"/> EZOLV Sets how the drive detects the position of the rotor when the motor starts. Note: • When you use an SPM motor, set $n8-35 = 0$. When you use an IPM motor, set $n8-35 = 0$ to 2. • When you set $n8-35 = 1$, do High Frequency Injection Auto-Tuning. 0 : Pull-in 1 : High Frequency Injection 2 : Pulse Injection	Determined by A1-02 (0 - 2)	773
n8-36 (0563)	HFI Frequency Level for L Tuning	<input type="checkbox"/> V/f <input type="checkbox"/> OLV <input checked="" type="checkbox"/> OLV/PM <input type="checkbox"/> AOLV/PM <input type="checkbox"/> EZOLV Sets the injection frequency for high frequency injection. Note: • Set $n8-35 = 1$ [Initial Pole Detection Method = High Frequency Injection] or $n8-57 = 1$ [HFI Overlap Selection = Enabled] to enable this parameter. • The drive automatically calculates this value when High Frequency Injection Auto-Tuning completes successfully.	500 Hz (200 - 1000 Hz)	774
n8-37 (0564) Expert	HFI Voltage Amplitude Level	<input type="checkbox"/> V/f <input type="checkbox"/> OLV <input checked="" type="checkbox"/> OLV/PM <input type="checkbox"/> AOLV/PM <input type="checkbox"/> EZOLV Sets the high frequency injection amplitude as a percentage where 200 V = 100% for 200 V class drives and 400 V = 100% for a 400 V class drives. Usually it is not necessary to change this setting. Note: • Set $n8-35 = 1$ [Initial Pole Detection Method = High Frequency Injection] or $n8-57 = 1$ [HFI Overlap Selection = Enabled] to enable this parameter. • The drive automatically calculates this value when High Frequency Injection Auto-Tuning completes successfully.	20.0% (0.0 - 50.0%)	774
n8-39 (0566)	HFI LPF Cutoff Freq	<input type="checkbox"/> V/f <input type="checkbox"/> OLV <input checked="" type="checkbox"/> OLV/PM <input type="checkbox"/> AOLV/PM <input type="checkbox"/> EZOLV Sets the low-pass filter shut-off frequency for high frequency injection. Note: • Set $n8-35 = 1$ [Initial Pole Detection Method = High Frequency Injection] or $n8-57 = 1$ [HFI Overlap Selection = Enabled] to enable this parameter. • The drive automatically calculates this value when High Frequency Injection Auto-Tuning completes successfully.	250 Hz (0 - 1000 Hz)	774
n8-41 (0568) Expert	HFI P Gain	<input type="checkbox"/> V/f <input type="checkbox"/> OLV <input checked="" type="checkbox"/> OLV/PM <input type="checkbox"/> AOLV/PM <input type="checkbox"/> EZOLV Sets the response gain for the high frequency injection speed estimation. Note: • Set $n8-35 = 1$ [Initial Pole Detection Method = High Frequency Injection] or $n8-57 = 1$ [HFI Overlap Selection = Enabled] to enable this parameter. • When $A1-02 = 6$ [Control Method Selection = AOLV/PM] and you do High Frequency Injection Auto-Tuning, the drive automatically sets this parameter .	2.5 (-10.0 - +10.0)	774
n8-42 (0569) Expert	HFI I Time	<input type="checkbox"/> V/f <input type="checkbox"/> OLV <input checked="" type="checkbox"/> OLV/PM <input type="checkbox"/> AOLV/PM <input type="checkbox"/> EZOLV Sets the integral time constant for the high frequency injection speed estimation. Usually it is not necessary to change this setting.	0.10 s (0.00 - 9.99 s)	774
n8-45 (0538)	Speed Feedback Detection Gain	<input type="checkbox"/> V/f <input type="checkbox"/> OLV <input checked="" type="checkbox"/> OLV/PM <input type="checkbox"/> AOLV/PM <input type="checkbox"/> EZOLV Sets the internal speed feedback detection reduction unit gain as a magnification value. Usually it is not necessary to change this setting.	0.80 (0.00 - 10.00)	775
n8-46 (0539) Expert	PM Phase Compensation Gain	<input type="checkbox"/> V/f <input type="checkbox"/> OLV <input checked="" type="checkbox"/> OLV/PM <input type="checkbox"/> AOLV/PM <input type="checkbox"/> EZOLV Sets the gain to compensate for phase differences. Usually it is not necessary to change this setting.	0.3 (0.0 - 10.0)	775
n8-47 (053A)	Pull-in Current Comp Filter Time	<input type="checkbox"/> V/f <input type="checkbox"/> OLV <input checked="" type="checkbox"/> OLV/PM <input type="checkbox"/> AOLV/PM <input type="checkbox"/> EZOLV Sets the time constant the drive uses to align the pull-in current reference value with the actual current value. Usually it is not necessary to change this setting.	5.0 s (0.0 - 100.0 s)	775
n8-48 (053B) RUN	Pull-in/Light Load Id Current	<input type="checkbox"/> V/f <input type="checkbox"/> OLV <input checked="" type="checkbox"/> OLV/PM <input type="checkbox"/> AOLV/PM <input type="checkbox"/> EZOLV On the basis that parameter $E5-03$ [Motor Rated Current (FLA)] is the 100% value, this parameter sets the d-axis current that flows to the motor during run at constant speed as a percentage.	30% (0 - 200%)	775

11.12 n: Special Adjustment

No. (Hex.)	Name	Description	Default (Range)	Ref.
n8-49 (053C) RUN Expert	Heavy Load Id Current	<input type="checkbox"/> V/f <input type="checkbox"/> OLV <input checked="" type="checkbox"/> OLV/PM <input type="checkbox"/> AOLV/PM <input type="checkbox"/> EZOLV Sets the d-axis current to that the drive will supply to the motor to run it at a constant speed with a heavy load. Considers <i>E5-03 [PM Motor Rated Current (FLA)]</i> to be 100%. Usually it is not necessary to change this setting.	Determined by E5-01 (-200.0 - +200.0%)	776
n8-50 (053D) Expert	Medium Load Iq Level (High)	<input type="checkbox"/> V/f <input type="checkbox"/> OLV <input checked="" type="checkbox"/> OLV/PM <input type="checkbox"/> AOLV/PM <input type="checkbox"/> EZOLV Sets the load current level at which heavy load control starts where <i>E5-03 [Motor Rated Current (FLA)]</i> is 100%. Usually it is not necessary to change this setting.	80% (50 - 255)	776
n8-51 (053E)	Pull-in Current @ Acceleration	<input type="checkbox"/> V/f <input type="checkbox"/> OLV <input checked="" type="checkbox"/> OLV/PM <input type="checkbox"/> AOLV/PM <input type="checkbox"/> EZOLV Sets the pull-in current allowed to flow during acceleration/deceleration as a percentage of the motor rated current. Note: Parameter <i>A1-02 [Control Method Selection]</i> selects which parameter is the motor rated current. • <i>A1-02 = 5 [OLV/PM]</i> : <i>E5-03 [PM Motor Rated Current (FLA)]</i> • <i>A1-02 = 8 [EZOLV]</i> : <i>E9-06 [Motor Rated Current (FLA)]</i>	Determined by A1-02 (0 - 200%)	776
n8-54 (056D) Expert	Voltage Error Compensation Time	<input type="checkbox"/> V/f <input type="checkbox"/> OLV <input checked="" type="checkbox"/> OLV/PM <input type="checkbox"/> AOLV/PM <input type="checkbox"/> EZOLV Sets the time constant that the drive uses when adjusting for voltage errors.	1.00 s (0.00 - 10.00 s)	776
n8-55 (056E)	Motor to Load Inertia Ratio	<input type="checkbox"/> V/f <input type="checkbox"/> OLV <input checked="" type="checkbox"/> OLV/PM <input type="checkbox"/> AOLV/PM <input type="checkbox"/> EZOLV Sets the ratio between motor inertia and machine inertia. 0 : Below 1:10 1 : Between 1:10 and 1:30 2 : Between 1:30 and 1:50 3 : Beyond 1:50	0 (0 - 3)	777
n8-56 (056F) Expert	PM High Performance Selection	<input type="checkbox"/> V/f <input type="checkbox"/> OLV <input checked="" type="checkbox"/> OLV/PM <input type="checkbox"/> AOLV/PM <input type="checkbox"/> EZOLV Sets the high efficiency control method for IPM motors. Usually it is not necessary to change this setting. 0 : Disabled 1 : Enabled (Vd) 2 : Enabled (Vd & Vq)	1 (0 - 2)	777
n8-57 (0574)	HFI Overlap Selection	<input type="checkbox"/> V/f <input type="checkbox"/> OLV <input type="checkbox"/> OLV/PM <input checked="" type="checkbox"/> AOLV/PM <input type="checkbox"/> EZOLV Sets the function that detects motor speed with high frequency injection. Note: When you set <i>n8-57 = 1</i> , do High Frequency Injection Auto-Tuning. 0 : Disabled 1 : Enabled	0 (0, 1)	778
n8-62 (057D) Expert	Output Voltage Limit Level	<input type="checkbox"/> V/f <input type="checkbox"/> OLV <input checked="" type="checkbox"/> OLV/PM <input type="checkbox"/> AOLV/PM <input type="checkbox"/> EZOLV Sets the output voltage limit to prevent saturation of the output voltage. Usually it is not necessary to change this parameter. Note: When <i>A1-02 = 8 [Control Method Selection = EZOLV]</i> , the default settings are: • 200 V class: 230.0 V • 400 V class: 460.0 V	200 V Class: 200.0 V, 400 V: 400.0 V (200 V Class: 0.0 to 240.0 V, 400 V Class: 0.0 to 480.0 V)	778
n8-63 (057E) Expert	Output Voltage Limit P Gain	<input type="checkbox"/> V/f <input type="checkbox"/> OLV <input checked="" type="checkbox"/> OLV/PM <input type="checkbox"/> AOLV/PM <input type="checkbox"/> EZOLV Sets the proportional gain for output voltage control. Usually it is not necessary to change this setting.	1.00 (0.00 - 100.00)	778
n8-64 (057F) Expert	Output Voltage Limit I Time	<input type="checkbox"/> V/f <input type="checkbox"/> OLV <input checked="" type="checkbox"/> OLV/PM <input type="checkbox"/> AOLV/PM <input type="checkbox"/> EZOLV Sets the integral time for output voltage control. Usually it is not necessary to change this setting.	0.040 s (0.000 - 5.000)	778
n8-65 (065C) Expert	Speed Fdbk Gain @ oV Suppression	<input type="checkbox"/> V/f <input type="checkbox"/> OLV <input checked="" type="checkbox"/> OLV/PM <input type="checkbox"/> AOLV/PM <input type="checkbox"/> EZOLV Sets the gain of internal speed feedback detection suppression while the overvoltage suppression function is operating as a magnification value. Usually it is not necessary to change this parameter.	1.50 (0.00 - 10.00)	778
n8-69 (065D) Expert	Speed Observer Control P Gain	<input type="checkbox"/> V/f <input type="checkbox"/> OLV <input type="checkbox"/> OLV/PM <input checked="" type="checkbox"/> AOLV/PM <input type="checkbox"/> EZOLV Usually it is not necessary to change this setting. Sets the Proportional gain that the drive uses for speed estimation.	1.00 (0.00 - 20.00)	779
n8-70 (065E) Expert	Speed Observer Control I Time	<input type="checkbox"/> V/f <input type="checkbox"/> OLV <input type="checkbox"/> OLV/PM <input checked="" type="checkbox"/> AOLV/PM <input type="checkbox"/> EZOLV Sets the speed estimator integral time constant. It is available when <i>n8-72 = 1 [Speed Estimation Method Select = Method 2]</i> . Usually it is not necessary to change this setting.	0.0 s (0.0 - 100.0)	779
n8-71 (065F) Expert	Speed Observer Control D Gain	<input type="checkbox"/> V/f <input type="checkbox"/> OLV <input type="checkbox"/> OLV/PM <input checked="" type="checkbox"/> AOLV/PM <input type="checkbox"/> EZOLV Set the speed estimator differential gain. It is available when <i>n8-72 = 1 [Speed Estimation Method Select = Method 2]</i> . Usually it is not necessary to change this setting.	5.00 (0.00 - 50.00)	779

No. (Hex.)	Name	Description	Default (Range)	Ref.
n8-72 (0655) Expert	Speed Estimation Method Select	<input type="checkbox"/> V/f <input type="checkbox"/> OLV <input type="checkbox"/> OLV/PM <input checked="" type="checkbox"/> AOLV/PM <input type="checkbox"/> EZOLV Selects the speed estimation method. Usually it is not necessary to change this setting. 0 : Method 1 1 : Method 2	1 (0, 1)	779
n8-73 (0656) Expert	Observer Mode Switch-Over Speed	<input type="checkbox"/> V/f <input type="checkbox"/> OLV <input type="checkbox"/> OLV/PM <input checked="" type="checkbox"/> AOLV/PM <input type="checkbox"/> EZOLV Sets the speed level for pull-in current control at motor start as a percentage of <i>E1-06 [Base Frequency]</i> . Usually it is not necessary to change this setting.	10% (0 - 100)	779
n8-74 (05C3) Expert	Light Load Iq Level	<input type="checkbox"/> V/f <input type="checkbox"/> OLV <input type="checkbox"/> OLV/PM <input checked="" type="checkbox"/> AOLV/PM <input type="checkbox"/> EZOLV Set <i>n8-48 [Pull-in/Light Load Id Current]</i> to the percentage of load current (q-axis current) that you will apply, where <i>E5-03 [Motor Rated Current (FLA)] = a setting value of 100%</i> .	30% (0 - 255%)	779
n8-75 (05C4) Expert	Medium Load Iq Level (low)	<input type="checkbox"/> V/f <input type="checkbox"/> OLV <input type="checkbox"/> OLV/PM <input checked="" type="checkbox"/> AOLV/PM <input type="checkbox"/> EZOLV Set <i>n8-78 [Medium Load Id Current]</i> to the percentage of load current (q-axis current) that you will apply, where <i>E5-03 [Motor Rated Current (FLA)] = a setting value of 100%</i> .	50% (0 - 255%)	780
n8-76 (05CD) Expert	Id Switching Filter Time	<input type="checkbox"/> V/f <input type="checkbox"/> OLV <input type="checkbox"/> OLV/PM <input checked="" type="checkbox"/> AOLV/PM <input type="checkbox"/> EZOLV Sets the filter time constant for the d-axis current reference. Usually it is not necessary to change this setting.	200 ms (0 - 5000 ms)	780
n8-77 (05CE) Expert	Heavy Load Iq Level	<input type="checkbox"/> V/f <input type="checkbox"/> OLV <input type="checkbox"/> OLV/PM <input checked="" type="checkbox"/> AOLV/PM <input type="checkbox"/> EZOLV Set <i>n8-49 [Heavy Load Id Current]</i> to the percentage of load current (q-axis current) that you will apply, where <i>E5-03 [Motor Rated Current (FLA)] = a setting value of 100%</i> .	90% (0 - 255%)	780
n8-78 (05F4) RUN Expert	Medium Load Id Current	<input type="checkbox"/> V/f <input type="checkbox"/> OLV <input type="checkbox"/> OLV/PM <input checked="" type="checkbox"/> AOLV/PM <input type="checkbox"/> EZOLV Sets the level of the pull-in current as a percentage, where <i>E5-03 [PM Motor Rated Current (FLA)] = 100%</i> .	0% (0 - 255%)	780
n8-79 (05FE)	Pull-in Current @ Deceleration	<input type="checkbox"/> V/f <input type="checkbox"/> OLV <input type="checkbox"/> OLV/PM <input checked="" type="checkbox"/> AOLV/PM <input type="checkbox"/> EZOLV Sets the pull-in current that can flow during deceleration as a percentage of the <i>E5-03 [PM Motor Rated Current (FLA)]</i> . Note: When <i>n8-79 = 0</i> , the drive will use the value set in <i>n8-51 [Pull-in Current @ Acceleration]</i> .	50% (0 - 200%)	780
n8-84 (02D3) Expert	Polarity Detection Current	<input type="checkbox"/> V/f <input type="checkbox"/> OLV <input type="checkbox"/> OLV/PM <input checked="" type="checkbox"/> AOLV/PM <input type="checkbox"/> EZOLV Sets the current that the drive uses to estimate the initial motor magnetic pole as a percentage where <i>E5-03 [PM Motor Rated Current (FLA)] = 100%</i> .	100% (0 - 150%)	780
n8-87 (02DA)	Output Voltage Limit Method	<input type="checkbox"/> V/f <input type="checkbox"/> OLV <input type="checkbox"/> OLV/PM <input checked="" type="checkbox"/> AOLV/PM <input type="checkbox"/> EZOLV Sets the method of output voltage limit. If there is vibration in the constant output range, set Feedforward Method. Usually it is not necessary to change this setting. 0 : Feedback Method 1 : Feedforward Method	0 (0, 1)	781
n8-88 (02BD)	Vout Limit Switching Level	<input type="checkbox"/> V/f <input type="checkbox"/> OLV <input type="checkbox"/> OLV/PM <input checked="" type="checkbox"/> AOLV/PM <input type="checkbox"/> EZOLV Sets the current level at which output voltage limit sequence selection occurs as a percentage where the motor rated current is 100%. Normally there is no need to change this setting. Note: Parameter <i>A1-02 [Control Method Selection]</i> selects which parameter is the motor rated current. • <i>A1-02 = 5, 6 [OLV/PM, AOLV/PM]: E5-03 [PM Motor Rated Current (FLA)]</i> • <i>A1-02 = 8 [EZOLV]: E9-06 [PM Motor Rated Current (FLA)]</i>	400% (0 - 400%)	781
n8-89 (02BE)	Vout Limit Switching Hysteresis	<input type="checkbox"/> V/f <input type="checkbox"/> OLV <input type="checkbox"/> OLV/PM <input checked="" type="checkbox"/> AOLV/PM <input type="checkbox"/> EZOLV Sets the hysteresis width of the current level at which output voltage limit sequence selection occurs as a percentage where the motor rated current is 100%. Normally there is no need to change this setting. Note: Parameter <i>A1-02 [Control Method Selection]</i> selects which parameter is the motor rated current. • <i>A1-02 = 5, 6 [OLV/PM, AOLV/PM]: E5-03 [PM Motor Rated Current (FLA)]</i> • <i>A1-02 = 8 [EZOLV]: E9-06 [PM Motor Rated Current (FLA)]</i>	3% (0 - 400%)	781
n8-90 (02BF)	Vout Limit Switching Speed	<input type="checkbox"/> V/f <input type="checkbox"/> OLV <input type="checkbox"/> OLV/PM <input checked="" type="checkbox"/> AOLV/PM <input type="checkbox"/> EZOLV Sets the speed level at which output voltage limit sequence selection occurs as a percentage where the maximum output frequency is 100%. Usually it is not necessary to change this setting. Note: Parameter <i>A1-02 [Control Method Selection]</i> selects which parameter is the maximum output frequency. • <i>A1-02 = 5, 6 [OLV/PM, AOLV/PM]: E1-04 [Maximum Output Frequency]</i> • <i>A1-02 = 8: E9-02 [Motor Max Revolutions]</i>	200% (0 - 200%)	781

11.12 n: Special Adjustment

No. (Hex.)	Name	Description	Default (Range)	Ref.
n8-91 (02F7)	Id Limit at Voltage Saturation	<div style="display: flex; justify-content: space-between; margin-bottom: 5px;"> V/f OLV OLV/PM AOLV/PM EZOLV </div> <p>Sets the limit value of feedback output voltage limit Id operation. Enabled when $n8-87 = 0$ [Output Voltage Control Selection = Speed Feedback Form]. Usually it is not necessary to change this setting.</p>	-50% (-200 - 0%)	781
n8-94 (012D) Expert	Flux Position Estimation Method	<div style="display: flex; justify-content: space-between; margin-bottom: 5px;"> V/f OLV OLV/PM AOLV/PM EZOLV </div> <p>Sets the criteria that the drive uses to find changes in speed or load. Usually it is not necessary to change this setting. 0 : Softstarter 1 : Speed Feedback</p>	1 (0, 1)	781
n8-95 (012E) Expert	Flux Position Est Filter Time	<div style="display: flex; justify-content: space-between; margin-bottom: 5px;"> V/f OLV OLV/PM AOLV/PM EZOLV </div> <p>Sets the time constant of the filter used for the recognition criteria value for speed and load changes. Usually it is not necessary to change this setting.</p>	30 ms (0 - 100 ms)	782

◆ nA: PM Motor Control Tuning

No. (Hex.)	Name	Description	Default (Range)	Ref.
nA-01 (3129) Expert	Observer Calc Gain 3	<div style="display: flex; justify-content: space-between; margin-bottom: 5px;"> V/f OLV OLV/PM AOLV/PM EZOLV </div> <p>Sets the gain for speed estimation. Usually it is not necessary to change this setting.</p>	30.0 (0.0 - 1000.0)	782

11.13 o: Keypad-Related Settings

◆ o1: Keypad Display

No. (Hex.)	Name	Description	Default (Range)	Ref.
o1-01 (0500) RUN	User Monitor Selection	V/f OLV OLV/PM AOLV/PM EZOLV Sets the <i>U</i> monitor for the Drive Mode. This parameter is only available with an LED keypad.	106 (104 - 855)	784
o1-02 (0501) RUN	Monitor Selection at Power-up	V/f OLV OLV/PM AOLV/PM EZOLV Sets the monitor item that the keypad screen shows after you energize the drive. Refer to "U: Monitors" for information about the monitor items that the keypad screen can show. This parameter is only available with an LED keypad. 1 : Frequency Reference (U1-01) 2 : Direction 3 : Output Frequency (U1-02) 4 : Output Current (U1-03) 5 : User Monitor (<i>o1-01</i>)	1 (1 - 5)	784
o1-03 (0502)	Frequency Display Unit Selection	V/f OLV OLV/PM AOLV/PM EZOLV Sets the display units for the frequency reference and output frequency. 0 : 0.01 Hz 1 : 0.01% (100% = E1-04) 2 : Revolutions Per Minute (RPM) 3 : User units (Set with o1-10, o1-11)	Determined by A1-02 (0 - 3)	784
o1-04 (0503)	V/f Pattern Display Unit	V/f OLV OLV/PM AOLV/PM EZOLV Sets the setting unit for parameters that set the V/f pattern frequency. 0 : Hz 1 : min ⁻¹ (r/min) units	Determined by A1-02 (0, 1)	785
o1-05 (0504) RUN	LCD Contrast Adjustment	V/f OLV OLV/PM AOLV/PM EZOLV Sets the contrast of the LCD display on the keypad.	5 (0 - 10)	786
o1-10 (0520)	User Units Maximum Value	V/f OLV OLV/PM AOLV/PM EZOLV Sets the value that the drive shows as the maximum output frequency.	Determined by o1-03 (1 - 60000)	786
o1-11 (0521)	User Units Decimal Position	V/f OLV OLV/PM AOLV/PM EZOLV Sets the number of decimal places for frequency reference and monitor values. 0 : No Decimal Places (XXXXXX) 1 : One Decimal Places (XXXX.X) 2 : Two Decimal Places (XXX.XX) 3 : Three Decimal Places (XX.XXX)	Determined by o1-03 (0 - 3)	786
o1-24 (11AD) RUN	Custom Monitor 1	V/f OLV OLV/PM AOLV/PM EZOLV You can select a maximum of 12 monitors as user monitors and set them to parameters <i>o1-24</i> to <i>o1-35</i> . This parameter sets the user monitor to show on the first line. The registered monitor is also used for different monitor displays of bar graph, analog meter, and waveform.	101 (0, 101 - 999)	786
o1-25 (11AE) RUN	Custom Monitor 2	V/f OLV OLV/PM AOLV/PM EZOLV You can select a maximum of 12 monitors as user monitors and set them to parameters <i>o1-24</i> to <i>o1-35</i> . This parameter sets the user monitor to show on the second line. The registered monitor is also used for different monitor displays of bar graph and waveform.	102 (0, 101 - 999)	786
o1-26 (11AF) RUN	Custom Monitor 3	V/f OLV OLV/PM AOLV/PM EZOLV You can select a maximum of 12 monitors as user monitors and set them to parameters <i>o1-24</i> to <i>o1-35</i> . This parameter sets the user monitor to show on the third line. The registered monitor is also used for the monitor display of the bar graph.	103 (0, 101 - 999)	786
o1-27 (11B0) RUN	Custom Monitor 4	V/f OLV OLV/PM AOLV/PM EZOLV You can select a maximum of 12 monitors as user monitors and set them to parameters <i>o1-24</i> to <i>o1-35</i> . This parameter sets the user monitor to show on the fourth line.	0 (0, 101 - 999)	786
o1-28 (11B1) RUN	Custom Monitor 5	V/f OLV OLV/PM AOLV/PM EZOLV You can select a maximum of 12 monitors as user monitors and set them to parameters <i>o1-24</i> to <i>o1-35</i> . This parameter sets the user monitor to show on the fifth line.	0 (0, 101 - 999)	786
o1-29 (11B2) RUN	Custom Monitor 6	V/f OLV OLV/PM AOLV/PM EZOLV You can select a maximum of 12 monitors as user monitors and set them to parameters <i>o1-24</i> to <i>o1-35</i> . This parameter sets the user monitor to show on the sixth line.	0 (0, 101 - 999)	786

11.13 o: Keypad-Related Settings

No. (Hex.)	Name	Description	Default (Range)	Ref.
o1-30 (11B3) RUN	Custom Monitor 7	V/f OLV OLV/PM AOLV/PM EZOLV You can select a maximum of 12 monitors as user monitors and set them to parameters o1-24 to o1-35. This parameter sets the user monitor to show on the seventh line.	0 (0, 101 - 999)	786
o1-31 (11B4) RUN	Custom Monitor 8	V/f OLV OLV/PM AOLV/PM EZOLV You can select a maximum of 12 monitors as user monitors and set them to parameters o1-24 to o1-35. This parameter sets the user monitor to show on the eighth line.	0 (0, 101 - 999)	786
o1-32 (11B5) RUN	Custom Monitor 9	V/f OLV OLV/PM AOLV/PM EZOLV You can select a maximum of 12 monitors as user monitors and set them to parameters o1-24 to o1-35. This parameter sets the user monitor to show on the ninth line.	0 (0, 101 - 999)	786
o1-33 (11B6) RUN	Custom Monitor 10	V/f OLV OLV/PM AOLV/PM EZOLV You can select a maximum of 12 monitors as user monitors and set them to parameters o1-24 to o1-35. This parameter sets the user monitor to show on the 10th line.	0 (0, 101 - 999)	786
o1-34 (11B7) RUN	Custom Monitor 11	V/f OLV OLV/PM AOLV/PM EZOLV You can select a maximum of 12 monitors as user monitors and set them to parameters o1-24 to o1-35. This parameter sets the user monitor to show on the 11th line.	0 (0, 101 - 999)	786
o1-35 (11B8) RUN	Custom Monitor 12	V/f OLV OLV/PM AOLV/PM EZOLV You can select a maximum of 12 monitors as user monitors and set them to parameters o1-24 to o1-35. This parameter sets the user monitor to show on the 12th line.	0 (0, 101 - 999)	786
o1-36 (11B9) RUN	LCD Backlight Brightness	V/f OLV OLV/PM AOLV/PM EZOLV Sets the intensity of the LCD keypad backlight.	5 (1 - 5)	787
o1-37 (11BA) RUN	LCD Backlight ON/OFF Selection	V/f OLV OLV/PM AOLV/PM EZOLV Sets the automatic shut off function for the LCD backlight. 0 : OFF 1 : ON	1 (0, 1)	787
o1-38 (11BB) RUN	LCD Backlight Off-Delay	V/f OLV OLV/PM AOLV/PM EZOLV Sets the time until the LCD backlight automatically turns off.	60 s (10 - 300 s)	787
o1-39 (11BC) RUN	Show Initial Setup Screen	V/f OLV OLV/PM AOLV/PM EZOLV Sets the function to show the LCD keypad initial setup screen each time you energize the drive. This parameter is only available with an LCD keypad. 0 : No 1 : Yes	1 (0, 1)	788
o1-40 (11BD) RUN	Home Screen Display Selection	V/f OLV OLV/PM AOLV/PM EZOLV Sets the monitor display mode for the Home screen. This parameter is only available with an LCD keypad. 0 : Custom Monitor 1 : Bar Graph 2 : Analog Gauge 3 : Trend Plot	0 (0 - 3)	788
o1-41 (11C1) RUN	1st Monitor Area Selection	V/f OLV OLV/PM AOLV/PM EZOLV Sets the horizontal axis value used to display the monitor set in o1-24 [Custom Monitor 1] as a bar graph. This parameter is only available with an LCD keypad. 0 : +/- Area (- o1-42 ~ o1-42) 1 : + Area (0 ~ o1-42)	0 (0 - 1)	788
o1-42 (11C2) RUN	1st Monitor Area Setting	V/f OLV OLV/PM AOLV/PM EZOLV Sets the horizontal axis value used to display the monitor set in o1-24 [Custom Monitor 1] as a bar graph. This parameter is only available with an LCD keypad.	100.0% (0.0 - 100.0%)	788
o1-43 (11C3) RUN	2nd Monitor Area Selection	V/f OLV OLV/PM AOLV/PM EZOLV Selects the horizontal range used to display the monitor set in o1-25 [Custom Monitor 2] as a bar graph. This parameter is only available with an LCD keypad. 0 : +/- Area (- o1-44 ~ o1-44) 1 : + Area (0 ~ o1-44)	0 (0 - 1)	788
o1-44 (11C4) RUN	2nd Monitor Area Setting	V/f OLV OLV/PM AOLV/PM EZOLV Sets the horizontal axis value used to display the monitor set in o1-25 [Custom Monitor 2] as a bar graph. This parameter is only available with an LCD keypad.	100.0% (0.0 - 100.0%)	789

No. (Hex.)	Name	Description	Default (Range)	Ref.
o1-45 (11C5) RUN	3rd Monitor Area Selection	V/f OLV OLV/PM AOLV/PM EZOLV Sets the horizontal axis value used to display the monitor set in o1-26 [Custom Monitor 3] as a bar graph. This parameter is only available with an LCD keypad. 0 : +/- Area (- o1-46 ~ o1-46) 1 : + Area (0 ~ o1-46)	0 (0 - 1)	789
o1-46 (11C6) RUN	3rd Monitor Area Setting	V/f OLV OLV/PM AOLV/PM EZOLV Sets the horizontal axis value used to display the monitor set in o1-26 [Custom Monitor 3] as a bar graph. This parameter is only available with an LCD keypad.	100.0% (0.0 - 100.0%)	789
o1-47 (11C7) RUN	Trend Plot 1 Scale Minimum Value	V/f OLV OLV/PM AOLV/PM EZOLV Sets the horizontal axis minimum value used to display the monitor set in o1-24 [Custom Monitor 1] as a trend plot. This parameter is only available with an LCD keypad.	-100.0% (-300.0 - +299.9%)	789
o1-48 (11C8) RUN	Trend Plot 1 Scale Maximum Value	V/f OLV OLV/PM AOLV/PM EZOLV Sets the maximum value for the vertical axis used to display the monitor that was set in o1-24 [Custom Monitor 1] as a trend plot. This parameter is only available with an LCD keypad.	100.0% (-299.9 - +300.0%)	789
o1-49 (11C9) RUN	Trend Plot 2 Scale Minimum Value	V/f OLV OLV/PM AOLV/PM EZOLV Sets the horizontal axis minimum value used to display the monitor set in o1-25 [Custom Monitor 2] as a trend plot. This parameter is only available with an LCD keypad.	-100.0% (-300.0 - +299.9%)	789
o1-50 (11CA) RUN	Trend Plot 2 Scale Maximum Value	V/f OLV OLV/PM AOLV/PM EZOLV Sets the maximum value for the vertical axis used to display the monitor that was set in o1-25 [Custom Monitor 2] as a trend plot. This parameter is only available with an LCD keypad.	100.0% (-299.9 - +300.0%)	790
o1-51 (11CB) RUN	Trend Plot Time Scale Setting	V/f OLV OLV/PM AOLV/PM EZOLV Sets the time scale (horizontal axis) to display the trend plot. When you change this setting, the drive automatically adjusts the data sampling time. This parameter is only available with an LCD keypad.	300 s (1 - 3600 s)	790
o1-55 (11EE) RUN	Analog Gauge Area Selection	V/f OLV OLV/PM AOLV/PM EZOLV Sets the range used to display the monitor set in o1-24 [Custom Monitor 1] as an analog gauge. This parameter is only available with an LCD keypad. 0 : +/- Area (- o1-56 ~ o1-56) 1 : + Area (0 ~ o1-56)	1 (0, 1)	790
o1-56 (11EF) RUN	Analog Gauge Area Setting	V/f OLV OLV/PM AOLV/PM EZOLV Sets the value used to display the monitor set in o1-24 [Custom Monitor 1] as an analog meter. This parameter is only available with an LCD keypad.	100.0% (0.0 - 100.0%)	790
o1-58 (3125)	Motor Power Unit Selection	V/f OLV OLV/PM AOLV/PM EZOLV Sets the setting unit for parameters that set the motor rated power. 0 : kW 1 : HP	1 (0, 1)	790

◆ o2: Keypad Operation

No. (Hex.)	Name	Description	Default (Range)	Ref.
o2-01 (0505)	LO/RE Key Function Selection	V/f OLV OLV/PM AOLV/PM EZOLV Sets the function that lets you use LO/RE to switch between LOCAL and REMOTE Modes. 0 : Disabled 1 : Enabled	1 (0, 1)	791
o2-02 (0506)	STOP Key Function Selection	V/f OLV OLV/PM AOLV/PM EZOLV Sets the function to use STOP on the keypad to stop the drive when the Run command source for the drive is REMOTE (external) and not assigned to the keypad. 0 : Disabled 1 : Enabled	1 (0, 1)	791
o2-03 (0507)	User Parameter Default Value	V/f OLV OLV/PM AOLV/PM EZOLV Sets the function to keep the settings of changed parameters as user parameter defaults to use during initialization. 0 : No change 1 : Set defaults 2 : Clear all	0 (0 - 2)	791
o2-04 (0508)	Drive Model (KVA) Selection	V/f OLV OLV/PM AOLV/PM EZOLV Sets the Drive Model code. Set this parameter after replacing the control board.	Determined by the drive (-)	792

11.13 o: Keypad-Related Settings

No. (Hex.)	Name	Description	Default (Range)	Ref.
o2-05 (0509)	Home Mode Freq Ref Entry Mode	<p>V/f OLV OLV/PM AOLV/PM EZOLV</p> <p>Sets the function that makes it necessary to push  to use the keypad to change the frequency reference value while in Drive Mode. 0 : ENTER Key Required 1 : Immediate / MOP-style</p>	0 (0, 1)	793
o2-06 (050A)	Keypad Disconnect Detection	<p>V/f OLV OLV/PM AOLV/PM EZOLV</p> <p>Sets the function that stops the drive if you disconnect the keypad connection cable from the drive or if you damage the cable while the keypad is the Run command source. 0 : Disabled 1 : Enabled</p>	1 (0, 1)	793
o2-07 (0527)	Keypad RUN Direction @ Power-up	<p>V/f OLV OLV/PM AOLV/PM EZOLV</p> <p>Sets the direction of motor rotation when the drive is energized and the keypad is the Run command source. 0 : Forward 1 : Reverse</p>	0 (0, 1)	793
o2-09 (050D)	Reserved	-	-	793
o2-19 (061F) Expert	Parameter Write during Uv	<p>V/f OLV OLV/PM AOLV/PM EZOLV</p> <p>Lets you change parameters during Uv [Undervoltage]. 0 : Disable 1 : Enabled</p>	0 (0, 1)	794
o2-23 (11F8) RUN	External 24V Powerloss Detection	<p>V/f OLV OLV/PM AOLV/PM EZOLV</p> <p>Sets the function to give a warning if the backup external 24 V power supply turns off when the main circuit power supply is in operation. 0 : Disabled 1 : Enabled</p>	0 (0, 1)	794
o2-26 (1563)	Alarm Display at Ext. 24V Power	<p>V/f OLV OLV/PM AOLV/PM EZOLV</p> <p>When you connect a backup external 24 V power supply, this parameter sets the function to trigger an alarm when the main circuit power supply voltage decreases. Note: The drive will not run when it is operating from one 24-V external power supply. 0 : Disabled 1 : Enabled</p>	1 (0, 1)	794
o2-27 (1565)	bCE Detection Selection	<p>V/f OLV OLV/PM AOLV/PM EZOLV</p> <p>Sets drive operation if the Bluetooth device is disconnected when you operate the drive in Bluetooth Mode. 0 : Ramp to Stop 1 : Coast to Stop 2 : Fast Stop (Use C1-09) 3 : Alarm Only 4 : No Alarm Display</p>	3 (0 - 4)	794

◆ o3: Copy Keypad Function

No. (Hex.)	Name	Description	Default (Range)	Ref.
o3-01 (0515)	Copy Keypad Function Selection	<p>V/f OLV OLV/PM AOLV/PM EZOLV</p> <p>Sets the function that saves and copies drive parameters to a different drive with the keypad. 0 : Copy Select 1 : Backup (drive → keypad) 2 : Restore (keypad → drive) 3 : Verify (check for mismatch) 4 : Erase (backup data of keypad)</p>	0 (0 - 4)	795
o3-02 (0516)	Copy Allowed Selection	<p>V/f OLV OLV/PM AOLV/PM EZOLV</p> <p>Sets the copy function when o3-01 = 1 [Copy Keypad Function Selection = Backup (drive → keypad)]. 0 : Disabled 1 : Enabled</p>	0 (0, 1)	795

No. (Hex.)	Name	Description	Default (Range)	Ref.
o3-04 (0B3E)	Select Backup/Restore Location	V/f OLV OLV/PM AOLV/PM EZOLV Sets the storage location for drive parameters when you back up and restore parameters. This parameter is only available when using an LCD keypad. 0 : Memory Location 1 1 : Memory Location 2 2 : Memory Location 3 3 : Memory Location 4	0 (0 - 3)	795
o3-05 (0BDA)	Select Items to Backup/Restore	V/f OLV OLV/PM AOLV/PM EZOLV Sets which parameters are backed up, restored, and referenced. This parameter is only available when using an LCD keypad. 0 : Standard Parameters 1 : Standard + DWEZ Parameters	1 (0, 1)	795
o3-06 (0BDE)	Auto Parameter Backup Selection	V/f OLV OLV/PM AOLV/PM EZOLV Sets the function that automatically backs up parameters. This parameter is only available when using an LCD keypad. 0 : Disabled 1 : Enabled	1 (0, 1)	796
o3-07 (0BDF)	Auto Parameter Backup Interval	V/f OLV OLV/PM AOLV/PM EZOLV Sets the interval at which the automatic parameter backup function saves parameters from the drive to the keypad. Note: This parameter is only available when using an LCD keypad. 0 : Every 10 minutes 1 : Every 30 minutes 2 : Every 60 minutes 3 : Every 12 hours	1 (0 - 3)	796

◆ o4: Maintenance Monitors

No. (Hex.)	Name	Description	Default (Range)	Ref.
o4-01 (050B)	Elapsed Operating Time Setting	V/f OLV OLV/PM AOLV/PM EZOLV Sets the initial value of the cumulative drive operation time in 10-hour units.	0 h (0 - 9999 h)	796
o4-02 (050C)	Elapsed Operating Time Selection	V/f OLV OLV/PM AOLV/PM EZOLV Sets the condition that counts the cumulative operation time. 0 : U4-01 Shows Total Power-up Time 1 : U4-01 Shows Total RUN Time	0 (0, 1)	797
o4-03 (050E)	Fan Operation Time Setting	V/f OLV OLV/PM AOLV/PM EZOLV Sets the value from which to start the cumulative drive cooling fan operation time in 10-hour units.	0 h (0 - 9999 h)	797
o4-05 (051D)	Capacitor Maintenance Setting	V/f OLV OLV/PM AOLV/PM EZOLV Sets the U4-05 [CapacitorMaintenance] monitor value.	0% (0 - 150%)	797
o4-07 (0523)	Softcharge Relay Maintenance Set	V/f OLV OLV/PM AOLV/PM EZOLV Sets the U4-06 [PreChargeRelayMainte] monitor value.	0% (0 - 150%)	797
o4-09 (0525)	IGBT Maintenance Setting	V/f OLV OLV/PM AOLV/PM EZOLV Sets the U4-07 [IGBT Maintenance] monitor value.	0% (0 - 150%)	797
o4-11 (0510)	Fault Trace/History Init (U2/U3)	V/f OLV OLV/PM AOLV/PM EZOLV Resets the records of Monitors U2-xx [Fault Trace] and U3-xx [Fault History]. 0 : Disabled 1 : Enabled	0 (0, 1)	798
o4-12 (0512)	kWh Monitor Initialization	V/f OLV OLV/PM AOLV/PM EZOLV Resets the monitor values for U4-10 [kWh, Lower 4 Digits] and U4-11 [kWh, Upper 5 Digits]. 0 : No Reset 1 : Reset	0 (0, 1)	798
o4-13 (0528)	RUN Command Counter @ Initialize	V/f OLV OLV/PM AOLV/PM EZOLV Resets the monitor values for U4-02 [Num of Run Commands], U4-24 [Number of Runs (Low)], and U4-25 [Number of Runs (High)]. 0 : No Reset 1 : Reset	0 (0, 1)	798

11.13 o: Keypad-Related Settings

No. (Hex.)	Name	Description	Default (Range)	Ref.
o4-22 (154F) RUN	Time Format	V/f OLV OLV/PM AOLV/PM EZOLV Sets the time display format. This parameter is only available when using an LCD keypad. 0 : 24 Hour Clock 1 : 12 Hour Clock 2 : 12 Hour JP Clock	1 (0 - 2)	798
o4-23 (1550) RUN	Date Format	V/f OLV OLV/PM AOLV/PM EZOLV Sets the date display format. This parameter is only available when using an LCD keypad. 0 : YYYY/MM/DD 1 : DD/MM/YYYY 2 : MM/DD/YYYY	2 (0 - 2)	799
o4-24 (310F) RUN	bAT Detection Selection	V/f OLV OLV/PM AOLV/PM EZOLV Sets the operation when the drive detects <i>bAT</i> [Keypad Battery Low Voltage] and <i>TiM</i> [Keypad Time Not Set]. This parameter is only available when you use an LCD keypad. 0 : Disable 1 : Enable (Alarm Detected) 2 : Enable (Fault Detected)	0 (0 - 2)	799

◆ o5: Log Function

No. (Hex.)	Name	Description	Default (Range)	Ref.
o5-01 (1551) RUN	Log Start/Stop Selection	V/f OLV OLV/PM AOLV/PM EZOLV Sets the data log function. This parameter is only available when using an LCD keypad. 0 : OFF 1 : ON	0 (0 - 1)	802
o5-02 (1552) RUN	Log Sampling Interval	V/f OLV OLV/PM AOLV/PM EZOLV Sets the data log sampling cycle. This parameter is only available when using an LCD keypad.	100 ms (100 - 60000 ms)	802
o5-03 (1553) RUN	Log Monitor Data 1	V/f OLV OLV/PM AOLV/PM EZOLV Sets the data log monitor. This parameter is only available with an LCD keypad.	101 (000, 101 - 999)	802
o5-04 (1554) RUN	Log Monitor Data 2	V/f OLV OLV/PM AOLV/PM EZOLV Sets the data log monitor. This parameter is only available when using an LCD keypad.	102 (000, 101 - 999)	802
o5-05 (1555) RUN	Log Monitor Data 3	V/f OLV OLV/PM AOLV/PM EZOLV Sets the data log monitor. This parameter is only available with an LCD keypad.	103 (000, 101 - 999)	802
o5-06 (1556) RUN	Log Monitor Data 4	V/f OLV OLV/PM AOLV/PM EZOLV Sets the data log monitor. This parameter is only available with an LCD keypad.	107 (000, 101 - 999)	803
o5-07 (1557) RUN	Log Monitor Data 5	V/f OLV OLV/PM AOLV/PM EZOLV Sets the data log monitor. This parameter is only available with an LCD keypad.	108 (000, 101 - 999)	803
o5-08 (1558) RUN	Log Monitor Data 6	V/f OLV OLV/PM AOLV/PM EZOLV Sets the data log monitor. This parameter is only available when using an LCD keypad.	V/f, OLV/PM : 000, OLV, AOLV/PM, EZOLV : 105 (000, 101 - 999)	803
o5-09 (1559) RUN	Log Monitor Data 7	V/f OLV OLV/PM AOLV/PM EZOLV Sets the data log monitor. This parameter is only available when using an LCD keypad.	110 (000, 101 - 999)	803
o5-10 (155A) RUN	Log Monitor Data 8	V/f OLV OLV/PM AOLV/PM EZOLV Sets the data log monitor. This parameter is only available with an LCD keypad.	112 (000, 101 - 999)	803
o5-11 (155B) RUN	Log Monitor Data 9	V/f OLV OLV/PM AOLV/PM EZOLV Sets the data log monitor. This parameter is only available with an LCD keypad.	000 (000, 101 - 999)	804
o5-12 (155C) RUN	Log Monitor Data 10	V/f OLV OLV/PM AOLV/PM EZOLV Sets the data log monitor. This parameter is only available with an LCD keypad.	000 (000, 101 - 999)	804

11.14 q: DriveWorksEZ Parameters

◆ q1-01 to qx-xx: Reserved for DriveWorksEZ

No. (Hex.)	Name	Description	Default (Range)
q1-01 to qx-xx (1600 - xxxx)	Reserved for DriveWorksEZ	V/f OLV OLV/PM AOLV/PM EZOLV These parameters are reserved for use with DriveWorksEZ.	Refer to "DriveWorksEZ Operation Manual".

11.15 r: DWEZ Connection 1-20

◆ r1-01 to r1-40: DriveWorksEZ Connection Parameters 1 to 20 (Upper / Lower)

No. (Hex.)	Name	Description	Default (Range)
r1-01 to r1-40: (1840 - 1867)	DriveWorksEZ Connection Parameters 1 to 20 (Upper / Lower)	V/f OLV OLV/PM AOLV/PM EZOLV DriveWorksEZ Connection Parameters 1 to 20 (Upper / Lower)	0 (0 - FFFFH)

11.16 T: Motor Tuning

◆ T0: Tuning Mode Selection

No. (Hex.)	Name	Description	Default (Range)	Ref.
T0-00 (1197)	Tuning Mode Selection	<p>V/f OLV OLV/PM AOLV/PM EZOLV</p> <p>Sets the type of Auto-Tuning. 0 : Motor Parameter Tuning 1 : Control Tuning</p>	0 (0, 1)	805

◆ T1: Induction Motor Auto-Tuning

No. (Hex.)	Name	Description	Default (Range)	Ref.
T1-00 (0700)	Motor 1/Motor 2 Selection	<p>V/f OLV OLV/PM AOLV/PM EZOLV</p> <p>Sets which motor to tune when motor 1/2 switching is enabled. You can only use the keypad to set this parameter. You cannot use external input terminals to set it. Note: This parameter is enabled when $H1-xx = 16$ [Motor 2 Selection] is set. When $H1-xx \neq 16$ the keypad will not show this parameter. 1 : Motor 1 2 : Motor 2</p>	1 (1, 2)	805
T1-01 (0701)	Auto-Tuning Mode Selection	<p>V/f OLV OLV/PM AOLV/PM EZOLV</p> <p>Sets the type of Auto-Tuning. 0 : Rotational Auto-Tuning 1 : Stationary Auto-Tuning 1 2 : Stationary Line-Line Resistance</p>	Determined by A1-02 (Determined by A1-02)	806
T1-02 (0702)	Motor Rated Power	<p>V/f OLV OLV/PM AOLV/PM EZOLV</p> <p>Uses the units set in $o1-58$ [Motor Power Unit Selection] to set the motor rated output power.</p>	Determined by $o2-04$, C6-01 (0.00 - 650.00 HP)	806
T1-03 (0703)	Motor Rated Voltage	<p>V/f OLV OLV/PM AOLV/PM EZOLV</p> <p>Sets the rated voltage (V) of the motor. Enter the base speed voltage for constant output motors.</p>	Determined by $o2-04$, C6-01 (200 V Class: 0.0 - 255.5 V, 400 V Class: 0.0 - 511.0 V)	806
T1-04 (0704)	Motor Rated Current	<p>V/f OLV OLV/PM AOLV/PM EZOLV</p> <p>Sets the rated current (A) of the motor.</p>	Determined by $o2-04$ (10% to 200% of the drive rated current)	806
T1-05 (0705)	Motor Base Frequency	<p>V/f OLV OLV/PM AOLV/PM EZOLV</p> <p>Sets the base frequency (Hz) of the motor.</p>	60.0 Hz (0.0 - 590.0 Hz)	806
T1-06 (0706)	Number of Motor Poles	<p>V/f OLV OLV/PM AOLV/PM EZOLV</p> <p>Sets the number of motor poles.</p>	4 (2 to 120)	807
T1-07 (0707)	Motor Base Speed	<p>V/f OLV OLV/PM AOLV/PM EZOLV</p> <p>Sets the motor base speed for Auto-Tuning (min^{-1} (r/min)).</p>	1750 min^{-1} (r/min) (0 - 35400 min^{-1} (r/min))	807
T1-09 (0709)	Motor No-Load Current	<p>V/f OLV OLV/PM AOLV/PM EZOLV</p> <p>Sets the no-load current of the motor.</p>	- (0A - T1-04; max. of 2999.9)	807
T1-10 (070A)	Motor Rated Slip Frequency	<p>V/f OLV OLV/PM AOLV/PM EZOLV</p> <p>Sets motor rated slip.</p>	- (0.000 - 20.000 Hz)	807
T1-11 (070B)	Motor Iron Loss	<p>V/f OLV OLV/PM AOLV/PM EZOLV</p> <p>Sets the iron loss to calculate the energy-saving coefficient.</p>	Determined by E2-10 or E4-10 (0 - 65535 W)	807

No. (Hex.)	Name	Description	Default (Range)	Ref.
T1-12 (0BDB)	Test Mode Selection	<p><input type="checkbox"/> Vf <input checked="" type="checkbox"/> OLV <input type="checkbox"/> OLV/PM <input type="checkbox"/> AOLV/PM <input type="checkbox"/> EZOLV</p> <p>Sets the function to enable Test Mode after Stationary Auto-Tuning. When you can operate the motor with a light load attached after Stationary Auto-Tuning is complete, enable this parameter.</p> <p>Note: You must first set $T1-10 = 0$ [Motor Rated Slip Frequency = 0 Hz] to enable this parameter.</p> <p>0 : No 1 : Yes</p>	0 (0, 1)	807
T1-13 (0BDC)	No-load voltage	<p><input type="checkbox"/> Vf <input checked="" type="checkbox"/> OLV <input type="checkbox"/> OLV/PM <input type="checkbox"/> AOLV/PM <input type="checkbox"/> EZOLV</p> <p>Sets the no-load voltage of the motor. When the no-load voltage at rated speed is available, for example on the motor test report, set the voltage in this parameter. If the no-load voltage is not available, do not change this parameter.</p> <p>Note:</p> <ul style="list-style-type: none"> To get the same qualities as a Yaskawa 1000-series drive or previous series drive, set this parameter = $T1-03$ [Motor Rated Voltage]. The default setting is different for different models. <ul style="list-style-type: none"> -B001 - B006, 2001 - 2008, 4001 - 4004: $T1-03 \times 0.85$ -B010 - B018, 2010 - 2082, 4005 - 4060: $T1-03 \times 0.90$ 	$T1-03 \times 0.9$ (200 V Class: 0.0 - 255.0 V, 400 V Class: 0.0 - 510.0 V)	808

◆ T2: PM Motor Auto-Tuning

No. (Hex.)	Name	Description	Default (Range)	Ref.
T2-01 (0750)	PM Auto-Tuning Selection	<p><input type="checkbox"/> Vf <input type="checkbox"/> OLV <input checked="" type="checkbox"/> OLV/PM <input type="checkbox"/> AOLV/PM <input type="checkbox"/> EZOLV</p> <p>Sets the type of Auto-Tuning for PM motors.</p> <p>0 : Manual Entry w/ Motor Data Sheet 1 : Stationary (Ld, Lq, R) 2 : Stationary (R Only) 4 : Rotational (Ld, Lq, R, back-EMF) 5 : High Frequency Injection</p>	0 (Determined by A1-02)	808
T2-02 (0751)	PM Motor Code Selection	<p><input type="checkbox"/> Vf <input type="checkbox"/> OLV <input checked="" type="checkbox"/> OLV/PM <input type="checkbox"/> AOLV/PM <input type="checkbox"/> EZOLV</p> <p>If the drive is operating an SMRD, SMRA, or SSR1 series Yaskawa PM motor, enter the PM motor code in to align with the rotation speed and motor output.</p>	FFFF (0000 - FFFF)	808
T2-03 (0752)	PM Motor Type	<p><input type="checkbox"/> Vf <input type="checkbox"/> OLV <input checked="" type="checkbox"/> OLV/PM <input type="checkbox"/> AOLV/PM <input type="checkbox"/> EZOLV</p> <p>Sets the type of PM motor the drive will operate.</p> <p>0 : IPM motor 1 : SPM motor</p>	1 (0, 1)	809
T2-04 (0730)	PM Motor Rated Power	<p><input type="checkbox"/> Vf <input type="checkbox"/> OLV <input checked="" type="checkbox"/> OLV/PM <input type="checkbox"/> AOLV/PM <input type="checkbox"/> EZOLV</p> <p>Uses the units set in $o1-58$ [Motor Power Unit Selection] to set the PM motor rated output power.</p>	Determined by $o2-04$, C6-01 (0.00 - 650.00 HP)	809
T2-05 (0732)	PM Motor Rated Voltage	<p><input type="checkbox"/> Vf <input type="checkbox"/> OLV <input checked="" type="checkbox"/> OLV/PM <input type="checkbox"/> AOLV/PM <input type="checkbox"/> EZOLV</p> <p>Sets the rated voltage (V) of the motor.</p>	200 V Class: 230.0 V, 400 V Class: 460.0 V (200 V Class: 0.0 - 255.0 V, 400 V Class: 0.0 - 510.0 V)	809
T2-06 (0733)	PM Motor Rated Current	<p><input type="checkbox"/> Vf <input type="checkbox"/> OLV <input checked="" type="checkbox"/> OLV/PM <input type="checkbox"/> AOLV/PM <input type="checkbox"/> EZOLV</p> <p>Sets the rated current (A) of the motor.</p>	Determined by $o2-04$ (10% to 200% of the drive rated current)	809
T2-07 (0753)	PM Motor Base Frequency	<p><input type="checkbox"/> Vf <input type="checkbox"/> OLV <input checked="" type="checkbox"/> OLV/PM <input type="checkbox"/> AOLV/PM <input type="checkbox"/> EZOLV</p> <p>Sets the base frequency (Hz) of the motor.</p>	60.0 Hz (0.0 - 590.0 Hz)	809
T2-08 (0734)	Number of PM Motor Poles	<p><input type="checkbox"/> Vf <input type="checkbox"/> OLV <input checked="" type="checkbox"/> OLV/PM <input type="checkbox"/> AOLV/PM <input type="checkbox"/> EZOLV</p> <p>Sets the number of motor poles.</p>	4 (2 - 120)	809
T2-09 (0731)	PM Motor Base Speed	<p><input type="checkbox"/> Vf <input type="checkbox"/> OLV <input type="checkbox"/> OLV/PM <input checked="" type="checkbox"/> AOLV/PM <input type="checkbox"/> EZOLV</p> <p>Sets the motor base speed (min^{-1} (r/min)).</p>	1750 min^{-1} (r/min) (0 - 3450 min^{-1} (r/min))	809
T2-10 (0754)	PM Motor Stator Resistance	<p><input type="checkbox"/> Vf <input type="checkbox"/> OLV <input checked="" type="checkbox"/> OLV/PM <input type="checkbox"/> AOLV/PM <input type="checkbox"/> EZOLV</p> <p>Sets the stator resistance for each motor phase.</p> <p>Note: This parameter does not set line-to-line resistance.</p>	Determined by T2-02 (0.000 - 65.000 Ω)	810
T2-11 (0735)	PM Motor d-Axis Inductance	<p><input type="checkbox"/> Vf <input type="checkbox"/> OLV <input checked="" type="checkbox"/> OLV/PM <input type="checkbox"/> AOLV/PM <input type="checkbox"/> EZOLV</p> <p>Sets the d-axis inductance of the motor on a per phase basis.</p>	Determined by T2-02 (0.00 - 600.00 mH)	810
T2-12 (0736)	PM Motor q-Axis Inductance	<p><input type="checkbox"/> Vf <input type="checkbox"/> OLV <input checked="" type="checkbox"/> OLV/PM <input type="checkbox"/> AOLV/PM <input type="checkbox"/> EZOLV</p> <p>Sets the q-axis inductance of the motor on a per phase basis.</p>	Determined by T2-02 (0.00 - 600.00 mH)	810

No. (Hex.)	Name	Description	Default (Range)	Ref.
T2-13 (0755)	Back-EMF Units Selection	<input type="radio"/> V/f <input type="radio"/> OLV <input checked="" type="radio"/> OLV/PM <input type="radio"/> AOLV/PM <input type="radio"/> EZOLV Sets the units that the drive uses to set the induced voltage constant. 0 : mV/(rev/min) 1 : mV/(rad/sec)	0 (0, 1)	810
T2-14 (0737)	Back-EMF Voltage Constant (Ke)	<input type="radio"/> V/f <input type="radio"/> OLV <input checked="" type="radio"/> OLV/PM <input type="radio"/> AOLV/PM <input type="radio"/> EZOLV Sets the motor induced voltage constant (Ke).	Determined by T2-13 (0.0 - 2000.0)	810
T2-15 (0756)	Pull-In Current Level	<input type="radio"/> V/f <input type="radio"/> OLV <input checked="" type="radio"/> OLV/PM <input type="radio"/> AOLV/PM <input type="radio"/> EZOLV Sets the level of the pull-in current as a percentage of E5-03 [PM Motor Rated Current (FLA)]. Usually it is not necessary to change this setting.	30% (0 - 120%)	810

◆ T3: ASR and Inertia Tuning

No. (Hex.)	Name	Description	Default (Range)	Ref.
T3-00 (1198)	Control Loop Tuning Selection	<input type="radio"/> V/f <input type="radio"/> OLV <input checked="" type="radio"/> OLV/PM <input type="radio"/> AOLV/PM <input type="radio"/> EZOLV Sets the type of Control Auto-Tuning. 2 : Deceleration Rate Tuning 3 : KEB Tuning	2 (2, 3)	811



◆ T4: EZ Tuning

No. (Hex.)	Name	Description	Default (Range)	Ref.
T4-01 (3130)	EZ Tuning Mode Selection	<input type="radio"/> V/f <input type="radio"/> OLV <input type="radio"/> OLV/PM <input type="radio"/> AOLV/PM <input checked="" type="radio"/> EZOLV Sets the type of Auto-Tuning for EZOLV control. 0 : Motor Parameter Setting 1 : Line-to-Line Resistance	0 (0, 1)	811
T4-02 (3131)	Motor Type Selection	<input type="radio"/> V/f <input type="radio"/> OLV <input type="radio"/> OLV/PM <input type="radio"/> AOLV/PM <input checked="" type="radio"/> EZOLV Sets the type of motor. 0 : Induction (IM) 1 : Permanent Magnet (PM) 2 : Synchronous Reluctance (SynRM)	0 (0, 1, 2)	811
T4-04 (3133)	Motor Rated Revolutions	<input type="radio"/> V/f <input type="radio"/> OLV <input type="radio"/> OLV/PM <input type="radio"/> AOLV/PM <input checked="" type="radio"/> EZOLV Sets rated rotation speed (min ⁻¹) of the motor.	- ((40 Hz to 120 Hz) × 60 × 2/E9-08)	811
T4-05 (3134)	Motor Rated Frequency	<input type="radio"/> V/f <input type="radio"/> OLV <input type="radio"/> OLV/PM <input type="radio"/> AOLV/PM <input checked="" type="radio"/> EZOLV Sets the rated frequency (Hz) of the motor.	Determined by E9-01 and o2-04 (40.0 - 120.0 Hz)	812
T4-06 (3135)	Motor Rated Voltage	<input type="radio"/> V/f <input type="radio"/> OLV <input type="radio"/> OLV/PM <input type="radio"/> AOLV/PM <input checked="" type="radio"/> EZOLV Sets the rated voltage (V) of the motor.	200 V Class: 230.0 V, 400 V Class: 460.0 V (200 V Class: 0.0 - 255.0 V, 400 V Class: 0.0 - 510.0 V)	812
T4-07 (3136)	Motor Rated Current	<input type="radio"/> V/f <input type="radio"/> OLV <input type="radio"/> OLV/PM <input type="radio"/> AOLV/PM <input checked="" type="radio"/> EZOLV Sets the rated current (A) of the motor.	Determined by o2-04, C6-01 (10% to 200% of the drive rated current)	812
T4-08 (3137)	Motor Rated Capacity	<input type="radio"/> V/f <input type="radio"/> OLV <input type="radio"/> OLV/PM <input type="radio"/> AOLV/PM <input checked="" type="radio"/> EZOLV Sets the motor rated power in the units set in o1-58 [Motor Power Unit Selection].	Determined by E9-10 (0.10 - 650.00 HP)	812
T4-09 (3138)	Number of Poles	<input type="radio"/> V/f <input type="radio"/> OLV <input type="radio"/> OLV/PM <input type="radio"/> AOLV/PM <input checked="" type="radio"/> EZOLV Sets the number of motor poles.	Determined by E9-01 (2 - 120)	812

11.17 U: Monitors

◆ U1: Operation Status Monitors



No. (Hex.)	Name	Description	MFAO Signal Level
U1-01 (0040)	Frequency Reference	<p>V/f OLV OLV/PM AOLV/PM EZOLV</p> <p>Shows the frequency reference value. Parameter <i>o1-03</i> [Keypad Display Unit Selection] sets the display units. Unit: 0.01 Hz</p>	10 V = Maximum frequency (0 V to +10 V)
U1-02 (0041)	Output frequency	<p>V/f OLV OLV/PM AOLV/PM EZOLV</p> <p>Shows the output frequency. Parameter <i>o1-03</i> [Keypad Display Unit Selection] sets the display units. Unit: 0.01 Hz</p>	10 V = Maximum frequency (0 V to +10 V)
U1-03 (0042)	Output Current	<p>V/f OLV OLV/PM AOLV/PM EZOLV</p> <p>Shows the actual output current. The keypad shows the value of <i>U1-03</i> in amperes (A). When looking at the monitor through MEMOBUS/Modbus communications, the current is "8192 = drive rated current (A)". Calculate the current from the monitor value that is in at MEMOBUS/Modbus communications using "Numerals being displayed / 8192 × drive rated current (A)." Unit: When the drive model changes, the display units for this parameter also change. • 0.01 A units: B001 - B018, 2001 - 2042, 4001 - 4023 • 0.1A units: 2056 - 2082, 4031 - 4060</p>	10 V = Drive rated current
U1-04 (0043)	Control method selection	<p>V/f OLV OLV/PM AOLV/PM EZOLV</p> <p>Shows the drive control method. 0 : V/f Control 2 : Open Loop Vector 5 : PM Open Loop Vector 6 : PM Advanced Open Loop Vector 8 : EZ Vector Control</p>	No signal output available
U1-05 (0044)	Motor Speed	<p>V/f OLV OLV/PM AOLV/PM EZOLV</p> <p>Shows the detected motor speed. Parameter <i>o1-03</i> [Keypad Display Unit Selection] sets the display units. Unit: 0.01 Hz</p>	10 V = Maximum frequency (0 V to +10 V)
U1-06 (0045)	Output Voltage Ref	<p>V/f OLV OLV/PM AOLV/PM EZOLV</p> <p>Shows the output voltage reference. Unit: 0.1 V</p>	200 V Class: 10 V = 200 Vrms 400 V Class: 10 V = 400 Vrms
U1-07 (0046)	DC Bus Voltage	<p>V/f OLV OLV/PM AOLV/PM EZOLV</p> <p>Shows the DC bus voltage. Unit: 1 V</p>	200 V Class: 10 V = 400 V 400 V Class: 10 V = 800 V
U1-08 (0047)	Output Power	<p>V/f OLV OLV/PM AOLV/PM EZOLV</p> <p>Shows the internally-calculated output power. When you change <i>A1-02</i> [Control Method Selection], it will also change the signal level of the analog output. • A1-02 = 0: Drive capacity (kW) • A1-02 = 2: Motor Rated Power [E2-11] (kW) • A1-02 = 5, 6: PM Motor Rated Power [E5-02] (kW) • A1-02 = 8: Motor Rated Power [E9-07] (kW) Unit: When the drive model changes, the display units for this parameter also change. • 0.01 kW: B001 - B018, 2001 - 2042, 4001 - 4023 • 0.1 kW: 2056 - 2082, 4031 - 4060</p>	10 V: Drive capacity (motor rated power) kW (0 V to +10 V)
U1-09 (0048)	Torque Reference	<p>V/f OLV OLV/PM AOLV/PM EZOLV</p> <p>Shows the internal torque reference value. Unit: 0.1%</p>	10 V = Motor rated torque (0 V to +10 V)

No. (Hex.)	Name	Description	MFAO Signal Level
U1-10 (0049)	Input Terminal Status	<p>V/f OLV OLV/PM AOLV/PM EZOLV</p> <p>Shows the status of the MFDO terminal where $\overset{\cdot}{i}$ = ON and i = OFF.</p> <p>For example, <i>U1-10</i> shows  when terminals S1 and S3 are ON.</p> <p>bit0 : Terminal S1 (MFDI 1) bit1 : Terminal S2 (MFDI 2) bit2 : Terminal S3 (MFDI 3) bit3 : Terminal S4 (MFDI 4) bit4 : Terminal S5 (MFDI 5) bit5 : Terminal S6 (MFDI 6) bit6 : Terminal S7 (MFDI 7) bit7 : Not used (normal value of [\cdot]).</p>	No signal output available
U1-11 (004A)	Output Terminal Status	<p>V/f OLV OLV/PM AOLV/PM EZOLV</p> <p>Shows the status of the MFDO terminal where $\overset{\cdot}{i}$ = ON and i = OFF.</p> <p>For example, <i>U1-11</i> shows  when terminals MA and P2 are ON.</p> <p>Note: When <i>H2-xx</i> = 100 to 1A7 [<i>U1-11 Inverse U1-11 Output of Function</i>], <i>U1-11</i> does not show the status in inverse.</p> <p>bit0 : Terminal MA/MB-MC bit1 : Terminal P1-C1 bit2 : Terminal P2-C2 bit3 : Not used (normal value of [\cdot]). bit4 : Not used (normal value of [\cdot]). bit5 : Not used (normal value of [\cdot]). bit6 : Not used (normal value of [\cdot]). bit7 : Not used (normal value of [\cdot]).</p>	No signal output available
U1-12 (004B)	Drive Status	<p>V/f OLV OLV/PM AOLV/PM EZOLV</p> <p>Shows drive status where $\overset{\cdot}{i}$ = ON and i = OFF.</p> <p>For example, <i>U1-12</i> shows  during run with the Reverse Run command.</p> <p>bit0 : During Run bit1 : During zero-speed bit2 : During reverse bit3 : During fault reset signal input bit4 : During speed agreement bit5 : Drive Ready bit6 : During minor fault detection bit7 : During fault detection</p>	No signal output available
U1-13 (004E)	Terminal A1 Level	<p>V/f OLV OLV/PM AOLV/PM EZOLV</p> <p>Shows the signal level of terminal A1. Unit: 0.1%</p>	10 V = 100% (0 V to +10 V)
U1-14 (004F)	Terminal A2 Level	<p>V/f OLV OLV/PM AOLV/PM EZOLV</p> <p>Shows the signal level of terminal A2. Unit: 0.1%</p>	10 V = 100% (0 V to +10 V)
U1-16 (0053)	SFS Output Frequency	<p>V/f OLV OLV/PM AOLV/PM EZOLV</p> <p>Shows the output frequency after soft start. Shows the frequency with acceleration and deceleration times and S-curves. Parameter <i>o1-03</i> [<i>Keypad Display Unit Selection</i>] sets the display units. Unit: 0.01 Hz</p>	10 V = Maximum frequency (0 V to +10 V)
U1-18 (0061)	oPE Fault Parameter	<p>V/f OLV OLV/PM AOLV/PM EZOLV</p> <p>Shows the parameter number that caused the <i>oPE02</i> [<i>Parameter Range Setting Error</i>] or <i>oPE08</i> [<i>Parameter Selection Error</i>].</p>	No signal output available

No. (Hex.)	Name	Description	MFAO Signal Level
U1-19 (0066)	MEMOBUS/Modbus Error Code	<p>V/f OLV OLV/IPM AOLV/IPM EZOLV</p> <p>Shows the contents of the MEMOBUS/Modbus communication error where i = "error" and t = "no error".</p> <p>For example, U1-19 shows  when the drive detects a CRC error.</p> <p>bit0 : CRC Error bit1 : Data Length Error</p> <p>bit2 : Not used (normal value of [t]). bit3 : Parity Error bit4 : Overrun Error bit5 : Framing Error bit6 : Timed Out</p> <p>bit7 : Not used (normal value of [t]).</p>	No signal output available
U1-24 (007D)	Input Pulse Monitor	<p>V/f OLV OLV/IPM AOLV/IPM EZOLV</p> <p>Shows the frequency to pulse train input terminal RP. Unit: 1 Hz</p>	Determined by H6-02
U1-25 (004D)	Software number	<p>V/f OLV OLV/IPM AOLV/IPM EZOLV</p> <p>Shows the ID.</p>	No signal output available
U1-26 (005B)	SoftwareNumber ROM	<p>V/f OLV OLV/IPM AOLV/IPM EZOLV</p> <p>Shows the ROM ID.</p>	No signal output available
U1-50 (1199) Expert	Virtual Analog Input	<p>V/f OLV OLV/IPM AOLV/IPM EZOLV</p> <p>Shows the virtual analog input value.</p>	Determined by H7-40

◆ U2: Fault Trace

No. (Hex.)	Name	Description	MFAO Signal Level
U2-01 (0080)	Current Fault	<p>V/f OLV OLV/IPM AOLV/IPM EZOLV</p> <p>Shows the fault that the drive has when viewing the monitor.</p>	No signal output available
U2-02 (0081)	Previous Fault	<p>V/f OLV OLV/IPM AOLV/IPM EZOLV</p> <p>Shows the fault that occurred most recently.</p>	No signal output available
U2-03 (0082)	Freq Reference@Fault	<p>V/f OLV OLV/IPM AOLV/IPM EZOLV</p> <p>Shows the frequency reference at the fault that occurred most recently. Use U1-01 [Frequency Reference] to monitor the frequency reference value. Unit: 0.01 Hz</p>	No signal output available
U2-04 (0083)	Output Freq @ Fault	<p>V/f OLV OLV/IPM AOLV/IPM EZOLV</p> <p>Shows the output frequency at the fault that occurred most recently. Use U1-02 [Output Frequency] to monitor the actual output frequency. Unit: 0.01 Hz</p>	No signal output available
U2-05 (0084)	Output Current@Fault	<p>V/f OLV OLV/IPM AOLV/IPM EZOLV</p> <p>Shows the output current at the fault that occurred most recently. Use U1-03 [Output Current] to monitor the actual output current. The keypad shows the value of U1-03 in amperes (A). When looking at the monitor through MEMOBUS/Modbus communications, the current is "8192 = drive rated current (A)". Calculate the current from the monitor value that is in at MEMOBUS/Modbus communications using "Numerals being displayed / 8192 × drive rated current (A)." Unit: When the drive model changes, the display units for this parameter also change. • 0.01 A units: B001 - B018, 2001 - 2042, 4001 - 4023 • 0.1A units: 2056 - 2082, 4031 - 4060</p>	No signal output available
U2-06 (0085)	Motor Speed @ Fault	<p>V/f OLV OLV/IPM AOLV/IPM EZOLV</p> <p>Shows the motor speed at the fault that occurred most recently. Use U1-05 [Motor Speed] to monitor the motor speed. Unit: 0.01 Hz</p>	No signal output available
U2-07 (0086)	Output Voltage@Fault	<p>V/f OLV OLV/IPM AOLV/IPM EZOLV</p> <p>Shows the output voltage reference at the fault that occurred most recently. Use U1-06 [Output Voltage Ref] to monitor the output voltage reference. Unit: 0.1 V</p>	No signal output available

No. (Hex.)	Name	Description	MFAO Signal Level
U2-08 (0087)	DC Bus Voltage@Fault	<p>V/f OLV OLV/PM AOLV/PM EZOLV</p> <p>Shows the DC bus voltage at the fault that occurred most recently. Use U1-07 [DC Bus Voltage] to monitor the DC bus voltage. Unit: 1 V</p>	No signal output available
U2-09 (0088)	Output Power @ Fault	<p>V/f OLV OLV/PM AOLV/PM EZOLV</p> <p>Shows the output power at the fault that occurred most recently. Use U1-08 [Output Power] to monitor the output power. Unit: 0.1 kW</p>	No signal output available
U2-10 (0089)	Torque Ref @ Fault	<p>V/f OLV OLV/PM AOLV/PM EZOLV</p> <p>Shows the torque reference at the fault that occurred most recently as a percentage of the motor rated torque. Use U1-09 [Torque Reference] to monitor the torque reference. Unit: 0.1%</p>	No signal output available
U2-11 (008A)	Input Terminal Status @ Fault	<p>V/f OLV OLV/PM AOLV/PM EZOLV</p> <p>Shows the status of the MFDI terminals at the most recent fault where $\overset{\cdot}{I}$ = ON and $\overset{\cdot}{I}$ = OFF.</p> <p>For example, U2-11 shows  when terminals S1 and S3 are ON. Use U1-10 [Input Terminal Status] to monitor the actual MFDI terminal status.</p> <p>bit0 : Terminal S1 bit1 : Terminal S2 bit2 : Terminal S3 bit3 : Terminal S4 bit4 : Terminal S5 bit5 : Terminal S6 bit6 : Terminal S7 bit7 : Not used (normal value of [$\overset{\cdot}{I}$]).</p>	No signal output available
U2-12 (008B)	Output Terminal Status @ Fault	<p>V/f OLV OLV/PM AOLV/PM EZOLV</p> <p>Shows the status of the MFDO terminals at the most recent fault where $\overset{\cdot}{I}$ = ON and $\overset{\cdot}{I}$ = OFF.</p> <p>For example, U2-12 shows  when terminals MA and P2 are ON. Use U1-11 [Output Terminal Status] to monitor the actual MFDO terminal status.</p> <p>bit0 : Terminal MA/MB-MC bit1 : Terminal P1-C1 bit2 : Terminal P2-C2 bit3 : Not used (normal value of [$\overset{\cdot}{I}$]). bit4 : Not used (normal value of [$\overset{\cdot}{I}$]). bit5 : Not used (normal value of [$\overset{\cdot}{I}$]). bit6 : Not used (normal value of [$\overset{\cdot}{I}$]). bit7 : Not used (normal value of [$\overset{\cdot}{I}$]).</p>	No signal output available
U2-13 (008C)	Operation Status @ Fault	<p>V/f OLV OLV/PM AOLV/PM EZOLV</p> <p>Shows the status of the MFDO terminals at the most recent fault where $\overset{\cdot}{I}$ = ON and $\overset{\cdot}{I}$ = OFF.</p> <p>For example, U2-13 shows  during run. Use U1-12 [Drive Status] to monitor the actual MFDO terminal status.</p> <p>bit0 : During Run bit1 : During zero-speed bit2 : During reverse bit3 : During fault reset signal input bit4 : During speed agreement bit5 : Drive Ready bit6 : During minor fault detection bit7 : During fault detection</p>	No signal output available
U2-14 (008D)	Elapsed Time @ Fault	<p>V/f OLV OLV/PM AOLV/PM EZOLV</p> <p>Shows the cumulative operation time of the drive at the fault that occurred most recently. Use U4-01 [Cumulative Ope Time] to monitor the cumulative operation time. Unit: 1 h</p>	No signal output available

11.17 U: Monitors

No. (Hex.)	Name	Description	MFAO Signal Level
U2-15 (07E0)	SFS Output @ Fault	<p>V/f OLV OLV/IPM AOLV/IPM EZOLV</p> <p>Shows the output frequency after soft start at the fault that occurred most recently. Use U1-16 [SFS Output Frequency] to monitor the output frequency after soft start. Unit: 0.01 Hz</p>	No signal output available
U2-16 (07E1)	q-Axis Current@Fault	<p>V/f OLV OLV/IPM AOLV/IPM EZOLV</p> <p>Shows the q-Axis current of the motor at the fault that occurred most recently. Use U6-01 [Iq Secondary Current] to monitor the q-Axis current of the motor. Unit: 0.1 %</p>	No signal output available
U2-17 (07E2)	d-Axis Current@Fault	<p>V/f OLV OLV/IPM AOLV/IPM EZOLV</p> <p>Shows the d-Axis current of the motor at the fault that occurred most recently. Use U6-02 [Id ExcitationCurrent] to monitor the d-Axis current of the motor. Unit: 0.1%</p>	No signal output available
U2-19 (07E4)	ControlDeviation@FIt	<p>V/f OLV OLV/IPM AOLV/IPM EZOLV</p> <p>Shows the amount of control axis deviation ($\Delta\theta$) at the fault that occurred most recently. Use U6-10 [ContAxisDeviation $\Delta\theta$] to monitor the actual amount of control axis deviation ($\Delta\theta$). Unit: 0.1 °</p>	No signal output available
U2-20 (008E)	Heatsink Temp @Fault	<p>V/f OLV OLV/IPM AOLV/IPM EZOLV</p> <p>Shows the heatsink temperature at the fault that occurred most recently. Use U4-08 [Heatsink Temperature] to monitor the temperature of the heatsink. Unit: 1 °C</p>	No signal output available
U2-21 (1166) Expert	STPo Detect @ Fault	<p>V/f OLV OLV/IPM AOLV/IPM EZOLV</p> <p>Monitors conditions to detect STPo [Motor Step-Out Detected] faults. The bit for each condition is shown as I = ON or I = OFF.</p> <p>For example, U2-21 shows  when the drive detects excessive current.</p> <p>bit0 : Excessive current bit1 : Induced voltage deviation bit2 : d-axis current deviation bit3 : Motor lock at startup bit4 : Acceleration stall continue bit5 : Acceleration stall repeat bit6 : Not used (normal value of [I]). bit7 : Not used (normal value of [I]).</p>	No signal output available

◆ U3: Fault History

No. (Hex.)	Name	Description	MFAO Signal Level
U3-01 (0090)	1st MostRecent Fault	<p>V/f OLV OLV/IPM AOLV/IPM EZOLV</p> <p>Shows the fault history of the most recent fault.</p> <p>Note: The drive saves this fault history to two types of registers at the same time for the MEMOBUS/Modbus communications.</p>	No signal output available
U3-02 (0091)	2nd MostRecent Fault	<p>V/f OLV OLV/IPM AOLV/IPM EZOLV</p> <p>Shows the fault history of the second most recent fault.</p> <p>Note: The drive saves this fault history to two types of registers at the same time for the MEMOBUS/Modbus communications.</p>	No signal output available
U3-03 (0092)	3rd MostRecent Fault	<p>V/f OLV OLV/IPM AOLV/IPM EZOLV</p> <p>Shows the fault history of the third most recent fault.</p> <p>Note: The drive saves this fault history to two types of registers at the same time for the MEMOBUS/Modbus communications.</p>	No signal output available
U3-04 (0093)	4th MostRecent Fault	<p>V/f OLV OLV/IPM AOLV/IPM EZOLV</p> <p>Shows the fault history of the fourth most recent fault.</p> <p>Note: The drive saves this fault history to two types of registers at the same time for the MEMOBUS/Modbus communications.</p>	No signal output available
U3-05 (0804)	5th MostRecent Fault	<p>V/f OLV OLV/IPM AOLV/IPM EZOLV</p> <p>Shows the fault history of the fifth most recent fault.</p>	No signal output available

No. (Hex.)	Name	Description	MFAO Signal Level
U3-06 (0805)	6th MostRecent Fault	V/f OLV OLV/PM AOLV/PM EZOLV Shows the fault history of the sixth most recent fault.	No signal output available
U3-07 (0806)	7th MostRecent Fault	V/f OLV OLV/PM AOLV/PM EZOLV Shows the fault history of the seventh most recent fault.	No signal output available
U3-08 (0807)	8th MostRecent Fault	V/f OLV OLV/PM AOLV/PM EZOLV Shows the fault history of the eighth most recent fault.	No signal output available
U3-09 (0808)	9th MostRecent Fault	V/f OLV OLV/PM AOLV/PM EZOLV Shows the fault history of the ninth most recent fault.	No signal output available
U3-10 (0809)	10th MostRecentFault	V/f OLV OLV/PM AOLV/PM EZOLV Shows the fault history of the tenth most recent fault.	No signal output available
U3-11 (0094)	ElapsedTime@1stFault	V/f OLV OLV/PM AOLV/PM EZOLV Shows the cumulative operation time when the most recent fault occurred. Note: The drive saves this cumulative operation time to two types of registers at the same time for the MEMOBUS/Modbus communications. Unit: 1 h	No signal output available
U3-12 (0095)	ElapsedTime@2ndFault	V/f OLV OLV/PM AOLV/PM EZOLV Shows the cumulative operation time when the second most recent fault occurred. Note: The drive saves this cumulative operation time to two types of registers at the same time for the MEMOBUS/Modbus communications. Unit: 1 h	No signal output available
U3-13 (0096)	ElapsedTime@3rdFault	V/f OLV OLV/PM AOLV/PM EZOLV Shows the cumulative operation time when the third most recent fault occurred. Note: The drive saves this cumulative operation time to two types of registers at the same time for the MEMOBUS/Modbus communications. Unit: 1 h	No signal output available
U3-14 (0097)	ElapsedTime@4thFault	V/f OLV OLV/PM AOLV/PM EZOLV Shows the cumulative operation time when the fourth most recent fault occurred. Note: The drive saves this cumulative operation time to two types of registers at the same time for the MEMOBUS/Modbus communications. Unit: 1 h	No signal output available
U3-15 (080E)	ElapsedTime@5thFault	V/f OLV OLV/PM AOLV/PM EZOLV Shows the cumulative operation time when the fifth most recent fault occurred. Unit: 1 h	No signal output available
U3-16 (080F)	ElapsedTime@6thFault	V/f OLV OLV/PM AOLV/PM EZOLV Shows the cumulative operation time when the sixth most recent fault occurred. Unit: 1 h	No signal output available
U3-17 (0810)	ElapsedTime@7thFault	V/f OLV OLV/PM AOLV/PM EZOLV Shows the cumulative operation time when the seventh most recent fault occurred. Unit: 1 h	No signal output available
U3-18 (0811)	ElapsedTime@8thFault	V/f OLV OLV/PM AOLV/PM EZOLV Shows the cumulative operation time when the eighth most recent fault occurred. Unit: 1 h	No signal output available
U3-19 (0812)	ElapsedTime@9thFault	V/f OLV OLV/PM AOLV/PM EZOLV Shows the cumulative operation time when the ninth most recent fault occurred. Unit: 1 h	No signal output available
U3-20 (0813)	ElapsedTime@10 Fault	V/f OLV OLV/PM AOLV/PM EZOLV Shows the cumulative operation time when the tenth most recent fault occurred. Unit: 1 h	No signal output available

◆ U4: Maintenance Monitors

No. (Hex.)	Name	Description	MFAO Signal Level
U4-01 (004C)	Cumulative Ope Time	<p>V/f OLV OLV/PM AOLV/PM EZOLV</p> <p>Shows the cumulative operation time of the drive.</p> <p>Use parameter <i>o4-01 [Elapsed Operating Time Setting]</i> to reset this monitor. Use parameter <i>o4-02 [Elapsed Operating Time Selection]</i> to select the cumulative operation times from:</p> <ul style="list-style-type: none"> The time from when the drive is energized until it is de-energized. The time at which the Run command is turned ON. <p>The maximum value that the monitor will show is <i>99999</i>. After this value is more than <i>99999</i>, the drive automatically resets it and starts to count from <i>0</i> again.</p> <p>Unit: 1 h</p> <p>Note: The MEMOBUS/Modbus communication data is shown in 10 h units. Use register 0099H for data in 1 h units.</p>	10 V: 99999 h
U4-02 (0075)	Num of Run Commands	<p>V/f OLV OLV/PM AOLV/PM EZOLV</p> <p>Shows how many times that the drive has received a Run command.</p> <p>Use parameter <i>o4-13 [RUN Command Counter @ Initialize]</i> to reset this monitor. The maximum value that the monitor will show is <i>65535</i>. After this value is more than <i>65535</i>, the drive automatically resets it and starts to count from <i>0</i> again.</p> <p>Unit: 1</p>	10 V: 65535 times
U4-03 (0067)	Cooling Fan Ope Time	<p>V/f OLV OLV/PM AOLV/PM EZOLV</p> <p>Shows the cumulative operation time of the cooling fans.</p> <p>Use parameter <i>o4-03 [Fan Operation Time Setting]</i> to reset this monitor. The maximum value that the monitor will show is <i>99999</i>. After this value is more than <i>99999</i>, the drive automatically resets it and starts to count from <i>0</i> again.</p> <p>Unit: 1 h</p> <p>Note: The MEMOBUS/Modbus communication data is shown in 10 h units. Use register 009BH for data in 1 h units.</p>	10 V: 99999 h
U4-04 (007E)	Cool Fan Maintenance	<p>V/f OLV OLV/PM AOLV/PM EZOLV</p> <p>Shows the cumulative operation time of the cooling fans as a percentage of the estimated performance life of the cooling fans.</p> <p>The default value is 0. The value counts up from 0.</p> <p>Use <i>o4-03 [Fan Operation Time Setting]</i> to reset this monitor.</p> <p>Unit: 1%</p> <p>Note: Replace the cooling fans when this monitor is at 90%.</p>	10 V: 100%
U4-05 (007C)	CapacitorMaintenance	<p>V/f OLV OLV/PM AOLV/PM EZOLV</p> <p>Shows the operation time of the electrolytic capacitors for the main circuit and control circuit as a percentage of the estimated performance life of the electrolytic capacitors.</p> <p>The default value is 0. The value counts up from 0.</p> <p>Use <i>o4-05 [Capacitor Maintenance Setting]</i> to reset this monitor.</p> <p>Unit: 1%</p> <p>Note: Replace the electrolytic capacitor when this monitor is at 90%.</p>	10 V: 100%
U4-06 (07D6)	PreChargeRelayMainte	<p>V/f OLV OLV/PM AOLV/PM EZOLV</p> <p>Shows the operation time of the soft charge bypass relay as a percentage of the estimated performance life of the soft charge bypass relay.</p> <p>The default value is 0. The value counts up from 0.</p> <p>Use <i>o4-07 [Softcharge Relay Maintenance Set]</i> to reset this monitor.</p> <p>Unit: 1%</p> <p>Note: Replace the drive when this monitor is at 90%.</p>	10 V: 100%
U4-07 (07D7)	IGBT Maintenance	<p>V/f OLV OLV/PM AOLV/PM EZOLV</p> <p>Shows the operation time of the IGBTs as a percentage of the estimated performance life of the IGBTs.</p> <p>The default value is 0. The value counts up from 0.</p> <p>Use <i>o4-09 [IGBT Maintenance Setting]</i> to reset this monitor.</p> <p>Unit: 1%</p> <p>Note: Replace the drive when this monitor is at 90%.</p>	10 V: 100%
U4-08 (0068)	Heatsink Temperature	<p>V/f OLV OLV/PM AOLV/PM EZOLV</p> <p>Shows the heatsink temperature of the drive.</p> <p>Unit: 1 °C</p>	10 V: 100 °C

No. (Hex.)	Name	Description	MFAO Signal Level
U4-09 (005E)	LED Check	<p>V/f OLV OLV/PM AOLV/PM EZOLV</p> <p>Turns on all of the keypad LEDs to make sure that the LEDs operate correctly.</p> <p>1. With <i>U4-09</i> displayed, press . All LEDs on the keypad will turn on.</p> <p>Note: When Safety input 2 CH is open (STo), READY will flash.</p>	No signal output available
U4-10 (005C)	kWh, Lower 4 Digits	<p>V/f OLV OLV/PM AOLV/PM EZOLV</p> <p>Shows the lower 4 digits of the watt hour value for the drive. Unit: 1 kWh</p> <p>Note: The watt hour is displayed in 9 digits. Monitor <i>U4-11 [kWh, Upper 5 Digits]</i> shows the upper 5 digits and <i>U4-10</i> shows the lower 4 digits. Example for 12345678.9 kWh: <i>U4-10</i>: 678.9 kWh <i>U4-11</i>: 12345 MWh</p>	No signal output available
U4-11 (005D)	kWh, Upper 5 Digits	<p>V/f OLV OLV/PM AOLV/PM EZOLV</p> <p>Shows the upper 5 digits of the watt hour value for the drive. Unit: 1 MWh</p> <p>Note: Monitor <i>U4-11</i> shows the upper 5 digits and <i>U4-10 [kWh, Lower 4 Digits]</i> shows the lower 4 digits. Example for 12345678.9 kWh: <i>U4-10</i>: 678.9 kWh <i>U4-11</i>: 12345 MWh</p>	No signal output available
U4-13 (07CF)	Peak Hold Current	<p>V/f OLV OLV/PM AOLV/PM EZOLV</p> <p>Shows the hold value of the peak value (rms) for the drive output current. Use <i>U4-14 [PeakHold Output Freq]</i> to show the drive output frequency at the time that the drive holds the output current.</p> <p>The drive will hold the peak hold current at the next start up and restart of the power supply. The drive keeps the value that was under hold during baseblock (during stop).</p> <p>The keypad shows the value of <i>U4-13</i> in amperes (A). When looking at the monitor through MEMOBUS/Modbus communications, the current is "8192 = drive rated current (A)". Calculate the current from the monitor value that is in at MEMOBUS/Modbus communications using "Numerals being displayed / 8192 × drive rated current (A)".</p> <p>Unit: When the drive model changes, the display units for this parameter also change.</p> <ul style="list-style-type: none"> • 0.01 A units: B001 - B018, 2001 - 2042, 4001 - 4023 • 0.1A units: 2056 - 2082, 4031 - 4060 	No signal output available
U4-14 (07D0)	PeakHold Output Freq	<p>V/f OLV OLV/PM AOLV/PM EZOLV</p> <p>Shows the output frequency at which the peak value (rms) of the drive output current is held. The peak hold current can be monitored by <i>U4-13 [Peak Hold Current]</i>.</p> <p>The peak hold output frequency will be cleared at the next startup and restart of the power supply. The drive keeps the value that was under hold during baseblock (during stop).</p> <p>Unit: 0.01 Hz</p>	No signal output available
U4-16 (07D8)	Motor oL1 Level	<p>V/f OLV OLV/PM AOLV/PM EZOLV</p> <p>Shows the integrated value of oL1 [<i>Motor Overload</i>] as a percentage of oL1 detection level. Unit: 0.1%</p>	10 V: 100%
U4-18 (07DA)	Reference Source	<p>V/f OLV OLV/PM AOLV/PM EZOLV</p> <p>Shows the selected frequency reference source. The keypad shows the frequency reference source as "XY-nn" as specified by these rules: X: <i>External Reference 1/2 Selection [H1-xx = 2]</i> selection status</p> <ul style="list-style-type: none"> • 1: <i>b1-01 [Frequency Reference Selection 1]</i> • 2: <i>b1-15 [Frequency Reference Selection 2]</i> <p>Y-nn: Frequency reference source</p> <ul style="list-style-type: none"> • 0-01: Keypad (<i>d1-01 [Reference 1]</i>) • 1-00: Analog input (unassigned) • 1-01: MFAI terminal A1 • 1-02: MFAI terminal A2 • 2-02 to 2-17: Multi-step speed reference (<i>d1-02 to d1-17 [Reference 2 to 16, Jog Reference]</i>) • 3-01: MEMOBUS/Modbus communications • 4-01: Communication option card • 5-01: Pulse train input • 7-01: DriveWorksEZ • 9-01: Up/Down command 	No signal output available

11.17 U: Monitors

No. (Hex.)	Name	Description	MFAO Signal Level
U4-19 (07DB)	Modbus FreqRef (dec)	<p>V/f OLV OLV/PM AOLV/PM EZOLV</p> <p>Shows the frequency reference sent to the drive from the MEMOBUS/Modbus communications as a decimal. Unit: 0.01%</p>	10 V: Maximum frequency (0 V to +10 V)
U4-20 (07DC)	Option Freq Ref(dec)	<p>V/f OLV OLV/PM AOLV/PM EZOLV</p> <p>Shows the frequency reference sent to the drive from the communication option as a decimal. Unit: 0.01 %</p>	10 V: Maximum frequency (0 V to +10 V)
U4-21 (07DD)	Run Command Source	<p>V/f OLV OLV/PM AOLV/PM EZOLV</p> <p>Shows the selected Run command source. The keypad shows the Run command source as "XY-nn" as specified by these rules: X: <i>External Reference 1/2 Selection [H1-xx = 2]</i> selection status</p> <ul style="list-style-type: none"> • 1: <i>b1-02 [Run Command Selection 1]</i> • 2: <i>b1-16 [Run Command Selection 2]</i> <p>Y: Run command source</p> <ul style="list-style-type: none"> • 0: Keypad • 1: Control circuit terminal • 3: MEMOBUS/Modbus communications • 4: Communication option card • 7: DriveWorksEZ <p>nn: Run command limit status data</p> <ul style="list-style-type: none"> • 00: No limit status. • 01: The Run command was left ON when the drive stopped in the Programming Mode. • 02: The Run command was left ON when switching from LOCAL Mode to REMOTE Mode. • 03: The Run command is in standby after the drive was energized until the soft charge bypass contactor turns ON. <p>Note: The drive will detect <i>Uv1 [DC Bus Undervoltage]</i> or <i>Uv [Undervoltage]</i> if the soft charge bypass contactor does not turn ON after 10 s.</p> <ul style="list-style-type: none"> • 04: Restart after run stop is prohibited. • 05: Fast stop has been executed using the MFDI terminal. Or, the motor has ramped to stop by pressing the STOP key on the keypad. • 06: <i>b1-17 = 0 [Run Command at Power Up = Disregard Existing RUN Command]</i> is set. • 07: During baseblock while coast to stop with timer. • 08: Frequency reference is below <i>E1-09 [Minimum Output Frequency]</i> during baseblock. • 09: Waiting for the Enter command from PLC. 	No signal output The keypad shows the Run command source as "XY-nn" as specified by these rules: available
U4-22 (07DE)	Modbus CmdData (hex)	<p>V/f OLV OLV/PM AOLV/PM EZOLV</p> <p>Shows the operation signal (register 0001H) sent to the drive from MEMOBUS/Modbus communications as a 4-digit hexadecimal number (zero suppress). The keypad shows the operation signal as specified by these rules:</p> <p>bit 0 : Forward run/Stop bit 1 : Reverse run/Stop bit 2 : External fault bit 3 : Fault Reset Procedure bit 4 : Multi-function input 1 bit 5 : Multi-function input 2 bit 6 : Multi-function input 3 bit 7 : Multi-function input 4 bit 8 : Multi-function input 5 bit 9 : Multi-function input 6 bit A : Multi-function input 7 bit B : Not used (normal value of 0). bit C : Not used (normal value of 0). bit D : Not used (normal value of 0). bit E : Not used (normal value of 0). bit F : Not used (normal value of 0).</p>	No signal output available

No. (Hex.)	Name	Description	MFAO Signal Level
U4-23 (07DF)	Option CmdData (hex)	<p>V/f OLV OLV/PM AOLV/PM EZOLV</p> <p>Shows the operation signal (register 0001H) sent to the drive from MEMOBUS/Modbus communications as a 4-digit hexadecimal number.</p> <p>The keypad shows the operation signal as specified by these rules:</p> <p>bit 0 : Forward run/Stop bit 1 : Reverse run/Stop bit 2 : External fault bit 3 : Fault Reset Procedure bit 4 : Multi-function input 1 bit 5 : Multi-function input 2 bit 6 : Multi-function input 3 bit 7 : Multi-function input 4 bit 8 : Multi-function input 5 bit 9 : Multi-function input 6 bit A : Multi-function input 7 bit B : Not used (normal value of 0). bit C : Not used (normal value of 0). bit D : Not used (normal value of 0). bit E : Not used (normal value of 0). bit F : Not used (normal value of 0).</p>	No signal output available
U4-24 (07E6)	Number of Runs (Low)	<p>V/f OLV OLV/PM AOLV/PM EZOLV</p> <p>Shows the lower 4 digits of the drive run count.</p> <p>Note: The drive run count is an 8-digit number. Monitor <i>U4-25 [Number of Runs(High)]</i> shows the upper 4 digits and <i>U4-24</i> shows the lower 4 digits.</p>	No signal output available
U4-25 (07E7)	Number of Runs(High)	<p>V/f OLV OLV/PM AOLV/PM EZOLV</p> <p>Shows the upper 4 digits of the drive run count.</p> <p>Note: The drive run count is an 8-digit number. Monitor <i>U4-25</i> shows the upper 4 digits and <i>U4-24 [Number of Runs (Low)]</i> shows the lower 4 digits.</p>	No signal output available
U4-52 (1592)	Torque Ref from Comm	<p>V/f OLV OLV/PM AOLV/PM EZOLV</p> <p>Shows the torque reference that the drive received from a serial communication option card or from MEMOBUS/Modbus communications as a decimal number.</p> <p>Unit: 0.1%</p>	10 V: 100% (0 V to +10 V)

◆ U5: PID Monitors

No. (Hex.)	Name	Description	MFAO Signal Level
U5-01 (0057)	PID Feedback	<p>V/f OLV OLV/PM AOLV/PM EZOLV</p> <p>Shows the PID control feedback value. Parameter <i>b5-20 [PID Unit Selection]</i> sets the display units.</p> <p>Unit: 0.01%</p>	10 V: Maximum frequency (0 V to +10 V)
U5-02 (0063)	PID Input	<p>V/f OLV OLV/PM AOLV/PM EZOLV</p> <p>Shows the change between the PID setpoint and PID feedback (the quantity of PID input) as a percentage of the maximum output frequency.</p> <p>Unit: 0.01%</p>	10 V: Maximum frequency (0 V to +10 V)
U5-03 (0064)	PID Output	<p>V/f OLV OLV/PM AOLV/PM EZOLV</p> <p>Shows the PID control output as a percentage of the maximum output frequency.</p> <p>Unit: 0.01%</p>	10 V: Maximum frequency (0 V to +10 V)
U5-04 (0065)	PID Setpoint	<p>V/f OLV OLV/PM AOLV/PM EZOLV</p> <p>Shows the PID setpoint. Parameter <i>b5-20 [PID Unit Selection]</i> sets the display units.</p> <p>Unit: 0.01%</p>	10 V: Maximum frequency (0 V to +10 V)
U5-05 (07D2)	PID DifferentialFdbk	<p>V/f OLV OLV/PM AOLV/PM EZOLV</p> <p>Shows the PID differential feedback value as a percentage of the maximum output frequency.</p> <p>Set <i>H3-02</i> or <i>H3-10 = 16 [MFAI Function Selection = Differential PID Feedback]</i> to enable this monitor.</p> <p>Unit: 0.01%</p>	10 V: Maximum frequency (0 V to +10 V)
U5-06 (07D3)	PID Fdbk-Diff PID Fdbk	<p>V/f OLV OLV/PM AOLV/PM EZOLV</p> <p>Shows the difference from calculating <i>U5-05 - U5-01 [PID DifferentialFdbk] - [PID Feedback]</i>.</p> <p>Unit: 0.01%</p> <p>Note: <i>U5-01 [PID Feedback] = U5-06</i> when <i>H3-02</i> or <i>H3-10 ≠ 16 [MFAI Function Selection ≠ Differential PID Feedback]</i>.</p>	10 V: Maximum frequency (0 V to +10 V)

No. (Hex.)	Name	Description	MFAO Signal Level
U5-21 (0872) Expert	Energy Save Coeff Ki	<input type="checkbox"/> V/f <input type="checkbox"/> OLV <input type="checkbox"/> OLV/IPM <input type="checkbox"/> AOLV/IPM <input type="checkbox"/> EZOLV Shows the energy-saving coefficient Ki value for PM. Unit: 0.01	No signal output available
U5-22 (0873) Expert	Energy Save Coeff Kt	<input type="checkbox"/> V/f <input type="checkbox"/> OLV <input type="checkbox"/> OLV/IPM <input type="checkbox"/> AOLV/IPM <input type="checkbox"/> EZOLV Shows the energy-saving coefficient Kt value for PM. Unit: 0.01	No signal output available
U5-99 (1599)	PID Setpoint Command	<input checked="" type="checkbox"/> V/f <input type="checkbox"/> OLV <input type="checkbox"/> OLV/IPM <input type="checkbox"/> AOLV/IPM <input type="checkbox"/> EZOLV Shows the PID setpoint command. Parameter b5-20 [PID Unit Selection] sets the display units. Unit: 0.01%	10 V: Maximum frequency (0 V to +10 V)

◆ U6: Operation Status Monitors

No. (Hex.)	Name	Description	MFAO Signal Level
U6-01 (0051)	Iq Secondary Current	<input type="checkbox"/> V/f <input type="checkbox"/> OLV <input type="checkbox"/> OLV/IPM <input type="checkbox"/> AOLV/IPM <input type="checkbox"/> EZOLV Shows the value calculated for the motor secondary current (q-Axis) as a percentage of the motor rated secondary current. Unit: 0.1%	10 V: Motor secondary rated current (0 V to +10 V)
U6-02 (0052)	Id ExcitationCurrent	<input type="checkbox"/> V/f <input type="checkbox"/> OLV <input type="checkbox"/> OLV/IPM <input type="checkbox"/> AOLV/IPM <input type="checkbox"/> EZOLV Shows the value calculated for the motor excitation current (d-Axis) as a percentage of the motor rated secondary current. Unit: 0.1%	10 V: Motor secondary rated current (0 V to +10 V)
U6-03 (0054)	ASR Input	<input type="checkbox"/> V/f <input type="checkbox"/> OLV <input type="checkbox"/> OLV/IPM <input type="checkbox"/> AOLV/IPM <input type="checkbox"/> EZOLV Shows the ASR input value as a percentage of the maximum frequency. Unit: 0.01%	10 V: Maximum frequency (0 V to +10 V)
U6-04 (0055)	ASR Output	<input type="checkbox"/> V/f <input type="checkbox"/> OLV <input type="checkbox"/> OLV/IPM <input type="checkbox"/> AOLV/IPM <input type="checkbox"/> EZOLV Shows the ASR output value as a percentage of the motor rated secondary current. Unit: 0.01%	10 V: Motor secondary rated current (0 V to +10 V)
U6-05 (0059)	OutputVoltageRef: Vq	<input type="checkbox"/> V/f <input type="checkbox"/> OLV <input type="checkbox"/> OLV/IPM <input type="checkbox"/> AOLV/IPM <input type="checkbox"/> EZOLV Shows the drive internal voltage reference for motor secondary current control (q-Axis). Unit: 0.1 V	200 V Class: 10 V = 200 Vrms 400 V Class: 10 V = 400 Vrms (0 V to +10 V)
U6-06 (005A)	OutputVoltageRef: Vd	<input type="checkbox"/> V/f <input type="checkbox"/> OLV <input type="checkbox"/> OLV/IPM <input type="checkbox"/> AOLV/IPM <input type="checkbox"/> EZOLV Shows the drive internal voltage reference for motor excitation current control (d-Axis). Unit: 0.1 V	200 V Class: 10 V = 200 Vrms 400 V Class: 10 V = 400 Vrms (0 V to +10 V)
U6-07 (005F) Expert	q-Axis ACR Output	<input type="checkbox"/> V/f <input type="checkbox"/> OLV <input type="checkbox"/> OLV/IPM <input type="checkbox"/> AOLV/IPM <input type="checkbox"/> EZOLV Shows the output value for current control related to motor secondary current (q axis). Unit: 0.1 %	200 V Class: 10 V = 200 Vrms 400 V Class: 10 V = 400 Vrms (0 V to +10 V)
U6-08 (0060) Expert	d-Axis ACR Output	<input type="checkbox"/> V/f <input type="checkbox"/> OLV <input type="checkbox"/> OLV/IPM <input type="checkbox"/> AOLV/IPM <input type="checkbox"/> EZOLV Shows the output value for current control related to motor excitation current (d axis). Unit: 0.1 %	200 V Class: 10 V = 200 Vrms 400 V Class: 10 V = 400 Vrms (0 V to +10 V)
U6-09 (07C0) Expert	AdvPhase Compen Δθcmp	<input type="checkbox"/> V/f <input type="checkbox"/> OLV <input type="checkbox"/> OLV/IPM <input type="checkbox"/> AOLV/IPM <input type="checkbox"/> EZOLV Displays the data on forward phase compensation for the calculation results of the amount of control axis deviation. Unit: 1 °	5 V: 180 ° (-10 V to +10 V)
U6-10 (07C1) Expert	ContAxisDeviation Δθ	<input type="checkbox"/> V/f <input type="checkbox"/> OLV <input type="checkbox"/> OLV/IPM <input type="checkbox"/> AOLV/IPM <input type="checkbox"/> EZOLV Shows the deviation between the γδ-Axis that the drive uses for motor control and the dq-Axis. Unit: 0.1 °	5 V: 180 ° (-10 V to +10 V)
U6-14 (07CB) Expert	MagPolePosition(Obs)	<input type="checkbox"/> V/f <input type="checkbox"/> OLV <input type="checkbox"/> OLV/IPM <input type="checkbox"/> AOLV/IPM <input type="checkbox"/> EZOLV Shows the value of the flux position estimation. Unit: 0.1 °	10 V: 180 ° (-10 V to +10 V)

No. (Hex.)	Name	Description	MFAO Signal Level
U6-17 (07D1) Expert	Energy Save Coeff	V/f OLV OLV/PM AOLV/PM EZOLV Shows the total time of direction of motor rotation detections for Speed Estimation Speed Searches. This value adjusts <i>b3-26 [Direction Determination Level]</i> . Note: Upper limit is +32767 and lower limit is -32767.	No signal output available
U6-20 (07D4)	UP/DOWN 2 Bias Value	V/f OLV OLV/PM AOLV/PM EZOLV Shows the bias value used to adjust the frequency reference. Unit: 0.1%	10 V: Maximum Frequency
U6-21 (07D5)	Offset Frequency	V/f OLV OLV/PM AOLV/PM EZOLV Shows the total value of <i>d7-01 to d7-03 [Offset Frequency 1 to 3]</i> selected with <i>Add Offset Frequency 1 to 3 [H1-xx = 44 to 46]</i> . Unit: 0.1%	10 V: Maximum Frequency
U6-31 (007B)	TorqueDetect Monitor	V/f OLV OLV/PM AOLV/PM EZOLV Monitors the torque reference or the output current after applying the filter set to <i>L6-07 [Torque Detection Filter Time]</i> . Unit: 0.1%	10 V:100%
U6-36 (0720) Expert	Comm Errors-Host	V/f OLV OLV/PM AOLV/PM EZOLV Shows the number of inter-CPU communication errors. When you de-energize the drive, this value resets to 0.	No signal output available
U6-37 (0721) Expert	Comm Errors-Sensor	V/f OLV OLV/PM AOLV/PM EZOLV Shows the number of inter-CPU communication errors. When you de-energize the drive, this value resets to 0.	No signal output available
U6-57 (07C4)	PolePolarityDeterVal	V/f OLV OLV/PM AOLV/PM EZOLV Shows the change from the integrated current when the drive finds the polarity. Unit: 1 Note: If the change from the integrated current is less than 819, increase <i>n8-84 [Polarity Detection Current]</i> . <i>U6-57 = 8192</i> is equivalent to the motor rated current.	No signal output available
U6-80 (07B0)	Option IP Address 1	V/f OLV OLV/PM AOLV/PM EZOLV Shows the currently available local IP Address (1st octet).	No signal output available
U6-81 (07B1)	Option IP Address 2	V/f OLV OLV/PM AOLV/PM EZOLV Shows the currently available local IP Address (2nd octet).	No signal output available
U6-82 (07B2)	Option IP Address 3	V/f OLV OLV/PM AOLV/PM EZOLV Shows the currently available local IP Address (3rd octet).	No signal output available
U6-83 (07B3)	Option IP Address 4	V/f OLV OLV/PM AOLV/PM EZOLV Shows the currently available local IP Address (4th octet).	No signal output available
U6-84 (07B4)	Online Subnet 1	V/f OLV OLV/PM AOLV/PM EZOLV Shows the currently available subnet mask (1st octet).	No signal output available
U6-85 (07B5)	Online Subnet 2	V/f OLV OLV/PM AOLV/PM EZOLV Shows the currently available subnet mask (2nd octet).	No signal output available
U6-86 (07B6)	Online Subnet 3	V/f OLV OLV/PM AOLV/PM EZOLV Shows the currently available subnet mask (3rd octet).	No signal output available
U6-87 (07B7)	Online Subnet 4	V/f OLV OLV/PM AOLV/PM EZOLV Shows the currently available subnet mask (4th octet).	No signal output available
U6-88 (07B8)	Online Gateway 1	V/f OLV OLV/PM AOLV/PM EZOLV Shows the currently available Gateway address (1st octet).	No signal output available
U6-89 (07B9)	Online Gateway 2	V/f OLV OLV/PM AOLV/PM EZOLV Shows the currently available Gateway address (2nd octet).	No signal output available
U6-90 (07F0)	Online Gateway 3	V/f OLV OLV/PM AOLV/PM EZOLV Shows the currently available Gateway address (3rd octet).	No signal output available
U6-91 (07F1)	Online Gateway 4	V/f OLV OLV/PM AOLV/PM EZOLV Shows the currently available Gateway address (4th octet).	No signal output available
U6-92 (07F2)	Online Speed	V/f OLV OLV/PM AOLV/PM EZOLV Shows the currently available communications speed. 10: 10 Mbps 100: 100 Mbps	No signal output available
U6-93 (07F3)	Online Duplex	V/f OLV OLV/PM AOLV/PM EZOLV Shows the currently available Duplex setting.	No signal output available

No. (Hex.)	Name	Description	MFAO Signal Level
U6-98 (07F8)	First Fault	V/f OLV OLV/IPM AOLV/IPM EZOLV Shows the contents of the most recent communication options fault (DeviceNet, Modbus TCP/IP, EtherNet/IP).	No signal output available
U6-99 (07F9)	Current Fault	V/f OLV OLV/IPM AOLV/IPM EZOLV Shows the contents of current fault from communication options (DeviceNet, Modbus TCP/IP, EtherNet/IP).	No signal output available

◆ U8: DriveWorksEZ Monitors

No. (Hex.)	Name	Description	MFAO Signal Level
U8-01 (1950)	DWEZ Monitor 1	V/f OLV OLV/IPM AOLV/IPM EZOLV Shows DWEZ Monitor 1. (Display range: 0.00% to 999.99%) Unit: 0.01%	10 V = 100%
U8-02 (1951)	DWEZ Monitor 2	V/f OLV OLV/IPM AOLV/IPM EZOLV Shows DWEZ Monitor 2. (Display range: 0.00% to 999.99%) Unit: 0.01%	10 V = 100%
U8-03 (1952)	DWEZ Monitor 3	V/f OLV OLV/IPM AOLV/IPM EZOLV Shows DWEZ Monitor 3. (Display range: 0.00% to 999.99%) Unit: 0.01%	10 V = 100%
U8-04 (1953)	DWEZ Monitor 4	V/f OLV OLV/IPM AOLV/IPM EZOLV Shows DWEZ Monitor 4. (Display range: 0.00% to 999.99%) Unit: 0.01%	10 V = 100%
U8-05 (1954)	DWEZ Monitor 5	V/f OLV OLV/IPM AOLV/IPM EZOLV Shows DWEZ Monitor 5. (Display range: 0.00% to 999.99%) Unit: 0.01%	10 V = 100%
U8-06 (1955)	DWEZ Monitor 6	V/f OLV OLV/IPM AOLV/IPM EZOLV Shows DWEZ Monitor 6. (Display range: 0.00% to 999.99%) Unit: 0.01%	10 V = 100%
U8-07 (1956)	DWEZ Monitor 7	V/f OLV OLV/IPM AOLV/IPM EZOLV Shows DWEZ Monitor 7. (Display range: -999.9% to +999.99%) Unit: 0.01%	10 V = 100%
U8-08 (1957)	DWEZ Monitor 8	V/f OLV OLV/IPM AOLV/IPM EZOLV Shows DWEZ Monitor 8. (Display range: -999.9% to +999.99%) Unit: 0.01%	10 V = 100%
U8-09 (1958)	DWEZ Monitor 9	V/f OLV OLV/IPM AOLV/IPM EZOLV Shows DWEZ Monitor 9. (Display range: -999.9% to +999.99%) Unit: 0.01%	10 V = 100%
U8-10 (1959)	DWEZ Monitor 10	V/f OLV OLV/IPM AOLV/IPM EZOLV Shows DWEZ Monitor 10.	No signal output available
U8-11 (195A)	DWEZ Version 1	V/f OLV OLV/IPM AOLV/IPM EZOLV Shows the Upper three digits of the user ID. When you click the setting button on the title bar of the PC tool to open the setting screen, you can confirm the user ID with the primary user ID display.	No signal output available
U8-12 (195B)	DWEZ Version 2	V/f OLV OLV/IPM AOLV/IPM EZOLV Shows the lower five digits of the user ID. When you click the setting button on the title bar of the PC tool to open the setting screen, you can confirm the user ID with the primary user ID display.	No signal output available
U8-13 (195C)	DWEZ Version 3	V/f OLV OLV/IPM AOLV/IPM EZOLV Shows the software ID.	No signal output available
U8-18 (1961)	DWEZ Platform Ver	V/f OLV OLV/IPM AOLV/IPM EZOLV Shows the DriveWorksEZ platform version.	No signal output available
U8-21 (1964)	DWEZ Monitor 21	V/f OLV OLV/IPM AOLV/IPM EZOLV Shows DWEZ Monitor 21. (Display range: -999.9% to +999.99%) Unit: 0.01%	10 V = 100%
U8-22 (1965)	DWEZ Monitor 22	V/f OLV OLV/IPM AOLV/IPM EZOLV Shows DWEZ Monitor 22. Unit: The number of decimal points shown is set with Q2-21.	10 V = 100%

No. (Hex.)	Name	Description	MFAO Signal Level
U8-23 (1966)	DWEZ Monitor 23	V/f OLV OLV/PM AOLV/PM EZOLV Shows DWEZ Monitor 23. Unit: The number of decimal points shown is set with Q2-22.	10 V = 100%
U8-24 (1967)	DWEZ Monitor 24	V/f OLV OLV/PM AOLV/PM EZOLV Shows DWEZ Monitor 24. Unit: The number of decimal points shown is set with Q2-23.	10 V = 100%
U8-25 (1968)	DWEZ Monitor 25	V/f OLV OLV/PM AOLV/PM EZOLV Shows DWEZ Monitor 25. Unit: The number of decimal points shown is set with Q2-24.	10 V = 100%
U8-31 (196E)	DWEZ Monitor 31	V/f OLV OLV/PM AOLV/PM EZOLV Shows DWEZ Monitor 31. (Display range: 0.00% to 999.99%) Unit: 0.01%	10 V = 100%
U8-32 (196F)	DWEZ Monitor 32	V/f OLV OLV/PM AOLV/PM EZOLV Shows DWEZ Monitor 32. (Display range: 0.00% to 999.99%) Unit: 0.01%	10 V = 100%
U8-33 (1970)	DWEZ Monitor 33	V/f OLV OLV/PM AOLV/PM EZOLV Shows DWEZ Monitor 33. (Display range: 0.00% to 999.99%) Unit: 0.01%	10 V = 100%
U8-34 (1971)	DWEZ Monitor 34	V/f OLV OLV/PM AOLV/PM EZOLV Shows DWEZ Monitor 34. (Display range: 0.00% to 999.99%) Unit: 0.01%	10 V = 100%
U8-35 (1972)	DWEZ Monitor 35	V/f OLV OLV/PM AOLV/PM EZOLV Shows DWEZ Monitor 35. (Display range: 0.00% to 999.99%) Unit: 0.01%	10 V = 100%
U8-36 (1973)	DWEZ Monitor 36	V/f OLV OLV/PM AOLV/PM EZOLV Shows DWEZ Monitor 36. (Display range: 0.00% to 999.99%) Unit: 0.01%	10 V = 100%
U8-37 (1974)	DWEZ Monitor 37	V/f OLV OLV/PM AOLV/PM EZOLV Shows DWEZ Monitor 37. (Display range: -999.9% to +999.99%) Unit: 0.01%	10 V = 100%
U8-38 (1975)	DWEZ Monitor 38	V/f OLV OLV/PM AOLV/PM EZOLV Shows DWEZ Monitor 38. (Display range: -999.9% to +999.99%) Unit: 0.01%	10 V = 100%
U8-39 (1976)	DWEZ Monitor 39	V/f OLV OLV/PM AOLV/PM EZOLV Shows DWEZ Monitor 39. (Display range: -999.9% to +999.99%) Unit: 0.01%	10 V = 100%
U8-40 (1977)	DWEZ Monitor 40	V/f OLV OLV/PM AOLV/PM EZOLV Shows DWEZ Monitor 40.	No signal output available
U8-51 (1982)	DWEZ Monitor 51	V/f OLV OLV/PM AOLV/PM EZOLV Shows DWEZ Monitor 51. (Display range: -999.9% to +999.99%) Unit: 0.01%	10 V = 100%
U8-52 (1983)	DWEZ Monitor 52	V/f OLV OLV/PM AOLV/PM EZOLV Shows DWEZ Monitor 52. Unit: The number of decimal points shown is set with Q2-41.	10 V = 100%
U8-53 (1984)	DWEZ Monitor 53	V/f OLV OLV/PM AOLV/PM EZOLV Shows DWEZ Monitor 53. Unit: The number of decimal points shown is set with Q2-42.	10 V = 100%
U8-54 (1985)	DWEZ Monitor 54	V/f OLV OLV/PM AOLV/PM EZOLV Shows DWEZ Monitor 54. Unit: The number of decimal points shown is set with Q2-43.	10 V = 100%
U8-55 (1986)	DWEZ Monitor 55	V/f OLV OLV/PM AOLV/PM EZOLV Shows DWEZ Monitor 55. Unit: The number of decimal points shown is set with Q2-44.	10 V = 100%

11.17 U: Monitors

No. (Hex.)	Name	Description	MFAO Signal Level
U8-60 (198B)	RemoteIO Status	<p>V/f OLV OLV/PM AOLV/PM EZOLV</p> <p>Shows the operation status of Remote IO as 1 (ON) and 0 (OFF). If the DriveWorksEZ MEMOBUS master active signal is ON, for example, the monitor shows <i>U8-60 = 00000001</i>.</p> <p>bit 0 : Bit 0: DriveWorksEZ MEMOBUS Master Active bit 1 : Not used (normal value of 0) bit 2 : Not used (normal value of 0) bit 3 : Not used (normal value of 0) bit 4 : Not used (normal value of 0) bit 5 : Not used (normal value of 0) bit 6 : Not used (normal value of 0) bit 7 : Not used (normal value of 0)</p>	No signal output available
U8-61 (198C)	RemoteDI Monitor 0-7bit	<p>V/f OLV OLV/PM AOLV/PM EZOLV</p> <p>Shows the operation status of Remote DI1 to DI8 as 1 (ON) and 0 (OFF). If Remote DI1 and DI2 are ON, for example, the monitor shows <i>U8-61 = 00000011</i>.</p> <p>bit 0 : Remote DI1 bit 1 : Remote DI2 bit 2 : Remote DI3 bit 3 : Remote DI4 bit 4 : Remote DI5 bit 5 : Remote DI6 bit 6 : Remote DI7 bit 7 : Remote DI8</p>	No signal output available
U8-62 (198D)	RemoteDI Monitor 8-Fbit	<p>V/f OLV OLV/PM AOLV/PM EZOLV</p> <p>Shows the operation status of Remote DI9 to DI16 as 1 (ON) and 0 (OFF). If Remote DI9 and DI10 are ON, for example, the monitor shows <i>U8-62 = 00000011</i>.</p> <p>bit 0 : Remote DI9 bit 1 : Remote DI10 bit 2 : Remote DI11 bit 3 : Remote DI12 bit 4 : Remote DI13 bit 5 : Remote DI14 bit 6 : Remote DI15 bit 7 : Remote DI16</p>	No signal output available
U8-63 (198E)	RemoteDO Monitor 0-7bit	<p>V/f OLV OLV/PM AOLV/PM EZOLV</p> <p>Shows the operation status of Remote DO1 to DO8 as 1 (ON) and 0 (OFF). If Remote DO1 and DO2 are ON, for example, the monitor shows <i>U8-63 = 00000011</i>.</p> <p>bit 0 : Remote DO1 bit 1 : Remote DO2 bit 2 : Remote DO3 bit 3 : Remote DO4 bit 4 : Remote DO5 bit 5 : Remote DO6 bit 6 : Remote DO7 bit 7 : Remote DO8</p>	No signal output available
U8-64 (198F)	RemoteDO Monitor 8-Fbit	<p>V/f OLV OLV/PM AOLV/PM EZOLV</p> <p>Shows the operation status of Remote DO9 to DO16 as 1 (ON) and 0 (OFF). If Remote DO9 and DO10 are ON, for example, the monitor shows <i>U8-64 = 00000011</i>.</p> <p>bit 0 : Remote DO9 bit 1 : Remote DO10 bit 2 : Remote DO11 bit 3 : Remote DO12 bit 4 : Remote DO13 bit 5 : Remote DO14 bit 6 : Remote DO15 bit 7 : Remote DO16</p>	No signal output available

11.18 Parameters that Change from the Default Settings with A1-02 [Control Method Selection]

The values for the parameters in these tables depend on the values for parameter A1-02. When you change the setting for A1-02, the default settings will change.

Table 11.1 A1-02 = 0, 2 [V/f, OLV]

No.	Name	Range	Unit	Control Method (A1-02 Setting)	
				V/f (0)	OLV (2)
b2-01	DC Injection/Zero SpeedThreshold	0.0 - 10.0	0.1 Hz	0.5	0.5
b2-04	DC Inject Braking Time at Stop	0.00 - 10.00	0.01 s	0.50	0.50
b3-01	Speed Search at Start Selection	0 - 1	1	0	0
b3-02	SpeedSearch Deactivation Current	0 - 200	1%	120	100
b3-08	Speed Estimation ACR P Gain	0.00 - 6.00	0.01	0.50 <i>*1</i>	0.50 <i>*1</i>
b3-09	Speed Estimation ACR I Time	0.0 - 1000.0	0.1 ms	2.0	2.0
b3-14	Bi-directional Speed Search	0 - 1	1	0	0
b5-15	PID Sleep Function Start Level	0.0 - 400.0	0.1 Hz	0.0	0.0
b6-01	Dwell Reference at Start	0.0 - 400.0	0.1 Hz	0.0	0.0
b6-03	Dwell Reference at Stop	0.0 - 400.0	0.1 Hz	0.0	0.0
b8-02	Energy Saving Gain	0.0 - 10.0	0.1	-	0.7
b8-03	Energy Saving Filter Time	0.00 - 10.00	0.01 s	-	0.50
b8-19	E-Save Search Injection Freq	10 - 300	1 Hz	100	100
C1-11	Accel/Decel Time Switchover Freq	0.0 - 400.0	0.1 Hz	0.0	0.0
C2-01	S-Curve Time @ Start of Accel	0.00 - 10.00	0.01 s	0.20	0.20
C3-01	Slip Compensation Gain	0.0 - 2.5	0.1	0.0	1.0
C3-02	Slip Compensation Delay Time	0 - 10000	1 ms	2000	200
C4-01	Torque Compensation Gain	0.00 - 2.50	0.01	1.00	1.00
C4-02	Torque Compensation Delay Time	0 - 10000	1 ms	200	20
C5-01	ASR Proportional Gain 1	0.00 - 300.00	0.01	-	-
C5-02	ASR Integral Time 1	0.000 - 60.000	0.001 s	-	-
C5-03	ASR Proportional Gain 2	0.00 - 300.00	0.01	-	-
C5-04	ASR Integral Time 2	0.000 - 10.000	0.001 s	-	-
C5-06	ASR Delay Time	0.000 - 0.500	0.001 s	-	-
C5-07	ASR Gain Switchover Frequency	0.0 - 400.0	0.1 Hz	0.0Hz	0.0Hz
C6-02	Carrier Frequency Selection	1 - F	1	1 <i>*2</i>	1 <i>*2</i>
d3-01	Jump Frequency 1	0.0 - 400.0	0.1 Hz	0.0	0.0
d3-02	Jump Frequency 2	0.0 - 400.0	0.1 Hz	0.0	0.0
d3-03	Jump Frequency 3	0.0 - 400.0	0.1 Hz	0.0	0.0
d3-04	Jump Frequency Width	0.0 - 20.0	0.1 Hz	1.0	1.0

11.18 Parameters that Change from the Default Settings with A1-02 [Control Method Selection]

No.	Name	Range	Unit	Control Method (A1-02 Setting)	
				V/f (0)	OLV (2)
E1-04	Maximum Output Frequency	40.0 - 400.0 *2 *3	0.1 Hz	60.0 *4	60.0
E1-05	Maximum Output Voltage	0.0 - 255.0 *5	0.1 V	200.0 *4	200.0
E1-06	Base Frequency	0.0 - 400.0 *3	0.1 Hz	60.0 *4	60.0
E1-07	Mid Point A Frequency	0.0 - 400.0 *3	0.1 Hz	3.0 *4	3.0
E1-08	Mid Point A Voltage	0.0 - 255.0 *5	0.1 V	15.0 *4	11.0
E1-09	Minimum Output Frequency	0.0 - 400.0 *3	0.1 Hz	1.5 *4	0.5
E1-10	Minimum Output Voltage	0.0 - 255.0 *5	0.1 V	9.0 *4	2.0
F1-09	Overspeed Detection Delay Time	0.0 - 2.0	0.1 s	-	-
L1-01	Motor Overload (oL1) Protection	0 - 4	1	2	2
L2-31	KEB Start Voltage Offset Level	0 - 100 *5	1 V	0	0
L3-05	Stall Prevention during RUN	0 - 3	1	1	1
L3-20	DC Bus Voltage Adjustment Gain	0.00 - 5.00	0.01	1.00	0.30
L3-21	OVSsuppression Accel/Decel P Gain	0.10 - 10.00	0.01	1.00	1.00
L3-36	Current Suppression Gain@Accel	0.0 - 100.0	0.1	10.0	20.0
L4-01	Speed Agree Detection Level	0.0 - 400.0 *6	0.1	0.0 Hz	0.0 Hz
L4-02	Speed Agree Detection Width	0.0 - 20.0	0.1	2.0 Hz	2.0 Hz
L4-03	Speed Agree Detection Level(+/-)	-400.0 - +400.0 *7	0.1	0.0 Hz	0.0 Hz
L4-04	Speed Agree Detection Width(+/-)	0.0 - 20.0	0.1	2.0 Hz	2.0 Hz
L8-40	Carrier Freq Reduction Off-Delay	0.00 - 2.00	0.01 s	0.50	0.50
L8-90	STPo Detection Level (Low Speed)	0 - 5000	1	-	-
n5-04	Speed Response Frequency	0.00 - 500.00	0.00 Hz	-	-
n8-35	Initial Pole Detection Method	0 - 2	1	-	-
n8-51	Pull-in Current @ Acceleration	0 - 200%	1	0	0
o1-03	Frequency Display Unit Selection	0 - 3	1	0	0
o1-04	V/f Pattern Display Unit	0 - 1	1	-	-

*1 The default setting changes when the setting for o2-04 [Drive Model Selection] changes.

*2 The default setting changes when the setting of C6-01 [Normal / Heavy Duty Selection] changes.

*3 The setting range changes when the setting of E5-01 [PM Motor Code Selection] changes when A1-02 = 5 [OLV/PM].

*4 The default setting changes when the drive model and E1-03 [V/f Pattern Selection] change.

*5 This is the value for 200 V class drives. Double the value for 400 V class drives.

*6 When A1-02 = 5 [OLV/PM], the maximum value of the setting range is 100.0.

*7 When A1-02 = 5 [OLV/PM], the setting range is -100.0 to +100.0.

11.18 Parameters that Change from the Default Settings with A1-02 [Control Method Selection]

Table 11.2 A1-02 = 5, 6, 8 [OLV/PM, AOLV/PM, EZOLV]

No.	Name	Range	Unit	Control Method (A1-02 Setting)		
				OLV/PM (5)	AOLV/PM (6)	EZOLV (8)
b2-01	DC Injection/Zero SpeedThreshold	0.0 - 10.0	0.1	0.5 Hz	1.0%	0.5Hz
b2-04	DC Inject Braking Time at Stop	0.00 - 10.00	0.01 s	0.00	0.00	0.00
b3-01	Speed Search at Start Selection	0 - 1	1	0	0	0
b3-02	SpeedSearch Deactivation Current	0 - 200	1%	-	-	-
b3-08	Speed Estimation ACR P Gain	0.00 - 6.00	0.01	0.30	0.30	0.30
b3-09	Speed Estimation ACR I Time	0.0 - 1000.0	0.1 ms	4.0	4.0	4.0
b3-14	Bi-directional Speed Search	0 - 1	1	-	-	0
b5-15	PID Sleep Function Start Level	0.0 - 400.0 *1	0.1	0.0 Hz	0.0%	0.0%
b6-01	Dwell Reference at Start	0.0 - 400.0 *1	0.1	0.0 Hz	0.0%	0.0%
b6-03	Dwell Reference at Stop	0.0 - 400.0 *1	0.1	0.0 Hz	0.0%	0.0%
b8-02	Energy Saving Gain	0.0 - 10.0	0.1	-	-	-
b8-03	Energy Saving Filter Time	0.00 - 10.00	0.01 s	-	-	-
b8-19	E-Save Search Injection Freq	10 - 300	1 Hz	100	100	20
C1-11	Accel/Decel Time Switchover Freq	0.0 - 400.0 *1	0.1	0.0 Hz	0.0%	0.0%
C2-01	S-Curve Time @ Start of Accel	0.00 - 10.00	0.01 s	1.00	0.20	1.00
C3-01	Slip Compensation Gain	0.0 - 2.5	0.1	-	-	0
C3-02	Slip Compensation Delay Time	0 - 10000	1 ms	-	-	200
C4-01	Torque Compensation Gain	0.00 - 2.50	0.01	0.00	-	0.00
C4-02	Torque Compensation Delay Time	0 - 10000	1 ms	100	-	100
C5-01	ASR Proportional Gain 1	0.00 - 300.00	0.01	10.00	10.00	10.00
C5-02	ASR Integral Time 1	0.000 - 60.000	0.001 s	0.500	0.500	0.500
C5-03	ASR Proportional Gain 2	0.00 - 300.00	0.01	-	10.00	10.00
C5-04	ASR Integral Time 2	0.000 - 10.000	0.001 s	-	0.500	0.500
C5-06	ASR Delay Time	0.000 - 0.500	0.001 s	-	0.016	0.004
C5-07	ASR Gain Switchover Frequency	0.0 - 400.0 *1	0.1	0.0Hz	0.0%	0.0%
C6-02	Carrier Frequency Selection	1 - F	1	2	2	2
d3-01	Jump Frequency 1	0.0 - 400.0 *1	0.1	0.0 Hz	0.0%	0.0%
d3-02	Jump Frequency 2	0.0 - 400.0 *1	0.1	0.0 Hz	0.0%	0.0%
d3-03	Jump Frequency 3	0.0 - 400.0 *1	0.1	0.0 Hz	0.0 %	0.0 %
d3-04	Jump Frequency Width	0.0 - 20.0 *2	0.1	1.0 Hz	1.0 %	1.0 %
E1-04	Maximum Output Frequency	40.0 - 400.0 *3	0.1 Hz	Determined by E5-01	Determined by E5-01	Determined by E5-01
E1-05	Maximum Output Voltage	0.0 - 255.0 *4	0.1 V	Determined by E5-01	Determined by E5-01	Determined by E5-01
E1-06	Base Frequency	0.0 - 400.0	0.1 Hz	Determined by E5-01	Determined by E5-01	Determined by E5-01
E1-07	Mid Point A Frequency	0.0 - 400.0	0.1 Hz	-	-	-
E1-08	Mid Point A Voltage	0.0 - 255.0 *4	0.1 V	-	-	-

11.18 Parameters that Change from the Default Settings with A1-02 [Control Method Selection]

No.	Name	Range	Unit	Control Method (A1-02 Setting)		
				OLV/PM (5)	AOLV/PM (6)	EZOLV (8)
E1-09	Minimum Output Frequency	0.0 - 400.0	0.1 Hz	Determined by E5-01	Determined by E5-01	Determined by E5-01
E1-10	Minimum Output Voltage	0.0 - 255.0 *4	0.1 V	-	-	-
F1-09	Overspeed Detection Delay Time	0.0 - 2.0	0.1 s	-	0.0	-
L1-01	Motor Overload (oL1) Protection	0 - 4	1	4	4	Determined by E9-01
L2-31	KEB Start Voltage Offset Level	0 - 100 *4	1 V	50	50	50
L3-05	Stall Prevention during RUN	0 - 3	1	1	-	3
L3-20	DC Bus Voltage Adjustment Gain	0.00 - 5.00	0.01	0.65	0.65	0.65
L3-21	OV Suppression Accel/Decel P Gain	0.10 - 10.00	0.01	1.00	1.00	1.00
L3-36	Current Suppression Gain@Accel	0.0 - 100.0	0.1	-	-	-
L4-01	Speed Agree Detection Level	0.0 - 400.0 *1	0.1	0.0 Hz	0.0%	0.0%
L4-02	Speed Agree Detection Width	0.0 - 20.0 *2	0.1	2.0 Hz	4.0%	4.0%
L4-03	Speed Agree Detection Level(+/-)	-400.0 - +400.0 *5	0.1	0.0 Hz	0.0%	0.0%
L4-04	Speed Agree Detection Width(+/-)	0.0 - 20.0 *2	0.1	2.0 Hz	4.0%	4.0%
L8-40	Carrier Freq Reduction Off-Delay	0.00 - 2.00	0.01 s	0.00	0.00	0.00
L8-90	STPo Detection Level (Low Speed)	0 - 5000	1	0	80	-
n5-04	Speed Response Frequency	0.00 - 500.00	0.00 Hz	-	20.00	-
n8-35	Initial Pole Detection Method	0 - 2	1	0	1	-
n8-51	Pull-in Current @ Acceleration	0 - 200%	1	50%	0	80%
o1-03	Frequency Display Unit Selection	0 - 3	1	0	1	1
o1-04	V/f Pattern Display Unit	0 - 1	1	-	1	-

*1 The setting range is 0.0 to 100.0 when A1-02 = 6 [PM Advanced Open Loop Vector].

*2 The setting range is 0.0 to 40.0 when A1-02 = 6 [PM Advanced Open Loop Vector].

*3 The default setting changes when the setting for C6-01 [Normal / Heavy Duty Selection] changes.

*4 This is the value for 200 V class drives. Double the value for 400 V class drives.

*5 The setting range is -100.0 to +100.0 when A1-02 = 6 [PM Advanced Open Loop Vector].

11.19 Parameters that Change from the Default Settings with E3-01 [Motor 2 Control Mode Selection]

The values for the parameters in these tables depend on the values for parameter *E3-01*. When you change the setting for *E3-01*, the default settings will change.

No.	Name	Range	Unit	Motor 2 Control Method (setting value of E3-01)	
				V/f (0)	OLV (2)
C3-21	Motor 2 Slip Compensation Gain	0.0 - 2.50	0.1	0.0	1.0
C3-22	Motor 2 Slip Comp Delay Time	0 - 10000	1 ms	2000	200
E3-04	Motor 2 Maximum Output Frequency	40.0 - 590.0	0.1 Hz	60.0	60.0
E3-05	Motor 2 Maximum Output Voltage	0.0 - 255.0 *1	0.1 V	200.0	200.0
E3-06	Motor 2 Base Frequency	0.0 - 590.0	0.1 Hz	60.0	60.0
E3-07	Motor 2 Mid Point A Frequency	0.0 - 590.0	0.1 Hz	3.0	3.0
E3-08	Motor 2 Mid Point A Voltage	0.0 - 255.0 *1	0.1 V	15.0	11.0
E3-09	Motor 2 Minimum Output Frequency	0.0 - 590.0	0.1 Hz	1.5	0.5
E3-10	Motor 2 Minimum Output Voltage	0.0 - 255.0 *1	0.1 V	9.0	2.0
E3-11	Motor 2 Mid Point B Frequency	0.0 - 590.0	Determined by o1-04	0.0	0.0
E3-12	Motor 2 Mid Point B Voltage	0.0 - 255.0 *1	0.1 V	0.0	0.0
E3-13	Motor 2 Base Voltage	0.0 - 255.0 *1	0.1 V	0.0	0.0

*1 This is the value for 200 V class drives. Double the value for 400 V class drives.

11.20 Parameters Changed by E1-03 [V/f Pattern Selection]

The values for parameters *A1-02* [Control Method Selection] and *E1-03* [V/f Pattern Selection] change the default settings for the parameters in these tables:

Table 11.3 Parameters Changed by E1-03 (B001 - B018, 2001 - 2021, and 4001 - 4012)

No.	Unit	Setting Value																Control Method (A1-02 Setting)			
		0	1	2	3	4	5	6	7	8	9	A	B	C	D	E	F ^{*1}	OLV (2)	OLV/PM (5)	AOL V/PM (6)	
E1-04	Hz	50.0	60.0	60.0	72.0	50.0	50.0	60.0	60.0	50.0	50.0	60.0	60.0	90.0	120.0	180.0	60.0	60.0	*2	*2	
E1-05 ^{*3}	V	230.0	230.0	230.0	230.0	230.0	230.0	230.0	230.0	230.0	230.0	230.0	230.0	230.0	230.0	230.0	230.0	230.0	230.0	*2	*2
E1-06	Hz	50.0	60.0	50.0	60.0	50.0	50.0	60.0	60.0	50.0	50.0	60.0	60.0	60.0	60.0	60.0	60.0	60.0	60.0	*2	*2
E1-07	Hz	2.5	3.0	3.0	3.0	25.0	25.0	30.0	30.0	2.5	2.5	3.0	3.0	3.0	3.0	3.0	3.0	3.0	3.0	-	-
E1-08 ^{*3}	V	18.4	18.4	18.4	18.4	40.3	57.5	40.3	57.5	21.9	27.6	21.9	27.6	18.4	18.4	18.4	18.4	13.8	-	-	
E1-09	Hz	1.3	1.5	1.5	1.5	1.3	1.3	1.5	1.5	1.3	1.3	1.5	1.5	1.5	1.5	1.5	1.5	0.5	*2	*2	
E1-10 ^{*3}	V	13.8	13.8	13.8	13.8	9.2	10.4	9.2	10.4	13.8	15.0	13.8	17.3	13.8	13.8	13.8	13.8	2.9	-	-	

*1 These values are the default settings for *E1-04* to *E1-10* and *E3-04* to *E3-10* [V/f Pattern for Motor 2]. These settings are the same as those for the V/f pattern when *E1-03* = 1 [Const Trq, 60Hz base, 60Hz max].

*2 The default setting varies depending on the setting of *E5-01* [PM Motor Code Selection].

*3 This is the value for 200 V class drives. Double the value for 400 V class drives.

Table 11.4 Parameters Changed by E1-03 (2030 - 2082 and 4018 - 4060)

No.	Unit	Setting Value																Control Method (A1-02 Setting)			
		0	1	2	3	4	5	6	7	8	9	A	B	C	D	E	F ^{*1}	OLV (2)	OLV/PM (5)	AOL V/PM (6)	
E1-04	Hz	50.0	60.0	60.0	72.0	50.0	50.0	60.0	60.0	50.0	50.0	60.0	60.0	90.0	120.0	180.0	60.0	60.0	*2	*2	
E1-05 ^{*3}	V	230.0	230.0	230.0	230.0	230.0	230.0	230.0	230.0	230.0	230.0	230.0	230.0	230.0	230.0	230.0	230.0	230.0	230.0	*2	*2
E1-06	Hz	50.0	60.0	50.0	60.0	50.0	50.0	60.0	60.0	50.0	50.0	60.0	60.0	60.0	60.0	60.0	60.0	60.0	60.0	*2	*2
E1-07	Hz	2.5	3.0	3.0	3.0	25.0	25.0	30.0	30.0	2.5	2.5	3.0	3.0	3.0	3.0	3.0	3.0	3.0	3.0	-	-
E1-08 ^{*3}	V	16.1	16.1	16.1	16.1	40.3	57.5	40.3	57.5	20.7	26.5	20.7	26.5	16.1	16.1	16.1	16.1	12.7	-	-	
E1-09	Hz	1.3	1.5	1.5	1.5	1.3	1.3	1.5	1.5	1.3	1.3	1.5	1.5	1.5	1.5	1.5	1.5	0.5	*2	*2	
E1-10 ^{*3}	V	8.1	8.1	8.1	8.1	6.9	8.1	6.9	8.1	10.4	12.7	10.4	15.0	8.1	8.1	8.1	8.1	2.3	-	-	

*1 These values are the default settings for *E1-04* to *E1-10* and *E3-04* to *E3-10* [V/f Pattern for Motor 2]. These settings are the same as those for the V/f pattern when *E1-03* = 1 [Const Trq, 60Hz base, 60Hz max].

*2 The default setting varies depending on the setting of *E5-01* [PM Motor Code Selection].

*3 This is the value for 200 V class drives. Double the value for 400 V class drives.

11.21 Defaults by Drive Model and Duty Rating ND/HD

The values for the parameters in these tables depend on the values for parameters *o2-04* and *C6-01*. Changing the settings for *o2-04* and *C6-01* will change the default settings.

◆ Single-Phase 200 V Class

No. */	Name	Unit	Default							
			B001		B002		B004		B006	
-	Drive Model	-	HD	ND	HD	ND	HD	ND	HD	ND
C6-01	Normal / Heavy Duty Selection	-	0	1	0	1	0	1	0	1
o2-04	Drive Model (KVA) Selection	Hex.	30		31		32		33	
E2-11 (E4-11, E5-02)	Motor Rated Power	kW	0.1	0.2	0.2	0.4	0.4	0.75	0.75	1.1
b3-04	V/f Gain during Speed Search	%	100	100	100	100	100	100	100	100
b3-06	Speed Estimation Current Level 1	-	1	1	1	1	1	1	0.5	0.5
b3-08	Speed Estimation ACR P Gain	-	0.5	0.5	0.5	0.5	0.5	0.5	0.5	0.5
b3-26	Direction Determination Level	-	1000	1000	1000	1000	1000	1000	1000	1000
b8-03	Energy Saving Filter Time	s	0.5	0.5	0.5	0.5	0.5	0.5	0.5	0.5
b8-04	Energy Saving Coefficient Value	-	481.7	356.9	356.9	288.2	288.2	223.7	223.7	196.6
C6-02	Carrier Frequency Selection	-	4	7	4	7	4	7	4	7
E2-01 (E4-01)	Motor Rated Current (FLA)	A	0.6	1.1	1.1	1.9	1.9	3.3	3.3	6.2
E2-02 (E4-02)	Motor Rated Slip	Hz	2.5	2.6	2.6	2.9	2.9	2.5	2.5	2.6
E2-03 (E4-03)	Motor No-Load Current	A	0.4	0.8	0.8	1.2	1.2	1.8	1.8	2.8
E2-05 (E4-05)	Motor Line-to-Line Resistance	Ω	35.98	20.56	20.56	9.842	9.842	5.156	5.156	1.997
E2-06 (E4-06)	Motor Leakage Inductance	%	21.6	20.1	20.1	18.2	18.2	13.8	13.8	18.5
E2-10 (E4-10)	Motor Iron Loss	W	6	11	11	14	14	26	26	53
E5-01	PM Motor Code Selection	-	FFFF	FFFF	FFFF	FFFF	FFFF	FFFF	FFFF	FFFF
L2-02	Power Loss Ride Through Time	s	0.1	0.1	0.1	0.1	0.1	0.1	0.2	0.2
L2-03	Minimum Baseblock Time	s	0.2	0.3	0.2	0.3	0.2	0.3	0.3	0.4
L2-04	Powerloss V/f Recovery Ramp Time	s	0.3	0.3	0.3	0.3	0.3	0.3	0.3	0.3

11.21 Defaults by Drive Model and Duty Rating ND/HD

No. */	Name	Unit	Default							
			B001		B002		B004		B006	
-	Drive Model	-	HD	ND	HD	ND	HD	ND	HD	ND
C6-01	Normal / Heavy Duty Selection	-	0	1	0	1	0	1	0	1
o2-04	Drive Model (KVA) Selection	Hex.	30		31		32		33	
E2-11 (E4-11, E5-02)	Motor Rated Power	kW	0.1	0.2	0.2	0.4	0.4	0.75	0.75	1.1
L2-05	Undervoltage Detection Lvl (Uv1)	-	160	160	160	160	160	160	160	160
L3-02	Stall Prevent Level during Accel	%	150	120	150	120	150	120	150	120
L3-06	Stall Prevent Level during Run	%	150	120	150	120	150	120	150	120
L3-24	Motor Accel Time @ Rated Torque	s	0.178	0.178	0.178	0.178	0.178	0.142	0.142	0.142
L8-02	Overheat Alarm Level	°C	105	105	105	105	115	115	115	115
L8-09	Output Ground Fault Detection	-	0	0	0	0	0	0	0	0
n1-03	Hunting Prevention Time Constant	ms	10	10	10	10	10	10	10	10
n3-02	HSB Current Limit Level	%	150	120	150	120	150	120	150	120
n5-02	Motor Inertia Acceleration Time	s	0.178	0.178	0.178	0.142	0.178	0.142	0.142	0.142

*1 Parameters within parentheses are for motor 2.

No. */	Name	Unit	Default					
			B010		B012		B018	
-	Drive Model	-	HD	ND	HD	ND	HD	ND
C6-01	Normal / Heavy Duty Selection	-	0	1	0	1	0	1
o2-04	Drive Model (KVA) Selection	Hex.	34		35		37	
E2-11 (E4-11, E5-02)	Motor Rated Power	kW	1.5	2.2	2.2	3.0	3.7	5.5
b3-04	V/f Gain during Speed Search	%	100	100	100	100	100	100
b3-06	Speed Estimation Current Level 1	-	0.5	0.5	0.5	0.5	0.5	0.5
b3-08	Speed Estimation ACR P Gain	-	0.5	0.5	0.5	0.5	0.5	0.5
b3-26	Direction Determination Level	-	1000	1000	1000	1000	1000	1000
b8-03	Energy Saving Filter Time	s	0.5	0.5	0.5	0.5	0.5	0.5
b8-04	Energy Saving Coefficient Value	-	169.4	156.8	156.8	136.4	122.9	94.75
C6-02	Carrier Frequency Selection	-	3	7	3	7	3	7
E2-01 (E4-01)	Motor Rated Current (FLA)	A	6.2	8.5	8.5	11.4	14	19.6

No. */	Name	Unit	Default					
			B010		B012		B018	
-	Drive Model	-	HD	ND	HD	ND	HD	ND
C6-01	Normal / Heavy Duty Selection	-	0	1	0	1	0	1
o2-04	Drive Model (KVA) Selection	Hex.	34		35		37	
E2-11 (E4-11, E5-02)	Motor Rated Power	kW	1.5	2.2	2.2	3.0	3.7	5.5
E2-02 (E4-02)	Motor Rated Slip	Hz	2.6	2.9	2.9	2.7	2.73	1.5
E2-03 (E4-03)	Motor No-Load Current	A	2.8	3	3	3.7	4.5	5.1
E2-05 (E4-05)	Motor Line-to-Line Resistance	Ω	1.997	1.601	1.601	1.034	0.771	0.399
E2-06 (E4-06)	Motor Leakage Inductance	%	18.5	18.4	18.4	19	19.6	18.2
E2-10 (E4-10)	Motor Iron Loss	W	53	77	77	91	112	172
E5-01	PM Motor Code Selection	-	FFFF	FFFF	FFFF	FFFF	FFFF	FFFF
L2-02	Power Loss Ride Through Time	s	0.3	0.3	0.5	0.5	1	1
L2-03	Minimum Baseblock Time	s	0.4	0.5	0.5	0.5	0.6	0.7
L2-04	Powerloss V/f Recovery Ramp Time	s	0.3	0.3	0.3	0.3	0.3	0.3
L2-05	Undervoltage Detection Lvl (Uv1)	-	160	160	160	160	160	160
L3-02	Stall Prevent Level during Accel	%	150	120	150	120	150	120
L3-06	Stall Prevent Level during Run	%	150	120	150	120	150	120
L3-24	Motor Accel Time @ Rated Torque	s	0.166	0.145	0.145	0.145	0.154	0.168
L8-02	Overheat Alarm Level	°C	105	105	110	110	115	115
L8-09	Output Ground Fault Detection	-	0	0	0	0	0	0
n1-03	Hunting Prevention Time Constant	ms	10	10	10	10	10	10
n3-02	HSB Current Limit Level	%	150	120	150	120	150	120
n5-02	Motor Inertia Acceleration Time	s	0.166	0.145	0.145	0.145	0.154	0.168

*1 Parameters within parentheses are for motor 2.

◆ Three-Phase 200 V Class

No. */	Name	Unit	Default							
			2001		2002		2004		2006	
-	Drive Model	-	HD	ND	HD	ND	HD	ND	HD	ND
C6-01	Normal / Heavy Duty Selection	-	0	1	0	1	0	1	0	1
o2-04	Drive Model (KVA) Selection	Hex.	60		61		62		63	
E2-11 (E4-11, E5-02)	Motor Rated Power	kW	0.1	0.2	0.2	0.4	0.4	0.75	0.75	1.1
b3-04	V/f Gain during Speed Search	%	100	100	100	100	100	100	100	100
b3-06	Speed Estimation Current Level 1	-	1	1	1	1	1	1	0.5	0.5
b3-08	Speed Estimation ACR P Gain	-	0.5	0.5	0.5	0.5	0.5	0.5	0.5	0.5
b3-26	Direction Determination Level	-	1000	1000	1000	1000	1000	1000	1000	1000
b8-03	Energy Saving Filter Time	s	0.5	0.5	0.5	0.5	0.5	0.5	0.5	0.5
b8-04	Energy Saving Coefficient Value	-	481.7	356.9	356.9	288.2	288.2	223.7	223.7	196.6
C6-02	Carrier Frequency Selection	-	4	7	4	7	4	7	4	7
E2-01 (E4-01)	Motor Rated Current (FLA)	A	0.6	1.1	1.1	1.9	1.9	3.3	3.3	4.9
E2-02 (E4-02)	Motor Rated Slip	Hz	2.5	2.6	2.6	2.9	2.9	2.5	2.5	2.6
E2-03 (E4-03)	Motor No-Load Current	A	0.4	0.8	0.8	1.2	1.2	1.8	1.8	2.3
E2-05 (E4-05)	Motor Line-to-Line Resistance	Ω	35.98	20.56	20.56	9.842	9.842	5.156	5.156	3.577
E2-06 (E4-06)	Motor Leakage Inductance	%	21.6	20.1	20.1	18.2	18.2	13.8	13.8	18.5
E2-10 (E4-10)	Motor Iron Loss	W	6	11	11	14	14	26	26	38
E5-01	PM Motor Code Selection	-	FFFF	FFFF	FFFF	FFFF	FFFF	FFFF	FFFF	FFFF
L2-02	Power Loss Ride Through Time	s	0.1	0.1	0.1	0.1	0.1	0.1	0.2	0.2
L2-03	Minimum Baseblock Time	s	0.2	0.3	0.2	0.3	0.2	0.3	0.3	0.4
L2-04	Powerloss V/f Recovery Ramp Time	s	0.3	0.3	0.3	0.3	0.3	0.3	0.3	0.3
L2-05	Undervoltage Detection Lvl (Uv1)	-	190	190	190	190	190	190	190	190
L3-02	Stall Prevent Level during Accel	%	150	120	150	120	150	120	150	120

No. */	Name	Unit	Default							
			2001		2002		2004		2006	
-	Drive Model	-								
C6-01	Normal / Heavy Duty Selection	-	HD	ND	HD	ND	HD	ND	HD	ND
			0	1	0	1	0	1	0	1
o2-04	Drive Model (KVA) Selection	Hex.	60		61		62		63	
E2-11 (E4-11, E5-02)	Motor Rated Power	kW	0.1	0.2	0.2	0.4	0.4	0.75	0.75	1.1
L3-06	Stall Prevent Level during Run	%	150	120	150	120	150	120	150	120
L3-24	Motor Accel Time @ Rated Torque	s	0.178	0.178	0.178	0.178	0.178	0.142	0.142	0.142
L8-02	Overheat Alarm Level	°C	115	115	115	115	115	115	120	120
L8-09	Output Ground Fault Detection	-	0	0	0	0	0	0	0	0
n1-03	Hunting Prevention Time Constant	ms	10	10	10	10	10	10	10	10
n3-02	HSB Current Limit Level	l	150	120	150	120	150	120	150	120
n5-02	Motor Inertia Acceleration Time	s	0.178	0.178	0.178	0.142	0.178	0.142	0.142	0.142

*1 Parameters within parentheses are for motor 2.

No. */	Name	Unit	Default							
			2010		2012		2021		2030	
-	Drive Model	-								
C6-01	Normal / Heavy Duty Selection	-	HD	ND	HD	ND	HD	ND	HD	ND
			0	1	0	1	0	1	0	1
o2-04	Drive Model (KVA) Selection	Hex.	65		66		68		6A	
E2-11 (E4-11, E5-02)	Motor Rated Power	kW	1.5	2.2	2.2	3.0	3.7	5.5	5.5	7.5
b3-04	V/f Gain during Speed Search	%	100	100	100	100	100	100	100	100
b3-06	Speed Estimation Current Level 1	-	0.5	0.5	0.5	0.5	0.5	0.5	0.5	0.5
b3-08	Speed Estimation ACR P Gain	-	0.5	0.5	0.5	0.5	0.5	0.5	0.5	0.5
b3-26	Direction Determination Level	-	1000	1000	1000	1000	1000	1000	1000	1000
b8-03	Energy Saving Filter Time	s	0.5	0.5	0.5	0.5	0.5	0.5	0.5	0.5
b8-04	Energy Saving Coefficient Value	-	169.4	156.8	156.8	136.4	122.9	94.75	94.75	72.69
C6-02	Carrier Frequency Selection	-	3	7	3	7	3	7	3	7
E2-01 (E4-01)	Motor Rated Current (FLA)	A	6.2	8.5	8.5	11.4	14	19.6	19.6	26.6

11.21 Defaults by Drive Model and Duty Rating ND/HD

No. */	Name	Unit	Default							
			2010		2012		2021		2030	
-	Drive Model	-	HD	ND	HD	ND	HD	ND	HD	ND
C6-01	Normal / Heavy Duty Selection	-	0	1	0	1	0	1	0	1
o2-04	Drive Model (KVA) Selection	Hex.	65		66		68		6A	
E2-11 (E4-11, E5-02)	Motor Rated Power	kW	1.5	2.2	2.2	3.0	3.7	5.5	5.5	7.5
E2-02 (E4-02)	Motor Rated Slip	Hz	2.6	2.9	2.9	2.7	2.73	1.5	1.5	1.3
E2-03 (E4-03)	Motor No-Load Current	A	2.8	3	3	3.7	4.5	5.1	5.1	8
E2-05 (E4-05)	Motor Line-to-Line Resistance	Ω	1.997	1.601	1.601	1.034	0.771	0.399	0.399	0.288
E2-06 (E4-06)	Motor Leakage Inductance	%	18.5	18.4	18.4	19	19.6	18.2	18.2	15.5
E2-10 (E4-10)	Motor Iron Loss	W	53	77	77	91	112	172	172	262
E5-01	PM Motor Code Selection	-	FFFF	FFFF	FFFF	FFFF	FFFF	FFFF	FFFF	FFFF
L2-02	Power Loss Ride Through Time	s	0.3	0.3	0.5	0.5	1	1	1	1
L2-03	Minimum Baseblock Time	s	0.4	0.5	0.5	0.5	0.6	0.7	0.7	0.8
L2-04	Powerloss V/f Recovery Ramp Time	s	0.3	0.3	0.3	0.3	0.3	0.3	0.3	0.3
L2-05	Undervoltage Detection Lvl (Uvl)	-	190	190	190	190	190	190	190	190
L3-02	Stall Prevent Level during Accel	%	150	120	150	120	150	120	150	120
L3-06	Stall Prevent Level during Run	%	150	120	150	120	150	120	150	120
L3-24	Motor Accel Time @ Rated Torque	s	0.166	0.145	0.145	0.145	0.154	0.168	0.168	0.175
L8-02	Overheat Alarm Level	°C	110	110	110	110	115	115	105	105
L8-09	Output Ground Fault Detection	-	0	0	0	0	0	0	1	1
n1-03	Hunting Prevention Time Constant	ms	10	10	10	10	10	10	10	10
n3-02	HSB Current Limit Level	1	150	120	150	120	150	120	150	120
n5-02	Motor Inertia Acceleration Time	s	0.166	0.145	0.145	0.145	0.154	0.168	0.168	0.175

*1 Parameters within parentheses are for motor 2.

No. */	Name	Unit	Default							
			2042		2056		2070		2082	
-	Drive Model	-	HD	ND	HD	ND	HD	ND	HD	ND
C6-01	Normal / Heavy Duty Selection	-	0	1	0	1	0	1	0	1
o2-04	Drive Model (KVA) Selection	Hex.	6B		6D		6E		6F	
E2-11 (E4-11, E5-02)	Motor Rated Power	kW	7.5	11	11	15	15	18.5	18.5	22
b3-04	V/f Gain during Speed Search	%	100	100	100	100	100	100	100	100
b3-06	Speed Estimation Current Level 1	-	0.5	0.5	0.5	0.5	0.5	0.5	0.5	0.5
b3-08	Speed Estimation ACR P Gain	-	0.5	0.5	0.5	0.5	0.5	0.5	0.5	0.5
b3-26	Direction Determination Level	-	1000	1000	1000	1000	1000	1000	1000	1000
b8-03	Energy Saving Filter Time	s	0.5	0.5	0.5	0.5	0.5	0.5	0.5	0.5
b8-04	Energy Saving Coefficient Value	-	72.69	70.44	70.44	63.13	63.13	57.87	57.87	51.79
C6-02	Carrier Frequency Selection	-	3	7	3	7	3	7	3	7
E2-01 (E4-01)	Motor Rated Current (FLA)	A	26.6	39.7	39.7	53	53	65.8	65.8	77.2
E2-02 (E4-02)	Motor Rated Slip	Hz	1.3	1.7	1.7	1.6	1.6	1.67	1.67	1.7
E2-03 (E4-03)	Motor No-Load Current	A	8	11.2	11.2	15.2	15.2	15.7	15.7	18.5
E2-05 (E4-05)	Motor Line-to-Line Resistance	Ω	0.288	0.23	0.23	0.138	0.138	0.101	0.101	0.079
E2-06 (E4-06)	Motor Leakage Inductance	%	15.5	19.5	19.5	17.2	17.2	15.7	20.1	19.5
E2-10 (E4-10)	Motor Iron Loss	W	262	245	245	272	272	505	505	538
E5-01	PM Motor Code Selection	-	FFFF	FFFF	FFFF	FFFF	FFFF	FFFF	FFFF	FFFF
L2-02	Power Loss Ride Through Time	s	1	1	2	2	2	2	2	2
L2-03	Minimum Baseblock Time	s	0.8	0.9	0.9	1	1	1	1	1
L2-04	Powerloss V/f Recovery Ramp Time	s	0.3	0.3	0.3	0.6	0.6	0.6	0.6	0.6
L2-05	Undervoltage Detection Lvl (UV1)	-	190	190	190	190	190	190	190	190
L3-02	Stall Prevent Level during Accel	%	150	120	150	120	150	120	150	120
L3-06	Stall Prevent Level during Run	%	150	120	150	120	150	120	150	120

11.21 Defaults by Drive Model and Duty Rating ND/HD

No. */	Name	Unit	Default							
			2042		2056		2070		2082	
-	Drive Model	-								
C6-01	Normal / Heavy Duty Selection	-	HD	ND	HD	ND	HD	ND	HD	ND
			0	1	0	1	0	1	0	1
o2-04	Drive Model (KVA) Selection	Hex.	6B		6D		6E		6F	
E2-11 (E4-11, E5-02)	Motor Rated Power	kW	7.5	11	11	15	15	18.5	18.5	22
L3-24	Motor Accel Time @ Rated Torque	s	0.175	0.265	0.265	0.244	0.244	0.317	0.317	0.355
L8-02	Overheat Alarm Level	°C	115	115	125	125	120	120	135	135
L8-09	Output Ground Fault Detection	-	1	1	1	1	1	1	1	1
n1-03	Hunting Prevention Time Constant	ms	10	10	10	10	10	10	10	10
n3-02	HSB Current Limit Level	l	150	120	150	120	150	120	150	120
n5-02	Motor Inertia Acceleration Time	s	0.175	0.265	0.265	0.244	0.244	0.317	0.317	0.355

*1 Parameters within parentheses are for motor 2.

◆ Three-Phase 400 V Class

No. */	Name	Unit	Default							
			4001		4002		4004		4005	
-	Drive Model	-								
C6-01	Normal / Heavy Duty Selection	-	HD	ND	HD	ND	HD	ND	HD	ND
			0	1	0	1	0	1	0	1
o2-04	Drive Model (KVA) Selection	Hex.	91		92		93		94	
E2-11 (E4-11, E5-02)	Motor Rated Power	kW	0.2	0.4	0.4	0.75	0.75	1.5	1.5	2.2
b3-04	V/f Gain during Speed Search	%	100	100	100	100	100	100	100	100
b3-06	Speed Estimation Current Level 1	-	1.0	1.0	0.5	0.5	0.5	0.5	0.5	0.5
b3-08	Speed Estimation ACR P Gain	-	0.5	0.5	0.5	0.5	0.5	0.5	0.5	0.5
b3-26	Direction Determination Level	-	1000	1000	1000	1000	1000	1000	1000	1000
b8-03	Energy Saving Filter Time	s	0.5	0.5	0.5	0.5	0.5	0.5	0.5	0.5
b8-04	Energy Saving Coefficient Value	-	713.8	576.4	576.4	447.4	447.4	338.8	338.8	313.6
C6-02	Carrier Frequency Selection	-	3	7	3	7	3	7	3	7
E2-01 (E4-01)	Motor Rated Current (FLA)	A	0.6	1	1	1.6	1.6	3.1	3.1	4.2

No. */	Name	Unit	Default							
			4001		4002		4004		4005	
-	Drive Model	-	HD	ND	HD	ND	HD	ND	HD	ND
C6-01	Normal / Heavy Duty Selection	-	0	1	0	1	0	1	0	1
o2-04	Drive Model (KVA) Selection	Hex.	91		92		93		94	
E2-11 (E4-11, E5-02)	Motor Rated Power	kW	0.2	0.4	0.4	0.75	0.75	1.5	1.5	2.2
E2-02 (E4-02)	Motor Rated Slip	Hz	2.5	2.9	2.9	2.6	2.6	2.5	2.5	3
E2-03 (E4-03)	Motor No-Load Current	A	0.4	0.6	0.6	0.8	0.8	1.4	1.4	1.5
E2-05 (E4-05)	Motor Line-to-Line Resistance	Ω	83.94	38.198	38.198	22.459	22.459	10.1	10.1	6.495
E2-06 (E4-06)	Motor Leakage Inductance	%	21.9	18.2	18.2	14.3	14.3	18.3	18.3	18.7
E2-10 (E4-10)	Motor Iron Loss	W	12	14	14	26	26	53	53	77
E5-01	PM Motor Code Selection	-	FFFF	FFFF	FFFF	FFFF	FFFF	FFFF	FFFF	FFFF
L2-02	Power Loss Ride Through Time	s	0.1	0.1	0.1	0.1	0.2	0.2	0.3	0.3
L2-03	Minimum Baseblock Time	s	0.2	0.2	0.2	0.3	0.3	0.4	0.4	0.5
L2-04	Powerloss V/f Recovery Ramp Time	s	0.3	0.3	0.3	0.3	0.3	0.3	0.3	0.3
L2-05	Undervoltage Detection Lvl (Uv1)	-	380	380	380	380	380	380	380	380
L3-02	Stall Prevent Level during Accel	%	150	120	150	120	150	120	150	120
L3-06	Stall Prevent Level during Run	%	150	120	150	120	150	120	150	120
L3-24	Motor Accel Time @ Rated Torque	s	0.178	0.178	0.178	0.142	0.142	0.166	0.166	0.145
L8-02	Overheat Alarm Level	°C	120	120	120	120	105	105	90	90
L8-09	Output Ground Fault Detection	-	0	0	0	0	0	0	0	0
n1-03	Hunting Prevention Time Constant	ms	10	10	10	10	10	10	10	10
n3-02	HSB Current Limit Level	%	150	120	150	120	150	120	150	120
n5-02	Motor Inertia Acceleration Time	s	0.178	0.178	0.178	0.142	0.142	0.166	0.166	0.145

*1 Parameters within parentheses are for motor 2.

11.21 Defaults by Drive Model and Duty Rating ND/HD

No. */	Name	Unit	Default							
			4007		4009		4012		4018	
-	Drive Model	-	HD	ND	HD	ND	HD	ND	HD	ND
C6-01	Normal / Heavy Duty Selection	-	0	1	0	1	0	1	0	1
o2-04	Drive Model (KVA) Selection	Hex.	95		96		97		99	
E2-11 (E4-11, E5-02)	Motor Rated Power	kW	2.2	3.0	3.0	3.7	4.0	5.5	5.5	7.5
b3-04	V/f Gain during Speed Search	%	100	100	100	100	100	100	100	100
b3-06	Speed Estimation Current Level 1	-	0.5	0.5	0.5	0.5	0.5	0.5	0.5	0.5
b3-08	Speed Estimation ACR P Gain	-	0.5	0.5	0.5	0.5	0.5	0.5	0.5	0.5
b3-26	Direction Determination Level	-	1000	1000	1000	1000	1000	1000	1000	1000
b8-03	Energy Saving Filter Time	s	0.5	0.5	0.5	0.5	0.5	0.5	0.5	0.5
b8-04	Energy Saving Coefficient Value	-	313.6	265.7	265.7	245.8	245.8	189.5	189.5	145.38
C6-02	Carrier Frequency Selection	-	3	7	3	7	3	7	3	7
E2-01 (E4-01)	Motor Rated Current (FLA)	A	4.2	5.7	5.7	7	7	9.8	9.8	13.3
E2-02 (E4-02)	Motor Rated Slip	Hz	3	2.7	2.7	2.7	2.7	1.5	1.5	1.3
E2-03 (E4-03)	Motor No-Load Current	A	1.5	1.9	1.9	2.3	2.3	2.6	2.6	4
E2-05 (E4-05)	Motor Line-to-Line Resistance	Ω	6.495	4.36	4.36	3.333	3.333	1.595	1.595	1.152
E2-06 (E4-06)	Motor Leakage Inductance	%	18.7	19	19	19.3	19.3	18.2	18.2	15.5
E2-10 (E4-10)	Motor Iron Loss	W	77	105	105	130	130	193	193	263
E5-01	PM Motor Code Selection	-	FFFF	FFFF	FFFF	FFFF	FFFF	FFFF	FFFF	FFFF
L2-02	Power Loss Ride Through Time	s	0.5	0.5	0.5	0.5	0.5	0.5	0.8	0.8
L2-03	Minimum Baseblock Time	s	0.5	0.5	0.5	0.6	0.6	0.7	0.7	0.8
L2-04	Powerloss V/f Recovery Ramp Time	s	0.3	0.3	0.3	0.3	0.3	0.3	0.3	0.3
L2-05	Undervoltage Detection Lvl (Uv1)	-	380	380	380	380	380	380	380	380
L3-02	Stall Prevent Level during Accel	%	150	120	150	120	150	120	150	120
L3-06	Stall Prevent Level during Run	%	150	120	150	120	150	120	150	120

No. */	Name	Unit	Default							
			4007		4009		4012		4018	
-	Drive Model	-								
C6-01	Normal / Heavy Duty Selection	-	HD	ND	HD	ND	HD	ND	HD	ND
			0	1	0	1	0	1	0	1
o2-04	Drive Model (KVA) Selection	Hex.	95		96		97		99	
E2-11 (E4-11, E5-02)	Motor Rated Power	kW	2.2	3.0	3.0	3.7	4.0	5.5	5.5	7.5
L3-24	Motor Accel Time @ Rated Torque	s	0.145	0.145	0.145	0.154	0.154	0.168	0.168	0.175
L8-02	Overheat Alarm Level	°C	90	90	115	115	110	110	120	120
L8-09	Output Ground Fault Detection	-	0	0	0	0	0	0	0	0
n1-03	Hunting Prevention Time Constant	ms	10	10	10	10	10	10	10	10
n3-02	HSB Current Limit Level	%	150	120	150	120	150	120	150	120
n5-02	Motor Inertia Acceleration Time	s	0.145	0.145	0.145	0.154	0.154	0.168	0.168	0.175

*1 Parameters within parentheses are for motor 2.

No. */	Name	Unit	Default							
			4023		4031		4038		4044	
-	Drive Model	-								
C6-01	Normal / Heavy Duty Selection	-	HD	ND	HD	ND	HD	ND	HD	ND
			0	1	0	1	0	1	0	1
o2-04	Drive Model (KVA) Selection	Hex.	9A		REV:A: 9C REV:B: 19C *2		REV:A: 9D REV:B: 19D *2		9E	
E2-11 (E4-11, E5-02)	Motor Rated Power	kW	7.5	11	11	15	15	18.5	18.5	22
b3-04	V/f Gain during Speed Search	%	100	100	100	100	100	100	100	100
b3-06	Speed Estimation Current Level 1	-	0.5	0.5	0.5	0.5	0.5	0.5	0.5	0.5
b3-08	Speed Estimation ACR P Gain	-	0.5	0.5	0.5	0.5	0.5	0.5	0.5	0.5
b3-26	Direction Determination Level	-	1000	1000	1000	1000	1000	1000	1000	1000
b8-03	Energy Saving Filter Time	s	0.5	0.5	0.5	0.5	0.5	0.5	0.5	0.5
b8-04	Energy Saving Coefficient Value	-	145.38	140.88	140.88	126.26	126.26	115.74	115.74	103.58
C6-02	Carrier Frequency Selection	-	3	7	3	7	3	7	3	7
E2-01 (E4-01)	Motor Rated Current (FLA)	A	13.3	19.9	19.9	26.5	26.5	32.9	32.9	38.6
E2-02 (E4-02)	Motor Rated Slip	Hz	1.3	1.7	1.7	1.6	1.6	1.67	1.67	1.7

11.21 Defaults by Drive Model and Duty Rating ND/HD

No. */	Name	Unit	Default							
			4023		4031		4038		4044	
-	Drive Model	-	HD	ND	HD	ND	HD	ND	HD	ND
C6-01	Normal / Heavy Duty Selection	-	0	1	0	1	0	1	0	1
o2-04	Drive Model (KVA) Selection	Hex.	9A		REV:A: 9C REV:B: 19C *2		REV:A: 9D REV:B: 19D *2		9E	
E2-11 (E4-11, E5-02)	Motor Rated Power	kW	7.5	11	11	15	15	18.5	18.5	22
E2-03 (E4-03)	Motor No-Load Current	A	4	5.6	5.6	7.6	7.6	7.8	7.8	9.2
E2-05 (E4-05)	Motor Line-to-Line Resistance	Ω	1.152	0.922	0.922	0.55	0.55	0.403	0.403	0.316
E2-06 (E4-06)	Motor Leakage Inductance	%	15.5	19.6	19.6	17.2	17.2	20.1	20.1	23.5
E2-10 (E4-10)	Motor Iron Loss	W	263	385	385	440	440	508	508	586
E5-01	PM Motor Code Selection	-	FFFF	FFFF	FFFF	FFFF	FFFF	FFFF	FFFF	FFFF
L2-02	Power Loss Ride Through Time	s	1	1	2	2	2	2	2	2
L2-03	Minimum Baseblock Time	s	0.8	0.9	0.9	1	1	1	1	1
L2-04	Powerloss V/f Recovery Ramp Time	s	0.3	0.3	0.3	0.6	0.6	0.6	0.6	0.6
L2-05	Undervoltage Detection Lvl (Uv1)	-	380	380	380	380	380	380	380	380
L3-02	Stall Prevent Level during Accel	%	150	120	150	120	150	120	150	120
L3-06	Stall Prevent Level during Run	%	150	120	150	120	150	120	150	120
L3-24	Motor Accel Time @ Rated Torque	s	0.175	0.265	0.265	0.244	0.244	0.317	0.317	0.355
L8-02	Overheat Alarm Level	°C	120	120	120	120	120	120	125	125
L8-09	Output Ground Fault Detection	-	0	0	1	1	1	1	1	1
n1-03	Hunting Prevention Time Constant	ms	10	10	10	10	10	10	10	10
n3-02	HSB Current Limit Level	%	150	120	150	120	150	120	150	120
n5-02	Motor Inertia Acceleration Time	s	0.175	0.265	0.265	0.244	0.244	0.317	0.317	0.355

*1 Parameters within parentheses are for motor 2.

*2 The value is different for different drive hardware revisions. The "REV" column on the nameplate on the right side of the drive identifies the hardware revision.

No. */	Name	Unit	Default	
-	Drive Model	-	4060	
C6-01	Normal / Heavy Duty Selection	-	HD	ND
			0	1
o2-04	Drive Model (KVA) Selection	Hex.	9F	
E2-11 (E4-11, E5-02)	Motor Rated Power	kW	22	30
b3-04	V/f Gain during Speed Search	%	100	100
b3-06	Speed Estimation Current Level 1	-	0.5	0.5
b3-08	Speed Estimation ACR P Gain	-	0.5	0.5
b3-26	Direction Determination Level	-	1000	1000
b8-03	Energy Saving Filter Time	s	0.5	0.5
b8-04	Energy Saving Coefficient Value	-	103.58	92.54
C6-02	Carrier Frequency Selection	-	3	7
E2-01 (E4-01)	Motor Rated Current (FLA)	A	38.6	52.3
E2-02 (E4-02)	Motor Rated Slip	Hz	1.7	1.8
E2-03 (E4-03)	Motor No-Load Current	A	9.2	10.9
E2-05 (E4-05)	Motor Line-to-Line Resistance	Ω	0.316	0.269
E2-06 (E4-06)	Motor Leakage Inductance	%	23.5	20.7
E2-10 (E4-10)	Motor Iron Loss	W	586	750
E5-01	PM Motor Code Selection	-	FFFF	FFFF
L2-02	Power Loss Ride Through Time	s	2	2
L2-03	Minimum Baseblock Time	s	1	1.1
L2-04	Powerloss V/f Recovery Ramp Time	s	0.6	0.6
L2-05	Undervoltage Detection Lvl (Uv1)	-	380	380
L3-02	Stall Prevent Level during Accel	%	150	120
L3-06	Stall Prevent Level during Run	%	150	120
L3-24	Motor Accel Time @ Rated Torque	s	0.355	0.323
L8-02	Overheat Alarm Level	°C	115	115
L8-09	Output Ground Fault Detection	-	1	1
n1-03	Hunting Prevention Time Constant	ms	10	10
n3-02	HSB Current Limit Level	%	150	120
n5-02	Motor Inertia Acceleration Time	s	0.355	0.323

*1 Parameters within parentheses are for motor 2.

Parameter Details

12.1	Section Safety	500
12.2	A: Initialization Parameters	501
12.3	b: Application	513
12.4	C: Tuning	559
12.5	d: References	581
12.6	E: Motor Parameters	597
12.7	F: Options	618
12.8	H: Terminal Function Selection	643
12.9	L: Protection Functions	713
12.10	n: Special Adjustment	761
12.11	o: Keypad-Related Settings	783
12.12	T: Auto-Tuning	805

12.1 Section Safety

 **DANGER**

Do not ignore the safety messages in this manual.

If you ignore the safety messages in this manual, it will cause serious injury or death. The manufacturer is not responsible for injuries or damage to equipment.

12.2 A: Initialization Parameters

A parameters [Initialization Parameters] set the operating environment and operating conditions for the drive.

◆ A1: Initialization

A1 parameters set the operating environment and operating conditions for the drive. For example, these parameters set the keypad language, the control method, and the parameter access level for the drive.

■ A1-00: Language Selection

No. (Hex.)	Name	Description	Default (Range)
A1-00 (0100) RUN	Language Selection	<div style="display: flex; gap: 5px;"> V/f OLV OLV/PM AOLV/PM EZOLV </div> Sets the language for the LCD keypad.	0 (0 - 12)

Note:

- This parameter is only available when you use an LCD keypad or a Bluetooth LCD Keypad.
- When you use *A1-03* [Initialize Parameters] to initialize the drive, the drive will not reset this parameter.

0 : English

1 : Japanese

2 : German

3 : French

4 : Italian

5 : Spanish

6 : Portuguese

7 : Chinese

8 : Czech

9 : Russian

10 : Turkish

11 : Polish

12 : Greek

■ A1-01: Access Level Selection

No. (Hex.)	Name	Description	Default (Range)
A1-01 (0101) RUN	Access Level Selection	<div style="display: flex; gap: 5px;"> V/f OLV OLV/PM AOLV/PM EZOLV </div> Sets user access to parameters. The access level controls which parameters the keypad will display, and which parameters the user can set.	2 (0 - 3)

0 : Operation Only

Access to *A1-00*, *A1-01*, *A1-04* [Password], and the *U* Monitors.

1 : User Parameters

Access to *A1-00*, *A1-01*, *A1-04*, and *A2-01* to *A2-32* [User Parameters 1 to 32].

2 : Advanced Level

Access to all parameters, but not Expert Mode parameters.

3 : Expert Level

Access to all parameters including Expert Mode parameters.

Table 12.1 shows which keypad screens are available for each *A1-01* settings.

Table 12.1 Access Level and Available Keypad Screens

Mode	Keypad Screen	A1-01 [Access Level Selection] Setting			
		0	1	2	3
Drive Mode	Monitors	Yes	Yes	Yes	Yes
Programming Mode	Parameters	Yes	Yes	Yes	Yes
	User Custom Parameters	No	Yes	Yes	Yes
	Parameter Backup/Restore	No	No	Yes	Yes
	Modified Parameters/Fault Log	No	No	Yes	Yes
	Auto-Tuning	No	No	Yes	Yes
	Initial Setup Screen	No	No	Yes	Yes
	Diagnostic Tools	No	No	Yes	Yes

Note:

- When you use A1-04 and A1-05 [Password Setting] to set a password, you cannot change the values set in A1-01 to A1-03, A1-06, A1-07, or A2-01 to A2-32.
- When H1-xx = 1B [MFDI Function Select = Program Lockout], you must activate the terminal to change parameter settings.
- When you use MEMOBUS/Modbus communications, you must send the Enter command from the controller to the drive and complete the serial communication write process before you can use the keypad to change parameter settings.

■ A1-02: Control Method Selection

No. (Hex.)	Name	Description	Default (Range)
A1-02 (0102)	Control Method Selection	<div style="display: flex; gap: 5px;"> V/f OLV OLV/PM AOLV/PM EZOLV </div> Sets the control method for the drive application and the motor.	2 (0, 2, 5, 6, 8)

Note:

When you change the control methods, the parameter values specified by A1-02 and E3-01 [Motor 2 Control Mode Selection] are changed to their default values.

Sets the control method for the drive application and the motor.

0 : V/f Control

Use this control method in these applications and conditions:

- For general variable-speed control applications in which a high level of responsiveness or high-precision speed control is not necessary.
- Applications in which more than one motor are connected to one drive
- When there is not sufficient data to set the motor parameters
- When it is not possible to do Auto-Tuning. The speed control range is 1:40.

2 : Open Loop Vector

Use this control method for general variable-speed control applications in which high-precision speed control is necessary. In this control method, a feedback signal from the motor is not necessary to have high torque response and high torque when operating at low speeds. The speed control range is 1:100.

5 : PM Open Loop Vector

The drive controls an IPM motor or SPM motor in this control method. Use this control method for general variable-speed control applications in which a high level of responsiveness or high-precision speed control are not necessary. The speed control range is 1:10.

6 : PM Advanced Open Loop Vector

The drive can control an IPM motor in this control method. Use this control method for general variable-speed control applications in which high-precision speed control and torque limit are necessary. The speed control range is 1:20. The speed control range is 1:10 when n8-57 = 1 [HFI Overlap Selection = Enabled].

8 : EZ Vector Control

The drive controls induction motors and PM motors in this control method. This control method uses an easier procedure to operate motors with more efficiency. Use this control method for derating torque applications. For example, fans and pumps.

■ A1-03: Initialize Parameters

No. (Hex.)	Name	Description	Default (Range)
A1-03 (0103)	Initialize Parameters	 Sets parameters to default values.	0 (0 - 3330)

Note:

- After you initialize the drive, the drive automatically sets $A1-03 = 0$.
- User Parameters can save the parameter values for your application and use these values as default values for drive initialization.
- To use the 2 motor switchover function, first turn OFF the terminal to which $H1-xx = 16$ [MFDI Function Selection = Motor 2 Selection] is set, then change the $A1-03$ setting. An incorrect procedure will trigger $oPE08$ [Parameter Selection Error].

0 : No Initialization

1110 : User Initialization

Sets parameters to the values set by the user as user settings. Set $o2-03 = 1$ [User Parameter Default Value = Set defaults] to save the user settings.

You can save the parameter settings that were adjusted for the test run as user-set default values to the drive. When you make changes to the parameter values after you save the settings as User Parameter Settings, the drive will set the parameters to the User Parameter Setting value when you initialize with $A1-03 = 1110$.

Follow this procedure to save User Parameter setting values, and to do a User Initialization.

1. Set parameters correctly for the application.
2. Set $o2-03 = 1$ [User Parameter Default Value = Set defaults].
This saves parameter settings for a User Initialization.
The drive will then automatically set $o2-03 = 0$.
3. Set $A1-03 = 1110$ to reset to the saved parameter settings.
When you initialize the drive, the drive sets the parameter values to the User Parameter setting values.

2220 : 2-Wire Initialization

Sets MFDI terminal S1 to Forward Run and terminal S2 to Reverse Run, and resets all parameters to default settings.

3330 : 3-Wire Initialization

Sets MFDI terminal S1 to Run, terminal S2 to Stop, and terminal S5 to FWD/REV, and resets all parameters to default settings.

The drive will not initialize the parameters in [Table 12.2](#) when $A1-03 = 2220, 3330$.

Table 12.2 Parameters that are not Initialized Using a 2-Wire Sequence or a 3-Wire Sequence

No.	Name
A1-00	Language Selection
A1-02	Control Method Selection
A1-07	DriveWorksEZ Function Selection
A1-12 <i>*1</i>	Bluetooth ID
E1-03	V/f Pattern Selection
E5-01	PM Motor Code Selection
E5-02	PM Motor Rated Power
E5-03	Motor Rated Current (FLA)
E5-04	PM Motor Pole Count
E5-05	PM Motor Resistance (ohms/phase)
E5-06	PM d-axis Inductance (mH/phase)
E5-07	PM q-axis Inductance (mH/phase)

12.2 A: Initialization Parameters





No.	Name
E5-09	PM Back-EMF V _{peak} (mV/(rad/s))
E5-24	PM Back-EMF L-L V _{rms} (mV/rpm)
E5-25	Polarity Estimation Timeout
F6-08	Comm Parameter Reset @Initialize
F6-xx/F7-xx	Communication Option Parameters Set F6-08 = 1 [Comm Parameter Reset @Initialize = Reset Back to Factory Default] to initialize communication option parameters.
L8-35	Installation Method Selection
o2-04	Drive Model (KVA) Selection
q1-xx - q8-xx	DriveWorksEZ Parameters
r1-xx	DWEZ Connection 1-20

*1 When you use A1-03 [Initialize Parameters] to initialize drives with software versions PRG:01013 and later, the drive will not reset A1-12. The "PRG" column on the nameplate on the right side of the drive identifies the software version. You can also use UI-25 [SoftwareNumber Flashr] to identify the software version.

Note:

- Set A1-06 [Application Preset] to let the drive automatically set the best parameter settings for the selected application. The drive does not initialize A1-02 when A1-03 = 2220, 3330.
- When A1-03 = 2220, 3330, the drive automatically set A1-05 [Password Setting] = 0000. Make sure that you set the password again for applications where a password is necessary.

■ A1-04: Password

No. (Hex.)	Name	Description	Default (Range)
A1-04 (0104)	Password	     Entry point for the password set in A1-05 [Password Setting]. The user can view the settings of parameters that are locked without entering the password. Enter the correct password in this parameter to change parameter settings.	0000 (0000 - 9999)

If the password entered in A1-04 does not agree with the password setting in A1-05, you cannot change these parameters:

- A1-01 [Access Level Selection]
- A1-02 [Control Method Selection]
- A1-03 [Initialize Parameters]
- A1-06 [Application Preset]
- A1-07 [DriveWorksEZ Function Selection]
- A2-01 to A2-32 [User Parameter 1 to 32]









To lock parameter settings after making changes without changing the password, enter the incorrect password in A1-04 and push .





Enter the Password to Unlock Parameters

Use this procedure to unlock parameter settings.

Set the password in A1-05 [Password Setting], and show the Parameter Setting Mode screen on the keypad.





This procedure verifies the password, and makes sure that the parameter settings are unlocked.

1. Push  or  to select "A: Initialization Parameters", then push .
2. Push  or  to select [A1-04], then push .
You can now change parameter settings.
3. Push  or  to move the digit and enter the password.
4. Push  to confirm the password.
The drive unlocks the parameters and automatically shows the Parameters Screen.

5. Push  or  to show [A1-02], then push .
- The keypad shows the setting value for [A1-02].
6. Push  or  to make sure that you can change the setting value.

Push  (Back) until the keypad shows the Parameter Setup Mode screen.



■ A1-05: Password Setting

No. (Hex.)	Name	Description	Default (Range)
A1-05 (0105)	Password Setting	     Set the password to lock parameters and prevent changes to parameter settings. Enter the correct password in A1-04 [Password] to unlock parameters and accept changes.	0000 (0000 - 9999)

This parameter locks these parameters:





- A1-01 [Access Level Selection]
- A1-02 [Control Method Selection]
- A1-03 [Initialize Parameters]
- A1-06 [Application Preset]
- A1-07 [DriveWorksEZ Function Selection]
- A2-01 to A2-32 [User Parameter 1 to 32]

Note:

- Usually, the keypad will not show A1-05. To show and set A1-05, show A1-04 [Password] and then push  and  on the keypad at the same time.
- After you set A1-05, the keypad will not show it again until you enter the correct password in A1-04. Make sure that you remember the A1-05 setting value. If you do not know the A1-05 setting value, contact Yaskawa or your nearest sales representative.
- When A1-03 = 2220, 3330 [2-Wire Initialization, 3-Wire Initialization], the drive is initialized to A1-05 = 0000. Be sure to set the password again when a password is necessary for the application.
- Change the setting value in A1-05 to change the password. The new setting value becomes the new password.
- When you use the password to unlock and change a parameter, enter a value other than the password in A1-04 to lock the parameter again with the same password.
- If A1-04 ≠ A1-05, MEMOBUS Communication cannot read or write A1-05.

■ A1-06: Application Preset

WARNING! Sudden Movement Hazard. Check the I/O signals and the external sequences for the drive before you set the Application Preset function. When you set the Application Preset function (A1-06 ≠ 0), it changes the I/O terminal functions for the drive and it can cause equipment to operate unusually. This can cause serious injury or death.

No. (Hex.)	Name	Description	Default (Range)
A1-06 (0127)	Application Preset	     Sets the drive to operate in selected application conditions.	0 (0 - 5, 8)

The drive software contains the application presets shown below. Set A1-06 to align with the application to let the drive automatically set the best parameter settings for the selected application. The drive saves parameters that you frequently use the application in parameters A2-01 to A2-16 [User Parameters 1 to 16] for easy configuration and reference in Setup Mode.

- Water supply pump
- Conveyor
- Exhaust fan
- HVAC fan
- Air compressor

12.2 A: Initialization Parameters

Note:

- Before you set *A1-06*, make sure that you set *A1-03* = 2220, 3330 [*Initialize Parameters* = 2-Wire Initialization, 3-Wire Initialization] to initialize parameters.
- It is not possible to change the *A1-06* value. To set an application preset, set *A1-03* = 2220 to initialize parameters, then set this parameter. If initializing all parameters will cause a problem, do not change the settings.
- If you set *A2-33* = 1 [*User Parameter Auto Selection* = Enabled: *Auto Save Recent Params*] to set parameters to *A2-17* to *A2-32* [*User Parameters 17 to 32*] automatically, the drive will reset these parameters when you change the *A1-06* setting.

0 : General-purpose

The drive saves the parameters in [Table 12.3](#) as User Parameters.

Table 12.3 Parameters Saved as User Parameters with the General-purpose Preset

User Parameter No.	Parameter No. Saved	Name
A2-01	A1-02	Control Method Selection
A2-02	b1-01	Frequency Reference Selection 1
A2-03	b1-02	Run Command Selection 1
A2-04	b1-03	Stopping Method Selection
A2-05	C1-01	Acceleration Time 1
A2-06	C1-02	Deceleration Time 1
A2-07	C6-01	Normal / Heavy Duty Selection
A2-08	C6-02	Carrier Frequency Selection
A2-09	d1-01	Reference 1
A2-10	d1-02	Reference 2
A2-11	d1-03	Reference 3
A2-12	d1-04	Reference 4
A2-13	d1-17	Jog Reference
A2-14	E1-01	Input AC Supply Voltage
A2-15	E1-03	V/f Pattern Selection
A2-16	E1-04	Maximum Output Frequency
A2-17	E1-05	Maximum Output Voltage
A2-18	E1-06	Base Frequency
A2-19	E1-09	Minimum Output Frequency
A2-20	E1-13	Base Voltage
A2-21	E2-01	Motor Rated Current (FLA)
A2-22	E2-04	Motor Pole Count
A2-23	E2-11	Motor Rated Power
A2-24	H4-02	Terminal AM Analog Output Gain
A2-25	L1-01	Motor Overload (oL1) Protection
A2-26	L3-04	Stall Prevention during Decel

1 : Water Supply Pump 2

The drive automatically sets the parameters in [Table 12.4](#) for a water supply pump application.

Table 12.4 Best Parameter Settings for Water Supply Pump Applications

No.	Name	Optimal Value
A1-02	Control Method Selection	0: V/f Control
b1-04	Reverse Operation Selection	1: Reverse Disabled
C1-01	Acceleration Time 1	1.0 s
C1-02	Deceleration Time 1	1.0 s

No.	Name	Optimal Value
C6-01	Normal / Heavy Duty Selection	1: Normal Duty Rating
E1-03	V/f Pattern Selection	F: Custom
E1-07	Mid Point A Frequency	30.0 Hz
E1-08	Mid Point A Voltage	50.0 V
L2-01	Power Loss Ride Through Select	1: Enabled
L3-04	Stall Prevention during Decel	1: General Purpose

The drive saves the parameters in [Table 12.5](#) as User Parameters.

Table 12.5 Parameters Saved as User Parameters with the Water Supply Pump Preset

User Parameter No.	Parameter No. Saved	Name
A2-01	b1-01	Frequency Reference Selection 1
A2-02	b1-02	Run Command Selection 1
A2-03	b1-04	Reverse Operation Selection
A2-04	C1-01	Acceleration Time 1
A2-05	C1-02	Deceleration Time 1
A2-06	E1-03	V/f Pattern Selection
A2-07	E1-07	Mid Point A Frequency
A2-08	E1-08	Mid Point A Voltage
A2-09	E2-01	Motor Rated Current (FLA)
A2-10	H1-05	Terminal S5 Function Selection
A2-11	H1-06	Terminal S6 Function Selection
A2-12	H1-07	Terminal S7 Function Selection
A2-13	L5-01	Number of Auto-Restart Attempts

2 : Conveyor

The drive automatically sets the parameters in [Table 12.6](#) for a conveyor application.

Table 12.6 Best Parameter Settings for Conveyor Applications

No.	Name	Optimal Value
A1-02	Control Method Selection	0: V/f Control
C1-01	Acceleration Time 1	3.0 s
C1-02	Deceleration Time 1	3.0 s
C6-01	Normal / Heavy Duty Selection	0: Heavy Duty Rating
L3-04	Stall Prevention during Decel	1: General Purpose

The drive saves the parameters in [Table 12.7](#) as User Parameters.

Table 12.7 Parameters Saved as User Parameters with the Conveyor Preset

User Parameter No.	Parameter No. Saved	Name
A2-01	A1-02	Control Method Selection
A2-02	b1-01	Frequency Reference Selection 1
A2-03	b1-02	Run Command Selection 1
A2-04	C1-01	Acceleration Time 1
A2-05	C1-02	Deceleration Time 1
A2-06	E2-01	Motor Rated Current (FLA)
A2-07	L3-04	Stall Prevention during Decel

3 : Exhaust Fan

The drive automatically sets the parameters in [Table 12.8](#) for an exhaust fan application.

Table 12.8 Best Parameter Settings for Exhaust Fan Applications

No.	Name	Optimal Value
A1-02	Control Method Selection	0: V/f Control
b1-04	Reverse Operation Selection	1: Reverse Disabled
C6-01	Normal / Heavy Duty Selection	1: Normal Duty Rating
E1-03	V/f Pattern Selection	F: Custom
E1-07	Mid Point A Frequency	30.0 Hz
E1-08	Mid Point A Voltage	50.0 V
L2-01	Power Loss Ride Through Select	1: Enabled
L3-04	Stall Prevention during Decel	1: General Purpose

The drive saves the parameters in [Table 12.9](#) as User Parameters.

Table 12.9 Parameters Saved as User Parameters with the Exhaust Fan Preset

User Parameter No.	Parameter No. Saved	Name
A2-01	b1-01	Frequency Reference Selection 1
A2-02	b1-02	Run Command Selection 1
A2-03	b1-04	Reverse Operation Selection
A2-04	b3-01	Speed Search at Start Selection
A2-05	C1-01	Acceleration Time 1
A2-06	C1-02	Deceleration Time 1
A2-07	E1-03	V/f Pattern Selection
A2-08	E1-07	Mid Point A Frequency
A2-09	E1-08	Mid Point A Voltage
A2-10	E2-01	Motor Rated Current (FLA)
A2-11	H1-05	Terminal S5 Function Selection
A2-12	H1-06	Terminal S6 Function Selection
A2-13	H1-07	Terminal S7 Function Selection
A2-14	L5-01	Number of Auto-Restart Attempts

4 : HVAC Fan

The drive automatically sets the parameters in [Table 12.10](#) for an HVAC fan application.

Table 12.10 Best Parameter Settings for HVAC Fan Applications

No.	Name	Optimal Value
A1-02	Control Method Selection	0: V/f Control
b1-04	Reverse Operation Selection	1: Reverse Disabled
b1-17	Run Command at Power Up	1: Accept Existing RUN Command
C6-01	Normal / Heavy Duty Selection	1: Normal Duty Rating
C6-02	Carrier Frequency Selection	3: 8.0 kHz (6.0 kHz for AOLV/PM)
H2-03	Terminal P2-C2 Function Selection	39: Watt Hour Pulse Output
L2-01	Power Loss Ride Through Select	2: Enabled while CPU Power Active
L8-03	Overheat Pre-Alarm Selection	4: Operate at Reduced Speed (L8-19)

The drive saves the parameters in [Table 12.11](#) as User Parameters.

Table 12.11 Parameters Saved as User Parameters with the HVAC Fan Preset

User Parameter No.	Parameter No. Saved	Name
A2-01	b1-01	Frequency Reference Selection 1
A2-02	b1-02	Run Command Selection 1
A2-03	b1-03	Stopping Method Selection
A2-04	b1-04	Reverse Operation Selection
A2-05	C1-01	Acceleration Time 1
A2-06	C1-02	Deceleration Time 1
A2-07	C6-02	Carrier Frequency Selection
A2-08	d2-01	Frequency Reference Upper Limit
A2-09	d2-02	Frequency Reference Lower Limit
A2-10	E1-03	V/f Pattern Selection
A2-11	E1-04	Maximum Output Frequency
A2-12	E2-01	Motor Rated Current (FLA)
A2-13	H3-11	Terminal A2 Gain Setting
A2-14	H3-12	Terminal A2 Bias Setting
A2-15	L2-01	Power Loss Ride Through Select
A2-16	o4-12	kWh Monitor Initialization

5 : Air Compressor

The drive automatically sets the parameters in [Table 12.12](#) for an air compressor application.

Table 12.12 Best Parameter Settings for Air Compressor Applications

No.	Name	Optimal Value
A1-02	Control Method Selection	0: V/f Control
b1-04	Reverse Operation Selection	1: Reverse Disabled
C1-01	Acceleration Time 1	5.0 s
C1-02	Deceleration Time 1	5.0 s
C6-01	Normal / Heavy Duty Selection	0: Heavy Duty Rating
E1-03	V/f Pattern Selection	F: Custom
L2-01	Power Loss Ride Through Select	1: Enabled
L3-04	Stall Prevention during Decel	1: General Purpose

The drive saves the parameters in [Table 12.13](#) as User Parameters.

Table 12.13 Parameters Saved as User Parameters with the Air Compressor Preset

User Parameter No.	Parameter No. Saved	Name
A2-01	b1-01	Frequency Reference Selection 1
A2-02	b1-02	Run Command Selection 1
A2-03	b1-04	Reverse Operation Selection
A2-04	C1-01	Acceleration Time 1
A2-05	C1-02	Deceleration Time 1
A2-06	E1-03	V/f Pattern Selection
A2-07	E1-07	Mid Point A Frequency
A2-08	E1-08	Mid Point A Voltage
A2-09	E2-01	Motor Rated Current (FLA)

8 : Conveyor 2

The drive automatically sets the parameters in [Table 12.14](#) for a conveyor 2 application.

Table 12.14 Best Parameter Settings for Conveyor 2 Application

No.	Name	Optimal Value
A1-02	Control Method Selection	0: V/f Control
C1-01	Acceleration Time 1	3.0 s
C1-02	Deceleration Time 1	3.0 s
C6-01	Normal / Heavy Duty Selection	0: Heavy Duty Rating
L3-04	Stall Prevention during Decel	7: Overexcitation/High Flux 3
n3-13	OverexcitationBraking (OEB) Gain	1.40
n3-21	HSB Current Suppression Level	150

The drive saves the parameters in [Table 12.15](#) as User Parameters.

Table 12.15 Parameters Saved as User Parameters with the Conveyor 2 Preset

User Parameter No.	Parameter No. Saved	Name
A2-01	A1-02	Control Method Selection
A2-02	b1-01	Frequency Reference Selection 1
A2-03	b1-02	Run Command Selection 1
A2-04	C1-01	Acceleration Time 1
A2-05	C1-02	Deceleration Time 1
A2-06	E2-01	Motor Rated Current (FLA)
A2-07	L3-04	Stall Prevention during Decel
A2-08	n3-13	OverexcitationBraking (OEB) Gain
A2-09	n3-21	HSB Current Suppression Level

■ A1-07: DriveWorksEZ Function Selection

No. (Hex.)	Name	Description	Default (Range)
A1-07 (0128)	DriveWorksEZ Function Selection	<div style="display: flex; gap: 5px;"> V/f OLV OLV/PM AOLV/PM EZOLV </div> Sets the drive to operate with DriveWorksEZ.	0 (0 - 2)

DriveWorksEZ is a simple visual programming tool that lets you connect function blocks to customize the drive and add PLC functions.

Note:

- DriveWorksEZ will overwrite drive settings when it uses MFDI/MFDO and MFAI/MFAO. When you use DriveWorksEZ to make changes to the drive, the changes will stay after you disable DriveWorksEZ.
- For more information about DriveWorksEZ, contact Yaskawa or your nearest sales representative.

0 : DWEZ Disabled

1 : DWEZ Enabled

2 : Enabled/Disabled wDigital Input

Set $H1-xx = 9F$ [MFDI Function Select = DWEZ Disable]. Deactivate the digital input to enable programs made with DriveWorksEZ. Activate the terminal to disable the programs.

If $A1-07 = 1$ [DriveWorksEZ Function Selection = DWEZ Enabled], the drive will continue to disable DWEZ when these conditions are true:

- Drive is not in operation
- The MFDI terminals set for $H1-xx = 9F$ activate.

■ A1-11: Firmware Update Lock

No. (Hex.)	Name	Description	Default (Range)
A1-11 (111D) Expert	Firmware Update Lock	<div style="display: flex; gap: 5px;"> V/f OLV OLV/PM AOLV/PM EZOLV </div> Protects the drive firmware. When you enable the protection, you cannot update the drive firmware.	0 (0, 1)

0 : Disabled

Lock is disabled.

1 : Enabled

Lock is enabled.

■ A1-12: Bluetooth ID

No. (Hex.)	Name	Description	Default (Range)
A1-12 (1564)	Bluetooth ID	<div style="display: flex; gap: 5px;"> V/f OLV OLV/PM AOLV/PM EZOLV </div> Sets the password necessary to use Bluetooth to control the drive with a smartphone or tablet.	- (0000 - 9999)

◆ A2: User Parameters

You can register frequently used parameters and recently changed parameters here to access them quickly. Use Setup Mode to show the saved parameters.

■ A2-01 to A2-32: User Parameters 1 to 32

No. (Hex.)	Name	Description	Default (Range)
A2-01 to A2-32 (0106 - 0125)	User Parameters 1 to 32	<div style="display: flex; gap: 5px;"> V/f OLV OLV/PM AOLV/PM EZOLV </div> You can select a maximum of 32 parameters for the drive and save the values to parameters <i>A2-01 to A2-32</i> . Use Setup Mode to show the saved parameters. You can immediately access these saved parameters.	Parameters in General-Purpose Setup Mode (Determined by A1-06)

Note:

- When the *A1-06 [Application Preset]* value changes, the settings for *A2-01 to A2-32* change.
- You must set *A1-01 = 1 [Access Level Selection = User Parameters]* to access parameters *A2-01 to A2-32*.
- When *A1-07 = 1 or 2 [DriveWorksEZ Function Selection = DWEZ Enabled or Enabled/Disabled wDigital Input]*, the drive saves *qx-xx [DriveWorksEZ Parameters]* to *A2-01 to A2-32*.

The drive saves these parameters to *A2-01 to A2-32*.

- The drive saves a maximum of 32 parameters.

Note:

Set *A1-01 = 2 [Advanced Level]* or *A1-01 = 3 [Expert Level]* to save the necessary parameters.

- The drive automatically saves changed parameters to *A2-17 to A2-32*.

Note:

Set *A2-33 = 1 [User Parameter Auto Selection = Enabled]*.

■ A2-33: User Parameter Auto Selection

No. (Hex.)	Name	Description	Default (Range)
A2-33 (0126)	User Parameter Auto Selection	<div style="display: flex; gap: 5px;"> V/f OLV OLV/PM AOLV/PM EZOLV </div> Sets the automatic save feature for changes to parameters <i>A2-17 to A2-32 [User Parameters 17 to 32]</i> .	Determined by A1-06 (0, 1)

0 : Disabled: Manual Entry Required

Set User Parameters manually.

1 : Enabled: Auto Save Recent Parm

12.2 A: Initialization Parameters

The drive automatically registers changed parameter *A2-17 to A2-32*. The drive automatically saves the most recently changed parameter to *A2-17*, and saves a maximum of 16 parameters. After the drive registers 16 parameters, when you save a new parameter, the drive will remove a parameter from the User Parameter list to make space for the new parameter. The drive removes parameters with First In, First Out.

Use Setup Mode to show the saved parameters.

Note:

In General-Purpose Setup Mode, the drive saves parameters starting with *A2-27* because the drive saves parameters *A2-26* and lower by default.

12.3 b: Application

b parameters set these functions:

- Frequency reference source/Run command source
- Stopping method settings
- DC Injection Braking
- Speed Search
- Timer Function
- PID control
- Dwell function
- Energy-Saving Control

◆ b1: Operation Mode Selection

b1 parameters set the operation mode for the drive.

■ b1-01: Frequency Reference Selection 1

No. (Hex.)	Name	Description	Default (Setting Range)
b1-01 (0180)	Frequency Reference Selection 1	<div style="display: flex; justify-content: space-around; align-items: center;"> V/f OLV OLVPM AOLVPM EZOLV </div> Sets the input method for the frequency reference.	1 (0 - 4)

Note:

- Push **LO/RE** on the keypad to set the input mode to LOCAL and use the keypad to enter the frequency reference.
- If the frequency reference is 0 Hz or less than the value set in *E1-09 [Minimum Output Frequency]* and the drive receives the Run command, the RUN LED on the keypad will flash. Examine the setting for the frequency reference input and enter a value \geq E1-09.

0 : Keypad

Use the keypad to enter the frequency reference.

Use **▲** and **▼** on the keypad to change the frequency reference.

1 : Analog Input

Use MFAI terminals A1 and A2 to input an analog frequency reference with a voltage or current input signal.

• Voltage Input

Refer to [Table 12.16](#) to use a voltage signal input to one of the MFAI terminals.

Table 12.16 Frequency Reference Voltage Input

Terminal	Terminal Signal Level	Parameter Settings				Note
		Signal Level Selection	Function Selection	Gain	Bias	
A1	0 - 10 V	H3-01 = 0	H3-02 = 0	H3-03	H3-04	-
	-10 - +10 V	H3-01 = 4	[Frequency Reference]			
A2	0 - 10 V	H3-09 = 0	H3-10 = 0	H3-11	H3-12	Set DIP switch S1 to "V" for voltage input.
	-10 - +10 V	H3-09 = 4	[Frequency Reference]			

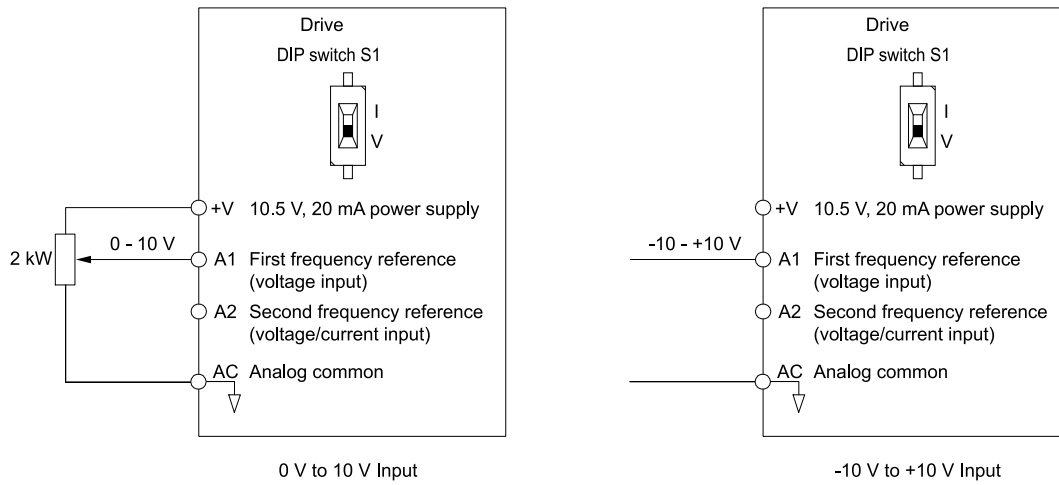

Figure 12.1 Example of Setting the Frequency Reference with a Voltage Signal to Terminal A1

Note:

You can also use this diagram to wire terminal A2.

• **Current Input**

Refer to [Table 12.17](#) to use a current signal input to one of the MFAI terminals.

Table 12.17 Frequency Reference Current Input

Terminal	Signal Level	Parameter Settings				Note
		Signal Level Selection	Function Selection	Gain	Bias	
A2	4 - 20 mA	H3-09 = 2	H3-10 = 0 [Frequency Reference]	H3-11	H3-12	Set DIP switch S1 to "I" for current input.
	0 - 20 mA	H3-09 = 3				

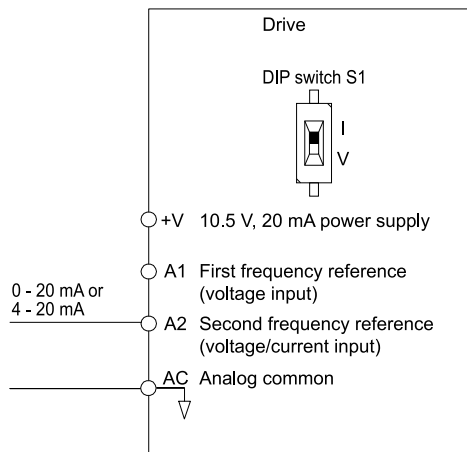

Figure 12.2 Example of Setting the Frequency Reference with a Current Signal to Terminal A2

Changing between Master and Auxiliary Frequency References

Use the multi-step speed reference function to change the frequency reference input between terminals A1 and A2.

2 : Memobus/Modbus Communications

Use MEMOBUS/Modbus communications to enter the frequency reference.

3 : Option PCB

Use a communications option connected to the drive to enter the Run command.

Refer to the instruction manual included with the option to install and set the option.

Note:

If *b1-01 = 3* but you did not connect an option, *oPE05 [Run Cmd/Freq Ref Source Sel Err]* will flash on the keypad.





4 : Pulse Train Input

Use a pulse train signal from the pulse train input terminal RP to enter the frequency reference.

Do this procedure to make sure that the pulse train signal is operating correctly.

1. Set $b1-01 = 4$, $H6-01 = 0$ [*Terminal RP Pulse Train Function = Frequency Reference*].
2. Set $H6-02$ [*Terminal RP Frequency Scaling*] to the number of pulses that determine 100% of the frequency reference.
3. Enter a pulse train signal on the terminal RP and make sure that the keypad shows a correct frequency reference.

■ b1-02: Run Command Selection 1

No. (Hex.)	Name	Description	Default (Range)
b1-02 (0181)	Run Command Selection 1	     Sets the input method for the Run command.	1 (0 - 3)

0 : Keypad

Use the keypad to enter the Run command.

You can use the JOG operation or the FWD/REV commands from the keypad.

Note:

The  on the keypad is on while keypad is the Run command source.

1 : Analog Input

Use the control circuit terminals to enter the Run command. Select the input method for the Run command with an $H1-xx$ parameter.

Set $H1-xx = 0, 40$ to 43 [*3-Wire Sequence, Run Command (2-Wire Sequence)*]. The default setting is 2-wire sequence 1.

- 2-wire Sequence 1
This sequence has two input types: FWD/Stop and REV/Stop. Set $A1-03 = 2220$ [*Initialize Parameters = 2-Wire Initialization*] to initialize the drive and set terminals S1 and S2 for a 2-wire sequence.
- 2-wire Sequence 2
This sequence has two input types: Run/Stop and FWD/REV.
- 3-Wire Sequence
This sequence has three input types: Run, Stop, and FWD/REV. Set $A1-03 = 3330$ [*Initialize Parameters = 3-Wire Initialization*] to initialize the drive and set terminals S1, S2, and S5 for a 3-wire sequence.

2 : Memobus/Modbus Communications

Use MEMOBUS/Modbus communications to enter the Run command.

3 : Option PCB





Use a communications option card or input option card connected to the drive to enter the Run command.

Refer to the instruction manual included with the option card to install and set the option card.

Note:

If $b1-02 = 3$, but you did not connect a communications option card, $oPE05$ [*Run Cmd/Freq Ref Source Sel Err*] will flash on the keypad.

■ b1-03: Stopping Method Selection

No. (Hex.)	Name	Description	Default (Range)
b1-03 (0182)	Stopping Method Selection	     Sets the method to stop the motor after removing a Run command or entering a Stop command.	0 (0 - 3)

Note:

When $A1-02 = 5, 6, 8$ [*Control Method Selection = OLV/PM, AOLV/PM, EZOLV*], the setting range is 0, 1, 3.

Select the applicable stopping method for the application from these four options:

0 : Ramp to Stop

When you enter the Stop command or turn OFF the Run command, the drive ramps the motor to stop.

The drive ramps the motor to stop as specified by the deceleration time. The default setting for the deceleration time is *C1-02 [Deceleration Time 1]*. The actual deceleration time changes as the load conditions change (for example, mechanical loss and inertia).

If the output frequency is less than or equal to the value set in *b2-01 [DC Injection/Zero SpeedThreshold]* during deceleration, the drive will do DC Injection Braking, Zero Speed Control, or Short Circuit Braking, as specified by the control method.

• Ramp to Stop with V/f Control and OLV Control Methods

Parameter *b2-01* sets the frequency to start DC Injection Braking at stop. If the output frequency is less than or equal to the value set in *b2-01* during deceleration, then the drive will perform DC Injection Braking for the time set in *b2-04 [DC Inject Braking Time at Stop]*.

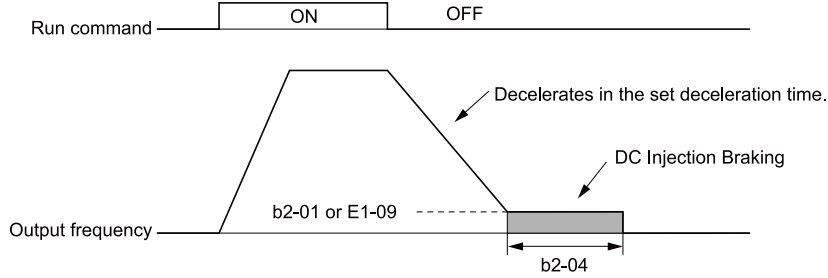

Figure 12.3 Ramp to Stop with V/f and OLV Control Methods

Note:

When $b2-01 \leq E1-09$ [Minimum Output Frequency], the drive will start DC Injection Braking from the frequency set in *E1-09*.

• Ramp to Stop with OLV/PM, AOLV/PM, and EZOLV Control Methods

Parameter *b2-01* sets the frequency to start Short Circuit Braking. When the output frequency is less than or equal to the value set in *b2-01* during deceleration, then the drive will do Short Circuit Braking for the time set in *b2-13 [Short Circuit Brake Time @ Stop]*. When $b2-04 \neq 0$, the drive will do DC Injection Braking for the time set in *b2-04* when Short Circuit Braking is complete.

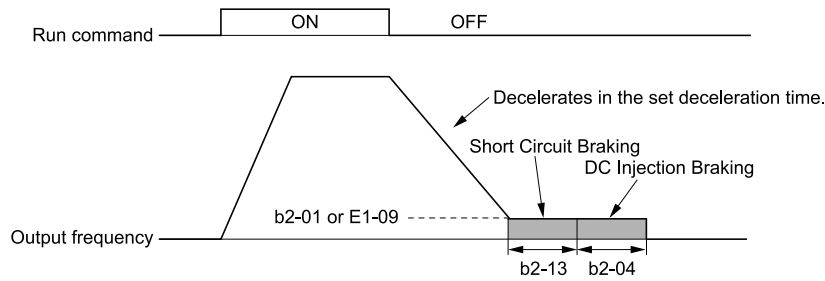

Figure 12.4 Ramp to Stop with OLV/PM, AOLV/PM, and EZOLV Control Methods

Note:

When $b2-01 \leq E1-09$, the drive will start Short Circuit Braking from the frequency set in *E1-09*.

If $b2-01 = 0$ Hz and $E1-09 = 0$ Hz, the drive will not do Short Circuit Braking.

1 : Coast to Stop

When you enter the Stop command or turn OFF the Run command, the drive turns OFF the output and coasts the motor to stop.

Load conditions will have an effect on the deceleration rate as the motor coasts to stop (for example, mechanical loss and inertia).

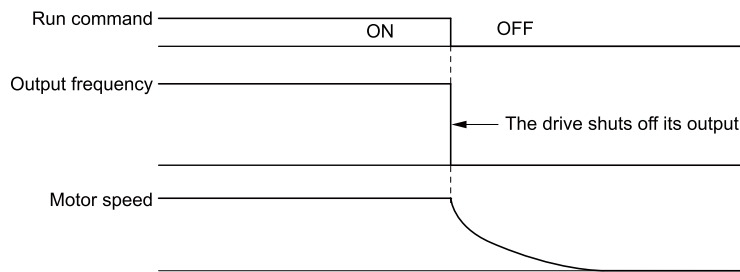

Figure 12.5 Coast to Stop

Note:

When you enter the Stop command or turn OFF the Run command, the drive ignores the Run command for the time set in *L2-03* [Minimum Baseblock Time]. Do not enter the Run command until the motor comes to a complete stop. Use DC Injection or Speed Search to restart the motor before it stops.

2 : DC Injection Braking to Stop

When you enter the Stop command or turn OFF the Run command, the drive turns OFF the output for the time set in *L2-03*. The drive waits for the minimum baseblock time and then injects the amount of DC current into the motor set in *b2-02* [DC Injection Braking Current] to stop the motor with DC current.

DC Injection Braking stops the motor more quickly than coast to stop.

Note:

If *A1-02* = 5, 6, DC Injection Braking to Stop is not available.

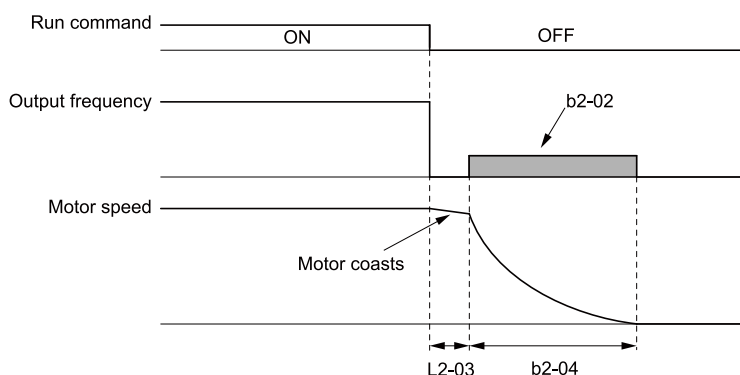

Figure 12.6 DC Injection Braking to Stop

The value set in *b2-04* and the output frequency when the drive receives the Stop command determine the DC Injection Braking time. The drive calculates the DC Injection Braking time as in Figure 12.7.

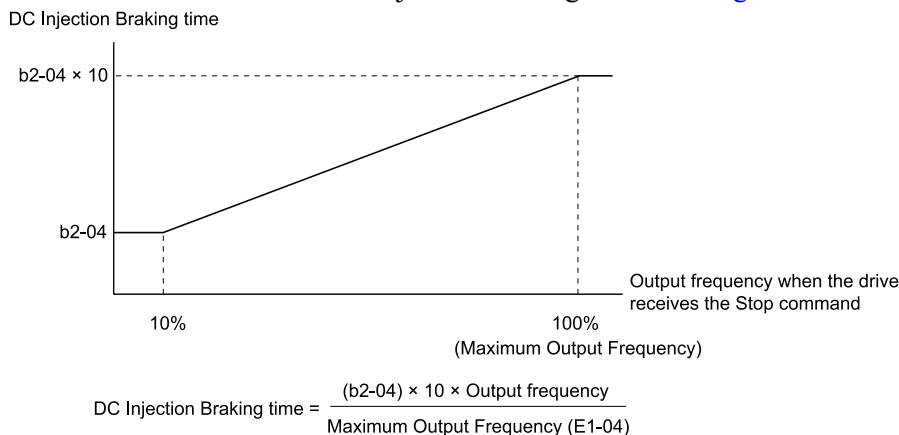

Figure 12.7 DC Injection Braking Time and Output Frequency

Note:

Set *L2-03* to a high value that will not trigger *oC* [Overcurrent] when the drive uses DC Injection Braking to stop the motor.

3 : Coast to Stop with Timer

Enter the Stop command or turn OFF the Run command and turn OFF drive output and coast the motor to stop. The drive ignores the Run command until the “Run wait time t ” is expired.

To start the drive again, wait until the the “Run wait time t ” is expired then enter the Run command.

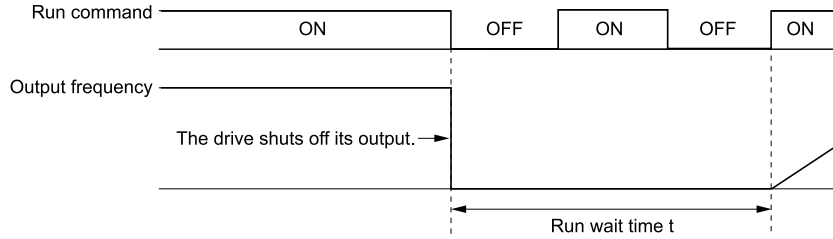

Figure 12.8 Coast to Stop with Timer

The active deceleration time and the output frequency when drive receives the Stop command determine the length of “Run wait time t ”.

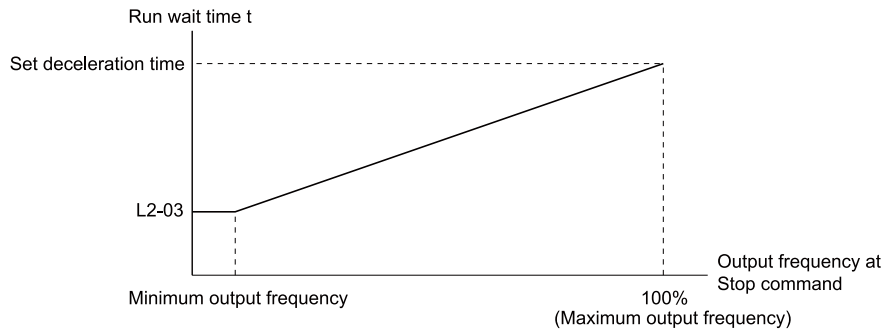

Figure 12.9 Run Wait Time and Output Frequency

■ b1-04: Reverse Operation Selection

No. (Hex.)	Name	Description	Default (Range)
b1-04 (0183)	Reverse Operation Selection	<input type="checkbox"/> V/f <input type="checkbox"/> OLV <input type="checkbox"/> OLV/PM <input type="checkbox"/> AOLV/PM <input type="checkbox"/> EZOLV Sets the reverse operation function. Disable reverse operation in fan or pump applications where reverse rotation is dangerous.	0 (0, 1)

When reverse operation is prohibited, the drive will not accept a Reverse operation command.

0 : Reverse Enabled

The drive will accept a Reverse operation command.

1 : Reverse Disabled

The drive will not accept a Reverse operation command.

■ b1-06: Digital Input Reading

No. (Hex.)	Name	Description	Default (Range)
b1-06 (0185)	Digital Input Reading	<input type="checkbox"/> V/f <input type="checkbox"/> OLV <input type="checkbox"/> OLV/PM <input type="checkbox"/> AOLV/PM <input type="checkbox"/> EZOLV Sets the number of times that the drive reads the sequence input command to prevent malfunction because of electrical interference.	1 (0, 1)

0 : Single Scan

The drive reads the terminal status one time. The drive immediately reads all changes to the terminal status.

This setting lets the drive quickly respond to changes in the sequence, but noise can cause malfunction.

1 : Double Scan

The drive reads all changes to the terminal status two times to make sure that the reading is the same.

The drive responds slower than when it reads the sequence one time, but this setting prevents malfunction because of electrical interference.

■ b1-07: LOCAL/REMOTE Run Selection

No. (Hex.)	Name	Description	Default (Range)
b1-07 (0186)	LOCAL/REMOTE Run Selection	V/f OLV OLV/PM AOLV/PM EZOLV Sets drive response to an existing Run command when the drive receives a second Run command from a different location.	0 (0, 1)

This parameter interlocks the drive to help prevent accidents that can occur if the motor starts to rotate because the Run command source changed.

To switch the RUN command source, push **LO/RE** on the keypad or set $HI-xx = 1, 2$ [MFDI Function Selection = LOCAL/REMOTE Selection, External Reference 1/2 Selection] and activate/deactivate the terminal.

0 : Disregard Existing RUN Command

If a Run command is enabled when you switch between Run command sources, the drive will not operate the motor. When the drive is operating the motor, turn OFF the Run command to stop the motor. Enter the Run command again to start operation.

1 : Accept Existing RUN Command

If a Run command is enabled when you switch between Run command sources, the drive will start to operate the motor or continue to operate the motor.

WARNING! Sudden Movement Hazard. When you use a 3-Wire sequence, set $A1-03 = 3330$ [Initialize Parameters = 3-Wire Initialization] and make sure that $b1-17 = 0$ [Run Command at Power Up = Disregard Existing RUN Command] (default). If you do not correctly set the drive parameters for 3-Wire operation before you energize the drive, the motor can suddenly rotate when you energize the drive.

■ b1-08: Run Command Select in PRG Mode

No. (Hex.)	Name	Description	Default (Range)
b1-08 (0187)	Run Command Select in PRG Mode	V/f OLV OLV/PM AOLV/PM EZOLV Sets the conditions for the drive to accept a Run command entered from an external source when using the keypad to set parameters.	0 (0 - 2)

As a safety precaution, when the drive is in Programming Mode, it will not respond to a Run command.

This parameter helps prevent accidents that can occur if the motor starts to rotate because the drive received a Run command from an external source while the user is programming the drive. You can also set the drive to not show the Programming Mode when a Run command is active.

Note:

Refer to this table for Drive Mode and Programming Mode functions.

Mode	Keypad Screen	Function
Drive Mode	Monitors	Sets monitor display.
Programming Mode	Parameters	Changes parameter settings.
	User Custom Parameters	Shows the User Parameters.
	Parameter Backup/Restore	Saves parameters to the keypad as backup.
	Modified Parameters/Fault Log	Shows modified parameters and fault history.
	Auto-Tuning	Auto-Tunes the drive.
	Initial Setup Screen	Changes initial settings.
	Diagnostic Tools	Sets data logs and backlight.

0 : Disregard RUN while Programming

The drive does not accept the Run command when setting the parameters in the Programming Mode.

1 : Accept RUN while Programming

The drive accepts a Run command entered from an external source when setting the parameters in Programming Mode.

2 : Allow Programming Only at Stop

The drive does not allow the user to enter the Programming Mode while the drive is operating. The keypad does not display the Programming Mode while the drive is operating.

■ **b1-14: Phase Order Selection**

No. (Hex.)	Name	Description	Default (Range)
b1-14 (01C3)	Phase Order Selection	<div style="display: flex; justify-content: space-between; align-items: center;"> V/f OLV OLV/PM AOLV/PM EZOLV </div> <p>Sets the phase order for output terminals U/T1, V/T2, and W/T3. This parameter can align the Forward Run command from the drive and the forward direction of the motor without changing wiring.</p>	0 (0, 1)

0 : Standard

1 : Switch Phase Order

■ **b1-15: Frequency Reference Selection 2**

No. (Hex.)	Name	Description	Default (Range)
b1-15 (01C4)	Frequency Reference Selection 2	<div style="display: flex; justify-content: space-between; align-items: center;"> V/f OLV OLV/PM AOLV/PM EZOLV </div> <p>Sets the input method for frequency reference 2.</p>	0 (0 - 4)

This parameter is enabled when $H1-xx = 2$ [MFDI Function Selection = External Reference 1/2 Selection] is activated.

Note:

- Push **LO/RE** on the keypad to set the input mode to LOCAL and use the keypad to enter the frequency reference.
- If the frequency reference is 0 Hz or less than or equal to the value set in $E1-09$ [Minimum Output Frequency] and the drive receives the Run command, the RUN LED on the keypad will flash. Examine the setting for the frequency reference input and enter a value more than or equal to $E1-09$.

0 : Keypad

Use the keypad to enter the frequency reference.

Use **▲** and **▼** on the keypad to change the frequency reference.

1 : Analog Input

Use MFAI terminals A1 and A2 to input an analog frequency reference with a voltage or current input signal.

• Voltage Input

Refer to [Table 12.18](#) to use a voltage signal input to one of the MFAI terminals.

Table 12.18 Frequency Reference Voltage Input

Terminal	Terminal Signal Level	Parameter Settings				Note
		Signal Level Selection	Function Selection	Gain	Bias	
A1	0 - 10 V	H3-01 = 0	H3-02 = 0	H3-03	H3-04	-
	-10 - +10 V	H3-01 = 4	[Frequency Reference]			
A2	0 - 10 V	H3-09 = 0	H3-10 = 0	H3-11	H3-12	Set DIP switch S1 to "V" for voltage input.
	-10 - +10 V	H3-09 = 4	[Frequency Reference]			

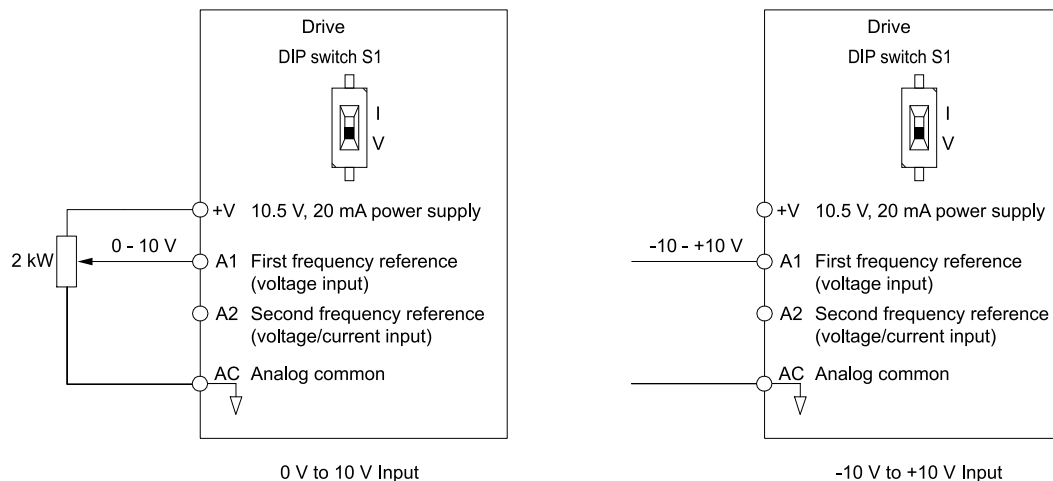

Figure 12.10 Example of Setting the Frequency Reference with a Voltage Signal to Terminal A1

Note:

You can also use this diagram to wire terminal A2.

• **Current Input**

Refer to Table 12.19 to use a current signal input to one of the MFAI terminals.

Table 12.19 Frequency Reference Current Input

Terminal	Signal Level	Parameter Settings				Note
		Signal Level Selection	Function Selection	Gain	Bias	
A2	4 - 20 mA	H3-09 = 2	H3-10 = 0	H3-11	H3-12	Set DIP switch S1 to "I" for current input.
	0 - 20 mA	H3-09 = 3	[Frequency Reference]			

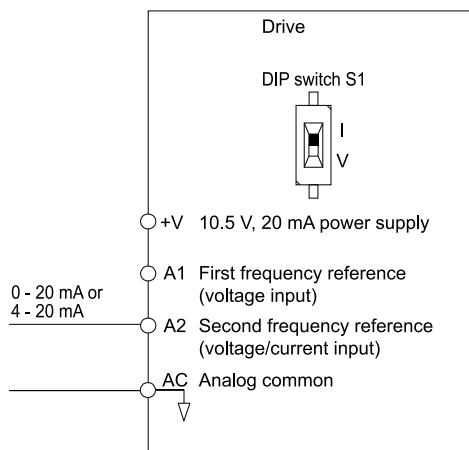

Figure 12.11 Example of Setting the Frequency Reference with a Current Signal to Terminal A2

Changing between Master and Auxiliary Frequency References

Use the multi-step speed reference function to change the frequency reference input between terminals A1 and A2.

2 : Memobus/Modbus Communications

Use MEMOBUS/Modbus communications to enter the frequency reference.

3 : Option PCB

Use a communications option card connected to the drive to enter the Run command.

Refer to the instruction manual included with the option card to install and set the option card.

Note:

If you set *b1-15* = 3 but you do not connect an option card, *oPE03* [Multi-Function Input Setting Err] will flash on the keypad.

4 : Pulse Train Input





12.3 b: Application

Use a pulse train signal from the pulse train input terminal RP to enter the frequency reference.

Do this procedure to make sure that the pulse train signal is operating correctly.

1. Set $b1-15 = 4$, $H6-01 = 0$ [*Terminal RP Pulse Train Function = Frequency Reference*].
2. Set $H6-02$ [*Terminal RP Frequency Scaling*] to the number of pulses that determine 100% of the frequency reference.
3. The terminal set in $H1-xx = 2$ [*MFDI Function Selection = External Reference 1/2 Selection*] is activated.
4. Enter a pulse train signal on the terminal RP and make sure that the keypad shows a correct frequency reference.

■ b1-16: Run Command Selection 2

No. (Hex.)	Name	Description	Default (Range)
b1-16 (01C5)	Run Command Selection 2	     Sets the input method for Run Command 2 when the user switches the control circuit terminals ON/OFF to change the Run command source.	0 (0 - 3)

Activate $H1-xx = 2$ [*MFDI Function Selection = External Reference 1/2 Selection*] to enable this parameter.

0 : Keypad

Use the keypad to enter the Run command.

You can use the JOG operation or the FWD/REV commands from the keypad.

Note:

The  is on while the keypad is the Run command source.

1 : Digital Input

Use the control circuit terminals to enter the Run command. Select the input method for the Run command with an $H1-xx$ parameter.

Set $H1-xx = 0, 40$ to 43 [*3-Wire Sequence, Run Command (2-Wire Sequence)*]. The default setting is 2-wire sequence 1.

- 2-wire Sequence 1
This sequence has two input types: FWD/Stop and REV/Stop. Set $A1-03 = 2220$ [*Initialize Parameters = 2-Wire Initialization*] to initialize the drive and set terminals S1 and S2 for a 2-wire sequence.
- 2-wire Sequence 2
This sequence has two input types: Run/Stop and FWD/REV.
- 3-Wire Sequence
This sequence has three input types: Run, Stop, and FWD/REV. Set $A1-03 = 3330$ [*Initialize Parameters = 3-Wire Initialization*] to initialize the drive and set terminals S1, S2, and S5 for a 3-wire sequence.

2 : Memobus/Modbus Communications

Use MEMOBUS/Modbus communications to enter the Run command.

3 : Option PCB





Use a communications option card or input option card connected to the drive to enter the Run command.

Refer to the instruction manual included with the option card to install and set the option card.

Note:

If $b1-16 = 3$ but no option card is connected, then $oPE03$ [*Multi-Function Input Setting Err*] will flash on the keypad.

■ b1-17: Run Command at Power Up

No. (Hex.)	Name	Description	Default (Range)
b1-17 (01C6)	Run Command at Power Up	     Sets drive response when the CPU changes from de-energized to energized and there is an active Run command. Set this parameter in applications where energizing or de-energizing the drive enables the Run command. When the CPU stays energized during loss of power, $L2-01$ [<i>Power Loss Ride Through Select</i>] sets operation.	0 (0, 1)

0 : Disregard Existing RUN Command

The drive does not start to operate the application when you apply power, even when there is an existing Run command.

Enter the Run command again to operate the application.

Note:



When you energize the drive,  on the keypad will flash quickly if the Run command is already enabled from an external source.

1 : Accept Existing RUN Command

When there is an existing Run command, the drive starts to operate the application when you apply power.

WARNING! Sudden Movement Hazard. When you use a 3-Wire sequence, set $A1-03 = 3330$ [Initialize Parameters = 3-Wire Initialization] and make sure that $b1-17 = 0$ [Run Command at Power Up = Disregard Existing RUN Command] (default). If you do not correctly set the drive parameters for 3-Wire operation before you energize the drive, the motor can suddenly rotate when you energize the drive.

■ b1-35: Digital Input Deadband Time

No. (Hex.)	Name	Description	Default (Range)
b1-35 (1117) Expert	Digital Input Deadband Time	V/f OLV OLV/PM AOLV/PM EZOLV Sets the deadband time for MFDIs.	0.0 ms (0.0 to 100.0 ms)

When the on/off time for MFDIs is longer than the time set in $b1-35$, the drive activates the MFDI. Set this parameter to prevent malfunctions caused by relay chattering for applications in which relays send input to MFDI terminals.

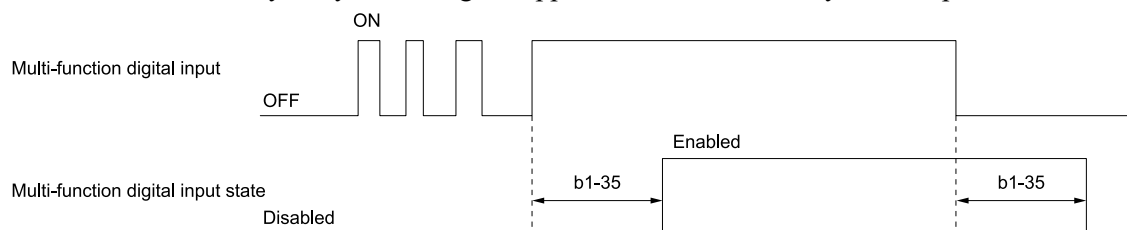

◆ b2: DC Injection Braking and Short Circuit Braking

$b2$ parameters set the DC Injection Braking and Short Circuit Braking functions.

- DC Injection Braking: A braking method that injects DC current into the motor windings. This function should not be used too frequently, because it generates a fair amount of heat in the motor.
- Short Circuit Braking: A braking method for PM motors.

■ b2-01: DC Injection/Zero SpeedThreshold

No. (Hex.)	Name	Description	Default (Range)
b2-01 (0189)	DC Injection/Zero SpeedThreshold	V/f OLV OLV/PM AOLV/PM EZOLV Sets the frequency to start DC Injection Braking or Short Circuit Braking near the end of a stop ramp.	Determined by A1-02 (0.0 - 10.0 Hz)

Note:

This parameter is available when $b1-03 = 0$ [Stopping Method Selection = Ramp to Stop].

When the control method selected in $A1-02$ [Control Method Selection] changes, the $b2-01$ function changes.

Parameter Settings	Functions of b2-01
$A1-02 = 0, 2 [V/f \text{ or } OLV]$	<p>Parameter $b2-01$ sets the frequency to start DC Injection Braking at stop. When the output frequency is less than or equal to the value set in $b2-01$, the drive will inject the quantity of DC current set in $b2-02$ [DC Injection Braking Current] into the motor for the time set in $b2-04$ [DC Inject Braking Time at Stop].</p> <p>Figure 12.12 DC Injection Braking at Stop</p> <p>Note: When $b2-01 \leq E1-09$ [Minimum Output Frequency], the drive will start DC Injection Braking from the frequency set in $E1-09$.</p>
$A1-02 = 5, 6, \text{ or } 8 [OLV/PM, AOLV/PM, \text{ or } EZOLV]$	<p>Parameter $b2-01$ sets the frequency to start Short Circuit Braking at stop. When the output frequency is less than or equal to the value set in $b2-01$, the drive will do Short Circuit Braking for the time set in $b2-13$ [Short Circuit Brake Time @ Stop]. When $b2-04 > 0.00 \text{ s}$, the drive will complete Short Circuit Braking, then do DC Injection Braking for the time set in $b2-04$.</p> <p>Figure 12.13 Short Circuit Braking at Stop</p> <p>Note: When $b2-01 \leq E1-09$, the drive will start Short Circuit Braking from the frequency set in $E1-09$. If $b2-01$ and $E1-09 = 0 \text{ Hz}$, the drive will not do Short Circuit Braking.</p>

■ **b2-02: DC Injection Braking Current**

No. (Hex.)	Name	Description	Default (Range)
b2-02 (018A)	DC Injection Braking Current	V/f OLV OLV/PM AOLV/PM EZOLV Sets the DC Injection Braking current as a percentage of the drive rated current.	50% (0 - 75%)

When the DC Injection Braking current is more than 50%, the drive decreases the carrier frequency to 1 kHz. The motor rated current determines how much DC Injection Braking current that the drive can use.

The DC Injection Braking current level has an effect on the strength of the magnetic field that locks the motor shaft. As the current level increases, the motor windings will supply more heat. Do not set this parameter higher than the level that is necessary to hold the motor shaft.

■ **b2-03: DC Inject Braking Time at Start**

No. (Hex.)	Name	Description	Default (Range)
b2-03 (018B)	DC Inject Braking Time at Start	V/f OLV OLV/PM AOLV/PM EZOLV Sets the DC Injection Braking Time at stop.	0.00 s (0.00 - 10.00 s)

This function stops then restarts a coasting motor and increases motor flux to make high starting torque (a process called initial excitation). Set this parameter to 0.00 to disable the function.

Note:

To restart a coasting motor, use DC Injection Braking to stop and then restart the motor, or enable Speed Search. Enable DC Injection Braking or Speed Search to prevent *ov* [Overvoltage] or *oC* [Overcurrent] faults.

■ **b2-04: DC Inject Braking Time at Stop**

No. (Hex.)	Name	Description	Default (Range)
b2-04 (018C)	DC Inject Braking Time at Stop	V/f OLV OLV/PM AOLV/PM EZOLV Sets the DC Injection Braking Time at stop.	Determined by A1-02 (0.00 - 10.00 s)

This function fully stops a motor with a large inertia during deceleration and will not let the inertia continue to rotate the motor.

Set this parameter to 0.00 to disable the function.

When a longer time is required to stop the motor, increase the value.

■ b2-08: Magnetic Flux Compensation Value

No. (Hex.)	Name	Description	Default (Range)
b2-08 (0190)	Magnetic Flux Compensation Value	<div style="display: flex; justify-content: space-between; align-items: center;"> V/f OLV OLV/PM AOLV/PM EZOLV </div> Sets how much current the drive injects when DC Injection Braking at Start starts (Initial Excitation) as a percentage of E2-03 [Motor No-Load Current].	0% (0 - 1000%)

This parameter is effective when you start a high-capacity motor (a motor with a large secondary circuit time constant). This function can quickly increase motor flux to make high starting torque (a process called initial excitation).

The current level for DC Injection Braking at start changes linearly from the setting of b2-08 to the setting of b2-03 as shown in Figure 12.14.

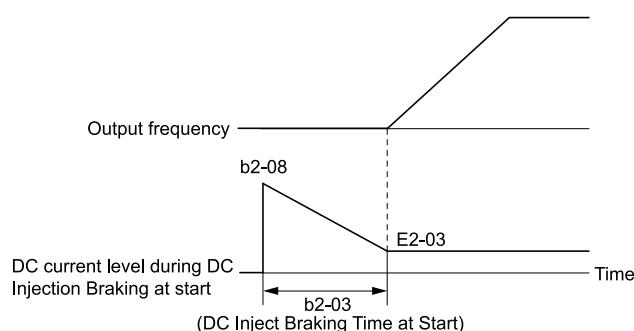

Figure 12.14 DC Current Level during DC Injection Braking at Start

Note:

- If $b2-08 < 100\%$, flux will develop very slowly.
- When $b2-08 = 0\%$, the DC current level will be the DC Injection current set in b2-02 [DC Injection Braking Current].
- If $b2-08$ is set too high, DC Injection Braking at start can cause a large noise. Adjust $b2-08$ to decrease the volume to the permitted level.

■ b2-12: Short Circuit Brake Time @ Start

No. (Hex.)	Name	Description	Default (Range)
b2-12 (01BA)	Short Circuit Brake Time @ Start	<div style="display: flex; justify-content: space-between; align-items: center;"> V/f OLV OLV/PM AOLV/PM EZOLV </div> Sets the Short Circuit Braking time at start.	0.00 s (0.00 - 25.50 s)

This function stops and restarts a coasting PM motor. The drive short circuits all the three motor phases to make braking torque in the motor.

Set this parameter to 0.00 to disable the function.

Note:

- Short circuit Braking will let external forces rotate the PM motor. Use DC Injection Braking to prevent motor rotation from external forces.
- Motor speed and load conditions can make it necessary to install a dynamic braking option on the drive.

■ b2-13: Short Circuit Brake Time @ Stop

No. (Hex.)	Name	Description	Default (Range)
b2-13 (01BB)	Short Circuit Brake Time @ Stop	<div style="display: flex; justify-content: space-between; align-items: center;"> V/f OLV OLV/PM AOLV/PM EZOLV </div> Sets the Short Circuit Braking time at stop.	A1-02 = 8: 0.00 s Other than A1-02 = 8: 0.50 s (0.00 - 25.50 s)

This function fully stops a PM motor with a large inertia during deceleration and will not let the inertia continue to rotate the motor.

12.3 b: Application

Short Circuit Braking operates for the time set in *b2-13* when output frequency is less than the value set in *b2-01* [*DC Injection/Zero SpeedThreshold*] or *E1-09* [*Minimum Output Frequency*].

Set this parameter to 0.00 to disable the function.

Note:

Motor speed and load conditions can make it necessary to install a dynamic braking option on the drive.

■ b2-18: Short Circuit Braking Current

No. (Hex.)	Name	Description	Default (Range)
b2-18 (0177)	Short Circuit Braking Current	<div style="display: flex; gap: 5px;"> V/f OLV OLV/PM AOLV/PM EZOLV </div> Sets the Short Circuit Braking Current as a percentage of the motor rated current.	100.0% (0.0 - 200.0%)

The Short Circuit Braking current cannot be higher than the drive rated current, although you can use *b2-18* to set a higher current level. The maximum rated current is 120% when the drive is set for Normal Duty (*C6-01* = 1 [*Normal Duty Rating*]). The maximum rated current is 150% when the drive is set for Heavy Duty (*C6-01* = 0 [*Heavy Duty Rating*]).

◆ b3: Speed Search

The Speed Search function detects the actual speed of a coasting motor, then restarts the motor before the motor stops. Use Speed Search in these conditions:

- To continue operation after momentary power loss
- To switch from commercial power supply to drive power
- To restart a coasting fan

For example, the drive output turns off and the motor coasts when there is a momentary loss of power. After you return power, the drive does Speed Search on the coasting motor, and restarts the motor from the detected speed.

When you use a PM motor, enable *b3-01* [*Speed Search at Start Selection*].

There are two types of Speed Search for induction motors: Current Detection and Speed Estimation. Use parameter *b3-24* [*Speed Search Method Selection*] to select the type of Speed Search.

Parameter settings are different for different types of Speed Search. Refer to [Table 12.20](#) for more information.

Table 12.20 Speed Search and Related Parameters

Parameter	Speed Estimation	Current Detection 2
	b3-24 = 1	b3-24 = 2
b3-01 [Speed Search at Start Selection]	x	x
b3-03 [Speed Search Deceleration Time]	-	x
b3-05 [Speed Search Delay Time]	x	x
b3-06 [Speed Estimation Current Level 1]	x	-
b3-07 [Speed Estimation Current Level 2]	x	-
b3-08 [Speed Estimation ACR P Gain]	x	-
b3-09 [Speed Estimation ACR I Time]	x	-
b3-10 [Speed Estimation Detection Gain]	x	-
b3-14 [Bi-directional Speed Search]	x	x
b3-17 [Speed Est Retry Current Level]	x	x
b3-18 [Speed Est Retry Detection Time]	x	x
b3-19 [Speed Search Restart Attempts]	x	x
b3-24 [Speed Search Method Selection]	x (1)	x (2)
b3-25 [Speed Search Wait Time]	x	x
b3-26 [Direction Determination Level]	x	-
b3-29 [Speed Search Back-EMF Threshold]	-	-

Parameter	Speed Estimation	Current Detection 2
	b3-24 = 1	b3-24 = 2
b3-31 [Spd Search Current Reference Lvl]	-	x
b3-32 [Spd Search Current Complete Lvl]	-	x
b3-33 [Speed Search during Uv Selection]	x	x
b3-54 [Search Time]	-	-
b3-55 [Current Increment Time]	-	-
b3-56 [InverseRotationSearch WaitTime]	-	x

Note:

- To use Speed Estimation Speed Search with V/f Control, do Rotational Auto-Tuning before you set the Speed Search function. If the wire length between the drive and motor changed since the last time you did Auto-Tuning, do Stationary Auto-Tuning for Line-to-Line Resistance process again.
- If $A1-02 = 5, 6$ [PM Open Loop Vector, PM Advanced Open Loop Vector] and the wiring distance between the motor and drive is long or if the motor is coasting at more than or equal to 120 Hz, do not use Speed Search to restart the motor. Use Short Circuit Braking.

■ Current Detection 2

Use this Speed Search function with induction motors. Set $b3-24 = 2$ [Speed Search Method Selection = Current Detection 2]. Current Detection Speed Search injects current into the motor to detect the speed of an induction motor. Speed Search increases the output voltage for the time set in $L2-04$ [Powerloss V/f Recovery Ramp Time], starting from the maximum output frequency or the frequency reference.

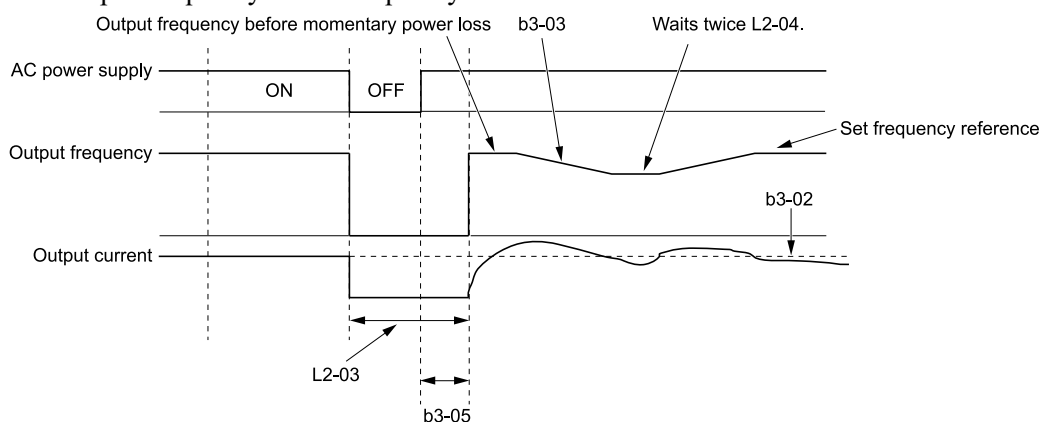

Figure 12.15 Current Detection 2 after Momentary Power Loss

Note:

After you restore power, the drive will not do Speed Search until the time set in $b3-05$ [Speed Search Delay Time] expires. This means that the drive will not always start Speed Search when the time set in $L2-03$ [Minimum Baseblock Time] expires.

If you enter the Run command at the same time as Speed Search, the drive will not do Speed Search until the time set in $L2-03$ expires. When the value set in $L2-03 < b3-05$, the drive will use the wait time set in $b3-05$.

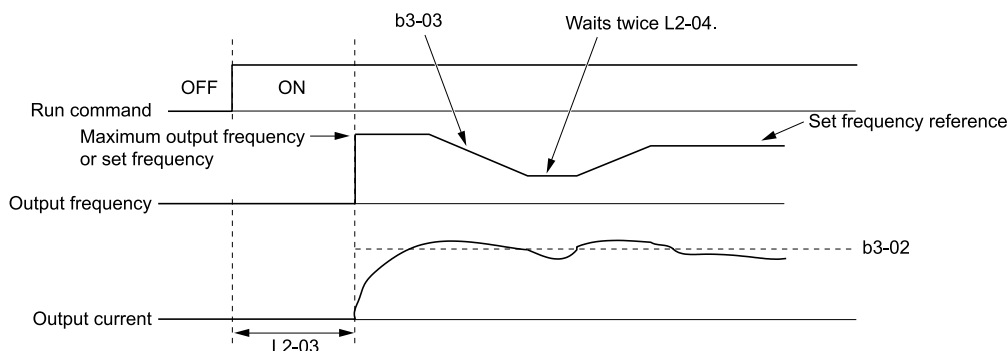

Figure 12.16 Speed Search Selection at Start (Current Detection Type)

WARNING! Sudden Movement Hazard. Do not do Current Detection Speed Search with light loads or a stopped motor. If you do Auto-Tuning in these conditions, the motor can suddenly accelerate and cause serious injury or death.

Note:

- You cannot use Current Detection Speed Search with PM motors.
- If the motor is rotating in reverse, you cannot do Speed Search.
- If the drive detects *oL1* [Motor Overload] during Current Detection Speed Search, decrease *b3-03*.
- If the drive detects *oC* [Overcurrent] or *ov* [Overvoltage] during Current Detection Speed Search after the drive recovers from a momentary power loss, increase *L2-03*.

■ **Speed Estimation**

Use this Speed Search function with induction motors. Set *b3-24* = 1 [Speed Search Method Selection = Speed Estimation]. This function uses less current and has a shorter search time than other functions. This function lets you do Speed Search when the motor is rotating in reverse. When you return power after a power loss, the motor will not suddenly accelerate.

Note:

You cannot do Speed Estimation Speed Search in these conditions:

- When You Operate More than One Motor with One Drive
- When you use a high-speed motor (120 Hz or higher)
- When you use a 1.5 kW or smaller motor.
- When the motor output is more than 1 frame size smaller than the drive capacity
- When there is a long wiring distance between the drive and motor

For these conditions, use Current Detection Speed Search.

Speed Estimation Speed Search uses these two steps to estimate the motor speed:

1. Residual Voltage Search

When there is a short baseblock time, the drive searches for residual voltage. The drive uses the residual voltage in the motor to estimate the motor speed and direction of rotation. The drive outputs the estimated motor speed as frequency, then uses the deceleration rate set in *L2-04* to increase the voltage. When the output voltage aligns with the V/f pattern, the drive accelerates or decelerates the motor to the frequency reference. If the drive cannot estimate the motor speed because of low residual voltage, it will automatically do Current Injection.

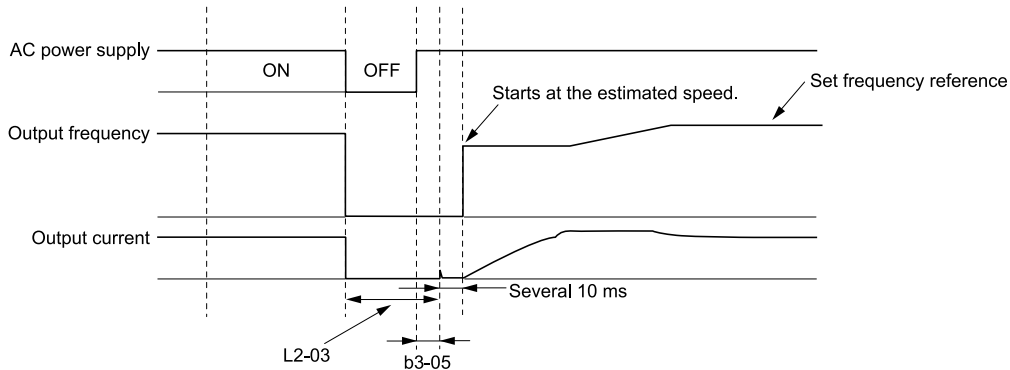

Figure 12.17 Speed Search after Baseblock

Note:

After you return power, the drive waits for the time set in *b3-05*. If power loss is longer than the time set in *L2-03*, the drive will start Speed Search when the time set in *b3-05* is expired after the power recovery.

2. Current Injection

If there is not sufficient residual voltage in the motor, the drive does Current Injection. The drive injects the quantity of DC current set in *b3-06* [Speed Estimation Current Level 1] into the motor windings to estimate the motor speed and direction of rotation. The drive outputs the estimated motor speed as frequency, then uses the deceleration rate set in *L2-04* to increase the voltage. When the output voltage aligns with the V/f pattern, the drive accelerates or decelerates the motor to the frequency reference.

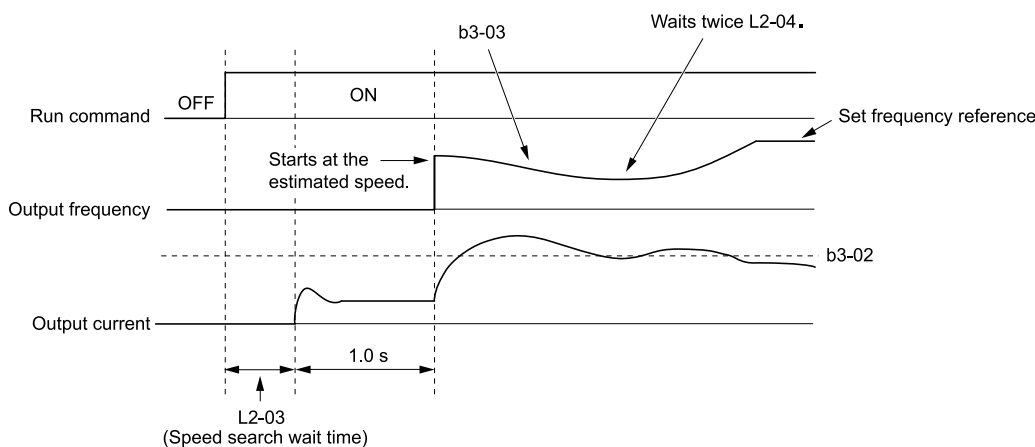

Figure 12.18 Speed Search Selection at Start

Note:

Set the lower limit of the delay time to *b3-05* for when Speed Search starts.

■ Speed Search and Operation Conditions

These conditions apply to Speed Search operation. When *A1-02 = 0, 2* [Control Method Selection = *V/f* Control, Open Loop Vector], set *b3-24* [Speed Search Method Selection] before you do Speed Search.

- Do Speed Search with each Run Command
The drive ignores a Speed Search command from the external terminals.
- Use an MFDI to do an External Speed Search Command
To use an MFDI to do Speed Search, input the Run command at the same time that terminal *Sx* set for Speed Search activates, or after Speed Search activates.
Set Speed Search to *H1-xx* to do the function externally. You cannot set external Speed Search 1 and 2 at the same time.

Table 12.21 Execute Speed Search via the Digital Input Terminals

H1-xx Setting	Name	Current Detection 2	Speed Estimation
61	Speed Search from <i>Fmax</i>	ON: Speed Search starts from <i>E1-04</i> [Maximum Output Frequency].	External Speed Search commands 1 and 2 work the same.
62	Speed Search from <i>Fref</i>	ON: Speed Search starts from the frequency reference immediately before you input the Speed Search command.	The drive estimates the motor speed, then starts Speed Search from the estimated speed.

- Do Speed Search with Each Auto Restart
Set *L5-01* [Number of Auto-Restart Attempts] = 1 or more. After an Auto Restart fault, the drive automatically does Speed Search.
- Do Speed Search after Momentary Power Loss
Set *L2-01 = 1, 2* [Power Loss Ride Through Select = Enabled for L2-02 Time, Enabled while CPU Power Active].
- Do Speed Search after You Clear the External Baseblock Command
When there is an active Run command and the output frequency is higher than the minimum frequency, you must clear the external baseblock command to do Speed Search.

■ b3-01: Speed Search at Start Selection

No. (Hex.)	Name	Description	Default (Range)
b3-01 (0191)	Speed Search at Start Selection	<div style="display: flex; gap: 5px;"> V/f OLV OLV/PM AOLV/PM EZOLV </div> Sets the Speed Search at Start function so the drive will do Speed Search with each Run command.	Determined by <i>A1-02</i> (0, 1)

0 : Disabled

Enter a Run command to start to operate the drive at the minimum output frequency.

When the Run command is enabled and the *Speed Search from Fmax or Fref* [*H1-xx = 61, 62*] is input from a multi-function input terminal, the drive will do Speed Search and start to operate the motor.

1 : Enabled

Enter the Run command to do Speed Search. The drive completes Speed Search, then starts to operate the motor.

■ b3-02: SpeedSearch Deactivation Current

No. (Hex.)	Name	Description	Default (Range)
b3-02 (0192)	SpeedSearch Deactivation Current	<div style="display: flex; gap: 5px;"> V/f OLV OLV/PM AOLV/PM EZOLV </div> <p>Sets the current level that stops Speed Search as a percentage of the drive rated output current. Usually it is not necessary to change this setting.</p>	Determined by A1-02 (0 - 200%)

If the drive cannot restart the motor, decrease this setting.

■ b3-03: Speed Search Deceleration Time

No. (Hex.)	Name	Description	Default (Range)
b3-03 (0193)	Speed Search Deceleration Time	<div style="display: flex; gap: 5px;"> V/f OLV OLV/PM AOLV/PM EZOLV </div> <p>Sets the deceleration time during Speed Search operation. Set the length of time to decelerate from the maximum output frequency to the minimum output frequency.</p>	2.0 s (0.1 - 10.0 s)

This is the output frequency deceleration time used by Current Detection Speed Search and by the Current Injection Method of Speed Estimation Speed Search.

Note:

- When $A1-02 = 8$ [Control Method Selection = EZOLV], this parameter takes effect only in Expert Mode.
- If the drive detects $oL1$ [Motor Overload] during Current Detection Speed Search, decrease the value set in $b3-03$.

■ b3-04: V/f Gain during Speed Search

No. (Hex.)	Name	Description	Default (Range)
b3-04 (0194)	V/f Gain during Speed Search	<div style="display: flex; gap: 5px;"> V/f OLV OLV/PM AOLV/PM EZOLV </div> <p>Sets the ratio used to reduce the V/f during searches to reduce the output current during speed searches.</p>	Determined by o2-04 (10 - 100)

Use this formula to calculate the output voltage during Speed Search:

Output voltage during Speed Search = Configured V/f × b3-04

When the current detection search operates correctly, this configuration is not necessary.

■ b3-05: Speed Search Delay Time

No. (Hex.)	Name	Description	Default (Range)
b3-05 (0195)	Speed Search Delay Time	<div style="display: flex; gap: 5px;"> V/f OLV OLV/PM AOLV/PM EZOLV </div> <p>Sets the Speed Search delay time to activate a magnetic contactor installed between the drive and motor.</p>	0.2 s (0.0 - 100.0 s)

When you use a magnetic contactor between the drive and motor, you must close the contactor before the drive will do Speed Search. This parameter sets a delay time to activate the magnetic contactor.

■ b3-06: Speed Estimation Current Level 1

No. (Hex.)	Name	Description	Default (Range)
b3-06 (0196) Expert	Speed Estimation Current Level 1	<div style="display: flex; gap: 5px;"> V/f OLV OLV/PM AOLV/PM EZOLV </div> <p>Sets the level of current that flows to the motor during Speed Estimation Speed Search as a coefficient of the motor rated current. Usually it is not necessary to change this setting.</p>	Determined by o2-04 (0.0 - 2.0)

When the speed estimation value is the minimum output frequency, increase this setting. You can do this when the motor coasts at a high speed while the drive estimates the speed during Speed Estimation Speed Search. The limit of the output current during speed search is automatically the drive rated current.

Note:

- When the drive cannot accurately estimate the speed after you adjust this parameter, use Current Detection Speed Search.

■ b3-07: Speed Estimation Current Level 2

No. (Hex.)	Name	Description	Default (Range)
b3-07 (0197) Expert	Speed Estimation Current Level 2	<div style="display: flex; gap: 5px;"> V/f OLV OLV/PM AOLV/PM EZOLV </div> <p>Sets the level of current that flows to the motor during Speed Estimation Speed Search as a coefficient of E2-03 [Motor No-Load Current] or E4-03 [Motor 2 Rated No-Load Current]. Usually it is not necessary to change this setting.</p>	1.0 (0.0 - 3.0)

During Speed Estimation Speed Searches, when the speed estimation value aligns with the minimum output frequency, increase the setting value in 0.1-unit increments. The limit of the output current during speed search is automatically the drive rated current.

■ b3-08: Speed Estimation ACR P Gain

No. (Hex.)	Name	Description	Default (Range)
b3-08 (0198)	Speed Estimation ACR P Gain	<div style="display: flex; gap: 5px;"> V/f OLV OLV/PM AOLV/PM EZOLV </div> <p>Sets the proportional gain for the automatic current regulator during Speed Estimation Speed Search. Also adjusts speed search responsiveness. Usually it is not necessary to change this setting.</p>	Determined by A1-02 and o2-04 (0.00 - 6.00)

■ b3-09: Speed Estimation ACR I Time

No. (Hex.)	Name	Description	Default (Range)
b3-09 (0199)	Speed Estimation ACR I Time	<div style="display: flex; gap: 5px;"> V/f OLV OLV/PM AOLV/PM EZOLV </div> <p>Sets the integral time for the automatic current regulator during Speed Estimation Speed Search. Also adjusts speed search responsiveness. Usually it is not necessary to change this setting.</p>	Determined by A1-02 when A1-02 ≠ 5 20.0 when A1-02 = 5 (0.0 - 1000.0 ms)

■ b3-10: Speed Estimation Detection Gain

No. (Hex.)	Name	Description	Default (Range)
b3-10 (019A) Expert	Speed Estimation Detection Gain	<div style="display: flex; gap: 5px;"> V/f OLV OLV/PM AOLV/PM EZOLV </div> <p>Sets the gain to correct estimated frequencies from Speed Estimation Speed Search.</p>	1.05 (1.00 - 1.20)

If the drive detects *ov* [DC Bus Overvoltage] when you restart the motor, increase the setting value.

■ b3-14: Bi-directional Speed Search

No. (Hex.)	Name	Description	Default (Range)
b3-14 (019E)	Bi-directional Speed Search	<div style="display: flex; gap: 5px;"> V/f OLV OLV/PM AOLV/PM EZOLV </div> <p>Sets the direction of Speed Search to the direction of the frequency reference or in the motor rotation direction as detected by the drive.</p>	Determined by A1-02 and b3-24 (0, 1)

Note:

- When E9-01 = 0 [Motor Type Selection = Induction (IM)] and A1-02 = 0, 2, or 8 [Control Method Selection = V/f, OLV, or EZOLV], the default settings change when the setting of b3-24 [Speed Search Method Selection] changes.
 - b3-24 = 1 [Speed Estimation]: Refer to [Parameters that Change from the Default Settings with A1-02 \[Control Method Selection\] on page 479](#).
 - b3-24 = 2 [Current Detection 2]: 0

- When E9-01 = 1 or 2 [Permanent Magnet (PM), Synchronous Reluctance (SynRM)] and A1-02 = 0 or 8 [V/f, EZOLV], refer to [Parameters that Change from the Default Settings with A1-02 \[Control Method Selection\] on page 479](#).

When you set A1-02, b3-24, and E9-01, set b3-14.

0 : Disabled

The drive uses the frequency reference to detect the direction of motor rotation.

1 : Enabled

The drive detects the direction of motor rotation during Speed Search.

■ b3-17: Speed Est Retry Current Level

No. (Hex.)	Name	Description	Default (Range)
b3-17 (01F0) Expert	Speed Est Retry Current Level	<div style="display: flex; gap: 5px;"> V/f OLV OLV/PM AOLV/PM EZOLV </div> Sets the current level for the search retry function in Speed Estimation Speed Search as a percentage where drive rated current is a setting value of 100%.	150% (0 - 200%)

When a large quantity of current flows during Speed Estimation Speed Search, the drive temporarily stops operation to prevent overvoltage and overcurrent. When the current is at the level set in *b3-17*, the drive tries speed search again.

■ b3-18: Speed Est Retry Detection Time

No. (Hex.)	Name	Description	Default (Range)
b3-18 (01F1) Expert	Speed Est Retry Detection Time	<div style="display: flex; gap: 5px;"> V/f OLV OLV/PM AOLV/PM EZOLV </div> Sets the length of time that the drive will wait to retry Speed Estimation Speed Search when too much current flow stopped the Speed Search.	0.10 s (0.00 - 1.00 s)

When the current is more than the level set in *b3-17* [*Speed Est Retry Current Level*] during the time set in *b3-18*, the drive tries speed search again.

■ b3-19: Speed Search Restart Attempts

No. (Hex.)	Name	Description	Default (Range)
b3-19 (01F2)	Speed Search Restart Attempts	<div style="display: flex; gap: 5px;"> V/f OLV OLV/PM AOLV/PM EZOLV </div> Sets the number of times to restart Speed Search if Speed Search does not complete.	3 times (0 - 10 times)

If the drive does the number of Speed Search restarts set in this parameter, it will trigger an *SEr* [*Speed Search Retries Exceeded*] error.

■ b3-24: Speed Search Method Selection

No. (Hex.)	Name	Description	Default (Range)
b3-24 (01C0)	Speed Search Method Selection	<div style="display: flex; gap: 5px;"> V/f OLV OLV/PM AOLV/PM EZOLV </div> Sets the Speed Search method when you start the motor or when you restore power after a momentary power loss.	2 (1, 2)

Note:

- When *A1-02* = 8 [*Control Method Selection* = *EZOLV*], the default setting changes when the setting for *E9-01* [*Motor Type Selection*] and the drive model change.
 - *E9-01* = 0 [Induction (IM)]
 - *E9-01* = 1, 2 [Permanent Magnet (PM), Synchronous Reluctance (SynRM)]: 1
- When you set *A1-02* = 8 and *E9-01* = 1 or 2, set *b3-24* = 1. If *b3-24* = 2, the drive will detect *oPE08* [*Parameter Selection Error*].
- When you set *b3-24*, it will trigger the drive to initialize *b3-14* [*Bi-directional Speed Search*]. After you set *b3-24*, set *b3-14*.

Set *b3-01* = 1 [*Speed Search at Start Selection* = *Enabled*] to do Speed Search at start. Set *L2-01* = 1 [*Power Loss Ride Through Select* = *Enabled for L2-02 Time*] to do Speed Search after you restore power after a momentary power loss.

1 : Speed Estimation

The drive uses the residual voltage from a short baseblock time to estimate the motor speed.

If there is not sufficient residual voltage, then the drive will inject DC current into the motor to estimate the motor speed.

2 : Current Detection 2

The drive will inject DC current into the motor to estimate motor speed.

■ b3-25: Speed Search Wait Time

No. (Hex.)	Name	Description	Default (Range)
b3-25 (01C8) Expert	Speed Search Wait Time	<div style="display: flex; justify-content: space-between; margin-bottom: 5px;"> V/f OLV OLV/PM AOLV/PM EZOLV </div> Sets the length of time the drive will wait to start the Speed Search Retry function.	0.5 s (0.0 - 30.0 s)

If the drive detects these faults during speed search, increase the setting value:

- *oC* [Overcurrent]
- *ov* [Overvoltage]
- *SEr* [Speed Search Retries Exceeded]

■ b3-26: Direction Determination Level

No. (Hex.)	Name	Description	Default (Range)
b3-26 (01C7) Expert	Direction Determination Level	<div style="display: flex; justify-content: space-between; margin-bottom: 5px;"> V/f OLV OLV/PM AOLV/PM EZOLV </div> Sets the level to find the motor rotation direction. Increase the value if the drive cannot find the direction.	1000 (40 to 60000)

■ b3-29: Speed Search Back-EMF Threshold

No. (Hex.)	Name	Description	Default (Range)
b3-29 (077C) Expert	Speed Search Back-EMF Threshold	<div style="display: flex; justify-content: space-between; margin-bottom: 5px;"> V/f OLV OLV/PM AOLV/PM EZOLV </div> Sets the induced voltage for motors that use Speed Search. The drive will start Speed Search when the motor induced voltage level is the same as the setting value. Usually it is not necessary to change this setting.	10% (0 - 10%)

To make adjustments, gradually decrease the setting value. If you decrease the setting value too much, speed search will not operate correctly.

■ b3-31: Spd Search Current Reference Lvl

No. (Hex.)	Name	Description	Default (Range)
b3-31 (0BC0) Expert	Spd Search Current Reference Lvl	<div style="display: flex; justify-content: space-between; margin-bottom: 5px;"> V/f OLV OLV/PM AOLV/PM EZOLV </div> Sets the current level that decreases the output current during Current Detection Speed Search.	1.50 (1.50 - 3.50)

Set this parameter as a ratio of $E2-03$ [Motor No-Load Current]. The setting is a ratio with respect to 30% of the motor rated current when $E2-03 \leq E2-01$ [Motor Rated Current (FLA)] $\times 0.3$.

Note:

When $A1-02 = 8$ [Control Method Selection = EZOLV], the setting is a ratio with respect to $E9-06$ [Motor Rated Current (FLA)] $\times 0.5$.

■ b3-32: Spd Search Current Complete Lvl

No. (Hex.)	Name	Description	Default (Range)
b3-32 (0BC1) Expert	Spd Search Current Complete Lvl	<div style="display: flex; justify-content: space-between; margin-bottom: 5px;"> V/f OLV OLV/PM AOLV/PM EZOLV </div> Sets the current level that completes Speed Search.	1.20 (0.00 - 1.49)

The Current Detection Speed Search gradually decreases the output frequency to search for the motor speed when the output current is equal to or less than Speed Search Current Complete Level.

Set this parameter as a ratio of $E2-03$ [Motor No-Load Current]. The setting is a ratio with respect to 30% of the motor rated current when $E2-03 \leq E2-01$ [Motor Rated Current (FLA)] $\times 0.3$.

Note:

When $A1-02 = 8$ [Control Method Selection = EZOLV], the setting is a ratio with respect to $E9-06$ [Motor Rated Current (FLA)] $\times 0.5$.

■ b3-33: Speed Search during Uv Selection

No. (Hex.)	Name	Description	Default (Range)
b3-33 (0B3F) Expert	Speed Search during Uv Selection	<div style="display: flex; gap: 5px;"> V/f OLV OLV/PM AOLV/PM EZOLV </div> <p>Sets the function that starts Speed Search at start-up if the drive detects a Uv [Undervoltage] when it receives a Run command.</p>	1 (0, 1)

Set these three parameters as shown to enable b3-33:

- L2-01 = 1, 2 [Power Loss Ride Through Select = Enabled for L2-02 Time, Enabled while CPU Power Active]
- b3-01 = 1 [Speed Search at Start Selection = Enabled]
- b1-03 = 1 [Stopping Method Selection = Coast to Stop]

0 : Disabled

1 : Enabled

■ b3-39: Regen Judgment Lv of Spd Search

No. (Hex.)	Name	Description	Default (Range)
b3-39 (1B8F) Expert	Regen Judgment Lv of Spd Search	<div style="display: flex; gap: 5px;"> V/f OLV OLV/PM AOLV/PM EZOLV </div> <p>Sets the level to determine the regenerative state during speed search. Usually it is not necessary to change this setting.</p>	15% (0 - 50%)

If the speed search is not completed after starting the speed search, increase the setting value in 5% increments after the drive stops.

If the drive detects ov [Overvoltage] during speed search, decrease the setting value in 5% increments after the drive stops.

■ b3-54: Search Time

No. (Hex.)	Name	Description	Default (Range)
b3-54 (3123)	Search Time	<div style="display: flex; gap: 5px;"> V/f OLV OLV/PM AOLV/PM EZOLV </div> <p>Sets the length of time that the drive will run Speed Search.</p>	400 ms (10 - 2000 ms)

If you set this parameter too low, Speed Search will not operate correctly.

If the drive detects oC [Overcurrent] immediately after Speed Search Starts:

- Increase the value of L2-03 [Minimum Baseblock Time] and decrease the motor speed you use to start Speed Search.
- Increases the setting value of b3-08 [Speed Estimation ACR P Gain].
- Increase the value of b3-54.

If the drive detects oC or ov [DC Bus Overvoltage] during Speed Search, increase the value of b3-08.

■ b3-55: Current Increment Time

No. (Hex.)	Name	Description	Default (Range)
b3-55 (3124) Expert	Current Increment Time	<div style="display: flex; gap: 5px;"> V/f OLV OLV/PM AOLV/PM EZOLV </div> <p>Sets the length of time that the drive will increase the current from zero current to the setting value of b3-06 [Speed Estimation Current Level 1].</p>	10 ms (10 - 2000 ms)

Gradually increase the setting value when a large quantity of current flows after speed search starts. If you set this value too high, speed search will not operate correctly.

■ b3-56: InverseRotationSearch WaitTime

No. (Hex.)	Name	Description	Default (Range)
b3-56 (3126)	InverseRotationSearch WaitTime	<div style="display: flex; justify-content: space-between; align-items: center;"> V/f OLV OLV/PM AOLV/PM EZOLV </div> <p>Sets the wait time until the drive starts inverse rotation search after it completes forward search when you do inverse rotation search during Current Detection Speed Search.</p>	Determined by o2-04 (0.1 - 5.0 s)

■ b3-61: Initial Pole Detection Gain

No. (Hex.)	Name	Description	Default (Range)
b3-61 (1B96) Expert	Initial Pole Detection Response Gain	<div style="display: flex; justify-content: space-between; align-items: center;"> V/f OLV OLV/PM AOLV/PM EZOLV </div> <p>Sets the responsiveness for initial motor magnetic pole calculation when $A1-02 = 6$ [Control Method Selection = AOLV/PM]. Set $b3-61 > 0.0$ for an ordinary IPM motor.</p>	5.0 (-20.0 - +20.0)

Used when $n8-35 = 1$ [Initial Pole Detection Method = High Frequency Injection]. Sets the responsiveness for initial motor magnetic pole calculation. Set this parameter to a positive value for an ordinary motor. When you use High Frequency injection Tuning, it will automatically set this parameter.

◆ b4: Timer Function

The drive uses timers to delay activating and deactivating MFDO terminals.

Timers prevent sensors and switches from making chattering noise.

There are two types of timers:

- Timers that set a delay for timer inputs and timer outputs. These timers delay activating and deactivating of the MFDI and MFDOs. To enable this function, set $H1-xx = 18$ [MFDI Function Selection = Timer Function], and set $H2-01$ to $H2-03 = 12$ [MFDO Function Selection = Timer Output].
- Timers that set a delay to activate and deactivate MFDO terminals. These timers delay activating and deactivating MFDO terminals. To enable this function, set delay times in parameters $b4-03$ to $b4-08$.

■ Timer Function Operation

- Timers that Set a Delay for Timer Inputs and Timer Outputs
Triggers timer output if the timer input is active for longer than the time set in $b4-01$ [Timer Function ON-Delay Time]. Triggers timer output late for the time set in $b4-02$ [Timer Function OFF-Delay Time]. Figure 12.19 shows an example of how the timer function works.

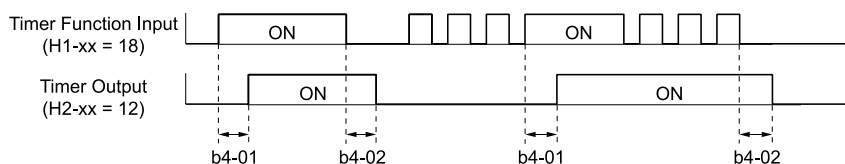

Figure 12.19 Example of Timer Function Operation

- Setting On/Off-delay Time for MFDO
Figure 12.20 uses H2-01 terminals to show an example of how the timer function works. Use $b4-03$ [Terminal M1-M2 ON-Delay Time] and $b4-04$ [Terminal M1-M2 OFF-Delay Time] to set this function.

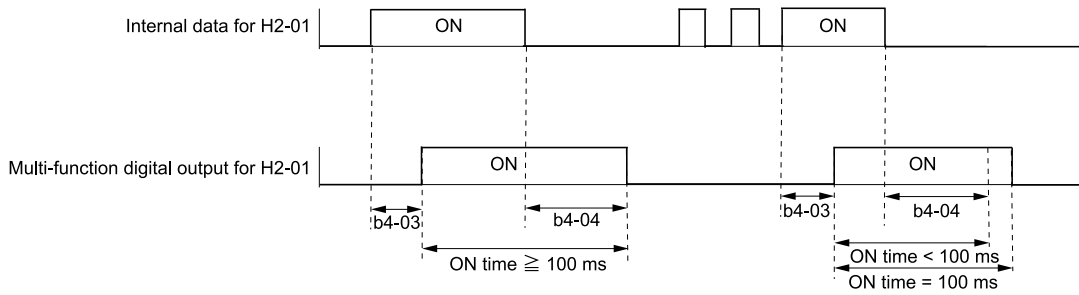

Figure 12.20 Example of How the Timer Function Works with H2-01 Terminals

Note:

When the terminal is triggered, it continues for a minimum of 100 ms. The on/off-delay time of MFDO terminal does not have an effect.

■ **b4-01: Timer Function ON-Delay Time**

No. (Hex.)	Name	Description	Default (Range)
b4-01 (01A3)	Timer Function ON-Delay Time	V/f OLV OLV/PM AOLV/PM EZOLV Sets the ON-delay time for the timer input.	0.0 s (0.0 - 3000.0 s)

■ **b4-02: Timer Function OFF-Delay Time**

No. (Hex.)	Name	Description	Default (Range)
b4-02 (01A4)	Timer Function OFF-Delay Time	V/f OLV OLV/PM AOLV/PM EZOLV Sets the OFF-delay time for the timer input.	0.0 s (0.0 - 3000.0 s)

■ **b4-03: Terminal M1-M2 ON-Delay Time**

No. (Hex.)	Name	Description	Default (Range)
b4-03 (0B30) Expert	Terminal M1-M2 ON-Delay Time	V/f OLV OLV/PM AOLV/PM EZOLV Sets the delay time to activate the contact after the function set in H2-01 activates.	0 ms (0 - 65000 ms)

■ **b4-04: Terminal M1-M2 OFF-Delay Time**

No. (Hex.)	Name	Description	Default (Range)
b4-04 (0B31) Expert	Terminal M1-M2 OFF-Delay Time	V/f OLV OLV/PM AOLV/PM EZOLV Sets the delay time to deactivate the contact after the function set in H2-01 deactivates.	0 ms (0 - 65000 ms)

■ **b4-05: Terminal M3-M4 ON-Delay Time**

No. (Hex.)	Name	Description	Default (Range)
b4-05 (0B32) Expert	Terminal M3-M4 ON-Delay Time	V/f OLV OLV/PM AOLV/PM EZOLV Sets the delay time to activate the contact after the function set in H2-02 activates.	0 ms (0 - 65000 ms)

■ **b4-06: Terminal M3-M4 OFF-Delay Time**

No. (Hex.)	Name	Description	Default (Range)
b4-06 (0B33) Expert	Terminal M3-M4 OFF-Delay Time	V/f OLV OLV/PM AOLV/PM EZOLV Sets the delay time to deactivate the contact after the function set in H2-02 deactivates.	0 ms (0 - 65000 ms)

■ b4-07: Terminal P2 ON-Delay Time

No. (Hex.)	Name	Description	Default (Range)
b4-07 (0B34) Expert	Terminal P2 ON-Delay Time	V/f OLV OLV/PM AOLV/PM EZOLV Sets the delay time until the contact is turned ON after the function set with <i>H2-03</i> turns ON.	0 ms (0 - 65000 ms)

■ b4-08: Terminal P2 OFF-Delay Time

No. (Hex.)	Name	Description	Default (Range)
b4-08 (0B35) Expert	Terminal P2 OFF-Delay Time	V/f OLV OLV/PM AOLV/PM EZOLV Sets the delay time to deactivate the contact after the function set in <i>H2-03</i> deactivates.	0 ms (0 - 65000 ms)

◆ b5: PID control

The drive has a PID control function. You can control drive output to adjust the proportional gain, integral time, and derivative time that has an effect on the bias between the target value and the feedback value to match the target value to the detected value. Use this function to adjust the drive output to accurately match the flow, pressure, and temperature in the application match the target value.

Use a combination of these controls to increase the performance:

- **P control**
P control has a proportional effect on the deviation. It outputs the product (the controlled output) proportional to the deviation. You cannot use only the offset from P control to get to zero deviation.
- **I control**
I control is the integral of the deviation. It uses an integral value of the deviation to output the product (the controlled output). I control helps align the feedback value and the target value. If you use only a proportional effect (P control), it will cause an offset. Use a proportional effect with integral control, and the offset will disappear over time.
- **D control**
D control is the derivative of the deviation. D control has an effect on drive output when there are sudden, large changes in the deviation or feedback value. It quickly returns drive output to the value before the sudden change. It multiplies a time constant by a derivative value of the deviation (slope of the deviation), and adds that result to PID input to calculate the deviation of the signal, then it corrects the deviation.

Note:

D control causes less stable operation because the noise changes the deviation signal. Use D control only when necessary.

■ PID Control Operation

Figure 12.21 shows PID control operation. The modified output (output frequency) changes when the drive uses PID control to keep the deviation (the difference between the target value and the feedback value) constant.

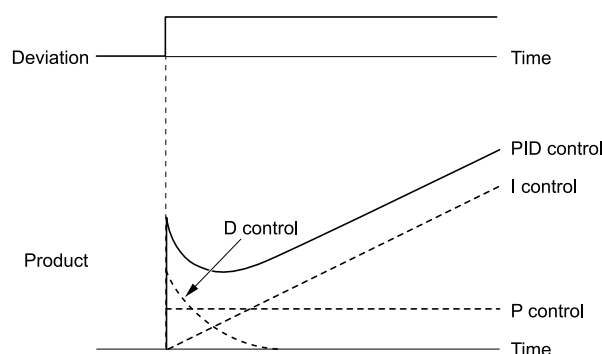

Figure 12.21 PID Control Operation

■ PID Control Applications

Table 12.22 shows applications for PID control.

Table 12.22 PID Control Applications

Application	Control Content	Sensors Used
Speed Control	<ul style="list-style-type: none"> The drive uses a feedback signal for the machine speed, and adjusts that speed to align with the target value. The drive uses speed data from other machinery as the target value to do synchronous control. The drive then adds that target value to the feedback from the machine it is operating to align its speed with the other machinery. 	Tacho generator
Pressure control	The drive uses feedback from the actual pressure to hold constant pressure.	Pressure sensor
Flow control	The drive uses feedback from the actual flow to hold constant flow.	Flow rate sensor
Temperature control	The drive uses feedback from the actual temperature to control a fan and hold constant temperature.	Thermocoupler, thermistor

■ Input Methods for the PID Setpoint

Use *b5-01 [PID Mode Setting]* to select how the PID setpoint is input to the drive.

One of the inputs in Table 12.23 will be the PID setpoint.

When the input in Table 12.23 is disabled, either the frequency reference set in *b1-01 [Frequency Reference Selection 1]* or *b1-15 [Frequency Reference Selection 2]* will be the PID setpoint.

Table 12.23 Input Methods for the PID Setpoint

Input Methods for the PID Setpoint	Setting Value
MFAI terminal A1	Set <i>H3-02 = C [Terminal A1 Function Selection = PID Setpoint]</i> .
MFAI terminal A2	Set <i>H3-10 [Terminal A2 Function Selection] = C</i> .
MEMOBUS/Modbus register 0006H	Sets MEMOBUS/Modbus register 000FH (Control Selection Setting) bit 1 to 1 (PID setpoint input). Enters the PID setpoint to MEMOBUS/Modbus register 0006H (PID Target, 0.01% units, signed).
Pulse train input terminal RP	Set <i>H6-01 = 2 [Terminal RP Pulse Train Function = PID Setpoint Value]</i> .
<i>b5-19 [PID Setpoint Value]</i>	Set <i>b5-18 = 1 [b5-19 PID Setpoint Selection = Enabled]</i> . Enters the PID setpoint to <i>b5-19</i> .

Note:

If you set two inputs for the PID setpoint, it will trigger operation error *oPE07 [Analog Input Selection Error]*.

■ Entering the PID Feedback Value

You can use two methods to input the PID feedback value to the drive. One method uses a single feedback signal for usual PID control. The other method uses two signals. The difference between those signals sets the deviation.

• Use a single feedback signal.

Use Table 12.24 to select how the feedback signal is input to the drive for PID control.

Table 12.24 PID Feedback Input Method

PID Feedback Input Method	Setting Value
MFAI terminal A1	Set <i>H3-02 = B [PID Feedback]</i> .
MFAI terminal A2	Set <i>H3-10 = B</i> .
Pulse train input terminal RP	Set <i>H6-01 = 1 [PID Feedback Value]</i> .

• Use two signals, and use the difference between those signals as the feedback signal.

The drive uses two feedback signals, and the difference between those signals becomes the deviation.

Use Table 12.25 to select how the second feedback value is input to the drive. The drive calculates the deviation of the second feedback value. Set *H3-02 or H3-10 = 16 [Terminal A1 or A2 Function Selection = Differential PID Feedback]* to enable the second feedback signal used to calculate the deviation.

Table 12.25 PID Differential Feedback Input Method

PID Differential Feedback Input Method	Setting Value
MFAI terminal A1	Set H3-02 = 16 [Differential PID Feedback].
MFAI terminal A2	Set H3-10 = 16.

Note:

If you set H3-02 and H3-10 = 16, it will trigger oPE07 [Analog Input Selection Error].

■ PID Control Block Diagram

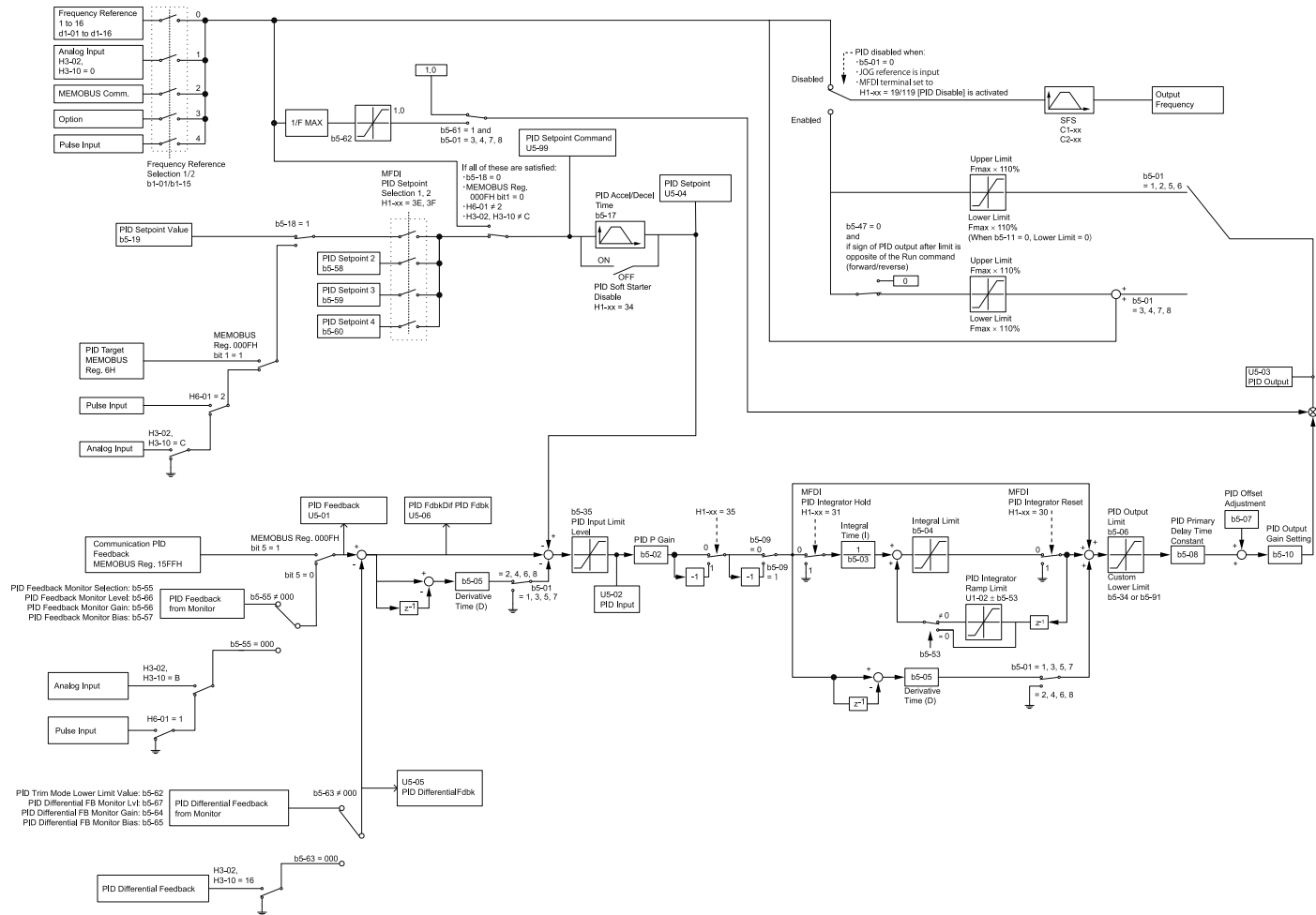

Figure 12.22 PID Control Block Diagram

■ PID Feedback Loss Detection

The PID feedback loss detection function detects broken sensors and defective wiring between the drive and sensors. Use the PID feedback loss detection function when you use PID control. If the feedback signal is too low, the motor can suddenly accelerate to the maximum output frequency. This function prevents such risks to the load.

The drive uses two methods to detect feedback loss:

• *PID Feedback Loss [FbL]*

Set these parameters for the PID feedback loss detection function.

The drive detects feedback loss when the feedback value is less than the value in b5-13 for longer than the time in b5-14.

- b5-12 [Feedback Loss Detection Select]
- b5-13 [PID Feedback Loss Detection Lvl]
- b5-14 [PID Feedback Loss Detection Time]

• *Excessive PID Feedback [FbH]*

Set these parameters to set how the drive detects a feedback level that is too high.

The drive detects too much PID feedback when the feedback value is more than the value in *b5-36* for longer than the time in *b5-37*.

- *b5-12 [Feedback Loss Detection Select]*
- *b5-36 [PID High Feedback Detection Lvl]*
- *b5-37 [PID High Feedback Detection Time]*

Figure 12.23 shows the operation principle when the feedback value is too low, and the drive detects feedback loss. The operation is the same when the drive detects too much feedback.

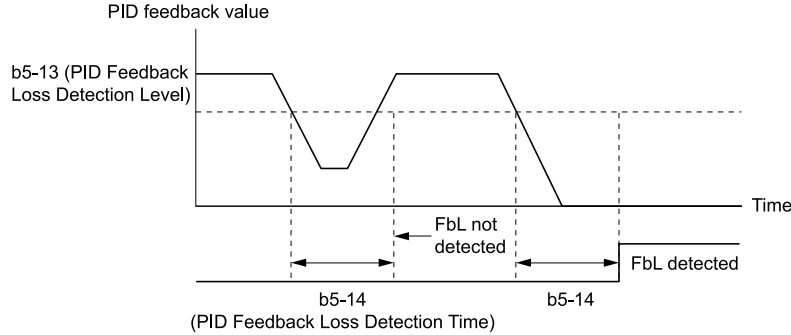

Figure 12.23 Time Chart for PID Feedback Loss Detection Time

■ **PID Sleep**

PID sleep stops drive operation when the PID output or the frequency reference is less than *b5-15 [PID Sleep Function Start Level]*. This function shuts off drive output after the motor decelerates to the set frequency.

The drive will automatically restart the motor when the PID output or the frequency reference is more than the *b5-15* value for the time set in *b5-16 [PID Sleep Delay Time]*.

Figure 12.24 shows the PID Sleep function.

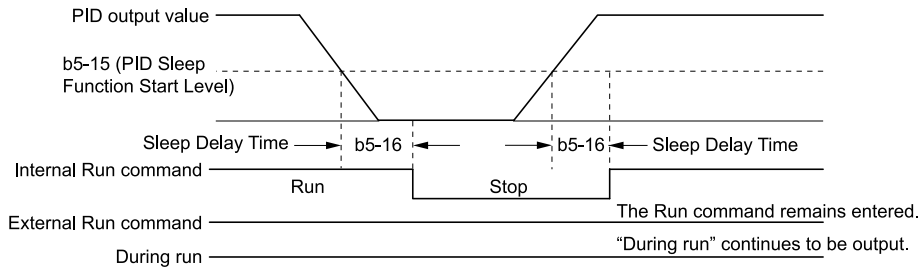

Figure 12.24 PID Sleep Time Chart

Note:

- The PID Sleep function is enabled when PID control is disabled.
- When the PID Sleep function is triggered, the drive will stop the motor as specified by *b1-03 [Stopping Method Selection]*.

■ **Fine-Tuning PID**

Fine-tune the following parameter settings to have PID control eliminate problems with overshoot and oscillation.

- *b5-02 [Proportional Gain (P)]*
- *b5-03 [Integral Time (I)]*
- *b5-05 [Derivative Time (D)]*
- *b5-08 [PID Primary Delay Time Constant]*

Purpose	Procedure	Results
Prevent overshoot.	<ul style="list-style-type: none"> Set <i>b5-05 [Derivative Time (D)]</i> to a smaller value. Set <i>b5-03 [Integral Time (I)]</i> to a larger value. 	<p>Response</p> <p>Time</p>
Quickly stabilize control.	<ul style="list-style-type: none"> Set <i>b5-05 [Derivative Time (D)]</i> to a larger value. Set <i>b5-03 [Integral Time (I)]</i> to a smaller value. 	<p>Response</p> <p>Time</p>
Prevent long-cycle oscillations.	Set <i>b5-03 [Integral Time (I)]</i> to a larger value.	<p>Response</p> <p>Time</p>
Prevent short-cycle oscillations.	<ul style="list-style-type: none"> Set <i>b5-05 [Derivative Time (D)]</i> to a smaller value. If you set <i>b5-05 = 0.00 [Derivative Time (D) = disabling D control]</i> and it does not stop oscillation, then set <i>b5-02 [Proportional Gain (P)]</i> to a smaller value or set <i>b5-08 [PID Primary Delay Time Constant]</i> to a larger value. 	<p>Response</p> <p>Time</p>

■ EZ Sleep/Wake-up Functionality

Set *b5-89 = 1 [Sleep Method Selection = EZ Sleep/Wake-up]* to enable the EZ Sleep/Wake-up function.

Note:

- When *b5-89 = 0 [Sleep Mode Selection = Standard]*, the EZ Sleep function and related parameters are disabled. Parameter *b5-91 [EZ Sleep Minimum Speed]* is not included in this rule.
- Set *b5-89 = 1* to disable *b5-15 [PID Sleep Function Start Level]*.

Setting Parameter	Description
<i>b5-90 [EZ Sleep Unit]</i>	This parameter sets the unit of measure for <i>b5-92 [EZ Sleep Level]</i> . When <i>b5-90 = 0 [0.1Hz units]</i> , the setting range of <i>b5-91 [EZ Sleep Minimum Speed]</i> is 0.0 to 590.0 Hz. When <i>b5-90 = 1 [rev/min]</i> , the setting range is 0 to 35400 min ⁻¹ (r/min). Note: When you change <i>b5-90</i> , the value of <i>b5-92</i> is not automatically updated.
<i>b5-91 [EZ Sleep Minimum Speed]</i>	Sets the output lower limit level for the PID control as Hz units or min ⁻¹ (r/min) units. When you use <i>b5-91</i> , set <i>b5-34 = 0.0 [PID Output Lower Limit Level = 0.0 (disabled)]</i> . When you set the lower limit for PID output as a percentage of the Maximum Output Frequency, refer to page 547. The <i>b5-89</i> setting does not have an effect.
<i>b5-92 [EZ Sleep Level]</i>	When the output frequency or motor speed is less than the value of <i>b5-92</i> for longer than the value of <i>b5-93 [EZ Sleep Time]</i> , the drive does to sleep.
<i>b5-95 = 0 [EZ Sleep Wake-up Mode = Absolute]</i>	When the PID feedback is less than the value of <i>b5-94 [EZ Sleep Wake-up Level]</i> for longer than the time set in <i>b5-96 [EZ Sleep Wake-up Time]</i> , the drive restarts operation from sleep.
<i>b5-95 = 1 [EZ Sleep Wake-up Mode = Setpoint Delta]</i>	The drive resumes operation from the sleep state when the PID feedback has dropped below the value defined as the PID setpoint value minus <i>b5-94</i> continuously for the time configured with <i>b5-96</i> .

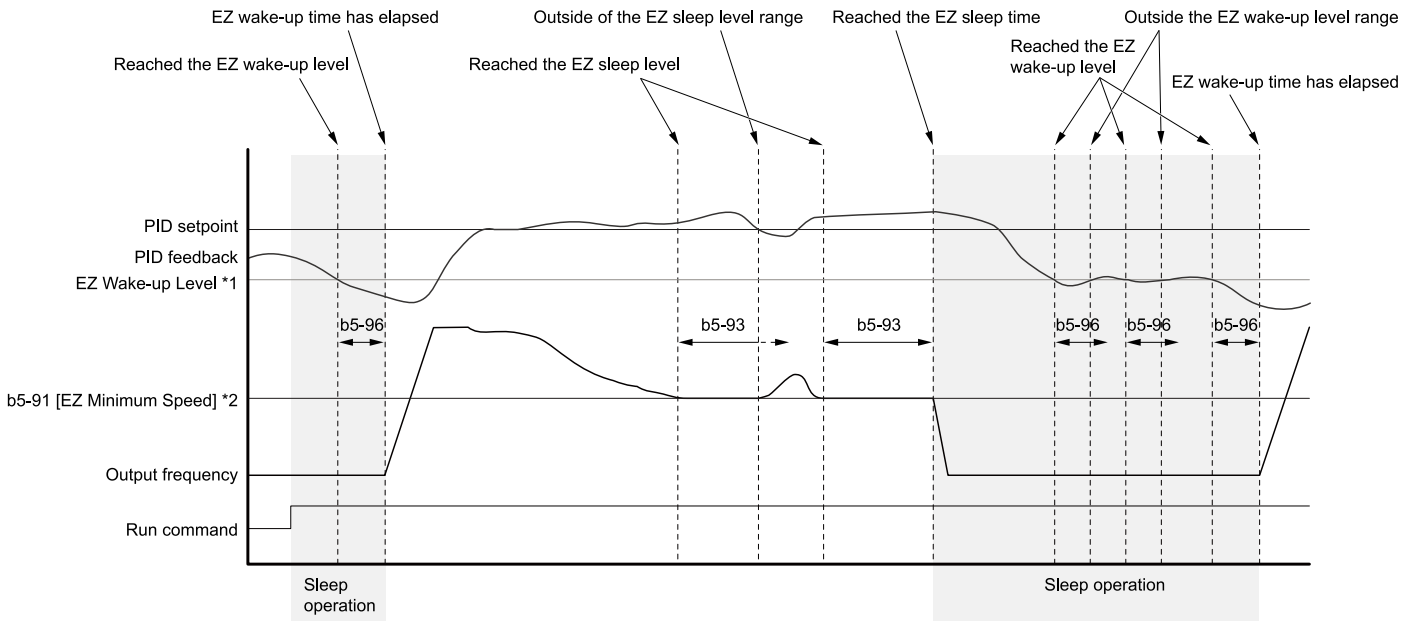

Figure 12.25 EZ Sleep/Wake-up Operation: PID Output is Normal and *b5-92 = 0.0 Hz*

*1 The values of *b5-94* and *b5-95* set operation.

*2 In the example, *b5-92* is at the default setting of 0.0 Hz. Parameter *b5-91* is the EZ sleep level.

■ b5-01: PID Mode Setting

No. (Hex.)	Name	Description	Default (Range)
b5-01 (01A5)	PID Mode Setting	<input type="checkbox"/> V/f <input type="checkbox"/> OLV <input type="checkbox"/> OLV/PM <input type="checkbox"/> AOLV/PM <input type="checkbox"/> EZOLV Sets the type of PID control.	0 (0 - 8)

0 : Disabled

1 : Standard

Enables PID control. The drive does D control on the difference between the feedback value and the PID setpoint output through *U5-02 [PID Input]*.

2 : Standard (D on feedback)

Enables PID control. The drive does D control on the feedback output through *U5-06 [PID FdbkDif PID Fdbk]*.

3 : Fref + PID Trim

Enables PID control. The drive adds the frequency reference to the PID output. The drive does D control on the difference between the feedback value and the PID setpoint output through *U5-02 [PID Input]*.

4 : Fref + PID Trim (D on feedback)

Enables PID control. The drive adds the frequency reference to the PID output. The drive does D control on the feedback output through *U5-06 [PID FdbkDif PID Fdbk]*.

5 : Same as 7series & prior, b5-01=1

6 : Same as 7series & prior, b5-01=2

7 : Same as 7series & prior, b5-01=3

8 : Same as 7series & prior, b5-01=4

Note:

Use settings 5 to 8 instead of settings 1 to 4 when the drive is a replacement for Varispeed F7.

■ b5-02: Proportional Gain (P)

No. (Hex.)	Name	Description	Default (Range)
b5-02 (01A6) RUN	Proportional Gain (P)	V/f OLV OLV/PM AOLV/PM EZOLV Sets the proportional gain (P) that is applied to PID input.	1.00 (0.00 - 25.00)

Larger values decrease errors, but can cause oscillations. Smaller values let too much offset between the setpoint and feedback.

Set *b5-02 = 0.00* to disable P control.

■ b5-03: Integral Time (I)

No. (Hex.)	Name	Description	Default (Range)
b5-03 (01A7) RUN	Integral Time (I)	V/f OLV OLV/PM AOLV/PM EZOLV Sets the integral time (I) that is applied to PID input.	1.0 s (0.0 - 360.0 s)

Set a short integral time in *b5-03* to remove the offset more quickly. If the integral time is too short, overshoot or oscillation can occur.

Set *b5-03 = 0.00* to disable I control.

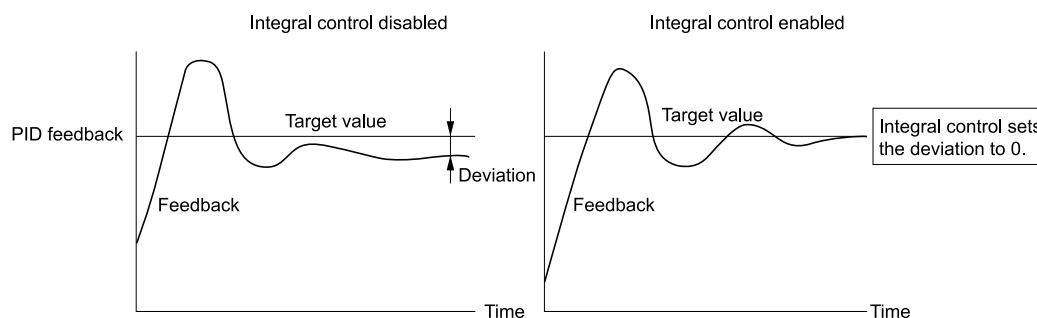

Figure 12.26 Integral Time and Deviation

■ b5-04: Integral Limit

No. (Hex.)	Name	Description	Default (Range)
b5-04 (01A8) RUN	Integral Limit	V/f OLV OLV/PM AOLV/PM EZOLV Sets the upper limit for integral control (I) as a percentage of the Maximum Output Frequency.	100.0% (0.0 - 100.0%)

Applications with loads that quickly change will cause the output of the PID function to oscillate. Set this parameter to a low value to prevent oscillation, mechanical loss, and motor speed loss.

■ b5-05: Derivative Time (D)

No. (Hex.)	Name	Description	Default (Range)
b5-05 (01A9) RUN	Derivative Time (D)	V/f OLV OLV/PM AOLV/PM EZOLV Sets the derivative time (D) for PID control. This parameter adjusts system responsiveness.	0.00 s (0.00 - 10.00 s)

When you increase the time setting, it will increase controller responsiveness, but it can also cause vibration. When you decrease the time setting, it will suppress overshoot and decrease controller responsiveness.

Set *b5-05 = 0.00* to disable D control.

■ b5-06: PID Output Limit

No. (Hex.)	Name	Description	Default (Range)
b5-06 (01AA) RUN	PID Output Limit	V/f OLV OLV/PM AOLV/PM EZOLV Sets the maximum possible output from the PID controller as a percentage of the Maximum Output Frequency.	100.0% (0.0 - 100.0%)

■ b5-07: PID Offset Adjustment

No. (Hex.)	Name	Description	Default (Range)
b5-07 (01AB) RUN	PID Offset Adjustment	V/f OLV OLV/PM AOLV/PM EZOLV Sets the offset for the PID control output as a percentage of the Maximum Output Frequency.	0.0% (-100.0 - +100.0%)

■ b5-08: PID Primary Delay Time Constant

No. (Hex.)	Name	Description	Default (Range)
b5-08 (01AC) RUN Expert	PID Primary Delay Time Constant	V/f OLV OLV/PM AOLV/PM EZOLV Sets the primary delay time constant for the PID control output. Usually it is not necessary to change this setting.	0.00 s (0.00 - 10.00 s)

Prevents resonance if there is a large quantity of mechanical friction or if rigidity is unsatisfactory. Set the value larger than the resonant frequency cycle. A value that is too large will decrease drive responsiveness.

■ b5-09: PID Output Level Selection

No. (Hex.)	Name	Description	Default (Range)
b5-09 (01AD)	PID Output Level Selection	V/f OLV OLV/PM AOLV/PM EZOLV Sets the polarity of the PID output.	0 (0, 1)

Use this parameter in applications that decrease the drive output frequency when you increase the PID setpoint.

0 : Normal Output (Direct Acting)

A positive PID input increases the PID output (direct acting).

1 : Reverse Output (Reverse Acting)

A positive PID input decreases the PID output (reverse acting).

■ b5-10: PID Output Gain Setting

No. (Hex.)	Name	Description	Default (Range)
b5-10 (01AE) RUN	PID Output Gain Setting	V/f OLV OLV/PM AOLV/PM EZOLV Sets the amount of gain to apply to the PID output.	1.00 (0.00 - 25.00)

Applies a gain to the PID output and can help when $b5-01 = 3$ or 4 [$PID Mode Setting = Fref + PID Trim, Fref + PID Trim (D on feedback)$].

■ b5-11: PID Output Reverse Selection

No. (Hex.)	Name	Description	Default (Range)
b5-11 (01AF)	PID Output Reverse Selection	<input type="checkbox"/> V/f <input type="checkbox"/> OLV <input type="checkbox"/> OLV/PM <input type="checkbox"/> AOLV/PM <input type="checkbox"/> EZOLV Sets the function that enables and disables reverse motor rotation for negative PID control output.	0 (0, 1)

This parameter is disabled when $b5-01 = 3, 4$ [$PID Mode Setting = Fref + PID Trim, Fref + PID Trim (D on feedback)$]. There is no limit for PID output (PID output can be positive or negative). Operates the same as setting “1: Enabled: Negative lower limit”.

0 : Lower Limit is Zero

When PID output is negative, PID output is limited to 0 and drive output is shut off.

1 : Negative Output Accepted

When the PID output is negative, the motor will rotate in reverse. When $b1-04 = 1$ [$Reverse Operation Selection = Reverse Disabled$], the lower limit is 0.

■ b5-12: Feedback Loss Detection Select

No. (Hex.)	Name	Description	Default (Range)
b5-12 (01B0)	Feedback Loss Detection Select	<input type="checkbox"/> V/f <input type="checkbox"/> OLV <input type="checkbox"/> OLV/PM <input type="checkbox"/> AOLV/PM <input type="checkbox"/> EZOLV Sets the drive response to PID feedback loss/excess. Sets drive operation after the drive detects PID feedback loss/excess.	0 (0 - 5)

0 : Digital Out Only, Always Detect

The MFDO terminal set for *PID Feedback Low* or *PID Feedback High* [$H2-01$ to $H2-03 = 3E, 3F$] activates. When the drive detects feedback loss/excess, the keypad will not show an alarm and the drive will continue operation.

When the feedback signal is less than the level set in $b5-13$ [$PID Feedback Loss Detection Lvl$] for longer than the time set in $b5-14$ [$PID Feedback Loss Detection Time$], the MFDO terminal set for *PID Feedback Low* activates.

When the feedback signal is more than the level set in $b5-36$ [$PID High Feedback Detection Lvl$] for longer than the time set in $b5-37$ [$PID High Feedback Detection Time$] the MFDO terminal set for *PID Feedback High* activates.

When the feedback value is not in the detection range, the drive resets the MFDO.

1 : Alarm + Digital Out, Always Det

The drive detects *FbL* [$PID Feedback Loss$] and *FbH* [$Excessive PID Feedback$]. The MFDO terminal set for *PID Feedback Low* or *PID Feedback High* [$H2-01$ to $H2-03 = 3E, 3F$] activates. The output terminal set for *Alarm* [$H2-01$ to $H2-03 = 10$] activates and the drive continues operation.

When the feedback signal is less than the level set in $b5-13$ for longer than the time set in $b5-14$, the MFDO terminal set for *PID Feedback Low* activates.

When the feedback signal is more than the level set in $b5-36$ for longer than the time set in $b5-37$, the MFDO terminal set for *PID Feedback High* activates.

When the feedback value is not in the detection range, the drive resets the MFDO.

2 : Fault + Digital Out, Always Det

The drive detects *FbL* and *FbH*. MFDO terminal MA-MC turns ON, MB-MC turns OFF, and the motor coasts to stop.

When the feedback signal is less than the level set in $b5-13$ for the time set in $b5-14$, the drive detects *FbL*.

When the feedback signal is more than the level set in $b5-36$ for the time set in $b5-37$, the drive detects *FbH*.

3 : Digital Out Only, @PID Enable

The MFDO terminal set for *PID Feedback Low* or *PID Feedback High* activates. The keypad will not show an alarm. The drive continues operation.

When the MFDI terminal set to *PID Disable* [$H1-xx = 19$] activates, the drive disables fault detection.

4 : Alarm + Digital Out, @PID Enable

12.3 b: Application

The drive detects *FbL* and *FbH*. The MFDO terminal set for *PID Feedback Low* or *PID Feedback High* activates. The output terminal set for *Alarm [H2-01 to H2-03 = 10]* activates and the drive continues operation.

When the MFDI terminal set to *PID Disable [H1-xx = 19]* activates, the drive disables fault detection.

5 : Fault + Digital Out, @PID Enable

The drive detects *FbL* and *FbH*. MFDO terminal MA-MC turns ON, MB-MC turns OFF, and the drive coasts to stop.

When the MFDI terminal set to *PID Disable [H1-xx = 19]* activates, the drive disables fault detection.

■ b5-13: PID Feedback Loss Detection Lvl

No. (Hex.)	Name	Description	Default (Range)
b5-13 (01B1)	PID Feedback Loss Detection Lvl	<input type="checkbox"/> V/f <input type="checkbox"/> OLV <input type="checkbox"/> OLV/PM <input type="checkbox"/> AOLV/PM <input type="checkbox"/> EZOLV Sets the level that triggers <i>PID Feedback Loss [FbL]</i> detection as a percentage of the Maximum Output Frequency.	0% (0 - 100%)

The drive detects *PID Feedback Loss [FbL]* when the feedback signal decreases to less than the level set in *b5-13* for longer than the time set in *b5-14 [PID Feedback Loss Detection Time]*.

■ b5-14: PID Feedback Loss Detection Time

No. (Hex.)	Name	Description	Default (Range)
b5-14 (01B2)	PID Feedback Loss Detection Time	<input type="checkbox"/> V/f <input type="checkbox"/> OLV <input type="checkbox"/> OLV/PM <input type="checkbox"/> AOLV/PM <input type="checkbox"/> EZOLV Sets the length of time that PID Feedback must be less than <i>b5-13 [PID Feedback Loss Detection Lvl]</i> to detect <i>PID Feedback Loss [FbL]</i> .	1.0 s (0.0 - 25.5 s)

■ b5-15: PID Sleep Function Start Level

No. (Hex.)	Name	Description	Default (Range)
b5-15 (01B3)	PID Sleep Function Start Level	<input type="checkbox"/> V/f <input type="checkbox"/> OLV <input type="checkbox"/> OLV/PM <input type="checkbox"/> AOLV/PM <input type="checkbox"/> EZOLV Sets the output level that triggers the PID Sleep function.	Determined by A1-02 (0.0 - 590.0)

The drive goes into Sleep mode when the PID output or frequency reference is less than *b5-15* for longer than the time set to *b5-16 [PID Sleep Delay Time]*. The drive continues operation when the PID output or frequency reference is more than *b5-15* for longer than the time set to *b5-16*.

■ b5-16: PID Sleep Delay Time

No. (Hex.)	Name	Description	Default (Range)
b5-16 (01B4)	PID Sleep Delay Time	<input type="checkbox"/> V/f <input type="checkbox"/> OLV <input type="checkbox"/> OLV/PM <input type="checkbox"/> AOLV/PM <input type="checkbox"/> EZOLV Sets a delay time to start or stop the PID Sleep function.	0.0 s (0.0 - 25.5 s)

■ b5-17: PID Accel/Decel Time

No. (Hex.)	Name	Description	Default (Range)
b5-17 (01B5) RUN	PID Accel/Decel Time	<input type="checkbox"/> V/f <input type="checkbox"/> OLV <input type="checkbox"/> OLV/PM <input type="checkbox"/> AOLV/PM <input type="checkbox"/> EZOLV Raises or lowers the PID setpoint using the acceleration and deceleration times set to the drive. This is a soft-starter for the PID setpoint.	0.0 s (0.0 - 6000.0 s)

The drive usually uses the acceleration and deceleration times set in *C1-xx [Accel and Decel Times]*, but when PID control is enabled, the drive applies *C1-xx* after PID output. If you frequently change the PID setpoint, the drive responsiveness decreases. When resonance with PID control causes hunting, overshoot, or undershoot, set *b5-17* for longer acceleration and deceleration times.

Decrease *C1-xx* until hunting stops, then use *b5-17* to check the acceleration and deceleration. To enable and disable the setting in *b5-17* through an MFDI terminal, set *PID Soft Starter Disable [H1-xx = 34]*.

■ b5-18: b5-19 PID Setpoint Selection

No. (Hex.)	Name	Description	Default (Range)
b5-18 (01DC)	b5-19 PID Setpoint Selection	V/f OLV OLV/PM AOLV/PM EZOLV Sets the function that enables and disables <i>b5-19 [PID Setpoint Value]</i> .	0 (0, 1)

0 : Disabled

The drive does not use the value set in *b5-19* as the PID setpoint.

1 : Enabled

The drive uses the value set in *b5-19* as the PID setpoint.

■ b5-19: PID Setpoint Value

No. (Hex.)	Name	Description	Default (Range)
b5-19 (01DD) RUN	PID Setpoint Value	V/f OLV OLV/PM AOLV/PM EZOLV Sets the PID setpoint when <i>b5-18 = 1 [b5-19 PID Setpoint Selection = Enabled]</i> .	0.00% (0.00 - 100.00%)

■ b5-20: PID Unit Selection

No. (Hex.)	Name	Description	Default (Range)
b5-20 (01E2)	PID Unit Selection	V/f OLV OLV/PM AOLV/PM EZOLV Sets the number of digits to set and show the PID setpoint.	1 (0 - 3)

Set the units for these parameters and monitors:

- b5-19 [PID Setpoint Value]
- b5-58 [PID Setpoint2]
- b5-59 [PID Setpoint3]
- b5-60 [PID Setpoint4]
- U5-01 [PID Feedback]
- U5-04 [PID Setpoint]
- U5-99 [PID Setpoint Command]

0 : 0.01Hz units

The drive uses 0.01 Hz units.

1 : 0.01% units

The drive uses 0.01% units. Set the value as a percentage of *E1-04 [Maximum Output Frequency]*.

2 : rev/min

The drive uses 1 rev/min unit. Set *E2-04, E4-04, or E5-04 [Motor Pole Count]*.

3 : User Units

The drive uses the units set in *b5-38 [PID User Unit Display Scaling]* and *b5-39 [PID User Unit Display Digits]* to show the PID setpoint in *U5-01, U5-04, U5-06 [PID Feedback, PID Setpoint, PID Fdbk-Diff PID Fdbk]*.

■ b5-34: PID Output Lower Limit Level

No. (Hex.)	Name	Description	Default (Range)
b5-34 (019F) RUN	PID Output Lower Limit Level	V/f OLV OLV/PM AOLV/PM EZOLV Sets the lower limit level for the PID control as a percentage of <i>E1-04 [Maximum Output Frequency]</i> .	0.0% (-100.0 - +100.0%)

Use a lower limit to keep PID control output from dropping below a fixed level.

When you use *b5-34*, set *b5-91 = 0 [EZ Sleep Minimum Speed = 0 (Disabled)]*.

When you set the output lower limit level in Hz or min^{-1} (r/min), refer to [b5-91: EZ Sleep Minimum Speed on page 552](#).

Set this parameter to 0.0% to disable this function.

■ b5-35: PID Input Limit Level

No. (Hex.)	Name	Description	Default (Range)
b5-35 (01A0) RUN	PID Input Limit Level	V/f OLV OLV/PM AOLV/PM EZOLV Sets the output upper limit for the PID control as a percentage of the Maximum Output Frequency.	1000.0% (0.0 - 1000.0%)

A large input value for PID control makes a high output. The drive applies this limit to the negative and positive domains.

■ b5-36: PID High Feedback Detection Lvl

No. (Hex.)	Name	Description	Default (Range)
b5-36 (01A1)	PID High Feedback Detection Lvl	V/f OLV OLV/PM AOLV/PM EZOLV Sets the level that triggers <i>Excessive PID Feedback [FbH]</i> as a percentage of the Maximum Output Frequency.	100% (0 - 100%)

When the feedback signal increases to more than the level set in *b5-36* for the time set in *b5-37* [*PID High Feedback Detection Time*], the drive will detect *Excessive PID Feedback [FbH]*.

■ b5-37: PID High Feedback Detection Time

No. (Hex.)	Name	Description	Default (Range)
b5-37 (01A2)	PID High Feedback Detection Time	V/f OLV OLV/PM AOLV/PM EZOLV Sets the length of time that the PID feedback signal must be more than the level set in <i>b5-36</i> [<i>PID Feedback High Detection Lvl</i>] to cause <i>Excessive PID Feedback [FbH]</i> .	1.0 s (0.0 - 25.5 s)

■ b5-38: PID User Unit Display Scaling

No. (Hex.)	Name	Description	Default (Range)
b5-38 (01FE)	PID User Unit Display Scaling	V/f OLV OLV/PM AOLV/PM EZOLV Sets the value that the drive sets or shows as the PID setpoint when at the maximum output frequency.	Determined by b5-20 (1 - 60000)

The drive uses this parameter and *b5-39* [*PID Setpoint Display Digits*] together.

When *b5-20* = 3 [*PID Unit Selection = User Units*], the drive applies user-set PID setpoint and display units to these parameters and monitors:

- b5-19 [PID Setpoint Value]
- b5-58 [PID Setpoint2]
- b5-59 [PID Setpoint3]
- b5-60 [PID Setpoint4]
- U5-01 [PID Feedback]
- U5-04 [PID Setpoint]
- U5-99 [PID Setpoint Command]

■ b5-39: PID User Unit Display Digits

No. (Hex.)	Name	Description	Default (Range)
b5-39 (01FF)	PID User Unit Display Digits	V/f OLV OLV/PM AOLV/PM EZOLV Sets the number of digits to set and show the PID setpoint.	Determined by b5-20 (0 - 3)

The drive uses this parameter and *b5-38* [*PID Setpoint User Display*] together.

When $b5-20 = 3$ [*PID Unit Selection = User Units*], the drive applies user-set PID setpoint and display units to these parameters and monitors:

- b5-19 [PID Setpoint Value]
- b5-58 [PID Setpoint2]
- b5-59 [PID Setpoint3]
- b5-60 [PID Setpoint4]
- U5-01 [PID Feedback]
- U5-04 [PID Setpoint]
- U5-99 [PID Setpoint Command]

0 : No Decimal Places (XXXXX)

1 : One Decimal Places (XXXX.X)

2 : Two Decimal Places (XXX.XX)

3 : Three Decimal Places (XX.XXX)

■ b5-40: Frequency Reference Monitor @PID

No. (Hex.)	Name	Description	Default (Range)
b5-40 (017F)	Frequency Reference Monitor @PID	<input type="checkbox"/> V/f <input type="checkbox"/> OLV <input type="checkbox"/> OLV/PM <input type="checkbox"/> AOLV/PM <input type="checkbox"/> EZOLV Sets the contents for monitor <i>UI-01</i> [<i>Frequency Reference</i>] in PID control.	0 (0, 1)

0 : U1-01 Includes PID Output

Monitor *UI-01* shows the frequency reference that was increased or decreased by the PID output.

1 : U1-01 Excludes PID Output

Monitor *UI-01* shows the actual frequency reference.

■ b5-47: PID Trim Mode Output Reverse Sel

No. (Hex.)	Name	Description	Default (Range)
b5-47 (017D)	PID Trim Mode Output Reverse Sel	<input type="checkbox"/> V/f <input type="checkbox"/> OLV <input type="checkbox"/> OLV/PM <input type="checkbox"/> AOLV/PM <input type="checkbox"/> EZOLV Sets reverse motor rotation when the PID control output is negative.	1 (0, 1)

This parameter is enabled when $b5-01 = 3$ or 4 [*PID Mode Setting = Fref + PID Trim, Fref + PID Trim (D on feedback)*].

0 : Lower Limit is Zero

When PID output is negative, PID output is limited to 0 and drive output is shut off.

1 : Negative Output Accepted

When the PID output is negative, the motor will rotate in reverse.

■ b5-53: PID Integrator Ramp Limit

No. (Hex.)	Name	Description	Default (Range)
b5-53 (0B8F) RUN	PID Integrator Ramp Limit	<input type="checkbox"/> V/f <input type="checkbox"/> OLV <input type="checkbox"/> OLV/PM <input type="checkbox"/> AOLV/PM <input type="checkbox"/> EZOLV Sets the responsiveness of PID control when the PID feedback changes quickly.	0.0 Hz (0.0 - 10.0 Hz)

Note:

- This parameter is disabled when set to 0.0 Hz.
- When $b5-53 > 0.0$ Hz and the drive enables the integrator ramp limit, the PID integrator value limit is the range set by the output frequency $\pm b5-53$.
- When the PID feedback changes quickly, gradually decrease the value of this parameter in increments of 0.1 Hz to decrease the speed of the response of PID control.

■ b5-55: PID Feedback Monitor Selection

No. (Hex.)	Name	Description	Default (Range)
b5-55 (0BE1)	PID Feedback Monitor Selection	<input type="checkbox"/> V/f <input type="checkbox"/> OLV <input type="checkbox"/> OLV/PM <input type="checkbox"/> AOLV/PM <input type="checkbox"/> EZOLV Sets the monitor (<i>Ux-xx</i>) used as the PID Feedback. Set the <i>x-xx</i> part of the <i>Ux-xx</i> [Monitor].	000 (000 - 999)

Note:

- You cannot select *parameter U5-xx*.
- This parameter is disabled when set to 000.

■ b5-56: PID Feedback Monitor Gain

No. (Hex.)	Name	Description	Default (Range)
b5-56 (0BE2)	PID Feedback Monitor Gain	<input type="checkbox"/> V/f <input type="checkbox"/> OLV <input type="checkbox"/> OLV/PM <input type="checkbox"/> AOLV/PM <input type="checkbox"/> EZOLV Sets the gain for the monitor set in <i>b5-55</i> [PID Feedback Monitor Selection].	1.00 (0.00 - 10.00)

■ b5-57: PID Feedback Monitor Bias

No. (Hex.)	Name	Description	Default (Range)
b5-57 (11DD)	PID Feedback Monitor Bias	<input type="checkbox"/> V/f <input type="checkbox"/> OLV <input type="checkbox"/> OLV/PM <input type="checkbox"/> AOLV/PM <input type="checkbox"/> EZOLV Sets the bias for the monitor specified in <i>b5-55</i> [PID Feedback Monitor Selection].	0.00 (-10.00 - +10.00)

■ b5-58 to b5-60: PID Setpoints 2 to 4

No. (Hex.)	Name	Description	Default (Range)
b5-58 to b5-60: (1182 - 1184) RUN	PID Setpoints 2 to 4	<input type="checkbox"/> V/f <input type="checkbox"/> OLV <input type="checkbox"/> OLV/PM <input type="checkbox"/> AOLV/PM <input type="checkbox"/> EZOLV Sets the PID setpoint when <i>H1-xx = 3E</i> or <i>3F</i> [MFDI Function Selection = PID Setpoint Selection 1/2]. This value is a percentage of the maximum output frequency.	0.00% (0.00 - 100.00%)

Table 12.26 shows how the different MFDI *H1-xx* values (*3E* and *3F*) have an effect on the PID setpoint value.

Table 12.26 Switching of MFDI and PID Setpoint Value

H1-xx = 3E	H1-xx = 3F	PID Setpoint Value
OFF	OFF	No switch
ON	OFF	b5-58 [PID Setpoint2]
OFF	ON	b5-59 [PID Setpoint3]
ON	ON	b5-60 [PID Setpoint4]

■ b5-61: PID Trim Mode Lower Limit Sel

No. (Hex.)	Name	Description	Default (Range)
b5-61 (119A)	PID Trim Mode Lower Limit Sel	<input type="checkbox"/> V/f <input type="checkbox"/> OLV <input type="checkbox"/> OLV/PM <input type="checkbox"/> AOLV/PM <input type="checkbox"/> EZOLV Sets the function that adjusts the PID output in relation to the frequency reference.	0 (0, 1)

0 : Disabled

Does not adjust the PID output with the frequency reference.

1 : Enabled

Adjusts the PID output in relation to the frequency reference. The setting value of *b5-62* [PID Trim Mode Lower Limit Value] sets the lower limit of the post-adjustment value. The maximum output frequency sets the upper limit.

Note:

- Set $b5-01 = 3, 4, 7, \text{ or } 8$ to enable this parameter.
- When $b5-61 = 1$, you can use this formula to adjust PID output proportional to the frequency reference:

$$U5-03 = U5-03 \times \left| \frac{Fref}{Fmax} \right|^{*1}$$

$U5-03$ [PID Output], $Fref$ [Frequency Reference], and $Fmax$ [Maximum Output Frequency]

*1 Lower limit = $b5-62$, Upper limit = Maximum output frequency

■ b5-62: PID Trim Mode Lower Limit Value

No. (Hex.)	Name	Description	Default (Range)
b5-62 (119B)	PID Trim Mode Lower Limit Value	<input type="checkbox"/> V/f <input type="checkbox"/> OLV <input type="checkbox"/> OLV/PM <input type="checkbox"/> AOLV/PM <input type="checkbox"/> EZOLV Sets the PID Trim Mode Lower Limit Value as a percentage of the maximum output frequency.	0.00% (0.00 - 100.00%)

Note:

Set $b5-01 = 3, 4, 7, \text{ or } 8$ to enable this parameter.

■ b5-63: PID Differential FB Monitor Sel

No. (Hex.)	Name	Description	Default (Range)
b5-63 (119C)	PID Differential FB Monitor Sel	<input type="checkbox"/> V/f <input type="checkbox"/> OLV <input type="checkbox"/> OLV/PM <input type="checkbox"/> AOLV/PM <input type="checkbox"/> EZOLV Selects the monitor ($Ux-xx$) used as the PID Differential Feedback. Set the $x-xx$ part of the $Ux-xx$ [Monitor].	000 (000 - 999)

Note:

- You cannot select *parameter* $U5-xx$.
- This parameter is disabled when set to 000.

■ b5-64: PID Differential FB Monitor Gain

No. (Hex.)	Name	Description	Default (Range)
b5-64 (119D)	PID Differential FB Monitor Gain	<input type="checkbox"/> V/f <input type="checkbox"/> OLV <input type="checkbox"/> OLV/PM <input type="checkbox"/> AOLV/PM <input type="checkbox"/> EZOLV Sets the gain for the monitor specified in $b5-63$ [PID Differential FB Monitor Sel].	1.00 (0.00 - 10.00)

■ b5-65: PID Differential FB Monitor Bias

No. (Hex.)	Name	Description	Default (Range)
b5-65 (119F)	PID Differential FB Monitor Bias	<input type="checkbox"/> V/f <input type="checkbox"/> OLV <input type="checkbox"/> OLV/PM <input type="checkbox"/> AOLV/PM <input type="checkbox"/> EZOLV Sets the bias for the monitor specified in $b5-63$ [PID Differential FB Monitor Sel].	0.00 (-10.00 - +10.00)

■ b5-66: PID Feedback Monitor Level

No. (Hex.)	Name	Description	Default (Range)
b5-66 (11DE)	PID Feedback Monitor Level	<input type="checkbox"/> V/f <input type="checkbox"/> OLV <input type="checkbox"/> OLV/PM <input type="checkbox"/> AOLV/PM <input type="checkbox"/> EZOLV Sets the signal level for the monitor specified in $b5-55$ [PID Feedback Monitor Selection].	0 (0, 1)

0 : Absolute

1 : Bi-directional (+/-)

■ b5-67: PID Differential FB Monitor Lvl

No. (Hex.)	Name	Description	Default (Range)
b5-67 (11DF)	PID Differential FB Monitor Lvl	<input type="checkbox"/> V/f <input type="checkbox"/> OLV <input type="checkbox"/> OLV/PM <input type="checkbox"/> AOLV/PM <input type="checkbox"/> EZOLV Sets the signal level for the monitor specified in $b5-55$ [PID Differential FB Monitor Sel].	0 (0, 1)

0 : Absolute**1 : Bi-directional (+/-)****■ b5-89: Sleep Method Selection**

No. (Hex.)	Name	Description	Default (Range)
b5-89 (0B89) RUN	Sleep Method Selection	<input type="checkbox"/> V/f <input type="checkbox"/> OLV <input type="checkbox"/> OLV/PM <input type="checkbox"/> AOLV/PM <input type="checkbox"/> EZOLV Sets sleep and wake up operation when using PID.	0 (0, 1)

0 : Standard**1 : EZ Sleep/Wake-up****■ b5-90: EZ Sleep Unit**

No. (Hex.)	Name	Description	Default (Range)
b5-90 (0B90)	EZ Sleep Unit	<input type="checkbox"/> V/f <input type="checkbox"/> OLV <input type="checkbox"/> OLV/PM <input type="checkbox"/> AOLV/PM <input type="checkbox"/> EZOLV Sets the measurement units for b5-91 [EZ Sleep Minimum Speed] and b5-92 [EZ Sleep Level].	0 (0, 1)

0 : 0.1Hz units**1 : rev/min****■ b5-91: EZ Sleep Minimum Speed**

No. (Hex.)	Name	Description	Default (Range)
b5-91 (0B91) RUN	EZ Sleep Minimum Speed	<input type="checkbox"/> V/f <input type="checkbox"/> OLV <input type="checkbox"/> OLV/PM <input type="checkbox"/> AOLV/PM <input type="checkbox"/> EZOLV Sets the output lower limit level for the PID control as Hz units or min ⁻¹ (r/min) units.	0.0 Hz or 0 min ⁻¹ (r/min) (0.0 to 590.0 Hz or 0 to 35400 min ⁻¹ (r/min))

When you use b5-91, set b5-34 = 0.0 [PID Output Lower Limit Level = 0.0 (disabled)].

When you set the lower limit for PID output as a percentage of the Maximum Output Frequency, refer to page [b5-34: PID Output Lower Limit Level on page 547](#).

Note:

The value of b5-90 [EZ Sleep Unit] sets the units. When b5-90 changes, this parameter does not automatically update. Set this parameter again after you change b5-90.

■ b5-92: EZ Sleep Level

No. (Hex.)	Name	Description	Default (Range)
b5-92 (0B92) RUN	EZ Sleep Level	<input type="checkbox"/> V/f <input type="checkbox"/> OLV <input type="checkbox"/> OLV/PM <input type="checkbox"/> AOLV/PM <input type="checkbox"/> EZOLV Sets the value that the output frequency or motor speed must be less than for longer than b5-93 [EZ Sleep Time] to enter Sleep Mode.	0.0 Hz or 0 min ⁻¹ (r/min) (0.0 to 590.0 Hz or 0 to 35400 min ⁻¹ (r/min))

Note:

When b5-90 [EZ Sleep Unit] changes, this parameter does not automatically update. Set this parameter again after you change b5-90.

■ b5-93: EZ Sleep Time

No. (Hex.)	Name	Description	Default (Range)
b5-93 (0B93) RUN	EZ Sleep Time	<input type="checkbox"/> V/f <input type="checkbox"/> OLV <input type="checkbox"/> OLV/PM <input type="checkbox"/> AOLV/PM <input type="checkbox"/> EZOLV Sets the length of time that the output frequency or motor speed must be less than b5-92 [EZ Sleep Level] to enter Sleep Mode.	5.0 s (0.0 - 1000.0 s)

■ b5-94: EZ Sleep Wake-up Level

No. (Hex.)	Name	Description	Default (Range)
b5-94 (0B94) RUN	EZ Sleep Wake-up Level	<div style="display: flex; gap: 5px;"> V/f OLV OLV/PM AOLV/PM EZOLV </div> Sets the level at which the drive resumes operation when exiting Sleep Mode.	0.00% (0.00 - 600.00%)

Note:

The values of *b5-20* [PID Unit Selection], *b5-38* [PID User Unit Display Scaling], and *b5-39* [PID User Unit Display Digits] set the units. When *b5-20*, *b5-38*, and *b5-39* change, this parameter does not automatically update. Set this parameter again after you change *b5-20*, *b5-38*, and *b5-39* are changed.

- When *b5-95* = 0 [EZ Sleep Wake-up Mode = Absolute]:
When *b5-09* = 0 [PID Output Level Selection = Normal Output (Direct Acting)], and the PID Feedback [H3-xx = B] is less than the value of *b5-94* for a time longer than the value of *b5-96* [EZ Sleep Wake-up Time], the drive will exit sleep and start operation again. When *b5-09* = 1 [Reverse Output (Reverse Acting)], and the PID feedback is more than setting value of *b5-94* for a time longer than the setting value of *b5-96*, the drive will exit sleep and start operation again.
- When *b5-95* = 1 [Setpoint Delta]:
When *b5-09* = 0, and the PID feedback is less than the value of "PID setpoint value - *b5-94*" for a time longer than the value of *b5-96*, the drive will exit sleep and start operation again. When *b5-09* = 1, and the PID feedback is more than the value of "PID setpoint value + *b5-94*" for a time longer than the setting value of *b5-96*, the drive will exit sleep and start operation again.

■ b5-95: EZ Sleep Wake-up Mode

No. (Hex.)	Name	Description	Default (Range)
b5-95 (0B95)	EZ Sleep Wake-up Mode	<div style="display: flex; gap: 5px;"> V/f OLV OLV/PM AOLV/PM EZOLV </div> Sets the wake-up mode to use when exiting Sleep Mode.	0 (0, 1)

0 : Absolute

1 : Setpoint Delta

■ b5-96: EZ Sleep Wake-up Time

No. (Hex.)	Name	Description	Default (Range)
b5-96 (0B96) RUN	EZ Sleep Wake-up Time	<div style="display: flex; gap: 5px;"> V/f OLV OLV/PM AOLV/PM EZOLV </div> Sets the EZ Wake-up time.	1.0 s (0.0 - 1000.0 s)

When the PID feedback is less than the value of *b5-94* [EZ Sleep Wake-up Level] continuously for the time set in *b5-96*, the drive will exit sleep and start operation again.

◆ b6: Dwell Function

The Dwell function momentarily holds the output frequency at start and stop.

This prevents motor speed loss when you start and stop heavy loads. The Dwell function is also enabled when backlash on the machine side causes sudden movement at the start of acceleration and deceleration.

At the start of acceleration, the drive uses the output frequency and acceleration time set for the Dwell function to automatically operate at low speed to minimize the effects of backlash. Then, the drive can accelerate again. The Dwell function operates the same for deceleration.

For conveyor applications, the Dwell function also lets the drive interlock the output frequency and a delay time for the holding brake on the load side.

The Dwell function momentarily stops during acceleration to prevent a PM motor from stepping out. [Figure 12.27](#) shows how the Dwell function works.

Note:

When you use the Dwell function at stop, set *b1-03* = 0 [Stopping Method Selection = Ramp to Stop].

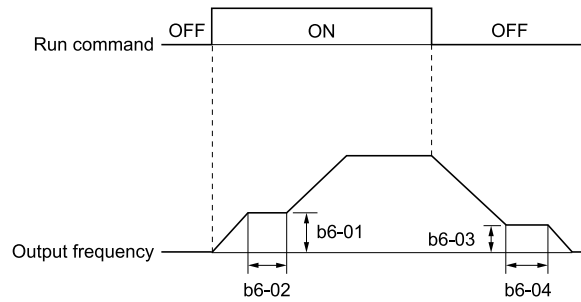

Figure 12.27 Time Chart for the Dwell Function at Start/Stop

■ **b6-01: Dwell Reference at Start**

No. (Hex.)	Name	Description	Default (Range)
b6-01 (01B6)	Dwell Reference at Start	V/f OLV OLV/PM AOLV/PM EZOLV Sets the output frequency that the drive will hold momentarily when the motor starts.	0.0 (Determined by A1-02)

When the drive accelerates to the output frequency set in *b6-01*, it holds that frequency for the time set in *b6-02* [Dwell Time at Start], and starts to accelerate again.

■ **b6-02: Dwell Time at Start**

No. (Hex.)	Name	Description	Default (Range)
b6-02 (01B7)	Dwell Time at Start	V/f OLV OLV/PM AOLV/PM EZOLV Sets the length of time that the drive will hold the output frequency when the motor starts.	0.0 s (0.0 - 10.0 s)

■ **b6-03: Dwell Reference at Stop**

No. (Hex.)	Name	Description	Default (Range)
b6-03 (01B8)	Dwell Reference at Stop	V/f OLV OLV/PM AOLV/PM EZOLV Sets the output frequency that the drive will hold momentarily when ramping to stop the motor.	0.0 (Determined by A1-02)

When the drive decelerates to the output frequency set in *b6-03*, it holds that frequency for the time set in *b6-04* [Dwell Time at Stop] and starts to decelerate again.

■ **b6-04: Dwell Time at Stop**

No. (Hex.)	Name	Description	Default (Range)
b6-04 (01B9)	Dwell Time at Stop	V/f OLV OLV/PM AOLV/PM EZOLV Sets the length of time for the drive to hold the output frequency when ramping to stop the motor.	0.0 s (0.0 - 10.0 s)

◆ **b8: Energy Saving**

Energy-saving control improves overall system operating efficiency by operating the motor at its most efficient level. Set *b8-01* and these parameters according to the control method and the motor.

- When you use V/f Control, set parameters *b8-04* to *b8-06*.
- When you use vector control with an induction motor, set parameters *b8-02* and *b8-03*.
- When you use a PM motor, set parameters *b8-16* and *b8-17*.

Note:

- Energy-saving control is not appropriate for applications with sudden changes in the load, or applications driving heavy loads such as a traverse car application.
- Energy-saving control maximizes operation based on precise motor data set to the drive. Make sure that you do Auto-Tuning and enter the correct information about the motor before you use the Energy-saving control.

■ b8-01: Energy Saving Control Selection

No. (Hex.)	Name	Description	Default (Range)
b8-01 (01CC)	Energy Saving Control Selection	<div style="display: flex; justify-content: space-between; align-items: center;"> V/f OLV OLV/PM AOLV/PM EZOLV </div> Sets the Energy-saving control function.	0 (0 - 2)

0 : Disabled

1 : Enabled

2 : Automatic Optimization

Note:

When A1-02 = 6 [Control Method Selection = AOLV/PM], you can only select setting 2 in Expert Mode.

■ b8-02: Energy Saving Gain

No. (Hex.)	Name	Description	Default (Range)
b8-02 (01CD) RUN Expert	Energy Saving Gain	<div style="display: flex; justify-content: space-between; align-items: center;"> V/f OLV OLV/PM AOLV/PM EZOLV </div> Sets the gain for Energy-saving control.	Determined by A1-02 (0.0 - 10.0)

Increase the setting value to increase energy saving. If the setting value is too large, the motor will stall.

■ b8-03: Energy Saving Filter Time

No. (Hex.)	Name	Description	Default (Range)
b8-03 (01CE) RUN Expert	Energy Saving Filter Time	<div style="display: flex; justify-content: space-between; align-items: center;"> V/f OLV OLV/PM AOLV/PM EZOLV </div> Sets the responsiveness for Energy-saving control.	Determined by A1-02 , C6-01 and o2-04 (0.00 - 10.00 s)

Decrease the setting value to increase responsiveness. If the setting value is too low, operation will not be stable.

■ b8-04: Energy Saving Coefficient Value

No. (Hex.)	Name	Description	Default (Range)
b8-04 (01CF) Expert	Energy Saving Coefficient Value	<div style="display: flex; justify-content: space-between; align-items: center;"> V/f OLV OLV/PM AOLV/PM EZOLV </div> Sets the Energy-saving control coefficient to maintain maximum motor efficiency. The default setting is for Yaskawa motors.	Determined by C6-01, E2-11, and o2-04 (0.00 - 655.00)

When you use a motor from a different manufacturer, increase the setting value in 5% increments to find the minimum value for U1-08 [Output Power] at light loads.

When you decrease the setting value, it decreases the output voltage and decreases power consumption. If the setting value is too low, the motor will stall.

Note:

When you do Rotational Auto-Tuning, the drive will automatically set the energy-saving coefficient.

■ b8-05: Power Detection Filter Time

No. (Hex.)	Name	Description	Default (Range)
b8-05 (01D0) Expert	Power Detection Filter Time	<div style="display: flex; justify-content: space-between; align-items: center;"> V/f OLV OLV/PM AOLV/PM EZOLV </div> Sets the time constant to measure output power.	20 ms (0 - 2000 ms)

Decrease the setting value to increase responsiveness to load changes. If you set the value too low during operation at light loads, motor speed is not stable.

■ b8-06: Search Operation Voltage Limit

No. (Hex.)	Name	Description	Default (Range)
b8-06 (01D1) Expert	Search Operation Voltage Limit	<div style="display: flex; gap: 5px;"> V/f OLV OLV/PM AOLV/PM EZOLV </div> Sets the voltage limit for Search Operation as a percentage of the motor rated voltage.	0% (0 - 100%)

The Search Operation changes the output voltage in small increments to find a setpoint at which the drive can use minimum power to operate.

Set this parameter to 0 to disable Search Operation. This will not disable Energy-saving control.

If the setting value is too low, the motor will stall when loads suddenly increase.

■ b8-16: PM E-Save Coefficient Ki

No. (Hex.)	Name	Description	Default (Range)
b8-16 (01F8) Expert	PM E-Save Coefficient Ki	<div style="display: flex; gap: 5px;"> V/f OLV OLV/PM AOLV/PM EZOLV </div> Sets torque linearity. This parameter uses the Ki value from the motor nameplate. Usually it is not necessary to change this setting.	1.00 (0.00 - 3.00)

When $b8-16 = 1.00$ (default), the drive will automatically calculate and control the energy-saving coefficient. If the motor nameplate has a description for “Ki”, set this parameter to the Ki value.

Do this procedure to prevent oscillation when you set $b8-01 = 1$ [Energy Saving Control Selection = Enabled].

1. Check U5-21 [Energy Save Coeff Ki] and make sure that it aligns with the Ki value on the motor nameplate.
2. If the numbers are different, set $b8-16$ to the Ki value on the motor nameplate.

■ b8-17: PM E-Save Coefficient Kt

No. (Hex.)	Name	Description	Default (Range)
b8-17 (01F9) Expert	PM E-Save Coefficient Kt	<div style="display: flex; gap: 5px;"> V/f OLV OLV/PM AOLV/PM EZOLV </div> Sets torque linearity. This parameter uses the Kt value from the motor nameplate. Usually it is not necessary to change this setting.	1.00 (0.00 - 3.00)

When $E5-01 = 1xxx$ [PM Motor Code Selection = Yaskawa SSR1 series IPM motor], the drive automatically calculates the energy-saving coefficient Kt and uses that value to control operation.

Do this procedure to prevent oscillation when you set $b8-01 = 1$ [Energy Saving Control Selection = Enabled].

1. Check U5-22 [Energy Save Coeff Kt] and make sure that it aligns with the Kt value on the motor nameplate.
2. If the numbers are different, set $b8-17$ to the Kt value on the motor nameplate.

■ b8-18: E-Save d-axis Current FilterTime

No. (Hex.)	Name	Description	Default (Range)
b8-18 (01FA) Expert	E-Save d-axis Current FilterTime	<div style="display: flex; gap: 5px;"> V/f OLV OLV/PM AOLV/PM EZOLV </div> Sets the d-axis current reference filter time constant.	0.100 s (0.000 - 5.000 s)

■ b8-19: E-Save Search Frequency

No. (Hex.)	Name	Description	Default (Range)
b8-19 (0B40) Expert	E-Save Search Frequency	<div style="display: flex; gap: 5px;"> V/f OLV OLV/PM AOLV/PM EZOLV </div> Sets the frequency of Energy-saving control search operations. Usually it is not necessary to change this setting.	Determined by A1-02 (10 - 300 Hz)

Note:

- If low inertia causes vibration in the machine, increase the setting value in 10 Hz increments and check the response. If $A1-02 = 8$ [Control Method Selection = EZOLV], increase the setting value in 1 Hz increments.
- To make the motor more efficient, decrease the setting value in 1 Hz increments until the point immediately before machine vibration starts to occur.

■ b8-20: E-Save Search Width

No. (Hex.)	Name	Description	Default (Range)
b8-20 (0B41) Expert	E-Save Search Width	<div style="display: flex; justify-content: space-between; align-items: center;"> V/f OLV OLV/PM AOLV/PM EZOLV </div> Sets the amplitude of Energy-saving control search operations.	1.0 degrees (0.1 - 5.0 degrees)

An increase in the value can make the operational efficiency better. However, if the load inertia is small, it may be necessary to adjust the value to prevent machine vibration.

Note:

- If low inertia causes vibration in the machine, decrease the setting value in 1.0-degree increments and check the response.
- To make the motor more efficient, increase the setting value in 1.0-degree increments until the point immediately before machine vibration starts to occur.

■ b8-21: PM E-Save Search Gain

No. (Hex.)	Name	Description	Default (Range)
b8-21 (0B42) Expert	PM E-Save Search Gain	<div style="display: flex; justify-content: space-between; align-items: center;"> V/f OLV OLV/PM AOLV/PM EZOLV </div> Sets the gain of Energy-saving control search operations.	0.3Hz (0.1 - 20.0 Hz)

When you decrease the value of $C5-01$ [ASR Proportional Gain 1], also decrease the value of $b8-21$ to keep the correct ratio.

■ b8-22: PM E-Save Search LPF Cutoff Freq

No. (Hex.)	Name	Description	Default (Range)
b8-22 (0B43) Expert	PM E-Save Search LPF Cutoff Freq	<div style="display: flex; justify-content: space-between; align-items: center;"> V/f OLV OLV/PM AOLV/PM EZOLV </div> Sets the frequency of the filter used to extract the high-efficiency phase from search operations. Usually it is not necessary to change this setting.	10.0 Hz (1.0 - 30.0 Hz)

■ b8-23: PM E-Save Search Limit

No. (Hex.)	Name	Description	Default (Range)
b8-23 (0B44) Expert	PM E-Save Search Limit	<div style="display: flex; justify-content: space-between; align-items: center;"> V/f OLV OLV/PM AOLV/PM EZOLV </div> Sets the search operations output limit. Usually it is not necessary to change this setting.	15.0 degrees (0.0 - 30.0 degrees)

When the motor characteristics are correct, increase this value to make the motor more efficient.

■ b8-24: PM E-Save High Freq ACR Gain

No. (Hex.)	Name	Description	Default (Range)
b8-24 (0B45) Expert	PM E-Save High Freq ACR Gain	<div style="display: flex; justify-content: space-between; align-items: center;"> V/f OLV OLV/PM AOLV/PM EZOLV </div> Sets the gain for high-frequency current control.	200.0 Hz (100.0 - 1000.0 Hz)

Note:

If the drive detects oC [Overcurrent], decrease the value.

■ b8-25: PM E-Save Search Start Level

No. (Hex.)	Name	Description	Default (Range)
b8-25 (0B46) Expert	PM E-Save Search Start Level	<div style="display: flex; justify-content: space-between; align-items: center;"> V/f OLV OLV/PM AOLV/PM EZOLV </div> Sets the start level for search operations.	10.0% (0.0 - 100.0%)

Note:

If there is vibration in the machine, increase the value.

■ b8-26: PM E-Save Power Setpoint

No. (Hex.)	Name	Description	Default (Range)
b8-26 (0B47) Expert	PM E-Save Power Setpoint	<div style="display: flex; justify-content: space-between; align-items: center;"> V/f OLV OLV/PM AOLV/PM EZOLV </div> Sets a value to increase torque accuracy.	0.0% (-10.0 - +10.0%)

■ b8-28: Over Excitation Action Selection

No. (Hex.)	Name	Description	Default (Range)
b8-28 (0B8B) Expert	Over Excitation Action Selection	<div style="display: flex; justify-content: space-between; align-items: center;"> V/f OLV OLV/PM AOLV/PM EZOLV </div> Sets the function for excitation operation.	0 (0, 1)

When operation is not stable at low speeds, set this parameter to 1 to enable the function.

0 : Disabled

1 : Enabled

■ b8-29: Energy Saving Priority Selection

No. (Hex.)	Name	Description	Default (Range)
b8-29 (0B8C)	Energy Saving Priority Selection	<div style="display: flex; justify-content: space-between; align-items: center;"> V/f OLV OLV/PM AOLV/PM EZOLV </div> Sets the priority of drive response between changes to the load or Energy-saving control. Enable this to prioritize energy-saving control. Disable this to prioritize tracking related to fast load changes, and prevent motor stall.	0 (0, 1)

Enable this parameter when there are small changes in the load. It is possible that the motor cannot respond correctly to changes in the load.

0 : Priority: Drive Response

1 : Priority: Energy Savings

12.4 C: Tuning

C parameters adjust drive operation, including:

- Acceleration Time
- Deceleration Time
- Slip Compensation
- Torque Compensation
- Carrier Frequency

◆ C1: Accel & Decel Time

You can set four different acceleration and deceleration time pairs in the drive. When you activate and deactivate H1-xx = 7, 16, 1A [MFDI Function Select = Accel/Decel Time Selection 1, Motor 2 Selection, Accel/Decel Time Selection 2], you can switch acceleration and deceleration times during run.

Acceleration time parameters always set the time to accelerate from 0 Hz to *E1-04* [Maximum Output Frequency]. Deceleration time parameters always set the time to decelerate from *E1-04* to 0 Hz.

C1-01 [Acceleration Time 1] and *C1-02* [Deceleration Time 1] are the default active accel/decel settings.

Parameter	Range
<i>C1-01</i> [Acceleration Time 1]	0.0 to 6000.0 s
<i>C1-02</i> [Deceleration Time 1]	
<i>C1-03</i> [Acceleration Time 2]	
<i>C1-04</i> [Deceleration Time 2]	
<i>C1-05</i> [Acceleration Time 3]	
<i>C1-06</i> [Deceleration Time 3]	
<i>C1-07</i> [Acceleration Time 4]	
<i>C1-08</i> [Deceleration Time 4]	

Note:

The setting range for acceleration and deceleration times is 0.00 to 600.00 s when *C1-10* = 0 [Accel/Decel Time Setting Units = 0.01 s (0.00 to 600.00 s)].

■ Use MFDIs to Switch Acceleration Times

Table 12.27 shows the different acceleration and deceleration times.

Table 12.27 Accel/Decel Times and Active Parameters

H1-xx = 7 [Accel/Decel Time Selection 1]	H1-xx = 1A [Accel/Decel Time Selection 2]	Active Parameter	
		Acceleration Time	Deceleration Time
OFF	OFF	<i>C1-01</i> [Acceleration Time 1]	<i>C1-02</i> [Deceleration Time 1]
ON	OFF	<i>C1-03</i> [Acceleration Time 2]	<i>C1-04</i> [Deceleration Time 2]
OFF	ON	<i>C1-05</i> [Acceleration Time 3]	<i>C1-06</i> [Deceleration Time 3]
ON	ON	<i>C1-07</i> [Acceleration Time 4]	<i>C1-08</i> [Deceleration Time 4]

Figure 12.28 shows an operation example to change acceleration and deceleration times. It is necessary to set *b1-03* = 0 [Stopping Method Selection = Ramp to Stop] for this example.

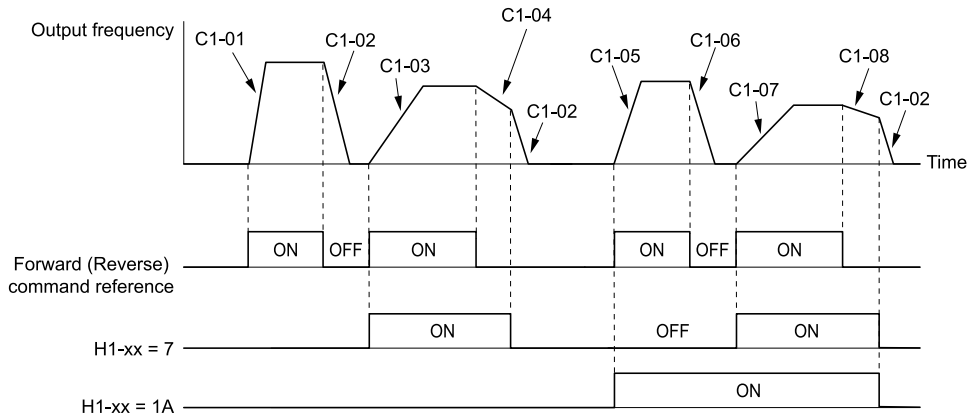

Figure 12.28 Timing Diagram of Acceleration and Deceleration Times

■ Use Motor Selection to Switch Acceleration and Deceleration Times

When you set $H1-xx = 16$ [MFDI Function Selection = Motor 2 Selection], you can activate and deactivate the input terminal to switch between motor 1 and motor 2.

Note:

You cannot use the Motor 2 Selection function with PM motors.

Table 12.28 shows the possible acceleration and deceleration time combinations when you use the Motor 2 Selection function.

Table 12.28 Motor Selection and Acceleration and Deceleration Times

H1-xx = 7 [Accel/Decel Time Selection 1]	H1-xx = 16 [Motor 2 Selection]			
	Motor 2 Selection: OFF		Motor 2 Selection: ON	
	Acceleration Time	Deceleration Time	Acceleration Time	Deceleration Time
OFF	C1-01	C1-02	C1-05	C1-06
ON	C1-03	C1-04	C1-07	C1-08

■ Use Output Frequency Level to Switch Acceleration and Deceleration Times

The drive can use output frequency to automatically switch between different acceleration and deceleration times. When the output frequency = $C1-11$ [Accel/Decel Time Switchover Freq], the drive automatically switches the acceleration and deceleration times. Set $C1-11 = 0.0$ Hz to disable this function.

Note:

- Acceleration and deceleration times set to MFDIs are more important than the automatic switch using the frequency level set in $C1-11$. For example, if you set the switchover frequency to $C1-11$, the drive will not automatically switch acceleration and deceleration times when the MFDI terminal set for *Accel/Decel Time Selection 1* [$H1-xx = 7$] is activated.
- If Motor 2 Selection [$H1-xx = 16$] is activated, the drive will set the acceleration/deceleration time to $C1-05$ and $C1-06$ for motor 2 when the output frequency is more than the frequency level set in $C1-11$.

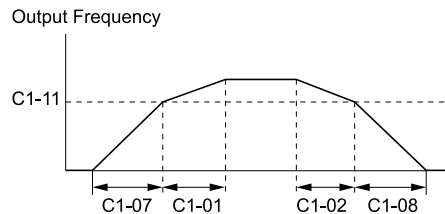

When the output frequency $\geq C1-11$, drive uses Accel/Decel Time 1 (C1-01, C1-02)
 When the output frequency $< C1-11$, drive uses Accel/Decel Time 4 (C1-07, C1-08)

Figure 12.29 Accel/Decel Time Switching Frequency

■ C1-01: Acceleration Time 1

No. (Hex.)	Name	Description	Default (Range)
C1-01 (0200) RUN	Acceleration Time 1	V/f OLV OLV/PM AOLV/PM EZOLV Sets the length of time to accelerate from zero to maximum output frequency.	10.0 s (0.0 - 6000.0 s)

Note:

When $C1-10 = 0$ [Accel/Decel Time Setting Units = 0.01 s (0.00 to 600.00 s)], the setting range is 0.00 to 600.00 s.

■ C1-02: Deceleration Time 1

No. (Hex.)	Name	Description	Default (Range)
C1-02 (0201) RUN	Deceleration Time 1	V/f OLV OLV/PM AOLV/PM EZOLV Sets the length of time to decelerate from maximum output frequency to zero.	10.0 s (0.0 - 6000.0 s)

Note:

When $C1-10 = 0$ [Accel/Decel Time Setting Units = 0.01 s (0.00 to 600.00 s)], the setting range is 0.00 to 600.00 s.

■ C1-03: Acceleration Time 2

No. (Hex.)	Name	Description	Default (Range)
C1-03 (0202) RUN	Acceleration Time 2	V/f OLV OLV/PM AOLV/PM EZOLV Sets the length of time to accelerate from zero to maximum output frequency.	10.0 s (0.0 - 6000.0 s)

Note:

When $C1-10 = 0$ [Accel/Decel Time Setting Units = 0.01 s (0.00 to 600.00 s)], the setting range is 0.00 to 600.00 s.

■ C1-04: Deceleration Time 2

No. (Hex.)	Name	Description	Default (Range)
C1-04 (0203) RUN	Deceleration Time 2	V/f OLV OLV/PM AOLV/PM EZOLV Sets the length of time to decelerate from maximum output frequency to zero.	10.0 s (0.0 - 6000.0 s)

Note:

When $C1-10 = 0$ [Accel/Decel Time Setting Units = 0.01 s (0.00 to 600.00 s)], the setting range is 0.00 to 600.00 s.

■ C1-05: Acceleration Time 3

No. (Hex.)	Name	Description	Default (Range)
C1-05 (0204) RUN	Acceleration Time 3	V/f OLV OLV/PM AOLV/PM EZOLV Sets the length of time to accelerate from zero to maximum output frequency.	10.0 s (0.0 - 6000.0 s)

Note:

When $C1-10 = 0$ [Accel/Decel Time Setting Units = 0.01 s (0.00 to 600.00 s)], the setting range is 0.00 to 600.00 s.

■ C1-06: Deceleration Time 3

No. (Hex.)	Name	Description	Default (Range)
C1-06 (0205) RUN	Deceleration Time 3	V/f OLV OLV/PM AOLV/PM EZOLV Sets the length of time to decelerate from maximum output frequency to zero.	10.0 s (0.0 - 6000.0 s)

Note:

When $C1-10 = 0$ [Accel/Decel Time Setting Units = 0.01 s (0.00 to 600.00 s)], the setting range is 0.00 to 600.00 s.

■ C1-07: Acceleration Time 4

No. (Hex.)	Name	Description	Default (Range)
C1-07 (0206) RUN	Acceleration Time 4	<div style="display: flex; justify-content: space-between; align-items: center;"> V/f OLV OLV/PM AOLV/PM EZOLV </div> Sets the length of time to accelerate from zero to maximum output frequency.	10.0 s (0.0 - 6000.0 s)

Note:

When $C1-10 = 0$ [Accel/Decel Time Setting Units = 0.01 s (0.00 to 600.00 s)], the setting range is 0.00 to 600.00 s.

■ C1-08: Deceleration Time 4

No. (Hex.)	Name	Description	Default (Range)
C1-08 (0207) RUN	Deceleration Time 4	<div style="display: flex; justify-content: space-between; align-items: center;"> V/f OLV OLV/PM AOLV/PM EZOLV </div> Sets the length of time to decelerate from maximum output frequency to zero.	10.0 s (0.0 - 6000.0 s)

Note:

When $C1-10 = 0$ [Accel/Decel Time Setting Units = 0.01 s (0.00 to 600.00 s)], the setting range is 0.00 to 600.00 s.

■ C1-09: Fast Stop Time

No. (Hex.)	Name	Description	Default (Range)
C1-09 (0208) RUN	Fast Stop Time	<div style="display: flex; justify-content: space-between; align-items: center;"> V/f OLV OLV/PM AOLV/PM EZOLV </div> Sets the length of time that the drive will decelerate to zero for a Fast Stop.	10.0 s (0.0 - 6000.0 s)

Note:

- When $C1-10 = 0$ [Accel/Decel Time Setting Units = 0.01 s (0.00 to 600.00 s)], the setting range is 0.00 to 600.00 s.
- When $L2-29 = 0$ [Kinetic Energy Backup Method = Single Drive KEB Ride-Thru 1] and you do KEB Auto-Tuning, the drive will automatically set $C1-09$. If you must not change the Fast Stop time, do not do KEB Auto-Tuning.

The Fast Stop function will be triggered in the following circumstances.

- The Fast Stop operation will be triggered by the input of the Fast Stop command via the multi-function digital input terminal.
- The Fast Stop operation is will be triggered when by the input of the Fast Stop command is input via the multi-function digital input terminal.

Set $H1-xx = 15, 17$ [MFDI Function Select = Fast Stop (N.O.), Fast Stop (N.C.)].

When the Fast Stop command is input, the Fast Stop operation will be triggered at the deceleration time set to $C1-09$. The drive cannot be restarted after initiating a Fast Stop operation until deceleration is complete. Complete deceleration and cycle the Run command to clear the Fast Stop input.

The terminal set for $H2-xx = 4C$ [MFDO Function Select = During Fast Stop] will be ON during Fast Stop.

Note:

Decelerating too quickly can cause an *ov* [Overvoltage] fault that shuts off the drive while the motor to coasts to a stop. Set a Fast Stop time in $C1-09$ that prevents motor coasting and makes sure that the motor stops quickly and safely.

■ C1-10: Accel/Decel Time Setting Units

No. (Hex.)	Name	Description	Default (Range)
C1-10 (0209)	Accel/Decel Time Setting Units	<div style="display: flex; justify-content: space-between; align-items: center;"> V/f OLV OLV/PM AOLV/PM EZOLV </div> Sets the setting units for $C1-01$ to $C1-08$ [Accel/Decel Times 1 to 4], $C1-09$ [Fast Stop Time], $L2-06$ [Kinetic Energy Backup Decel Time], and $L2-07$ [Kinetic Energy Backup Accel Time].	1 (0, 1)

0 : 0.01 s (0.00 to 600.00 s)

Sets acceleration and deceleration times in 0.01 s units. The setting range is 0.0 to 6000.0 s.

If one of these parameters is set to 1000.0 s or longer, you cannot set $C1-10 = 0$:

- $C1-01$ to $C1-09$

- L2-06
- L2-07

When one of those parameters is set to a value between 600.1 s and 1000.0 s, you can set $C1-10 = 0$, but the time will change to 600.00 s.

1 : 0.1 s (0.0 to 6000.0 s)

Sets acceleration and deceleration times in 0.1 s units. The setting range is 0.0 to 6000.0 s.

■ C1-11: Accel/Decel Time Switchover Freq

No. (Hex.)	Name	Description	Default (Range)
C1-11 (020A)	Accel/Decel Time Switching Frequency	V/f OLV OLV/PM AOLV/PM EZOLV Sets the frequency at which the drive will automatically change acceleration and deceleration times.	Determined by A1-02 (0.0 - 590.0 Hz)

When the output frequency is at the $C1-11$ value, the drive automatically switches the acceleration and deceleration times. Set this parameter to 0.0 to disable this function.

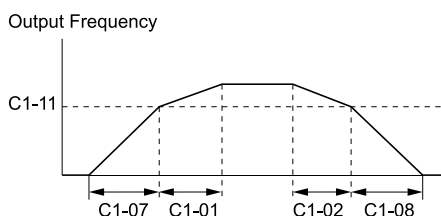

When the output frequency $\geq C1-11$, drive uses Accel/Decel Time 1 (C1-01, C1-02)
When the output frequency $< C1-11$, drive uses Accel/Decel Time 4 (C1-07, C1-08)

Figure 12.30 Accel/Decel Time Switchover Freq

Table 12.29 lists the possible combinations of acceleration and deceleration time switchover frequencies and the acceleration times for the Motor 2 Selection function.

Table 12.29 Motor and Acceleration and Deceleration Time Combination

C1-11	Motor 1		Motor 2	
	Acceleration Time	Deceleration Time	Acceleration Time	Deceleration Time
Less than the setting value	C1-07 [Acceleration Time 4]	C1-08 [Deceleration Time 4]	C1-07 [Acceleration Time 4]	C1-08 [Deceleration Time 4]
Equal to or more than the setting value	C1-01 [Acceleration Time 1]	C1-02 [Deceleration Time 1]	C1-05 [Acceleration Time 3]	C1-06 [Deceleration Time 3]

■ C1-14: Accel/Decel Rate Frequency

No. (Hex.)	Name	Description	Default (Range)
C1-14 (0264) RUN	Accel/Decel Rate Frequency	V/f OLV OLV/PM AOLV/PM EZOLV Sets the base frequency used to calculate acceleration and deceleration rates.	0.0 Hz (0.0 - 590.0 Hz)

The acceleration and deceleration rates set in $C1-01$ to $C1-09$ [Acceleration/Deceleration Times 1 to 4, Fast Stop Time] will change when the value of $C1-14$ changes.

- When $C1-14 = 0.0$ Hz
 - $C1-01$, $C1-03$, $C1-05$, $C1-07$ [Acceleration Times 1 to 4]: Time to accelerate from 0 Hz to $E1-04$ [Maximum Output Frequency]
 - $C1-02$, $C1-04$, $C1-06$, $C1-08$ [Deceleration Times 1 to 4], $C1-09$ [Fast Stop Time]: Time to decelerate from $E1-04$ to 0 Hz.

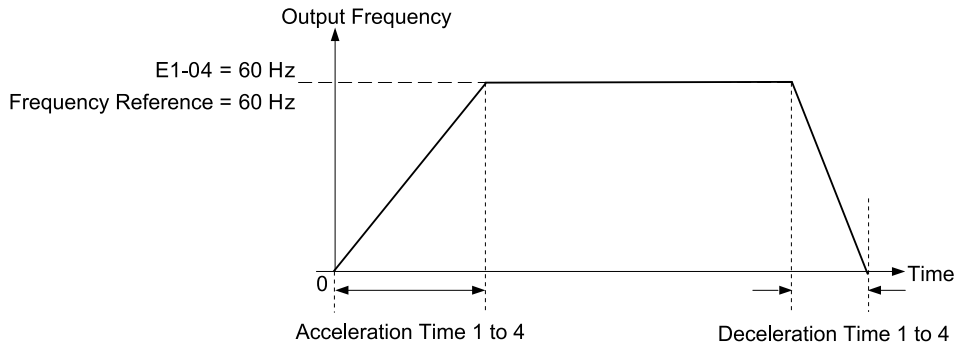

Figure 12.31 Example 1: Acceleration/Deceleration Rate (When C1-14 = 0 Hz, E1-04 = 60 Hz, and the Frequency Reference is 60 Hz)

- When $C1-14 \neq 0.0$ Hz
 - C1-01, C1-03, C1-05, C1-07: Time to accelerate from 0 Hz to C1-14
 - C1-02, C1-04, C1-06, C1-08, C1-09: Time to decelerate from C1-14 to 0 Hz

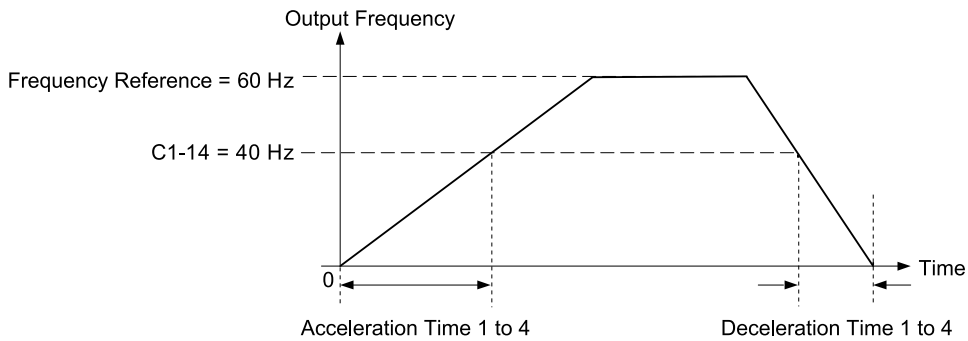

Figure 12.32 Example 2: Acceleration/Deceleration Rate (When C1-14 = 40 Hz, E1-04 = 60 Hz, and the Frequency Reference is 60 Hz)

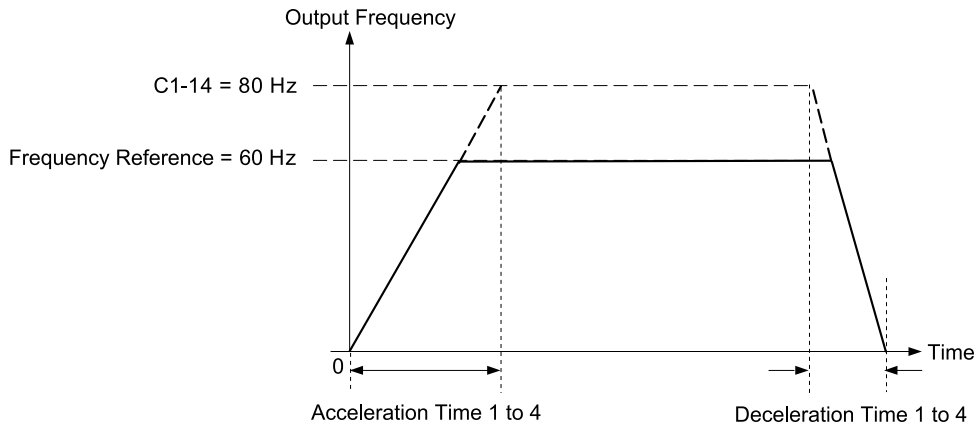

Figure 12.33 Example 3: Acceleration/Deceleration Rate (When C1-14 = 80 Hz, E1-04 = 60 Hz, and the Frequency Reference is 60 Hz)

Note:

- Figure 12.31 to Figure 12.33 show the accel/decel times when $C2-01$ to $C2-04$ [S-Curve Times @ Start/End of Accel/Decel] = 0.00 s.
- When $L3-01 \neq 0$ [Stall Prevention during Accel ≠ Disabled], Stall Prevention could cause the acceleration time to be longer than the set value.
- When $L3-04 \neq 0$ [Stall Prevention during Decel ≠ Disabled], Stall Prevention could cause the deceleration time to be longer than the set value.

◆ C2: S-Curve Characteristics

Use S-curve characteristics to smooth acceleration and deceleration and to minimize abrupt shock to the load. Set S-curve characteristic time during acceleration/deceleration at start and acceleration/deceleration at stop. The following figure explains how S-curves are applied.

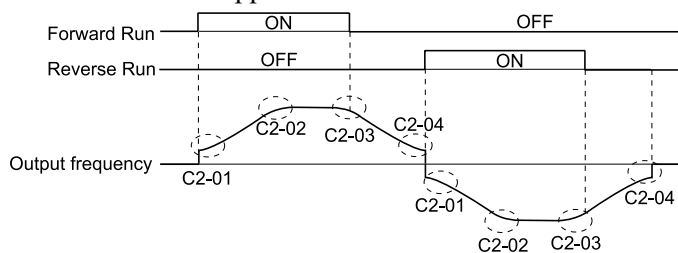

Figure 12.34 S-Curve Timing Diagram - Forward/Reverse Operation

Note:

- If *STPo* [Motor Step-Out Detected] occurs when starting a PM motor, try increasing the value set to *C2-01*.
- Setting the S-curve will increase the acceleration and deceleration times.

$$\text{Acceleration time} = \text{Selected acceleration time} + \frac{C2-01 + C2-02}{2}$$

$$\text{Deceleration time} = \text{Selected deceleration time} + \frac{C2-03 + C2-04}{2}$$

■ C2-01: S-Curve Time @ Start of Accel

No. (Hex.)	Name	Description	Default (Range)
C2-01 (020B)	S-Curve Time @ Start of Accel	<input type="checkbox"/> V/f <input type="checkbox"/> OLV <input type="checkbox"/> OLV/PM <input type="checkbox"/> AOLV/PM <input type="checkbox"/> EZOLV Sets the S-curve acceleration time at start.	Determined by A1-02 (0.00 - 10.00 s)

■ C2-02: S-Curve Time @ End of Accel

No. (Hex.)	Name	Description	Default (Range)
C2-02 (020C)	S-Curve Time @ End of Accel	<input type="checkbox"/> V/f <input type="checkbox"/> OLV <input type="checkbox"/> OLV/PM <input type="checkbox"/> AOLV/PM <input type="checkbox"/> EZOLV Sets the S-curve acceleration time at completion.	0.20 s (0.00 - 10.00 s)

■ C2-03: S-Curve Time @ Start of Decel

No. (Hex.)	Name	Description	Default (Range)
C2-03 (020D)	S-Curve Time @ Start of Decel	<input type="checkbox"/> V/f <input type="checkbox"/> OLV <input type="checkbox"/> OLV/PM <input type="checkbox"/> AOLV/PM <input type="checkbox"/> EZOLV Sets the S-curve deceleration time at start.	0.20 s (0.00 - 10.00 s)

■ C2-04: S-Curve Time @ End of Decel

No. (Hex.)	Name	Description	Default (Range)
C2-04 (020E)	S-Curve Time @ End of Decel	<input type="checkbox"/> V/f <input type="checkbox"/> OLV <input type="checkbox"/> OLV/PM <input type="checkbox"/> AOLV/PM <input type="checkbox"/> EZOLV Sets the S-curve deceleration time at completion.	0.00 s (0.00 - 10.00 s)

◆ C3: Slip Compensation

The Slip Compensation function improves the speed accuracy of an induction motor. As loads on induction motors increase, motor slip increases and motor speed decreases. By adjusting the output frequency in accordance with the motor load, it compensates the slip and makes the motor speed equal to the frequency reference.

■ C3-01: Slip Compensation Gain

No. (Hex.)	Name	Description	Default (Range)
C3-01 (020F) RUN	Slip Compensation Gain	<div style="display: flex; gap: 5px;"> V/f OLV OLV/PM AOLV/PM EZOLV </div> <p>Sets the gain for the slip compensation function. Usually it is not necessary to change this setting.</p>	Determined by A1-02 (0.0 - 2.5)

Note:

Correctly set these parameters before changing the slip compensation gain:

- E2-01 [Motor Rated Current (FLA)]
- E2-02 [Motor Rated Slip]
- E2-03 [Motor No-Load Current]

Adjust this parameter as follows if necessary:

- If the motor speed is slower than the frequency reference, increase this parameter in 0.1-unit increments.
- If the motor speed is slower than the frequency reference value, decrease this parameter value in 0.1-unit increments.

■ C3-02: Slip Compensation Delay Time

No. (Hex.)	Name	Description	Default (Range)
C3-02 (0210) RUN	Slip Compensation Delay Time	<div style="display: flex; gap: 5px;"> V/f OLV OLV/PM AOLV/PM EZOLV </div> <p>Sets the slip compensation delay time when speed is unstable or when the slip compensation response is too slow. Usually it is not necessary to change this setting.</p>	Determined by A1-02 (0 - 10000 ms)

Use these settings to adjust this parameter as necessary:

- When the speed is not stable, increase the setting.
- When the slip compensation response is too slow, decrease the setting.

■ C3-03: Slip Compensation Limit

No. (Hex.)	Name	Description	Default (Range)
C3-03 (0211)	Slip Compensation Limit	<div style="display: flex; gap: 5px;"> V/f OLV OLV/PM AOLV/PM EZOLV </div> <p>Sets the upper limit for the slip compensation function as a percentage of the motor rated slip.</p>	200% (0 - 250%)

If you increase the value of C3-01 [Slip Compensation Gain] and the motor speed is slow, use this parameter. The drive uses this parameter when the slip is at the upper limit of slip compensation. Make sure that you measure the motor speed when you increase this parameter value. Set this parameter to make the frequency reference and the slip compensation limit less than the permitted range of the machine.

The slip compensation limit is constant in the constant torque range (frequency reference \leq E1-06 [Base Frequency]). In the constant output range where the frequency reference $>$ E1-06, the slip compensation limit increases with the C3-03 value and the output frequency as shown in Figure 12.35.

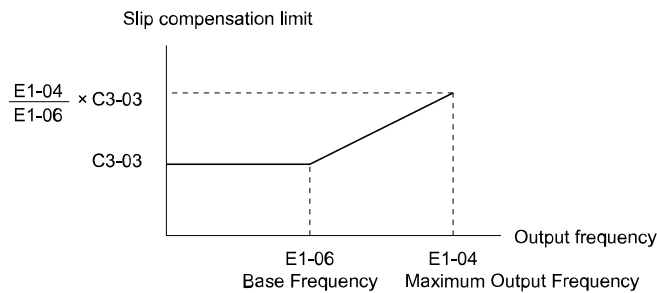

Figure 12.35 Slip Compensation Limit

■ C3-04: Slip Compensation at Regen

No. (Hex.)	Name	Description	Default (Range)
C3-04 (0212)	Slip Compensation at Regen	<input type="radio"/> V/f <input checked="" type="radio"/> OLV <input type="radio"/> OLV/PM <input type="radio"/> AOLV/PM <input type="radio"/> EZOLV Sets the slip compensation function during regeneration.	0 (0 - 2)

If you apply a regenerative load when the slip compensation function during regeneration is active, the quantity of regeneration can increase immediately. In this condition, it is necessary to use a dynamic braking option (braking resistor or braking resistor unit).

0 : Disabled

The drive will not do Slip compensation during regeneration.

The load and operation status (regenerative operation) can cause the motor speed to be higher or lower than the frequency reference.

1 : Enabled Above 6Hz

Slip compensation function is enabled during regeneration. Slip compensation is disabled at output frequencies of 6 Hz or less.

2 : Enabled Above Defined Range

The drive uses *E2-02 [Motor Rated Slip]* to automatically calculate the frequency range where it will disable slip compensation function during regenerative operation.

Slip compensation is enabled at frequencies as low as 2 Hz.

■ C3-05: Output Voltage Limit Selection

No. (Hex.)	Name	Description	Default (Range)
C3-05 (0213)	Output Voltage Limit Selection	<input type="radio"/> V/f <input checked="" type="radio"/> OLV <input type="radio"/> OLV/PM <input type="radio"/> AOLV/PM <input type="radio"/> EZOLV Sets the automatic reduction of motor magnetic flux when the output voltage is saturated.	0 (0, 1)

The drive will decrease flux and increase current to compensate torque when voltage is saturated. Make sure that the drive has sufficient output current capacity before you enable this parameter. When this parameter = 1 [Enabled], the output current will increase by 10% at a maximum (at rated load) before it is enabled.

Enable this parameter to increase speed precision when you move heavy loads at high speeds in these conditions:

- Power supply voltage is low
- Motor rated voltage is high

Do not enable this parameter in these conditions:

- Operating a motor in the middle speed range or low speed range
- Power supply voltage is a minimum of 10% more than the motor rated voltage

When you enable this parameter, if the power supply voltage is much less than the motor rated voltage, torque control will not be accurate.

0 : Disabled

1 : Enabled

■ C3-16: Vout Modulation Limit Start Lvl

No. (Hex.)	Name	Description	Default (Range)
C3-16 (0261) Expert	Vout Modulation Limit Start Lvl	<input type="radio"/> V/f <input checked="" type="radio"/> OLV <input type="radio"/> OLV/PM <input type="radio"/> AOLV/PM <input type="radio"/> EZOLV Sets the modulation factor that starts the output voltage limit operation when C3-05 = 1 [Output Voltage Limit Selection = Enabled].	90.0% (70.0 - 90.0%)

■ C3-17: Vout Modulation Limit Max Level

No. (Hex.)	Name	Description	Default (Range)
C3-17 (0262) Expert	Vout Modulation Limit Max Level	<div style="display: flex; justify-content: space-between; align-items: center;"> V/f OLV OLV/PM AOLV/PM EZOLV </div> Sets the modulation factor used with C3-18 [Output Voltage Limit Level] for the output voltage limit operation when C3-05 = 1 [Output Voltage Limit Selection = Enabled].	100.0% (85.0 - 100.0%)

■ C3-18: Output Voltage Limit Level

No. (Hex.)	Name	Description	Default (Range)
C3-18 (0263) Expert	Output Voltage Limit Level	<div style="display: flex; justify-content: space-between; align-items: center;"> V/f OLV OLV/PM AOLV/PM EZOLV </div> Sets the maximum drop width of the voltage reference when C3-05 = 1 [Output Voltage Limit Selection = Enabled].	90.0% (50.0 - 100.0%)

■ C3-21: Motor 2 Slip Compensation Gain

No. (Hex.)	Name	Description	Default (Range)
C3-21 (033E) RUN	Motor 2 Slip Compensation Gain	<div style="display: flex; justify-content: space-between; align-items: center;"> V/f OLV OLV/PM AOLV/PM EZOLV </div> Sets the gain for the motor 2 slip compensation function. Usually it is not necessary to change this setting.	Determined by E3-01 (0.0 - 2.5)

Note:

Correctly set these parameters before you change the slip compensation gain:

- E4-01 [Motor 2 Rated Current]
- E4-02 [Motor 2 Rated Slip]
- E4-03 [Motor 2 Rated No-Load Current]

Adjust this parameter as follows if necessary:

- If the motor speed is slower than the frequency reference, increase C3-01 in 0.1-unit increments.
- If the motor speed is faster than the frequency reference, decrease C3-01 in 0.1-unit increments.

■ C3-22: Motor 2 Slip Comp Delay Time

No. (Hex.)	Name	Description	Default (Range)
C3-22 (0241) RUN	Motor 2 Slip Comp Delay Time	<div style="display: flex; justify-content: space-between; align-items: center;"> V/f OLV OLV/PM AOLV/PM EZOLV </div> Sets the slip compensation delay time for motor 2 when speed is unstable or when the slip compensation response is too slow. Usually it is not necessary to change this setting.	Determined by E3-01 (0 - 10000 ms)

Use these settings to adjust this parameter as necessary:

- When the speed is not stable, increase the setting.
- When the slip compensation response is too slow, decrease the setting.

■ C3-23: Motor 2 Slip Compensation Limit

No. (Hex.)	Name	Description	Default (Range)
C3-23 (0242)	Motor 2 Slip Compensation Limit	<div style="display: flex; justify-content: space-between; align-items: center;"> V/f OLV OLV/PM AOLV/PM EZOLV </div> Sets the upper limit for the slip compensation function as a percentage of the motor 2 rated slip.	200% (0 - 250%)

If you increase the value of C3-21 [Motor 2 Slip Compensation Gain] and the motor speed is slow, use this parameter. The drive uses this parameter when the slip is at the upper limit of slip compensation. Make sure that you measure the motor speed when you increase this parameter value. Set this parameter to make the frequency reference and the slip compensation limit less than the permitted range of the machine.

The slip compensation limit is constant in the constant torque range (frequency reference \leq E3-06 [Motor 2 Base Frequency]). In the constant power range where the frequency reference $>$ E3-06, the slip compensation limit increases with the C3-23 value and the output frequency as shown in [Figure 12.36](#).

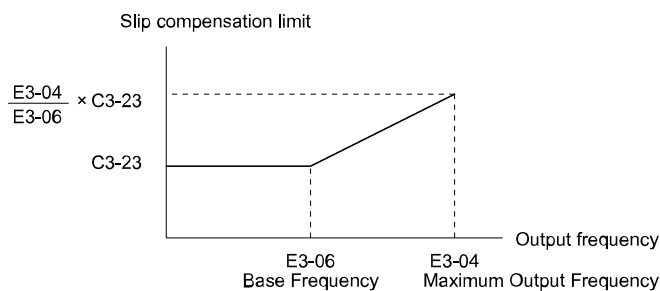

Figure 12.36 Motor 2 Slip Compensation Limit

■ C3-24: Motor 2 Slip Comp during Regen

No. (Hex.)	Name	Description	Default (Range)
C3-24 (0243)	Motor 2 Slip Comp during Regen	<input type="checkbox"/> V/f <input type="checkbox"/> OLV <input type="checkbox"/> OLV/PM <input type="checkbox"/> AOLV/PM <input type="checkbox"/> EZOLV Sets the slip compensation during regenerative operation function for motor 2.	0 (0 - 2)

If you apply a regenerative load when the slip compensation function during regeneration is active, the quantity of regeneration can increase immediately. In this condition, it is necessary to use a dynamic braking option (braking resistor or braking resistor unit).

0 : Disabled

The drive will not do Slip compensation during regeneration.

The load and operation status (regenerative operation) can cause the motor speed to be higher or lower than the frequency reference.

1 : Enabled Above 6Hz

Slip compensation function is enabled during regeneration. Slip compensation is disabled at output frequencies of 6 Hz or less.

2 : Enabled Above Defined Range

The drive uses *E2-02 [Motor Rated Slip]* to automatically calculate the frequency range where it will disable slip compensation function during regenerative operation.

Slip compensation is enabled at frequencies as low as 2 Hz.

■ C3-29: Slip Compensation Gain @ Low Spd

No. (Hex.)	Name	Description	Default (Range)
C3-29 (1B5D) Expert	Slip Compensation Gain @ Low Spd	<input type="checkbox"/> V/f <input type="checkbox"/> OLV <input type="checkbox"/> OLV/PM <input type="checkbox"/> AOLV/PM <input checked="" type="checkbox"/> EZOLV Sets the gain for the slip compensation function in the low speed range. Usually it is not necessary to change this setting.	0.0 (0.0 - 2.5)

Adjust this parameter as follows if necessary:

- If the motor speed is slower than the frequency reference, increase the setting value in 0.1 unit increments.
- If the motor speed is faster than the frequency reference, decrease the setting value in 0.1 unit increments.

◆ C4: Torque Compensation

Torque compensation is a function that increases voltage to increase output torque as compensation for insufficient torque production at start-up or low-speed operation.

Voltage drops due to motor winding resistance cause torque generating voltage to decrease, which causes insufficient torque. If the main circuit cable connecting the drive and motor is long, this can also cause insufficient torque due to voltage drops.

Note:

Set the motor parameters and V/f pattern properly before setting *C4 parameters*.

■ C4-01: Torque Compensation Gain

No. (Hex.)	Name	Description	Default (Range)
C4-01 (0215) RUN	Torque Compensation Gain	<div style="display: flex; justify-content: space-between; align-items: center;"> V/f OLV OLV/PM AOLV/PM EZOLV </div> Sets the gain for the torque compensation function. Use this parameter value for motor 1 when operating multiple motors.	Determined by A1-02 (0.00 - 2.50)

For these control methods and states, adjust the setting value.

A1-02 [Control Method Selection]	Status	Adjustment
0 [V/f Control] 8 [EZ Vector Control]	Torque is not sufficient during low-speed operation of 10 Hz or less.	Increase the setting in 0.05-unit increments.
	There is vibration in the motor or the motor hunts when operating the drive with a light load.	Decrease the setting in 0.05-unit decrements.
	The cable length between the drive and motor is too long.	Increase the setting in 0.05-unit increments.

Note:

- Adjust C4-01 to make sure that output current is not more than the drive rated current while the drive operates at low speed.
- When A1-02 = 2 [Open Loop Vector], do not change this parameter under normal conditions. Torque accuracy will decrease.
- When A1-02 = 5 [PM Open Loop Vector], do not change this parameter under normal conditions. Setting this value too high can cause overcompensation and motor oscillation.
- When A1-02 = 8 [EZ Vector Control], you cannot change this parameter during drive run.

■ C4-02: Torque Compensation Delay Time

No. (Hex.)	Name	Description	Default (Range)
C4-02 (0216) RUN	Torque Compensation Delay Time	<div style="display: flex; justify-content: space-between; align-items: center;"> V/f OLV OLV/PM AOLV/PM EZOLV </div> Sets the torque compensation delay time. Usually it is not necessary to change this setting.	Determined by A1-02 (0 - 60000 ms)

Note:

When A1-02 = 5, 8 [Control Method Selection = OLV/PM, EZOLV], you cannot change the setting while the drive is running.

Set this parameter in these conditions:

- If there is vibration in the motor, increase the setting.
- If the motor speed or motor torque response is too slow, decrease the setting.

■ C4-03: Torque Compensation @ FWD Start

No. (Hex.)	Name	Description	Default (Range)
C4-03 (0217)	Torque Compensation @ FWD Start	<div style="display: flex; justify-content: space-between; align-items: center;"> V/f OLV OLV/PM AOLV/PM EZOLV </div> Set the amount of torque reference for forward start as a percentage of the motor rated torque.	0.0% (0.0 - 200.0%)

The torque compensation function is performed using the time constant set in C4-05 [Torque Compensation Time]. This is available only when you start the motor with the forward command. Set this parameter to 0.0 to disable this function.

■ C4-04: Torque Compensation @ REV Start

No. (Hex.)	Name	Description	Default (Range)
C4-04 (0218)	Torque Compensation @ REV Start	<div style="display: flex; justify-content: space-between; align-items: center;"> V/f OLV OLV/PM AOLV/PM EZOLV </div> Sets the amount of torque reference for reverse start as a percentage of the motor rated torque.	0.0% (-200.0 - 0.0%)

The drive uses the time constant set in C4-05 [Torque Compensation Time] to do the torque compensation function. This is available only when you start the motor with the reverse Run command.

■ C4-05: Torque Compensation Time

No. (Hex.)	Name	Description	Default (Range)
C4-05 (0219)	Torque Compensation Time	<div style="display: flex; justify-content: space-between; align-items: center;"> V/f OLV OLV/PM AOLV/PM EZOLV </div> Sets the starting torque constant to use with C4-03 and C4-04 [Torque Compensation @ FWD/REV Start].	10 ms (0 - 200 ms)

■ C4-06: Motor 2 Torque Comp Delay Time

No. (Hex.)	Name	Description	Default (Range)
C4-06 (021A)	Motor 2 Torque Comp Delay Time	<div style="display: flex; justify-content: space-between; align-items: center;"> V/f OLV OLV/PM AOLV/PM EZOLV </div> Sets the value if <i>ov</i> [Overvoltage] occurs with sudden changes in the load, at the end of acceleration, or at the start of deceleration.	150 ms (0 - 10000 ms)

Sets the time constant used during Speed Search or during regenerative operation when *ov* occurs.

Adjust this parameter in the following circumstances.

- Gradually reduce the setting in 10 ms increments and check the performance to improve motor torque speed response when *ov* occurs.

Note:

- Ensure that $C4-06 \geq C4-02$ [Torque Compensation Delay Time].
- Increase the setting value of $n2-03$ [Automatic Freq Regulator Time 2] proportional to C4-06.

■ C4-07: Motor 2 Torque Compensation Gain

No. (Hex.)	Name	Description	Default (Range)
C4-07 (0341) RUN	Motor 2 Torque Compensation Gain	<div style="display: flex; justify-content: space-between; align-items: center;"> V/f OLV OLV/PM AOLV/PM EZOLV </div> Sets the gain for motor 2 torque compensation function when using the Motor Switch function.	1.00 (0.00 - 2.50)

In V/f Control, adjust the value in 0.05-unit increments for these conditions:

- When torque is not sufficient during low-speed operation of 10 Hz or less, increase the setting value
- When there is vibration in the motor or when the motor hunts when operating the drive with a light load, decrease the setting value
- When you use a long motor cable, increase the setting value.

Note:

- Adjust C4-07 to make sure that the output current is not more than the drive rated current during low-speed operation.
- When $A1-02 = 2$ [Control Method Selection = OLV], usually it is not necessary to change the setting. Torque accuracy will decrease.

■ C4-23: Current Control Gain

No. (Hex.)	Name	Description	Default (Range)
C4-23 (1583) Expert	Current Control Gain	<div style="display: flex; justify-content: space-between; align-items: center;"> V/f OLV OLV/PM AOLV/PM EZOLV </div> Sets the Current control gain. Usually it is not necessary to change this parameter.	1.00 (0.50 - 2.50)

◆ C5: Auto Speed Regulator (ASR)

The ASR adjusts the torque reference to decrease the difference between frequency reference and motor speed.

A1-02 [Control Method Selection]	Targets of Adjustment
<ul style="list-style-type: none"> • 6: PM Advanced Open Loop Vector (AOLV/PM) • 8: EZ Vector Control (EZOLV) 	Torque Reference

Figure 12.37 is a speed control block diagram of each control method.

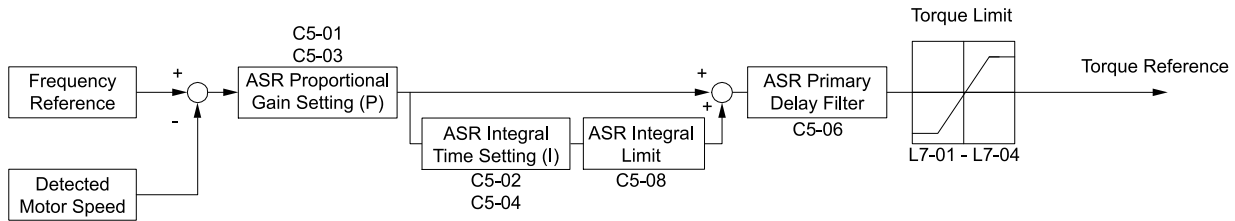

Figure 12.37 Speed Control Block Diagram for AOLV/PM and EZOLV

Note:

The detected speed is the speed estimation value when configured such that $A1-02 = 6$ or 8 [Control Method Selection = AOLV/PM or EZOLV].

■ Before You Adjust ASR Parameters

- Do Auto-Tuning and set up all motor data correctly.
- Always make adjustments with the load connected to the motor.
- Use analog output signals to monitor $U1-16$ [SFS Output Frequency] and $U1-05$ [Motor Speed] when you adjust the ASR.

■ ASR Adjustment Procedure for AOLV/PM and EZOLV

Do this procedure to adjust ASR parameters:

1. Run the motor at zero speed or low speed and increase $C5-01$ [ASR Proportional Gain 1] until immediately before vibration starts to occur.
2. Run the motor at zero speed or low speed and decrease $C5-02$ [ASR Integral Time 1] until immediately before vibration starts to occur.
3. Check for oscillation when you run the motor at maximum speed.
4. If oscillation occurs, increase $C5-02$ and decrease $C5-01$.
When there is no oscillation, the adjustment procedure is complete.
5. Set the low-speed gain. Run the motor at zero speed or low speed and increase $C5-03$ [ASR Proportional Gain 2] until immediately before vibration starts to occur.

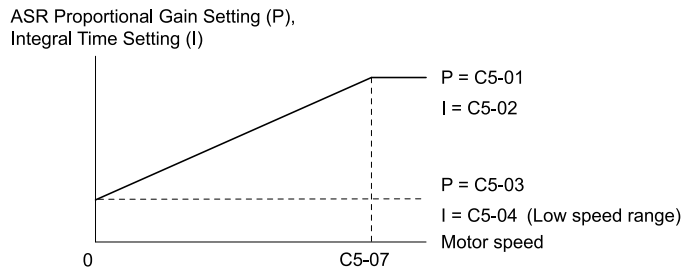

Figure 12.38 Low-speed/High-speed Gain Settings

6. Set the low-speed integral time. Run the motor at zero speed or low speed and decrease $C5-04$ [ASR Integral Time 2] until immediately before vibration starts to occur.
7. Set $C5-07$ [ASR Gain Switchover Frequency].
8. Check for oscillation when you run the motor at speeds more than the setting in $C5-07$.

Note:

- If overshooting occurs when acceleration ends, decrease the value set in $C5-01$ and increase the value set in $C5-02$.
- If undershoot occurs at stop, decrease $C5-03$ and increase $C5-04$.

■ Use MFDI Switch for Proportional Gain

You can use the input terminals set for ASR Gain ($C5-03$) Select [$HI-xx = 77$] to switch the proportional gains set with $C5-01$ and $C5-03$. When the configured input terminal is deactivated, the proportional gain set for $C5-01$ is selected. When the terminal is activated, the proportional gain set for $C5-03$ is selected. The proportional gain changes linearly over the time set in $C5-02$ [ASR Integral Time 1]. The signals from this MFDI are more important than $C5-07$ [ASR Gain Switchover Frequency].

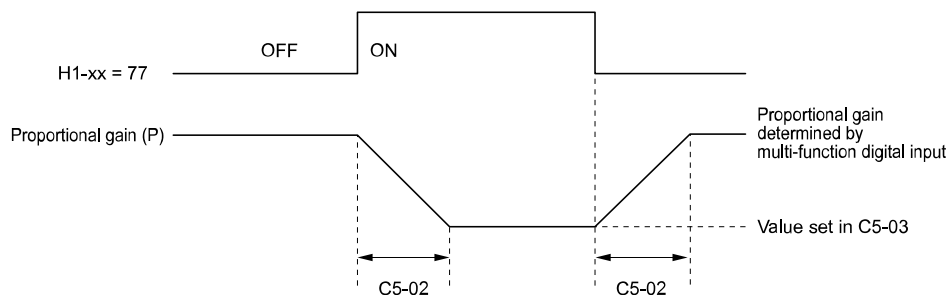

Figure 12.39 Proportional Gain through Multi-function Digital Input Switch

■ Speed Waveform Monitoring Method

To make small adjustments of ASR parameters, monitor the speed waveforms when you make the adjustments. Table 12.30 shows example settings of parameters to monitor speed waveforms.

Table 12.30 Example Settings of MFAO Terminals to Monitor Speed Waveforms

No.	Name	Setting Value	Description
H4-01	Terminal AM Analog Output Select	116	Lets you use terminal AM to monitor <i>U1-16</i> [SFS Output Frequency].
H4-02	Terminal AM Analog Output Gain	100.0%	
H4-03	Terminal AM Analog Output Bias	0.0%	
H4-07	Terminal AM Signal Level Select	0	Lets you monitor in a 0 V to 10 V range.

Based on this setting, MFAO terminal AM outputs the output frequency after SFS in a 0 V to 10 V (0% to 100%) range. The MFAO common is terminal AC:

Yaskawa recommends that you monitor the output frequency after SFS and the motor speed for delays in response and differences in reference values.

■ Adjust ASR Parameters

Use Table 12.31 to adjust ASR. The table lists parameters for motor 1. You can make the same changes to motor 2 parameters when you run a second motor.

Note:

When adjusting the proportional gain and integral time, adjust the proportional gain first.

Table 12.31 ASR Response and Possible Solutions

Problem		Possible Solutions
Speed response is slow.		<ul style="list-style-type: none"> • Increase <i>C5-01/C5-03</i> [ASR Proportional Gain]. • Decrease <i>C5-02/C5-04</i> [ASR Integral Time].
Overshoot or undershoot occurs at the end of acceleration or deceleration.		<ul style="list-style-type: none"> • Decrease <i>C5-01/C5-03</i>. • Increase <i>C5-02/C5-04</i>.

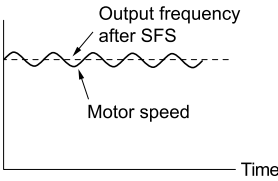
Problem		Possible Solutions
Vibration and oscillation occur at constant speed.		<ul style="list-style-type: none"> Decrease C5-01/C5-03. Increase C5-02/C5-04. Increase C5-06 [ASR Delay Time].
Oscillation at low speed and response is too slow at high speed. Oscillation at high speed and response is too slow at low speed.	-	When A1-02 = 6 [Control Method Selection = AOLV/PM], use C5-01 to C5-04 to set the best ASR settings for high and low speed. Use C5-07 [ASR Gain Switchover Frequency] to switch the ASR proportional gain and ASR integral time as specified by the output frequency.

■ C5-01: ASR Proportional Gain 1

No. (Hex.)	Name	Description	Default (Range)
C5-01 (021B) RUN	ASR Proportional Gain 1	<input checked="" type="radio"/> V/f <input type="radio"/> OLV <input type="radio"/> OLV/PM <input type="radio"/> AOLV/PM <input type="radio"/> EZOLV Sets the gain to adjust ASR response.	Determined by A1-02 (0.00 - 300.00)

A higher gain provides a higher speed response. Usually, the gain increases with larger loads. Too much gain will cause vibration.

Note:

- When A1-02 = 0 [Control Method Selection = V/f], set H6-01 = 3 [Terminal RP Pulse Train Function = Speed Feedback (V/F Control)] to enable this parameter.
- The drive usually sets Motor 1 ASR with C5-01 and C5-02 [ASR Integral Time 1]. When you set H1-xx = 77 [MFDI Function Select = ASR Gain Switch], you can switch between C5-01 and C5-03 [ASR Proportional Gain 2]. You can also use C5-01 as an alternative to C5-03 and C5-02 as an alternative to C5-04 when the speed is less than or equal to the frequency set in C5-07 [ASR Gain Switchover Frequency].
- The drive automatically adjusts C5-01 in ASR Tuning.

■ C5-02: ASR Integral Time 1

No. (Hex.)	Name	Description	Default (Range)
C5-02 (021C) RUN	ASR Integral Time 1	<input checked="" type="radio"/> V/f <input type="radio"/> OLV <input type="radio"/> OLV/PM <input type="radio"/> AOLV/PM <input type="radio"/> EZOLV Sets the ASR integral time.	Determined by A1-02 (0.000 - 60.000 s)

When you increase the integral time, the responsiveness will decrease. An integral time that is too short can cause oscillation.

Note:

When A1-02 = 0 [Control Method Selection = V/f], set H6-01 = 3 [Terminal RP Pulse Train Function = Speed Feedback (V/F Control)] to enable this parameter.

■ C5-03: ASR Proportional Gain 2

No. (Hex.)	Name	Description	Default (Range)
C5-03 (021D) RUN	ASR Proportional Gain 2	<input checked="" type="radio"/> V/f <input type="radio"/> OLV <input type="radio"/> OLV/PM <input type="radio"/> AOLV/PM <input type="radio"/> EZOLV Sets the gain to adjust ASR response.	Determined by A1-02 (0.00 - 300.00)

A higher gain provides a higher speed response. Usually, the gain increases with larger loads. Too much gain will cause vibration.

Note:

When A1-02 = 0 [Control Method Selection = V/f], set H6-01 = 3 [Terminal RP Pulse Train Function = Speed Feedback (V/F Control)] to enable this parameter.

■ C5-04: ASR Integral Time 2

No. (Hex.)	Name	Description	Default (Range)
C5-04 (021E) RUN	ASR Integral Time 2	<div style="display: flex; justify-content: space-between; align-items: center;"> V/f OLV OLV/PM AOLV/PM EZOLV </div> Sets the ASR integral time.	Determined by A1-02 (0.000 - 60.000 s)

When you increase the integral time, the responsiveness will decrease. An integral time that is too short can cause oscillation.

Note:

When A1-02 = 0 [Control Method Selection = V/f], set H6-01 = 3 [Terminal RP Pulse Train Function = Speed Feedback (V/F Control)] to enable this parameter.

■ C5-05: ASR Limit

No. (Hex.)	Name	Description	Default (Range)
C5-05 (021F)	ASR Limit	<div style="display: flex; justify-content: space-between; align-items: center;"> V/f OLV OLV/PM AOLV/PM EZOLV </div> Sets the ASR output limit where E1-04 [Maximum Output Frequency] is 100%.	5.0% (0.0 - 20.0%)

If the motor rated slip is high, it is necessary to increase the setting for correct motor speed control. Use U6-04 [ASR Output] to make sure that ASR is operating at the limit set in this parameter. When ASR is operating at the limit, correctly set the encoder (PG) signal before you make changes to C5-05.

Note:

When A1-02 = 0 [Control Method Selection = V/f], set H6-01 = 3 [Terminal RP Pulse Train Function = Speed Feedback (V/F Control)] to enable this parameter.

■ C5-06: ASR Delay Time

No. (Hex.)	Name	Description	Default (Range)
C5-06 (0220)	ASR Delay Time	<div style="display: flex; justify-content: space-between; align-items: center;"> V/f OLV OLV/PM AOLV/PM EZOLV </div> Sets the filter time constant of the torque reference output from the speed loop. Usually it is not necessary to change this setting.	Determined by A1-02 (0.000 - 0.500 s)

If you have a load with low rigidity or if oscillation is a problem, decrease C5-01 in 2-unit decrements or decrease C5-06 in 0.001-unit decrements.

■ C5-07: ASR Gain Switchover Frequency

No. (Hex.)	Name	Description	Default (Range)
C5-07 (0221)	ASR Gain Switchover Frequency	<div style="display: flex; justify-content: space-between; align-items: center;"> V/f OLV OLV/PM AOLV/PM EZOLV </div> Sets the frequency where the drive will switch between these parameters: C5-01 and C5-03 [ASR Proportional Gain 1/2] C5-02 and C5-04 [ASR Integral Time 1/2]	Determined by A1-02 (Determined by A1-02)

Switching the proportional gain and integral time in the low or high speed range can help operation become stable. A good switching point is 80% of the frequency where oscillation occurs or at 80% of the maximum output frequency.

Note:

An MFDI set for H1-xx = 77 [MFDI Function Selection = ASR Gain (C5-03) Select] will have priority over the ASR gain switching frequency.

■ C5-08: ASR Integral Limit

No. (Hex.)	Name	Description	Default (Range)
C5-08 (0222)	ASR Integral Limit	<div style="display: flex; justify-content: space-between; align-items: center;"> V/f OLV OLV/PM AOLV/PM EZOLV </div> Set the upper limit of the ASR integral amount as a percentage of the rated load.	400% (0 - 400%)

■ C5-12: Integral Operation @ Accel/Decel

No. (Hex.)	Name	Description	Default (Range)
C5-12 (0386)	Integral Operation @ Accel/Decel	<input checked="" type="checkbox"/> V/f <input type="checkbox"/> OLV <input type="checkbox"/> OLV/PM <input type="checkbox"/> AOLV/PM <input type="checkbox"/> EZOLV Sets ASR integral operation during acceleration and deceleration.	0 (0, 1)

Set this parameter to *1* to keep the motor speed near the frequency reference during operation and acceleration/ deceleration.

Note:

- When $A1-02 = 0$ [Control Method Selection = V/f], set $H6-01 = 3$ [Terminal RP Pulse Train Function = Speed Feedback (V/F Control)] to enable this parameter.
- If you enable integral control, overshoot or undershoot can occur when acceleration or deceleration complete. If there are problems with overshooting and undershooting, set this parameter to *0*.

0 : Disabled

The drive will not enable integral operation during acceleration or deceleration. The drive always enables integral operation during constant speed.

1 : Enabled

Integral operation is always enabled.

■ C5-29: Speed Control Response

No. (Hex.)	Name	Description	Default (Range)
C5-29 (0B18) Expert	Speed Control Response	<input checked="" type="checkbox"/> V/f <input type="checkbox"/> OLV <input type="checkbox"/> OLV/PM <input type="checkbox"/> AOLV/PM <input type="checkbox"/> EZOLV Sets the level of speed control responsiveness. Usually it is not necessary to change this setting.	1 (0, 1)

If a high level of speed control responsiveness is necessary, set $C5-29 = 1$, then adjust the speed control (ASR) parameter.

0 : Standard

1 : High Performance 1

■ C5-39: ASR Primary Delay Time Const 2

No. (Hex.)	Name	Description	Default (Range)
C5-39 (030D)	ASR Primary Delay Time Const 2	<input type="checkbox"/> V/f <input type="checkbox"/> OLV <input type="checkbox"/> OLV/PM <input checked="" type="checkbox"/> AOLV/PM <input type="checkbox"/> EZOLV Sets the filter time constant used when the torque reference is output from ASR. Usually it is not necessary to change this parameter.	0.000 s (0.000 - 0.500 s)

If you have a load with low rigidity or if oscillation is a problem, increase this setting in 0.01 unit increments.

◆ C6: Duty & Carrier Frequency

C6 parameters are used to set the selection of drive duty rating, selection of carrier frequency, and upper and lower limits of carrier frequencies.

■ C6-01: Normal / Heavy Duty Selection

No. (Hex.)	Name	Description	Default (Range)
C6-01 (0223)	Normal / Heavy Duty Selection	<input checked="" type="checkbox"/> V/f <input type="checkbox"/> OLV <input type="checkbox"/> OLV/PM <input type="checkbox"/> AOLV/PM <input type="checkbox"/> EZOLV Sets the drive duty rating.	1 (0, 1)

0 : Heavy Duty Rating

The overload tolerance is 150% of the rated output current for 60 seconds.

1 : Normal Duty Rating

The overload tolerance is 110% of the rated output current for 60 seconds.

There are two types of load ratings for this product depending on the load characteristics of the application: Heavy Duty Rating (HD) and Normal Duty Rating (ND).

The drive rated output current, overload tolerance, and acceleration stall prevention level change when the duty rating changes. Set the drive to agree with the duty rating of the selected drive capacity. In HD, the tolerance is 150% overload for 60 seconds. In ND, the tolerance is 110% overload for 60 seconds. The rated output current for ND drives is higher than the rated output current for HD drives. Refer to *Model-Specific Specifications (Single-Phase 200 V Class)* on page 344, *Model Specifications (Three-Phase 200 V Class)* on page 345, and *Model Specifications (Three-Phase 400 V Class)* on page 348 for more information about the rated output current.

Table 12.32 Differences between Heavy Duty Rating and Normal Duty Rating

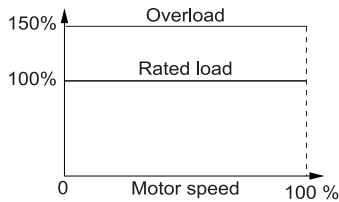
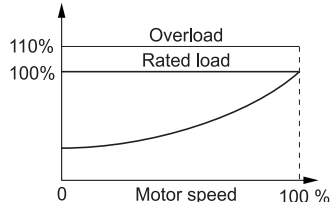
Item	Heavy Duty Rating (HD)	Normal Duty Rating (ND)
C6-01 Setting	0	1
Load Characteristics		
Application	<p>A high overload tolerance is necessary during start up, acceleration, deceleration, and equivalent conditions.</p> <ul style="list-style-type: none"> • Extruder • Conveyor • Constant torque or high overload capacity are necessary. 	<p>Overload tolerance is not necessary.</p> <ul style="list-style-type: none"> • Fan • Pump • Blower
Overload Tolerance	150% - 60 seconds	110% - 60 seconds
Stall Prevent Level during Accel	150%	120%
Stall Prevent Level during Run	150%	120%
Carrier Frequency	2 kHz	2 kHz Swing-PWM

Note:

- Set the stall prevention level during acceleration with *L3-02* and the stall prevention level during run with *L3-06*.
- Changing *C6-01* also changes the maximum capacity of applicable drive motors. The drive automatically changes the setting values *E2-xx* and *E4-xx* to applicable values. The drive also automatically changes these parameters that depend on motor output:
 - b8-04 [Energy Saving Coefficient Value]
 - L2-03 [Minimum Baseblock Time]
 - L3-24 [Motor Accel Time @ Rated Torque]
 - n5-02 [Motor Inertia Acceleration Time]

■ C6-02: Carrier Frequency Selection

No. (Hex.)	Name	Description	Default (Range)
C6-02 (0224)	Carrier Frequency Selection	<div style="display: flex; gap: 5px;"> V/f OLV OLV/PM AOLV/PM EZOLV </div> <p>Sets the carrier frequency for the transistors in the drive.</p>	Determined by A1-02, C6-01, and o2-04 (Determined by A1-02)

Changes to the switching frequency will decrease audible noise and decrease leakage current.

Note:

Increasing the carrier frequency to more than the default setting will automatically decrease the drive current rating.

1 : 2.0 kHz

2 : 5.0 kHz (AOLV/PM: 4.0 kHz)

3 : 8.0 kHz (AOLV/PM: 6.0 kHz)

4 : 10.0 kHz (AOLV/PM: 8.0 kHz)

5 : 12.5 kHz (AOLV/PM: 10.0 kHz)

6 : 15.0 kHz (AOLV/PM: 12.0 kHz)

7 : Swing PWM4 (Audible Sound 1)

8 : Swing PWM4 (Audible Sound 2)

9 : Swing PWM4 (Audible Sound 3)

A : Swing PWM4 (Audible Sound 4)

B : Leakage Current Rejection PWM

Set this when the wiring distance between the drive and motor is long and there is a fault in the current monitor or the drive detects and alarm because of the effect of a leakage current.

The carrier frequency is equivalent to 2.0 kHz.

F : User Defined (C6-03 to C6-05)

Use C6-03 to C6-05 to set detailed setting values.

Note:

- The setting range changes when the A1-02 [Control Method Selection] value changes:
 - 5, 8 [OLV/PM, EZOLV]: You can set C6-02 = 1 to 6, B, and F.
 - 6 [AOLV/PM]: You can set C6-02 = 1 to 6.
- The carrier frequency for Swing PWM 1 is equivalent to 2.0 kHz. Swing PWM applies a special PWM pattern to decrease the audible noise.

Table 12.33 Guidelines for Carrier Frequency Parameter Setup

Symptom	Remedy
Speed and torque are not stable at low speed.	Decrease the carrier frequency.
Speed and torque are not stable at low speed.	Decrease the carrier frequency.
Too much leakage current from the drive.	Decrease the carrier frequency.
Wiring between the drive and motor is too long.	Decrease the carrier frequency. Note: If the motor cable is too long, it can be necessary to decrease the carrier frequency. Refer to Table 12.34 for the wiring distance and decrease the carrier frequency.
Audible motor noise is too loud.	Increase the carrier frequency. Use Swing PWM. Note: The default carrier frequency in ND is C6-02 = 7 [Swing PWM1 (Audible Sound 1)], with a 2 kHz base. You can increase the carrier frequency in Normal Duty mode, but this will decrease the drive rated current.

Table 12.34 Wiring Distance

Wiring Distance	50 m (164 ft) Maximum	100 m (328 ft) Maximum	More than 100 m (328 ft)
C6-02 [Carrier Frequency Selection]	1 to F (up to 15 kHz)	1 to 2 (up to 5 kHz), 7	1 (up to 2 kHz), 7

Note:

- If the length of the wire between the drive and an induction motor is longer than 100 m (328 ft), set A1-02 = 0 [V/f].
- The maximum wiring cable length between the drive and a PM motor is 100 m (328 ft).
- If the cable length between the drive and the motor is too long when A1-02 = 6, set A1-02 = 5.

■ C6-03: Carrier Frequency Upper Limit

No. (Hex.)	Name	Description	Default (Range)
C6-03 (0225)	Carrier Frequency Upper Limit	<div style="display: flex; gap: 5px;"> V/f OLV OLV/PM AOLV/PM EZOLV </div> Sets the upper limit of the carrier frequency. Set C6-02 = F [Carrier Frequency Selection = User Defined (C6-03 to C6-05)] to set this parameter.	Determined by C6-02 (1.0 - 15.0 kHz)

Setting a Fixed User-Defined Carrier Frequency

When you cannot use C6-02 to set a carrier frequency between set selectable values, you can set the value in C6-03. The carrier frequency will be fixed to the value set to C6-03.

When A1-02 = 0 [Control Method Selection = V/f], set C6-03 = C6-04 [Carrier Frequency Lower Limit] to fix the carrier frequency.

Setting a Variable Carrier Frequency to Agree with the Output Frequency

When A1-02 = 0, set C6-03, C6-04, and C6-05 [Carrier Freq Proportional Gain] as shown in Figure 12.40 to make the carrier frequency change linearly with the output frequency.

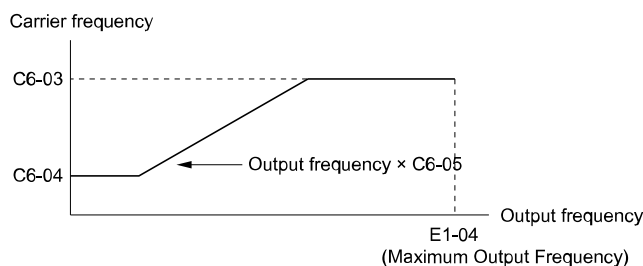

Figure 12.40 Setting a Variable Carrier Frequency to Agree with the Output Frequency

Note:

- When $C6-05 \leq 7$, the drive disables $C6-04$. The carrier frequency is fixed to the value set to $C6-03$.
- The drive detects *oPE11* [Carrier Frequency Setting Error] when these conditions are correct at the same time:
 - $C6-05 \geq 6$
 - $C6-04 \geq C6-03$
- When $A1-02 = 0, 2, 5, 8$ [Control Method Selection = *v/f*, *OLV*, *OLV/PM*, *EZOLV*], in the area where the output frequency is more than $C6-03$ and $C6-12$, the carrier frequency = output frequency \times 12, and it will change with the output frequency.

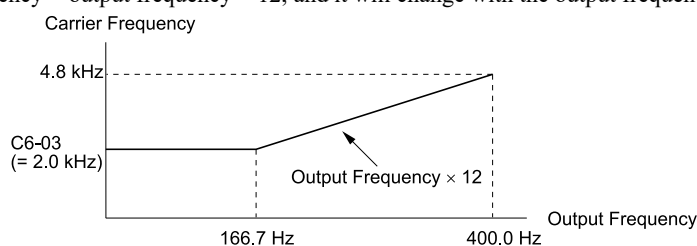

Figure 12.41 Carrier Frequency when $C6-03 = 2.0$ kHz, $E1-04 = 400.0$ Hz

■ C6-04: Carrier Frequency Lower Limit

No. (Hex.)	Name	Description	Default (Range)
C6-04 (0226)	Carrier Frequency Lower Limit	<input checked="" type="radio"/> <i>v/f</i> <input type="radio"/> <i>OLV</i> <input type="radio"/> <i>OLV/PM</i> <input type="radio"/> <i>AOLV/PM</i> <input type="radio"/> <i>EZOLV</i> Sets the lower limit of the carrier frequency. Set $C6-02 = F$ [Carrier Frequency Selection = User Defined (C6-03 to C6-05)] to set this parameter.	Determined by C6-02 (1.0 - 15.0 kHz)

Set $C6-03$ [Carrier Frequency Upper Limit], $C6-04$, and $C6-05$ [Carrier Freq Proportional Gain] to make the carrier frequency change linearly with the output frequency.

Note:

The drive detects *oPE11* [Carrier Frequency Setting Error] when these conditions are correct at the same time:

- $C6-04 \geq C6-03$
- $C6-05 \geq 6$

■ C6-05: Carrier Freq Proportional Gain

No. (Hex.)	Name	Description	Default (Range)
C6-05 (0227)	Carrier Freq Proportional Gain	<input checked="" type="radio"/> <i>v/f</i> <input type="radio"/> <i>OLV</i> <input type="radio"/> <i>OLV/PM</i> <input type="radio"/> <i>AOLV/PM</i> <input type="radio"/> <i>EZOLV</i> Sets the proportional gain for the carrier frequency. Set $C6-02 = F$ [Carrier Frequency Selection = User Defined (C6-03 to C6-05)] to set this parameter.	Determined by C6-02 (0 - 99)

Set $C6-03$ [Carrier Frequency Upper Limit], $C6-04$ [Carrier Frequency Lower Limit], and $C6-05$ to make the carrier frequency change linearly with the output frequency.

■ C6-09: Carrier Freq at Rotational Tune

No. (Hex.)	Name	Description	Default (Range)
C6-09 (022B)	Carrier Freq at Rotational Tune	<input type="radio"/> <i>v/f</i> <input checked="" type="radio"/> <i>OLV</i> <input type="radio"/> <i>OLV/PM</i> <input type="radio"/> <i>AOLV/PM</i> <input type="radio"/> <i>EZOLV</i> Sets the Auto-Tuning carrier frequency. Usually it is not necessary to change this setting.	0 (0, 1)

If $C6-09 = 0$ and you do Auto-Tuning on a high frequency motor or low impedance motor, it can cause oC [*Overcurrent*]. To prevent oC , increase the carrier frequency value, set $C6-09 = 1$, then do Auto-Tuning.

The procedure to set the carrier frequency when the $A1-02$ [*Control Method Selection*] setting changes.

- When $A1-02 = 2$ [*OLV*], set $C6-02 = F$ [*Carrier Frequency Selection = User Defined (C6-03 to C6-05)*] and then increase the value set to $C6-03$ [*Carrier Frequency Upper Limit*].
- When $A1-02 = 5$ or 6 [*OLV/PM or AOLV/PM*], use $C6-02$ to increase the carrier frequency.

0 : 5 kHz

Note:

When $A1-02 = 5$ or 6 , the carrier frequency is 2 kHz.

1 : Use C6-03

Note:

When $A1-02 = 5$ or 6 , the carrier frequency is the value set to $C6-02$.

12.5 d: References

d parameters [References] set the frequency reference input method and dead band range. They also set torque control, field weakening, and field forcing functions.

WARNING! Sudden Movement Hazard. Use fast stop circuits to safely and quickly stop the drive. After you wire the fast stop circuits, you must check their operation. Test the operation of the fast stop function before you use the drive. If you do not test the fast stop circuit before you operate the drive, it can cause serious injury or death.

◆ d1: Frequency Reference

Figure 12.42 shows the frequency reference input method, command source selection method, and priority descriptions.

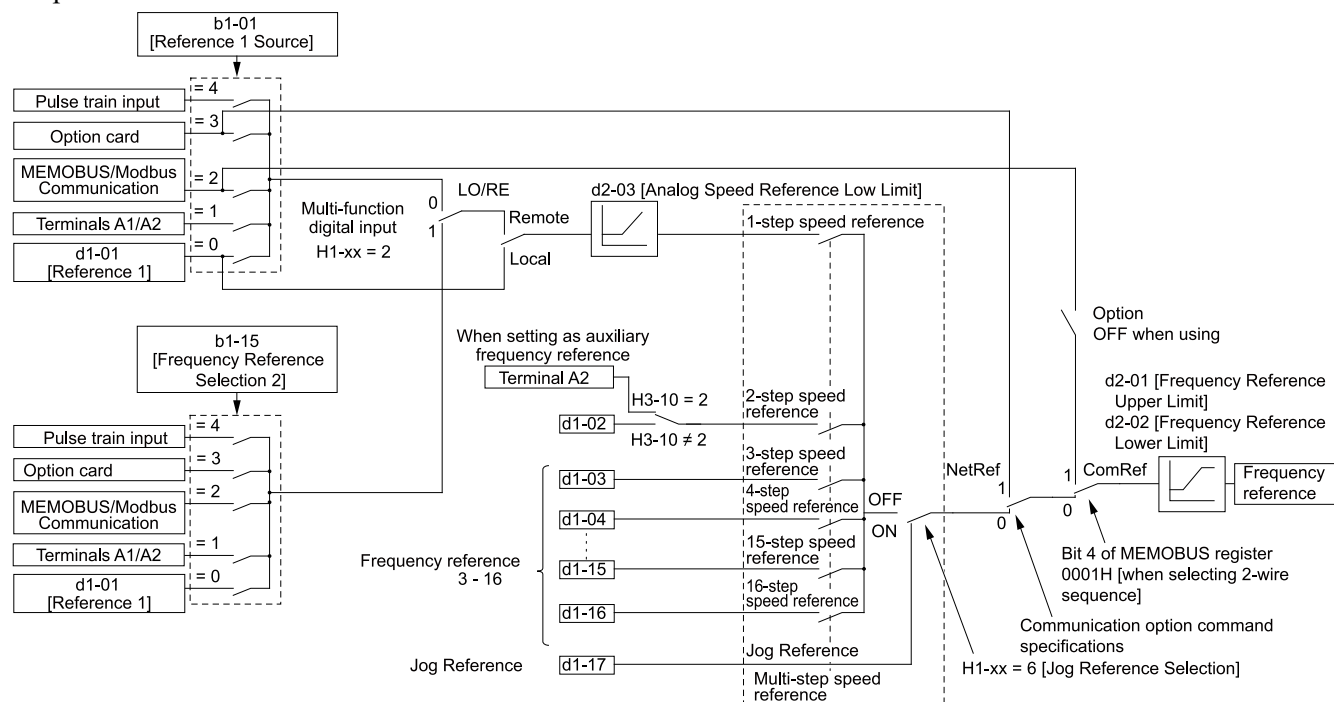

Figure 12.42 Frequency Reference Setting Hierarchy

■ Multi-Step Speed Operation

The drive has a multi-step speed operation function that can set many frequency references in advance. Set frequency references in *d1-xx* parameters. You can select the set frequency references with MFDI signals from an external source. Activate and deactivate the digital input to select the frequency reference to change the motor speed in steps. You can use the 16-step frequency reference and one Jog Frequency Reference (JOG command) to switch the speed to the maximum 17-step speeds.

Note:

- The Jog Frequency Reference (JOG command) overrides all other frequency references.
- You can use the MFDI to switch the frequency reference when the motor is running. The drive will apply the enabled acceleration and deceleration times.
- The default settings for Multi-Step Speed Reference 1 (master frequency reference) and Multi-Step Speed Reference 2 (auxiliary frequency reference) are the analog frequency reference. Also, voltage command input terminal A1 and current input terminal A2 for Multi-Step Speed Reference 1 (master frequency reference) are added internally by default. The drive uses Multi-Step Speed Reference 1 when the signal is connected to an analog input terminal.

■ Setting Procedures for Multi-step Speed Operation

Use an Analog Input as Reference 1 and 2

This section gives information about the procedures to set these examples:

- Multi-Step Speed 6 (6 types of frequency references)

- When you set the voltage input of analog inputs from terminals A1 and A2 to 0 V to 10 V (Lower Limit at 0)

Procedure	Configuration Parameter	Task Contents
1	Reference 1	1. Sets $b1-01 = 1$ [Frequency Reference Selection 1 = Analog Input]. 2. Sets $H3-02 = 0$ [Terminal A1 Function Selection = Frequency Reference]. 3. Sets $H3-01 = 0$ [Terminal A1 Signal Level Select = 0 V to 10 V (Lower Limit at 0)].
2	Reference 2	1. Sets $H3-10 = 2$ [Terminal A2 Function Selection = Auxiliary Frequency Reference 1]. 2. Sets $H3-09 = 0$ [Terminal A2 Signal Level Select = 0 V to 10 V (Lower Limit at 0)].
3	Signal type of analog input	Set DIP switch S1 on the control circuit board to the V-side (voltage) to set terminal A2 only for voltage input. Note: Set this before you energize the drive.
4	Reference 3	Sets the value of $d1-03$ [Reference 3].
5	Reference 4	Sets the value of $d1-04$ [Reference 4].
6	Reference 5	Sets the value of $d1-05$ [Reference 5].
7	Jog Reference	Sets $d1-17$ [Jog Reference] to the jog speed.
8	External digital input (3 inputs)	Set the Multi-Step Speed Reference 1 to 3 [$H1-xx = 3, 4, 5$] to one of the MFDI terminals S1 to S7.
9	JOG command	Set the Jog Reference Selection [$H1-xx = 6$] to one of the MFDI terminals S1 to S7.

Use the Maximum 17-Step Speed with All Digital Inputs

This section is the procedure to set the 17-step speeds (17 types of frequency references) without an analog input.

Procedure	Configuration Parameter	Task Contents
1	Analog reference	1. Sets $H3-02 = F$ [Terminal A1 Function Selection = Not Used], and disables the analog reference. 2. Sets $H3-10 = F$ [Terminal A2 Function Selection = Not Used], and disables the analog reference.
2	Reference 2 to 16	Sets the values of $d1-02$ to $d1-16$ [Reference 2 to 16].
3	Jog Reference	Sets $d1-17$ [Jog Reference] to the jog speed.
4	External digital input (4 inputs)	Set Multi-Step Speed Reference 1 to 4 [$H1-xx = 3, 4, 5, 32$] to one of the MFDI terminals S1 to S7.
5	JOG command	Set the Jog Reference Selection [$H1-xx = 6$] to one of the MFDI terminals S1 to S7.

Multi-step Speed Operation Combinations

Refer to [Table 12.35](#) and [Figure 12.43](#) for information about multi-step speed reference combinations. The selected frequency reference changes when the combination of digital input signals from an external source changes.

Table 12.35 Multi-step Speed Reference and MFDI Terminal Combinations

Related Parameters	Multi-Step Speed Reference 1 $H1-xx = 3$	Multi-Step Speed Reference 2 $H1-xx = 4$	Multi-Step Speed Reference 3 $H1-xx = 5$	Multi-Step Speed Reference 4 $H1-xx = 32$	Jog Reference $H1-xx = 6$
Reference 1 (set in $b1-01$)	OFF	OFF	OFF	OFF	OFF
Reference 2 ($d1-02$ or terminals A1, A2)	ON	OFF	OFF	OFF	OFF
Reference 3 ($d1-03$ or terminals A1, A2)	OFF	ON	OFF	OFF	OFF
Reference 4 ($d1-04$)	ON	ON	OFF	OFF	OFF
Reference 5 ($d1-05$)	OFF	OFF	ON	OFF	OFF
Reference 6 ($d1-06$)	ON	OFF	ON	OFF	OFF
Reference 7 ($d1-07$)	OFF	ON	ON	OFF	OFF
Reference 8 ($d1-08$)	ON	ON	ON	OFF	OFF
Reference 9 ($d1-09$)	OFF	OFF	OFF	ON	OFF
Reference 10 ($d1-10$)	ON	OFF	OFF	ON	OFF
Reference 11 ($d1-11$)	OFF	ON	OFF	ON	OFF
Reference 12 ($d1-12$)	ON	ON	OFF	ON	OFF
Reference 13 ($d1-13$)	OFF	OFF	ON	ON	OFF

Related Parameters	Multi-Step Speed Reference 1 H1-xx = 3	Multi-Step Speed Reference 2 H1-xx = 4	Multi-Step Speed Reference 3 H1-xx = 5	Multi-Step Speed Reference 4 H1-xx = 32	Jog Reference H1-xx = 6
Reference 14 (d1-14)	ON	OFF	ON	ON	OFF
Reference 15 (d1-15)	OFF	ON	ON	ON	OFF
Reference 16 (d1-16)	ON	ON	ON	ON	OFF
Jog Reference (d1-17) *1	-	-	-	-	ON

*1 The Jog Frequency Reference (JOG command) overrides all other frequency references.

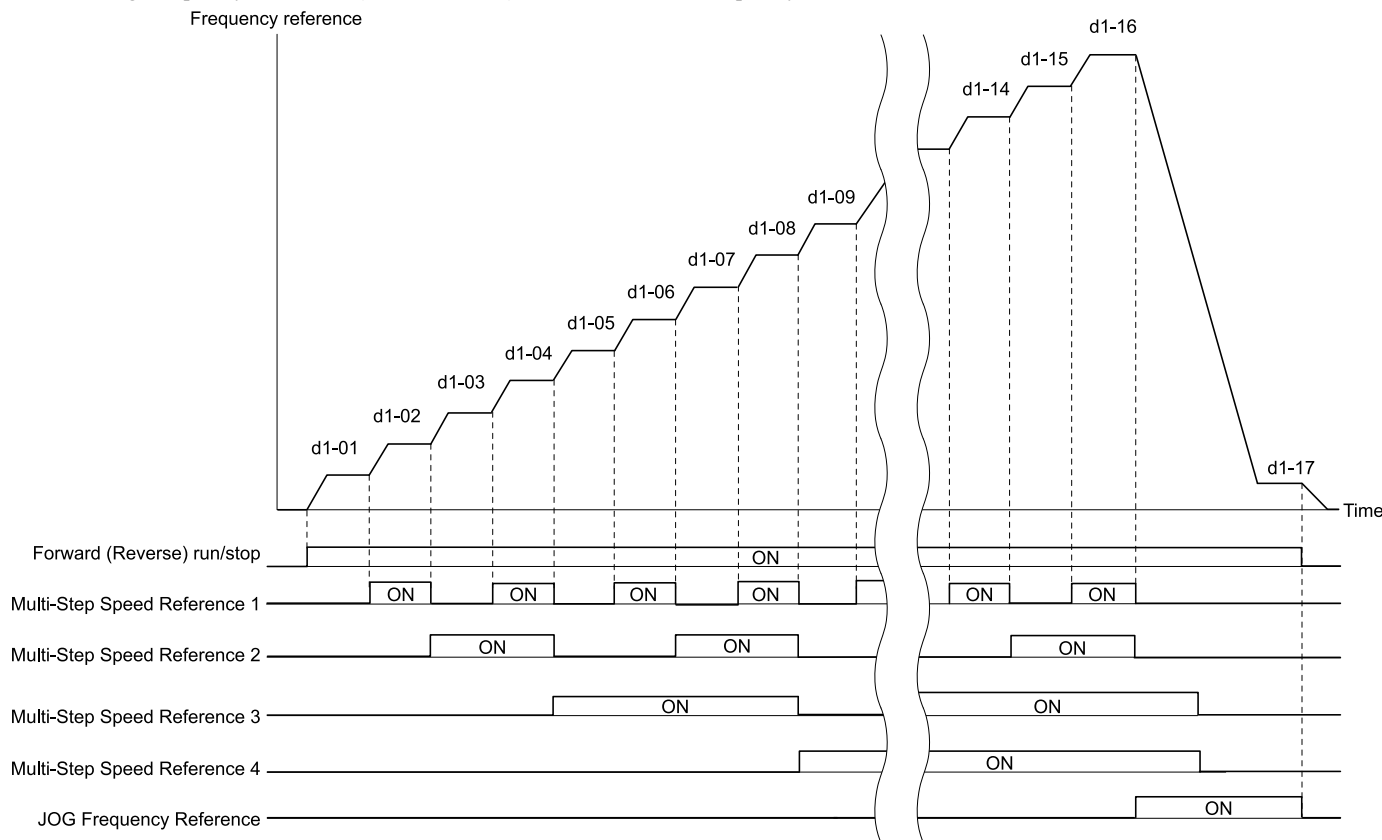

Figure 12.43 Time Chart for Multi-step Speed Reference/JOG Reference

■ d1-01: Reference 1

No. (Hex.)	Name	Description	Default (Range)
d1-01 (0280) RUN	Reference 1	V/f OLV OLV/PM AOLV/PM EZOLV Sets the frequency reference in the units from o1-03 [Frequency Display Unit Selection].	0.00 Hz (0.00 - 590.00 Hz)

Note:

- The upper limit value changes when the E1-04 [Maximum Output Frequency] and d2-01 [Frequency Reference Upper Limit] values change. Calculate the upper limit value with this formula:

$$\text{Upper limit value} = (E1-04) \times (d2-01) / 100$$
- When A1-02 = 6 [Control Method Selection = AOLV/PM], the drive sets o1-03 = 1 [0.01% (100% = E1-04)].
- To set d1-01 to 1-step speed parameter in a multi-step speed operation, set b1-01 = 0 [Frequency Reference Selection 1 = Keypad].

■ d1-02: Reference 2

No. (Hex.)	Name	Description	Default (Range)
d1-02 (0281) RUN	Reference 2	<div style="display: flex; gap: 5px;"> V/f OLV OLV/PM AOLV/PM EZOLV </div> Sets the frequency reference in the units from <i>o1-03</i> [Frequency Display Unit Selection].	0.00 Hz (0.00 - 590.00 Hz)

Note:

- The upper limit value changes when the *E1-04* [Maximum Output Frequency] and *d2-01* [Frequency Reference Upper Limit] values change.
- When *A1-02* = 6 [Control Method Selection = AOLV/PM], the drive sets *o1-03* = 1 [0.01% (100% = *E1-04*)].
- To set *d1-02* to Multi-Step Speed 2, set *H3-02* and *3-10* ≠ 2 [MFAI Function Select ≠ Auxiliary Frequency Reference 1].

■ d1-03: Reference 3

No. (Hex.)	Name	Description	Default (Range)
d1-03 (0282) RUN	Reference 3	<div style="display: flex; gap: 5px;"> V/f OLV OLV/PM AOLV/PM EZOLV </div> Sets the frequency reference in the units from <i>o1-03</i> [Frequency Display Unit Selection].	0.00 Hz (0.00 - 590.00 Hz)

Note:

- The upper limit value changes when the *E1-04* [Maximum Output Frequency] and *d2-01* [Frequency Reference Upper Limit] values change.
- When *A1-02* = 6 [Control Method Selection = AOLV/PM], the drive sets *o1-03* = 1 [0.01% (100% = *E1-04*)].
- To set *d1-03* to Multi-Step Speed 3, set *H3-02* and *H3-10* ≠ 3 [MFAI Function Select ≠ Auxiliary Frequency Reference 2].

■ d1-04: Reference 4

No. (Hex.)	Name	Description	Default (Range)
d1-04 (0283) RUN	Reference 4	<div style="display: flex; gap: 5px;"> V/f OLV OLV/PM AOLV/PM EZOLV </div> Sets the frequency reference in the units from <i>o1-03</i> [Frequency Display Unit Selection].	0.00 Hz (0.00 - 590.00 Hz)

Note:

- The upper limit value changes when the *E1-04* [Maximum Output Frequency] and *d2-01* [Frequency Reference Upper Limit] values change.
- When *A1-02* = 6 [Control Method Selection = AOLV/PM], the drive sets *o1-03* = 1 [0.01% (100% = *E1-04*)].
- This parameter sets the frequency reference of Multi-Step Speed 4.

■ d1-05: Reference 5

No. (Hex.)	Name	Description	Default (Range)
d1-05 (0284) RUN	Reference 5	<div style="display: flex; gap: 5px;"> V/f OLV OLV/PM AOLV/PM EZOLV </div> Sets the frequency reference in the units from <i>o1-03</i> [Frequency Display Unit Selection].	0.00 Hz (0.00 - 590.00 Hz)

Note:

- The upper limit value changes when the *E1-04* [Maximum Output Frequency] and *d2-01* [Frequency Reference Upper Limit] values change.
- When *A1-02* = 6 [Control Method Selection = AOLV/PM], the drive sets *o1-03* = 1 [0.01% (100% = *E1-04*)].
- This parameter sets the frequency reference of Multi-Step Speed 5.

■ d1-06: Reference 6

No. (Hex.)	Name	Description	Default (Range)
d1-06 (0285) RUN	Reference 6	<div style="display: flex; gap: 5px;"> V/f OLV OLV/PM AOLV/PM EZOLV </div> Sets the frequency reference in the units from <i>o1-03</i> [Frequency Display Unit Selection].	0.00 Hz (0.00 - 590.00 Hz)

Note:

- The upper limit value changes when the *E1-04 [Maximum Output Frequency]* and *d2-01 [Frequency Reference Upper Limit]* values change.
- When *A1-02 = 6 [Control Method Selection = AOLV/PM]*, the drive sets *o1-03 = 1 [0.01% (100% = E1-04)]*.
- This parameter sets the frequency reference of Multi-Step Speed 6.

■ d1-07: Reference 7

No. (Hex.)	Name	Description	Default (Range)
d1-07 (0286) RUN	Reference 7	<div style="display: flex; justify-content: space-between; align-items: center;"> V/f OLV OLV/PM AOLV/PM EZOLV </div> Sets the frequency reference in the units from <i>o1-03 [Frequency Display Unit Selection]</i> .	0.00 Hz (0.00 - 590.00 Hz)

Note:

- The upper limit value changes when the *E1-04 [Maximum Output Frequency]* and *d2-01 [Frequency Reference Upper Limit]* values change.
- When *A1-02 = 6 [Control Method Selection = AOLV/PM]*, the drive sets *o1-03 = 1 [0.01% (100% = E1-04)]*.
- This parameter sets the frequency reference of Multi-Step Speed 7.

■ d1-08: Reference 8

No. (Hex.)	Name	Description	Default (Range)
d1-08 (0287) RUN	Reference 8	<div style="display: flex; justify-content: space-between; align-items: center;"> V/f OLV OLV/PM AOLV/PM EZOLV </div> Sets the frequency reference in the units from <i>o1-03 [Frequency Display Unit Selection]</i> .	0.00 Hz (0.00 - 590.00 Hz)

Note:

- The upper limit value changes when the *E1-04 [Maximum Output Frequency]* and *d2-01 [Frequency Reference Upper Limit]* values change.
- When *A1-02 = 6 [Control Method Selection = AOLV/PM]*, the drive sets *o1-03 = 1 [0.01% (100% = E1-04)]*.
- This parameter sets the frequency reference of Multi-Step Speed 8.

■ d1-09: Reference 9

No. (Hex.)	Name	Description	Default (Range)
d1-09 (0288) RUN	Reference 9	<div style="display: flex; justify-content: space-between; align-items: center;"> V/f OLV OLV/PM AOLV/PM EZOLV </div> Sets the frequency reference in the units from <i>o1-03 [Frequency Display Unit Selection]</i> .	0.00 Hz (0.00 - 590.00 Hz)

Note:

- The upper limit value changes when the *E1-04 [Maximum Output Frequency]* and *d2-01 [Frequency Reference Upper Limit]* values change.
- When *A1-02 = 6 [Control Method Selection = AOLV/PM]*, the drive sets *o1-03 = 1 [0.01% (100% = E1-04)]*.
- This parameter sets the frequency reference of Multi-Step Speed 9.

■ d1-10: Reference 10

No. (Hex.)	Name	Description	Default (Range)
d1-10 (028B) RUN	Reference 10	<div style="display: flex; justify-content: space-between; align-items: center;"> V/f OLV OLV/PM AOLV/PM EZOLV </div> Sets the frequency reference in the units from <i>o1-03 [Frequency Display Unit Selection]</i> .	0.00 Hz (0.00 - 590.00 Hz)

Note:

- The upper limit value changes when the *E1-04 [Maximum Output Frequency]* and *d2-01 [Frequency Reference Upper Limit]* values change.
- When *A1-02 = 6 [Control Method Selection = AOLV/PM]*, the drive sets *o1-03 = 1 [0.01% (100% = E1-04)]*.
- This parameter sets the frequency reference of Multi-Step Speed 10.

■ d1-11: Reference 11

No. (Hex.)	Name	Description	Default (Range)
d1-11 (028C) RUN	Reference 11	<div style="display: flex; justify-content: space-between; align-items: center;"> V/f OLV OLV/PM AOLV/PM EZOLV </div> Sets the frequency reference in the units from o1-03 [Frequency Display Unit Selection].	0.00 Hz (0.00 - 590.00 Hz)

Note:

- The upper limit value changes when the E1-04 [Maximum Output Frequency] and d2-01 [Frequency Reference Upper Limit] values change.
- When A1-02 = 6 [Control Method Selection = AOLV/PM], the drive sets o1-03 = 1 [0.01% (100% = E1-04)].
- This parameter sets the frequency reference of Multi-Step Speed 11.

■ d1-12: Reference 12

No. (Hex.)	Name	Description	Default (Range)
d1-12 (028D) RUN	Reference 12	<div style="display: flex; justify-content: space-between; align-items: center;"> V/f OLV OLV/PM AOLV/PM EZOLV </div> Sets the frequency reference in the units from o1-03 [Frequency Display Unit Selection].	0.00 Hz (0.00 - 590.00 Hz)

Note:

- The upper limit value changes when the E1-04 [Maximum Output Frequency] and d2-01 [Frequency Reference Upper Limit] values change.
- When A1-02 = 6 [Control Method Selection = AOLV/PM], the drive sets o1-03 = 1 [0.01% (100% = E1-04)].
- This parameter sets the frequency reference of Multi-Step Speed 12.

■ d1-13: Reference 13

No. (Hex.)	Name	Description	Default (Range)
d1-13 (028E) RUN	Reference 13	<div style="display: flex; justify-content: space-between; align-items: center;"> V/f OLV OLV/PM AOLV/PM EZOLV </div> Sets the frequency reference in the units from o1-03 [Frequency Display Unit Selection].	0.00 Hz (0.00 - 590.00 Hz)

Note:

- The upper limit value changes when the E1-04 [Maximum Output Frequency] and d2-01 [Frequency Reference Upper Limit] values change.
- When A1-02 = 6 [Control Method Selection = AOLV/PM], the drive sets o1-03 = 1 [0.01% (100% = E1-04)].
- This parameter sets the frequency reference of Multi-Step Speed 13.

■ d1-14: Reference 14

No. (Hex.)	Name	Description	Default (Range)
d1-14 (028F) RUN	Reference 14	<div style="display: flex; justify-content: space-between; align-items: center;"> V/f OLV OLV/PM AOLV/PM EZOLV </div> Sets the frequency reference in the units from o1-03 [Frequency Display Unit Selection].	0.00 Hz (0.00 - 590.00 Hz)

Note:

- The upper limit value changes when the E1-04 [Maximum Output Frequency] and d2-01 [Frequency Reference Upper Limit] values change.
- When A1-02 = 6 [Control Method Selection = AOLV/PM], the drive sets o1-03 = 1 [0.01% (100% = E1-04)].
- This parameter sets the frequency reference of Multi-Step Speed 14.

■ d1-15: Reference 15

No. (Hex.)	Name	Description	Default (Range)
d1-15 (0290) RUN	Reference 15	<div style="display: flex; justify-content: space-between; align-items: center;"> V/f OLV OLV/PM AOLV/PM EZOLV </div> Sets the frequency reference in the units from o1-03 [Frequency Display Unit Selection].	0.00 Hz (0.00 - 590.00 Hz)

Note:

- The upper limit value changes when the *E1-04* [Maximum Output Frequency] and *d2-01* [Frequency Reference Upper Limit] values change.
- When *A1-02* = 6 [Control Method Selection = AOLV/PM], the drive sets *o1-03* = 1 [0.01% (100% = *E1-04*)].
- This parameter sets the frequency reference of Multi-Step Speed 15.

■ d1-16: Reference 16

No. (Hex.)	Name	Description	Default (Range)
d1-16 (0291) RUN	Reference 16	<div style="display: flex; justify-content: space-between; align-items: center;"> V/f OLV OLV/PM AOLV/PM EZOLV </div> Sets the frequency reference in the units from <i>o1-03</i> [Frequency Display Unit Selection].	0.00 Hz (0.00 - 590.00 Hz)

Note:

- The upper limit value changes when the *E1-04* [Maximum Output Frequency] and *d2-01* [Frequency Reference Upper Limit] values change.
- When *A1-02* = 6 [Control Method Selection = AOLV/PM], the drive sets *o1-03* = 1 [0.01% (100% = *E1-04*)].
- This parameter sets the frequency reference of Multi-Step Speed 16.

■ d1-17: Jog Reference

No. (Hex.)	Name	Description	Default (Range)
d1-17 (0292) RUN	Jog Reference	<div style="display: flex; justify-content: space-between; align-items: center;"> V/f OLV OLV/PM AOLV/PM EZOLV </div> Sets the Jog frequency reference in the units from <i>o1-03</i> [Frequency Display Unit Selection]. Set <i>H1-xx</i> = 6 [MFDI Function Select = Jog Reference Selection] to use the Jog frequency reference.	6.00 Hz (0.00 - 590.00 Hz)

Note:

- The upper limit value changes when the *E1-04* [Maximum Output Frequency] and *d2-01* [Frequency Reference Upper Limit] values change.
- When *A1-02* = 6 [Control Method Selection = AOLV/PM], the drive sets *o1-03* = 1 [0.01% (100% = *E1-04*)].

◆ d2: Reference Limits

d2 parameters set the upper and lower frequency limits to control the motor speed. Apply these parameters to for example, run the motor at low-speed due to mechanical strength concerns, or if the motor should not be run at low speed because of lubrication issues with the gears and bearings.

The upper frequency limit is set in *d2-01* [Frequency Reference Upper Limit] and the lower limit is set in *d2-02* [Frequency Reference Lower Limit].

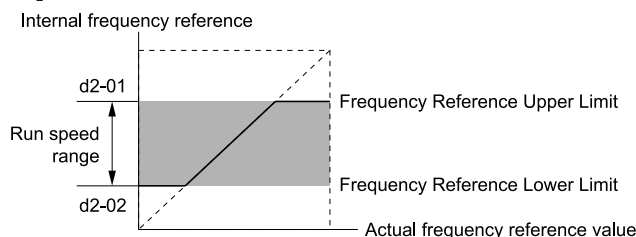

Figure 12.44 Upper and Lower Frequency Limits

■ d2-01: Frequency Reference Upper Limit

No. (Hex.)	Name	Description	Default (Range)
d2-01 (0289)	Frequency Reference Upper Limit	<div style="display: flex; justify-content: space-between; align-items: center;"> V/f OLV OLV/PM AOLV/PM EZOLV </div> Sets maximum limit for all frequency references. The maximum output frequency is 100%.	100.0% (0.0 - 110.0%)

When the frequency reference is more than the value set in *d2-01* the drive will continue to operate at the value set in *d2-01*.

■ **d2-02: Frequency Reference Lower Limit**

No. (Hex.)	Name	Description	Default (Range)
d2-02 (028A)	Frequency Reference Lower Limit	V/f OLV OLV/PM AOLV/PM EZOLV Sets minimum limit for all frequency references. The maximum output frequency is 100%.	0.0% (0.0 - 110.0%)

When the frequency reference is less than the value set in *d2-02*, the drive will continue to operate at the value set in *d2-02*. The motor will accelerate to the *d2-02* value after the drive receives a Run command and a lower frequency reference than *d2-02* has been entered.

■ **d2-03: Analog Frequency Ref Lower Limit**

No. (Hex.)	Name	Description	Default (Range)
d2-03 (0293)	Analog Frequency Ref Lower Limit	V/f OLV OLV/PM AOLV/PM EZOLV Sets the lower limit for the master frequency reference (the first frequency of the multi-step speed reference) as a percentage. The maximum output frequency is 100%.	0.0% (0.0 - 110.0%)

This parameter does not change the lower limit of Jog reference, frequency reference for multi-step speed operation, or the auxiliary frequency reference.

The drive operates at the value set in *d2-03* when the frequency reference decreases to less than the value set in *d2-03*.

Note:

When lower limits are set to parameters *d2-02* [*Frequency Reference Lower Limit*] and *d2-03*, the drive uses the larger value as the lower limit.

◆ **d3: Jump Frequency**

The Jump frequency is a function that sets the dead band to a specified frequency band. If a machine that operated at constant speed is operated with variable speed, it can make resonance. To operate the machine without resonance from the natural frequency of the machinery mechanical system, use a frequency band jump.

You can program the drive to have three different Jump frequencies. Set *d3-01* [*Jump Frequency 1*] to *d3-03* [*Jump Frequency 3*] to the center value for the frequency to avoid and set *d3-04* [*Jump Frequency Width*] to be 1/2 of the total band to avoid.

When you input a frequency reference that is the same as or near the Jump frequency width, the frequency reference changes automatically.

The drive accelerates or decelerates the motor smoothly until the frequency reference is not in the range of the Jump frequency band. The drive will use the active accel/decel time to go through the specified dead band range. If the frequency reference is not in the range of the Jump frequency band, switch to constant speed operation.

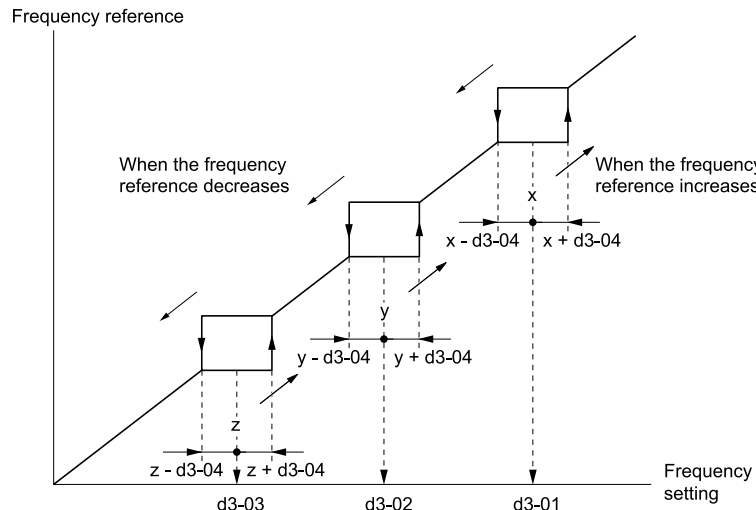

Figure 12.45 Jump Frequency

Note:

- When you set Jump Frequencies 1 to 3, make sure that the parameters do not overlap. The drive will not indicate this condition.
- When the drive is in the range of the Jump frequency, the frequency reference changes automatically. When the drive jumps frequencies, the output frequency changes smoothly as specified by the values set in *C1-01 [Acceleration Time 1]* and *C1-02 [Deceleration Time 1]*.

■ d3-01: Jump Frequency 1

No. (Hex.)	Name	Description	Default (Range)
d3-01 (0294)	Jump Frequency 1	<div style="display: flex; gap: 5px;"> V/f OLV OLV/PM AOLV/PM EZOLV </div> Sets the median value of the frequency band that the drive will avoid.	0.0 Hz (Determined by A1-02)

Note:

Set this parameter to 0.0 Hz to disable the Jump frequency.

■ d3-02: Jump Frequency 2

No. (Hex.)	Name	Description	Default (Range)
d3-02 (0295)	Jump Frequency 2	<div style="display: flex; gap: 5px;"> V/f OLV OLV/PM AOLV/PM EZOLV </div> Sets the median value of the frequency band that the drive will avoid.	0.0 Hz (Determined by A1-02)

Note:

Set this parameter to 0.0 Hz to disable the Jump frequency.

■ d3-03: Jump Frequency 3

No. (Hex.)	Name	Description	Default (Range)
d3-03 (0296)	Jump Frequency 3	<div style="display: flex; gap: 5px;"> V/f OLV OLV/PM AOLV/PM EZOLV </div> Sets the median value of the frequency band that the drive will avoid.	0.0 Hz (Determined by A1-02)

Note:

Set this parameter to 0.0 Hz to disable the Jump frequency.

■ d3-04: Jump Frequency Width

No. (Hex.)	Name	Description	Default (Range)
d3-04 (0297)	Jump Frequency Width	<div style="display: flex; gap: 5px;"> V/f OLV OLV/PM AOLV/PM EZOLV </div> Sets the width of the frequency band that the drive will avoid.	1.0 Hz (Determined by A1-02)

◆ d4: Frequency Ref Up/Down & Hold

The *d4 parameters* set the Frequency Reference Hold function and Up/Down and Up/Down 2 commands.

- Frequency Reference Hold Function Command: This acceleration/deceleration ramp hold command uses an MFDI to momentarily stop the acceleration/deceleration of the motor, and continues to operate the motor at the output frequency at which the command reference was input. Turn OFF the acceleration/deceleration ramp hold command to continue acceleration/deceleration.
- Up/Down command: The Up/Down command is a function to activate and deactivate an MFDI to increase and decrease the frequency reference. The Up/Down command overrides frequency references from the analog input terminal, pulse train input terminal, and keypad.
- Up/Down 2 command: The Up/Down 2 command is a function that adds a set bias value to the frequency reference to accelerate or decelerate. The Up/Down 2 command activates and deactivates the MFDI to add a bias value.

■ d4-01: Freq Reference Hold Selection

No. (Hex.)	Name	Description	Default (Range)
d4-01 (0298)	Freq Reference Hold Selection	<div style="display: flex; gap: 5px;"> V/f OLV OLV/PM AOLV/PM EZOLV </div> Sets the function that saves the frequency reference or the frequency bias (Up/Down 2) after a Stop command or when de-energizing the drive.	0 (0, 1)

Set *HI-xx* [MFDI Function Selection] to one of these values to enable this parameter:

- *A* [Accel/Decel Ramp Hold]
- *10/11* [Up/Down Command]
- *75/76* [Up/Down 2 Command]

0 : Disabled

- **Acceleration/Deceleration Ramp Hold**
When you enter a Stop command or de-energize the drive, the hold value is reset to 0 Hz. The drive will use the active frequency reference when it restarts.
- **Up/Down Command**
When you enter a Stop command or de-energize the drive, the frequency reference value is reset to 0 Hz. The drive will start from 0 Hz when it restarts.
- **Up/Down 2 Command**
When you enter the Stop command or 5 s after you release the Up/Down 2 command, the drive does not save the frequency bias. The Up/Down 2 function will start with a bias of 0% when the drive restarts.

1 : Enabled

- **Acceleration/Deceleration Ramp Hold**
When you clear the Run command or de-energize the drive, it will save the last hold value. The drive will use the saved value as the frequency reference when it restarts.

Note:

When you energize the drive, continuously enable the MFDI terminal set for *Accel/Decel Ramp Hold* [*HI-xx = A*]. If the digital input does not activate, the drive will clear the hold value and set it to 0 Hz.

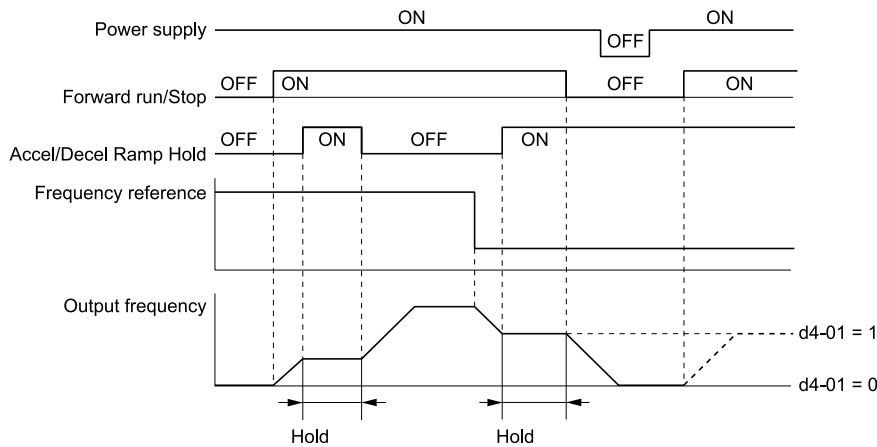

Figure 12.46 Frequency Reference Hold with Accel/Decel Hold Function

- **Up/Down Command**
When you clear the Run command or de-energize the drive, it will save the frequency reference value. The drive will use the saved value as the frequency reference when it restarts.
- **Up/Down 2 Command with Frequency Reference from Keypad**
When a Run command is active and you release the Up/Down 2 command for longer than 5 s, the drive adds the Up/Down 2 bias value to the frequency reference and sets it to 0. The drive saves the frequency reference value to which the bias value was added. The drive will use the new value as the frequency reference when it restarts.

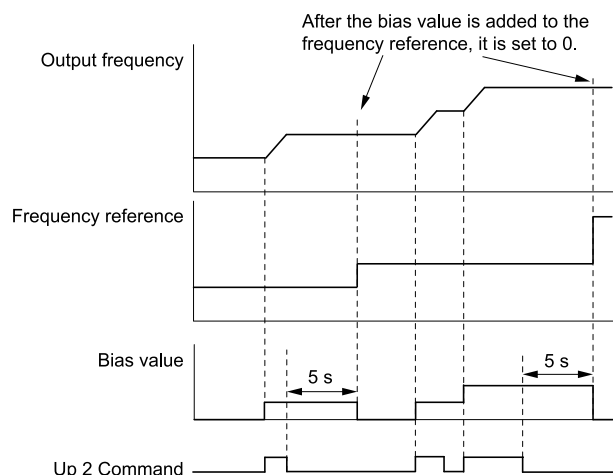

Figure 12.47 Up/Down 2 Example with Reference from Keypad and d4-01 = 1

- Up/Down 2 Command with Frequency Reference from Input Sources Other Than the Keypad
When a Run command is active and you release the Up/Down 2 command for longer than 5 s, the drive will save the bias value in *d4-06* [*Frequency Ref Bias (Up/Down 2)*]. The drive saves the frequency reference + *d4-06* as a frequency reference value. The drive will use the new value as the frequency reference when it restarts.

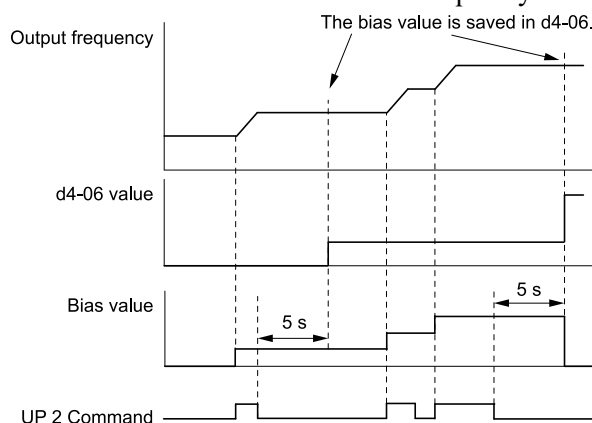

Figure 12.48 Up/Down 2 Example with Other Reference than Keypad and d4-01 = 1

Note:

To use the combination of the frequency reference hold function and the Up/Down 2 function, configure the Up/Down 2 upper limit [*d4-08*] and lower limit [*d4-09*] correctly.

Remove the Saved Frequency Reference Value

The procedure to remove the saved frequency reference value is different for different functions. Use these methods to remove the value:

- Release the input programmed for *Accel/Decel Ramp Hold* [*HI-xx = A*].
- Set an Up or Down command while no Run command is active.
- Use the Up/Down 2 Command to set *d4-06* = 0.0 or set *d4-06* = 0.0 during stop.

■ d4-03: Up/Down 2 Bias Step Frequency

No. (Hex.)	Name	Description	Default (Range)
d4-03 (02AA) RUN	Up/Down 2 Bias Step Frequency	V/f OLV OLV/PM AOLV/PM EZOLV Sets the bias that the Up/Down 2 function adds to or subtracts from the frequency reference.	0.00 Hz (0.00 - 99.99 Hz)

The operation is different for different setting values:

- **Setting d4-03 = 0.00 Hz**

When the *Up/Down 2 Command* [$H1-xx = 75, 76$] is active, the drive uses the accel/decel times set in $d4-04$ [*Up/Down 2 Ramp Selection*] to increase or decrease the bias value.

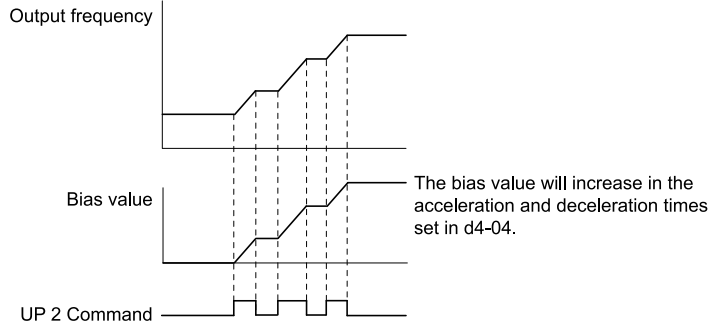

Figure 12.49 Up/Down 2 Bias when $d4-03 = 0.00$ Hz

• **Setting $d4-03 \neq 0.00$ Hz**

When the *Up/Down 2 Command* [$H1-xx = 75, 76$] is active, the drive increases or decreases the bias in steps for the value set in $d4-03$. The drive uses the acceleration and deceleration times set in $d4-04$.

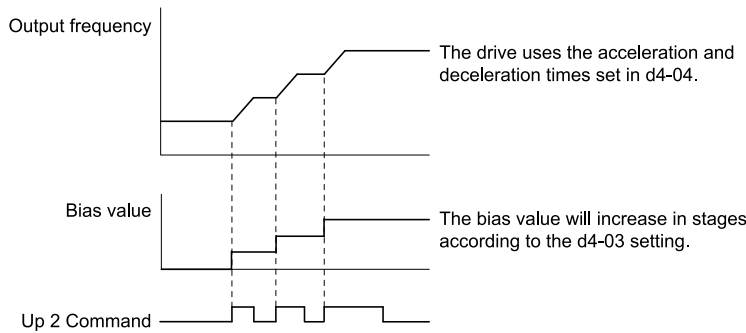

Figure 12.50 Up/Down 2 Bias when $d4-03 \neq 0.00$ Hz

■ **d4-04: Up/Down 2 Ramp Selection**

No. (Hex.)	Name	Description	Default (Range)
d4-04 (02AB) RUN	Up/Down 2 Ramp Selection	<input type="radio"/> V/f <input type="radio"/> OLV <input type="radio"/> OLV/IPM <input type="radio"/> AOL/IPM <input type="radio"/> EZOLV Sets the acceleration and deceleration times for the Up/Down 2 function to apply the bias to the frequency reference.	0 (0, 1)

0 : Use Selected Accel/Decel Time

Use the active acceleration and deceleration times to increase or decrease the bias.

1 : Use Accel/Decel Time 4

Use $C1-07$ [*Acceleration Time 4*] and $C1-08$ [*Deceleration Time 4*] to increase or decrease the bias.

■ **d4-05: Up/Down 2 Bias Mode Selection**

No. (Hex.)	Name	Description	Default (Range)
d4-05 (02AC) RUN	Up/Down 2 Bias Mode Selection	<input type="radio"/> V/f <input type="radio"/> OLV <input type="radio"/> OLV/IPM <input type="radio"/> AOL/IPM <input type="radio"/> EZOLV Sets the function that saves the bias value to the drive when you open or close the two <i>Up/Down 2 Commands</i> [$H1-xx = 75, 76$]. Set $d4-03$ [<i>Up/Down 2 Bias Step Frequency</i>] = 0.00 before you set this parameter.	0 (0, 1)

0 : Hold when Neither Up/Down Closed

When the two MFDI terminals set for *Up/Down 2 Command* [$H1-xx = 75, 76$] activate or deactivate, the drive will hold the bias value.

1 : Reset when Neither / Both Closed

When the two MFDI terminals set for *Up/Down 2 Command* [$H1-xx = 75, 76$] activate or deactivate, the drive will reset the bias value to 0. The drive will use the acceleration and deceleration times set in *d4-04* [*Up/Down 2 Ramp Selection*] to accelerate and decelerate the motor to the selected output frequency.

■ d4-06: Frequency Ref Bias (Up/Down 2)

No. (Hex.)	Name	Description	Default (Range)
d4-06 (02AD)	Frequency Ref Bias (Up/Down 2)	V/f OLV OLV/PM AOLV/PM EZOLV Saves the bias value from the Up/Down 2 Command where the Maximum Output Frequency is 100%.	0.0% (-99.9 - +100.0%)

The Up/Down 2 function setting changes the function of *d4-06*:

Note:

When the keypad sets the frequency reference, you do not usually use parameter *d4-06*.

- When $d4-01 = 0$ [*Freq Reference Hold Selection = Disabled*] and a source other than the keypad sets the frequency reference, the drive adds the value set in *d4-06* to the frequency reference. If the value set in *d4-06* is a negative number, the drive will subtract it from frequency reference.
- When $d4-01 = 1$ [*Enabled*] and a source other than the keypad sets the frequency reference, the drive will store the bias value adjusted with the Up/Down 2 command in *d4-06* 5 seconds after you release the Up/Down 2 command. The drive adds or subtracts the value set in *d4-06* to the frequency reference.

Conditions that Reset or Disable d4-06

The drive resets and disables the bias value in these conditions:

- $d4-01 = 0$ and the Run command was cleared.
- $H1-xx = 75, 76$ [*MFDI Function Select = Up/Down 2 Command*] is not set.
- The frequency reference source was changed.
This includes switching LOCAL/REMOTE and multi-step speed reference.
- A digital input changed the frequency reference value.
- $d4-03$ [*Up/Down 2 Bias Step Frequency*] = 0 and $d4-05 = 1$ [*Up/Down 2 Bias Mode Selection = Reset when Neither / Both Closed*], and the two MFDI terminals set for *Up/Down 2 Command* [$H1-xx = 75/76$] are activated or deactivated.
- The value of *E1-04* [*Maximum Output Frequency*] was changed.

■ d4-07: Analog Freq Ref Fluctuate Limit

No. (Hex.)	Name	Description	Default (Range)
d4-07 (02AE) RUN	Analog Freq Ref Fluctuate Limit	V/f OLV OLV/PM AOLV/PM EZOLV If the frequency reference changes for more than the level set to this parameter, then the bias value will be held. The value is set as a percentage of the Maximum Output Frequency.	1.0% (0.1 - 100.0%)

Handles frequency reference changes while *Up/Down 2 Command* [$H1-xx = 75, 76$] is activated. When the frequency reference changes for more than the level set in *d4-07*, the drive will hold the bias value, and the drive will accelerate or decelerate to the frequency reference. When the drive is at the frequency reference, it releases the bias hold and the bias follows the Up/Down 2 input commands.

This parameter is applicable only when an analog or pulse input sets the frequency reference.

■ d4-08: Up/Down 2 Bias Upper Limit

No. (Hex.)	Name	Description	Default (Range)
d4-08 (02AF) RUN	Up/Down 2 Bias Upper Limit	V/f OLV OLV/PM AOLV/PM EZOLV Sets the upper limit of the Up/Down 2 bias as a percentage of the Maximum Output Frequency.	100.0% (0.0 - 100.0%)

The drive saves the set bias upper limit in *d4-06* [*Frequency Ref Bias (Up/Down 2)*]. Set *d4-08* an applicable value before you use the Up/Down 2 function.

Note:

When $d4-01 = 1$ [*Freq Reference Hold Selection = Enabled*] and $b1-01 = 0$ [*Frequency Reference Selection 1 = Keypad*], the drive will add the bias value to the frequency reference when it does not receive an Up/Down 2 command for 5 s. Then the drive will reset the value to 0 at which time you can increase the bias to the limit set in $d4-08$ again.

■ **d4-09: Up/Down 2 Bias Lower Limit**

No. (Hex.)	Name	Description	Default (Range)
d4-09 (02B0) RUN	Up/Down 2 Bias Lower Limit	V/f OLV OLV/PM AOLV/PM EZOLV Sets the lower limit of the Up/Down 2 bias as a percentage of the Maximum Output Frequency.	0.0% (-99.9 - 0.0%)

The drive saves the set bias lower limit in $d4-06$ [*Frequency Ref Bias (Up/Down 2)*]. Set $d4-09$ to an applicable value before you use the Up/Down 2 function.

Note:

When $d4-01 = 1$ [*Freq Reference Hold Selection = Enabled*] and $b1-01 = 0$ [*Frequency Reference Selection 1 = Keypad*], the drive will add the bias value to the frequency reference when it does not receive an Up/Down 2 command for 5 s. Then the drive will reset the value to 0.

If you increase the bias with the Up 2 command and $d4-09 = 0$, you cannot use a Down 2 command to decrease the frequency reference. To decrease speed in this condition, set a negative lower limit in $d4-09$.

■ **d4-10: Up/Down Freq Lower Limit Select**

No. (Hex.)	Name	Description	Default (Range)
d4-10 (02B6)	Up/Down Freq Lower Limit Select	V/f OLV OLV/PM AOLV/PM EZOLV Sets the lower frequency limit for the Up/Down function.	0 (0, 1)

0 : Greater of d2-02 or Analog

The higher value between $d2-02$ [*Frequency Reference Lower Limit*] and an analog input programmed for *Frequency Reference* [$H3-02, H3-10 = 0$] sets the lower frequency reference limit.

Note:

When you use *External Reference 1/2 Selection* [$H1-xx = 2$] to switch between the Up/Down function and an analog input as the reference source, the analog value becomes the lower reference limit when the Up/Down command is active. Set $d4-10 = 1$ to isolate the Up/Down function and the analog input value.

1 : d2-02

You can only use $d2-02$ to set the lower limit of the frequency reference.

◆ **d6: Field Weakening /Forcing**

$d6$ parameters set the field weakening and field forcing functions.

The field weakening function decreases the energy consumption of the motor. It decreases the output voltage of the drive to a set level. The function decreases the motor excitation current inversely proportional to speed in a constant output range, and does not let the induced voltage of the motor become more than the power supply voltage. To enable this function, set *Field Weakening* [$H1-xx = 63$] ON.

Note:

Use the Field Weakening function in constant light-load applications. To control the energy consumption of the motor for other load conditions, use the $b8$ parameters [*Energy Saving*].

The Field Forcing function adjusts the delaying influence of the motor time constant when the drive changes the excitation current reference and it also increases motor responsiveness. This function uses a high motor excitation current reference for drive start-up only to help develop actual motor excitation current. Enable the Field Forcing function to increase motor responsiveness.

Note:

You cannot use Field Forcing during DC Injection Braking.

■ d6-01: Field Weakening Level

No. (Hex.)	Name	Description	Default (Range)
d6-01 (02A0)	Field Weakening Level	<div style="display: flex; gap: 5px;"> V/f OLV OLV/PM AOLV/PM EZOLV </div> Sets the drive output voltage as a percentage of <i>E1-05 [Maximum Output Voltage]</i> when <i>H1-xx = 63 [Field Weakening]</i> is activated.	80% (0 - 100%)

■ d6-02: Field Weakening Frequency Limit

No. (Hex.)	Name	Description	Default (Range)
d6-02 (02A1)	Field Weakening Frequency Limit	<div style="display: flex; gap: 5px;"> V/f OLV OLV/PM AOLV/PM EZOLV </div> Sets the minimum output frequency to start field weakening.	0.0 Hz (0.0 - 590.0 Hz)

Make sure that these two conditions are correct to enable the Field Weakening command:

- The output frequency \geq *d6-02*.
- There is a speed agreement status.

■ d6-03: Field Forcing Selection

No. (Hex.)	Name	Description	Default (Range)
d6-03 (02A2)	Field Forcing Selection	<div style="display: flex; gap: 5px;"> V/f OLV OLV/PM AOLV/PM EZOLV </div> Sets the field forcing function.	0 (0, 1)

0 : Disabled

1 : Enabled

■ d6-06: Field Forcing Limit

No. (Hex.)	Name	Description	Default (Range)
d6-06 (02A5)	Field Forcing Limit	<div style="display: flex; gap: 5px;"> V/f OLV OLV/PM AOLV/PM EZOLV </div> Sets the limit value for field forcing to increase the motor excitation current reference as a percentage of <i>E2-03 [Motor No-Load Current]</i> . Usually it is not necessary to change this setting.	400% (100 - 400%)

Note:

You cannot use Field Forcing during DC Injection Braking.

◆ d7: Offset Frequency

The drive will use 3 digital signal inputs to add or subtract the set frequency (offset frequency) to/from the frequency reference and correct the speed. The drive uses the terminal set in *H1-xx = 44 to 46 [MFDI Function Selection = Add Offset Frequency 1 (d7-01) to Add Offset Frequency 3 (d7-03)]* to set the offset frequency. When you close more than one input at the same time, the drive adds the selected offset values together.

Figure 12.51 shows the Offset frequency function:

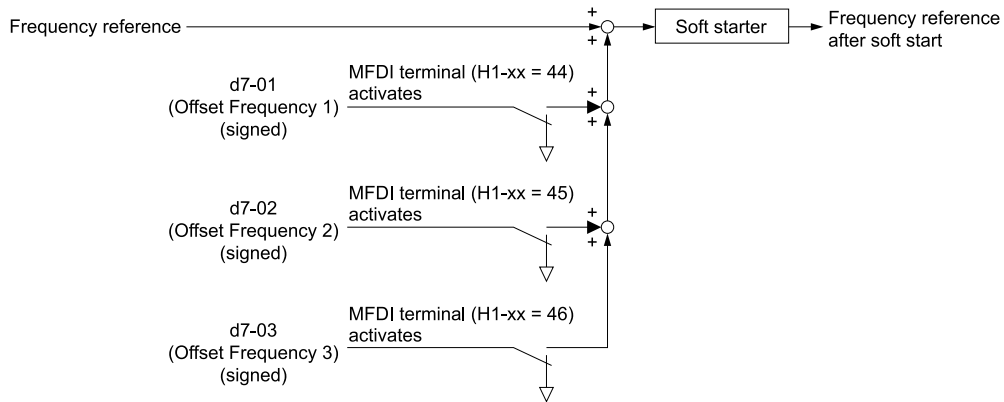

Figure 12.51 Offset Frequency Operation

■ d7-01: Offset Frequency 1

No. (Hex.)	Name	Description	Default (Range)
d7-01 (02B2) RUN	Offset Frequency 1	V/f OLV OLV/PM AOLV/PM EZOLV Uses H1-xx = 44 [MFDI Function Select = Add Offset Frequency 1 (d7-01)] as a percentage of the Maximum Output Frequency to add or subtract the set frequency to/from the frequency reference.	0.0% (-100.0 - +100.0%)

■ d7-02: Offset Frequency 2

No. (Hex.)	Name	Description	Default (Range)
d7-02 (02B3) RUN	Offset Frequency 2	V/f OLV OLV/PM AOLV/PM EZOLV Uses H1-xx = 45 [MFDI Function Select = Add Offset Frequency 2 (d7-02)] as a percentage of the Maximum Output Frequency to add or subtract the set frequency to/from the frequency reference.	0.0% (-100.0 - +100.0%)

■ d7-03: Offset Frequency 3

No. (Hex.)	Name	Description	Default (Range)
d7-03 (02B4) RUN	Offset Frequency 3	V/f OLV OLV/PM AOLV/PM EZOLV Uses H1-xx = 46 [MFDI Function Select = Add Offset Frequency 3 (d7-03)] as a percentage of the Maximum Output Frequency to add or subtract the set frequency to/from the frequency reference.	0.0% (-100.0 - +100.0%)

12.6 E: Motor Parameters

E parameters cover drive input voltage, V/f pattern, and motor parameters.

◆ E1: V/f Pattern for Motor 1

E1 parameters set the drive input voltage and motor V/f characteristics. To switch drive operation from one motor to another motor, set the V/f characteristics for motor 1.

■ V/f Pattern Settings

The drive uses a V/f pattern to adjust the output voltage relative to the frequency reference.

This product has been preconfigured with 15 voltage/frequency (V/f) patterns. Use *E1-03 [V/f Pattern Selection]* to select the V/f pattern that is appropriate for the application.

Additionally, one custom V/f pattern is available. Set *E1-03 = F [Custom]* and then manually set parameters *E1-04* to *E1-10*.

Table 12.36 Predefined V/f Patterns

Setting Value	Specification	Characteristic	Application
0	Const Trq, 50Hz base, 50Hz max	Constant torque	For general purpose applications. This pattern is used when the load torque is constant without any rotation speed such as that used for linear conveyor systems.
1	Const Trq, 60Hz base, 60Hz max		
2	Const Trq, 50Hz base, 60Hz max		
3	Const Trq, 60Hz base, 72Hz max		
4	VT, 50Hz, 65% Vmid reduction	Derated Torque characteristics	This pattern is used for torque loads proportional to 2 or 3 times the rotation speed, such as is the case with fans and pumps.
5	VT, 50Hz, 50% Vmid reduction		
6	VT, 60Hz, 65% Vmid reduction		
7	VT, 60Hz, 50% Vmid reduction		
8	High Trq, 50 Hz, 25% Vmin boost	High starting torque	This pattern is used when strong torque is required during startup.
9	High Trq, 50 Hz, 65% Vmin boost		
A	High Trq, 60 Hz, 25% Vmin boost		
B	High Trq, 60 Hz, 65% Vmin boost		
C	High Freq, 60Hz base, 90Hz max	Constant output	This pattern is used to rotate motors at greater than 60 Hz. Output voltage is constant when operating at greater than 60 Hz.
D	High Freq, 60Hz base, 120Hz max		
E	High Freq, 60Hz base, 180Hz max		
F	Custom	Constant torque	Enables a custom V/f pattern by changing <i>E1-04</i> to <i>E1-13 [V/f Pattern for Motor 1]</i> . The default settings for <i>E1-04</i> to <i>E1-13</i> are the same as <i>Setting Value 1 [Const Trq, 60Hz base, 60Hz max]</i> .

Note:

When you manually set V/f patterns, note these items:

- To set linear V/f characteristics at frequencies lower than E1-06 [Base Frequency], set E1-07 = E1-09 [Mid Point A Frequency = Minimum Output Frequency]. In this application, the drive ignores E1-08 [Mid Point A Voltage].
- Set the five frequencies as specified by these rules: Incorrect settings will cause oPE10 [V/f Data Setting Error].
 $E1-09 \leq E1-07 < E1-06 \leq E1-11 \leq E1-04$ [Minimum Output Frequency \leq Mid Point A Frequency $<$ Base Frequency \leq Mid Point B Frequency \leq Maximum Output Frequency]
- Setting E1-11 = 0 [Mid Point B Frequency = 0 Hz] disables E1-12 [Mid Point B Voltage]. Ensure that the four frequencies are set according to the following rules;
 $E1-09 \leq E1-07 < E1-06 \leq E1-04$
- When you use A1-03 [Initialize Parameters] to initialize the drive, it will not reset E1-03.

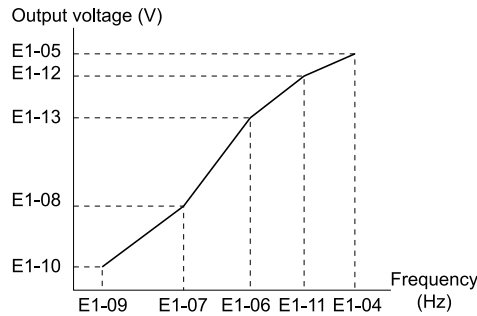

Figure 12.52 V/f Pattern

■ **E1-01: Input AC Supply Voltage**

No. (Hex.)	Name	Description	Default (Range)
E1-01 (0300)	Input AC Supply Voltage	<input checked="" type="checkbox"/> V/f <input type="checkbox"/> OLV <input type="checkbox"/> OLV/PM <input type="checkbox"/> AOLV/PM <input type="checkbox"/> EZOLV Sets the drive input voltage.	200 V Class: 240 V, 400 V Class: 480 V (200 V Class: 155 to 255 V, 400 V Class: 310 to 510 V)

NOTICE: Damage to Equipment. Set E1-01 [Input AC Supply Voltage] to align with the drive input voltage (not motor voltage). If this parameter is incorrect, the protective functions of the drive will not operate correctly and it can cause damage to the drive.

Values Related to the Drive Input Voltage

The value set in E1-01 is the base value that the drive uses for the motor protective functions in Table 12.37. With a 400 V class drive, the detection level changes for some motor protective functions.

Table 12.37 Values Related to the Drive Input Voltage

Voltage	E1-01 Setting	Approximate Values				
		ov Detection Level	BTR Operation Level (rr Detection Level)*1	L2-05 [Undervoltage Detection Lvl (Uv1)]	L2-11 [KEB DC Bus Voltage Setpoint]	L3-17 [DC Bus Regulation Level]
200 V Class	All settings	410 V	394 V	190 V	260 V	375 V
400 V Class	Setting value \geq 400 V	820 V	788 V	380 V	500 V	750 V
	Setting value $<$ 400 V	820 V	788 V	350 V	460 V	750 V

*1 This is the protection function enabled in drives with built-in braking transistors. These values show the level that will trigger the built-in braking transistor. Refer to "YASKAWA AC Drive Series Option Braking Unit and Braking Resistor Unit Installation Manual (TOBPC72060001)" for more information.

■ **E1-03: V/f Pattern Selection**

No. (Hex.)	Name	Description	Default (Range)
E1-03 (0302)	V/f Pattern Selection	<input checked="" type="checkbox"/> V/f <input type="checkbox"/> OLV <input type="checkbox"/> OLV/PM <input type="checkbox"/> AOLV/PM <input type="checkbox"/> EZOLV Sets the V/f pattern for the drive and motor. You can use one of the preset patterns or you can make a custom pattern.	F (Determined by A1-02)

Note:

- When $A1-02 = 2$ [Control Method Selection = OLV], settings 0 to E are not available.
- Set the correct V/f pattern for the application and operation area. An incorrect V/f pattern can decrease motor torque and increase current from overexcitation.
- Parameter $A1-03$ [Initialize Parameters] will not reset the value of $E1-03$.

0 : Const Trq, 50Hz base, 50Hz max

Use this constant torque pattern for general applications. This pattern is used when the load torque is constant without any rotation speed such as that used for linear conveyor systems.

Note:

The voltage values in the figures are for 200 V class drives. Multiply the values by 2 for 400 V class drives.



1 : Const Trq, 60Hz base, 50Hz max

Use this constant torque pattern for general applications. This pattern is used when the load torque is constant without any rotation speed such as that used for linear conveyor systems.

Note:

The voltage values in the figures are for 200 V class drives. Multiply the values by 2 for 400 V class drives.

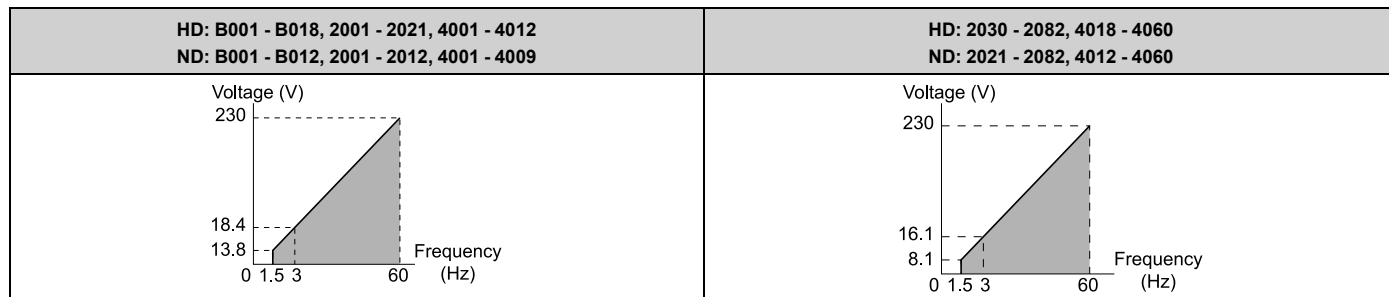

2 : Const Trq, 50Hz base, 60Hz max

Use this constant torque pattern for general applications. This pattern is used when the load torque is constant without any rotation speed such as that used for linear conveyor systems.

Note:

The voltage values in the figures are for 200 V class drives. Multiply the values by 2 for 400 V class drives.

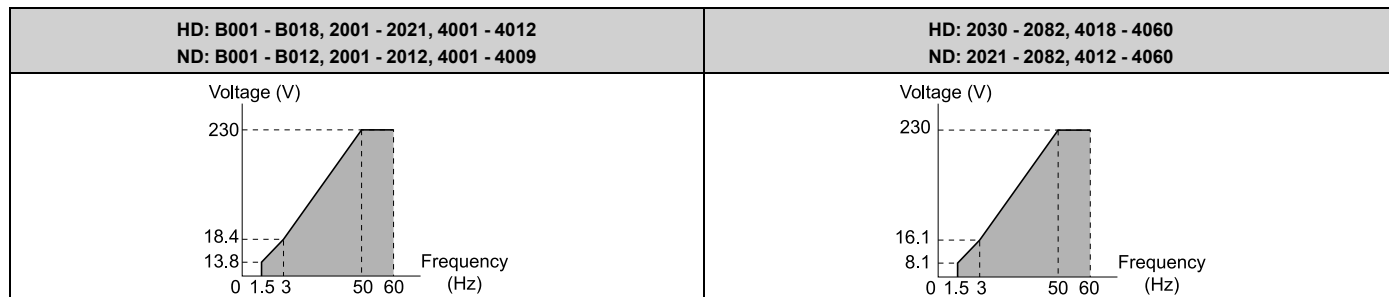

3 : Const Trq, 60Hz base, 72Hz max

Use this constant torque pattern for general applications. This pattern is used when the load torque is constant without any rotation speed such as that used for linear conveyor systems.

12.6 E: Motor Parameters

Note:

The voltage values in the figures are for 200 V class drives. Multiply the values by 2 for 400 V class drives.

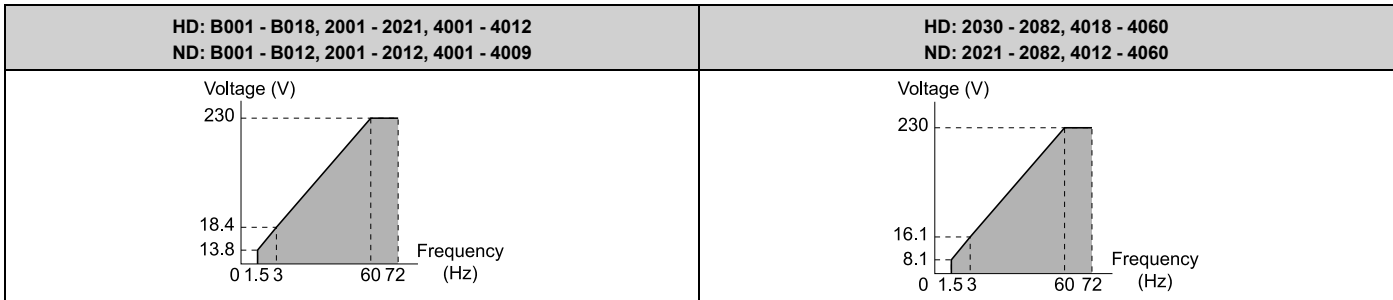

4 : VT, 50Hz, 65% Vmid reduction

Use this derated torque pattern for torque loads proportional to three times the rotation speed. For example, fans and pumps.

Note:

The voltage values in the figures are for 200 V class drives. Multiply the values by 2 for 400 V class drives.

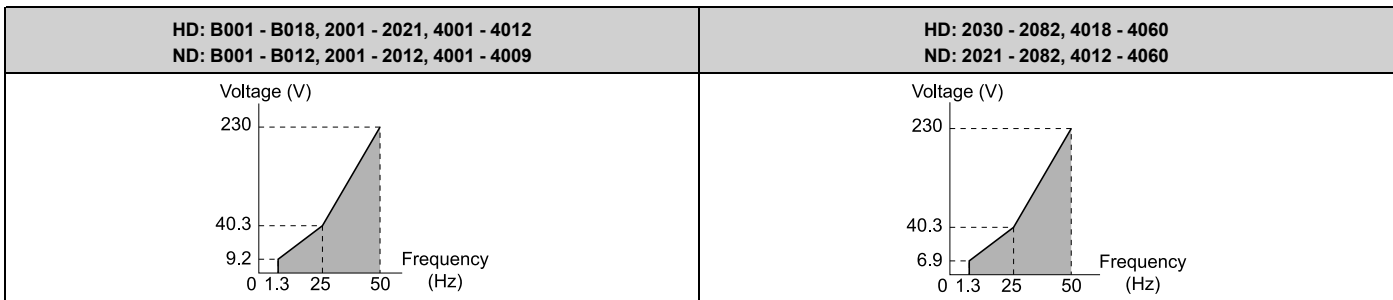

5 : VT, 50Hz, 50% Vmid reduction

Use this derated torque pattern for torque loads proportional to two times the rotation speed. For example, fans and pumps.

Note:

The voltage values in the figures are for 200 V class drives. Multiply the values by 2 for 400 V class drives.

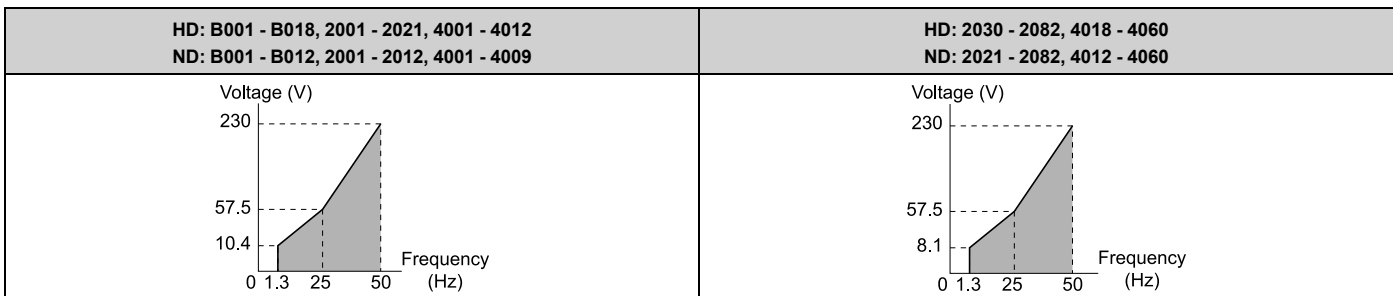

6 : VT, 60Hz, 65% Vmid reduction

Use this derated torque pattern for torque loads proportional to three times the rotation speed. For example, fans and pumps.

Note:

The voltage values in the figures are for 200 V class drives. Multiply the values by 2 for 400 V class drives.

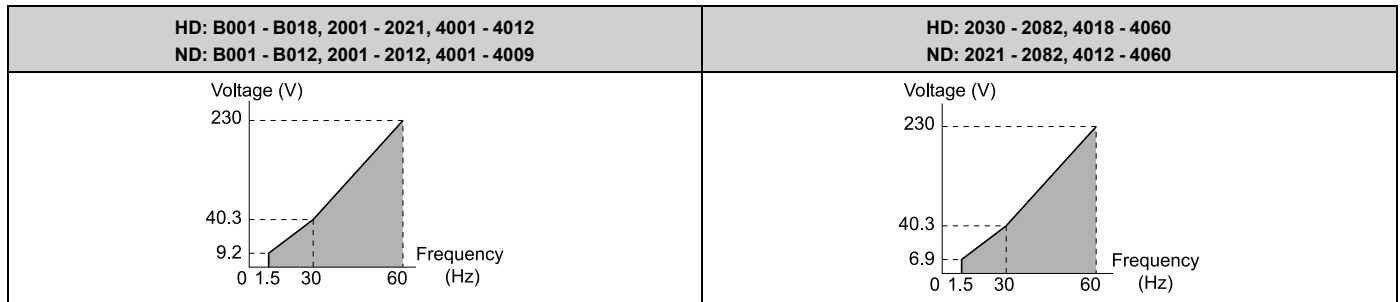

7 : VT, 60Hz, 50% Vmid reduction

Use this derated torque pattern for torque loads proportional to two times the rotation speed. For example, fans and pumps.

Note:

The voltage values in the figures are for 200 V class drives. Multiply the values by 2 for 400 V class drives.

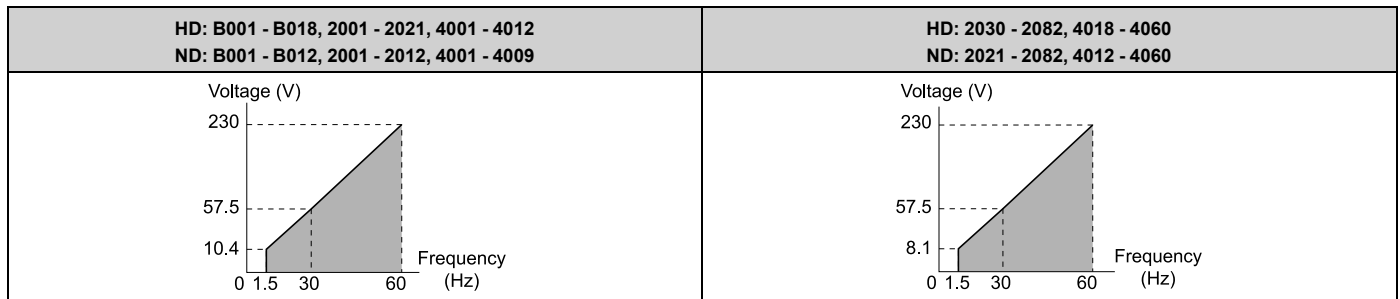

8 : High Trq, 50 Hz, 25% Vmin Boost

Use this pattern when moderate torque is necessary during start up.

Select this pattern only in these conditions:

- The wiring distance between the drive and motor is 150 m (492.1 ft) minimum
- There is an AC reactor connected to the drive output.

Note:

The voltage values in the figures are for 200 V class drives. Multiply the values by 2 for 400 V class drives.



9 : High Trq, 50 Hz, 65% Vmin Boost

Use this pattern when high torque is necessary during start up.

Select this pattern only in these conditions:

- The wiring distance between the drive and motor is 150 m (492.1 ft) minimum
- There is an AC reactor connected to the drive output.

Note:

The voltage values in the figures are for 200 V class drives. Multiply the values by 2 for 400 V class drives.

12.6 E: Motor Parameters

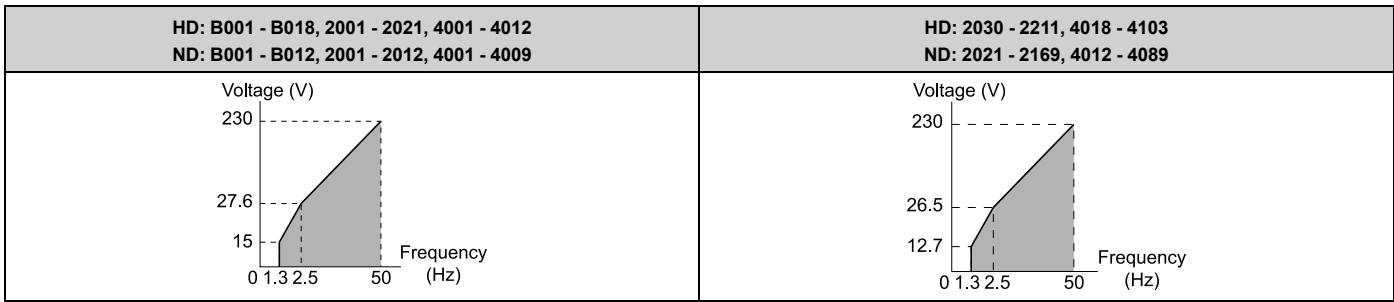

A : High Trq, 60 Hz, 25% Vmin Boost

Use this pattern when moderate torque is necessary during start up.

Select this pattern only in these conditions:

- The wiring distance between the drive and motor is 150 m (492.1 ft) minimum
- There is an AC reactor connected to the drive output.

Note:

The voltage values in the figures are for 200 V class drives. Multiply the values by 2 for 400 V class drives.

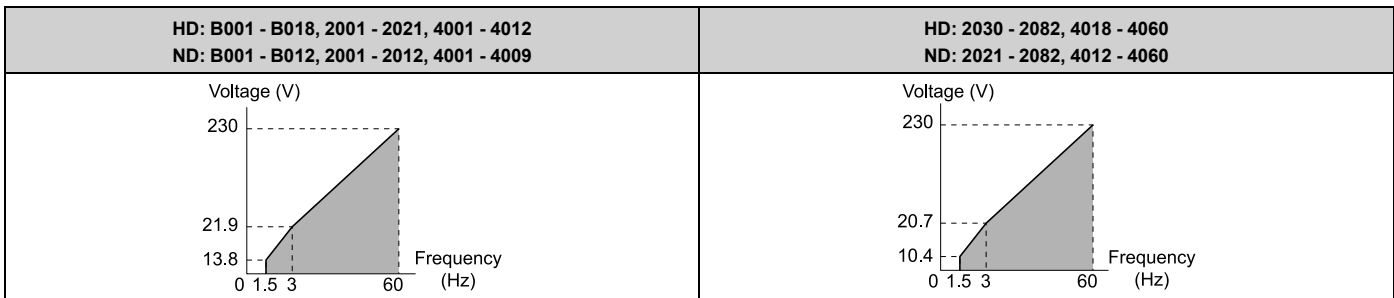

B : High Trq, 60 Hz, 65% Vmin Boost

Use this pattern when high torque is necessary during start up.

Select this pattern only in these conditions:

- The wiring distance between the drive and motor is 150 m (492.1 ft) minimum
- There is an AC reactor connected to the drive output.

Note:

The voltage values in the figures are for 200 V class drives. Multiply the values by 2 for 400 V class drives.

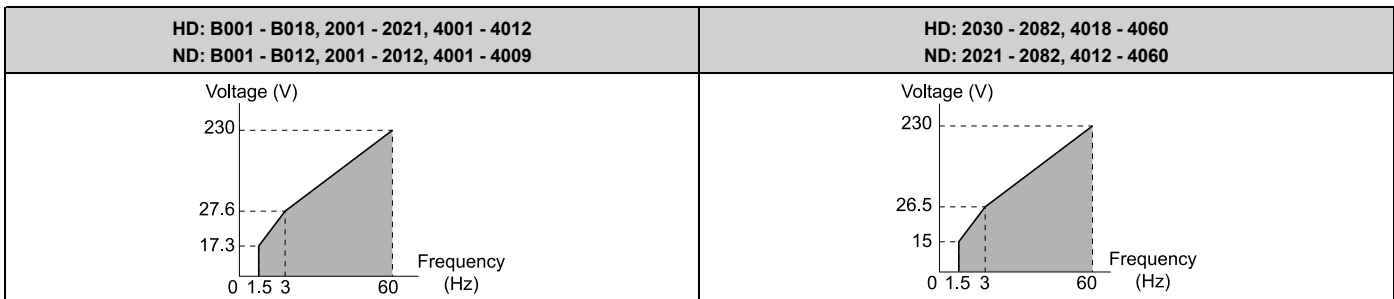

C : Const Trq, 60Hz base, 90Hz max

Use this constant output pattern to rotate motors at more than 60 Hz. Output voltage is constant when you operate at more than 60 Hz.

Note:

The voltage values in the figures are for 200 V class drives. Multiply the values by 2 for 400 V class drives.

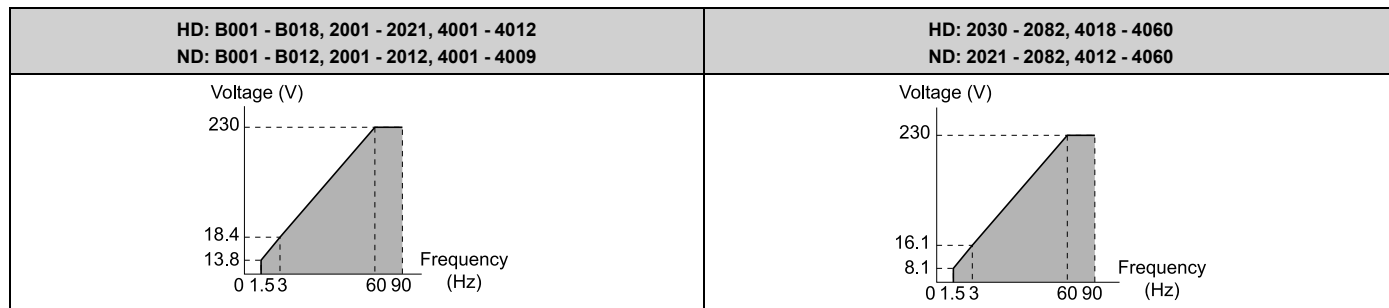

D : Const Trq, 60Hz base, 120Hz max

Use this constant output pattern to rotate motors at more than 60 Hz. Output voltage is constant when you operate at more than 60 Hz.

Note:

The voltage values in the figures are for 200 V class drives. Multiply the values by 2 for 400 V class drives.

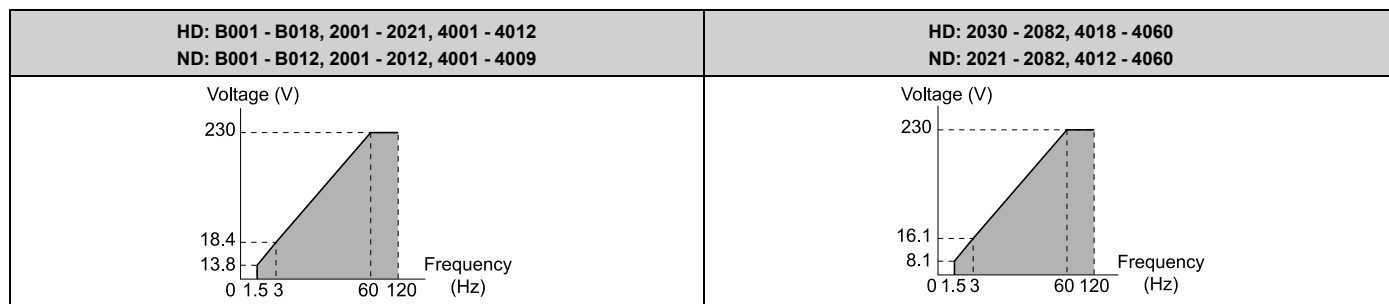

E : Const Trq, 60Hz base, 180Hz max

Use this constant output pattern to rotate motors at more than 60 Hz. Output voltage is constant when you operate at more than 60 Hz.

Note:

The voltage values in the figures are for 200 V class drives. Multiply the values by 2 for 400 V class drives.

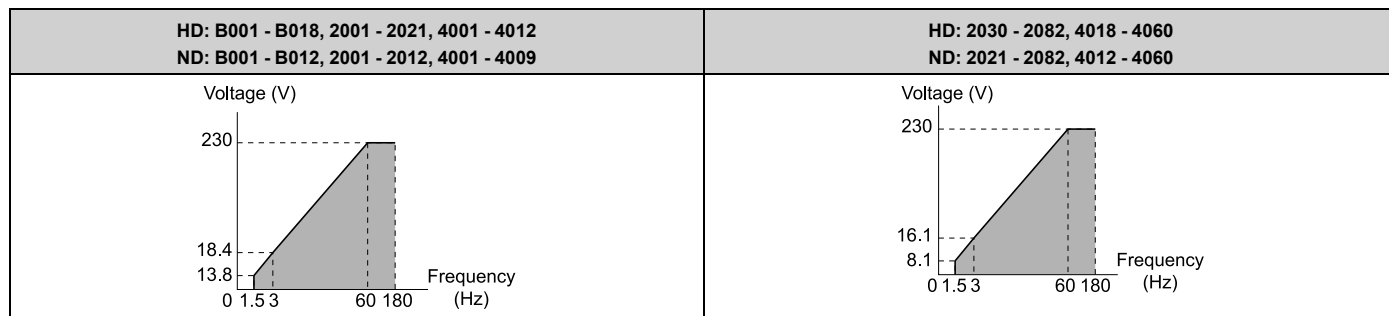

F : Custom

Set E1-04 to E1-13 [V/f Pattern for Motor 1] to set the values for this custom pattern.

The default settings are the same as Setting Value 1 [Const Trq, 60Hz base, 60Hz max].

E1-04: Maximum Output Frequency

No. (Hex.)	Name	Description	Default (Range)
E1-04 (0303)	Maximum Output Frequency	<div style="display: flex; gap: 5px;"> V/f OLV OLV/PM AOLV/PM EZOLV </div> <p>Sets the maximum output frequency for the V/f pattern.</p>	Determined by A1-02 and E5-01 (Determined by A1-02 and E5-01)

■ E1-05: Maximum Output Voltage

No. (Hex.)	Name	Description	Default (Range)
E1-05 (0304)	Maximum Output Voltage	<div style="display: flex; gap: 5px;"> V/f OLV OLV/PM AOLV/PM EZOLV </div> Sets the maximum output voltage for the V/f pattern.	200 V Class: 230.0 V, 400 V: 460.0 V (200 V Class: 0.0 - 255.0 V, 400 V Class: 0.0 - 510.0 V)

■ E1-06: Base Frequency

No. (Hex.)	Name	Description	Default (Range)
E1-06 (0305)	Base Frequency	<div style="display: flex; gap: 5px;"> V/f OLV OLV/PM AOLV/PM EZOLV </div> Sets the base frequency for the V/f pattern.	Determined by A1-02 and E5-01 (0.0 - E1-04)

■ E1-07: Mid Point A Frequency

No. (Hex.)	Name	Description	Default (Range)
E1-07 (0306)	Mid Point A Frequency	<div style="display: flex; gap: 5px;"> V/f OLV OLV/PM AOLV/PM EZOLV </div> Sets a middle output frequency for the V/f pattern.	Determined by A1-02 (0.0 - E1-04)

■ E1-08: Mid Point A Voltage

No. (Hex.)	Name	Description	Default (Range)
E1-08 (0307)	Mid Point A Voltage	<div style="display: flex; gap: 5px;"> V/f OLV OLV/PM AOLV/PM EZOLV </div> Sets a middle output voltage for the V/f pattern.	Determined by A1-02, C6-01 and o2-04 (200 V Class: 0.0 - 255.0 V, 400 V Class: 0.0 - 510.0 V)

Note:

Default setting is determined by A1-02 [Control Method Selection], C6-01 [Normal / Heavy Duty Selection], and o2-04 [Drive Model Selection].

■ E1-09: Minimum Output Frequency

No. (Hex.)	Name	Description	Default (Range)
E1-09 (0308)	Minimum Output Frequency	<div style="display: flex; gap: 5px;"> V/f OLV OLV/PM AOLV/PM EZOLV </div> Sets the minimum output frequency for the V/f pattern.	Determined by A1-02 and E5-01 (Determined by A1-02, E1-04, and E5-01)

■ E1-10: Minimum Output Voltage

No. (Hex.)	Name	Description	Default (Range)
E1-10 (0309)	Minimum Output Voltage	<div style="display: flex; gap: 5px;"> V/f OLV OLV/PM AOLV/PM EZOLV </div> Sets the minimum output voltage for the V/f pattern.	Determined by A1-02 (200 V Class: 0.0 to 255.0 V, 400 V Class: 0.0 to 510.0 V)

■ E1-11: Mid Point B Frequency

No. (Hex.)	Name	Description	Default (Range)
E1-11 (030A) Expert	Mid Point B Frequency	<div style="display: flex; gap: 5px;"> V/f OLV OLV/PM AOLV/PM EZOLV </div> Sets a middle output frequency for the V/f pattern.	0.0 Hz (0.0 - E1-04)

Note:

Set this parameter to 0.0 to disable the function.

■ E1-12: Mid Point B Voltage

No. (Hex.)	Name	Description	Default (Range)
E1-12 (030B) Expert	Mid Point B Voltage	<div style="display: flex; justify-content: space-between; align-items: center;"> V/f OLV OLV/PM AOLV/PM EZOLV </div> Sets a middle point voltage for the V/f pattern.	0.0 V (200 V Class: 0.0 to 255.0 V, 400 V Class: 0.0 to 510.0 V)

Note:

Set this parameter to 0.0 to disable the function.

■ E1-13: Base Voltage

No. (Hex.)	Name	Description	Default (Range)
E1-13 (030C) Expert	Base Voltage	<div style="display: flex; justify-content: space-between; align-items: center;"> V/f OLV OLV/PM AOLV/PM EZOLV </div> Sets the base voltage for the V/f pattern.	0.0 V (200 V Class: 0.0 - 255.0 V, 400 V Class: 0.0 - 510.0 V)

Note:

- After Auto-Tuning, the value of *E1-13* = *E1-05* [Maximum Output Voltage].
- When *E1-13* = 0.0, use the value of *E1-05* to control the voltage.

■ E1-21: No-Load Voltage Adjustment

No. (Hex.)	Name	Description	Default (Range)
E1-21 (1568)	No-Load Voltage Adjustment	<div style="display: flex; justify-content: space-between; align-items: center;"> V/f OLV OLV/PM AOLV/PM EZOLV </div> Sets the type of Auto-Tuning. Considers <i>T1-13</i> [PM Motor Rated Voltage] <i>FLA</i>] to be 100%.	85.0% (0.0 - 100.0%)

Note:

The default setting is different for different models.

- 85.0%: B001 - B018, 2001 - 2056, 4001 - 4031
- 90.0%: 2070, 2082, 4038 - 4060

◆ E2: Motor Parameters

E2 parameters [Motor Parameters] are used to set induction motor data. To switch drive operation from one motor to another motor, configure the first motor (motor 1).

If Auto-Tuning cannot be performed, set the *E2 parameters* manually. Performing Auto-Tuning automatically sets the *E2 parameters* to the optimal values.

Note:

If *A1-02* [Control Method Selection] is set to the following control modes, the keypad does not display *E2-xx*.

- 5 [PM Open Loop Vector]
- 6 [PM Advanced Open Loop Vector]
- 8 [EZ Vector Control]

■ E2-01: Motor Rated Current (FLA)

No. (Hex.)	Name	Description	Default (Range)
E2-01 (030E)	Motor Rated Current (FLA)	<div style="display: flex; justify-content: space-between; align-items: center;"> V/f OLV OLV/PM AOLV/PM EZOLV </div> Sets the motor rated current in amps.	Determined by o2-04, C6-01 (10% to 200% of the drive rated current)

Note:

- If *E2-01* < *E2-03* [Motor No-Load Current], the drive will detect *oPE02* [Parameter Range Setting Error].
- When the drive model changes, the display units for this parameter also change.
 - 0.01 A: B001 to B018, 2001 to 2042, 4001 to 4023
 - 0.1 A: 2056 to 2082, 4031 to 4060

The value set for *E2-01* becomes the reference value for motor protection and the torque limit. Enter the motor rated current written on the motor nameplate. Auto-Tuning the drive will automatically set *E2-01* to the value input for *T1-04* [*Motor Rated Current*].

■ E2-02: Motor Rated Slip

No. (Hex.)	Name	Description	Default (Range)
E2-02 (030F)	Motor Rated Slip	<input type="checkbox"/> V/f <input checked="" type="checkbox"/> OLV <input type="checkbox"/> OLV/PM <input type="checkbox"/> AOLV/PM <input type="checkbox"/> EZOLV Sets motor rated slip.	Determined by o2-04, C6-01 (0.000 - 20.000 Hz)

This parameter value becomes the base slip compensation value. The drive automatically sets this parameter during Auto-Tuning. When you cannot do Auto-Tuning, calculate the motor rated slip with the information on the motor nameplate and this formula:

$$E2-02 = f - (n \times p) / 120$$

- f: Motor rated frequency (Hz)
- n: Rated motor speed (min⁻¹ (r/min))
- p: Number of motor poles

■ E2-03: Motor No-Load Current

No. (Hex.)	Name	Description	Default (Range)
E2-03 (0310)	Motor No-Load Current	<input type="checkbox"/> V/f <input checked="" type="checkbox"/> OLV <input type="checkbox"/> OLV/PM <input type="checkbox"/> AOLV/PM <input type="checkbox"/> EZOLV Sets the no-load current for the motor in amps when operating at the rated frequency and the no-load voltage.	Determined by o2-04, C6-01 (0 to E2-01)

Note:

When the drive model changes, the display units for this parameter also change.

- 0.01 A: B001 - B018, 2001 - 2042, 4001 - 4023
- 0.1 A: 2056 - 2082, 4031 - 4060

The drive automatically sets this parameter during Auto-Tuning. When you cannot do Auto-Tuning, you can also use the motor no-load current on the motor test report to enter this value manually. Get the test report from the motor manufacturer.

Note:

The default setting of the no-load current is for a 4-pole motor recommended by Yaskawa.

■ E2-04: Motor Pole Count

No. (Hex.)	Name	Description	Default (Range)
E2-04 (0311)	Motor Pole Count	<input type="checkbox"/> V/f <input checked="" type="checkbox"/> OLV <input type="checkbox"/> OLV/PM <input type="checkbox"/> AOLV/PM <input type="checkbox"/> EZOLV Sets the number of motor poles.	4 (2 - 120)

Note:

- When *A1-02* = 0 [*Control Method Selection* = V/f], the maximum value is 120.
- When *A1-02* = 2 [*OLV*], the maximum value is 48.

Auto-Tuning automatically sets this parameter to the value of [Number of Motor Poles].

■ E2-05: Motor Line-to-Line Resistance

No. (Hex.)	Name	Description	Default (Range)
E2-05 (0312)	Motor Line-to-Line Resistance	<input type="checkbox"/> V/f <input checked="" type="checkbox"/> OLV <input type="checkbox"/> OLV/PM <input type="checkbox"/> AOLV/PM <input type="checkbox"/> EZOLV Sets the line-to-line resistance for the motor stator windings.	Determined by o2-04, C6-01 (0.000 - 65.000 Ω)

Note:

This value is the motor line-to-line resistance. Do not set this parameter with the resistance per phase.

Auto-Tuning automatically sets this parameter. If you cannot do Auto-Tuning, use the test report from the motor manufacturer to configure the settings. Use one of these formulas to calculate the motor line-to-line resistance:

- E-type insulation: [the resistance value (Ω) shown on the test report at 75 °C] \times 0.822
- B-type insulation: [the resistance value (Ω) shown on the test report at 75 °C] \times 0.822
- F-type insulation: [the resistance value (Ω) shown on the test report at 115 °C] \times 0.728

■ E2-06: Motor Leakage Inductance

No. (Hex.)	Name	Description	Default (Range)
E2-06 (0313)	Motor Leakage Inductance	<div style="display: flex; justify-content: space-between; border: 1px solid black; padding: 2px;"> V/f OLV OLV/PM AOLV/PM EZOLV </div> Sets the voltage drop from motor leakage inductance when the motor is operating at the rated frequency and rated current. This value is a percentage of Motor Rated Voltage.	Determined by o2-04, C6-01 (0.0 - 60.0%)

The drive automatically sets this parameter during Auto-Tuning.

Note:

The motor nameplate does not usually show the quantity of voltage drop. If you do not know the value of the motor leakage inductance, contact the motor manufacturer to receive a copy of the motor test report.

■ E2-07: Motor Saturation Coefficient 1

No. (Hex.)	Name	Description	Default (Range)
E2-07 (0314)	Motor Saturation Coefficient 1	<div style="display: flex; justify-content: space-between; border: 1px solid black; padding: 2px;"> V/f OLV OLV/PM AOLV/PM EZOLV </div> Sets the motor iron-core saturation coefficient at 50% of the magnetic flux.	0.50 (0.00 - 0.50)

The drive uses this coefficient when it operates with constant output. The drive uses this coefficient when it operates the motor in the constant output range.

■ E2-08: Motor Saturation Coefficient 2

No. (Hex.)	Name	Description	Default (Range)
E2-08 (0315)	Motor Saturation Coefficient 2	<div style="display: flex; justify-content: space-between; border: 1px solid black; padding: 2px;"> V/f OLV OLV/PM AOLV/PM EZOLV </div> Sets the motor iron-core saturation coefficient at 75% of the magnetic flux.	0.75 (E2-07 - 0.75)

The drive uses this coefficient when it operates with constant output. The drive uses this coefficient when it operates the motor in the constant output range.

■ E2-09: Motor Mechanical Loss

No. (Hex.)	Name	Description	Default (Range)
E2-09 (0316) Expert	Motor Mechanical Loss	<div style="display: flex; justify-content: space-between; border: 1px solid black; padding: 2px;"> V/f OLV OLV/PM AOLV/PM EZOLV </div> Sets the mechanical loss of the motor. It is set as a percentage of E2-11 [Motor Rated Power]. Usually it is not necessary to change this setting.	0.0% (0.0 - 10.0%)

Adjust this parameter in these conditions. The drive adds the configured mechanical loss to the torque reference value as a torque compensation value:

- There is a large quantity of torque loss from motor bearing friction.
- There is a large quantity of torque loss in fans and pumps.

■ E2-10: Motor Iron Loss

No. (Hex.)	Name	Description	Default (Range)
E2-10 (0317)	Motor Iron Loss	<div style="display: flex; justify-content: space-between; border: 1px solid black; padding: 2px;"> V/f OLV OLV/PM AOLV/PM EZOLV </div> Sets the motor iron loss.	Determined by o2-04, C6-01 (0 - 65535 W)

■ **E2-11: Motor Rated Power**

No. (Hex.)	Name	Description	Default (Range)
E2-11 (0318)	Motor Rated Power	<div style="display: flex; gap: 5px;"> V/f OLV OLV/PM AOLV/PM EZOLV </div> Sets the motor rated output in the units from 01-58 [Motor Power Unit Selection].	Determined by o2-04, C6-01 (0.00 - 650.00)

The drive automatically sets this parameter to the value input for “Motor Rated Power” during Auto-Tuning.

◆ **E3: V/f Pattern for Motor 2**

E3 parameters [V/f Pattern for Motor 2] set the control mode and V/f pattern used for motor 2.

Note:

V/f preset patterns equivalent to those set with E1-03 [V/f Pattern Selection] are not available for E3 parameters. Use E3-04 [Motor 2 Maximum Output Frequency] to E3-10 [Motor 2 Minimum Output Voltage] to manually set the V/f pattern.

■ **Notes on Manually Setting V/f Patterns**

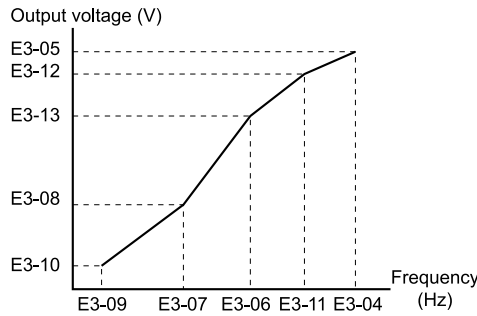

Figure 12.53 Motor 2 V/f Pattern Diagram

- To configure a linear V/f pattern at frequencies lower than E3-06 [Motor 2 Base Frequency], set E3-07 = E3-09 [Motor 2 Mid Point A Frequency = Motor 2 Minimum Output Frequency]. In this application, the drive ignores E1-08 [Mid Point A Voltage].
- Set the five frequencies as specified by these rules:
 $E3-09 \leq E3-07 < E3-06 \leq E3-11 \leq E3-04$ [Motor 2 Minimum Output Frequency ≤ Motor 2 Mid Point A Frequency < Motor 2 Base Frequency ≤ Motor 2 Mid Point B Frequency ≤ Motor 2 Maximum Output Frequency]
 Incorrect settings will trigger oPE10 [V/f Data Setting Error].
- If E3-11 = 0.0 Hz, the drive will ignore the V/f pattern settings.
- When you use A1-03 [Initialize Parameters] to initialize the drive, the drive will reset the manually set values for E3-04 to E3-13 [Motor 2 Base Voltage] to default values.

■ **E3-01: Motor 2 Control Mode Selection**

No. (Hex.)	Name	Description	Default (Range)
E3-01 (0319)	Motor 2 Control Mode Selection	<div style="display: flex; gap: 5px;"> V/f OLV OLV/PM AOLV/PM EZOLV </div> Sets the control method for motor 2.	0 (0, 2)

Note:

- When you change this setting, the drive will set all parameters that are dependent on E3-01 to their default settings.
- Parameter L1-01 [Motor Overload (oL1) Protection] sets the protection operation of oL1 [Motor Overload] the same as Motor 1.
- When you use parameter A1-03 [Initialize Parameters] to initialize the drive, this parameter is not reset.

0 : V/f Control

2 : Open Loop Vector

■ E3-04: Motor 2 Maximum Output Frequency

No. (Hex.)	Name	Description	Default (Range)
E3-04 (031A)	Motor 2 Maximum Output Frequency	V/f OLV OLV/PM AOLV/PM EZOLV Set the maximum output frequency for the motor 2 V/f pattern.	Determined by E3-01 (40.0 - 590.0 Hz)

■ E3-05: Motor 2 Maximum Output Voltage

No. (Hex.)	Name	Description	Default (Range)
E3-05 (031B)	Motor 2 Maximum Output Voltage	V/f OLV OLV/PM AOLV/PM EZOLV Sets the maximum output voltage for the motor 2 V/f pattern.	Determined by E3-01 (200 V Class: 0.0 - 255.0 V, 400 V Class: 0.0 - 510.0 V)

■ E3-06: Motor 2 Base Frequency

No. (Hex.)	Name	Description	Default (Range)
E3-06 (031C)	Motor 2 Base Frequency	V/f OLV OLV/PM AOLV/PM EZOLV Sets the base frequency for the motor 2 V/f pattern.	Determined by E3-01 (0.0 - E3-04)

■ E3-07: Motor 2 Mid Point A Frequency

No. (Hex.)	Name	Description	Default (Range)
E3-07 (031D)	Motor 2 Mid Point A Frequency	V/f OLV OLV/PM AOLV/PM EZOLV Sets a middle output frequency for the motor 2 V/f pattern.	Determined by E3-01 (0.0 - E3-04)

■ E3-08: Motor 2 Mid Point A Voltage

No. (Hex.)	Name	Description	Default (Range)
E3-08 (031E)	Motor 2 Mid Point A Voltage	V/f OLV OLV/PM AOLV/PM EZOLV Sets a middle output voltage for the motor 2 V/f pattern.	Determined by E3-01 (200 V Class: 0.0 - 255.0 V, 400 V Class: 0.0 - 510.0 V)

■ E3-09: Motor 2 Minimum Output Frequency

No. (Hex.)	Name	Description	Default (Range)
E3-09 (031F)	Motor 2 Minimum Output Frequency	V/f OLV OLV/PM AOLV/PM EZOLV Sets the minimum output frequency for the motor 2 V/f pattern.	Determined by E3-01 (0.0 - E3-04)

■ E3-10: Motor 2 Minimum Output Voltage

No. (Hex.)	Name	Description	Default (Range)
E3-10 (0320)	Motor 2 Minimum Output Voltage	V/f OLV OLV/PM AOLV/PM EZOLV Sets the minimum output voltage for the motor 2 V/f pattern.	Determined by E3-01 (200 V Class: 0.0 - 255.0 V, 400 V Class: 0.0 - 510.0 V)

■ E3-11: Motor 2 Mid Point B Frequency

No. (Hex.)	Name	Description	Default (Range)
E3-11 (0345) Expert	Motor 2 Mid Point B Frequency	V/f OLV OLV/PM AOLV/PM EZOLV Sets a middle output frequency for the motor 2 V/f pattern. Set this parameter to adjust the V/f pattern for the constant output range. Usually it is not necessary to change this parameter.	0.0 Hz (0.0 - E3-04)

Note:

- Set this parameter to 0.0 to disable the function.
- When you initialize the drive, this parameter is reset to the default value.

■ **E3-12: Motor 2 Mid Point B Voltage**

No. (Hex.)	Name	Description	Default (Range)
E3-12 (0346) Expert	Motor 2 Mid Point B Voltage	<div style="display: flex; gap: 5px;"> V/f OLV OLV/PM AOLV/PM EZOLV </div> <p>Sets a middle output voltage for the motor 2 V/f pattern. Set this parameter to adjust the V/f pattern for the constant output range. Usually it is not necessary to change this parameter.</p>	0.0 V (200 V Class: 0.0 to 255.0 V, 400 V Class: 0.0 to 510.0 V)

Note:

- Set this parameter to 0.0 to disable the function.
- When you initialize the drive, this parameter is reset to the default value.
- The setting value changes automatically when you do Auto-Tuning (rotational and stationary 1 or 2).

■ **E3-13: Motor 2 Base Voltage**

No. (Hex.)	Name	Description	Default (Range)
E3-13 (0347) Expert	Motor 2 Base Voltage	<div style="display: flex; gap: 5px;"> V/f OLV OLV/PM AOLV/PM EZOLV </div> <p>Sets the base voltage for the motor 2 V/f pattern. Set this parameter to adjust the V/f pattern for the constant output range. Usually it is not necessary to change this parameter.</p>	0.0 V (200 V Class: 0.0 to 255.0 V, 400 V Class: 0.0 to 510.0 V)

Note:

- When you initialize the drive, this parameter is reset to the default value.
- The setting value changes automatically when you do Auto-Tuning (rotational and stationary 1 or 2).

◆ **E4: Motor 2 Parameters**

E4 parameters [Motor 2 Parameters] set induction motor data. To switch drive operation from one motor to a different motor, configure motor 2.

Auto-Tuning automatically sets the *E4 parameters* to the best values for the application. If you cannot do Auto-Tuning, set the *E4 parameters* manually.

Note:

E3-xx and *E4-xx* are available when *H1-xx = 16 [MFDI Function Select = Motor 2 Selection]*.

■ **E4-01: Motor 2 Rated Current**

No. (Hex.)	Name	Description	Default (Range)
E4-01 (0321)	Motor 2 Rated Current	<div style="display: flex; gap: 5px;"> V/f OLV OLV/PM AOLV/PM EZOLV </div> <p>Sets the motor rated current for motor 2 in amps.</p>	Determined by o2-04, C6-01 (10% to 200% of the drive rated current)

Note:

- If $E4-01 \leq E4-03$ [*Motor 2 Rated No-Load Current*], the drive will detect *oPE02 [Parameter Range Setting Error]*.
- When the drive model changes, the display units for this parameter also change.
 -0.01 A: B001 - B018, 2001 - 2042, 4001 - 4023
 -0.1 A: 2056 - 2082, 4031 - 4060

The value set for *E4-01* becomes the reference value for motor protection, the torque limit, and torque control. Enter the motor rated current written on the motor nameplate. Auto-Tuning automatically sets the value of *E4-01* to the value input for [*Motor Rated Current*].

■ **E4-02: Motor 2 Rated Slip**

No. (Hex.)	Name	Description	Default (Range)
E4-02 (0322)	Motor 2 Rated Slip	<div style="display: flex; gap: 5px;"> V/f OLV OLV/PM AOLV/PM EZOLV </div> <p>Sets the motor rated slip for motor 2.</p>	Determined by o2-04, C6-01 (0.000 - 20.000 Hz)

The value set in *E4-02* becomes the base slip compensation value. The drive sets this parameter during Rotational Auto-Tuning and Stationary Auto-Tuning. If you cannot do Auto-Tuning, use the information written on the motor nameplate and this formula to calculate the motor rated slip:

$$E4-02 = f - (n \times p) / 120$$

- f: Motor rated frequency (Hz)
- n: Rated motor speed (min^{-1} (r/min))
- p: Number of motor poles

■ E4-03: Motor 2 Rated No-Load Current

No. (Hex.)	Name	Description	Default (Range)
E4-03 (0323)	Motor 2 Rated No-Load Current	V/f OLV OLV/PM AOLV/PM EZOLV Sets the no-load current for motor 2 in amps when operating at the rated frequency and the no-load voltage.	Determined by o2-04, C6-01 (0 to E4-01)

Note:

When the drive model changes, the display units for this parameter also change.

- 0.01 A: B001 - B018, 2001 - 2042, 4001 - 4023
- 0.1 A: 2056 - 2082, 4031 - 4060

You can also manually enter the motor no-load current shown on the motor test report to *E4-03*. Contact the motor manufacturer for the motor test report.

Note:

The default setting of the no-load current is for a 4-pole motor recommended by Yaskawa.

■ E4-04: Motor 2 Motor Poles

No. (Hex.)	Name	Description	Default (Range)
E4-04 (0324)	Motor 2 Motor Poles	V/f OLV OLV/PM AOLV/PM EZOLV Sets the number of poles for motor 2.	4 (2 - 120)

Auto-Tuning automatically sets *E4-04* to the value input for [Number of Motor Poles].

■ E4-05: Motor 2 Line-to-Line Resistance

No. (Hex.)	Name	Description	Default (Range)
E4-05 (0325)	Motor 2 Line-to-Line Resistance	V/f OLV OLV/PM AOLV/PM EZOLV Sets the line-to-line resistance for the motor 2 stator windings.	Determined by o2-04, C6-01 (0.000 - 65.000 Ω)

Note:

This value is the line-to-line resistance for motor 2. Do not set this parameter with the resistance per phase.

Auto-Tuning automatically sets this parameter. If you cannot do Auto-Tuning, use the test report from the motor manufacturer to configure the settings. To calculate the motor line-to-line resistance, use the information shown on the motor nameplate with one of these formulas:

- E-type insulation: [the resistance value (Ω) shown on the test report at 75 °C] \times 0.822
- B-type insulation: [the resistance value (Ω) shown on the test report at 75 °C] \times 0.822
- F-type insulation: [the resistance value (Ω) shown on the test report at 115 °C] \times 0.728

■ E4-06: Motor 2 Leakage Inductance

No. (Hex.)	Name	Description	Default (Range)
E4-06 (0326)	Motor 2 Leakage Inductance	V/f OLV OLV/PM AOLV/PM EZOLV Sets the voltage drop from motor 2 leakage inductance as a percentage of Motor Rated Voltage when motor 2 operates at the rated frequency and rated current.	Determined by o2-04, C6-01 (0.0 - 60.0%)

The drive sets this parameter during Rotational Auto-Tuning and Stationary Auto-Tuning.

Note:

You cannot usually find the quantity of voltage drop on the motor nameplate. If you do not know the value of the motor 2 leakage inductance, get the test report from the motor manufacturer.

■ E4-07: Motor 2 Saturation Coefficient 1

No. (Hex.)	Name	Description	Default (Range)
E4-07 (0343)	Motor 2 Saturation Coefficient 1	<div style="display: flex; justify-content: space-between; align-items: center;"> V/f OLV OLV/PM AOLV/PM EZOLV </div> Sets the motor 2 iron-core saturation coefficient at 50% of the magnetic flux.	0.50 (0.00 - 0.50)

The drive sets this parameter during Rotational Auto-Tuning. The drive uses this value when it operates the motor in the constant output range.

■ E4-08: Motor 2 Saturation Coefficient 2

No. (Hex.)	Name	Description	Default (Range)
E4-08 (0344)	Motor 2 Saturation Coefficient 2	<div style="display: flex; justify-content: space-between; align-items: center;"> V/f OLV OLV/PM AOLV/PM EZOLV </div> Sets the motor 2 iron-core saturation coefficient at 75% of the magnetic flux.	0.75 (E4-07 - 0.75)

The drive sets this parameter during Rotational Auto-Tuning. The drive uses this value when it operates the motor in the constant output range.

■ E4-09: Motor 2 Mechanical Loss

No. (Hex.)	Name	Description	Default (Range)
E4-09 (033F) Expert	Motor 2 Mechanical Loss	<div style="display: flex; justify-content: space-between; align-items: center;"> V/f OLV OLV/PM AOLV/PM EZOLV </div> Sets the mechanical loss of motor 2. It is set as a percentage of <i>E4-11 [Motor 2 Rated Power]</i> . Usually it is not necessary to change this setting.	0.0% (0.0 - 10.0%)

Adjust this parameter in these conditions. The drive adds the configured mechanical loss to the torque reference value as a torque compensation value:

- There is a large quantity of torque loss from motor bearing friction.
- There is a large quantity of torque loss in fans and pumps.

■ E4-10: Motor 2 Iron Loss

No. (Hex.)	Name	Description	Default (Range)
E4-10 (0340)	Motor 2 Iron Loss	<div style="display: flex; justify-content: space-between; align-items: center;"> V/f OLV OLV/PM AOLV/PM EZOLV </div> Sets the motor iron loss for motor 2.	Determined by o2-04, C6-01 (0 - 65535 W)

■ E4-11: Motor 2 Rated Power

No. (Hex.)	Name	Description	Default (Range)
E4-11 (0327)	Motor 2 Rated Power	<div style="display: flex; justify-content: space-between; align-items: center;"> V/f OLV OLV/PM AOLV/PM EZOLV </div> Sets the motor rated power in the units from <i>o1-58 [Motor Power Unit Selection]</i> .	Determined by o2-04, C6-01 (0.00 - 650.00 HP)

Auto-Tuning automatically sets this parameter to the value input for [Motor Rated Power].

◆ E5: PM Motor Settings

E5 parameters are used to set PM motor data.

Set *E5-01* to the motor code when using PM motors recommended by Yaskawa. *E5* and other related motor parameters will be automatically set to the optimal values.

Perform Auto-Tuning for all other PM motors. If information from motor nameplates or test reports is available, the *E5 parameters* can be manually entered.

Note:

- The keypad shows *E5-xx* only when *A1-02 = 5, 6 [Control Method Selection = OLV/PM, AOLV/PM]*.
- *E5-xx parameters* are not reset when the drive is initialized using parameter *A1-03 [Initialize Parameters]*.

■ E5-01: PM Motor Code Selection

No. (Hex.)	Name	Description	Default (Range)
E5-01 (0329)	PM Motor Code Selection	<div style="display: flex; justify-content: space-between; border: 1px solid black; padding: 2px;"> V/f OLV OLV/PM AOLV/PM EZOLV </div> <p>Sets the motor code for Yaskawa PM motors. The drive uses the motor code to automatically set some parameters to their correct settings.</p>	FFFF (0000 - FFFF)

Note:

- If the drive hunts or shows an alarm after you enter a motor code, use the keypad to enter the value shown on the nameplate to *E5-xx*.
- When you use a PM motor other than a Yaskawa SMRD, SMRA, or SSR1 series, set *E5-01* = *FFFF*.

Figure 12.54 gives information about the motor code setting digits.

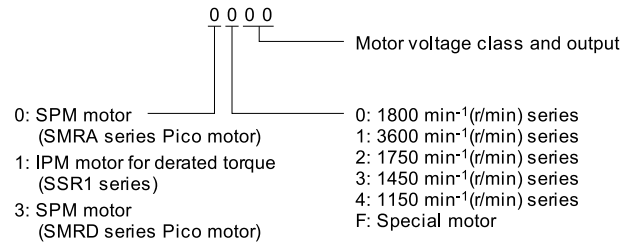

Figure 12.54 PM Motor Code

■ E5-02: PM Motor Rated Power

No. (Hex.)	Name	Description	Default (Range)
E5-02 (032A)	PM Motor Rated Power	<div style="display: flex; justify-content: space-between; border: 1px solid black; padding: 2px;"> V/f OLV OLV/PM AOLV/PM EZOLV </div> <p>Sets the PM motor rated output in the units from <i>o1-58</i> [Motor Power Unit Selection].</p>	Determined by <i>o2-04</i> , <i>C6-01</i> (0.10 - 30.00 kW)

These Auto-Tuning methods will automatically set this parameter:

- PM Motor Parameter Settings
- PM Stationary Auto-Tuning
- PM Rotational Auto-Tuning

■ E5-03: Motor Rated Current (FLA)

No. (Hex.)	Name	Description	Default (Range)
E5-03 (032B)	Motor Rated Current (FLA)	<div style="display: flex; justify-content: space-between; border: 1px solid black; padding: 2px;"> V/f OLV OLV/PM AOLV/PM EZOLV </div> <p>Sets the PM motor rated current (FLA).</p>	Determined by <i>o2-04</i> , <i>C6-01</i> (10% to 200% of the drive rated current)

Note:

When the drive model changes, the display units for this parameter also change.

- 0.01 A: B001 - B018, 2001 - 2042, 4001 - 4023
- 0.1 A: 2056 - 2082, 4031 - 4060

The drive automatically sets *E5-03* to the value input for *T2-06* [PM Motor Rated Current] after you do these types of Auto-Tuning:

- PM Motor Parameter Settings
- PM Stationary Auto-Tuning
- PM Stationary Tuning for Stator Resistance
- PM Rotational Auto-Tuning

■ E5-04: PM Motor Pole Count

No. (Hex.)	Name	Description	Default (Range)
E5-04 (032C)	PM Motor Pole Count	<div style="display: flex; justify-content: space-between; border: 1px solid black; padding: 2px;"> V/f OLV OLV/PM AOLV/PM EZOLV </div> <p>Sets the number of PM motor poles.</p>	4 (2 - 120)

These types of Auto-Tuning will automatically set this parameter to the value of [Number of Motor Poles]:

- Manual Entry w/ Motor Data Sheet
- PM Stationary Auto-Tuning
- Rotational (Ld, Lq, R, back-EMF)

■ **E5-05: PM Motor Resistance (ohms/phase)**

No. (Hex.)	Name	Description	Default (Range)
E5-05 (032D)	PM Motor Resistance (ohms/phase)	<div style="display: flex; justify-content: space-between; align-items: center;"> V/f OLV OLV/PM AOLV/PM EZOLV </div> Sets the resistance per phase of a PM motor. Set 50% of the line-to-line resistance.	0.100 Ω (0.000 - 65.000 Ω)

PM motor Auto-Tuning automatically sets this parameter to the value of [PM Motor Stator Resistance].

Note:

Do not change the setting calculated by Auto-Tuning unless it is necessary.

■ **E5-06: PM d-axis Inductance (mH/phase)**

No. (Hex.)	Name	Description	Default (Range)
E5-06 (032E)	PM d-axis Inductance (mH/phase)	<div style="display: flex; justify-content: space-between; align-items: center;"> V/f OLV OLV/PM AOLV/PM EZOLV </div> Sets the PM motor d-axis inductance.	1.00 mH (0.00 - 300.00 mH)

PM motor Auto-Tuning automatically sets this parameter to the value of [PM Motor d-Axis Inductance].

Note:

Do not change the setting calculated by Auto-Tuning unless it is necessary.

■ **E5-07: PM q-axis Inductance (mH/phase)**

No. (Hex.)	Name	Description	Default (Range)
E5-07 (032F)	PM q-axis Inductance (mH/phase)	<div style="display: flex; justify-content: space-between; align-items: center;"> V/f OLV OLV/PM AOLV/PM EZOLV </div> Sets the PM motor q-axis inductance.	1.00 mH (0.00 - 600.00 mH)

PM motor Auto-Tuning automatically sets this parameter to the value of [PM Motor q-Axis Inductance].

Note:

Do not change the setting calculated by Auto-Tuning unless it is necessary.

■ **E5-09: PM Back-EMF Vpeak (mV/(rad/s))**

No. (Hex.)	Name	Description	Default (Range)
E5-09 (0331)	PM Back-EMF Vpeak (mV/(rad/s))	<div style="display: flex; justify-content: space-between; align-items: center;"> V/f OLV OLV/PM AOLV/PM EZOLV </div> Sets the peak value of PM motor induced voltage.	0.0 mV/(rad/sec) (0.0 - 2000.0 mV/(rad/s))

Set this parameter when you use an IPM motor (SSR1-Series).

PM motor Auto-Tuning automatically sets this parameter to the value of [Back-EMF Voltage Constant (Ke)].

When E5-01 = FFFF, only set E5-09 or E5-24 [PM Back-EMF L-L Vrms (mV/rpm)] as the induced voltage constant.

Note:

When you set this parameter, also set E5-24 = 0.0. The drive will detect oPE08 [Parameter Selection Error] in these conditions:

- E5-09 = 0.0 and E5-24 = 0.0
- E5-09 ≠ 0.0 and E5-24 ≠ 0.0

■ E5-24: PM Back-EMF L-L Vrms (mV/rpm)

No. (Hex.)	Name	Description	Default (Range)
E5-24 (0353)	PM Back-EMF L-L Vrms (mV/rpm)	<div style="display: flex; justify-content: space-between; border-bottom: 1px solid black; margin-bottom: 5px;"> V/f OLV OLV/PM AOLV/PM EZOLV </div> Sets the RMS value for PM motor line voltage.	200 V Class: 100.0 mV/min ⁻¹ 400 V Class: 200.0 mV/min ⁻¹ (0.0 - 6500.0 mV/min ⁻¹)

Set this parameter when you use an SPM motor (SMRD-Series).

PM motor Auto-Tuning automatically sets this parameter to the value of [Back-EMF Voltage Constant (Ke)].

When *E5-01* = FFFF, only set *E5-09* [PM Back-EMF Vpeak (mV/(rad/s))] or *E5-24* as the induced voltage constant.

Note:

When you set this parameter, also set *E5-09* = 0.0. The drive will detect *oPE08* [Parameter Selection Error] in these conditions:

- *E5-09* = 0.0 and *E5-24* = 0.0
- *E5-09* ≠ 0.0 and *E5-24* ≠ 0.0

■ E5-25: Polarity Estimation Timeout

No. (Hex.)	Name	Description	Default (Range)
E5-25 (035E) Expert	Polarity Estimation Timeout	<div style="display: flex; justify-content: space-between; border-bottom: 1px solid black; margin-bottom: 5px;"> V/f OLV OLV/PM AOLV/PM EZOLV </div> Sets the function that switches polarity for initial polarity estimation. Usually it is not necessary to change this setting.	0 (0, 1)

When “Sd = 1” is shown on the motor nameplate or test report for Yaskawa motors, set this parameter to 1.

0 : Disabled

1 : Enabled

◆ E9: Motor Setting

E9 parameters are used to configure induction motors, PM motors, and SynRM motors. Configure these parameters only for derating torque applications in which a high level of responsiveness and accurate speed control are not required.

E9 parameters are automatically configured with values input by the Auto-Tuning process for motor parameter settings. *E9 parameters* can be manually configured when the EZ Tuning process cannot be performed.

■ E9-01: Motor Type Selection

No. (Hex.)	Name	Description	Default (Range)
E9-01 (11E4)	Motor Type Selection	<div style="display: flex; justify-content: space-between; border-bottom: 1px solid black; margin-bottom: 5px;"> V/f OLV OLV/PM AOLV/PM EZOLV </div> Sets the type of motor.	0 (0 - 2)

EZ Tuning automatically sets this parameter to the value of [Motor Type Selection].

0 : Induction (IM)

1 : Permanent Magnet (PM)

2 : Synchronous Reluctance (SynRM)

■ E9-02: Maximum Speed

No. (Hex.)	Name	Description	Default (Range)
E9-02 (11E5)	Maximum Speed	<div style="display: flex; justify-content: space-between; border-bottom: 1px solid black; margin-bottom: 5px;"> V/f OLV OLV/PM AOLV/PM EZOLV </div> Sets the maximum speed of the motor.	Determined by E9-01 (40.0 - 120.0 Hz)

Note:

The unit of measure changes when the setting of *o1-04* [V/f Pattern Display Unit].

EZ Tuning automatically sets this parameter to the value of [Motor Max Revolutions].

■ E9-03: Rated Speed

No. (Hex.)	Name	Description	Default (Range)
E9-03 (11E6)	Rated Speed	<div style="display: flex; justify-content: space-between; align-items: center;"> V/f OLV OLV/PM AOLV/PM EZOLV </div> Sets the rated rotation speed of the motor.	Determined by E9-01 (100 - 7200 min ⁻¹)

EZ Tuning automatically sets this parameter to the value of [Rated Speed].

Note:

Set $E9-01 = 0$ [Motor Type Selection = Induction (IM)] before you set this parameter.

■ E9-04: Base Frequency

No. (Hex.)	Name	Description	Default (Range)
E9-04 (11E7)	Base Frequency	<div style="display: flex; justify-content: space-between; align-items: center;"> V/f OLV OLV/PM AOLV/PM EZOLV </div> Sets the rated frequency of the motor.	Determined by E9-01 (40.0 - 120.0 Hz)

Note:

The unit of measure changes when the setting of $o1-04$ [V/f Pattern Display Unit].

EZ Tuning automatically sets this parameter to the value of [Base Frequency].

■ E9-05: Base Voltage

No. (Hex.)	Name	Description	Default (Range)
E9-05 (11E8)	Motor Rated Voltage	<div style="display: flex; justify-content: space-between; align-items: center;"> V/f OLV OLV/PM AOLV/PM EZOLV </div> Sets the rated voltage of the motor.	200 V Class: 230.0 V, 400 V Class: 460.0 V (200 V Class: 0.0 - 255.0 V, 400 V Class: 0.0 - 510.0 V)

EZ Tuning automatically sets this parameter to the value of [Base Voltage].

■ E9-06: Motor Rated Current (FLA)

No. (Hex.)	Name	Description	Default (Range)
E9-06 (11E9)	Motor Rated Current (FLA)	<div style="display: flex; justify-content: space-between; align-items: center;"> V/f OLV OLV/PM AOLV/PM EZOLV </div> Sets the motor rated current in amps.	Determined by E9-01 and $o2-04$ (10% to 200% of the drive rated current)

Note:

When the drive model changes, the display units for this parameter also change.

- 0.01 A: B001 to B018, 2001 to 2042, 4001 to 4023
- 0.1 A: 2056 to 2082, 4031 to 4060

The setting value of $E9-06$ is the reference value for motor protection. Enter the motor rated current written on the motor nameplate. Auto-Tuning the drive will automatically set $E9-06$ to the value input for $T4-07$ [Motor Rated Current].

■ E9-07: Motor Rated Power

No. (Hex.)	Name	Description	Default (Range)
E9-07 (11EA)	Motor Rated Power	<div style="display: flex; justify-content: space-between; align-items: center;"> V/f OLV OLV/PM AOLV/PM EZOLV </div> Sets the motor rated output in the units from $o1-58$ [Motor Power Unit Selection].	Determined by E9-02 and $o2-04$ (0.00 - 650.00 kW)

Auto-Tuning automatically sets this parameter to the value of [Motor Rated Power (kW)].

■ E9-08: Motor Pole Count

No. (Hex.)	Name	Description	Default (Range)
E9-08 (11EB)	Motor Pole Count	V/f OLV OLV/PM AOLV/PM EZOLV Sets the number of motor poles.	4 (2 to 120)

Auto-Tuning automatically sets this parameter to the value of [Number of Motor Poles].

■ E9-09: Motor Rated Slip

No. (Hex.)	Name	Description	Default (Range)
E9-09 (11EC)	Motor Rated Slip	V/f OLV OLV/PM AOLV/PM EZOLV Sets the motor rated slip.	0.000 Hz (0.000 - 20.000 Hz)

The setting value of this parameter is the slip compensation reference value.

The drive uses the setting values of *E9-03*, *E9-04*, and *E9-08* to calculate this parameter. When Motor Rated Slip = 0, Auto-Tuning automatically sets this parameter to the value of [Motor Rated Slip].

Note:

Set *E9-01* = 0 [Motor Type Selection = Induction (IM)] before you set this parameter.

■ E9-10: Motor Line-to-Line Resistance

No. (Hex.)	Name	Description	Default (Range)
E9-10 (11ED)	Motor Line-to-Line Resistance	V/f OLV OLV/PM AOLV/PM EZOLV Sets the line-to-line resistance for the motor stator windings.	Determined by o2-04 (0.000 - 65.000 Ω)

Note:

This value is the motor line-to-line resistance. Do not set this parameter with the resistance per phase.

Stationary Auto-Tuning automatically sets this parameter. If you cannot do Stationary Auto-Tuning, use the test report from the motor manufacturer. Use one of these formulas to calculate the motor line-to-line resistance:

- E-type insulation: [the resistance value (Ω) shown on the test report at 75 °C] × 0.822
- B-type insulation: [the resistance value (Ω) shown on the test report at 75 °C] × 0.822
- F-type insulation: [the resistance value (Ω) shown on the test report at 115 °C] × 0.728

12.7 F: Options

F parameters are used to set option cards, which function as interfaces for encoders, analog I/O, digital I/O, and fieldbus communication.

◆ F1: Fault Detection in PG Speed Control

F1 parameters set the fault detection function in Speed Feedback (V/F Control). When $A1-02 = 0$ [Control Method Selection = V/f], set $H6-01 = 3$ [Terminal RP Pulse Train Function = Speed Feedback (V/F Control)] to enable this function. For speed feedback, connect the single-channel pulse signal from the PG encoder to pulse train input terminal RP. Use the Slip Compensation signal to improve the accuracy of Speed Control. This function is available for Motor 1.

WARNING! Sudden Movement Hazard. Do test runs and examine the drive to make sure that the command references are correct. If you set the command reference incorrectly, it can cause damage to the drive or serious injury or death.

WARNING! Sudden Movement Hazard. Make sure that the host controller circuitry has correct safety design that will let you keep control of the motor if the drive loses speed feedback. If you do not have control of the motor, it can cause serious injury or death.

■ F1-02: Encoder Signal Loss Detect Sel

No. (Hex.)	Name	Description	Default (Range)
F1-02 (0381)	Encoder Signal Loss Detect Sel	<div style="display: flex; gap: 5px;"> V/f OLV OLV/PM AOLV/PM EZOLV </div> Sets the method to stop the motor or let the motor continue operating when the drive detects <i>PGo</i> [Encoder (PG) Feedback Loss].	1 (0 - 4)

If the drive does not detect output pulses from the encoder for the time set in $F1-14$ [Encoder Open-Circuit Detect Time], it will trigger *PGo*.

Note:

- When $A1-02 = 0$ [Control Method Selection = V/f], set $H6-01 = 3$ [Terminal RP Pulse Train Function = Speed Feedback (V/F Control)] to enable this parameter.
- Motor speed and load conditions can cause *ov* [Overvoltage] and *oC* [Overcurrent] faults.

0 : Ramp to Stop

The drive ramps the motor to stop in the deceleration time. The output terminal set for *Fault* [$H2-01$ to $H2-03 = E$] activates.

1 : Coast to Stop

The output turns off and the motor coasts to stop. The output terminal set for *Fault* [$H2-01$ to $H2-03 = E$] activates.

2 : Fast Stop (Use C1-09)

The drive stops the motor in the deceleration time set in $C1-09$ [Fast Stop Time]. The output terminal set for *Fault* [$H2-01$ to $H2-03 = E$] activates.

3 : Alarm Only

The keypad shows *PGo* and the drive continues operation. Only use this setting in special conditions to prevent damage to the motor and machinery. The output terminal set to *Alarm* [$H2-01$ to $H2-03 = 10$] activates.

4 : No Alarm Display

The drive continues operation and does not show *PGo* on the keypad. Only use this setting in special conditions to prevent damage to the motor and machinery.

■ F1-03: Overspeed Detection Selection

No. (Hex.)	Name	Description	Default (Range)
F1-03 (0382)	Overspeed Detection Selection	<div style="display: flex; gap: 5px;"> V/f OLV OLV/PM AOLV/PM EZOLV </div> Sets the method to stop the motor or let the motor continue to operate when the drive detects <i>oS</i> [Overspeed].	1 (0 - 3)

When the motor speed is more than the value set in $F1-08$ [Overspeed Detection Level] for longer than the time set in $F1-09$ [Overspeed Detection Delay Time] it will trigger *oS*.

0 : Ramp to Stop

The drive ramps the motor to stop in the deceleration time. The output terminal set for *Fault [H2-01 to H2-03 = E]* activates.

1 : Coast to Stop

The output turns off and the motor coasts to stop. The output terminal set for *Fault [H2-01 to H2-03 = E]* activates.

2 : Fast Stop (Use C1-09)

The drive stops the motor in the deceleration time set in *C1-09 [Fast Stop Time]*. The output terminal set for *Fault [H2-01 to H2-03 = E]* activates.

3 : Alarm Only

The keypad shows *oS* and the drive continues operation. Only use this setting in special conditions to prevent damage to the motor and machinery. The output terminal set to *Alarm [H2-01 to H2-03 = 10]* activates.

Note:

- When *A1-02 = 0 [Control Method Selection = V/f]*, set *H6-01 = 3 [Terminal RP Pulse Train Function = Speed Feedback (V/F Control)]* to enable this parameter.
- When *A1-02 = 6 [Control Method Selection = AOLV/PM]*, the drive will automatically set *F1-03 = 1 [Coast to Stop]*. You cannot change this value.

■ F1-04: Speed Deviation Detection Select

No. (Hex.)	Name	Description	Default (Range)
F1-04 (0383)	Speed Deviation Detection Select	<div style="display: flex; gap: 5px;"> V/f OLV OLV/PM AOLV/PM EZOLV </div> <p>Sets the method to stop the motor or let the motor continue to operate when the drive detects <i>dEv</i> [Speed Deviation].</p>	3 (0 - 3)

When the difference between the frequency reference and the motor speed is more than the value set in *F1-10 [Speed Deviation Detection Level]* for longer than the time set in *F1-11 [Speed Deviation Detect DelayTime]*, it will trigger *dEv*.

Note:

When *A1-02 = 0 [Control Method Selection = V/f]*, set *H6-01 = 3 [Terminal RP Pulse Train Function = Speed Feedback (V/F Control)]* to enable this parameter.

0 : Ramp to Stop

The drive ramps the motor to stop in the deceleration time. The output terminal set for *Fault [H2-01 to H2-03 = E]* activates.

1 : Coast to Stop

The output turns off and the motor coasts to stop. The output terminal set for *Fault [H2-01 to H2-03 = E]* activates.

2 : Fast Stop (Use C1-09)

The drive stops the motor in the deceleration time set in *C1-09 [Fast Stop Time]*. The output terminal set for *Fault [H2-01 to H2-03 = E]* activates.

3 : Alarm Only

The keypad shows *dEv* and the drive continues operation. Only use this setting in special conditions to prevent damage to the motor and machinery. The output terminal set to *Alarm [H2-01 to H2-03 = 10]* activates.

■ F1-08: Overspeed Detection Level

No. (Hex.)	Name	Description	Default (Range)
F1-08 (0387)	Overspeed Detection Level	<div style="display: flex; gap: 5px;"> V/f OLV OLV/PM AOLV/PM EZOLV </div> <p>Sets the detection level of <i>oS</i> [Overspeed] as a percentage when the maximum output frequency is 100%.</p>	115% (0 - 120%)

When the motor speed is more than the value set in *F1-08* for longer than the time set in *F1-09 [Overspeed Detection Delay Time]*, the drive will detect *oS*.

Note:

When *A1-02 = 0 [Control Method Selection = V/f]*, set *H6-01 = 3 [Terminal RP Pulse Train Function = Speed Feedback (V/F Control)]* to enable this parameter.

■ F1-09: Overspeed Detection Delay Time

No. (Hex.)	Name	Description	Default (Range)
F1-09 (0388)	Overspeed Detection Delay Time	<input checked="" type="checkbox"/> V/f <input type="checkbox"/> OLV <input type="checkbox"/> OLV/PM <input type="checkbox"/> AOLV/PM <input type="checkbox"/> EZOLV Sets the length of time that the speed feedback must be more than the <i>F1-08</i> level to cause <i>oS</i> [Overspeed].	Determined by A1-02 (0.0 - 2.0 s)

When the motor speed is more than the value set in *F1-08* [Overspeed Detection Level] for longer than the time set in *F1-09*, the drive will detect *oS*.

Note:

When *A1-02* = 0 [Control Method Selection = V/f], set *H6-01* = 3 [Terminal RP Pulse Train Function = Speed Feedback (V/F Control)] to enable this parameter.

■ F1-10: Speed Deviation Detection Level

No. (Hex.)	Name	Description	Default (Range)
F1-10 (0389)	Speed Deviation Detection Level	<input checked="" type="checkbox"/> V/f <input type="checkbox"/> OLV <input type="checkbox"/> OLV/PM <input type="checkbox"/> AOLV/PM <input type="checkbox"/> EZOLV Sets the detection level of <i>dEv</i> [Speed Deviation] as a percentage when the maximum output frequency is 100%.	10% (0 - 50%)

When the speed deviation between the frequency reference and the actual motor speed is more than the value set in *F1-10* for longer than the time set in *F1-11* [Speed Deviation Detect DelayTime], the drive will detect *dEv*.

Note:

When *A1-02* = 0 [Control Method Selection = V/f], set *H6-01* = 3 [Terminal RP Pulse Train Function = Speed Feedback (V/F Control)] to enable this parameter.

■ F1-11: Speed Deviation Detect DelayTime

No. (Hex.)	Name	Description	Default (Range)
F1-11 (038A)	Speed Deviation Detect DelayTime	<input checked="" type="checkbox"/> V/f <input type="checkbox"/> OLV <input type="checkbox"/> OLV/PM <input type="checkbox"/> AOLV/PM <input type="checkbox"/> EZOLV Sets the length of time that the difference between the frequency reference and speed feedback must be more than the level in <i>F1-10</i> to cause <i>dEv</i> [Speed Deviation].	0.5 s (0.0 - 10.0 s)

When the speed deviation between the frequency reference and the actual motor speed is more than the value set in *F1-10* [Speed Deviation Detection Level] for longer than the time set in *F1-11*, the drive will detect *dEv*.

Note:

When *A1-02* = 0 [Control Method Selection = V/f], set *H6-01* = 3 [Terminal RP Pulse Train Function = Speed Feedback (V/F Control)] to enable this parameter.

■ F1-14: Encoder Open-Circuit Detect Time

No. (Hex.)	Name	Description	Default (Range)
F1-14 (038D)	Encoder Open-Circuit Detect Time	<input checked="" type="checkbox"/> V/f <input type="checkbox"/> OLV <input type="checkbox"/> OLV/PM <input type="checkbox"/> AOLV/PM <input type="checkbox"/> EZOLV Sets the length of time that the drive must not receive a pulse signal to cause <i>PGo</i> [Encoder (PG) Feedback Loss].	2.0 s (0.0 - 10.0 s)

If the drive does not detect output pulses from the encoder for the time set in *F1-14*, it will trigger *PGo*.

Note:

- When *A1-02* = 0 [Control Method Selection = V/f], set *H6-01* = 3 [Terminal RP Pulse Train Function = Speed Feedback (V/F Control)] to enable this parameter.
- Motor speed and load conditions can cause *ov* [Overvoltage] and *oC* [Overcurrent] faults.

◆ F6, F7: Communication Options

F6 and *F7* parameters are used to set the basic communication settings and method of fault detection for the communication option card. The communication option card parameters include common option card parameters and communication protocol-specific parameters.

The following table lists the parameters that need to be set for each communication option card.

Refer to the technical manual for each communication option card for more information on installing, wiring, and configuring the details needed before starting communication.

WARNING! Sudden Movement Hazard. Do test runs and examine the drive to make sure that the command references are correct. If you set the command reference incorrectly, it can cause damage to the drive or serious injury or death.

Table 12.38 Correspondence Between Communication Protocols and Parameters (SI-C3, SI-T3, SI-ET3, SI-P3, SI-S3, and SI-ES3)

Parameter	CC-Link SI-C3	MECHATROLINK-II SI-T3	MECHATROLINK-III SI-ET3	PROFIBUS-DP SI-P3	CANopen SI-S3	EtherCAT SI-ES3
F6-01 to F6-03	x	x	x	x	x	x
F6-04	x	-	-	-	-	-
F6-06 to F6-08	x	x	x	x	x	x
F6-10, F6-11	x	-	-	-	-	-
F6-14	x	x	x	x	x	x
F6-16	x	x	x	x	x	x
F6-20, F6-21	-	x	x	-	-	-
F6-22	-	x	-	-	-	-
F6-23 to F6-26	-	x	x	-	-	-
F6-30 to F6-32	-	-	-	x	-	-
F6-35, F6-36	-	-	-	-	x	-
F6-50 to F6-71	-	-	-	-	-	-
F7-01 to F7-15	-	-	-	-	-	-
F7-16	-	-	-	-	-	-
F7-17 to F7-42	-	-	-	-	-	-
F7-60 to F7-79	-	-	-	x	-	-

Table 12.39 Relation Between Communication Protocols and Parameters (SI-B3, SI-N3, SI-W3, SI-EM3, SI-EP3, and SI-EN3)

Parameter	DeviceNet SI-N3	LonWorks SI-W3	Modbus TCP/IP SI-EM3	PROFINET SI-EP3	EtherNet/IP SI-EN3
F6-01 to F6-03	x	x	x	x	x
F6-04	-	-	-	-	-
F6-06 to F6-08	x	x	x	x	x
F6-10, F6-11	-	-	-	-	-
F6-14	x	x	x	x	x
F6-16	x	x	x	x	x
F6-20, F6-21	-	-	-	-	-
F6-22	-	-	-	-	-
F6-23 to F6-26	-	-	-	-	-
F6-30 to F6-32	-	-	-	-	-
F6-35, F6-36	-	-	-	-	-
F6-50 to F6-71	x	-	-	-	-
F7-01 to F7-15	-	-	x	x	x
F7-16	-	-	x	-	-
F7-17 to F7-42	-	-	-	x	x
F7-60 to F7-79	-	-	-	-	-

■ Gateway Mode

Note:

When you use Gateway Mode, do not install the communication option in slave drives. If you install a communication option in a slave drive, the drive commands and responses will not synchronize.

In gateway mode, you can use one communication option to communicate with more than one drive.

You can use one communication option to connect a maximum of five drives to the field bus communications. Refer to [Figure 12.55](#) for more information.

When you install a communication option on the master drive, you can use the RS-485 communication terminals to transmit data to slave drives that do not have a communication option.

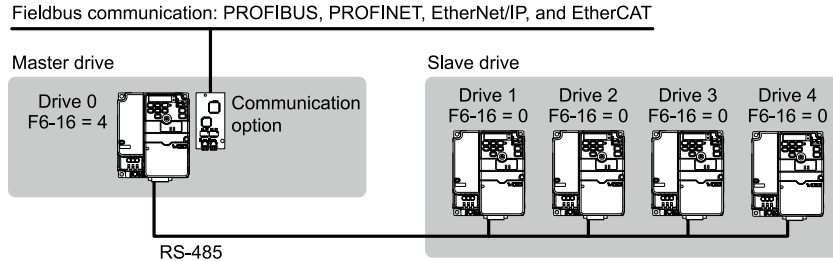

Figure 12.55 Connection Examples in Gateway Mode

Table 12.40 Specification

Item	Specification
Applicable options	All options that support the MEMOBUS access function (for example, PROFIBUS-DP, PROFINET, EtherNet/IP, EtherCAT)
Compatible Products	Drives that can set F6-16 [Gateway Mode] *1
Number of connected drives	Maximum: 5 units
Communication specifications	MEMOBUS/Modbus (RTUmode) communications
Commands/responses	The controller can send this data to each drive (Drive 0 to Drive 4): <ul style="list-style-type: none"> • Control commands: Run commands and frequency references • Control responses: Output frequency and drive status (during run, faults) • Read and write parameters • Read monitors
Synchronous control	Not supported

*1 Gateway Mode is not available with Yaskawa 1000-series drives or previous series drives.

Note:

- The communication speed in gateway mode is slower than the speed in fieldbus communications. Make sure that the speed is acceptable for your system.
- Response speed with the communication option is slower than with point-to-point communications.
- Set H5-03 [Communication Parity Selection] to the same value on the master drive and slave drives.

WARNING! Injury to Personnel. Separately prepare safety protection equipment and systems, for example fast stop switches. If the motor does not stop correctly from the disconnection of communications cable or electrical interference, it can cause serious injury.

Setting Gateway Mode

Table 12.41 shows sample settings to connect 4 slave drives:

Table 12.41 Sample Settings for Using Gateway Mode

	F6-16 [Gateway Mode]	H5-01 [Drive Node Address] *1	H5-02 [Communication Speed Selection] H5-03 [Communication Parity Selection]	H5-06 [Drive Transmit Wait Time]	H5-09 [CE Detection Time]	b1-01 [Frequency Reference Selection 1]	b1-02 [Run Command Selection 1]
Drive 0 (Master Drive)	1 - 4 *2	1F (Default)	*5	5 ms (Default) *6	≥ 2.0 s *7	3 [Option PCB]	3 [Option PCB]
Drive 1 (Slave Drive)	0	01 *3 *4	*5	5 ms (Default) *6	≥ 0.9 s *7	2 [Memobus/Modbus Communications] *8	2 [Memobus/Modbus Communications] *8

	F6-16 [Gateway Mode]	H5-01 [Drive Node Address] *1	H5-02 [Communication Speed Selection] H5-03 [Communication Parity Selection]	H5-06 [Drive Transmit Wait Time]	H5-09 [CE Detection Time]	b1-01 [Frequency Reference Selection 1]	b1-02 [Run Command Selection 1]
Drive 2 (Slave Drive)	0	02 *3 *4	*5	5 ms (Default) *6	≥ 0.9 s *7	2 [Memobus/Modbus Communications] *8	2 [Memobus/Modbus Communications] *8
Drive 3 (Slave Drive)	0	03 *3 *4	*5	5 ms (Default) *6	≥ 0.9 s *7	2 [Memobus/Modbus Communications] *8	2 [Memobus/Modbus Communications] *8
Drive 4 (Slave Drive)	0	04 *3 *4	*5	5 ms (Default) *6	≥ 0.9 s *7	2 [Memobus/Modbus Communications] *8	2 [Memobus/Modbus Communications] *8

- *1 Re-energize the drive to apply the new settings.
- *2 Specify the number of slave drives you will connect.
- *3 Setting 0 will not let the drive respond to MEMOBUS/Modbus communications.
- *4 Set a slave address that is different from other slave devices.
- *5 Enter the same value that you use for the master drive.
- *6 To correctly detect the response timeout, do not change the value of H5-06 from the default value.
- *7 Set H5-09 ≥ 0.9. When H5-09 < 0.9, the drive will detect CE [Modbus Communication Error] before it detects a response timeout.
- *8 On each slave drive, set b1-01 [Frequency Reference Selection 1] and b1-02 [Run Command Selection 1] to 2 [Memobus/Modbus Communications].

An Overview of Gateway Mode

When in gateway mode, the drive will operate as shown in Table 12.42.

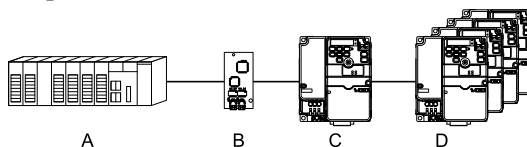

A - Controller

B - Communication option

C - Master Drive (Drive 0)

D - Slave Drives (Drives 1 to 4)

Table 12.42 Operation in Gateway Mode

Controller to Communication Option	Communication Option to Master Drive (Drive 0)	Master Drive (Drive 0) to Slave Drives (Drives 1 to 4)
<ul style="list-style-type: none"> • The controller and card communicate in the format of each field bus communications protocol. • Drive 0 sends commands and monitors through normal field bus communications. • The special registers of Drive 0 use read and write to send commands to and monitor Drives 1 to 4. 	Field bus communication data is written to and read from the special registers of Drive 0.	<ul style="list-style-type: none"> • Uses MEMOBUS communications. • Drive 0 sends data from its special registers to Drives 1 to 4.

Note:

Energize the slave drive before you energize the master drive. If you energize the master drive first, the drive detects CE [Modbus Communication Error].

Operations at the Time of Communication Error

Communication Error	Error Codes	Operation
From controller to communication option	bUS	<ul style="list-style-type: none"> Master drive Detects <i>bUS</i> [Option Communication Error] and operates as specified by <i>F6-01</i> [Communication Error Selection]. Slave drive Detects <i>CE</i> [Modbus Communication Error] and operates as specified by <i>H5-04</i> [Communication Error Stop Method]. <p>Note:</p> <ul style="list-style-type: none"> After error detection, each drive can continue the operation specified by the last received command if the <i>F6-01</i> and <i>H5-04</i> settings agree. Because the controller cannot stop the operation, you must supply a stopping method, for example an emergency stop switch. If you set <i>H5-05</i> = 0 [Comm Fault Detection Selection = Disabled], the drive will not detect <i>CE</i>. The <i>H5-04</i> setting does not have an effect.
From communication option to master drive	oFAxx	<ul style="list-style-type: none"> Master drive Detects <i>oFAxx</i> and coasts to stop. Slave drive Detects <i>hLCE</i> [High Level Communication Errors] and coasts to stop.
From master drive to slave drive	CE	<p>The master drive stops communicating with the slave drive in these conditions: Reset the fault to restart communication.</p> <p>The slave drive detects <i>CE</i> after <i>H5-09</i> [CE Detection Time] is expired. Then it operates in as specified with <i>H5-04</i> [Communication Error Stop Method].</p> <ul style="list-style-type: none"> A message error occurred in the send data from the slave drive 10 consecutive times. Response from the slave drive timed out 10 consecutive times.

Gateway Special Register Specification

Table 12.43 Command Data

Register No. (Hex.)	Description	
15C5	Command source update	
	This flag enables command updates.	
	bit 0	Drive 1 Update Command Enabled
	bit 1	Drive 2 Update Command Enabled
	bit 2	Drive 3 Update Command Enabled
	bit 3	Drive 4 Update Command Enabled
	bit 4	Update Register Access Command Enabled
bit 5 - F	Reserved	
15C6	Run Command (Drive 1)	
	bit 0	H5-12 = 0: FWD/Stop 0 = Stop 1 = Forward run
		H5-12 = 1: Run/Stop 0 = Stop 1 = Run
	bit 1	H5-12 = 0: REV/Stop 0 = Stop 1 = Reverse run
		H5-12 = 1: FWD/REV 0 = Forward run 1 = Reverse run
	bit 2	External fault
	bit 3	Fault Reset
	bit 4	ComRef
	bit 5	ComCtrl
bit 6 - F	Reserved	
15C7	Frequency Reference (Drive 1)	The unit of measure changes when <i>oI-03</i> changes.
15C8	Run Command (Drive 2)	Refer to "15C6: Run Command (Drive 1)" for more information.
15C9	Frequency Reference (Drive 2)	The unit of measure changes when <i>oI-03</i> changes.
15CA	Run Command (Drive 3)	Refer to "15C6: Run Command (Drive 1)" for more information.

Register No. (Hex.)	Description	
15CB	Frequency Reference (Drive 3)	
15CC	Run Command (Drive 4)	
15CD	Frequency Reference (Drive 4)	
15CE	Slave Address for Reg. Access + Read/Write	
	bit 0	Slave address 0: Broadcast Messages (MEMOBUS)
	bit 1	1: Drive 1
	bit 2	2: Drive 2
	bit 3	3: Drive 3 4: Drive 4 5: Broadcast Messages (run command and frequency reference)
bit 4	0: Read, 1: Write	
bit 5 - F	Reserved	
15CF	Register number	
15D0	Data (write register)	

Table 12.44 Monitor Data

Register No. (Hex.)	Description		
15E7	Drive Status (Drive 1)		
	bit 0	During Run	
	bit 1	During Reverse Run	
	bit 2	Drive ready	
	bit 3	Fault	
	bit 4	Frequency Reference Setting Fault	1: Upper/Lower Limit Fault
	bit 5	No response from slave	1: Response has timed out.
	bit 6	Communication Error	1: The drive detected a fault from a slave.
	bit 7	No response from slave 10 consecutive attempts.	1: Timeout occurred 10 consecutive times.
	bit 8	Communication fault occurred 10 consecutive times.	1: Fault has occurred from a slave 10 consecutive times.
	bit 9	Receive broadcast command while drive is running	1: Drive operates as specified by the broadcast message command.
	bit A	Communication error with master drive	1: The slave cannot communicate with the master because of a communication error.
	bit B - D	Reserved	
	bit E	ComRef status	
bit F	ComCtrl status		
15E8	Output frequency or frequency reference (Drive Status Bit 1: ON) (Drive 1) Drive Status Bit 4 = 0 [Output Frequency] Drive Status Bit 4 = 1 [Frequency Reference]	The unit of measure changes when <i>o1-03</i> changes. Outputs when: <ul style="list-style-type: none"> Normal operation: Output frequency Drive detects Frequency Reference Setting Fault: Frequency reference when the error occurs Clears the value when the drive detects a communication error or communication stops.	
15E9	Drive Status (Drive 2)		
15EA	Output frequency or frequency reference (Drive Status Bit 4: ON) (Drive 2)	The unit of measure changes when <i>o1-03</i> changes. Outputs when: <ul style="list-style-type: none"> Normal operation: Output frequency Drive detects Frequency Reference Setting Fault: Frequency reference when the error occurs Clears the value when the drive detects a communication error or communication stops.	
15EB	Drive Status (Drive 3)		
	Refer to "15E7: Drive Status (Drive 1)" for more information.		

Register No. (Hex.)	Description	
15EC	Output frequency or frequency reference (Drive Status Bit 4: ON) (Drive 3)	The unit of measure changes when <i>o1-03</i> changes. Outputs when: <ul style="list-style-type: none"> • Normal operation: Output frequency • Drive detects Frequency Reference Setting Fault: Frequency reference when the error occurs Clears the value when the drive detects a communication error or communication stops.
15ED	Drive Status (Drive 4)	Refer to "15E7: Drive Status (Drive 1)" for more information.
15EE	Output frequency or frequency reference (Drive Status Bit 4: ON) (Drive 4)	The unit of measure changes when <i>o1-03</i> changes. Outputs when: <ul style="list-style-type: none"> • Normal operation: Output frequency • Drive detects Frequency Reference Setting Fault: Frequency reference when the error occurs Clears the value when the drive detects a communication error or communication stops.
15EF	Slave Address for Reg. Access + During MEMOBUS process & ErrCode	
	bit 0 bit 1 bit 2 bit 3 bit 4 bit 5 bit 6 bit 7	00H: MEMOBUS/Modbus Communication Complete 02H: Register number not registered 21H: Upper/Lower Limit Fault 22H: Write Mode Error 23H: Write performed during <i>U_v</i> 24H: Write performed while writing parameter settings FFH: During MEMOBUS/Modbus Communication
	bit 8 bit 9 bit A	Slave address 0: Broadcast Messages (MEMOBUS) 1: Drive 1 2: Drive 2 3: Drive 3 4: Drive 4 5: Broadcast Messages (run command and frequency reference)
	bit B - F	Reserved
15F0	Register number	
15F1	Data (write register)	

■ **F6-01: Communication Error Selection**

No. (Hex.)	Name	Description	Default (Range)
F6-01 (03A2)	Communication Error Selection	<div style="display: flex; gap: 5px;"> V/f OLV OLV/PM AOLV/PM EZOLV </div> Sets the method to stop the motor or let the motor continue operating when the drive detects <i>bUS</i> [Option Communication Error].	1 (0 - 5)

0 : Ramp to Stop

The drive ramps the motor to stop in the deceleration time. The output terminal set for *Fault* [H2-01 to H2-03 = E] activates.

1 : Coast to Stop

The output turns off and the motor coasts to stop. The output terminal set for *Fault* [H2-01 to H2-03 = E] activates.

2 : Fast Stop (Use C1-09)

The drive stops the motor in the deceleration time set in *C1-09* [Fast Stop Time]. The output terminal set for *Fault* [H2-01 to H2-03 = E] activates.

3 : Alarm Only

The keypad shows *bUS* and the drive continues operation at the current frequency reference.

Note:

Separately prepare safety protection equipment and systems, for example fast stop switches.

The output terminal set to *Alarm* [H2-01 to H2-03 = 10] activates.

4 : Alarm (Run at d1-04)

The keypad shows *bUS* and the drive continues operation at the speed set in *d1-04* [Reference 4].

Note:

Separately prepare safety protection equipment and systems, for example fast stop switches.

5 : Alarm - Ramp Stop

The drive stops the motor during the deceleration time set in *C1-02* [Deceleration Time 1].

After you remove the *bUS* alarm, the motor will accelerate to the previous frequency reference.

■ F6-02: Comm External Fault (EF0) Detect

No. (Hex.)	Name	Description	Default (Range)
F6-02 (03A3)	Comm External Fault (EF0) Detect	<input type="checkbox"/> V/f <input type="checkbox"/> OLV <input type="checkbox"/> OLV/PM <input type="checkbox"/> AOLV/PM <input type="checkbox"/> EZOLV Sets the conditions at which <i>EF0</i> [Option Card External Fault] is detected.	0 (0, 1)

0 : Always Detected

1 : Detected during RUN Only

■ F6-03: Comm External Fault (EF0) Select

No. (Hex.)	Name	Description	Default (Range)
F6-03 (03A4)	Comm External Fault (EF0) Select	<input type="checkbox"/> V/f <input type="checkbox"/> OLV <input type="checkbox"/> OLV/PM <input type="checkbox"/> AOLV/PM <input type="checkbox"/> EZOLV Sets the method to stop the motor or let the motor continue operating when the drive detects <i>EF0</i> [Option Card External Fault].	1 (0 - 3)

0 : Ramp to Stop

The drive ramps the motor to stop in the deceleration time. The output terminal set for *Fault* [H2-01 to H2-03 = E] activates.

1 : Coast to Stop

The output turns off and the motor coasts to stop. The output terminal set for *Fault* [H2-01 to H2-03 = E] activates.

2 : Fast Stop (Use C1-09)

The drive stops the motor in the deceleration time set in *C1-09* [Fast Stop Time]. The output terminal set for *Fault* [H2-01 to H2-03 = E] activates.

3 : Alarm Only

The keypad shows *EF0* and the drive continues operation.

Note:

Separately prepare safety protection equipment and systems, for example fast stop switches.

The output terminal set to *Alarm* [H2-01 to H2-03 = 10] activates.

■ F6-04: bUS Error Detection Time

No. (Hex.)	Name	Description	Default (Range)
F6-04 (03A5)	bUS Error Detection Time	<input type="checkbox"/> V/f <input type="checkbox"/> OLV <input type="checkbox"/> OLV/PM <input type="checkbox"/> AOLV/PM <input type="checkbox"/> EZOLV Sets the delay time for the drive to detect <i>bUS</i> [Option Communication Error].	2.0 s (0.0 - 12.0 s)

Note:

When you install a CC-Link option (SI-C3) to the drive, the setting value changes to 0.0 s.

■ F6-06: Torque Reference/Limit by Comm

No. (Hex.)	Name	Description	Default (Range)
F6-06 (03A7)	Torque Reference/Limit by Comm	<input type="checkbox"/> V/f <input type="checkbox"/> OLV <input type="checkbox"/> OLV/PM <input type="checkbox"/> AOLV/PM <input type="checkbox"/> EZOLV Sets the function that enables and disables the torque reference and torque limit received from the communication option.	0 (0, 1)

0 : Disabled

1 : Enabled

■ F6-07: Multi-Step Ref @ NetRef/ComRef

No. (Hex.)	Name	Description	Default (Range)
F6-07 (03A8)	Multi-Step Ref @ NetRef/ComRef	<div style="display: flex; gap: 5px;"> V/f OLV OLV/PM AOLV/PM EZOLV </div> <p>Sets the function that enables and disables the multi-step speed reference when the frequency reference source is NetRef or ComRef (communication option card or MEMOBUS/Modbus communications).</p>	1 (0, 1)

0 : Disable Multi-Step References

When NetRef or ComRef are the frequency reference source, the multi-step speed reference (2-step speed to 16-step speed references) and the Jog Frequency Reference (JOG command) are disabled.

1 : Enable Multi-Step References

When NetRef or ComRef are the frequency reference source, the multi-step speed reference (2-step speed through 16-step speed references) and the Jog Frequency Reference (JOG command) are enabled, and you can change the frequency reference.

■ F6-08: Comm Parameter Reset @Initialize

No. (Hex.)	Name	Description	Default (Range)
F6-08 (036A)	Comm Parameter Reset @Initialize	<div style="display: flex; gap: 5px;"> V/f OLV OLV/PM AOLV/PM EZOLV </div> <p>Sets the function to initialize F6-xx and F7-xx parameters when the drive is initialized with A1-03 [Initialize Parameters].</p>	0 (0, 1)

0 : No Reset - Parameters Retained

1 : Reset Back to Factory Default

Note:

When you use A1-03 to initialize the drive, this setting will not change.

■ F6-10: CC-Link Node Address

No. (Hex.)	Name	Description	Default (Range)
F6-10 (03B6)	CC-Link Node Address	<div style="display: flex; gap: 5px;"> V/f OLV OLV/PM AOLV/PM EZOLV </div> <p>Sets the node address for CC-Link communication. Restart the drive after you change the parameter setting.</p>	0 (0 - 64)

Note:

Be sure to set a node address that is different than all other node addresses. Do not set this parameter to 0. Incorrect parameter settings will cause AEr [Station Address Setting Error] errors and the L.ERR LED on the option will come on.

When the only drive is connected, you can connect a maximum of 42 nodes. Follow these rules to connect devices that are not drives:

- $\{(1 \times a) + (2 \times b) + (3 \times c) + (4 \times d)\} \leq 64$
(a: number of units that occupies 1 node, b: number of units that occupies 2 nodes, c: number of units that occupies 3 nodes, d: number of units that occupies 4 nodes)
- $\{(16 \times A) + (54 \times B) + (88 \times C)\} \leq 2304$
(A: number of remote I/O nodes (64 max.), B: number of remote device nodes (42 max.), C: number of local nodes (26 max.))

■ F6-11: CC-Link Communication Speed

No. (Hex.)	Name	Description	Default (Range)
F6-11 (03B7)	CC-Link Communication Speed	<div style="display: flex; gap: 5px;"> V/f OLV OLV/PM AOLV/PM EZOLV </div> <p>Sets the communication speed for CC-Link communication. Restart the drive after you change the parameter setting.</p>	0 (0 - 4)

0 : 156 kbps

- 1 : 625 kbps
- 2 : 2.5 Mbps
- 3 : 5 Mbps
- 4 : 10 Mbps

■ F6-14: BUS Error Auto Reset

No. (Hex.)	Name	Description	Default (Range)
F6-14 (03BB)	BUS Error Auto Reset	V/f OLV OLV/PM AOLV/PM EZOLV Sets the automatic reset function for <i>bUS</i> [Option Communication Errors].	0 (0, 1)

- 0 : Disable
- 1 : Enabled

■ F6-15: Comm. Option Parameters Reload

No. (Hex.)	Name	Description	Default (Range)
F6-15 (0B5B)	Comm. Option Parameters Reload	V/f OLV OLV/PM AOLV/PM EZOLV Sets the update method when you change <i>F6-xx</i> , <i>F7-xx</i> [Communication Options].	0 (0 - 2)

Note:

- Set *F6-15* = 0, 1 to reload *F6-xx*, *F7-xx*.
- Set *F6-15* = 0, 1 to reset the display on the keypad to 0.

0 : Reload at Next Power Cycle

Restart the drive to update parameters.

1 : Reload Now

The changed parameters are updated without restarting the drive.

2 : Cancel Reload Request

Cancels *CyPo* [Cycle Power to Accept Changes].

■ F6-16: Gateway Mode

No. (Hex.)	Name	Description	Default (Range)
F6-16 (0B8A)	Gateway Mode	V/f OLV OLV/PM AOLV/PM EZOLV Sets the gateway mode operation and the number of connected slave drives.	0 (0 to 4)

0 : Disabled

- 1 : Enabled: 1 Slave Drives
- 2 : Enabled: 2 Slave Drives
- 3 : Enabled: 3 Slave Drives
- 4 : Enabled: 4 Slave Drives

■ F6-20: MECHATROLINK Station Address

No. (Hex.)	Name	Description	Default (Range)
F6-20 (036B)	MECHATROLINK Station Address	V/f OLV OLV/PM AOLV/PM EZOLV Sets the station address for MECHATROLINK communication. Change the parameter then cycle power on the drive.	0021h (MECHATROLINK-II: 0020h - 003Fh, MECHATROLINK-III: 0003h - 00EFh)

Note:

- The setting range changes if using MECHATROLINK-II or MECHATROLINK-III:
 - MECHATROLINK-II (SI-T3) range: 20 to 3F
 - MECHATROLINK-III (SI-ET3) range: 03 to EF
- Be sure to set a node address that is different than all other node addresses. Incorrect parameter settings will cause *AEr* [Station Address Setting Error] errors and the L.ERR LED on the option will come on.
- The drive detects *AEr* errors when the station address is 20 or 3F.

■ **F6-21: MECHATROLINK Frame Size**

No. (Hex.)	Name	Description	Default (Range)
F6-21 (036C)	MECHATROLINK Frame Size	<div style="display: flex; gap: 5px;"> V/f OLV OLV/PM AOLV/PM EZOLV </div> Sets the frame size for MECHATROLINK communication. Restart the drive after you change the parameter setting.	0 (0, 1)

0 : 32byte (M-2) / 64byte (M-3)

1 : 17byte (M-2) / 32byte (M-3)

■ **F6-22: MECHATROLINK Link Speed**

No. (Hex.)	Name	Description	Default (Range)
F6-22 (036D)	MECHATROLINK Link Speed	<div style="display: flex; gap: 5px;"> V/f OLV OLV/PM AOLV/PM EZOLV </div> Sets the communications speed for MECHATROLINK-II. Restart the drive after you change the parameter setting.	0 (0, 1)

Note:

This parameter is only available with the MECHATROLINK-II option.

0 : 10 Mbps

1 : 4 Mbps

■ **F6-23: MECHATROLINK Monitor Select (E)**

No. (Hex.)	Name	Description	Default (Range)
F6-23 (036E)	MECHATROLINK Monitor Select (E)	<div style="display: flex; gap: 5px;"> V/f OLV OLV/PM AOLV/PM EZOLV </div> Sets the MEMOBUS register used for the monitor functions of INV_CTL (drive operation control command) and INV_I/O (drive I/O control command). Restart the drive after you change the parameter setting.	0000h (0000h - FFFFh)

To enable the MEMOBUS register set in *F6-23*, set SEL_MON2/1 to 0EH or set SEL_MON3/4 and SEL_MON 5/6 to 0EH. Bytes of the response data enable the MEMOBUS register content that was set in *F6-23*.

■ **F6-24: MECHATROLINK Monitor Select (F)**

No. (Hex.)	Name	Description	Default (Range)
F6-24 (036F)	MECHATROLINK Monitor Select (F)	<div style="display: flex; gap: 5px;"> V/f OLV OLV/PM AOLV/PM EZOLV </div> Sets the MEMOBUS register used for the monitor functions of INV_CTL (drive operation control command) and INV_I/O (drive I/O control command). Restart the drive after you change the parameter setting.	0000h (0000h - FFFFh)

To enable the MEMOBUS register set in *F6-24*, set SEL_MON2/1 to 0FH or set SEL_MON3/4 and SEL_MON 5/6 to 0FH. Bytes of the response data enable the MEMOBUS register content that was set *F6-24*.

■ **F6-25: MECHATROLINK Watchdog Error Sel**

No. (Hex.)	Name	Description	Default (Range)
F6-25 (03C9)	MECHATROLINK Watchdog Error Sel	<div style="display: flex; gap: 5px;"> V/f OLV OLV/PM AOLV/PM EZOLV </div> Sets the method to stop the motor or let the motor continue operating when the drive detects <i>E5</i> [MECHATROLINK Watchdog Timer Err].	1 (0 - 3)

0 : Ramp to Stop

The drive ramps the motor to stop in the deceleration time. The output terminal set for *Fault [H2-01 to H2-03 = E]* activates.

1 : Coast to Stop

The output turns off and the motor coasts to stop. The output terminal set for *Fault [H2-01 to H2-03 = E]* activates.

2 : Fast Stop (Use C1-09)

The drive stops the motor in the deceleration time set in *C1-09 [Fast Stop Time]*. The output terminal set for *Fault [H2-01 to H2-03 = E]* activates.

3 : Alarm Only

The keypad shows *E5*, and the drive continues to operate.

Note:

Separately prepare safety protection equipment and systems, for example fast stop switches.

The output terminal set to *Alarm [H2-01 to H2-03 = 10]* activates.

■ F6-26: MECHATROLINK Allowable No of Err

No. (Hex.)	Name	Description	Default (Range)
F6-26 (03CA)	MECHATROLINK Allowable No of Err	<div style="display: flex; gap: 5px;"> V/f OLV OLV/PM AOLV/PM EZOLV </div> <p>Sets the number of times that the option must detect a <i>bUS</i> alarm to cause a <i>bUS [Option Communication Error]</i>.</p>	2 (2 - 10 times)

■ F6-30: PROFIBUS-DP Node Address

No. (Hex.)	Name	Description	Default (Range)
F6-30 (03CB)	PROFIBUS-DP Node Address	<div style="display: flex; gap: 5px;"> V/f OLV OLV/PM AOLV/PM EZOLV </div> <p>Sets the node address for PROFIBUS-DP communication. Restart the drive after you change the parameter setting.</p>	0 (0 - 125)

Note:

- Be sure to set a node address that is different than all other node addresses.
- Node addresses 0, 1, and 2 are usually reserved for control, maintenance, and device self-diagnosis.

■ F6-31: PROFIBUS-DP Clear Mode Selection

No. (Hex.)	Name	Description	Default (Range)
F6-31 (03CC)	PROFIBUS-DP Clear Mode Selection	<div style="display: flex; gap: 5px;"> V/f OLV OLV/PM AOLV/PM EZOLV </div> <p>Sets what the drive will do after it receives the Clear Mode command.</p>	0 (0, 1)

0 : Reset

Resets drive settings, for example frequency reference and I/O settings.

1 : Hold Previous State

The drive keeps the same status as before it received the command.

■ F6-32: PROFIBUS-DP Data Format Select

No. (Hex.)	Name	Description	Default (Range)
F6-32 (03CD)	PROFIBUS-DP Data Format Select	<div style="display: flex; gap: 5px;"> V/f OLV OLV/PM AOLV/PM EZOLV </div> <p>Sets the data format of PROFIBUS-DP communication. Restart the drive after you change the parameter setting.</p>	0 (0 - 5)

Note:

The *H5-11 [Comm ENTER Command Mode]* setting makes the RAM enter command necessary or not necessary to write parameters over network communication. When *F6-32 = 0, 1, or 2*, the *H5-11* setting does not have an effect. The RAM enter command is always necessary to write parameters.

0 : PPO Type

1 : Conventional

2 : PPO (bit0)

This function operates when bit 0 and bit 4 in the register STW have values of 1 (operate). Refer to the PROFIBUS-DP communication manual for more information.

3 : PPO (Enter)**4 : Conventional (Enter)****5 : PPO (bit0, Enter)**

This function operates when bit 0 and bit 4 in the register STW have values of 1 (operate). Refer to the PROFIBUS-DP communication manual for more information.

■ F6-35: CANopen Node ID Selection

No. (Hex.)	Name	Description	Default (Range)
F6-35 (03D0)	CANopen Node ID Selection	<input type="checkbox"/> V/f <input type="checkbox"/> OLV <input type="checkbox"/> OLV/PM <input type="checkbox"/> AOLV/PM <input type="checkbox"/> EZOLV Sets the node address for CANopen communication. Restart the drive after you change the parameter setting.	0 (0 - 126)

Note:

Be sure to set an address that is different than all other node addresses. Do not set this parameter to 0. Incorrect parameter settings will cause *AEr [Station Address Setting Error]* errors and the L.ERR LED on the option will come on.

■ F6-36: CANopen Communication Speed

No. (Hex.)	Name	Description	Default (Range)
F6-36 (03D1)	CANopen Communication Speed	<input type="checkbox"/> V/f <input type="checkbox"/> OLV <input type="checkbox"/> OLV/PM <input type="checkbox"/> AOLV/PM <input type="checkbox"/> EZOLV Sets the CANopen communications speed. Restart the drive after you change the parameter setting.	6 (0 - 8)

0 : Auto-detection

The drive detects the network communication speed and automatically adjusts the communications speed.

1 : 10 kbps**2 : 20 kbps****3 : 50 kbps****4 : 125 kbps****5 : 250 kbps****6 : 500 kbps****7 : 800 kbps****8 : 1 Mbps****■ F6-50: DeviceNet MAC Address**

No. (Hex.)	Name	Description	Default (Range)
F6-50 (03C1)	DeviceNet MAC Address	<input type="checkbox"/> V/f <input type="checkbox"/> OLV <input type="checkbox"/> OLV/PM <input type="checkbox"/> AOLV/PM <input type="checkbox"/> EZOLV Sets the MAC address for DeviceNet communication. Restart the drive after you change the parameter setting.	64 (0 - 64)

Note:

Be sure to set a MAC address that is different than all other node addresses. Do not set this parameter to 0. Incorrect parameter settings will cause *AEr [Station Address Setting Error]* errors and the MS LED on the option will flash.

■ F6-51: DeviceNet Baud Rate

No. (Hex.)	Name	Description	Default (Range)
F6-51 (03C2)	DeviceNet Baud Rate	<input type="checkbox"/> V/f <input type="checkbox"/> OLV <input type="checkbox"/> OLV/PM <input type="checkbox"/> AOLV/PM <input type="checkbox"/> EZOLV Sets the DeviceNet communications speed. Restart the drive after you change the parameter setting.	4 (0 - 4)

0 : 125 kbps

1 : 250 kbps

2 : 500 kbps

3 : Adjustable from Network

The controller sets the communications speed.

4 : Detect Automatically

The drive detects the network communication speed and automatically adjusts the communications speed.

■ F6-52: DeviceNet PCA Setting

No. (Hex.)	Name	Description	Default (Range)
F6-52 (03C3)	DeviceNet PCA Setting	<input type="checkbox"/> V/f <input type="checkbox"/> OLV <input type="checkbox"/> OLV/PM <input type="checkbox"/> AOLV/PM <input type="checkbox"/> EZOLV Sets the format of data that the DeviceNet communication master sends to the drive.	21 (0 - 255)

Note:

If F6-52 [DeviceNet PCA Setting] and F6-53 [DeviceNet PPA Setting] are not correct, the value is reset to default.

■ F6-53: DeviceNet PPA Setting

No. (Hex.)	Name	Description	Default (Range)
F6-53 (03C4)	DeviceNet PPA Setting	<input type="checkbox"/> V/f <input type="checkbox"/> OLV <input type="checkbox"/> OLV/PM <input type="checkbox"/> AOLV/PM <input type="checkbox"/> EZOLV Sets the format of data that the drive sends to the DeviceNet communication master.	71 (0 - 255)

Note:

If F6-52 [DeviceNet PCA Setting] and F6-53 [DeviceNet PPA Setting] are not correct, the value is reset to default.

■ F6-54: DeviceNet Idle Fault Detection

No. (Hex.)	Name	Description	Default (Range)
F6-54 (03C5)	DeviceNet Idle Fault Detection	<input type="checkbox"/> V/f <input type="checkbox"/> OLV <input type="checkbox"/> OLV/PM <input type="checkbox"/> AOLV/PM <input type="checkbox"/> EZOLV Sets the function to detect <i>EF0</i> [Option Card External Fault] when the drive does not receive data from the DeviceNet master.	0 (0 - 4)

0 : Enabled

1 : Disabled, No Fault Detection

This will not trigger *EF0*.

2 : Vendor Specific

3 : RUN Forward

4 : RUN Reverse

■ F6-55: DeviceNet Baud Rate Monitor

No. (Hex.)	Name	Description	Default (Range)
F6-55 (03C6)	DeviceNet Baud Rate Monitor	<input type="checkbox"/> V/f <input type="checkbox"/> OLV <input type="checkbox"/> OLV/PM <input type="checkbox"/> AOLV/PM <input type="checkbox"/> EZOLV Sets the function to see the actual DeviceNet communications speed using the keypad. This parameter functions as a monitor only.	0 (0 - 2)

0 : 125 kbps

1 : 250 kbps

2 : 500 kbps

■ F6-56: DeviceNet Speed Scaling

No. (Hex.)	Name	Description	Default (Range)
F6-56 (03D7)	DeviceNet Speed Scaling	<input type="checkbox"/> V/f <input type="checkbox"/> OLV <input type="checkbox"/> OLV/PM <input type="checkbox"/> AOLV/PM <input type="checkbox"/> EZOLV Sets the speed scale for DeviceNet communication.	0 (-15 - +15)

■ F6-57: DeviceNet Current Scaling

No. (Hex.)	Name	Description	Default (Range)
F6-57 (03D8)	DeviceNet Current Scaling	<input type="checkbox"/> V/f <input type="checkbox"/> OLV <input type="checkbox"/> OLV/IPM <input type="checkbox"/> AOLV/IPM <input type="checkbox"/> EZOLV Sets the current scale of the DeviceNet communication master.	0 (-15 - +15)

■ F6-58: DeviceNet Torque Scaling

No. (Hex.)	Name	Description	Default (Range)
F6-58 (03D9)	DeviceNet Torque Scaling	<input type="checkbox"/> V/f <input type="checkbox"/> OLV <input type="checkbox"/> OLV/IPM <input type="checkbox"/> AOLV/IPM <input type="checkbox"/> EZOLV Sets the torque scale of the DeviceNet communication master.	0 (-15 - +15)

■ F6-59: DeviceNet Power Scaling

No. (Hex.)	Name	Description	Default (Range)
F6-59 (03DA)	DeviceNet Power Scaling	<input type="checkbox"/> V/f <input type="checkbox"/> OLV <input type="checkbox"/> OLV/IPM <input type="checkbox"/> AOLV/IPM <input type="checkbox"/> EZOLV Sets the power scale of the DeviceNet communication master.	0 (-15 - +15)

■ F6-60: DeviceNet Voltage Scaling

No. (Hex.)	Name	Description	Default (Range)
F6-60 (03DB)	DeviceNet Voltage Scaling	<input type="checkbox"/> V/f <input type="checkbox"/> OLV <input type="checkbox"/> OLV/IPM <input type="checkbox"/> AOLV/IPM <input type="checkbox"/> EZOLV Sets the voltage scale of the DeviceNet communication master.	0 (-15 - +15)

■ F6-61: DeviceNet Time Scaling

No. (Hex.)	Name	Description	Default (Range)
F6-61 (03DC)	DeviceNet Time Scaling	<input type="checkbox"/> V/f <input type="checkbox"/> OLV <input type="checkbox"/> OLV/IPM <input type="checkbox"/> AOLV/IPM <input type="checkbox"/> EZOLV Sets the time scale of the DeviceNet communication master.	0 (-15 - +15)

■ F6-62: DeviceNet Heartbeat Interval

No. (Hex.)	Name	Description	Default (Range)
F6-62 (03DD)	DeviceNet Heartbeat Interval	<input type="checkbox"/> V/f <input type="checkbox"/> OLV <input type="checkbox"/> OLV/IPM <input type="checkbox"/> AOLV/IPM <input type="checkbox"/> EZOLV Sets the heartbeat for DeviceNet communication. Set this parameter to 0 to disable the heartbeat function.	0 (0 - 10)

■ F6-63: DeviceNet Network MAC ID

No. (Hex.)	Name	Description	Default (Range)
F6-63 (03DE)	DeviceNet Network MAC ID	<input type="checkbox"/> V/f <input type="checkbox"/> OLV <input type="checkbox"/> OLV/IPM <input type="checkbox"/> AOLV/IPM <input type="checkbox"/> EZOLV Sets the function to see the actual DeviceNet MAC address using the keypad. This parameter functions as a monitor only.	63 (0 - 63)

■ F6-64 to F6-67: Dynamic Out Assembly 109 Param1 to 4

No. (Hex.)	Name	Description	Default (Range)
F6-64 to F6-67 (03DF - 03E2)	Dynamic Out Assembly 109 Param 1 to 4	<input type="checkbox"/> V/f <input type="checkbox"/> OLV <input type="checkbox"/> OLV/IPM <input type="checkbox"/> AOLV/IPM <input type="checkbox"/> EZOLV Sets Configurable Outputs 1 to 4 written to the MEMOBUS register.	0000H (0000H - FFFFH)

■ F6-68 to F6-71: Dynamic In Assembly 159 Param 1 to 4

No. (Hex.)	Name	Description	Default (Range)
F6-68 to F6-71 (03E3, 03E4, 03C7, and 03C8)	Dynamic In Assembly 159 Param 1 to 4	V/f OLV OLV/PM AOLV/PM EZOLV Sets Configurable Inputs 1 to 4 read from the MEMOBUS register.	0000H (0000H - FFFFH)

■ F6-72: PowerLink Node Address

No. (Hex.)	Name	Description	Default (Range)
F6-72 (081B)	PowerLink Node Address	V/f OLV OLV/PM AOLV/PM EZOLV Sets the node ID for PowerLink communication.	0 (0 - 255)

■ F7-01: IP Address 1

No. (Hex.)	Name	Description	Default (Range)
F7-01 (03E5)	IP Address 1	V/f OLV OLV/PM AOLV/PM EZOLV Sets the first octet of the IP Address for the device that is connecting to the network. Restart the drive after you change this parameter.	192 (0 - 255)

Note:

When *F7-13 = 0* [Address Mode at Startup = Static]:

- Use parameters *F7-01 to F7-04* [IP Address 1 to 4] to set the IP Address. Be sure to set a different IP address for each drive on the network.
- Also set parameters *F7-05 to F7-12* [Subnet Mask 1 to 4, Gateway Address 1 to 4].

■ F7-02: IP Address 2

No. (Hex.)	Name	Description	Default (Range)
F7-02 (03E6)	IP Address 2	V/f OLV OLV/PM AOLV/PM EZOLV Sets the second octet of the IP Address for the device that is connecting to the network. Restart the drive after you change this parameter.	168 (0 - 255)

Note:

When *F7-13 = 0* [Address Mode at Startup = Static]:

- Use parameters *F7-01 to F7-04* [IP Address 1 to 4] to set the IP Address. Be sure to set a different IP address for each drive on the network.
- Also set parameters *F7-05 to F7-12* [Subnet Mask 1 to 4, Gateway Address 1 to 4].

■ F7-03: IP Address 3

No. (Hex.)	Name	Description	Default (Range)
F7-03 (03E7)	IP Address 3	V/f OLV OLV/PM AOLV/PM EZOLV Sets the third octet of the IP Address for the device that is connecting to the network. Restart the drive after you change this parameter.	1 (0 - 255)

Note:

When *F7-13 = 0* [Address Mode at Startup = Static]:

- Use parameters *F7-01 to F7-04* [IP Address 1 to 4] to set the IP Address. Be sure to set a different IP address for each drive on the network.
- Also set parameters *F7-05 to F7-12* [Subnet Mask 1 to 4, Gateway Address 1 to 4].

■ F7-04: IP Address 4

No. (Hex.)	Name	Description	Default (Range)
F7-04 (03E8)	IP Address 4	V/f OLV OLV/PM AOLV/PM EZOLV Sets the fourth octet of the IP Address for the device that is connecting to the network. Restart the drive after you change this parameter.	20 (0 - 255)

Note:

When $F7-13 = 0$ [Address Mode at Startup = Static]:

- Use parameters $F7-01$ to $F7-04$ [IP Address 1 to 4] to set the IP Address. Be sure to set a different IP address for each drive on the network.
- Also set parameters $F7-05$ to $F7-12$ [Subnet Mask 1 to 4, Gateway Address 1 to 4].

■ **F7-05: Subnet Mask 1**

No. (Hex.)	Name	Description	Default (Range)
F7-05 (03E9)	Subnet Mask 1	<div style="display: flex; gap: 5px;"> V/f OLV OLV/IPM AOLV/IPM EZOLV </div> Sets the first octet of the subnet mask of the connected network.	255 (0 - 255)

Note:

Set this parameter when $F7-13 = 0$ [Address Mode at Startup = Static].

■ **F7-06: Subnet Mask 2**

No. (Hex.)	Name	Description	Default (Range)
F7-06 (03EA)	Subnet Mask 2	<div style="display: flex; gap: 5px;"> V/f OLV OLV/IPM AOLV/IPM EZOLV </div> Sets the second octet of the subnet mask of the connected network.	255 (0 - 255)

Note:

Set this parameter when $F7-13 = 0$ [Address Mode at Startup = Static].

■ **F7-07: Subnet Mask 3**

No. (Hex.)	Name	Description	Default (Range)
F7-07 (03EB)	Subnet Mask 3	<div style="display: flex; gap: 5px;"> V/f OLV OLV/IPM AOLV/IPM EZOLV </div> Sets the third octet of the subnet mask of the connected network.	255 (0 - 255)

Note:

Set this parameter when $F7-13 = 0$ [Address Mode at Startup = Static].

■ **F7-08: Subnet Mask 4**

No. (Hex.)	Name	Description	Default (Range)
F7-08 (03EC)	Subnet Mask 4	<div style="display: flex; gap: 5px;"> V/f OLV OLV/IPM AOLV/IPM EZOLV </div> Sets the fourth octet of the subnet mask of the connected network.	0 (0 - 255)

Note:

Set this parameter when $F7-13 = 0$ [Address Mode at Startup = Static].

■ **F7-09: Gateway Address 1**

No. (Hex.)	Name	Description	Default (Range)
F7-09 (03ED)	Gateway Address 1	<div style="display: flex; gap: 5px;"> V/f OLV OLV/IPM AOLV/IPM EZOLV </div> Sets the first octet of the gateway address of the connected network.	192 (0 - 255)

Note:

Set this parameter when $F7-13 = 0$ [Address Mode at Startup = Static].

■ **F7-10: Gateway Address 2**

No. (Hex.)	Name	Description	Default (Range)
F7-10 (03EE)	Gateway Address 2	<div style="display: flex; gap: 5px;"> V/f OLV OLV/IPM AOLV/IPM EZOLV </div> Sets the second octet of the gateway address of the connected network.	168 (0 - 255)

Note:

Set this parameter when $F7-13 = 0$ [Address Mode at Startup = Static].

■ F7-11: Gateway Address 3

No. (Hex.)	Name	Description	Default (Range)
F7-11 (03EF)	Gateway Address 3	V/f OLV OLV/PM AOLV/PM EZOLV Sets the third octet of the gateway address of the connected network.	1 (0 - 255)

Note:

Set this parameter when $F7-13 = 0$ [Address Mode at Startup = Static].

■ F7-12: Gateway Address 4

No. (Hex.)	Name	Description	Default (Range)
F7-12 (03F0)	Gateway Address 4	V/f OLV OLV/PM AOLV/PM EZOLV Sets the fourth octet of the gateway address of the connected network.	1 (0 - 255)

Note:

Set this parameter when $F7-13 = 0$ [Address Mode at Startup = Static].

■ F7-13: Address Mode at Startup

No. (Hex.)	Name	Description	Default (Range)
F7-13 (03F1)	Address Mode at Startup	V/f OLV OLV/PM AOLV/PM EZOLV Sets the method to set option card IP addresses.	2 (0 - 2)

0 : Static

1 : BOOTP

2 : DHCP

Note:

• The following setting values are available when using the PROFINET communication option card (SI-EP3).

–0: Static

–2: DCP

• When $F7-13 = 0$, set parameters $F7-01$ to $F7-12$ [IP Address 1 to Gateway Address 4] to set the IP Address. Be sure to set a different IP address for each drive on the network.

■ F7-14: Duplex Mode Selection

No. (Hex.)	Name	Description	Default (Range)
F7-14 (03F2)	Duplex Mode Selection	V/f OLV OLV/PM AOLV/PM EZOLV Sets the duplex mode setting method.	1 (0 - 8)

0 : Half/Half

1 : Auto/Auto

2 : Full/Full

3 : Half/Auto

Port 1 is set to “Half” and port 2 is set to “Auto”.

4 : Half/Full

Port 1 is set to “Half” and port 2 is set to “Full”.

5 : Auto/Half

Port 1 is set to “Auto” and port 2 is set to “Half”.

6 : Auto/Full

Port 1 is set to “Auto” and port 2 is set to “Full”.

7 : Full/Half

Port 1 is set to “Full” and port 2 is set to “Half”.

8 : Full/Auto

Port 1 is set to “Full” and port 2 is set to “Auto”.

■ F7-15: Communication Speed Selection

No. (Hex.)	Name	Description	Default (Range)
F7-15 (03F3)	Communication Speed Selection	<input type="checkbox"/> V/f <input type="checkbox"/> OLV <input type="checkbox"/> OLV/PM <input type="checkbox"/> AOLV/PM <input type="checkbox"/> EZOLV Sets the communications speed.	10 (10, 100 - 102)

10 : 10/10 Mbps**100 : 100/100 Mbps****101 : 10/100 Mbps****102 : 100/10 Mbps****Note:**

Set this parameter when *F7-14 = 0* or *2* [*Duplex Mode Selection = Half/Half or Full/Full*].

■ F7-16: Timeout Value

No. (Hex.)	Name	Description	Default (Range)
F7-16 (03F4)	Timeout Value	<input type="checkbox"/> V/f <input type="checkbox"/> OLV <input type="checkbox"/> OLV/PM <input type="checkbox"/> AOLV/PM <input type="checkbox"/> EZOLV Sets the detection time for a communications timeout.	0.0 s (0.0 - 30.0 s)

Note:

Set this parameter to 0.0 to disable the connection timeout function.

■ F7-17: EtherNet/IP Speed Scaling Factor

No. (Hex.)	Name	Description	Default (Range)
F7-17 (03F5)	EtherNet/IP Speed Scaling Factor	<input type="checkbox"/> V/f <input type="checkbox"/> OLV <input type="checkbox"/> OLV/PM <input type="checkbox"/> AOLV/PM <input type="checkbox"/> EZOLV Sets the scaling factor for the speed monitor in the EtherNet/IP Class ID 2AH Object.	0 (-15 - +15)

■ F7-18: EtherNet/IP Current Scale Factor

No. (Hex.)	Name	Description	Default (Range)
F7-18 (03F6)	EtherNet/IP Current Scale Factor	<input type="checkbox"/> V/f <input type="checkbox"/> OLV <input type="checkbox"/> OLV/PM <input type="checkbox"/> AOLV/PM <input type="checkbox"/> EZOLV Sets the scaling factor for the output current monitor in the EtherNet/IP Class ID 2AH Object.	0 (-15 - +15)

■ F7-19: EtherNet/IP Torque Scale Factor

No. (Hex.)	Name	Description	Default (Range)
F7-19 (03F7)	EtherNet/IP Torque Scale Factor	<input type="checkbox"/> V/f <input type="checkbox"/> OLV <input type="checkbox"/> OLV/PM <input type="checkbox"/> AOLV/PM <input type="checkbox"/> EZOLV Sets the scaling factor for the torque monitor in the EtherNet/IP Class ID 2AH Object.	0 (-15 - +15)

■ F7-20: EtherNet/IP Power Scaling Factor

No. (Hex.)	Name	Description	Default (Range)
F7-20 (03F8)	EtherNet/IP Power Scaling Factor	<input type="checkbox"/> V/f <input type="checkbox"/> OLV <input type="checkbox"/> OLV/PM <input type="checkbox"/> AOLV/PM <input type="checkbox"/> EZOLV Sets the scaling factor for the power monitor in the EtherNet/IP Class ID 2AH Object.	0 (-15 - +15)

■ F7-21: EtherNet/IP Voltage Scale Factor

No. (Hex.)	Name	Description	Default (Range)
F7-21 (03F9)	EtherNet/IP Voltage Scale Factor	<input type="checkbox"/> V/f <input type="checkbox"/> OLV <input type="checkbox"/> OLV/PM <input type="checkbox"/> AOLV/PM <input type="checkbox"/> EZOLV Sets the scaling factor for the voltage monitor in the EtherNet/IP Class ID 2AH Object.	0 (-15 - +15)

■ F7-22: EtherNet/IP Time Scaling

No. (Hex.)	Name	Description	Default (Range)
F7-22 (03FA)	EtherNet/IP Time Scaling	V/f OLV OLV/PM AOLV/PM EZOLV Sets the scaling factor for the time monitor in the EtherNet/IP Class ID 2AH Object.	0 (-15 - +15)

■ F7-23 to F7-32: Dynamic Out Param 1 to 10 for CommCard

No. (Hex.)	Name	Description	Default (Range)
F7-23 to F7-27 (03FB - 03FF) F7-28 to F7-32 (0370 - 0374)	Dynamic Out Param 1 to 10 for CommCard	V/f OLV OLV/PM AOLV/PM EZOLV When you use an Ethernet/IP option, sets Output Assembly 116. The drive writes the values from Output Assembly 116 to the MEMOBUS/Modbus address register that is stored for each parameter. The drive will not write the values from Output Assembly 116 to the registers when the MEMOBUS/Modbus address is 0. When you use a ProfiNet option, set <i>F7-23</i> to <i>F7-27</i> to configurable Output 1-5.	0

■ F7-33 to F7-42: Dynamic In Param 1 to 10 for CommCard

No. (Hex.)	Name	Description	Default (Range)
F7-33 to F7-42 (0375 - 037E)	Dynamic In Param 1 to 10 for CommCard	V/f OLV OLV/PM AOLV/PM EZOLV When you use an Ethernet/IP option, sets Input Assembly 166. The drive sends the values from the MEMOBUS/Modbus address registers stored for each parameter to Input Assembly 166. The drive returns the default register value for the option card when the MEMOBUS/Modbus address is 0 and the value sent to Input Assembly 166 is not defined. When you use a ProfiNet option, set <i>F7-33</i> to <i>F7-37</i> to configurable inputs 1-5.	0

■ F7-60: PZD1 Write (Control Word)

No. (Hex.)	Name	Description	Default (Range)
F7-60 (0780)	PZD1 Write (Control Word)	V/f OLV OLV/PM AOLV/PM EZOLV When you use a Profibus option, set the MEMOBUS/Modbus address for PZD1 (PPO output). PZD1 (PPO output) functions as the STW when <i>F7-60</i> = 0 to 2.	0

■ F7-61: PZD2 Write (Frequency Reference)

No. (Hex.)	Name	Description	Default (Range)
F7-61 (0781)	PZD2 Write (Frequency Reference)	V/f OLV OLV/PM AOLV/PM EZOLV When you use a Profibus option, sets the MEMOBUS/Modbus address for PZD2 (PPO output). PZD2 (PPO output) functions as the HSW when <i>F7-61</i> = 0 to 2.	0

■ F7-62: PZD3 Write

No. (Hex.)	Name	Description	Default (Range)
F7-62 (0782)	PZD3 Write	V/f OLV OLV/PM AOLV/PM EZOLV When you use a Profibus option, sets the MEMOBUS/Modbus address for PZD3 (PPO output). A value of 0, 1, or 2 will disable the PZD3 (PPO output) write operation to the MEMOBUS/Modbus register.	0

■ F7-63: PZD4 Write

No. (Hex.)	Name	Description	Default (Range)
F7-63 (0783)	PZD4 Write	V/f OLV OLV/PM AOLV/PM EZOLV When you use a Profibus option, sets the MEMOBUS/Modbus address for PZD4 (PPO output). A value of 0, 1, or 2 will disable the PZD4 (PPO output) write operation to the MEMOBUS/Modbus register.	0

■ F7-64: PZD5 Write

No. (Hex.)	Name	Description	Default (Range)
F7-64 (0784)	PZD5 Write	<p>V/f OLV OLV/PM AOLV/PM EZOLV</p> <p>When you use a Profibus option, sets the MEMOBUS/Modbus address for PZD5 (PPO output). A value of 0, 1, or 2 will disable the PZD5 (PPO output) write operation to the MEMOBUS/Modbus register.</p>	0

■ F7-65: PZD6 Write

No. (Hex.)	Name	Description	Default (Range)
F7-65 (0785)	PZD6 Write	<p>V/f OLV OLV/PM AOLV/PM EZOLV</p> <p>When you use a Profibus option, sets the MEMOBUS/Modbus address for PZD6 (PPO output). A value of 0, 1, or 2 will disable the PZD6 (PPO output) write operation to the MEMOBUS/Modbus register.</p>	0

■ F7-66: PZD7 Write

No. (Hex.)	Name	Description	Default (Range)
F7-66 (0786)	PZD7 Write	<p>V/f OLV OLV/PM AOLV/PM EZOLV</p> <p>When you use a Profibus option, sets the MEMOBUS/Modbus address for PZD7 (PPO output). A value of 0, 1, or 2 will disable the PZD7 (PPO output) write operation to the MEMOBUS/Modbus register.</p>	0

■ F7-67: PZD8 Write

No. (Hex.)	Name	Description	Default (Range)
F7-67 (0787)	PZD8 Write	<p>V/f OLV OLV/PM AOLV/PM EZOLV</p> <p>When you use a Profibus option, sets the MEMOBUS/Modbus address for PZD8 (PPO output). A value of 0, 1, or 2 will disable the PZD8 (PPO output) write operation to the MEMOBUS/Modbus register.</p>	0

■ F7-68: PZD9 Write

No. (Hex.)	Name	Description	Default (Range)
F7-68 (0788)	PZD9 Write	<p>V/f OLV OLV/PM AOLV/PM EZOLV</p> <p>When you use a Profibus option, sets the MEMOBUS/Modbus address for PZD9 (PPO output). A value of 0, 1, or 2 will disable the PZD9 (PPO output) write operation to the MEMOBUS/Modbus register.</p>	0

■ F7-69: PZD10 Write

No. (Hex.)	Name	Description	Default (Range)
F7-69 (0789)	PZD10 Write	<p>V/f OLV OLV/PM AOLV/PM EZOLV</p> <p>When you use a Profibus option, sets the MEMOBUS/Modbus address for PZD10 (PPO output). A value of 0, 1, or 2 will disable the PZD10 (PPO output) write operation to the MEMOBUS/Modbus register.</p>	0

■ F7-70: PZD1 Read (Status Word)

No. (Hex.)	Name	Description	Default (Range)
F7-70 (078A)	PZD1 Read (Status Word)	<p>V/f OLV OLV/PM AOLV/PM EZOLV</p> <p>When you use a Profibus option, sets the MEMOBUS/Modbus address for PZD1 (PPO input). PZD1 (PPO input) functions as the ZSW when $F7-70 = 0$.</p>	0

■ F7-71: PZD2 Read (Output Frequency)

No. (Hex.)	Name	Description	Default (Range)
F7-71 (078B)	PZD2 Read (Output Frequency)	<p>V/f OLV OLV/PM AOLV/PM EZOLV</p> <p>When you use a Profibus option, sets the MEMOBUS/Modbus address for PZD2 (PPO input). PZD2 (PPO input) functions as the HIW when <i>F7-71 = 0</i>.</p>	0

■ F7-72: PZD3 Read

No. (Hex.)	Name	Description	Default (Range)
F7-72 (078C)	PZD3 Read	<p>V/f OLV OLV/PM AOLV/PM EZOLV</p> <p>When you use a Profibus option, sets the MEMOBUS/Modbus address for PZD3 (PPO input). A value of 0 will disable the PZD3 (PPO input) load operation from the MEMOBUS/Modbus register.</p>	0

■ F7-73: PZD4 Read

No. (Hex.)	Name	Description	Default (Range)
F7-73 (078D)	PZD4 Read	<p>V/f OLV OLV/PM AOLV/PM EZOLV</p> <p>When you use a Profibus option, sets the MEMOBUS/Modbus address for PZD4 (PPO input). A value of 0 will disable the PZD4 (PPO input) load operation from the MEMOBUS/Modbus register.</p>	0

■ F7-74: PZD5 Read

No. (Hex.)	Name	Description	Default (Range)
F7-74 (078E)	PZD5 Read	<p>V/f OLV OLV/PM AOLV/PM EZOLV</p> <p>When you use a Profibus option, sets the MEMOBUS/Modbus address for PZD5 (PPO input). A value of 0 will disable the PZD5 (PPO input) load operation from the MEMOBUS/Modbus register.</p>	0

■ F7-75: PZD6 Read

No. (Hex.)	Name	Description	Default (Range)
F7-75 (078F)	PZD6 Read	<p>V/f OLV OLV/PM AOLV/PM EZOLV</p> <p>When you use a Profibus option, sets the MEMOBUS/Modbus address for PZD6 (PPO input). A value of 0 will disable the PZD6 (PPO input) load operation from the MEMOBUS/Modbus register.</p>	0

■ F7-76: PZD7 Read

No. (Hex.)	Name	Description	Default (Range)
F7-76 (0790)	PZD7 Read	<p>V/f OLV OLV/PM AOLV/PM EZOLV</p> <p>When you use a Profibus option, sets the MEMOBUS/Modbus address for PZD7 (PPO input). A value of 0 will disable the PZD7 (PPO input) load operation from the MEMOBUS/Modbus register.</p>	0

■ F7-77: PZD8 Read

No. (Hex.)	Name	Description	Default (Range)
F7-77 (0791)	PZD8 Read	<p>V/f OLV OLV/PM AOLV/PM EZOLV</p> <p>When you use a Profibus option, sets the MEMOBUS/Modbus address for PZD8 (PPO input). A value of 0 will disable the PZD8 (PPO input) load operation from the MEMOBUS/Modbus register.</p>	0

■ F7-78: PZD9 Read

No. (Hex.)	Name	Description	Default (Range)
F7-78 (0792)	PZD9 Read	<p>V/f OLV OLV/PM AOLV/PM EZOLV</p> <p>When you use a Profibus option, sets the MEMOBUS/Modbus address for PZD9 (PPO input). A value of 0 will disable the PZD9 (PPO input) load operation from the MEMOBUS/Modbus register.</p>	0

■ F7-79: PZD10 Read

No. (Hex.)	Name	Description	Default (Range)
F7-79 (0793)	PZD10 Read	V/f OLV OLV/PM AOLV/PM EZOLV When you use a Profibus option, sets the MEMOBUS/Modbus address for PZD10 (PPO input). A value of 0 will disable the PZD10 (PPO input) load operation from the MEMOBUS/Modbus register.	0

12.8 H: Terminal Function Selection

H parameters set functions for external input and output terminals.

◆ H1: Digital Inputs

H1 Parameters set the MFDI terminal functions.

■ H1-01 to H1-07 Terminal S1 to S7 Function Selection

The drive has 7 MFDI terminals. Refer to [Table 12.45](#) for drive default settings and functions.

Table 12.45 MFDI Default Settings and Functions

No.	Name	Default	Function
H1-01	Terminal S1 Function Selection	40 (F) <i>*I</i>	Forward RUN (2-Wire)
H1-02	Terminal S2 Function Selection	41 (F) <i>*I</i>	Reverse RUN (2-Wire)
H1-03	Terminal S3 Function Selection	24	External Fault (NO-Always-Coast)
H1-04	Terminal S4 Function Selection	14	Fault Reset
H1-05	Terminal S5 Function Selection	3 (0) <i>*I</i>	Multi-Step Speed Reference 1
H1-06	Terminal S6 Function Selection	4 (3) <i>*I</i>	Multi-Step Speed Reference 2
H1-07	Terminal S7 Function Selection	6 (4) <i>*I</i>	Jog Reference Selection

*1 The value in parentheses identifies the default setting when you set $A1-03 = 3330$ [Initialize Parameters = 3-Wire Initialization].

Refer to the [Table 12.46](#) and use *H1-xx* [MFDI Function Select] to set the function.

Table 12.46 MFDI Setting Values

Setting Value	Function	Ref.	Setting Value	Function	Ref.
0 <i>*I</i>	3-Wire Sequence	647	17 <i>*I</i>	Fast Stop (N.C.)	654
1	LOCAL/REMOTE Selection	648	18	Timer Function	655
2	External Reference 1/2 Selection	648	19	PID Disable	655
3	Multi-Step Speed Reference 1	648	1A	Accel/Decel Time Selection 2	655
4	Multi-Step Speed Reference 2	648	1B <i>*2</i>	Programming Lockout	655
5	Multi-Step Speed Reference 3	649	1E	Reference Sample Hold	655
6	Jog Reference Selection	649	20 to 2F <i>*I</i>	External Fault	656
7	Accel/Decel Time Selection 1	649	30	PID Integrator Reset	657
8 <i>*I</i>	Baseblock Command (N.O.)	649	31	PID Integrator Hold	657
9 <i>*I</i>	Baseblock Command (N.C.)	649	32	Multi-Step Speed Reference 4	657
A	Accel/Decel Ramp Hold	650	34	PID Soft Starter Disable	657
B	Overheat Alarm (oH2)	650	35	PID Input (Error) Invert	658
C	Analog Terminal Enable Selection	650	3E	PID Setpoint Selection 1	658
E	ASR Integral Reset	650	3F	PID Setpoint Selection 2	658
F	Through Mode	650	40 <i>*I</i>	Forward RUN (2-Wire)	658
10	Up Command	650	41 <i>*I</i>	Reverse RUN (2-Wire)	658
11	Down Command	652	42 <i>*I</i>	Run Command (2-Wire Sequence 2)	659
12 <i>*I</i>	Forward Jog	653	43 <i>*I</i>	FWD/REV (2-Wire Sequence 2)	659
13 <i>*I</i>	Reverse Jog	653	44	Add Offset Frequency 1 (d7-03)	659
14	Fault Reset	653	45	Add Offset Frequency 2 (d7-03)	659
15 <i>*I</i>	Fast Stop (N.O.)	653	46	Add Offset Frequency 3 (d7-03)	659
16	Motor 2 Selection	654	47	Node Setup (CANopen)	660

12.8 H: Terminal Function Selection

Setting Value	Function	Ref.
60	DC Injection Braking Command	660
61	Speed Search from Fmax	660
62	Speed Search from Fref	660
63	Field Weakening	661
65 */	KEB Ride-Thru 1 Activate (N.C.)	661
66 */	KEB Ride-Thru 1 Activate (N.O.)	661
67	Communications Test Mode	661
68	High Slip Braking (HSB) Activate	661
6A	Drive Enable	662
75	Up 2 Command	662
76	Down 2 Command	663
77	ASR Gain (C5-03) Select	663

Setting Value	Function	Ref.
78	Analog TorqueRef Polarity Invert	663
7A */	KEB Ride-Thru 2 Activate (N.C.)	664
7B */	KEB Ride-Thru 2 Activate (N.O.)	664
7C */	Short Circuit Braking (N.O.)	664
7D */	Short Circuit Braking (N.C.)	664
7E	Reverse Rotation Identifier	665
90 to 96 */	DWEZ Digital Inputs 1 to 7	665
9F	DWEZ Disable	665
101 - 19F	Inverse Inputs of 1 to 9F Sets the function of the selected MFDI to operate inversely. To select the function for inverse input, enter two digits 01 to 9F for the "xx" in "1xx".	665

*1 Inverse input is not available.

*2 You cannot use H7-01 to H7-04 [Virtual Multi-Function Input 1 to 4] to set this.

■ H1-01: Terminal S1 Function Selection

No. (Hex.)	Name	Description	Default (Range)
H1-01 (0438)	Terminal S1 Function Selection	<input type="checkbox"/> V/f <input type="checkbox"/> OLV <input type="checkbox"/> OLV/PM <input type="checkbox"/> AOLV/PM <input type="checkbox"/> EZOLV Sets the function for MFDI terminal S1.	40 (1 - 1FF)

Note:

The default setting is *F* when you initialize the drive for *3-Wire Initialization* [A1-03 = 3330].

■ H1-02: Terminal S2 Function Selection

No. (Hex.)	Name	Description	Default (Range)
H1-02 (0439)	Terminal S2 Function Selection	<input type="checkbox"/> V/f <input type="checkbox"/> OLV <input type="checkbox"/> OLV/PM <input type="checkbox"/> AOLV/PM <input type="checkbox"/> EZOLV Sets the function for MFDI terminal S2.	41 (1 - 1FF)

Note:

The default setting is *F* when you initialize the drive for *3-Wire Initialization* [A1-03 = 3330].

■ H1-03: Terminal S3 Function Selection

No. (Hex.)	Name	Description	Default (Range)
H1-03 (0400)	Terminal S3 Function Selection	<input type="checkbox"/> V/f <input type="checkbox"/> OLV <input type="checkbox"/> OLV/PM <input type="checkbox"/> AOLV/PM <input type="checkbox"/> EZOLV Sets the function for MFDI terminal S3.	24 (0 - 1FF)

■ H1-04: Terminal S4 Function Selection

No. (Hex.)	Name	Description	Default (Range)
H1-04 (0401)	Terminal S4 Function Selection	<input type="checkbox"/> V/f <input type="checkbox"/> OLV <input type="checkbox"/> OLV/PM <input type="checkbox"/> AOLV/PM <input type="checkbox"/> EZOLV Sets the function for MFDI terminal S4.	14 (0 - 1FF)

■ H1-05: Terminal S5 Function Selection

No. (Hex.)	Name	Description	Default (Range)
H1-05 (0402)	Terminal S5 Function Selection	<input type="checkbox"/> V/f <input type="checkbox"/> OLV <input type="checkbox"/> OLV/PM <input type="checkbox"/> AOLV/PM <input type="checkbox"/> EZOLV Sets the function for MFDI terminal S5.	3 (0 - 1FF)

Note:

The default setting is 0 when the drive is initialized for *3-Wire Initialization* [A1-03 = 3330].

■ H1-06: Terminal S6 Function Selection

No. (Hex.)	Name	Description	Default (Range)
H1-06 (0403)	Terminal S6 Function Selection	<input type="checkbox"/> V/f <input type="checkbox"/> OLV <input type="checkbox"/> OLV/PM <input type="checkbox"/> AOLV/PM <input type="checkbox"/> EZOLV Sets the function for MFDI terminal S6.	4 (0 - 1FF)

Note:

The default setting is 3 when the drive is initialized for *3-Wire Initialization* [A1-03 = 3330].

■ H1-07: Terminal S7 Function Selection

No. (Hex.)	Name	Description	Default (Range)
H1-07 (0404)	Terminal S7 Function Selection	<input type="checkbox"/> V/f <input type="checkbox"/> OLV <input type="checkbox"/> OLV/PM <input type="checkbox"/> AOLV/PM <input type="checkbox"/> EZOLV Sets the function for MFDI terminal S7.	6 (0 - 1FF)

Note:

The default setting is 4 when the drive is initialized for *3-Wire Initialization* [A1-03 = 3330].

■ H1-21: Terminal S1 Function Select 2

No. (Hex.)	Name	Description	Default (Range)
H1-21 (0B70)	Terminal S1 Function Selection 2	<input type="checkbox"/> V/f <input type="checkbox"/> OLV <input type="checkbox"/> OLV/PM <input type="checkbox"/> AOLV/PM <input type="checkbox"/> EZOLV Sets the second function for MFDI terminal S1.	F (1 - 19F)

When MFDI terminal S1 activates, it will operate the function set to *H1-01* [Terminal S1 Function Selection] and the function set to *H1-21* at the same time.

When the setting value is *F*, the function is disabled.

■ H1-22: Terminal S2 Function Select 2

No. (Hex.)	Name	Description	Default (Range)
H1-22 (0B71)	Terminal S2 Function Select 2	<input type="checkbox"/> V/f <input type="checkbox"/> OLV <input type="checkbox"/> OLV/PM <input type="checkbox"/> AOLV/PM <input type="checkbox"/> EZOLV Sets the second function for MFDI terminal S2.	F (1 - 19F)

When MFDI terminal S2 activates, it will operate the function set to *H1-02* [Terminal S2 Function Selection] and the function set to *H1-22* at the same time.

When the setting value is *F*, the function is disabled.

■ H1-23: Terminal S3 Function Select 2

No. (Hex.)	Name	Description	Default (Range)
H1-23 (0B72)	Terminal S3 Function Selection 2	<input type="checkbox"/> V/f <input type="checkbox"/> OLV <input type="checkbox"/> OLV/PM <input type="checkbox"/> AOLV/PM <input type="checkbox"/> EZOLV Sets the second function for MFDI terminal S3.	F (1 - 19F)

When MFDI terminal S3 activates, it will operate the function set to *H1-03* [Terminal S3 Function Selection] and the function set to *H1-23* at the same time.

When the setting value is *F*, the function is disabled.

■ H1-24: Terminal S4 Function Selection 2

No. (Hex.)	Name	Description	Default (Range)
H1-24 (0B73)	Terminal S4 Function Selection 2	<input type="checkbox"/> V/f <input type="checkbox"/> OLV <input type="checkbox"/> OLV/PM <input type="checkbox"/> AOLV/PM <input type="checkbox"/> EZOLV Sets the second function for MFDI terminal S4.	F (1 - 19F)

When MFDI terminal S4 activates, it will operate the function set to *H1-04* [Terminal S4 Function Selection] and the function set to *H1-24* at the same time.

When the setting value is *F*, the function is disabled.

■ **H1-25: Terminal S5 Function Select 2**

No. (Hex.)	Name	Description	Default (Range)
H1-25 (0B74)	Terminal S5 Function Selection 2	<div style="display: flex; gap: 5px;"> V/f OLV OLV/PM AOLV/PM EZOLV </div> Sets the second function for MFDI terminal S5.	F (1 - 19F)

When MFDI terminal S5 activates, it will operate the function set to *H1-05* [Terminal S5 Function Selection] and the function set to *H1-25* at the same time.

When the setting value is *F*, the function is disabled.

■ **H1-26: Terminal S6 Function Select 2**

No. (Hex.)	Name	Description	Default (Range)
H1-26 (0B75)	Terminal S6 Function Selection 2	<div style="display: flex; gap: 5px;"> V/f OLV OLV/PM AOLV/PM EZOLV </div> Sets the second function for MFDI terminal S6.	F (1 - 19F)

When MFDI terminal S6 activates, it will operate the function set to *H1-06* [Terminal S6 Function Selection] and the function set to *H1-26* at the same time.

When the setting value is *F*, the function is disabled.

■ **H1-27: Terminal S7 Function Select 2**

No. (Hex.)	Name	Description	Default (Range)
H1-27 (0B76)	Terminal S7 Function Selection 2	<div style="display: flex; gap: 5px;"> V/f OLV OLV/PM AOLV/PM EZOLV </div> Sets the second function for MFDI terminal S7.	F (1 - 19F)

When MFDI terminal S7 activates, it will operate the function set to *H1-07* [Terminal S7 Function Selection] and the function set to *H1-27* at the same time.

When the setting value is *F*, the function is disabled.

■ **MEMOBUS/Modbus MFDI 1 to 3 Function Selection**

You can set the function for the MFDI to MEMOBUS register *bit 0 to 2* of [15C0(Hex.)]. Use *H1-40 to H1-42* [Extend MFDI Function Selection] to select the bit function for each bit.

Note:

- Refer to [MFDI Setting Values on page 647](#) for more information about MFDI setting values.
- You cannot set values *0* [3-Wire Sequence] and *20 to 2F* [External Fault] for *H1-40 to H1-42*.
- When you will not use *H1-40 to H1-42*, set them to *F* [Through Mode].

■ **H1-40: Mbus Reg 15C0h bit0 Input Func**

No. (Hex.)	Name	Description	Default (Range)
H1-40 (0B54)	Mbus Reg 15C0h bit0 Input Func	<div style="display: flex; gap: 5px;"> V/f OLV OLV/PM AOLV/PM EZOLV </div> Sets MFDI function to set to <i>bit 0</i> of the MEMOBUS register <i>15C0</i> (Hex.).	F (1 - 19F)

■ **H1-41: Mbus Reg 15C0h bit1 Input Func**

No. (Hex.)	Name	Description	Default (Range)
H1-41 (0B55)	Mbus Reg 15C0h bit1 Input Func	<div style="display: flex; gap: 5px;"> V/f OLV OLV/PM AOLV/PM EZOLV </div> Sets MFDI function to set to <i>bit 1</i> of the MEMOBUS register <i>15C0</i> (Hex.).	F (1 - 19F)

■ H1-42: Mbus Reg 15C0h bit2 Input Func

No. (Hex.)	Name	Description	Default (Range)
H1-42 (0B56)	Mbus Reg 15C0h bit2 Input Func	<div style="display: flex; justify-content: space-between; align-items: center;"> V/f OLV OLV/PM AOLV/PM EZOLV </div> Sets MFDI function to set to bit 2 of the MEMOBUS register 15C0 (Hex.).	F (1 - 19F)

◆ MFDI Setting Values

Selects a function set with H1-01 to H1-42.

■ 0: 3-Wire Sequence

Setting Value	Function	Description
0	3-Wire Sequence	<div style="display: flex; justify-content: space-between; align-items: center;"> V/f OLV OLV/PM AOLV/PM EZOLV </div> Sets the direction of motor rotation for 3-wire sequence.

If the 3-wire sequence is set to a terminal that is not MFDI terminals S1 and S2, these terminals will be the input terminals for Forward run/Reverse run command. The drive will automatically set terminal S1 to Run command (RUN) and terminal S2 to Stop command (STOP).

When terminal S1 (Run command) activates for 1 ms minimum, the drive rotates the motor. When terminal S2 (Stop command) deactivates, the drive stops. When terminal Sx that is set in 3-wire sequence deactivates, the drive operates in the forward direction, and when it activates, the drive operates in the reverse direction.

WARNING! Sudden Movement Hazard. Set the MFDI parameters before you close control circuit switches. Incorrect Run/Stop circuit sequence settings can cause serious injury or death from moving equipment.

WARNING! Sudden Movement Hazard. When you use a 3-Wire sequence, set A1-03 = 3330 [Initialize Parameters = 3-Wire Initialization] and make sure that b1-17 = 0 [Run Command at Power Up = Disregard Existing RUN Command] (default). If you do not correctly set the drive parameters for 3-Wire operation before you energize the drive, the motor can suddenly rotate when you energize the drive.

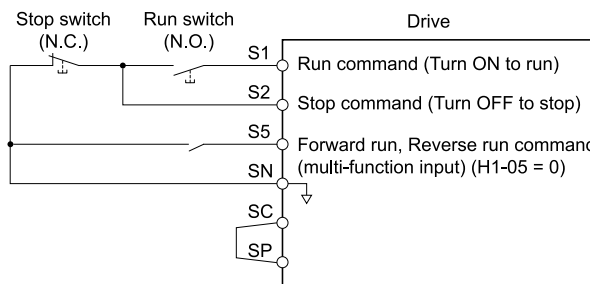

Figure 12.56 3-Wire Sequence Wiring Example

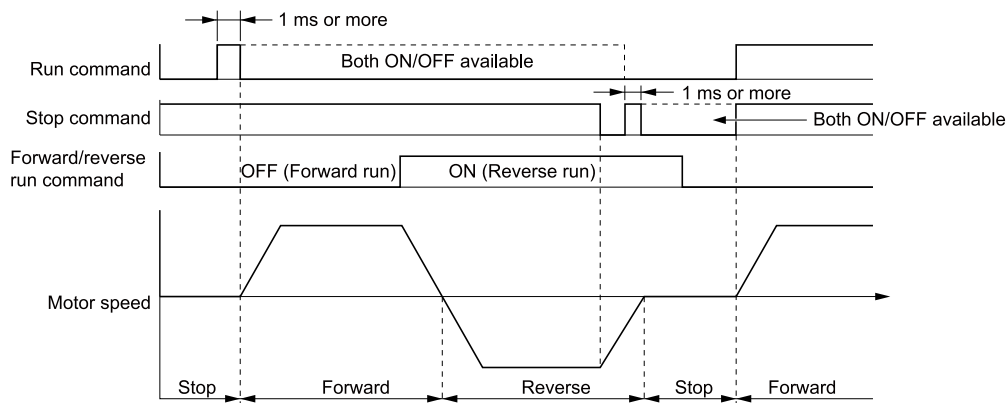







Figure 12.57 3-Wire Sequence Time Chart



Note:

- To input the Run command, activate the terminal for 1 ms minimum.
- The default setting for *b1-17 [Run Command at Power Up]* is 0 [Disregard existing RUN command]. If you enable the Run command on an energized drive, the protective function activates and the  flashes quickly. When the application will let an energized drive Run, set *b1-17 = 1 [Accept Existing RUN Command]*.

1: LOCAL/REMOTE Selection

Setting Value	Function	Description
1	LOCAL/REMOTE Selection	     Sets drive control for the keypad (LOCAL) or an external source (REMOTE).

Note:

- When the MFDI terminal sets the LOCAL/REMOTE selection,  on the keypad is disabled.
- When LOCAL Mode is selected, the green light for  comes on.
- When the Run command is ON, you cannot switch between LOCAL Mode and REMOTE Mode.





ON : LOCAL

The keypad is the Frequency reference source and Run command source.

OFF : REMOTE

The frequency reference and Run command settings are set in *b1-01, b1-02 [Frequency Reference Selection 1/2]* or *b1-15, b1-16 [Run Command Selection 1/2]*.

2: External Reference 1/2 Selection

Setting Value	Function	Description
2	External Reference 1/2 Selection	     Sets the drive to use Run command source 1/2 or Reference command source 1/2 when in REMOTE Mode.

Note:

The ability to switch the Run command source and frequency reference source depends on the setting of *b1-07 [LOCAL/REMOTE Run Selection]*.





Table 12.47 Ability to Switch the Run Command Source and Frequency Reference Source when Inputting the Run Command

<i>b1-07</i>	Run command source	Frequency reference source
0 [Disregard Existing RUN Command] (Default)	No	Yes
1 [Accept Existing RUN Command]	Yes	Yes

ON : *b1-15 [Frequency Reference Selection 2], b1-16 [Run Command Selection 2]*

OFF : *b1-01 [Frequency Reference Selection 1], b1-02 [Run Command Selection 1]*





3: Multi-Step Speed Reference 1

Setting Value	Function	Description
3	Multi-Step Speed Reference 1	     Uses speed references <i>d1-01 to d1-16</i> to set a multi-step speed reference.

Note:

Refer to [Setting Procedures for Multi-step Speed Operation on page 581](#) for more information.

4: Multi-Step Speed Reference 2

Setting Value	Function	Description
4	Multi-Step Speed Reference 2	     Uses speed references <i>d1-01 to d1-16</i> to set a multi-step speed reference.

Note:

Refer to [Setting Procedures for Multi-step Speed Operation on page 581](#) for more information.

5: Multi-Step Speed Reference 3

Setting Value	Function	Description
5	Multi-Step Speed Reference 3	V/f OLV OLV/PM AOLV/PM EZOLV Uses speed references <i>d1-01</i> to <i>d1-16</i> to set a multi-step speed reference.

Note:

Refer to [Setting Procedures for Multi-step Speed Operation on page 581](#) for more information.

6: Jog Reference Selection

Setting Value	Function	Description
6	Jog Reference Selection	V/f OLV OLV/PM AOLV/PM EZOLV Sets the drive to use the JOG Frequency Reference (JOG command) set in <i>d1-17</i> . The JOG Frequency Reference (JOG command) overrides <i>Frequency References 1 to 16 (d1-01 to d1-16)</i> .

7: Accel/Decel Time Selection 1

Setting Value	Function	Description
7	Accel/Decel Time Selection 1	V/f OLV OLV/PM AOLV/PM EZOLV Sets the drive to use <i>Acceleration/Deceleration Time 1 [C1-01, C1-02]</i> or <i>Acceleration/Deceleration Time 2 [C1-03, C1-04]</i> .

Note:

Refer to [C1: Accel & Decel Time on page 559](#) for more information.

8: Baseblock Command (N.O.)

Setting Value	Function	Description
8	Baseblock Command (N.O.)	V/f OLV OLV/PM AOLV/PM EZOLV Sets the command that stops drive output and coasts the motor to stop when the input is ON.

WARNING! Incorrect Operation. Yaskawa recommends that you use *H1-xx = 9 [Baseblock Command (N.C.)]*. If a circuit error occurs in the MFDI, the drive cannot stop the output when the terminal set to *H1-xx = 8 [Baseblock Command (N.O.)]* turns ON.

The keypad flashes *bb [Baseblock]*. If you cancel the baseblock command when the Run command is active, the drive will restart the motor and use the speed search function.

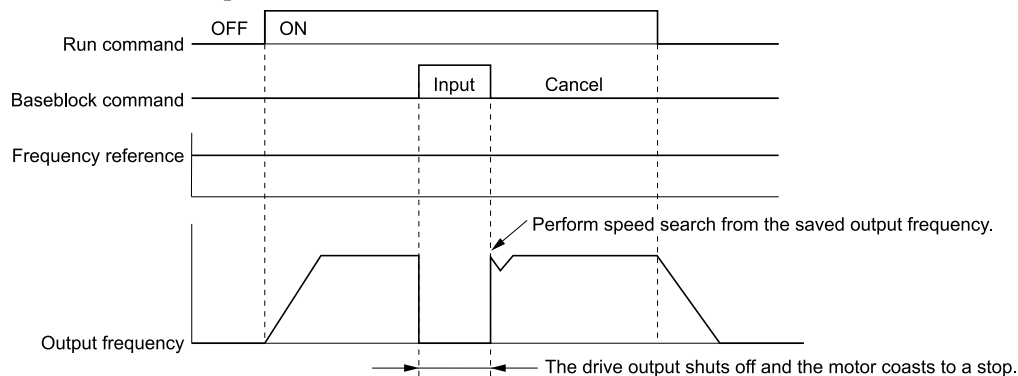

Figure 12.58 Baseblock Command Time Chart

ON : Baseblock (drive output stop)

OFF : Normal operation

9: Baseblock Command (N.C.)

Setting Value	Function	Description
9	Baseblock Command (N.C.)	V/f OLV OLV/PM AOLV/PM EZOLV Sets the command that stops drive output and coasts the motor to stop when the input terminal is OFF.

The keypad flashes *bb [Baseblock]*. If you cancel the baseblock command when the Run command is active, the drive will restart the motor and use the speed search function.

ON : Normal operation

OFF : Baseblock (drive output stop)

■ **A: Accel/Decel Ramp Hold**

Setting Value	Function	Description
A	Accel/Decel Ramp Hold	<div style="display: flex; justify-content: space-between; align-items: center;"> V/f OLV OLV/IPM AOLV/IPM EZOLV </div> <p>Momentarily pauses motor acceleration and deceleration when the terminal is turned ON, retains the output frequency that was stored in the drive at the time of the pause, and restarts motor operation.</p>

If the terminal is deactivated, the drive restarts acceleration and deceleration.

When the acceleration/deceleration ramp hold terminal is activated and $d4-01 = 1$ [*Freq Reference Retention Select = Enabled*], the drive will store the output frequency in memory. While the acceleration/deceleration ramp hold command is activated, the drive will always restart the motor at this output frequency.

Note:

Refer to *d4-01: Freq Reference Hold Selection on page 589* for more information.

■ **B: Overheat Alarm (oH2)**

Setting Value	Function	Description
B	Overheat Alarm (oH2)	<div style="display: flex; justify-content: space-between; align-items: center;"> V/f OLV OLV/IPM AOLV/IPM EZOLV </div> <p>Sets the drive to show an oH2 [<i>External Overheat (HI-XX=B)</i>] alarm when the input terminal is ON. The alarm does not have an effect on drive operation.</p>

■ **C: Analog Terminal Enable Selection**

Setting Value	Function	Description
C	Analog Terminal Enable Selection	<div style="display: flex; justify-content: space-between; align-items: center;"> V/f OLV OLV/IPM AOLV/IPM EZOLV </div> <p>Sets the command that enables or disables the terminals selected in <i>H3-14 [Analog Input Terminal Enable Sel]</i>.</p>

ON : Terminal selected with H3-14 is enabled

OFF : Terminal selected with H3-14 is disabled

■ **E: ASR Integral Reset**

Setting Value	Function	Description
E	ASR Integral Reset	<div style="display: flex; justify-content: space-between; align-items: center;"> V/f OLV OLV/IPM AOLV/IPM EZOLV </div> <p>Sets the command to reset the integral value and use PI control or P control for the speed control loop.</p>

ON : P control

OFF : PI control

■ **F: Not Used**

Setting Value	Function	Description
F	Not Used	<div style="display: flex; justify-content: space-between; align-items: center;"> V/f OLV OLV/IPM AOLV/IPM EZOLV </div> <p>Use this setting for unused terminals or to use terminals in through mode.</p>

Through Mode uses the signal input to the terminal as a digital input for the upper sequence through a communication option or MEMOBUS/Modbus communications. This input signal does not have an effect on drive operation.

■ **10: Up Command**

Setting Value	Function	Description
10	Up Command	<div style="display: flex; justify-content: space-between; align-items: center;"> V/f OLV OLV/IPM AOLV/IPM EZOLV </div> <p>Sets the command to use a push button switch to increase the drive frequency reference. You must also set <i>Setting 11 [Down Command]</i>.</p>

ON : Increases the frequency reference.

OFF : Holds the current frequency reference.

Note:

- If you set only the Up command or only the Down command, the drive will detect *oPE03* [Multi-Function Input Setting Err].
- If you set two or more of these functions at the same time, the drive will detect *oPE03*:
 - Up/Down command
 - Accel/Decel Ramp Hold
 - Reference Sample Hold
 - Offset Frequency 1, 2, 3 addition
 - Up/Down 2 Command
- The Up/Down command does not function in these conditions:
 - b1-01 = 2, 3* [Frequency Reference Selection 1 = Memobus/Modbus Communications, Option PCB]
 - b1-02 ≠ 1* [Run Command Selection 1 ≠ Control Circuit Terminal]
 - Drive is in LOCAL mode
 - Set to *b1-15* [Frequency Reference Selection 2] by use of *H1-xx = 2* [MFDI Function Select = External Reference 1/2 Selection]

When you enter the UP command, the frequency reference increases.

The Up and Down commands have priority over all other frequency references. When you enable the Up/Down command, the drive will ignore these frequency references:

- Frequency reference from Keypad [*b1-01 = 0*]
- Frequency reference from Analog Input [*b1-01 = 1*]
- Frequency reference from Pulse Train Input [*b1-01 = 4*]

Table 12.48 shows the Up and Down commands with their operation.

Table 12.48 Up Command and Down Command

Command status		Drive operation
Up command (10)	Down command (11)	
OFF	OFF	Keeps the current frequency reference.
ON	OFF	Increases the frequency reference.
OFF	ON	Decreases the frequency reference.
ON	ON	Keeps the current frequency reference.

Combine Frequency Reference Hold Functions and Up/Down Commands

- When you clear the Run command or when *d4-01 = 0* [Freq Reference Hold Selection = Disabled], and you restart the drive, the Up/Down command resets to 0.
- When *d4-01 = 1* [Enabled], the drive saves the frequency reference set during the Up/Down command. When you cycle the Run command or restart the drive, the drive saves the frequency reference value and restarts the motor at this frequency value. After you clear the Run command, activate the terminal set for the Up command or Down command to set the saved reference value to 0.

Note:

Refer to *d4-01: Freq Reference Hold Selection on page 589* for more information.

Combine Upper/Lower Limits of the Frequency Reference and the Up/Down Commands

Set the upper limit value of the frequency reference to *d2-01* [Frequency Reference Upper Limit].

Use an analog input or *d2-02* [Frequency Reference Lower Limit] to set the lower limit value of the frequency reference. The configurable values change when the setting for *d4-10* [Up/Down Freq Lower Limit Select] changes. When you input a Run command, these are the lower limits of the frequency reference:

- When the lower limit of the frequency reference is set only for *d2-02*, the drive accelerates the motor to the lower limit value of the frequency reference at the same time that you input the Run command.
- When the lower limit of the frequency reference is set only for analog input, the drive accelerates the motor to the lower limit value of the frequency reference when the Run command, and Up command or Down command for the drive is enabled. When only the Run command is enabled, the motor does not start.
- When these conditions occur, the drive accelerates the motor to the *d2-02* setting value when the Run command is input. When the motor accelerates to the setting value of *d2-02*, if the Up/Down command is enabled, the motor accelerates to the lower limit value of the analog input.
 - The lower limit value of the frequency reference is set for the analog input and *d2-02*

– The lower limit value of the analog input is higher than the setting value of *d2-02*

Note:

Refer to *d4-01: Freq Reference Hold Selection on page 589* for more information.

Figure 12.59 shows an example of how Up/Down command operates. In this example, the lower limit value of the frequency reference is set in *d2-02*. Figure 12.59 shows the time chart when Freq Reference Retention Select [*d4-01*] is enabled and disabled.

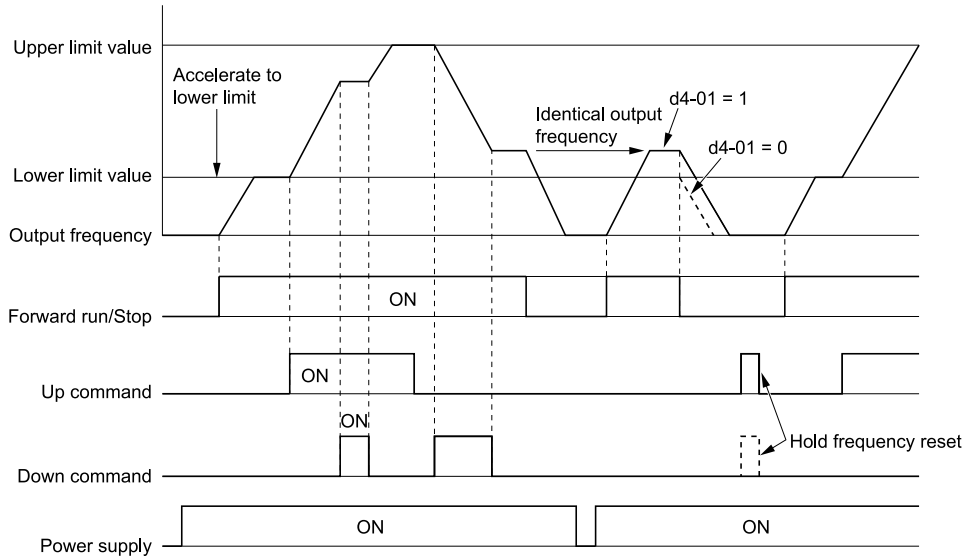

Figure 12.59 Up/Down Command Time Chart

■ 11: Down Command

Setting Value	Function	Description
11	Down Command	<div style="display: flex; gap: 5px;"> V/f OLV OLV/PM AOLV/PM EZOLV </div> <p>Sets the command to use a push button switch to decrease the drive frequency reference. You must also set <i>Setting 10 [Up Command]</i>.</p>

ON : Decreases the frequency reference.

OFF : Holds the current frequency reference.

Note:

- If you set only the Up command or only the Down command, the drive will detect *oPE03 [Multi-Function Input Setting Err]*.
- If you set two or more of these functions at the same time, the drive will detect *oPE03*:
 - Up/Down command
 - Accel/Decel Ramp Hold
 - Reference Sample Hold
 - Offset Frequency 1, 2, 3 addition
 - Up/Down 2 Command
- The Up/Down command does not function in these conditions:
 - b1-01 = 2, 3 [Frequency Reference Selection 1 = Memobus/Modbus Communications, Option PCB]*
 - b1-02 ≠ 1 [Run Command Selection 1 ≠ Control Circuit Terminal]*
 - Drive is in LOCAL mode
 - Set to *b1-15 [Frequency Reference Selection 2]* by use of *H1-xx = 2 [MFDI Function Select = External Reference 1/2 Selection]*

When you enter the UP command, the frequency reference increases. When you enter the Down command, the frequency reference decreases.

The Up and Down commands have priority over all other frequency references. When you enable the Up/Down command, the drive will ignore these frequency references:

- Frequency reference from Keypad [*b1-01 = 0*]
- Frequency reference from Analog Input [*b1-01 = 1*]
- Frequency reference from Pulse Train Input [*b1-01 = 4*]

12: Forward Jog

Setting Value	Function	Description
12	Forward Jog	<div style="display: flex; justify-content: space-between; align-items: center;"> V/f OLV OLV/PM AOLV/PM EZOLV </div> Sets the command to operate the motor in the forward direction at the Jog Frequency set in <i>d1-17</i> [Jog Reference].

Note:

- It is not necessary to input the Run command.
- The Forward JOG command has priority over all other frequency references.
- When the Forward JOG and Reverse JOG commands are activated at the same time for 500 ms or longer, the drive will ramp to stop.

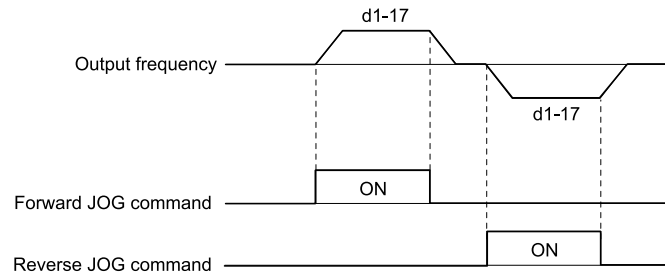

Figure 12.60 JOG Operation Pattern

13: Reverse Jog

Setting Value	Function	Description
13	Reverse Jog	<div style="display: flex; justify-content: space-between; align-items: center;"> V/f OLV OLV/PM AOLV/PM EZOLV </div> Sets the command to operate the motor in the reverse direction at the Jog Frequency set in <i>d1-17</i> [Jog Reference].

Note:

- It is not necessary to input the Run command.
- The Reverse JOG command has priority over all other frequency references.
- When the Forward JOG and Reverse JOG commands are activated at the same time for 500 ms or longer, the drive will ramp to stop.

14: Fault Reset

Setting Value	Function	Description
14	Fault Reset	<div style="display: flex; justify-content: space-between; align-items: center;"> V/f OLV OLV/PM AOLV/PM EZOLV </div> Sets the command to reset the current fault when the Run command is inactive.

If the drive detects a fault, the drive will activate the fault relay output, turn off the output, and the motor will coast to stop.

If the drive detects a fault for which you can set the stopping method, apply the appropriate Stopping Method. Then push  (RESET) on the keypad to turn the Run command OFF, or activate the fault reset terminal to reset the fault.

Note:

The drive ignores the fault reset command when the Run command is active. Remove the Run command before trying to reset a fault.

15: Fast Stop (N.O.)

Setting Value	Function	Description
15	Fast Stop (N.O.)	<div style="display: flex; justify-content: space-between; align-items: center;"> V/f OLV OLV/PM AOLV/PM EZOLV </div> Sets the command to ramp to stop in the deceleration time set in <i>C1-09</i> [Fast Stop Time] when the input terminal is ON while the drive is operating.

WARNING! Incorrect Operation. Yaskawa recommends that you use *H1-xx = 17* [Fast Stop (N.C.)]. If a circuit error occurs in the MFDI, the drive cannot stop the output when the terminal set to *H1-xx = 15* [Fast Stop (N.O.)] turns ON.

If you cancel the fast stop input, the drive will not restart the motor until you meet these conditions:

- Fully stop the motor
- Cancel the Run command
- Cancel the fast stop command

Note:

- To use the N.C. switch to input the fast stop command, set $H1-xx = 17$ [Fast Stop (N.C.)].
- Refer to [C1-09: Fast Stop Time on page 562](#) for more information.
- Set $C1-09$ [Fast Stop Time] to a correct deceleration time. If the deceleration time is too short, it can cause an overvoltage fault, which will not stop the motor from coasting.

■ **16: Motor 2 Selection**

Setting Value	Function	Description
16	Motor 2 Selection	<div style="display: flex; gap: 5px;"> V/f OLV OLV/PM AOLV/PM EZOLV </div> <p>Sets the command for the drive to operate motor 1 or motor 2. Stop the motors before switching.</p>

You can use an external input to switch operation between two induction motors. The drive will save the control methods, V/f patterns, and motor parameters for the two motors.

ON : Operate motor 2

OFF : Operate motor 1

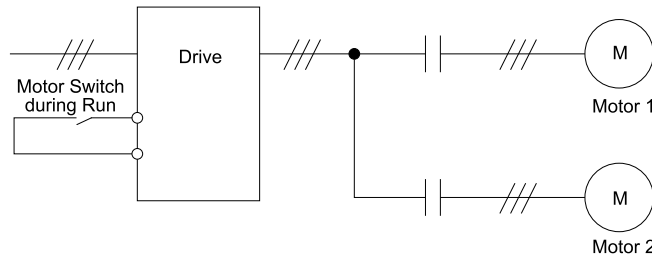

When you select motor 2, the drive will switch to motor 2 parameters.

Table 12.49 Parameters that Switch between Motor 1 and Motor 2

Parameter	Motor 2 Selection	
	OFF (Motor 1)	ON (Motor 2)
C1-xx [Accel & Decel Time]	C1-01 to C1-04	C1-05 to C1-08
C3-xx [Slip Compensation]	C3-01 to C3-04	C3-21 to C3-24
C4-xx [Torque Compensation]	C4-01	C4-07
C5-xx [Automatic Speed Regulator (ASR)]	C5-01 to C5-08, C5-12	-
E1-xx, E3-xx [V/f Patterns] E2-xx, E4-xx [Motor Parameters]	E1-xx, E2-xx	E3-xx, E4-xx

Note:

- When you use 2 motors, the drive applies the protective function set in $L1-01$ [Motor Overload Protection Select] to motor 1 and motor 2.
- You cannot switch between motors 1 and 2 during run. If you try to switch motors when they are running, it will cause a rUn error.
- You must wait 200 ms minimum to input a Run command.

■ **17: Fast Stop (N.C.)**

Setting Value	Function	Description
17	Fast Stop (N.C.)	<div style="display: flex; gap: 5px;"> V/f OLV OLV/PM AOLV/PM EZOLV </div> <p>Sets the command to ramp to stop in the deceleration time set in $C1-09$ [Fast Stop Time] when the input terminal is ON while the drive is operating.</p>

If you cancel the fast stop input, the drive will not restart the motor until you meet these conditions:

- Fully stop the motor
- Cancel the Run command
- Cancel the fast stop command

Note:

- To use the N.O. switch to input the fast stop command, set 15 (Fast Stop (N.O.)).
- Refer to [C1-09: Fast Stop Time on page 562](#) for more information.
- Set $C1-09$ [Fast Stop Time] to a correct deceleration time. If the deceleration time is too short, it can cause an overvoltage fault and failure to stop the motor from coasting.

Figure 12.61 shows an example of how fast stop operates.

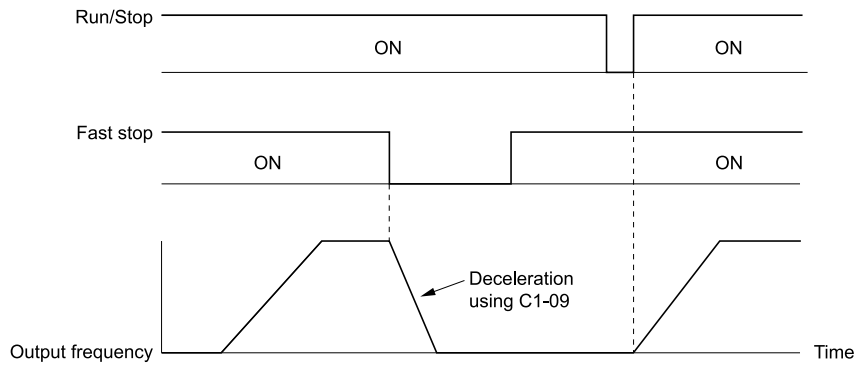

Figure 12.61 Fast Stop Time Chart

18: Timer Function

Setting Value	Function	Description
18	Timer Function	<input type="checkbox"/> V/f <input type="checkbox"/> OLV <input type="checkbox"/> OLV/PM <input type="checkbox"/> AOLV/PM <input type="checkbox"/> EZOLV Sets the command to start the timer function. Use this setting with <i>Timer Output</i> [H2-xx = 12].

Note:

Refer to [b4: Timer Function on page 535](#) for more information.

19: PID Disable

Setting Value	Function	Description
19	PID Disable	<input type="checkbox"/> V/f <input type="checkbox"/> OLV <input type="checkbox"/> OLV/PM <input type="checkbox"/> AOLV/PM <input type="checkbox"/> EZOLV Sets the command to disable PID control when <i>b5-01 = 1 to 8</i> [PID Mode Setting = Enabled].

ON : PID control disabled

OFF : PID control enabled

1A: Accel/Decel Time Selection 2

Setting Value	Function	Description
1 A	Accel/Decel Time Selection 2	<input type="checkbox"/> V/f <input type="checkbox"/> OLV <input type="checkbox"/> OLV/PM <input type="checkbox"/> AOLV/PM <input type="checkbox"/> EZOLV Set this function and <i>H1-xx = 7</i> [Accel/Decel Time Selection 1] together. Sets the drive to use <i>Acceleration/Deceleration Time 3</i> [C1-05, C1-06] or <i>Acceleration/Deceleration Time 4</i> [C1-07, C1-08].

Note:

Refer to [C1: Accel & Decel Time on page 559](#) for more information.

1B: Programming Lockout

Setting Value	Function	Description
1B	Programming Lockout	<input type="checkbox"/> V/f <input type="checkbox"/> OLV <input type="checkbox"/> OLV/PM <input type="checkbox"/> AOLV/PM <input type="checkbox"/> EZOLV Sets the command to prevent parameter changes when the terminal is OFF.

You can continue to view parameter setting values when the terminal is OFF [*Parameter Write Prohibit*].

ON : Programming Lockout

OFF : Parameter Write Prohibit

1E: Reference Sample Hold

Setting Value	Function	Description
1E	Reference Sample Hold	<input type="checkbox"/> V/f <input type="checkbox"/> OLV <input type="checkbox"/> OLV/PM <input type="checkbox"/> AOLV/PM <input type="checkbox"/> EZOLV Sets the command to sample the frequency reference at terminal A1 or A2, and hold the frequency reference at that frequency.

When the terminal is active for 100 ms, this function reads a sample of the analog frequency reference and holds that sample. When you input the sample/hold command again, the function again reads a sample of the analog frequency

reference and holds that sample. When you turn off the power, the drive erases the saved analog frequency and resets the frequency reference to 0.

Figure 12.62 shows an example of how the function operates.

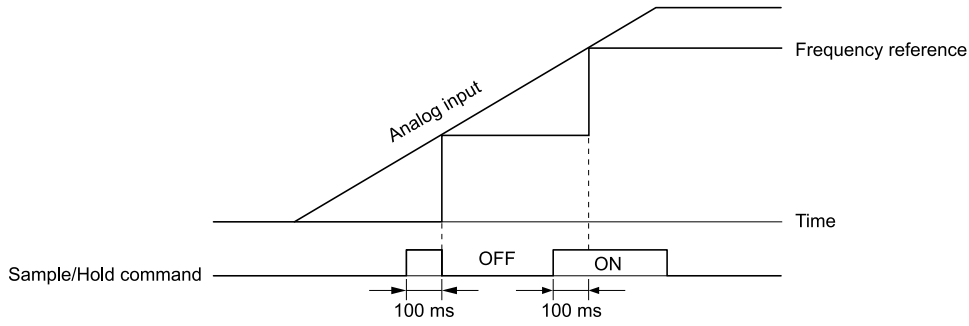

Figure 12.62 Reference Sample Hold

You cannot set the Reference Sample Hold function at the same time as these functions:

- H1-xx = A [Accel/Decel Ramp Hold]
- H1-xx = 10, 11 [Up Command, Down Command]
- H1-xx = 44 to 46 [Add Offset Frequency 1 to 3]
- H1-xx = 75, 76 [Up 2 Command, Down 2 Command]

If you set them at the same time, the drive will detect oPE03 [Multi-Function Input Setting Err].

■ 20 to 2F: External Fault

Setting Value	Function	Description
20 to 2F	External Fault	<div style="display: flex; gap: 5px;"> V/f OLV OLV/PM AOLV/PM EZOLV </div> Sets a command to stop the drive when a failure or fault occurs on an external device.

WARNING! Incorrect Operation. Yaskawa recommends that you use H1-xx = 21, 23, 25, 27, 29, 2B, 2D, 2F [External Fault (N.C.)]. If a circuit error occurs in the MFDI, the drive cannot stop the output when the terminal set to H1-xx = 20, 22, 24, 26, 28, 2A, 2C, 2E [External Fault (N.O.)] turns ON.

If an external fault is input to the drive, the keypad will show EFX [External Fault (Terminal Sx)], where x is the number of the terminal (terminal Sx) to which the external fault signal is assigned. For example, when an external fault signal is input to terminal S3, the keypad will show EF3 [External Fault (Terminal S3)].

Use these conditions to select the value to set in H1-xx:

- Signal input method from peripheral devices
- External fault detection method
- Motor stopping method (operation after external fault detection)

Table 12.50 shows the relation between the conditions and the value set to H1-xx.

Table 12.50 Stopping Methods for External Fault

Setting	Signal Input Method from Peripheral Devices *1		External Fault Detection Method *2		Stopping Method			
	N.O.	N.C.	Always Detected	Detected during RUN Only	Ramp to Stop (Fault)	Coast to Stop (Fault)	Fast Stop (Fault)	Continuous Operation (Alarm Only)
20	x	-	x	-	x	-	-	-
21	-	x	x	-	x	-	-	-
22	x	-	-	x	x	-	-	-
23	-	x	-	x	x	-	-	-
24	x	-	x	-	-	x	-	-
25	-	x	x	-	-	x	-	-
26	x	-	-	x	-	x	-	-
27	-	x	-	x	-	x	-	-

Setting	Signal Input Method from Peripheral Devices ^{*1}		External Fault Detection Method ^{*2}		Stopping Method			
	N.O.	N.C.	Always Detected	Detected during RUN Only	Ramp to Stop (Fault)	Coast to Stop (Fault)	Fast Stop (Fault)	Continuous Operation (Alarm Only)
28	x	-	x	-	-	-	x	-
29	-	x	x	-	-	-	x	-
2A	x	-	-	x	-	-	x	-
2B	-	x	-	x	-	-	x	-
2C	x	-	x	-	-	-	-	x
2D	-	x	x	-	-	-	-	x
2E	x	-	-	x	-	-	-	x
2F	-	x	-	x	-	-	-	x

*1 Set the terminal to N.O. (detects external fault when switched ON) or N.C. (detects external fault when switched OFF).

*2 Set the drive to always detect each fault or to detect only during run.

■ 30: PID Integrator Reset

Setting Value	Function	Description
30	PID Integrator Reset	<div style="display: flex; gap: 5px;"> V/f OLV OLV/PM AOLV/PM EZOLV </div> Sets the command to reset and hold the PID control integral to 0 when the terminal is ON.

Note:

Refer to [b5: PID control on page 537](#) for more information.

■ 31: PID Integrator Hold

Setting Value	Function	Description
31	PID Integrator Hold	<div style="display: flex; gap: 5px;"> V/f OLV OLV/PM AOLV/PM EZOLV </div> Sets the command to hold the integral value of the PID control while the terminal is activated.

When you turn off the input terminal, PID control restarts the integral.

Note:

Refer to [b5: PID control on page 537](#) for more information.

■ 32: Multi-Step Speed Reference 4

Setting Value	Function	Description
32	Multi-Step Speed Reference ⁴	<div style="display: flex; gap: 5px;"> V/f OLV OLV/PM AOLV/PM EZOLV </div> Uses speed references <i>d1-01</i> to <i>d1-16</i> to set a multi-step speed reference.

Note:

Refer to [Setting Procedures for Multi-step Speed Operation on page 581](#) for more information.

■ 34: PID Soft Starter Disable

Setting Value	Function	Description
34	PID Soft Starter Disable	<div style="display: flex; gap: 5px;"> V/f OLV OLV/PM AOLV/PM EZOLV </div> Sets the PID soft starter function.

ON : Disable

Disables *b5-17* [PID Accel/Decel Time].

OFF : Enabled

Enables *b5-17* [PID Accel/Decel Time].

Note:

Refer to [b5: PID control on page 537](#) for more information.

■ 35: PID Input (Error) Invert

Setting Value	Function	Description
35	PID Input (Error) Invert	<div style="display: flex; justify-content: space-between; align-items: center;"> V/f OLV OLV/PM AOLV/PM EZOLV </div> <p>Sets the command to turn the terminal ON and OFF to switch the PID input level (polarity).</p>

Note:

Refer to [b5: PID control on page 537](#) for more information.

■ 3E: PID Setpoint Selection 1

Setting Value	Function	Description
3E	PID Setpoint Selection 1	<div style="display: flex; justify-content: space-between; align-items: center;"> V/f OLV OLV/PM AOLV/PM EZOLV </div> <p>Set this function and $H1-xx = 3F$ [PID Setpoint Selection 2] together. Sets the function to switch the PID setpoint to b5-58 to b5-60 [PID Setpoint 2 to 4].</p>

Refer to [b5-58 to b5-60: PID Setpoints 2 to 4 on page 550](#) for more information.

■ 3F: PID Setpoint Selection 2

Setting Value	Function	Description
3F	PID Setpoint Selection 2	<div style="display: flex; justify-content: space-between; align-items: center;"> V/f OLV OLV/PM AOLV/PM EZOLV </div> <p>Set this function and $H1-xx = 3E$ [PID Setpoint Selection 1] at the same time. Sets the function to switch the PID setpoint to b5-58 to b5-60 [PID Setpoint 2 to 4].</p>

Refer to [b5-58 to b5-60: PID Setpoints 2 to 4 on page 550](#) for more information.

■ 40: Forward RUN (2-Wire)

Setting Value	Function	Description
40	Forward RUN (2-Wire)	<div style="display: flex; justify-content: space-between; align-items: center;"> V/f OLV OLV/PM AOLV/PM EZOLV </div> <p>Sets the Forward Run command for 2-wire sequence 1. Set this function and $H1-xx = 41$ [Reverse RUN (2-Wire)] together.</p>

ON : Forward Run

OFF : Stop

Note:

- If you turn ON the Forward Run command terminal and the Reverse Run command terminal, it will cause an *EF [FWD/REV Run Command Input Error]* alarm and the motor will ramp to stop.
- Initialize the drive with a 2-wire sequence to set the Forward Run command to terminal S1.
- This function will not operate at the same time as $H1-xx = 42, 43$ [Run Command (2-Wire Sequence 2), FWD/REV (2-Wire Sequence 2)].

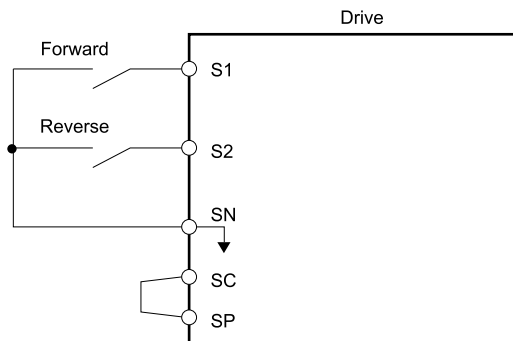

Figure 12.63 2-Wire Sequence Wiring Example

■ 41: Reverse RUN (2-Wire)

Setting Value	Function	Description
41	Reverse RUN (2-Wire)	<div style="display: flex; justify-content: space-between; align-items: center;"> V/f OLV OLV/PM AOLV/PM EZOLV </div> <p>Sets the Forward Run command for 2-wire sequence 1. Set this function and $H1-xx = 40$ [Forward RUN (2-Wire)] together.</p>

ON : Reverse Run

OFF : Stop**Note:**

- If you turn ON the Forward Run command terminal and the Reverse Run command terminal, it will cause an *EF [FWD/REV Run Command Input Error]* alarm and the motor will ramp to stop.
- Initialize the drive with a 2-wire sequence to set the Reverse Run command to terminal S2.
- This function will not operate at the same time as $H1-xx = 42, 43$ [*Run Command (2-Wire Sequence 2), FWD/REV (2-Wire Sequence 2)*].

■ 42: Run Command (2-Wire Sequence 2)

Setting Value	Function	Description
42	Run Command (2-Wire Sequence 2)	V/f OLV OLV/PM AOLV/PM EZOLV Sets the Run command for 2-wire sequence 2. Set this function and $H1-xx = 43$ [<i>FWD/REV (2-Wire Sequence 2)</i>] together.

ON : Run**OFF : Stop****Note:**

This function will not operate at the same time as $H1-xx = 40, 41$ [*Forward RUN (2-Wire), Reverse RUN (2-Wire)*].

■ 43: FWD/REV (2-Wire Sequence 2)

Setting Value	Function	Description
43	FWD/REV (2-Wire Sequence 2)	V/f OLV OLV/PM AOLV/PM EZOLV Sets the direction of motor rotation for 2-wire sequence 2. Set this function and $H1-xx = 42$ [<i>Run Command (2-Wire Sequence 2)</i>] together.

ON : Reverse Run**OFF : Forward Run****Note:**

- You must input the Run command to rotate the motor.
- This function will not operate at the same time as $H1-xx = 40, 41$ [*Forward RUN (2-Wire), Reverse RUN (2-Wire)*].

■ 44: Add Offset Frequency 1 (d7-01)

Setting Value	Function	Description
44	Add Offset Frequency 1 (d7-01)	V/f OLV OLV/PM AOLV/PM EZOLV Sets the function to add the offset frequency set in $d7-01$ [<i>Offset Frequency 1</i>] to the frequency reference when the terminal activates.

Note:

Refer to [d7: Offset Frequency on page 595](#) for more information.

■ 45: Add Offset Frequency 2 (d7-02)

Setting Value	Function	Description
45	Add Offset Frequency 2 (d7-02)	V/f OLV OLV/PM AOLV/PM EZOLV Sets the function to add the offset frequency set in $d7-02$ [<i>Offset Frequency 2</i>] to the frequency reference when the terminal activates.

Note:

Refer to [d7: Offset Frequency on page 595](#) for more information.

■ 46: Add Offset Frequency 3 (d7-03)

Setting Value	Function	Description
46	Add Offset Frequency 3 (d7-03)	V/f OLV OLV/PM AOLV/PM EZOLV Sets the function to add the offset frequency set in $d7-03$ [<i>Offset Frequency 3</i>] to the frequency reference when the terminal activates.

Note:

Refer to [d7: Offset Frequency on page 595](#) for more information.

■ 47: Node Setup (CANopen)

Setting Value	Function	Description
47	Node Setup (CANopen)	<div style="display: flex; justify-content: space-between; align-items: center;"> V/f OLV OLV/IPM AOLV/IPM EZOLV </div> <p>Sets the function in CANopen communications to start the Node Setup function to set the drive node address from the host controller.</p>

■ 60: DC Injection Braking Command

Setting Value	Function	Description
60	DC Injection Braking Command	<div style="display: flex; justify-content: space-between; align-items: center;"> V/f OLV OLV/IPM AOLV/IPM EZOLV </div> <p>Sets the command to use DC Injection Braking to stop the motor.</p>

If you input the Run command or JOG command, it will cancel DC Injection Braking.

Figure 12.64 shows the time chart of the DC Injection Braking function.

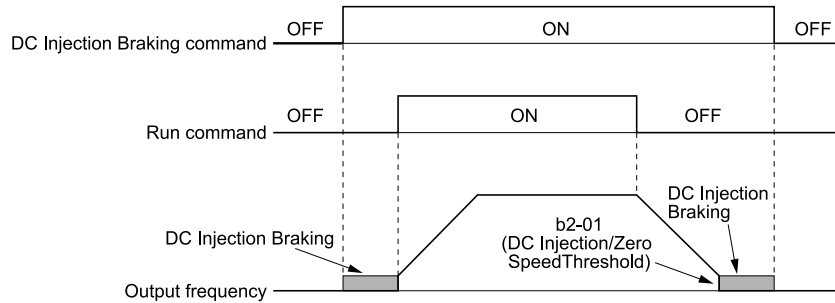

Figure 12.64 DC Injection Braking Time Chart

Note:

- When $A1-02 = 8$ [Control Method Selection = EZOLV], this function is available with a PM motor.
- Refer to [b2: DC Injection Braking and Short Circuit Braking on page 523](#) for more information.

■ 61: Speed Search from Fmax

Setting Value	Function	Description
61	Speed Search from Fmax	<div style="display: flex; justify-content: space-between; align-items: center;"> V/f OLV OLV/IPM AOLV/IPM EZOLV </div> <p>Sets the function to use an external reference to start speed search although $b3-01 = 0$ [Speed Search Selection at Start = Disabled] to not allow speed search at start.</p>

When the terminal is activated for $b3-24 = 2$ [Speed Search Method Selection = Current Detection 2], the drive starts speed search from the maximum output frequency.

Note:

- The drive will detect $oPE03$ [Multi-Function Input Setting Err] if you set $H1-xx = 61$ and $H1-xx = 62$ at the same time.
- Refer to [b3: Speed Search on page 526](#) for more information.

■ 62: Speed Search from Fref

Setting Value	Function	Description
62	Speed Search from Fref	<div style="display: flex; justify-content: space-between; align-items: center;"> V/f OLV OLV/IPM AOLV/IPM EZOLV </div> <p>Sets the function to use an external reference to start speed search although $b3-01 = 0$ [Speed Search Selection at Start = Disabled] to not allow speed search at start.</p>

When the terminal is activated for $b3-24 = 2$ [Speed Search Method Selection = Current Detection 2], the drive starts speed search from the frequency reference.

Note:

- The drive will detect $oPE03$ [Multi-Function Input Setting Err] if you set $H1-xx = 61$ and $H1-xx = 62$ at the same time.
- Refer to [b3: Speed Search on page 526](#) for more information.

■ 63: Field Weakening

Setting Value	Function	Description
63	Field Weakening	<div style="display: flex; justify-content: space-between; align-items: center;"> V/f OLV OLV/PM AOLV/PM EZOLV </div> <p>Sets the function to send the Field Weakening Level and Field Weakening Frequency Limit commands set in <i>d6-01 [Field Weakening Level]</i> and <i>d6-02 [Field Weakening Frequency Limit]</i> when the input terminal is activated.</p>

Note:

Refer to [d6: Field Weakening /Forcing on page 594](#) for more information.

■ 65: KEB Ride-Thru 1 Activate (N.C.)

Setting Value	Function	Description
65	KEB Ride-Thru 1 Activate (N.C.)	<div style="display: flex; justify-content: space-between; align-items: center;"> V/f OLV OLV/PM AOLV/PM EZOLV </div> <p>Sets operation of the KEB1 function through the KEB Ride-Thru 1 (N.C.).</p>

ON : Normal operation

OFF : Deceleration during momentary power loss

When you enable KEB Ride-Thru 1, set *L2-29 [KEB Method Selection]*. The drive operates with the selected KEB method.

Note:

- If you set *KEB Ride-Thru 1 [H1-xx = 65, 66]* and *KEB Ride-Thru 2 [H1-xx = 7A, 7B]* at the same time, the drive will detect *oPE03 [Multi-Function Input Setting Err]*.
- Refer to [KEB Ride-Thru Function on page 720](#) for more information.

■ 66: KEB Ride-Thru 1 Activate (N.O.)

Setting Value	Function	Description
66	KEB Ride-Thru 1 Activate (N.O.)	<div style="display: flex; justify-content: space-between; align-items: center;"> V/f OLV OLV/PM AOLV/PM EZOLV </div> <p>Sets operation of the KEB1 function through the KEB Ride-Thru 1 (N.O.).</p>

ON : Deceleration during momentary power loss

OFF : Normal operation

When you enable KEB Ride-Thru 1, set *L2-29 [KEB Method Selection]*. The drive operates with the selected KEB method.

Note:

- If you set *KEB Ride-Thru 1 [H1-xx = 65, 66]* and *KEB Ride-Thru 2 [H1-xx = 7A, 7B]* at the same time, the drive will detect *oPE03 [Multi-Function Input Setting Err]*.
- Refer to [KEB Ride-Thru Function on page 720](#) for more information.

■ 67: Communications Test Mode

Setting Value	Function	Description
67	Communications Test Mode	<div style="display: flex; justify-content: space-between; align-items: center;"> V/f OLV OLV/PM AOLV/PM EZOLV </div> <p>Set the function for the drive to self-test RS-485 serial communications operation.</p>

The Self-Diagnostics function connects the transmission terminal of the control terminal block to the reception terminal. The function transmits the data that the drive sent to make sure that the drive can communicate correctly.

Note:

Refer to [Self-Diagnostics on page 235](#) for more information.

■ 68: High Slip Braking (HSB) Activate

Setting Value	Function	Description
68	High Slip Braking (HSB) Activate	<div style="display: flex; justify-content: space-between; align-items: center;"> V/f OLV OLV/PM AOLV/PM EZOLV </div> <p>Sets the command to use high-slip braking to stop the motor.</p>

Note:

- When you restart the drive after you use high-slip braking, make sure that the drive fully stops the motor, then clear the high-slip braking input.
- Refer to *High Slip Braking (HSB) on page 763* for more information.

■ **6A: Drive Enable**

Setting Value	Function	Description
6 A	Drive Enable	<div style="display: flex; justify-content: space-between; align-items: center;"> V/f OLV OLV/PM AOLV/PM EZOLV </div> <p>Sets the function to show <i>dnE [Drive Disabled]</i> on the keypad and ignore Run commands when the terminal is OFF.</p>

If you input the Run command before you turn ON the Drive Enable terminal, you must input the Run command again to operate the drive. When you deactivate the terminal set for Drive Enable while the drive is operating, the drive will use the stopping method set in *b1-03 [Stopping Method Selection]* to stop the motor.

ON : Run command is accepted.

OFF : Run command is disabled. When the drive is running, it stops according to *b1-03* setting.

■ **75: Up 2 Command**

Setting Value	Function	Description
75	Up 2 Command	<div style="display: flex; justify-content: space-between; align-items: center;"> V/f OLV OLV/PM AOLV/PM EZOLV </div> <p>Sets the function to increase the frequency reference bias value to accelerate the motor when the terminal is activated. Set this function and <i>H1-xx = 76 [Down 2 Command]</i> together.</p>

When you activate the terminal set for Up2 Command, the bias will increase. When you activate the terminal set for Down 2 Command, the bias will decrease. When you activate or deactivate the two commands, the drive will hold the frequency reference. [Table 12.51](#) gives information about the relation between operation of the Up/Down 2 Command and *d4-01, d4-03, and 4-05*.

Note:

- When you use this function, set the optimal bias limit values with *d4-08* and *d4-09 [Up/Down 2 Bias Upper Limit/Lower Limit]*.
- Refer to *d4: Frequency Ref Up/Down & Hold on page 589* for more information.

Table 12.51 Up 2 Command, Down 2 Command

Function	Frequency Reference Source	d4-03	d4-05	d4-01	Operation	Storing the Frequency Reference or Frequency Bias
1	Multi-step speed reference	0.00	0	0	<ul style="list-style-type: none"> • When the Up 2 Command is active, the drive accelerates the motor (increases the bias value). • When the Down 2 Command is active, the drive decelerates the motor (decreases the bias value) • When the Up 2 Command and Down 2 Command are active or not active, the drive holds the output frequency. (holds the bias value). • When the frequency changes, it will reset the bias. • For all other statuses, the drive will follow the frequency reference. 	Not stored.
2				1		When the bias value and frequency reference are constant for 5 seconds after the frequency reference hold starts, the drive will add the bias value to the enabled frequency reference, then reset.
3				-		Not stored.
4	Multi-step speed reference	> 0	-	0	<ul style="list-style-type: none"> • When the Up 2 Command is active, the drive accelerates the motor to "Frequency Reference + <i>d4-03</i>" (the bias value will increase to the value set in <i>d4-03</i>) • When the Down 2 Command is active, the drive decelerates the motor to "Frequency Reference - <i>d4-03</i>" (the bias value will decrease to the value set in <i>d4-03</i>). • When the Up 2 Command and Down 2 Command are active or not active, the drive holds the output frequency. (holds the bias value). • When the frequency changes, it will reset the bias. • For all other statuses, the drive will follow the frequency reference. 	Not stored.
5				1		When the bias value and frequency reference are constant for 5 seconds after the frequency reference hold starts, the drive will add the bias value to the enabled frequency reference, then reset.

Function	Frequency Reference Source	d4-03	d4-05	d4-01	Operation	Storing the Frequency Reference or Frequency Bias
6	Others (Analog input, transmission)	0	0	0	<ul style="list-style-type: none"> When the Up 2 Command is active, the drive accelerates the motor (increases the bias value). When the Down 2 Command is active, the drive decelerates the motor (decreases the bias value) When the Up 2 Command and Down 2 Command are active or not active, the drive holds the output frequency (holds the bias value). During acceleration or deceleration, when the frequency reference increases or decreases more than <i>d4-07</i>, the drive holds the bias value until the output frequency and the actual frequency reference agree (speed agreement). 	Not stored.
7				1		When the bias value is constant for 5 seconds after the frequency reference hold starts, the drive will store the bias value in <i>d4-06</i> . You cannot rewrite the frequency reference is not possible. The drive will store only the bias value.
8	Others (Analog input, transmission)	0	1	-	<ul style="list-style-type: none"> When the Up 2 Command is active, the drive accelerates the motor (increases the bias value). When the Down 2 Command is active, the drive decelerates the motor (decreases the bias value) For all other statuses, the drive will follow the frequency reference. 	Not stored.
9				0		Not stored.
10		> 0	-	1	<ul style="list-style-type: none"> When the Up 2 Command is active, the drive accelerates the motor to "Frequency Reference + <i>d4-03</i>" (the bias value will increase to the value set in <i>d4-03</i>) When the Down 2 Command is active, the drive decelerates the motor to "Frequency Reference - <i>d4-03</i>" (the bias value will decrease to the value set in <i>d4-03</i>). During acceleration or deceleration, when the frequency reference increases or decreases more than <i>d4-07</i>, the drive holds the bias value until the output frequency and the actual frequency reference agree (speed agreement). 	When the bias value is constant for 5 seconds after the frequency reference hold starts, the drive will store the bias value in <i>d4-06</i> . You cannot rewrite the frequency reference is not possible. The drive will store only the bias value.

■ 76: Down 2 Command

Setting Value	Function	Description
76	Down 2 Command	<div style="display: flex; gap: 5px;"> V/f OLV OLV/PM AOLV/PM EZOLV </div> <p>Sets the function to decrease the frequency reference bias value to decelerate the motor when the terminal is activated. Set this function and <i>H1-xx = 75 [Up 2 Command]</i> together.</p>

When you activate the terminal set for Up2 Command, the bias will increase. When you activate the terminal set for Down 2 Command, the bias will decrease. When you activate or deactivate the two commands, the drive will hold the frequency reference.

Note:

- When you use this function, set the optimal bias limit values with *d4-08* and *d4-09 [Up/Down 2 Bias Upper Limit/Lower Limit]*.
- Refer to [d4: Frequency Ref Up/Down & Hold on page 589](#) for more information.

■ 77: ASR Gain (C5-03) Select

Setting Value	Function	Description
77	ASR Gain (C5-03) Select	<div style="display: flex; gap: 5px;"> V/f OLV OLV/PM AOLV/PM EZOLV </div> <p>Sets the function to switch the ASR proportional gain to <i>C5-01 [ASR Proportional Gain 1]</i> or <i>C5-03 [ASR Proportional Gain 2]</i>.</p>

ON : C5-03

Switches the proportional gain to *C5-03 [ASR Proportional Gain 2]*.

OFF : C5-01

Switches the proportional gain to *C5-01 [ASR Proportional Gain 1]*.

Note:

Refer to [C5: Auto Speed Regulator \(ASR\) on page 571](#) for more information.

■ 78: Analog TorqueRef Polarity Invert

Setting Value	Function	Description
78	Analog TorqueRef Polarity Invert	<div style="display: flex; gap: 5px;"> V/f OLV OLV/PM AOLV/PM EZOLV </div> <p>Sets the rotation direction of the external torque reference.</p>

ON : External torque reference reverse direction

OFF : External torque reference forward direction

■ **7A: KEB Ride-Thru 2 Activate (N.C.)**

Setting Value	Function	Description
7A	KEB Ride-Thru 2 Activate (N.C.)	<div style="display: flex; justify-content: space-between; align-items: center;"> V/f OLV OLV/PM AOLV/PM EZOLV </div> Sets operation of the KEB2 function through the KEB Ride-Thru 2 (N.C.).

ON : Normal operation

OFF : Deceleration during momentary power loss

When KEB Ride-Thru 2 is input, the drive will use Single Drive KEB Ride-Thru 2 for KEB operation. The L2-29 [KEB Method Selection] setting will not have an effect.

Note:

- If you set KEB Ride-Thru 1 [H1-xx = 65, 66] and KEB Ride-Thru 2 [H1-xx = 7A, 7B] at the same time, the drive will detect oPE03 [Multi-Function Input Setting Err].
- Refer to [KEB Ride-Thru Function on page 720](#) for more information.

■ **7B: KEB Ride-Thru 2 Activate (N.O.)**

Setting Value	Function	Description
7B	KEB Ride-Thru 2 Activate (N.O.)	<div style="display: flex; justify-content: space-between; align-items: center;"> V/f OLV OLV/PM AOLV/PM EZOLV </div> Sets operation of the KEB2 function through the KEB Ride-Thru 2 (N.O.).

ON : Deceleration during momentary power loss

OFF : Normal operation

When KEB Ride-Thru 2 is input, the drive will use Single Drive KEB Ride-Thru 2 for KEB operation. The L2-29 [KEB Method Selection] setting will not have an effect.

Note:

- If you set KEB Ride-Thru 1 [H1-xx = 65, 66] and KEB Ride-Thru 2 [H1-xx = 7A, 7B] at the same time, the drive will detect oPE03 [Multi-Function Input Setting Err].
- Refer to [KEB Ride-Thru Function on page 720](#) for more information.

■ **7C: Short Circuit Braking (N.O.)**

Setting Value	Function	Description
7C	Short Circuit Braking (N.O.)	<div style="display: flex; justify-content: space-between; align-items: center;"> V/f OLV OLV/PM AOLV/PM EZOLV </div> Sets operation of Short Circuit Braking (N.O.).

WARNING! Incorrect Operation. Yaskawa recommends that you use H1-xx = 7D [Short Circuit Braking (N.C.)]. If a circuit error occurs in the MFDI, the motor can take longer than expected to stop when the terminal set to H1-xx = 7C [Short Circuit Braking (N.O.)] turns ON.

The drive will short circuit the three phases of a PM motor to cause braking torque in the spinning motor.

Note:

- When A1-02 = 8 [Control Method Selection = EZOLV], this function is available only when you use a PM motor.
- Refer to [b2: DC Injection Braking and Short Circuit Braking on page 523](#) for more information.

ON : Short Circuit Braking is enabled.

OFF : Normal operation

■ **7D: Short Circuit Braking (N.C.)**

Setting Value	Function	Description
7D	Short Circuit Braking (N.C.)	<div style="display: flex; justify-content: space-between; align-items: center;"> V/f OLV OLV/PM AOLV/PM EZOLV </div> Sets operation of Short Circuit Braking (N.C.).

The drive will short circuit the three phases of a PM motor to cause braking torque in the spinning motor.

Note:

- When A1-02 = 8 [Control Method Selection = EZOLV], this function is available only when you use a PM motor.
- Refer to [b2: DC Injection Braking and Short Circuit Braking on page 523](#) for more information.

ON : Normal operation

OFF : Short Circuit Braking is enabled.

■ 7E: Reverse Rotation Identifier

Setting Value	Function	Description
7E	Reverse Rotation Identifier	<div style="display: flex; justify-content: space-between; align-items: center;"> V/f OLV OLV/PM AOLV/PM EZOLV </div> Sets the motor rotation direction when you use Simple Closed Loop V/f Control method.

ON : Reverse run

The drive knows that the motor is rotating in the reverse direction.

OFF : Forward run

The drive knows that the motor is rotating in the forward direction.

■ 90 to 96: DWEZ Digital Inputs 1 to 7

Setting Value	Function	Description
90 - 96	DWEZ Digital Inputs 1 to 7	<div style="display: flex; justify-content: space-between; align-items: center;"> V/f OLV OLV/PM AOLV/PM EZOLV </div> Sets digital inputs used with DriveWorksEZ. Refer to the DriveWorksEZ online manual for more information.

Note:

You cannot set values 90 to 96 for inverse output.

■ 9F: DWEZ Disable

Setting Value	Function	Description
9F	DWEZ Disable	<div style="display: flex; justify-content: space-between; align-items: center;"> V/f OLV OLV/PM AOLV/PM EZOLV </div> Sets operation of the DriveWorksEZ program saved in the drive.

Note:

Set $A1-07 = 2$ [DriveWorksEZ Function Selection = Enabled/Disabled wDigital Input] to use this function.

ON : Disabled

OFF : Enabled

■ 101 to 19F: Inverse Input of 1 to 9F

Setting Value	Function	Description
101 to 19F	Inverse Input of 1 to 9F	Sets the function of the selected MFDI to operate inversely. To select the function, enter "1xx", where the "xx" is the function setting value.

For example, to use the inverse input of E [ASR Integral Reset], set $H1-xx = 10E$.

Note:

You cannot use inverse input for all functions. Refer to [Table 12.46](#) for more information.

◆ H2: MFDO

$H2$ parameters set the MFDO terminal functions.

■ H2-01 to H2-03 Terminal MA/MB-MC, P1-C1, P2-C2 Function Selection

The drive has four MFDO terminals. [Table 12.52](#) shows the default function settings for the terminals.

Table 12.52 MFDO Terminals Default Function Settings

No.	Name	Default	Function
H2-01	Term MA/MB-MC Function Selection (Contact)	E	Fault
H2-02	Term P1-C1 Function Selection	0	During Run
H2-03	Term P2-C2 Function Selection	2	Speed Agree 1

Refer to [Table 12.53](#) to set $H2-xx$ [MFDO Function Select].

Table 12.53 MFDO Setting Values

Setting Value	Function	Reference	Setting Value	Function	Reference
0	During Run	675	20	Drive Overheat Pre-Alarm (oH)	683
1	Zero Speed	675	21	Safety Monitor Output Status	683
2	Speed Agree 1	675	22	Mechanical Weakening Detection	683
3	User-Set Speed Agree 1	676	2F	Maintenance Notification	683
4	Frequency Detection 1	676	30	During Torque Limit	684
5	Frequency Detection 2	677	37	During Frequency Output	684
6	Drive Ready	677	38	Drive Enabled	684
7	DC Bus Undervoltage	678	39	Watt Hour Pulse Output	684
8	During Baseblock (N.O.)	678	3C	LOCAL Control Selected	685
9	Frequency Reference from Keypad	678	3D	During Speed Search	685
A	Run Command Source	678	3E	PID Feedback Low	685
B	Torque Detection 1 (N.O.)	678	3F	PID Feedback High	685
C	Frequency Reference Loss	678	4A	During KEB Ride-Thru	685
D	Braking Resistor Fault	679	4B	During Short Circuit Braking	685
E	Fault	679	4C	During Fast Stop	686
F *1	Not Used	679	4D	oH Pre-Alarm Time Limit	686
10	Alarm	679	4E	Braking Transistor Fault (rr)	686
11	Fault Reset Command Active	679	4F	Braking Resistor Overheat (rH)	686
12	Timer Output	679	61	Pole Position Detection Complete	686
13	Speed Agree 2	679	62	Modbus Reg 1 Status Satisfied	686
14	User-Set Speed Agree 2	680	63	Modbus Reg 2 Status Satisfied	686
15	Frequency Detection 3	680	66	Comparator1	686
16	Frequency Detection 4	681	67	Comparator2	687
17	Torque Detection 1 (N.C.)	681	69	External Power 24V Supply	687
18	Torque Detection 2 (N.O.)	681	6A	Data Logger Error	688
19	Torque Detection 2 (N.C.)	682	90 to 92	DWEZ Digital Output 1 to 3	688
1A	During Reverse	682	100 to 192	Inverse output of 0 to 92 Sets an inverse output of the function for the MFDO. Put a 1 at the front of the function setting to set inverse output. For example, set 138 for inverse output of 38 [Drive Enabled].	688
1B	During Baseblock (N.C.)	682			
1C	Motor 2 Selection	682			
1E	Executing Auto-Restart	683			
1F	Motor Overload Alarm (oL1)	683			

*1 Inverse output is not available.

Extended MFDO1 to MFDO3 Function Selection

You can set MFDO functions to bit 0 to bit 2 [MEMOBUS MFDO1 to 3] of MEMOBUS register 15E0 (Hex.). Use H2-40 to H2-42 [Mbus Reg 15E0h bit0 to bit2 Output Func] to select the function.

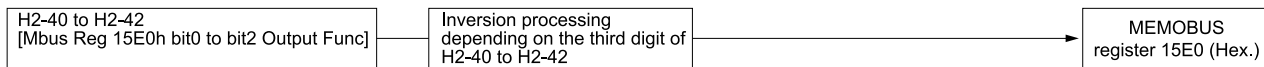

Figure 12.65 Functional Block Diagram of MEMOBUS Multi-function Output

Table 12.54 MEMOBUS MFDO Registers

Register number (Hex.)	Name	
15E0	bit0	MEMOBUS MFDO 1
	bit1	MEMOBUS MFDO 2
	bit2	MEMOBUS MFDO 3

Note:

- Refer to *MFDO Setting Values on page 674* for more information about MFDO setting values.
- When you do not set functions to H2-40 to H2-42, set them to F.

Output of Logical Operation Results of MFDO

This enables the logical operation results of two MFDOs to be output to one MFDO terminal.

Use H2-60, H2-63, and H2-66 [Term MA,MB,MC Secondary Function, Terminal P1 Secondary Function, and Terminal P2 Secondary Function] to set the function of the output signal for which you will perform logical operations.

Use H2-61, H2-64, and H2-67 [Term MA,MB,MC Logical Operation, Terminal P1 Logical Operation, and Terminal P2 Logical Operation] to set the logical operation.

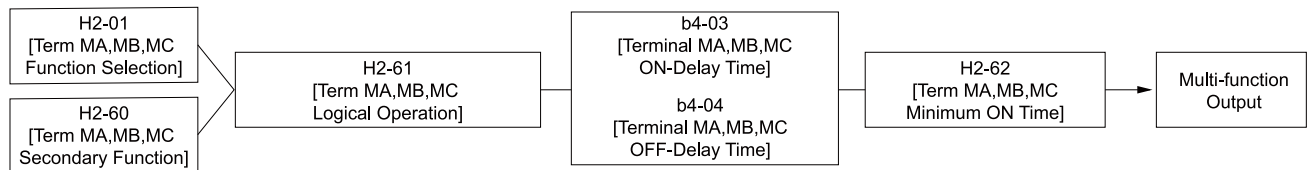

Figure 12.66 Functional Block Diagram of Logical Operation Output for MFDO 1

Table 12.55 MFDO Logical Operation Table

Logical Operation Selection	Logical Operation Expression	Logical Operation Notation
H2-61, H2-64, H2-67		
0	A=B=1	
1	A=1 or B=1	
2	A=0 or B=0	
3	A=B=0	
4	A=B	A=B
5	A != B	
6	AND (A, B̄)	
7	OR (A, B̄)	
8	-	On

Note:

- If you use the function to output logical calculation results, you cannot set H2-01 to H2-03 = 1xx [Inverse Output of xx]. If you do, the drive will detect oPE33 [Digital Output Selection Error].
- When you do not use H2-60, H2-63, and H2-66, set them to F. The through mode function is not supported.

◆ H2 MFDO Parameters

■ H2-01: Term MA/MB-MC Function Selection

No. (Hex.)	Name	Description	Default (Range)
H2-01 (040B)	Term MA/MB-MC Function Selection	V/f OLV OLV/IPM AOLV/IPM EZOLV Sets the function set for MFDO terminal MA-MC or MB-MC.	E (0 - 1FF)

Note:

Set this parameter to *F* when the terminal is not being used or to use the terminal in through mode.

■ H2-02: Term P1-C1 Function Selection

No. (Hex.)	Name	Description	Default (Range)
H2-02 (040C)	Term P1-C1 Function Selection	V/f OLV OLV/IPM AOLV/IPM EZOLV Sets the function for MFDO terminal P1-C1.	0 (0 - 1FF)

Note:

Set this parameter to *F* when the terminal is not being used or to use the terminal in through mode.

■ H2-03: Term P2-C2 Function Selection

No. (Hex.)	Name	Description	Default (Range)
H2-03 (040D)	Term P2-C2 Function Selection	V/f OLV OLV/IPM AOLV/IPM EZOLV Sets the function for MFDO terminal P2-C2.	2 (0 - 1FF)

Note:

Set this parameter to *F* when the terminal is not being used or to use the terminal in through mode.

■ H2-06: Watt Hour Output Unit Selection

No. (Hex.)	Name	Description	Default (Range)
H2-06 (0437)	Watt Hour Output Unit Selection	V/f OLV OLV/IPM AOLV/IPM EZOLV Sets the unit for the output signal when H2-01 to H2-03 = 39 [MFDO Function Selection = Watt Hour Pulse Output].	0 (0 - 4)

This output is input to the Watt hour meter or PLC through a 200 ms pulse signal. The drive triggers a 200 ms pulse each time the kWh data is at the value set in H2-06. This parameter sets the kWh unit for each pulse output.

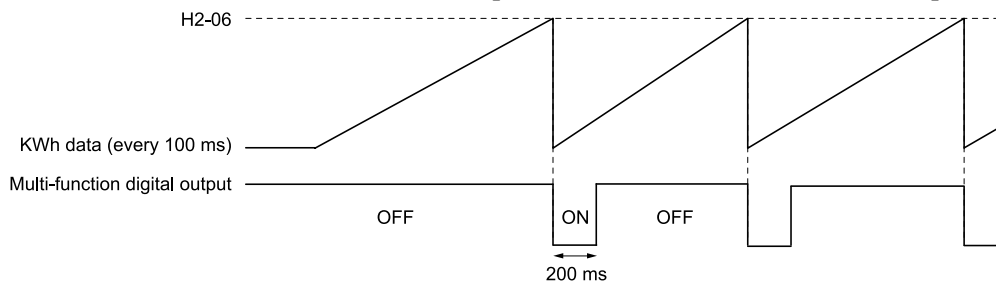

Figure 12.67 Example MFDO when Configured for Watt Hours

Note:

- When the power value is a negative value (regenerative state), the drive does not count Watt hours.
- When the control power supply to the drive is operating, the drive will keep the Watt hours. If a momentary power loss causes the drive to lose control power, the Watt hour count will reset.

0 : 0.1 kWh units

1 : 1 kWh units

2 : 10 kWh units

3 : 100 kWh units

4 : 1000 kWh units

■ H2-07: Modbus Register 1 Address Select

No. (Hex.)	Name	Description	Default (Range)
H2-07 (0B3A)	Modbus Register 1 Address Select	<input type="checkbox"/> V/f <input type="checkbox"/> OLV <input type="checkbox"/> OLV/PM <input type="checkbox"/> AOLV/PM <input type="checkbox"/> EZOLV Sets the address of the MEMOBUS/Modbus register output to the MFDO terminal.	0001 (0001 - 1FFF)

Sets the address of the register that is output to *Modbus Reg 1 Status Satisfied* [H2-01 to H2-03 = 62] and uses the bit in H2-08 [Modbus Register 1 Bit Select].

■ H2-08: Modbus Register 1 Bit Select

No. (Hex.)	Name	Description	Default (Range)
H2-08 (0B3B)	Modbus Register 1 Bit Select	<input type="checkbox"/> V/f <input type="checkbox"/> OLV <input type="checkbox"/> OLV/PM <input type="checkbox"/> AOLV/PM <input type="checkbox"/> EZOLV Sets the bit of the MEMOBUS/Modbus register output to the MFDO terminal.	0000 (0000 - FFFF)

Sets the bit of the register that is output to *Modbus Reg 1 Status Satisfied* [H2-01 to H2-03 = 62] and uses the address in H2-07 [Modbus Register 1 Address Select].

■ H2-09: Modbus Register 2 Address Select

No. (Hex.)	Name	Description	Default (Range)
H2-09 (0B3C)	Modbus Register 2 Address Select	<input type="checkbox"/> V/f <input type="checkbox"/> OLV <input type="checkbox"/> OLV/PM <input type="checkbox"/> AOLV/PM <input type="checkbox"/> EZOLV Sets the address of the MEMOBUS/Modbus register output to the MFDO terminal.	0001 (0001 - 1FFF)

Sets the address of the register that is output to *Modbus Reg 2 Status Satisfied* [H2-01 to H2-03 = 63] and uses the bit in H2-10 [Modbus Register 2 Bit Select].

■ H2-10: Modbus Register 2 Bit Select

No. (Hex.)	Name	Description	Default (Range)
H2-10 (0B3D)	Modbus Register 2 Bit Select	<input type="checkbox"/> V/f <input type="checkbox"/> OLV <input type="checkbox"/> OLV/PM <input type="checkbox"/> AOLV/PM <input type="checkbox"/> EZOLV Sets the bit of the MEMOBUS/Modbus register output to the MFDO terminal.	0000 (0000 - FFFF)

Sets the bit of the register that is output to *Modbus Reg 2 Status Satisfied* [H2-01 to H2-03 = 63] and uses the address in H2-09 [Modbus Register 2 Address Select].

■ H2-20: Comparator 1 Monitor Selection

No. (Hex.)	Name	Description	Default (Range)
H2-20 (1540)	Comparator 1 Monitor Selection	<input type="checkbox"/> V/f <input type="checkbox"/> OLV <input type="checkbox"/> OLV/PM <input type="checkbox"/> AOLV/PM <input type="checkbox"/> EZOLV Sets the monitor number for comparator 1. Set the x-xx part of the Ux-xx [Monitor]. For example, set H2-20 = 102 to monitor U1-02 [Output Frequency].	102 (000 - 999)

Note:

- For information on the comparator function, refer to [66: Comparator1 on page 686](#) and [67: Comparator2 on page 687](#).
- The configurable monitor changes when the control method changes.

■ H2-21: Comparator 1 Lower Limit

No. (Hex.)	Name	Description	Default (Range)
H2-21 (1541)	Comparator 1 Lower Limit	<input type="checkbox"/> V/f <input type="checkbox"/> OLV <input type="checkbox"/> OLV/PM <input type="checkbox"/> AOLV/PM <input type="checkbox"/> EZOLV Sets the lower limit detection level for comparator 1 when the full scale analog output for the monitor selected in H2-20 [Comparator 1 Monitor Selection] is the 100% value.	0.0% (0.0 - 300.0%)

Note:

For information on the comparator function, refer to [66: Comparator1 on page 686](#) and [67: Comparator2 on page 687](#).

■ **H2-22: Comparator 1 Upper Limit**

No. (Hex.)	Name	Description	Default (Range)
H2-22 (1542)	Comparator 1 Upper Limit	<div style="display: flex; gap: 5px;"> V/f OLV OLV/IPM AOLV/IPM EZOLV </div> <p>Sets the upper limit detection level for comparator 1 when the full scale analog output for the monitor selected in H2-20 [Comparator 1 Monitor Selection] is the 100% value.</p>	0.0% (0.0 - 300.0%)

Note:

For information on the comparator function, refer to [66: Comparator1 on page 686](#) and [67: Comparator2 on page 687](#).

■ **H2-23: Comparator 1 Hysteresis**

No. (Hex.)	Name	Description	Default (Range)
H2-23 (1543)	Comparator 1 Hysteresis	<div style="display: flex; gap: 5px;"> V/f OLV OLV/IPM AOLV/IPM EZOLV </div> <p>Sets the hysteresis level for comparator 1 as a percentage of the full scale analog output for the monitor selected in H2-20 [Comparator 1 Monitor Selection].</p>	0.0% (0.0 - 10.0%)

Note:

For information on the comparator function, refer to [66: Comparator1 on page 686](#) and [67: Comparator2 on page 687](#).

■ **H2-24: Comparator 1 On-Delay Time**

No. (Hex.)	Name	Description	Default (Range)
H2-24 (1544)	Comparator 1 On-Delay Time	<div style="display: flex; gap: 5px;"> V/f OLV OLV/IPM AOLV/IPM EZOLV </div> <p>Sets the on-delay time for comparator 1.</p>	0.0 s (0.0 - 600.0 s)

Note:

For information on the comparator function, refer to [66: Comparator1 on page 686](#) and [67: Comparator2 on page 687](#).

■ **H2-25: Comparator 1 Off-Delay Time**

No. (Hex.)	Name	Description	Default (Range)
H2-25 (1545)	Comparator 1 Off-Delay Time	<div style="display: flex; gap: 5px;"> V/f OLV OLV/IPM AOLV/IPM EZOLV </div> <p>Sets the off-delay time for comparator 1.</p>	0.0 s (0.0 - 600.0 s)

Note:

For information on the comparator function, refer to [66: Comparator1 on page 686](#) and [67: Comparator2 on page 687](#).

■ **H2-26: Comparator 2 Monitor Selection**

No. (Hex.)	Name	Description	Default (Range)
H2-26 (1546)	Comparator 2 Monitor Selection	<div style="display: flex; gap: 5px;"> V/f OLV OLV/IPM AOLV/IPM EZOLV </div> <p>Sets the monitor number for comparator 2. Set the x-xx part of the Ux-xx [Monitor]. For example, set H2-26 = 103 to monitor U1-03 [Output Current].</p>	103 (000 - 999)

Note:

- The configurable monitor changes when the control method changes.
- When you use the terminal in through mode, set this parameter to 000 or 031. You can set the terminal output level from the PLC through MEMOBUS/Modbus communications or the communication option.
- For information on the comparator function, refer to [66: Comparator1 on page 686](#) and [67: Comparator2 on page 687](#).

■ **H2-27: Comparator 2 Lower Limit**

No. (Hex.)	Name	Description	Default (Range)
H2-27 (1547)	Comparator 2 Lower Limit	<div style="display: flex; gap: 5px;"> V/f OLV OLV/IPM AOLV/IPM EZOLV </div> <p>Sets the lower limit detection level for comparator 2 as a percentage of the full scale analog output for the monitor selected in H2-26 [Comparator 2 Monitor Selection].</p>	0.0% (0.0 - 300.0%)

Note:

For information on the comparator function, refer to [66: Comparator1 on page 686](#) and [67: Comparator2 on page 687](#).

■ H2-28: Comparator 2 Upper Limit

No. (Hex.)	Name	Description	Default (Range)
H2-28 (1548)	Comparator 2 Upper Limit	<div style="display: flex; justify-content: space-between; align-items: center;"> V/f OLV OLV/PM AOLV/PM EZOLV </div> <p>Sets the upper limit detection level for comparator 2 as a percentage of the full scale analog output for the monitor selected in H2-26 [Comparator 2 Monitor Selection].</p>	0.0% (0.0 - 300.0%)

Note:

For information on the comparator function, refer to [66: Comparator1 on page 686](#) and [67: Comparator2 on page 687](#).

■ H2-29: Comparator 2 Hysteresis

No. (Hex.)	Name	Description	Default (Range)
H2-29 (1549)	Comparator 2 Hysteresis	<div style="display: flex; justify-content: space-between; align-items: center;"> V/f OLV OLV/PM AOLV/PM EZOLV </div> <p>Sets the hysteresis level for comparator 2 as a percentage of the full scale analog output for the monitor selected in H2-26 [Comparator 2 Monitor Selection].</p>	0.0% (0.0 - 10.0%)

Note:

For information on the comparator function, refer to [66: Comparator1 on page 686](#) and [67: Comparator2 on page 687](#).

■ H2-30: Comparator 2 On-Delay Time

No. (Hex.)	Name	Description	Default (Range)
H2-30 (154A)	Comparator 2 On-Delay Time	<div style="display: flex; justify-content: space-between; align-items: center;"> V/f OLV OLV/PM AOLV/PM EZOLV </div> <p>Sets the on-delay time for comparator 2.</p>	0.0 s (0.0 - 600.0 s)

Note:

For information on the comparator function, refer to [66: Comparator1 on page 686](#) and [67: Comparator2 on page 687](#).

■ H2-31: Comparator 2 Off-Delay Time

No. (Hex.)	Name	Description	Default (Range)
H2-31 (154B)	Comparator 2 Off-Delay Time	<div style="display: flex; justify-content: space-between; align-items: center;"> V/f OLV OLV/PM AOLV/PM EZOLV </div> <p>Sets the off-delay time for comparator 2.</p>	0.0 s (0.0 - 600.0 s)

Note:

For information on the comparator function, refer to [66: Comparator1 on page 686](#) and [67: Comparator2 on page 687](#).

■ H2-32: Comparator 1 Filter Time

No. (Hex.)	Name	Description	Default (Range)
H2-32 (159A)	Comparator 1 Filter Time	<div style="display: flex; justify-content: space-between; align-items: center;"> V/f OLV OLV/PM AOLV/PM EZOLV </div> <p>Sets the time constant that is applied to the primary delay filter used for the analog output of the monitor selected with H2-20 [Comparator 1 Monitor Selection].</p>	0.0s (0.0 - 10.0 s)

Note:

For information on the comparator function, refer to [66: Comparator1 on page 686](#) and [67: Comparator2 on page 687](#).

■ H2-33: Comparator1 Protection Selection

No. (Hex.)	Name	Description	Default (Range)
H2-33 (159B)	Comparator1 Protection Selection	<div style="display: flex; justify-content: space-between; align-items: center;"> V/f OLV OLV/PM AOLV/PM EZOLV </div> <p>Sets drive operation when it detects CPI [Comparator1 Limit Fault].</p>	4 (0 - 4)

0 : Ramp to Stop

The drive ramps the motor to stop in the deceleration time. The output terminal set for *Fault [H2-01 to H2-03 = E]* activates.

1 : Coast to Stop

The output turns off and the motor coasts to stop. The output terminal set for *Fault [H2-01 to H2-03 = E]* activates.

2 : Fast Stop (Use C1-09)

The drive stops the motor in the deceleration time set in *C1-09 [Fast Stop Time]*. The output terminal set for *Fault [H2-01 to H2-03 = E]* activates.

3 : Alarm Only

The keypad shows *CP1* and the drive continues operation at the current frequency reference.

Note:

The output terminal set to *Alarm [H2-01 to H2-03 = 10]* activates.

4 : Digital Output Only

■ **H2-34: Comparator 2 Filter Time**

No. (Hex.)	Name	Description	Default (Range)
H2-34 (159C)	Comparator 2 Filter Time	 Sets the time constant that is applied to the primary delay filter used for the analog output of the monitor selected with <i>H2-26 [Comparator 2 Monitor Selection]</i> .	0.0s (0.0 - 10.0 s)

■ **H2-35: Comparator2 Protection Selection**

No. (Hex.)	Name	Description	Default (Range)
H2-35 (159D)	Comparator2 Protection Selection	 Sets drive operation when it detects <i>CP2 [Comparator2 Limit Fault]</i> .	4 (0 - 4)

0 : Ramp to Stop

The drive ramps the motor to stop in the deceleration time. The output terminal set for *Fault [H2-01 to H2-03 = E]* activates.

1 : Coast to Stop

The output turns off and the motor coasts to stop. The output terminal set for *Fault [H2-01 to H2-03 = E]* activates.

2 : Fast Stop (Use C1-09)

The drive stops the motor in the deceleration time set in *C1-09 [Fast Stop Time]*. The output terminal set for *Fault [H2-01 to H2-03 = E]* activates.

3 : Alarm Only

The keypad shows *CP2* and the drive continues operation at the current frequency reference.

Note:

The output terminal set to *Alarm [H2-01 to H2-03 = 10]* activates.

4 : Digital Output Only

■ **H2-36: Comparator 1 Ineffective Time**

No. (Hex.)	Name	Description	Default (Range)
H2-36 (159E)	Comparator 1 Ineffective Time	 Sets the length of time that <i>CP1 [Comparator1 Limit Fault]</i> is disabled.	0.0 s (0.0 - 1000.0 s)

Note:

- After you enter a Run command and wait for the time set in this parameter, the drive will monitor operation and make sure that it is in the Comparator 1 range until you enter the Stop command.
- When *CP1* detection is disabled, the drive will activate the output terminal set for *Comparator 1 [H2-xx = 66]*.

■ H2-37: Comparator 2 Ineffective Time

No. (Hex.)	Name	Description	Default (Range)
H2-37 (159F)	Comparator 2 Ineffective Time	<div style="display: flex; gap: 5px;"> V/f OLV OLV/PM AOLV/PM EZOLV </div> Sets the length of time that CP2 [Comparator2 Limit Fault] is disabled.	0.0 s (0.0 - 1000.0 s)

Note:

- After you enter a Run command and wait for the time set in this parameter, the drive will monitor operation and make sure that it is in the Comparator 2 range until you enter the Stop command.
- When CP2 detection is disabled, the drive will activate the output terminal set for *Comparator 2* [H2-xx = 67].

■ H2-40: Mbus Reg 15E0h bit0 Output Func

No. (Hex.)	Name	Description	Default (Range)
H2-40 (0B58)	Mbus Reg 15E0h bit0 Output Func	<div style="display: flex; gap: 5px;"> V/f OLV OLV/PM AOLV/PM EZOLV </div> Sets the MFDO for bit 0 of MEMOBUS register 15E0 (Hex.).	F (0 - 1FF)

■ H2-41: Mbus Reg 15E0h bit1 Output Func

No. (Hex.)	Name	Description	Default (Range)
H2-41 (0B59)	Mbus Reg 15E0h bit1 Output Func	<div style="display: flex; gap: 5px;"> V/f OLV OLV/PM AOLV/PM EZOLV </div> Sets the MFDO for bit 1 of MEMOBUS register 15E0 (Hex.).	F (0 - 1FF)

■ H2-42: Mbus Reg 15E0h bit2 Output Func

No. (Hex.)	Name	Description	Default (Range)
H2-42 (0B5A)	Mbus Reg 15E0h bit2 Output Func	<div style="display: flex; gap: 5px;"> V/f OLV OLV/PM AOLV/PM EZOLV </div> Sets the MFDO for bit 2 of MEMOBUS register 15E0 (Hex.).	F (0 - 1FF)

■ H2-60: Term MA,MB,MC Secondary Function

No. (Hex.)	Name	Description	Default (Range)
H2-60 (1B46) Expert	Term MA,MB,MC Secondary Function	<div style="display: flex; gap: 5px;"> V/f OLV OLV/PM AOLV/PM EZOLV </div> Sets the second function for terminal MA/MB-MC. Outputs the logical calculation results of the terminals set to functions by H2-01 [Term MA,MB,MC Function Selection].	F (0 - FF)

■ H2-61: Term MA,MB,MC Logical Operation

No. (Hex.)	Name	Description	Default (Range)
H2-61 (1B47) Expert	Term MA,MB,MC Logical Operation	<div style="display: flex; gap: 5px;"> V/f OLV OLV/PM AOLV/PM EZOLV </div> Sets the logical operation for the functions set in H2-01 [Term MA,MB,MC Function Selection] and H2-60 [Term MA,MB,MC Secondary Function].	0 (0 - 8)

Note:

Refer to [Output of Logical Operation Results of MFDO on page 667](#) for more information about the relation between parameter settings and logical operations.

■ H2-62: Term MA,MB,MC Minimum ON Time

No. (Hex.)	Name	Description	Default (Range)
H2-62 (1B48) Expert	Term MA,MB,MC Minimum ON Time	<div style="display: flex; gap: 5px;"> V/f OLV OLV/PM AOLV/PM EZOLV </div> Sets the minimum ON time that the drive uses to output the logical calculation results from terminal MA/MB-MC.	0.1 s (0.0 - 25.0 s)

■ H2-63: Terminal P1 Secondary Function

No. (Hex.)	Name	Description	Default (Range)
H2-63 (1B49) Expert	Terminal P1 Secondary Function	<input type="checkbox"/> V/f <input type="checkbox"/> OLV <input type="checkbox"/> OLV/IPM <input type="checkbox"/> AOLV/IPM <input type="checkbox"/> EZOLV Sets the second function for terminal P1-C1. Outputs the logical calculation results of the terminals set to functions by H2-02 [Term P1 Function Selection].	F (0 - FF)

■ H2-64: Terminal P1 Logical Operation

No. (Hex.)	Name	Description	Default (Range)
H2-64 (1B4A) Expert	Terminal P1 Logical Operation	<input type="checkbox"/> V/f <input type="checkbox"/> OLV <input type="checkbox"/> OLV/IPM <input type="checkbox"/> AOLV/IPM <input type="checkbox"/> EZOLV Sets the logical operation for the functions set in H2-02 [Term P1 Function Selection] and H2-63 [Terminal P1 Secondary Function].	0 (0 - 8)

Note:

Refer to [Output of Logical Operation Results of MFDO on page 667](#) for more information about the relation between parameter settings and logical operations.

■ H2-65: Terminal P1 Minimum ON Time

No. (Hex.)	Name	Description	Default (Range)
H2-65 (1B4B) Expert	Terminal P1 Minimum ON Time	<input type="checkbox"/> V/f <input type="checkbox"/> OLV <input type="checkbox"/> OLV/IPM <input type="checkbox"/> AOLV/IPM <input type="checkbox"/> EZOLV Sets the minimum ON time used to output the logical calculation results from terminal P1-C1.	0.1 s (0.0 - 25.0 s)

■ H2-66: Terminal P2 Secondary Function

No. (Hex.)	Name	Description	Default (Range)
H2-66 (1B4C) Expert	Terminal P2 Secondary Function	<input type="checkbox"/> V/f <input type="checkbox"/> OLV <input type="checkbox"/> OLV/IPM <input type="checkbox"/> AOLV/IPM <input type="checkbox"/> EZOLV Sets the second function for terminal P2-C2. Outputs the logical calculation results of the terminals assigned to functions by H2-03 [Term P2 Function Selection].	F (0 - FF)

■ H2-67: Terminal P2 Logical Operation

No. (Hex.)	Name	Description	Default (Range)
H2-67 (1B4D) Expert	Terminal P2 Logical Operation	<input type="checkbox"/> V/f <input type="checkbox"/> OLV <input type="checkbox"/> OLV/IPM <input type="checkbox"/> AOLV/IPM <input type="checkbox"/> EZOLV Sets the logical operation for the functions set in H2-03 [Term P2 Function Selection] and H2-66 [Terminal P2 Secondary Function].	0 (0 - 8)

Note:

Refer to [Output of Logical Operation Results of MFDO on page 667](#) for more information about the relation between parameter settings and logical operations.

■ H2-68: Terminal P2 Minimum ON Time

No. (Hex.)	Name	Description	Default (Range)
H2-68 (1B4E) Expert	Terminal P2 Minimum ON Time	<input type="checkbox"/> V/f <input type="checkbox"/> OLV <input type="checkbox"/> OLV/IPM <input type="checkbox"/> AOLV/IPM <input type="checkbox"/> EZOLV Sets the minimum ON time used to output the logical calculation results from terminal P2-C2.	0.1 s (0.0 - 25.0 s)

◆ MFDO Setting Values

Selects the function configured to MFDO.

■ 0: During Run

Setting Value	Function	Description
0	During Run	<div style="display: flex; justify-content: space-between; align-items: center;"> V/f OLV OLV/PM AOLV/PM EZOLV </div> <p>The terminal activates when you input a Run command and when the drive is outputting voltage.</p>

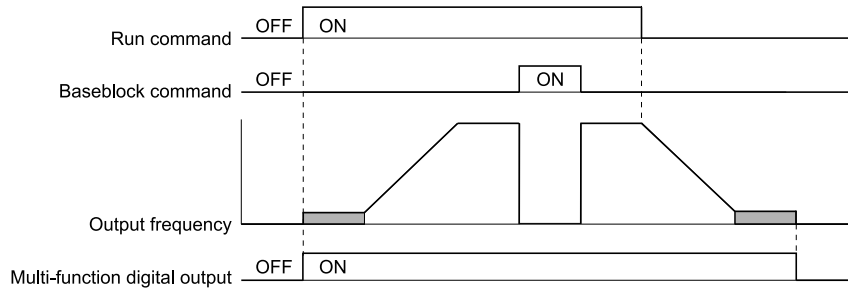

Figure 12.68 Drive Running Time Chart

ON : Drive is running

The drive is receiving a Run command or outputting voltage.

OFF : Drive is stopping

■ 1: Zero Speed

Setting Value	Function	Description
1	Zero Speed	<div style="display: flex; justify-content: space-between; align-items: center;"> V/f OLV OLV/PM AOLV/PM EZOLV </div> <p>The terminal activates when the output frequency is less than <i>E1-09</i> [Minimum Output Frequency] or <i>b2-01</i> [DC Injection/Zero SpeedThreshold].</p>

Note:

Parameter *A1-02* [Control Method Selection] selects which parameter is the reference.

A1-02 Setting	Control Method Selection	Parameter Used as the Reference
0	V/f	<i>E1-09</i>
2	OLV	<i>b2-01</i>
5	OLV/PM	<i>E1-09</i>
6	AOLV/PM	<i>E1-09</i>
8	EZOLV	<i>E1-09</i>

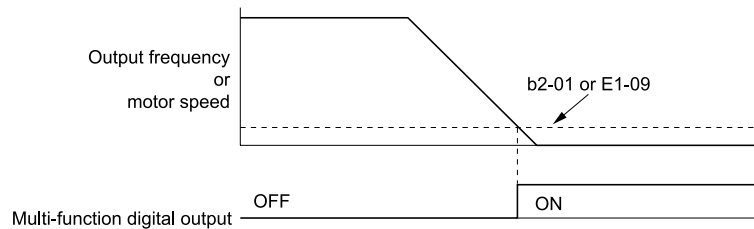

Figure 12.69 Zero Speed Time Chart

ON : Output frequency < value of *E1-09* or *b2-01*.

OFF : Output frequency ≥ value of *E1-09* or *b2-01*.

■ 2: Speed Agree 1

Setting Value	Function	Description
2	Speed Agree 1	<div style="display: flex; justify-content: space-between; align-items: center;"> V/f OLV OLV/PM AOLV/PM EZOLV </div> <p>The terminal activates when the output frequency is in the range of the frequency reference ± <i>L4-02</i> [Speed Agree Detection Width].</p>

Note:

The detection function operates in the two motor rotation directions.

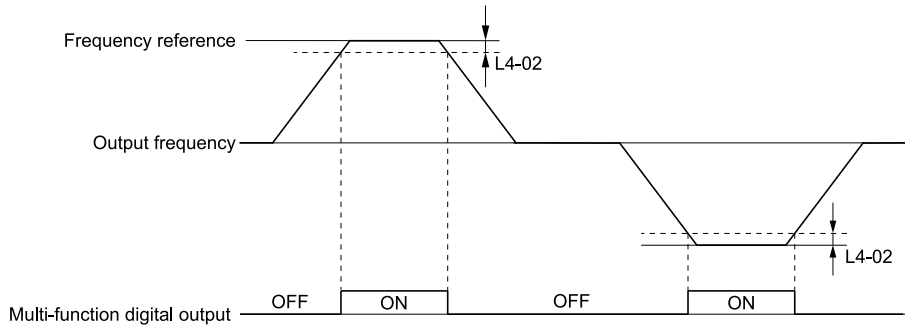

Figure 12.70 Speed Agree 1 Time Chart

ON : The output frequency is in the range of “frequency reference \pm L4-02”.

OFF : The output frequency does not align with the frequency reference although the drive is running.

■ 3: User-Set Speed Agree 1

Setting Value	Function	Description
3	User-Set Speed Agree 1	<div style="display: flex; gap: 5px;"> V/f OLV OLV/PM AOLV/PM EZOLV </div> <p>The terminal activates when the output frequency is in the range of L4-01 [Speed Agree Detection Level] \pm L4-02 [Speed Agree Detection Width] and in the range of the frequency reference \pm L4-02.</p>

Note:

The detection function operates in the two motor rotation directions. The drive uses the L4-01 value as the forward/reverse detection level.

ON : The output frequency is in the range of “L4-01 \pm L4-02” and the range of frequency reference \pm L4-02.

OFF : The output frequency is not in the range of “L4-01 \pm L4-02” nor the range of frequency reference \pm L4-02.

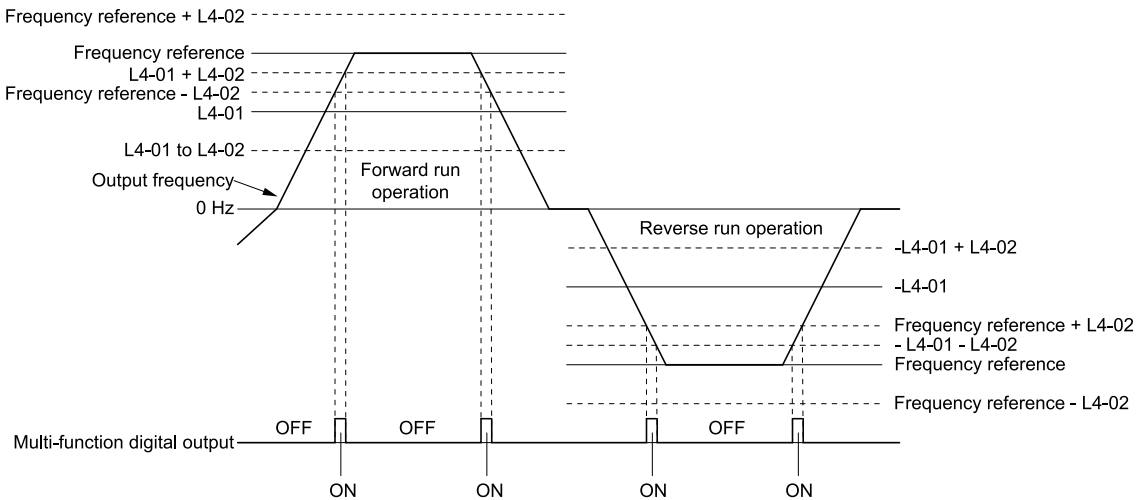

Figure 12.71 User-Defined Speed Agree 1 Time Chart

■ 4: Frequency Detection 1

Setting Value	Function	Description
4	Frequency Detection 1	<div style="display: flex; gap: 5px;"> V/f OLV OLV/PM AOLV/PM EZOLV </div> <p>The terminal deactivates when the output frequency is higher than the value of L4-01 [Speed Agree Detection Level] + L4-02 [Speed Agree Detection Width]. After the terminal deactivates, the terminal stays deactivated until the output frequency = L4-01.</p>

Note:

The detection function operates in the two motor rotation directions. The drive uses the L4-01 value as the forward/reverse detection level.

ON : The output frequency is less than the value of $L4-01$ or does not exceed the value of $L4-01 + L4-02$.

OFF : The output frequency is higher than the value of $L4-01 + L4-02$.

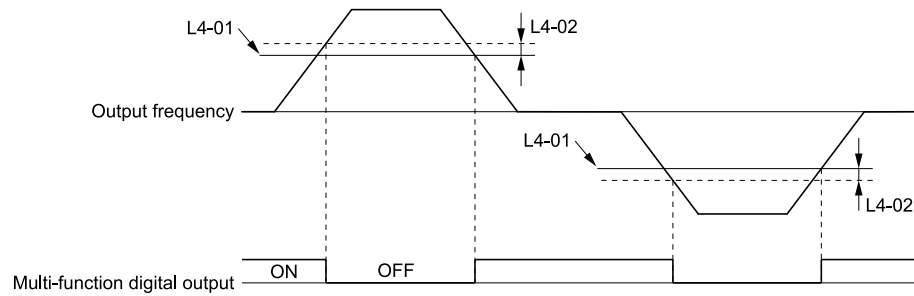

Figure 12.72 Frequency Detection 1 Time Chart

Note:

Figure 12.72 shows the result of the configuration when $L4-07 = 1$ [Speed Agree Detection Selection = Detection Always Enabled]. The default setting of $L4-07$ is 0 [No detection during baseblock]. When the speed agreement detection selection is “No Detection during Baseblock”, the terminal is deactivated when the drive output stops.

5: Frequency Detection 2

Setting Value	Function	Description
5	Frequency Detection 2	<p>V/f OLV OLV/PM AOLV/PM EZOLV</p> <p>The terminal activates when the output frequency is higher than the value of $L4-01$ [Speed Agree Detection Level]. After the terminal activates, the terminal stays activated until the output frequency is at the value of $L4-01 - L4-02$.</p>

Note:

The detection function operates in the two motor rotation directions. The drive uses the $L4-01$ value as the forward/reverse detection level.

ON : The output frequency is higher than the value of $L4-01$.

OFF : The output frequency is less than the value of “ $L4-01 - L4-02$,” or it is not more than the value of $L4-01$.

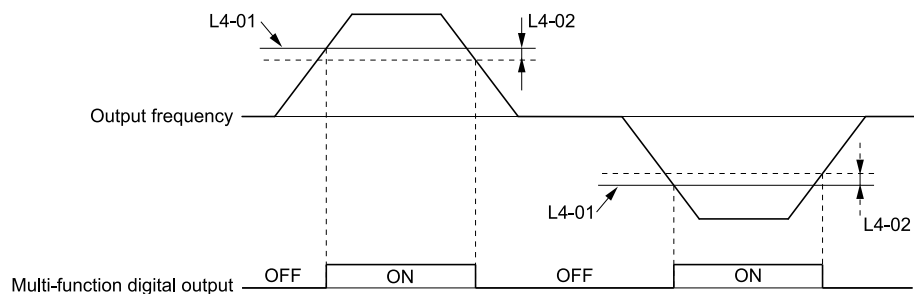

Figure 12.73 Frequency Detection 2 Time Chart

6: Drive Ready

Setting Value	Function	Description
6	Drive Ready	<p>V/f OLV OLV/PM AOLV/PM EZOLV</p> <p>The terminal activates when the drive is ready and running.</p>

The terminal deactivates in these conditions:

- When the power supply is OFF
- During a fault
- When there is problem with the control power supply
- When there is a parameter setting error and the drive cannot operate although there is a Run command
- When you enter a Run command and it immediately triggers an overvoltage or undervoltage fault because the drive has an overvoltage or undervoltage fault during stop
- When the drive is in Programming Mode and will not accept a Run command

- When the Safe Disable function is active

■ 7: DC Bus Undervoltage

Setting Value	Function	Description
7	DC Bus Undervoltage	<div style="display: flex; gap: 5px;"> V/f OLV OLV/IPM AOLV/IPM EZOLV </div> <p>The terminal activates when the DC bus voltage or control circuit power supply is at the voltage set in L2-05 [Undervoltage Detection Lvl (UvL)] or less. The terminal also activates when there is a fault with the DC bus voltage.</p>

ON : The DC bus voltage \leq L2-05

OFF : The DC bus voltage $>$ L2-05

■ 8: During Baseblock (N.O.)

Setting Value	Function	Description
8	During Baseblock (N.O.)	<div style="display: flex; gap: 5px;"> V/f OLV OLV/IPM AOLV/IPM EZOLV </div> <p>The terminal activates during baseblock. When the drive is in baseblock, the drive output transistor stops switching and does not make DC bus voltage.</p>

ON : During baseblock

OFF : The drive is not in baseblock.

■ 9: Frequency Reference from Keypad

Setting Value	Function	Description
9	Frequency Reference from Keypad	<div style="display: flex; gap: 5px;"> V/f OLV OLV/IPM AOLV/IPM EZOLV </div> <p>Shows the selected frequency reference source.</p>

ON : The keypad is the frequency reference source.

OFF : b1-01 or b1-15 [Frequency Reference Selection 1 or 2] is the frequency reference source.

■ A: Run Command from Keypad

Setting Value	Function	Description
A	Run Command Source	<div style="display: flex; gap: 5px;"> V/f OLV OLV/IPM AOLV/IPM EZOLV </div> <p>Shows the selected Run command source.</p>

ON : The keypad is the Run command source.

OFF : b1-02 or b1-16 [Run Command Selection 1 or 2] is the Run command source.

■ B: Torque Detection 1 (N.O.)

Setting Value	Function	Description
B	Torque Detection 1 (N.O.)	<div style="display: flex; gap: 5px;"> V/f OLV OLV/IPM AOLV/IPM EZOLV </div> <p>The terminal activates when the drive detects overtorque or undertorque.</p>

ON : The output current/torque $>$ L6-02 [Torque Detection Level 1], or the output current/torque $<$ L6-02 for longer than the time set in L6-03 [Torque Detection Time 1].

Note:

- When L6-01 \geq 5, the drive will detect when the output current/torque is less than L6-02 for longer than L6-03.
- Refer to [L6: Torque Detection on page 745](#) for more information.

■ C: Frequency Reference Loss

Setting Value	Function	Description
C	Frequency Reference Loss	<div style="display: flex; gap: 5px;"> V/f OLV OLV/IPM AOLV/IPM EZOLV </div> <p>The terminal activates when the drive detects a loss of frequency reference.</p>

Note:

Refer to [L4-05: Fref Loss Detection Selection on page 740](#) for more information.

■ D: Braking Resistor Fault

Setting Value	Function	Description
D	Braking Resistor Fault	<div style="display: flex; gap: 5px;"> V/f OLV OLV/PM AOLV/PM EZOLV </div> <p>The terminal activates when the mounting-type braking resistor is overheating or when there is a braking transistor fault.</p>

■ E: Fault

Setting Value	Function	Description
E	Fault	<div style="display: flex; gap: 5px;"> V/f OLV OLV/PM AOLV/PM EZOLV </div> <p>The terminal activates when the drive detects a fault.</p>

Note:

The terminal will not activate for *CPF00* and *CPF01* [Control Circuit Error] faults.

■ F: Not Used

Setting Value	Function	Description
F	Not Used	<div style="display: flex; gap: 5px;"> V/f OLV OLV/PM AOLV/PM EZOLV </div> <p>Use this setting for unused terminals or to use terminals in through mode. Also use this setting as the PLC contact output via MEMOBUS/Modbus or the communication option. This signal does not function if you do not configure signals from the PLC.</p>

■ 10: Alarm

Setting Value	Function	Description
10	Alarm	<div style="display: flex; gap: 5px;"> V/f OLV OLV/PM AOLV/PM EZOLV </div> <p>The terminal activates when the drive detects a minor fault.</p>

■ 11: Fault Reset Command Active

Setting Value	Function	Description
11	Fault Reset Command Active	<div style="display: flex; gap: 5px;"> V/f OLV OLV/PM AOLV/PM EZOLV </div> <p>The terminal activates when the drive receives the Reset command from the control circuit terminal, serial communications, or the communication option.</p>

■ 12: Timer Output

Setting Value	Function	Description
12	Timer Output	<div style="display: flex; gap: 5px;"> V/f OLV OLV/PM AOLV/PM EZOLV </div> <p>Sets the terminal as the timer output. Use this setting with the timer input set in <i>H1-xx = 18</i> [MFDI Function Selection = Timer Function].</p>

Note:

Refer to [Timer Function Operation on page 535](#) for more information.

■ 13: Speed Agree 2

Setting Value	Function	Description
13	Speed Agree 2	<div style="display: flex; gap: 5px;"> V/f OLV OLV/PM AOLV/PM EZOLV </div> <p>The terminal activates when the output frequency is in the range of the frequency reference $\pm L4-04$ [Speed Agree Detection Width (+/-)].</p>

Note:

The detection function operates in the two motor rotation directions.

ON : The output frequency is in the range of “frequency reference $\pm L4-04$ ”.

OFF : The output frequency is not in the range of “frequency reference $\pm L4-04$ ”.

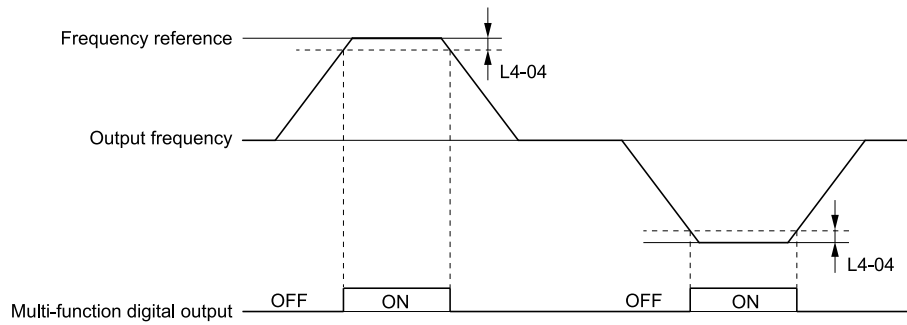

Figure 12.74 Speed Agree 2 Time Chart

■ 14: User-Set Speed Agree 2

Setting Value	Function	Description
14	User-Set Speed Agree 2	<p>V/f OLV OLV/PM AOLV/PM EZOLV</p> <p>The terminal activates when the output frequency is in the range of $L4-03$ [Speed Agree Detection Level(+/-)] \pm $L4-04$ [Speed Agree Detection Width(+/-)] and in the range of the frequency reference \pm $L4-04$.</p>

Note:

The detection level set with $L4-03$ is a signed value. The drive will only detect in one direction.

ON : The output frequency is in the range of “ $L4-03 \pm L4-04$ ” and the range of frequency reference \pm $L4-04$.

OFF : The output frequency is not in the range of “ $L4-03 \pm L4-04$ ” nor the range of frequency reference \pm $L4-04$.

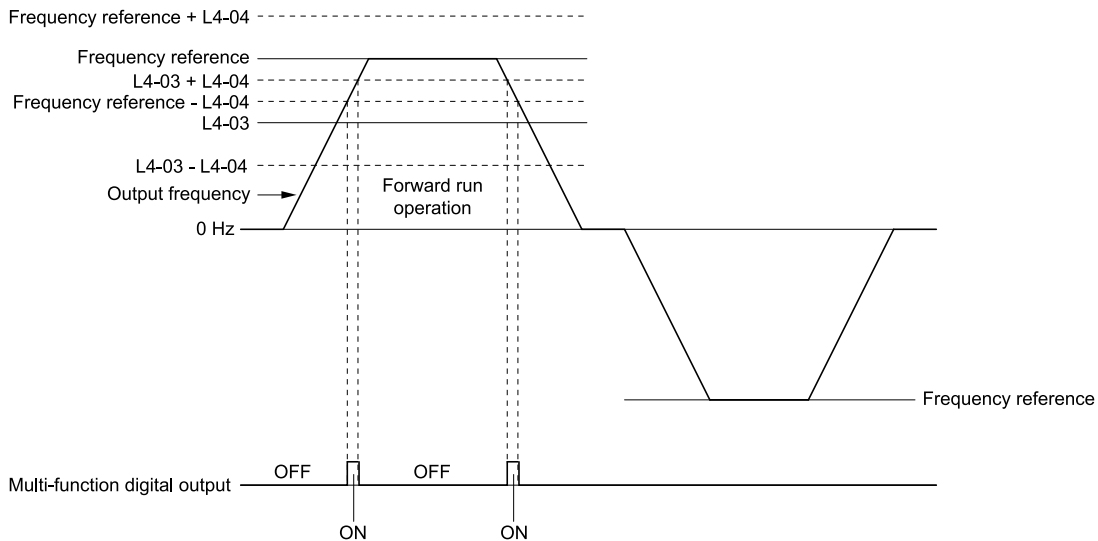

Figure 12.75 Example of User-set Speed Agree 2 (L4-03 Is Positive)

■ 15: Frequency Detection 3

Setting Value	Function	Description
15	Frequency Detection 3	<p>V/f OLV OLV/PM AOLV/PM EZOLV</p> <p>The terminal deactivates when the output frequency is more than “$L4-03$ [Speed Agree Detection Level(+/-)] + $L4-04$ [Speed Agree Detection Width(+/-)]”. After the terminal deactivates, the terminal stays deactivated until the output frequency is at the value of $L4-03$.</p>

Note:

The detection level set with $L4-03$ is a signed value. The drive will only detect in one direction.

ON : The output frequency is less than the value of $L4-03$ or it is not more than the value of $L4-03 + L4-04$.

OFF : The output frequency is higher than the value of $L4-03 + L4-04$.

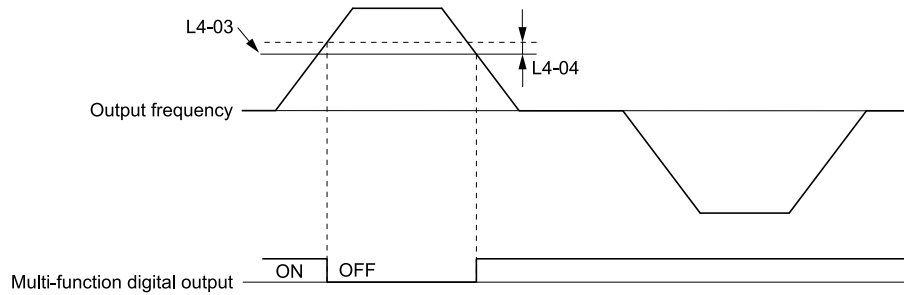

Figure 12.76 Example of Frequency Detection 3 (value of L4-03 Is Positive)

Note:

Figure 12.76 shows the result of the configuration when $L4-07 = 1$ [Speed Agree Detection Selection = Detection Always Enabled]. The default setting of $L4-07$ is 0 [No detection during baseblock]. When the speed agreement detection selection is “No Detection during Baseblock”, the terminal is deactivated when the drive output stops.

■ **16: Frequency Detection 4**

Setting Value	Function	Description
16	Frequency Detection 4	<input checked="" type="checkbox"/> V/f <input checked="" type="checkbox"/> OLV <input checked="" type="checkbox"/> OLV/PM <input checked="" type="checkbox"/> AOLV/PM <input checked="" type="checkbox"/> EZOLV The terminal activates when the output frequency is higher than the value of $L4-03$ [Speed Agree Detection Level(+/-)]. After the terminal activates, the terminal stays activated until the output frequency = $L4-03 - L4-04$.

Note:

The detection level set with $L4-03$ is a signed value. The drive will only detect in one direction.

ON : The output frequency is higher than the value of $L4-03$.

OFF : The output frequency is less than the value of “ $L4-03 - L4-04$,” or it is not more than the value of $L4-03$.

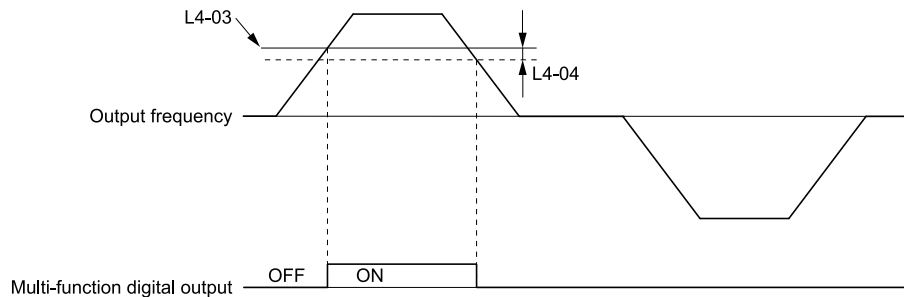

Figure 12.77 Example of Frequency Detection 4 (value of L4-03 Is Positive)

■ **17: Torque Detection 1 (N.C.)**

Setting Value	Function	Description
17	Torque Detection 1 (N.C.)	<input checked="" type="checkbox"/> V/f <input checked="" type="checkbox"/> OLV <input checked="" type="checkbox"/> OLV/PM <input checked="" type="checkbox"/> AOLV/PM <input checked="" type="checkbox"/> EZOLV The terminal deactivates when the drive detects overtorque or undertorque.

Use the $L6$ [Torque Detection] parameters to set torque detection.

OFF : The output current/torque > $L6-02$ [Torque Detection Level 1], or the output current/torque < $L6-02$ for longer than the time set in $L6-03$ [Torque Detection Time 1].

Note:

- When $L6-01 \geq 5$, the drive will detect when the output current/torque is less than $L6-02$ for longer than $L6-03$.
- Refer to [L6: Torque Detection on page 745](#) for more information.

■ **18: Torque Detection 2 (N.O.)**

Setting Value	Function	Description
18	Torque Detection 2 (N.O.)	<input checked="" type="checkbox"/> V/f <input checked="" type="checkbox"/> OLV <input checked="" type="checkbox"/> OLV/PM <input checked="" type="checkbox"/> AOLV/PM <input checked="" type="checkbox"/> EZOLV The terminal activates when the drive detects overtorque or undertorque.

Use the *L6 [Torque Detection]* parameters to set torque detection.

ON : The output current/torque > *L6-05 [Torque Detection Level 2]*, or the output current/torque < *L6-05* for longer than the time set in *L6-06 [Torque Detection Time 2]*.

Note:

- When *L6-04* ≥ 5, the drive will detect when the output current/torque is less than *L6-05* for longer than *L6-06*.
- Refer to *L6: Torque Detection on page 745* for more information.

■ **19: Torque Detection 2 (N.C.)**

Setting Value	Function	Description
19	Torque Detection 2 (N.C.)	<div style="display: flex; justify-content: space-between; align-items: center;"> V/f OLV OLV/IPM AOLV/IPM EZOLV </div> <p>The terminal deactivates when the drive detects overtorque or undertorque.</p>

Use the *L6 [Torque Detection]* parameters to set torque detection.

OFF : The output current/torque > *L6-05 [Torque Detection Level 2]*, or the output current/torque < *L6-05* for longer than the time set in *L6-06 [Torque Detection Time 2]*.

Note:

- When *L6-04* ≥ 5, the drive will detect when the output current/torque is less than *L6-05* for longer than *L6-06*.
- Refer to *L6: Torque Detection on page 745* for more information.

■ **1A: During Reverse**

Setting Value	Function	Description
1A	During Reverse	<div style="display: flex; justify-content: space-between; align-items: center;"> V/f OLV OLV/IPM AOLV/IPM EZOLV </div> <p>The terminal activates when the motor operates in the reverse direction.</p>

ON : The motor is operating in the reverse direction.

OFF : The motor is operating in the forward direction or the motor stopped.

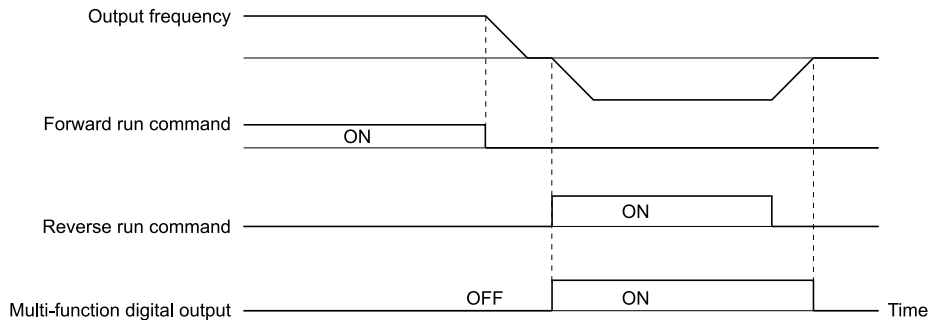

Figure 12.78 Reverse Operation Output Time Chart

■ **1B: During Baseblock (N.C.)**

Setting Value	Function	Description
1B	During Baseblock (N.C.)	<div style="display: flex; justify-content: space-between; align-items: center;"> V/f OLV OLV/IPM AOLV/IPM EZOLV </div> <p>The terminal deactivates during baseblock. When the drive is in baseblock, the drive output transistor stops switching and does not make DC bus voltage.</p>

ON : The drive is not in baseblock.

OFF : During baseblock

■ **1C: Motor 2 Selected**

Setting Value	Function	Description
1C	Motor 2 Selected	<div style="display: flex; justify-content: space-between; align-items: center;"> V/f OLV OLV/IPM AOLV/IPM EZOLV </div> <p>The terminal activates when you select motor 2.</p>

ON : Motor 2 Selected

OFF : Motor 1 Selected

■ 1E: Executing Auto-Restart

Setting Value	Function	Description
1E	Executing Auto-Restart	<div style="display: flex; justify-content: space-between; align-items: center;"> V/f OLV OLV/PM AOLV/PM EZOLV </div> <p>The terminal activates when the Auto Restart function is trying to restart after a fault.</p>

The terminal deactivates when the Auto Restart function automatically resets a fault. The terminal deactivates when the Auto Restart function detects the fault again because there were too many restart attempts as specified by *L5-01 [Number of Auto Restart Attempts]*.

Note:

Refer to [L5: Fault Restart on page 742](#) for more information.

■ 1F: Motor Overload Alarm (oL1)

Setting Value	Function	Description
1F	Motor Overload Alarm (oL1)	<div style="display: flex; justify-content: space-between; align-items: center;"> V/f OLV OLV/PM AOLV/PM EZOLV </div> <p>The terminal activates when the electronic thermal protection value of the motor overload protective function is a minimum of 90% of the detection level.</p>

Note:

Refer to [L1-01: Motor Overload \(oL1\) Protection on page 714](#) for more information.

■ 20: Drive Overheat Pre-Alarm (oH)

Setting Value	Function	Description
20	Drive Overheat Pre-Alarm (oH)	<div style="display: flex; justify-content: space-between; align-items: center;"> V/f OLV OLV/PM AOLV/PM EZOLV </div> <p>The terminal activates when the drive heatsink temperature is at the level set with <i>L8-02 [Overheat Alarm Level]</i>.</p>

Note:

Refer to [L8-02: Overheat Alarm Level on page 753](#) for more information.

■ 21: Safe Torque OFF

Setting Value	Function	Description
21	Safe Torque OFF	<div style="display: flex; justify-content: space-between; align-items: center;"> V/f OLV OLV/PM AOLV/PM EZOLV </div> <p>The terminal activates (safety stop state) when the safety circuit and safety diagnosis circuit are operating correctly and when terminals H1-HC and H2-HC are OFF (Open).</p>

Note:

EDM = External Device Monitor

ON : Safety stop state

Terminals H1-HC and H2-HC are OFF (Open) (safety stop state).

OFF : Safety circuit fault or RUN/READY

Terminal H1-HC or terminal H2-HC is OFF (Open) (safety circuit fault), or the two terminals are ON or have short circuited (RUN/READY).

■ 22: Mechanical Weakening Detection

Setting Value	Function	Description
22	Mechanical Weakening Detection	<div style="display: flex; justify-content: space-between; align-items: center;"> V/f OLV OLV/PM AOLV/PM EZOLV </div> <p>The terminal activates when the drive detects mechanical weakening.</p>

Note:

Refer to [Mechanical Weakening Detection on page 746](#) for more information.

■ 2F: Maintenance Notification

Setting Value	Function	Description
2F	Maintenance Notification	<div style="display: flex; justify-content: space-between; align-items: center;"> V/f OLV OLV/PM AOLV/PM EZOLV </div> <p>The terminal activates when drive components are at their estimated maintenance period.</p>

Tells you about the maintenance period for these items:

- IGBT
- Cooling Fan
- Capacitor
- Soft charge bypass relay

Note:

Refer to *Maintenance on page 323* for more information.

■ **30: During Torque Limit**

Setting Value	Function	Description
30	During Torque Limit	<div style="display: flex; justify-content: space-between; align-items: center;"> V/f OLV OLV/PM AOLV/PM EZOLV </div> <p>The terminal activates when the torque reference is the torque limit set with <i>L7 parameters</i> or <i>H3-02</i> or <i>H3-10</i> [<i>MFAI Function Selection</i>].</p>

Note:

Refer to *L7: Torque Limit on page 750* for more information.

■ **37: During Frequency Output**

Setting Value	Function	Description
37	During Frequency Output	<div style="display: flex; justify-content: space-between; align-items: center;"> V/f OLV OLV/PM AOLV/PM EZOLV </div> <p>The terminal activates when the drive outputs frequency.</p>

ON : The drive is outputting frequency.

OFF : The drive is not outputting frequency.

Note:

The terminal deactivates in these conditions:

- During Stop
- During Baseblock
- During DC Injection Braking (initial excitation)
- During Short Circuit Braking
- Pole Position Detection Complete

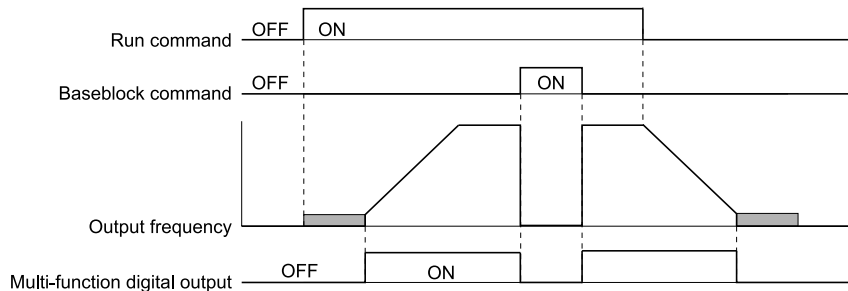

Figure 12.79 Active Frequency Output Time Chart

■ **38: Drive Enabled**

Setting Value	Function	Description
38	Drive Enabled	<div style="display: flex; justify-content: space-between; align-items: center;"> V/f OLV OLV/PM AOLV/PM EZOLV </div> <p>This terminal activates when the <i>H1-xx = 6A</i> [<i>Drive Enable</i>] terminal activates.</p>

■ **39: Watt Hour Pulse Output**

Setting Value	Function	Description
39	Watt Hour Pulse Output	<div style="display: flex; justify-content: space-between; align-items: center;"> V/f OLV OLV/PM AOLV/PM EZOLV </div> <p>Outputs the pulse that shows the watt hours.</p>

Note:

Refer to [H2-06: Watt Hour Output Unit Selection on page 668](#) for more information.

3C: LOCAL Control Selected

Setting Value	Function	Description
3C	LOCAL Control Selected	<div style="display: flex; justify-content: space-between; align-items: center;"> V/f OLV OLV/PM AOLV/PM EZOLV </div> <p>The terminal activates when the Run command source or frequency reference source is LOCAL.</p>

ON : LOCAL

The keypad is the Run command source or the frequency reference source.

OFF : REMOTE

The Run command source or frequency reference source is an external source set with *b1-01* [*Frequency Reference Selection 1*], *b1-15* [*Frequency Reference Selection 2*], *b1-02* [*Run Command Selection 1*], or *b1-16* [*Run Command Selection 2*].

3D: During Speed Search

Setting Value	Function	Description
3D	During Speed Search	<div style="display: flex; justify-content: space-between; align-items: center;"> V/f OLV OLV/PM AOLV/PM EZOLV </div> <p>The terminal activates when the drive is doing speed search.</p>

Note:

Refer to [b3: Speed Search on page 526](#) for more information.

3E: PID Feedback Low

Setting Value	Function	Description
3E	PID Feedback Low	<div style="display: flex; justify-content: space-between; align-items: center;"> V/f OLV OLV/PM AOLV/PM EZOLV </div> <p>The terminal activates when the drive detects <i>FbL</i> [<i>PID Feedback Loss</i>].</p>

The drive detects *FbL* [*PID Feedback Loss*] when the PID feedback value < *b5-13* [*PID Feedback Loss Detection Lvl*] for longer than *b5-14* [*PID Feedback Loss Detection Time*].

Note:

Refer to [PID Feedback Loss Detection on page 539](#) for more information.

3F: PID Feedback High

Setting Value	Function	Description
3F	PID Feedback High	<div style="display: flex; justify-content: space-between; align-items: center;"> V/f OLV OLV/PM AOLV/PM EZOLV </div> <p>The terminal activates when the drive detects <i>FbH</i> [<i>Excessive PID Feedback</i>].</p>

The drive detects *FbH* [*Excessive PID Feedback*] when the PID feedback value > *b5-36* [*PID High Feedback Detection Lvl*] for longer than *b5-37* [*PID High Feedback Detection Time*].

Note:

Refer to [PID Feedback Loss Detection on page 539](#) for more information.

4A: During KEB Ride-Thru

Setting Value	Function	Description
4 A	During KEB Ride-Thru	<div style="display: flex; justify-content: space-between; align-items: center;"> V/f OLV OLV/PM AOLV/PM EZOLV </div> <p>The activates during KEB Ride-Thru.</p>

Note:

Refer to [KEB Ride-Thru Function on page 720](#) for more information.

4B: During Short Circuit Braking

Setting Value	Function	Description
4B	During Short Circuit Braking	<div style="display: flex; justify-content: space-between; align-items: center;"> V/f OLV OLV/PM AOLV/PM EZOLV </div> <p>The terminal activates during Short Circuit Braking.</p>

12.8 H: Terminal Function Selection

Note:

- When $A1-02 = 8$ [Control Method Selection = EZOLV], this function is available only when you use a PM motor.
- Refer to [b2: DC Injection Braking and Short Circuit Braking on page 523](#) for more information.

■ 4C: During Fast Stop

Setting Value	Function	Description
4C	During Fast Stop	<div style="display: flex; justify-content: space-between; align-items: center;"> V/f OLV OLV/IPM AOLV/IPM EZOLV </div> <p>The terminal activates when the fast stop is in operation.</p>

■ 4D: oH Pre-Alarm Time Limit

Setting Value	Function	Description
4D	oH Pre-Alarm Time Limit	<div style="display: flex; justify-content: space-between; align-items: center;"> V/f OLV OLV/IPM AOLV/IPM EZOLV </div> <p>The terminal activates when $L8-03 = 4$ [Overheat Pre-Alarm Selection = Operate at Reduced Speed (L8-19)] and oH [Heatsink Overheat] does not clear after the drive decreases the frequency for 10 cycles.</p>

Note:

Refer to [L8-03: Overheat Pre-Alarm Selection on page 753](#) for more information.

■ 4E: Braking Transistor Fault (rr)

Setting Value	Function	Description
4E	Braking Transistor Fault (rr)	<div style="display: flex; justify-content: space-between; align-items: center;"> V/f OLV OLV/IPM AOLV/IPM EZOLV </div> <p>The terminal activates when the internal braking transistor overheats and the drive detects an rr [Dynamic Braking Transistor Fault] fault.</p>

■ 4F: Braking Resistor Overheat (rH)

Setting Value	Function	Description
4F	Braking Resistor Overheat (rH)	<div style="display: flex; justify-content: space-between; align-items: center;"> V/f OLV OLV/IPM AOLV/IPM EZOLV </div> <p>The terminal activates when the braking resistor overheats and the drive detects an rH [Braking Resistor Overheat] fault.</p>

The braking resistor overheats when the deceleration time is short and there is too much motor regeneration energy.

■ 61: Pole Position Detection Complete

Setting Value	Function	Description
61	Pole Position Detection Complete	<div style="display: flex; justify-content: space-between; align-items: center;"> V/f OLV OLV/IPM AOLV/IPM EZOLV </div> <p>The terminal activates when drive receives a Run command and the drive detects the motor magnetic pole position of the PM motor.</p>

■ 62: Modbus Reg 1 Status Satisfied

Setting Value	Function	Description
62	Modbus Reg 1 Status Satisfied	<div style="display: flex; justify-content: space-between; align-items: center;"> V/f OLV OLV/IPM AOLV/IPM EZOLV </div> <p>The terminal activates when the bit specified by $H2-08$ [Modbus Register 1 Bit Select] for the MEMOBUS register address set with $H2-07$ [Modbus Register 1 Address Select] activates.</p>

■ 63: Modbus Reg 2 Status Satisfied

Setting Value	Function	Description
63	Modbus Reg 2 Status Satisfied	<div style="display: flex; justify-content: space-between; align-items: center;"> V/f OLV OLV/IPM AOLV/IPM EZOLV </div> <p>The terminal activates when the bit specified by $H2-10$ [Modbus Register 2 Bit Select] for the MEMOBUS register address set with $H2-09$ [Modbus Register 2 Address Select] activates.</p>

■ 66: Comparator1

Setting Value	Function	Description
66	Comparator1	<div style="display: flex; justify-content: space-between; align-items: center;"> V/f OLV OLV/IPM AOLV/IPM EZOLV </div> <p>The terminal activates if the monitor value set with $H2-20$ [Comparator 1 Monitor Selection] is in range of the values of $H2-21$ [Comparator 1 Lower Limit] and $H2-22$ [Comparator 1 Upper Limit] for the time set in $H2-24$ [Comparator 1 On-Delay Time].</p>

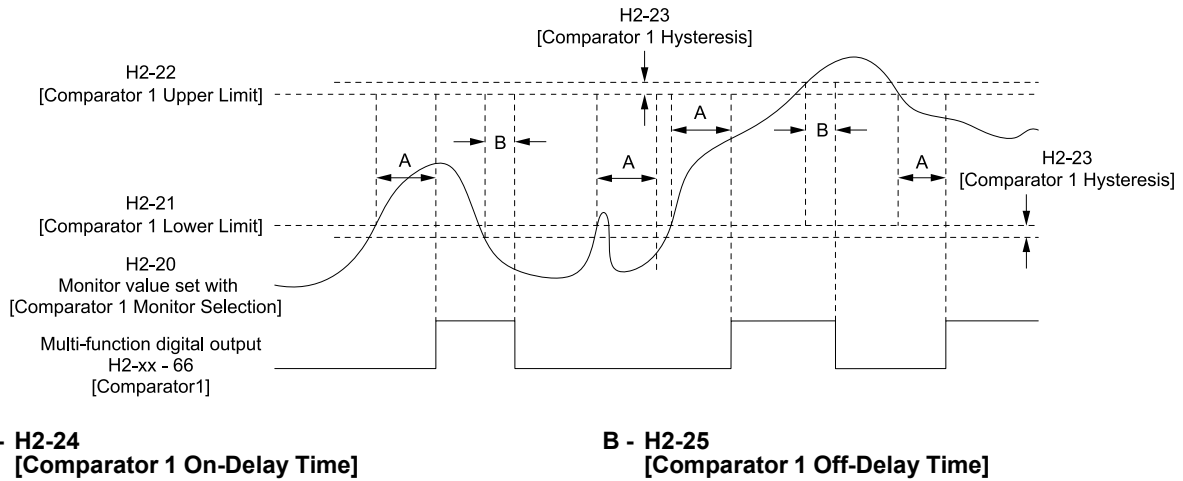

Figure 12.80 Comparator 1 Output Time Chart

Note:

The drive compares the monitors set with H2-20 as absolute values.

■ **67: Comparator2**

Setting Value	Function	Description
67	Comparator2	<p>V/f OLV OLV/PM AOLV/PM EZOLV</p> <p>The terminal activates if the monitor value set with H2-26 [Comparator 2 Monitor Selection] is not in the range of the values of H2-27 [Comparator 2 Lower Limit] and H2-28 [Comparator 2 Upper Limit] for the time set in H2-30 [Comparator 2 On-Delay Time].</p>

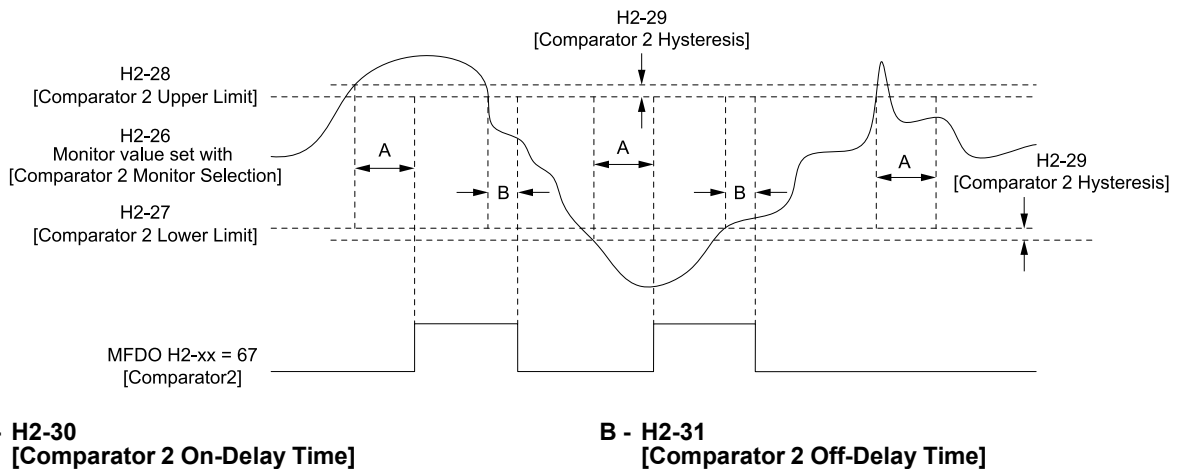

Figure 12.81 Comparator 2 Output Time Chart

Note:

The drive compares the monitors set with H2-26 as absolute values.

■ **69: External Power 24V Supply**

Setting Value	Function	Description
69	External Power 24V Supply	<p>V/f OLV OLV/PM AOLV/PM EZOLV</p> <p>The terminal activates when there is an external 24V power supply between terminals PS-AC.</p>

ON : The external 24V power supply is supplying power.

OFF : The external 24V power supply is not supplying power.

■ **6A: Data Logger Error**

Setting Value	Function	Description
6 A	Data Logger Error	<div style="display: flex; gap: 5px;"> V/f OLV OLV/PM AOLV/PM EZOLV </div> <p>The terminal activates when the drive detects a <i>LoG [Com Error / Abnormal SD card]</i>.</p>

■ **90 to 92: DWEZ Digital Output 1 to 3**

Setting Value	Function	Description
90 - 92	DWEZ Digital Output 1 to 3	<div style="display: flex; gap: 5px;"> V/f OLV OLV/PM AOLV/PM EZOLV </div> <p>Sets the DriveWorksEZ digital output. Refer to the DriveWorksEZ online manual for more information.</p>

■ **100 to 192: Inverse output of 0 to 92**

Setting Value	Function	Description
100 - 192	Inverse output of 0 to 92	<div style="display: flex; gap: 5px;"> V/f OLV OLV/PM AOLV/PM EZOLV </div> <p>Causes inverse output of the function for the selected MFDO. Uses the last two digits of <i>Ixx</i> to select which function to inversely output.</p>

For example, set $H2-xx = 10E$ for the inverse output of *E [Fault]*.

◆ **H3: Analog Inputs**

WARNING! *Sudden Movement Hazard. Do test runs and examine the drive to make sure that the command references are correct. If you set the command reference incorrectly, it can cause damage to the drive or serious injury or death.*

Drives have two analog input terminals: terminals A1 and A2. Use *H3 parameters* to set the functions to these analog input terminals and adjust signal levels.

Table 12.56 shows the functions that you can set to analog input terminals. Use *H3-02 and H3-10 [MFAI Function Select]* to set functions.

Table 12.56 Multi-Function Analog Input Terminal Settings

Setting Value	Function	Reference	Setting Value	Function	Reference
0	Frequency Reference	693	E	Motor Temperature (PTC Input)	696
1	Frequency Gain	693	F	Through Mode	696
2	Auxiliary Frequency Reference 1	694	10	Forward Torque Limit	696
3	Auxiliary Frequency Reference 2	694	11	Reverse Torque Limit	698
4	Output Voltage Bias	694	12	Regenerative Torque Limit	698
5	Accel/Decel Time Gain	694	13	Torque Reference / Torque Limit	698
6	DC Injection Braking Current	695	14	Torque Compensation	698
7	Torque Detection Level	695	15	General Torque Limit	698
8	Stall Prevent Level during Run	695	16	PID DifferentialFdbk	698
9	Output Frequency Lower Limit	695	1F	Through Mode	698
B	PID Feedback	696	30	DWEZ Analog Input 1	699
C	PID Setpoint	696	31	DWEZ Analog Input 2	699
D	Frequency Bias	696			

Note:

All analog input scaling uses gain and bias for adjustment. Set the gain and bias values correctly.

Example Analog Input Settings	Terminal A1 Setting	Frequency Reference
Frequency Reference When You Adjust the Gain Setting	<ul style="list-style-type: none"> H3-02 = 0 [Terminal A1 Function Selection = Frequency Reference] H3-03 = 200.0 [Terminal A1 Gain Setting = 200%] H3-04 = 0.0 [Terminal A1 Bias Setting = 0.0%] 	<ul style="list-style-type: none"> When you input a 10 V signal, the frequency reference will be 200%. When you input a 5 V signal, the frequency reference will be 100%. <p>When you input a 5 V or more signal, E1-04 [Maximum Output Frequency] will limit the drive output and the frequency reference will be 100%.</p> <div style="display: flex; justify-content: space-around;"> <div style="text-align: center;"> <p>H3-01 = 0</p> </div> <div style="text-align: center;"> <p>H3-01 = 4</p> </div> </div>
Frequency Reference When You Set the Bias to a Negative Number	<ul style="list-style-type: none"> H3-02 = 0 [Frequency Reference] H3-03 = 100.0 [100.0%] H3-04 = -25.0 [-25.0%] 	<ul style="list-style-type: none"> When you input a 0 V signal, the frequency reference will be -25%. When H3-01 = 0 [Terminal A1 Signal Level Select = 0 V to 10 V (Lower Limit at 0)] <ul style="list-style-type: none"> When you input a 0 V to 2 V signal, the frequency reference will be 0%. When you input a 2 V to 10 V signal, the frequency reference will be 0% to 100%. When H3-01 = 4 [-10 V to +10 V] <ul style="list-style-type: none"> When you input a 0 V to 2 V signal, it enables signals of positive and negative polarities and the motor rotates in reverse. <div style="display: flex; justify-content: space-around;"> <div style="text-align: center;"> <p>H3-01 = 0</p> </div> <div style="text-align: center;"> <p>H3-01 = 4</p> </div> </div>

MEMOBUS/Modbus MFAI 1 to 3 Function Selection

You can set the MFAI function to MEMOBUS/Modbus register 15C1 to 15C3 (Hex.) [Mbus Reg 15C1h through 15C3h Input Function]. Use H3-40 to H3-42 [Mbus Reg 15C1h through 15C3h Input Function] to set the function for each register and use H3-43 [Mbus Reg Inputs FilterTime Const] to set the input filter.

Table 12.57 MEMOBUS Multi-Function AI Command Register

Register number (Hex.)	Name	Range *1	Parameter
15C1	Mbus Reg 15C1h Input Function	-32767 to +32767	H3-40
15C2	Mbus Reg 15C2h Input Function	-32767 to +32767	H3-41
15C3	Mbus Reg 15C3h Input Function	-32767 to +32767	H3-42

*1 Set as 100% = 4096.

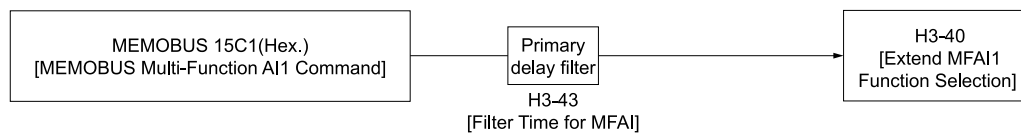

Figure 12.82 Functional Block Diagram for MEMOBUS Multi-Function AI Command 1

Note:

- Refer to *Multi-Function Analog Input Terminal Settings on page 693* for the analog input setting values.
- When you will not use the terminal, set *H3-40 to H3-42 = F*. Parameters *H3-40 to H3-42* do not support the through mode.
- You cannot use *H3-40 to H3-42* to set these MFAI functions:

H3-xx Setting Value	Function
0	Frequency Reference
1	Frequency Gain
2	Auxiliary Frequency Reference 1
3	Auxiliary Frequency Reference 2
30	DWEZ Analog Input 1
31	DWEZ Analog Input 2

◆ H3: MFAI Parameters

■ H3-01: Terminal A1 Signal Level Select

No. (Hex.)	Name	Description	Default (Range)
H3-01 (0410)	Terminal A1 Signal Level Select	<input type="radio"/> V/f <input type="radio"/> OLV <input type="radio"/> OLV/IPM <input type="radio"/> AOLV/IPM <input type="radio"/> EZOLV Sets the input signal level for MFAI terminal A1.	0 (0, 4)

0 : 0 to 10V (Lower Limit at 0)

The voltage signal is 0 Vdc to 10 Vdc. The minimum input level limit is 0%. The drive will read a negative input signal caused by gain and bias settings as 0%.

4 : -10 to +10V (Bipolar Reference)

The voltage signal is -10 Vdc to 10 Vdc. Signals of both positive and negative polarities are enabled. When this setting is used as the frequency reference, the motor runs reverse when the Forward run command is input, or runs forward when the Reverse run signal is input, while the signal is a negative number due to gain and bias.

■ H3-02: Terminal A1 Function Selection

No. (Hex.)	Name	Description	Default (Range)
H3-02 (0434)	Terminal A1 Function Selection	<input type="radio"/> V/f <input type="radio"/> OLV <input type="radio"/> OLV/IPM <input type="radio"/> AOLV/IPM <input type="radio"/> EZOLV Sets the function for MFAI terminal A1.	0 (0 - 32)

■ H3-03: Terminal A1 Gain Setting

No. (Hex.)	Name	Description	Default (Range)
H3-03 (0411) RUN	Terminal A1 Gain Setting	<input type="radio"/> V/f <input type="radio"/> OLV <input type="radio"/> OLV/IPM <input type="radio"/> AOLV/IPM <input type="radio"/> EZOLV Sets the gain of the analog signal input to MFAI terminal A1.	100.0% (-999.9 - +999.9%)

This parameter sets the quantity of reference for the function set for terminal A1 as a percentage when 10 V (or 20 mA) is input.

Use this parameter and *H3-04 [Terminal A1 Bias Setting]* to adjust the characteristics of the analog input signal to terminal A1.

■ H3-04: Terminal A1 Bias Setting

No. (Hex.)	Name	Description	Default (Range)
H3-04 (0412) RUN	Terminal A1 Bias Setting	<input type="radio"/> V/f <input type="radio"/> OLV <input type="radio"/> OLV/IPM <input type="radio"/> AOLV/IPM <input type="radio"/> EZOLV Sets the bias of the analog signal input to MFAI terminal A1.	0.0% (-999.9 - +999.9%)

This parameter sets the bias for the function set for terminal A1 as a percentage when 0 V (4 mA or 0 mA) is input. Use this parameter and *H3-03 [Terminal A1 Gain Setting]* to adjust the characteristics of the analog input signal to terminal A1.

■ H3-09: Terminal A2 Signal Level Select

No. (Hex.)	Name	Description	Default (Range)
H3-09 (0417)	Terminal A2 Signal Level Select	<input type="radio"/> V/f <input type="radio"/> OLV <input type="radio"/> OLV/PM <input type="radio"/> AOLV/PM <input type="radio"/> EZOLV Sets the input signal level for MFAI terminal A2.	2 (0, 2 - 4)

0 : 0-10V (LowLim=0)

The voltage signal is 0 Vdc to 10 Vdc. The minimum input level limit is 0%. The drive will read a negative input signal caused by gain and bias settings as 0%.

2 : 4 to 20 mA

The current signal is 4 mA to 20 mA. The minimum input level is limited to 0%, so that a negative input signal due to gain and bias settings will be read as 0%.

3 : 0 to 20 mA

The current signal is 0 mA to 20 mA. The minimum input level is limited to 0%, so that a negative input signal due to gain and bias settings will be read as 0%.

4 : -10 to +10V (Bipolar Reference)

The voltage signal is -10 Vdc to 10 Vdc. Signals of both positive and negative polarities are enabled. When this setting is used as the frequency reference, the motor runs reverse when the Forward run command is input, or runs forward when the Reverse run signal is input, while the signal is a negative number due to gain and bias.

Note:

When *H3-09 = 0, 4*, set DIP switch S1 to the V side (voltage). When *H3-09 = 2, 3*, set DIP switch S1 to the I side (current). The default setting is the I side (current).

■ H3-10: Terminal A2 Function Selection

No. (Hex.)	Name	Description	Default (Range)
H3-10 (0418)	Terminal A2 Function Selection	<input type="radio"/> V/f <input type="radio"/> OLV <input type="radio"/> OLV/PM <input type="radio"/> AOLV/PM <input type="radio"/> EZOLV Sets the function for MFAI terminal A2.	0 (0 - 32)

■ H3-11: Terminal A2 Gain Setting

No. (Hex.)	Name	Description	Default (Range)
H3-11 (0419) RUN	Terminal A2 Gain Setting	<input type="radio"/> V/f <input type="radio"/> OLV <input type="radio"/> OLV/PM <input type="radio"/> AOLV/PM <input type="radio"/> EZOLV Sets the gain of the analog signal input to MFAI terminal A2.	100.0% (-999.9 - +999.9%)

When 10 V (or 20 mA) is input, this parameter sets the reference quantity for the function set for terminal A2 as a percentage.

Use this parameter and *H3-12 [Terminal A2 Bias Setting]* to adjust the characteristics of the analog input signal to terminal A2.

■ H3-12: Terminal A2 Bias Setting

No. (Hex.)	Name	Description	Default (Range)
H3-12 (041A) RUN	Terminal A2 Bias Setting	<input type="radio"/> V/f <input type="radio"/> OLV <input type="radio"/> OLV/PM <input type="radio"/> AOLV/PM <input type="radio"/> EZOLV Sets the bias of the analog signal input to MFAI terminal A2.	0.0% (-999.9 - +999.9%)

When 0 V (4 mA or 0 mA) is input, this parameter sets the bias for the function set for terminal A2 as a percentage.

Use this parameter and *H3-11 [Terminal A2 Gain Setting]* to adjust the characteristics of the analog input signal to terminal A2.

■ H3-13: Analog Input FilterTime Constant

No. (Hex.)	Name	Description	Default (Range)
H3-13 (041B)	Analog Input FilterTime Constant	V/f OLV OLV/PM AOLV/PM EZOLV Sets the time constant for primary delay filters on MFAI terminals.	0.03 s (0.00 - 2.00 s)

Apply the primary delay filter to the analog input to enable an analog input signal without the use of high-frequency noise components. An analog input filter prevents irregular drive control. Drive operation becomes more stable as the programmed time becomes longer, but it also becomes less responsive to quickly changing analog signals.

■ H3-14: Analog Input Terminal Enable Sel

No. (Hex.)	Name	Description	Default (Range)
H3-14 (041C)	Analog Input Terminal Enable Sel	V/f OLV OLV/PM AOLV/PM EZOLV Sets the enabled terminal or terminals when $H1-xx = C$ [MFDI Function Select = Analog Terminal Enable Selection] is ON.	7 (1, 2, 7)

Input signals do not have an effect on terminals not set as targets.

1 : Terminal A1 only

2 : Terminal A2 only

7 : Terminals A1 and A2

Note:

- The ON/OFF operation of terminal Sx set in *Analog Terminal Input Selection [H1-xx = C]* has an effect on only the analog input terminal selected with *H3-14*.
- When $H1-xx \neq C$, the functions set to terminals A1 and A2 are always enabled.

■ H3-16: Terminal A1 Offset

No. (Hex.)	Name	Description	Default (Range)
H3-16 (02F0)	Terminal A1 Offset	V/f OLV OLV/PM AOLV/PM EZOLV Sets the offset level for analog signals input to terminal A1. Usually it is not necessary to change this setting.	0 (-500 - +500)

Adds the offset value for the analog input value. For voltage input, this parameter will set the offset when a signal of 0 V is input.

■ H3-17: Terminal A2 Offset

No. (Hex.)	Name	Description	Default (Range)
H3-17 (02F1)	Terminal A2 Offset	V/f OLV OLV/PM AOLV/PM EZOLV Sets the offset level for analog signals input to terminal A2. Usually it is not necessary to change this setting.	0 (-500 - +500)

Adds the offset value for the analog input value. For voltage input, this parameter will set the offset when a signal of 0 V is input. For current input, this parameter will set the offset when a signal of 4 mA [$H3-09 = 2$] or 0 mA [$H3-09 = 3$] is input.

■ H3-40: Mbus Reg 15C1h Input Function

No. (Hex.)	Name	Description	Default (Range)
H3-40 (0B5C)	Mbus Reg 15C1h Input Function	V/f OLV OLV/PM AOLV/PM EZOLV Sets the MEMOBUS AII function.	F (4 - 2F)

You can use the MFAI function from MEMOBUS/Modbus communications. Use this parameter to set the function. Sets the function for MEMOBUS/Modbus register 15C1h.

Refer to [H3: Analog Inputs on page 688](#) for the setting values.

■ H3-41: Mbus Reg 15C2h Input Function

No. (Hex.)	Name	Description	Default (Range)
H3-41 (0B5F)	Mbus Reg 15C2h Input Function	<input type="checkbox"/> V/f <input type="checkbox"/> OLV <input type="checkbox"/> OLV/PM <input type="checkbox"/> AOLV/PM <input type="checkbox"/> EZOLV Sets the MEMOBUS AI2 function.	F (4 - 2F)

You can use the MFAI function from MEMOBUS/Modbus communications. Use this parameter to set the function. Sets the function for MEMOBUS/Modbus register 15C2h.

Refer to [H3: Analog Inputs on page 688](#) for the setting values.

■ H3-42: Mbus Reg 15C3h Input Function

No. (Hex.)	Name	Description	Default (Range)
H3-42 (0B62)	Mbus Reg 15C3h Input Function	<input type="checkbox"/> V/f <input type="checkbox"/> OLV <input type="checkbox"/> OLV/PM <input type="checkbox"/> AOLV/PM <input type="checkbox"/> EZOLV Sets the MEMOBUS AI3 function.	F (4 - 2F)

You can use the MFAI function from MEMOBUS/Modbus communications. Use this parameter to set the function. Sets the function for MEMOBUS/Modbus register 15C3h.

Refer to [H3: Analog Inputs on page 688](#) for the setting values.

■ H3-43: Mbus Reg Inputs FilterTime Const

No. (Hex.)	Name	Description	Default (Range)
H3-43 (117F)	Mbus Reg Inputs FilterTime Const	<input type="checkbox"/> V/f <input type="checkbox"/> OLV <input type="checkbox"/> OLV/PM <input type="checkbox"/> AOLV/PM <input type="checkbox"/> EZOLV Sets the time constant to apply a primary delay filter to the MEMOBUS analog input register values.	0.00 s (0.00 - 2.00 s)

◆ Multi-Function Analog Input Terminal Settings

This section gives information about the functions set with *H3-02*, *H3-10*, and *H3-40* to *H3-42*.

■ 0: Frequency Reference

Setting Value	Function	Description
0	Frequency Reference	<input type="checkbox"/> V/f <input type="checkbox"/> OLV <input type="checkbox"/> OLV/PM <input type="checkbox"/> AOLV/PM <input type="checkbox"/> EZOLV The input value from the MFAI terminal set with this function becomes the master frequency reference.

- You can copy the configuration to more than one of the analog input terminals A1 and A2. When you set more than one analog input terminal with the master frequency reference, the sum value becomes the frequency bias.
- If you use this function to set the analog input value as the master frequency reference, set $b1-01 = 1$ [*Frequency Reference Selection 1 = Analog Input*]. This setting value is the default value for terminals A1 and A2.
- The frequency reference is the sum of the input values for terminals A1 and A2 when they are used at the same time. For example, when a 20% bias is input to terminal A2 while a frequency reference of 50% is input from terminal A1, the calculated frequency reference will be 70% of the maximum output frequency.

■ 1: Frequency Gain

Setting Value	Function	Description
1	Frequency Gain	<input type="checkbox"/> V/f <input type="checkbox"/> OLV <input type="checkbox"/> OLV/PM <input type="checkbox"/> AOLV/PM <input type="checkbox"/> EZOLV The drive multiplies the analog frequency reference with the input value from the MFAI set with this function.

Example: When you set frequency gain for terminal A2

- $H3-10 = 1$ [*Terminal A2 Function Selection = Frequency Gain*]
- A 50% frequency gain is input to terminal A2
- A frequency reference of 80% is input from terminal A1

The calculated frequency reference is 40% of the maximum output frequency.

■ 2: Auxiliary Frequency Reference 1

Setting Value	Function	Description
2	Auxiliary Frequency Reference 1	<div style="display: flex; justify-content: space-between; align-items: center;"> V/f OLV OLV/IPM AOLV/IPM EZOLV </div> <p>Sets Reference 2 through multi-step speed reference to enable the command reference (Auxiliary Frequency Reference 1) from the analog input terminal set here. This value is a percentage where the Maximum Output Frequency setting is a setting value of 100%.</p>

■ 3: Auxiliary Frequency Reference 2

Setting Value	Function	Description
3	Auxiliary Frequency Reference 2	<div style="display: flex; justify-content: space-between; align-items: center;"> V/f OLV OLV/IPM AOLV/IPM EZOLV </div> <p>Sets Reference 3 through multi-step speed reference to enable the command reference (Auxiliary Frequency Reference 2) from the analog input terminal set here. This value is a percentage where the Maximum Output Frequency setting is a setting value of 100%.</p>

■ 4: Output Voltage Bias

Setting Value	Function	Description
4	Output Voltage Bias	<div style="display: flex; justify-content: space-between; align-items: center;"> V/f OLV OLV/IPM AOLV/IPM EZOLV </div> <p>Set this parameter to input a bias signal to amplify the output voltage.</p>

The gain (%) for the MFAI terminals A1 and A2 is 100% of the voltage class standard, which is 200 V for 200 V class drives and 400 V for 400 V class drives. The bias (%) for MFAI terminals A1 and A2 is 100% of the voltage configured for E1-05 [Maximum Output Voltage].

Note:

The gain for each terminal A1 and A2 is set independently with H3-03 [Terminal A1 Gain Setting] and H3-11 [Terminal A2 Gain Setting]. The bias for each terminal A1 and A2 is set independently with H3-04 [Terminal A1 Bias Setting] and H3-12 [Terminal A2 Bias Setting].

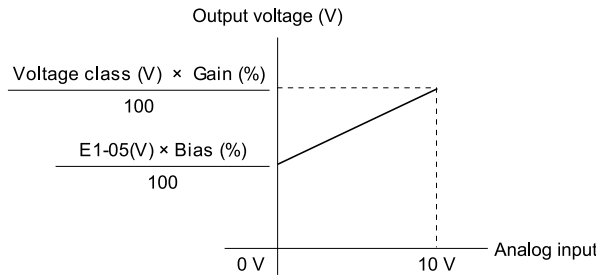

Figure 12.83 Output Voltage Bias through Analog Input

■ 5: Accel/Decel Time Gain

Setting Value	Function	Description
5	Accel/Decel Time Gain	<div style="display: flex; justify-content: space-between; align-items: center;"> V/f OLV OLV/IPM AOLV/IPM EZOLV </div> <p>Enters a signal to adjust the gain used for C1-01 to C1-08 [Acceleration/Deceleration Times 1 to 4] and C1-09 [Fast Stop Time] when the full scale analog signal (10 V or 20 mA) is 100%.</p>

When you enable C1-01 [Acceleration Time 1], the acceleration time is:

$$\text{Acceleration Time 1} = \text{Setting value of C1-01} \times \text{acceleration and deceleration time gain} / 100$$

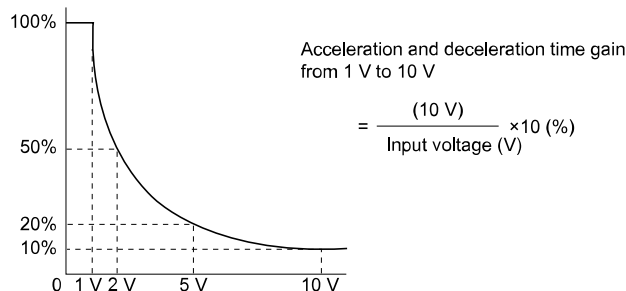

Figure 12.84 Acceleration/Deceleration Time Gain through Analog Input

6: DC Injection Braking Current

Setting Value	Function	Description
6	DC Injection Braking Current	<div style="display: flex; justify-content: space-between; align-items: center;"> V/f OLV OLV/PM AOLV/PM EZOLV </div> Enters a signal to adjust the current level used for DC Injection Braking when the drive rated output current is 100%.

Note:

When you set this function, it will disable the setting value of *b2-02 [DC Injection Braking Current]*.

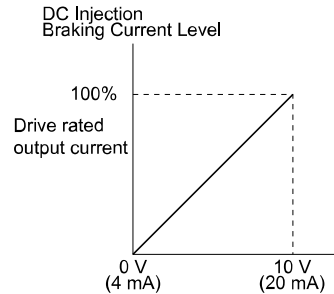

Figure 12.85 DC Injection Braking Current through Analog Input

7: Torque Detection Level

Setting Value	Function	Description
7	Torque Detection Level	<div style="display: flex; justify-content: space-between; align-items: center;"> V/f OLV OLV/PM AOLV/PM EZOLV </div> Enters a signal to adjust the overtorque/undertorque detection level.

When *A1-02 = 0, 5 [Control Method Selection = V/f, OLV/PM]*, the drive rated current is 100%. When *A1-02 = 2, 6, 8 [OLV, AOLV/PM, or EZOLV]*, the motor rated current is 100%.

Note:

Use this function with *L6-01 [Torque Detection Selection 1]*. This parameter functions as an alternative to *L6-02 [Torque Detection Level 1]*.

8: Stall Prevent Level during Run

Setting Value	Function	Description
8	Stall Prevent Level during Run	<div style="display: flex; justify-content: space-between; align-items: center;"> V/f OLV OLV/PM AOLV/PM EZOLV </div> Enters a signal to adjust the stall prevention level during run if the drive rated current is 100%.

Note:

The drive will use the smaller value of these values for Stall Prevent Level during Run:

- Multi-function analog input terminal analog input value
- *L3-06 [Stall Prevent Level during Run]*

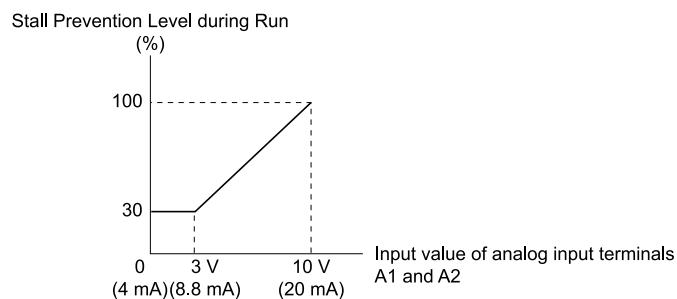

Figure 12.86 Stall Prevention Level during Run with Analog Input

9: Output Frequency Lower Limit

Setting Value	Function	Description
9	Output Frequency Lower Limit	<div style="display: flex; justify-content: space-between; align-items: center;"> V/f OLV OLV/PM AOLV/PM EZOLV </div> Enters a signal to adjust the output frequency lower limit level as a percentage of the maximum output frequency.

■ B: PID Feedback

Setting Value	Function	Description
B	PID Feedback	<div style="display: flex; justify-content: space-between; align-items: center;"> V/f OLV OLV/IPM AOLV/IPM EZOLV </div> Enter the PID feedback value as a percentage of the maximum output frequency.

When you use this function, set $b5-01 = 1$ to 8 [PID Mode Setting = Enabled].

■ C: PID Setpoint

Setting Value	Function	Description
C	PID Setpoint	<div style="display: flex; justify-content: space-between; align-items: center;"> V/f OLV OLV/IPM AOLV/IPM EZOLV </div> Enters the PID setpoint as a percentage of the maximum output frequency.

When you use this function, set $b5-01 = 1$ to 8 [PID Mode Setting = Enabled].

Note:

Configuring this function disables the frequency reference set with $b1-01$ [Frequency Reference Selection 1].

■ D: Frequency Bias

Setting Value	Function	Description
D	Frequency Bias	<div style="display: flex; justify-content: space-between; align-items: center;"> V/f OLV OLV/IPM AOLV/IPM EZOLV </div> Enters the bias value added to the frequency reference as a percentage of the maximum output frequency.

The drive adds the input value from the MFAI terminal set with this function to the frequency reference as the bias value.

Note:

When you select $d1-01$ to $d1-16$ or $d1-17$ [Reference 1 to 16 or JOG Frequency Reference] as the frequency reference, it will disable this function.

■ E: Motor Temperature (PTC Input)

Setting Value	Function	Description
E	Motor Temperature (PTC Input)	<div style="display: flex; justify-content: space-between; align-items: center;"> V/f OLV OLV/IPM AOLV/IPM EZOLV </div> Uses the motor Positive Temperature Coefficient (PTC) thermistor to prevent heat damage to the motor as a percentage of the current value when the 10 V analog signal is input.

- You can use the Positive Temperature Coefficient (PTC) thermistor as an auxiliary or alternative detection function for $oL1$ [Motor Overload] problems to help prevent heat damage to motors. If the PTC input signal is more than the overload alarm level, $oH3$ [Motor Overheat (PTC Input)] will flash on the keypad.
- When the drive detects $oH3$, the motor stops with the setting in $L1-03$. When the drive detects $oH4$, the motor stops with the setting in $L1-04$. When the drive incorrectly detects motor overheating problems, set $L1-05$.

■ F: Not Used

Setting Value	Function	Description
F	Not Used	<div style="display: flex; justify-content: space-between; align-items: center;"> V/f OLV OLV/IPM AOLV/IPM EZOLV </div> Use this setting for unused terminals or to use terminals in through mode.

When you set a terminal that is not in use to F, you can use the signal input to the terminal as PLC analog signal input through MEMOBUS/Modbus communications or the communication option. This input signal does not have an effect on drive operation. This functions the same as setting 1F (Through Mode).

■ 10: Forward Torque Limit

Setting Value	Function	Description
10	Forward Torque Limit	<div style="display: flex; justify-content: space-between; align-items: center;"> V/f OLV OLV/IPM AOLV/IPM EZOLV </div> Enters the forward torque limit if the motor rated torque is 100%.

WARNING! Sudden Movement Hazard. Set correct torque limits for applications, for example elevator applications. If you set torque limits incorrectly, motor torque that is not sufficient can cause damage to equipment and cause serious injury or death.

Torque Limit Configuration Method

Use one of these methods to set torque limits:

- Individually set the four torque limit quadrants using *L7-01 to L7-04 [Torque Limit]*.
- Use MFAI to individually set the four torque limit quadrants. Set *H3-02, H3-10 = 10, 11, 12 [MFAI Function Select = Forward/Reverse/Regenerative Torque Limit]*.
- Use MFAI to set all four torque limit quadrants together. Set *H3-02, H3-10 = 15 [General Torque Limit]*.
- Use a communication option to set all four torque limit quadrants together.

Figure 12.87 shows the configuration method for each quadrant.

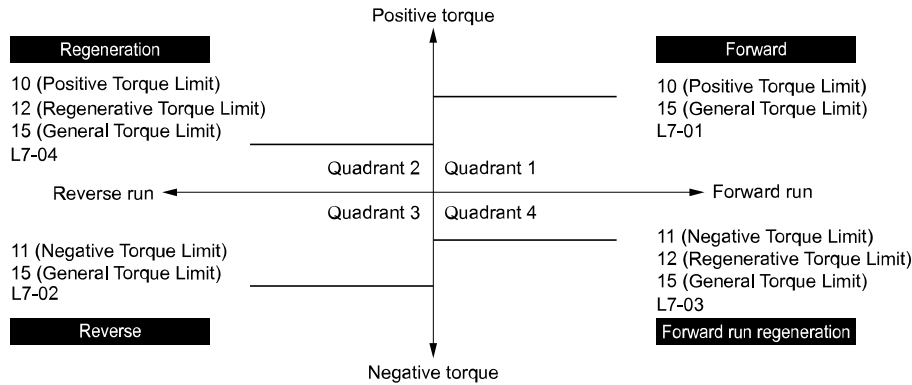

Figure 12.87 Torque Limits and Analog Input Setting Parameters

Note:

- When *L7-01 to L7-04* and analog inputs or communication option torque limits set torque limits for the same quadrant, the lower value is enabled. In this example of parameter settings, the torque limit for quadrant 1 is 130% and the torque limit for quadrants 2, 3, and 4 is 150%. Settings: *L7-01 = 130%, L7-02 to L7-04 = 200%*, and MFAI torque limit = 150%
- The drive output current limits maximum output torque. The torque limit is 150% of the rated output current for HD and to 120% of the rated output current for ND. The actual output torque is not more than the limits of the drive rated output current when you set the torque limit to a high value.

If you use drives in applications where the vertical axis can fall, make sure that you know these items:

- Correctly configure drives and motors.
- Correctly set parameters.
- You can change parameter values after you do Auto-Tuning.
- Use a system that will not let the vertical axis fall if the drive fails.

Figure 12.88 shows the relation between torque limits from parameters and torque limits from analog input.

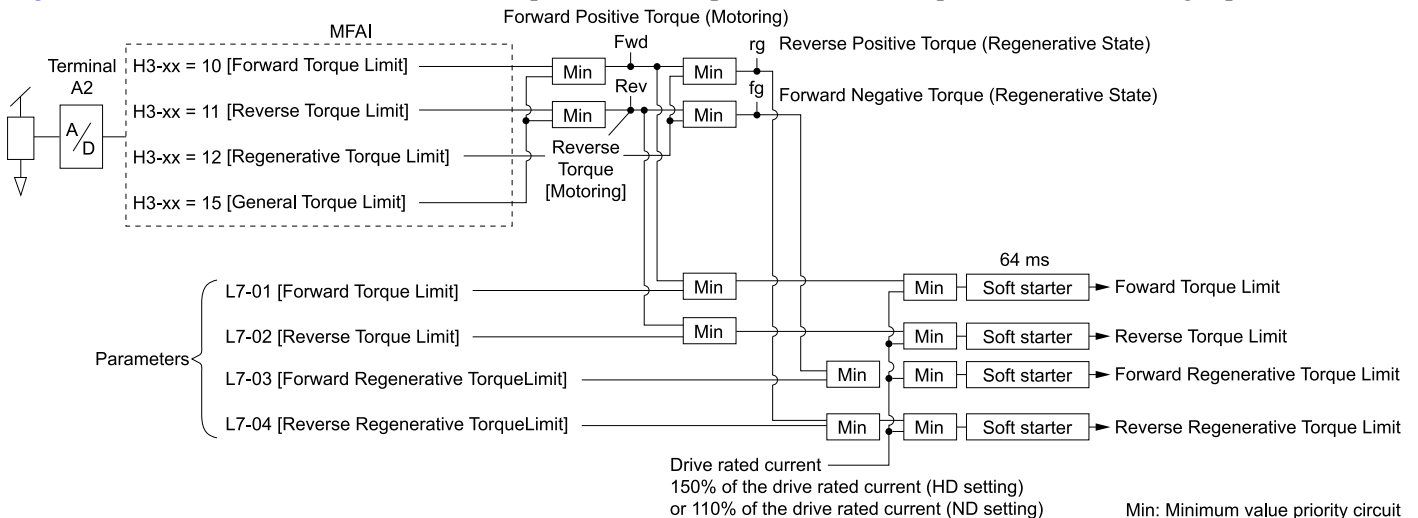

Figure 12.88 Torque Limits from Parameters and Analog Inputs

Parameter Details

■ 11: Reverse Torque Limit

Setting Value	Function	Description
11	Reverse Torque Limit	<div style="display: flex; gap: 5px;"> V/f OLV OLV/IPM AOLV/IPM EZOLV </div> Enters the load torque limit if the motor rated torque is 100%.

Note:

When you use *L7-01 to L7-04* and analog inputs to set torque limits for the same quadrant, it will enable the lower torque limit.

■ 12: Regenerative Torque Limit

Setting Value	Function	Description
12	Regenerative Torque Limit	<div style="display: flex; gap: 5px;"> V/f OLV OLV/IPM AOLV/IPM EZOLV </div> Enters the regenerative torque limit if the motor rated torque is 100%.

Note:

When you use *L7-01 to L7-04* and analog inputs to set torque limits for the same quadrant, it will enable the lower torque limit.

■ 13: Torque Reference / Torque Limit

Setting Value	Function	Description
13	Torque Reference / Torque Limit	<div style="display: flex; gap: 5px;"> V/f OLV OLV/IPM AOLV/IPM EZOLV </div> Enters the torque reference if the motor rated torque is 100%. This setting is the torque limit for speed control.

Note:

When you use *L7-01 to L7-04* and analog inputs to set torque limits for the same quadrant, it will enable the lower torque limit.

■ 14: Torque Compensation

Setting Value	Function	Description
14	Torque Compensation	<div style="display: flex; gap: 5px;"> V/f OLV OLV/IPM AOLV/IPM EZOLV </div> Enters the torque compensation value if the motor rated torque is 100%.

■ 15: General Torque Limit

Setting Value	Function	Description
15	General Torque Limit	<div style="display: flex; gap: 5px;"> V/f OLV OLV/IPM AOLV/IPM EZOLV </div> Enters the torque limit that is the same for all quadrants for forward, reverse, and regenerative operation if the motor rated torque is 100%.

■ 16: Differential PID Feedback

Setting Value	Function	Description
16	Differential PID Feedback	<div style="display: flex; gap: 5px;"> V/f OLV OLV/IPM AOLV/IPM EZOLV </div> Enters the PID differential feedback value if the full scale analog signal (10 V or 20 mA) is 100%.

The drive uses the deviation between the PID feedback and the differential feedback value signals to calculate the PID input.

■ 1F: Not Used

Setting Value	Function	Description
1F	Not Used	<div style="display: flex; gap: 5px;"> V/f OLV OLV/IPM AOLV/IPM EZOLV </div> Use this setting for unused terminals or to use terminals in through mode.

When you set a terminal that you do not use to 1F, you can use the signal that is input to that terminal as the PLC analog signal input from MEMOBUS/Modbus communications or the communication option. This input signal does not have an effect on drive operation. This signal functions the same as F (Through Mode).

■ 30: DWEZ Analog Input 1

Setting Value	Function	Description
30	DWEZ Analog Input 1	<div style="display: flex; gap: 5px;"> V/f OLV OLV/PM AOLV/PM EZOLV </div> Use with DriveWorksEZ. Refer to the DriveWorksEZ online manual for more information.

■ 31: DWEZ Analog Input 2

Setting Value	Function	Description
31	DWEZ Analog Input 2	<div style="display: flex; gap: 5px;"> V/f OLV OLV/PM AOLV/PM EZOLV </div> Use with DriveWorksEZ. Refer to the DriveWorksEZ online manual for more information.

◆ H4: Analog Outputs

H4 parameters set the drive analog monitors. These parameters select monitor parameters, adjust gain and bias, and select output signal levels.

■ Calibrate Meters Connected to MFAO Terminal AM

Use these parameters to calibrate meters connected to terminal AM:

- H4-02 [Terminal AM Analog Output Gain]
- H4-03 [Terminal AM Analog Output Bias]

Set these parameters where the output voltage of 10 V and output current of 20 mA are 100% of the signal level. Use jumper switch *S5* and parameter *H4-07* [Terminal AM Signal Level Select] to set the voltage output and current output.

No.	Name	Range	Default
H4-02	Terminal AM Analog Output Gain	-999.9 - +999.9%	100.0%
H4-03	Terminal AM Analog Output Bias	-999.9 - +999.9%	0.0%
H4-07	Terminal AM Signal Level Select	0: 0 +10 VDC 2: 4-20 mA	0

Figure 12.89 and Figure 12.90 show the gain and bias.

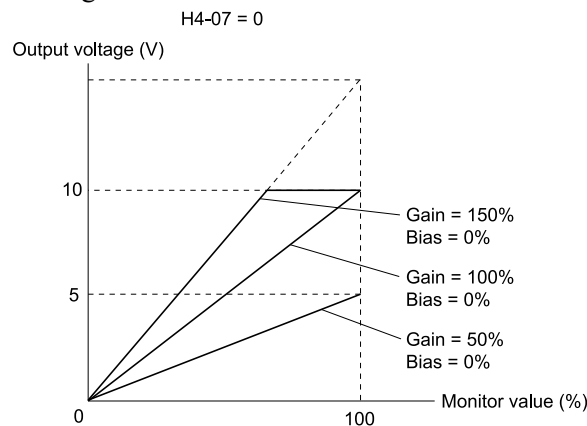

Figure 12.89 Analog Output Gain/Bias Configuration Example 1

For example, when the parameter value set to analog output is 0, and a 3 V signal is to be output to terminal AM, set *H4-03* [AM Analog Output Bias] = 30%.

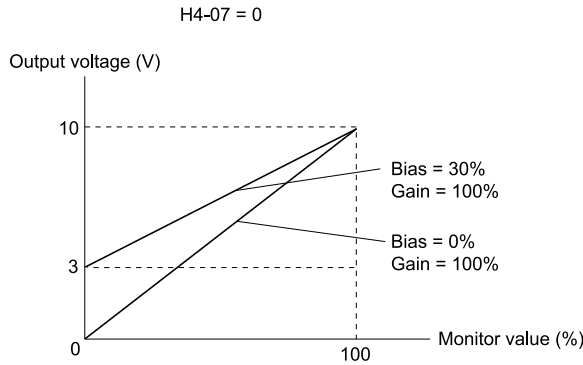

Figure 12.90 Analog Output Gain/Bias Configuration Example 2

Calibrate Terminal AM

Stop the drive to calibrate meters. Use this procedure to calibrate:

1. Show *H4-02 [Terminal AM Analog Output Gain]* on the keypad. Terminal AM outputs the analog signal when the monitor item that you set in *H4-01 [Terminal AM Analog Output Select]* is 100%.
2. Adjust *H4-02* while referencing the meter scale connected to terminal AM.
3. Show *H4-03 [Terminal AM Analog Output Bias]* on the keypad. The analog signal at the time when the monitor item selected with *H4-01* is 0% is output from terminal AM.
4. Adjust *H4-03* while referencing the meter scale connected to terminal AM.

■ H4-01: Terminal AM Analog Output Select

No. (Hex.)	Name	Description	Default (Range)
H4-01 (041D)	Terminal AM Analog Output Select	<input type="checkbox"/> V/f <input type="checkbox"/> OLV <input type="checkbox"/> OLV/IPM <input type="checkbox"/> AOLV/IPM <input type="checkbox"/> EZOLV Sets the monitoring number to be output from the MFAO terminal AM.	102 (000 - 999)

Set the *x-xx* part of the *Ux-xx [Monitor]*. For example, set *H4-01 = 102* to monitor *U1-02 [Output Frequency]*.

Note:

- You cannot use all of the monitors in all of the control methods.
- When you use the terminal in through mode, set this parameter to *000* or *031*. You can set the terminal AM output level from the PLC through MEMOBUS/Modbus communications or the communication option.

■ H4-02: Terminal AM Analog Output Gain

No. (Hex.)	Name	Description	Default (Range)
H4-02 (041E) RUN	Terminal AM Analog Output Gain	<input type="checkbox"/> V/f <input type="checkbox"/> OLV <input type="checkbox"/> OLV/IPM <input type="checkbox"/> AOLV/IPM <input type="checkbox"/> EZOLV Sets the gain of the monitor signal that is sent from MFAO terminal AM.	100.0% (-999.9 - +999.9%)

The analog signal output from the AM terminal is a maximum of 10 V (or 20 mA). Use *H4-07 [Terminal AM Signal Level Select]* to set the signal level.

■ H4-03: Terminal AM Analog Output Bias

No. (Hex.)	Name	Description	Default (Range)
H4-03 (041F) RUN	Terminal AM Analog Output Bias	<input type="checkbox"/> V/f <input type="checkbox"/> OLV <input type="checkbox"/> OLV/IPM <input type="checkbox"/> AOLV/IPM <input type="checkbox"/> EZOLV Sets the bias of the monitor signal that is sent from MFAO terminal AM.	0.0% (-999.9 - +999.9%)

The analog signal output from the AM terminal is a maximum of 10 V (or 20 mA). Use *H4-07 [Terminal AM Signal Level Select]* to set the signal level.

■ H4-07: Terminal AM Signal Level Select

No. (Hex.)	Name	Description	Default (Range)
H4-07 (0423)	Terminal AM Signal Level Select	<div style="display: flex; justify-content: space-between; align-items: center;"> V/f OLV OLV/PM AOLV/PM EZOLV </div> Sets the MFAO terminal AM output signal level.	0 (0, 2)

Note:

Set jumper S5 on the control circuit terminal block accordingly when changing these parameters.

0 : 0-10V

2 : 4 to 20 mA

■ H4-20: Analog Power Monitor 100% Level

No. (Hex.)	Name	Description	Default (Range)
H4-20 (0B53)	Analog Power Monitor 100% Level	<div style="display: flex; justify-content: space-between; align-items: center;"> V/f OLV OLV/PM AOLV/PM EZOLV </div> Sets the level at 10 V when U1-08 [Output Power] is set for analog output.	0.00 kW (0.00 - 650.00 kW)

Note:

• When H4-20 = 0.00 kW, the output power monitor 10 V level = motor rated power (kW). The setting changes when the A1-02 [Control Method Selection] value changes:

– A1-02 = 0 [V/f]: E2-11 [Motor Rated Power]

– A1-02 = 2 [OLV]: E2-11 [Motor Rated Power]

– A1-02 = 5, 6 [OLV/PM, AOLV/PM]: E5-02 [PM Motor Rated Power]

– A1-02 = 8 [EZOLV]: E9-07 [Motor Rated Power]

◆ H5: Memobus/Modbus Communication

H5 parameters configure the drive to use MEMOBUS/Modbus communications.

You can use the MEMOBUS/Modbus protocol over the RS-485 port (terminals D+ and D-) in the drive to use serial communication with programmable controllers (PLC).

■ H5-01: Drive Node Address

No. (Hex.)	Name	Description	Default (Range)
H5-01 (0425)	Drive Node Address	<div style="display: flex; justify-content: space-between; align-items: center;"> V/f OLV OLV/PM AOLV/PM EZOLV </div> Sets the communication slave address for drives.	1FH (0 - FFH)

Note:

- Re-energize the drive or set H5-20 = 1 [Communication Parameters Reload = Reload Now] after you change the parameter setting.
- Setting 0 will not let the drive respond to MEMOBUS/Modbus communications.

To enable the drive to communicate with the controller (master) over MEMOBUS/Modbus communications, you must set the drive with a slave address. Set H5-01 ≠ 0.

Set a node address that is different from the master and other slave devices.

■ H5-02: Communication Speed Selection

No. (Hex.)	Name	Description	Default (Range)
H5-02 (0426)	Communication Speed Selection	<div style="display: flex; justify-content: space-between; align-items: center;"> V/f OLV OLV/PM AOLV/PM EZOLV </div> Sets the communications speed for MEMOBUS/Modbus communications.	3 (0 - 8)

Note:

Re-energize the drive or set H5-20 = 1 [Communication Parameters Reload = Reload Now] after you change the parameter setting.

0 : 1200 bps

1 : 2400 bps

2 : 4800 bps

- 3 : 9600 bps
- 4 : 19.2 kbps
- 5 : 38.4 kbps
- 6 : 57.6 kbps
- 7 : 76.8 kbps
- 8 : 115.2 kbps

■ H5-03: Communication Parity Selection

No. (Hex.)	Name	Description	Default (Range)
H5-03 (0427)	Communication Parity Selection	<div style="display: flex; gap: 5px;"> V/f OLV OLV/PM AOLV/PM EZOLV </div> Sets the communications parity used for MEMOBUS/Modbus communications.	0 (0 - 2)

Note:

Re-energize the drive or set $H5-20 = 1$ [*Communication Parameters Reload = Reload Now*] after you change the parameter setting.

- 0 : No parity
- 1 : Even parity
- 2 : Odd parity

■ H5-04: Communication Error Stop Method

No. (Hex.)	Name	Description	Default (Range)
H5-04 (0428)	Communication Error Stop Method	<div style="display: flex; gap: 5px;"> V/f OLV OLV/PM AOLV/PM EZOLV </div> Sets the motor Stopping Method when the drive detects <i>CE</i> [<i>MEMOBUS/Modbus Communication Err</i>] issues.	3 (0 - 3)

0 : Ramp to Stop

The drive ramps the motor to stop in the deceleration time. The output terminal set for *Fault* [$H2-01$ to $H2-03 = E$] activates.

1 : Coast to Stop

The output turns off and the motor coasts to stop. The output terminal set for *Fault* [$H2-01$ to $H2-03 = E$] activates.

2 : Fast Stop (Use C1-09)

The drive stops the motor in the deceleration time set in $C1-09$ [*Fast Stop Time*]. The output terminal set for *Fault* [$H2-01$ to $H2-03 = E$] activates.

3 : Alarm Only

The keypad shows *CE* and the drive continues operation. The output terminal set for *Alarm* [$H2-01$ to $H2-03 = 10$] activates.

■ H5-05: Comm Fault Detection Selection

No. (Hex.)	Name	Description	Default (Range)
H5-05 (0429)	Comm Fault Detection Selection	<div style="display: flex; gap: 5px;"> V/f OLV OLV/PM AOLV/PM EZOLV </div> Sets the function that detects <i>CE</i> [<i>Modbus Communication Error</i>] issues during MEMOBUS/Modbus communications.	1 (0, 1)

If the drive does not receive data from the master during the time set in $H5-09$ [*CE Detection Time*], it will detect a *CE* error.

0 : Disabled

Does not detect *CE*. The drive continues operation.

1 : Enabled

Detects *CE*. If the drive detects *CE*, it will operate as specified by the setting of $H5-04$ [*Communication Error Stop Method*].

■ H5-06: Drive Transmit Wait Time

No. (Hex.)	Name	Description	Default (Range)
H5-06 (042A)	Drive Transmit Wait Time	V/f OLV OLV/PM AOLV/PM EZOLV Sets the time to wait to send a response message after the drive receives a command message from the master.	5 ms (0 - 65 ms)

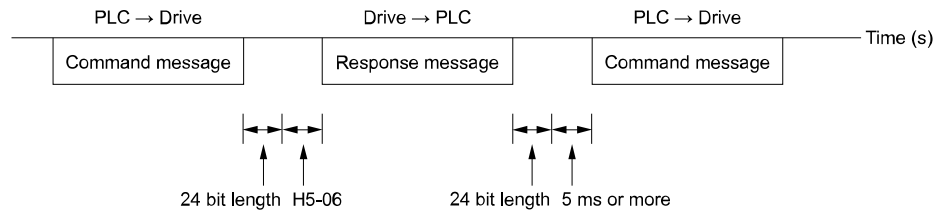

Figure 12.91 Drive Transmit Wait Time

■ H5-09: CE Detection Time

No. (Hex.)	Name	Description	Default (Range)
H5-09 (0435)	CE Detection Time	V/f OLV OLV/PM AOLV/PM EZOLV Sets the detection time for CE [Modbus Communication Error] issues when communication stops.	2.0 s (0.0 - 25.0 s)

■ H5-10: Modbus Register 0025H Unit Sel

No. (Hex.)	Name	Description	Default (Range)
H5-10 (0436)	Modbus Register 0025H Unit Sel	V/f OLV OLV/PM AOLV/PM EZOLV Sets the unit of measure used for the MEMOBUS/Modbus communications monitor register 0025H (output voltage reference monitor).	0 (0, 1)

0 : 0.1 V units

1 : 1 V units

■ H5-11: Comm ENTER Command Mode

No. (Hex.)	Name	Description	Default (Range)
H5-11 (043C) RUN	Comm ENTER Command Mode	V/f OLV OLV/PM AOLV/PM EZOLV Sets the function to make the Enter command necessary to change parameters through MEMOBUS/Modbus communications.	1 (0, 1)

0 : ENTER Command Required

Make all parameter changes then input the Enter command. You must use the Enter command to enable changes to parameters.

1 : ENTER Command Not Required

It is not necessary to input the Enter command to change parameters.

■ H5-12: Run Command Method Selection

No. (Hex.)	Name	Description	Default (Range)
H5-12 (043D)	Run Command Method Selection	V/f OLV OLV/PM AOLV/PM EZOLV Sets the input method for the Run command when $b1-02 = 2$ [Run Command Selection 1 = Memobus/Modbus Communications] or $b1-16 = 2$ [Run Command Selection 2 = Memobus/Modbus Communications].	0 (0, 1)

0 : FWD/Stop, REV/Stop

The drive uses bit 0 in command data 0001H of the MEMOBUS register in the motor forward Run command (bit 0 = 1) and the stop command (bit 0 = 0). The drive uses bit 1 in the motor reverse Run command (bit 1 = 1) and the stop command (bit 1 = 0).

1 : Run/Stop, FWD/REV

The drive uses bit 0 in command data 0001H of the MEMOBUS register in the motor Run command (bit 0 = 1) and the stop command (bit 0 = 0). The drive uses bit 1 in the direction of motor rotation command (Forward run (bit1 = 0) or Reverse run (bit 1 = 1)).

■ H5-17: ENTER command response @CPU BUSY

No. (Hex.)	Name	Description	Default (Range)
H5-17 (11A1) Expert	ENTER command response @CPU BUSY	V/f OLV OLV/PM AOLV/PM EZOLV Sets operation when the EEPROM write command is sent without EEPROM write available. Usually it is not necessary to change this setting.	0 (0, 1)

0 : Ignore Command(No ROM/RAM Write)**1 : Write to RAM Only****■ H5-18: Motor Speed Filter over Comms**

No. (Hex.)	Name	Description	Default (Range)
H5-18 (11A2)	Motor Speed Filter over Comms	V/f OLV OLV/PM AOLV/PM EZOLV Sets the filter time constant used when monitoring motor speed during MEMOBUS/Modbus communications or with a communication option.	0 ms (0 - 100 ms)

Sets the filter time constant when you monitor the output frequency or motor speed during MEMOBUS/Modbus communications or use of the communication option.

These are the MEMOBUS registers:

- 003EH (Output Frequency)
- 003FH (Output Frequency)
- 0044H (U1-05: Motor Speed)
- 00ACH (U1-05: Motor Speed)
- 00ADH (U1-05: Motor Speed)

■ H5-20: Communication Parameters Reload

No. (Hex.)	Name	Description	Default (Range)
H5-20 (0B57)	Communication Parameters Reload	V/f OLV OLV/PM AOLV/PM EZOLV Sets the function to immediately enable updated MEMOBUS/Modbus communications parameters.	0 (0, 1)

0 : Reload at Next Power Cycle**1 : Reload Now****Note:**

- The setting value automatically returns to H5-20 = 0 after you enable MEMOBUS/Modbus communications parameter changes.
- The setting values of these parameters are enabled:
 - H5-01 [Drive Node Address]
 - H5-02 [Communication Speed Selection]
 - H5-03 [Communication Parity Selection]
 - H5-06 [Drive Transmit Wait Time]

■ H5-22: Speed Search from MODBUS

No. (Hex.)	Name	Description	Default (Range)
H5-22 (11CF)	Speed Search from MODBUS	V/f OLV OLV/PM AOLV/PM EZOLV Enables the MEMOBUS/Modbus communication register Speed Search function (bit0 of 15DFH).	0 (0, 1)

0 : Disabled**1 : Enabled**

If you set $H5-22 = 1$ and $H1-xx = 62$ [*Speed Search from Fref*] at the same time, the drive will detect *oPE03* [*Multi-Function Input Setting Err*].

■ H5-25: Function 5A Register 1 Selection

No. (Hex.)	Name	Description	Default (Range)
H5-25 (1589) RUN	Function 5A Register 1 Selection	V/f OLV OLV/PM AOLV/PM EZOLV Returns the contents of the specified MEMOBUS/Modbus communications register when responding to the master device.	0044H (U1-05) (0000H - FFFFH)

Note:

Refer to [Writing to More than One Holding Register/Reading the Indicated Register on page 231](#) for more information.

■ H5-26: Function 5A Register 2 Selection

No. (Hex.)	Name	Description	Default (Range)
H5-26 (158A) RUN	Function 5A Register 2 Selection	V/f OLV OLV/PM AOLV/PM EZOLV Returns the contents of the specified MEMOBUS/Modbus communications register when responding to the master device.	0045H (U1-06) (0000H - FFFFH)

Note:

Refer to [Writing to More than One Holding Register/Reading the Indicated Register on page 231](#) for more information.

■ H5-27: Function 5A Register 3 Selection

No. (Hex.)	Name	Description	Default (Range)
H5-27 (158B) RUN	Function 5A Register 3 Selection	V/f OLV OLV/PM AOLV/PM EZOLV Returns the contents of the specified MEMOBUS/Modbus communications register when responding to the master device.	0042H (U1-03) (0000H - FFFFH)

Note:

Refer to [Writing to More than One Holding Register/Reading the Indicated Register on page 231](#) for more information.

■ H5-28: Function 5A Register 4 Selection

No. (Hex.)	Name	Description	Default (Range)
H5-28 (158C) RUN	Function 5A Register 4 Selection	V/f OLV OLV/PM AOLV/PM EZOLV Returns the contents of the specified MEMOBUS/Modbus communications register when responding to the master device.	0049H (U1-10) (0000H - FFFFH)

Note:

Refer to [Writing to More than One Holding Register/Reading the Indicated Register on page 231](#) for more information.

◆ H6: Pulse Train Input/Output

H6 parameters set the drive pulse train input and pulse train monitor. These parameters select input and monitor parameters and adjust the pulse train frequency.

A pulse train signal with a maximum single pulse of 32 kHz can be input to the drive input terminal RP. You can use the pulse train signal as the frequency reference, PID feedback value, PID setpoint value, and speed feedback for V/f Control mode.

A pulse train signal with a maximum frequency of 32 kHz can be output from the drive output terminal MP as the monitor value. Sinking mode and sourcing mode are supported.

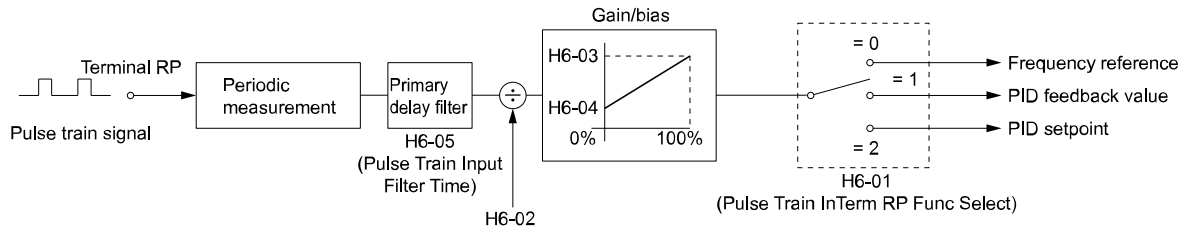

Figure 12.92 Pulse Train Input Block Diagram

■ H6-01: Terminal RP Pulse Train Function

No. (Hex.)	Name	Description	Default (Range)
H6-01 (042C)	Terminal RP Pulse Train Function	V/f OLV OLV/PM AOLV/PM EZOLV Sets the function for pulse train input terminal RP.	0 (0 - 3)

0 : Frequency Reference

When $b1-01 = 4$ [Frequency Reference Selection 1 = Pulse Train Input] or $b1-15 = 4$ [Frequency Reference Selection 2 = Pulse Train Input], the drive inputs the frequency reference received from terminal RP.

1 : PID Feedback Value

The drive inputs the PID control feedback value received from terminal RP.

2 : PID Setpoint Value

The drive inputs the PID control target value received from terminal RP.

3 : Speed Feedback (V/F Control)

Select V/f Control method to enable simple encoder feedback.

Use motor speed feedback for better speed control precision. The drive compares the frequency reference to the motor speed feedback received from the encoder, and uses the ASR function to compensates for motor slip. You cannot use input terminal RP used for the simple encoder to detect the direction of motor rotation. Use a different method to detect motor rotation.

Use these methods to detect the direction of motor rotation.

- Use MFDI
Set MFDI $H1-xx = 7E$ [Reverse Rotation Identifier]. When the configured terminal is activated, the motor operates in Reverse run. When the terminal is deactivated, the motor operates in Forward run.
Use an encoder that outputs 2-tracks (phase A, B) to detect the direction of motor rotation.
- Use the frequency reference
When you do not use the MFDI, the Forward/Reverse run command is the same as the direction of motor rotation.

Figure 12.93 shows speed control in Simple Closed Loop V/f Mode.

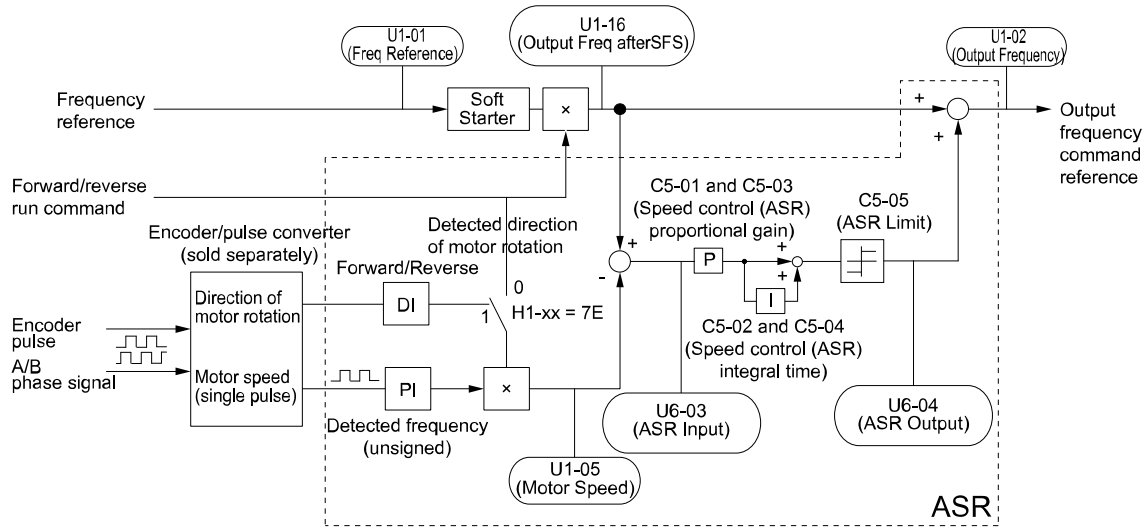

Figure 12.93 Simple Closed Loop Speed Control Block Diagram

Enable Simple Closed Loop V/f Mode

1. Connect the encoder output pulse wiring to terminal RP.
2. Set $A1-02 = 0$ [Control Method Selection = V/f Control].
3. Set $H6-01 = 3$.
4. Set $H6-02$ [Terminal RP Frequency Scaling] to the speed feedback (pulse train input signal) frequency at the time when the frequency reference is 100%.
Make sure that $H6-04$ [Terminal RP Function Bias] = 0% and $H6-03$ [Terminal RP Function Gain] = 100%.
5. Select the detection method for the direction of motor rotation.
When you use an MFDI, set $H1-xx = 7E$.
6. Set $C5$ parameters related to ASR gain and integral time to adjust responsiveness.

Note:

- Set $A1-02 = 0$ and $H6-01 = 3$ to show $C5$ parameters.
- You cannot use Simple Closed Loop V/f Mode with the Motor Switch function.

H6-02: Terminal RP Frequency Scaling

No. (Hex.)	Name	Description	Default (Range)
H6-02 (042D) RUN	Terminal RP Frequency Scaling	<p>V/f OLV OLV/PM AOLV/PM EZOLV</p> <p>Sets the frequency of the pulse train input signal used when the item selected with $H6-01$ [Terminal RP Pulse Train Function] is input at 100%.</p>	1440 Hz (100 - 32000 Hz)

H6-03: Terminal RP Function Gain

No. (Hex.)	Name	Description	Default (Range)
H6-03 (042E) RUN	Terminal RP Function Gain	<p>V/f OLV OLV/PM AOLV/PM EZOLV</p> <p>Sets the gain used when the function in $H6-01$ [Terminal RP Pulse Train Function] is input to terminal RP.</p>	100.0% (0.0 - 1000.0%)

H6-04: Terminal RP Function Bias

No. (Hex.)	Name	Description	Default (Range)
H6-04 (042F) RUN	Terminal RP Function Bias	<p>V/f OLV OLV/PM AOLV/PM EZOLV</p> <p>Sets the bias used when the function in $H6-01$ [Terminal RP Pulse Train Function] is input to terminal RP. Sets a value at the time when the pulse train is 0 Hz.</p>	0.0% (-100.0 - 100.0%)

■ H6-05: Terminal RP Filter Time

No. (Hex.)	Name	Description	Default (Range)
H6-05 (0430) RUN	Terminal RP Filter Time	V/f OLV OLV/PM AOLV/PM EZOLV Sets the time constant for the pulse train input primary delay filters.	0.10 s (0.00 - 2.00 s)

■ H6-06: Terminal MP Monitor Selection

No. (Hex.)	Name	Description	Default (Range)
H6-06 (0431) RUN	Terminal MP Monitor Selection	V/f OLV OLV/PM AOLV/PM EZOLV Sets a function for pulse train monitor output terminal MP. Sets the "x-xx" part of the $Ux-xx$ monitor.	102 (000, 031, 101, 102, 105, 116, 501, 502, 801 - 809, 821 - 825, 831 - 839, 851 - 855)

Note:

To use in through mode or when terminal MP is not used, set this parameter to 000 or 031.

When you use the pulse train monitor, make sure that you connect peripheral devices as specified by these load conditions:

Incorrect connections can make the characteristics not sufficient or cause mechanical damage.

- Use the pulse train monitor as the sourcing output.

Output Voltage VRL(V)	Load Impedance (kΩ)
5 V or more	1.5 kΩ or more
8 V or more	4.0 kΩ or more
10 V or more	10 kΩ or more

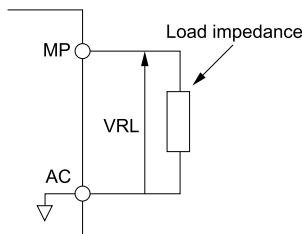

Figure 12.94 Circuit Diagram When Used as the Sourcing Output

- Use the pulse train monitor as the sinking input

External Power Supply (V)	12 VDC ± 10%, 15 VDC ± 10%
Sinking current (mA)	16 mA or less

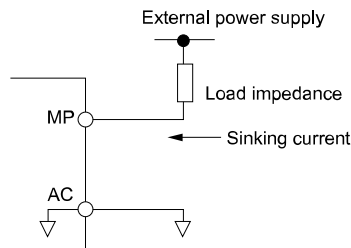

Figure 12.95 Circuit Diagram When Used as the Sinking Input

■ H6-07: Terminal MP Frequency Scaling

No. (Hex.)	Name	Description	Default (Range)
H6-07 (0432) RUN	Terminal MP Frequency Scaling	<div style="display: flex; justify-content: space-between; font-size: small;"> V/f OLV OLV/PM AOLV/PM EZOLV </div> Sets the frequency of the pulse train output signal used when the monitor set with H6-06 [Terminal MP Monitor Selection] is 100%.	1440 Hz (0 - 32000 Hz)

When H6-06 = 102 [Terminal MP Monitor Selection = Output Frequency] and H6-07 = 0, the pulse train output terminal MP outputs the same frequency as the drive output frequency.

■ H6-08: Terminal RP Minimum Frequency

No. (Hex.)	Name	Description	Default (Range)
H6-08 (043F)	Terminal RP Minimum Frequency	<div style="display: flex; justify-content: space-between; font-size: small;"> V/f OLV OLV/PM AOLV/PM EZOLV </div> Sets the minimum frequency of the pulse train signal that terminal RP can detect.	0.5 Hz (0.1 - 1000.0 Hz)

- When you input a pulse train frequency that is less than the value of H6-08, the pulse train input is 0.0 Hz.
- Set H6-01 = 0, 1, or 2 [Terminal RP Pulse Train Function = Frequency Reference, PID Feedback Value, or PID Setpoint Value] to enable this parameter.
- When H6-01 = 3 [Speed Feedback (V/F Control)], the drive applies the setting of F1-14 [Encoder Open-Circuit Detect Time] to the minimum frequency.

◆ H7: Virtual MFIO Selection

The virtual I/O function performs the following.

- Inputs the result of the output from the MFDO terminal to the MFDI terminal without external wiring.
- Inputs the result of the output from the MFAO terminal to the MFAI terminal without external wiring.

WARNING! Sudden Movement Hazard. Before you do a test run, make sure that the setting values for virtual input and output function parameters are correct. Virtual input and output functions can have different default settings and operation than wired input and output functions. Incorrect function settings can cause serious injury or death.

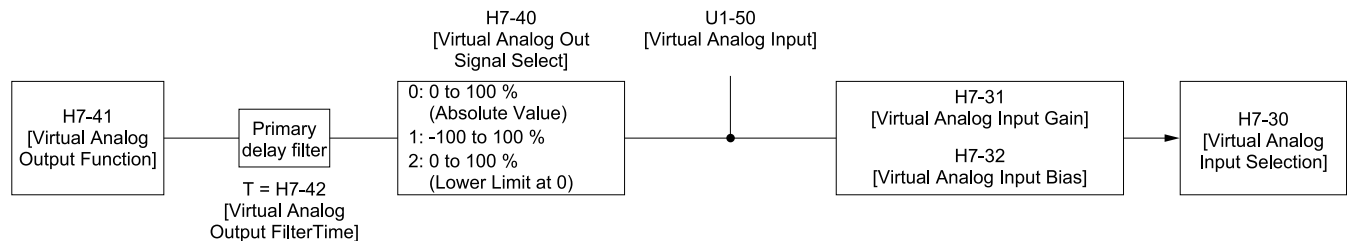

Figure 12.96 Virtual Analog I/O Functional Block Diagram

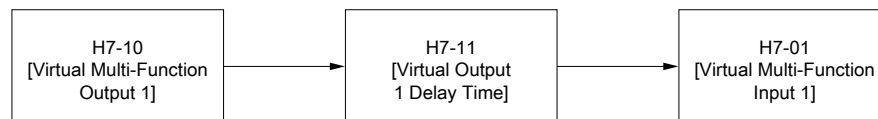

Figure 12.97 Virtual Digital I/O Functional Block Diagram

Note:

- Refer to [MFDI Setting Values on page 647](#) for more information on the virtual digital input functions.
- Refer to [MFDO Setting Values on page 674](#) for more information on the virtual digital output functions.
- Refer to [Multi-Function Analog Input Terminal Settings on page 693](#) for more information on the virtual analog input functions.
- Refer to [H4: Analog Outputs on page 699](#) for more information on the virtual analog output functions.
- You cannot set 0 [3-Wire Sequence] and 20 or 2F [External Fault] to H7-01 to H7-04 [Virtual Multi-Function Input 1 to 4].
- If you do not use virtual I/O, set H7-01 to H7-04 = F. This does not support the through mode.

■ H7-00: Virtual MFIO selection

No. (Hex.)	Name	Description	Default (Range)
H7-00 (116F) Expert	Virtual MFIO selection	<div style="display: flex; gap: 5px;"> V/f OLV OLV/PM AOLV/PM EZOLV </div> Sets the function to enable and disable the virtual I/O function. Set this parameter to 1 to operate the virtual I/O function.	0 (0, 1)

0 : Disabled

1 : Enabled

■ H7-01: Virtual Multi-Function Input 1

No. (Hex.)	Name	Description	Default (Range)
H7-01 (1185) Expert	Virtual Multi-Function Input 1	<div style="display: flex; gap: 5px;"> V/f OLV OLV/PM AOLV/PM EZOLV </div> Sets the function that enters the virtual input set in H7-10 [Virtual Multi-Function Output 1].	F (1 - 19F)

Note:

1B [Programming Lockout] and 11B [Inverse Input of 1B] are not available.

■ H7-02: Virtual Multi-Function Input 2

No. (Hex.)	Name	Description	Default (Range)
H7-02 (1186) Expert	Virtual Multi-Function Input 2	<div style="display: flex; gap: 5px;"> V/f OLV OLV/PM AOLV/PM EZOLV </div> Sets the function that enters the virtual input set in H7-12 [Virtual Multi-Function Output 2].	F (1 - 19F)

Note:

1B [Programming Lockout] and 11B [Inverse Input of 1B] are not available.

■ H7-03: Virtual Multi-Function Input 3

No. (Hex.)	Name	Description	Default (Range)
H7-03 (1187) Expert	Virtual Multi-Function Input 3	<div style="display: flex; gap: 5px;"> V/f OLV OLV/PM AOLV/PM EZOLV </div> Sets the function that enters the virtual input set in H7-14 [Virtual Multi-Function Output 3].	F (1 - 19F)

Note:

1B [Programming Lockout] and 11B [Inverse Input of 1B] are not available.

■ H7-04: Virtual Multi-Function Input 4

No. (Hex.)	Name	Description	Default (Range)
H7-04 (1188) Expert	Virtual Multi-Function Input 4	<div style="display: flex; gap: 5px;"> V/f OLV OLV/PM AOLV/PM EZOLV </div> Sets the function that enters the virtual input set in H7-16 [Virtual Multi-Function Output 4].	F (1 - 19F)

Note:

1B [Programming Lockout] and 11B [Inverse Input of 1B] are not available.

■ H7-10: Virtual Multi-Function Output 1

No. (Hex.)	Name	Description	Default (Range)
H7-10 (11A4) Expert	Virtual Multi-Function Output 1	<div style="display: flex; gap: 5px;"> V/f OLV OLV/PM AOLV/PM EZOLV </div> Sets the function for virtual digital output 1.	F (0 - 1A7)

■ H7-11: Virtual Output 1 Delay Time

No. (Hex.)	Name	Description	Default (Range)
H7-11 (11A5) Expert	Virtual Output 1 Delay Time	<div style="display: flex; gap: 5px;"> V/f OLV OLV/PM AOLV/PM EZOLV </div> Sets the minimum ON time for virtual digital output 1.	0.1 s (0.0 - 25.0 s)

■ H7-12: Virtual Multi-Function Output 2

No. (Hex.)	Name	Description	Default (Range)
H7-12 (11A6) Expert	Virtual Multi-Function Output 2	<div style="display: flex; gap: 5px;"> V/f OLV OLV/PM AOLV/PM EZOLV </div> Sets the function for virtual digital output 2.	F (0 - 1A7)

■ H7-13: Virtual Output 2 Delay Time

No. (Hex.)	Name	Description	Default (Range)
H7-13 (11A7) Expert	Virtual Output 2 Delay Time	<div style="display: flex; gap: 5px;"> V/f OLV OLV/PM AOLV/PM EZOLV </div> Sets the minimum ON time for virtual digital output 2.	0.1 s (0.0 - 25.0 s)

■ H7-14: Virtual Multi-Function Output 3

No. (Hex.)	Name	Description	Default (Range)
H7-14 (11A8) Expert	Virtual Multi-Function Output 3	<div style="display: flex; gap: 5px;"> V/f OLV OLV/PM AOLV/PM EZOLV </div> Sets the function for virtual digital output 3.	F (0 - 1A7)

■ H7-15: Virtual Output 3 Delay Time

No. (Hex.)	Name	Description	Default (Range)
H7-15 (11A9) Expert	Virtual Output 3 Delay Time	<div style="display: flex; gap: 5px;"> V/f OLV OLV/PM AOLV/PM EZOLV </div> Sets the minimum ON time for virtual digital output 3.	0.1 s (0.0 - 25.0 s)

■ H7-16: Virtual Multi-Function Output 4

No. (Hex.)	Name	Description	Default (Range)
H7-16 (11AA) Expert	Virtual Multi-Function Output 4	<div style="display: flex; gap: 5px;"> V/f OLV OLV/PM AOLV/PM EZOLV </div> Sets the function for virtual digital output 4.	F (0 - 1A7)

■ H7-17: Virtual Output 4 Delay Time

No. (Hex.)	Name	Description	Default (Range)
H7-17 (11AB) Expert	Virtual Output 4 Delay Time	<div style="display: flex; gap: 5px;"> V/f OLV OLV/PM AOLV/PM EZOLV </div> Sets the minimum ON time for virtual digital output 4.	0.1 s (0.0 - 25.0 s)

■ H7-30: Virtual Analog Input Selection

No. (Hex.)	Name	Description	Default (Range)
H7-30 (1177) Expert	Virtual Analog Input Selection	<div style="display: flex; gap: 5px;"> V/f OLV OLV/PM AOLV/PM EZOLV </div> Sets the virtual analog input function.	F (0 - 32)

■ H7-31: Virtual Analog Input Gain

No. (Hex.)	Name	Description	Default (Range)
H7-31 (1178) RUN Expert	Virtual Analog Input Gain	<div style="display: flex; gap: 5px;"> V/f OLV OLV/PM AOLV/PM EZOLV </div> Sets the virtual analog input gain.	100.0% (-999.9 - 999.9%)

■ H7-32: Virtual Analog Input Bias

No. (Hex.)	Name	Description	Default (Range)
H7-32 (1179) RUN Expert	Virtual Analog Input Bias	<div style="display: flex; gap: 5px;"> V/f OLV OLV/PM AOLV/PM EZOLV </div> Sets the virtual analog input bias.	0.0% (-999.9 - 999.9%)

■ H7-40: Virtual Analog Out Signal Select

No. (Hex.)	Name	Description	Default (Range)
H7-40 (1163)	Virtual Analog Out Signal Select	<div style="display: flex; gap: 5px;"> V/f OLV OLV/PM AOLV/PM EZOLV </div> Sets the signal level of the virtual analog output.	0 (0 - 2)

0 : 0 to 100% (Absolute Value)

1 : -100 to 100%

2 : 0 to 100% (Lower Limit at 0)

■ H7-41: Virtual Analog Output Function

No. (Hex.)	Name	Description	Default (Range)
H7-41 (1164)	Virtual Analog Output Function	<div style="display: flex; gap: 5px;"> V/f OLV OLV/PM AOLV/PM EZOLV </div> Sets the monitor to be output from the virtual analog output.	102 (0 - 999)

Set the $x-xx$ part of the $Ux-xx$ [Monitor]. For example, set $H7-41 = 102$ to monitor $U1-02$ [Output Frequency].

■ H7-42: Virtual Analog Output FilterTime

No. (Hex.)	Name	Description	Default (Range)
H7-42 (1165)	Virtual Analog Output FilterTime	<div style="display: flex; gap: 5px;"> V/f OLV OLV/PM AOLV/PM EZOLV </div> Sets the time constant for a primary filter of the virtual analog output.	0.00 s (0.00 - 2.00 s)

12.9 L: Protection Functions

L parameters set the following functions.

- Motor Overload Protection
- Operation During Momentary Power Loss
- Stall Prevention
- Speed Detection
- Auto Restart
- Detection of Overtorque/Undertorque
- Torque Limit
- Hardware Protection

◆ L1: Motor Protection

L1 parameters set the motor overload protection function.

■ Motor Protection Using Positive Temperature Coefficient (PTC) Thermistors

Connect the PTC thermistor input from the motor to analog input terminal on the drive.

The temperature resistance characteristics of three PTC thermistors in the motor stator winding protect the motor from overheating.

A PTC thermistor must have the characteristics shown in [Figure 12.98](#) for each motor phase.

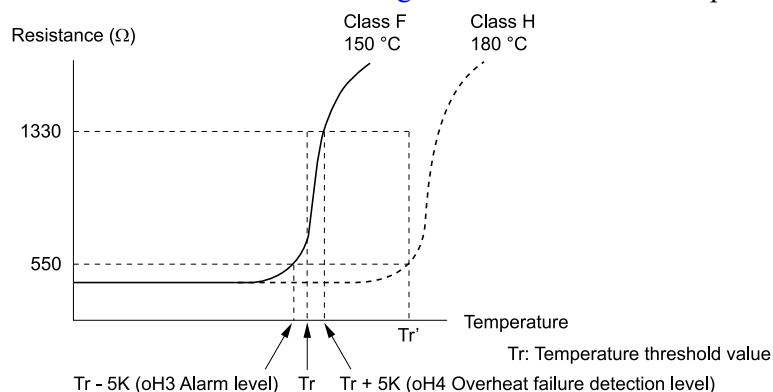

Figure 12.98 PTC Thermistor Temperature and Resistance

If the PTC input signal input to the drive is more than the overload alarm level, the drive detects *oH3* [*Motor Overheat (PTC Input)*]. The drive continues the operation set in *L1-03* [*Motor Thermistor oH Alarm Select*]. By default, the keypad shows *oH3* and the drive continues operation.

The overheat fault level triggers an *oH4* [*Motor Overheat Fault (PTC Input)*] fault, and outputs a fault signal. The drive outputs a fault signal and uses the stop method set in *L1-04* [*Motor Thermistor oH Fault Select*] to stop the motor.

Note:

PTC is an acronym for Positive Temperature Coefficient.

The following shows the configuration procedure when you use terminal A2.

1. Connect the PTC thermistor input from the motor to analog input terminal A2 on the drive.

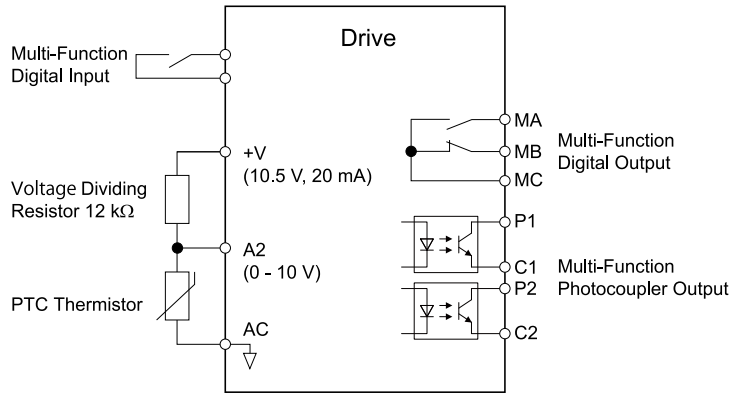

Figure 12.99 Connect Motor to PTC Thermistor Input

2. Set drive DIP switch S1 to V (voltage).

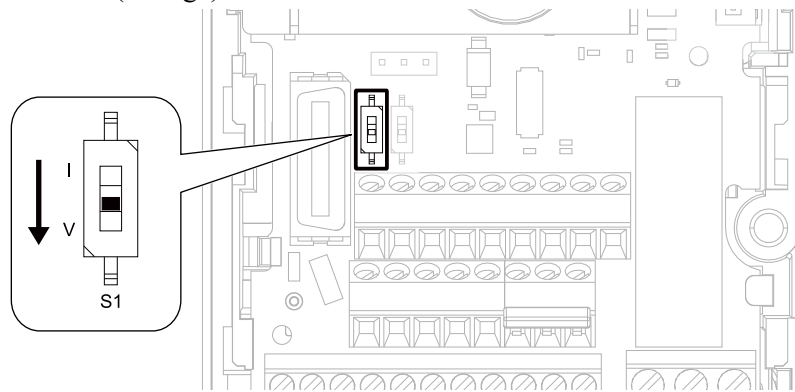

Figure 12.100 Settings for DIP Switches

3. Set these MFAI terminals:

- H3-09 = 0 [Terminal A2 Signal Level Select = 0-10V (LowLim=0)].
- H3-10 = E [Terminal A2 Function Selection = Motor Temperature (PTC input)].

4. Set these L1 parameters:

- L1-03 [Motor Thermistor oH Alarm Select]
- L1-04 [Motor Thermistor oH Fault Select]
- L1-05 [Motor Thermistor Filter Time]

■ L1-01: Motor Overload (oL1) Protection

No. (Hex.)	Name	Description	Default (Range)
L1-01 (0480)	Motor Overload (oL1) Protection	V/f OLV OLV/PM AOLV/PM EZOLV Sets the motor overload protection with electronic thermal protectors.	Determined by A1-02 (0 - 6)

This parameter enables and disables the motor overload protection with electronic thermal protectors.

The cooling capability of the motor changes when the speed control range of the motor changes. Use an electronic thermal protector that aligns with the permitted load characteristics of the motor to select motor protection.

The electronic thermal protector of the drive uses these items to calculate motor overload tolerance and supply overload protection for the motor:

- Output current
- Output frequency
- Motor thermal characteristics
- Time characteristics

If the drive detects motor overload, the drive will trigger an oL1 [Motor Overload] and stop drive output.

Set H2-01 = 1F [Term MA/MB-MC Function Selection = Motor Overload Alarm (oL1)] to set a motor overload alarm. If the motor overload level is more than 90% of the oLI detection level, the output terminal activates and triggers an overload alarm.

0 : Disabled

Disable motor protection when motor overload protection is not necessary or when the drive is operating more than one motor.

Refer to Figure 12.101 for an example of the circuit configuration to connect more than one motor to one drive.

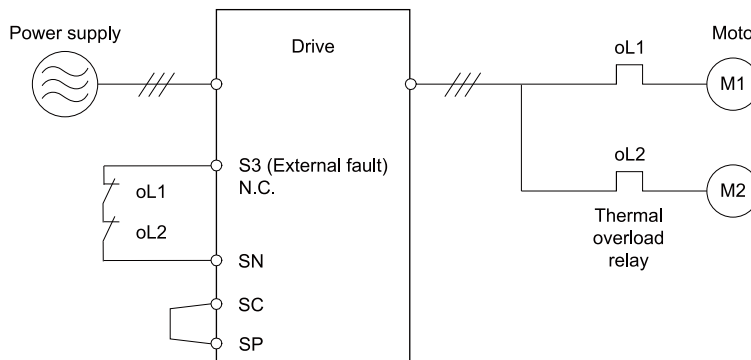

Figure 12.101 Protection Circuit Configuration to Connect More than One Motor to One Drive

NOTICE: When you connect more than one motor to one drive or when the motor amp rating is higher than the drive amp rating, set L1-01 = 0 [Motor Overload (oL1) Protection = Disabled] and install thermal overload relays for each motor. The electronic thermal protection of the drive will not function and it can cause damage to the motor.

1 : Variable Torque

Use this setting for general-purpose motors with a 60 Hz base frequency.

The overload tolerance decreases as motor speed decreases because the cooling fan speed decreases and the ability of the motor to cool decreases in the low speed range.

The overload tolerance characteristics of the motor change the trigger point for the electronic thermal protector. This provides motor overheat protection from low speed to high speed across the full speed range.

Load Tolerance	Cooling Capability	Overload Characteristics (at 100% motor load)
	<p>This motor is designed to operate with commercial line power. Operate at a 60 Hz base frequency to maximize the motor cooling ability.</p>	<p>If the motor operates at frequencies less than 60 Hz, the drive will detect oLI. The drive triggers a fault relay output and the motor coasts to stop.</p>

2 : Constant Torque 10:1 Speed Range

Use this setting for drive-dedicated motors with a speed range for constant torque of 1:10.

The speed control for this motor is 10% to 100% when at 100% load. Operating slower than 10% speed at 100% load will cause motor overload.

12.9 L: Protection Functions

Load Tolerance	Cooling Capability	Overload Characteristics (at 100% motor load)
	<p>This motor is designed to withstand increased temperatures during continuous operation in the low speed range (10% base frequency).</p>	<p>The motor operates continuously at 10% to 100% base frequency. Operating slower than 10% speed at 100% load will cause motor overload.</p>

3 : Constant Torque 100:1 SpeedRange

Use this setting for vector motors with a speed range for constant torque of 1:100.

The speed control for this motor is 1% to 100% when at 100% load. Operating slower than 1% speed at 100% load will cause motor overload.

Load Tolerance	Cooling Capability	Overload Characteristics (at 100% motor load)
	<p>This motor is designed to withstand increased temperatures during continuous operation in the low speed range (1% base frequency).</p>	<p>The motor operates continuously at 1% to 100% base frequency. Operating slower than 1% speed at 100% load will cause motor overload.</p>

4 : PM Variable Torque

Use this setting for PM motors with derated torque characteristics.

The overload tolerance decreases as motor speed decreases because the cooling fan speed decreases and the ability of the motor to cool decreases in the low speed range.

The overload tolerance characteristics of the motor change the trigger point for the electronic thermal protector. This provides motor overheat protection from low speed to high speed across the full speed range.

Load Tolerance	Cooling Capability	Overload Characteristics (at 100% motor load)
	<p>This motor is designed to withstand increased temperatures during continuous operation at rated speed and rated torque.</p>	<p>If the motor operates continuously at lower speed than rated rotation speed at more than 100% torque, the drive will detect <i>oL1</i>. The drive triggers a fault relay output and the motor coasts to stop.</p>

5 : PM Constant Torque

Use this setting with a PM motor for constant torque that has a speed range for constant torque of 1:500.

The speed control for this motor is 0.2% to 100% when at 100% load. Operating slower than 0.2% speed at 100% load will cause motor overload.

Load Tolerance	Cooling Capability	Overload Characteristics (at 100% motor load)
	<p>This motor is designed to withstand increased temperatures during continuous operation in the low speed range (0.2% base frequency).</p>	<p>The motor operates continuously at 0.2% to 100% rated speed. Operating slower than 0.2% speed at 100% load will cause motor overload.</p>

6 : Variable Torque (50Hz)

Use this setting for general-purpose motors with a 50 Hz base frequency.

The overload tolerance decreases as motor speed decreases because the cooling fan speed decreases and the ability of the motor to cool decreases in the low speed range.

The overload tolerance characteristics of the motor change the trigger point for the electronic thermal protector. This provides motor overheat protection from low speed to high speed across the full speed range.

Load Tolerance	Cooling Capability	Overload Characteristics (at 100% motor load)
	<p>This motor is designed to operate with commercial line power. Operate at a 50 Hz base frequency to maximize the motor cooling ability.</p>	<p>If the motor operates at frequencies less than commercial line power, the drive will detect <i>oLL</i>. The drive triggers a fault relay output and the motor coasts to stop.</p>

■ L1-02: Motor Overload Protection Time

No. (Hex.)	Name	Description	Default (Range)
L1-02 (0481)	Motor Overload Protection Time	<p>V/f OLV OLV/PM AOLV/PM EZOLV</p> <p>Sets the operation time for the electronic thermal protector of the drive to prevent damage to the motor. Usually it is not necessary to change this setting.</p>	1.0 min (0.1 - 5.0 min)

Set the overload tolerance time to the length of time that the motor can operate at 150% load from continuous operation at 100% load.

When the motor operates at 150% load continuously for 1 minute after continuous operation at 100% load (hot start), the default setting triggers the electronic thermal protector.

Figure 12.102 shows an example of the electronic thermal protector operation time. Motor overload protection operates in the range between a cold start and a hot start.

This example shows a general-purpose motor operating at the base frequency with L1-02 set to 1.0 min.

- Cold start
Shows the motor protection operation time characteristics when the overload occurs immediately after starting operation from a complete stop.
- Hot start
Shows the motor protection operation time characteristics when overload occurs from continuous operation below the motor rated current.

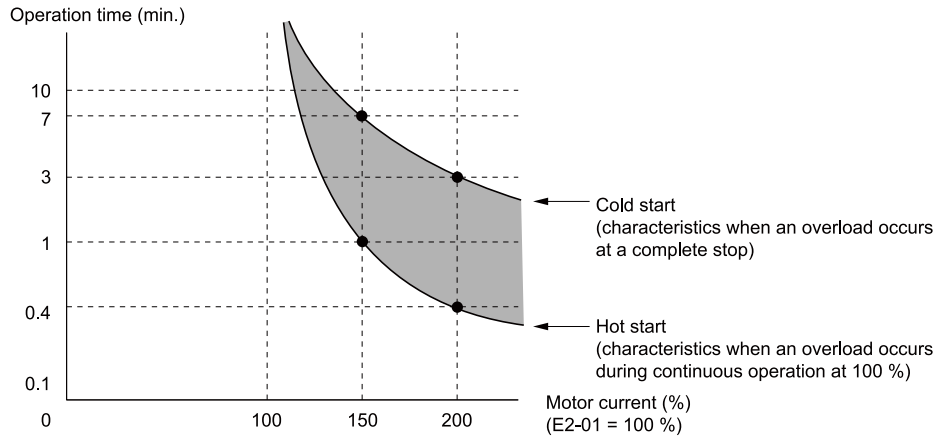

Figure 12.102 Protection Operation Time for a General-purpose Motor at Rated Output Frequency

■ L1-03: Motor Thermistor oH Alarm Select

No. (Hex.)	Name	Description	Default (Range)
L1-03 (0482)	Motor Thermistor oH Alarm Select	<input type="checkbox"/> V/f <input type="checkbox"/> OLV <input type="checkbox"/> OLV/IPM <input type="checkbox"/> AOLV/IPM <input type="checkbox"/> EZOLV Sets drive operation when the PTC input signal entered into the drive is at the oH3 [Motor Overheat Alarm] detection level.	3 (0 - 3)

0 : Ramp to Stop

The drive ramps the motor to stop in the deceleration time. The output terminal set for *Fault [H2-01 to H2-03 = E]* activates.

1 : Coast to Stop

The output turns off and the motor coasts to stop. The output terminal set for *Fault [H2-01 to H2-03 = E]* activates.

2 : Fast Stop

The drive stops the motor in the deceleration time set in *C1-09 [Fast Stop Time]*. The output terminal set for *Fault [H2-01 to H2-03 = E]* activates.

3 : Alarm Only

The keypad shows *oH3* and the drive continues operation. The output terminal set for *Alarm [H2-01 to H2-03 = 10]* activates.

■ L1-04: Motor Thermistor oH Fault Select

No. (Hex.)	Name	Description	Default (Range)
L1-04 (0483)	Motor Thermistor oH Fault Select	<input type="checkbox"/> V/f <input type="checkbox"/> OLV <input type="checkbox"/> OLV/IPM <input type="checkbox"/> AOLV/IPM <input type="checkbox"/> EZOLV Sets the drive operation when the PTC input signal to the drive is at the oH4 [Motor Overheat Fault (PTC Input)] detection level.	1 (0 - 2)

0 : Ramp to Stop

The drive ramps the motor to stop in the deceleration time. The output terminal set for *Fault [H2-01 to H2-03 = E]* activates.

1 : Coast to Stop

The output turns off and the motor coasts to stop. The output terminal set for *Fault [H2-01 to H2-03 = E]* activates.

2 : Fast Stop

The drive stops the motor in the deceleration time set in *C1-09 [Fast Stop Time]*. The output terminal set for *Fault [H2-01 to H2-03 = E]* activates.

■ L1-05: Motor Thermistor Filter Time

No. (Hex.)	Name	Description	Default (Range)
L1-05 (0484)	Motor Thermistor Filter Time	<div style="display: flex; justify-content: space-between; align-items: center;"> V/f OLV OLV/PM AOLV/PM EZOLV </div> <p>Sets the primary delay time constant for the PTC input signal entered to the drive. This parameter prevents accidental motor overheat faults.</p>	0.20 s (0.00 - 10.00 s)

■ L1-08: oL1 Current Level

No. (Hex.)	Name	Description	Default (Range)
L1-08 (1103)	oL1 Current Level	<div style="display: flex; justify-content: space-between; align-items: center;"> V/f OLV OLV/PM AOLV/PM EZOLV </div> <p>Sets the reference current for the motor 1 thermal overload detection. When the current level > 0.0 A, you cannot set this value < 10% of drive rated current.</p>	0.0 A (0.0 A or 10% to 150% of the drive rated current)

When $L1-08 = 0.0 A$, the drive uses $E2-01$ [Motor Rated Current (FLA)] to detect the motor overload protection. In PM control mode, the drive uses $E5-03$ [PM Motor Rated Current (FLA)] to detect the motor overload protection. When $L1-08 \neq 0.0 A$, the set value is the reference for motor overload protection.

Note:

- Display is in these units:
 - 0.01 A: B001 to B018, 2001 to 2042, 4001 to 4023
 - 0.1 A: 2056 to 2082, 4031 to 4060
- When the current level > 0.0 A, you cannot set this value < 10% of drive rated current.

■ L1-09: oL1 Current Level for Motor 2

No. (Hex.)	Name	Description	Default (Range)
L1-09 (1104)	oL1 Current Level for Motor 2	<div style="display: flex; justify-content: space-between; align-items: center;"> V/f OLV OLV/PM AOLV/PM EZOLV </div> <p>Sets the reference current for the motor 2 thermal overload detection. When the current level > 0.0 A, you cannot set this value < 10% of drive rated current.</p>	0.0 A (0.0 A or 10 to 150% of the drive rated current)

When $L1-09 = 0.0 A$, the drive uses $E4-01$ [Motor 2 Rated Current] to detect the motor overload protection. When $L1-09 \neq 0.0 A$, the set value is the reference for motor overload protection.

Note:

- Display is in these units:
 - 0.01 A: B001 to B018, 2001 to 2042, 4001 to 4023
 - 0.1 A: 2056 to 2082, 4031 to 4060
- When the current level > 0.0 A, you cannot set this value < 10% of drive rated current.

■ L1-13: Motor Overload Memory Selection

No. (Hex.)	Name	Description	Default (Range)
L1-13 (046D)	Motor Overload Memory Selection	<div style="display: flex; justify-content: space-between; align-items: center;"> V/f OLV OLV/PM AOLV/PM EZOLV </div> <p>Sets the function that keeps the current electronic thermal protector value when the drive stops receiving power.</p>	1 (0, 1)

0 : Disabled

1 : Enabled

Sets if the drive will calculate the motor again when the drive is energized again.

■ L1-22: Leakage Current Filter Time1

No. (Hex.)	Name	Description	Default (Range)
L1-22 (0768) RUN	Leakage Current Filter Time1	<div style="display: flex; justify-content: space-between; align-items: center;"> V/f OLV OLV/PM AOLV/PM EZOLV </div> <p>Sets the leakage current detection reduction filter time constant during constant speed run.</p>	Determined by C6-02 (0.0 - 60.0 s)

Note:

You can set this parameter when $C6-02 = B$ [Carrier Frequency Selection = Leakage Current Detection Reduction Rate PWM].

If incorrect detection of alarms, for example *oL1* [Motor Overload], occur or errors occur in the values on the current monitor because of a leakage current, increase the setting value.

■ **L1-23: Leakage Current Filter Time2**

No. (Hex.)	Name	Description	Default (Range)
L1-23 (0769) RUN	Leakage Current Filter Time2	<div style="display: flex; gap: 5px;"> V/f OLV OLV/PM AOLV/PM EZOLV </div> <p>Sets the leakage current detection reduction filter time constant during acceleration/deceleration.</p>	Determined by C6-02 (0.0 - 60.0 s)

Note:

- You can set this parameter when $C6-02 = B$ [Carrier Frequency Selection = Leakage Current Detection Reduction Rate PWM].
- When the setting value increases, the current monitor will start up slowly. Examine the relevant sequence for problems.

If errors occur in the values on the current monitor during acceleration/deceleration, increase the setting value.

◆ **L2: Power Loss Ride Through**

L2 parameters set the drive operation during momentary power loss and the KEB Ride-Thru function method of operation.

■ **KEB Ride-Thru Function**

KEB is an acronym for Kinetic Energy Backup. If the drive detects a power loss or momentary power loss, it will quickly decelerate the motor. The drive uses regenerative energy from the motor to keep the main circuit operating. When you return power during motor deceleration, the drive returns operation to the status before the power loss. The KEB Ride-Thru function is different than other functions for continuous operation. If the drive detects momentary power loss, the motor will ramp to stop. It will not coast to stop. This function is applicable for applications in which it is necessary to prevent materials from running out, for example control for film and fiber lines.

The KEB Ride-Thru function has 4 methods of operation. Parameter *L2-29* [Kinetic Energy Backup Method] sets the method.

When you use the KEB Ride-Thru function with one drive, set $L2-29 = 0, 1$ [Single Drive KEB Ride-Thru 1, Single Drive KEB Ride-Thru 2].

If deceleration in coordination with more than one drive is necessary, for example textile machinery line systems, set $L2-29 = 2, 3$ [System KEB Ride-Thru 1, System KEB Ride-Thru 2].

Table 12.58 KEB Ride-Thru Function Operation Method

L2-29	Kinetic Energy Backup Method	Operation	Configuration Precautions
0	Single Drive KEB Ride-Thru 1	The drive uses regenerative energy from the motor to keep the DC bus voltage at the level set in <i>L2-11</i> [KEB DC Bus Voltage Setpoint] while it adjusts the rate of deceleration. The KEB operation continues while the drive adjusts the deceleration rate with the setting of <i>C1-09</i> [Fast Stop Time].	<ul style="list-style-type: none"> • Set <i>C1-09</i> correctly to prevent <i>Uv1</i> [DC Bus Undervoltage] and <i>ov</i> [Overvoltage]. • If the drive detects <i>Uv1</i> during the KEB operation, decrease the value set in <i>C1-09</i>. • If the drive detects <i>ov</i> during the KEB operation, increase the value set in <i>C1-09</i>.
1	Single Drive KEB Ride-Thru 2	The drive uses information about the inertia of the connected machinery to find the deceleration rate necessary to keep the DC bus voltage at the level set in parameter <i>L2-11</i> . The drive uses system inertia to calculate the deceleration time. You cannot adjust this value.	<ul style="list-style-type: none"> • If the drive detects <i>Uv1</i> during the KEB operation, increase the setting value of <i>L3-20</i> [DC Bus Voltage Adjustment Gain] and <i>L3-21</i> [OV/Suppression Accel/Decel P Gain]. • If the drive detects <i>ov</i> during the KEB operation, decrease the setting values of <i>L3-20</i> and <i>L3-21</i>.
2	System KEB Ride-Thru 1	The drive does not monitor the DC bus voltage. The drive decelerates at the KEB deceleration time set in <i>L2-06</i> . Use <i>L2-06</i> to set the time necessary to decelerate from the current frequency reference to 0 Hz. More than one drive can decelerate and keep a constant speed ratio between drives.	Use the dynamic braking option with System KEB Ride-Thru 1.
3	System KEB Ride-Thru 2	The drive uses the KEB deceleration time set in <i>L2-06</i> to decelerate and it also monitors the DC bus voltage. If the voltage level increases, the drive momentarily holds the frequency to prevent an <i>ov</i> before it continues to decelerate.	If you cannot use the dynamic braking option, use System KEB Ride-Thru 2.

■ KEB Ride Thru Start

When $L2-01 = 3, 4, 5$ [*Power Loss Ride Through Select = Kinetic Energy Backup: L2-02, Kinetic Energy Backup: CPU Power, Kinetic Energy Backup: DecelStop*], the drive starts the KEB operation immediately after it detects a momentary power loss. When one of these conditions occur, the drive will activate KEB Ride-Thru:

- KEB Ride-Thru 1 set for the MFDI terminal becomes enabled (terminal is deactivated when $HI-xx = 65$ or terminal is activated when $HI-xx = 66$).
The drive uses the mode selected $L2-29$ [*Kinetic Energy Backup Method*] to start KEB operation.
- KEB Ride-Thru 2 set for the MFDI terminal becomes enabled (terminal is deactivated when $HI-xx = 7A$ or terminal is activated when $HI-xx = 7B$).
The drive automatically starts Single KEB Ride-Thru 2 and it ignores the setting of $L2-29$.
- The DC bus voltage is less than the level set in $L2-05$ [*Undervoltage Detection Lvl (Uv1)*].
The KEB operation will start as specified in $L2-29$.

Note:

If you try to set KEB Ride-Thru 1 and 2 to the MFDI terminals at the same time, it will trigger $oPE03$ [*Multi-Function Input Setting Err*].

In this example, the drive detects that the DC bus voltage is less than the level set in $L2-05$ and starts the KEB operation. When you return power during KEB operation, the drive will continue KEB operation when the KEB Ride-Thru is input, although the time set in $L2-10$ [*Minimum KEB Time*] expired. The motor accelerates again after you cancel the KEB Ride-Thru.

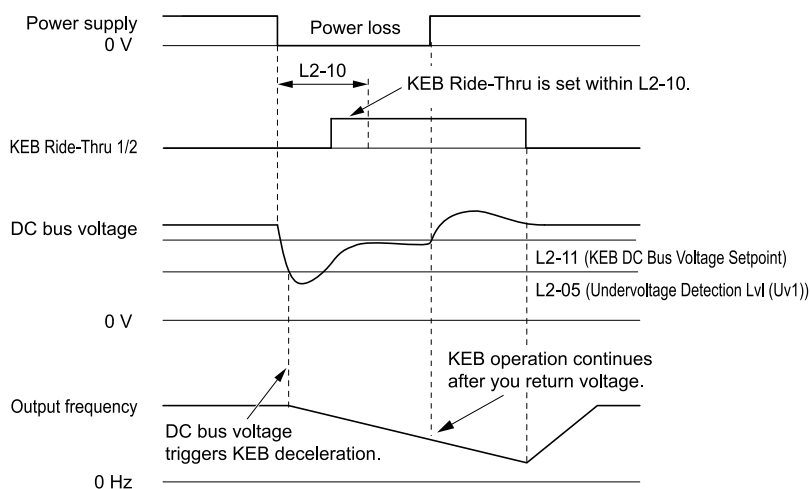

Figure 12.103 KEB Operation through KEB Ride-Thru Input

■ KEB Ride-Thru End Detection

Parameter $L2-01$ [*Power Loss Ride Through Select*] and a digital input programmed for KEB set the KEB function end detection.

Use the Momentary Power Loss Ride-Thru Time to Cancel KEB Operation

shows an example with this configuration:

- $L2-01 = 3$ [*Kinetic Energy Backup: L2-02*] is set.
- KEB Ride-Thru is not used.

The drive starts deceleration through KEB operation. When the time set in $L2-10$ [*Minimum KEB Time*] expires, the drive stops the KEB operation and then it accelerates the motor again until it is at the frequency reference value used before the power loss.

If you do not return the DC bus voltage in the time set in $L2-02$ [*Power Loss Ride Through Time*], the drive detects $Uv1$ [*DC Bus Undervoltage*] and the drive turns off its output.

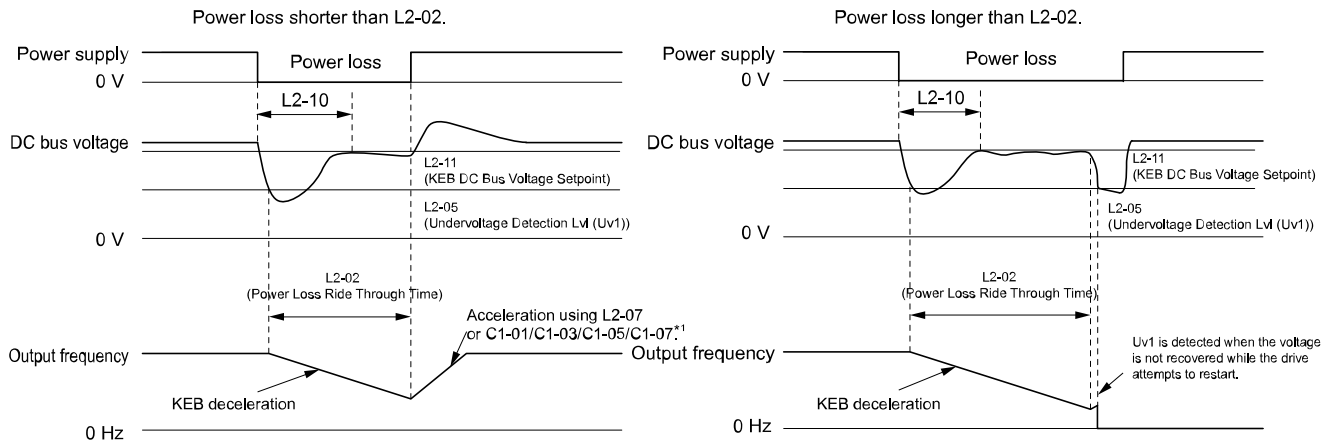

Figure 12.104 Cancel the KEB Operation after the Momentary Power Loss Ride-Thru Time Is Expired without KEB Ride-Thru

*1 When $L2-07 = 0.00$ [Kinetic Energy Backup Accel Time = 0.00 s], the drive accelerates again as specified by the applicable Acceleration Time [C1-01, C1-03, C1-05, C1-07], and usual operation continues.

Use the Momentary Power Loss Ride-Thru Time and KEB Ride-Thru to Cancel KEB Operation

shows an example with this configuration:

- $L2-01 = 3$.
- Use KEB Ride-Thru 1 [H1-xx = 65, 66] or KEB Ride-Thru 2 [H1-xx = 7A, 7B].

The drive starts deceleration through KEB operation. The drive decelerates for the time set in parameter $L2-10$, then it measures the DC bus voltage and the status of the digital input terminal set for KEB Ride-Thru. When the DC bus voltage is less than the level set in $L2-11$ [KEB DC Bus Voltage Setpoint], or if the KEB digital input is active, KEB deceleration continues. When the DC bus voltage is more than the level set in $L2-11$, the drive ends KEB operation. The drive accelerates the motor to the frequency reference value before the power loss, and usual operation continues. If the time set in $L2-02$ is expired, the drive detects $Uv1$. When you cancel the KEB Ride-Thru, the motor accelerates again, and usual operation continues.

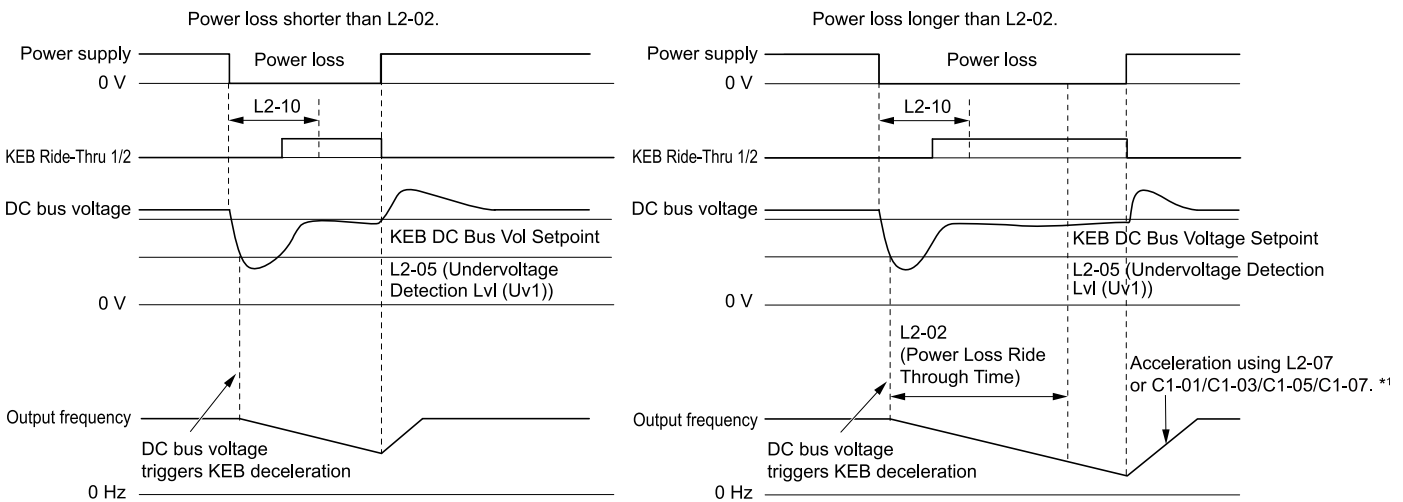

Figure 12.105 Use the Momentary Power Loss Ride-Thru Time and KEB Ride-Thru to Cancel KEB Operation

*1 When $L2-07 = 0.00$, the drive accelerates again as specified by the applicable Acceleration Time [C1-01, C1-03, C1-05, C1-07], and usual operation continues.

Cancel KEB Operation When Restoration of Power Occurs while the Control Power (Power Supply to the Control Board) is Maintained

shows an example with this configuration:

- $L2-01 = 4$ [Kinetic Energy Backup: CPU Power] is set.
- KEB Ride-Thru is not used.

The drive starts deceleration through KEB operation. The drive decelerates for the time set in parameter $L2-10$, and then measures the DC bus voltage level. When the DC bus voltage is lower than the level set in $L2-11$, the drive uses the KEB Ride-Thru function to continue deceleration. When the DC bus voltage is more than the level set in $L2-11$, usual operation continues. The drive accelerates the motor to the frequency reference value before the power loss, and usual operation continues.

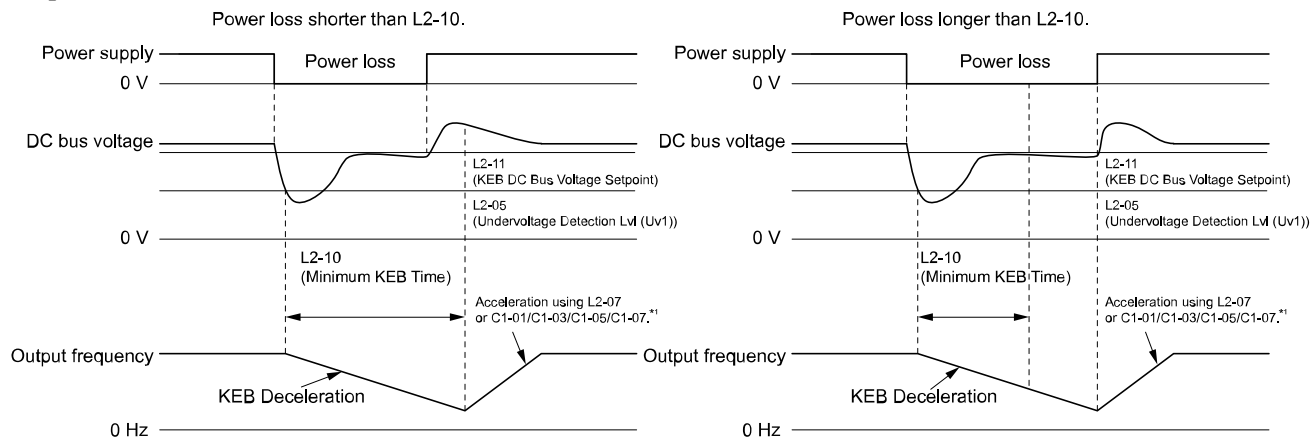

Figure 12.106 Cancel KEB Operation without Using the KEB Ride-Thru if Restoration of Power Occurs while the Control Power (Power Supply to the Control Board) is Maintained

*1 When $L2-07 = 0.00$ s, the drive accelerates again as specified by the applicable *Acceleration Time* [$C1-01$, $C1-03$, $C1-05$, $C1-07$], and usual operation continues.

Use the KEB Ride-Thru to Cancel KEB Operation when Restoration of Power Occurs while the Control Power (Power Supply to the Control Board) is Maintained

shows an example with this configuration:

- $L2-01 = 4$.
- Use *KEB Ride-Thru 1* [$H1-xx = 65, 66$] or *KEB Ride-Thru 2* [$H1-xx = 7A, 7B$].

The drive starts deceleration through KEB operation. When the motor decelerates for the time set in $L2-10$, the drive measures the DC bus voltage and the status of the digital input set for KEB Ride-Thru. When the DC bus voltage is less than the level set in $L2-11$, or if the digital input set to KEB Ride-Thru is active, deceleration continues. When the DC bus voltage is more than the level set in $L2-11$, the drive ends KEB operation. The drive accelerates the motor to the frequency reference value before the power loss, and usual operation continues. When the KEB Ride-Thru continues to be input after the time set in $L2-02$ is expired, the drive uses the KEB Ride-Thru function to continue to decelerate. When you cancel the KEB Ride-Thru, the motor accelerates again, and usual operation continues.

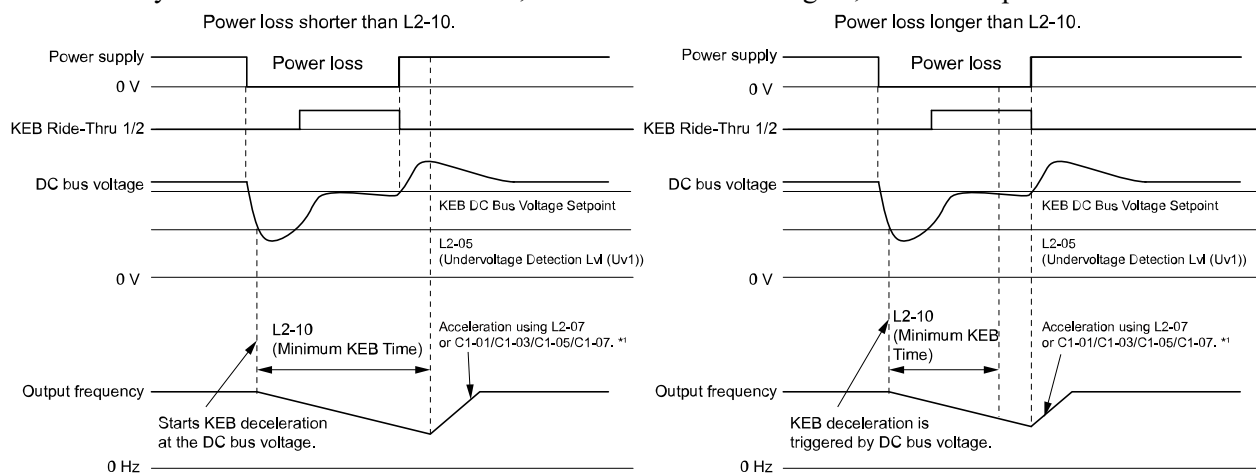

Figure 12.107 Use the KEB Ride-Thru to Cancel KEB Operation when Restoration of Power Occurs while the Control Power (Power Supply to the Control Board) is Maintained

*1 When $L2-07 = 0.00$ s, the drive accelerates again as specified by the applicable *Acceleration Time* [$C1-01$, $C1-03$, $C1-05$, $C1-07$], and usual operation continues.

KEB Operation when L2-01 = 5 [Kinetic Energy Backup: DecelStop]

The drive starts deceleration through KEB operation. If you do not input the Run command, the motor cannot restart. The drive will continue to decelerate until the motor comes to the minimum output frequency or a complete stop. If you return power during deceleration, the drive continues to decelerate.

KEB Operation Wiring Example

Figure 12.108 shows an example that uses an undervoltage relay to trigger the KEB Ride-Thru at power loss. When a power loss occurs, the undervoltage relay triggers *KEB Ride-Thru* [H1-06 = 65, 66, 7A, 7B] at terminal S6.

Note:

- Set the drive to activate the Run command while the KEB function is operating. If you turn off the Run command, the drive will not accelerate back to speed when you return power.
- When you set L2-29 = 2 [Kinetic Energy Backup Method = System KEB Ride-Thru 1], install a dynamic braking option.

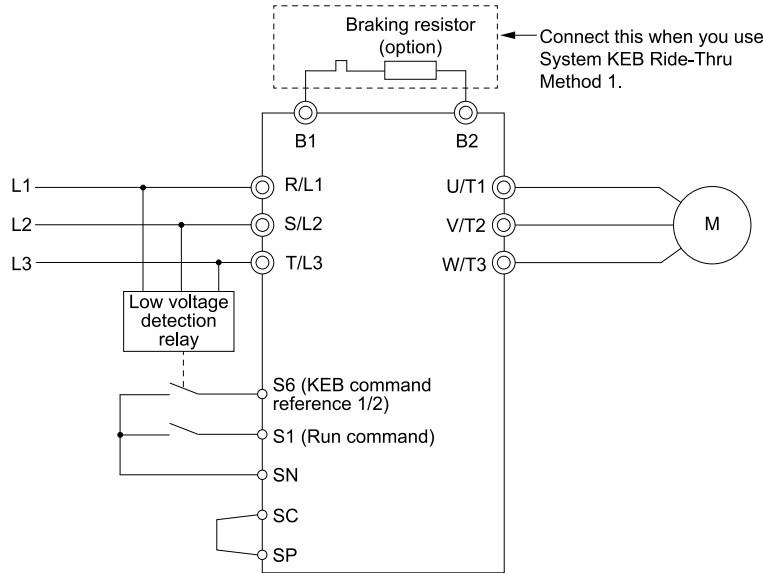

Figure 12.108 KEB Function Wiring Example

Parameters for KEB Ride-Thru

Table 12.59 shows the parameters that adjust the KEB Ride-Thru function. Parameter settings are different for the different KEB methods set in L2-29 [KEB Energy Backup Method].

Table 12.59 Parameters for KEB Ride-Thru

No.	Name	Configuring Settings	L2-29 [Kinetic Energy Backup Method]			
			0	1	2	3
C1-09	Fast Stop Time	<ul style="list-style-type: none"> • If <i>ov</i> [Overvoltage] occurs during KEB deceleration, increase the setting value. • If <i>Uv1</i> [DC Bus Undervoltage] occurs during KEB deceleration, decrease the setting value. 	x *1	-	-	-
C2-03	S-Curve Time @ Start of Decel	<ul style="list-style-type: none"> • If <i>ov</i> occurs immediately after you start KEB deceleration, increase the setting value. • If <i>Uv1</i> occurs immediately after you start operation, decrease the setting value. 	x	-	x	x
L2-05	Undervoltage Detection Lvl (Uv1)	If <i>Uv1</i> occurs immediately after you start KEB deceleration, increase the setting value to detect power loss more quickly.	x	x	x	x
L2-06	Kinetic Energy Backup Decel Time	<ul style="list-style-type: none"> • Does KEB Tuning. • If <i>ov</i> or <i>Uv1</i> occur during KEB deceleration after the KEB Tuning, set L2-06 in these conditions: <ul style="list-style-type: none"> – If <i>ov</i> occurs, increase the setting value – If <i>Uv1</i> occurs, decrease the setting value. 	-	-	x *2	x *2
L2-07	Kinetic Energy Backup Accel Time	Sets the acceleration time to return to the frequency reference value before a power loss, after you cancel the KEB operation. When L2-07 = 0, the drive uses the standard acceleration times set in C1-01, C1-03, C1-05, and C1-07 [Acceleration Time].	x	x	x	x

No.	Name	Configuring Settings	L2-29 [Kinetic Energy Backup Method]			
			0	1	2	3
L2-08	Frequency Gain at KEB Start	<ul style="list-style-type: none"> If <i>ov</i> occurs immediately after you start operation, decrease the setting value. If <i>Uv1</i> occurs immediately after you start KEB deceleration, increase the setting value. 	x	-	x	x
L2-10	Minimum KEB Time	<ul style="list-style-type: none"> With KEB Ride-Thru There is <i>Uv1</i> because you set a digital input for KEB Ride-Thru and the device that controls the input operated too slowly after power loss. Without KEB Ride-Thru If the DC bus voltage overshoots immediately after KEB Ride-Thru starts, increase L2-10 to longer than the overshoot. 	x	x	x	x
L2-11	KEB DC Bus Voltage Setpoint	<ul style="list-style-type: none"> Single Drive KEB Ride-Thru 2 Set to approximately 1.22 x input voltage. Single Drive KEB Ride-Thru 1, System KEB Ride-Thru 1, or System KEB Ride-Thru 2 Set to approximately 1.4 x input voltage. 	x	x	x	x
L3-20	DC Bus Voltage Adjustment Gain	<ul style="list-style-type: none"> If <i>ov</i> or <i>Uv1</i> occurs at the start of deceleration when you use KEB operation, increase this value in 0.1-unit increments. If there is torque ripple during deceleration when you use KEB Ride-Thru, decrease the value. 	-	x	-	-
L3-21	OVSuppression Accel/Decel P Gain	<p>If there is large speed or current ripple, decrease the value in 0.05 unit increments.</p> <p>Note: If the setting value is too low, then the drive will have unsatisfactory DC bus voltage control response. The drive can detect <i>ov</i> or <i>Uv1</i>.</p>	-	x	-	-
L3-24	Motor Accel Time @ Rated Torque	Set the motor acceleration time to the maximum frequency at the motor rated torque.	-	x	-	-
L3-25	Load Inertia Ratio	Sets the ratio between motor inertia and machine inertia.	-	x *3	-	-

*1 When $L2-29 = 0$ [KEB Energy Backup Method = Single Drive KEB Ride-Thru 1] and you do KEB Auto-Tuning, the drive will automatically set $C1-09$. If you must not change the Fast Stop time, do not do KEB Tuning.

*2 If you do KEB Tuning when $L2-29 = 1, 2, \text{ or } 3$ [KEB Energy Backup Method = Single Drive KEB Ride-Thru 2, System KEB Ride-Thru 1 or System KEB Ride-Thru 2], the drive will automatically set $L2-06$ [KEB Decel Time].

*3 The drive sets this value automatically when KEB Tuning completes correctly.

■ L2-01: Power Loss Ride Through Select

No. (Hex.)	Name	Description	Default (Range)
L2-01 (0485)	Power Loss Ride Through Select	 Sets the drive operation after a momentary power loss.	0 (0 - 5)

The drive detects momentary power loss when the drive DC bus voltage is less than the value set in $L2-05$ [Undervoltage Detection Lvl (*Uv1*)].

0 : Disabled

A momentary power loss triggers *Uv1* [DC Bus Undervoltage].

If you do not restore power in 15 ms, a *Uv1* is triggered and the drive shuts off the output. The motor coasts to stop.

1 : Enabled

This setting will enable for the time set in $L2-02$ [Power Loss Ride Through Time] or until the CPU is inactive. When the CPU is inactive, $b1-17$ [Run Command at Power Up] sets operation at power up.

When power returns in the time set in $L2-02$, the drive will restart. If power does not return in the time set in $L2-02$, the drive will detect *Uv1*.

The drive momentarily turns OFF its output after a power loss. If the power returns in the time set to $L2-02$, the drive will do Speed Search and try to continue operation.

If the DC bus voltage is less than or equal to the *Uv1* detection level for the time set in $L2-02$, the drive will detect *Uv1* and output a fault signal.

Note:

- The necessary time for the drive to restart after power returns is different for different drive capacities.
- The upper limit of the possible momentary power loss Ride-Thru time is different for different drive models.

2 : Enabled while CPU Power Active

This setting will enable for the time set in *L2-02 [Power Loss Ride Through Time]* or until the CPU is inactive. When the CPU is inactive, *b1-17 [Run Command at Power Up]* sets operation at power up.

When power returns and the drive control circuit has power, the drive will restart. This will not trigger *Uv1*.

When there is a momentary power loss, the drive output will turn OFF. If the power returns and the drive control circuit has power, the drive will do Speed Search and try to continue operation. This will not trigger a *Uv1*. This function lets the drive lose power for longer than when *L2-01 = 1*.

3 : Kinetic Energy Backup: L2-02

If power does not return in the time set in *L2-02*, the drive will detect *Uv1*.

If the drive detects momentary power loss, the drive will use regenerative energy from the motor and ramp to stop. When you return power in the time set in *L2-02*, the drive will accelerate to the frequency reference value that the drive used before the power loss. If you do not return power in the time set to *L2-02*, the drive will detect *Uv1* and the drive output will turn OFF. *L2-29 [Kinetic Energy Backup Method]* sets the type of KEB operation.

4 : Kinetic Energy Backup: CPU Power

When power returns and the drive control circuit has power, the drive will restart.

The drive decelerates using regenerative energy from the motor until the power returns and then restarts when a momentary power loss is detected. When power is restored during deceleration, the drive accelerates the motor again to the frequency reference value used before the power loss. If the motor comes to a stop before the power returns, the drive loses control power and the drive output shuts off. A *Uv1* is not triggered when power is restored while power to the CPU in the drive is maintained. *L2-29* sets the type of KEB operation.

5 : Kinetic Energy Backup: DecelStop

When power returns, the drive will continue to decelerate until the motor fully stops.

If the drive detects momentary power loss, the drive will use regenerative energy from the motor and ramp to stop. When you return power to the drive, the drive will continue to decelerate until the motor comes to a full stop. After you return power, the drive will ramp to stop in the set deceleration time. *L2-29* sets the type of KEB operation.

Note:

When you set *L2-01*, make sure that you know these items:

- You can use a Momentary Power Loss Unit on models 2001 to 2042 and 4001 to 4023 for a longer momentary power loss ride through time. A Momentary Power Loss Unit makes it possible to continue operation of the drive after a maximum of 2 seconds of power loss.
- When you set *L2-01 = 1 to 4*, keep the magnetic contactor on the drive input side ON and keep the control signal while the drive does KEB operation.
- When *L2-01 = 1 to 5*, *Uv [DC Bus Undervoltage]* will flash on the keypad while the drive is attempting to recover from a momentary power loss. The drive will not output a fault signal at this time.
- When you use a magnetic contactor between the motor and the drive, keep the magnetic contactor closed while the drive does KEB operation or tries to restart with Speed Search.
- Keep the Run command active during KEB operation. The drive cannot accelerate back to the frequency reference when the power returns.
- When *L2-01 = 3 to 5*, if the control power supply voltage is less than the CPU operation level during KEB Ride-Thru, it will trigger *Uv1*.

■ L2-02: Power Loss Ride Through Time

No. (Hex.)	Name	Description	Default (Range)
L2-02 (0486)	Power Loss Ride Through Time	<div style="display: flex; gap: 5px;"> V/f OLV OLV/PM AOLV/PM EZOLV </div> <p>Sets the length of time that the drive will wait before it tries to restart if the DC bus voltage is less than <i>L2-05 [Undervoltage Detection Lvl (Uv1)]</i> after a momentary power loss.</p>	Determined by o2-04, C6-01 (0.0 - 25.5 s)

This function is applicable when *L2-01 = 1, 3 [Power Loss Ride Through Select = Enabled, Kinetic Energy Backup: L2-02]*.

After a power loss, if these conditions are satisfied, the drive detects *Uv1 [DC Bus Undervoltage]*, shuts off the output, and the motor coasts to stop:

- After the DC bus voltage decreases less than the level of *L2-05 [Undervoltage Detection Lvl (Uv1)]*, the time set in *L2-02* is expired.
- The drive does not detect a *Uv2 [Control Power Undervoltage]*.

Depending on use conditions, if the time set in *L2-02* is long, the drive may detect *Uv2* before *Uv1*. If this is a problem, decrease the time set in *L2-02* to prevent *Uv2*.

Note:

- The length of time that the drive can recover after a power loss changes when drive capacity changes.
- The upper limit of the possible momentary power loss Ride-Thru time changes when drive capacity changes.

■ L2-03: Minimum Baseblock Time

No. (Hex.)	Name	Description	Default (Range)
L2-03 (0487)	Minimum Baseblock Time	<div style="display: flex; justify-content: space-between; align-items: center;"> V/f OLV OLV/PM AOLV/PM EZOLV </div> Sets the minimum time to continue the drive output block (baseblock) after a baseblock.	Determined by o2-04, C6-01 (0.1 - 5.0 s)

Sets the length of time that the drive will wait for the residual voltage in the motor to dissipate in estimation to the secondary circuit time constant of the motor. If *oC* [*Overcurrent*] or *ov* [*DC Bus Overvoltage*] occur at the start of Speed Search, after power returns, or during DC Injection Braking, increase this setting.

■ L2-04: Powerloss V/f Recovery Ramp Time

No. (Hex.)	Name	Description	Default (Range)
L2-04 (0488)	Powerloss V/f Recovery Ramp Time	<div style="display: flex; justify-content: space-between; align-items: center;"> V/f OLV OLV/PM AOLV/PM EZOLV </div> Sets the time for the drive output voltage to go back to correct voltage after completing speed searches.	Determined by o2-04, C6-01 (0.0 - 5.0 s)

Sets the time for voltage to recover from 0 V to the value set in *E1-05* [*Maximum Output Voltage*].

■ L2-05: Undervoltage Detection Lvl (Uv1)

No. (Hex.)	Name	Description	Default (Range)
L2-05 (0489)	Undervoltage Detection Lvl (Uv1)	<div style="display: flex; justify-content: space-between; align-items: center;"> V/f OLV OLV/PM AOLV/PM EZOLV </div> Sets the voltage at which a <i>Uv1</i> [<i>DC Bus Undervoltage</i>] fault is triggered or at which the KEB function is activated. Usually it is not necessary to change this setting.	Determined by o2-04 and E1-01 (200 V Class: 150 - 210 V, 400 V Class: 300 - 420 V)

NOTICE: Damage to Equipment. When you set this parameter to a value lower than the default, you must install an AC reactor on the input side of the power supply. If you do not install an AC reactor, it will cause damage to the drive circuitry.

Note:

If the low voltage detection level is near the lower limit value of *L2-05*, the drive will detect *Uv1* during KEB Ride-Thru operation. Do not set the value too low when you use the KEB Ride-Thru function.

■ L2-06: Kinetic Energy Backup Decel Time

No. (Hex.)	Name	Description	Default (Range)
L2-06 (048A) Expert	Kinetic Energy Backup Decel Time	<div style="display: flex; justify-content: space-between; align-items: center;"> V/f OLV OLV/PM AOLV/PM EZOLV </div> Sets the deceleration time during KEB operation used to decrease the maximum output frequency to 0.	0.0 s (0.0 - 6000.0 s)

Set *L2-29* = 2 or 3 [*Kinetic Energy Backup Method = System KEB Ride-Thru 1 or System KEB Ride-Thru 2*] to enable this function. When *L2-29* = 1, 2, 3 [*Kinetic Energy Backup Method = Single Drive KEB Ride-Thru 2, System KEB Ride-Thru 1, System KEB Ride-Thru 2*] and you do KEB Auto-Tuning, the drive will automatically set this value.

Sets the deceleration time necessary to decelerate from the frequency reference to 0 Hz when the drive detects a momentary power loss. If a *Uv1* [*DC Bus Undervoltage*] fault occurs during KEB operation, decrease the deceleration time. If an *ov* [*Overvoltage*] fault occurs, increase the deceleration time.

- *L2-06* = 0

The drive automatically decreases *C1-09* [*Fast Stop Time*] to the base value to keep the DC bus voltage above the low voltage detection level. The drive ignores *L2-02* [*Momentary Power Loss Ride-Thru Time*] in this condition.

- *L2-06* ≠ 0

As shown in [Figure 12.109](#), the frequency reference decelerates to the KEB frequency level as specified by the deceleration rate set in *L2-06* and then returns to the initial frequency reference as specified by *C1-01* [*Acceleration Time 1*]. The drive uses the setting value of the KEB frequency rate as shown in the this formula to set the KEB frequency level:

$$\text{KEB frequency level} = \text{Output frequency before power loss} \times (1 - (L2-02) / (L2-06))$$

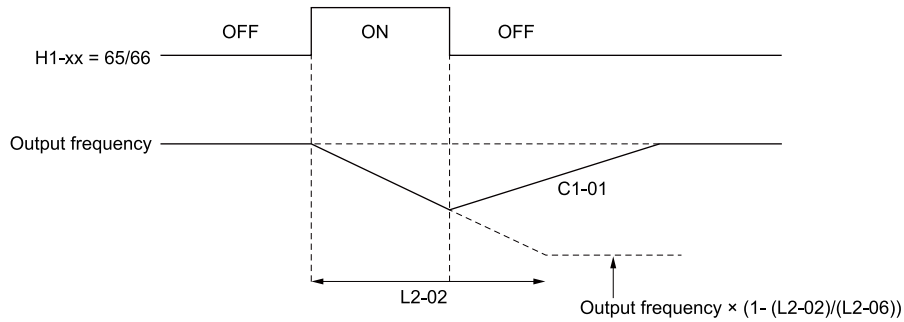

Figure 12.109 Kinetic Energy Backup Decel Time

■ **L2-07: Kinetic Energy Backup Accel Time**

No. (Hex.)	Name	Description	Default (Range)
L2-07 (048B) Expert	Kinetic Energy Backup Accel Time	<input type="checkbox"/> V/f <input type="checkbox"/> OLV <input type="checkbox"/> OLV/PM <input type="checkbox"/> AOLV/PM <input type="checkbox"/> EZOLV Sets the acceleration time to return the frequency to the frequency reference before a power loss after canceling KEB operation.	0.0 s (0.0 - 6000.0 s)

Set this parameter to 0.0 to disable the function. The drive uses the acceleration time in C1-01, C1-03, C1-05, and C1-07 to accelerate again after KEB operation completes.

■ **L2-08: Frequency Gain at KEB Start**

No. (Hex.)	Name	Description	Default (Range)
L2-08 (048C) Expert	Frequency Gain at KEB Start	<input type="checkbox"/> V/f <input type="checkbox"/> OLV <input type="checkbox"/> OLV/PM <input type="checkbox"/> AOLV/PM <input type="checkbox"/> EZOLV Sets the quantity of output frequency reduction used when KEB operation starts as a percentage of the motor rated slip before starting KEB operation.	100% (0 - 300%)

Decreases the output frequency in steps to quickly set the motor to a regenerative condition. Use this formula to calculate the value:

$$\text{Output frequency reduction} = \text{Motor rated slip before KEB operation} \times (L2-08/100) \times 2$$

■ **L2-09: KEB Minimum Frequency Level**

No. (Hex.)	Name	Description	Default (Range)
L2-09 (048D) Expert	KEB Minimum Frequency Level	<input type="checkbox"/> V/f <input type="checkbox"/> OLV <input type="checkbox"/> OLV/PM <input type="checkbox"/> AOLV/PM <input type="checkbox"/> EZOLV Sets the quantity of output frequency reduction used as a percentage of E2-02 [Motor Rated Slip] when KEB operation starts.	20% (0 - 100%)

These conditions set the quantity of decrease:

- Motor rated slip $\times (L2-09/100)$
- The larger value between the value calculated with L2-08 and the value calculated with L2-09

■ **L2-10: Minimum KEB Time**

No. (Hex.)	Name	Description	Default (Range)
L2-10 (048E) Expert	Minimum KEB Time	<input type="checkbox"/> V/f <input type="checkbox"/> OLV <input type="checkbox"/> OLV/PM <input type="checkbox"/> AOLV/PM <input type="checkbox"/> EZOLV Sets the minimum length of time to operate the KEB after the drive detects a momentary power loss.	50 ms (0 - 25500 ms)

When you return power while KEB is operating, the drive continues KEB operation until the time set in L2-10 is expired. When the DC bus voltage is less than the level of L2-05 [Undervoltage Detection Lvl (Uv1)] in one of these conditions, KEB operation continues until the time set in L2-10 is expired:

- L2-01 = 3 [Power Loss Ride Through Select = Kinetic Energy Backup: L2-02]

- $L2-01 = 4$ [Kinetic Energy Backup: CPU Power]
- $L2-01 = 5$ [Kinetic Energy Backup: DecelStop]
- KEB Ride-Thru 1/2 [H1-xx = 65, 66, 7A, or 7B] is input into the drive.

When you input KEB Ride-Thru, KEB operation continues after the time set in $L2-10$ is expired. When you cancel KEB Ride-Thru, the motor accelerates again. When you do not input KEB Ride-Thru during the time set in $L2-10$, the drive accelerates to the frequency reference that the drive had before power loss in the applicable acceleration time.

When $L2-01 = 3, 4, \text{ or } 5$, and the DC bus voltage is a minimum of the value of $L2-11$ [KEB DC Bus Voltage Setpoint], the drive accelerates again after the time set in $L2-10$ is expired. When the DC bus voltage is less than the $L2-11$ value, KEB operation continues after the time set in $L2-10$ is expired.

Note:

- When $L2-01 = 0, 1, \text{ or } 2$ [Disabled, Enabled for L2-02 Time, or Enabled while CPU Power Active], increase the value of $L2-10$. Set $L2-10$ to cancel KEB operation if the KEB Ride-Thru is not input.
- Setting $L2-10$ to 0 ms disables the function of $L2-10$.

■ L2-11: KEB DC Bus Voltage Setpoint

No. (Hex.)	Name	Description	Default (Range)
L2-11 (0461) Expert	KEB DC Bus Voltage Setpoint	<div style="display: flex; gap: 5px;"> V/f OLV OLV/PM AOLV/PM EZOLV </div> Sets the target value that controls the DC bus voltage to a constant level in Single Drive KEB Ride-Thru 2. Sets the DC bus voltage level that completes the KEB operation for all other KEB methods.	Determined by E1-01 (Determined by E1-01)

■ L2-29: Kinetic Energy Backup Method

No. (Hex.)	Name	Description	Default (Range)
L2-29 (0475) Expert	Kinetic Energy Backup Method	<div style="display: flex; gap: 5px;"> V/f OLV OLV/PM AOLV/PM EZOLV </div> Sets the KEB function operation mode.	0 (0 - 3)

Set $L2-01 = 3, 4, \text{ or } 5$ [Power Loss Ride Through Select = Kinetic Energy Backup: L2-02, Kinetic Energy Backup: CPU Power, or Kinetic Energy Backup: DecelStop] or KEB Ride-Thru 1/2 [H1-xx = 65, 66, 7A, or 7B], to enable the KEB function.

0 : Single Drive KEB Ride-Thru 1

The drive monitors the DC bus voltage and uses regenerative energy from the motor to hold the DC bus voltage at the level set in $L2-11$ [KEB DC Bus Voltage Setpoint].

The KEB operation continues and the deceleration rate changes as specified by $C1-09$ [Fast Stop Time].

Note:

- If the drive detects $Uv1$ [DC Bus Undervoltage] during KEB operation, decrease the value of $C1-09$.
- If the drive detects ov [Overvoltage] during KEB operation, increase the value of $C1-09$.

1 : Single Drive KEB Ride-Thru 2

The drive does KEB operation and automatically calculates the deceleration rate to make sure that the main circuit electrical energy and main current voltage from motor regenerative energy is equal to $L2-11$.

2 : System KEB Ride-Thru 1

The drive does not monitor the DC bus voltage and decelerates as specified by the KEB deceleration time set in $L2-06$.

Use $L2-06$ to set the time necessary to decelerate from the current frequency reference to 0 Hz. More than one drive can decelerate and keep a constant speed ratio between drives.

Note:

If you keep constant deceleration rates for more than one drive, it can trigger ov faults. Use the dynamic braking option with System KEB Ride-Thru 1.

3 : System KEB Ride-Thru 2

The drive uses the KEB deceleration time set in $L2-06$ to decelerate and it also monitors the DC bus voltage.

If the voltage level increases, the drive momentarily holds the frequency to prevent an *ov* before it continues to decelerate.

Note:

When you cannot use a dynamic braking option, use System KEB Ride-Thru.

■ **L2-30: KEB Zero Speed Operation**

No. (Hex.)	Name	Description	Default (Range)
L2-30 (045E) Expert	KEB Zero Speed Operation	<div style="display: flex; gap: 5px;"> V/f OLV OLV/PM AOLV/PM EZOLV </div> <p>Sets the operation when the output frequency decreases below the zero level (DC braking injection starting frequency) during KEB deceleration when <i>L2-01 = 3 to 5</i> [<i>Power Loss Ride Through Select = Kinetic Energy Backup: L2-02, Kinetic Energy Backup: CPU Power, or Kinetic Energy Backup: DecelStop</i>].</p>	0 (0, 1)

0 : Baseblock

1 : DC/SC Braking

Does DC injection braking and short circuit braking as specified by *b2-04* [*DC Inject Braking Time at Stop*] and *b2-13* [*Short Circuit Brake Time @ Stop*].

■ **L2-31: KEB Start Voltage Offset Level**

No. (Hex.)	Name	Description	Default (Range)
L2-31 (045D) Expert	KEB Start Voltage Offset Level	<div style="display: flex; gap: 5px;"> V/f OLV OLV/PM AOLV/PM EZOLV </div> <p>Sets the KEB start voltage offset.</p>	Determined by A1-02 (200 V Class: 0 - 100 V, 400 V Class: 0 - 200 V)

The drive uses this formula to calculate the KEB start voltage:

$$\text{KEB start voltage} = L2-05 [\text{Undervoltage Detect Level (Uv1)}] + L2-31$$

◆ **L3: Stall Prevention**

L3 parameters set the Stall Prevention function and overvoltage suppression function.

■ **Stall Prevention**

If the load is too heavy or the acceleration and deceleration times are too short, the motor can slip too much because it cannot work at the same rate as the frequency reference. If the motor stalls during acceleration, current increases as the slip increases to cause an *oC* [*Overcurrent*], *oL2* [*Drive Overload*], or *oL1* [*Motor Overload*] and the drive will stop. If the motor stalls during deceleration, too much regenerative power will flow back into the DC bus capacitors, and cause the drive to detect an *ov* [*Overvoltage*] fault and stop.

The stall prevention function will let the motor get to the set speed without stalling and it is not necessary for you to change the acceleration or deceleration time settings. You can set a separate stall prevention functions for acceleration, operating at constant speeds, and deceleration.

■ **Overvoltage Suppression Function**

Decreases the regenerative torque limit and increases the output frequency when the DC bus voltage increases to prevent *ov*. This function can drive loads with cyclic regenerative operation, for example punch presses or other applications with repeated crank movements. When you use this function, set *L3-11 = 1* [*Overvoltage Suppression Select = Enabled*].

The drive adjusts the regenerative torque limit and the output frequency during overvoltage suppression to make sure that the DC bus voltage is not more than the level set in *L3-17* [*DC Bus Regulation Level*].

Set these parameters as necessary when you use the overvoltage suppression function:

- *L3-20* [*DC Bus Voltage Adjustment Gain*]
- *L3-21* [*OVSuppression Accel/Decel P Gain*]
- *L3-24* [*Motor Accel Time @ Rated Torque*]
- *L3-25* [*Load Inertia Ratio*]

Note:

- When overvoltage suppression is triggered, the motor speed is more than the frequency reference. Do not use overvoltage suppression for applications where the frequency reference and the motor speed must align.
- When you use a braking resistor, set $L3-11 = 0$ [Disabled].
- The overvoltage suppression function is enabled only when you operate immediately below the maximum frequency. Overvoltage suppression does not increase the output frequency to more than the maximum frequency. Make sure that the motor and machine specifications are correct for the application, then increase the maximum frequency.
- If there is a sudden increase to a regenerative load, ov can occur.

■ L3-01: Stall Prevention during Accel

No. (Hex.)	Name	Description	Default (Range)
L3-01 (048F)	Stall Prevention during Accel	<div style="display: flex; gap: 5px;"> V/f OLV OLV/PM AOLV/PM EZOLV </div> Sets the method of the Stall Prevention During Acceleration.	1 (0 - 3)

Note:

When $A1-02 = 5$ [Control Method Selection = OLV/PM], the setting range is 0 and 1.

Stall prevention during acceleration prevents the stalling and stopping of motors when the drive detects oC [Overcurrent], $oL2$ [Drive Overloaded], or $oL1$ [Motor Overload] when you apply a large load during acceleration or when you set sudden acceleration times related to load inertia.

0 : Disable

The Stall Prevention function does not operate during acceleration, and acceleration occurs for the set acceleration time. If the acceleration time is too short, the motor does not fully accelerate during the set time, which causes the drive to detect $oL1$ or $oL2$ and the motor to stop.

1 : Enabled

Enables the Stall Prevention During Acceleration function. Operation is different for different control methods.

• V/f Control, Open Loop Vector Control, or EZ Open Loop Vector Control

When the output current is more than the value set in $L3-02$ [Stall Prevent Level during Accel], the drive stops acceleration. The drive stops deceleration when the output current is less than $L3-02 - 15\%$. The Stall Prevention function level automatically decreases for constant output ranges.

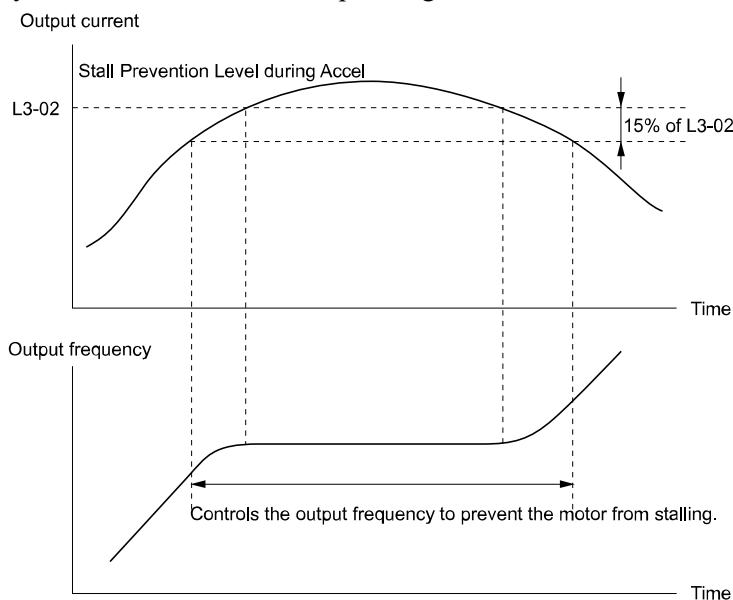

Figure 12.110 Stall Prevention During Acceleration when Using Induction Motors

• Open Loop Vector Control for PM

When the output current is more than $L3-02$, the drive stops acceleration. When the time set in $L3-27$ [Stall Prevention Detection Time] is expired and the output current = $L3-02$, the drive will start deceleration as specified by the value set in $L3-22$ [PM Stall Prevention Decel Time]. The drive starts acceleration again when the output current is less than $L3-02 - 15\%$. When the time set in $L3-27$ is expired, the drive starts acceleration again.

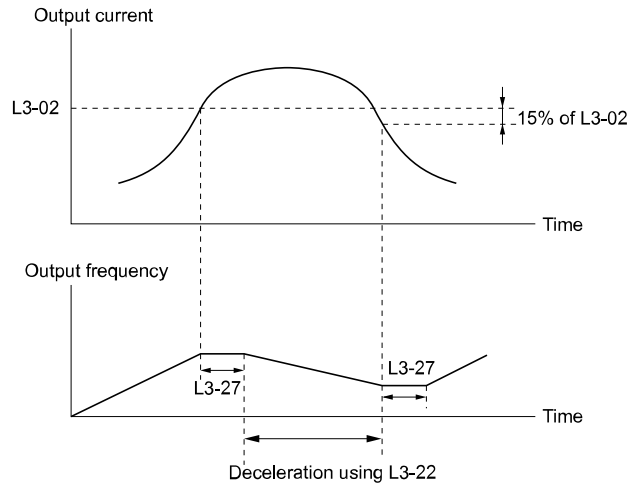

Figure 12.111 Stall Prevention During Acceleration Function in OLV/PM

2 : Intelligent (Ignore Accel Ramp)

The drive ignores the acceleration time setting and the drive starts to accelerate in the minimum length of time. The drive automatically adjusts the acceleration rate to make sure that the output current is not more than *L3-02*.

3 : Current Limit Acceleration

This function uses the *L3-02* value to limit the output current and automatically adjust the acceleration rate. When the load (output current) increases to more than the current limit level during acceleration, the drive automatically adjusts the acceleration rate.

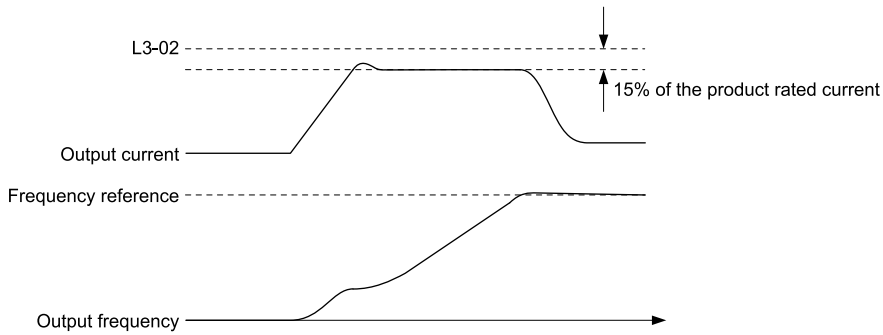

Figure 12.112 Current Limit Acceleration

■ L3-02: Stall Prevent Level during Accel

No. (Hex.)	Name	Description	Default (Range)
L3-02 (0490)	Stall Prevent Level during Accel	V/f OLV OLV/PM AOLV/PM EZOLV Sets the output current level at which the Stall Prevention function operates during acceleration where the drive rated output current is 100%.	Determined by C6-01 (0 - 150%)

Note:

- If you use a motor that is small compared to the drive and the motor stalls, decrease the setting value.
- When you operate the motor in the constant power range, set *L3-03* [Stall Prevent Limit during Accel].
- The upper limit to the setting range changes when the setting for *C6-01* [Normal / Heavy Duty Selection] changes.
 - 150% when *C6-01* = 0 [Heavy Duty Rating]
 - 120% when *C6-01* = 1 [Normal Duty Rating]

■ L3-03: Stall Prevent Limit during Accel

No. (Hex.)	Name	Description	Default (Range)
L3-03 (0491)	Stall Prevent Limit during Accel	V/f OLV OLV/PM AOLV/PM EZOLV Sets the lower limit for the stall prevention level used in the constant output range as a percentage of the drive rated output current.	50% (0 - 100%)

The stall prevention level set in *L3-02 [Stall Prevent Level during Accel]* is automatically reduced when the motor is running within the constant output range. Parameter *L3-03* is the limit value used to prevent the stall prevention level during constant output ranges to fall below the minimum required level.

Note:

The function to automatically reduce the stall prevention level does not operate when *L3-01 = 3 [Stall Prevention during Accel = Current Limit Method]*.

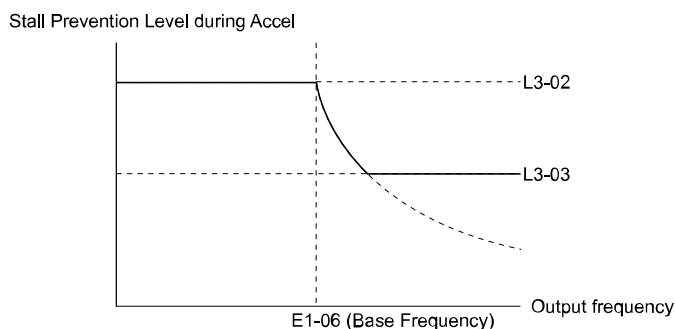

Figure 12.113 Stall Prevent Level during Accel/Limit

■ L3-04: Stall Prevention during Decel

No. (Hex.)	Name	Description	Default (Range)
L3-04 (0492)	Stall Prevention during Decel	<input type="checkbox"/> V/f <input type="checkbox"/> OLV <input type="checkbox"/> OLV/PM <input type="checkbox"/> AOLV/PM <input type="checkbox"/> EZOLV Sets the method that the drive will use to prevent overvoltage faults when decelerating.	1 (Determined by A1-02)

Note:

- To connect a dynamic braking option (braking resistor or braking resistor unit) to the drive, set this parameter to *0* or *3*. Parameter settings *1*, *2*, *4*, *5*, and *7* will enable Stall Prevention function during deceleration, and the dynamic braking option will not function.
- The setting range changes when the *A1-02 [Control Method Selection]* value changes:
 - When *A1-02 = 5 [OLV/PM]*, the setting range is *0* to *2*.
 - When *A1-02 = 6* or *8 [AOLV/PM or EZOLV]*, the setting range is *0* or *1*.

Stall Prevention during deceleration controls the deceleration as specified by the DC bus voltage and does not let high inertia or fast deceleration cause *ov [Overvoltage]* faults.

0 : Disabled

The drive decelerates as specified by the deceleration time. If the deceleration time is too short, the drive can detect an *ov* fault.

Note:

If an *ov* fault occurs, connect a dynamic braking option to the drive. If an *ov* fault occurs when you connect a dynamic braking option and *A1-02 = 0* or *2 [Control Method Selection = V/f or OLV]* and *L3-04 = 0*, set *L3-04 = 3*.

1 : General Purpose

The drive decelerates as specified by the deceleration time. When the DC bus voltage is more than the Stall Prevention level, the drive stops deceleration until the DC bus voltage is less than the Stall Prevention Level. The drive then starts to decelerate at the set deceleration time. Frequent use of Stall Prevention will help prevent *ov* faults when the deceleration time is shorter than the drive can usually accept.

Note:

The Decel Stall Prevention function will increase the deceleration time to stop and the deceleration time will be longer than the setting. This function is not applicable for conveyor applications because the precision of the stop position is very important. As an alternative, use a dynamic braking option in these applications.

The input voltage setting of *E1-01 [Input AC Supply Voltage]* sets the DC bus voltage level for Stall Prevention.

Table 12.60 Stall Prevention Level during Deceleration

Drive Input Voltage	Stall Prevention Level during Deceleration
200 V Class	377 V
400 V Class	754 V

Figure 12.114 shows the Stall Prevention during deceleration function.

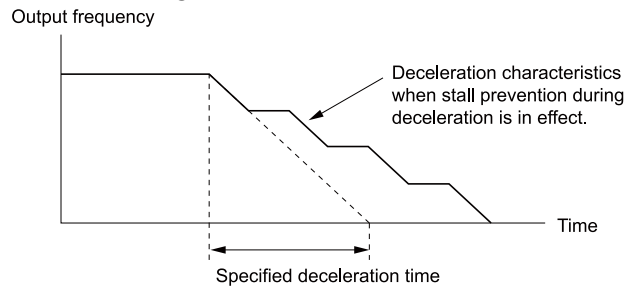

Figure 12.114 Stall Prevention Operation during Deceleration

2 : Intelligent (Ignore Decel Ramp)

The drive adjusts the deceleration rate to keep the DC bus voltage at the *L3-17 [DC Bus Regulation Level]* level. This makes the shortest possible deceleration time and will not let the motor stall. The drive ignores the selected deceleration time and the possible deceleration time cannot be less than 1/10 of the set deceleration time.

This function uses these parameters to adjust the deceleration rate:

- *L3-20 [DC Bus Voltage Adjustment Gain]*
- *L3-21 [OVSuppression Accel/Decel P Gain]*
- *L3-24 [Motor Accel Time @ Rated Torque]*
- *L3-25 [Load Inertia Ratio]*

Note:

The deceleration time is not constant. For applications where the precision of the stop position is very important, use a dynamic braking option and set *L3-04 = 0*. If an *ov* occurs, set *L3-04 = 3*.

3 : General Purpose w/ DB resistor

A braking resistor is necessary for this setting. The braking resistor and the drive work together for the Stall Prevention during deceleration function.

4 : Overexcitation/High Flux 1

Enables Overexcitation/High Flux and enables a shorter deceleration time than when *L3-04 = 0*.

Note:

- If the overexcitation time is long and you decelerate frequently, the drive can detect *oL1 [Motor Overload]* faults. If the drive detects *oL1*, decrease the deceleration time or install a braking resistor to the drive.
- The deceleration time during Overexcitation Deceleration changes when the motor characteristics and machine inertia change. Adjust the *n3-13 [OverexcitationBraking (OEB) Gain]* and *n3-23 [Overexcitation Braking Operation]* levels. Refer to [Overexcitation Deceleration on page 764](#) for more information.

5 : Overexcitation/High Flux 2

Enables Overexcitation/High Flux 2. This function decreases the possible deceleration time more than *Overexcitation/High Flux*.

The drive decreases motor speed and tries to keep the DC bus voltage at the *L3-17* level.

If the drive detects *oL1*, decrease the values set in *n3-13* and *n3-21*. If the drive detects *ov*, increase the values set in *C1-02*, *C1-04*, *C1-06*, and *C1-08 [Deceleration Times]*.

Note:

- During Overexcitation/High Flux 2, the drive disables Hunting Prevention in V/f Control and also disables Speed Control that uses torque limit in OLV Control.
- Refer to [Overexcitation Deceleration on page 764](#) for more information.

7 : Overexcitation/High Flux 3

If you set *L3-04 = 7 [Overexcitation Braking 3]*, the overexcitation increases compared with 4 [*Overexcitation/High Flux*]. This can decrease the deceleration time.

Note:

When *L3-04 = 7*, the overexcitation current increases as compared with 4. Motor load becomes larger, and it can cause *oL1 [Motor Overload]*. When you can use *L3-04 = 4* to operate the drive, set *L3-04 = 4*.

■ L3-05: Stall Prevention during RUN

No. (Hex.)	Name	Description	Default (Range)
L3-05 (0493)	Stall Prevention during RUN	<div style="display: flex; gap: 5px;"> V/f OLV OLV/PM AOLV/PM EZOLV </div> Sets the function to enable and disable Stall Prevention During Run.	2 (0 - Determined by A1-02)

Stall Prevention function during run prevents the motor from stalling by automatically reducing the speed when an *oL1* [Motor Overload] occurs while the motor is running at constant speed.

Note:

- An output frequency less than 6 Hz disables Stall Prevention during Run. The setting values of L3-05 and L3-06 [Stall Prevent Level during Run] do not have an effect.
- The setting range changes when the A1-02 [Control Method Selection] value changes:
 - A1-02 = 0, 5 [V/f, OLV/PM] : 0 to 2
 - A1-02 = 8 [EZOLV] : 0, 3

0 : No

The drive runs at the set frequency reference. A heavy load can cause the motor to stall and trip the drive with *oC* [Overcurrent] or *oL1*.

1 : Deceleration Time 1 (C1-02)

The drive will decelerate for the time set in C1-02 [Deceleration Time 1] when the current is more than the Stall Prevention level set in L3-06. When the current level is less than the “L3-06 setting value - 2%” for 100 ms, the drive accelerates again for the acceleration time applicable at that time until it is at the set frequency.

2 : Deceleration Time 2 (C1-04)

This setting functions the same as Setting 1 [Deceleration Time 1 (C1-02)]. When you enable the Stall Prevention function, the drive decelerates in the time set in C1-04 [Deceleration Time 2].

3 : Intelligent (Ignore Decel Ramp)

Enabled when A1-02 = 8 [EZOLV]. The drive operates with the largest possible output current to prevent motor stalling.

■ L3-06: Stall Prevent Level during Run

No. (Hex.)	Name	Description	Default (Range)
L3-06 (0494)	Stall Prevent Level during Run	<div style="display: flex; gap: 5px;"> V/f OLV OLV/PM AOLV/PM EZOLV </div> Sets the output current level at which the Stall Prevention function is enabled during run when the drive rated output current is 100%.	Determined by C6-01 (5 - 150%)

Note:

- This parameter is applicable when L3-05 = 1, 2 [Stall Prevention during RUN = Deceleration Time 1 (C1-02), Deceleration Time 2 (C1-04)].
- When L3-23 = 1 [Stall P Reduction at Constant HP = Automatic Reduction @ CHP Region], the drive will automatically decrease the level in the constant output range.
- The upper limit to the setting range changes when the setting for C6-01 [Normal / Heavy Duty Selection] changes.
 - 150% when C6-01 = 0 [Heavy Duty Rating]
 - 120% when C6-01 = 1 [Normal Duty Rating]

Use an Analog Input to Change the Stall Prevent Level during Run

When H3-xx = 8 [MFAI Function Select = Stall Prevent Level During Run], you can use the input gain and bias settings for terminals A1 and A2 to change the stall prevention level during run.

If you set the input level for terminals A1 and A2 [H3-xx = 8] and L3-06, the drive will use the smaller value for Stall Prevent Level during Run.

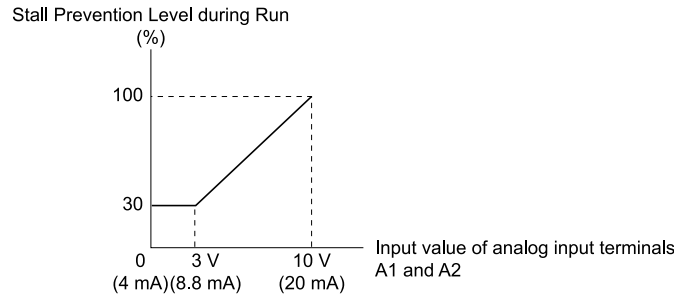

Figure 12.115 Stall Prevention Level during Run with Analog Input

■ **L3-11: Overvoltage Suppression Select**

No. (Hex.)	Name	Description	Default (Range)
L3-11 (04C7)	Overvoltage Suppression Select	<input type="radio"/> V/f <input type="radio"/> OLV <input type="radio"/> OLV/PM <input type="radio"/> AOLV/PM <input type="radio"/> EZOLV Sets the overvoltage suppression function.	0 (0, 1)

0 : Disabled

The drive does not adjust the regenerative torque limit or the output frequency. If you apply a regenerative load, the drive can detect an *ov* [Overvoltage] fault. Use this setting with a dynamic braking option.

1 : Enabled

When a regenerative load increases the DC bus voltage, the drive decreases the regenerative torque limit and increases the output frequency to prevent *ov*

■ **L3-17: DC Bus Regulation Level**

No. (Hex.)	Name	Description	Default (Range)
L3-17 (0462)	DC Bus Regulation Level	<input type="radio"/> V/f <input type="radio"/> OLV <input type="radio"/> OLV/PM <input type="radio"/> AOLV/PM <input type="radio"/> EZOLV Sets the target value for the DC bus voltage when the overvoltage suppression function and the Decel Stall Prevention function (Intelligent Stall Prevention) are active.	200 V Class: 375 V, 400 V Class: 750 V (200 V Class: 150 to 400 V, 400 V Class: 300 to 800 V)

Note:

This value is initialized when *E1-01* [Input AC Supply Voltage] is changed.

Sets this parameter for any of the following circumstances.

- *L3-11 = 1* [OV Suppression Function Select = Enabled].
- *L3-04 = 2* [Decel Stall Prevention Selection = Automatic Decel Reduction].

■ **L3-20: DC Bus Voltage Adjustment Gain**

No. (Hex.)	Name	Description	Default (Range)
L3-20 (0465) Expert	DC Bus Voltage Adjustment Gain	<input type="radio"/> V/f <input type="radio"/> OLV <input type="radio"/> OLV/PM <input type="radio"/> AOLV/PM <input type="radio"/> EZOLV Sets the proportional gain used to control the DC bus voltage.	Determined by A1-02 (0.00 - 5.00)

Set one of these parameters to enable L3-20:

- *L2-29 = 1* [Kinetic Energy Backup Method = Single Drive KEB Ride-Thru 2]
- *L3-04 = 2* [Stall Prevention during Decel = Intelligent (Ignore Decel Ramp)]
- *L3-11 = 1* [Overvoltage Suppression Select = Enabled]
- *H1-xx = 7A or 7B* [MFDI Function Selection = KEB Ride-Thru 2 Activate (N.O./N.C.)]

Note:

- If stall prevention during deceleration function causes *ov* [Overvoltage] and *Uv1* [DC Bus Undervoltage] faults when you start deceleration and $L2-29 = 1$, $H1-xx = 7A$ or $7B$, or $L3-04 = 2$, gradually increase this parameter in 0.1-unit increments. If the setting value is too high, it can cause large speed or current ripples.
- If sudden increases in the regenerative load cause *ov* faults and $L3-11 = 1$, gradually increase this parameter in 0.1-unit increments. If the setting value is too high, it can cause large speed or current ripples.

■ L3-21: OVSUPPRESSION ACCEL/DECCEL P GAIN

No. (Hex.)	Name	Description	Default (Range)
L3-21 (0466) Expert	OVSUPPRESSION ACCEL/DECCEL P Gain	<input type="checkbox"/> V/f <input type="checkbox"/> OLV <input checked="" type="checkbox"/> OLV/PM <input type="checkbox"/> AOLV/PM <input type="checkbox"/> EZOLV Sets the proportional gain to calculate acceleration and deceleration rates.	Determined by A1-02 (0.10 - 10.00)

Set one of these parameters to enable L3-20:

- $L2-29 = 1$ [Kinetic Energy Backup Method = Single Drive KEB Ride-Thru 2]
- $L3-04 = 2$ [Stall Prevention during Decel = Intelligent (Ignore Decel Ramp)]
- $L3-11 = 1$ [Overvoltage Suppression Select = Enabled]
- $H1-xx = 7A$ or $7B$ [MFDI Function Selection = KEB Ride-Thru 2 Activate (N.O./N.C.)]

Note:

- If stall prevention during deceleration function causes large speed or current ripples and $L2-29 = 1$, $H1-xx = 7A$ or $7B$, or $L3-04 = 2$, gradually decrease this parameter in 0.05-unit increments. If the drive detects *ov* [Overvoltage] or *oC* [Overcurrent], decrease L3-21. If you decrease the gain too much, it can cause a delay in control in the DC bus voltage or the deceleration time could be longer than the best deceleration time.
- If sudden increases in the regenerative load cause *ov* faults and $L3-11 = 1$, gradually increase this parameter in 0.1-unit increments. If there are large speed ripples, gradually decrease this parameter in 0.05-unit increments.

■ L3-22: PM STALL PREVENTION DECCEL TIME

No. (Hex.)	Name	Description	Default (Range)
L3-22 (04F9)	PM Stall Prevention Decel Time	<input type="checkbox"/> V/f <input type="checkbox"/> OLV <input checked="" type="checkbox"/> OLV/PM <input type="checkbox"/> AOLV/PM <input type="checkbox"/> EZOLV Sets the momentary deceleration time that the drive will use when it tries to accelerate a PM motor and detected motor stalls. This function is applicable when $L3-01 = 1$ [Stall Prevention during Accel = Enabled].	0.0 s (0.0 - 6000.0 s)

Set this parameter to 0.0 s to disable this function. The drive will decelerates in the deceleration time applicable at the time when a motor stall occurs.

■ L3-23: STALL P REDUCTION AT CONSTANT HP

No. (Hex.)	Name	Description	Default (Range)
L3-23 (04FD)	Stall P Reduction at Constant HP	<input type="checkbox"/> V/f <input type="checkbox"/> OLV <input checked="" type="checkbox"/> OLV/PM <input type="checkbox"/> AOLV/PM <input type="checkbox"/> EZOLV Sets the function to automatically decrease the Stall Prevention Level during Run for constant output ranges.	0 (0, 1)

0 : Use L3-06 for Entire Speed Range

The drive uses the level set in $L3-06$ [Stall Prevent Level during Run] through the full speed range.

1 : Automatic Reduction @ CHP Region

The drive decreases the Stall Prevention level during run in the constant power range. The lower limit is 40% of $L3-06$ value.

■ L3-24: Motor Accel Time @ Rated Torque

No. (Hex.)	Name	Description	Default (Range)
L3-24 (046E) Expert	Motor Accel Time @ Rated Torque	<input type="checkbox"/> V/f <input type="checkbox"/> OLV <input checked="" type="checkbox"/> OLV/PM <input type="checkbox"/> AOLV/PM <input type="checkbox"/> EZOLV Sets the motor acceleration time to reach the maximum frequency at the motor rated torque for stopped single-drive motors.	Determined by o2-04, C6-01, E2-11, and E5-01 (0.001 - 10.000 s)

Set one of these parameters to enable L3-20:

12.9 L: Protection Functions

- L2-29 = 1 [Kinetic Energy Backup Method = Single Drive KEB Ride-Thru 2]
- L3-04 = 2 [Stall Prevention during Decel = Intelligent (Ignore Decel Ramp)]
- L3-11 = 1 [Overvoltage Suppression Select = Enabled]
- H1-xx = 7A or 7B [MFDI Function Select = KEB Ride-Thru 2 Activate (N.O./N.C.)]

Note:

When Auto-Tuning changes the value of E2-11 [Motor Rated Power (kW)], the drive will automatically set *this parameter* to the value for a Yaskawa standard motor (4 poles). When you use a PM motor, the drive uses the value in E5-01 [PM Motor Code Selection] to change L3-24.

■ L3-25: Load Inertia Ratio

No. (Hex.)	Name	Description	Default (Range)
L3-25 (046F) Expert	Load Inertia Ratio	<div style="display: flex; gap: 5px;"> V/f OLV OLV/IPM AOLV/IPM EZOLV </div> <p>Sets the ratio between motor inertia and machine inertia.</p>	1.0 (0.1 - 1000.0)

Set one of these parameters to enable L3-20:

- L2-29 = 1 [Kinetic Energy Backup Method = Single Drive KEB Ride-Thru 2]
- L3-04 = 2 [Stall Prevention during Decel = Intelligent (Ignore Decel Ramp)]
- L3-11 = 1 [Overvoltage Suppression Select = Enabled]
- H1-xx = 7A or 7B [MFDI Function Select = KEB Ride-Thru 2 Activate (N.O./N.C.)]

Note:

- If you set this value incorrectly when L2-29 = 1, H1-xx = 7A or 7B, or L3-11 = 1, it can cause large current ripples and *ov* [Overvoltage], *Uv1* [DC Bus Undervoltage], or *oC* [Overcurrent] faults.
- KEB Tuning will automatically set this value.

■ L3-26: Additional DC Bus Capacitors

No. (Hex.)	Name	Description	Default (Range)
L3-26 (0455) Expert	Additional DC Bus Capacitors	<div style="display: flex; gap: 5px;"> V/f OLV OLV/IPM AOLV/IPM EZOLV </div> <p>Sets the capacity for external main circuit capacitors. Usually it is not necessary to change this setting. Sets this parameter when you use the KEB Ride-Thru function.</p>	0 μF (0 to 65000 μF)

■ L3-27: Stall Prevention Detection Time

No. (Hex.)	Name	Description	Default (Range)
L3-27 (0456)	Stall Prevention Detection Time	<div style="display: flex; gap: 5px;"> V/f OLV OLV/IPM AOLV/IPM EZOLV </div> <p>Sets a delay time between reaching the Stall Prevention level and starting the Stall Prevention function.</p>	60 ms (0 - 5000 ms)

■ L3-34: Torque Limit Delay Time

No. (Hex.)	Name	Description	Default (Range)
L3-34 (016F) Expert	Torque Limit Delay Time	<div style="display: flex; gap: 5px;"> V/f OLV OLV/IPM AOLV/IPM EZOLV </div> <p>Sets the filter time constant that returns the torque limit to its initial value when KEB operation operates in Single Drive KEB Ride-Thru mode.</p>	Determined by A1-02 (0.000 - 1.000 s)

When vibration occurs during operation of Single Drive KEB Ride-Thru 2, increase this parameter in 0.010-unit increments.

Note:

The Single Drive KEB Ride-Thru 2 mode operates when L2-29 = 1 [KEB Method Selection = Single Drive KEB Ride-Thru 2] and H1-xx = 7A or 7B [Terminal Sx Function Selection = KEB Ride-Thru 2 (N.C./N.O.)].

■ L3-35: Speed Agree Width for Auto Decel

No. (Hex.)	Name	Description	Default (Range)
L3-35 (0747) Expert	Speed Agree Width for Auto Decel	<div style="display: flex; justify-content: space-between; align-items: center;"> V/f OLV OLV/PM AOLV/PM EZOLV </div> <p>Sets the width for speed agreement when $L3-04 = 2$ [Stall Prevention during Decel = Intelligent (Ignore Decel Ramp)]. Usually it is not necessary to change this setting.</p>	0.00 Hz (0.00 - 1.00 Hz)

Set this parameter when hunting occurs while you use a frequency reference through an analog input.

■ L3-36: Current Suppression Gain@Accel

No. (Hex.)	Name	Description	Default (Range)
L3-36 (11D0)	Current Suppression Gain@Accel	<div style="display: flex; justify-content: space-between; align-items: center;"> V/f OLV OLV/PM AOLV/PM EZOLV </div> <p>Sets the gain to suppress current and motor speed hunting during operation when $L3-01 = 3$ [Stall Prevention during Accel = Current Limit Method]. Usually it is not necessary to change this setting.</p>	Determined by A1-02 (0.0 - 100.0)

If there is vibration in the output current during acceleration, increase the setting value.

Note:

Set $L3-01 = 3$ [Stall Prevention during Accel = Current Limit Method] to enable this function.

■ L3-37: Current Limit P Gain @Accel

No. (Hex.)	Name	Description	Default (Range)
L3-37 (11D1) Expert	Current Limit P Gain @Accel	<div style="display: flex; justify-content: space-between; align-items: center;"> V/f OLV OLV/PM AOLV/PM EZOLV </div> <p>Suppresses current hunting during acceleration. Usually it is not necessary to change this setting.</p>	5 ms (0 - 100 ms)

Note:

Set $L3-01 = 3$ [Stall Prevention during Accel = Current Limit Acceleration] to enable this function.

■ L3-38: Current Limit I Time @ Accel

No. (Hex.)	Name	Description	Default (Range)
L3-38 (11D2) Expert	Current Limit I Time @ Accel	<div style="display: flex; justify-content: space-between; align-items: center;"> V/f OLV OLV/PM AOLV/PM EZOLV </div> <p>Suppresses current hunting and overshooting that occurs when the drive stalls during acceleration. Usually it is not necessary to change this setting.</p>	10.0 (0.0 - 100.0)

Note:

Set $L3-01 = 3$ [Stall Prevention during Accel = Current Limit Method] to enable this function.

■ L3-39: Current Limit Filter Time@Accel

No. (Hex.)	Name	Description	Default (Range)
L3-39 (11D3)	Current Limit Filter Time@Accel	<div style="display: flex; justify-content: space-between; align-items: center;"> V/f OLV OLV/PM AOLV/PM EZOLV </div> <p>Sets the time constant to adjust the acceleration rate when $L3-01 = 3$ [Stall Prevention during Accel = Current Limit Acceleration]. Usually it is not necessary to change this setting.</p>	100.0 ms (1.0 - 1000.0 ms)

Note:

Set $L3-01 = 3$ [Stall Prevention during Accel = Current Limit Acceleration] to enable this function.

■ L3-40: Current Limit S-Curve @ Acc/Dec

No. (Hex.)	Name	Description	Default (Range)
L3-40 (11D4)	Current Limit S-Curve @ Acc/Dec	<div style="display: flex; justify-content: space-between; align-items: center;"> V/f OLV OLV/PM AOLV/PM EZOLV </div> <p>Sets the function to enable and disable the best S-curve characteristic used for current-limited acceleration.</p>	0 (0, 1)

Makes the best motor acceleration rate for start up. If you set this parameter to 1, it will make acceleration smoother, but it can also increase the acceleration time to be longer than the set time. If the drive detects *oC* [Overcurrent] faults immediately after acceleration starts, set this parameter.

0 : Disable

1 : Enabled

Note:

Set L3-01 = 3 [Stall Prevention during Accel = Current Limit Method] to enable this function.

◆ L4: Speed Detection

L4 parameters set the output of signals to the MFDO terminals, for example frequency agree and speed detection.

■ L4-01: Speed Agree Detection Level

No. (Hex.)	Name	Description	Default (Range)
L4-01 (0499)	Speed Agree Detection Level	<input type="checkbox"/> V/f <input type="checkbox"/> OLV <input type="checkbox"/> OLV/IPM <input type="checkbox"/> AOLV/IPM <input type="checkbox"/> EZOLV Sets the level to detect speed agree or motor speed.	Determined by A1-02 (Determined by A1-02)

Sets the level to detect speed agree or motor speed when H2-01 to H2-03 = 2, 3, 4, 5 [MFDO Function Selection = Speed Agree 1, User-set Speed Agree 1, Frequency Detection 1, Frequency Detection 2].

■ L4-02: Speed Agree Detection Width

No. (Hex.)	Name	Description	Default (Range)
L4-02 (049A)	Speed Agree Detection Width	<input type="checkbox"/> V/f <input type="checkbox"/> OLV <input type="checkbox"/> OLV/IPM <input type="checkbox"/> AOLV/IPM <input type="checkbox"/> EZOLV Sets the width to detect speed agree or motor speed.	Determined by A1-02 (Determined by A1-02)

Sets the width to detect speed agree or motor speed when H2-01 to H2-03 = 2, 3, 4, 5 [MFDO Function Selection = Speed Agree 1, User-set Speed Agree 1, Frequency Detection 1, Frequency Detection 2].

■ L4-03: Speed Agree Detection Level(+/-)

No. (Hex.)	Name	Description	Default (Range)
L4-03 (049B)	Speed Agree Detection Level(+/-)	<input type="checkbox"/> V/f <input type="checkbox"/> OLV <input type="checkbox"/> OLV/IPM <input type="checkbox"/> AOLV/IPM <input type="checkbox"/> EZOLV Sets the level to detect speed agree or motor speed.	Determined by A1-02 (Determined by A1-02)

Sets the level to detect speed agree or motor speed when H2-01 to H2-03 = 13, 14, 15, 16 [MFDO Function Selection = Speed Agree 2, User-set Speed Agree 2, Frequency Detection 3, Frequency Detection 4].

■ L4-04: Speed Agree Detection Width(+/-)

No. (Hex.)	Name	Description	Default (Range)
L4-04 (049C)	Speed Agree Detection Width(+/-)	<input type="checkbox"/> V/f <input type="checkbox"/> OLV <input type="checkbox"/> OLV/IPM <input type="checkbox"/> AOLV/IPM <input type="checkbox"/> EZOLV Sets the width to detect speed agree or motor speed.	Determined by A1-02 (Determined by A1-02)

Sets the width to detect speed agree or motor speed when H2-01 to H2-03 = 13, 14, 15, 16 [MFDO Function Selection = Speed Agree 2, User-set Speed Agree 2, Frequency Detection 3, Frequency Detection 4].

■ L4-05: Fref Loss Detection Selection

No. (Hex.)	Name	Description	Default (Range)
L4-05 (049D)	Fref Loss Detection Selection	<input type="checkbox"/> V/f <input type="checkbox"/> OLV <input type="checkbox"/> OLV/IPM <input type="checkbox"/> AOLV/IPM <input type="checkbox"/> EZOLV Sets the operation when the drive detects a loss of frequency reference.	0 (0, 1)

Enables the detection of a loss of an analog frequency reference when MFAI terminals (A1 and A2) input the frequency reference. Set $H2-01$ to $H2-03 = C$ [$MFDO$ Function Selection = Frequency Reference Loss] to enable this function.

If the frequency reference is less than 10% in 400 ms, the drive detects frequency reference loss.

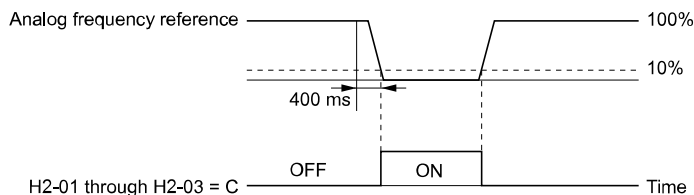

Figure 12.116 Detection of Frequency Reference Loss

0 : Stop

The drive follows the frequency reference and stops the motor.

1 : Run at (L4-06 x Last Reference)

The drive continues to operate at the frequency reference value set in $L4-06$ [$FreqReference$ at Reference Loss]. When you return the external frequency reference value, the drive continues to operate with the frequency reference.

■ L4-06: Frequency Reference @Loss of Ref

No. (Hex.)	Name	Description	Default (Range)
L4-06 (04C2)	Frequency Reference @Loss of Ref	<input type="radio"/> V/f <input checked="" type="radio"/> OLV <input type="radio"/> OLV/PM <input type="radio"/> AOLV/PM <input type="radio"/> EZOLV Sets the frequency reference as a percentage to continue drive operation after it detects a frequency reference loss. The value is a percentage of the frequency reference before the drive detected the loss.	80.0% (0.0 - 100.0%)

Set $L4-05 = 1$ [$FrefLoss$ Detection Selection = Run at (L4-06 x Last Reference)] to enable this parameter.

■ L4-07: Speed Agree Detection Selection

No. (Hex.)	Name	Description	Default (Range)
L4-07 (0470)	Speed Agree Detection Selection	<input type="radio"/> V/f <input checked="" type="radio"/> OLV <input type="radio"/> OLV/PM <input type="radio"/> AOLV/PM <input type="radio"/> EZOLV Sets the condition that activates speed detection.	0 (0, 1)

0 : No Detection during Baseblock

Detects the frequency while the drive is operating. When the drive turns off its output, it will not detect frequency.

1 : Detection Always Enabled

■ L4-08: Speed Agree Source Selection

No. (Hex.)	Name	Description	Default (Range)
L4-08 (047F)	Speed Agree Source Selection	<input type="radio"/> V/f <input checked="" type="radio"/> OLV <input type="radio"/> OLV/PM <input type="radio"/> AOLV/PM <input type="radio"/> EZOLV Sets the drive to use the soft starter output frequency or the motor speed (estimation value) for speed detection.	0 (0, 1)

0 : Softstarter Output (Reference)

1 : Motor Speed (Actual Speed)

The setting for $L4-08$ has an effect:

- When you set detection conditions for $oL3$ [$Overtorque$ 1], $oL3$ [$Overtorque$ Detection 1], $oL4$ [$Overtorque$ 2], and $oL4$ [$Overtorque$ Detection 2]:
 - $L6-01 = 1, 3, 5, 7$ [$Torque$ Detection Selection 1 = UL @ Speed Agree]
 - $L6-04 = 1, 3, 5, 7$ [$Torque$ Detection Selection 2 = UL @ Speed Agree]
- When you use speed agreement with DriveWorksEZ.
- When the MFDI terminals set for $H1-xx = 75, 76$ [$Up/Down$ 2 command] activate.

- When you set *H2-xx [MFDO Function Select]* to these functions:

Setting Value	Function
2	Speed Agree 1
3	User-Set Speed Agree 1
4	Frequency Detection 1
5	Frequency Detection 2

Setting Value	Function
13	Speed Agree 2
14	User-Set Speed Agree 2
15	Frequency Detection 3
16	Frequency Detection 4

- When you use these functions for MEMOBUS monitor data:

Register No.	Description	
002CH	Drive Status 2	
	bit2	Speed agreement 1: During agreement
	bit3	User-defined speed agreement 1: During agreement
	bit4	Frequency Detection 1 1: Output frequency ≤ L4-01
	bit5	Frequency Detection 2 1: Output frequency ≥ L4-01
004BH	U1-12 [Drive Status]	
	bit4	1: During speed agreement

- When you use these functions for monitor parameters:

No. (Hex.)	Name	Description
U1-12 (004B)	Drive Status	bit 4: During speed agreement

◆ L5: Fault Restart

The Auto Restart function tries to keep machines operating when the drive detects a transient fault.

The drive can do a self-diagnostic check and continue the operation after a fault. If the cause of the fault goes away, the drive does speed search and restarts. It will not stop and the drive will not record a fault history. Use *L5-02 [Fault Contact at Restart Select]* to select the operation of fault relay signals during Auto Restart operation.

Sets if the drive will do Auto Restart and the number of times the drive will try to do Auto Restart in a set time. If the number of Auto Restart tries is more than the set value during the set time, drive output shuts off and operation stops. If this happens, remove the cause of the fault and manually restart the drive.

The drive can do Auto Restart when these faults occur:

Note:

You can disable Auto Restart for some faults if you must not restart the machine after the fault with parameters *L5-07* and *L5-08*.

Table 12.61 List of Faults during which Auto Restart is Available

Fault	Name	Parameters to Disable Auto Restart	Fault	Name	Parameters to Disable Auto Restart
GF	Ground Fault	L5-08	oL4	Overtorque Detection 2	L5-07
LF	Output Phase Loss	-	ov	Overvoltage	L5-08
oC	Overcurrent	-	PF	Input Phase Loss	-
oH1	Heatsink Overheat	L5-08	rH	Braking Resistor Overheat	-
oL1	Motor Overload	L5-07	rr	Dynamic Braking Transistor Fault	-
oL2	Drive Overload	L5-07	STPo	Motor Step-Out Detected	-
oL3	Overtorque Detection 1	L5-07	Uv1	DC Bus Undervoltage <i>*/</i>	L5-08

*1 *Uv1* is the target for the auto restart process when *L2-01 = 1, 2, 3, or 4* [*Power Loss Ride Through Select = Enabled for L2-02 Time, Enabled while CPU Power Active, Kinetic Energy Backup: L2-02, or Kinetic Energy Backup: CPU Power*].

■ L5-01: Number of Auto-Restart Attempts

No. (Hex.)	Name	Description	Default (Range)
L5-01 (049E)	Number of Auto-Restart Attempts	V/f OLV OLV/PM AOLV/PM EZOLV Sets the number of times that the drive will try to restart.	0 (0 - 10 times)

The drive resets the number of Auto Restart attempts to 0 in these conditions:

- The drive operates correctly for 10 minutes after a fault restart.
- When you manually clear a fault after the drive triggers protective functions.
- When you re-energize the drive.

■ L5-02: Fault Contact at Restart Select

No. (Hex.)	Name	Description	Default (Range)
L5-02 (049F)	Fault Contact at Restart Select	V/f OLV OLV/PM AOLV/PM EZOLV Sets the function that sends signals to the MFDO terminal set for <i>Fault [H2-xx = E]</i> while the drive is automatically restarting.	0 (0, 1)

0 : Active Only when Not Restarting

1 : Always Active

■ L5-04: Interval Method Restart Time

No. (Hex.)	Name	Description	Default (Range)
L5-04 (046C)	Interval Method Restart Time	V/f OLV OLV/PM AOLV/PM EZOLV Sets the time interval between each Auto Restart attempt. This function is enabled when <i>L5-05 = 1</i> [<i>Auto Restart Operation Selection = Use L5-04 Time</i>].	10.0 s (0.5 - 600.0 s)

■ L5-05: Auto-Restart Method

No. (Hex.)	Name	Description	Default (Range)
L5-05 (0467)	Auto-Restart Method	V/f OLV OLV/PM AOLV/PM EZOLV Sets the count method for the Auto Restart operation.	0 (0, 1)

0 : Continuous/Immediate Attempts

Counts the number of successful fault resets through Auto Restart.

When this value > *L5-01*, the drive will send a fault signal and fault code to the keypad and the motor will coast to stop.

1 : Interval/Attempt after L5-04 sec

Counts the number of all fault resets (successful and unsuccessful) through Auto Restart. The drive repeats the Auto Restart process in the intervals set in *L5-04* [*Interval Method Restart Time*].

When this value > *L5-01*, the drive will send a fault signal and fault code to the keypad and the motor will coast to stop.

■ L5-07: Fault Reset Enable Select Grp1

No. (Hex.)	Name	Description	Default (Range)
L5-07 (0B2A)	Fault Reset Enable Select Grp1	V/f OLV OLV/PM AOLV/PM EZOLV Use these 4 digits to set the Auto Restart function for <i>oL1</i> to <i>oL4</i> . From left to right, the digits set <i>oL1</i> , <i>oL2</i> , <i>oL3</i> , and <i>oL4</i> , in order.	1111 (0000 - 1111)

0000 : Disabled

0001 : Enabled (—/—/—/oL4)

- 0010 : Enabled (—/—/oL3/—)
- 0011 : Enabled (—/—/oL3/oL4)
- 0100 : Enabled (—/oL2/—/—)
- 0101 : Enabled (—/oL2/—/oL4)
- 0110 : Enabled (—/oL2/oL3/—)
- 0111 : Enabled (—/oL2/oL3/oL4)
- 1000 : Enabled (oL1/—/—/—)
- 1001 : Enabled (oL1/—/—/oL4)
- 1010 : Enabled (oL1/—/oL3/—)
- 1011 : Enabled (oL1/—/oL3/oL4)
- 1100 : Enabled (oL1/oL2/—/—)
- 1101 : Enabled (oL1/oL2/—/oL4)
- 1110 : Enabled (oL1/oL2/oL3/—)
- 1111 : Enabled (oL1/oL2/oL3/oL4)

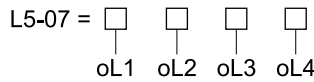

Figure 12.117 Setting Digits and Fault Code

■ L5-08: Fault Reset Enable Select Grp2

No. (Hex.)	Name	Description	Default (Range)
L5-08 (0B2B)	Fault Reset Enable Select Grp2	<div style="display: flex; justify-content: space-between; align-items: center;"> V/f OLV OLV/PM AOLV/PM EZOLV </div> <p>Use these 4 digits to set the Auto Restart function for <i>Uv1</i>, <i>ov</i>, <i>oH1</i>, and <i>GF</i>. From left to right, the digits set <i>Uv1</i>, <i>ov</i>, <i>oH1</i>, and <i>GF</i>, in order.</p>	1111 (0000 - 1111)

- 0000 : Disabled
- 0001 : Enabled (—/—/—/GF)
- 0010 : Enabled (—/—/oH1/—)
- 0011 : Enabled (—/—/oH1/GF)
- 0100 : Enabled (—/ov/—/—)
- 0101 : Enabled (—/ov/—/GF)
- 0110 : Enabled (—/ov/oH1/—)
- 0111 : Enabled (—/ov/oH1/GF)
- 1000 : Enabled (Uv1/—/—/—)
- 1001 : Enabled (Uv1/—/—/GF)
- 1010 : Enabled (Uv1/—/oH1/—)
- 1011 : Enabled (Uv1/—/oH1/GF)
- 1100 : Enabled (Uv1/ov/—/—)
- 1101 : Enabled (Uv1/ov/—/GF)
- 1110 : Enabled (Uv1/ov/oH1/—)
- 1111 : Enabled (Uv1/ov/oH1/GF)

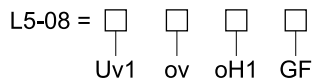

Figure 12.118 Setting Digits and Fault Code

◆ L6: Torque Detection

The overtorque/undertorque detection function prevents damage to machinery and loads.

Overtorque is when there is too much load on the machine. If the motor current or output torque is at the overtorque detection level for the overtorque detection time, the drive will output an alarm and turn off the output.

Undertorque is when a load suddenly decreases. When the motor current or output torque is at the undertorque detection level for the undertorque detection time, the drive will output an alarm and turn off the output.

You can use the undertorque detection function to detect these conditions, for example:

- Machine belt cuts
- Unusual operation of the electromagnetic contactor on the drive output side
- Clogged output side air filters in fans and blowers
- Damage to blade tips and broken string

Note:

If there is *oC* [Overcurrent] or *oL1* [Motor Overload], the drive can stop during overtorque conditions. Use torque detection to identify overload conditions before the drive detects *oC* or *oL1* and stops. Use this function to detect issues that occur in the application.

■ Parameter Settings

You can individually set the two overtorque/undertorque detection functions with the drive. Use the information in [Table 12.62](#) to set the parameters.

Table 12.62 Overtorque/Undertorque Detection Parameters

Configuration Parameter	Overtorque/Undertorque Detection 1	Overtorque/Undertorque Detection 2
MFDO Function Select	H2-01, H2-02, and H2-03 = B	H2-01, H2-02, and H2-03 = 18
• Terminal MA-MC	N.O.: Activated when detected	N.O.: Activated when detected
• Terminal P1-C1	H2-01, H2-02, and H2-03 = 17	H2-01, H2-02, and H2-03 = 19
• Terminal P2-C2	N.C.: Deactivated when detected	N.C.: Deactivated when detected
Detection conditions and selection of operation after detection	L6-01	L6-04
Detection Level	L6-02	L6-05
	Analog Input Terminal ^{*1} H3-xx = 7	-
Detection Time	L6-03	L6-06

*1 You can also use an analog input terminal to supply the torque detection level. To enable this function, set *H3-xx = 7* [MFAI Function Selection = Overtorque/Undertorque DetectLvl]. If both *L6-02* and *H3-xx = 7* are set, the analog input has priority and the setting of *L6-02* is disabled.

You cannot use Overtorque/Undertorque Detection 2 to set the detection level for the analog input terminals.

Note:

In V/f Control, the drive uses the current level (100% of the drive rated output current) to detect overtorque/undertorque. In vector control, the drive uses the motor torque (100% of the motor rated torque) to detect overtorque/undertorque. When you enable the mechanical weakening detection function, the overtorque/undertorque detection level for all control modes is the current level (100% of the drive rated output current).

■ Time Chart for Detection of Overtorque/Undertorque

Overtorque Detection Time Chart

When you use Overtorque/Undertorque Detection 1, the drive detects overtorque if the motor current or motor torque is at the detection level set in *L6-02* [Torque Detection Level 1] for the time set in *L6-03* [Torque Detection Time 1]. Parameter *L6-01* [Torque Detection Selection 1] sets the operation after detection.

When you use Overtorque/Undertorque Detection 2, set *L6-04* [Torque Detection Selection 2], *L6-05* [Torque Detection Level 2], and *L6-06* [Torque Detection Time 2].

Set the terminal that outputs the alarm in *H2-01* to *H2-03* [MFDO Function Select].

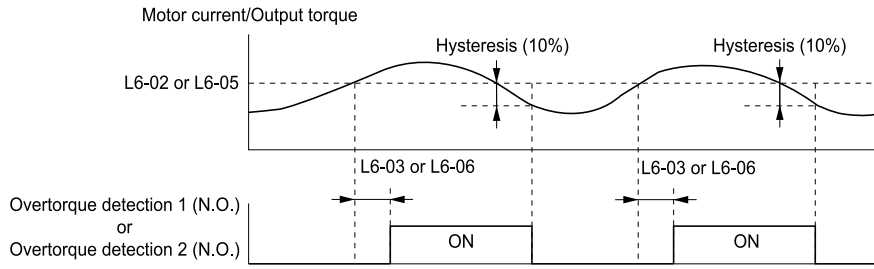

Figure 12.119 Overtorque Detection Time Chart

Note:

The drive applies a hysteresis of approximately 10% of the drive rated output current or the motor rated torque to the overtorque/undertorque detection function.

Undertorque Detection Time Chart

When you use Overtorque/Undertorque Detection 1, the drive detects undertorque if the motor current or motor torque is less than or equal to the detection level set in L6-02 for the time set in L6-03. Parameter L6-01 sets the operation after detection.

When you use Overtorque/Undertorque Detection 2, set the operation in L6-04, L6-05, and L6-06.

Set the terminal that outputs an alarm in H2-01 to H2-03.

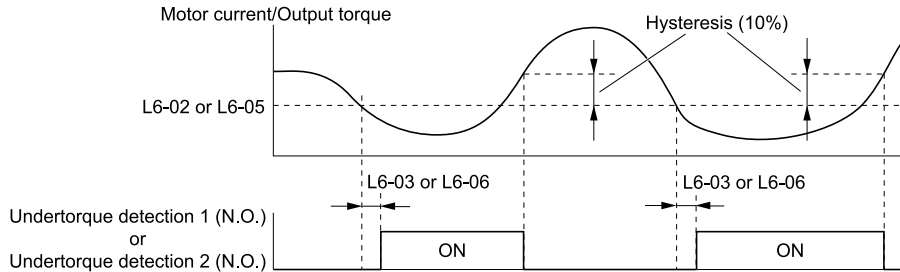

Figure 12.120 Undertorque Detection Time Chart

Note:

The drive applies a hysteresis of approximately 10% of the drive rated output current or the motor rated torque to the overtorque/undertorque detection function.

■ Mechanical Weakening Detection

The Mechanical Weakening Detection function detects the mechanical weakening of a machine that can cause overtorque or undertorque because of motor speed and total drive operation time.

The drive activates the function if the drive total operation time is longer than the time set in L6-11 [Mech Fatigue Hold Off Time]. You can use U4-01 [Cumulative Ope Time] to monitor the total operation time.

Parameter Settings

If overtorque or undertorque occur during the speed range set in L6-08 [Mechanical Fatigue Detect Select] and L6-09 [Mech Fatigue Detect Speed Level] for the length of time set in L6-10 [Mech Fatigue Detect Delay Time], the drive will detect Mechanical Weakening. The drive uses L6-01 to L6-03 [Torque Detection 1 Setting Parameter] to detect oL5 [Mechanical Weakening Detection 1] or UL5 [Mechanical Weakening Detection 2]. Parameter L6-08 sets the operation after detection.

Set the terminal that outputs the fault in H2-01 to H2-03 [MFDO Function Selection].

Table 12.63 Mechanical Weakening Detection Settings Parameters

Configuration Parameter	Mechanical Deterioration Detection
MFDO Function Select • Terminal MA-MC • Terminal P1-C1 • Terminal P2-C2	H2-01, H2-02, and H2-03 = 22
Operation Selection after Detection	L6-08

Configuration Parameter		Mechanical Deterioration Detection
Detection Start Time		L6-11
Speed Range	Detection Criteria	L6-08
	Detection Level	L6-09
	Detection Time	L6-10
Overtorque	Detection Criteria	L6-01
	Detection Level	L6-02
	Detection Time	L6-03

■ L6-01: Torque Detection Selection 1

No. (Hex.)	Name	Description	Default (Range)
L6-01 (04A1)	Torque Detection Selection 1	<div style="display: flex; gap: 5px;"> V/f OLV OLV/PM AOLV/PM EZOLV </div> <p>Sets torque detection conditions that will trigger an overtorque or undertorque response from the drive.</p>	0 (0 - 8)

The drive detects overtorque if the motor current or output torque is more than the level set in *L6-02* [*Torque Detection Level 1*] for the length of time set in *L6-03* [*Torque Detection Time 1*]. The drive detects undertorque if the motor current or output torque is less than the level set in *L6-02* for the length the time set in *L6-03*.

0 : Disabled

The drive will not detect overtorque or undertorque.

1 : oL @ Speed Agree - Alarm only

The drive detects overtorque when the output frequency aligns with the frequency reference. Detection does not occur during acceleration/deceleration. The drive outputs an *oL3* [*Overtorque Detection 1*] and operation continues.

2 : oL @ RUN - Alarm only

When the Run command is enabled, the drive constantly detects overtorque. The drive outputs an *oL3* and operation continues.

3 : oL @ Speed Agree - Fault

The drive detects overtorque when the output frequency aligns with the frequency reference. Detection does not occur during acceleration/deceleration. The drive outputs an *oL3* and operation stops.

4 : oL @ RUN - Fault

When the Run command is enabled, the drive constantly detects overtorque. The drive outputs an *oL3* and operation stops.

5 : UL @ Speed Agree - Alarm only

The drive detects undertorque when the output frequency aligns with the frequency reference. Detection does not occur during acceleration/deceleration. The drive outputs a *UL3* [*Undertorque Detection 1*] and operation continues.

6 : UL @ RUN - Alarm only

When the Run command is enabled, the drive constantly detects undertorque. The drive outputs a *UL3* and operation continues.

7 : UL @ Speed Agree - Fault

The drive detects undertorque when the output frequency aligns with the frequency reference. Detection does not occur during acceleration/deceleration. The drive outputs a *UL3* and operation stops.

8 : UL @ RUN - Fault

When the Run command is enabled, the drive constantly detects undertorque. The drive outputs a *UL3* and operation stops.

■ L6-02: Torque Detection Level 1

No. (Hex.)	Name	Description	Default (Range)
L6-02 (04A2)	Torque Detection Level 1	<div style="display: flex; gap: 5px;"> V/f OLV OLV/PM AOLV/PM EZOLV </div> Sets the detection level for Overtorque/Undertorque Detection 1. In V/f control, drive rated output current = 100% value. In vector control, motor rated torque = 100% value.	150% (0 - 300%)

Note:

- Set the torque detection level as a percentage of the drive rated output current in all control methods to set the mechanical weakening detection level.
- You can also use an analog input terminal to supply the torque detection level. To enable this function, set $H3-xx = 7$ [MFAI Function Select = Overtorque/Undertorque DetectLvl]. If you set L6-02 and $H3-x = 7$, the analog input is most important and the drive disables L6-02.

■ L6-03: Torque Detection Time 1

No. (Hex.)	Name	Description	Default (Range)
L6-03 (04A3)	Torque Detection Time 1	<div style="display: flex; gap: 5px;"> V/f OLV OLV/PM AOLV/PM EZOLV </div> Sets the detection time for Overtorque/Undertorque Detection 1.	0.1 s (0.0 - 10.0 s)

■ L6-04: Torque Detection Selection 2

No. (Hex.)	Name	Description	Default (Range)
L6-04 (04A4)	Torque Detection Selection 2	<div style="display: flex; gap: 5px;"> V/f OLV OLV/PM AOLV/PM EZOLV </div> Sets the speed range that detects overtorque and undertorque and the operation of drives (operation status) after detection.	0 (0 - 8)

The drive detects overtorque if the motor current or output torque is more than the level set in L6-05 [Torque Detection Level 2] for the length of time set in L6-06 [Torque Detection Time 2]. The drive detects undertorque if the motor current or output torque is less than the level set in L6-05 for the length the time set in L6-06.

0 : Disabled

The drive will not detect overtorque or undertorque.

1 : oL @ Speed Agree - Alarm only

The drive detects overtorque when the output frequency aligns with the frequency reference. Detection does not occur during acceleration/deceleration. The drive outputs an *oL4* [Overtorque Detection 2] and operation continues.

2 : oL @ RUN - Alarm only

When the Run command is enabled, the drive constantly detects overtorque. The drive outputs an *oL4* and operation continues.

3 : oL @ Speed Agree - Fault

The drive detects overtorque when the output frequency aligns with the frequency reference. Detection does not occur during acceleration/deceleration. The drive outputs an *oL4* [Overtorque Detection 2] and operation stops.

4 : oL @ RUN - Fault

When the Run command is enabled, the drive constantly detects overtorque. The drive outputs an *oL4* and operation stops.

5 : UL @ Speed Agree - Alarm only

The drive detects undertorque when the output frequency aligns with the frequency reference. Detection does not occur during acceleration/deceleration. The drive outputs a *UL4* [Undertorque Detection 2] and operation continues.

6 : UL @ RUN - Alarm only

When the Run command is enabled, the drive constantly detects undertorque. The drive outputs a *UL4* and operation continues.

7 : UL @ Speed Agree - Fault

The drive detects undertorque when the output frequency aligns with the frequency reference. Detection does not occur during acceleration/deceleration. The drive outputs a *UL4* and operation stops.

8 : UL @ RUN - Fault

When the Run command is enabled, the drive constantly detects undertorque. The drive outputs a *UL4* and operation stops

■ L6-05: Torque Detection Level 2

No. (Hex.)	Name	Description	Default (Range)
L6-05 (04A5)	Torque Detection Level 2	<div style="display: flex; gap: 5px;"> V/f OLV OLV/PM AOLV/PM EZOLV </div> <p>Sets the detection level for Overtorque/Undertorque Detection 2. In V/f control, drive rated output current = 100% value. In vector control, motor rated torque = 100% value.</p>	150% (0 - 300%)

Note:

Overtorque/Undertorque Detection 2 cannot set the detection level for the analog input terminal.

■ L6-06: Torque Detection Time 2

No. (Hex.)	Name	Description	Default (Range)
L6-06 (04A6)	Torque Detection Time 2	<div style="display: flex; gap: 5px;"> V/f OLV OLV/PM AOLV/PM EZOLV </div> <p>Sets the detection time for Overtorque/Undertorque Detection 2.</p>	0.1 s (0.0 - 10.0 s)

■ L6-07: Torque Detection Filter Time

No. (Hex.)	Name	Description	Default (Range)
L6-07 (04E5)	Torque Detection Filter Time	<div style="display: flex; gap: 5px;"> V/f OLV OLV/PM AOLV/PM EZOLV </div> <p>Sets the time constant for a primary filter to the torque reference or to the output current used to detect overtorque/undertorque.</p>	0 ms (0 - 1000 ms)

■ L6-08: Mechanical Fatigue Detect Select

No. (Hex.)	Name	Description	Default (Range)
L6-08 (0468)	Mechanical Fatigue Detect Select	<div style="display: flex; gap: 5px;"> V/f OLV OLV/PM AOLV/PM EZOLV </div> <p>Sets the speed where the drive detects mechanical deterioration and how the drive operates (operation status) after detection.</p>	0 (0 - 8)

The drive detects mechanical weakening through overtorque or undertorque as specified by the conditions set in *L6-08 to L6-11* [*Mechanical Deterioration Detection Settings Parameters*]. Set overtorque/undertorque detection conditions in *L6-01 to L6-03* [*Torque Detection 1 Settings Parameters*]. The drive disables the operation selection set in *L6-01* [*Torque Detection Selection 1*].

0 : Disabled

The drive does not detect mechanical weakening.

1 : oL5 @ Speed > L6-09 - Alarm

When the speed (signed) \geq *L6-09* [*Mech Fatigue Detect Speed Level*], the drive detects mechanical weakening. The drive will detect *oL5* [*Mechanical Weakening Detection 1*] and continue operation.

2 : oL5 @ |Speed| > L6-09 - Alarm

When the speed (absolute value) \geq *L6-09*, the drive detects mechanical weakening. The drive will detect *oL5* and continue operation.

3 : oL5 @ Speed > L6-09 - Fault

When the speed (signed) \geq *L6-09*, the drive detects mechanical weakening. The drive will detect *oL5* and stop operation.

4 : oL5 @ |Speed| > L6-09 - Fault

When the speed (absolute value) \geq *L6-09*, the drive detects mechanical weakening. The drive will detect *oL5* and stop operation.

5 : UL5 @ Speed < L6-09 - Alarm

When the speed (signed) \leq *L6-09*, the drive detects mechanical weakening. The drive will detect *UL5* [*Mechanical Weakening Detection 2*] and continue operation.

6 : UL5 @ |Speed| < L6-09 - Alarm

When the speed (absolute value) $\leq L6-09$, the drive detects mechanical weakening. The drive will detect *UL5* and continue operation.

7 : UL5 @ Speed < L6-09 - Fault

When the speed (signed) $\leq L6-09$, the drive detects mechanical weakening. The drive will detect *UL5* and stop operation.

8 : UL5 @ |Speed| < L6-09 - Fault

When the speed (absolute value) $\leq L6-09$, the drive detects mechanical weakening. The drive will detect *UL5* and stop operation.

■ L6-09: Mech Fatigue Detect Speed Level

No. (Hex.)	Name	Description	Default (Range)
L6-09 (0469)	Mech Fatigue Detect Speed Level	<div style="display: flex; gap: 5px;"> V/f OLV OLV/PM AOLV/PM EZOLV </div> <p>Sets the speed level where the drive will operate the mechanical deterioration detection function, as a percentage of the Maximum Output Frequency.</p>	110.0% (-110.0 - 110.0%)

Parameters *L6-01 to L6-03 [Torque Detection 1 Settings Parameters]* set the overtorque/undertorque detection conditions.

When *L6-08 = 2, 4, 6, 8 [Mechanical Fatigue Detect Select = Speed : unsigned]*, the setting value of *L6-09* is the absolute value. When *L6-09* is set to a negative number, the drive processes this value as a positive number.

■ L6-10: Mech Fatigue Detect Delay Time

No. (Hex.)	Name	Description	Default (Range)
L6-10 (046A)	Mech Fatigue Detect Delay Time	<div style="display: flex; gap: 5px;"> V/f OLV OLV/PM AOLV/PM EZOLV </div> <p>Sets the time for mechanical deterioration detection.</p>	0.1 s (0.0 - 10.0 s)

When the detection conditions set in *L6-08 [Mechanical Weakening Detect Ope]* continue for the time set in *L6-10*, the drive will detect mechanical weakening.

■ L6-11: Mech Fatigue Hold Off Time

No. (Hex.)	Name	Description	Default (Range)
L6-11 (046B)	Mech Fatigue Hold Off Time	<div style="display: flex; gap: 5px;"> V/f OLV OLV/PM AOLV/PM EZOLV </div> <p>Sets the time that the drive will start mechanical deterioration detection triggered by the cumulative operation time of the drive.</p>	0 h (0 - 65535 h)

When the total operation time of the drive is more than the value set in *L6-11*, the drive will detect mechanical weakening. Use *U4-01 [Cumulative Ope Time]* to monitor the drive total operation time.

◆ L7: Torque Limit

The torque limit function limits the internal torque reference for the drive to and keeps the torque from the motor constant. This function limits the torque applied to loads and regenerative torque to a value less than a set quantity. This function also prevents damage to machinery and increases the reliability of continuous operation. You can set torque limits individually for the four quadrants, which include torque direction (motoring/regeneration) and direction of motor rotation (forward/reverse). When the torque reference value is at the set torque limit, the MFDO terminal set for *During Torque Limit [H2-xx = 30]* activates.

Note:

- The drive output current limits maximum output torque. The drive limits torque to 150% of the rated output current for Heavy Duty Rating (HD) and to 110% of the rated output current for Normal Duty Rating (ND). The actual output torque is not more than the limits of the drive rated output current when you set the torque limit to a high value.
- When you use torque limits for lifting applications, do not lower the torque limit value too much. When the torque limit function is triggered, falls and rollbacks can occur because of sudden acceleration stops and stalls of the motor.

■ Configuring Settings

Use one of these methods to set torque limits:

- Individually set the four torque limit quadrants using L7-01 to L7-04 [Torque Limit].
- Use MFAI to individually set the four torque limit quadrants. Set H3-02, H3-10 = 10, 11, 12 [MFAI Function Select = Forward Torque Limit, Reverse Torque Limit, Regenerative Torque Limit].
- Use MFAI to set all four torque limit quadrants together. Set H3-02, H3-10 = 15 [General Torque Limit].
- Use a communication option to set all four torque limit quadrants together.

Figure 12.121 shows the configuration method for each quadrant.

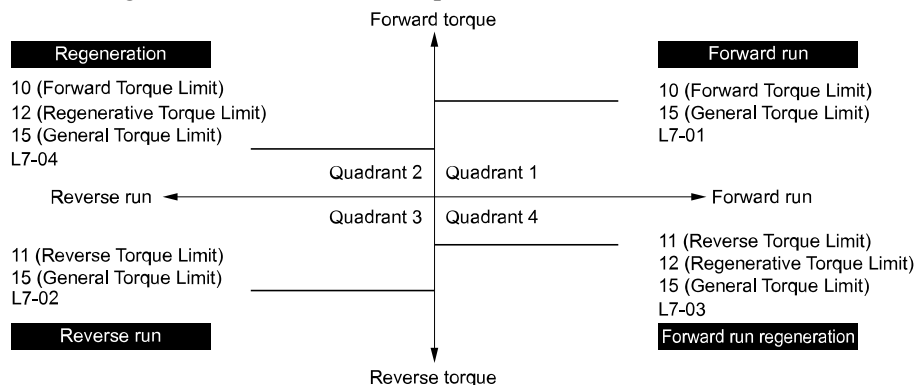

Figure 12.121 Torque Limits and Analog Input Setting Parameters

Note:

- When L7-01 to L7-04 and analog inputs or communication option torque limits set torque limits for the same quadrant, the drive enables the lowest value. In this example of parameter settings, the torque limit for quadrant 1 is 130% and the torque limit for quadrants 2, 3, and 4 is 150%. Settings: L7-01 = 130%, L7-02 to L7-04 = 200%, and MFAI torque limit = 150%
- The drive output current limits maximum output torque. The torque limit is 150% of the rated output current for HD and to 120% of the rated output current for ND. The actual output torque is not more than the limits of the drive rated output current when you set the torque limit to a high value.

■ L7-01: Forward Torque Limit

No. (Hex.)	Name	Description	Default (Range)
L7-01 (04A7) RUN	Forward Torque Limit	<input type="checkbox"/> V/f <input checked="" type="checkbox"/> OLV <input type="checkbox"/> OLV/PM <input type="checkbox"/> AOLV/PM <input type="checkbox"/> EZOLV Sets the torque limit value for forward motoring as a percentage, where motor rated torque is the 100% value.	200% (0 - 300%)

Note:

- The lower torque limit is enabled when you set the torque limit by the following method.
 - Set H3-02 or H3-10 = 10, 15 [MFAI Function Select = Forward Torque Limit, General Torque Limit].
 - Use a communication option to set the torque limits
- You must think about drive capacity when a large quantity of torque is necessary. If you set the value too high, the drive can detect oC [Overcurrent].
- If you set the value too low with large loads, the motor can stall.

■ L7-02: Reverse Torque Limit

No. (Hex.)	Name	Description	Default (Range)
L7-02 (04A8) RUN	Reverse Torque Limit	<input type="checkbox"/> V/f <input checked="" type="checkbox"/> OLV <input type="checkbox"/> OLV/PM <input type="checkbox"/> AOLV/PM <input type="checkbox"/> EZOLV Sets the torque limit value for reversed motoring as a percentage, where motor rated torque is the 100% value.	200% (0 - 300%)

Note:

- The lower torque limit is enabled when you set the torque limit by the following method.
 - Set H3-02 or H3-10 = 10, 15 [MFAI Function Select = Forward, Reverse/Regenerative Torque Limit].
 - Use a communication option to set the torque limits
- You must think about drive capacity when a large quantity of torque is necessary. If you set the value too high, the drive can detect *oC* [Overcurrent].
- If you set the value too low with large loads, the motor can stall.

■ L7-03: Forward Regenerative Trq Limit

No. (Hex.)	Name	Description	Default (Range)
L7-03 (04A9) RUN	Forward Regenerative Trq Limit	<div style="display: flex; gap: 5px;"> V/f OLV OLV/PM AOLV/PM EZOLV </div> Sets the torque limit value for forward regenerative conditions as a percentage of the motor rated torque.	200% (0 - 300%)

Note:

- The lower torque limit is enabled when you set the torque limit by the following method.
 - Set H3-02 or H3-10 = 10, 15 [MFAI Function Select = Forward, Reverse/Regenerative Torque Limit].
 - Use a communication option to set the torque limits
- You must think about drive capacity when a large quantity of torque is necessary. If you set the value too high, the drive can detect *oC* [Overcurrent].
- If you set the value too low with large loads, the motor can stall.

■ L7-04: Reverse Regenerative Trq Limit

No. (Hex.)	Name	Description	Default (Range)
L7-04 (04AA) RUN	Reverse Regenerative Trq Limit	<div style="display: flex; gap: 5px;"> V/f OLV OLV/PM AOLV/PM EZOLV </div> Sets the torque limit value for reversed regenerative conditions as a percentage of the motor rated torque.	200% (0 - 300%)

Note:

- Use this method to set the torque limit and enable the lower torque limit:
 - Set H3-02 or H3-10 = 10, 15 [MFAI Function Select = Forward, Reverse/Regenerative Torque Limit].
 - Use a communication option to set the torque limits
- You must think about drive capacity when a large quantity of torque is necessary. If you set the value too high, the drive can detect *oC* [Overcurrent].
- If you set the value too low with large loads, the motor can stall.

■ L7-06: Torque Limit Integral Time

No. (Hex.)	Name	Description	Default (Range)
L7-06 (04AC)	Torque Limit Integral Time	<div style="display: flex; gap: 5px;"> V/f OLV OLV/PM AOLV/PM EZOLV </div> Sets the integral time constant for the torque limit function.	200 ms (5 - 10000 ms)

Decrease the setting value to increase torque limit responsiveness when you use torque limits and L7-07 = 1 [Torque Limit during Accel/Decel = Proportional & Integral control].

If there is hunting when torque limits are active, increase the setting value.

■ L7-07: Torque Limit during Accel/Decel

No. (Hex.)	Name	Description	Default (Range)
L7-07 (04C9)	Torque Limit during Accel/Decel	<div style="display: flex; gap: 5px;"> V/f OLV OLV/PM AOLV/PM EZOLV </div> Sets the torque limit function during acceleration and deceleration.	0 (0, 1)

0 : Proportional only

The torque limit function works with proportional control during acceleration and deceleration, and switches to integral control at constant speed. Use this setting when quickly reaching the target speed is more important than the torque limit during speed changes.

1 : Proportional & Integral control

The torque limit function always uses integral control. Use this setting when a very accurate torque limit is necessary during speed changes, for example in winding machine applications.

If you make the torque limit the most important, it can:

- Increase the acceleration and deceleration times.
- Not let the motor speed reach the frequency reference value during run at constant speed.

■ L7-16: Torque Limit Process at Start

No. (Hex.)	Name	Description	Default (Range)
L7-16 (044D)	Torque Limit Process at Start	<input type="checkbox"/> V/f <input checked="" type="checkbox"/> OLV <input type="checkbox"/> OLV/PM <input type="checkbox"/> AOLV/PM <input type="checkbox"/> EZOLV Assigns a time filter to allow the torque limit to build at start.	1 (0, 1)

0 : Disabled

There is torque limit at start without a delay time.

Use this setting to maximize the response time when sudden acceleration or deceleration at start is necessary.

1 : Enabled

There is a delay time of 64 ms at start to build the torque limit.

◆ L8: Drive Protection

L8 parameters set protective functions that prevent faults such as overheating, phase loss, and ground faults.

■ L8-01: 3% ERF DB Resistor Protection

No. (Hex.)	Name	Description	Default (Range)
L8-01 (04AD)	3% ERF DB Resistor Protection	<input type="checkbox"/> V/f <input checked="" type="checkbox"/> OLV <input type="checkbox"/> OLV/PM <input type="checkbox"/> AOLV/PM <input type="checkbox"/> EZOLV Sets the function to enable braking resistor protection with a Yaskawa ERF series braking resistor (3% ED) installed on the heatsink.	0 (0, 1)

0 : No

Disables braking resistor protection. Use this setting for dynamic braking options that are not Yaskawa ERF series braking resistors.

1 : Yes

Enables protection for Yaskawa ERF series braking resistors.

Note:

Set L8-01 = 1 and H2-01 to H2-03 = D [MFDO Function Select = Braking Resistor Fault]. Use a sequence to turn OFF power with MFDO.

■ L8-02: Overheat Alarm Level

No. (Hex.)	Name	Description	Default (Range)
L8-02 (04AE)	Overheat Alarm Level	<input type="checkbox"/> V/f <input checked="" type="checkbox"/> OLV <input type="checkbox"/> OLV/PM <input type="checkbox"/> AOLV/PM <input type="checkbox"/> EZOLV Sets the oH detection level in temperature.	Determined by o2-04, C6-01 (50 - 150 °C)

If the heatsink temperature is more than the temperature set in this parameter, the drive detects an overheat pre-alarm. To enable this function, set one of H2-01 to H2-03 [MFDO Function Select] to 20 [Drive Overheat Pre-Alarm (oH)].

If the temperature increases to the overheat fault level, the drive will trigger an oH1 [Heatsink Overheat] fault and stop operation.

■ L8-03: Overheat Pre-Alarm Selection

No. (Hex.)	Name	Description	Default (Range)
L8-03 (04AF)	Overheat Pre-Alarm Selection	<input type="checkbox"/> V/f <input checked="" type="checkbox"/> OLV <input type="checkbox"/> OLV/PM <input type="checkbox"/> AOLV/PM <input type="checkbox"/> EZOLV Sets operation after the drive detects an oH alarm.	3 (0 - 4)

0 : Ramp to Stop

The drive ramps the motor to stop in the deceleration time. The output terminal set for *Fault* [H2-01 to H2-03 = E] activates.

1 : Coast to Stop

The output turns off and the motor coasts to stop. The output terminal set for *Fault* [H2-01 to H2-03 = E] activates.

2 : Fast Stop (Use C1-09)

The drive stops the motor in the deceleration time set in C1-09 [Fast Stop Time]. The output terminal set for *Fault* [H2-01 to H2-03 = E] activates.

3 : Alarm Only

The keypad shows *oH* and the drive continues operation. The output terminal set for *Alarm* [H2-01 to H2-03 = 10] activates.

4 : Operate at Reduced Speed (L8-19)

The drive decelerates to the level set in L8-19 [Freq Reduction @ *oH* Pre-Alarm] and continues operation. *oH* flashes on the keypad.

If the overheat pre-alarm is still ON after 10 s, the drive decelerates again. When the alarm is output, the drive decelerates each 10 seconds. If the drive decelerates 10 times and the alarm continues to be output, the output terminal set for *oH Pre-Alarm Reduction Limit* [H2-01 to H2-03 = 4D] activates. When the alarm is not output during deceleration, the drive accelerates until it is at the frequency reference that was applicable before the alarm was turned off. Figure 12.122 shows the output of the alarm and the drive operation at a decreased output frequency.

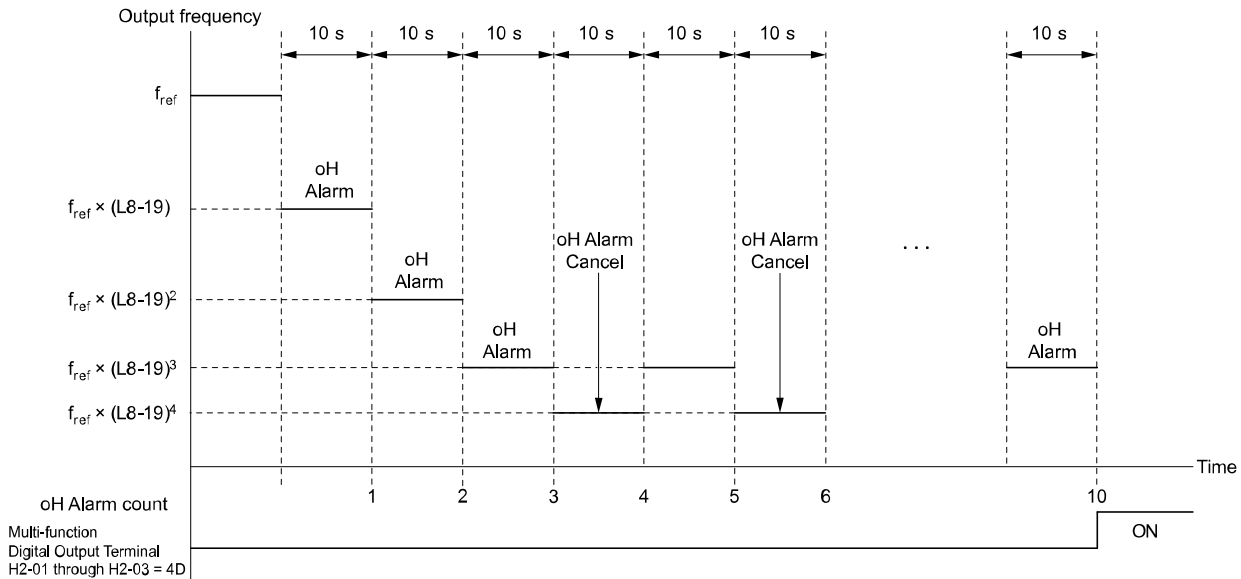

Figure 12.122 Drive Operation at a Decreased Output Frequency when the Overheat Alarm is Output

■ **L8-05: Input Phase Loss Protection Sel**

No. (Hex.)	Name	Description	Default (Range)
L8-05 (04B1)	Input Phase Loss Protection Sel	<input type="checkbox"/> V/f <input type="checkbox"/> OLV <input type="checkbox"/> OLV/PM <input type="checkbox"/> AOLV/PM <input type="checkbox"/> EZOLV Sets the function to enable and disable input phase loss detection.	Determined by o2-04 (Determined by o2-04)

0 : Disabled

1 : Enabled

The drive measures ripples in DC bus voltage to detect input phase loss.

The drive detects phase loss when power supply phase loss occurs or the main circuit capacitor becomes unusable, which causes *PF* [Input Phase Loss] to show on the keypad.

Disable the detection of the input power supply phase loss function in these conditions:

- During deceleration

- The run command is not input
- The output current is less than 30% of the drive rated current.

■ L8-07: Output Phase Loss Protection Sel

No. (Hex.)	Name	Description	Default (Range)
L8-07 (04B3)	Output Phase Loss Protection Sel	<input type="checkbox"/> V/f <input type="checkbox"/> OLV <input type="checkbox"/> OLV/PM <input type="checkbox"/> AOLV/PM <input type="checkbox"/> EZOLV Sets the function to enable and disable output phase loss detection. The drive starts output phase loss detection when the output current decreases to less than 5% of the drive rated current.	1 (0 - 2)

Note:

The drive can incorrectly start output phase loss detection in these conditions:

- The motor rated current is very small compared to the drive rating.
- The drive is operating a PM motor with a small load.

0 : Disabled

1 : Fault when one phase is lost

If the drive loses one output phase, it will trigger *LF [Output Phase Loss]*.

The output turns off and the motor coasts to stop.

2 : Fault when two phases are lost

If the drive loses more than one output phase, it will trigger *LF [Output Phase Loss]*.

The output turns off and the motor coasts to stop.

■ L8-09: Output Ground Fault Detection

No. (Hex.)	Name	Description	Default (Range)
L8-09 (04B5)	Output Ground Fault Detection	<input type="checkbox"/> V/f <input type="checkbox"/> OLV <input type="checkbox"/> OLV/PM <input type="checkbox"/> AOLV/PM <input type="checkbox"/> EZOLV Sets the function to enable and disable ground fault protection.	Determined by o2-04 (0, 1)

0 : Disabled

The drive will not detect ground faults.

1 : Enabled

If there is high leakage current or a ground short circuit in one or two output phases, the drive will detect *GF [Ground Fault]*.

Note:

If the ground path impedance is low, the drive can detect *oC [Overcurrent]*, *SC [Short Circuit/IGBT Failure]*, or *ov [Overvoltage]* instead of *GF*.

■ L8-10: Heatsink Fan Operation Selection

No. (Hex.)	Name	Description	Default (Range)
L8-10 (04B6)	Heatsink Fan Operation Selection	<input type="checkbox"/> V/f <input type="checkbox"/> OLV <input type="checkbox"/> OLV/PM <input type="checkbox"/> AOLV/PM <input type="checkbox"/> EZOLV Sets operation of the heatsink cooling fan.	0 (0 - 2)

0 : During Run, w/ L8-11 Off-Delay

The drive turns on the fan when a Run command is active.

When you release the Run command and the delay time set in *L8-11 [Heatsink Fan Off-Delay Time]* is expired, the fan stops. This setting extends the fan lifetime.

1 : Always On

The fan turns on when you supply power to the drive.

2 : Temperature-Dependent Fan Ctrl.

The fan turns on when the drive detects that the main circuit is overheating.

■ **L8-11: Heatsink Fan Off-Delay Time**

No. (Hex.)	Name	Description	Default (Range)
L8-11 (04B7)	Heatsink Fan Off-Delay Time	<div style="display: flex; justify-content: space-between; align-items: center;"> V/f OLV OLV/PM AOLV/PM EZOLV </div> <p>Sets the length of time that the drive will wait before it stops the cooling fan after it cancels the Run command when $L8-10 = 0$ [Heatsink Fan Operation Selection = During Run, w/ L8-11 Off-Delay].</p>	60 s (0 - 300 s)

■ **L8-12: Ambient Temperature Setting**

No. (Hex.)	Name	Description	Default (Range)
L8-12 (04B8)	Ambient Temperature Setting	<div style="display: flex; justify-content: space-between; align-items: center;"> V/f OLV OLV/PM AOLV/PM EZOLV </div> <p>Sets the ambient temperature of the drive installation area.</p>	40 °C (-10 °C - +60 °C)

Note:

The setting range changes when the L8-35 [Installation Method Selection] value changes:

- 0 [IP20/UL Open Type]: -10 °C to +60 °C
- 1 [Side-by-Side Mounting]: -10 °C to +50 °C
- 2 [IP20/UL Type 1]: -10 °C to +50 °C
- 3 [External Heatsink/Finless]: -10 °C to +50 °C

The drive automatically adjusts the drive rated current to the best value as specified by the set temperature. Set the ambient temperature of the area where you install the drive to a value that is more than the drive rating.

Refer to [Derating Depending on Ambient Temperature on page 355](#) for information about derating as specified by ambient temperature.

■ **L8-15: Drive oL2 @ Low Speed Protection**

No. (Hex.)	Name	Description	Default (Range)
L8-15 (04BB)	Drive oL2 @ Low Speed Protection	<div style="display: flex; justify-content: space-between; align-items: center;"> V/f OLV OLV/PM AOLV/PM EZOLV </div> <p>Sets the function to decrease the drive overload level at which the drive will trigger oL2 [Drive Overload] during low speed operation (6 Hz or slower) to prevent damage to the main circuit transistors.</p>	1 (0, 1)

Note:

Contact Yaskawa or your nearest sales representative before disabling this function at low speeds. If you frequently operate drives with high output current in low speed ranges, it can cause heat stress and decrease the life span of drive IGBTs.

0 : Disabled (No Additional Derate)

The drive does not decrease the overload protection level.

1 : Enabled (Reduced oL2 Level)

When the drive detects oL2 during low speed operation, it automatically decreases the overload detection level.

At zero speed, the drive derates the overload by 50%.

■ **L8-18: Software Current Limit Selection**

No. (Hex.)	Name	Description	Default (Range)
L8-18 (04BE)	Software Current Limit Selection	<div style="display: flex; justify-content: space-between; align-items: center;"> V/f OLV OLV/PM AOLV/PM EZOLV </div> <p>Set the software current limit selection function to prevent damage to the main circuit transistor caused by too much current.</p>	0 (0, 1)

0 : Disabled

When the output current is at the software current limit value, the drive does not restrict the output voltage.

Note:

The drive may detect an oC [Overcurrent] when loads are particularly heavy or the acceleration time is particularly short.

1 : Enabled

When the output current is at the software current limit value, the drive decreases output voltage to decrease output current.

When the output current decreases to the software current limit level, the drive starts usual operation.

■ L8-19: Freq Reduction @ oH Pre-Alarm

No. (Hex.)	Name	Description	Default (Range)
L8-19 (04BF)	Freq Reduction @ oH Pre-Alarm	<input type="checkbox"/> V/f <input type="checkbox"/> OLV <input checked="" type="checkbox"/> OLV/PM <input type="checkbox"/> AOLV/PM <input type="checkbox"/> EZOLV Sets the ratio at which the drive derates the frequency reference during an oH alarm.	0.8 (0.1 - 0.9)

When these two conditions are correct, this function is enabled:

- $L8-03 = 4$ [Overheat Pre-Alarm Ope Selection = Run@L8-19 Rate]
- oH alarm is output

■ L8-27: Overcurrent Detection Gain

No. (Hex.)	Name	Description	Default (Range)
L8-27 (04DD)	Overcurrent Detection Gain	<input type="checkbox"/> V/f <input type="checkbox"/> OLV <input checked="" type="checkbox"/> OLV/PM <input type="checkbox"/> AOLV/PM <input type="checkbox"/> EZOLV Sets the PM motor overcurrent detection level as a percentage of the motor rated current value.	300.0% (0.0 - 1000.0%)

Note:

- If the setting value for L8-27 is the same or almost the same as the setting value for L7-xx [Torque Limit], the drive can detect oC2 [Overcurrent2].
- Set L8-27 = 0.0 Hz to disable this function. Usually do not set L8-27 = 0.0.
- If the drive rated current is much higher than the motor rated current, PM motor magnets can demagnetize when current flows at the drive overcurrent detection level. When you set a low overcurrent detection level to prevent PM motor demagnetization, make sure that you adjust L8-27.

■ L8-29: Output Unbalance Detection Sel

No. (Hex.)	Name	Description	Default (Range)
L8-29 (04DF)	Output Unbalance Detection Sel	<input type="checkbox"/> V/f <input type="checkbox"/> OLV <input checked="" type="checkbox"/> OLV/PM <input type="checkbox"/> AOLV/PM <input type="checkbox"/> EZOLV Sets the function to detect LF2 [Output Current Imbalance].	1 (0, 1)

This function prevents damage to PM motors. Current unbalance can heat a PM motor and demagnetize the magnets. When the current is unbalanced, the drive will detect LF2 to stop the motor and prevent damage to the motor.

0 : Disabled

1 : Enabled

Note:

You must set E9-01 = 1 [Motor Type Selection = Permanent Magnet (PM)] and A1-02 = 8 [EZOLV] to show L8-29.

■ L8-31: LF2 Detection Time

No. (Hex.)	Name	Description	Default (Range)
L8-31 (04E1)	LF2 Detection Time	<input type="checkbox"/> V/f <input type="checkbox"/> OLV <input checked="" type="checkbox"/> OLV/PM <input type="checkbox"/> AOLV/PM <input type="checkbox"/> EZOLV Sets the LF2 [Output Current Imbalance] detection time.	3 (1 - 100)

When the output current is unbalanced for longer than the time set in L8-31, the drive detects LF2.

Note:

- Set L8-29 = 1 [Output Unbalance Detection Sel = Enabled] to enable L8-31.
- If the drive incorrectly detects LF2, increase L8-31 in 5-unit increments.
- The keypad shows L8-31 when E9-01 = 1 [Motor Type Selection = Permanent Magnet (PM)] in EZ Vector Control.

■ L8-35: Installation Method Selection

No. (Hex.)	Name	Description	Default (Range)
L8-35 (04EC)	Installation Method Selection	<input type="checkbox"/> V/f <input type="checkbox"/> OLV <input checked="" type="checkbox"/> OLV/PM <input type="checkbox"/> AOLV/PM <input type="checkbox"/> EZOLV Sets the type of drive installation.	0, 3 (0 - 3)

Note:

- Parameter *A1-03 [Initialize Parameters]* does not initialize this parameter.
- This parameter is set to the correct value when the drive is shipped. Change the value only in these conditions:
 - Side-by-Side installation
 - When you install a UL Type 1 kit on an IP20/UL Open Type drive to convert the drive to an IP20/UL Type 1 drive.
 - Mounting a standard drive with the heatsink outside the enclosure panel.
- Do not change the settings for finless-type drives.

The drive automatically adjusts the overload protection detection level to the best value for each setting value. Refer to *Derating Depending on Ambient Temperature on page 355* for information about derating as specified by ambient temperature.

0 : IP20/UL Open Type

Use this setting to install IP20/UL Open Type drives.

Make sure that there is 30 mm (1.18 in) minimum of space between drives or between the drive and side of the enclosure panel.

1 : Side-by-Side Mounting

Use this setting to install more than one drive side-by-side.

Note:

You cannot install finless-type drives side-by-side.

2 : IP20/UL Type1

Use this setting to install IP20/UL Type 1 drives.

Note:

You cannot install an IP20/UL Type 1 Kit (optional) on a finless-type drive.

3 : External Heatsink/Finless

Use this setting when the heatsink (cooling fin) is outside the enclosure panel or when you install a finless-type drive.

■ L8-40: Carrier Freq Reduction Off-Delay

No. (Hex.)	Name	Description	Default (Range)
L8-40 (04F1)	Carrier Freq Reduction Off-Delay	<div style="display: flex; gap: 5px;"> <input type="checkbox"/> V/f <input type="checkbox"/> OLV <input type="checkbox"/> OLV/PM <input type="checkbox"/> AOLV/PM <input type="checkbox"/> EZOLV </div> <p>Sets the length of time until the automatically reduced carrier frequency returns to the condition before the reduction.</p>	Determined by A1-02 (0.00 - 2.00 s)

Set *L8-40* $\neq 0.00$ to enable the carrier frequency reduction function during start-up. When operation starts, the drive automatically decreases the carrier frequency. When the time set in *L8-40* is expired, the carrier frequency returns to the value set in *C6-02 [Carrier Frequency Selection]*.

■ L8-41: High Current Alarm Selection

No. (Hex.)	Name	Description	Default (Range)
L8-41 (04F2)	High Current Alarm Selection	<div style="display: flex; gap: 5px;"> <input type="checkbox"/> V/f <input type="checkbox"/> OLV <input type="checkbox"/> OLV/PM <input type="checkbox"/> AOLV/PM <input type="checkbox"/> EZOLV </div> <p>Sets the function to cause an <i>HCA [Current Alarm]</i> when the output current is more than 150% of the drive rated current.</p>	0 (0, 1)

0 : No

The drive will not detect *HCA*.

1 : Yes

If the output current is more than 150% of the drive rated current, the drive will detect *HCA*.

The MFDO terminal set for an *Alarm [H2-01 to H2-03 = 10]* activates.

■ L8-51: STPo I Detection Level

No. (Hex.)	Name	Description	Default (Range)
L8-51 (0471) Expert	STPo I Detection Level	V/f OLV OLV/PM AOLV/PM EZOLV Sets the <i>STPo</i> [Motor Step-Out Detected] detection level as a percentage of the motor rated current.	0.0% (0.0 - 300.0%)

Note:

The detection level is automatically calculated when $L8-51 = 0$.

■ L8-52: STPo Integration Level

No. (Hex.)	Name	Description	Default (Range)
L8-52 (0472) Expert	STPo Integration Level	V/f OLV OLV/PM AOLV/PM EZOLV Sets the detection level for <i>STPo</i> [Motor Step-Out Detected] related to the ACR integral value.	1.0 (0.1 - 2.0)

■ L8-53: STPo Integration Time

No. (Hex.)	Name	Description	Default (Range)
L8-53 (0473) Expert	STPo Integration Time	V/f OLV OLV/PM AOLV/PM EZOLV Sets the length of time until the drive detects <i>STPo</i> after it is more than the value of <i>L8-51</i> [<i>STPo I</i> Detection Level].	1.0 s (1.0 - 10.0 s)

■ L8-54: STPo Id Diff Detection

No. (Hex.)	Name	Description	Default (Range)
L8-54 (0474) Expert	STPo Id Diff Detection	V/f OLV OLV/PM AOLV/PM EZOLV Sets the Id deviation detection function for <i>STPo</i> [Motor Step-Out Detected].	1 (0, 1)

0 : Disabled

1 : Enabled

■ L8-55: Internal DB TransistorProtection

No. (Hex.)	Name	Description	Default (Range)
L8-55 (045F)	Internal DB TransistorProtection	V/f OLV OLV/PM AOLV/PM EZOLV Sets the protection function for the internal braking transistor.	1 (0, 1)

0 : Disable

Disables braking transistor protection.

Use this setting, if enabling the braking transistor can cause an *rF* [Braking Resistor Fault] in these conditions:

- With a regenerative converter, for example D1000.
- With a regenerative unit, for example R1000.
- When connecting braking resistor options to the drive, for example CDBR units.
- Without an internal braking transistor.

1 : Protection Enabled

Protects internal braking transistor when using a braking transistor or optional braking resistors.

■ L8-56: Stall P @ Accel Activation Time

No. (Hex.)	Name	Description	Default (Range)
L8-56 (047D) Expert	Stall P @ Accel Activation Time	<div style="display: flex; justify-content: space-between; align-items: center;"> V/f OLV OLV/PM AOLV/PM EZOLV </div> Sets the length time that the acceleration stall prevention function can continue to operate before the drive detects an <i>STPo</i> [Motor Step-Out Detected].	5000 ms (100 - 5000 ms)

Note:

If this value is too small, it can cause incorrect detection of *STPo*. If this value is too large, the drive will not detect *STPo*.

■ L8-57: Stall Prevention Retry Counts

No. (Hex.)	Name	Description	Default (Range)
L8-57 (047E) Expert	Stall Prevention Retry Counts	<div style="display: flex; justify-content: space-between; align-items: center;"> V/f OLV OLV/PM AOLV/PM EZOLV </div> Sets the number of times the acceleration stall prevention function can operate until speeds agree before the drive detects an <i>STPo</i> [Motor Step-Out Detected].	10 (1 - 10 times)

Note:

If this value is too small, it can cause incorrect detection of *STPo*. If this value is too large, the drive will not detect *STPo*.

■ L8-90: STPo Detection Level (Low Speed)

No. (Hex.)	Name	Description	Default (Range)
L8-90 (0175) Expert	STPo Detection Level (Low Speed)	<div style="display: flex; justify-content: space-between; align-items: center;"> V/f OLV OLV/PM AOLV/PM EZOLV </div> Sets the detection level that the control fault must be equal to or more than to cause an <i>STPo</i> [Motor Step-Out Detected].	Determined by A1-02 (0 - 5000 times)

This function detects when PM motors are not synchronized.

The drive cannot detect when motors are not synchronized because the frequency reference is low during start up and the motor is locked. If fault detection is necessary in these conditions, set the control fault detection level to enable detection of desynchronization because of motor locking. Increase the setting in 5-unit increments.

■ L8-93: Low Speed Pull-out DetectionTime

No. (Hex.)	Name	Description	Default (Range)
L8-93 (073C) Expert	Low Speed Pull-out DetectionTime	<div style="display: flex; justify-content: space-between; align-items: center;"> V/f OLV OLV/PM AOLV/PM EZOLV </div> Sets the length of time the drive will wait to start baseblock after detecting <i>LSo</i> [Low Speed Motor Step-Out].	1.0 s (0.0 - 10.0 s)

Set this parameter to 0.0 to disable the function.

■ L8-94: Low Speed Pull-out Detect Level

No. (Hex.)	Name	Description	Default (Range)
L8-94 (073D) Expert	Low Speed Pull-out Detect Level	<div style="display: flex; justify-content: space-between; align-items: center;"> V/f OLV OLV/PM AOLV/PM EZOLV </div> Sets the detection level for <i>LSo</i> [Low Speed Motor Step-Out] as a percentage of <i>E1-04</i> [Maximum Output Frequency].	3% (0 - 10%)

■ L8-95: Low Speed Pull-out Amount

No. (Hex.)	Name	Description	Default (Range)
L8-95 (077F) Expert	Low Speed Pull-out Amount	<div style="display: flex; justify-content: space-between; align-items: center;"> V/f OLV OLV/PM AOLV/PM EZOLV </div> Sets the average count of <i>LSo</i> [Low Speed Motor Step-Out] detections.	10 (1 - 50 times)

12.10 n: Special Adjustment

n parameters set these functions:

- Function to prevent hunting
- High-slip braking
- Motor line-to-line resistance online tuning
- Fine-tune the parameters that adjust motor control

◆ n1: Hunting Prevention

The Hunting Prevention function will not let low inertia or operation with a light load cause hunting. Hunting frequently occurs when you have a high carrier frequency and an output frequency less than 30 Hz.

■ n1-01: Hunting Prevention Selection

No. (Hex.)	Name	Description	Default (Range)
n1-01 (0580)	Hunting Prevention Selection	<input checked="" type="radio"/> V/f <input type="radio"/> OLV <input type="radio"/> OLV/PM <input type="radio"/> AOLV/PM <input type="radio"/> EZOLV Sets the function to prevent hunting.	0 (0, 1)

Note:

When you replace a V1000-series drive with a GA500 drive, set $n1-01 = 1$ [Hunting Prevention Selection = Enabled].

When drive response is more important than the decrease of motor vibration, disable this function.

0 : Disable

1 : Enabled

■ n1-02: Hunting Prevention Gain Setting

No. (Hex.)	Name	Description	Default (Range)
n1-02 (0581) Expert	Hunting Prevention Gain Setting	<input checked="" type="radio"/> V/f <input type="radio"/> OLV <input type="radio"/> OLV/PM <input type="radio"/> AOLV/PM <input type="radio"/> EZOLV Sets the performance of the hunting prevention function. Usually it is not necessary to change this parameter.	1.00 (0.00 - 2.50)

Adjust this parameter in these conditions:

- When $n1-01 = 1$ [Hunting Prevention Selection = Enabled (Normal)], if oscillation occurs when you operate a motor with a light load, increase the setting value in 0.1-unit increments.
- When $n1-01 = 2$, if the motor stalls, decrease the setting value in 0.1-unit increments.

■ n1-03: Hunting Prevention Time Constant

No. (Hex.)	Name	Description	Default (Range)
n1-03 (0582) Expert	Hunting Prevention Time Constant	<input checked="" type="radio"/> V/f <input type="radio"/> OLV <input type="radio"/> OLV/PM <input type="radio"/> AOLV/PM <input type="radio"/> EZOLV Sets the primary delay time constant of the hunting prevention function. Usually it is not necessary to change this parameter.	Determined by o2-04 (0 - 500 ms)

Adjust this parameter in these conditions:

- Load inertia is large: Increase the setting value. If the setting value is too high, response will be slower. Also, there will be oscillation when the frequency is low.
- Oscillation occurs at low frequencies: Decrease the setting value.

■ n1-05: Hunting Prevent Gain in Reverse

No. (Hex.)	Name	Description	Default (Range)
n1-05 (0530) Expert	Hunting Prevent Gain in Reverse	<input checked="" type="radio"/> V/f <input type="radio"/> OLV <input type="radio"/> OLV/PM <input type="radio"/> AOLV/PM <input type="radio"/> EZOLV Sets the performance of the hunting prevention function. This parameter adjusts Reverse run. Usually it is not necessary to change this parameter.	0.00 (0.00 - 2.50)

Note:

When you set $n1-05 = 0$, the value set in $n1-02$ [Hunting Prevention Gain Setting] is effective when the motor rotates in reverse.

Adjust this parameter in these conditions:

- When $n1-01 = 1$ [Hunting Prevention Selection = Enabled (Normal)], if oscillation occurs when you operate a motor with a light load, increase the setting value in 0.1-unit increments.
- When $n1-01 = 2$, if the motor stalls, decrease the setting value in 0.1-unit increments.

■ **n1-13: DC Bus Stabilization Control**

No. (Hex.)	Name	Description	Default (Range)
n1-13 (1B59) Expert	DC Bus Stabilization Control	<div style="display: flex; justify-content: space-between; align-items: center;"> V/f OLV OLV/PM AOLV/PM EZOLV </div> Sets the oscillation suppression function for the DC bus voltage.	0 (0, 1)

0 : Disabled

1 : Enabled

Note:

If the DC bus voltage does not become stable with light loads and the drive detects *ov* [Overvoltage], set this parameter to 1.

■ **n1-14: DC Bus Stabilization Time**

No. (Hex.)	Name	Description	Default (Range)
n1-14 (1B5A) Expert	DC Bus Stabilization Time	<div style="display: flex; justify-content: space-between; align-items: center;"> V/f OLV OLV/PM AOLV/PM EZOLV </div> Adjusts the responsiveness of the oscillation suppression function for the DC bus voltage. Set $n1-13 = 1$ [DC Bus Stabilization Control = Enabled] to enable this parameter.	100.0 ms (50.0 - 500.0 ms)

Note:

Adjust this parameter in 100 ms increments.

◆ **n2: Auto Freq Regulator (AFR)**

The speed feedback detection reduction function (or AFR: Automatic Frequency Regulator) helps the speed become stable when you suddenly apply or remove a load.

Note:

Before you change $n2-xx$ parameters, do one of these procedures:

- Set the motor parameters and V/f pattern correctly.
- Do Rotational Auto-Tuning.

■ **n2-01: Automatic Freq Regulator Gain**

No. (Hex.)	Name	Description	Default (Range)
n2-01 (0584)	Automatic Freq Regulator Gain	<div style="display: flex; justify-content: space-between; align-items: center;"> V/f OLV OLV/PM AOLV/PM EZOLV </div> Sets the gain of the AFR function as a magnification value. Usually it is not necessary to change this setting.	1.00 (0.00 - 10.00)

Adjust this parameter in these conditions:

- If hunting or oscillation occurs with light loads, increase the setting value in 0.05-unit increments and examine the response.
- When torque is not sufficient with heavy loads or to make the torque or speed response better, decrease the setting value in 0.05-unit increments and examine the response.

■ n2-02: Automatic Freq Regulator Time 1

No. (Hex.)	Name	Description	Default (Range)
n2-02 (0585)	Automatic Freq Regulator Time 1	<div style="display: flex; justify-content: space-between; border-bottom: 1px solid black; margin-bottom: 5px;"> V/f OLV OLV/PM AOLV/PM EZOLV </div> Sets the time constant that sets the rate of change for the AFR function. Usually it is not necessary to change this setting.	50 ms (0 - 2000 ms)

Adjust this parameter in these conditions:

- If there is hunting or oscillation with a light load, increase the setting value in 50 ms increments and examine the response. If the load inertia is large, increase the setting value in 50 ms increments and examine the response.
- If torque is not sufficient with a heavy load or if you must increase torque or speed responsiveness, decrease the setting value in 10 ms increments and examine the response.

Note:

- Set $n2-02 \leq n2-03$ [Automatic Freq Regulator Time 2]. If $n2-02 > n2-03$, the drive will detect *oPE08* [Parameter Selection Error].
- When you change the value in $n2-02$, also change the value in $C4-02$ [Torque Compensation Delay Time] by the same ratio.

■ n2-03: Automatic Freq Regulator Time 2

No. (Hex.)	Name	Description	Default (Range)
n2-03 (0586)	Automatic Freq Regulator Time 2	<div style="display: flex; justify-content: space-between; border-bottom: 1px solid black; margin-bottom: 5px;"> V/f OLV OLV/PM AOLV/PM EZOLV </div> Sets the time constant that sets the speed difference of the AFR function. Use this parameter for speed searches or regeneration. Usually it is not necessary to change this setting.	750 ms (0 - 2000 ms)

Adjust this parameter in these conditions:

- If the drive detects *ov* [Overvoltage] when acceleration stops under high-inertia loads, increase the setting value in 50 ms increments.
If the drive detects *ov* when the load changes suddenly, increase the setting value in 50 ms increments.
- To increase the responsiveness of torque and speed, decrease the setting value in 10 ms increments and examine the response.

Note:

- Set $n2-02 \leq n2-03$ [Automatic Freq Regulator Time 2]. If $n2-02 > n2-03$, the drive will detect *oPE08* [Parameter Selection Error].
- When you change the value in $n2-03$, also change the value in $C4-06$ [Motor 2 Torque Comp Delay Time] by the same ratio.

◆ n3: High Slip Braking (HSB) and Overexcitation Braking

$n3$ parameters configure High Slip Braking and Overexcitation Deceleration.

■ High Slip Braking (HSB)

High slip braking quickly decelerates motors without braking resistors.

This lets you stop a motor more quickly than with the ramp to stop processes. This function is best for applications that do not frequently stop the motor, for example the fast stop function for high-inertia loads. Braking starts when the MFDD for *High Slip Braking (HSB) Activate* [$H1-xx = 68$] activates.

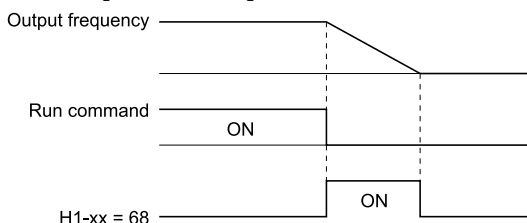

Figure 12.123 High Slip Braking Time Chart

An induction motor is necessary to use high slip braking. Set $A1-02 = 0$ [Control Method Selection = *V/f* Control] to enable high slip braking:

Principles of Operation

HSB increases motor slip by significantly decreasing the frequency supplied to the motor at the same time that deceleration starts. A large quantity of current flows through the motor to increase the motor loss, and the motor decelerates while the motor windings consume the regenerative energy.

The drive keeps the motor current at a constant level during deceleration to prevent overvoltage and do automatic braking and it also keeps a slip level that causes the maximum quantity of deceleration torque.

High Slip Braking Precautions

- Do not use the high slip braking function in these applications:
 - Frequent deceleration
 - Deceleration time differences
 - Continuous regenerative loads
 - It is necessary to accelerate again during deceleration
- Motor loss increases during high slip braking. Use this function when the duty time factor is 5% ED or less and the braking time is 90 seconds or less. The load inertia and motor characteristics have an effect on the braking time.
- The drive ignores the configured deceleration time during high slip braking. To stop motors in the configured deceleration time, set $L3-04 = 4$ [*Stall Prevention during Decel = Overexcitation/High Flux*].
- You cannot use high slip braking to decelerate deceleration at user-defined speeds. To decelerate at user-defined speeds, use the overexcitation deceleration function.
- You cannot accelerate the motor again during high slip braking until you fully stop the motor and input the Run command again.
- You cannot use high slip braking and the KEB Ride-Thru function at the same time. If you enable those two functions, the drive will detect *oPE03* [*Multi-Function Input Setting Err*].

■ Overexcitation Deceleration

Overexcitation deceleration quickly decelerates motors without braking resistors.

This lets you stop a motor more quickly than with the ramp to stop processes.

Overexcitation deceleration increases excitation current during deceleration to cause a large quantity of braking torque through motor overexcitation.

You can set the deceleration speed to adjust the deceleration time for overexcitation deceleration. Overexcitation deceleration lets you accelerate the motor again during deceleration. Enter the Run command during overexcitation deceleration to cancel overexcitation deceleration and accelerate the drive to the specified speed.

To enable this function, set $L3-04 = 4, 5$ [*Stall Prevention during Decel = Overexcitation/High Flux, Overexcitation/High Flux 2*].

When $L3-04 = 4$, the motor will decelerate for the *Deceleration Times* [*C1-02, C1-04, C1-06, or C1-08*]. If the drive detects *ov* [*Overvoltage*], increase the deceleration time.

When $L3-04 = 5$, the drive uses the value in *C1-02, C1-04, C1-06, or C1-08* to decelerate and it adjusts the deceleration rate to keep the DC bus voltage at the level set in $L3-17$ [*DC Bus Regulation Level*]. The load inertia and motor characteristics have an effect on the braking time.

Notes on Overexcitation Deceleration

- Do not use Overexcitation Deceleration with a braking resistor.
- Do not use Overexcitation Deceleration for these applications. Connect a braking resistor to the drive as an alternative to Overexcitation Deceleration.
 - Frequent sudden decelerations
 - Continuous regenerative loads
 - Low inertia machines
 - Machines that have no tolerance for torque ripples
- Motor loss increases during overexcitation deceleration. Use this function when the duty time factor is 5% ED or less and the braking time is 90 seconds or less. The load inertia and motor characteristics have an effect on the braking time.

- You can use overexcitation deceleration in OLV control, but this control method decreases the precision of torque control and braking efficiency. Use V/f control for the best results.
- The drive disables these functions during braking with Overexcitation Deceleration 2:
 - Hunting Prevention Function (V/f Control)
 - Torque Limit Speed Control (OLV Control)

■ n3-01: HSB Deceleration Frequency Width

No. (Hex.)	Name	Description	Default (Range)
n3-01 (0588) Expert	HSB Deceleration Frequency Width	<div style="display: flex; justify-content: space-between; align-items: center;"> V/f OLV OLV/PM AOLV/PM EZOLV </div> <p>Sets the amount by which the output frequency is to be lowered during high-slip braking, as a percentage of <i>E1-04 [Maximum Output Frequency]</i>, which represents the 100% value.</p>	5% (1 - 20%)

When you must detect *ov [DC Bus Overvoltage]* during high-slip braking, set this parameter to a large value.

■ n3-02: HSB Current Limit Level

No. (Hex.)	Name	Description	Default (Range)
n3-02 (0589) Expert	HSB Current Limit Level	<div style="display: flex; justify-content: space-between; align-items: center;"> V/f OLV OLV/PM AOLV/PM EZOLV </div> <p>Sets the maximum current output during high-slip braking as a percentage, where <i>E2-01 [Motor Rated Current (FLA)]</i> is 100%. Also set the current suppression to prevent exceeding drive overload tolerance.</p>	Determined by C6-01 (0 - 150%)

Note:

The upper limit to the setting range changes when the setting for *C6-01 [Normal / Heavy Duty Selection]* changes.

- 150% when *C6-01 = 0 [Heavy Duty Rating]*
- 120% when *C6-01 = 1 [Normal Duty Rating]*

When you decrease the setting value for current suppression, it will make the deceleration time longer.

- When you must detect *ov [DC Bus Overvoltage]* during high-slip braking, set this parameter to a low value.
- If the motor current increases during high-slip braking, decrease the setting value to prevent burn damage in the motor.
- The overload tolerance for the drive is 150% for Heavy Duty Rating (HD) and 110% for Normal Duty Rating (ND).

■ n3-03: HSB Dwell Time at Stop

No. (Hex.)	Name	Description	Default (Range)
n3-03 (058A) Expert	HSB Dwell Time at Stop	<div style="display: flex; justify-content: space-between; align-items: center;"> V/f OLV OLV/PM AOLV/PM EZOLV </div> <p>Sets the dwell time, a length of time when high-slip braking is ending and during which the motor speed decreases and runs at a stable speed. For a set length of time, the drive will hold the actual output frequency at the minimum output frequency set in <i>E1-09</i>.</p>	1.0 s (0.0 - 10.0 s)

If there is too much inertia or when the motor is coasting to a stop after high-slip braking is complete, increase the setting value. If the setting value is too low, machine inertia can cause the motor to rotate after high-slip braking is complete.

■ n3-04: HSB Overload Time

No. (Hex.)	Name	Description	Default (Range)
n3-04 (058B) Expert	HSB Overload Time	<div style="display: flex; justify-content: space-between; align-items: center;"> V/f OLV OLV/PM AOLV/PM EZOLV </div> <p>Sets the time used to detect <i>oL7 [High Slip Braking Overload]</i>, which occurs when the output frequency does not change during high-slip braking. Usually it is not necessary to change this parameter.</p>	40 s (30 - 1200 s)

If a force on the load side is rotating the motor or if there is too much load inertia connected to the motor, the drive will detect *oL7*.

The current flowing to the motor from the load can overheat the motor and cause burn damage to the motor. Set this parameter to prevent burn damage to the motor.

■ n3-13: OverexcitationBraking (OEB) Gain

No. (Hex.)	Name	Description	Default (Range)
n3-13 (0531)	OverexcitationBraking (OEB) Gain	<div style="display: flex; gap: 5px;"> V/f OLV OLV/PM AOLV/PM EZOLV </div> Sets the gain value that the drive multiplies by the V/f pattern output value during overexcitation deceleration to calculate the overexcitation level.	1.10 (1.00 - 1.40)

The V/f pattern output value goes back to its usual level after the motor stops or accelerates again to the frequency reference speed.

The best value of this parameter changes when the flux saturation characteristics of the motor change.

- Gradually increase the value of *n3-13* to 1.25 or 1.30 to increase the braking power of Overexcitation Deceleration. If the gain is too much, the motor can have flux saturation and cause a large quantity of current to flow.
- This can increase the deceleration time. Decrease the setting value if flux saturation causes overcurrent. If you increase the setting value, the drive can detect *oC* [Overcurrent], *oL1* [Motor Overload], and *oL2* [Drive Overload]. Decrease the value of *n3-21* [HSB Current Suppression Level] to prevent *oC* and *oL*.
- If you use overexcitation deceleration frequently or if you use overexcitation deceleration for an extended period of time, it can increase motor temperature. Decrease the setting value in these conditions.
- If *ov* [Overvoltage] occurs, increase the deceleration time.

■ n3-14: OEB High Frequency Injection

No. (Hex.)	Name	Description	Default (Range)
n3-14 (0532) Expert	OEB High Frequency Injection	<div style="display: flex; gap: 5px;"> V/f OLV OLV/PM AOLV/PM EZOLV </div> Sets the function that injects harmonic signals during overexcitation deceleration.	0 (0, 1)

Enable this parameter to set a shorter deceleration time.

Note:

- If you frequently use overexcitation deceleration on a motor, the motor loss will increase the risk of burn damage.
- When you set this parameter to 1, the motor can make a loud excitation sound during overexcitation deceleration. If the excitation sound is unwanted, set this parameter to 0 to disable the function.

0 : Disabled

1 : Enabled

The drive injects harmonic signals at the time of overexcitation deceleration. You can decrease the deceleration time because motor loss increases.

■ n3-21: HSB Current Suppression Level

No. (Hex.)	Name	Description	Default (Range)
n3-21 (0579)	HSB Current Suppression Level	<div style="display: flex; gap: 5px;"> V/f OLV OLV/PM AOLV/PM EZOLV </div> Sets the upper limit of the current that is suppressed at the time of overexcitation deceleration as a percentage of the drive rated current.	100% (0 - 150%)

If flux saturation during Overexcitation Deceleration makes the motor current become more than the value set in *n3-21*, the drive will automatically decrease the overexcitation gain. If *oC* [Overcurrent], *oL1* [Motor Overload], or *oL2* [Drive Overload] occur during overexcitation deceleration, decrease the setting value.

If repetitive or long overexcitation deceleration cause the motor to overheat, decrease the setting value.

■ n3-23: Overexcitation Braking Operation

No. (Hex.)	Name	Description	Default (Range)
n3-23 (057B)	Overexcitation Braking Operation	<div style="display: flex; gap: 5px;"> V/f OLV OLV/PM AOLV/PM EZOLV </div> Sets the direction of motor rotation where the drive will enable overexcitation.	0 (0 - 2)

0 : Disabled

1 : Enabled Only when Rotating FWD

2 : Enabled Only when Rotating REV

Note:

When $n3-23 = 1, 2$, the drive enables overexcitation only in the direction of motor rotation in which a regenerative load is applied. Increased motor loss can decrease *ov* [Overvoltage] faults.

◆ n5: Feed Forward Control

Feed forward control increases the responsiveness of acceleration and deceleration as specified by the speed reference.

Increase the values set in *C5-01* and *C5-03* [ASR Proportional Gain] to apply feed forward control to machines that have low rigidity and are possible to have hunting and vibration or to machines that have a large quantity of inertia. Refer to [Figure 12.124](#) for more information about parameters related to feed forward control.

Set *A1-02* = 6 [Control Method Selection = Advanced Open Loop Vector Control for PM] to enable feed forward control.

Note:

- You cannot use feed forward control to increase responsiveness in applications where you apply loads externally during run at constant speed.
- You cannot use feed forward control with motor 2.

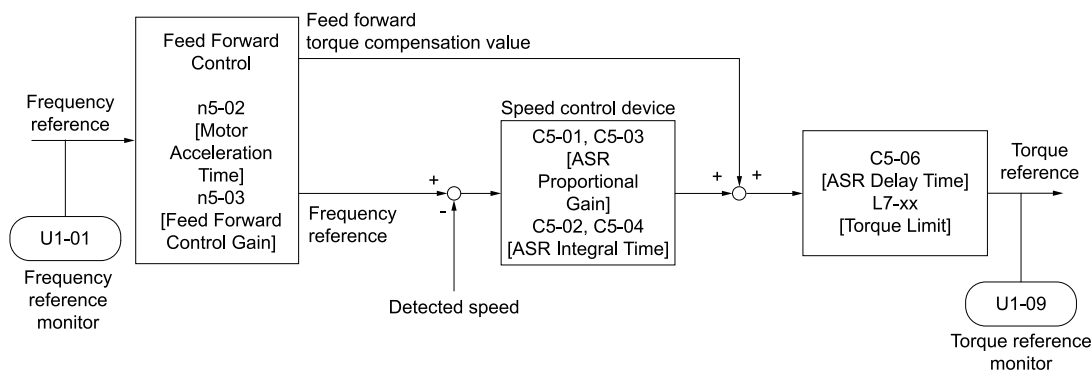

Figure 12.124 Configure Feed Forward Control

■ Before You Use Feed Forward Control

Do one of these procedures before you use feed forward control.

- Run Auto-Tuning to set motor parameters. When you cannot do Auto-Tuning, manually set motor parameters with the information on the motor nameplate or test reports. Set the *E2* parameters for induction motors. Set the *E5* parameters for PM motors.
- Set *C5* parameters [Automatic Speed Regulator (ASR)] individually to adjust the speed control loop (ASR).
- If you can connect a motor to a machine and rotate it during Auto-Tuning, do Inertia Tuning. The drive automatically adjusts feed forward parameters during Inertia Tuning.
- If you cannot do Inertia Tuning, refer to [Figure 12.124](#) and set the parameters related to feed forward control individually.

■ n5-01: Feed Forward Control Selection

No. (Hex.)	Name	Description	Default (Range)
n5-01 (05B0)	Feed Forward Control Selection	<input type="checkbox"/> V/f <input type="checkbox"/> OLV <input type="checkbox"/> OLV/PM <input checked="" type="checkbox"/> AOLV/PM <input type="checkbox"/> EZOLV Sets the feed forward function.	0 (0, 1)

0 : Disabled

1 : Enabled

■ n5-02: Motor Inertia Acceleration Time

No. (Hex.)	Name	Description	Default (Range)
n5-02 (05B1)	Motor Inertia Acceleration Time	<div style="display: flex; justify-content: space-between; border-bottom: 1px solid black; margin-bottom: 5px;"> V/f OLV OLV/PM AOLV/PM EZOLV </div> Sets the length of time for the motor to accelerate from the stopped to the maximum frequency with a single motor at the rated torque. Inertia Tuning automatically sets the motor acceleration time.	Determined by C6-01, E5-01, and o2-04 (0.001 - 10.000 s)

If you cannot do Inertia Tuning, calculate the motor acceleration time as shown here or measure the motor acceleration time and set *n5-02* to this value.

Calculate the Motor Acceleration Time

Use this formula to find the motor acceleration time:

$$n5-02 = \frac{2\pi \cdot J_{\text{Motor}} \cdot n_{\text{rated}}}{60 \cdot T_{\text{rated}}}$$

- J_{Motor} = Moment of inertia of motor (kg m²)
- n_{rated} = Motor rated speed (min⁻¹, r/min)
- T_{rated} = Motor rated torque (N m)

You can also use this formula to find the motor acceleration time:

$$n5-02 = \frac{4\pi \cdot J_{\text{Motor}} \cdot f_{\text{rated}}}{P \cdot T_{\text{rated}}}$$

- f_{rated} = Motor rated frequency (Hz)
- P = Number of motor poles

Calculate the Motor Acceleration Time

Use this procedure to calculate the motor acceleration time:

1. Use *A1-02 [Control Method Selection]* to set the control method.
2. Disconnect the motor and load.
3. Run Auto-Tuning to set motor parameters.
When you cannot do Auto-Tuning, manually set motor parameters with the information on the motor nameplate or test reports. Set the *E2 parameters* for induction motors. Set the *E5 parameters* for PM motors.
4. Set *C5 parameters [Automatic Speed Regulator (ASR)]*.
5. Set *C1-01 [Acceleration Time 1] = 0*.
6. Set *L7-01 [Forward Torque Limit]* to 100%.
7. Set the frequency reference to the same value as the motor rated speed.
8. Measure the length of time for the motor to reach the rated speed.
Show *U1-05 [Motor Speed]* on the keypad and enter the Run command (forward run).
9. Stop the motor.
10. Set *n5-02* to the measured motor acceleration time value.

Reset all of the parameters that you changed to the previous setting values.

■ n5-03: Feed Forward Control Gain

No. (Hex.)	Name	Description	Default (Range)
n5-03 (05B2)	Feed Forward Control Gain	<div style="display: flex; justify-content: space-between; border-bottom: 1px solid black; margin-bottom: 5px;"> V/f OLV OLV/PM AOLV/PM EZOLV </div> Sets the ratio between load inertia and motor inertia. Inertia Tuning automatically sets the Feedforward Control Gain value.	1.00 (0.00 - 100.00)

When you cannot do Inertia Tuning, use this procedure to set *n5-03*:

Set *n5-02 [Motor Inertia Acceleration Time]*.

1. Connect the motor and load.
2. Set *C1-01 [Acceleration Time 1] = 0*.
3. Use *L7-01 to L7-04 [Torque Limit]* to set the expected test run torque limit levels.

4. Set the frequency reference as specified by the high speed range of the machine.
5. Measure the length of time for the motor to reach the command reference speed. Show *U1-05 [Motor Speed]* on the keypad and enter the Run command.
6. Stop the motor.
7. Replace the values in the this formula and set *n5-03* to the value of the formula.

$$n5-03 = \frac{t_{\text{accel}} \cdot T_{\text{Lim_Test}} \cdot f_{\text{rated}}}{n5-02 \cdot f_{\text{ref_Test}} \cdot 100} - 1$$

- t_{accel} = Acceleration time (s)
- f_{rated} = Motor rated frequency (Hz)
- $T_{\text{Lim_Test}}$ = Test run torque limit (%)
- $f_{\text{ref_Test}}$ = Test run frequency reference (Hz)

WARNING! Sudden Movement Hazard. Machinery can accelerate suddenly. Do not use this function with machinery that must not accelerate suddenly. Sudden starts can cause serious injury or death.

Reset all of the parameters that you changed to the previous setting values.

Note:

- If response to the speed reference is slow, increase the value set in *n5-03*.
- Increase the value set in *n5-03* when response to the speed reference is slow.
 - The speed is overshooting.
 - A negative torque reference is output when acceleration ends.

■ n5-04: Speed Response Frequency

No. (Hex.)	Name	Description	Default (Range)
n5-04 (05B3) RUN Expert	Speed Response Frequency	<div style="display: flex; justify-content: space-between; border: 1px solid gray; padding: 2px;"> V/f OLV OLV/PM AOLV/PM EZOLV </div> Sets the response frequency for the speed reference. Usually it is not necessary to change this parameter.	Determined by A1-02 (0.00 - 500.00 Hz)

If you set *n5-03 [Feed Forward Control Gain]* too high, the motor speed will momentarily increase to more than the set frequency.

◆ n6: Online Tuning

n6 parameters are used to set the online tuning function for motor line-to-line resistance.

The Online Tuning for motor line-to-line resistance is used to prevent degradation of speed control accuracy due to motor temperature fluctuation and motor stalls due to insufficient torque.

■ n6-01: Online Tuning Selection

No. (Hex.)	Name	Description	Default (Range)
n6-01 (0570)	Online Tuning Selection	<div style="display: flex; justify-content: space-between; border: 1px solid gray; padding: 2px;"> V/f OLV OLV/PM AOLV/PM EZOLV </div> Sets the type of motor data that Online Tuning uses for OLV control.	0 (0 - 2)

0 : Disabled

1 : Line-to-Line Resistance Tuning

The drive adjusts the motor line-to-line resistance during run. This procedure is applicable for speed values 6 Hz and less. It also adjusts the motor resistance value to increase the overload capacity in the low speed range.

2 : Voltage Correction Tuning

The drive adjusts the output voltage during run to increase overload tolerance and minimize the effects of high temperatures on speed precision.

Note:

Setting 2 is enabled only when *b8-01 = 0 [Energy Saving Control Selection = Disabled]*.

■ n6-05: Online Tuning Gain

No. (Hex.)	Name	Description	Default (Range)
n6-05 (05C7) Expert	Online Tuning Gain	<div style="display: flex; justify-content: space-between; border-bottom: 1px solid black; margin-bottom: 5px;"> V/f OLV OLV/PM AOLV/PM EZOLV </div> Sets the compensation gain when $n6-01 = 2$ [Online Tuning Selection = Voltage Correction Tuning]. Usually it is not necessary to change this parameter.	1.0 (0.1 - 50.0)

When you use a motor that has a large secondary circuit time constant, decrease the setting value.

If the drive detects *oL1* [Motor Overload], increase the setting value in 0.1-unit increments.

◆ n7: EZ Drive

The *n7 parameters* provide special adjustments for EZ Vector Control.

■ n7-01: Damping Gain for Low Frequency

No. (Hex.)	Name	Description	Default (Range)
n7-01 (3111) Expert	Damping Gain for Low Frequency	<div style="display: flex; justify-content: space-between; border-bottom: 1px solid black; margin-bottom: 5px;"> V/f OLV OLV/PM AOLV/PM EZOLV </div> Sets the oscillation suppression gain for the low speed range.	1.0 (0.1 - 10.0)

Note:

- If oscillation occurs in the low speed range, increase the acceleration time or increase the setting value in 0.5-unit increments.
- To get starting torque with the setting for *C4-01* [Torque Compensation Gain], decrease the setting value in 0.3-unit increments.

■ n7-05: Response Gain for Load Changes

No. (Hex.)	Name	Description	Default (Range)
n7-05 (3115) Expert	Response Gain for Load Changes	<div style="display: flex; justify-content: space-between; border-bottom: 1px solid black; margin-bottom: 5px;"> V/f OLV OLV/PM AOLV/PM EZOLV </div> Sets the response gain related to changes in the load.	50 (10 - 1000)

Note:

To make tracking related to load changes better, increase the setting value in 5-unit increments. If oscillation occurs during load changes, decrease the setting value in 5-unit increments.

■ n7-07: Speed Calculation Gain1

No. (Hex.)	Name	Description	Default (Range)
n7-07 (3117) Expert	Speed Calculation Gain1	<div style="display: flex; justify-content: space-between; border-bottom: 1px solid black; margin-bottom: 5px;"> V/f OLV OLV/PM AOLV/PM EZOLV </div> Sets the speed calculation gain during usual operation. Usually it is not necessary to change this setting.	15.0 (1.0 - 50.0)

■ n7-08: Speed Calculation Gain2

No. (Hex.)	Name	Description	Default (Range)
n7-08 (3118) Expert	Speed Calculation Gain2	<div style="display: flex; justify-content: space-between; border-bottom: 1px solid black; margin-bottom: 5px;"> V/f OLV OLV/PM AOLV/PM EZOLV </div> Sets the speed calculation gain during a speed search.	25.0 (1.0 - 50.0)

Note:

When you increase the setting value, you can do a speed search of a motor rotating at a high frequency. If the setting value is too high, the calculated speed will oscillate and a restart will fail. Decrease the setting value in these conditions.

■ n7-10: Pull-in Current Switching Speed

No. (Hex.)	Name	Description	Default (Range)
n7-10 (311A) Expert	Pull-in Current Switching Speed	<div style="display: flex; justify-content: space-between; align-items: center;"> V/f OLV OLV/PM AOLV/PM EZOLV </div> <p>Sets the speed range to operate with the pull-in current command. Drive rated frequency = 100% value. If there is a large quantity of oscillation when you operate in the low speed range, increase the setting value.</p>	10.0% (0.0 - 100.0%)

Note:

- When the drive accelerates, it enables these settings:
 - Motor speed $\leq n7-10 + n7-11$ [*Drv Mode Switch Hysteresis Band*]: $n8-51$ [*Pull-in Current @ Acceleration*]
 - Motor speed $> n7-10 + n7-11$: $b8-01$ [*Energy Saving Control Selection*]
- When the drive decelerates, it enables these settings:
 - Motor speed $\leq n7-10$: $n8-51$ [*Pull-in Current @ Acceleration*]
 - Motor speed $> n7-10$: $b8-01$ [*Energy Saving Control Selection*]
- If there is a large quantity of oscillation when you operate in the low speed range, increase the setting value.
- When it is most important to save energy in the low speed range, decrease the setting value.

■ n7-17: Resistance Temperature Correction

No. (Hex.)	Name	Description	Default (Range)
n7-17 (3122)	Resistance Temperature Correction	<div style="display: flex; justify-content: space-between; align-items: center;"> V/f OLV OLV/PM AOLV/PM EZOLV </div> <p>Sets the function to adjust for changes in the motor resistance value caused by changes in the temperature.</p>	1 (0 to 2)

0 : Invalid

1 : Valid (Only 1 time)

2 : Valid (Every time)

Note:

- For settings 1 and 2, the adjustment time can cause a delay before startup.
- For settings 1 and 2, the drive can set the line-to-line resistance value of $E9-10$ [*Motor Line-to-Line Resistance*].
- When the temperature will change at startup, use setting 2.
- To decrease the startup time, set this parameter to 0, then do line-to-line resistance tuning.
- If you will start from coasting, set this parameter to 0, then do line-to-line resistance tuning.

■ n7-19: Flux Error Compensation Gain

No. (Hex.)	Name	Description	Default (Range)
n7-19 (3128) Expert	Flux Error Compensation Gain	<div style="display: flex; justify-content: space-between; align-items: center;"> V/f OLV OLV/PM AOLV/PM EZOLV </div> <p>Sets the gain for magnetic flux compensation. Usually it is not necessary to change this setting.</p>	5000% (0 - 50000%)

◆ n8: PM Motor Control Tuning

$n8$ parameters are used to make adjustments when controlling PM motors.

■ n8-01: Pole Position Detection Current

No. (Hex.)	Name	Description	Default (Range)
n8-01 (0540)	Pole Position Detection Current	<div style="display: flex; justify-content: space-between; align-items: center;"> V/f OLV OLV/PM AOLV/PM EZOLV </div> <p>Sets the Initial Rotor Position Estimated Current as a percentage where $E5-03$ [<i>PM Motor Rated Current (FLA)</i>] = 100%. Usually it is not necessary to change this setting.</p>	50% (0 - 100%)

The drive uses the Initial Rotor Position Estimated Current to detect the initial position of rotors.

Use the "Si" value on the motor nameplate, if available.

Note:

When $A1-02 = 7$ [*CLV/PM*], this parameter takes effect only in Expert Mode.

■ n8-02: Pole Alignment Current Level

No. (Hex.)	Name	Description	Default (Range)
n8-02 (0541)	Pole Alignment Current Level	<div style="display: flex; justify-content: space-between; border-bottom: 1px solid black; margin-bottom: 5px;"> V/f OLV OLV/PM AOLV/PM EZOLV </div> Sets the current at the time of polar attraction as a percentage where <i>E5-03 [motor rated current]</i> is 100%. Usually it is not necessary to change this setting.	80% (0 - 150%)

The drive uses the polar pull-in current to attract the rotor after it detects the initial rotor position. When you increase the value of *n8-02*, the starting torque also increases.

- If the motor does not track correctly at the time of the polar attraction, increase the value in 10% increments.
- If the motor oscillates at the time of the polar attraction, decrease the value in 10% increments.

■ n8-11: Observer Calculation Gain 2

No. (Hex.)	Name	Description	Default (Range)
n8-11 (054A) Expert	Observer Calculation Gain 2	<div style="display: flex; justify-content: space-between; border-bottom: 1px solid black; margin-bottom: 5px;"> V/f OLV OLV/PM AOLV/PM EZOLV </div> Sets the gain for speed estimation. Usually it is not necessary to change this setting.	Determined by n8-72 (0.0 - 1000.0)

Note:

When *n8-72 = 0 [Speed Estimation Method Select = Method 1]*, the default value is 50.0. When *n8-72 = 1 [Method 2]*, the default value is 150.0.

■ n8-14: Polarity Compensation Gain 3

No. (Hex.)	Name	Description	Default (Range)
n8-14 (054D) Expert	Polarity Compensation Gain 3	<div style="display: flex; justify-content: space-between; border-bottom: 1px solid black; margin-bottom: 5px;"> V/f OLV OLV/PM AOLV/PM EZOLV </div> Sets the gain for speed estimation. Usually it is not necessary to change this setting.	1.000 (0.000 - 10.000)

■ n8-15: Polarity Compensation Gain 4

No. (Hex.)	Name	Description	Default (Range)
n8-15 (054E) Expert	Polarity Compensation Gain 4	<div style="display: flex; justify-content: space-between; border-bottom: 1px solid black; margin-bottom: 5px;"> V/f OLV OLV/PM AOLV/PM EZOLV </div> Sets the gain for speed estimation. Usually it is not necessary to change this setting.	0.500 (0.000 - 10.000)

■ n8-21: Motor Back-EMF (Ke) Gain

No. (Hex.)	Name	Description	Default (Range)
n8-21 (0554) Expert	Motor Back-EMF (Ke) Gain	<div style="display: flex; justify-content: space-between; border-bottom: 1px solid black; margin-bottom: 5px;"> V/f OLV OLV/PM AOLV/PM EZOLV </div> Sets the gain for speed estimation. Usually it is not necessary to change this setting.	0.90 (0.80 - 1.00)

■ n8-23: ACR q Gain @PoleEst

No. (Hex.)	Name	Description	Default (Range)
n8-23 (0556) Expert	ACR q Gain @PoleEst	<div style="display: flex; justify-content: space-between; border-bottom: 1px solid black; margin-bottom: 5px;"> V/f OLV OLV/PM AOLV/PM EZOLV </div> Sets the proportional gain for current regulator q-axis control when the drive estimates the initial pole. Usually it is not necessary to change this setting.	0 (0 - 2000)

■ n8-24: ACR q Integral Time @PoleEst

No. (Hex.)	Name	Description	Default (Range)
n8-24 (0557) Expert	ACR q Integral Time @PoleEst	V/f OLV OLV/PM AOLV/PM EZOLV Sets the integral time for current regulator q-axis control when the drive estimates the initial pole. Usually it is not necessary to change this setting.	0.0 ms (0.0 - 100.0 ms)

■ n8-25: ACR q Limit @PoleEst

No. (Hex.)	Name	Description	Default (Range)
n8-25 (0558) Expert	ACR q Limit @PoleEst	V/f OLV OLV/PM AOLV/PM EZOLV Sets the q-axis limit of the current regulator when the drive estimates the initial pole. Usually it is not necessary to change this setting.	0% (0 - 150%)

■ n8-26: ACR d Gain @PoleEst

No. (Hex.)	Name	Description	Default (Range)
n8-26 (0559) Expert	ACR d Gain @PoleEst	V/f OLV OLV/PM AOLV/PM EZOLV Sets the proportional gain for current regulator d-axis control when the drive estimates the initial pole. Usually it is not necessary to change this setting.	500 (0 - 2000)

■ n8-27: ACR d Integral Time @PoleEst

No. (Hex.)	Name	Description	Default (Range)
n8-27 (055A) Expert	ACR d Integral Time @PoleEst	V/f OLV OLV/PM AOLV/PM EZOLV Sets the integral time for current regulator d-axis control when the drive estimates the initial pole. Usually it is not necessary to change this setting.	0.0 ms (0.0 - 100.0 ms)

■ n8-28: ACR d Lim @PoleEst

No. (Hex.)	Name	Description	Default (Range)
n8-28 (055B) Expert	ACR d Lim @PoleEst	V/f OLV OLV/PM AOLV/PM EZOLV Sets the d-axis limit of the current regulator when the drive estimates the initial pole. Usually it is not necessary to change this setting.	100% (0 - 150%)

■ n8-35: Initial Pole Detection Method

No. (Hex.)	Name	Description	Default (Range)
n8-35 (0562)	Initial Pole Detection Method	V/f OLV OLV/PM AOLV/PM EZOLV Sets how the drive detects the position of the rotor when the motor starts.	Determined by A1-02 (0 - 2)

Note:

- When you use an SPM motor, set $n8-35 = 0$. When you use an IPM motor, set $n8-35 = 0$ to 2 .
- When you set $n8-35 = 1$, do High Frequency Injection Auto-Tuning.
- When you set $n8-35 = 0$ or 2 , always evaluate the drive with the equipment being used for the application. If the drive incorrectly detects the polarity, the motor can rotate in the direction opposite of the Run command.

0 : Pull-in

Starts the rotor with pull-in current.

1 : High Frequency Injection

Injects high frequency to detect the rotor position. This setting can cause a loud excitation sound when the motor starts.

Note:

When you set 1 , do High Frequency Injection Auto-Tuning.

2 : Pulse Injection

Inputs the pulse signal to the motor to detect the rotor position.

■ n8-36: HFI Frequency Level for L Tuning

No. (Hex.)	Name	Description	Default (Range)
n8-36 (0563)	HFI Frequency Level for L Tuning	<input type="checkbox"/> V/f <input type="checkbox"/> OLV <input checked="" type="checkbox"/> OLV/IPM <input type="checkbox"/> AOLV/IPM <input type="checkbox"/> EZOLV Sets the injection frequency for high frequency injection.	500 Hz (200 - 1000 Hz)

Note:

- Set $n8-35 = 1$ [Initial Pole Detection Method = High Frequency Injection] or $n8-57 = 1$ [HFI Overlap Selection = Enabled] to enable this parameter.
- The drive automatically calculates this value when High Frequency Injection Auto-Tuning completes successfully.

■ n8-37: HFI Voltage Amplitude Level

No. (Hex.)	Name	Description	Default (Range)
n8-37 (0564) Expert	HFI Voltage Amplitude Level	<input type="checkbox"/> V/f <input type="checkbox"/> OLV <input checked="" type="checkbox"/> OLV/IPM <input type="checkbox"/> AOLV/IPM <input type="checkbox"/> EZOLV Sets the high frequency injection amplitude as a percentage where 200 V = 100% for 200 V class drives and 400 V = 100% for a 400 V class drives. Usually it is not necessary to change this setting.	20.0% (0.0 - 50.0%)

Note:

- Set $n8-35 = 1$ [Initial Pole Detection Method = High Frequency Injection] or $n8-57 = 1$ [HFI Overlap Selection = Enabled] to enable this parameter.
- The drive automatically calculates this value when High Frequency Injection Auto-Tuning completes successfully.

■ n8-39: HFI LPF Cutoff Freq

No. (Hex.)	Name	Description	Default (Range)
n8-39 (0566)	HFI LPF Cutoff Freq	<input type="checkbox"/> V/f <input type="checkbox"/> OLV <input checked="" type="checkbox"/> OLV/IPM <input type="checkbox"/> AOLV/IPM <input type="checkbox"/> EZOLV Sets the low-pass filter shut-off frequency for high frequency injection.	250 Hz (0 - 1000 Hz)

Note:

- Set $n8-35 = 1$ [Initial Pole Detection Method = High Frequency Injection] or $n8-57 = 1$ [HFI Overlap Selection = Enabled] to enable this parameter.
- The drive automatically calculates this value when High Frequency Injection Auto-Tuning completes successfully.

■ n8-41: HFI P Gain

No. (Hex.)	Name	Description	Default (Range)
n8-41 (0568) Expert	HFI P Gain	<input type="checkbox"/> V/f <input type="checkbox"/> OLV <input checked="" type="checkbox"/> OLV/IPM <input type="checkbox"/> AOLV/IPM <input type="checkbox"/> EZOLV Sets the response gain for the high frequency injection speed estimation.	2.5 (-10.0 - +10.0)

Note:

- Set $n8-35 = 1$ [Initial Pole Detection Method = High Frequency Injection] or $n8-57 = 1$ [HFI Overlap Selection = Enabled] to enable this parameter.
- When $A1-02 = 6$ [Control Method Selection = AOLV/IPM] and you do High Frequency Injection Auto-Tuning, the drive automatically sets this parameter.
- Set $n8-41 > 0.0$ for IPM motors.

Set this parameter as follows.

- If there is oscillation or hunting, decrease the setting in units of 0.5.
- When it is necessary to track load changes, increase the setting in units of 0.5.

■ n8-42: HFI I Time

No. (Hex.)	Name	Description	Default (Range)
n8-42 (0569) Expert	HFI I Time	<input type="checkbox"/> V/f <input type="checkbox"/> OLV <input checked="" type="checkbox"/> OLV/IPM <input type="checkbox"/> AOLV/IPM <input type="checkbox"/> EZOLV Sets the integral time constant for the high frequency injection speed estimation. Usually it is not necessary to change this setting.	0.10 s (0.00 - 9.99 s)

Note:

Set $n8-35 = 1$ [Initial Pole Detection Method = High Frequency Injection] or $n8-57 = 1$ [HFI Overlap Selection = Enabled] to enable this parameter.

■ n8-45: Speed Feedback Detection Gain

No. (Hex.)	Name	Description	Default (Range)
n8-45 (0538)	Speed Feedback Detection Gain	V/f OLV OLV/PM AOLV/PM EZOLV Sets the internal speed feedback detection reduction unit gain as a magnification value. Usually it is not necessary to change this setting.	0.80 (0.00 - 10.00)

Adjust this parameter in these conditions:

- If vibration or hunting occur, increase the setting value in 0.05 unit increments.
- If the responsiveness of torque and speed is unsatisfactory, decrease the setting value 0.05 unit increments and examine the response.

■ n8-46: PM Phase Compensation Gain

No. (Hex.)	Name	Description	Default (Range)
n8-46 (0539) Expert	PM Phase Compensation Gain	V/f OLV OLV/PM AOLV/PM EZOLV Sets the gain to compensate for phase differences. Usually it is not necessary to change this setting.	0.3 (0.0 - 10.0)

If there is vibration in the motor, increase the value. When you must detect *oC* [Overcurrent] or *ov* [DC Bus Overvoltage], set this parameter to a low value.

■ n8-47: Pull-in Current Comp Filter Time

No. (Hex.)	Name	Description	Default (Range)
n8-47 (053A)	Pull-in Current Comp Filter Time	V/f OLV OLV/PM AOLV/PM EZOLV Sets the time constant the drive uses to align the pull-in current reference value with the actual current value. Usually it is not necessary to change this setting.	5.0 s (0.0 - 100.0 s)

Adjust this parameter in these conditions:

- If the time for the reference value of the pull-in current to align with the target value is too long, increase the setting value.
- If vibration or hunting occur, decrease the setting value in 0.2 unit increments.
- If the motor stalls during run at constant speed, decrease the setting value in 0.2 unit increments.

■ n8-48: Pull-in/Light Load Id Current

No. (Hex.)	Name	Description	Default (Range)
n8-48 (053B) RUN	Pull-in/Light Load Id Current	V/f OLV OLV/PM AOLV/PM EZOLV On the basis that parameter <i>E5-03</i> [Motor Rated Current (FLA)] is the 100% value, this parameter sets the d-axis current that flows to the motor during run at constant speed as a percentage.	30% (0 - 200%)

Adjust in the following situations.

- Slightly reduce this value if there is too much current when driving a light load at a constant speed.
- Increase the setting value in steps of 5% when hunting or vibration occurs during run at constant speed.
- Increase the setting value in steps of 5% if the motor stalls during run at constant speed.

■ **n8-49: Heavy Load Id Current**

No. (Hex.)	Name	Description	Default (Range)
n8-49 (053C) RUN Expert	Heavy Load Id Current	<div style="display: flex; justify-content: space-between; border-bottom: 1px solid black; margin-bottom: 5px;"> V/f OLV OLV/PM AOLV/PM EZOLV </div> Sets the d-axis current to that the drive will supply to the motor to run it at a constant speed with a heavy load. Considers <i>E5-03 [PM Motor Rated Current (FLA)]</i> to be 100%. Usually it is not necessary to change this setting.	Determined by E5-01 (-200.0 - +200.0%)

When you use an IPM motor, you can use the reluctance torque of the motor to make the motor more efficient and help conserve energy.

When you operate an SPN motor, set this parameter to 0.

Adjust in the following situations.

- If the load is large and motor rotation is not stable, decrease the setting value.
- When you change the *E5 parameters [PM Motor Settings]*, set *n8-49 = 0*, then adjust this parameter.

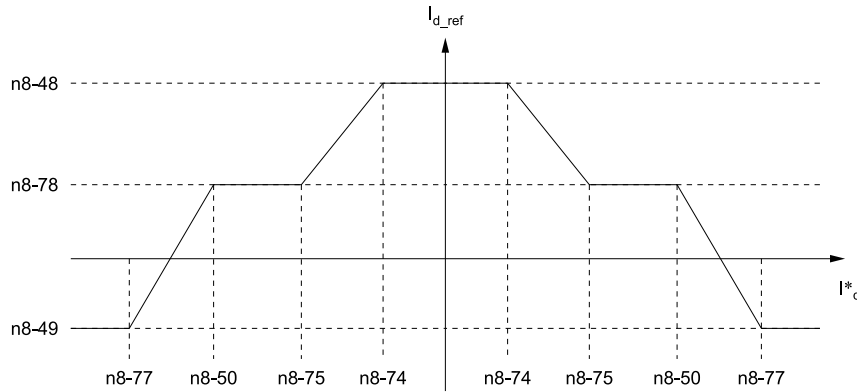

■ **n8-50: Medium Load Iq Level (High)**

No. (Hex.)	Name	Description	Default (Range)
n8-50 (053D) Expert	Medium Load Iq Level (High)	<div style="display: flex; justify-content: space-between; border-bottom: 1px solid black; margin-bottom: 5px;"> V/f OLV OLV/PM AOLV/PM EZOLV </div> Sets the load current level at which heavy load control starts where <i>E5-03 [Motor Rated Current (FLA)]</i> is 100%. Usually it is not necessary to change this setting.	80% (50 - 255)

■ **n8-51: Pull-in Current @ Acceleration**

No. (Hex.)	Name	Description	Default (Range)
n8-51 (053E)	Pull-in Current @ Acceleration	<div style="display: flex; justify-content: space-between; border-bottom: 1px solid black; margin-bottom: 5px;"> V/f OLV OLV/PM AOLV/PM EZOLV </div> Sets the pull-in current allowed to flow during acceleration/deceleration as a percentage of the motor rated current.	Determined by A1-02 (0 - 200%)

Adjust in the following situations.

- When the motor does not smoothly because of large loads, increase the setting value in 5% increments.
- If too much current flows during acceleration, decrease the setting value.

Note:

When *A1-02 = 8 [Control Method Selection = EZOLV]*, this parameter will always be in effect for speed ranges less than *n7-10 [Pull-in Current Switching Speed]*.

■ **n8-54: Voltage Error Compensation Time**

No. (Hex.)	Name	Description	Default (Range)
n8-54 (056D) Expert	Voltage Error Compensation Time	<div style="display: flex; justify-content: space-between; border-bottom: 1px solid black; margin-bottom: 5px;"> V/f OLV OLV/PM AOLV/PM EZOLV </div> Sets the time constant that the drive uses when adjusting for voltage errors.	1.00 s (0.00 - 10.00 s)

Adjust this parameter in these conditions:

- If oscillation occurs at the time of start up, increase the setting value.
- If hunting occurs when operating at low speed, increase the setting value.
- If fast changes in the load cause hunting, increase the setting value in 0.1-unit increments. If you cannot stop hunting, set *n8-51 [Pull-in Current @ Acceleration]* to 0% and set *n8-54* to 0.00 s, and disable compensation for voltage errors.

■ n8-55: Motor to Load Inertia Ratio

No. (Hex.)	Name	Description	Default (Range)
n8-55 (056E)	Motor to Load Inertia Ratio	<div style="display: flex; justify-content: space-between; align-items: center;"> V/f OLV OLV/PM AOLV/PM EZOLV </div> Sets the ratio between motor inertia and machine inertia.	0 (0 - 3)

Sets the ratio between motor inertia and machine inertia to adjust the ACR.

Adjust in the following situations.

- If torque and speed response are unsatisfactory, gradually increase the setting from 0.
- If the motor does not run smoothly, gradually increase the setting from 0.
- If the motor stalls during run at constant speed, gradually increase the setting from 0.
- If there is vibration or hunting, decrease the setting.

Note:

- If the value too low, the drive will detect *STPo [Motor Step-Out Detected]*.
- If you use one motor or more than motor at low inertia and the value is too high, there can be vibration in the motor.

0 : Below 1:10

Use this setting in these conditions:

- The ratio between the motor inertia and machine inertia is less than 1:10
- There are large current ripples

1 : Between 1:10 and 1:30

Use this setting in these conditions:

- The ratio between the motor inertia and machine inertia is approximately 1:10 to 1:30
- Parameter *n8-55 = 0* and the drive detects *STPo* because of an impact load or sudden acceleration/deceleration.

2 : Between 1:30 and 1:50

Use this setting in these conditions:

- The ratio between the motor inertia and machine inertia is approximately 1:30 to 1:50
- Parameter *n8-55 = 1* and the drive detects *STPo* because of an impact load or sudden acceleration/deceleration.

3 : Beyond 1:50

Adjust this parameter in these conditions:

- The ratio between the motor inertia and machine inertia is more than 1:50
- Parameter *n8-55 = 2* and the drive detects *STPo* because of an impact load or sudden acceleration/deceleration.

■ n8-56: PM High Performance Selection

No. (Hex.)	Name	Description	Default (Range)
n8-56 (056F) Expert	PM High Performance Selection	<div style="display: flex; justify-content: space-between; align-items: center;"> V/f OLV OLV/PM AOLV/PM EZOLV </div> Sets the high efficiency control method for IPM motors. Usually it is not necessary to change this setting.	1 (0 - 2)

0 : Disabled

1 : Enabled (Vd)

2 : Enabled (Vd & Vq)

■ n8-57: HFI Overlap Selection

No. (Hex.)	Name	Description	Default (Range)
n8-57 (0574)	HFI Overlap Selection	<div style="display: flex; justify-content: space-between; align-items: center;"> V/f OLV OLV/PM AOLV/PM EZOLV </div> Sets the function that detects motor speed with high frequency injection.	0 (0, 1)

Note:

- When you set $n8-57 = 1$, do High Frequency Injection Auto-Tuning.
- When there is high frequency injection, the motor will make an excitation sound.
- When you use Zero Speed Control, set $E1-09 = 0.0$ [Minimum Output Frequency = 0.0 Hz].

0 : Disabled

Use this setting with SPM motors. The speed control range is approximately 1:20.

When $n8-57 = 0$, you cannot set $E1-09$ [Minimum Output Frequency] $\leq 1/20$ of the value of $E1-06$ [Base Frequency].

1 : Enabled

The speed control range is 1:100. It gives sufficient speed detection at low speeds.

Note:

- It is not available with an SPM motor.
- The speed control range 1:100 is the momentary operation area. When you operate the motor continuously, make sure that the drive capacity and motor capacity are acceptable.

■ n8-62: Output Voltage Limit Level

No. (Hex.)	Name	Description	Default (Range)
n8-62 (057D) Expert	Output Voltage Limit Level	<div style="display: flex; justify-content: space-between; align-items: center;"> V/f OLV OLV/PM AOLV/PM EZOLV </div> Sets the output voltage limit to prevent saturation of the output voltage. Usually it is not necessary to change this parameter.	200 V Class: 200.0 V, 400 V: 400.0 V (200 V Class: 0.0 to 240.0 V, 400 V Class: 0.0 to 480.0 V)

Set this parameter lower than the input power supply voltage.

Note:

- When $A1-02 = 8$ [EZOLV], the default settings are:
–200 V class: 230.0 V
–400 V class: 460.0 V

■ n8-63: Output Voltage Limit P Gain

No. (Hex.)	Name	Description	Default (Range)
n8-63 (057E) Expert	Output Voltage Limit P Gain	<div style="display: flex; justify-content: space-between; align-items: center;"> V/f OLV OLV/PM AOLV/PM EZOLV </div> Sets the proportional gain for output voltage control. Usually it is not necessary to change this setting.	1.00 (0.00 - 100.00)

■ n8-64: Output Voltage Limit I Time

No. (Hex.)	Name	Description	Default (Range)
n8-64 (057F) Expert	Output Voltage Limit I Time	<div style="display: flex; justify-content: space-between; align-items: center;"> V/f OLV OLV/PM AOLV/PM EZOLV </div> Sets the integral time for output voltage control. Usually it is not necessary to change this setting.	0.040 s (0.000 - 5.000)

■ n8-65: Speed Fdbk Gain @ oV Suppression

No. (Hex.)	Name	Description	Default (Range)
n8-65 (065C) Expert	Speed Fdbk Gain @ oV Suppression	<div style="display: flex; justify-content: space-between; align-items: center;"> V/f OLV OLV/PM AOLV/PM EZOLV </div> Sets the gain of internal speed feedback detection suppression while the overvoltage suppression function is operating as a magnification value. Usually it is not necessary to change this parameter.	1.50 (0.00 - 10.00)

Adjust this parameter in these conditions:

- If there is resonance or hunting when you use the overvoltage suppression function, increase the setting value.
- If motor response is low when you use the overvoltage suppression function, decrease the setting value in 0.05-unit increments.

■ n8-69: Speed Observer Control P Gain

No. (Hex.)	Name	Description	Default (Range)
n8-69 (065D) Expert	Speed Observer Control P Gain	V/f OLV OLV/PM AOLV/PM EZOLV Usually it is not necessary to change this setting. Sets the Proportional gain that the drive uses for speed estimation.	1.00 (0.00 - 20.00)

■ n8-70: Speed Observer Control I Time

No. (Hex.)	Name	Description	Default (Range)
n8-70 (065E) Expert	Speed Observer Control I Time	V/f OLV OLV/PM AOLV/PM EZOLV Sets the speed estimator integral time constant. It is available when $n8-72 = 1$ [Speed Estimation Method Select = Method 2]. Usually it is not necessary to change this setting.	0.0 s (0.0 - 100.0)

■ n8-71: Speed Observer Control D Gain

No. (Hex.)	Name	Description	Default (Range)
n8-71 (065F) Expert	Speed Observer Control D Gain	V/f OLV OLV/PM AOLV/PM EZOLV Set the speed estimator differential gain. It is available when $n8-72 = 1$ [Speed Estimation Method Select = Method 2]. Usually it is not necessary to change this setting.	5.00 (0.00 - 50.00)

■ n8-72: Speed Estimation Method Select

No. (Hex.)	Name	Description	Default (Range)
n8-72 (0655) Expert	Speed Estimation Method Select	V/f OLV OLV/PM AOLV/PM EZOLV Selects the speed estimation method. Usually it is not necessary to change this setting.	1 (0, 1)

0 : Method 1

1 : Method 2

■ n8-73: Observer Mode Switch-Over Speed

No. (Hex.)	Name	Description	Default (Range)
n8-73 (0656) Expert	Observer Mode Switch-Over Speed	V/f OLV OLV/PM AOLV/PM EZOLV Sets the speed level for pull-in current control at motor start as a percentage of $E1-06$ [Base Frequency]. Usually it is not necessary to change this setting.	10% (0 - 100)

■ n8-74: Light Load Iq Level

No. (Hex.)	Name	Description	Default (Range)
n8-74 (05C3) Expert	Light Load Iq Level	V/f OLV OLV/PM AOLV/PM EZOLV Set $n8-48$ [Pull-in/Light Load Id Current] to the percentage of load current (q-axis current) that you will apply, where $E5-03$ [Motor Rated Current (FLA)] = a setting value of 100%.	30% (0 - 255%)

Note:

- If $n8-74 > n8-75$ [Medium Load Iq Level (low)], the drive will detect $oPE08$ [Parameter Selection Error].
- The change is linear between $n8-74$ and $n8-75$ and the level of the pull-in current from $n8-48$ to $n8-78$ [Medium Load Id Current].

■ n8-75: Medium Load Iq Level (low)

No. (Hex.)	Name	Description	Default (Range)
n8-75 (05C4) Expert	Medium Load Iq Level (low)	<div style="display: flex; justify-content: space-between; border-bottom: 1px solid black; padding-bottom: 2px;"> V/f OLV OLV/PM AOLV/PM EZOLV </div> Set n8-78 [Medium Load Id Current] to the percentage of load current (q-axis current) that you will apply, where E5-03 [Motor Rated Current (FLA)] = a setting value of 100%.	50% (0 - 255%)

Note:

- If n8-74 [Light Load Iq Level] > n8-75, the drive will detect oPE08 [Parameter Selection Error].
- The change is linear between n8-74 and n8-75 and the level of the pull-in current from n8-48 to n8-78 [Medium Load Id Current].

■ n8-76: Id Switching Filter Time

No. (Hex.)	Name	Description	Default (Range)
n8-76 (05CD) Expert	Id Switching Filter Time	<div style="display: flex; justify-content: space-between; border-bottom: 1px solid black; padding-bottom: 2px;"> V/f OLV OLV/PM AOLV/PM EZOLV </div> Sets the filter time constant for the d-axis current reference. Usually it is not necessary to change this setting.	200 ms (0 - 5000 ms)

■ n8-77: Heavy Load Iq Level

No. (Hex.)	Name	Description	Default (Range)
n8-77 (05CE) Expert	Heavy Load Iq Level	<div style="display: flex; justify-content: space-between; border-bottom: 1px solid black; padding-bottom: 2px;"> V/f OLV OLV/PM AOLV/PM EZOLV </div> Set n8-49 [Heavy Load Id Current] to the percentage of load current (q-axis current) that you will apply, where E5-03 [Motor Rated Current (FLA)] = a setting value of 100%.	90% (0 - 255%)

Note:

The change is linear between n8-75 [Medium Load Iq Level (low)] and n8-77 and the level of the pull-in current from n8-78 [Medium Load Id Current] to n8-49 [Heavy Load Id Current].

■ n8-78: Medium Load Id Current

No. (Hex.)	Name	Description	Default (Range)
n8-78 (05F4) RUN Expert	Medium Load Id Current	<div style="display: flex; justify-content: space-between; border-bottom: 1px solid black; padding-bottom: 2px;"> V/f OLV OLV/PM AOLV/PM EZOLV </div> Sets the level of the pull-in current as a percentage, where E5-03 [PM Motor Rated Current (FLA)] = 100%.	0% (0 - 255%)

■ n8-79: Pull-in Current @ Deceleration

No. (Hex.)	Name	Description	Default (Range)
n8-79 (05FE)	Pull-in Current @ Deceleration	<div style="display: flex; justify-content: space-between; border-bottom: 1px solid black; padding-bottom: 2px;"> V/f OLV OLV/PM AOLV/PM EZOLV </div> Sets the pull-in current that can flow during deceleration as a percentage of the E5-03 [PM Motor Rated Current (FLA)].	50% (0 - 200%)

If overcurrent occurs during deceleration, slowly decrease the setting in 5% increments.

Note:

When n8-79 = 0, the drive will use the value set in n8-51 [Pull-in Current @ Acceleration].

■ n8-84: Polarity Detection Current

No. (Hex.)	Name	Description	Default (Range)
n8-84 (02D3) Expert	Polarity Detection Current	<div style="display: flex; justify-content: space-between; border-bottom: 1px solid black; padding-bottom: 2px;"> V/f OLV OLV/PM AOLV/PM EZOLV </div> Sets the current that the drive uses to estimate the initial motor magnetic pole as a percentage where E5-03 [PM Motor Rated Current (FLA)] = 100%.	100% (0 - 150%)

WARNING! Sudden Movement Hazard. Make sure that the polarity is correct before you send a Run command. If the drive incorrectly detects the polarity, the drive can rotate in the direction opposite of the Run command and cause serious injury or death.

When you use a Yaskawa motor, check the motor nameplate for an "Si" value and set this parameter $\geq "Si \times 2"$. Consult the motor manufacturer for information about maximum setting values.

Find the Polarity of Magnetic Poles

When you start operation, the drive estimates the magnetic poles and finds the polarity of the magnetic poles.

Use U6-57 [PolePolarityDeterVal] to make sure that the magnetic pole estimate was correct.

When you do High Frequency Injection Auto-Tuning, the drive automatically sets n8-84.

■ n8-87: Output Voltage Limit Method

No. (Hex.)	Name	Description	Default (Range)
n8-87 (02DA)	Output Voltage Limit Method	V/f OLV OLV/PM AOLV/PM EZOLV Sets the method of output voltage limit. If there is vibration in the constant output range, set Feedforward Method. Usually it is not necessary to change this setting.	0 (0, 1)

0 : Feedback Method

1 : Feedforward Method

■ n8-88: Vout Limit Switching Level

No. (Hex.)	Name	Description	Default (Range)
n8-88 (02BD)	Vout Limit Switching Level	V/f OLV OLV/PM AOLV/PM EZOLV Sets the current level at which output voltage limit sequence selection occurs as a percentage where the motor rated current is 100%. Normally there is no need to change this setting.	400% (0 - 400%)

■ n8-89: Vout Limit Switching Hysteresis

No. (Hex.)	Name	Description	Default (Range)
n8-89 (02BE)	Vout Limit Switching Hysteresis	V/f OLV OLV/PM AOLV/PM EZOLV Sets the hysteresis width of the current level at which output voltage limit sequence selection occurs as a percentage where the motor rated current is 100%. Normally there is no need to change this setting.	3% (0 - 400%)

■ n8-90: Vout Limit Switching Speed

No. (Hex.)	Name	Description	Default (Range)
n8-90 (02BF)	Vout Limit Switching Speed	V/f OLV OLV/PM AOLV/PM EZOLV Sets the speed level at which output voltage limit sequence selection occurs as a percentage where the maximum output frequency is 100%. Usually it is not necessary to change this setting.	200% (0 - 200%)

■ n8-91: Id Limit at Voltage Saturation

No. (Hex.)	Name	Description	Default (Range)
n8-91 (02F7)	Id Limit at Voltage Saturation	V/f OLV OLV/PM AOLV/PM EZOLV Sets the limit value of feedback output voltage limit Id operation. Enabled when n8-87 = 0 [Output Voltage Control Selection = Speed Feedback Form]. Usually it is not necessary to change this setting.	-50% (-200 - 0%)

■ n8-94: Flux Position Estimation Method

No. (Hex.)	Name	Description	Default (Range)
n8-94 (012D) Expert	Flux Position Estimation Method	V/f OLV OLV/PM AOLV/PM EZOLV Sets the criteria that the drive uses to find changes in speed or load. Usually it is not necessary to change this setting.	1 (0, 1)

0 : Softstarter

1 : Speed Feedback

Set $n8-57 = 1$ [*HFI Overlap Selection = Enabled*] to enable this parameter. Increases the stability when the speed or load suddenly change, for example with rapid acceleration/deceleration or impact loads.

■ **n8-95: Flux Position Est Filter Time**

No. (Hex.)	Name	Description	Default (Range)
n8-95 (012E) Expert	Flux Position Est Filter Time	<div style="display: flex; justify-content: space-between; border-bottom: 1px solid black; margin-bottom: 5px;"> V/f OLV OLV/PM AOLV/PM EZOLV </div> Sets the time constant of the filter used for the recognition criteria value for speed and load changes. Usually it is not necessary to change this setting.	30 ms (0 - 100 ms)

Note:

Enabled when $n8-94 = 1$ [*Flux Position Estimation Method = Speed Feedback*].

◆ **nA: PM Motor Control Tuning**

nA parameters make adjustments for controlling PM motors.

■ **nA-01: Observer Calc Gain 3**

No. (Hex.)	Name	Description	Default (Range)
nA-01 (3129) Expert	Observer Calc Gain 3	<div style="display: flex; justify-content: space-between; border-bottom: 1px solid black; margin-bottom: 5px;"> V/f OLV OLV/PM AOLV/PM EZOLV </div> Sets the gain for speed estimation. Usually it is not necessary to change this setting.	30.0 (0.0 - 1000.0)

12.11 o: Keypad-Related Settings

o parameters set keypad functions.

Note:

You cannot use the optional LED keypad to set these parameters.

Table 12.64 Parameters You Cannot Set with the LED Keypad

No.	Name	No.	Name
o1-05	LCD Contrast Adjustment	o3-04	Select Backup/Restore Location
o1-24 to o1-35	Custom Monitor 1 to 12	o3-05	Select Items to Backup/Restore
o1-36	LCD Backlight Brightness	o3-06	Auto Parameter Backup Selection
o1-37	LCD Backlight ON/OFF Selection	o3-07	Auto Parameter Backup Interval
o1-38	LCD Backlight Off-Delay	o4-22	Time Format
o1-39	Show Initial Setup Screen	o4-23	Date Format
o1-40	Home Screen Display Selection	o4-24	bAT Detection Selection
o1-41 to o1-46	1st to 3rd Monitor Area Selections/Settings	o5-01	Log Start/Stop Selection
o1-47 to o1-51	Trend Plot 1 or 2 Scale Settings	o5-02	Log Sampling Interval
o1-55 to o1-56	Analog Gauge Area Selection/Setting	o5-03 to o5-12	Log Monitor Data 1 to 10
o2-27	bCE Detection Selection		

◆ o1: Keypad Display Selection

o1 parameters select the parameters shown on the initial keypad screen and to configure the parameter setting units and display units. These parameters also adjust the backlight and contrast of the LCD display.

■ Home Screen Display Format

o1-40 [Home Screen Display Selection] changes the display of the monitor shown on the Home screen. You can show numerical values or one of these three displays on the Home screen monitor:

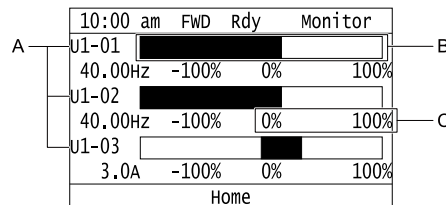

- A - Set *Ux-xx* [Monitors] to o1-24, o1-25, and o1-26. C - Set display ranges to o1-42, o1-44, and o1-46.**
B - Set display regions to o1-41, o1-43, and o1-45.

Figure 12.125 Bar Graph Display

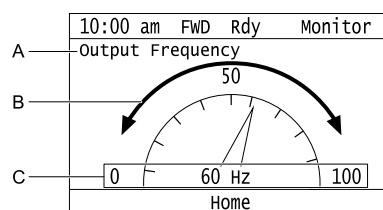

- A - Set *Ux-xx* [Monitors] to o1-24. C - Set display ranges to o1-55.**
B - Set display regions to o1-56.

Figure 12.126 Analog Gauge Display

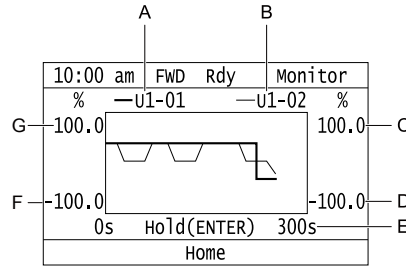

- A - Set *Ux-xx [Monitors] (Monitor 1)* to *o1-24*.
- B - Set *Ux-xx [Monitors] (Monitor 2)* to *o1-25*.
- C - Set the maximum value of Monitor 2 to *o1-50*.
- D - Set the minimum value of Monitor 2 to *o1-49*.
- E - Set the time scale to *o1-51*.
- F - Set the minimum value of Monitor 1 to *o1-47*.
- G - Set the maximum value of Monitor 1 to *o1-48*.

Figure 12.127 Trend Plot Display

■ **o1-01: User Monitor Selection**

No. (Hex.)	Name	Description	Default (Range)
o1-01 (0500) RUN	User Monitor Selection	<div style="display: flex; gap: 5px;"> V/f OLV OLV/PM AOLV/PM EZOLV </div> <p>Sets the <i>U monitor</i> for the Drive Mode. This parameter is only available with an LED keypad.</p>	106 (104 - 855)

When the drive is in Drive Mode, push on the keypad to cycle through this data: frequency reference → rotational direction → output frequency → output current → *o1-01* selection.

Set the *x-xx* part of *Ux-xx* that is shown in the fifth position in Drive Mode. For example, to show *U1-05 [Motor Speed]*, set *o1-01 = 105*.

Note:

The monitors that you can select are different for different control methods.

■ **o1-02: Monitor Selection at Power-up**

No. (Hex.)	Name	Description	Default (Range)
o1-02 (0501) RUN	Monitor Selection at Power-up	<div style="display: flex; gap: 5px;"> V/f OLV OLV/PM AOLV/PM EZOLV </div> <p>Sets the monitor item that the keypad screen shows after you energize the drive. Refer to "U: Monitors" for information about the monitor items that the keypad screen can show. This parameter is only available with an LED keypad.</p>	1 (1 - 5)

1 : Frequency Reference (U1-01)

2 : Direction

3 : Output Frequency (U1-02)

4 : Output Current (U1-03)

5 : User Monitor (o1-01)

Shows the monitor item selected in *o1-01 [User Monitor Selection]*.

■ **o1-03: Frequency Display Unit Selection**

No. (Hex.)	Name	Description	Default (Range)
o1-03 (0502)	Frequency Display Unit Selection	<div style="display: flex; gap: 5px;"> V/f OLV OLV/PM AOLV/PM EZOLV </div> <p>Sets the display units for the frequency reference and output frequency.</p>	Determined by A1-02 (0 - 3)

Note:

- Select the setting unit of these parameters:
 - d1-01 to d1-17 [Reference 1 to 17]
 - U1-01 [Frequency Reference]
 - U1-02 [Output Frequency]
 - U1-05 [Motor Speed]
 - U1-16 [SFS Output Frequency]
 - U4-14 [PeakHold Output Freq]
- For monitor 2, the setting value is always 0 [Hz Unit].

0 : 0.01 Hz**1 : 0.01% (100% = E1-04)**

The maximum output frequency is 100%.

2 : min⁻¹ (r/min) units

The drive uses the maximum output frequency and number of motor poles to calculate this value automatically.

Note:

When you set *o1-03* = 2 [min⁻¹ (r/min) units], make sure that you set the number of motor poles in these parameters:

- E2-04 [Motor Pole Count]
- E4-04 [Motor 2 Motor Poles]
- E5-04 [PM Motor Pole Count]
- E9-08 [Number of Poles]

3 : User Units (o1-10 & o1-11)

Uses *o1-10* and *o1-11* to set the unit of measure. The value of parameter *o1-10* is the value when you remove the decimal point from the maximum output frequency. Parameter *o1-11* is to the number of digits after the decimal point in the maximum output frequency.

To display a maximum output frequency of 100.00, set parameters to these values:

- o1-10 = 10000
- o1-11 = 2 [User Units Decimal Position = 2 Dec (XXX.XX)]

■ o1-04: V/f Pattern Display Unit

No. (Hex.)	Name	Description	Default (Range)
o1-04 (0503)	V/f Pattern Display Unit	<div style="display: flex; gap: 5px;"> V/f OLV OLV/PM AOLV/PM EZOLV </div> Sets the setting unit for parameters that set the V/f pattern frequency.	Determined by A1-02 (0, 1)

Note:

- Select the setting unit of these parameters:
 - E1-04 [Maximum Output Frequency]
 - E1-06 [Base Frequency]
 - E1-07 [Mid Point A Frequency]
 - E1-09 [Minimum Output Frequency]
 - E1-11 [Mid Point B Frequency]
 - E9-02 [Maximum Speed]
 - E9-04 [Base Frequency]
- For monitor 2, the setting value is always 0 [Hz Unit].

0 : Hz**1 : min⁻¹ (r/min) units**

When you set *o1-04* = 1, make sure that you set the number of motor poles in these parameters:

- E5-04 [PM Motor Pole Count]
- E9-08 [Motor Pole Count]

■ **o1-05: LCD Contrast Adjustment**

No. (Hex.)	Name	Description	Default (Range)
o1-05 (0504) RUN	LCD Contrast Adjustment	V/f OLV OLV/PM AOLV/PM EZOLV Sets the contrast of the LCD display on the keypad.	5 (0 - 10)

When you decrease the setting value, the contrast of the LCD display decreases. When you increase the setting value, the contrast increases.

■ **o1-10: User Units Maximum Value**

No. (Hex.)	Name	Description	Default (Range)
o1-10 (0520)	User Units Maximum Value	V/f OLV OLV/PM AOLV/PM EZOLV Sets the value that the drive shows as the maximum output frequency.	Determined by o1-03 (1 - 60000)

To display a maximum output frequency of 100.00, set parameters to these values:

- o1-10 = 10000
- o1-11 = 2 [User Units Decimal Position = Two Decimal Places (XXX.XX)]

Note:

Set o1-03 = 3 [Frequency Display Unit Selection = User Units (o1-10 & o1-11)] before you set o1-10 and o1-11.

■ **o1-11: User Units Decimal Position**

No. (Hex.)	Name	Description	Default (Range)
o1-11 (0521)	User Units Decimal Position	V/f OLV OLV/PM AOLV/PM EZOLV Sets the number of decimal places for frequency reference and monitor values.	Determined by o1-03 (0 - 3)

0 : No Decimal Places (XXXXX)

1 : One Decimal Places (XXXX.X)

2 : Two Decimal Places (XXX.XX)

3 : Three Decimal Places (XX.XXX)

Note:

Set o1-03 = 3 [Frequency Display Unit Selection = User Units (o1-10 & o1-11)] before you set o1-10 [User Units Maximum Value] and o1-11.

■ **o1-24 to o1-35: Custom Monitor 1 to 12**





No. (Hex.)	Name	Description	Default (Range)
o1-24 to o1-35: (11AD - 11B8) RUN	Custom Monitor 1 to 12	V/f OLV OLV/PM AOLV/PM EZOLV Sets a maximum of 12 monitors as user monitors. This parameter is only available when using an LCD keypad.	o1-24: 101 o1-25: 102 o1-26: 103 o1-27 to o1-35: 0 (0, 101 - 999)

These parameters save the monitor items selected by the LCD keypad [Custom Monitor].

Note:





- You can show a maximum of three selected monitors on one LCD keypad screen.
 - When you select only one monitor, the text size of this monitor increases. For example, when $o1-25$ to $o1-35 = 0$, the text size of the monitor saved in $o1-24$ increases.
 - When you select two monitors, the text size of these monitors increase.
 - When you select four or more monitors, the fourth monitor and all additional monitors are shown on the next screens.
- Monitors selected with $o1-24$ to $o1-26$ can be displayed as a bar graph, analog gauge, or trend plot.
 - Bar graph display: 3 monitors maximum
Select with $o1-24$, $o1-25$, and $o1-26$.
 - Analog gauge display: 1 monitor
Select with $o1-24$.
 - Trend plot display: 2 monitors
Select with $o1-24$ and $o1-25$.
- You can only set parameters $o1-24$ to $o1-26$ with analog output monitors.
- You can set all monitors to parameters $o1-27$ to $o1-35$.

■ o1-36: LCD Backlight Brightness

No. (Hex.)	Name	Description	Default (Range)
o1-36 (11B9) RUN	LCD Backlight Brightness	     Sets the intensity of the LCD keypad backlight.	5 (1 - 5)

When you decrease the setting value, the intensity of the backlight decreases.

■ o1-37: LCD Backlight ON/OFF Selection

No. (Hex.)	Name	Description	Default (Range)
o1-37 (11BA) RUN	LCD Backlight ON/OFF Selection	     Sets the automatic shut off function for the LCD backlight.	1 (0, 1)

Note:



Use $o1-36$ [LCD Backlight Brightness] to adjust the intensity of the LCD backlight.

0 : OFF

The backlight will automatically turn off after the time set in $o1-38$ [LCD Backlight Off-Delay] is expired.

When the backlight is off, push a key on the keypad to temporarily turn the backlight on. After the backlight turns on, it will turn off automatically after the time set in $o1-38$ is expired.





Note:

When the backlight is off, push a key on the keypad to temporarily turn the backlight on. Push any key to start keypad operation. Push  to turn the backlight on, then push  again to enter a Run command to the drive.

1 : ON

The backlight will always be ON.

■ o1-38: LCD Backlight Off-Delay

No. (Hex.)	Name	Description	Default (Range)
o1-38 (11BB) RUN	LCD Backlight Off-Delay	     Sets the time until the LCD backlight automatically turns off.	60 s (10 - 300 s)

When $o1-37 = 0$ [LCD Backlight ON/OFF Selection = OFF], the backlight will automatically turn off after the time set in $o1-38$ expires.

When the backlight is off, push a key on the keypad to temporarily turn the backlight on. After the backlight turns on, it will turn off automatically after the time set in $o1-38$ is expired.

■ o1-39: Show Initial Setup Screen

No. (Hex.)	Name	Description	Default (Range)
o1-39 (11BC) RUN	Show Initial Setup Screen	<div style="display: flex; gap: 5px;"> V/f OLV OLV/PM AOLV/PM EZOLV </div> <p>Sets the function to show the LCD keypad initial setup screen each time you energize the drive. This parameter is only available with an LCD keypad.</p>	1 (0, 1)

The initial setup screen shows a menu where you can select the display language, set the date, time, and other basic settings. When you set this parameter to 0, the drive will not show this screen each time you energize the drive.

0 : No

The drive will not show the initial setup display screen each time you energize the drive. The drive will show the Home screen.

1 : Yes

When you input the Run command before you energize the drive or when you turn on the Run command while the drive shows the initial setup screen, the drive will replace the initial setup screen with the Home screen.

■ o1-40: Home Screen Display Selection

No. (Hex.)	Name	Description	Default (Range)
o1-40 (11BD) RUN	Home Screen Display Selection	<div style="display: flex; gap: 5px;"> V/f OLV OLV/PM AOLV/PM EZOLV </div> <p>Sets the monitor display mode for the Home screen. This parameter is only available with an LCD keypad.</p>	0 (0 - 3)

0 : Custom Monitor

1 : Bar Graph

2 : Analog Gauge

3 : Trend Plot

■ o1-41: 1st Monitor Area Selection

No. (Hex.)	Name	Description	Default (Range)
o1-41 (11C1) RUN	1st Monitor Area Selection	<div style="display: flex; gap: 5px;"> V/f OLV OLV/PM AOLV/PM EZOLV </div> <p>Sets the horizontal axis value used to display the monitor set in o1-24 [Custom Monitor 1] as a bar graph. This parameter is only available with an LCD keypad.</p>	0 (0 - 1)

0 : +/- Area (- o1-42 ~ o1-42)

1 : + Area (0 ~ o1-42)

■ o1-42: 1st Monitor Area Setting

No. (Hex.)	Name	Description	Default (Range)
o1-42 (11C2) RUN	1st Monitor Area Setting	<div style="display: flex; gap: 5px;"> V/f OLV OLV/PM AOLV/PM EZOLV </div> <p>Sets the horizontal axis value used to display the monitor set in o1-24 [Custom Monitor 1] as a bar graph. This parameter is only available with an LCD keypad.</p>	100.0% (0.0 - 100.0%)

■ o1-43: 2nd Monitor Area Selection

No. (Hex.)	Name	Description	Default (Range)
o1-43 (11C3) RUN	2nd Monitor Area Selection	<div style="display: flex; gap: 5px;"> V/f OLV OLV/PM AOLV/PM EZOLV </div> <p>Selects the horizontal range used to display the monitor set in o1-25 [Custom Monitor 2] as a bar graph. This parameter is only available with an LCD keypad.</p>	0 (0 - 1)

0 : +/- Area (- o1-44 ~ o1-44)

1 : + Area (0 ~ o1-44)

■ o1-44: 2nd Monitor Area Setting

No. (Hex.)	Name	Description	Default (Range)
o1-44 (11C4) RUN	2nd Monitor Area Setting	<div style="display: flex; justify-content: space-between; align-items: center;"> V/f OLV OLV/PM AOLV/PM EZOLV </div> <p>Sets the horizontal axis value used to display the monitor set in o1-25 [Custom Monitor 2] as a bar graph. This parameter is only available with an LCD keypad.</p>	100.0% (0.0 - 100.0%)

■ o1-45: 3rd Monitor Area Selection

No. (Hex.)	Name	Description	Default (Range)
o1-45 (11C5) RUN	3rd Monitor Area Selection	<div style="display: flex; justify-content: space-between; align-items: center;"> V/f OLV OLV/PM AOLV/PM EZOLV </div> <p>Sets the horizontal axis value used to display the monitor set in o1-26 [Custom Monitor 3] as a bar graph. This parameter is only available with an LCD keypad.</p>	0 (0 - 1)

0 : +/- Area (- o1-46 ~ o1-46)

1 : + Area (0 ~ o1-46)

■ o1-46: 3rd Monitor Area Setting

No. (Hex.)	Name	Description	Default (Range)
o1-46 (11C6) RUN	3rd Monitor Area Setting	<div style="display: flex; justify-content: space-between; align-items: center;"> V/f OLV OLV/PM AOLV/PM EZOLV </div> <p>Sets the horizontal axis value used to display the monitor set in o1-26 [Custom Monitor 3] as a bar graph. This parameter is only available with an LCD keypad.</p>	100.0% (0.0 - 100.0%)

■ o1-47: Trend Plot 1 Scale Minimum Value

No. (Hex.)	Name	Description	Default (Range)
o1-47 (11C7) RUN	Trend Plot 1 Scale Minimum Value	<div style="display: flex; justify-content: space-between; align-items: center;"> V/f OLV OLV/PM AOLV/PM EZOLV </div> <p>Sets the horizontal axis minimum value used to display the monitor set in o1-24 [Custom Monitor 1] as a trend plot. This parameter is only available with an LCD keypad.</p>	-100.0% (-300.0 - +299.9%)

Note:

Parameter o1-48 [Trend Plot 1 Scale Maximum Value] sets the upper limit. The upper limit is (o1-48 - 0.1)%.

■ o1-48: Trend Plot 1 Scale Maximum Value

No. (Hex.)	Name	Description	Default (Range)
o1-48 (11C8) RUN	Trend Plot 1 Scale Maximum Value	<div style="display: flex; justify-content: space-between; align-items: center;"> V/f OLV OLV/PM AOLV/PM EZOLV </div> <p>Sets the maximum value for the vertical axis used to display the monitor that was set in o1-24 [Custom Monitor 1] as a trend plot. This parameter is only available with an LCD keypad.</p>	100.0% (-299.9 - +300.0%)

Note:

Parameter o1-47 [Trend Plot 1 Scale Minimum Value] sets the lower limit. The lower limit is (o1-47 + 0.1)%.

■ o1-49: Trend Plot 2 Scale Minimum Value

No. (Hex.)	Name	Description	Default (Range)
o1-49 (11C9) RUN	Trend Plot 2 Scale Minimum Value	<div style="display: flex; justify-content: space-between; align-items: center;"> V/f OLV OLV/PM AOLV/PM EZOLV </div> <p>Sets the horizontal axis minimum value used to display the monitor set in o1-25 [Custom Monitor 2] as a trend plot. This parameter is only available with an LCD keypad.</p>	-100.0% (-300.0 - +299.9%)

Note:

Parameter o1-50 [Trend Plot 2 Scale Maximum Value] sets the upper limit. The upper limit is (o1-50 - 0.1)%.

■ o1-50: Trend Plot 2 Scale Maximum Value

No. (Hex.)	Name	Description	Default (Range)
o1-50 (11CA) RUN	Trend Plot 2 Scale Maximum Value	<div style="display: flex; justify-content: space-between; align-items: center;"> V/f OLV OLV/PM AOLV/PM EZOLV </div> <p>Sets the maximum value for the vertical axis used to display the monitor that was set in <i>o1-25</i> [<i>Custom Monitor 2</i>] as a trend plot. This parameter is only available with an LCD keypad.</p>	100.0% (-299.9 - +300.0%)

Note:

Parameter *o1-49* [*Trend Plot 2 Scale Minimum Value*] sets the lower limit. The lower limit is (*o1-49* + 0.1)%.

■ o1-51: Trend Plot Time Scale Setting

No. (Hex.)	Name	Description	Default (Range)
o1-51 (11CB) RUN	Trend Plot Time Scale Setting	<div style="display: flex; justify-content: space-between; align-items: center;"> V/f OLV OLV/PM AOLV/PM EZOLV </div> <p>Sets the time scale (horizontal axis) to display the trend plot. When you change this setting, the drive automatically adjusts the data sampling time. This parameter is only available with an LCD keypad.</p>	300 s (1 - 3600 s)

■ o1-55: Analog Gauge Area Selection

No. (Hex.)	Name	Description	Default (Range)
o1-55 (11EE) RUN	Analog Gauge Area Selection	<div style="display: flex; justify-content: space-between; align-items: center;"> V/f OLV OLV/PM AOLV/PM EZOLV </div> <p>Sets the range used to display the monitor set in <i>o1-24</i> [<i>Custom Monitor 1</i>] as an analog gauge. This parameter is only available with an LCD keypad.</p>	1 (0, 1)

0 : +/- Area (- o1-56 ~ o1-56)

1 : + Area (0 ~ o1-56)

■ o1-56: Analog Gauge Area Setting

No. (Hex.)	Name	Description	Default (Range)
o1-56 (11EF) RUN	Analog Gauge Area Setting	<div style="display: flex; justify-content: space-between; align-items: center;"> V/f OLV OLV/PM AOLV/PM EZOLV </div> <p>Sets the value used to display the monitor set in <i>o1-24</i> [<i>Custom Monitor 1</i>] as an analog meter. This parameter is only available with an LCD keypad.</p>	100.0% (0.0 - 100.0%)

■ o1-58: Motor Power Unit Selection

No. (Hex.)	Name	Description	Default (Range)
o1-58 (3125)	Motor Power Unit Selection	<div style="display: flex; justify-content: space-between; align-items: center;"> V/f OLV OLV/PM AOLV/PM EZOLV </div> <p>Sets the setting unit for parameters that set the motor rated power.</p>	1 (0, 1)

The drive shows these parameter values in the set units:

- E2-11 [Motor Rated Power]
- E4-11 [Motor 2 Rated Power]
- E5-02 [PM Motor Rated Power]
- E9-07 [Motor Rated Power]
- T1-02 [Motor Rated Power]
- T2-04 [PM Motor Rated Power]
- T4-08 [Motor Rated Capacity]

0 : kW

Shows the motor output in kW units.

1 : HP







Shows the motor output in HP units.

Note:

When you use an LED keypad, use *o1-58* to make sure that the units for the monitors and parameters are correct.

◆ o2: Keypad Operation

■ o2-01: LO/RE Key Function Selection

No. (Hex.)	Name	Description	Default (Range)
o2-01 (0505)	LO/RE Key Function Selection	     Sets the function that lets you use  to switch between LOCAL and REMOTE Modes.	1 (0, 1)

0 : Disabled

You cannot use  to switch between LOCAL and REMOTE Modes.

1 : Enabled

You can use  to switch between LOCAL and REMOTE Modes when the drive is stopped. When LOCAL Mode is selected,  on the keypad will come on.







WARNING! Sudden Movement Hazard. If you change the control source when b1-07 = 1 [LOCAL/REMOTE Run Selection = Accept Existing RUN Command], the drive can start suddenly. Before you change the control source, remove all personnel from the area around the drive, motor, and load. Sudden starts can cause serious injury or death.

WARNING! Sudden Movement Hazard. Fully examine all mechanical and electrical connections before you change o2-01 [LO/RE Key Function Selection] or b1-07 [LOCAL/REMOTE Run Selection]. Sudden starts can cause serious injury or death. If b1-07 = 1 [Accept Existing RUN Command] and there is an active Run command when you switch from LOCAL to REMOTE Mode, the drive can start suddenly.

Table 12.65 Function Settings with o2-01 and b1-07

 Function Selection	LOCAL/REMOTE Run Selection	Switching from LOCAL Mode to REMOTE Mode	Switching from REMOTE Mode to LOCAL Mode
o2-01 = 0 [Disabled]	b1-07 = 0 [Disregard Existing RUN Command]	The drive will not switch modes.	The drive will not switch modes.
	b1-07 = 1 [Accept Existing RUN Command]		
o2-01 = 1 [Enabled]	b1-07 = 0 [Disregard Existing RUN Command]	The drive will not start operating although the Run command is active. When you set Run command to active again, the drive will start to run.	The drive cannot operate because the Run command is not enabled.
	b1-07 = 1 [Accept Existing RUN Command]	When the Run command is active, the drive will start to run immediately when the mode switches from LOCAL to REMOTE.	The drive cannot operate because the Run command is not enabled.

■ o2-02: STOP Key Function Selection

No. (Hex.)	Name	Description	Default (Setting Range)
o2-02 (0506)	STOP Key Function Selection	     Sets the function to use  on the keypad to stop the drive when the Run command source for the drive is REMOTE (external) and not assigned to the keypad.	1 (0, 1)





0 : Disabled

1 : Enabled

 stays enabled when the Run command source has not been assigned to the keypad.

To start the drive again after you push  to stop operation, turn the external Run command OFF and ON again.

■ o2-03: User Parameter Default Value

No. (Hex.)	Name	Description	Default (Range)
o2-03 (0507)	User Parameter Default Value	     Sets the function to keep the settings of changed parameters as user parameter defaults to use during initialization.	0 (0 - 2)

12.11 o: Keypad-Related Settings

When you set $o2-03 = 1$ [Set defaults], the drive saves changed parameter settings as user parameter setting values in a part of the memory that is isolated from drive parameters.

When you set $A1-03 = 1110$ [Initialize Parameters = User Initialization] to initialize the drive, the drive resets the internal parameter setting values to those user parameter setting values.

0 : No change

1 : Set defaults

Saves changed parameter setting values as user default settings.





Set $o2-03 = 1$ then push  to save the user parameter setting values. After the drive saves the setting value, $o2-03$ automatically resets to 0.

2 : Clear all

Deletes all of the saved user parameter setting values.

Set $o2-03 = 2$ then push  to clear the user parameter setting values. The drive will automatically reset $o2-03$ to 0. If you delete the user parameter setting values, you cannot set $A1-03 = 1110$ to initialize parameters.

■ o2-04: Drive Model (KVA) Selection

No. (Hex.)	Name	Description	Default (Setting Range)
o2-04 (0508)	Drive Model (KVA) Selection	     Sets the Drive Model code. Set this parameter after replacing the control board.	Determined by the drive (-)

NOTICE: Set $o2-04$ [Drive Model (KVA) Selection] correctly. If you set this parameter incorrectly, it will decrease drive performance, cause the protection function to operate incorrectly, and cause damage to the drive.

Note:



When the setting value of $o2-04$ changes, related parameter setting values also change. Refer to [Defaults by Drive Model and Duty Rating ND/HD on page 485](#) for more information.

Table 12.66 lists the relation between $o2-04$ setting values and drive models.

Table 12.66 Drive Models and o2-04 Settings

Drive Model	o2-04 Setting	Drive Model	o2-04 Setting
B001	30	2056	6D
B002	31	2070	6E
B004	32	2082	6F
B006	33	4001	91
B010	34	4002	92
B012	35	4004	93
B018	37	4005	94
2001	60	4007	95
2002	61	4009	96
2004	62	4012	97
2006	63	4018	99
2010	65	4023	9A
2012	66	4031	9C
2021	68	4038	9D
2030	6A	4044	9E
2042	6B	4060	9F



■ o2-05: Home Mode Freq Ref Entry Mode

No. (Hex.)	Name	Description	Default (Setting Range)
o2-05 (0509)	Home Mode Freq Ref Entry Mode	 Sets the function that makes it necessary to push  to use the keypad to change the frequency reference value while in Drive Mode.	0 (0, 1)

0 : ENTER Key Required

You must push  to use the keypad to change the frequency reference value.

1 : Immediate / MOP-style

The frequency reference changes when you enter it with the keypad. This then changes the output frequency. It is not necessary to push . The drive keeps the frequency reference for 5 seconds after you use  and  on the keypad to change the frequency reference value.

■ o2-06: Keypad Disconnect Detection

No. (Hex.)	Name	Description	Default (Range)
o2-06 (050A)	Keypad Disconnect Detection	 Sets the function that stops the drive if you disconnect the keypad connection cable from the drive or if you damage the cable while the keypad is the Run command source.	1 (0, 1)

This parameter continues to operate if the keypad installed to the drive becomes disconnected.

This parameter is enabled in these conditions:

- When $b1-02 = 0$ [Run Command Selection 1 = Keypad] or $b1-16 = 0$ [Run Command Selection 2 = Keypad]
- In LOCAL Mode

0 : Disabled

The drive continues operation when it detects a keypad disconnection.

1 : Enabled

The drive stops operation, detects oPr [Keypad Connection Fault], and the motor coasts to stop when the drive detects a keypad disconnection.

■ o2-07: Keypad RUN Direction @ Power-up

No. (Hex.)	Name	Description	Default (Range)
o2-07 (0527)	Keypad RUN Direction @ Power-up	 Sets the direction of motor rotation when the drive is energized and the keypad is the Run command source.	0 (0, 1)

This parameter is enabled in these conditions:

- When $b1-02 = 0$ [Run Command Selection 1 = Keypad] or $b1-16 = 0$ [Run Command Selection 2 = Keypad]
- In LOCAL Mode

0 : Forward

1 : Reverse

■ o2-09: Reserved

No. (Hex.)	Name	Description	Default (Range)
o2-09 (050D)	Reserved	-	-

■ o2-19: Parameter Write during Uv

No. (Hex.)	Name	Description	Default (Range)
o2-19 (061F) Expert	Parameter Write during Uv	V/f OLV OLV/PM AOLV/PM EZOLV Lets you change parameters during Uv [<i>Undervoltage</i>].	0 (0, 1)

0 : Disable

1 : Enabled

■ o2-23: External 24V Powerloss Detection

No. (Hex.)	Name	Description	Default (Setting Range)
o2-23 (11F8) RUN	External 24V Powerloss Detection	V/f OLV OLV/PM AOLV/PM EZOLV Sets the function to give a warning if the backup external 24 V power supply turns off when the main circuit power supply is in operation.	0 (0, 1)

Note:

The drive will not run when it is operating from one 24-V external power supply.

0 : Disabled

The drive does not detect the loss of the 24-V external power supply.

1 : Enabled

The keypad shows the *L24v* [*Loss of External Power 24 Supply*] indicator if the drive detects the loss of the 24-V external power supply.

Note:

A minor fault signal is not output from *H2-xx = 10* [*MFDO Function Selection = Alarm*].

■ o2-26: Alarm Display at Ext. 24V Power

No. (Hex.)	Name	Description	Default (Range)
o2-26 (1563)	Alarm Display at Ext. 24V Power	V/f OLV OLV/PM AOLV/PM EZOLV When you connect a backup external 24 V power supply, this parameter sets the function to trigger an alarm when the main circuit power supply voltage decreases.	1 (0, 1)

0 : Disabled

The drive will not detect *EP24v* [*External Power 24V Supply*] if the main circuit power supply voltage decreases. The [Ready] light on the LED Status Ring flashes quickly to identify that drive operation is not possible.

1 : Enabled

The drive detects *EP24v* when the main circuit power supply voltage decreases.

Note:

A minor fault signal is not output from *H2-xx = 10* [*MFDO Function Selection = Alarm*].

■ o2-27: bCE Detection Selection

No. (Hex.)	Name	Description	Default (Range)
o2-27 (1565)	bCE Detection Selection	V/f OLV OLV/PM AOLV/PM EZOLV Sets drive operation if the Bluetooth device is disconnected when you operate the drive in Bluetooth Mode.	3 (0 - 4)

0 : Ramp to Stop

1 : Coast to Stop

2 : Fast Stop (Use C1-09)

3 : Alarm Only

4 : No Alarm Display

◆ o3: Copy Function

o3 parameters set the operation of the parameter backup function.

■ o3-01: Copy Keypad Function Selection

No. (Hex.)	Name	Description	Default (Range)
o3-01 (0515)	Copy Keypad Function Selection	V/f OLV OLV/PM AOLV/PM EZOLV Sets the function that saves and copies drive parameters to a different drive with the keypad.	0 (0 - 4)

0 : Copy Select

1 : Backup (drive → keypad)

The parameter setting values are read from the drive and saved in the keypad.

2 : Restore (keypad → drive)

Copies the parameter setting values saved in the keypad to a different drive.

3 : Verify (check for mismatch)

Makes sure that the parameter setting values in the drive agree with the parameters saved in the keypad.

4 : Erase (backup data of keypad)

Deletes the parameter setting values saved in the keypad.

■ o3-02: Copy Allowed Selection

No. (Hex.)	Name	Description	Default (Range)
o3-02 (0516)	Copy Allowed Selection	V/f OLV OLV/PM AOLV/PM EZOLV Sets the copy function when <i>o3-01</i> = 1 [Copy Keypad Function Selection = Backup (drive → keypad)].	0 (0, 1)

Note:

When you select [Parameter Backup] on the keypad menu screen to do the backup function, the drive automatically sets *o3-02* = 1.

0 : Disabled

1 : Enabled

■ o3-04: Select Backup/Restore Location

No. (Hex.)	Name	Description	Default (Range)
o3-04 (0B3E)	Select Backup/Restore Location	V/f OLV OLV/PM AOLV/PM EZOLV Sets the storage location for drive parameters when you back up and restore parameters. This parameter is only available when using an LCD keypad.	0 (0 - 3)

You can use the LCD keypad to make a maximum of 4 parameter backup sets.

0 : Memory Location 1

1 : Memory Location 2

2 : Memory Location 3

3 : Memory Location 4

■ o3-05: Select Items to Backup/Restore

No. (Hex.)	Name	Description	Default (Range)
o3-05 (0BDA)	Select Items to Backup/Restore	V/f OLV OLV/PM AOLV/PM EZOLV Sets which parameters are backed up, restored, and referenced. This parameter is only available when using an LCD keypad.	1 (0, 1)

0 : Standard Parameters

1 : Standard + DWEZ Parameters

Note:

- Parameters *qx-xx* [DriveWorksEZ Parameters] and *rx-xx* [DriveWorksEZ Connections] show when $A1-07 = 1$ or 2 [DriveWorksEZ Function Selection = DWEZ Enabled or Enabled/Disabled wDigital Input].
- The password for DriveWorksEZ PC software is necessary to back up *qx-xx* and *rx-xx*. If you enter an incorrect password, the drive detects *PWEr* [DWEZ Password Mismatch].

■ o3-06: Auto Parameter Backup Selection

No. (Hex.)	Name	Description	Default (Range)
o3-06 (0BDE)	Auto Parameter Backup Selection	<div style="display: flex; gap: 5px;"> V/f OLV OLV/PM AOLV/PM EZOLV </div> <p>Sets the function that automatically backs up parameters. This parameter is only available when using an LCD keypad.</p>	1 (0, 1)

When you connect the drive and keypad, parameters set to the drive are automatically backed up to the keypad as specified by the setting of parameters *o3-06* and *o3-07*.

0 : Disabled

1 : Enabled

Note:

When you replace the LCD keypad then energize the drive, the keypad shows the restore operation screen automatically to restore the drive configuration with the parameters backed up to the LCD keypad. If you connect an LCD keypad that does not have parameter backup data, the keypad will not show the restore operation screen.

■ o3-07: Auto Parameter Backup Interval

No. (Hex.)	Name	Description	Default (Range)
o3-07 (0BDF)	Auto Parameter Backup Interval	<div style="display: flex; gap: 5px;"> V/f OLV OLV/PM AOLV/PM EZOLV </div> <p>Sets the interval at which the automatic parameter backup function saves parameters from the drive to the keypad.</p>	1 (0 - 3)

The drive saves parameter settings to the keypad at these times:

- After you energize the drive and the auto backup period passes.
- When you use ROM enter or the keypad to change parameters, the drive saves those changes in the drive, waits for the auto backup period to pass, then saves those parameters in the keypad.

Note:

The drive can write data to the keypad a maximum of 100,000 times. If you write data to the keypad more than 100,000 times, you must replace the keypad.

0 : Every 10 minutes

1 : Every 30 minutes

2 : Every 60 minutes

3 : Every 12 hours

◆ o4: Maintenance Mon Settings

o4 parameters set the expected service life to help you know when to replace parts. The drive will show an alarm to tell you when the replacement part interval is near.

■ o4-01: Elapsed Operating Time Setting

No. (Hex.)	Name	Description	Default (Range)
o4-01 (050B)	Elapsed Operating Time Setting	<div style="display: flex; gap: 5px;"> V/f OLV OLV/PM AOLV/PM EZOLV </div> <p>Sets the initial value of the cumulative drive operation time in 10-hour units.</p>	0 h (0 - 9999 h)

When you select *o4-01* on the keypad, it will show the current value of *U4-01* in units of 10 hours (h). When you change the setting of *o4-01* through the monitor, the *U4-01* count starts again as specified by the setting of *o4-01*.

Note:

Set this parameter in 10-hour (h) units. When $o4-01 = 30$, $U4-01$ [Cumulative Ope Time] = 300 h.

■ o4-02: Elapsed Operating Time Selection

No. (Hex.)	Name	Description	Default (Range)
o4-02 (050C)	Elapsed Operating Time Selection	<div style="display: flex; gap: 5px;"> V/f OLV OLV/PM AOLV/PM EZOLV </div> Sets the condition that counts the cumulative operation time.	0 (0, 1)

0 : U4-01 Shows Total Power-up Time

Counts the time from when the drive is energized to when it is de-energized.

1 : U4-01 Shows Total RUN Time

Counts the time that the drive outputs voltage.

■ o4-03: Fan Operation Time Setting

No. (Hex.)	Name	Description	Default (Range)
o4-03 (050E)	Fan Operation Time Setting	<div style="display: flex; gap: 5px;"> V/f OLV OLV/PM AOLV/PM EZOLV </div> Sets the value from which to start the cumulative drive cooling fan operation time in 10-hour units.	0 h (0 - 9999 h)

Use monitor *U4-03 [Cooling Fan Ope Time]* to view the total operation time of the cooling fan. When you replace a cooling fan, set *o4-03 = 0* to reset *U4-03*. Select *o4-03* on the keypad to show the current value of *U4-03* in 10-hour (h) units. If you use the monitor to change *o4-03*, the recount of *U4-03* starts with the *o4-03* setting.

Note:

The drive sets *o4-03* in 10-hour (h) units. When *o4-03 = 30*, *U4-03 [Cooling Fan Ope Time]* will show "300 h".

■ o4-05: Capacitor Maintenance Setting

No. (Hex.)	Name	Description	Default (Range)
o4-05 (051D)	Capacitor Maintenance Setting	<div style="display: flex; gap: 5px;"> V/f OLV OLV/PM AOLV/PM EZOLV </div> Sets the <i>U4-05 [CapacitorMaintenance]</i> monitor value.	0% (0 - 150%)

When you replace a drive, set *o4-05 = 0* to reset *U4-05*. When the *o4-05* setting changes, the count of *U4-05* starts again as specified by the setting of *o4-05*. After you complete the configuration, *o4-05* automatically resets to 0.

Note:

The maintenance period changes for different operating environments.

■ o4-07: Softcharge Relay Maintenance Set

No. (Hex.)	Name	Description	Default (Range)
o4-07 (0523)	Softcharge Relay Maintenance Set	<div style="display: flex; gap: 5px;"> V/f OLV OLV/PM AOLV/PM EZOLV </div> Sets the <i>U4-06 [PreChargeRelayMainte]</i> monitor value.	0% (0 - 150%)

When you replace a drive, set *o4-07 = 0* to reset *U4-06*. When the *o4-07* setting changes, the count of *U4-06* starts again as specified by the setting of *o4-07*. After you complete the configuration, *o4-07* automatically resets to 0.

Note:

The maintenance period changes for different operating environments.

■ o4-09: IGBT Maintenance Setting

No. (Hex.)	Name	Description	Default (Range)
o4-09 (0525)	IGBT Maintenance Setting	<div style="display: flex; gap: 5px;"> V/f OLV OLV/PM AOLV/PM EZOLV </div> Sets the <i>U4-07 [IGBT Maintenance]</i> monitor value.	0% (0 - 150%)

When you replace a drive, set *o4-09 = 0* to reset *U4-07*. When the *o4-09* setting changes, the count of *U4-07* starts again as specified by the setting of *o4-09*. After you complete the configuration, *o4-09* automatically resets to 0.

Note:

The maintenance period changes for different operating environments.

■ o4-11: Fault Trace/History Init (U2/U3)

No. (Hex.)	Name	Description	Default (Range)
o4-11 (0510)	Fault Trace/History Init (U2/U3)	V/f OLV OLV/PM AOLV/PM EZOLV Resets the records of Monitors U2-xx [Fault Trace] and U3-xx [Fault History].	0 (0, 1)

Note:

When you initialize the drive with A1-03 [Initialize Parameters], the drive will not reset the records for U2-xx and U3-xx.

0 : Disabled

Keeps the records of Monitors U2-xx and U3-xx.

1 : Enabled

Resets the records for Monitors U2-xx and U3-xx. After the reset, the drive automatically resets o4-11 to 0.

■ o4-12: kWh Monitor Initialization

No. (Hex.)	Name	Description	Default (Range)
o4-12 (0512)	kWh Monitor Initialization	V/f OLV OLV/PM AOLV/PM EZOLV Resets the monitor values for U4-10 [kWh, Lower 4 Digits] and U4-11 [kWh, Upper 5 Digits].	0 (0, 1)

Note:

When you initialize the drive with A1-03 [Initialize Parameters], the drive will not reset U4-10 and U4-11.

0 : No Reset

Keeps the monitor values for U4-10 and U4-11.

1 : Reset

Resets the values of U4-10 and U4-11. After the reset, the drive automatically resets o4-12 to 0.

■ o4-13: RUN Command Counter @ Initialize

No. (Hex.)	Name	Description	Default (Range)
o4-13 (0528)	RUN Command Counter @ Initialize	V/f OLV OLV/PM AOLV/PM EZOLV Resets the monitor values for U4-02 [Num of Run Commands], U4-24 [Number of Runs (Low)], and U4-25 [Number of Runs (High)].	0 (0, 1)

0 : No Reset

Keeps the monitor values for U4-02, U4-24, and U4-25.

1 : Reset

Resets the values of U4-02, U4-24, and U4-25. After the reset, the drive automatically resets o4-13 to 0.

■ o4-22: Time Format

No. (Hex.)	Name	Description	Default (Range)
o4-22 (154F) RUN	Time Format	V/f OLV OLV/PM AOLV/PM EZOLV Sets the time display format. This parameter is only available when using an LCD keypad.	1 (0 - 2)

Sets the display of the time shown in the upper-left of the LCD keypad screen.

0 : 24 Hour Clock

1 : 12 Hour Clock

2 : 12 Hour JP Clock

■ o4-23: Date Format

No. (Hex.)	Name	Description	Default (Range)
o4-23 (1550) RUN	Date Format	<div style="display: flex; gap: 5px;"> V/f OLV OLV/PM AOLV/PM EZOLV </div> Sets the date display format. This parameter is only available when using an LCD keypad.	2 (0 - 2)

Sets the date format that the drive uses for the fault history and other records.

0 : YYYY/MM/DD

1 : DD/MM/YYYY

2 : MM/DD/YYYY

■ o4-24: bAT Detection Selection

No. (Hex.)	Name	Description	Default (Range)
o4-24 (310F) RUN	bAT Detection Selection	<div style="display: flex; gap: 5px;"> V/f OLV OLV/PM AOLV/PM EZOLV </div> Sets the operation when the drive detects <i>bAT</i> [Keypad Battery Low Voltage] and <i>TiM</i> [Keypad Time Not Set]. This parameter is only available when you use an LCD keypad.	0 (0 - 2)

0 : Disable

The drive will not detect *bAT* or *TiM*.

1 : Enable (Alarm Detected)

The keypad shows *bAT* or *TiM* and the drive continues operation. The output terminal set to *Alarm* [H2-01 to H2-03 = 10] activates.

2 : Enable (Fault Detected)

The output turns off and the motor coasts to stop. The output terminal set for *Fault* [H2-01 to H2-03 = E] activates.

◆ o5: Log Function

The data log function saves drive status information as a CSV file in the microSD memory card in the keypad. Monitors *Ux-xx* are the source of data log information. You can record a maximum of 10 monitors.

Change the LCD keypad screen from the main menu to the Diagnostic Tools screen and select the data log function. Set the number of the monitor to record and the sampling time, then start to record the data log.

Table 12.67 Setting Parameters for Data Log Items

No.	Name	Default	Data Log Monitors
o5-03	Log Monitor Data 1	101	U1-01 [Frequency Reference]
o5-04	Log Monitor Data 2	102	U1-02 [Output Frequency]
o5-05	Log Monitor Data 3	103	U1-03 [Output Current]
o5-06	Log Monitor Data 4	107	U1-07 [DC Bus Voltage]
o5-07	Log Monitor Data 5	108	U1-08 [Output Power]
o5-08	Log Monitor Data 6	A1-02 = 0, 5: 000 A1-02 ≠ 0, 5: 105	A1-02 = 0, 5: Not selected A1-02 ≠ 0, 5: U1-05
o5-09	Log Monitor Data 7	110	U1-10
o5-10	Log Monitor Data 8	112	U1-12
o5-11	Log Monitor Data 9	000	Not selected
o5-12	Log Monitor Data 10	000	Not selected

Note:

- Do not de-energize the drive or disconnect the keypad from the drive during log transfer communication. A loss of connection can cause the log function to fail after you restore power or connect the keypad.
- You can use a microSDHC card that has a maximum of 32 GB capacity.

■ Log File Specifications

Item	Specification
File storage location	A folder called [Log_File] is created in the root directory of the microSD card.
Filename	GLOG0xxx.csv Note: [xxx] identifies a 3-digit decimal number
Maximum number of files	999 (GLOG0001.csv to GLOG0999.csv)
Character code	ASCII code
Line break code	<CR><LF>
Separating character	[,] (Commas)
Header rows	First Row: Drive information including the drive model, software version, control method, and sampling time Second Row: Log data information including the monitor number, number decimal points, and unit code

■ Log File Configuration

The [Log_Files] folder is created in the root directory of the micro SD card. This is where the log data is stored as CSV files. Log data files are created in this configuration. The number of rows changes when the number of selected monitors change.

First Row	Drive information
Second Row	Log data information
Third Row	Log data 1
:	Log data 2
:	Log data 3
:	:
Last Row	Log data n

First Row: Drive Information

This example shows the data text strings and data generated for the first row of log data.

Example of generated data: 00,0012,160107111230,GA500,VSVA01010,2,62,1000,000001

No.	Item	Number of Characters	Example	Description
1	Attribute	2	00	[00] shows that the record is a drive information record.
2	File number	4	0012	Generates the [xxx] part (a 3-digit decimal number) of the [GLOG0xxx.csv] filename of the log data in hexadecimal format. Example filename of [GLOG0018.csv]: 018 (Dec.) = 0012 (Hex.)
3	Time stamp ^{*1}	12	160107111230	Date file was generated • Date: 20YY/MM/DD • Time in 24-hour format: HH:MM:SS Example data of [160107111230]: 11:12:30 on January 7, 2016
4	Model	5	GA500	Drive model information
5	Software number	9	VSVA01011	Drive software number
6	Control Method Selection	1	2	Setting value (Hex.) of A1-02 [Control Method Selection]
7	Drive capacity	2	62	Setting value (Hex.) of o2-04 [Drive Model (KVA) Selection]
8	Sampling time	5 (Maximum)	1000	Setting value (Dec.) of o5-02 [Log Sampling Interval] Unit: ms
9	Row number	6	000001	Row number (Hex.) in the data log file

*1 If you do not set the time in the keypad, the text string of [000000000000] is generated to show the time.

Second Row: Log Data Information

This example shows the data text strings and data generated for the second row of log data.

12.11 o: Keypad-Related Settings

No.	Item	Number of Characters	Description
15	Encoding data	4	Log Monitor Data 1 to 10 Code Data (Hex.) Bits 0 through 9 show the encoding of log monitor data 1 through 10. A bit value of 1 shows that the data represents a negative value. (Log monitor data 1 through 10 is absolute value data without encoding) Example when log monitor data 2, 5, and 8 show negative values: Bits 1, 4, and 7 have values of 1, and the encoding data = 0010010010 (Bin.) = 0092 (Hex.)
16	Row number	6	Row number (Hex.) in the data log file

■ o5-01: Log Start/Stop Selection

No. (Hex.)	Name	Description	Default (Range)
o5-01 (1551) RUN	Log Start/Stop Selection	<input type="checkbox"/> V/f <input type="checkbox"/> OLV <input type="checkbox"/> OLV/IPM <input type="checkbox"/> AOLV/IPM <input type="checkbox"/> EZOLV Sets the data log function. This parameter is only available when using an LCD keypad.	0 (0 - 1)

0 : OFF

Stops the data log.

1 : ON

Starts the data log as specified by the sampling cycle set in o5-02 [Log Sampling Interval].

■ o5-02: Log Sampling Interval

No. (Hex.)	Name	Description	Default (Range)
o5-02 (1552) RUN	Log Sampling Interval	<input type="checkbox"/> V/f <input type="checkbox"/> OLV <input type="checkbox"/> OLV/IPM <input type="checkbox"/> AOLV/IPM <input type="checkbox"/> EZOLV Sets the data log sampling cycle. This parameter is only available when using an LCD keypad.	100 ms (100 - 60000 ms)

■ o5-03: Log Monitor Data 1

No. (Hex.)	Name	Description	Default (Range)
o5-03 (1553) RUN	Log Monitor Data 1	<input type="checkbox"/> V/f <input type="checkbox"/> OLV <input type="checkbox"/> OLV/IPM <input type="checkbox"/> AOLV/IPM <input type="checkbox"/> EZOLV Sets the data log monitor. This parameter is only available with an LCD keypad.	101 (000, 101 - 999)

Note:

Set the number of the *U monitor* to record the data log.

For example, to show U1-01 [Frequency Reference], set o5-03 = 101. When it is not necessary to set data log monitors, set this parameter to 000. You cannot set U2 monitor [Fault Trace] or U3 Monitor [Fault History].

■ o5-04: Log Monitor Data 2

No. (Hex.)	Name	Description	Default (Range)
o5-04 (1554) RUN	Log Monitor Data 2	<input type="checkbox"/> V/f <input type="checkbox"/> OLV <input type="checkbox"/> OLV/IPM <input type="checkbox"/> AOLV/IPM <input type="checkbox"/> EZOLV Sets the data log monitor. This parameter is only available when using an LCD keypad.	102 (000, 101 - 999)

Note:

Set the *U monitor* number you will log.

For example, to show U1-02 [Output Frequency], set o5-04 = 102. When it is not necessary to set data log monitor, set this parameter to 000.

■ o5-05: Log Monitor Data 3

No. (Hex.)	Name	Description	Default (Range)
o5-05 (1555) RUN	Log Monitor Data 3	<input type="checkbox"/> V/f <input type="checkbox"/> OLV <input type="checkbox"/> OLV/IPM <input type="checkbox"/> AOLV/IPM <input type="checkbox"/> EZOLV Sets the data log monitor. This parameter is only available with an LCD keypad.	103 (000, 101 - 999)

Note:

Sets the number of the *U* monitor you will log.

For example, to show *U1-03 [Output Current]*, set *o5-05 = 103*. When it is not necessary to set data log monitors, set this parameter to *000*. You cannot select *U2* monitor [*Fault Trace*] or *U3* Monitor [*Fault History*].

■ o5-06: Log Monitor Data 4

No. (Hex.)	Name	Description	Default (Range)
o5-06 (1556) RUN	Log Monitor Data 4	V/f OLV OLV/PM AOLV/PM EZOLV Sets the data log monitor. This parameter is only available with an LCD keypad.	107 (000, 101 - 999)

Note:

Sets the number of the *U* monitor you will log.

For example, to show *U1-07 [DC Bus Voltage]*, set *o5-06 = 107*. When it is not necessary to set data log monitors, set this parameter to *000*. You cannot select *U2* monitor [*Fault Trace*] or *U3* Monitor [*Fault History*].

■ o5-07: Log Monitor Data 5

No. (Hex.)	Name	Description	Default (Range)
o5-07 (1557) RUN	Log Monitor Data 5	V/f OLV OLV/PM AOLV/PM EZOLV Sets the data log monitor. This parameter is only available with an LCD keypad.	108 (000, 101 - 999)

Note:

Sets the number of the *U* monitor you will log.

For example, to show *U1-08 [Output Power]*, set *o5-07 = 108*. When it is not necessary to set data log monitors, set this parameter to *000*. You cannot select *U2* monitor [*Fault Trace*] or *U3* Monitor [*Fault History*].

■ o5-08: Log Monitor Data 6

No. (Hex.)	Name	Description	Default (Setting Range)
o5-08 (1558) RUN	Log Monitor Data 6	V/f OLV OLV/PM AOLV/PM EZOLV Sets the data log monitor. This parameter is only available when using an LCD keypad.	V/f, OLV/PM : 000, OLV, AOLV/PM, EZOLV : 105 (000, 101 - 999)

Note:

Set the *U* monitor number you want to log.

For example, to display *U1-01 [Frequency Reference]*, set *o5-08 = 101*. When it is not necessary to set a data log monitor, set this parameter to *000*. You cannot set *U2* Monitors [*Fault Trace*] or *U3* Monitors [*Fault History*].

■ o5-09: Log Monitor Data 7

No. (Hex.)	Name	Description	Default (Range)
o5-09 (1559) RUN	Log Monitor Data 7	V/f OLV OLV/PM AOLV/PM EZOLV Sets the data log monitor. This parameter is only available when using an LCD keypad.	110 (000, 101 - 999)

Note:

Set the *U* monitor number you will log.

For example, to show *U1-01 [Frequency Reference]*, set *o5-09 = 101*. When it is not necessary to set data log monitor, set this parameter to *000*.

■ o5-10: Log Monitor Data 8

No. (Hex.)	Name	Description	Default (Range)
o5-10 (155A) RUN	Log Monitor Data 8	V/f OLV OLV/PM AOLV/PM EZOLV Sets the data log monitor. This parameter is only available with an LCD keypad.	112 (000, 101 - 999)





12.11 o: Keypad-Related Settings

Note:

Sets the number of the *U monitor* you will log.

For example, to show *U1-01 [Frequency Reference]*, set *o5-10 = 101*. When it is not necessary to set data log monitors, set this parameter to *000*. You cannot select *U2 monitor [Fault Trace]* or *U3 Monitor [Fault History]*.

■ o5-11: Log Monitor Data 9





No. (Hex.)	Name	Description	Default (Range)
o5-11 (155B) RUN	Log Monitor Data 9	     Sets the data log monitor. This parameter is only available with an LCD keypad.	000 (000, 101 - 999)

Note:

Sets the number of the *U monitor* you will log.

For example, to show *U1-01 [Frequency Reference]*, set *o5-11 = 101*. When it is not necessary to set data log monitors, set this parameter to *000*. You cannot select *U2 monitor [Fault Trace]* or *U3 Monitor [Fault History]*.

■ o5-12: Log Monitor Data 10

No. (Hex.)	Name	Description	Default (Range)
o5-12 (155C) RUN	Log Monitor Data 10	     Sets the data log monitor. This parameter is only available with an LCD keypad.	000 (000, 101 - 999)

Note:

Sets the number of the *U monitor* you will log.

For example, to show *U1-01 [Frequency Reference]*, set *o5-12 = 101*. When it is not necessary to set data log monitors, set this parameter to *000*. You cannot select *U2 monitor [Fault Trace]* or *U3 Monitor [Fault History]*.





12.12 T: Auto-Tuning

Numbers identifying the *T* parameters are displayed when an LED keypad is used. The names of the parameters are displayed on the LCD screen of the LCD keypad. Set the following.

- Induction Motor Auto-Tuning
- PM Motor Auto-Tuning
- ASR and Inertia Tuning

◆ T0: Tuning Mode Selection

■ T0-00: Tuning Mode Selection

No. (Hex.)	Name	Description	Default (Range)
T0-00 (1197)	Tuning Mode Selection	     Sets the type of Auto-Tuning.	0 (0, 1)

When you use an LED keypad to do Control Tuning, set the tuning mode in this order:

1. Set $T0-00 = 1$.
2. Set $T3-00$ [*Control Loop Tuning Selection*] to set the tuning mode.

Note:

The available tuning modes are different for different control methods.

0 : Motor Parameter Tuning

1 : Control Tuning





◆ T1: Induction Motor Auto-Tuning

T1 parameters set the Auto-Tuning input data for induction motor tuning.

Note:

- The base frequency of drive dedicated motors and special motors for use with vector control may be lower than the base frequency of general-purpose motors, which is 50 Hz or 60 Hz. In such cases, this lower frequency is used as the value for $E1-06$ [*Base Frequency*] and $E1-04$ [*Maximum Output Frequency*] after Auto-Tuning completes. If the maximum output frequency is too low and causes problems, change the setting of $E1-04$ after Auto-Tuning completes.
- The following induction motor parameters are set automatically.
 - $E1-xx$ [*V/f Pattern for Motor 1*]
 - $E2-xx$ [*Motor Parameters*]
 - $E3-xx$ [*V/f Pattern for Motor 2*]
 - $E4-xx$ [*Motor 2 Parameters*]

■ T1-00: Motor 1/Motor 2 Selection

No. (Hex.)	Name	Description	Default (Range)
T1-00 (0700)	Motor 1/Motor 2 Selection	     Sets which motor to tune when motor 1/2 switching is enabled.	1 (1, 2)

Note:

Set $H1-xx = 16$ [*Motor 2 Selection*] to enable this parameter. When $H1-xx \neq 16$ the keypad will not show this parameter.

1 : Motor 1

Auto-Tuning automatically sets parameters $E1-xx$ and $E2-xx$ for motor 1.

2 : Motor 2

Auto-Tuning automatically sets parameters $E3-xx$ and $E4-xx$ for motor 2. Make sure that you connect motor 2 to the drive for Auto-Tuning.

■ T1-01: Auto-Tuning Mode Selection

No. (Hex.)	Name	Description	Default (Range)
T1-01 (0701)	Auto-Tuning Mode Selection	<input type="radio"/> V/f <input type="radio"/> OLV <input type="radio"/> OLV/PM <input type="radio"/> AOLV/PM <input type="radio"/> EZOLV Sets the type of Auto-Tuning.	Determined by A1-02 (Determined by A1-02)

0 : Rotational Auto-Tuning

1 : Stationary Auto-Tuning 1

2 : Stationary Line-Line Resistance

■ T1-02: Motor Rated Power

No. (Hex.)	Name	Description	Default (Range)
T1-02 (0702)	Motor Rated Power	<input type="radio"/> V/f <input type="radio"/> OLV <input type="radio"/> OLV/PM <input type="radio"/> AOLV/PM <input type="radio"/> EZOLV Uses the units set in o1-58 [Motor Power Unit Selection] to set the motor rated output power.	Determined by o2-04, C6-01 (0.00 - 650.00 HP)

■ T1-03: Motor Rated Voltage

No. (Hex.)	Name	Description	Default (Range)
T1-03 (0703)	Motor Rated Voltage	<input type="radio"/> V/f <input type="radio"/> OLV <input type="radio"/> OLV/PM <input type="radio"/> AOLV/PM <input type="radio"/> EZOLV Sets the rated voltage (V) of the motor. Enter the base speed voltage for constant output motors.	Determined by o2-04, C6-01 (200 V Class: 0.0 - 255.5 V, 400 V Class: 0.0 - 511.0 V)

If you do Auto-Tuning on a drive-dedicated motor or a specialized motor for vector control, the voltage or frequency can be lower than that of a general-purpose motor. Always compare the data from the nameplate or test report with the Auto-Tuning results and check for differences. Enter the voltage necessary to operate the motor in no-load conditions at rated speed for better control precision around rated speed. If the motor test report or the motor nameplate is not available, enter approximately 90% of the motor rated voltage.

If the drive input power supply voltage is low, enter approximately 90% of the input voltage. When the input power supply voltage is low, the current will increase. Make sure that the main power supply capacity is correct and use a molded-case circuit breaker for the drive.

■ T1-04: Motor Rated Current

No. (Hex.)	Name	Description	Default (Range)
T1-04 (0704)	Motor Rated Current	<input type="radio"/> V/f <input type="radio"/> OLV <input type="radio"/> OLV/PM <input type="radio"/> AOLV/PM <input type="radio"/> EZOLV Sets the rated current (A) of the motor.	Determined by o2-04 (10% to 200% of the drive rated current)

Set the motor rated current between 50% and 100% of the drive rated current for the best performance. Enter the current at the motor base speed.

■ T1-05: Motor Base Frequency

No. (Hex.)	Name	Description	Default (Range)
T1-05 (0705)	Motor Base Frequency	<input type="radio"/> V/f <input type="radio"/> OLV <input type="radio"/> OLV/PM <input type="radio"/> AOLV/PM <input type="radio"/> EZOLV Sets the base frequency (Hz) of the motor.	60.0 Hz (0.0 - 590.0 Hz)

When Auto-Tuning is carried out, the value of T1-05 is set to E1-04 [Maximum Output Frequency]. If T1-05 < 40 Hz, E1-04 = 40 Hz. If you operate the drive at a speed that is higher than the base frequency, or if you operate in the field weakening range, set E1-04 (E3-04 for motor 2) to the maximum output frequency after you complete Auto-Tuning.

■ T1-06: Number of Motor Poles

No. (Hex.)	Name	Description	Default (Range)
T1-06 (0706)	Number of Motor Poles	<input type="radio"/> V/f <input checked="" type="radio"/> OLV <input type="radio"/> OLV/PM <input type="radio"/> AOLV/PM <input type="radio"/> EZOLV Sets the number of motor poles.	4 (2 to 120)

■ T1-07: Motor Base Speed

No. (Hex.)	Name	Description	Default (Range)
T1-07 (0707)	Motor Base Speed	<input type="radio"/> V/f <input checked="" type="radio"/> OLV <input type="radio"/> OLV/PM <input type="radio"/> AOLV/PM <input type="radio"/> EZOLV Sets the motor base speed for Auto-Tuning (min ⁻¹ (r/min)).	1750 min ⁻¹ (r/min) (0 - 35400 min ⁻¹ (r/min))

■ T1-09: Motor No-Load Current

No. (Hex.)	Name	Description	Default (Range)
T1-09 (0709)	Motor No-Load Current	<input type="radio"/> V/f <input checked="" type="radio"/> OLV <input type="radio"/> OLV/PM <input type="radio"/> AOLV/PM <input type="radio"/> EZOLV Sets the no-load current of the motor.	- (0A - T1-04; max. of 2999.9)

Note:

The display units are different for different models:

- 0.01 A: B001 - B018, 2001 - 2042, 4001 - 4023
- 0.1 A: 2056 - 2082, 4031 - 4060

The value shown is the no-load current that the drive automatically calculates from the values set in *T1-02 [Motor Rated Power]* and *T1-04 [Motor Rated Current]*. Set the no-load current shown on the motor test report. If the motor test report is not available, do not change this parameter.

■ T1-10: Motor Rated Slip Frequency

No. (Hex.)	Name	Description	Default (Range)
T1-10 (070A)	Motor Rated Slip Frequency	<input type="radio"/> V/f <input checked="" type="radio"/> OLV <input type="radio"/> OLV/PM <input type="radio"/> AOLV/PM <input type="radio"/> EZOLV Sets motor rated slip.	- (0.000 - 20.000 Hz)

Shows 0.000 Hz as the default value. Set the rated slip shown on the motor test report. If the motor test report is not available, do not change this parameter.

■ T1-11: Motor Iron Loss

No. (Hex.)	Name	Description	Default (Range)
T1-11 (070B)	Motor Iron Loss	<input checked="" type="radio"/> V/f <input type="radio"/> OLV <input type="radio"/> OLV/PM <input type="radio"/> AOLV/PM <input type="radio"/> EZOLV Sets the iron loss to calculate the energy-saving coefficient.	Determined by E2-10 or E4-10 (0 - 65535 W)

Note:

The default setting is different for different motor codes and motor parameter settings.

The value shown is *E2-10 [Motor Iron Loss]* or *E4-10 [Motor 2 Iron Loss]* for the motor output set in *T1-02 [Motor Rated Power]*. If the motor test report is available, enter the motor iron loss value to *T1-11*.

■ T1-12: Test Mode Selection

No. (Hex.)	Name	Description	Default (Range)
T1-12 (0BDB)	Test Mode Selection	<input type="radio"/> V/f <input checked="" type="radio"/> OLV <input type="radio"/> OLV/PM <input type="radio"/> AOLV/PM <input type="radio"/> EZOLV Sets the function to enable Test Mode after Stationary Auto-Tuning. When you can operate the motor with a light load attached after Stationary Auto-Tuning is complete, enable this parameter.	0 (0, 1)

0 : No

1 : Yes

After Auto-Tuning, the drive automatically sets *E2-02 [Motor Rated Slip]* and *E2-03 [Motor No-Load Current]* when you operate the motor for the first time in Drive Mode.

Note:

After Auto-Tuning is complete and you set the drive to Drive Mode, operate the motor in these conditions:

- Make sure that you connect all wiring between the drive and motor
- Make sure that a mechanical brake on the motor shaft is not locked
- Keep the motor-load ratio at 30%
- Hold constant speed for longer than 1 second at a minimum of 30% of the speed set in *E1-06 [Base Frequency]* (the default setting is the same as the maximum frequency).

■ T1-13: No-load voltage

No. (Hex.)	Name	Description	Default (Range)
T1-13 (0BDC)	No-load voltage	<div style="display: flex; justify-content: space-between; align-items: center;"> V/f OLV OLV/PM AOLV/PM EZOLV </div> <p>Sets the no-load voltage of the motor. When the no-load voltage at rated speed is available, for example on the motor test report, set the voltage in this parameter. If the no-load voltage is not available, do not change this parameter.</p>	T1-03 × 0.9 (200 V Class: 0.0 - 255.0 V, 400 V Class: 0.0 - 510.0 V)

Note:

- To get the same qualities as a Yaskawa 1000-series drive or previous series drive, set this parameter = *T1-03 [Motor Rated Voltage]*.
- The default setting is different for different models.
 - B001 - B006, 2001 - 2008, 4001 - 4004: T1-03 × 0.85
 - B010 - B018, 2010 - 2082, 4005 - 4060: T1-03 × 0.90

◆ T2: PM Motor Auto-Tuning

T2 parameters set the Auto-Tuning input data for PM motor tuning.

Note:

The drive automatically sets these PM motor parameters:

- E1-xx [V/f Pattern for Motor 1]
- E5-xx [V/f Pattern for Motor 1]

■ T2-01: PM Auto-Tuning Selection

No. (Hex.)	Name	Description	Default (Range)
T2-01 (0750)	PM Auto-Tuning Selection	<div style="display: flex; justify-content: space-between; align-items: center;"> V/f OLV OLV/PM AOLV/PM EZOLV </div> <p>Sets the type of Auto-Tuning for PM motors.</p>	0 (Determined by A1-02)

Note:

Yaskawa recommends PM Rotational Auto-Tuning for specialized motors. Rotational Auto-Tuning rotates the motor to measure the actual induction voltage constants for more accurate control than Stationary Auto-Tuning.

0 : Manual Entry w/ Motor Data Sheet

1 : Stationary (Ld, Lq, R)

2 : Stationary (R Only)

4 : Rotational (Ld, Lq, R, back-EMF)

5 : High Frequency Injection

■ T2-02: PM Motor Code Selection

No. (Hex.)	Name	Description	Default (Range)
T2-02 (0751)	PM Motor Code Selection	<div style="display: flex; justify-content: space-between; align-items: center;"> V/f OLV OLV/PM AOLV/PM EZOLV </div> <p>If the drive is operating an SMRD, SMRA, or SSR1 series Yaskawa PM motor, enter the PM motor code in to align with the rotation speed and motor output.</p>	FFFF (0000 - FFFF)

Enter the motor code to automatically set parameters *T2-03 to T2-14*. When you are operating a specialized motor or a non-Yaskawa motor, set *T2-02 = FFFF* and enter the data from the motor nameplate or the motor test report.

You can only enter the permitted PM motor codes. Different drive control methods will accept different PM motor codes.

■ T2-03: PM Motor Type

No. (Hex.)	Name	Description	Default (Range)
T2-03 (0752)	PM Motor Type	<div style="display: flex; justify-content: space-between; align-items: center;"> V/f OLV OLV/PM AOLV/PM EZOLV </div> Sets the type of PM motor the drive will operate.	1 (0, 1)

0 : IPM motor

IPM motors have magnets in the rotor, and $L_d \neq L_q$.

1 : SPM motor

SPM motors have magnets attached to the surface of the rotor with adhesive material, and $L_d = L_q$.

■ T2-04: PM Motor Rated Power

No. (Hex.)	Name	Description	Default (Range)
T2-04 (0730)	PM Motor Rated Power	<div style="display: flex; justify-content: space-between; align-items: center;"> V/f OLV OLV/PM AOLV/PM EZOLV </div> Uses the units set in o1-58 [Motor Power Unit Selection] to set the PM motor rated output power.	Determined by o2-04, C6-01 (0.00 - 650.00 HP)

■ T2-05: PM Motor Rated Voltage

No. (Hex.)	Name	Description	Default (Range)
T2-05 (0732)	PM Motor Rated Voltage	<div style="display: flex; justify-content: space-between; align-items: center;"> V/f OLV OLV/PM AOLV/PM EZOLV </div> Sets the rated voltage (V) of the motor.	200 V Class: 230.0 V, 400 V Class: 460.0 V (200 V Class: 0.0 - 255.0 V, 400 V Class: 0.0 - 510.0 V)

■ T2-06: PM Motor Rated Current

No. (Hex.)	Name	Description	Default (Range)
T2-06 (0733)	PM Motor Rated Current	<div style="display: flex; justify-content: space-between; align-items: center;"> V/f OLV OLV/PM AOLV/PM EZOLV </div> Sets the rated current (A) of the motor.	Determined by o2-04 (10% to 200% of the drive rated current)

■ T2-07: PM Motor Base Frequency

No. (Hex.)	Name	Description	Default (Range)
T2-07 (0753)	PM Motor Base Frequency	<div style="display: flex; justify-content: space-between; align-items: center;"> V/f OLV OLV/PM AOLV/PM EZOLV </div> Sets the base frequency (Hz) of the motor.	60.0 Hz (0.0 - 590.0 Hz)

■ T2-08: Number of PM Motor Poles

No. (Hex.)	Name	Description	Default (Range)
T2-08 (0734)	Number of PM Motor Poles	<div style="display: flex; justify-content: space-between; align-items: center;"> V/f OLV OLV/PM AOLV/PM EZOLV </div> Sets the number of motor poles.	4 (2 - 120)

■ T2-09: PM Motor Base Speed

No. (Hex.)	Name	Description	Default (Range)
T2-09 (0731)	PM Motor Base Speed	<div style="display: flex; justify-content: space-between; align-items: center;"> V/f OLV OLV/PM AOLV/PM EZOLV </div> Sets the motor base speed (min^{-1} (r/min)).	1750 min^{-1} (r/min) (0 - 34500 min^{-1} (r/min))

■ T2-10: PM Motor Stator Resistance

No. (Hex.)	Name	Description	Default (Range)
T2-10 (0754)	PM Motor Stator Resistance	<input type="radio"/> V/f <input type="radio"/> OLV <input checked="" type="radio"/> OLV/PM <input type="radio"/> AOLV/PM <input type="radio"/> EZOLV Sets the stator resistance for each motor phase.	Determined by T2-02 (0.000 - 65.000 Ω)

Note:

This parameter does not set line-to-line resistance.

■ T2-11: PM Motor d-Axis Inductance

No. (Hex.)	Name	Description	Default (Range)
T2-11 (0735)	PM Motor d-Axis Inductance	<input type="radio"/> V/f <input type="radio"/> OLV <input checked="" type="radio"/> OLV/PM <input type="radio"/> AOLV/PM <input type="radio"/> EZOLV Sets the d-axis inductance of the motor on a per phase basis.	Determined by T2-02 (0.00 - 600.00 mH)

■ T2-12: PM Motor q-Axis Inductance

No. (Hex.)	Name	Description	Default (Range)
T2-12 (0736)	PM Motor q-Axis Inductance	<input type="radio"/> V/f <input type="radio"/> OLV <input checked="" type="radio"/> OLV/PM <input type="radio"/> AOLV/PM <input type="radio"/> EZOLV Sets the q-Axis inductance of the motor on a per phase basis.	Determined by T2-02 (0.00 - 600.00 mH)

■ T2-13: Back-EMF Units Selection

No. (Hex.)	Name	Description	Default (Range)
T2-13 (0755)	Back-EMF Units Selection	<input type="radio"/> V/f <input type="radio"/> OLV <input checked="" type="radio"/> OLV/PM <input type="radio"/> AOLV/PM <input type="radio"/> EZOLV Sets the units that the drive uses to set the induced voltage constant.	0 (0, 1)

0 : mV/(rev/min)

1 : mV/(rad/s)

Note:

- When $T2-13 = 0$, the drive will use $E5-24$ [PM Back-EMF L-L V_{rms} (mV/rpm)] and will automatically set $E5-09$ [PM Back-EMF V_{peak} (mV/(rad/s))] = 0.0.
- When $T2-13 = 1$, the drive will use $E5-09$ and will automatically set $E5-24 = 0.0$.

■ T2-14: Back-EMF Voltage Constant (Ke)

No. (Hex.)	Name	Description	Default (Range)
T2-14 (0737)	Back-EMF Voltage Constant (Ke)	<input type="radio"/> V/f <input type="radio"/> OLV <input checked="" type="radio"/> OLV/PM <input type="radio"/> AOLV/PM <input type="radio"/> EZOLV Sets the motor induced voltage constant (Ke).	Determined by T2-13 (0.0 - 2000.0)

■ T2-15: Pull-In Current Level

No. (Hex.)	Name	Description	Default (Range)
T2-15 (0756)	Pull-In Current Level	<input type="radio"/> V/f <input type="radio"/> OLV <input checked="" type="radio"/> OLV/PM <input type="radio"/> AOLV/PM <input type="radio"/> EZOLV Sets the level of the pull-in current as a percentage of $E5-03$ [PM Motor Rated Current (FLA)]. Usually it is not necessary to change this setting.	30% (0 - 120%)

If the load inertia is high, increase the setting value.

◆ T3: ASR and Inertia Tuning

■ T3-00: Control Loop Tuning Selection

No. (Hex.)	Name	Description	Default (Range)
T3-00 (1198)	Control Loop Tuning Selection	<input type="radio"/> V/f <input type="radio"/> OLV <input checked="" type="radio"/> OLV/PM <input type="radio"/> AOLV/PM <input type="radio"/> EZOLV Sets the type of Control Auto-Tuning.	2 (2, 3)

2 : Deceleration Rate Tuning

3 : KEB Tuning

◆ T4: EZ Tuning

Use *T4 parameters* to input the data necessary for motor parameter Auto-Tuning when $AI-02 = 8$ [Control Method Selection = EZ Vector Control]. These two modes are available:

T4-01 Setting	Operational overview	Items input for tuning	Items tuned
0	Follow the instructions in the setup wizard on the keypad to manually enter the necessary motor parameters.	<ul style="list-style-type: none"> T4-02 [Motor Type Selection] T4-03 [Motor Max Revolutions] T4-04 [Motor Rated Revolutions] T4-05 [Motor Rated Frequency] ^{*1} T4-06 [Motor Rated Voltage] T4-07 [Motor Rated Current] T4-08 [Motor Rated Capacity] T4-09 [Number of Poles] 	<ul style="list-style-type: none"> E9-01 [Motor Type Selection] E9-02 [Maximum Speed] E9-03 [Rated Speed] E9-04 [Base Frequency] E9-05 [Base Voltage] E9-06 [Motor Rated Current (FLA)] E9-07 [Motor Rated Power] E9-08 [Motor Pole Count] E9-09 [Motor Rated Slip] E9-10 [Motor Line-to-Line Resistance]
1	Do only line-to-line resistance tuning.	Motor Rated Current	E9-10 [Motor Line-to-Line Resistance]

*1 When you use a PM motor or a synchronous reluctance motor, it is not necessary to enter the rated frequency. The drive will use the rated rotation speed and number of motor poles to automatically calculate the rated frequency.

■ T4-01: EZ Tuning Mode Selection

No. (Hex.)	Name	Description	Default (Range)
T4-01 (3130)	EZ Tuning Mode Selection	<input type="radio"/> V/f <input type="radio"/> OLV <input type="radio"/> OLV/PM <input type="radio"/> AOLV/PM <input checked="" type="radio"/> EZOLV Sets the type of Auto-Tuning for EZOLV control.	0 (0, 1)

0 : Motor Parameter Setting

1 : Line-to-Line Resistance

■ T4-02: Motor Type Selection

No. (Hex.)	Name	Description	Default (Range)
T4-02 (3131)	Motor Type Selection	<input type="radio"/> V/f <input type="radio"/> OLV <input type="radio"/> OLV/PM <input type="radio"/> AOLV/PM <input checked="" type="radio"/> EZOLV Sets the type of motor.	0 (0, 1, 2)

0 : Induction (IM)

1 : Permanent Magnet (PM)

2 : Synchronous Reluctance (SynRM)

■ T4-04: Motor Rated Revolutions

No. (Hex.)	Name	Description	Default (Range)
T4-04 (3133)	Motor Rated Revolutions	<input type="radio"/> V/f <input type="radio"/> OLV <input type="radio"/> OLV/PM <input type="radio"/> AOLV/PM <input checked="" type="radio"/> EZOLV Sets rated rotation speed (min ⁻¹) of the motor.	- ((40 Hz to 120 Hz) × 60 × 2 / E9-08)

■ T4-05: Motor Rated Frequency

No. (Hex.)	Name	Description	Default (Range)
T4-05 (3134)	Motor Rated Frequency	<div style="display: flex; justify-content: space-between; align-items: center;"> V/f OLV OLV/PM AOLV/PM EZOLV </div> Sets the rated frequency (Hz) of the motor.	Determined by E9-01 and o2-04 (40.0 - 120.0 Hz)

Note:

When $T4-02 = 1, 2$ [Motor Type Selection = Permanent Magnet (PM), Synchronous Reluctance (SynRM)], input is not necessary because it assumes: Motor Rated Revolutions/60 × Number of Motor Poles/2.

■ T4-06: Motor Rated Voltage

No. (Hex.)	Name	Description	Default (Range)
T4-06 (3135)	Motor Rated Voltage	<div style="display: flex; justify-content: space-between; align-items: center;"> V/f OLV OLV/PM AOLV/PM EZOLV </div> Sets the rated voltage (V) of the motor.	200 V Class: 230.0 V, 400 V Class: 460.0 V (200 V Class: 0.0 - 255.0 V, 400 V Class: 0.0 - 510.0 V)

■ T4-07: Motor Rated Current

No. (Hex.)	Name	Description	Default (Range)
T4-07 (3136)	Motor Rated Current	<div style="display: flex; justify-content: space-between; align-items: center;"> V/f OLV OLV/PM AOLV/PM EZOLV </div> Sets the rated current (A) of the motor.	Determined by o2-04, C6-01 (10% to 200% of the drive rated current)

Note:

The value set here becomes the base value for motor protection, the torque limit, and torque control.

■ T4-08: Motor Rated Capacity

No. (Hex.)	Name	Description	Default (Range)
T4-08 (3137)	Motor Rated Capacity	<div style="display: flex; justify-content: space-between; align-items: center;"> V/f OLV OLV/PM AOLV/PM EZOLV </div> Sets the motor rated power in the units set in o1-58 [Motor Power Unit Selection].	Determined by E9-10 (0.10 - 650.00 HP)

■ T4-09: Number of Poles

No. (Hex.)	Name	Description	Default (Range)
T4-09 (3138)	Number of Poles	<div style="display: flex; justify-content: space-between; align-items: center;"> V/f OLV OLV/PM AOLV/PM EZOLV </div> Sets the number of motor poles.	Determined by E9-01 (2 - 120)

Index

Symbols

Numerics

24 V power supply

Power supply input terminals 94

A

AC reactor

Wiring 111

Acceleration and deceleration times

Switching by external input 559

Switching by output frequency 560

Switching by Motor 2 Selection commands 560

Acceleration time

Parameter 559

Unit of measurement setting 562

Adjustment of control functionality 157

AER 286

AFR

Parameter 762

Alarm 258, 286

Altitude

Derating 356

Environment 31

Ambient humidity 31

Ambient Temperature Setting 31

Derating 55, 355

Finless-Type 55

Parameter 356, 756

Analog input

Function selection for terminals A1 and A2 688

Analog Output

Gain/Bias Adjustment 699

Monitor Parameter Selection 699

Signal Level Selection 699

Terminal AM Monitor Selection 700

Application Preset 505

Operation 147

ASR

Fine tuning 573

Parameter 571

Vector Control Adjustment Procedure 572

Auto-Tuning 148, 151

ASR and Inertia Tuning Parameters 811

Induction Motor 148

Induction Motor Parameters 805

PM Motor Parameters 808

PM motors 149

Precautions 152

Rotational Auto-Tuning Precautions 153

Stationary Auto-Tuning for Line-to-Line Resistance
precautions 154

Stationary Auto-Tuning Precautions 153

Stator resistance Auto-Tuning precautions 154

Auto-Tuning Error 258, 301

B

Backup

Parameters (drive to keypad) 144

Backup function 795

Base frequency

Parameter 604

Base Frequency

Motor 2 Parameters 609

Base voltage

Motor 2 parameters 610

Parameter 605

Basic operation

Get started 136

bAT

Fault 264

Minor Fault 286

bb 286

bCE

Fault 264

Minor Fault 286

Bi-Directional function 594

boL

Fault 264

Minor Fault 286

Braking Resistor

Protection Functions 753

Wiring 106

bUS

Detection condition settings 631

Detection conditions 627

Fault 264

Minor Fault 286

Operation Selection after Detection 626

bUSy 287

C

CALL 287

Capacitor Maintenance Setting 797

Carrier frequency 577

Derating 353

Parameter 576

CE

Detection Selection 702

Detection time 703

Fault 264

Minor Fault 287

Operation Selection after Detection 702

CF 265

Checklist

Test run 162

Circulation Fan

Replacement 325

CoF 265

Communication option

Parameter 620

Control circuit terminal block

Replacement 331

Control circuit terminals

Configuration of terminal block 96

I/O terminals function selection switches 99

Terminal functions 92

Wire gauge 96

Wiring 91

Wiring procedure for terminal block 97

Control method

Selection 502

Cooling Fan

Activation Conditions Setting 755

Estimated Lifespan	323
Off Delay Timer	756
Replacement	325
Copy Function Error	258, 305
CP1	
Fault	265
Minor Fault	287
CP2	
Fault	265
Minor Fault	288
CPEr	305
CPF00	266
CPF01	266
CPF02	266
CPF03	266
CPF06	266
CPF08	266
CPF11	266
CPF12	267
CPF13	267
CPF14	267
CPF16	267
CPF17	267
CPF18	267
CPF19	267
CPF20	267
CPF21	268
CPF22	268
CPF23	268
CPF24	268
CPF25	268
CPF38	268
CPyE	305
Crimp ferrule	96
CrST	288
CSEr	305
Cumulative Operation TimeSetting	796
Current Detection Speed Search	527
CyC	288
CyPo	288
D	
DC Injection Braking	
Parameter	523
DC link choke	
Wiring	111
dCE1	268
dCE2	268
Deceleration time	
Parameter	559
Unit of measurement setting	562
Delete	
Delete Backed-up Parameters	146
Derating	
Altitude	356
Ambient Temperature Setting	55, 355–356, 756
Carrier frequency	353
Enclosure Type	356, 757
External Cooling Fin	356, 757
Finless	356, 757
Finless-Type	55
Side-by-side	356, 757
dEv	

Detection level	620
Detection time	620
Fault	268
Minor Fault	288
Operation Selection after Detection	619
dFPS	305
Diagnosing and Resetting Faults	307
Digital character	142
DIP switch	99
Disposal	
Drive	339–340
Packing material	339–340
dnE	288
Down 2 command	
Parameter	589, 594
Down command	650, 652
Parameter	589, 594
Drive	
Control Circuit Terminal Block Replacement	331
Disposal	339–340
Exterior Dimension Diagram (IP20)	358, 360, 363–365
Exterior Dimensions Diagram (IP20)	362
Initialization	503
Initialize Parameters	503
Inspection	320
Long-Term Storage	335
Rating (400 V)	348
Rating (Single-phase 200 V)	344
Rating (Three-phase 200 V)	345
Drive mode	131
Drive Mode Unit Monitor Select	784
Drive Model Selection	792
Drive watt loss	36–41
dv7	269
dWA2	288
dWA3	288
dWAL	288
Dwell function	
Parameter	553
dWF1	269
dWF2	269
dWF3	269
dWFL	269
E	
E5	
Fault	269
Minor Fault	289
Operation Selection after Detection	630
EF	289
EF0	
Detection conditions	627
Detection conditions setting (DeviceNet)	633
Fault	269
Minor Fault	289
Operation Selection after Detection	627
EF1	
Fault	270
Minor Fault	289
EF2	
Fault	270
Minor Fault	289
EF3	

Fault	270	Exterior Dimensions Diagram (IP20)	
Minor Fault	289	Drive	362
EF4		External 24 V power supply	
Fault	270	Power supply input terminals	94
Minor Fault	289	External Cooling Fin	
EF5		Derating	356, 757
Fault	270	F	
Minor Fault	290	Fan Operation Time Setting	797
EF6		Fast Stop Time	
Fault	270	Parameter	562
Minor Fault	290	Fault	258, 264
EF7		Fault code	
Fault	271	MEMOBUS/Modbus	250
Minor Fault	290	Fault Code List	259
Elapsed Operating Time Selection	797	Fault Reset	307
Electrolytic Capacitor		Fault Restart	
Estimated Lifespan	323	Parameter	742
Enclosure Type		FbH	
Derating	356, 757	Fault	271
Encoder option		Minor Fault	290
Parameter	618	FbL	
End1	301	Fault	271
End2	301	Minor Fault	290
End3	301	Feed Forward Control	
End4	301	Parameter	767
End5	301	Field Forcing	
End6	301	Parameter	594
End7	301	Field weakening	
End8	302	Parameter	594
End9	302	Fine tuning	157
Energy-saving control		Finless	
Parameter	554	Derating	356, 757
Enter command	234	Firmware update lock	511
EP24v	290	Freq Ref Setting Method Select	793
Er-01	302	Frequency Agreement	
Er-02	302	Parameter	740
Er-03	302	Frequency reference	
Er-04	303	Command source correlation diagram	581
Er-05	303	LOCAL/REMOTE Run selection	513, 581
Er-08	303	Offset frequency addition	595
Er-09	303	Switching between LOCAL/REMOTE	513, 520, 581
Er-10	303	Upper and lower frequency limits	587
Er-11	303	Frequency reference bias	
Er-12	304	Parameter	589, 594
Er-13	304	Frequency reference hold function	
Er-14	304	Parameter	589, 594
Er-15	304	G	
Er-16	304	Gateway Mode	622
Er-17	304	Getting set up	136
Er-18	304	GF	271
Er-19	304	Protection Functions	755
Er-20	304	Ground	
Er-25	304	Drive	83
ERF type braking resistor		Ground Fault Circuit Interrupter	
Protection Functions	753	GFCI	108
Wiring	106	Wiring	108
Err	271	Ground Fault Detection	
Error Code List	259	Protection Functions	755
Exterior and mounting dimensions		H	
Installation dimensions	47	HCA	291
Panel cut out dimensions	47	Alarm Settings	758
Exterior Dimension Diagram (IP20)			
Drive	358, 360, 363–365		

HD.....	343
Heavy Duty Rating.....	343
High-Slip Braking	
Parameter.....	763
Horsepower.....	790
How to read the catalog code.....	21
Humidity	
Environment.....	31
I	
iFEr.....	305
IGBT Maintenance Setting.....	797
Induction Motor	
Auto-Tuning.....	148
Induction motors	
Motor Parameters.....	605
Input Phase Detection	
Protection Functions.....	754
Input voltage	
Parameter.....	598
Inspection	
Drive.....	320
Installation	
Front cover.....	43
Keypad.....	45
Installation dimensions.....	47
Installation environment.....	31
Interlock	
Circuit example.....	105
Internal Drive Braking Transistor	
Protection Functions.....	759
J	
Jog command.....	587
Jump frequency	
Parameter.....	588
Jumper switch.....	99
K	
KEB ride-thru function	
Compensation Time.....	726
KEB Method Selection.....	729
Operation during momentary power loss.....	725
Parameter.....	720
Single Drive KEB Method.....	729
System KEB Method.....	729
Keypad	
Application Preset.....	147
Installation.....	45
Language selection.....	501
LED status.....	125
Method of operation.....	125
Remove.....	45
Keypad Display.....	783
Keypad Display Selection.....	784
Keypad Operation.....	791
Keypad-related settings.....	783
kWh Monitor Initialization.....	798
L	
L24v.....	291
Language selection.....	501
LCD contrast adjustment.....	786
Leakage current.....	719–720
LED display.....	142

LF.....	272
Protective function.....	755
LF2.....	272
Protection Functions.....	757
LKEB type braking resistor unit	
Wiring.....	106
Load Inertia Ratio	
Parameter.....	738
LO/RE Key Function Selection.....	791
LOCAL/REMOTE indicator.....	125
LoG.....	291
LSo.....	272
Protective function.....	760
LT-1.....	291
LT-2.....	291
LT-3.....	291
LT-4.....	292
M	
Main circuit terminals	
Configuration of terminal block.....	66
Line voltage drop.....	75
Wire gauge.....	75
Wiring.....	66
Wiring procedure for terminal block.....	87
Maintenance Period.....	796
Maximum Output Frequency	
Motor 2 Parameters.....	609
Parameter.....	603
Maximum Output Voltage	
Motor 2 Parameters.....	609
Parameter.....	604
MCCB.....	108
Mechanical Weakening Detection	
Parameter.....	746
MEMOBUS	
Broadcast Messages.....	249
Command data.....	235
Communication error code.....	252
Communication specifications.....	224
Enter command.....	234
Fault code.....	250
Loopback test.....	230
Minor fault code.....	251
Monitor data.....	238
Register reading.....	230
Register writing.....	230
Self-diagnosis.....	235
Wiring.....	224
MEMOBUS/Modbus Communications	
Parameter.....	701
Serial communication terminals.....	96
Setting for termination resistor.....	103
Mid point B frequency	
Motor 2 parameters.....	609
Parameter.....	604
Mid point B voltage	
Motor 2 parameters.....	610
Parameter.....	605
Middle Output Frequency	
Motor 2 Parameters.....	609
Parameter.....	604
Middle Output Frequency Voltage	

Motor 2 Parameters	609	Motor Overload	
Parameter	604	Electric Thermal Protection Operation Time	205, 717
Minimum output frequency		Protection Functions	202, 714
Parameter	604	Motor parameters	
Minimum Output Frequency		Motor 2	610
Motor 2 Parameters	609	Motor 2 Iron-Core Saturation Coefficient 1	612
Minimum Output Voltage		Motor 2 Iron-Core Saturation Coefficient 2	612
Motor 2 Parameters	609	Motor 2 number of motor poles	611
Parameter	604	Motor 2 rated power (kW)	612
Minor Fault	258, 286	Motor Parameters	597, 605
Minor fault code		Motor 2 Iron Loss	612
MEMOBUS/Modbus	251	Motor 2 Leakage Inductance	611
Minor Fault Code List	259	Motor 2 Line-to-Line Resistance	611
Modbus		Motor 2 No-load Current	611
Broadcast Messages	249	Motor 2 rated Current	610
Command data	235	Motor 2 Rated Slip	610
Communication error code	252	Motor parameters (induction motors)	605
Communication specifications	224	Leakage Inductance	607
Enter command	234	Line-to-Line Resistance	606
Fault code	250	Motor Iron Loss	607
Loopback test	230	Motor Iron-Core Saturation Coefficient 1	607
Minor fault code	251	Motor Iron-Core Saturation Coefficient 2	607
Monitor data	238	Motor rated power (kW)	608
Register reading	230	No-load Current	606
Register writing	230	Number of motor poles	606
Self-diagnosis	235	Rated current	201, 605
Wiring	224	Rated Slip	606
Molded-case circuit breaker	108	Motor Power Unit Selection	790
Momentary Power Loss		MotorDirect@PowUpWhenUsingKeypad	793
KEB Compensation Time	726	Multi-step speed operation	581
Monitors		Setting procedure	581
Display procedure	142	Multiple-unit connection	622
Motor		N	
Positive Temperature Coefficient (PTC) Thermistor	713	Nameplate	21
Wiring	66	ND	343
Wiring distance	83	ndAT	305
Motor 2		No-Load Voltage	
Base Frequency	609	Parameter	605
Base voltage	610	Noise filter	
Control mode settings	608	Wiring	113
Leakage Inductance	611	Normal Duty Rating	343
Line-to-Line Resistance	611	nSE	272
Maximum Output Frequency	609	NumOfRunCommands Counter Initial	798
Maximum Output Voltage	609	O	
Mid point B frequency	609	oC	273
Mid point B voltage	610	Overcurrent Detection Gain	757
Middle Output Frequency	609	oC2	274
Middle Output Frequency Voltage	609	oFA00	274
Minimum Output Frequency	609	oFA01	274
Minimum Output Voltage	609	oFA03	274
Motor Iron Loss	612	oFA04	274
Motor Iron-Core Saturation Coefficient 1	612	oFA05	274
Motor Iron-Core Saturation Coefficient 2	612	oFA06	274
Motor rated power (kW)	612	oFA10	275
No-load Current	611	oFA11	275
Number of motor poles	611	oFA12	275
Rated current	610	oFA13	275
Rated Slip	610	oFA14	275
V/f Pattern	608	oFA15	275
Motor Code Selection	613	oFA16	275
Motor Overheating		oFA17	275
Operation During Detection of Alarms	206, 718	oFA30	276
Operation During Detection of Faults (PTC Input)	206, 718		

oFA31	276
oFA32	276
oFA33	276
oFA34	276
oFA35	276
oFA36	276
oFA37	276
oFA38	277
oFA39	277
oFA40	277
oFA41	277
oFA42	277
oFA43	277
Off-Delay Timer	535
Offset frequency	
Parameter	595
oH	
Alarm Settings	753
Fault	277
Minor Fault	292
oH1	278
oH2	292
Alarm Settings	753
oH3	
Fault	278
Minor Fault	292
Operation During Detection of Alarms	206, 718
oH4	278
Operation During Detection of Faults (PTC Input)	206, 718
oL1	278
oL2	279
Protection Functions	756
oL3	
Fault	280
Minor Fault	292
oL4	
Fault	280
Minor Fault	293
oL5	
Fault	280
Minor Fault	293
oL7	280
On-Delay Timer	535
Ope Select @Keypad is Disconnect	793
oPE01	296
oPE02	296
oPE03	296
oPE05	297
oPE07	298
oPE08	298
oPE09	299
oPE10	299
oPE11	299
oPE13	299
oPE16	299
oPE33	300
Operation During Momentary Power Loss	
KEB ride-thru function	720
Operation method selection	725
Parameter	725
Speed Search function	526
oPr	280
Option card	

Parameter	618
Options	367
oS	
Detection level	619
Detection time	620
Fault	281
Minor Fault	293
Operation Select at Overspeed	618
Output Control	781
Output Phase Loss Detection	
Protective function	755
ov	
Fault	281
Minor Fault	293
ovEr	293
Overexcitation deceleration	
Parameter	764
Overtorque detection	
Parameter	745
P	
Panel cut out dimensions	47
Parameter	
Access Level Selection	501
Automatic selection	511
Backup (drive to keypad)	144
Changing setting values	143
Checking modified parameters	142
Delete Backed-up Parameters	146
Restore (keypad to drive)	145
Setup mode	143
User-set	511
Verify (keypad and drive)	145
Parameter Change	794
Parameter Setting Errors	258, 296
PASS	293
Password	
Setting	505
Verification	504
PC	
Connection procedure	104
PE1	282
PE2	282
Peripheral Devices	367
PF	282, 293
Protection Functions	754
PGo	
Detection time	620
Fault	282
Minor Fault	294
Operation Selection after Detection	618
Phase Order Selection	520
PID control	537
control block diagram	539
Feedback value input	538
fine tuning	540
Parameter	542
PID feedback loss detection	539
PID Sleep	540
Setpoint input	538
PM motor parameters	612
d-Axis inductance	614
Induced voltage constant 1	614

Induced voltage constant 2	615	Remove	
Motor rated current.....	202, 613	Front cover	43
Motor rated power (kW).....	613	Keypad.....	45
Number of motor poles	613	RESET key.....	125
q-Axis inductance	614	Restore	
Stator resistance	614	Parameters (keypad to drive)	145
PM motors		Reverse Operation Selection.....	518
Auto-Tuning.....	149	rF	282
PM Motors		rH.....	283
Fine Adjustment	771, 782	RJ-45 connector	125
Motor Code Selection.....	613	Rotational Auto-Tuning	
Motor parameters.....	612	Induction Motor	148
Positive Temperature Coefficient (PTC) Thermistor.....	713	PM motors.....	149
Power loss.....	36–41	Precautions	153
Programming mode.....	131	rr.....	283
Protection Functions		Protection Functions	759
DC bus undervoltage.....	727	rUn	294
Drive Overheating.....	753	Run command	
GF	755	LOCAL/REMOTE Run selection.....	515
Ground Fault Detection.....	755	Switching between LOCAL/REMOTE	515
HCA.....	758	Run Command at Power Up.....	522
Input Phase Detection.....	754	Run Command Selection 2	
Internal Drive Braking Transistor.....	759	Switching between LOCAL/REMOTE	522
LF2	757	RUN indicator	125
Motor Overheating	206, 718	RUN key	125
Motor Overheating (PTC Input).....	206, 718	S	
Motor Overload.....	202, 714	S-curve characteristics	
oC.....	757	Parameter	565
oH.....	753	SC	283
oH2	753	SCF.....	283
oH3	206, 718	Screen.....	142
oH4	206, 718	SE	294
oL2	756	SEr	283
Output Current Overload.....	758	Serial communication terminals	
Overcurrent.....	757	MEMOBUS/Modbus Communications	96
Overload	756	Short Circuit Braking	
PF.....	754	Parameter	523
rr	759	Side-by-side	
Software Current Limit Selection.....	756	Derating.....	356, 757
Uv1	727	Slip compensation	
Protective function		Parameter	565
Desynchronization.....	760	Softcharge Relay Maintenance Set	797
LF.....	755	Software Current Limit Selection	
Low Speed Desynchronization	760	Protection Functions	756
LSo	760	Speed Agreement	
Output Phase Loss Detection	755	Parameter	740
Pulse Train Input		Speed Detection	741
Terminal RP Function Selection.....	706	Parameter	740
Pulse Train Input/Output		Speed Estimation Speed Search.....	528
Parameter.....	705	Speed Search function	
Pulse train output		Operation during momentary power loss.....	725
Terminal MP function selection	708	Parameter	526
Wiring specifications.....	101	Stall Prevention function	
PWEr.....	305	Parameter	730
R		Stationary Auto-Tuning	
Rating (400 V)		Induction Motor	148
Drive	348	PM motors.....	149
Rating (Single-phase 200 V)		Precautions	153
Drive	344	Stationary Auto-Tuning for Line-to-Line Resistance	148
Rating (Three-phase 200 V)		Precautions	154
Drive	345	Stator resistance Auto-Tuning.....	149
rdEr.....	306	Precautions	154

SToF	294
Stop command	
LOCAL/REMOTE Run selection	515
STOP key	125
STOP Key Function Selection	791
Stop with Constant Distance	594
Stopping Method Selection	515
STPo	284
Surge protective device	
Connection	112
T	
Temperature	
Environment	31
Terminal block	
Configuration of control circuit terminal block	96
Configuration of main circuit terminal block	66
Control circuit terminal block functions	92
I/O terminals function selection switches	99
Terminal function selection	102
Terminal A2	99, 102
Terminal AM	99, 103
Termination resistor	
Setting switch	103
Test run	
Checklist	162
Fine tuning	157
Procedure	136
Procedure for no-load test run	155
Procedure for test run with actual load	155
Thermal overload relay	
Connection	109
Tightening torque	
Control circuit terminals	96
Main circuit terminals	75
TiM	
Fault	284
Minor Fault	294
Timer function	
Parameter	535
Torque Compensation	
Parameter	569
Torque limit function	
Parameter	750
Troubleshooting	
Code Displayed	259
No Code Displayed	309
Troubleshooting without Fault Display	309
TrPC	294
Tuning	559
U	
U2, U3 Initialization	798
UL3	
Fault	284
Minor Fault	295
UL4	
Fault	284
Minor Fault	295
UL5	
Fault	284
Minor Fault	295
Undertorque detection	
Parameter	745

Unit of measurement setting	
Acceleration and deceleration times	562
Unit selector	790
Up 2 command	
Parameter	589, 594
Up command	650, 652
Parameter	589, 594
USB port	125
Connecting a PC	104
User Monitor Select afterPowerUp	784
User Parameter Default Value	791
User-Set Display Units Max Value	786
User-SetDisplayUnits Dec Display	786
Uv	295, 794
Speed Search Selection at Start	534
Uv1	284
Detection level settings	727
Uv2	285
Uv3	285
V	
vAEr	306
V/f Pattern	597
Second Motor	608
V/f Pattern Display Unit	785
Verify	
Parameters (keypad and drive)	145
vFyE	306
Vibration-resistant	31
Voltage Limit	781
Voltage Saturation	781
W	
WEEE	340
Wire gauge	
Control circuit terminals	96
Main circuit terminals	75
Voltage drop	75
Wiring	108
AC reactor	111
Braking Resistor	106
Checklist	117
Control circuit terminal block	97
Control circuit terminals	91
DC link choke	111
Main circuit terminal block	87
Main circuit terminals	66
MEMOBUS/Modbus	224
Motor	66
Noise filter	113
Thermal overload relay	109
Wiring distance	
Drive and motor	83

Revision History

Date of Publication	Revision Number	Section	Revised Content
June 2023	2	All	Revision: Reviewed and corrected entire documentation. Upgraded drive software version to PRG: 01013, 01014, and 01015. Addition: Finless-type drives added along with corresponding data.
August 2019	1	All	Revision: Reviewed and corrected entire documentation
		2	Addition: "Install the Drive Horizontally"
June 2019	-	-	First Edition

YASKAWA

GA500 Drive TECHNICAL REFERENCE

YASKAWA AMERICA, INC.

2121, Norman Drive South, Waukegan, IL
60085, U.S.A.
Phone: +1-800-YASKAWA (927-5292) or +1-
847-887-7000 Fax: +1-847-887-7310
www.yaskawa.com

DRIVE CENTER (INVERTER PLANT)

2-13-1, Nishimiyaichi, Yukuhashi, Fukuoka,
824-8511, Japan
Phone: +81-930-25-2548 Fax: +81-930-25-
3431
www.yaskawa.co.jp

YASKAWA EUROPE GmbH

Philipp-Reis-Str. 6, 65795 Hattersheim am
Main, Germany
Phone: +49-6196-569-300 Fax: +49-6196-
569-398
E-mail: info@yaskawa.eu.com
www.yaskawa.eu.com

YASKAWA ELÉTRICO DO BRASIL LTDA.

777, Avenida Piraporinha, Diadema, São
Paulo, 09950-000, Brasil
Phone: +55-11-3585-1100 Fax: +55-11-3585-
1187
www.yaskawa.com.br

In the event that the end user of this product is to be the military and said product is to be employed in any weapons systems or the manufacture thereof, the export will fall under the relevant regulations as stipulated in the Foreign Exchange and Foreign Trade Regulations. Therefore, be sure to follow all procedures and submit all relevant documentation according to any and all rules, regulations and laws that may apply.

Specifications are subject to change without notice for ongoing product modifications and improvements.

Original Instructions

© 2019 YASKAWA Electric Corporation

YASKAWA ELECTRIC CORPORATION



SIEPC71061752

SIEPC71061752
Revision: C <2>-0
June 2023
Published in Japan
23-2-25_YAI