

Vickers®

# Cylinders

---



## Series TE/TF/TL Air & Hydraulic Cylinders

Installation & Service Manual



# Contents

---

Introduction .....	1
Cylinder Installation .....	2
Troubleshooting .....	3
Service .....	5
Exploded View .....	7
Maintenance .....	7
Replacement Parts .....	9
How to Order .....	21
Model Code (Cylinder Identification) .....	22

# Introduction

## Purpose of manual

This manual has been prepared to assist users of Vickers Series TE, TF and TL cylinders for properly maintaining and repairing their units. In the sections that follow, instructions are given for proper installation, maintenance and overhaul.

## General information

Model codes have many variations within a basic model series. They are covered by variables in the model code. Service inquiries should always include the complete model code number as stamped on the head or cap and three digit plant code.

## How to order

Vickers has developed an easy system for ordering cylinders. This system has been developed to improve ease of ordering. The model code consists of sixteen alpha-numeric digits which fully describe the most common standard options offered.

To specify your cylinder, review the Model Code section for a full description of each option available and corresponding code.

## Custom cylinders

Although the model code has been arranged to cover the vast majority of available options, there will be occasions when an option which cannot be coded will be required. When such an option has been specified, enter an "X" for the appropriate item in the model code. For example, an application which requires a custom thread on the end of the piston rod, an "X" is inserted for item 7. The cylinder will include a unique five digit design number.

## Replacement cylinders

Every custom cylinder is assigned a unique design number. This number is contained in the last five digits of the sixteen digit model code. Item 12 is always an alpha character. The "Stroke" and "Extra Rod Projection" positions (items 12 through 16) become the "Design Number" items for custom cylinders. When ordering a replacement part or cylinder, give the sixteen digit model code or the five digit design number to your local Vickers Representative.

## Replacement parts

Each design number has a completed bill of materials on file in a quick retrieval computerized storage system. This gives the Field Sales Representatives rapid access in identifying and specifying genuine Vickers replacements parts.

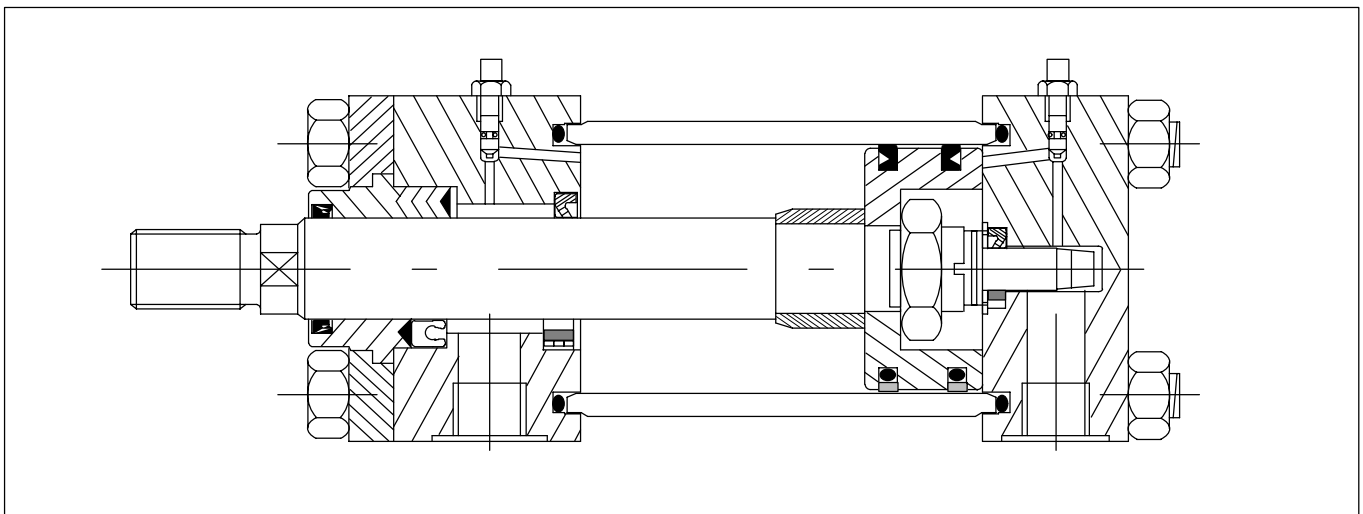

Figure 1. Cylinder Section View

# Cylinder Installation

---

All Vickers Series TE, TF and TL cylinders are individually tested and inspected before shipment to assure freedom from defects. Plugs are inserted in the ports to protect threads and keep foreign matter from entering the cylinder prior to installation.

## Mounting and alignment

Position the cylinder loosely in the mounting and check the alignment of the piston rod with the load connection at **both ends of the stroke**. If the cylinder is too large to move by hand, proceed with piping and installation and operate cylinder throughout the stroke prior to connection.

Trunnion and swivel mount bearings should fit closely for the entire length of the pin, and must be square with the load connection throughout the stroke.

Flush or foot mounted cylinders may be pinned or keyed to prevent shifting during high shock loads.

Always use the wrench flats when connecting piston rod to load to prevent damage to the sealing surface. Tighten piston rod against shoulder or use a locknut on full size threads. If cylinder has been pressurized, relieve all pressure prior to turning the piston rod.

## Piping connections

All piping connections should be deburred and the system thoroughly flushed to purge all contaminants prior to connecting cylinder ports. Care should be taken to prevent over tightening of the piping connections.

## Cylinder operation

Cycle cylinder a few times with reduced load and pressure. Hydraulic cylinders may be erratic due to trapped air, but will normally purge themselves after several cycles. Some cylinders may be equipped with air bleed screws which can be slowly loosened with a male key wrench, then re-tightened after air is purged.

Cushioned cylinders are adjusted and tested prior to shipping, but usually require additional adjustment after connection to the work load. If cushion adjustment screw has a locknut, loosen and hold with wrench while turning the screw.

To increase effectiveness of the cushion, turn the adjustment screw clockwise. To provide less cushion, turn the screw counterclockwise. Most orifices are fully open with two full turns of the screw from the closed position.

The final position of the screw should be a balance between any shock or bounce at the start of the cushion and the final impact of the piston at the end of stroke.

# Troubleshooting

Most problems in fluid power circuits result in a gradual or sudden loss of power in the work cylinders, which may cause them to stall or move slower than required. This chart assumes that all other components of the circuit such as

the pump, relief valve, control valves, hydraulic supply, etc. have been checked and the problem has been isolated to the cylinder.

Properly installed and maintained cylinders should function for millions of cycles. Premature cylinder failures are usually caused by system or application problems that can be prevented. The purpose of this chart is to aid in identifying and correcting the most common causes of premature cylinder failure.

Check Cylinder for Evidence of:	Caused By:	Action Required:
Excessive wear on piston rod.	Side load due to misalignment between cylinder and load.	Check alignment of rod with load connection at all points in stroke.
	Pivot mount cylinder without proper stop tubing.	Follow Vickers cylinder catalog design recommendations.
Contamination in cylinder.	Exceptionally dirty environment.	Clean and flush the entire system, deburr connections.
	Worn rod wiper/scrapper	Shield piston rod area from direct contact with contaminant.
Impact damage or broken parts.	Lack of, or improperly adjusted cushions.	Reference adjustment instructions in this manual.
	Load and piston speed combination exceeds cylinder cushion capacity.	Consult your Vickers Sales Engineer.
	Lack of, or improperly adjusted speed controls.	Add or adjust flow controls to reduce piston speed.
	Excessive system pressure.	Reduce pressure to minimum required to move the load.
Permanent deformation or damaged static seals.	System pressure in excess of cylinder rating.	Follow Vickers cylinder catalog design recommendations.
	High pressure developed in cylinder cushion.	Consult your Vickers Sales Engineer.
	Cyl. externally loaded while control valve is closed.	Reduce load magnitude or re-size cylinder.
Seal damage such as loss of elasticity, shape, etc.	Excessive temperature in environment or system.	Install replacement sealing system with proper rating.
	Incompatible hydraulic fluid.	Refer to Vickers cylinder catalog or page 6 of this manual for compatible sealing system.
	Cylinder stored in horizontal position for extended period.	Replace seals, store vertically with rod up.

Table 1.

## Additional Troubleshooting Information

The following information is intended to supplement the above troubleshooting table. Additional details help with the identification and resolution of frequent cylinder application problems.

Steps are provided for correcting each suspected application problem.

### 1. Excessive Side Load on Piston Rod

Excessive side loads imposed by improper alignment or other causes are a common misapplication of cylinders. Cylinders may bind, stick, or move erratically if the operating pressure is low. Higher operating pressures will force the cylinder to move, but eventually cause premature bearing wear, rod leakage, or extensive cylinder damage.

**High side loads are frequently caused by improper alignment.**

- A. Disconnect the piston rod end from the machine. Observe the alignment of the rod end at each end of the stroke and in midstroke.
- B. Adjust the cylinder mounting, if possible, or add a self aligning coupler on rigid mount cylinders.
- C. Additional clearances can sometimes be added to clevis mount cylinders to allow some lateral movement during the stroke.
- D. Spherical alignment bushings (SAB mounts) can be used to allow for some mounting misalignment.

# Troubleshooting

## 2. External Leakage (hydraulic)

Isolate the source of any visible external leakage to make sure it is coming from the cylinder, then find the exact location of the leakage. External leakage is generally confined to port connections, rod seals, body seals, and cushion adjustment screws.

### A. Port Connection:

1. Tighten NPTF ports or re-seal with thread sealing material.
2. Inspect SAE o-ring ports for damaged sealing surfaces or o-ring seals.

### B. Rod Seals:

1. Inspect for physical seal damage such as linear scratches, torn sealing edges, etc. If found, determine the cause of the damage (i.e. wrench marks etc.). Correct the source of the problem before installing new seals.
2. If the seals look good, check fluid compatibility and operating temperatures.
3. Pressure energized lip seals may exhibit some light leakage when circuit pressures, even momentarily, turn negative (instantaneous vacuum). This can occur on very fast operating cylinders with the exhausting fluid, in some servo circuits, and when there is an overrunning load (the load pushing the cylinder).

This problem may be corrected with the "wave washer" type of pre-load on the standard v-ring rod seals or by using another type of pre-loaded seal.

### C. Body Seals:

1. Check the tie rod torque value. Make sure it is even around all the rods.
2. O-rings should be replaced if there are any signs of seal damage.

3. If the tie rod torque is to proper specification, the most likely cause of any body seal leakage is excessive pressure within the cylinder. In addition to the working system pressure, look for hydraulic cushion shocks or high external load applied back to the cylinder when the control valve is closed.

4. Determine which circuit components may be the source of shock pressure. For example, certain types of air-to-oil boosters impart high peak shocks due to sudden action of the booster.

### D. Cushion Adjustment Screws:

1. Inspect o-ring seals for physical damage or other types of seal deterioration due to problems with fluid compatibility, heat, etc.

## 3. Internal Leakage (hydraulic)

A. Verify the type of piston seal found in the cylinder. Cast iron rings will always pass a small amount of fluid.

B. Check the internal leakage by first blocking the cylinder piston in mid-stroke, then pressurizing one side of the piston. If a rod clevis is available, the same check can be done by reversing the clevis on the rod, then letting the clevis ears come up against the rod end head while pressurizing the rod end of the cylinder.

C. Leaking piston seals usually result from damage caused by internal contaminants or scratched surfaces on the piston seal groove or body inside diameter.

D. Certain types of seals may take a compression set if the cylinder is stored in a horizontal position for a long time before being installed and operated.

## 4. Insufficient Cushion Action (hydraulic)

A. Adjust the cushion screws to minimize the "bump" at the start of the cushion and at the end of the stroke.

B. Floating metallic cushions should be able to shut off the motion of the cylinder about  $\frac{3}{4}$ " from the end of the stroke. Do not attempt to shut the screws all the way off unless you can operate the cylinder very slowly.

C. Occasionally, even though the cushion is sealing properly, the desired cushioning cannot be obtained by adjusting the cushion screws. In such applications, the combined load and velocity may require a custom design to achieve the proper performance.

D. Sometimes a reduction in working pressure will significantly improve cushion performance without adversely affecting the overall performance of the cylinder.

## 5. Insufficient Cushion Action (pneumatic)

A. Operate the pneumatic cylinder to check operation of the air cushion with the screw fully closed. The cylinder should stop short of its full stroke.

B. Due to the compressibility of air, pneumatic cushions are much more sensitive to adjustments than hydraulic cushions. First try adjusting the cushion screws to eliminate "bounce" at the beginning of the cushion, and to prevent high impact at the end of the stroke.

C. If the piston "punches through" the cushion with high impact at the head -- not enough air is being trapped. A speed control in the exhaust air line can often raise the back pressure enough to improve the cushion action, while not significantly slowing the speed of the stroke. Lowering the system air pressure slows the speed of the stroke and may also have a dramatic effect on the cushioning action.

D. If cushion "bounces" or has too much air spring, turn the screws wide open, increase air pressure and try to minimize back pressure in the exhaust line.

# Service

The following instructions describe the complete rebuilding of your Vickers TE, TF or TL cylinder.

Refer to Figure 4 exploded view.

## Warning

Before breaking a circuit connection, make certain that power is off and system pressure has been released. Lower all vertical cylinders, discharge accumulators, and block any load whose movement could generate pressure. Plug all removed units and cap all lines to prevent the entry of dirt into the system.

## Required Tools

- Spanner wrench
- Adjustable wrench
- Soft brass tool
- Thin tool (like a metal ruler)
- Copper padded vice
- Rubber mallet
- Torque wrench

## Replacing Rod Seals

1. Once the cylinder is removed from service, fully retract the piston rod and remove all port connections. Drain any hydraulic fluid by manually cycling the cylinder. Large cylinders can be carefully cycled with air pressure.
2. The Quick Change rod cartridge allows rod seal replacement without disturbing the tie rods. Remove any burrs from the wrench flat area of the piston rod. Place the cylinder in a vice, rod end up if possible. Remove the rod bearing retainer plate by removing the retainer screws. The retainer may be round, square or rectangular. Round retainers that are recessed into the head have a pry groove on the O.D. or two tapped holes to aid removal.
3. Remove the rod seals on smaller cylinders by placing your thumb over the rod end port and giving a quick pull on the piston rod. Use low pressure air in the rod end port for larger cylinders. Leave the bearing on the rod to catch the seals as they leave the seal cavity. Note the position of the male seal adaptor relative to the bearing and the seals.

Leave the male seal adapter in place if in the bottom of the seal cavity, to support the piston rod while performing the remaining disassembly.

4. Remove the elastomer rod wiper or rod scraper retainer from the rod bearing. Remove the rod scrapers if applicable.
5. For metallic scrapers, stack the new scraper rings so that the slots are staggered. Lightly lubricate the new wiper or retainer and push it into the bearing groove with a soft brass tool.
6. Lightly lubricate the new rod seals and replace, one at a time, by leading the outside sealing edge with a soft brass tool as each seal is inserted in the cavity. Be careful not to damage the seals when placing them over the piston rod.
7. Carefully replace the bearing on the rod. Slide the retainer plate into position. Replace the retainer screws, and tighten in a cross sequence pattern. Torque to values shown in Table 2 below.

## Retainer Screw Torque

Retainer Screw Size	Screw Part # 6893	Screw Part # 6894	Rec. Torque (ft-lbs)
1/4 - 28	-1, -2	-1, -2, -3	7
5/16 - 24	-3, -4	-4, -5	12
3/8 - 24	-5	-6, -7	22
1/2 - 20	-6, -7	-8, -9	50

Table 2.

## Complete Rebuild

1. Repeat steps 1, 2, 3, 4 and 5 in **Replacing rod seals** section.
2. Remove the tie rod nuts, loosening in a cross sequence pattern. Carefully remove the cap or head from the tie rods and inspect for damage or signs of contamination.
3. Remove the cylinder body from the head/cap. Slide the piston rod assembly out of the cylinder body. It is not necessary to remove the tie rods if threaded into a tapped head or cap for servicing, unless the tapped head or cap is mechanically damaged.

4. The piston does not have to be removed from the rod for normal piston seal replacement. Cast iron piston rings may be removed by inserting a thin tool under the joint and running it around the circumference of the piston.
5. Remove the nonmetallic wear band which simply snaps into the groove on the piston's outer diameter, if applicable.
6. If piston removal from the rod is required, slide the piston rod assembly out of the cylinder body. Clamp the rod securely in a copper padded vice that will protect the rod finish. If a locknut holds the piston to the rod, loosen and remove locknut.
7. If no locknut is present, heat the piston to approximately 350° F with a torch or in an oven to break the anaerobic adhesive. Insert a spanner wrench in the drilled holes on the piston face and break the seal by rapping the wrench with a rubber mallet, rotating the piston in a counterclockwise direction.

## CAUTION

### THE PISTON IS HOT!

8. Unscrew the piston and set it aside.
9. Remove the cushion collar from the rod, if the cylinder is cushioned on the head end. Let the rod cool before re-assembly.
10. Snugly secure the rod into the vice. Replace the cushion collar on the rod (if required). Thoroughly clean all metallic surfaces with a non-petroleum based cleaner and a wire brush, if necessary.
11. Apply anaerobic adhesive near the rod shoulder (or collar) on the rod threads and on the piston I.D. threads.

## NOTE

Be sure to follow the adhesive manufacturer's recommendations regarding surface preparation, priming requirements, proper adhesive for the thread size, and cure time prior to pressurization. Failure to do so could result in improper sealing and retention.

12. If piston is threaded, screw the piston onto the rod, hand tight. Insert the spanner wrench and tighten by lightly rapping it with a mallet. Otherwise slide the piston on the rod and screw the locknut on the rod and tighten.
13. Place the piston rings at an angle over the piston and slip them into the grooves. For elastomeric type seals, place the flexible seal into the top groove. Flip the piston over and repeat the process with the remaining seal.
14. New cup seals are installed by placing one side in the piston groove and stretching the seal around the circumference with the thin tool used in disassembly. Make sure that the lips of the seals face the outside of the piston.

Note the sleeve orientation in the groove before removal. Some sleeves are not symmetrical and new sleeves must be installed in the groove in the same orientation.

17. Shorter cylinders are more easily assembled in a vertical position. Insert the body o-ring in the cap body groove and position the cylinder body on the cap.
18. Place a ring compressor sleeve tool on the body. Lube the piston O.D. and the rings. Carefully insert the piston into the cylinder body.
19. Install the body o-ring in the head body groove. When properly installed, the o-ring should remain in the head when inverted. Grease will hold the o-ring in place if required. Place the cylinder head with tie rods on the body.

20. Repeat steps 6 and 7 in “**Replacing rod seals**” section.

21. Start the tie rod nuts until snug against the head or cap and lay the cylinder horizontally into a vice or clamped to a flat surface.
22. Tighten the tie rod nuts gradually in a cross sequence pattern to equally distribute forces around the cylinder with a torque wrench. The required torque values are listed in Table 3. Check each nut a second time after reaching full torque.

Bore Ø (in.)	Tie Rod Ø (in.)	Rec. Torque* (ft. lb.)
1½	¼ - 28	8
2, 2½	5/16 - 24	16
3¼, 4	3/8 - 24	28
5, 6, 7, 8	½ - 20	66
10, 12	5/8 - 18	130
14	¾ - 16	225

Table 3.

\* Recommended torque values using MoS<sub>2</sub> lubricant with 0.12 coefficient of friction.

15. Cylinder body o-rings are easily removed using a thin blade tool. Care should be taken to avoid damaging the surface finish in the groove with the tool.
16. Metallic cushion sleeves can be replaced by removing the snap ring sleeve retainers.

**Table 4. Seal Compatibility with Common Fluids**

Standard seal material is Nitrile and is compatible with most applications. Optional seal compounds are Viton<sup>†</sup> and EPR. The fluid compatibility of these standard and optional seal compounds is listed below:

Class of Hydraulic Fluid	Standard & Optional Seal Compounds		
	Nitrile (std)	EPR (opt)	Viton (opt)
Petroleum base	Compatible	Not compatible	Compatible
Phosphate ester	Not compatible	Compatible	Compatible
Silicone	Compatible	Compatible	Compatible
Water	Compatible	Compatible	Compatible
Water/Oil Emulsion	Compatible	Not compatible	Compatible
Water-Glycol	Compatible	Compatible	Compatible
Ethylene Glycol	Compatible	Compatible	Compatible
Auto Trans. Fluid	Compatible	Not compatible	Compatible
Auto Brake Fluid	Not compatible	Compatible	Not compatible
Temperature Ranges <sup>1</sup>	-40° F to +250° F	-65° F to +300° F	-20° F to +400° F

<sup>†</sup> E.I. du Pont trade name for fluoroelastomer (FPM).

<sup>1</sup> Maximum ratings for continuous exposure.



# Exploded view

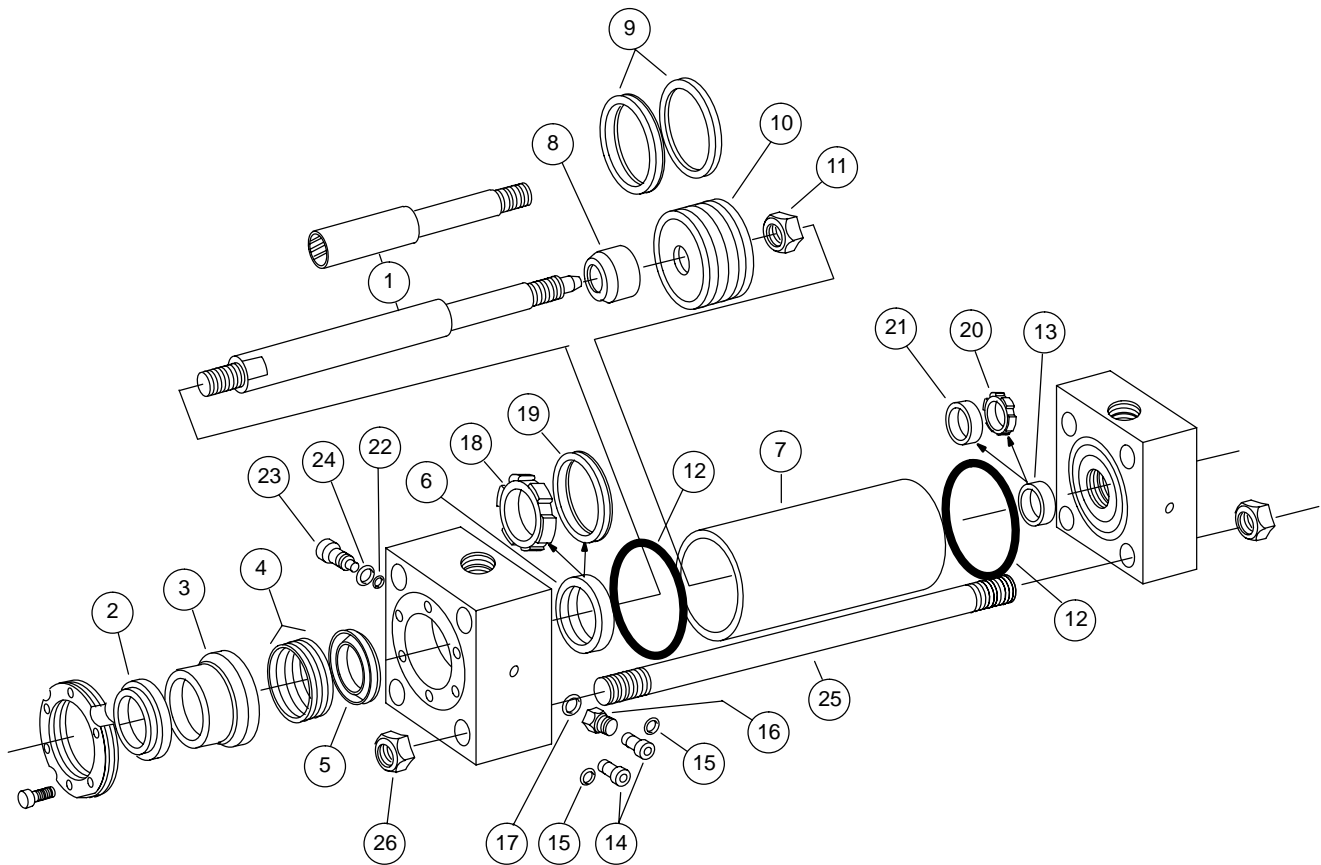

Figure 4.

## Maintenance

### Inspection

All parts in the unit must be kept clean during the overhaul. Handle each part with care and always work in a clean area.

Periodic inspection of the fluid condition and tube or piping connections can save time consuming breakdowns and unnecessary parts replacement. The following should be checked regularly:

1. All hydraulic connections must be kept tight. A loose connection in a pressure line will permit the fluid to leak out. If the fluid level becomes so low as to uncover the inlet pipe opening in the reservoir, extensive damage to the pump can result. In suction or return lines, loose connections permit air to be drawn into the system resulting in noisy and/or erratic operation.
2. Clean fluid is the best insurance for long service life. Therefore, the reservoir should be checked periodically for dirt or other contaminants. If the fluid becomes contaminated, the system should be drained and the reservoir cleaned before new fluid is added.
3. Filter elements also should be checked and replaced periodically. A clogged filter element results in a higher pressure drop. This can force particles through the filter which would ordinarily be trapped, or can cause the by-pass to open, resulting in a partial or complete loss of filtration.
4. Air bubbles in the reservoir can ruin the pump and other components. If bubbles are seen, locate the source of the air and seal the leak.

---

## Cleanliness

Thorough precautions should always be observed to insure the hydraulic system is clean:

1. Clean (flush) entire new system to remove paint, metal chips, welding shot, etc.
2. Filter each change of oil to prevent introduction of contaminants into the system.
3. Provide continuous oil filtration to remove sludge and products of wear and corrosion generated during the life of the system.
4. Provide continuous protection of system from entry of airborne contamination by sealing the system and/or by proper filtration of the air.
5. During usage, proper oil filling and servicing of filter, breathers, reservoirs, etc., cannot be over emphasized.
6. Thorough precautions should be taken by proper system and reservoir design, to insure that aeration of the oil will be kept to a minimum.

Vickers supports and recommends the hydraulic Systems Standards for Stationary Industrial Machinery advanced by the American National Standards Institute; ANSI/(NFPA/JIC) T2.24.1-1991. Key elements of this Standard as well as other vital information on the correct methods for treating hydraulic fluid are included in Vickers publication #561; "Vickers Guide to Systemic Contamination Control," available from your local Vickers distributor or by contacting Vickers. Recommendations on filtration and the selection of products to control fluid condition are included in this publication.

## Sound Level

Noise is only indirectly affected by the fluid selection, but the condition of the fluid is of paramount importance in obtaining optimum reduction of system sound levels.

Some of the major factors affecting the fluid conditions that cause the loudest noises in a hydraulic system are:

1. Very high viscosities at start-up temperature can cause pump noises due to cavitation.
2. Running with a moderately high viscosity fluid will slow the release of air captured in the fluid. The fluid will not be completely purged of such air in the time it remains in the reservoir before recycling through the system.
3. Aerated fluid can be caused by ingestion of air through the pipe joints of inlet lines, high velocity discharge lines, cylinder rod packings or by fluid discharging above the fluid level in the reservoir. Air in the fluid causes a noise similar to cavitation.

## Hydraulic Fluid Recommendations

Oil in a hydraulic system performs the dual function of lubrication and transmission of power. It constitutes a vital factor in a hydraulic system, and careful selection of it should be made with the assistance of a reputable supplier. Proper selection of oil assures satisfactory life and operation of system components with particular emphasis on hydraulic pumps. Any oil selected for use with pumps is acceptable for use with valves, cylinders or motors.

Order literature #694 for oil selection recommendations.

## Adding Fluid to the System

When hydraulic fluid is added to the system, it should be pumped through a 10 micron absolute filter. The use of a Vickers Clean Cart portable filtering transfer unit to filter clean fluid into the system is recommended. For further information on the Clean Cart transfer unit, obtain service drawing #601.

It is important that the fluid be kept clean and free from any substance that may cause improper operation or wear to the cylinder, pump and other hydraulic units. Therefore, the use of cloth to strain the fluid should be avoided to prevent lint from entering the system.

## Replacement Parts

Reliable operation throughout the specified operating range is assured only if genuine Vickers parts are used. Sophisticated design processes and materials are used in the manufacture of our parts. Substitutes may result in early failure.

## Product Life

The service life of these products is dependent on environment, duty cycle, operating parameters and system cleanliness. Since these parameters vary from application to application, the ultimate user must determine and establish the periodic maintenance required to maximize life and detect potential component problems.

## Fluids

Proper fluid condition is essential for long and satisfactory life of hydraulic components and systems. Hydraulic fluid must have the correct balance of cleanliness, materials and additives for protection against wear of components, elevated viscosity and inclusion of air.

Essential information on the correct methods for treating hydraulic fluid is included in Vickers publication 561; "Vickers Guide to Systemic Contamination Control," available from your local Vickers distributor or by contacting Vickers, Incorporated.

Recommendation of filtration and the selection of products to control fluid condition are included in #561.

Recommended cleanliness levels using petroleum oil under common conditions is based on the highest fluid pressure levels in the system.

Fluids other than petroleum, severe service cycles or temperature extremes are cause for adjustment of these cleanliness codes. See Vickers Publication 561 for exact details.

## System Pressure Level

Product	1000 psi	2000 psi	3000+ psi
Cylinders	20/18/15	20/18/15	20/18/15

# Replacement Parts - Single Rod Cylinders

Refer fold out page 20 – Figure 5

Key No.	Part Name	No Req'd	BORE SIZE 1 1/2"		BORE SIZE 2"	
			5/8" ROD	1" ROD	5/8" ROD	1 ROD
1	Piston rod Non-cushioned (# = rod end type) Cushioned head end Cushioned cap end Specify stroke Cushioned both ends	1	TE82C#DA10A_	TE82E#CA10A_	TE82C#DA10A_	TE82E#DA10A_
		1	TE82C#DF10A_	TE82E#CF10A_	TE82C#DF10A_	TE82E#DF10A_
		1	TE82C#DB10A_	TE82E#CB10A_	TE82C#DB10A_	TE82E#DB10A_
		1	TE82C#DK10A_	TE82E#CK10A_	TE82C#DK10A_	TE82E#DK10A_
2	Rod wiper (air) Rod scraper (hydraulic)	1	5026-5/8	5026-1	5026-5/8	5026-1
		1	5030-5/8	5030-1	5030-5/8	5030-1
3	Rod bearing	1	TX81C1020	TX81E1040	TX81C1000	TX81E1040
4	Rod seal	3	5070-14	5070-20	5070-14	5070-20
5	Seal adaptor	1	SM-77-2-B	SM-77-4-B	SM-77-2-B	SM-77-4-B
6	Cushion seal (head end) – for head end cushioned air cylinders only	1	5050-11	N/A	5050-2	N/A
7	Body (specify stroke)	1	TE57CA_	TE57CA_	TE57DA_	TE57DA_
8	Cushion collar	1	TE93C1	TE93EC1	TE93CD1	TE93ED1
9	Piston seal (U-cup design only)	2	5120-15	5120-15	5120-20	5120-20
10	Piston	1	TE53CU0C0	TE53CU0E0	TE53DU0B0	TE53DU0E0
11	Piston locknut	1	364	N/A	364	N/A
12	Body o-ring	2	5145-029-A	5145-029-A	5145-033-A	5145-033-A
13	Cushion seal (cap end) – for cap end cushioned air cylinders only	1	5050-10	5050-10	5050-10	5050-10
14	Cushion adjusting screw (2 req'd if cushioned both ends)	0-2	SM-95-1-B	SM-95-1-B	SM-95-1-B	SM-95-1-B
15	Cushion adjusting screw o-ring (2 req'd if cushioned both ends)	0-2	5145-006-A	5145-006-A	5145-006-A	5145-006-A
16	Cushion adjusting screw locknut (2 req'd if cushioned both ends)	0-2	SM-96-1-B	SM-96-1-B	SM-96-1-B	SM-96-1-B
17	Cushion adjusting screw locknut o-ring (2 req'd if cushioned both ends)	0-2	5145-010	5145-010	5145-010	5145-010
18	Cushion sleeve (head end) – for head end cushioned hydraulic cylinders only	1	S-92-3-1-B	N/A	S-92-4-1-B	LSM-294-AL
19	Sleeve retainer ring (head end) – for head end cushioned hydraulic cylinders only	1	S-92-3-2	N/A	S-92-4-2	N/A
20	Cushion sleeve (cap end) – for cap end cushioned hydraulic cylinders only	1	S-92-1-1-B	S-92-1-1-B	S-92-1-1-B	S-92-1-1-B
21	Sleeve retainer ring (cap end – for cap end cushioned hydraulic cylinders only)	1	S-92-1-2	S-92-1-2	S-92-1-2	S-92-1-2
22	Steel ball	1	N/A	N/A	N/A	5205-002
23	Ball retainer screw	1	N/A	N/A	N/A	5255-1/16
24	Ball retainer screw o-ring	1	N/A	N/A	N/A	N/A
25	Tie rods (specify mounting style/bore/stroke)	as req'd	consult factory			
26	Tie rod nuts (specify mounting style/bore)	as req'd	consult factory			

# Replacement Parts - Single Rod Cylinders

Refer fold out page 20 – Figure 5

Key No.	No Req'd	BORE SIZE 2"					BORE SIZE 2 1/2"				
		1 3/8" ROD		5/8" ROD		1 ROD	1 3/8" ROD		1 3/4" ROD		
1	1	TE82H#DA10A_	TE82C#EA10A_	TE82E#EA10A_	TE82H#EA10A_	TE82L#EA10A_	TE82H#DA10A_	TE82C#EA10A_	TE82E#EA10A_	TE82H#EA10A_	TE82L#EA10A_
	1	TE82H#DF10A_	TE82C#EF10A_	TE82E#EF10A_	TE82H#EF10A_	TE82L#EF10A_	TE82H#DF10A_	TE82C#EF10A_	TE82E#EF10A_	TE82H#EF10A_	TE82L#EF10A_
	1	TE82H#DB10A_	TE82C#EB10A_	TE82E#EB10A_	TE82H#EB10A_	TE82L#EB10A_	TE82H#DB10A_	TE82C#EB10A_	TE82E#EB10A_	TE82H#EB10A_	TE82L#EB10A_
	1	TE82H#DK10A_	TE82C#EK10A_	TE82E#EK10A_	TE82H#EK10A_	TE82L#EK10A_	TE82H#DK10A_	TE82C#EK10A_	TE82E#EK10A_	TE82H#EK10A_	TE82L#EK10A_
2	1	5026-13/8	5026-5/8	5026-1	5026-13/8	5026-13/4	5030-13/8	5030-5/8	5030-1	5030-13/8	5030-13/4
		5030-13/8	5030-5/8	5030-1	5030-13/8	5030-13/4	5030-13/8	5030-5/8	5030-1	5030-13/8	5030-13/4
3	1	TE81H1120	TX81C1000	TX81E1040	TE81H1120	TX81L1180					
4	3	5070-26-1	5070-14	5070-20	5070-26-1	5070-29-1					
5	1	SM-77-6-1-B	SM-77-2-B	SM-77-4-B	SM-77-6-1-B	SM-77-8-1-B					
6	1	N/A	5050-2	Use items 18 & 19	N/A	N/A					
7	1	TE57DA_	TE57EA_	TE57EA_	TE57EA_	TE57EA_					
8	1	TE93HD1	TE93CD1	TE93EE1	TE93HD1	TE93LE1					
9	2	5120-20	5120-25	5120-25	5120-25	5120-25					
10	1	TE53DU0H0	TE53EU0C0	TE53EU0E0	TE53EU0H0	TE53EU0L0					
11	1	N/A	364	N/A	N/A	N/A					
12	2	5145-033-A	5145-037-A	5145-037-A	5145-037-A	5145-037-A					
13	1	5050-10	5050-10	5050-10	5050-10	5050-10					
14	0-2	SM-95-1-B	SH-95-15	SH-95-15	SH-95-15	SH-95-15					
15	0-2	5145-006-A	5145-006-A	5145-006-A	5145-006-A	5145-006-A					
16	0-2	SM-96-1-B	N/A	N/A	N/A	N/A					
17	0-2	5145-010	N/A	N/A	N/A	N/A					
18	1	N/A	S-92-4-1-B	S-92-7-1-B	N/A	N/A					
19	1	N/A	S-92-4-2	S-92-7-2-A	N/A	N/A					
20	1	S-92-1-1-B	S-92-1-1-B	S-92-1-1-B	S-92-1-1-B	S-92-1-1-B					
21	1	S-92-1-2	S-92-1-2	S-92-1-2	S-92-1-2	S-92-1-2					
22	1	5205-002	N/A	N/A	5205-003	5205-002					
23	1	5255-1/16	N/A	N/A	SH-98-15	5255-1/16					
24	1	N/A	N/A	N/A	5145-006-A	N/A					
25	as req'd	consult factory									
26	as req'd	consult factory									

# Replacement Parts - Single Rod Cylinders

Refer fold out page 20 – Figure 5

Key No.	Part Name	No Req'd	BORE SIZE 3 1/4"			
			1" ROD	1 3/8" ROD	1 3/4" ROD	2" ROD
1	Piston rod (# = rod end type) Non-cushioned Cushioned head end Cushioned cap end Cushioned both ends Specify stroke	1	TE82E#HA10A_	TE82H#HA10A_	TE82L#HA10A_	TE82M#HA10A_
		1	TE82E#HF10A_	TE82H#HF10A_	TE82L#HF10A_	TE82M#HF10A_
		1	TE82E#HB10A_	TE82H#HB10A_	TE82L#HB10A_	TE82M#HB10A_
		1	TE82E#HK10A_	TE82H#HK10A_	TE82L#HK10A_	TE82M#HK10A_
2	Rod wiper (air) Rod scraper (hydraulic)	1	5026-1	5026-13/8	5026-13/4	5026-2
		1	5030-1	5030-13/8	5030-13/4	5030-2
3	Rod bearing	1	TX81E1040	TE81H1100	TE81L1580	TE81M1220
4	Rod seal	3	5070-20	5070-26	5070-29	5070-31
5	Seal adaptor	1	SM-77-4-B	SM-77-6-B	SM-77-8-B	SM-77-9-B
6	Cushion seal (head end) – for head end cushioned air cylinders only	1	5050-3	N/A	N/A	N/A
7	Body (specify stroke)	1	TE57GA_	TE57GA_	TE57GA_	TE57GA_
8	Cushion collar	1	TE93EH1	TE93HH1	TE93LH1	TE93MH1
9	Piston seal (U-cup design only)	2	5120-32	5120-32	5120-32	5120-32
10	Piston	1	TE53GU0E0	TE53GU0H0	TE53GU0L0	TE53GU0M0
11	Piston locknut	1	664	N/A	364	N/A
12	Body o-ring	2	5145-042-A	5145-042-A	5145-042-A	5145-042-A
13	Cushion seal (cap end) – for cap end cushioned air cylinders only	1	5050-1	5050-1	5050-1	5050-1
14	Cushion adjusting screw (2 req'd if cushioned both ends)	0-2	SH-95-15	SH-95-15	SH-95-15	SH-95-15
15	Cushion adjusting screw o-ring (2 req'd if cushioned both ends)	0-2	5145-006-A	5145-006-A	5145-006-A	5145-006-A
16	Cushion adjusting screw locknut (2 req'd if cushioned both ends)	0-2	N/A	N/A	N/A	N/A
17	Cushion adjusting screw locknut o-ring (2 req'd if cushioned both ends)	0-2	N/A	N/A	N/A	N/A
18	Cushion sleeve (head end) – for head end cushioned hydraulic cylinders only	1	LSM-92-5-B	N/A	N/A	N/A
19	Sleeve retainer ring (head end) – for head end cushioned hydraulic cylinders only	1	LSM-92-5-2	N/A	N/A	N/A
20	Cushion sleeve (cap end) – for cap end cushioned hydraulic cylinders only	1	S-92-2-1-B	S-92-2-1-B	S-92-2-1-B	S-92-2-1-B
21	Sleeve retainer ring (cap end) – for cap end cushioned hydraulic cylinders only	1	S-92-2-2	S-92-2-2	S-92-2-2	S-92-2-2
22	Steel ball	1	N/A	5205-003	5205-003	5205-003
23	Ball retainer screw	1	N/A	SH-98-15	SH-98-15	SH-98-15
24	Ball retainer screw o-ring	1	N/A	5145-006-A	5145-006-A	5145-006-A
25	Tie rods (specify mounting style/bore/stroke)	as req'd	consult factory			
26	Tie rod nuts (specify mounting style/bore)	as req'd	consult factory			

# Replacement Parts - Single Rod Cylinders

Refer fold out page 20 – Figure 5

Key No.	No Req'd	BORE SIZE 4"				
		1" ROD	1 3/8" ROD	1 3/4" ROD	2" ROD	2 1/2" ROD
1	1	TE82E#HA10A_	TE82H#HA10A_	TE82L#HA10A_	TE82M#HA10A_	TE82P#HA10A_
	1	TE82E#HF10A_	TE82H#HF10A_	TE82L#HF10A_	TE82M#HF10A_	TE82P#HF10A_
	1	TE82E#HB10A_	TE82H#HB10A_	TE82L#HB10A_	TE82M#HB10A_	TE82P#HB10A_
	1	TE82E#HK10A_	TE82H#HK10A_	TE82L#HK10A_	TE82M#HK10A_	TE82P#HK10A_
2	1	5026-1	5026-1-3/8	5026-1-3/4	5026-2	5026-2-1/2
		5030-1	5030-1-3/8	5030-1-3/4	5030-2	5030-2-1/2
3	1	TX81E1040	TE81H1100	TE81L1580	TE81M1220	TE81P1280
4	3	5070-20	5070-26	5070-29	5070-31	5070-35
5	1	SM-77-4-B	SM-77-6-B	SM-77-8-B	SM-77-9-B	SM-77-11-B
6	1	5050-3	N/A	N/A	N/A	N/A
7	1	TE57HA_	TE57HA_	TE57HA_	TE57HA_	TE57HA_
8	1	TE93EH1	TE93HH1	TE93LH1	TE93MH1	TE93PH1
9	2	5120-40	5120-40	5120-440	5120-40	5120-40
10	1	TE53HU0E0	TE53HU0H0	TE53HU0L0	TE53HU0M0	TE53HU0P0
11	1	N/A	364	N/A	N/A	N/A
12	2	5145-045-A	5145-045-A	5145-045-A	5145-045-A	5145-045-A
13	1	5050-1	5050-1	5050-1	5050-1	5050-1
14	0-2	SH-95-32	SH-95-32	SH-95-32	SH-95-32	SH-95-32
15	0-2	5145-008-A	5145-008-A	5145-008-A	5145-008-A	5145-008-A
16	0-2	N/A	N/A	N/A	N/A	N/A
17	0-2	N/A	N/A	N/A	N/A	N/A
18	1	LSM-92-5-1-B	N/A	N/A	N/A	N/A
19	1	LSM-92-5-2	N/A	N/A	N/A	N/A
20	1	S-92-2-1-B	S-92-2-1-B	S-92-2-1-B	S-92-2-1-B	S-92-2-1-B
21	1	S-92-2-2	S-92-2-2	S-92-2-2	S-92-2-2	S-92-2-2
22	1	N/A	5205-004	5205-004	5205-004	5205-004
23	1	N/A	SH-98-32	SH-98-32	SH-98-32	SH-98-32
24	1	N/A	5145-008-A	5145-008-A	5145-008-A	5145-008-A
25	as req'd	consult factory				
26	as req'd	consult factory				

# Replacement Parts - Single Rod Cylinders

Refer fold out page 20 – Figure 5

Key No.	Part Name	No Req'd	BORE SIZE 5"			
			1" ROD	1 <sup>3</sup> / <sub>8</sub> " ROD	1 <sup>3</sup> / <sub>4</sub> " ROD	2" ROD
1	Piston rod (# = rod end type) Specify stroke	1	TE82E#KA10A_	TE82H#KA10A_	TE82L#KA10A_	TE82M#KA10A_
		1	TE82E#KF10A_	TE82H#KF10A_	TE82L#KF10A_	TE82M#KF10A_
		1	TE82E#KB10A_	TE82H#KB10A_	TE82L#KB10A_	TE82M#KB10A_
		1	TE82E#KK10A_	TE82H#KK10A_	TE82L#KK10A_	TE82M#KK10A_
2	Rod wiper (air) Rod scraper (hydraulic)	1	5026-1	5026-13/8	5026-13/4	5026-2
		1	5030-1	5030-13/8	5030-13/4	5030-2
3	Rod bearing	1	TX81E1040	TE81H1100	TE81L1580	TE81M1220
4	Rod seal	3	5070-20	5070-26	5070-29	5070-31
5	Seal adaptor	1	SM-77-4-B	SM-77-6-B	SM-77-8-B	SM-77-9-B
6	Cushion seal (head end) – for head end cushioned air cylinders only	1	5050-3	N/A	N/A	N/A
7	Body (specify stroke)	1	TE57KA_	TE57KA_	TE57KA_	TE57KA_
8	Cushion collar	1	TE93EH1	TE93HH1	TE93LH1	TE93MH1
9	Piston seal (U-cup design only)	2	5120-50	5120-50	5120-50	5120-50
10	Piston	1	TE53KU0E0	TE53KU0H0	TE53KU0L0	TE53KU0M0
11	Piston locknut	1	664	N/A	364	N/A
12	Body o-ring	2	5145-049-A	5145-049-A	5145-049-A	5145-049-A
13	Cushion seal (cap end) – for cap end cushioned air cylinders only	1	5050-1	5050-1	5050-1	5050-1
14	Cushion adjusting screw (2 req'd if cushioned both ends)	0-2	SH-95-32	SH-95-32	SH-95-32	SH-95-32
15	Cushion adjusting screw o-ring (2 req'd if cushioned both ends)	0-2	5145-008-A	5145-008-A	5145-008-A	5145-008-A
16	Cushion adjusting screw locknut (2 req'd if cushioned both ends)	0-2	N/A	N/A	N/A	N/A
17	Cushion adjusting screw locknut o-ring (2 req'd if cushioned both ends)	0-2	N/A	N/A	N/A	N/A
18	Cushion sleeve (head end) – for head end cushioned hydraulic cylinders only	1	N/A	N/A	N/A	N/A
19	Sleeve retainer ring (head end) – for head end cushioned hydraulic cylinders only	1	N/A	N/A	N/A	N/A
20	Cushion sleeve (cap end) – for cap end cushioned hydraulic cylinders only	1	S-92-2-1-B	S-92-2-1-B	S-92-2-1-B	S-92-2-1-B
21	Sleeve retainer ring (cap end) – for cap end cushioned hydraulic cylinders only	1	S-92-2-2	S-92-2-2	S-92-2-2	S-92-2-2
22	Steel ball	1	N/A	N/A	5205-004	5205-004
23	Ball retainer screw	1	N/A	N/A	SH-98-32	SH-98-32
24	Ball retainer screw o-ring	1	N/A	N/A	5145-008-A	5145-008-A
25	Tie rods (specify mounting style/bore/stroke)	as req'd	consult factory			
26	Tie rod nuts (specify mounting style/bore)	as req'd	consult factory			

# Replacement Parts - Single Rod Cylinders

Refer fold out page 20 – Figure 5

Key No.	No Req'd	BORE SIZE 5"			BORE SIZE 6"	
		2 1/2" ROD	3" ROD	3 1/2" ROD	1 3/8" ROD	1 3/4" ROD
1	1	TE82P#KA10A_	TE82U#KA10A_	TE82V#KA10A_	TE82H#LA10A_	TE82L#LA10A_
	1	TE82P#KF10A_	TE82U#KF10A_	TE82V#KF10A_	TE82H#LF10A_	TE82L#LF10A_
	1	TE82P#KB10A_	TE82U#KB10A_	TE82V#KB10A_	TE82H#LB10A_	TE82L#LB10A_
	1	TE82P#KK10A_	TE82U#KK10A_	TE82V#KK10A_	TE82H#LK10A_	TE82L#LK10A_
2	1	5026-21/2	5026-3	5026-31/2	5026-13/8	5026-13/4
		5030-21/2	5030-3	5030-31/2	5030-13/8	5030-13/4
3	1	TE81P1300	TE81U1600	TE81V1460	TX81H1080	TX81L1160
4	3	5070-35	5070-40	5070-44	5070-26	5070-29
5	1	SM-77-11-B	SM-77-18-B	SM-77-14-B	SM-77-6-B	SM-77-8-B
6	1	N/A	N/A	N/A	5050-4	5050-4
7	1	TE57KA_	TE57KA_	TE57KA_	TE57LA_	TE57LA_
8	1	TE93PH1	TE93UH1	TE93VK1	TE93HL1	TE93LL1
9	2	5120-50	5120-50	5120-50	5120-60	5120-60
10	1	TE53KU0P0	TE53KU0V0	TE53KU0V0	TE53LU0H0	TE53LU0L0
11	1	N/A	364	N/A	N/A	N/A
12	2	5145-049-A	5145-049-A	5145-049-A	5145-163-A	5145-163-A
13	1	5050-1	5050-1	5050-1	5050-12	5050-12
14	0-2	SH-95-32	SH-95-32	SH-95-32	SH-95-60	SH-95-60
15	0-2	5145-008-A	5145-008-A	5145-008-A	5145-011	5145-011
16	0-2	N/A	N/A	N/A	N/A	N/A
17	0-2	N/A	N/A	N/A	N/A	N/A
18	1	N/A	N/A	N/A	LSM-92-7-1-B	LSM-92-7-1-B
19	1	N/A	N/A	N/A	LSM-92-7-2	LSM-92-7-2
20	1	S-92-2-1-B	S-92-2-1-B	S-92-2-1-B	S-92-6-1-B	S-92-6-1-B
21	1	S-92-2-2	S-92-2-2	S-92-2-2	S-92-6-2	S-92-6-2
22	1	5205-004	5205-004	5205-004	N/A	N/A
23	1	SH-98-32	SH-98-32	SH-98-32	N/A	N/A
24	1	5145-008-A	5145-008-A	5145-008-A	N/A	N/A
25	as req'd	consult factory				
26	as req'd	consult factory				



# Replacement Parts - Single Rod Cylinders

Refer fold out page 20 – Figure 5

Key No.	Part Name	No Req'd	BORE SIZE 6"		BORE SIZE 7"	
			2 1/2" ROD	4" ROD	1 3/8" ROD	1 3/4" ROD
1	Piston rod (# = rod end type) Non-cushioned Cushioned head end Cushioned cap end Cushioned both ends Specify stroke	1	TE82P#LA10A_ _ _ _	TE82W#LA10A_ _ _ _	TE82H#NA10A_ _ _ _	TE82L#NA10A_ _ _ _
		1	TE82P#LF10A_ _ _ _	TE82W#LF10A_ _ _ _	TE82H#NF10A_ _ _ _	TE82L#NF10A_ _ _ _
		1	TE82P#LB10A_ _ _ _	TE82W#LB10A_ _ _ _	TE82H#NB10A_ _ _ _	TE82L#NB10A_ _ _ _
		1	TE82P#LK10A_ _ _ _	TE82W#LK10A_ _ _ _	TE82H#NK10A_ _ _ _	TE82L#NK10A_ _ _ _
2	Rod wiper (air) Rod scraper (hydraulic)	1	5026-21/2	5026-4	5026-13/8	5026-13/4
		1	5030-21/2	5030-4	5030-13/8	5030-13/4
3	Rod bearing	1	TE81P1320	TE81W1520	TX81H1080	TX81L1160
4	Rod seal	3	5070-35	5070-49	5070-26	5070-29
5	Seal adaptor	1	SM-77-11-B	SM-77-22-B	SM-77-6-B	SM-77-8-B
6	Cushion seal (head end) – for head end cushioned air cylinders only	1	5050-5	N/A	5050-4	5050-4
7	Body (specify stroke)	1	TE57LA_ _ _	TE57LA_ _ _	TE57MA_ _ _	TE57MA_ _ _
8	Cushion collar	1	TE93PL1	TE93WL1	TE93HL1	TE93LL1
9	Piston seal (U-cup design only)	2	5120-60	5120-60	5120-70	5120-70
10	Piston	1	TE53LU0P0	TE53LU0W0	TE53MU0H0	TE53MU0L0
11	Piston locknut	1	N/A	N/A	N/A	N/A
12	Body o-ring	2	5145-163-A	5145-163-A	5145-167-A	5145-167-A
13	Cushion seal (cap end) – for cap end cushioned air cylinders only	1	5050-12	5050-12	5050-12	5050-12
14	Cushion adjusting screw (2 req'd if cushioned both ends)	0-2	SH-95-60	SH-95-60	SH-95-60	SH-95-60
15	Cushion adjusting screw o-ring (2 req'd if cushioned both ends)	0-2	5145-011	5145-011	5145-011	5145-011
16	Cushion adjusting screw locknut (2 req'd if cushioned both ends)	0-2	N/A	N/A	N/A	N/A
17	Cushion adjusting screw locknut o-ring (2 req'd if cushioned both ends)	0-2	N/A	N/A	N/A	N/A
18	Cushion sleeve (head end) – for head end cushioned hydraulic cylinders only	1	LSM-92-10-1-B	N/A	LSM-92-7-1-B	LSM-92-7-1-B
19	Sleeve retainer ring (head end) – for head end cushioned hydraulic cylinders only	1	LSM-92-10-2	N/A	LSM-92-7-2	LSM-92-7-2
20	Cushion sleeve (cap end) – for cap end cushioned hydraulic cylinders only	1	S-92-6-1-B	S-92-5-1-B	S-92-6-1-B	S-92-6-1-B
21	Sleeve retainer ring (cap end) – for cap end cushioned hydraulic cylinders only	1	S-92-6-2	S-92-6-2	S-92-6-2	S-92-6-2
22	Steel ball	1	N/A	5205-006	N/A	N/A
23	Ball retainer screw	1	N/A	SH-98-60	N/A	N/A
24	Ball retainer screw o-ring	1	N/A	5145-011	N/A	N/A
25	Tie rods (specify mounting style/bore/stroke)	as req'd	consult factory			
26	Tie rod nuts (specify mounting style/bore)	as req'd	consult factory			

# Replacement Parts - Single Rod Cylinders

Refer fold out page 20 – Figure 5

Key No.	No Req'd	BORE SIZE 7"		BORE SIZE 8"		
		3" ROD	5" ROD	1 3/8" ROD	1 3/4" ROD	3 1/2" ROD
1	1	TE82U#NA10A_	TE82Z#NA10A_	TE82H#NA10A_	TE82L#NA10A_	TE82V#NA10A_
	1	TE82U#NF10A_	TE82Z#NF10A_	TE82H#NF10A_	TE82L#NF10A_	TE82V#NF10A_
	1	TE82U#NB10A_	TE82Z#NB10A_	TE82H#NB10A_	TE82L#NB10A_	TE82V#NB10A_
	1	TE82U#NK10A_	TE82Z#NK10A_	TE82H#NK10A_	TE82L#NK10A_	TE82V#NK10A_
2	1	5026-3 5030-3	consult factory 5030-S-5	5026-13/8 5030-13/8	5026-13/4 5030-13/4	5026-31/2 5030-31/2
3	1	TE81U1400	S-881-500-B	TX81H1080	TX81L1160	TE81V1480
4	3	5070-40	5070-53	5070-26	5070-29	5070-44
5	1	SM-77-18-B	SM-77-16-B	SM-77-6-B	SM-77-8-B	SM-77-14-B
6	1	N/A	N/A	5050-4	5050-4	N/A
7	1	TE57MA_	TE57MA_	TE57NA_	TE57NA_	TE57NA_
8	1	S-693-300	TE93ZN1	TE93HL1	TE93LL1	S-1293-350
9	2	5120-70	5120-70	5120-80	5120-80	5120-80
10	1	TE53MU0U0	TE53MU0Z0	TE53NU0H0	TE53NU0L0	TE53NU0V0
11	1	N/A	364	N/A	N/A	N/A
12	2	5145-167-A	5145-167-A	5145-171-A	5145-171-A	5145-171-A
13	1	5050-12	5050-12	5050-12	5050-12	5050-12
14	0-2	SH-95-60	SH-95-60	SH-95-60	SH-95-60	SH-95-60
15	0-2	5145-011	5145-011	5145-011	5145-011	5145-011
16	0-2	N/A	N/A	N/A	N/A	N/A
17	0-2	N/A	N/A	N/A	N/A	N/A
18	1	N/A	N/A	LSM-92-7-1-B	LSM-92-7-1-B	N/A
19	1	N/A	N/A	LSM-92-7-2	LSM-92-7-2	N/A
20	1	S-92-6-1-B	S-92-6-1-B	S-92-6-1-B	S-92-6-1-B	S-92-6-1-B
21	1	S-92-6-2	S-92-6-2	S-92-6-2	S-92-6-2	S-92-6-2
22	1	N/A	5205-006	N/A	N/A	5205-006
23	1	N/A	SH-98-60	N/A	N/A	SH-98-60
24	1	N/A	5145-011	N/A	N/A	5145-011
25	as req'd	consult factory				
26	as req'd	consult factory				

# Replacement Parts - Single Rod Cylinders

Refer fold out page 20 – Figure 5

Key No.	Part Name	No Req'd	Bore Size 8"		Bore Size 10"	
			5 1/2" ROD	1 3/4" ROD	2" ROD	3 1/2" ROD
1	Piston rod (# = rod end type) Specify stroke	1	TE821#NA10A_	TE82L#RA10A_	TE82M#RA10A_	TE82V#RA10A_
		1	TE821#NF10A_	TE82L#RF10A_	TE82M#RF10A_	TE82V#RF10A_
		1	TE821#NB10A_	TE82L#RB10A_	TE82M#RB10A_	TE82V#RB10A_
		1	TE821#NK10A_	TE82L#RK10A_	TE82M#RK10A_	TE82V#RK10A_
2	Rod wiper (air) Rod scraper (hydraulic)	1	consult factory	5026-1-3/4	5026-2	5026-3-1/2
		1	5030-S-5-1/2	5030-1-3/4	5030-2	5030-3-1/2
3	Rod bearing	1	S-881-550-C	TX81L1160	TX81M1240	TE81V1480
4	Rod seal	3	5070-55	5070-29	5070-31	5070-44
5	Seal adaptor	1	SM-77-19-B	SM-77-8-B	SM-77-9-B	SM-77-14-B
6	Cushion seal (head end) – for head end cushioned air cylinders only	1	N/A	5050-6	5050-6	N/A
7	Body (specify stroke)	1	TE57NA_	TE57RA_	TE57RA_	TE57RA_
8	Cushion collar	1	S-893-550	TE93LR1	TE93LR1	S-1293-350
9	Piston seal (U-cup design only)	2	5080-80	5080-85	5080-85	5080-85
10	Piston	1	TE53NU0L0	S-1053-U	S-1053-U	S-1053-U-350
11	Piston locknut	1	N/A	N/A	N/A	N/A
12	Body o-ring	2	5145-171-A	5145-274-A	5145-274-A	5145-274-A
13	Cushion seal (cap end) – for cap end cushioned air cylinders only	1	5050-12	5050-2	5050-2	5050-2
14	Cushion adjusting screw (2 req'd if cushioned both ends)	0-2	SH-95-60	SH-95-3E	SH-95-3E	SH-95-3E
15	Cushion adjusting screw o-ring (2 req'd if cushioned both ends)	0-2	5145-011	5145-006-A	5145-006-A	5145-006-A
16	Cushion adjusting screw locknut (2 req'd if cushioned both ends)	0-2	N/A	N/A	N/A	N/A
17	Cushion adjusting screw locknut o-ring (2 req'd if cushioned both ends)	0-2	N/A	N/A	N/A	N/A
18	Cushion sleeve (head end) – for head end cushioned hydraulic cylinders only	1	N/A	LSM-92-9-1-B	LSM-92-9-1-B	N/A
19	Sleeve retainer ring (head end) – for head end cushioned hydraulic cylinders only	1	N/A	LSM-92-9-2	LSM-92-9-2	N/A
20	Cushion sleeve (cap end) – for cap end cushioned hydraulic cylinders only	1	S-92-6-1-B	S-92-4-1-B	S-92-4-1-B	S-92-4-1-B
21	Sleeve retainer ring (cap end) – for cap end cushioned hydraulic cylinders only	1	S-92-6-2	S-92-4-2	S-92-4-2	S-92-4-2
22	Steel ball	1	5205-006	N/A	N/A	5205-004
23	Ball retainer screw	1	SH-98-60	N/A	N/A	HH-298-NC
24	Ball retainer screw o-ring	1	5145-011	N/A	N/A	N/A
25	Tie rods (specify mounting style/bore/stroke)	as req'd	consult factory			
26	Tie rod nuts (specify mounting style/bore)	as req'd	consult factory			

# Replacement Parts - Single Rod Cylinders

Refer fold out page 20 – Figure 5

Key No.	No Req'd	BORE SIZE 12"				
		5 1/2" ROD	2" ROD	2 1/2" ROD	4" ROD	5 1/2" ROD
1	1	TE821#RA10A_	TE82M#SA10A_	TE82P#SA10A_	TE82W#SA10A_	TE821#SA10A_
	1	TE821#RF10A_	TE82M#SF10A_	TE82P#SF10A_	TE82W#SF10A_	TE821#SF10A_
	1	TE821#RB10A_	TE82M#SB10A_	TE82P#SB10A_	TE82W#SB10A_	TE821#SB10A_
	1	TE821#RK10A_	TE82M#SK10A_	TE82P#SK10A_	TE82W#SK10A_	TE821#SK10A_
2	1	consult factory 5030-3	5026-2 5030-S-5	5026-2-1/2 5030-2-1/2	5026-4 5030-4	consult factory 5030-S-5-1/2
3	1	S-881-550-C	TX81M1200	TX81P1260	TX81W1540	S-881-550-C
4	3	5070-55	5070-31	5070-35	5070-49	5070-55
5	1	SM-77-19-B	SM-77-9-B	SM-77-11-B	SM-77-22-B	SM-77-19-B
6	1	N/A	N/A	5050-4	5050-4	N/A
7	1	TE57RA_	TE57SA_	TE57SA_	TE57SA_	TE57SA_
8	1	S-893-550	TE93LR1	TE93PL1	TE93WL1	S-893-550
9	2	5080-85	5080-90	5080-90	5080-90	5080-90
10	1	S-1053-U-550	S-1253-U	S-1253-U-275	S-1253-U-400	S-1253-U-550
11	1	N/A	N/A	N/A	N/A	N/A
12	2	5145-274-A	5145-278-A	5145-278-A	5145-278-A	5145-278-A
13	1	5050-2	5050-2	5050-2	5050-2	5050-2
14	0-2	SM-95-3E	SM-95-3E	SM-95-3E	SM-95-3E	SM-95-3E
15	0-2	5145-006-A	5145-006-A	5145-006-A	5145-006-A	5145-006-A
16	0-2	N/A	N/A	N/A	N/A	N/A
17	0-2	N/A	N/A	N/A	N/A	N/A
18	1	N/A	LSM-92-9-1-B	LSM-92-10-1-B	N/A	N/A
19	1	N/A	LSM-92-9-2	LSM-92-10-2	N/A	N/A
20	1	S-92-4-1-B	S-92-4-1-B	S-92-4-1-B	S-92-4-1-B	S-92-4-1-B
21	1	S-92-4-2	S-92-4-2	S-92-4-2	S-92-4-2	S-92-4-2
22	1	5205-004			5205-004	5205-004
23	1	HH-298-NC			HH-298-NC	HH-298-NC
24	1	N/A			N/A	N/A
25	as req'd	consult factory				
26	as req'd	consult factory				

# Replacement Parts - Single Rod Cylinders

Refer fold out page 20 – Figure 5

Key No.	Part Name	No Req'd	Bore Size 14"			
			2 1/2" ROD	3" ROD	4" ROD	5 1/2" ROD
1	Piston rod (# = rod end type) Specify stroke	1	TE82P#TA10A_ _ _ _	TE82U#TA10A_ _ _ _	TE82W#TA10A_ _ _ _	TE821#TA10A_ _ _ _
		1	TE82P#TF10A_ _ _ _	TE82U#TF10A_ _ _ _	TE82W#TF10A_ _ _ _	TE821#TF10A_ _ _ _
		1	TE82P#TB10A_ _ _ _	TE82U#TB10A_ _ _ _	TE82W#TB10A_ _ _ _	TE821#TB10A_ _ _ _
		1	TE82P#TK10A_ _ _ _	TE82U#TK10A_ _ _ _	TE82W#TK10A_ _ _ _	TE821#TK10A_ _ _ _
2	Rod wiper (air) Rod scraper (hydraulic)	1	5026-2-1/2	5026-3	5026-4	consult factory 5030-S-5-1/2
		1	5030-2-1/2	5030-3	5030-4	
3	Rod bearing	1	TE81P1340	TE81U1400	TE81W1560	S-881-550-C
4	Rod seal	3	5070-35	5070-40	5070-49	5070-55
5	Seal adaptor	1	SM-77-11-B	SM-77-18-B	SM-77-22-B	SM-77-19-B
6	Cushion seal (head end) – for head end cushioned air cylinders only	1	5050-5	N/A	N/A	N/A
7	Body (specify stroke)	1	TE57TA_ _ _	TE57TA_ _ _	TE57TA_ _ _	TE57TA_ _ _
8	Cushion collar	1	TE93PL1	S-693-300	TE93WL1	TE931T1
9	Piston seal (U-cup design only)	2	5080-95	5080-95	5080-95	5080-95
10	Piston	1	S-1453-U	S-1453-U-300	S-1453-U-400	S-1453-U-550
11	Piston locknut	1	N/A	N/A	N/A	N/A
12	Body o-ring	2	5145-280-A	5145-280-A	5145-280-A	5145-280-A
13	Cushion seal (cap end) – for cap end cushioned air cylinders only	1	5050-3	5050-3	5050-3	5050-3
14	Cushion adjusting screw (2 req'd if cushioned both ends)	0-2	SH-95-3E	SH-95-3E	SH-95-3E	SH-95-3E
15	Cushion adjusting screw o-ring (2 req'd if cushioned both ends)	0-2	5145-006-A	5145-006-A	5145-006-A	5145-006-A
16	Cushion adjusting screw locknut (2 req'd if cushioned both ends)	0-2	N/A	N/A	N/A	N/A
17	Cushion adjusting screw locknut o-ring (2 req'd if cushioned both ends)	0-2	N/A	N/A	N/A	N/A
18	Cushion sleeve (head end) – for head end cushioned hydraulic cylinders only	1	LSM-92-10-1-B	N/A	N/A	N/A
19	Sleeve retainer ring (head end) – for head end cushioned hydraulic cylinders only	1	LSM-92-10-2	N/A	N/A	N/A
20	Cushion sleeve (cap end) – for cap end cushioned hydraulic cylinders only	1	LSM-92-5-1-B	LSM-92-5-1-B	LSM-92-5-1-B	LSM-92-5-1-B
21	Sleeve retainer ring (cap end) – for cap end cushioned hydraulic cylinders only	1	LSM-92-5-2	LSM-92-5-2	LSM-92-5-2	LSM-92-5-2
22	Steel ball	1	N/A	5205-004	5205-004	5205-004
23	Ball retainer screw	1	N/A	HH-298-NC	HH-298-NC	HH-298-NC
24	Ball retainer screw o-ring	1	N/A	N/A	N/A	N/A
25	Tie rods (specify mounting style/bore/stroke)	as req'd	consult factory			
26	Tie rod nuts (specify mounting style/bore)	as req'd	consult factory			

# Exploded view

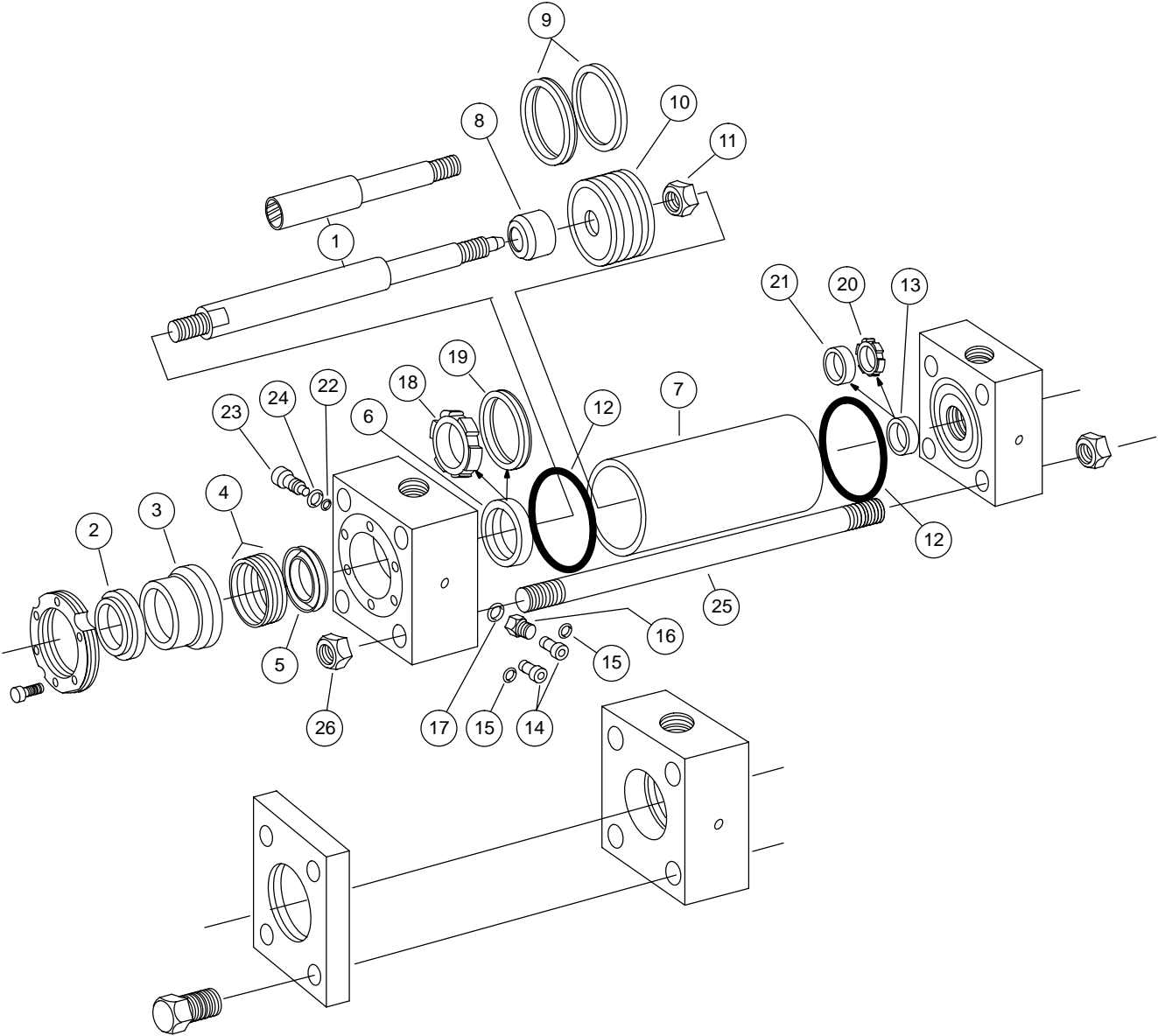

Figure 5.

# How to Order

---

## Standard Cylinders

Vickers has created an easy system for ordering cylinders. This system has been developed to improve our service to you. The model code consists of 16 alpha-numeric digits which fully describe the most common standard options offered.

To specify your cylinder, review the following pages for a full description of each option available and select the desired code.

This model code system will:

- † **Simplify the re-order process.**  
Each Vickers cylinder is assigned a 16 digit model code. That code is unique to a particular cylinder description. That way, when you re-order your cylinder, you're assured of exactly the same top quality cylinder design.
- † **Improve identification.**  
Every Vickers cylinder has its 16 digit model code clearly marked on the product. It is impression stamped in the metal head or cap. Each code completely describes a specific cylinder. This allows seals and replacement components to be easily identified in the field. For cylinders manufactured prior to January 3, 1984, every unit was permanently stamped with an 8 digit serial number that is unique to the quantity of identical cylinders manufactured at the same time.
- † **Facilitate communications.**  
This fully descriptive model code system or alternative serial number, allows you to work directly with your local Vickers sales engineer to identify and service your Vickers cylinder.

## Custom Cylinders

### New Cylinders

Although the model code has been arranged to cover the vast majority of available options, there will be occasions when you require an option which cannot be coded. When specifying such an option, enter an "X" for the appropriate item in the sixteen digit model code, then describe your requirements. For example, if you have an application which requires a custom thread on the end of the piston rod, enter an "X" for item 7. Then add a full description at the end of the model code, such as "With 3.25 inch total rod projection and M22 x 1,5 thread 1.375 inches long." The cylinder will then be given a unique five digit design number on receipt of order (as explained below).

### Replacement Cylinders

Every Vickers custom cylinder is assigned a unique design number. This number is contained in the last five digits of the 16 digit model code, and item 12 is always a alpha character (see page 19). In other words, the "Stroke" and "Extra Rod Projection" locations (items 12 through 16) become the "Design Number" items for custom cylinders. When ordering a replacement cylinder, simply give the 16 digit model code or the five digit design number to your local Vickers Sales Representative.

### Replacement Parts

Each design number is stored in a quick retrieval computerized storage system. This gives our field sales representatives rapid access to assist you in identifying and specifying genuine Vickers replacement parts.

# Model Code

**TE 01 E A C A 3 A A 108 00**

1,2   3,4   5   6   7   8   9   10   11   12,13,14   15,16

## 1,2 Series

**TE** – ANSI B93.15/NFPA  
250 psi air cylinder  
**TF** – ANSI B93.15/NFPA  
1000 psi hydraulic cylinder  
**TL** – ANSI B93.15/NFPA  
250 psi nonlube air cylinder

## 3,4 Mounting style

**Code**   **Mounting style**

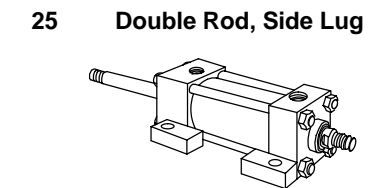
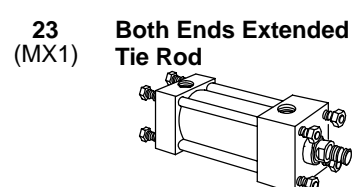
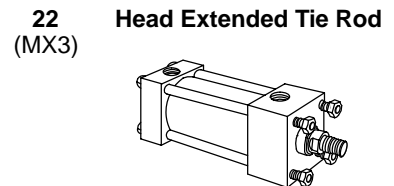
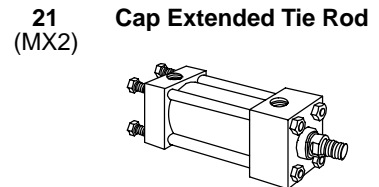
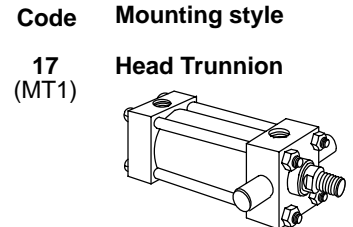
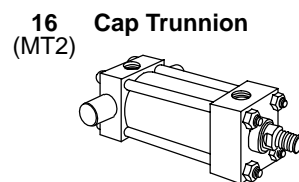
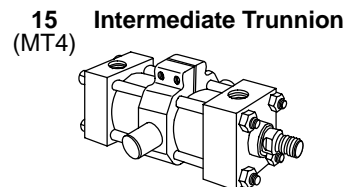
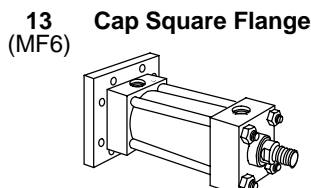
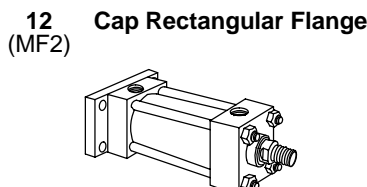
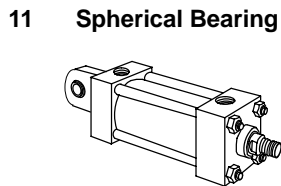
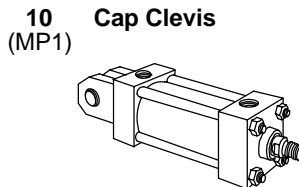
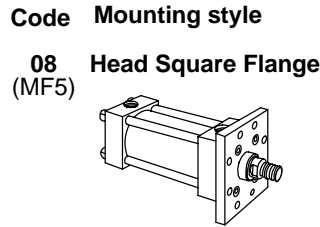
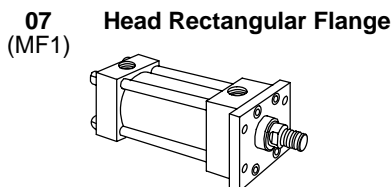
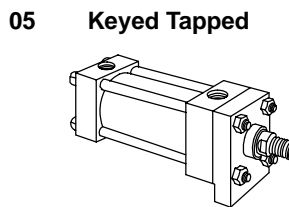
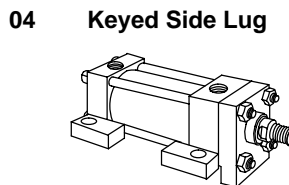
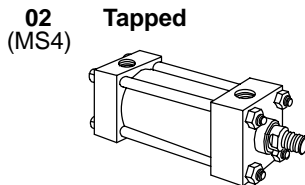
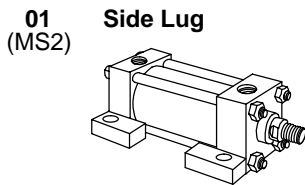

## **Code**   **Other mounting styles**

- 24** No Mount
- 26** Double Rod Tapped
- 28** Double Rod Keyed Side Lug
- 29** Double Rod Keyed Tapped
- 31** Double Rod Rectangular Flange
- 32** Double Rod Square Flange
- 34** Double Rod Intermediate Trunnion
- 35** Double Rod Head Trunnion
- 39** Double Rod Extended Tie Rod
- 40** Double Rod Both Ends Extended Tie Rod
- 41** Double Rod No Mount



# Model Code

**TE 01 E A C A 3 A A 108 00**

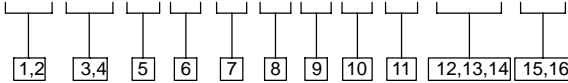

## 5 Bore Sizes (in inches)

Code	Bore
C-	1 1/2
D-	2
E-	2 1/2
G-	3 1/4
H-	4
K-	5
L-	6
M-	7
N-	8
R-	10
S-	12
T-	14

## 6 Cushion & Adjustment Position

Cushions are located as shown below when viewing cylinder from head end (mounting end of double rod cylinder). “-” in table indicates no cushion.

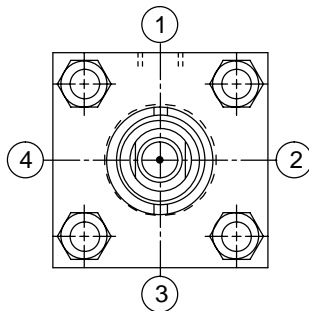

Code	Head	Cap
A-	-	-
B-	-	1
C-	-	2
D-	-	3
E-	-	4
F-	1	-
G-	2	-
H-	3	-
J-	4	-
K-	1	1
L-	1	2
M-	1	3
N-	1	4
P-	2	1
R-	2	2
S-	2	3
T-	2	4
U-	3	1
V-	3	2
W-	3	3
Y-	3	4
1-	4	1
2-	4	2
3-	4	3
4-	4	4

## 7 Rod Size & Rod End Types

**Type 2 rod end**  
Short female UN thread

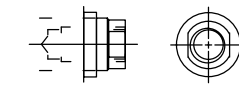

**Type 4 rod end**  
Full male UN thread

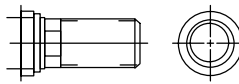

**Type 5 rod end**  
Small male UN thread

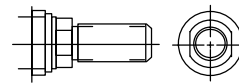

**Type 6 rod end**  
Plain  
No attachment

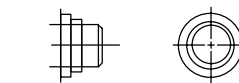

Bore Size (inch)	Rod Size (inch)	Code (for rod size & rod end type)			
		“2” rod end type	“4” rod end type	“5” rod end type	“6” rod end type
1 1/2	5/8	A	B	C	D
	1*	E	F	G	H
2	5/8	A	B	C	D
	1	E	F	G	H
2 1/2	1 3/8	J	K	L	M
	1 3/4	N	P	R	S
3 1/4	1	A	B	C	D
	1 3/8	E	F	G	H
4	1 3/4	J	K	L	M
	2	N	P	R	S
5	1	A	B	C	D
	1 3/8	E	F	G	H
5	1 3/4	J	K	L	M
	2	N	P	R	S
5	2 1/2	T	U	V	W
	3	Y	1	2	3
5	3 1/2	4	5	6	7

Bore Size (inch)	Rod Size (inch)	Code (for rod size & rod end type)			
		“2” rod end type	“4” rod end type	“5” rod end type	“6” rod end type
6	1 3/8	A	B	C	D
	1 3/4	E	F	G	H
	2 1/2	J	K	L	M
7	4	N	P	R	S
	1 3/8	A	B	C	D
	1 3/4	E	F	G	H
8	3	J	K	L	M
	5	N	P	R	S
	1 3/8	A	B	C	D
10	1 3/4	E	F	G	H
	3 1/2	J	K	L	M
	5 1/2	N	P	R	S
12	1 3/4	A	B	C	D
	2	E	F	G	H
	3 1/2	J	K	L	M
14	5 1/2	N	P	R	S
	2 1/2	A	B	C	D
	3	E	F	G	H
14	4	J	K	L	M
	5 1/2	N	P	R	S

\* Cushion cap end only on series TE & TL.

## 8 Seal options

Code	Piston	Seal Compound
A-	U-cups	Nitrile
B-	Cast iron rings	Nitrile
C-	Glass-filled Teflon*	Nitrile
D-	U-cups	Viton*
E-	Cast iron rings	Viton
F-	Glass-filled Teflon	Viton
K-	U-cups	Viton
L-	Cast iron rings	Viton
M-	Glass-filled Teflon	Viton

\* Teflon and Viton are registered trademarks of E. I. DuPont Co.

# TE 01 E A C A 3 A A 108 00

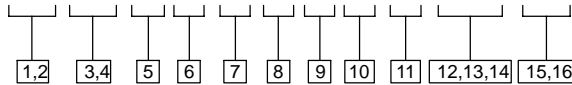

## 9 Port type and size

### Code Type

1	NPTF
2	Oversize NPTF
3	SAE/UN O-ring
4	Oversize SAE/UN
5	NFPA standard SAE/UN
6	SAE 4-bolt manifold

## 10 Port location

Ports are located as shown below when viewing cylinder from head end (mounting end of double rod cylinder).

With some mounting styles, certain port locations cannot be selected due to interference with the mounting.

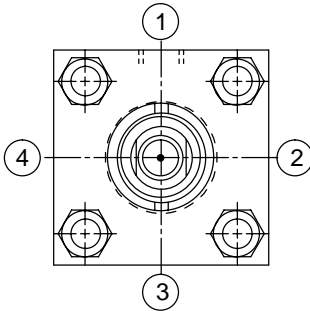

Code	Head	Cap
A	1	1
B	1	2
C	1	3
D	1	4
E	2	1
F	2	2
G	2	3
H	2	4
J	3	1
K	3	2
L	3	3
M	3	4
N	4	1
P	4	2
R	4	3
S	4	4

## 11 Limit switch / proximity switch position and type:

Positions are numbered as shown in item 10 at left.

Code	Head	Cap	Switch Type
A	—	—	none req'd
B	1	—	01
C	2	—	01
D	3	—	01
E	4	—	01
F	1	1	01
G	2	2	01
H	3	3	01
J	4	4	01
K	—	1	01
L	—	2	01
M	—	3	01
N	—	4	01
P	1	—	PS200
R	2	—	PS200
S	3	—	PS200
T	4	—	PS200
U	1	1	PS200
V	2	2	PS200
W	3	3	PS200
Y	4	4	PS200
1	—	1	PS200
2	—	2	PS200
3	—	3	PS200
4	—	4	PS200
5	1	1	03
6	2	2	03
7	3	3	03
8	4	4	03

## 12, 13, 14 Cylinder stroke

Items 12,13 indicate total stroke length from 00 inches to 99 inches.

Item 14 indicates fractions of an inch per the following codes:

Code	Fraction	Code	Fraction
0	0	8	1/2
1	1/16	9	9/16
2	1/8	A	5/8
3	3/16	B	11/16
4	1/4	C	3/4
5	5/16	D	13/16
6	3/8	E	7/8
7	7/16	F	15/16

## 15, 16 Extra rod projection

Item 15 indicates inches from 0 through 9.

Item 16 indicates fractions of an inch per codes shown for item 14 above.

## Ordering Replacement Parts

Any individual replacement part for Vickers cylinders may be ordered by calling out the part number as listed in the charts in this manual. Whenever possible, include the serial number of your cylinder to ensure exact replacement parts.

## Contents of Repair & Seal Kits

A complete Series 63 seal kit contains the following items:

- (3) Rod seals
- (2) Body o-rings
- (2) Piston seals (U-cup)
- (2) Cushion screw o-rings

## Repair Kit Number Coding

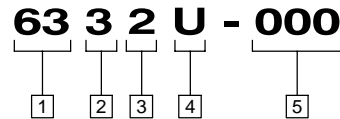

### 1 Seal kit

**63** - Series 63

### 2 Seal compound

- 3** - Nitrile
- 4** - Viton
- 5** - EPR

### 3 Cylinder series

**2** - TE/TF cylinders

### 4 Piston seal type

- R** - Cast iron rings
- U** - Elastomer U-cup

### 5 Dash number for bore size

## Series TE-TF-TL Cylinder Repair Kits

(Standard Nitrile Elastomer Seals)

Cylinder Bore (in.)	1 <sup>1</sup> / <sub>2</sub>		2		2 <sup>1</sup> / <sub>2</sub>			3 <sup>1</sup> / <sub>4</sub>			4			5			6			
Rod Diameter (in.)	1/2	1	1	1 <sup>3</sup> / <sub>8</sub>	1	1 <sup>3</sup> / <sub>8</sub>	1 <sup>3</sup> / <sub>4</sub>	1 <sup>3</sup> / <sub>8</sub>	1 <sup>3</sup> / <sub>4</sub>	2	1 <sup>3</sup> / <sub>4</sub>	2	2 <sup>1</sup> / <sub>2</sub>	2	2 <sup>1</sup> / <sub>2</sub>	3	3 <sup>1</sup> / <sub>2</sub>	2 <sup>1</sup> / <sub>2</sub>	3	4
Complete Seal Kit (cast iron rings) 6332R -	-124	-126	-129	-131	-134	-136	-137	-142	-143	-144	-150	-151	-151	-160	-162	-164	-165	-171	-173	-175

Cylinder Bore (in.)	7			8			10			12			14		
Rod Diameter (in.)	3	4	5	3 <sup>1</sup> / <sub>2</sub>	4	5 <sup>1</sup> / <sub>2</sub>	4 <sup>1</sup> / <sub>2</sub>	5 <sup>1</sup> / <sub>2</sub>	7	5 <sup>1</sup> / <sub>2</sub>	7	8	7	8	10
Complete Seal Kit (cast iron rings) 6332R -	-183	-185	-188	-196	-197	-201	-211	-213	-214	-225	-226	-227	-237	-238	-239

**Eaton**  
Fluid Power Group  
Hydraulics Business USA  
14615 Lone Oak Road  
Eden Prairie, MN 55344  
USA  
Tel: 952-937-9800  
Fax: 952-294-7722  
[www.eaton.com/hydraulics](http://www.eaton.com/hydraulics)

**Eaton**  
Fluid Power Group  
Hydraulics Business Europe  
Route de la Longeraie 7  
1110 Morges  
Switzerland  
Tel: +41 (0) 21 811 4600  
Fax: +41 (0) 21 811 4601

**Eaton**  
Fluid Power Group  
Hydraulics Business Asia Pacific  
11th Floor Hong Kong New World Tower  
300 Huaihai Zhong Road  
Shanghai 200021  
China  
Tel: 86-21-6387-9988  
Fax: 86-21-6335-3912