

068R9545

068R9545

EVSR 10

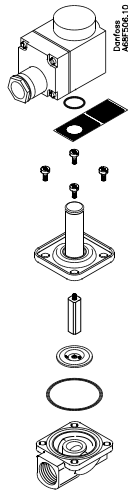
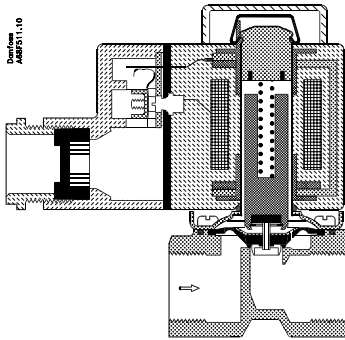

EVSR 12, 14, 18, 22

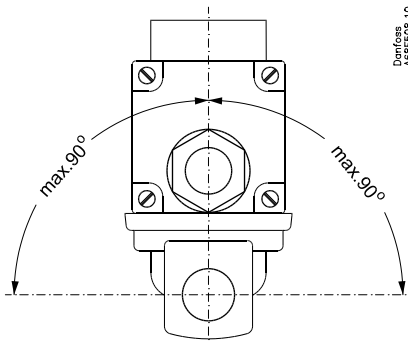
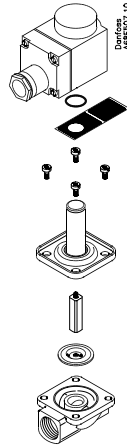
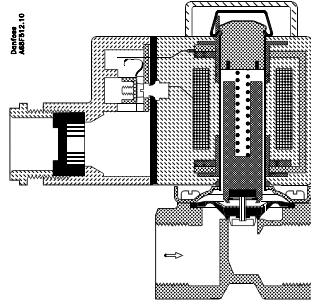

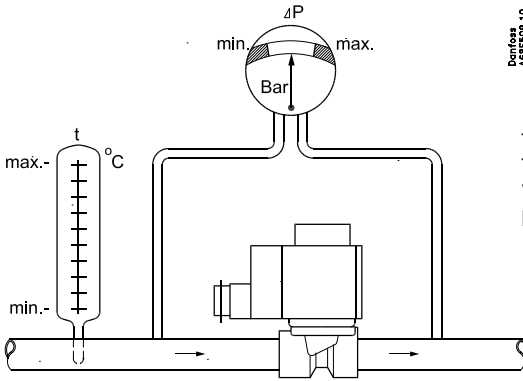

Danfoss
ABSF35.10

T_{amb} = +50°C max.
 T_{medium} = -35 → +60°C
 Viscosity = 50 cST. max.
 Max. test pressure = 16 bar

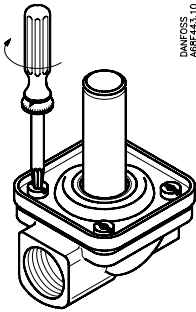

Danfoss
ABSF43.10

EVSR	Nm	kpm	ft-lbs
10	1.4	0.14	1.0
12	2.8	0.28	2.0
14	2.8	0.28	2.0
18	4.5	0.45	3.2
22	4.5	0.45	3.2

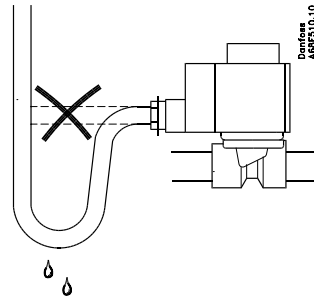

Danfoss
ABSF10.10

NC

Δp
bar

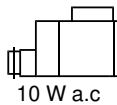

10 W a.c.

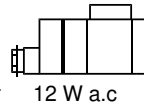

12 W a.c.

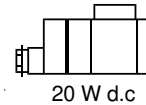

20 W d.c.

min.

max.

min.

max.

min.

max.

EVSR 10, 12
14, 18, 22

0.1

5.0

0.1

5.0

0.1

5.0

Clip-on

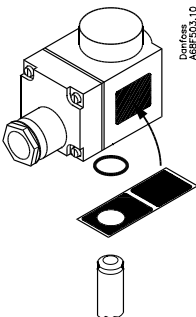

Danfoss
ABSF50.10

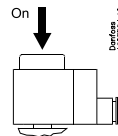

On

Danfoss
ABSF50.10

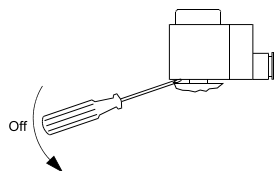

Off