

Data Sheet

Valve station
Type **ICF SS 20** and **ICF SS 25**

A complete range of modern, flexible stainless steel components
for Industrial refrigeration

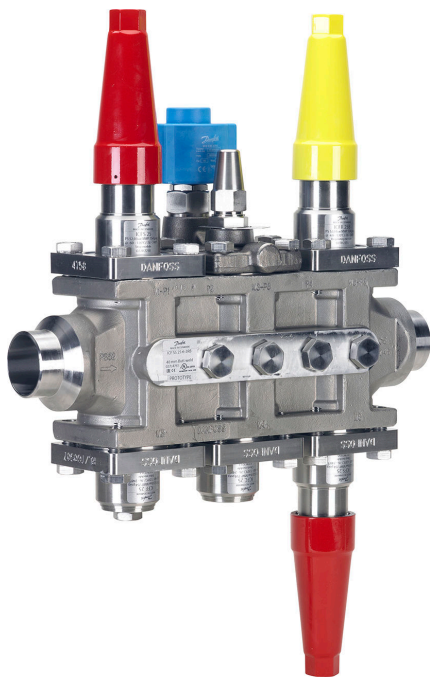

Based on advanced technology the ICF SS valve station incorporates several functions in one housing, which can replace a series of conventional mechanical, electro-mechanical and electronically operated valves.

This valve station not only provides a number of advantages in the design phase of a refrigeration plant but also in the installation, service and maintenance.

The ICF SS valve stations are designed for low and high pressure refrigerants and can be used in pumped liquid lines, liquid injection lines and hot gas lines.

Supplied as a complete assembly, it is fully tested at high pressure and its functions are tested under factory controlled conditions.

One code number equals one application solution.

Features

- Designed for industrial refrigeration applications for a maximum working pressure of 52 bar / 754 psig
- Applicable to HCFC, non flammable HFC, R717 (Ammonia) and R744 (CO₂). The use of ICF SS valve stations with flammable hydrocarbons is not recommended
- Direct weld connections (No leaks through flanges)
- Stainless steel valve housing and function modules
- Low weight and compact design
- V-port regulating cones on the control modules ensure optimum regulating accuracy particularly at part load
- Modular Concept
 - Each housing is available with butt-weld DIN connections in several sizes. Valve service is performed by replacing the function module
 - Side ports for the connection of pressure gauges, transmitters, sight glasses, service valve etc
- UL approved

Applications

To facilitate selection of the right ICF SS valve station Danfoss has predefined and grouped a large number of code numbers matching common applications:

Liquid feed

Table 1: Liquid feed

Application #		Sequence of functions					
1	Liquid feed (No hotgas defrost)	Stop	Filter	Solenoid	Man Open	Regul.	Stop
2	Liquid feed	Stop	Filter	Solenoid	Man Open	Regul.	Stop/Check
3	Liquid feed	Stop	Filter	Solenoid	Check	Regul.	Stop
10	Liquid feed (No hotgas defrost)	Stop	Filter	Solenoid	Regul.		
15	Liquid feed with external connection	Stop	Filter	Solenoid	Check	Welding	Regul.

Liquid injection

Table 2: Liquid injection

Application #		Sequence of functions					
5	Liquid injection (expansion)	Stop	Filter	Solenoid	Man Open	Motor	Stop
14	Liquid injection (expansion)	Stop	Filter	Motor	Stop		

Hot gas defrost

Table 3: Hot gas defrost

Application #		Sequence of functions					
9	Hot gas defrost	Stop	Filter	Solenoid	Solenoid		

Miscellaneous

Table 4: Miscellaneous

Application #		Sequence of functions					
90	Multipurpose configurations						

NOTE:

For specific identification of the different codes and flow capacity (K_v) please refer to ordering section.

Examples of application:

Liquid feed line

A valve combination for a flooded evaporator operating on/off from a thermostat and with electric defrost is required. Manual override of the solenoid valve is requested. Common ICF SS configurations for this kind of application is shown here:

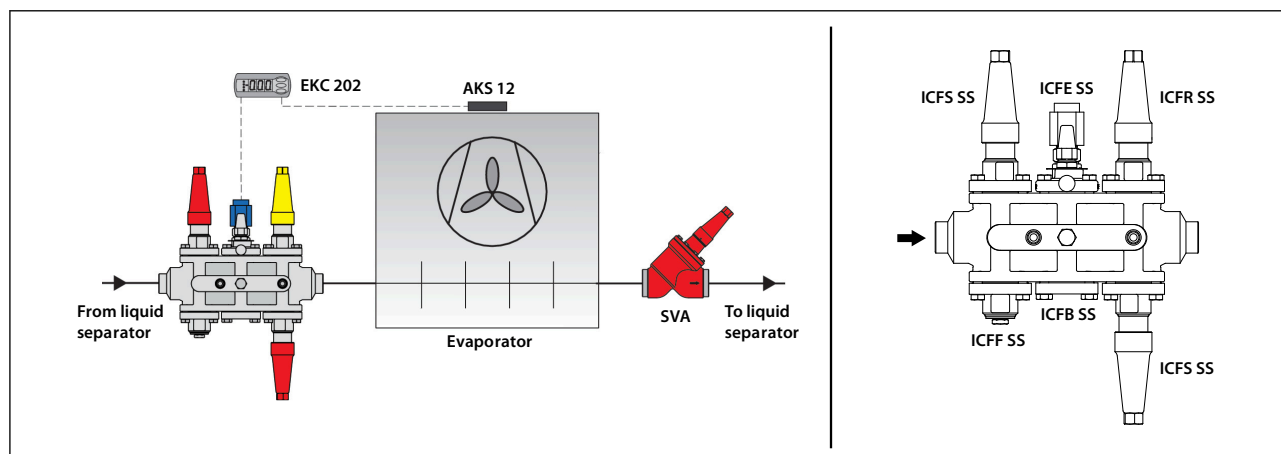

Valve station, Type ICF SS 20 and ICF SS 25

NOTE:

Not all valves are shown. Not to be used for construction purposes.

Liquid feed line/Hot gas defrost line

Evaporator with soft opening gas powered valve ICLX in the suction line and hot gas defrost featuring: ICF SS liquid feed station and ICF SS Hot gas station with side port to power ICLX. ICS+CVP as a defrost regulator (OFV optional depending on capacity).

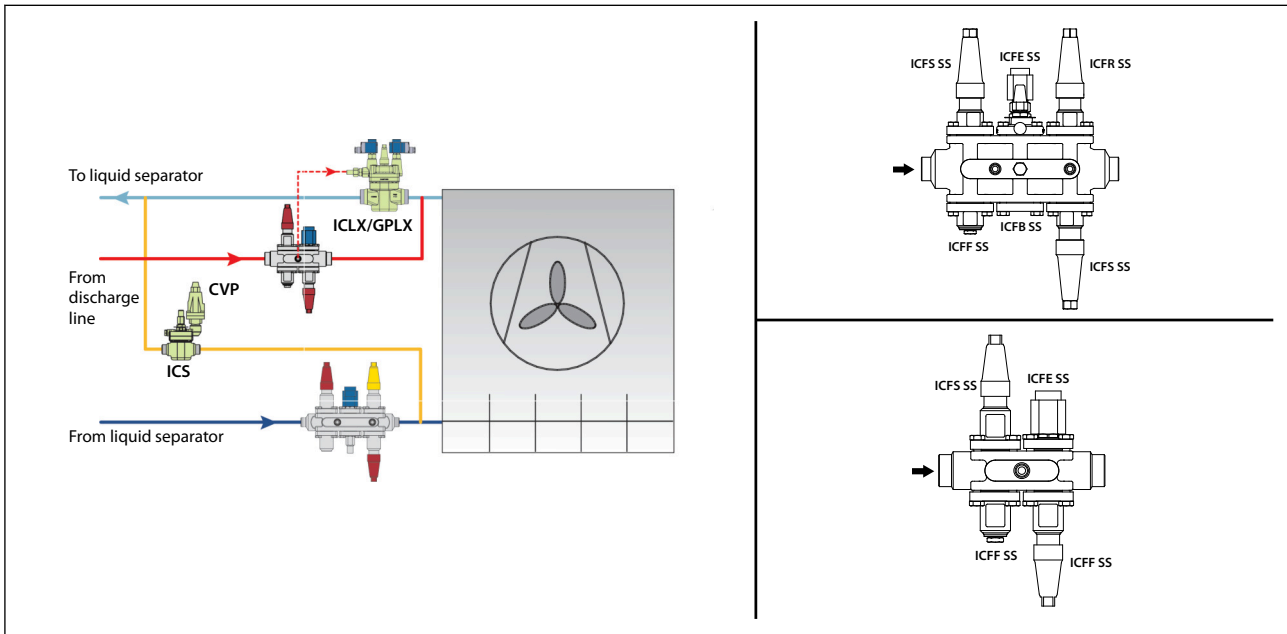

NOTE:

Not all valves are shown. Not to be used for construction purposes.

Liquid injection line

A valve combination for liquid injection to separator with electronic injection valve is required. It is requested to have a solenoid valve in front of the control valve.

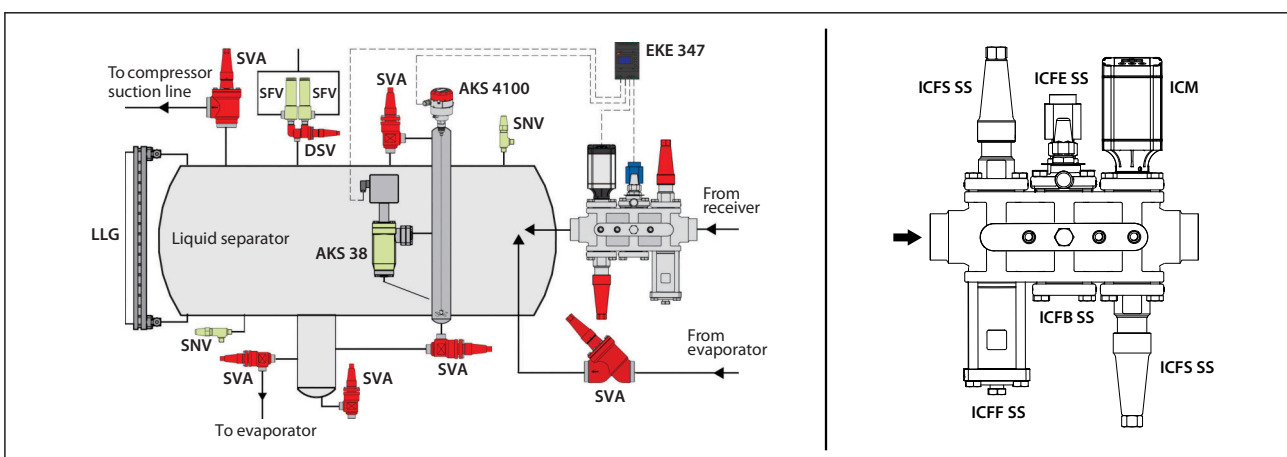

NOTE:

Not all valves are shown. Not to be used for construction purposes.

Liquid injection line

A valve combination for compressor liquid injection with electronic injection valve is required. It is a required to have a solenoid valve in front of the control valve.

Valve station, Type ICF SS 20 and ICF SS 25

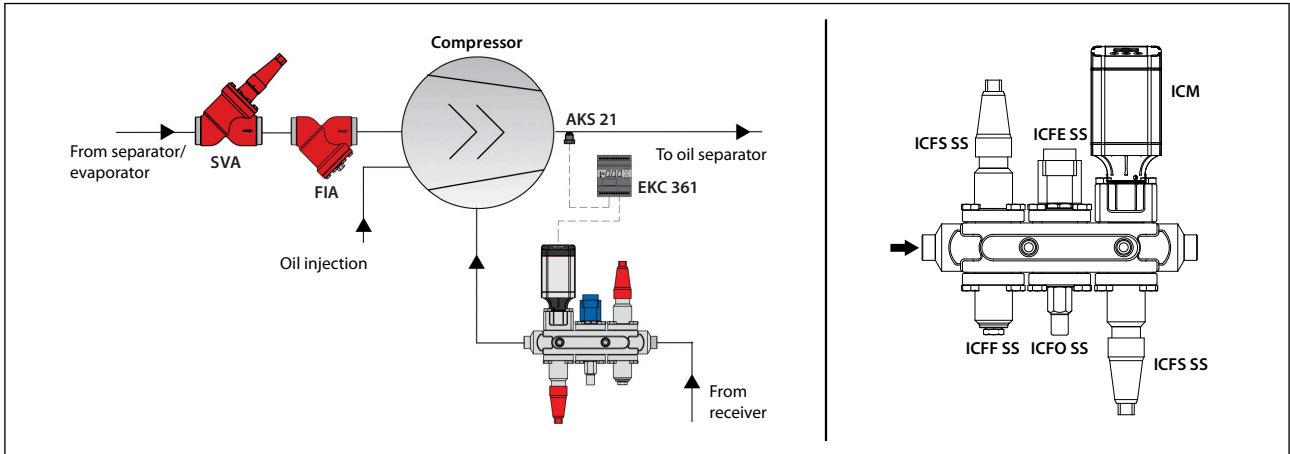

NOTE:

Not all valves are shown. Not to be used for construction purposes.

Functions

Function modules

Each housing accommodates a maximum of four or six function modules, of the following types:

- Stop valve module
- Manual regulating valve module
- Filter module
- Solenoid valve module
- Electronic expansion valve module
- Manual opening module
- Check valve module
- Stop/check valve module
- Motor valve module
- External welding connection module
- Blank top cover

Optional:

The housings are supplied with a predefined number of side ports for the following options:

- Sight glass
- Temperature or pressure sensor
- Pressure gauge
- Side exit for drain or bypass

Module and Sideport arrangement

Table 5: Modules

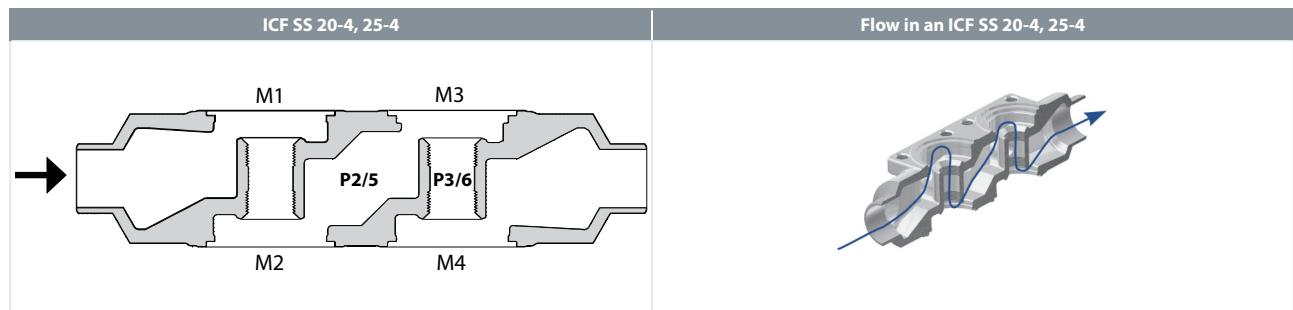
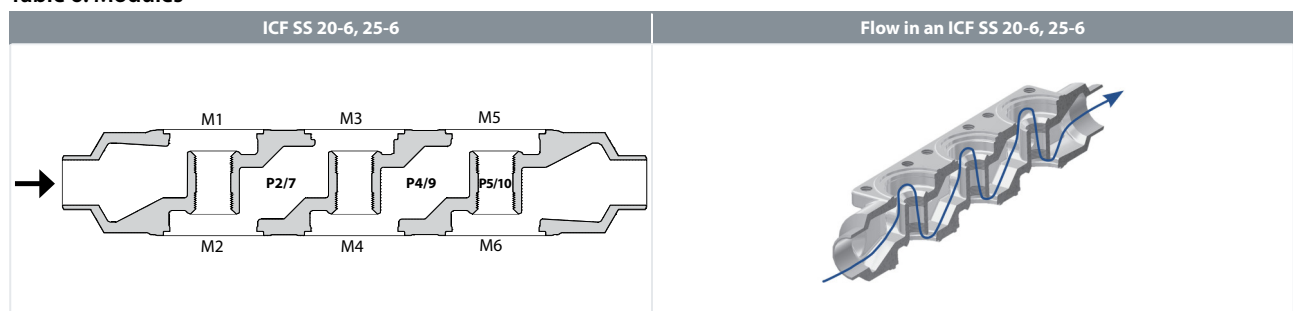

Table 6: Modules



Valve station, Type ICF SS 20 and ICF SS 25

Table 7: Sideports

ICF SS 20-4 DIN + ANSI connections 4 side ports DIN = G 3/8 in. ANSI = NPT 3/8 in. (2 opposite on each side)	ICF SS 25-4 DIN + ANSI connections 4 side ports DIN = G 3/8 in. ANSI = NPT 3/8 in. (2 opposite on each side)
 <p style="text-align: center;">Example: ICF SS 20-4-10RA</p>	 <p style="text-align: center;">Example: ICF SS 25-4-9</p>

Table 8: Sideports

ICF SS 20-6 DIN + ANSI connections 6 side ports DIN = G 3/8 in. ANSI = NPT 3/8 in. (3 opposite on each side)	ICF SS 25-6 DIN + ANSI connections 6 side ports DIN = G 3/8 in. ANSI = NPT 3/8 in. (3 opposite on each side)
 <p style="text-align: center;">Example: ICF SS 20-6-5HMB</p>	 <p style="text-align: center;">Example: ICF SS 25-6-3RA</p>

Description of the function modules for ICF SS 20

<p>ICFS SS 20 ICFR SS 20</p>			
<p>ICFS SS 20 Shut-off valve module This module has the function of a stop valve, and has a red cap</p> <p>ICFR SS 20, A or B Manual regulating valve module This module has the function of a hand regulating valve and has a yellow cap</p>	<p>ICFC SS 20 Check valve module This module has the function of a check valve.</p>	<p>ICFF SS 20 / ICFF SS 20E Strainer module This module functions as a strainer. ICFF SS 20: Pleated 150µ (100 mesh)/45 cm² (7.0 in²) ICFF SS 20E: Pleated 150µ (100 mesh)/160 cm² (24.8 in²)</p>	
<p>ICFN SS 20</p>	<p>ICFE SS 20 / ICFA SS 20</p>	<p>ICM SS 20-A, 20-B, 20-C, 20-A33 or 20-B66</p>	
<p>ICFN SS 20 Stop & check valve module This module has the function of a combined stop and check valve, and has a green cap.</p>	<p>ICFE SS 20 Solenoid valve module This module has the function of a normally closed solenoid valve for controlling the refrigerant flow.</p> <p>ICFA SS 20 Electronic expansion valve module This module has the function of an electronic pulse width modulating (PWM) expansion valve.</p>	<p>ICM SS 20-A, 20-B, 20-C, 20-A33 or 20-B66 Motor operated valve module This module is a stepper motor actuator valve for on/off and modulating control of the refrigerant flow.</p>	
<p>ICFO SS 20</p>	<p>ICFB SS 20</p>	<p>ICFE SS 20H</p>	<p>ICFW SS 20H</p>
<p>ICFO SS 20 Manual opening module This module facilitates the manual opening of the solenoid valve (type ICFE SS).</p>	<p>ICFB SS 20 Blind top cover This provides a blanking cover for unused module ports.</p>	<p>ICFE SS 20H Solenoid valve module with integrated manual opener This module has the function of a normally closed solenoid valve for controlling the refrigerant flow.</p>	<p>ICFW SS 20 Welding module 20 DIN This module is used for drain connection during hot-gas defrosting - in case of high capacity.</p>

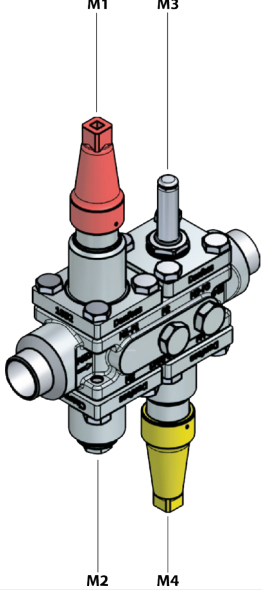
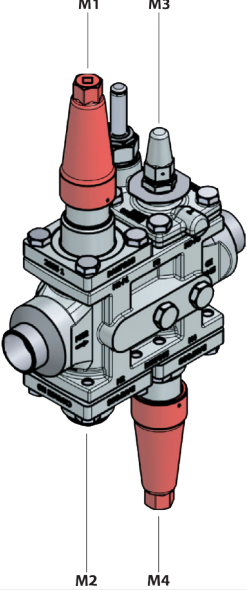
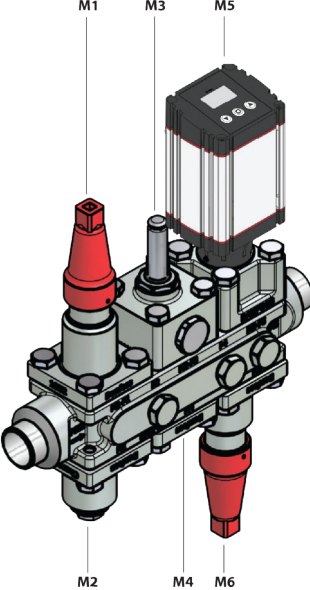
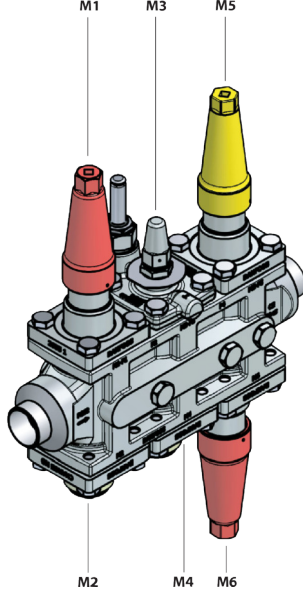
NOTE:

At about 10% of maximum mass flow of ICFE SS 25, the pressure differential correspond to about 0.07 Bar / 1 psi. ICFE SS 25 will start to open at these conditions.

At a pressure differential of minimum 0.2 Bar (2.9 psi) ICFE SS 25 will be 100 % open.

Description of the function modules for ICF SS 25

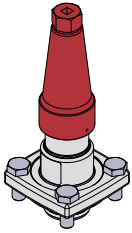
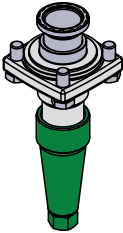
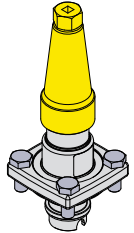
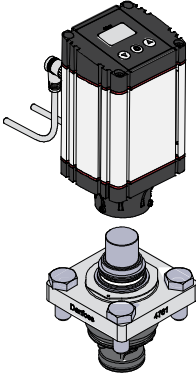
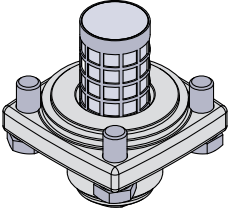
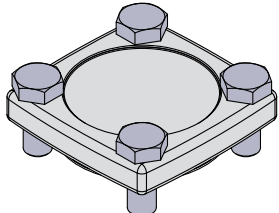
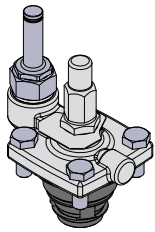
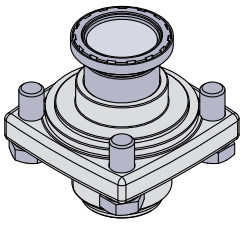
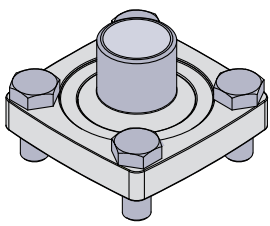
 <p>ICFS SS 25</p>	 <p>ICFN SS 25</p>	 <p>ICFR SS 25</p>
<p>ICFS SS 25 Shut-off valve module This module has the function of a stop valve, and has a red cap.</p>	<p>ICFN SS 25 Stop & check valve module This module has the function of a combined stop and check valve, and has a green cap.</p>	<p>ICFR SS 25, A or B Manual regulating valve module This module has the function of a hand regulating valve, and has a yellow cap.</p>
 <p>ICM SS 25-A or B</p>	 <p>ICFF SS 25 / ICFF SS 25E</p>	 <p>ICFB SS 25</p>
<p>ICM SS 25-A or B Motor operated valve module This module is a stepper motor actuator valve for on/off and modulating control of the refrigerant flow.</p>	<p>ICFF SS 25 Strainer module This module functions as a strainer. ICFF SS 25: Pleated 150μ (100 mesh)/160 cm² (24.8 in²) ICFF SS 25E: Pleated 150μ (100 mesh)/330 cm² (51.2 in²)</p>	<p>ICFB SS 25 Blind top cover This provides a blanking cover for unused module ports.</p>
 <p>ICFE SS 25</p>	 <p>ICFC SS 25</p>	 <p>ICFW SS 25</p>
<p>ICFE SS 25 Solenoid valve module This module has the function of a normally closed solenoid valve for controlling the refrigerant flow. It has a built-in manual opening function.</p>	<p>ICFC SS 25 Check valve module This module has the function of a check valve.</p>	<p>ICFW SS 25 Welding module, 25 DIN This module is used for drain connection during hot-gas defrosting - in case of high capacity.</p>

NOTE:

At about 10% of maximum mass flow of ICFE SS 25, the pressure differential correspond to about 0.07 Bar / 1 psi. ICFE SS 25 will start to open at these conditions.

At a pressure differential of minimum 0.2 Bar (2.9 psi) ICFE SS 25 will be 100 % open.

Media

Refrigerants

Applicable to HCFC, non flammable HFC, R717 (Ammonia) and R744 (CO₂). The use of ICF SS valve stations with flammable hydrocarbons is not recommended.

New refrigerants

Danfoss products are continually evaluated for use with new refrigerants depending on market requirements.

When a refrigerant is approved for use by Danfoss, it is added to the relevant portfolio, and the R number of the refrigerant (e.g. R513A) will be added to the technical data of the code number. Therefore, products for specific refrigerants are best checked at store.danfoss.com/en/, or by contacting your local Danfoss representative.

Product specification

Design

The design allows maximum capacity and minimum pressure drop, using advanced technology and double seats – offering higher capacity than conventional systems using individual valves and components.

The ICF SS valve station is multifunctional.

ICF SS valve station offers compact dimensions and shortened installation time due to the reduced number of direct welded connections.

Supplied as a complete assembly, it is leak tested at high pressure and its functions are tested under factory controlled conditions.

The main components of the ICF SS valve station are:

- A housing
- A maximum of four or six function modules

Housing and function module material: Stainless steel

NOTE: When using TIG/MIG/SMAW welding technology, it is possible to install the ICF SS valve station without prior removal of the function modules from the housing. If using other welding methods the modules must be removed during welding.

Please consult the product instruction for more details.

Housing

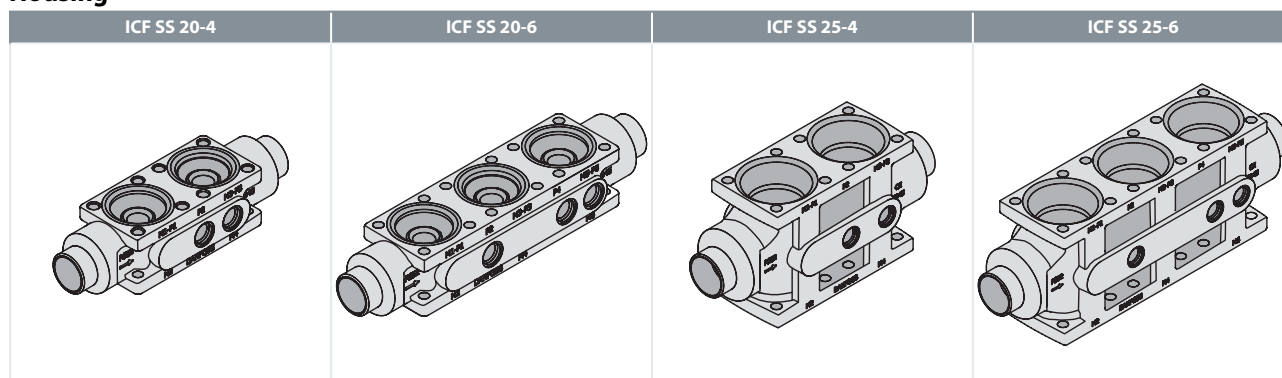

Pressure and temperature data

Temperature range: -60 – 120 °C / -76 – 248 °F

If the ICM module is going to be used in liquid refrigerant with a temperature above 75 °C / 167 °F, please contact Danfoss.

Ambient temperature for ICF SS with ICAD: -30 – 50 °C / -22 – 122 °F

Pressure

The ICF SS is designed for:

Max. working pressure: 52 bar / 754 psig

Opening differential pressure: Please refer to the individual function module data.

Material specification

ICF SS housing

Table 9: ICF SS housing

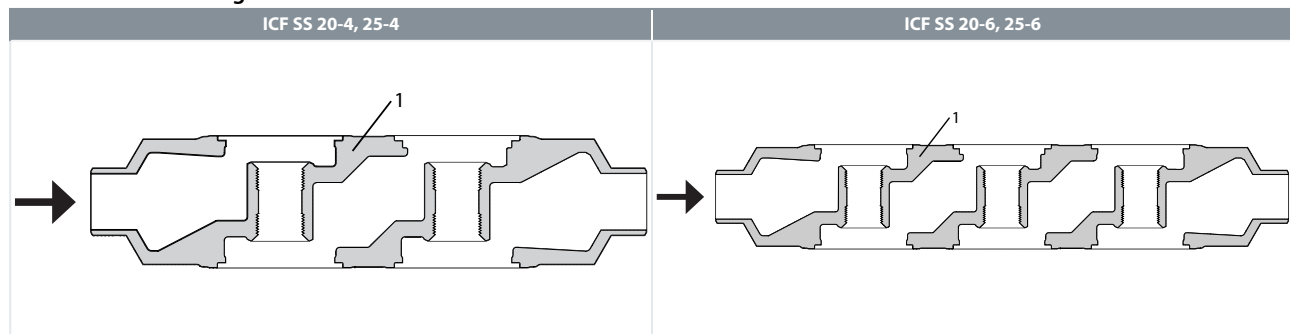

Pos.	Part	Material	EN	ASTM
1	Housing	Stainless steel	GX5CrNi19-10 EN10213-4	A304

ICFS SS 20 shut-off valve module

Figure 1: ICFS SS 20 shut-off valve module

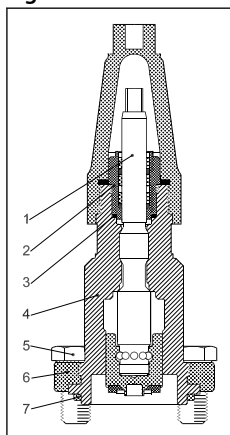

Table 10: ICFS SS 20 shut-off valve module

Pos.	Part	Material	EN	ASTM
1	Spindle	Stainless steel	X8CrNiS 18-9 EN 10088	A303
2	Thread part	Stainless steel		
3	AL-gasket/Refrig. gasket			
4	Bonnet	Stainless steel	X5CrNi 18-10 EN 10272	A304
5	Hex-head bolt M10 × 25	Stainless steel	A2-70	Type 308
6	Flange	Stainless steel	X5CrNi18-10 EN10088	A304
7	Gasket	Fiber non asbestos		

ICFF SS 20 strainer module

Figure 2: ICFF SS 20 strainer module

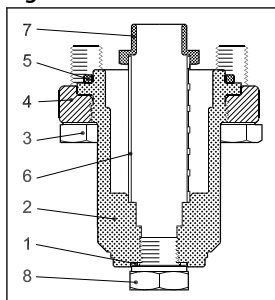

Table 11: ICFF SS 20 strainer module

Pos.	Part	Material	EN	ASTM
1	Gasket	AL 99 F11		
2	Bonnet	Stainless steel	X5CrNi 18-10 EN 10272	A304
3	Hex-head bolt M10 x 25	Stainless steel	A2-70	Type 308
4	Flange	Stainless steel	X5CrNi18-10 EN10088	A304
5	Gasket	Fiber non asbestos		
6	Filter element	Stainless steel 74µ and 150µ		
7	Plug	Steel		
8	Plug 1/4" RG for butt-weld	Stainless steel		

ICFF SS 20E extended strainer module

Figure 3: ICFF SS 20E extended strainer module

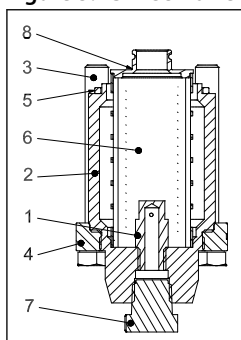

Table 12: ICFF SS 20E extended strainer module

Pos.	Part	Material	EN	ASTM
1	Dirt protection plug	Steel	11SMn30 EN 10087	Grade 1213 A29
2	Bonnet	Stainless steel	X5CrNi 18-10 EN 10272	A304
3	Hex-head bolt M12x80	Stainless steel	A2-70	Type 308
4	Flange	Stainless steel	X5CrNi18-10 EN10088	A304
5	Gasket	Fiber non asbestos		
6	Filter element	Stainless steel 250m		
7	Plug 3/8" NPT	Stainless steel		
8	Filter adaptor	Steel		

ICFE SS 20 solenoid valve module

Figure 4: ICFE SS 20 solenoid valve module

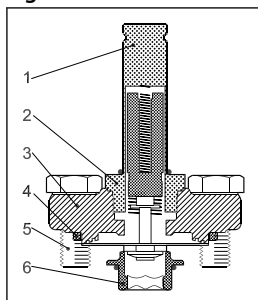

Table 13: ICFE SS 20 solenoid valve module

Pos.	Part	Material	EN	ASTM
1	Armature tube	Stainless steel		
2	Armature tube nut	Stainless steel	X8CrNiS18-9 EN 10088	
3	Flange	Stainless steel	X5CrNi18-10 EN10088	A304
4	Gasket	Fiber non asbestos		
5	Hex-Head bolt M10 × 25	Stainless steel	A2-70	Type 308
6	Seat	High density polymer		

ICFE SS 20H solenoid valve module

Figure 5: ICFE SS 20H solenoid valve module

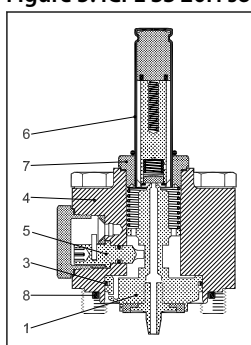

Table 14: ICFE SS 20H solenoid valve module

Pos.	Part	Material	EN	ASTMf
1	Piston	Steel	11SMn30 EN EN 10025	
2	Seat	Teflon		
3	Piston ring			
4	Bonnet cylinder	Stainless steel	X5CrNi18-10 EN10088	A304
5	Manual opener	Steel		
6	Armature tube	Stainless steel		
7	Armature tube nut	Stainless steel	X2CrNi19-11 EN10216	A320
8	Gasket	Fiber non asbestos		

ICFO SS 20 manual opening module

Figure 6: ICFO SS 20 manual opening module

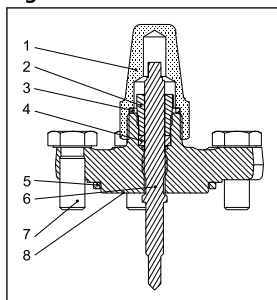

Table 15: ICFO SS 20 manual opening module

Pos.	Part	Material	EN	ASTM
1	Seal cap	Stainless steel		
2	Gland nut	Steel		
3	Seal cap gasket	Nylon	Polyamid A6	Polyamid PA6
4	Sealing ring	Teflon	PTFE	PTFE
5	Gasket	Fiber non asbestos	CR	CR
6	Spindle	Stainless steel	X8CrNiS 18-9 EN 10088	A303
7	Hex-head bolt M10 × 25	Stainless steel	A2-70	Type 308
8	Flange	Stainless steel	X5CrNi18-10 EN10088	A304

ICFR SS 20 manual regulating valve module, A or B

Figure 7: ICFR SS 20 manual regulating valve module, A or B

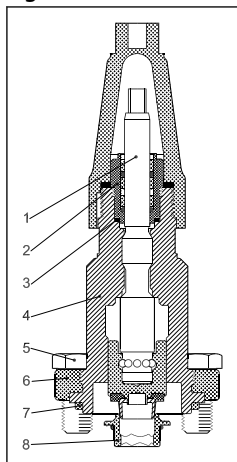

Table 16: ICFR SS 20 manual regulating valve module, A or B

Pos.	Part	Material	EN	ASTM
1	Spindle	Stainless steel	X8CrNiS 18-9 EN 10088	A303
2	Thread part	Stainless steel		
3	AL-gasket			
4	Bonnet	Stainless steel	X5CrNi 18-10 EN 10272	A304
5	Hex-head bolt M10 × 25	Stainless steel	A2-70	Type 308
6	Flange	Stainless steel	X5CrNi18-10 EN10088	A304
7	Gasket	Fiber non asbestos		
8	Seat	High density polymer		

ICFA SS 20 electronic expansion valve module

Figure 8: ICFA SS 20 electronic expansion valve module

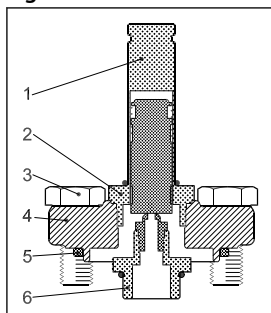

Table 17: ICFA SS 20 electronic expansion valve module

Pos.	Part	Material	EN	ASTM
1	Armature tube	Stainless steel		
2	Armature tube nut	Stainless steel	X8CrNi18-9 EN 10088	
3	Hex-head bolt M10 × 25	Stainless steel	A2-70	Type 308
4	Flange	Stainless steel	X5CrNi18-10 EN10088	A304
5	Gasket	Fiber non asbestos		
6	Adaptor	Stainless steel		

ICFC SS 20 check valve module

Figure 9: ICFC SS 20 check valve module

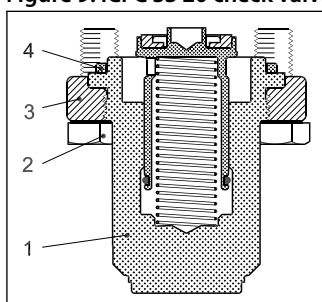

Table 18: ICFC SS 20 check valve module

Pos.	Part	Material	EN	ASTM
1	Bonnet	Stainless steel	X5CrNi 18-10 EN 10272	A304
2	Hex-head bolt M10 × 25	Stainless steel	A2-70	Type 308
3	Flange	Stainless steel	X5CrNi18-10 EN10088	A304
4	Gasket	Fiber non asbestos		

ICFN SS 20 stop & check valve module

Figure 10: ICFN SS 20 stop & check valve module

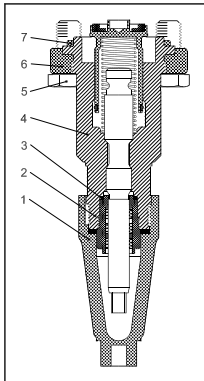

Table 19: ICFN SS 20 stop & check valve module

Pos.	Part	Material	EN	ASTM
1	Spindle	Stainless steel	X8CrNiS 18-9 EN 10088	A303
2	Thread part	Stainless steel		
3	AL-gasket			
4	Bonnet	Stainless steel	X5CrNi 18-10 EN 10272	A304
5	Hex-head bolt M10 × 25	Stainless steel	A2-70	Type 308
6	Flange	Stainless steel	X5CrNi18-10 EN10088	A304
7	Gasket	Fiber non asbestos		

ICM SS 20-A, 20-B, 20-C, 20-A33 or 20-B66 motor valve module

Figure 11: ICM SS 20-A, 20-B, 20-C, 20-A33 or 20-B66 motor valve module

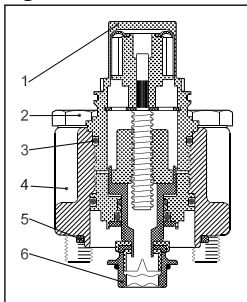

Table 20: ICM SS 20-A, 20-B, 20-C, 20-A33 or 20-B66 motor valve module

Pos.	Part	Material	EN	ASTM
1	Adapter	Stainless steel	X5CrNi18-10 EN 10088	A240
2	Hex-head bolt M10 × 55	Stainless steel	A2-70	Type 308
3	O-ring	Chloroprene		
4	Bonnet	Stainless steel	X5CrNi 18-10 EN 10088	A304
5	Gasket	Fiber non asbestos		
6	Seat	High density polymer		

ICFB SS 20 blank top cover

Figure 12: ICFB SS 20 blank top cover

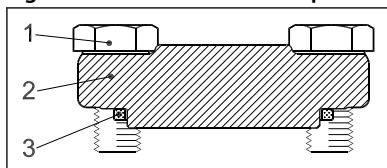

Table 21: ICFB SS 20 blank top cover

Pos.	Part	Material	EN	ASTM
1	Hex-head bolt M10 × 25	Stainless Steel	A2-70	Type 308
2	Flange	Stainless steel	X5CrNi18-10 EN10088	A304
3	Gasket	Fiber non asbestos		

ICFW SS 20D welding module, 20 DIN

Figure 13: ICFW SS 20D welding module, 20 DIN

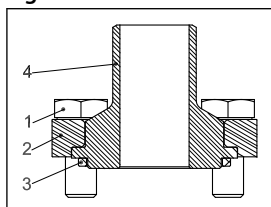

Table 22: ICFW SS 20D welding module, 20 DIN

Pos.	Part	Material	EN	ASTM
1	Hex-head bolt M10 × 25	Stainless Steel	A2-70	Type 308
2	Flange	Stainless steel	X5CrNi18-10 EN10088	A304
3	Gasket	Fiber non asbestos		
4	Weld connection	Stainless Steel		

ICFS SS 25 shut-off valve module

Figure 14: ICFS SS 25 shut-off valve module

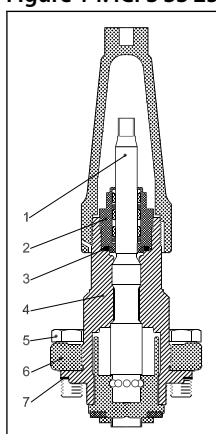

Table 23: ICFS SS 25 shut-off valve module

Pos.	Part	Material	EN	ASTM
1	Spindle	Stainless steel	X8CrNiS 18-9 EN 10088	A303
2	Thread part	Stainless steel		
3	O-ring	Chloroprene		

Valve station, Type ICF SS 20 and ICF SS 25

Pos.	Part	Material	EN	ASTM
4	Bonnet	Stainless steel	X5CrNi 18-10 EN 10272	A304
5	Hex-head bolt M12 × 30	Stainless steel	A2-70	Type 308
6	Flange	Stainless steel	X5CrNi18-10 EN10088	A304
7	Gasket	Fiber non asbestos		

ICFF SS 25 strainer module

Figure 15: ICFF SS 25 strainer module

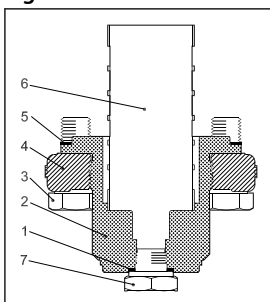

Table 24: ICFF SS 25 strainer module

Pos.	Part	Material	EN	ASTM
1	Al. Gasket	AL 99 F11		
2	Bonnet	Stainless steel	X5CrNi 18-10 EN 10272	A304
3	Hex-head bolt M12 × 30	Stainless steel	A2-70	Type 308
4	Flange	Stainless steel	X5CrNi18-10 EN10088	A304
5	Gasket	Fiber non asbestos		
6	Filter element	Stainless steel 150m		
7	Plug 1/4" RG for butt-weld	Stainless steel		

ICFF SS 25E extended strainer module

Figure 16: ICFF SS 25E extended strainer module

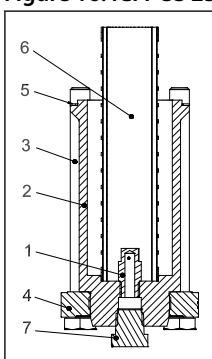

Table 25: ICFF SS 25E extended strainer module

Pos.	Part	Material	EN	ASTM
1	Dirt protection plug	Steel	115Mn30 EN 10087	Grade 1213 A29
2	Bonnet	Stainless steel	X5CrNi 18-10 EN 10222	A304
3	Hex-head bolt M12x140	Stainless steel	A2-70	Type 308
4	Flange	Stainless steel	X5CrNi18-10 EN10088	A304

Valve station, Type ICF SS 20 and ICF SS 25

Pos.	Part	Material	EN	ASTM
5	Gasket	Fiber non asbestos		
6	Filter element	Stainless steel 250m		
7	Plug 3/8" NPT	Stainless steel		

ICFE SS 25 solenoid valve module

Figure 17: ICFE SS 25 solenoid valve module

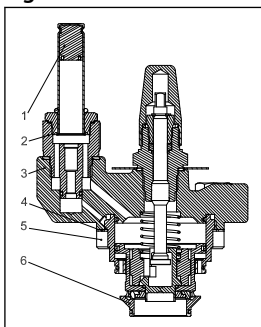

Table 26: ICFE SS 25 solenoid valve module

Pos.	Part	Material	EN	ASTM
1	Armature tube	Stainless steel		
2	Armature tube nut	Stainless steel	X8CrNiS18-9 EN 10088	
3	Bonnet	Stainless steel	X5CrNi 18-10 EN 10222	A304
4	Gasket	Fiber non asbestos		
5	Hex-Head bolt M10 x 30	Stainless steel	A2-70	Type 308
6	Seat	High density polymer		

ICFR SS 25 manual regulating valve module, A or B

Figure 18: ICFR SS 25 manual regulating valve module, A or B

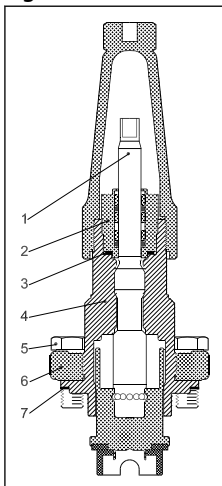

Table 27: ICFR SS 25 manual regulating valve module, A or B

Pos.	Part	Material	EN	ASTM
1	Spindle	Stainless steel	X8CrNiS 18-9 EN 10088	A303
2	Thread part	Stainless steel		
3	O-ring	Chloroprene		
4	Bonnet	Stainless steel	X5CrNi 18-10 EN 10272	A304
5	Hex-head bolt M12 x 30	Stainless steel	A2-70	Type 308

Valve station, Type ICF SS 20 and ICF SS 25

Pos.	Part	Material	EN	ASTM
6	Flange	Stainless steel	X5CrNi18-10 EN10088	A304
7	Gasket	Fiber non asbestos		
8	Seat	High density polymer		

ICFC SS 25 check valve module

Figure 19: ICFC SS 25 check valve module

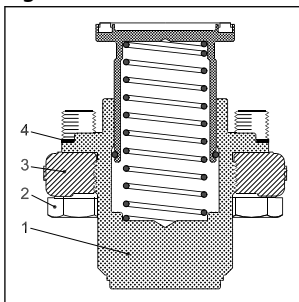

Table 28: ICFC SS 25 check valve module

Pos.	Part	Material	EN	ASTM
1	Bonnet	Stainless steel	X5CrNi 18-10 EN 10272	A304
2	Hex-head bolt M12 × 30	Stainless steel	A2-70	Type 308
3	Flange	Stainless steel	X5CrNi18-10 EN10088	A304
4	Gasket	Fiber non asbestos		

ICFN SS 25 stop & check valve module

Figure 20: ICFN SS 25 stop & check valve module

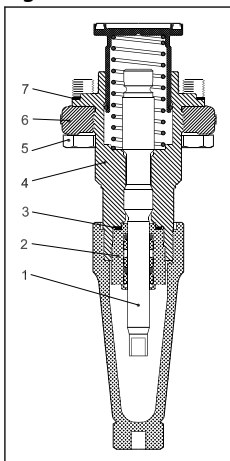

Table 29: ICFN SS 25 stop & check valve module

Pos.	Part	Material	EN	ASTM
1	Spindle	Stainless steel	X8CrNiS 18-9 EN 10088	A303
2	Thread part	Stainless steel		
3	O-ring	Chloroprene		
4	Bonnet	Stainless steel	X5CrNi 18-10 EN 10272	A304
5	Hex-head bolt M12 × 30	Stainless steel	A2-70	Type 308
6	Flange	Stainless steel	X5CrNi18-10 EN10088	A304
7	Gasket	Fiber non asbestos		

ICM SS 25-A or B motor valve module

Figure 21: ICM SS 25-A or B motor valve module

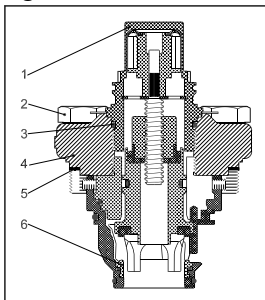

Table 30: ICM SS 25-A or B motor valve module

Pos.	Part	Material	EN	ASTM
1	Adapter	Stainless steel	X5CrNi18-10 EN 10088	A240
2	Hex-head bolt M12 × 30	Stainless steel	A2-70	Type 308
3	O-ring	Chloroprene		
4	Bonnet	Stainless steel	X5CrNi18-10 EN10088	A304
5	Gasket	Fiber non asbestos		
6	Seat	High density polymer		

ICFB SS 25 blank top cover

Figure 22: ICFB SS 25 blank top cover

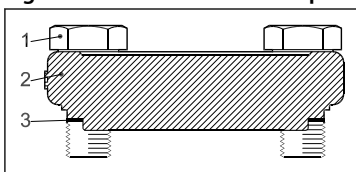

Table 31: ICFB SS 25 blank top cover

Pos.	Part	Material	EN	ASTM
1	Hex-head bolt M10 × 30	Stainless Steel	A2-70	Type 308
2	Flange	Stainless steel	X5CrNi18-10 EN10088	A304
3	Gasket	Fiber non asbestos		

ICFW SS 25 welding module, 25 DIN

Figure 23: ICFW SS 25 welding module, 25 DIN

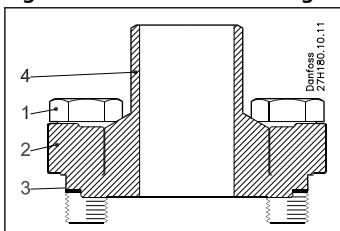

Table 32: ICFW SS 25 welding module, 25 DIN

Pos.	Part	Material	EN	ASTM
1	Hex-head bolt M10 × 30	Stainless Steel	A2-70	Type 308
2	Flange	Stainless steel	X5CrNi18-10 EN10088	A304
3	Gasket	Fiber non asbestos		
4	Weld connection	Stainless steel		

Connections

D: Butt-weld DIN (EN 10220)

Figure 24: D: Butt-weld DIN (EN 10220)

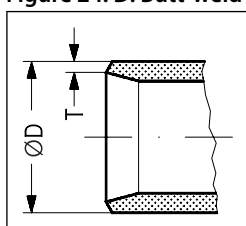

Table 33: D: Butt-weld DIN (EN 10220)

Size	Size	ØD	T	ØD	T
mm	in.	mm	mm	in.	in.
20	(3/4)	26.9	2.3	1.059	0.091
25	1	33.7	2.6	1.327	0.103
32	(1 1/4)	42.4	2.6	1.669	0.102
40	1 1/2	48.3	2.6	1.902	0.103

A: Butt-weld ANSI (B 36.19)

Figure 25: A: Butt-weld ANSI (B 36.19)

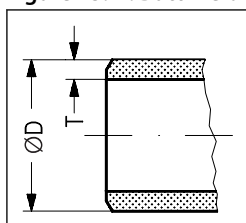

Table 34: A: Butt-weld ANSI (B 36.19)

Size	Size	ØD	T	ØD	T	Schedule
mm	in.	mm	mm	in.	in.	
20	(3/4)	26.9	2.9	1.059	0.11	40
25	1	33.7	3.5	1.327	0.14	40
32	1 1/4	42.4	3.6	1.669	0.14	40
40	1 1/2	48.3	3.7	1.902	0.15	40

Dimensions and weights

ICF SS 20-6

Figure 26: ICF SS 20-6

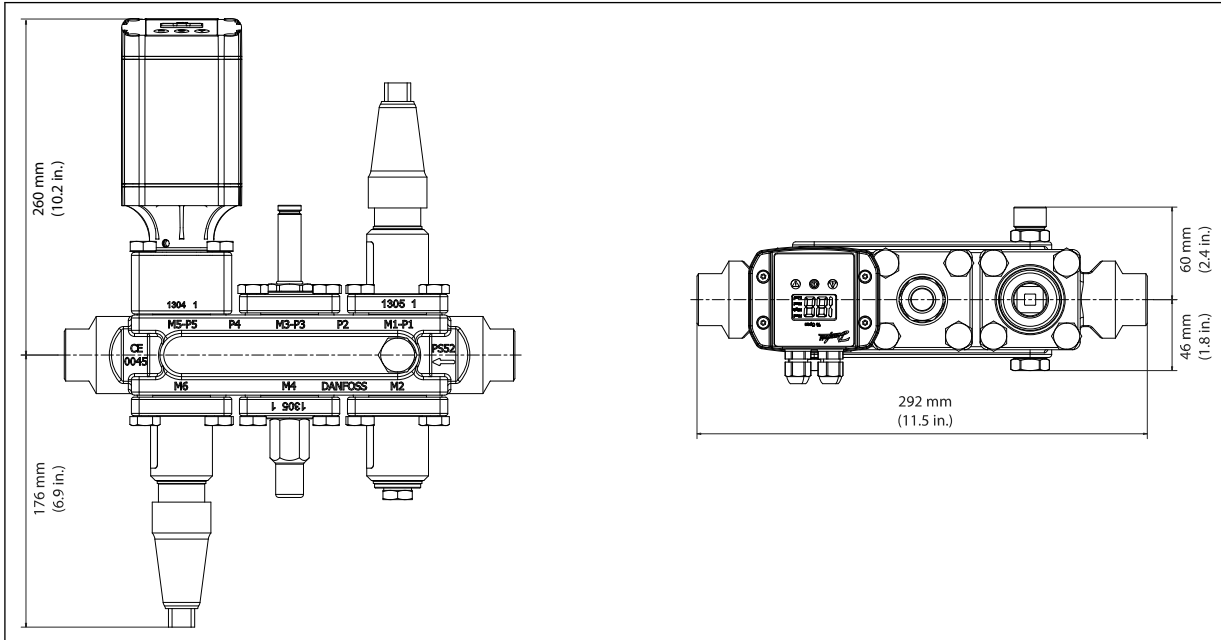

This example indicates the maximum dimensions for the ICF SS valve stations.

ICF SS 20-4

Figure 27: ICF SS 20-4

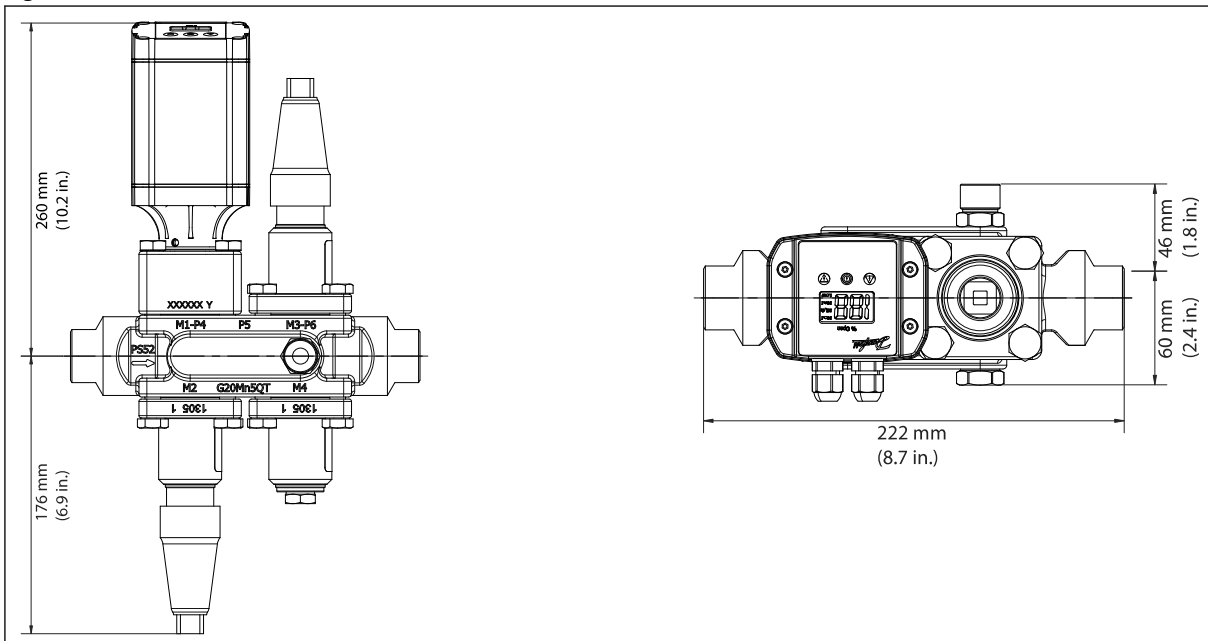

ICF SS 25-6

Figure 28: ICF SS 25-6

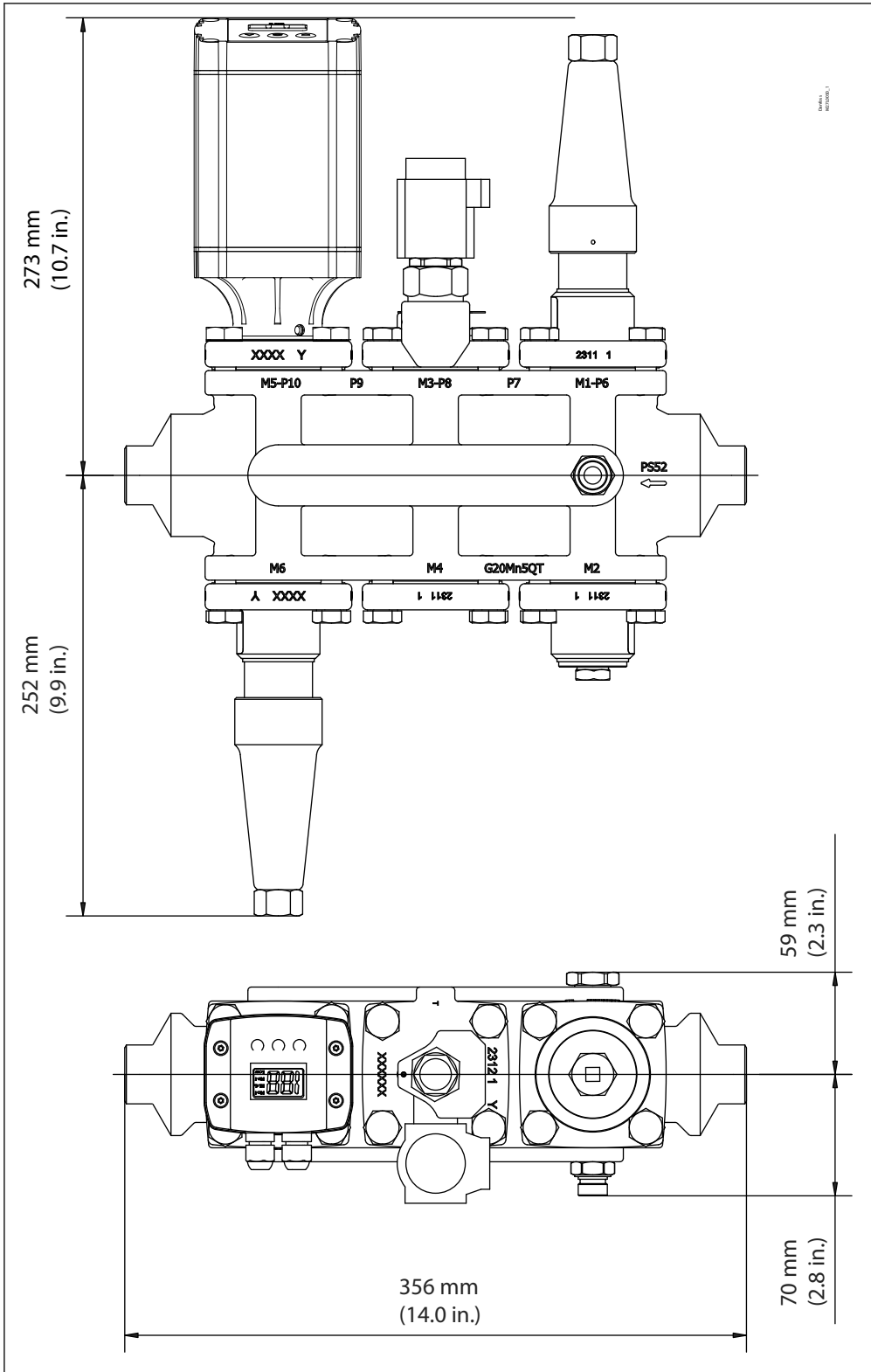

ICF SS 25-4

Figure 29: ICF SS 25-4

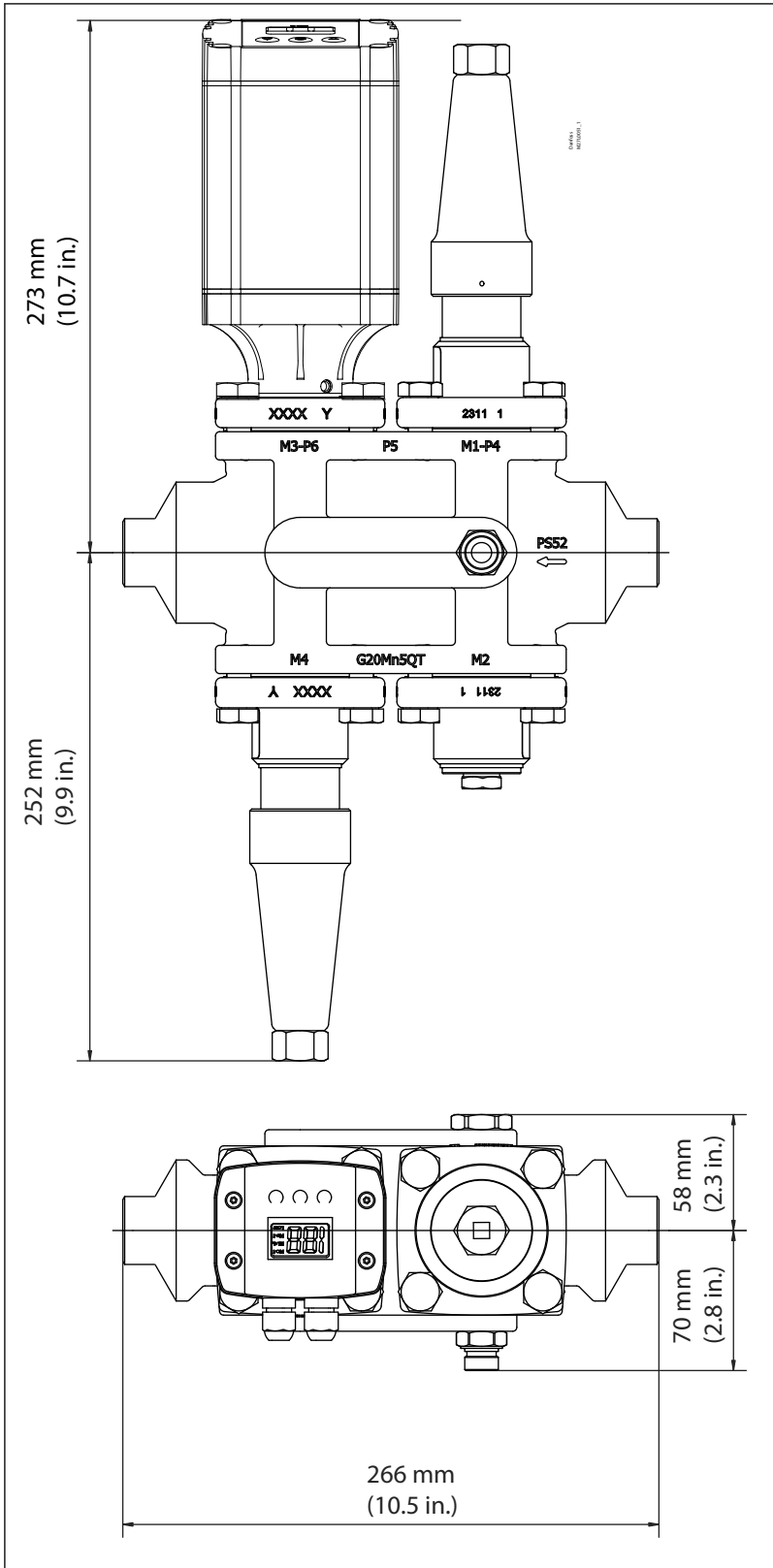

Ordering

Below Nomenclature show the generic configuration and application by identification of housing size, type and application group.

This designation is often used for discussion on possible solutions and will be the final identification on the valve label (see label example).

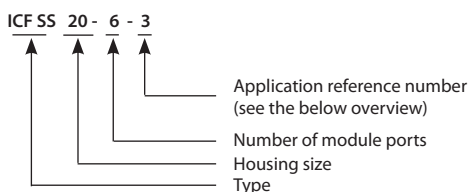

Figure 30: Label example:



For ordering, connection size and type must be chosen to get the final identification. **The final identification is done by code number only.** See (Page 27 to Page 32)

Code number selection

To determine the correct ICF SS valve station follow steps 1 through 5.

Step 1 Determine application and function requirements

- **Line:** Pumped liquid, Liquid Injection, Hot gas defrost, Liquid DX etc
- **Control:** On/off solenoid valve, motorised valve
- **Defrost:** Electric or hot gas

NOTE:

From the above determine the application reference number. See (Page 27 to Page 32)

Step 2 Selection criteria - Please use Coolselector®2

Download the software from: <http://refrigerationandairconditioning.danfoss.com/support-center/apps-and-software/coolselector/>

- Refrigerant
- Capacity
- Temperature
- Circulation rate

NOTE:

From the above determine the valve station required, e.g.: **ICF SS 20** complete with **ICM SS 20-C**

Step 3 Establish connection sizes and type

- DIN butt-weld / ANSI butt-weld
- 20 (¾ in.), 25 (1 in.), 32 (1 ¼ in.) or 40 (1 ½ in.)

Step 4 Establish code number. See (Page 27 to Page 32)

Liquid feed

Table 35: Application 1: Liquid feed (no hot gas defrost)

Type	# of modules	Appl. #	Connection size		Connection type	Module location						Weight		Code number
			[in.]	[mm]		M1	M2	M3	M4	M5	M6	kg	lbs	
ICF SS 20	6	1RA	¾	20	Butt-weld DIN-EN 10220	ICFS 20	ICFF 20	ICFE 20	ICFO 20	ICFR 20A	ICFS 20	9.5	20.9	027L4700
ICF SS 20	6	1RA	1	25	Butt-weld DIN-EN 10220	ICFS 20	ICFF 20	ICFE 20	ICFO 20	ICFR 20A	ICFS 20	9.7	21.3	027L4701
ICF SS 20	6	1RA	¾	20	Butt-weld ANSI (B 36.19)	ICFS 20	ICFF 20	ICFE 20	ICFO 20	ICFR 20A	ICFS 20	10.4	22.9	027L3555

Valve station, Type ICF SS 20 and ICF SS 25

Type	# of modules	Appl. #	Connection size		Connection type	Module location						Weight		Code number
			[in.]	[mm]		M1	M2	M3	M4	M5	M6	kg	lbs	
ICF SS 20	6	1RA	1	25	Butt-weld ANSI (B 36.19)	ICFS 20	ICFF 20E	ICFE 20	ICFO 20	ICFR 20A	ICFS 20	9.9	21.8	027L3556
ICF SS 20	6	1HRB	1	25	Butt-weld ANSI (B 36.19)	ICFS 20	ICFF 20E	ICFE 20H	ICFB 20	ICFR 20B	ICFS 20	10.9	24	027L3578
ICF SS 20	6	1HRB	1¼	32	Butt-weld ANSI (B 36.19)	ICFS 20	ICFF 20E	ICFE 20H	ICFB 20	ICFR 20B	ICFS 20	10.9	24	027L3557
ICF SS 25	6	1RA	1	25	Butt-weld ANSI (B 36.19)	ICFS 25	ICFF 25E	ICFE 25	ICFB 25	ICFR 25A	ICFS 25	24.1	53	027L3568
ICF SS 25	6	1RA	1¼	32	Butt-weld ANSI (B 36.19)	ICFS 25	ICFF 25E	ICFE 25	ICFB 25	ICFR 25A	ICFS 25	23.8	52.4	027L3569
ICF SS 25	6	1RB	1¼	32	Butt-weld ANSI (B 36.19)	ICFS 25	ICFF 25E	ICFE 25	ICFB 25	ICFR 25B	ICFS 25	24.2	53.2	027L3584
ICF SS 25	6	1RB	1½	40	Butt-weld ANSI (B 36.19)	ICFS 25	ICFF 25E	ICFE 25	ICFB 25	ICFR 25B	ICFS 25	23.8	52.4	027L3570

Table 36: Application 2: Liquid feed

Type	# of modules	Appl. #	Connection size		Connection type	Module location						Weight		Code number
			[in.]	[mm]		M1	M2	M3	M4	M5	M6	kg	lbs	
ICF SS 20	6	2RA	¾	20	Butt-weld DIN-EN 10220	ICFS 20	ICFF 20	ICFE 20	ICFO 20	ICFR 20A	ICFN 20	10	22.1	027L3428
ICF SS 20	6	2RA	1	25	Butt-weld DIN-EN 10220	ICFS 20	ICFF 20E	ICFE 20	ICFO 20	ICFR 20A	ICFN 20	10	22.1	027L3445
ICF SS 20	6	2RA	1	25	Butt-weld DIN-EN 10220	ICFS 20	ICFF 20	ICFE 20	ICFO 20	ICFR 20A	ICFN 20	9.7	21.3	027L4758
ICF SS 20	6	2HRB	1¼	32	Butt-weld DIN-EN 10220	ICFS 20	ICFF 20	ICFE 20H	ICFB 20	ICFR 20B	ICFN 20	9.2	20.2	027L4759
ICF SS 25	6	2RB	1¼	32	Butt-weld DIN-EN 10220	ICFS 25	ICFF 25	ICFE 25	ICFB 25	ICFR 25B	ICFN 25	23.9	52.6	027L4766
ICF SS 20	6	2RA	¾	20	Butt-weld ANSI (B 36.19)	ICFS 20	ICFF 20E	ICFE 20	ICFO 20	ICFR 20A	ICFN 20	10.1	22.2	027L3571
ICF SS 20	6	2RA	1	25	Butt-weld ANSI (B 36.19)	ICFS 20	ICFF 20E	ICFE 20	ICFO 20	ICFR 20A	ICFN 20	9.9	21.8	027L3572

Table 37: Application 3: Liquid feed

Type	# of modules	Appl. #	Connection size		Connection type	Module location						Weight		Code number
			[in.]	[mm]		M1	M2	M3	M4	M5	M6	kg	lbs	
ICF SS 20	6	3RA	¾	20	Butt-weld DIN-EN 10220	ICFS 20	ICFF 20	ICFE 20	ICFC 20	ICFR 20A	ICFS 20	9.6	21.1	027L4702
ICF SS 20	6	3RA	1	25	Butt-weld DIN-EN 10220	ICFS 20	ICFF 20	ICFE 20	ICFC 20	ICFR 20A	ICFS 20	9.7	21.3	027L4703
ICF SS 20	6	3HRA	1	25	Butt-weld DIN-EN 10220	ICFS 20	ICFF 20	ICFE 20H	ICFC 20	ICFR 20A	ICFS 20	10.6	23.3	027L4717
ICF SS 25	6	3RA	1	25	Butt-weld DIN-EN 10220	ICFS 25	ICFF 25	ICFE 25	ICFC 25	ICFR 25A	ICFS 25	23.4	51.5	027L4724
ICF SS 25	6	3RA	1¼	32	Butt-weld DIN-EN 10220	ICFS 25	ICFF 25	ICFE 25	ICFC 25	ICFR 25A	ICFS 25	23.2	51	027L4760
ICF SS 25	6	3RB	1¼	32	Butt-weld DIN-EN 10220	ICFS 25	ICFF 25	ICFE 25	ICFC 25	ICFR 25B	ICFS 25	23.8	52.4	027L4725
ICF SS 25	6	3RB	1½	40	Butt-weld DIN-EN 10220	ICFS 25	ICFF 25	ICFE 25	ICFC 25	ICFR 25B	ICFS 25	24	52.8	027L4761
ICF SS 25	6	3RB	1½	40	Butt-weld DIN-EN 10220	ICFS 25	ICFF 25E	ICFE 25	ICFC 25	ICFR 25B	ICFS 25	24.7	54.3	027L4191
ICF SS 20	6	3HRB	¾	20	Butt-weld ANSI (B 36.19)	ICFS 20	ICFF 20E	ICFE 20H	ICFC 20	ICFR 20B	ICFS 20	10.7	23.5	027L3579
ICF SS 20	6	3HRB	1	25	Butt-weld ANSI (B 36.19)	ICFS 20	ICFF 20E	ICFE 20H	ICFC 20	ICFR 20B	ICFS 20	11.2	24.6	027L3580
ICF SS 20	6	3HRB	1¼	32	Butt-weld ANSI (B 36.19)	ICFS 20	ICFF 20E	ICFE 20H	ICFC 20	ICFR 20B	ICFS 20	11.3	24.9	027L3581
ICF SS 25	6	3RA	1	25	Butt-weld ANSI (B 36.19)	ICFS 25	ICFF 25E	ICFE 25	ICFC 25	ICFR 25A	ICFS 25	24.2	53.2	027L3585

Valve station, Type ICF SS 20 and ICF SS 25

Type	# of modules	Appl. #	Connection size		Connection type	Module location						Weight		Code number
			[in.]	[mm]		M1	M2	M3	M4	M5	M6	kg	lbs	
ICF SS 25	6	3RA	1¼	32	Butt-weld ANSI (B 36.19)	ICFS 25	ICFF 25E	ICFE 25	ICFC 25	ICFR 25A	ICFS 25	24.1	53	027L3586
ICF SS 25	6	3RB	1¼	32	Butt-weld ANSI (B 36.19)	ICFS 25	ICFF 25E	ICFE 25	ICFC 25	ICFR 25B	ICFS 25	24.1	53	027L3587
ICF SS 25	6	3RB	1½	40	Butt-weld ANSI (B 36.19)	ICFS 25	ICFF 25E	ICFE 25	ICFC 25	ICFR 25B	ICFS 25	24.2	53.2	027L3588

Table 38: Application 10: Liquid feed (no hot gas defrost)

Type	# of modules	Appl. #	Connection size		Connection type	Module location				Weight		Code number
			[in.]	[mm]		M1	M2	M3	M4	kg	lbs	
ICF SS 20	4	10RA	¾	20	Butt-weld DIN-EN 10220	ICFS 20	ICFF 20	ICFE 20	ICFR 20B	7.4	16.2	027L3440
ICF SS 20	4	10RA	1	25	Butt-weld DIN-EN 10220	ICFS 20	ICFF 20	ICFE 20	ICFR 20A	7.2	15.8	027L4709
ICF SS 25	4	10RA	1	25	Butt-weld DIN-EN 10220	ICFS 25	ICFF 25	ICFE 25	ICFR 25A	15.9	35	027L4731
ICF SS 25	4	10RB	1¼	32	Butt-weld DIN-EN 10220	ICFS 25	ICFF 25	ICFE 25	ICFR 25B	15.4	33.9	027L4732
ICF SS 25	4	10RA	1	25	Butt-weld DIN-EN 10220	ICFS 25	ICFF 25E	ICFE 25	ICFR 25A	16.2	35.7	027L4590
ICF SS 20	4	10HRB	¾	20	Butt-weld ANSI (B 36.19)	ICFS 20	ICFF 20E	ICFE 20H	ICFR 20B	8.4	18.5	027L3582
ICF SS 20	4	10HRB	1	25	Butt-weld ANSI (B 36.19)	ICFS 20	ICFF 20E	ICFE 20H	ICFR 20B	7.8	17.2	027L3583
ICF SS 25	4	10RA	1	25	Butt-weld ANSI (B 36.19)	ICFS 25	ICFF 25E	ICFE 25	ICFR 25A	15.8	34.8	027L3592
ICF SS 25	4	10RB	1¼	32	Butt-weld ANSI (B 36.19)	ICFS 25	ICFF 25E	ICFE 25	ICFR 25B	16.2	35.6	027L3593
ICF SS 25	4	10RB	1½	40	Butt-weld ANSI (B 36.19)	ICFS 25	ICFF 25E	ICFE 25	ICFR 25B	16.2	35.6	027L3594

Table 39: Application 15: Liquid feed with external connection

Type	# of modules	Appl. #	Connection size		Connection type	Module location						Weight		Code number
			[in.]	[mm]		M1	M2	M3	M4	M5	M6	kg	lbs	
ICF SS 25	6	15RA	1	25	Butt-weld DIN-EN 10220	ICFS 25	ICFF 25	ICFE 25	ICFC 25	ICFW 25D	ICFR 25A	21.8	48	027L4733
ICF SS 25	6	15RB	1¼	32	Butt-weld DIN-EN 10220	ICFS 25	ICFF 25	ICFE 25	ICFC 25	ICFW 25D	ICFR 25B	22.7	49.9	027L4734

NOTE:

ICAD and coils are not included and must be ordered separately.

When used in systems with CO₂, the o-rings on the ICM module can swell (grow). At service, it is therefore recommended to install new o-rings, before the ICM function module is re-installed in the ICF SS valve body. ICAD and coils are not included and must be ordered separately.

Liquid injection

Table 40: Application 5: Liquid injection (expansion)

Type	# of modules	Appl. #	Connection size		Connection type	Module location						Weight		Code number
			[in.]	[mm]		M1	M2	M3	M4	M5	M6	kg	lbs	
ICF SS 20	6	5MA33	¾	20	Butt-weld DIN-EN 10220	ICFS 20	ICFF 20-74	ICFE 20	ICFO 20	ICM 20-A33	ICFS 20	9.8	21.6	027L4714
ICF SS 20	6	5MB66	¾	20	Butt-weld DIN-EN 10220	ICFS 20	ICFF 20	ICFE 20	ICFO 20	ICM 20-B66	ICFS 20	10.1	22.3	027L3443
ICF SS 20	6	5MA	1	25	Butt-weld DIN-EN 10220	ICFS 20	ICFF 20	ICFE 20	ICFO 20	ICM 20-A	ICFS 20	9.8	21.6	027L4704
ICF SS 20	6	5MB	1	25	Butt-weld DIN-EN 10220	ICFS 20	ICFF 20	ICFE 20	ICFO 20	ICM 20-B	ICFS 20	9.6	21.1	027L4705
ICF SS 20	6	5HMB	1	25	Butt-weld DIN-EN 10220	ICFS 20	ICFF 20	ICFE 20H	ICFB 20	ICM 20-B	ICFS 20	11.4	25.1	027L4718

Valve station, Type ICF SS 20 and ICF SS 25

Type	# of modules	Appl. #	Connection size		Connection type	Module location						Weight		Code number
			[in.]	[mm]		M1	M2	M3	M4	M5	M6	kg	lbs	
ICF SS 20	6	5MA33	1	25	Butt-weld DIN-EN 10220	ICFS 20	ICFF 20	ICFE 20	ICFO 20	ICM 20-A33	ICFS 20	9.6	21.1	027L4755
ICF SS 25	6	5MA	1	25	Butt-weld DIN-EN 10220	ICFS 25	ICFF 25	ICFE 25	ICFB 25	ICM 25-A	ICFS 25	22.8	50.2	027L4726
ICF SS 20	6	5MB66	1¼	32	Butt-weld DIN-EN 10220	ICFS 20	ICFF 20	ICFE 20	ICFO 20	ICM 20-B66	ICFS 20	9.6	21.1	027L4754
ICF SS 20	6	5HMB	1¼	32	Butt-weld DIN-EN 10220	ICFS 20	ICFF 20	ICFE 20H	ICFB 20	ICM 20-B	ICFS 20	10.2	22.4	027L4756
ICF SS 20	6	5MC	1½	32	Butt-weld DIN-EN 10220	ICFS 20	ICFF 20	ICFE 20	ICFO 20	ICM 20-C	ICFS 20	9.8	21.6	027L4706
ICF SS 20	6	5HMC	1¼	32	Butt-weld DIN-EN 10220	ICFS 20	ICFF 20	ICFE 20H	ICFB 20	ICM 20-C	ICFS 20	10.3	22.7	027L4719
ICF SS 25	6	5MB	1¼	32	Butt-weld DIN-EN 10220	ICFS 25	ICFF 25	ICFE 25	ICFB 25	ICM 25-B	ICFS 25	22.3	49	027L4727
ICF SS 25	6	5MB	1½	40	Butt-weld DIN-EN 10220	ICFS 25	ICFF 25	ICFE 25	ICFB 25	ICM 25-B	ICFS 25	22.3	49	027L4728
ICF SS 25	6	5MA	1½	40	Butt-weld DIN-EN 10220	ICFS 25	ICFF 25	ICFE 25	ICFB 25	ICM 25-A	ICFS 25	22.3	49	027L4735
ICF SS 20	6	5MA33	¾	20	Butt-weld ANSI (B 36.19)	ICFS 20	ICFF 20E	ICFE 20	ICFO 20	ICM 20-A33	ICFS 20	10.1	22.2	027L3573
ICF SS 20	6	5MA	¾	20	Butt-weld ANSI (B 36.19)	ICFS 20	ICFF 20E	ICFE 20	ICFO 20	ICM 20-A	ICFS 20	10	22	027L3574
ICF SS 20	6	5MA	1	25	Butt-weld ANSI (B 36.19)	ICFS 20	ICFF 20E	ICFE 20	ICFO 20	ICM 20-A	ICFS 20	10.1	22.2	027L3575
ICF SS 20	6	5MB	¾	20	Butt-weld ANSI (B 36.19)	ICFS 20	ICFF 20E	ICFE 20	ICFO 20	ICM 20-B	ICFS 20	9.8	21.6	027L3576
ICF SS 20	6	5MB	1	25	Butt-weld ANSI (B 36.19)	ICFS 20	ICFF 20E	ICFE 20	ICFO 20	ICM 20-B	ICFS 20	10	22	027L3577
ICF SS 25	6	5MA	1	25	Butt-weld ANSI (B 36.19)	ICFS 25	ICFF 25E	ICFE 25	ICFB 25	ICM 25-A	ICFS 25	23.1	50.8	027L3589
ICF SS 25	6	5MA	1¼	32	Butt-weld ANSI (B 36.19)	ICFS 25	ICFF 25E	ICFE 25	ICFB 25	ICM 25-A	ICFS 25	23.2	51	027L3590
ICF SS 25	6	5MA33	1½	40	Butt-weld ANSI (B 36.19)	ICFS 25	ICFF 25-E	ICFE 25	ICFB 25	ICM 25-A33	ICFS 25	23.1	50.8	027L3591

Table 41: Application 14: Liquid injection (expansion)

Type	# of modules	Appl. #	Connection size		Connection type	Module location				Weight		Code number
			[in.]	[mm]		M1	M2	M3	M4	kg	lbs	
ICF SS 20	4	14MA	¾	20	Butt-weld DIN-EN 10220	ICFS 20	ICFF 20	ICM 20-A	ICFS 20	7.3	16.1	027L4710
ICF SS 20	4	14MA	¾	20	Butt-weld DIN-EN 10220	ICFS 20	ICFF 20E	ICM 20-A	ICFS 20	6.9	15.1	027L3444
ICF SS 20	4	14MB	1	25	Butt-weld DIN-EN 10220	ICFS 20	ICFF 20	ICM 20-B	ICFS 20	7.2	15.8	027L4711
ICF SS 20	4	14MB66	1	25	Butt-weld DIN-EN 10220	ICFS 20	ICFF 20	ICM 20-B66	ICFS 20	7	15.4	027L4722
ICF SS 20	4	14MC	1¼	32	Butt-weld DIN-EN 10220	ICFS 20	ICFF 20	ICM 20-C	ICFS 20	7.3	16.1	027L4712
ICF SS 25	4	14MB	1	25	Butt-weld DIN-EN 10220	ICFS 25	ICFF 25	ICM 25-B	ICFS 25	14.8	32.5	027L4765
ICF SS 25	4	14MB	1¼	32	Butt-weld DIN-EN 10220	ICFS 25	ICFF 25	ICM 25-B	ICFS 25	14.8	32.5	027L4764

NOTE:

ICAD and coils are not included and must be ordered separately.

When used in systems with CO₂, the o-rings on the ICM module can swell (grow). At service, it is therefore recommended to install new o-rings, before the ICM function module is re-installed in the ICF SS valve body. ICAD and coils are not included and must be ordered separately.

Hot gas defrost

Table 42: Application 9: Hot gas defrost

Type	# of modules	Appl. #	Connection size		Connection type	Module location				Weight		Code number
			[in.]	[mm]		M1	M2	M3	M4	kg	lbs	
ICF SS 20	4	9	1	25	Butt-weld DIN-EN 10220	ICFS 20	ICFF 20	ICFE 20	ICFS 20	7.2	15.8	027L4707
ICF SS 20	4	9H	1	25	Butt-weld DIN-EN 10220	ICFS 20	ICFF 20	ICFE 20H	ICFS 20	8.2	18	027L4720
ICF SS 20	4	9	1¼	32	Butt-weld DIN-EN 10220	ICFS 20	ICFF 20	ICFE 20	ICFS 20	6.8	15	027L4708
ICF SS 20	4	9H	1¼	32	Butt-weld DIN-EN 10220	ICFS 20	ICFF 20	ICFE 20H	ICFS 20	7.6	16.7	027L4721
ICF SS 25	4	9	1	25	Butt-weld DIN-EN 10220	ICFS 25	ICFF 25	ICFE 25	ICFS 25	16.2	35.7	027L3429
ICF SS 25	4	9	1¼	32	Butt-weld DIN-EN 10220	ICFS 25	ICFF 25	ICFE 25	ICFS 25	15.7	34.5	027L4729
ICF SS 25	4	9	1½	40	Butt-weld DIN-EN 10220	ICFS 25	ICFF 25	ICFE 25	ICFS 25	15.7	34.5	027L4730
ICF SS 25	4	9	1½	40	Butt-weld DIN-EN 10220	ICFS 25	ICFW 25D	ICM 25-B	ICFS 25	16.6	36.6	027L4190
ICF SS 20	4	9H	¾	20	Butt-weld ANSI (B 36.19)	ICFS 20	ICFF 20E	ICFE 20H	ICFS 20	8	17.6	027L3552
ICF SS 20	4	9H	1	25	Butt-weld ANSI (B 36.19)	ICFS 20	ICFF 20E	ICFE 20H	ICFS 20	8.1	17.8	027L3553
ICF SS 20	4	9H	1¼	32	Butt-weld ANSI (B 36.19)	ICFS 20	ICFF 20E	ICFE 20H	ICFS 20	7.9	17.4	027L3554
ICF SS 25	4	9	1	25	Butt-weld ANSI (B 36.19)	ICFS 25	ICFF 25E	ICFE 25	ICFS 25	16	35.2	027L3565
ICF SS 25	4	9	1¼	32	Butt-weld ANSI (B 36.19)	ICFS 25	ICFF 25E	ICFE 25	ICFS 25	16	35.2	027L3566
ICF SS 25	4	9	1½	40	Butt-weld ANSI (B 36.19)½	ICFS 25	ICFF 25E	ICFE 25	ICFS 25	16.1	35.4	027L3567

Miscellaneous

Table 43: Application 90: Miscellaneous

Type	# of modules	Appl. #	Connection size		Connection type	Module location						Weight		Code number
			[in.]	[mm]		M1	M2	M3	M4	M5	M6	kg	lbs	
ICF SS 20	4	90	¾	20	Butt-weld DIN-EN 10220	ICFR 20A	ICFF 20	ICFA 20	ICFN 20			6.4	14.1	027L4716
ICF SS 20	6	90	¾	20	Butt-weld DIN-EN 10220	ICFS 20	ICFF 20	ICFE 20	ICFB 20	ICFR 20-A	ICFN 20	9.7	21.3	027L4713
ICF SS 20	6	90	¾	20	Butt-weld DIN-EN 10220	ICFS 20	ICFF 20	ICFE 20	ICFC 20	ICM 20-C	ICFS 20	9.7	21.3	027L4715
ICF SS 20	6	90	¾	20	Butt-weld DIN-EN 10220	ICFS 20	ICFF 20	ICFE 20	ICFC 20	ICFR 20A	ICFW 20D	8.9	17.8	027L4740
ICF SS 20	6	90	¾	20	Butt-weld DIN-EN 10220	ICFS 20	ICFF 20	ICFE 20	ICFC 20	ICFR 20B	ICFW 20D	8.9	17.8	027L4741
ICF SS 20	6	90	¾	20	Butt-weld DIN-EN 10220	ICFS 20	ICFF 20	ICFE 20H	ICFC 20	ICFR 20A	ICFW 20D	9.8	21.5	027L4748
ICF SS 20	6	90	¾	20	Butt-weld DIN-EN 10220	ICFS 20	ICFF 20	ICFE 20H	ICFC 20	ICFR 20B	ICFW 20D	9.8	21.5	027L4749
ICF SS 20	6	90	¾	20	Butt-weld DIN-EN 10220	ICFS 20	ICFF 20	ICFE 20	ICFC 20	ICFW 20D	ICFS 20	9.3	20.6	027L4768
ICF SS 20	6	90	¾	20	Butt-weld DIN-EN 10220	ICFS 20	ICFF 20	ICFE 20	ICFB 20	ICFR 20A	ICFS 20	9.9	21.8	027L3427
ICF SS 20	6	90	1	25	Butt-weld DIN-EN 10220	ICFS 20	ICFF 20E	ICFE 20H	ICFC 20	ICFR 20B	ICFW 20D	11.5	25.3	027L4723
ICF SS 20	6	90	1	25	Butt-weld DIN-EN 10220	ICFS 20	ICFF 20	ICFE 20	ICFC 20	ICFR 20A	ICFW 20D	8.9	17.8	027L4742
ICF SS 20	6	90	1	25	Butt-weld DIN-EN 10220	ICFS 20	ICFF 20	ICFE 20	ICFC 20	ICFR 20B	ICFW 20D	8.9	17.8	027L4743
ICF SS 20	6	90	1	25	Butt-weld DIN-EN 10220	ICFS 20	ICFF 20	ICFE 20H	ICFC 20	ICFR 20A	ICFW 20D	9.8	21.5	027L4750

Valve station, Type ICF SS 20 and ICF SS 25

Type	# of modules	Appl. #	Connection size		Connection type	Module location						Weight		Code number
			[in.]	[mm]		M1	M2	M3	M4	M5	M6	kg	lbs	
ICF SS 20	6	90	1	25	Butt-weld DIN-EN 10220	ICFS 20	ICFF 20	ICFE 20H	ICFC 20	ICFR 20B	ICFW 20D	9.8	21.5	027L4751
ICF SS 20	6	90	1	25	Butt-weld DIN-EN 10220	ICFS 20	ICFF 20	ICFE 20	ICFC 20	ICFR 20D	ICFS 20	9.3	20.6	027L4767
ICF SS 20	6	90	1¼	32	Butt-weld DIN-EN 10220	ICFS 20	ICFF 20	ICFE 20	ICFC 20	ICFR 20A	ICFW 20D	8.9	17.8	027L4746
ICF SS 20	6	90	1¼	32	Butt-weld DIN-EN 10220	ICFS 20	ICFF 20	ICFE 20	ICFC 20	ICFR 20B	ICFW 20D	8.9	17.8	027L4747
ICF SS 20	6	90	1¼	32	Butt-weld DIN-EN 10220	ICFS 20	ICFF 20	ICFE 20H	ICFC 20	ICFR 20A	ICFW 20D	9.8	21.5	027L4752
ICF SS 20	6	90	1¼r	32	Butt-weld DIN-EN 10220	ICFS 20	ICFF 20	ICFE 20H	ICFC 20	ICFR 20B	ICFW 20D	9.8	21.5	027L4753
ICF SS 25	6	90	1	25	Butt-weld DIN-EN 10220	ICFS 25	ICFF 25	ICFE 25	ICFN 25	ICFR 25B	ICFW 25D	24.2	53.2	027L4189
ICF SS 25	6	90	1	25	Butt-weld DIN-EN 10220	ICFS 25	ICFF 25	ICM 25-A	ICFC 25	ICFB 25	ICFS 25	23.6	51.9	027L4763
ICF SS 25	6	90	1¼	32	Butt-weld DIN-EN 10220	ICFS 25	ICFF 25	ICM 25-B	ICFC 25	ICFB 25	ICFS 25	23.6	51.9	027L4762

i NOTE:

ICAD and coils are not included and must be ordered separately.

When used in systems with CO₂, the o-rings on the ICM module can swell (grow). At service, it is therefore recommended to install new o-rings, before the ICM function module is re-installed in the ICF SS valve body. ICAD and coils are not included and must be ordered separately.

Modules

Table 44: ICF SS with four modules

Type	Function Module Type	Can be installed in these locations			
ICFS SS	Stop valve module	M1	M2	M3	M4
ICFR SS	Manual regulating valve module	M1	M2	M3	M4
ICFF SS	Filter (strainer) module	location not possible	M2	location not possible	M4
ICFE SS	Solenoid valve module	location not possible	location not possible	M3	location not possible
ICFC SS	Check valve module	location not possible	location not possible	location not possible	M4
ICFN SS	Stop / check valve module	location not possible	location not possible	location not possible	M4
ICM SS	Motor valve module	M1	location not possible	M3	location not possible
ICFB SS	Blank top cover	M1	M2	M3	M4
ICFA SS	Electronic expansion valve module (for ICF SS 20 only)	M1	location not possible	M3	location not possible
ICFE SS 20H	Solenoid valve module (for ICF SS 20 only)	M1	location not possible	M3	location not possible
ICFO SS	Manual opening module	location not possible	location not possible	location not possible	M4
ICFW SS	Welding module	M1	M2	M3	M4

Table 45: ICF SS with six modules

Type	Function Module Type	Can be installed in these locations					
ICFS SS	Stop valve module	M1	M2	M3	M4	M5	M6
ICFR SS	Manual regulating valve module	M1	M2	M3	M4	M5	M6
ICFF SS	Filter (strainer) module	location not possible	M2	location not possible	M4	location not possible	M6
ICFE SS	Solenoid valve module	location not possible	location not possible	M3	location not possible	location not possible	location not possible
ICFC SS	Check valve module	location not possible	location not possible	location not possible	M4	location not possible	M6
ICFN SS	Stop/check valve module	location not possible	location not possible	location not possible	M4	location not possible	M6
ICM SS	Motor valve module	M1	location not possible	M3	location not possible	M5	location not possible
ICFB SS	Blank top cover	M1	M2	M3	M4	M5	M6
ICFA SS	Electronic expansion valve module (for ICF SS 20 only)	M1	location not possible	M3	location not possible	M5	location not possible

Valve station, Type ICF SS 20 and ICF SS 25

Type	Function Module Type	Can be installed in these locations					
ICFE SS 20H	Solenoid valve module (for ICF SS 20 only)	M1	location not possible	M3	location not possible	M5	location not possible
ICFO SS	Manual opening module	location not possible	location not possible	location not possible	M4	location not possible	location not possible
ICFW SS	Welding module	M1	M2	M3	M4	M5	M6

NOTE:

Module locations are indicated by M1, M2, M3, M4, M5 and M6. With respect to refrigerant flow, M1 is closest to inlet.

Accessories

Table 46: Accessories

Blind SS plug	Connector SS 1/2 in. - 3/8 in.	Sight glass	1/2 in. weld connector SS	Adapter SS G3/8 - 3/8 FPT
				

Table 47: Blind SS plug

Quantity	Code no.
2 pcs. 3/8" RG	027L4811

Table 48: Connector SS 1/2 in. - 3/8 in.

Quantity	Code no.
2	027L4810

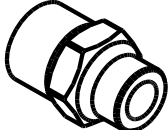
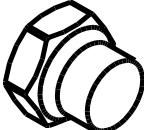
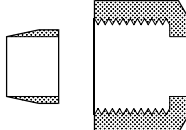
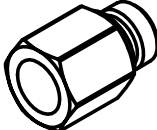
Table 49: Sight glass

Quantity	Code no.
2 pcs. 3/8" G	027L4812

Table 50: 1/2 in. weld connector SS

Quantity	Code no.
2	148B4689

Table 51: Adapter SS G3/8 - 3/8 FPT

Quantity	Code no.
2	027L4813

Table 52: ICAD 600A - cable, connector and protection cap

ICAD 600A	Cable	Connector	Protection cap
			

Table 53: ICAD 600A

Description	Code no.
ICAD 600A	With 1,5m cable 027H9075 Without cables 027H9120
Cable	Cable set 10 m. 027H0427 Cable set 15 m. 027H0435
Connector	Connector set female 027H0430
Protection cap	Protection cap for ICAD 027H0431

NOTE:

ICAD details see literature: **AI236186442940**

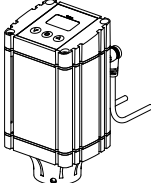
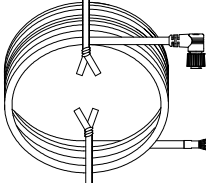
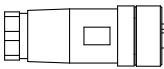
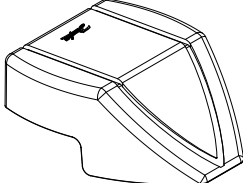
Valve station, Type ICF SS 20 and ICF SS 25

Table 54:

SNV-SS G ½ in.	SNV-SS ¾ in.

Table 55: SNV-SS

Description	Code no.
SNV-SS for ICF SS 20/SS 25 DIN butt weld connection. Side connection: G ½ in. Bottom connection: G ½ in. Included: Adapter SS (G ½ in. - G ¾ in.)	148B6545
SNV SS for ICF SS 20/SS 25 DIN butt weld connection. Side connection: ¾ in. FPT Bottom connection: ¾ in. MPT Included: Adapter SS (¾ FPT - G ¾ in.)	148B3750

Table 56: Coils - Alternating current AC

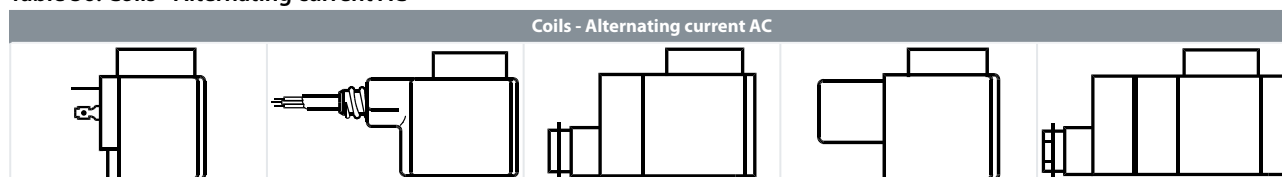

Table 57: Coils - Alternating current AC

Valve type	Voltage V	Frequency Hz	Code no.			Appendix no. *)	Power consumption
			With 1 m 3-core cable	With terminal box IP 67	With DIN plugs**)		
Alternating current AC							
ICFE	12	50		018F6706		15	Holding: 10 W 21 VA Inrush: 44 VA
	24	50	018F6257	018F6707	018F7358	16	
	220 – 230	50	018F6251	018F6701	018F7351	31	
	115	60	018F6260	018F6710		20	
Direct current DC (can not be used for ICF SS 20 configurations with ICM module) Coil type I							
ICFE/ICFA	12			018F6856		1	20 W
	24			018F6857		2	

Table 58: Special coils for ICFE

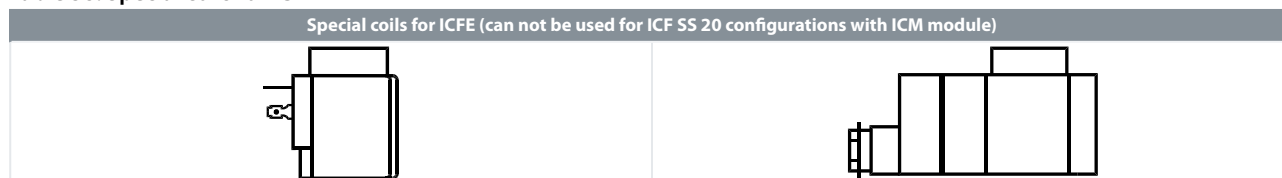

Table 59: Special coils for ICFE (can not be used for ICF SS 20 configurations with ICM module)

Valve type	Voltage V	Frequency Hz	Code no.	Appendix no. Indicates voltage and frequency	Power consumption
			With terminal box IP 67		
Alternating current AC					
ICFE	24	50	018F6807	16	Holding: 12 W 26 VA Inrush: 55 VA
	110	50	018F6811	22	
	220 – 230	50	018F6801	31	

NOTE:

For other coil types please refer to the technical leaflets for EVRA or AKVA valves.

Certificates, declarations, and approvals

The list contains all certificates, declarations, and approvals for this product type. Individual code number may have some or all of these approvals, and certain local approvals may not appear on the list.

Some approvals may change over time. You can check the most current status at danfoss.com or contact your local Danfoss representative if you have any questions.

The ICF SS concept is designed to fulfil global refrigeration requirements. For specific approval information, please contact Danfoss.

Table 60: Valid approvals

Type	File name	Document type	Document topic	Approval authority
ICF SS	033F0691.AD	Manufacturers Declaration	RoHS	
	033F0686.AG	Manufacturers Declaration	PED	
	19.10325.266	Marine - Safety Certificate		RMRS
ICF 20 - 25 SS	0C18678.513467890YTN	Pressure - Safety Certificate	TSSA	CRN
	SA7200	Mechanical - Safety Certificate	UL	
ICF 20 - 25 SS Body	0C19205.2	Pressure - Safety Certificate	TSSA	CRN

Table 61: Compliance

ICF SS valve station		
Nominal bore	DN ≤ 25 (1 in.)	DN 32-40 (1 ¼ - 1 ½")
Classified for	Fluid group I	
Category	Article 3, paragraph 3	II

Table 62: Compliance table ICF SS 20 and ISF SS 25

	Conformity Approvals UL approved
---	--

Online support

Danfoss offers a wide range of support along with our products, including digital product information, software, mobile apps, and expert guidance. See the possibilities below.

The Danfoss Product Store



The Danfoss Product Store is your one-stop shop for everything product related—no matter where you are in the world or what area of the cooling industry you work in. Get quick access to essential information like product specs, code numbers, technical documentation, certifications, accessories, and more.

Start browsing at store.danfoss.com.

Find technical documentation



Find the technical documentation you need to get your project up and running. Get direct access to our official collection of data sheets, certificates and declarations, manuals and guides, 3D models and drawings, case stories, brochures, and much more.

Start searching now at www.danfoss.com/en/service-and-support/documentation.

Get local information and support



Local Danfoss websites are the main sources for help and information about our company and products. Find product availability, get the latest regional news, or connect with a nearby expert—all in your own language.

Find your local Danfoss website here: www.danfoss.com/en/choose-region.

Danfoss Learning



Danfoss Learning is a free online learning platform. It features courses and materials specifically designed to help engineers, installers, service technicians, and wholesalers better understand the products, applications, industry topics, and trends that will help you do your job better.

Create your Danfoss Learning account for free at www.danfoss.com/en/service-and-support/learning.

Spare Parts



Get access to the Danfoss spare parts and service kit catalog right from your smartphone. The app contains a wide range of components for air conditioning and refrigeration applications, such as valves, strainers, pressure switches, and sensors.

Download the Spare Parts app for free at www.danfoss.com/en/service-and-support/downloads.

Coolselector®2 - find the best components for you HVAC/R system



Coolselector®2 makes it easy for engineers, consultants, and designers to find and order the best components for refrigeration and air conditioning systems. Run calculations based on your operating conditions and then choose the best setup for your system design.

Download Coolselector®2 for free at coolselector.danfoss.com.

Danfoss A/S

Climate Solutions • danfoss.com • +45 7488 2222

Any information, including, but not limited to information on selection of product, its application or use, product design, weight, dimensions, capacity or any other technical data in product manuals, catalogues descriptions, advertisements, etc. and whether made available in writing, orally, electronically, online or via download, shall be considered informative, and is only binding if and to the extent, explicit reference is made in a quotation or order confirmation. Danfoss cannot accept any responsibility for possible errors in catalogues, brochures, videos and other material. Danfoss reserves the right to alter its products without notice. This also applies to products ordered but not delivered provided that such alterations can be made without changes to form, fit or function of the product.

All trademarks in this material are property of Danfoss A/S or Danfoss group companies. Danfoss and the Danfoss logo are trademarks of Danfoss A/S. All rights reserved.