

Dimension			
L	W	H	
300	85	41 (1U)	mm
11.8	3.35	1.61 (1U)	inch



Front



Back



## Features

- Charger for lead-acid batteries (Gel, flooded and AGM) and Li-ion batteries (lithium iron and lithium manganese)
- Built-in default 3 stage charging curves and programmable curve
- Built-in I<sup>2</sup>C interface, PMBus protocol (Optional CANBus protocol)
- Output voltage and current programmable
- Universal AC input / Full range (Withstand 300VAC surge input for 5 seconds)
- Built-in active PFC function
- Forced air cooling by built-in DC fan
- Built-in OR-ing FET, support hot swap (hot plug)
- Active current sharing up to 8000W for one 19" rack shelf
- Protections: Battery under voltage / Battery no connection / Short circuit / Over voltage / Over temperature
- Optional conformal coating
- 5 years warranty

## Applications

- Large scale DC UPS or emergency backup system
- Marine battery charger module
- Electric scooter or vehicle charger station
- Wastewater treatment system
- Electrolysis system

## GTIN CODE

MW Search: <https://www.meanwell.com/serviceGTIN.aspx>

## Description

RCB-1600 series is a single output 1600W AC/DC charger with 1U low profile (41mm). It is an intelligent charger with embedded charging curves which are programmable. Users are also able to adjust the charging voltage and current via the built-in potentiometer, output programmable functions, PMBus, or CANBus to charge different types of batteries, such as lead-acid batteries and li-ion batteries. Various protection mechanisms as well as the temperature compensation function are provided to assure the normal and safe operations. The rack-mountable attribute allows RCB-1600 to perfectly suit the charging, backup or constant current source applications exploiting the rack architecture or central management.

## Model Encoding

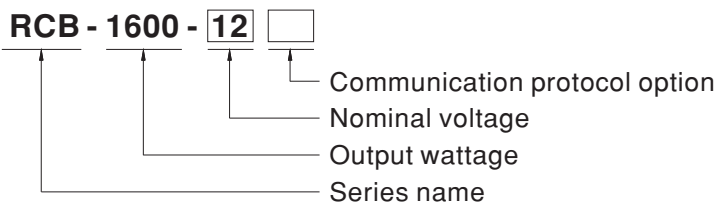

※ Note: 19" rack shelf, RHP-1U, available.

Type	Communication Protocol	Note
Blank	PMBus protocol	In Stock
CAN	CANBus protocol	By request



## SPECIFICATION

MODEL	RCB-1600-12	RCB-1600-24	RCB-1600-48	
OUTPUT	BOOST CHARGE VOLTAGE(Vboost)(default)	14.4V	28.8V	57.6V
	FLOAT CHARGE VOLTAGE(Vfloat)(default)	13.8V	27.6V	55.2V
	CONSTANT CURRENT(CC)(default)	100A	55A	27.5A
	RATED POWER	1440W	1584W	1584W
	VOLTAGE ADJ. RANGE	By built-in potentiometer, SVR		
		11.5 ~ 15V	23.5 ~ 30V	47.5 ~ 58.8V
	RECOMMENDED BATTERY CAPACITY(AMP HOURS) Note.3	330 ~ 1000Ah	180 ~ 550Ah	90 ~ 270Ah
LEAKAGE CURRENT FROM BATTERY (Typ.) Note.8	<45mA			
INPUT	VOLTAGE RANGE Note.4	90 ~ 264VAC 250 ~ 370VDC		
	FREQUENCY RANGE	47 ~ 63Hz		
	POWER FACTOR (Typ.)	0.97/230VAC at full load		
	EFFICIENCY (Typ.)	90.5%	92%	93%
	AC CURRENT (Typ.) Note.4	14A/115VAC 8A/230VAC	15A/115VAC 8.5A/230VAC	
	INRUSH CURRENT (Typ.)	COLD START 35A/230VAC		
	LEAKAGE CURRENT	<1.5mA / 230VAC		
PROTECTION	OVER VOLTAGE	15.75 ~ 18.75V	31.5 ~ 37.5V	63 ~ 75V
		Protection type : Shut down o/p voltage, re-power on to recover		
	OVER TEMPERATURE	Shut down o/p voltage, recovers automatically after temperature goes down		
FUNCTION	OUTPUT VOLTAGE PROGRAMMABLE(PV) Note 5	Adjustment of output voltage is allowable to 75 ~ 125% of nominal output voltage Please refer to the Function Manual.		
	OUTPUT CURRENT PROGRAMMABLE(PC) Note 5	Adjustment of output current is allowable to 20 ~ 100% of rated current Please refer to the Function Manual.		
	AUXILIARY POWER	5V @ 0.3A, 12V @ 0.8A		
	REMOTE ON-OFF CONTROL	By electrical signal or dry contact Power ON:short Power OFF:open. Please refer to the Function Manual		
	TEMPERATURE COMPENSATION	-3mV / °C / cell / (12V = 6 cells ; 24V = 12 cells ; 48V = 24 cells)		
	DC OK SIGNAL	The isolated TTL signal out. Please refer to the Installation Manual		
	AC OK SIGNAL	The isolated TTL signal out. Please refer to the Installation Manual		
ENVIRONMENT	WORKING TEMP.	-30 ~ +70°C (Refer to "Derating Curve")		
	WORKING HUMIDITY	20 ~ 90% RH non-condensing		
	STORAGE TEMP., HUMIDITY	-40 ~ +85°C, 10 ~ 95% RH non-condensing		
	TEMP. COEFFICIENT	±0.03%/°C (0 ~ 50°C)		
	VIBRATION	10 ~ 500Hz, 2G 10min./1cycle, 60min. each along X, Y, Z axes		
SAFETY & EMC (Note 6)	SAFETY STANDARDS	UL62368-1, TUV BS EN/EN62368-1, EAC TP TC 004 approved		
	WITHSTAND VOLTAGE	I/P-O/P:3KVAC I/P-FG:2KVAC O/P-FG:1.5KVAC (0.5KVAC for 12V)		
	ISOLATION RESISTANCE	I/P-O/P, I/P-FG, O/P-FG:100M Ohms / 500VDC / 25°C / 70% RH		
	EMC EMISSION	Compliance to BS EN/EN55032 (CISPR32) Conduction Class B, Radiation Class A ; BS EN/EN61000-3-2,-3, EAC TP TC 020		
EMC IMMUNITY	Compliance to BS EN/EN61000-4-2,3,4,5,6,8,11, BS EN/EN55035, EAC TP TC 020			
OTHERS	MTBF	476.7K hrs min. Telcordia SR-332 (Bellcore) ; 38.7K hrs min. MIL-HDBK-217F (25°C)		
	DIMENSION	300*85*41mm (L*W*H)		
	PACKING	1.87Kg; 6pcs/12.2Kg/1.16CUFT		
NOTE	<p>1. Modification for charger specification may be required for different battery specification. Please contact battery vendor and MEAN WELL for details.</p> <p>2. All parameters NOT specially mentioned are measured at 230VAC input, rated load and 25°C of ambient temperature.</p> <p>3. This is MEAN WELL's suggested range. Please consult your battery manufacturer for their suggestions about maximum charging current limitation.</p> <p>4. Derating may be needed under low input voltages. Please check the derating curve for more details.</p> <p>5. PV/PC functions when users are not operating on PMBus/CANBus. SVR functions when users are neither operating on PMBus/CANBus nor using PV/PC.</p> <p>6. The charger is considered a component which will be installed into a final equipment. All the EMC tests are been executed by mounting the unit on a 720mm*360mm metal plate with 1mm of thickness. The final equipment must be re-confirmed that it still meets EMC directives. For guidance on how to perform these EMC tests, please refer to "EMI testing of component power supplies." (as available on <a href="https://www.meanwell.com/Upload/PDF/EMI_statement_en.pdf">https://www.meanwell.com/Upload/PDF/EMI_statement_en.pdf</a>)</p> <p>7. The ambient temperature derating of 3.5°C/1000m with fanless models and of 5°C/1000m with fan models for operating altitude higher than 2000m(6500ft).</p> <p>8. When charging lead acid battery or battery without BMS, use breaker to disconnect charger and battery after fully charged.</p> <p>※ Product Liability Disclaimer : For detailed information, please refer to <a href="https://www.meanwell.com/serviceDisclaimer.aspx">https://www.meanwell.com/serviceDisclaimer.aspx</a></p>			

### Block Diagram

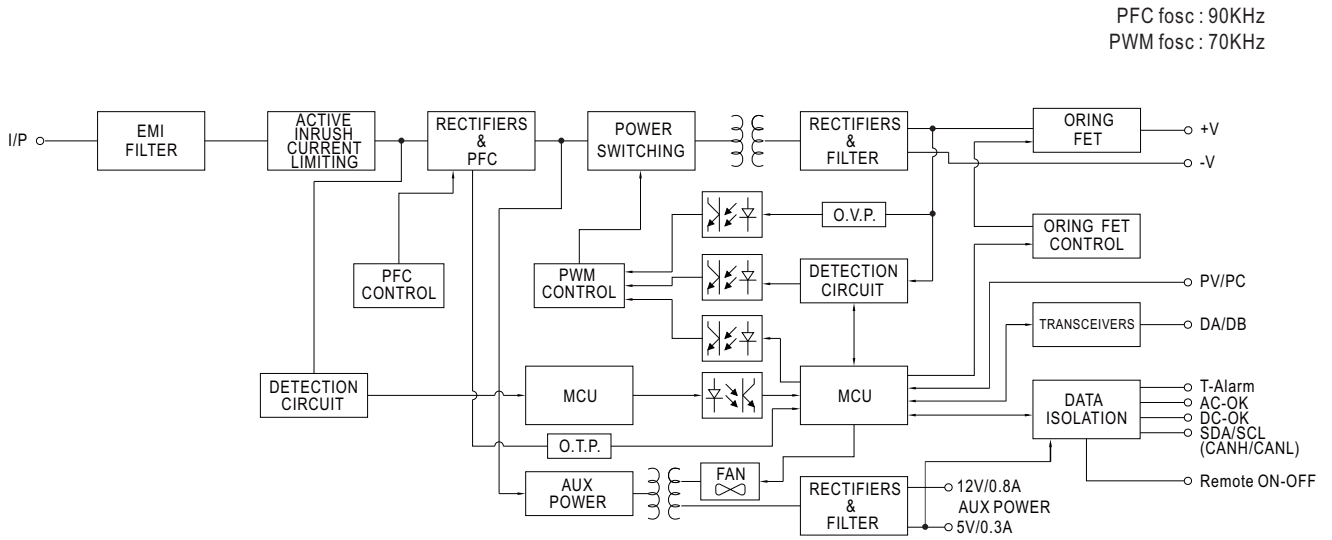

### Derating Curve

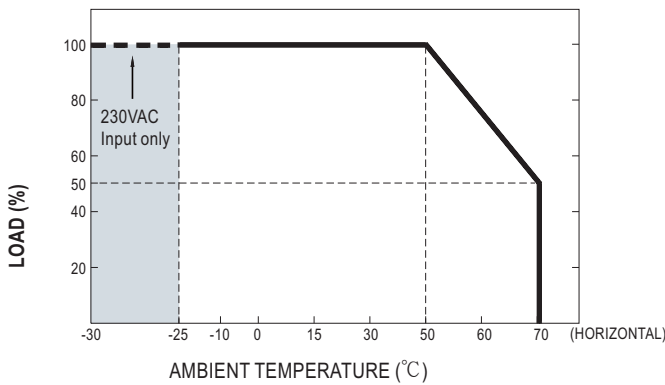

### Static Characteristics

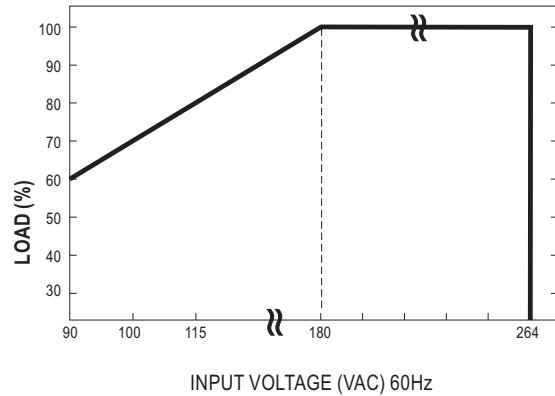

## Function Manual

### 1. PMBus Communication Interface

※ RCB-1600 supports PMBus Rev. 1.1 with maximum 100KHz bus speed, allowing information reading, status monitoring, output trimming, etc. For details, please refer to the Installation Manual.

### 2. Charging Curve

- ※ By factory default, this charger performs the default curve which can be programmed via PMBus and CANBus.
- ※ To disable/ enable the charging curve, change to a 2 stage curve, a different curve frequently used for certain types of batteries in the industry, switch to PMBus, CANBus, PV/PC or SVR control instead and so on, please refer to the Installation Manual.
- ※ To program the parameters of the charging curve, SBP-001, the smart battery charging programmer designed by MEAN WELL, and a personal computer are needed. Please contact MEAN WELL for details.

#### ☉ Default 3 stage charging curve

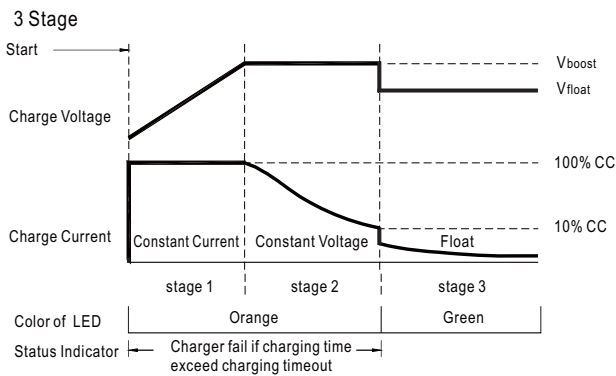

☉ Suitable for lead-acid batteries (flooded, Gel and AGM) and Li-ion batteries (lithium iron and lithium manganese).

#### ☉ Embedded 3 stage charging curve

MODEL	Description	Vboost	Vfloat	CC (default)
12V	Default, programmable	14.4	13.8	100A
	Pre-defined, gel battery	14	13.6	
	Pre-defined, flooded battery	14.2	13.4	
	Pre-defined, AGM battery	14.5	13.5	
24V	Default, programmable	28.8	27.6	55A
	Pre-defined, gel battery	28	27.2	
	Pre-defined, flooded battery	28.4	26.8	
	Pre-defined, AGM battery	29	27	
48V	Default, programmable	57.6	55.2	27.5A
	Pre-defined, gel battery	56	54.4	
	Pre-defined, flooded battery	56.8	53.6	
	Pre-defined, AGM battery	58	54	

### 3. Remote ON-OFF Control

The charger can be turned ON/OFF individually or along with other units in parallel by using the "Remote ON-OFF" function.

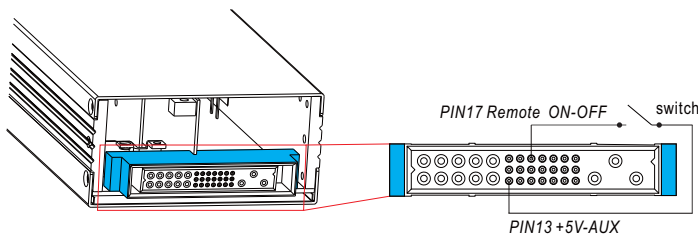

Between Remote ON-OFF and +5V-AUX	Charger Status
Switch Short	ON
Switch Open	OFF

#### 4. Output Voltage Programming (or, PV / remote voltage programming / remote adjust / margin programming / dynamic voltage trim)

※ In addition to the adjustment via the built-in potentiometer, the output voltage can be trimmed to 75~125% of the nominal voltage by applying EXTERNAL VOLTAGE.

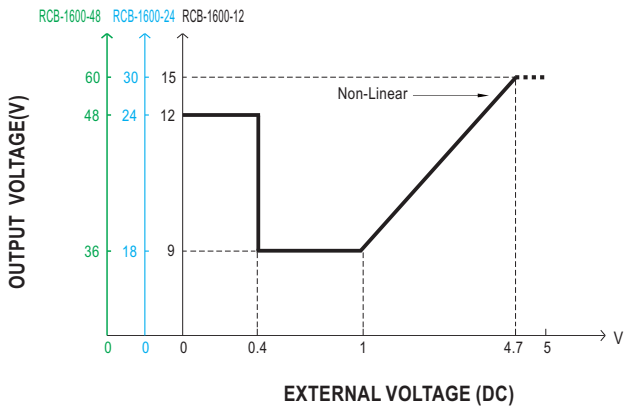
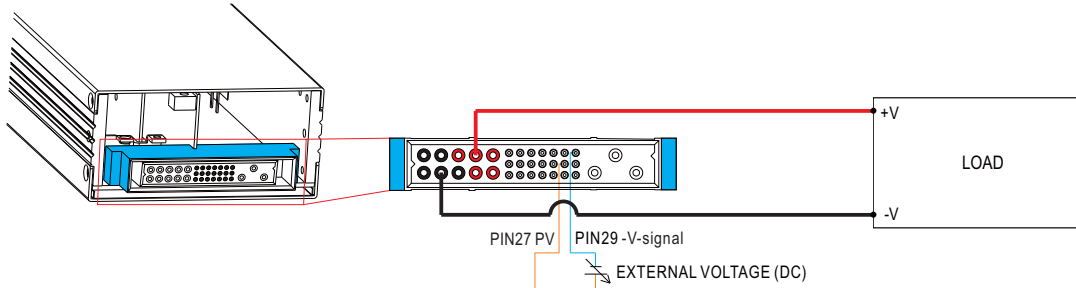

#### 5. Output Current Programming (or, PC / remote current programming / dynamic current trim)

※ The output current can be trimmed to 20~100% of the rated current by applying EXTERNAL VOLTAGE.

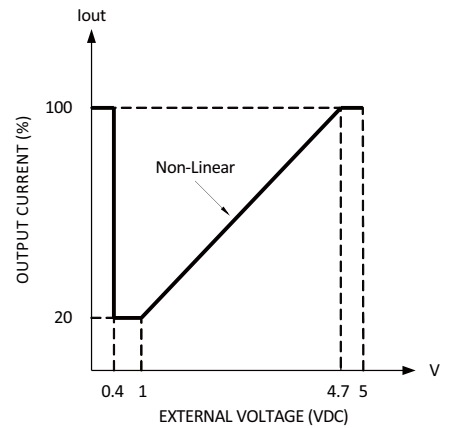
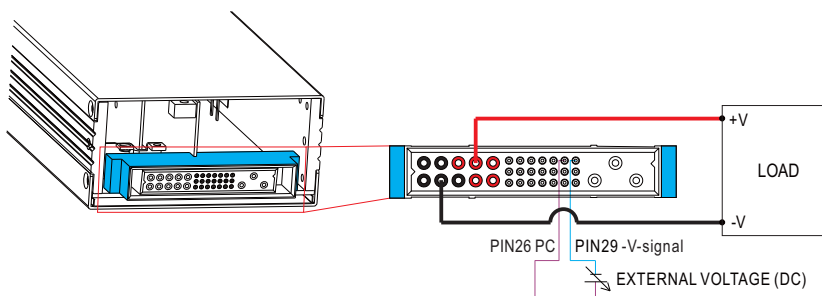

#### 6. Temperature Compensation

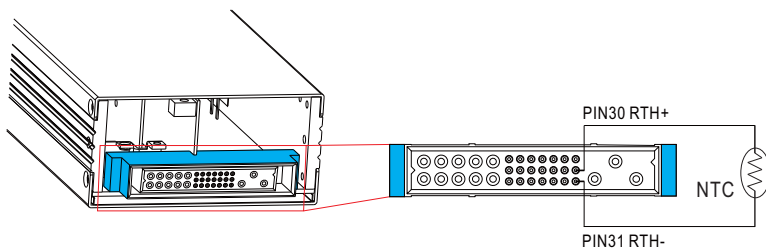

- ⊙ To exploit the temperature compensation function, please attach the temperature sensor, NTC, to the battery or the battery's vicinity.
- ⊙ The charger is able to work normally without the NTC.

■ Mechanical Specification

Case No.250 Unit:mm

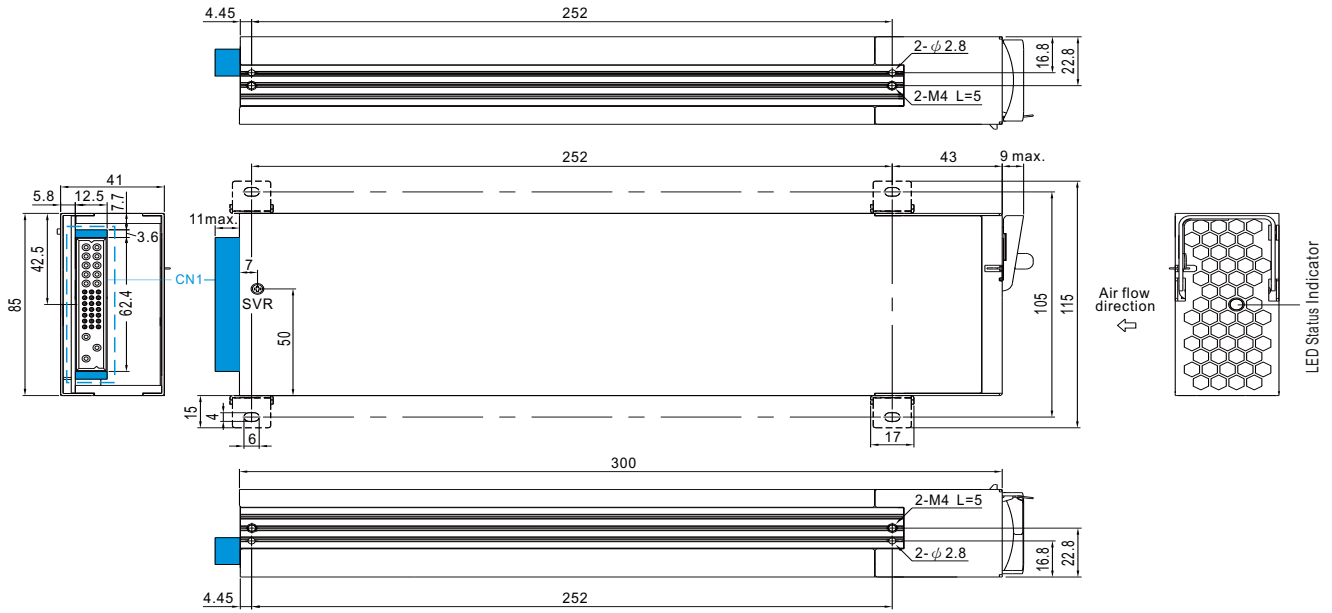

※ LED Status Indicators

LED	Description
	Float (stage 3)
	Charging (stage 1 or stage 2)
	The LED will present a constant red light when the abnormal status (OTP, OLP, fan fail and charging timeout) arises.
	The LED will flash with the red light when the internal temperature reaches 60°C; under this condition, the unit still operates normally without entering OTP. (In the meantime, an alarm signal will be sent out through the PMBus interface.)

※ Input / Output Connector Pin No. Assignment(CN1) : Positronic PCIM34W13M400A1

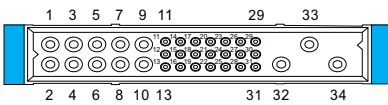

Mating Housing Positronic PCIM34W13F400A1

Pin No.	Function	Description
1,2,3,4,6	-V	Negative output terminal.
5,7,8,9,10	+V	Positive output terminal.
11	+12V-AUX	Auxiliary voltage output, 10.8~13.2V, referenced to GND-AUX (pin 12). The maximum load current is 0.8A. This output has the built-in "Oring diodes" and is not controlled by the Remote ON/OFF control.
12	GND-AUX	Auxiliary voltage output GND. The signal return is isolated from the output terminals (+V & -V).
13	+5V-AUX	Auxiliary voltage output, 4.5~5.5V, referenced to GND-AUX (pin 12). The maximum load current is 0.3A. This output has the built-in "Oring diodes" and is not controlled by the Remote ON/OFF control.
14	SCL	For PMBus model: Serial Clock used in the PMBus interface. (Note.2)
	CANL	For CANBus model: Data line used in CANBus interface. (Note.2)
15	SDA	For PMBus model: Serial Data used in the PMBus interface. (Note.2)
	CANH	For CANBus model: Data line used in CANBus interface. (Note.2)
16	T-ALARM	High (3.5 ~ 5.5V) : When the internal temperature exceeds the limit of temperature alarm, or when fan fails. Low (-0.5 ~ 0.5V) : When the internal temperature is normal, and when fan normally works. The maximum sourcing current is 10mA and only for output.(Note.2)
17	Remote ON-OFF	The unit can turn the output ON/OFF by electrical signal or dry contact between Remote ON/OFF and +5V-AUX. (Note.2) Short (4.5 ~ 5.5V) : Power ON ; Open (-0.5 ~ 0.5V) : Power OFF ; The maximum input voltage is 5.5V.
18	DC-OK	High (3.5 ~ 5.5V) : When the Vout ≤ 8V/16V/32V ± 1V. Low (-0.5 ~ 0.5V) : When Vout ≥ 8V/16V/32V ± 1V. The maximum sourcing current is 10mA and only for output. (Note.2) DC OK is associated with battery low protection.
19	AC-OK	High (3.5 ~ 5.5V) : When the input voltage is ≥ 87Vrms . Low (-0.5 ~ 0.5V) : When the input voltage is ≤ 75Vrms. The maximum sourcing current is 10mA and only for output. (Note.2)
20	D0	Charging mechanism control. This pin determines, for charging operation, whether charging curve is used, or control over PMBus, PV/PC or SVR is used. Please refer to the installation Manual. (Note.1)
21,22,23	A2,A1,A0	PMBus / CANBus interface address lines. (Note.1)
24,25	DB,DA	Differential digital signal for parallel control. (Note.1)
26	PC	Connection for output current programming. (Note.1)
27	PV	Connection for output voltage programming. (Note.1)
28	+V(signal)	Positive output voltage signal. It cannot be connected directly to the load.
29	-V(signal)	Negative output voltage signal. It is for certain function reference; it cannot be connected directly to the load.
30	RTH+	Temperature sense associated with the temperature compensation function.
31	RTH-	
32	FG	AC Ground connection.
33	AC/L	AC Line connection.
34	AC/N	AC Neutral connection.

Note1: Non-isolated signal, referenced to [-V(signal)].  
Note2: Isolated signal, referenced to GND-AUX.