

■ Features

- Constant Current mode output
- Circular shape PCB type design
- Built-in active PFC function
- Function options: output adjustable via potentiometer; 3 in 1 dimming; DALI
- Typical lifetime > 50000 hours
- 5 years warranty

■ Applications

- LED bay lighting
- LED down lighting
- LED spot lighting
- LED mining lighting
- LED stage lighting

■ GTIN CODE

MW Search: <https://www.meanwell.com/serviceGTIN.aspx>

■ Description

HBG-100P series is a 100W AC/DC PCB type LED driver featuring the circular shape design. It operates from 90~305VAC and offers constant current output models with different rated voltage ranging between 36V and 60V. Thanks to the high efficiency up to 91.5%, with the fanless design, the entire series is able to operate for -40°C ~ +45°C under free air convection. HBG-100P is equipped with various function options, such as dimming methodology, so as to provide the optimal design flexibility for LED lighting system.

■ Model Encoding

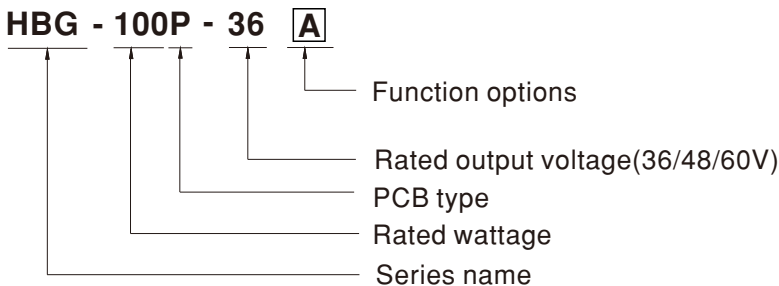

Type	Function	Note
A	Io adjustable through built-in potentiometer.	In Stock
B	3 in 1 dimming function (1~10Vdc, 10V PWM signal and resistance)	In Stock
DA	DALI control technology.	In Stock



SPECIFICATION

MODEL		HBG-100P-36 □	HBG-100P-48 □	HBG-100P-60 □
OUTPUT	RATED CURRENT	2.7A	2A	1.6A
	RATED POWER	97.2W	96W	96W
	CONSTANT CURRENT REGION <small>Note.2</small>	21.6 ~ 36V	28.8 ~ 48V	36 ~ 60V
	OPEN CIRCUIT VOLTAGE _(max.)	37V	49V	62V
	CURRENT ADJ. RANGE	Adjustable for A-Type only (via built-in potentiometer)		
		1.62 ~ 2.7A	1.2 ~ 2A	1.0 ~ 1.6A
	CURRENT RIPPLE	5.0% max. @rated current		
	CURRENT TOLERANCE	±5.0%		
SET UP TIME <small>Note.4</small>	2000ms / 115VAC 500ms / 230VAC			
INPUT	VOLTAGE RANGE <small>Note.3</small>	90 ~ 305VAC 127 ~ 431VDC (Please refer to "STATIC CHARACTERISTIC" section)		
	FREQUENCY RANGE	47 ~ 63Hz		
	POWER FACTOR	PF ≥ 0.96/115VAC, PF ≥ 0.96/230VAC, PF ≥ 0.94/277VAC@full load (Please refer to "POWER FACTOR (PF) CHARACTERISTIC" section)		
	TOTAL HARMONIC DISTORTION	THD < 20% (@load ≥ 60%/115VAC, 230VAC; @load ≥ 75%/277VAC) (Please refer to "TOTAL HARMONIC DISTORTION (THD)" section)		
	EFFICIENCY (Typ.) <small>Note.5</small>	91%	91%	91.5%
	AC CURRENT	1.1A / 115VAC	0.5A / 230VAC	0.45A / 277VAC
	INRUSH CURRENT(Typ.)	COLD START 60A(twidth=550µs measured at 50% Ipeak) at 230VAC; Per NEMA 410		
	MAX. No. of PSUs on 16A CIRCUIT BREAKER	4 units (circuit breaker of type B) / 8 units (circuit breaker of type C) at 230VAC		
LEAKAGE CURRENT	<0.75mA / 277VAC			
PROTECTION	OVER CURRENT	95 ~ 108% Constant current limiting, recovers automatically after fault condition is removed		
	OVER VOLTAGE	41 ~ 49V	54 ~ 63V	65 ~ 75V
	OVER TEMPERATURE <small>Note.10</small>	Shut down o/p voltage, re-power on to recovery		
ENVIRONMENT	WORKING TEMP.	Ta=-40 ~ +45°C (Please refer to " OUTPUT LOAD vs TEMPERATURE" section)		
	WORKING HUMIDITY	20 ~ 95% RH non-condensing		
	STORAGE TEMP., HUMIDITY	-40 ~ +80°C, 10 ~ 95% RH		
	TEMP. COEFFICIENT	±0.03%/°C (0 ~ 45°C)		
	VIBRATION	10 ~ 500Hz, 2G 12min./1cycle, period for 72min. each along X, Y, Z axes		
SAFETY & EMC	SAFETY STANDARDS	UL8750, CSA C22.2 No.250.13-12; ENEC BS EN/EN61347-1, BS EN/EN61347-2-13, BS EN/EN62384, GB19510.1, GB19510.14, EAC TP TC 004 approved		
	DALI STANDARDS	Compliance to IEC62386-101, 102, 207 for DA-Type only		
	WITHSTAND VOLTAGE	I/P-O/P:3.75KVAC I/P-FG:2KVAC O/P-FG:0.5KVAC		
	ISOLATION RESISTANCE	I/P-O/P, I/P-FG, O/P-FG:100M Ohms / 500VDC / 25°C / 70% RH		
	EMC EMISSION	Compliance to BS EN/EN55015, BS EN/EN61000-3-2 Class C (@load ≥ 60%); BS EN/EN61000-3-3, GB17743, GB17625.1, EAC TP TC 020		
	EMC IMMUNITY	Compliance to BS EN/EN61000-4-2,3,4,5,6,8,11, BS EN/EN61547, light industry level(surge immunity:Line-Earth:4KV, Line-Line:2KV), EAC TP TC 020		
OTHERS	MTBF	2612.1K hrs min. Telcordia SR-332 (Bellcore); 346.9K hrs min. MIL-HDBK-217F (25°C)		
	DIMENSION	Refer to mechanical specification		
	PACKING	0.3Kg; 45pcs/14.5Kg/1.60CUFT		
NOTE	<p>1. All parameters NOT specially mentioned are measured at 230VAC input, rated current and 25°C of ambient temperature.</p> <p>2. Please refer to "DRIVING METHODS OF LED MODULE".</p> <p>3. De-rating may be needed under low input voltages. Please refer to "STATIC CHARACTERISTIC" sections for details.</p> <p>4. Length of set up time is measured at first cold start. Turning ON/OFF the power supply may lead to increase of the set up time.</p> <p>5. The DA type power supply is less efficient than the typical efficiency in specification by 1%.</p> <p>6. The driver is considered as a component that will be operated in combination with final equipment. Since EMC performance will be affected by the complete installation, the final equipment manufacturers must re-quality EMC Directive on the complete installation again.</p> <p>7. This series meets the typical life expectancy of >50,000 hours of operation when Ta is about 45°C or less.</p> <p>8. Please refer to the warranty statement on MEAN WELL's website at http://www.meanwell.com</p> <p>9. The ambient temperature derating of 3.5°C/1000m with fanless models and of 5°C/1000m with fan models for operating altitude higher than 2000m(6500ft).</p> <p>10. All functional testing must be filled with potting, including OTP function .</p> <p>※ Product Liability Disclaimer : For detailed information, please refer to https://www.meanwell.com/serviceDisclaimer.aspx</p>			

■ BLOCK DIAGRAM

fosc : 100KHz

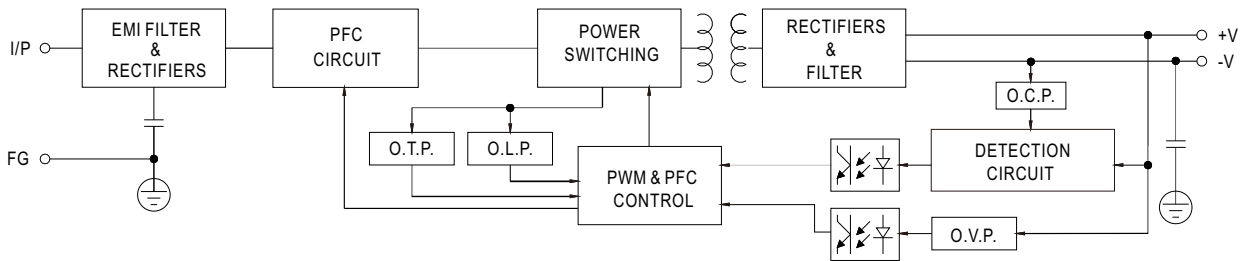

■ DRIVING METHODS OF LED MODULE

※ This series works in constant current mode to directly drive the LEDs.

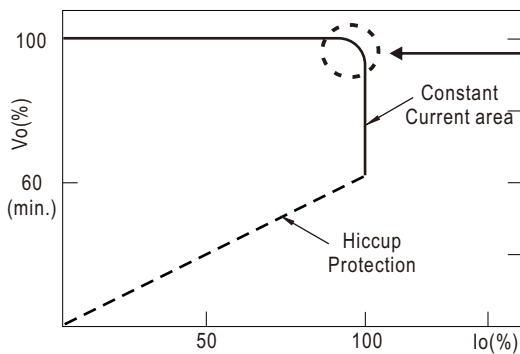

Typical output current normalized by rated current (%)

In the constant current region, the highest voltage at the output of the driver depends on the configuration of the end systems.

Should there be any compatibility issues, please contact MEAN WELL.

DIMMING OPERATION

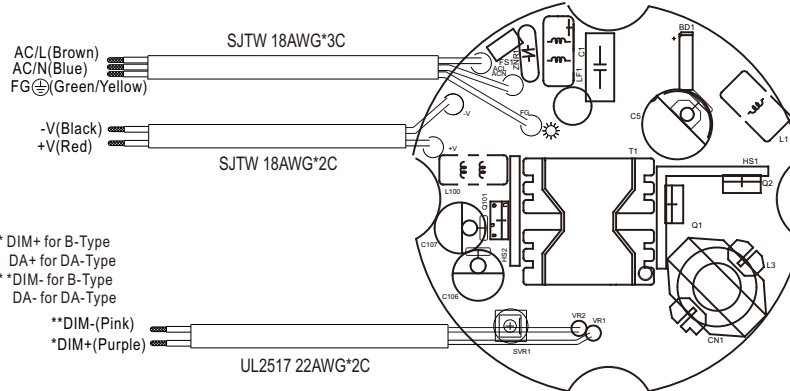

※ 3 in 1 dimming function (for B-Type)

- Output constant current level can be adjusted by applying one of the three methodologies between DIM+ and DIM-: 1 ~ 10VDC, or 10V PWM signal or resistance.
- Direct connecting to LEDs is suggested. It is not suitable to be used with additional drivers.
- Dimming source current from power supply: 100 μ A (typ.)

◎ Applying additive 1 ~ 10VDC

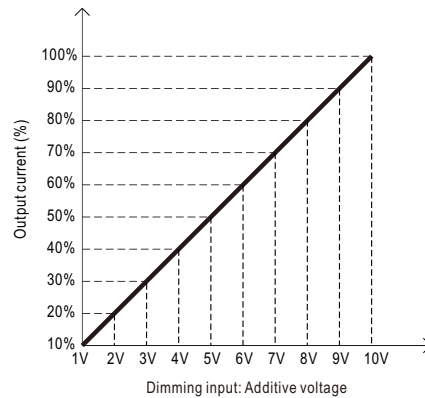
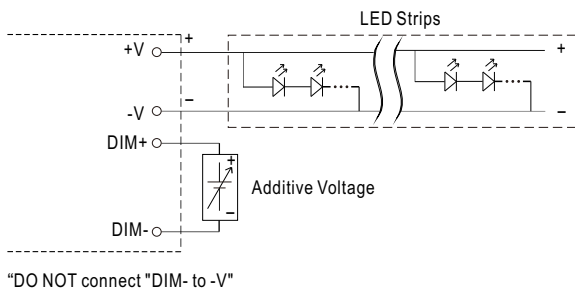

◎ Applying additive 10V PWM signal (frequency range 100Hz ~ 3KHz):

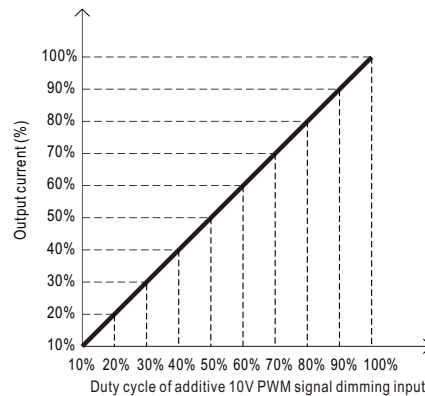
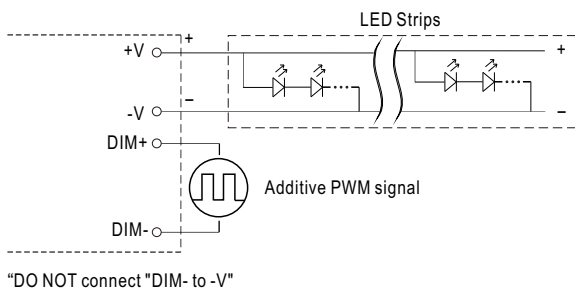

◎ Applying additive resistance:

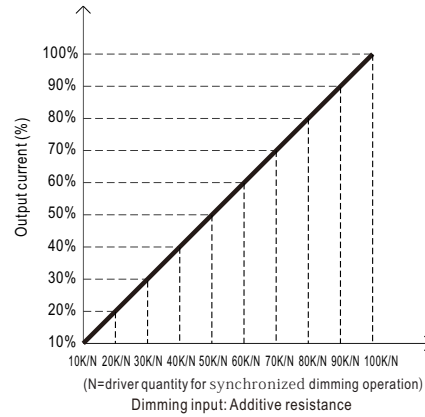
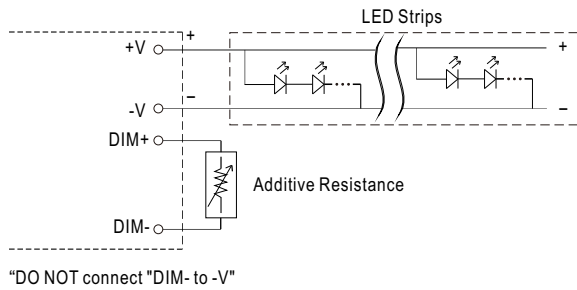

Note: In the case of turning the lighting fixture down to 0% brightness, please refer to the configuration as follow, or please contact MEAN WELL for other options.

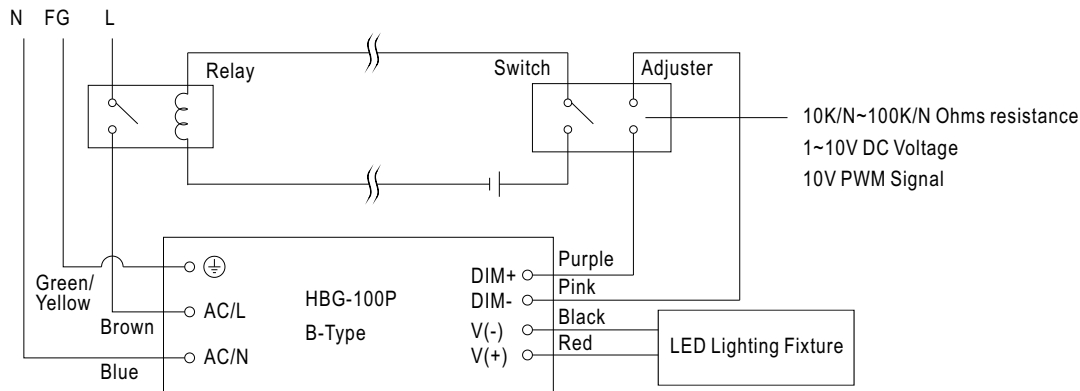

Using a switch and relay can turn ON/OFF the lighting fixture.

※ **DALI Interface (primary side; for DA-Type)**

- Apply DALI signal between DA+ and DA-.
- DALI protocol comprises 16 groups and 64 addresses.
- First step is fixed at 8% of output.

OUTPUT LOAD vs TEMPERATURE

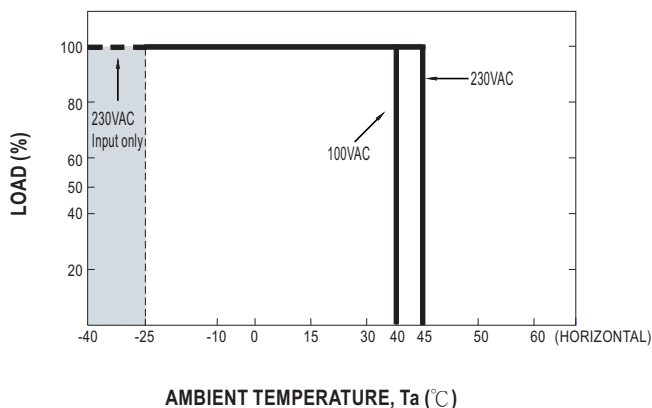

STATIC CHARACTERISTIC

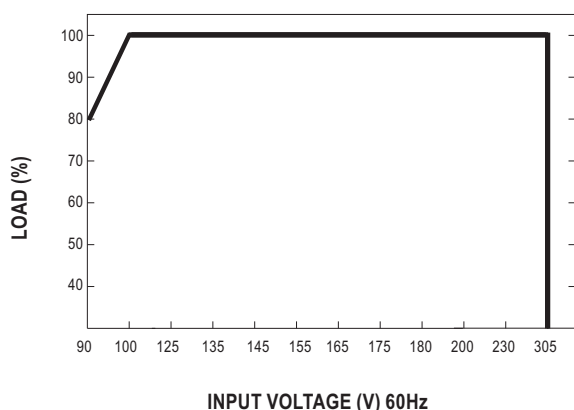

※ De-rating is needed under low input voltage.

TOTAL HARMONIC DISTORTION (THD)

※ 60V Model

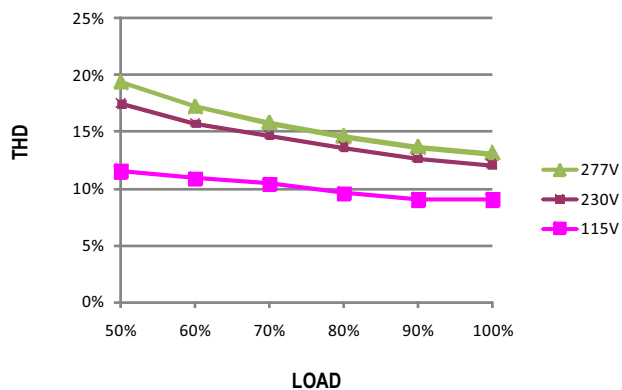

POWER FACTOR (PF) CHARACTERISTIC

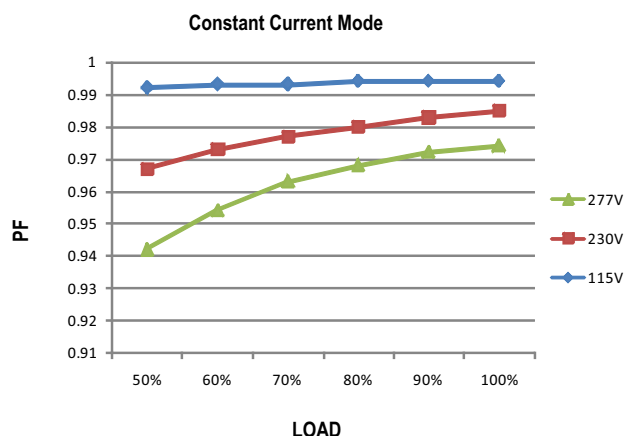

EFFICIENCY vs LOAD

HBG-100P series possess superior working efficiency that up to 91.5% can be reached in field applications.

※ 60V Model

