

# Compact Vacuum Unit Ejector/Vacuum Pump System

## ZB Series



**Quick response**

**Response time of the valve: 5 ms**  
**Vacuum response time: 28 ms**

**Energy-saving**

**Air consumption: 17% reduced\***  
**Vacuum pressure reached: 21% increased\***  
 \* Compared with current model

(Shortened by **25%**;  
**Comparison with other SMC products**)  
 \* Conditions: Nozzle size  $\phi 0.6$ , when the pressure reaches  $-60$  kPa, vacuum piping size  $\phi 4/\phi 2.5 \times 50$  mm

**Vacuum breaking time: 14 ms**  
 \* Conditions: Needle flow rate set to 10 L/min, when the pressure reaches atmospheric pressure, with supply pressure 0.5 MPa, vacuum piping size  $\phi 4/\phi 2.5 \times 50$  mm

**Compact/Lightweight**

**46 g**  
 \* Single unit weight

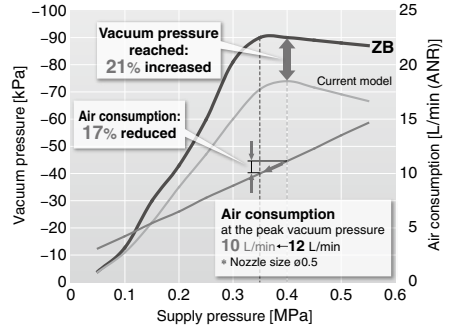

- ZK2
- ZQ
- ZR
- ZB**
- ZA
- ZX
- ZM
- ZL
- ZH
- ZH
- ZH-X267
- ZHP
- ZU
- VQD-V

### All-in-One

Supply valve, release valve, vacuum break flow adjustment needle, suction filter, and silencer

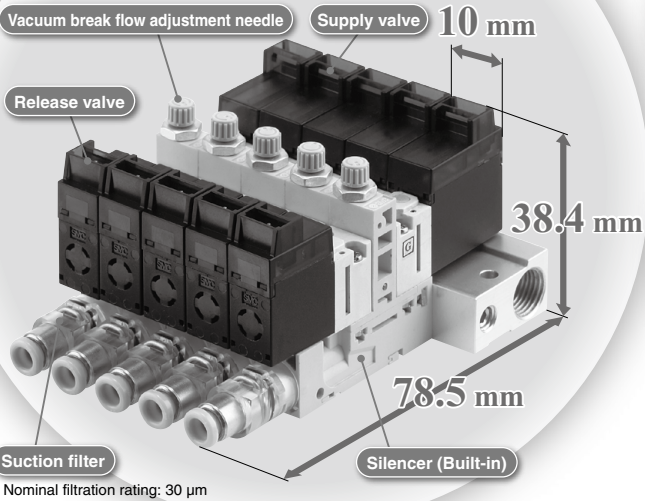

Nominal filtration rating: 30  $\mu$ m

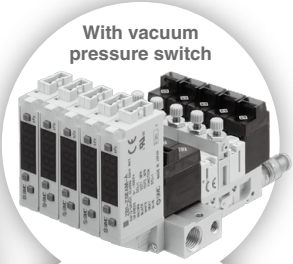

**Can copy to up to 10 switches simultaneously.**

The settings of the master sensor (source of copy) can be copied to the slave sensors.

- Reduction in setting work
- Prevention of mistakes in setting

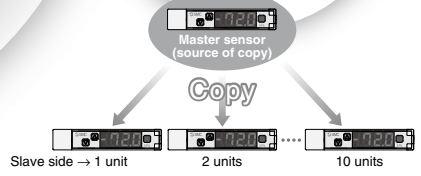

# ZB Series

## Unit with release pressure supply port can be selected.

Air pressure and release pressure can be adjusted separately.  
Release pressure can be adjusted to suit the workpiece.

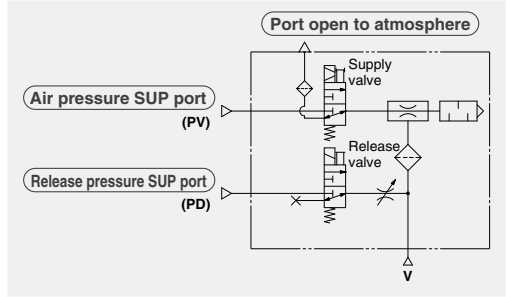
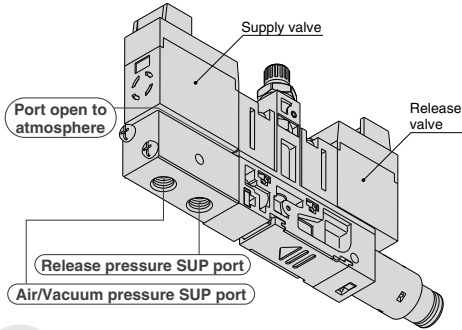

## Release response time is shortened by 25% by the port open to atmosphere.

Having the R port of the supply valve open to atmosphere allows instant vacuum break with the pump system and controls excessive increase of the release pressure.

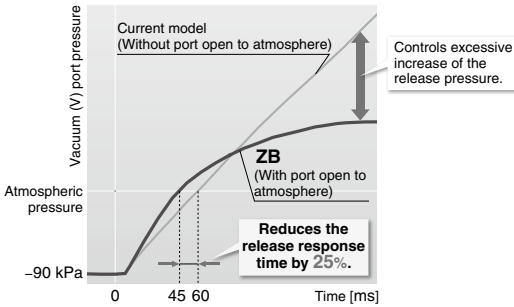

\* Conditions: Needle flow rate set to 5 L/min, with supply pressure 0.5 MPa, vacuum piping size  $\phi 4/\phi 2.5 \times 100$  mm

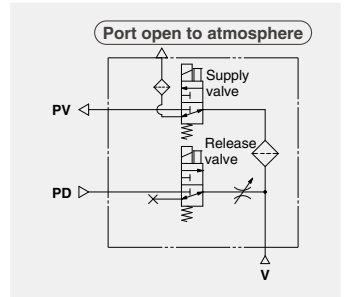

## Prevents incorrect vacuum break (exhaust interference).

Installing individual exhaust ports prevents incorrect vacuum break due to exhaust interference when used as a manifold. Individual exhaust port specification for which piping can be connected is also available.

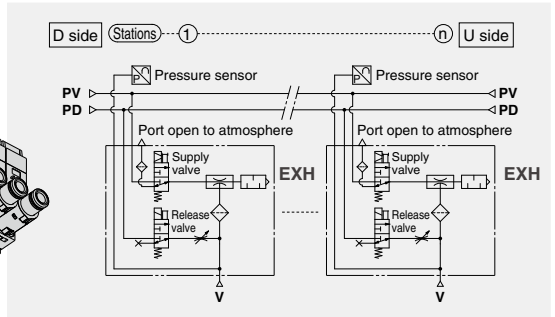
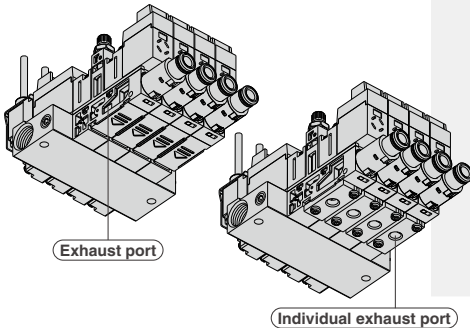

# Easy maintenance

Simple installation and removal without the use of screws

## ■ Replacement of filter element

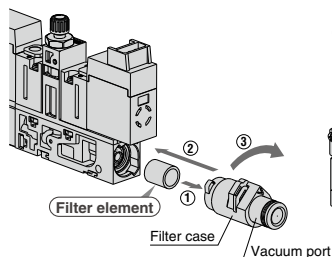

## ■ Replacement of sound absorbing material

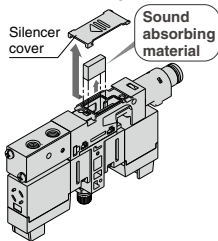

## Applicable to the latching type valve

Latching type can be selected for the supply valve. (Nozzle sizes:  $\phi 0.3$  and  $\phi 0.4$  only)

Reduces power consumption by reducing energization time when generating vacuum, and prevents workpieces being dropped if there is an instantaneous power cut due to lightning etc. (when the air supply is not stopped).

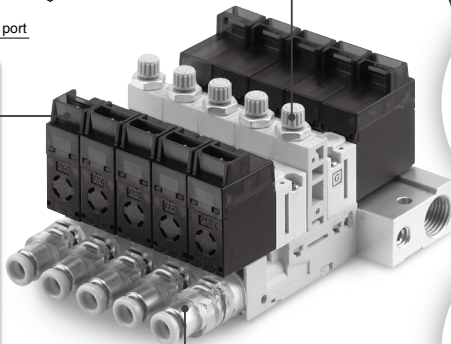

Unit either with pressure sensor or vacuum pressure switch can be selected.

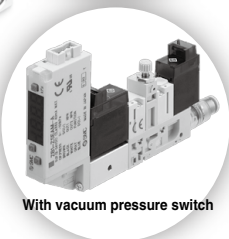
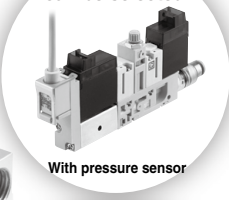

## Construction which reduces discharge of dust with the vacuum break air

This product has a construction with the vacuum pressure path and release pressure path separated, which reduces the amount of dust collected by the suction filter discharged to the atmosphere.

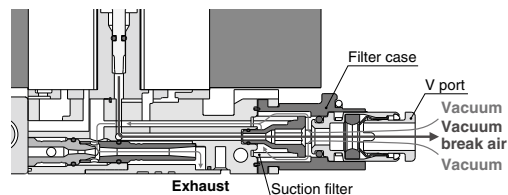

## Fine adjustment of the vacuum break

It can be adjusted from 1 to 14.5 L/min (ANR).

\* With the supply pressure 0.5 MPa

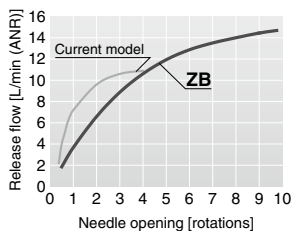

ZK2

ZQ

ZR

ZB

ZA

ZX

ZM

ZL

ZH

ZH

ZH-X267

ZHP

ZU

VQD-V

## Application Example

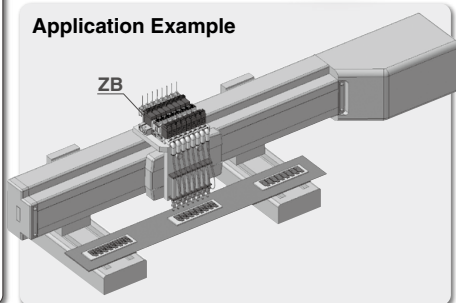

Single unit

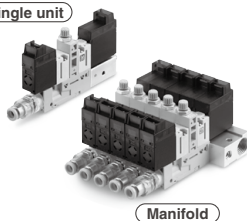

Manifold

## Variations

Model	Nozzle size	Supply valve		Release valve	Pressure sensor Vacuum pressure switch	Manifold stations
		Large flow (N.C.)	Latching	N.C.		
Vacuum pump system	ZB00	—	●	●	●	1 to 12 stations
Ejector	ZB03	$\phi 0.3$	●	—	●	
	ZB04	$\phi 0.4$	●	●	●	
	ZB05	$\phi 0.5$	●	—	●	
	ZB06	$\phi 0.6$	●	—	●	

# Compact Vacuum Unit

## ZB Series



### How to Order Single Unit

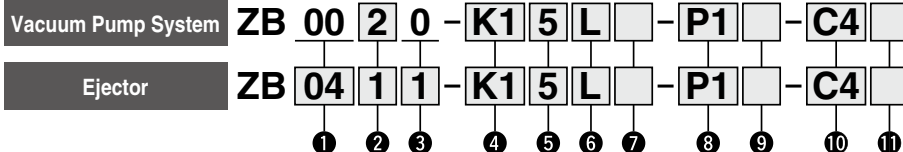

#### 1 Nominal Nozzle Size

Symbol	Nominal nozzle size	Applicable supply valve and standard supply pressure	
		Large flow (N.C.)	Latching
00 <small>Note 1)</small>	—	●	—
03	ø0.3	● (0.35 MPa)	● (0.4 MPa)
04	ø0.4	● (0.35 MPa)	● (0.45 MPa)
05	ø0.5	● (0.35 MPa)	—
06	ø0.6	● (0.5 MPa)	—

Note 1) Vacuum pump system only

#### 3 Exhaust Type

0	For vacuum pump system (Without silencer)		Without exhaust port
1	Silencer exhaust (Individual exhaust)		Exhaust direction
2	Port exhaust (Individual exhaust)		Exhaust port

#### 2 Body Type

Symbol	Body specification	Port specification <small>Note 2)</small>
1	Single unit	 PV, PD common port (PV = PD)
2	Single unit	 PV, PD individual port (PV ≠ PD)
3	For manifold	No distinction

Note 2) Names of the ports and functions are as follows.  
 PV: Air pressure SUP port (Ejector)  
 Vacuum pressure SUP port (Vacuum pump system)  
 PD: Release pressure SUP port  
 (For the unit with PD port, select the model with a release valve for ●.)  
 Specify the port specification of the body for manifold with the manifold model number.

#### 5 Rated Voltage

5	24 VDC
6	12 VDC

#### 6 Supply Valve/Release Valve Electrical Entry Note 4)

L	L-type plug connector With lead wire	
LO	L-type plug connector Without connector	
M	M-type plug connector With lead wire <small>Note 5)</small>	
MO	M-type plug connector Without connector <small>Note 5)</small>	

Note 4) All with light and surge suppressor.  
 Lead wire length is 300 mm for the models with lead wire. For other lead wire length, select a model without connector and include the connector assembly part number in **Table 2** on page 192.

Note 5) M- and MO-type connectors cannot be selected for models with pressure sensor or pressure switch for vacuum.

#### 4 Combination of Supply Valve and Release Valve Note 3)

Symbol	Supply valve	Release valve	Applicable body type			
			Ejector		Pump system	
			PV = PD	PV ≠ PD	PV = PD	PV ≠ PD
K1	Normally closed	Normally closed	●	●	—	●
J1	Normally closed	None	●*	—	●*	—
Q1	Latching (Positive common)	Normally closed	●	●	—	—
Q2	Latching (Positive common)	None	●*	—	—	—

\* Vacuum break by port open to atmosphere

Note 3) Refer to **Table 1** on page 192 for the part number of supply valve and release valve of each specification. Latching type is applicable only to the ejector nozzle sizes ø0.3 and ø0.4

#### 7 Manual Override Note 6)

Nil	Non-locking push type	
B	Locking type (Tool required) Semi-standard	

Note 6) Latching type (supply valve) has the push-locking type only, but either the push type or the locking type can be selected for the release valve.

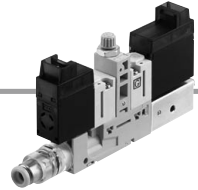

- ZK2
- ZQ
- ZR
- ZB**
- ZA
- ZX
- ZM
- ZL
- ZH
- ZH-X267
- ZHP
- ZU
- VQD-V

## 8 Pressure Sensor/Vacuum Pressure Switch Specifications

Symbol	Type	Pressure range [kPa]	Specifications
Nii	Without pressure sensor/vacuum pressure switch		
P1	Pressure sensor	0 to -101	Output: 1 to 5 V, accuracy: $\pm 2\%$ F.S. or less <sup>Note 7)</sup>
P3		-100 to 100	Output: 1 to 5 V, accuracy: $\pm 2\%$ F.S. or less <sup>Note 7)</sup>
EA	Vacuum pressure switch	0 to -101	NPN 2 outputs With unit switching function <sup>Note 8)</sup>
EAM			SI unit only <sup>Note 9)</sup>
EAP			With unit switching function [Initial value psj] <sup>Note 8)</sup>
EB			PNP 2 outputs With unit switching function <sup>Note 8)</sup>
EBM		SI unit only <sup>Note 9)</sup>	
EBP		With unit switching function [Initial value psj] <sup>Note 8)</sup>	
FA		-100 to 100	NPN 2 outputs With unit switching function <sup>Note 8)</sup>
FAM			SI unit only <sup>Note 9)</sup>
FAP			With unit switching function [Initial value psj] <sup>Note 8)</sup>
FB			PNP 2 outputs With unit switching function <sup>Note 8)</sup>
FBM	SI unit only <sup>Note 9)</sup>		
FBP	With unit switching function [Initial value psj] <sup>Note 8)</sup>		

P□: Pressure sensor

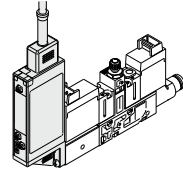
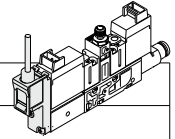

E□/F□: Vacuum pressure switch

Note 7) Only the lead wire length 3 m is available for the pressure sensor.

Note 8) The unit switching function is not available in Japan due to a new measurement law.

Note 9) Fixed unit: kPa

## 9 Lead Wire with Connector for Vacuum Pressure Switch

Nii	Without lead wire with connector (No need to specify for pressure sensor type.)
G	Lead wire with connector and connector cover, Lead wire length 2 m

## 10 Vacuum (V) Port <sup>Note 11)</sup>

C2	Straight $\phi 2$ one-touch fitting	Metric size	<p>Note 10) With suction filter</p>
C4	Straight $\phi 4$ one-touch fitting	Inch size	
N1	Straight $\phi 1/8"$ one-touch fitting	Inch size	<p>Note 10) With suction filter</p>
N3	Straight $\phi 5/32"$ one-touch fitting	Metric size	
L2	Elbow $\phi 2$ one-touch fitting	Metric size	<p>Note 10) With suction filter</p>
L4	Elbow $\phi 4$ one-touch fitting	Inch size	
LN1	Elbow $\phi 1/8"$ one-touch fitting	Inch size	<p>Note 10) With suction filter</p>
LN3	Elbow $\phi 5/32"$ one-touch fitting	Metric size	

Note 10) The filter included in this product is of a simple type, and will become clogged quickly in environments with high quantities of dust or particulates. Please make additional use of an air suction filter of the ZFA, ZFB or ZFC series.

Note 11) Be sure to hold the filter case when connecting and disconnecting the tube for the elbow type.

### ⚠ Warning

The filter case of this suction filter is made of nylon. Contact with alcohol or similar chemicals may cause it to be damaged. Also, do not use the filter when these chemicals are present in the atmosphere.

## 11 Option <sup>Note 12)</sup>

	Without option	
Nii		
B	With bracket for single unit (Enclosed with the product for shipment without being assembled)	<p>Bracket</p>
K	Screwdriver handling type vacuum break flow rate adjustment needle <sup>Note 13)</sup>	

Note 12) When multiple options are selected, state them in alphabetical order.

Note 13) Handle operated type is standard.

## How to Order Manifold

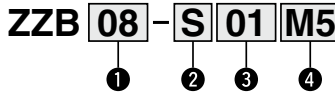

### 1 Stations

<b>01</b>	1 station
<b>02</b>	2 stations
⋮	⋮
<b>12</b>	12 stations

### 3 Common Supply (PV) Port Size

<b>01</b>	Rc1/8
<b>01N</b>	NPT1/8
<b>01F</b>	G1/8 (Note)
<b>M5</b>	M5 x 0.8

Note) G thread

Regarding thread ridge shape, it conforms to G thread standard (JIS B 0202), but it doesn't conform to ISO16030 and ISO1179 for the other shape.

### 2 Pressure Sensor/Vacuum Pressure Switch Mountable (Note)

<b>Nil</b>	Sensor/switch non-mountable base
<b>S</b>	Sensor/switch mountable base

Note) Select "S" when the model with either the pressure sensor or the vacuum pressure switch is selected in 3 for the single unit. (Refer to "Manifold" on page 200.)

### 4 Common Release Pressure (PD) Port Size (Note)

<b>Nil</b>	Without PD port (PV = PD)
<b>M5</b>	M5 x 0.8 (PV π PD)

Note) Refer to 4 on page 184 for the combinations of supply valve and release valve selectable.

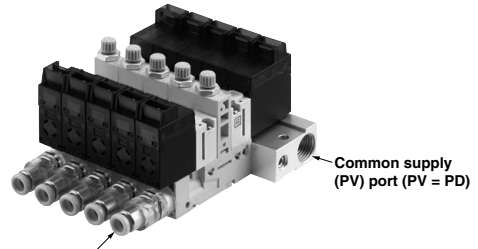

\* Prepare a part to plug the unused port if the unit is used with an air supply on one side. Example) For M5 x 0.8: M-5P

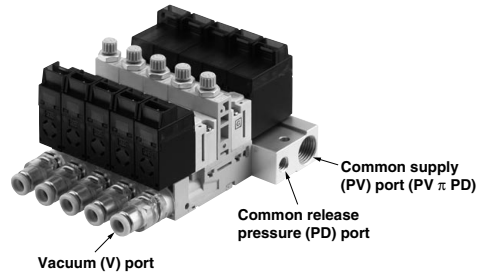

## How to Order the Product

### Single unit

Select the body type 1 or 2 referring to 2 Body type on page 1. (Example shows body type 1.)

Example) ZB041-K15L-P1-C4

### Manifold

Refer to "How to Order Manifold" and select the body type 3 referring to 2 Body type on page 1. Pre-fix "\*" to the part number for the single unit(s) to be mounted as a manifold. (Without "\*", they will be shipped as a spare part and will not be mounted as a manifold.)

\* The blanking plate assembly (Model: ZB1-BP2-A) can be mounted at portions where the single unit is not mounted. When ordering the product to be assembled into the base, specify an asterisk (\*) indicating the assembly. (If an asterisk (\*) is not specified, the product is not assembled into the base and is shipped separately.)

Example) ZZB08-01 .....1  
 \* ZB0531-K15L-C4 .....4 (Stations 1 to 4)  
 \* ZB0531-K15L-L4 .....3 (Stations 5 to 7)  
 \* ZB1-BP2-A .....1 (Stations 8)

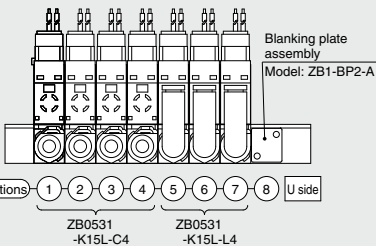

### Manifold Maximum Simultaneous Operating Stations

Supply (PV) port Fitting size	Ejector model Supply valve type	ZB03		ZB04		ZB05	ZB06
		Large flow (N.C.)	Latching	Large flow (N.C.)	Latching	Large flow (N.C.)	Large flow (N.C.)
Rc1/8 NPT1/8 G1/8	Supply from one side	12				10	12
	Supply from both sides					12	
M5 x 0.8	Supply from one side	10				8	10
	Supply from both sides	12				10	12

Note) These values are obtained under the standard supply pressure.

## Specifications

### General Specifications

<b>Operating temperature range</b>	-5 to 50°C (No condensation)
<b>Fluid</b>	Air
<b>Vibration resistance</b> <small>Note 1)</small>	30 m/s <sup>2</sup> (Without sensor/switch) 20 m/s <sup>2</sup> (With sensor/switch)
<b>Impact resistance</b> <small>Note 2)</small>	150 m/s <sup>2</sup> (Without sensor/switch) 100 m/s <sup>2</sup> (With sensor/switch)

Note 1) 10 to 500 Hz for 2 hours in each direction of X, Y and Z (During de-energizing)  
 Note 2) 3 times in each direction of X, Y and Z (During de-energizing)

### Supply Valve/Release Valve Common Specifications

<b>Valve construction</b>	3-port direct operated poppet valve
<b>Lubrication</b>	Not required
<b>Manual override</b> <small>Note)</small>	Non-locking push type, Locking type (Tool required)
<b>Enclosure</b>	Dustproof
<b>Rated coil voltage</b> <b>DC</b>	24 V, 12 V
<b>Allowable voltage range</b>	Rated voltage ±10%

Note) Push-locking type only for the latching type

### Supply Valve/Release Valve Specifications

Type	Supply valve			Release valve
	Large flow type (N.C.)		Latching type	Standard
Supply valve/release valve model	<b>ZB1-VQ110U</b> -□	<b>ZB1-VQ120U</b> -□	<b>ZB1-VQ110L</b> -□	<b>ZB1-VQ110</b> -□
Applicable system	Ejector (N.C.)	Pump system (N.C.)	Ejector <small>Note 1)</small>	Ejector (N.C.) Pump system (N.C.)
Maximum operating pressure	0.55 MPa	0.1 MPa	0.55 MPa	0.55 MPa
Minimum operating pressure	0.1 MPa	-0.1 MPa	0.1 MPa	0 MPa
Response time	5 ms or less	5 ms or less	5 ms or less	ON: 3.5 ms OFF: 2 ms
Rated coil voltage	24 VDC	0.7 W (29 mA) <small>Note 2)</small>	0.7 W (29 mA) <small>Note 2)</small>	1 W (42 mA)
Power consumption (Current)	12 VDC	0.7 W (58 mA) <small>Note 2)</small>	0.7 W (58 mA) <small>Note 2)</small>	1 W (83 mA)
Electrical entry	L-type plug connector (With light/surge voltage suppressor) M-type plug connector (With light/surge voltage suppressor) <small>Note 3)</small>			

Note 1) Latching type is applicable only to the ejector nozzle sizes ø0.3 and ø0.4

Note 2) Inrush: 3.1 W (10 ms after energized); Holding: 0.7 W

Note 3) M-type can also be selected when the ejector or the pump system is selected without pressure sensor/vacuum pressure switch.

### Ejector Specifications Note 1)

Model	ZB03		ZB04		ZB05	ZB06
Supply valve type	Large flow (N.C.)	Latching	Large flow (N.C.)	Latching	Large flow (N.C.)	Large flow (N.C.)
Nozzle size (mm)	0.3		0.4		0.5	0.6
Supply pressure range <small>Note 2)</small> (MPa)			0.2 to 0.55		0.3 to 0.55	
Standard supply pressure (MPa)	0.35	0.4	0.35	0.45	0.35	0.5
Air consumption (L/min (ANR))	3.5	4	6.5	8.5	10	18
Maximum suction flow (L/min (ANR))	2		3.5		4.5	7
Maximum vacuum pressure (kPa)	-86		-90			

Note 1) These values are representative values, and may vary depending on the atmospheric pressure (weather, height above sea level, etc.).

Note 2) The maximum operating pressure is 0.5 MPa when using the product either with pressure sensor or vacuum pressure switch.

### Suction Filter Specifications

Nominal filtration rating	30 μm
Filtration area	130 mm <sup>2</sup>

Refer to Vacuum Equipment Model Selection from pages 25 to 48 for the ejector model selection.

## Weight

### Single Unit

Single unit model	Weight (g)
ZB□1/2□-K1□ (Single unit, without sensor)	46
ZB□3□-K1□ (One station for manifold, without sensor)	40

### Pressure Sensor/Vacuum Pressure Switch

Pressure sensor/vacuum pressure switch model	Weight (g)
ZB1-PS□-A (Except pressure sensor, cable portion)	5
ZB1-ZS□□-A (Except vacuum pressure switch, lead wire assembly with connector)	14

### Manifold Base

	1 sta.	2 sta.	3 sta.	4 sta.	5 sta.	6 sta.	7 sta.	8 sta.	9 sta.	10 sta.	11 sta.	12 sta.
Weight (g)	16	22	28	34	41	47	53	60	66	72	79	85

### Calculation of weight for the manifold type

(Single unit weight x Number of stations) + (Pressure sensor/vacuum pressure switch weight x Number of stations) + Manifold base

Example) 5-station manifold with pressure sensors

$$40 \text{ g} \times 5 \text{ pcs.} + 5 \text{ g} \times 5 \text{ pcs.} + 41 \text{ g} = \boxed{266 \text{ g}}$$

## Ejector Exhaust Characteristics/Flow Rate Characteristics

### Nozzle Size $\phi 0.3$ Supply Valve, Large Flow Type (N.C.)/ZB03□□-K<sub>1</sub>

#### Exhaust Characteristics

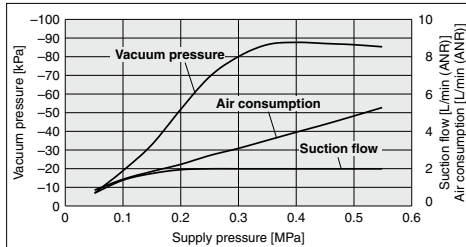

#### Flow Rate Characteristics

(Supply pressure: 0.35 MPa)

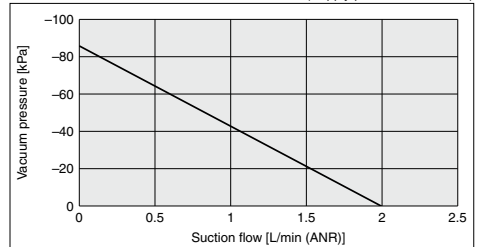

### Nozzle Size $\phi 0.4$ Supply Valve, Large Flow Type (N.C.)/ZB04□□-K<sub>1</sub>

#### Exhaust Characteristics

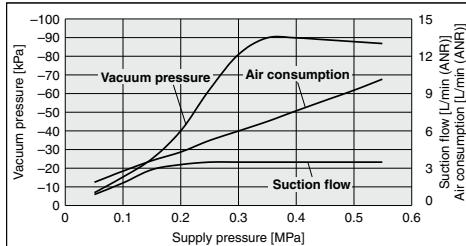

#### Flow Rate Characteristics

(Supply pressure: 0.35 MPa)

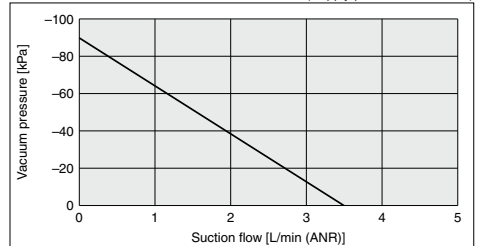

### Nozzle Size $\phi 0.5$ Supply Valve, Large Flow Type (N.C.)/ZB05□□-K<sub>1</sub>

#### Exhaust Characteristics

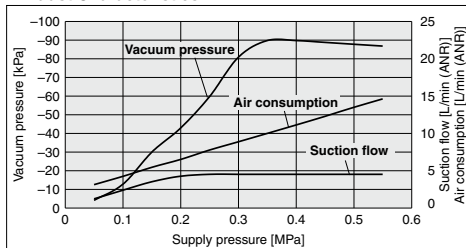

#### Flow Rate Characteristics

(Supply pressure: 0.35 MPa)

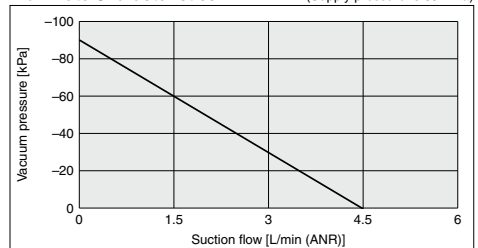

### Nozzle Size $\phi 0.6$ Supply Valve, Large Flow Type (N.C.)/ZB06□□-K<sub>1</sub>

#### Exhaust Characteristics

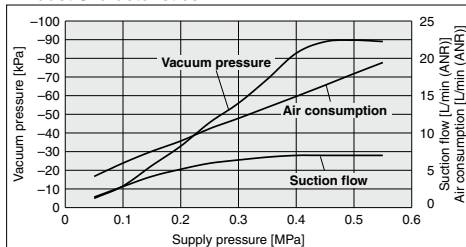

#### Flow Rate Characteristics

(Supply pressure: 0.5 MPa)

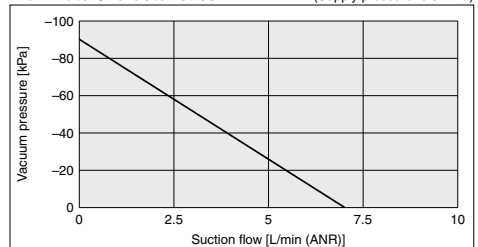



**Nozzle Size  $\phi 0.3$  Supply Valve, Latching Type/ZB03□□-Q $\frac{1}{2}$**

**Exhaust Characteristics**

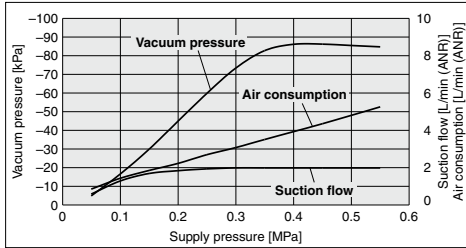

**Flow Rate Characteristics**

(Supply pressure: 0.4 MPa)

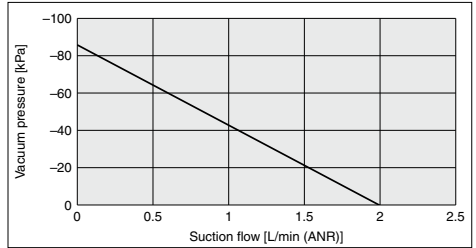

**Nozzle Size  $\phi 0.4$  Supply Valve, Latching Type/ZB04□□-Q $\frac{1}{2}$**

**Exhaust Characteristics**

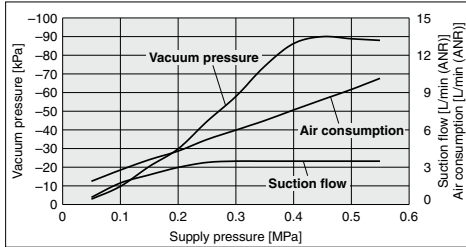

**Flow Rate Characteristics**

(Supply pressure: 0.45 MPa)

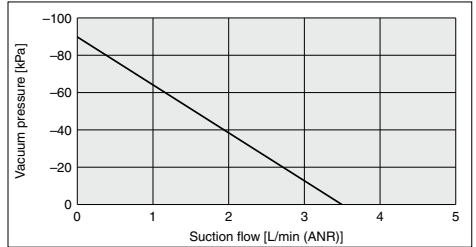

**Vacuum Pump System Flow Rate Characteristics/ZB00**

The graph shows the suction flow rate characteristics of the vacuum pump system at different vacuum pressures.

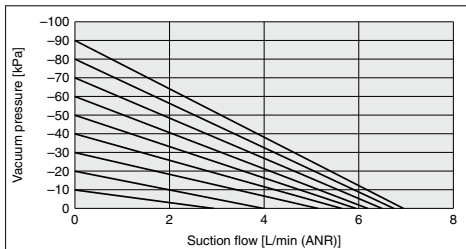

The actual suction flow at the point of suction varies depending on the vacuum pump's piping conditions. (For above graph, vacuum (V) port is  $\phi 4 \times 50$  mm.)

Flow rate characteristics: Cv : 0.025

**Release Flow Rate Characteristics (Ejector/Pump System)**

The graph shows the flow rate characteristics with various supply pressures when the vacuum break flow adjustment needle is opened from the fully close state.

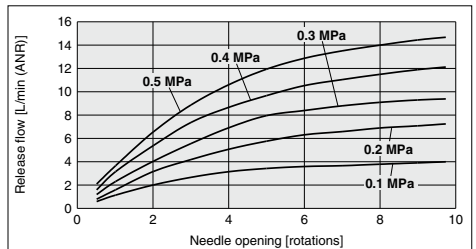

Note) The flow rate characteristics shown in this graph are representative values, and the flow at the absorption part may vary depending on the piping conditions to the vacuum (V) port, etc.

Flow rate characteristics: Cv : 0.011 (Needle full open)

**How to Read Flow Rate Characteristics Graph**

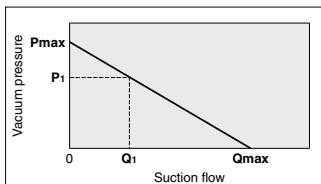

Flow rate characteristics are expressed in ejector vacuum pressure and suction flow. If suction flow changes, the vacuum pressure will also be changed. Normally this relationship is expressed in ejector standard operating pressure use. In graph, **Pmax** is max. vacuum pressure and **Qmax** is maximum suction flow. The values are specified according to catalog use. Changes in vacuum pressure are expressed in the below order.

1. When ejector suction port is covered and made airtight, suction flow becomes zero and vacuum pressure is at maximum value (**Pmax**).
2. When suction port is opened gradually, air can flow through, (air leakage), suction flow increases, but vacuum pressure decreases. (condition **P1** and **Q1**)
3. When suction port is opened further and fully opened, suction flow moves to maximum value (**Qmax**), but vacuum pressure is near zero (atmospheric pressure).

As described above, the vacuum pressure changes when the suction flow changes. In other words, when there is no leakage from the vacuum (V) port, the vacuum pressure can reach its maximum, but as the amount of leakage increases, the vacuum pressure decreases. When the amount of leakage and the max. suction flow become equal, the vacuum pressure becomes almost zero.

In the case when ventirative or leaky work should be adsorbed, please note that vacuum pressure will not rise.

ZK2  
ZQ  
ZR  
**ZB**  
ZA  
ZX  
ZM  
ZL  
ZH  
ZH  
ZH  
ZH  
-X267  
ZHP  
ZU  
VQD-V

# ZB Series

## Pressure Sensor/Vacuum Pressure Switch Specifications

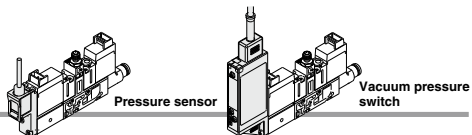

### Pressure Sensor/ZB1-PS□-A (Refer to the PSE series in Best Pneumatics No. 8 and Operation Manual for details.)

Model (Refer to the standard model number for the sensor unit on page 192.)	ZB1-PS1-A (PSE541)	ZB1-PS3-A (PSE543)
Rated pressure range	0 to -101 kPa	-100 to 100 kPa
Proof pressure	500 kPa	500 kPa
Output voltage	1 to 5 VDC	1 to 5 VDC
Output impedance	Approx. 1 kΩ	Approx. 1 kΩ
Power supply voltage	10 to 24 VDC±10%, Ripple (p-p) 10% or less	10 to 24 VDC±10%, Ripple (p-p) 10% or less
Current consumption	15 mA or less	15 mA or less
Accuracy	±2% F.S. (Ambient temperature: 25°C)	
Linearity	±0.4% F.S. or less	
Repeat accuracy	±0.2% F.S. or less	
Effect of power supply voltage	±0.8% F.S. or less	
Temperature characteristics	±2% F.S. or less (Ambient temperature: based on 25°C)	
Material	Case	Resin
	Pressure sensing section	Sensor pressure receiving area: Silicon, O-ring: HNBR Oil-resistant vinyl cabtire cable
Lead wire	2.7 x 3.2 mm (elliptic), Cross section: 0.15 mm <sup>2</sup> , 3 cores, 3 m, Insulator O.D.: 0.9 mm	

### Vacuum Pressure Switch/ZB1-ZS□□□□-A (Refer to the ZSE/ISE10 series in Best Pneumatics No. 8 and Operation Manual for details.)

Model (Refer to the standard model number for the switch unit on page 192.)	ZB1-ZSE□□□□-A (ZSE10)	ZB1-ZSF□□□□-A (ZSE10F)
Rated pressure range	0 to -101 kPa	-100 to 100 kPa
Set pressure range/Pressure display range	10 to -105 kPa	-105 to 105 kPa
Proof pressure	500 kPa	500 kPa
Minimum unit setting	0.1 kPa	0.1 kPa
Power supply voltage	12 to 24 VDC±10%, Ripple (p-p) 10% or less (with power supply polarity protection)	
Current consumption	40 mA or less	
Switch output	NPN or PNP open collector 2 outputs (Select)	
	Maximum load current	80 mA
	Maximum applied voltage	28 V (with NPN output)
	Residual voltage	2 V or less (with load current of 80 mA)
	Response time	2.5 ms or less (Response time selections with anti-chattering function: 20, 100, 500, 1000, 2000 ms)
	Short circuit protection	Yes
Repeat accuracy	±0.2% F.S. ±1 digit	
Hysteresis	Hysteresis mode	Variable (0 or above) <sup>Note 1)</sup>
	Window comparator mode	
Display	3 1/2 digit, 7-segment LED, 1-color display (Red)	
Display accuracy	±2% F.S. ±1 digit (Ambient temperature of 25 ±3°C)	
Indicator light	Lights up when output is turned ON. OUT1: Green, OUT2: Red	
Environmental resistance	Enclosure	IP40
	Operating humidity range	Operating/Stored: 35 to 85% RH (No condensation)
	Withstand voltage	1000 VAC for 1 minute between live parts and enclosure
Temperature characteristics	Insulation resistance	50 MΩ or more between live parts and enclosure (at 500 VDC mega)
	Lead wire	Oil-resistant vinyl cabtire cable Cross section: 0.15 mm <sup>2</sup> (AWG26), 5 cores, 2 m, Insulator O.D.: 1.0 mm

Note 1) If the applied voltage fluctuates around the set value, the hysteresis must be set to a value more than the fluctuating width, otherwise chattering will occur.  
Note 2) Refer to "General Specifications" on page 187 for the specifications not shown in the table.

## Description (Vacuum Pressure Switch)

Output (OUT1) display (Green)	Lights up when OUT1 is turned ON.
Output (OUT2) display (Red)	Lights up when OUT2 is turned ON.
LED display	Displays the current pressure, set mode and error code.
▲ button (UP)	Selects the mode or increases the ON/OFF set-value. Use for switching to the peak display mode.
▼ button (DOWN)	Selects the mode or decreases the ON/OFF set-value. Use for switching to the bottom display mode.
Ⓢ button (SET)	Use for changing the mode or setting the set-value.

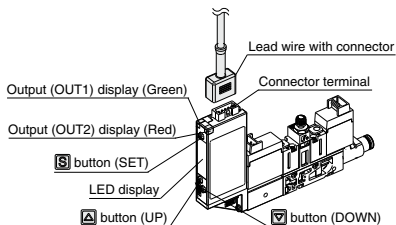

## Internal Circuit and Wiring Example

### ■ Pressure Sensor ZB1-PS□-A

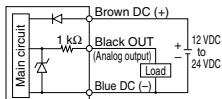

Voltage output type: 1 to 5 V  
Output impedance: Approx. 1 kΩ

### ■ Vacuum Pressure Switch ZB1-ZS□□□□-A NPN (2 outputs)

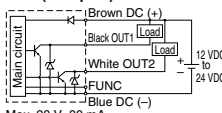

Max. 28 V, 80 mA  
Residual voltage: 2 V or less

### ZB1-ZS□□□□-A PNP (2 outputs)

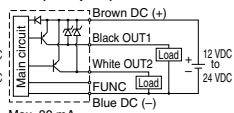

Max. 80 mA  
Residual voltage: 2 V or less

\* The FUNC terminal is connected when using the copy function. (Refer to the Operation Manual.)

## Construction

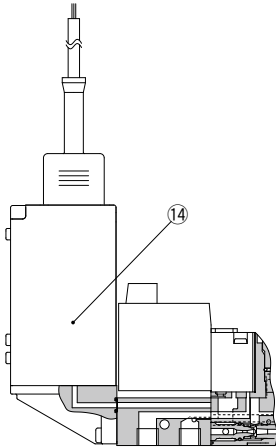

Single Unit/Vacuum Pressure Switch

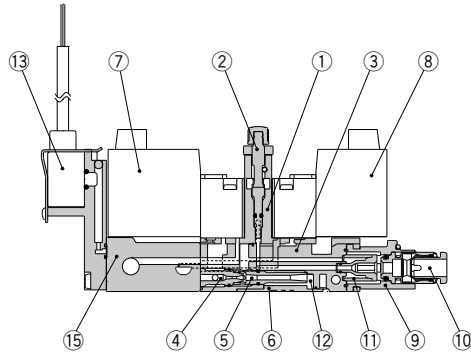

Manifold/Pressure Sensor

### Component Parts

No.	Description	Material	Note
1	Valve body assembly	Resin/HNBR	White
2	Needle assembly	Resin/Brass/NBR	—
3	Body	Resin	White
4	Nozzle	Aluminum	Vacuum pump system: Spacer
5	Diffuser	Aluminum	Vacuum pump system: None
6	Silencer cover	Resin	White

### Replacement Parts

No.	Description	Model (Refer to page 192.)	Note
7	Supply valve	ZB1-VQ110U-□□□ ZB1-VQ110L-□□ ZB1-VQ120U-□□□	Refer to <b>Table 1</b> on page 192 for applicable part number.
8	Release valve	ZB1-VQ110-□□□	
9	V-port assembly	ZB1-VPN3-□-A	With fitting and filter element (page 192) (Case material: Special clear nylon)
10	One-touch fitting	KJ□□-C1	It is required when replacing the fitting only.
11	Filter element	ZB1-FE3-A	Nominal filtration rating: 30 μm, 10 pcs. in 1 set
12	Sound absorbing material	ZB1-SE1-A	10 pcs. in 1 set
13	Pressure sensor assembly	ZB1-PS□-A	
14	Vacuum pressure switch assembly	ZB1-ZS□□□□-A	
15	Manifold base assembly	ZZB□-□□□	Refer to "Manifold" in "How to Order the Product" on page 186 for change in the number of stations.

### How to Replace the Filter

When adsorption performance decreases or when there is delay in response time due to clogging of the filter, stop the operation and replace the filter with a new one.

- Hold the V-port assembly with your fingers, turn it 45 degrees in the counterclockwise direction and pull it out. For the straight type fitting, it can be removed with a hexagon wrench (width across flats: 2) by inserting it until it touches the end and turning it 45 degrees in the counterclockwise direction. (When using a wrench, do not turn it more than 45 degrees by force as this will damage the hexagon hole which is made of resin.)
- Remove the filter element from the removed filter case, and mount a new filter element into the case.
- Confirm that the gasket at the V-port assembly mounted part of the body is not displaced and that it has no foreign matter stuck to it.
- Insert the tab of the V-port assembly along the groove, and rotate it approx. 45 degrees in the clockwise direction while pressing it gently until it stops. (Mount the filter case in the direction specified in the figure. If it is mounted with the tab downwards, it will interfere with the floor when the unit is installed on the floor.)

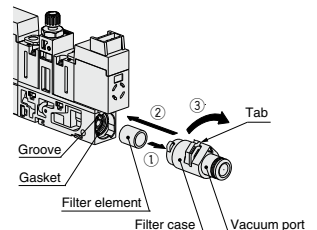

ZK2
ZQ
ZR
<b>ZB</b>
ZA
ZX
ZM
ZL
ZH
ZH
ZH-X267
ZHP
ZU
VQD-V

## How to Order Replacement Parts

### ⑦ Supply valve/⑧ Release valve

**Table 1** Combination of the supply valve and the release valve

\* The applicable supply valve specification varies depending on the nozzle size of the ejector.  
\* The symbols in the table correspond to the supply valves/release valves stated on the right.

Symbol	Supply valve/release valve specifications		Ejector								Pump system	
			ZB03		ZB04		ZB05		ZB06		ZB00	
			Supply valve	Release valve	Supply valve	Release valve	Supply valve	Release valve	Supply valve	Release valve	Supply valve	Release valve
<b>K1</b>	N.C.	N.C.	(1)	(4)	(1)	(4)	(1)	(4)	(1)	(4)	(3)	(4)
<b>J1</b>	N.C.	None	(1)		(1)		(1)		(1)		(3)	
<b>Q1</b>	Latch	N.C.	(2)	(4)	(2)	(4)						
<b>Q2</b>	Latch	None	(2)		(2)							

**Table 2** Connector assembly

**AXT661** - -

**Applicable valve**

<b>14A</b>	(1), (3), (4) (N.C.)
<b>13A</b>	(2) (Latching)

**Lead wire length (mm)**

<b>Nil</b>	300
<b>6</b>	600
<b>10</b>	1000
<b>20</b>	2000
<b>30</b>	3000

**Table 3** Supply valve/release valve accessories

Supply valve/release valve model	Accessories
<b>ZB1-VQ110U-□□</b>	Mounting screw (M1.7 x 15) 2 pcs.
<b>ZB1-VQ110U-□□B</b>	Mounting screw (M1.7 x 22) 2 pcs.
<b>ZB1-VQ110L-□□</b>	Mounting screw (M1.7 x 22) 2 pcs.
<b>ZB1-VQ120U-□□</b>	Mounting screw (M1.7 x 15) 2 pcs.
<b>ZB1-VQ120U-□□B</b>	Mounting screw (M1.7 x 22) 2 pcs.
<b>ZB1-VQ110-□□</b>	Mounting screw (M1.7 x 15) 2 pcs.
<b>ZB1-VQ110-□□B</b>	Mounting screw (M1.7 x 22) 2 pcs.

### ⑨ V-port assembly

**ZB1 - VPN3 - - A**

#### One-touch fitting

<b>C2</b>	Straight ø2 one-touch fitting	Metric size
<b>C4</b>	Straight ø4 one-touch fitting	Metric size
<b>N1</b>	Straight ø1/8" one-touch fitting	Inch size
<b>N3</b>	Straight ø5/32" one-touch fitting	Inch size
<b>L2</b>	Elbow ø2 one-touch fitting	Metric size
<b>L4</b>	Elbow ø4 one-touch fitting	Metric size
<b>LN1</b>	Elbow ø1/8" one-touch fitting	Inch size
<b>LN3</b>	Elbow ø5/32" one-touch fitting	Inch size

### ⑩ One-touch fitting (Purchasing order is available in units of 10 pieces.)

**KJ - C1**

**Body type**

<b>H</b>	Straight
<b>L</b>	Elbow

**Port size**

<b>02</b>	ø2 one-touch fitting	Metric size
<b>04</b>	ø4 one-touch fitting	Metric size
<b>01</b>	ø1/8" one-touch fitting	Inch size
<b>03</b>	ø5/32" one-touch fitting	Inch size

\* Body type: Only for the combination of the elbow type body and the ø4 one-touch fitting, add the suffix "-N" to the part number.

**KJL04-C1-N**

### ⑪ Filter element (10 pcs. in 1 set)

**ZB1 - FE3 - A**

\* Nominal filtration rating using suction filter: 30 µm

### ⑫ Sound absorbing material (10 pcs. in 1 set)

**ZB1 - SE1 - A**

192

### ■ Supply valve/release valve model

(1) **ZB1-VQ110U** - -

(2) **ZB1-VQ110L** - -

(3) **ZB1-VQ120U** - -

(4) **ZB1-VQ110** - -

#### Rated voltage

<b>5</b>	24 VDC
<b>6</b>	12 VDC

#### Connector entry direction <sup>Note 1)</sup>

<b>L</b>	L-type plug connector, with lead wire
<b>LO</b>	L-type plug connector, without connector
<b>M</b>	M-type plug connector, with lead wire <sup>Note 2)</sup>
<b>MO</b>	M-type plug connector, without connector <sup>Note 2)</sup>

Note 1) All with light and surge voltage suppressor.

Lead wire length is 300 mm for the models with lead wire.

For other lead wire length, select a model without connector and include the connector assembly part number.

Note 2) M-type plug connector is not available with the model with pressure sensor.

#### Manual override <sup>Note 3)</sup>

<b>Nil</b>	Non-locking push type
<b>B</b>	Locking type (Tool required), Semi-standard

Note 3) Only the push-locking type (no symbol) is available for the latching type.

Note 4) Refer to **Table 3** for the accessories.

### ⑬ Pressure sensor assembly

**ZB1 - PS - A**

#### Pressure sensor specifications

<b>1</b>	0 to -101 kPa, output: 1 to 5 V, accuracy: ±2% F.S. or less
<b>3</b>	-100 to 100 kPa, output: 1 to 5 V, accuracy: ±2% F.S. or less

\* Lead wire length: 3 m

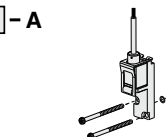

Mounting screw (M2 x 30) 2 pcs., O-ring 1 pc. are included.

### ⑭ Vacuum pressure switch assembly

**ZB1 - ZS - A**

#### Rated pressure range

<b>E</b>	0.0 to -101.0 kPa
<b>F</b>	-100.0 to 100 kPa

#### Lead wire with connector

<b>Nil</b>	Without lead wire with connector
<b>G</b>	With lead wire with connector (Lead wire length: 2 m)

#### Output specifications

<b>A</b>	NPN open collector 2 outputs
<b>B</b>	PNP open collector 2 outputs

#### Unit specifications

<b>Nil</b>	With unit switching function <sup>Note 1)</sup>
<b>M</b>	SI unit only <sup>Note 2)</sup>
<b>P</b>	With unit switching function (Initial value psi) <sup>Note 1)</sup>

Note 1) The unit switching function is not available in Japan due to a new measurement law.

Note 2) Fixed unit: kPa

\* If only the lead wire with connector is required, order using the following part number.

Part number of the lead wire with connector: **ZS-39-5G**

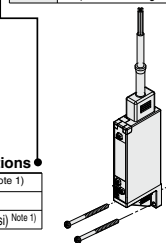

Mounting screw (M2 x 30) 2 pcs., O-ring 1 pc. are included.

**Dimensions: Single Unit**

ZB $\square$  $\frac{10}{20}$ - $\frac{K1}{Q1}$  $\square$ L(O) $\square$ M(O) $\square$ - $\square$

**Ejector/Vacuum pump system**  
**Silencer exhaust, With supply valve/release valve,**  
**Without sensor/switch**

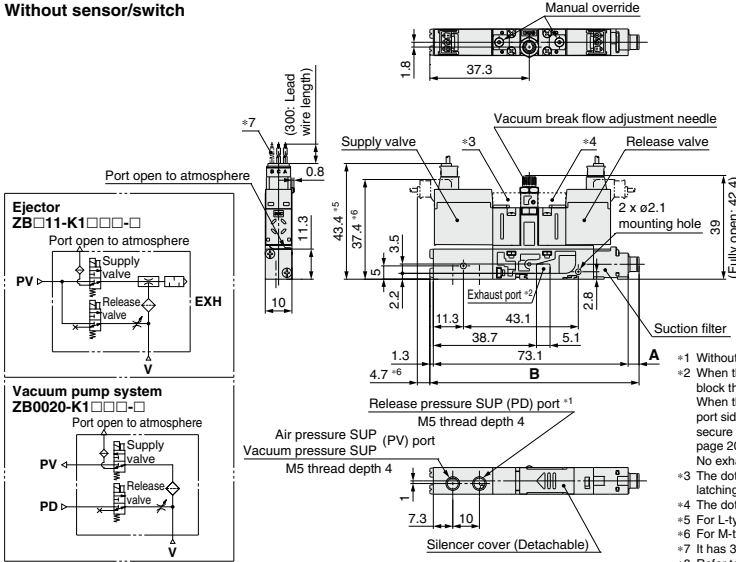

(mm)		
Port type	A	B
C2	4.1	78.5
C4	7.5	81.9
N1	7.4	81.8
N3	7.5	81.9
L2	8.4	82.8
L4	8.3	82.7
LN1	8.3	82.7
LN3	8.3	82.7

- \*1 Without port for PV=PD specification
- \*2 When this product is used as an ejector, do not block the exhaust port when mounting. When the product is mounted so that the exhaust port side will be against a wall, use a spacer to secure a clearance of at least 1 mm. (Refer to page 200 for details.)
- No exhaust port for pump system
- \*3 The dotted line shows the configuration of the latching type and the manual lock type.
- \*4 The dotted line shows the manual lock type.
- \*5 For L-type plug connector
- \*6 For M-type plug connector
- \*7 It has 3 lead wires for the latching type.
- \*8 Refer to page 197 for the dimensions for the various vacuum (V) ports.

ZB $\square$  $\frac{10}{11}$ - $\frac{J1}{Q2}$  $\square$ L(O) $\square$ M(O) $\square$ - $\square$

**Ejector/Vacuum pump system**  
**Silencer exhaust, With supply valve only,**  
**Without sensor/switch**

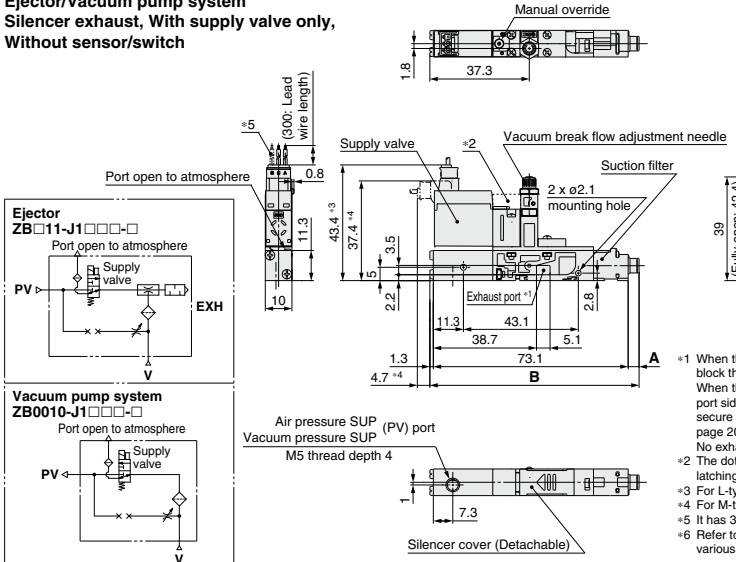

(mm)		
Port type	A	B
C2	4.1	78.5
C4	7.5	81.9
N1	7.4	81.8
N3	7.5	81.9
L2	8.4	82.8
L4	8.3	82.7
LN1	8.3	82.7
LN3	8.3	82.7

- \*1 When this product is used as an ejector, do not block the exhaust port when mounting. When the product is mounted so that the exhaust port side will be against a wall, use a spacer to secure a clearance of at least 1 mm. (Refer to page 200 for details.)
- No exhaust port for pump system
- \*2 The dotted line shows the configuration of the latching type and the manual lock type.
- \*3 For L-type plug connector
- \*4 For M-type plug connector
- \*5 It has 3 lead wires for the latching type.
- \*6 Refer to page 197 for the dimensions for the various vacuum (V) ports.

ZK2  
 ZQ  
 ZR  
 ZB  
 ZA  
 ZX  
 ZM  
 ZL  
 ZH  
 ZH  
 ZH  
 X267  
 ZHP  
 ZU  
 VQD-V

# ZB Series

## Dimensions: Single Unit

ZB□<sup>10</sup>/<sub>20</sub>□<sup>K1</sup>□L(O)□-P<sub>3</sub>-□

Ejector/Vacuum pump system  
Silencer exhaust,  
With supply valve/release valve,  
With pressure sensor

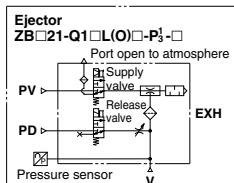

Vacuum pump system  
ZB0020-K1□L(O)□-P<sub>3</sub>-□

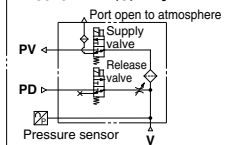

ZB□<sup>10</sup>/<sub>20</sub>□<sup>K1</sup>□L(O)□-F□□□□

Ejector/Vacuum pump system  
Silencer exhaust,  
With supply valve/release valve,  
With vacuum pressure switch

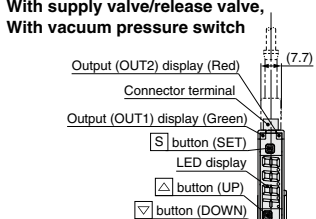

Ejector  
ZB□21-Q1□L(O)□-F□□□□

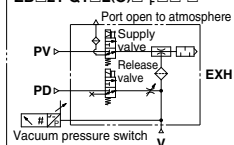

Vacuum pump system  
ZB0020-K1□L(O)□-F□□□□

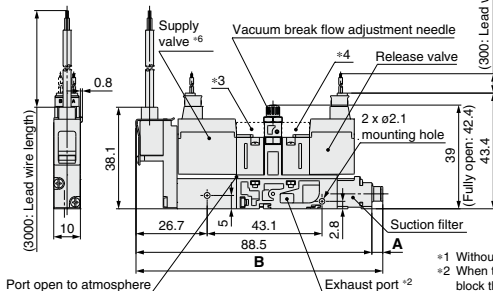
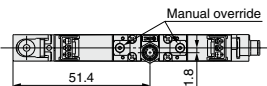
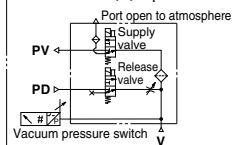

(mm)		
Port type	A	B
C2	4.1	92.6
C4	7.5	96
N1	7.4	95.9
N3	7.5	96
L2	8.4	96.9
L4	8.3	96.8
LN1	8.3	96.8
LN3	8.3	96.8

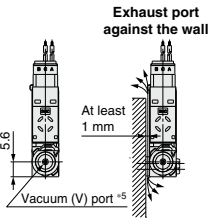

- \*1 Without port for PV=PD specification
- \*2 When this product is used as an ejector, do not block the exhaust port when mounting. When the product is mounted so that the exhaust port side will be against a wall, use a spacer to secure a clearance of at least 1 mm. (Refer to page 200 for details.)
- \*3 The dotted line shows the configuration of the latching type and the manual lock type.
- \*4 The dotted line shows the manual lock type.
- \*5 Refer to page 197 for the dimensions for the various vacuum (V) ports.
- \*6 For the unit with pressure sensor, M-type plug connector cannot be selected.

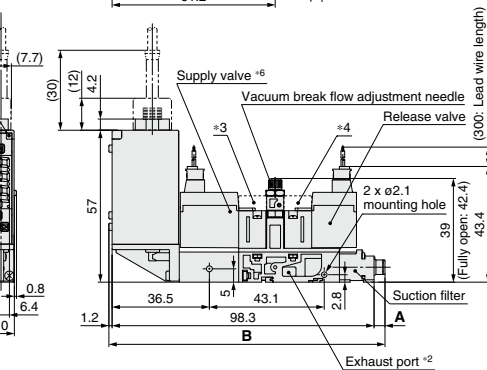
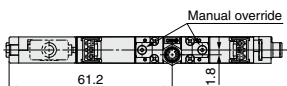
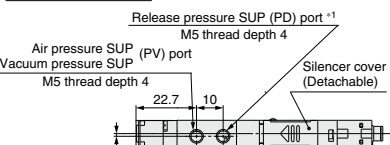

(mm)		
Port type	A	B
C2	4.1	103.6
C4	7.5	107
N1	7.4	106.9
N3	7.5	107
L2	8.4	107.9
L4	8.3	107.8
LN1	8.3	107.8
LN3	8.3	107.8

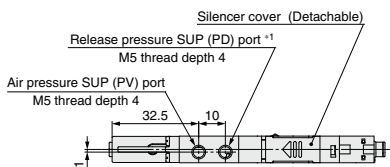
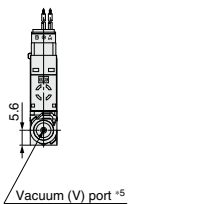

- \*1 Without port for PV=PD specification
- \*2 When this product is used as an ejector, do not block the exhaust port when mounting. When the product is mounted so that the exhaust port side will be against a wall, use a spacer to secure a clearance of at least 1 mm. (Refer to page 200 for details.)
- \*3 The dotted line shows the configuration of the latching type and the manual lock type.
- \*4 The dotted line shows the manual lock type.
- \*5 Refer to page 197 for the dimensions for the various vacuum (V) ports.
- \*6 For the unit with vacuum pressure switch, M-type plug connector cannot be selected.

**Dimensions: Manifold**

ZB□-01□  
M5

\*ZB□31-K1□L(O)□-□

**Ejector**

**Silencer exhaust,  
With supply valve/release valve,  
Without sensor/switch,  
PV, PD common port (PV = PD)**

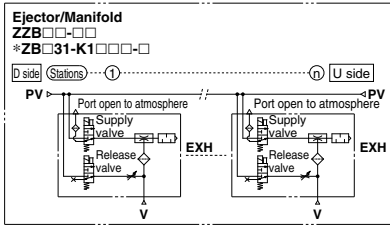
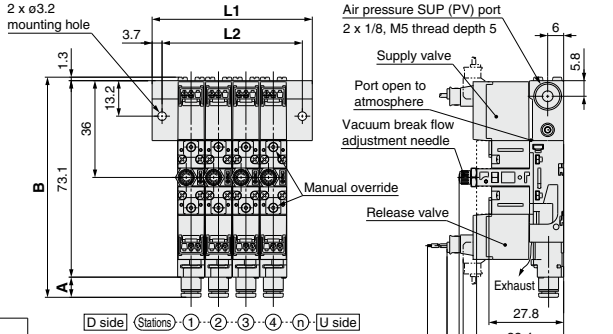

L	n	(mm)											
		1	2	3	4	5	6	7	8	9	10	11	12
L1	29	39.2	49.4	59.6	69.8	80	90.2	100.4	110.6	120.8	131	141.2	
L2	21.6	31.8	42	52.2	62.4	72.6	82.8	93	103.2	113.4	123.6	133.8	

D side (Stations) ① ② ③ ④ (n) U side

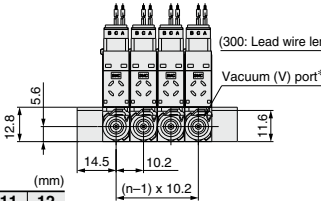

\* Refer to page 197 for the dimensions for the various vacuum (V) ports.

Port type	(mm)	
	A	B
C2	4.1	78.5
C4	7.5	81.9
N1	7.4	81.8
N3	7.5	81.9
L2	8.4	82.8
L4	8.3	82.7
LN1	8.3	82.7
LN3	8.3	82.7

ZB□-S01□ M5

\*ZB□31-K1□L(O)□-P3-□

**Ejector/Vacuum pump system**

**Silencer exhaust, With supply valve/release valve,  
With pressure sensor, PV, PD individual port (PV ≠ PD)**

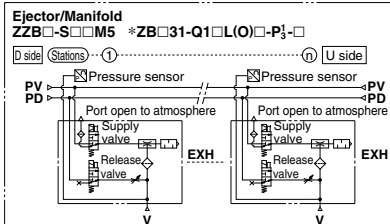
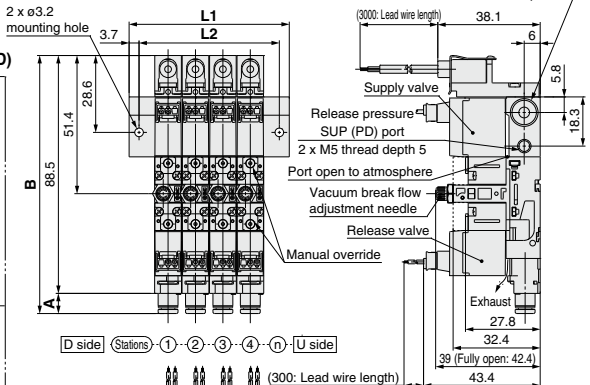

**Vacuum pump system/Manifold**

ZB□-S□M5 \*ZB0030-K1□L(O)□-P3-□

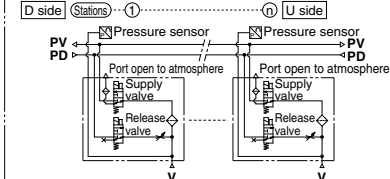

L	n	(mm)											
		1	2	3	4	5	6	7	8	9	10	11	12
L1	29	39.2	49.4	59.6	69.8	80	90.2	100.4	110.6	120.8	131	141.2	
L2	21.6	31.8	42	52.2	62.4	72.6	82.8	93	103.2	113.4	123.6	133.8	

D side (Stations) ① ② ③ ④ (n) U side

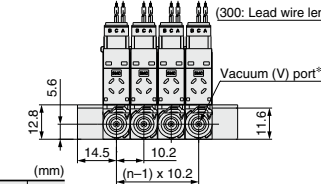

\* Refer to page 197 for the dimensions for the various vacuum (V) ports.

Port type	(mm)	
	A	B
C2	4.1	92.6
C4	7.5	96
N1	7.4	95.9
N3	7.5	96
L2	8.4	96.9
L4	8.3	96.8
LN1	8.3	96.8
LN3	8.3	96.8

- ZK2
- ZQ
- ZR
- ZB**
- ZA
- ZX
- ZM
- ZL
- ZH
- ZH
- ZH-X267
- ZHP
- ZU
- VQD-V

## Dimensions: Manifold

ZZB□-S□□M5

\*ZB□31-Q1□L(O)□-□□□□

Ejector/Vacuum pump system  
Silencer exhaust,

With supply valve/release valve,

With vacuum pressure switch,  
PV, PD individual port (PV ≠ PD)

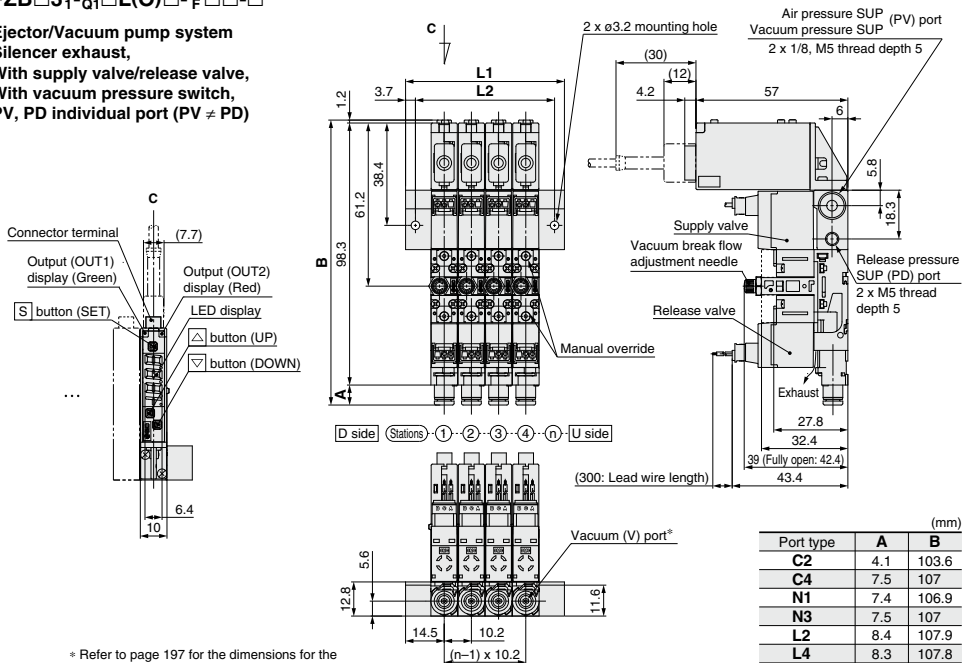

\* Refer to page 197 for the dimensions for the various vacuum (V) ports.

Port type	A	B
C2	4.1	103.6
C4	7.5	107
N1	7.4	106.9
N3	7.5	107
L2	8.4	107.9
L4	8.3	107.8
LN1	8.3	107.8
LN3	8.3	107.8

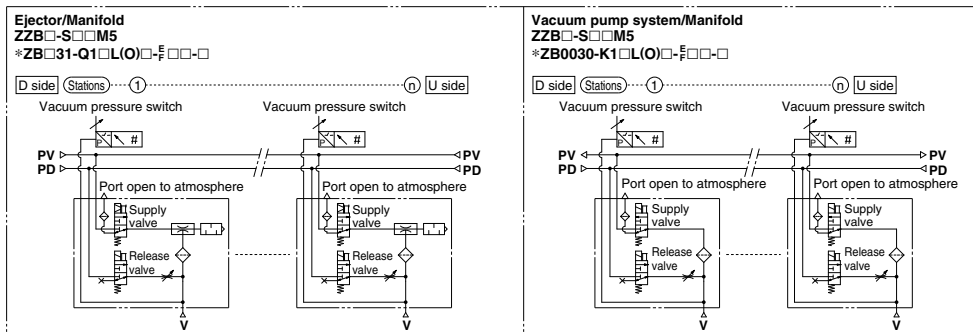

	n	1	2	3	4	5	6	7	8	9	10	11	12
L1		29	39.2	49.4	59.6	69.8	80	90.2	100.4	110.6	120.8	131	141.2
L2		21.6	31.8	42	52.2	62.4	72.6	82.8	93	103.2	113.4	123.6	133.8



## Dimensions

### ■ V-port dimensions

#### ● Straight type

C2: Straight  
ø2 one-touch fitting

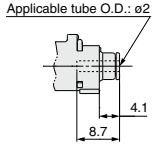

C4: Straight  
ø4 one-touch fitting

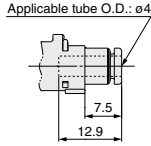

N1: Straight  
ø1/8" one-touch fitting

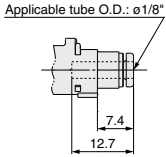

N3: Straight  
ø5/32" one-touch fitting

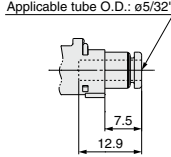

#### ● Elbow type

L2: Elbow  
ø2 one-touch fitting

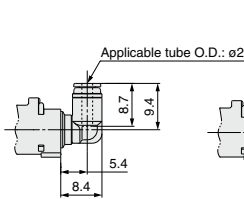

L4: Elbow  
ø4 one-touch fitting

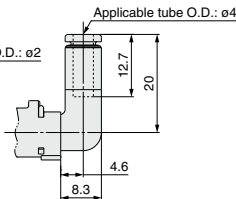

LN1: Elbow  
ø1/8" one-touch fitting

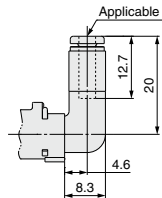

LN3: Elbow  
ø5/32" one-touch fitting

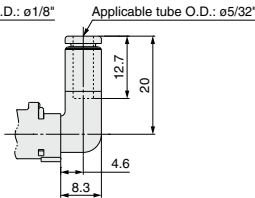

### ■ Common dimensions of the individual EXH port ZB□<sup>1</sup>/<sub>2</sub>2-□

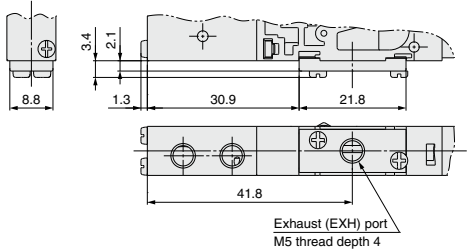

### ■ Bracket mounting dimensions for single unit

Bracket part number for single unit: **ZB1-BK1-A**

\* Mounting screw (M2 x 14, with washer) 2 pcs., M2 nut 2 pcs. included

#### Mounting the right side of the unit to the outside

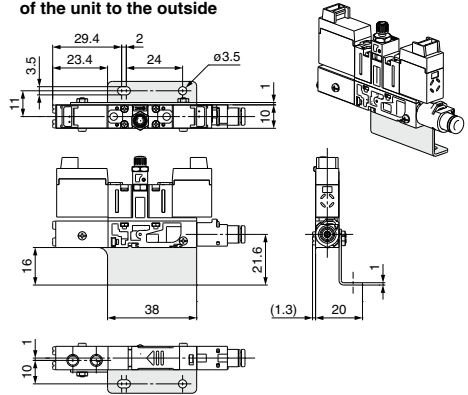

#### Mounting the left side of the unit to the inside

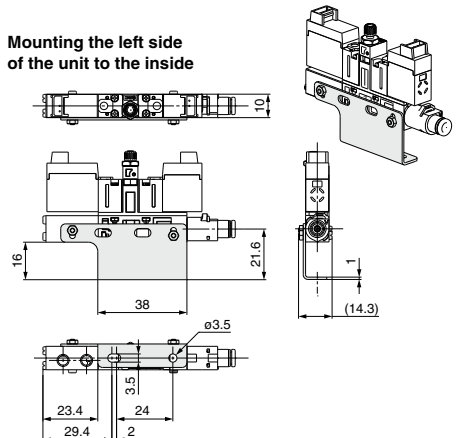

ZK2
ZQ
ZR
<b>ZB</b>
ZA
ZX
ZM
ZL
ZH
ZH-X267
ZHP
ZU
VQD-V



# ZB Series Specific Product Precautions 1

Be sure to read this before handling the products.

Refer to back page 50 for Safety Instructions and pages 49 to 51 for Vacuum Equipment Precautions.

## Supply Valve/Release Valve

### ⚠ Caution

#### 1. How to use the latching-type supply valve

Our latching-type solenoids are fitted with a self-detaining mechanism. Its construction features an armature inside the solenoid which is set or reset using spontaneous energization (20 ms or greater). Therefore, continuous energization is not required.

**<Special care must be taken for the latching type.>**

1. Avoid using this product with a circuit which electrifies both the set and reset signals simultaneously.
2. The minimum energization time required for self-detaining is 20 ms.
3. Contact SMC when using this product in locations where there are vibration levels of 30 m/s<sup>2</sup> or above or highly magnetic fields. No problems arise in normal usage or locations.
4. This supply valve retains the reset position (stops generation of vacuum) at the time of shipment. However, it may alter to the set position during transportation or due to vibration when mounting the supply valve. Therefore, confirm the home position either manually or with power supply prior to use.

Latching	Operation	Indicator light
A-C ON (Set)	Generates vacuum.	Orange
B-C ON (Reset)	Stops generation of vacuum.	Green

N.C.	Operation	Indicator light
A-C ON	Generates vacuum.	Orange
OFF	Stops generation of vacuum.	—

If the supply valve is latching type, continuous energization is not necessary because it maintains the switching position with momentary energization for at least 20 msec. Depending on the conditions, continuous energizing may cause operation failure such as ON operation failure due to operation voltage increase due to coil temperature rise.

When continuous energizing is necessary, the energizing time shall be 10 minutes or shorter. Before the next operation, the solenoid shall be de-energized (both A side and B side OFF) for longer than the energized time. Duty ratio shall be 50% or less.

#### 2. Avoid energizing the supply valve/release valve for long periods of time.

If a supply valve/release valve is energized for a long period of time, the coil will get hot and the performance may be reduced. Additionally, the peripheral equipment in close proximity may also be badly affected. Use a latching-type supply valve when the supply valve/release valve is energized continuously or when the duration of the energization is longer than the non-energized period each day so that periods of energization can be shortened. But, do not energize the coil on both A and B sides simultaneously when using the latching type.

Continuous energization of the supply valve/release valve shall be 10 minutes or shorter in duration and the energization period shall be shorter than the non-energized period. Duty ratio shall be 50% or less.

Take measures for any heat radiation so that the temperature is within the range of supply valve/release valve general specifications when the valve is mounted on the control panel. Please pay special attention to any temperature increases when a manifold type with 3 stations or more is energized continuously or when 3 individual units are placed in close proximity.

## How to Use the Supply Valve/Release Valve Plug Connector

### ⚠ Caution

#### Wiring Specifications

Wiring should be connected as shown below. Connect with the power supply respectively.

#### • N.C.

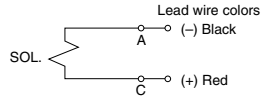

#### • Latching type (DC positive common)



## Light/Surge Voltage Suppressor of the Supply Valve/Release Valve

### ⚠ Caution

In the latching type, the set side and the reset side energization are indicated by two colors – orange and green.

\*( ) and the dotted lines indicate the latching and large flow type.

#### M-type plug connector

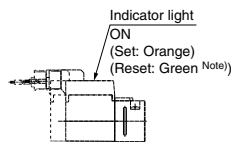

#### L-type plug connector

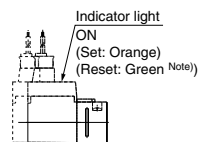

Note) In case of the latching type

#### • N.C.

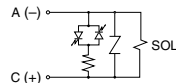

#### • Latching type (DC positive common)

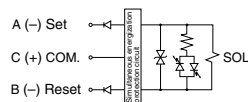

## Specific Product Precautions 2

Be sure to read this before handling the products.

Refer to back page 50 for Safety Instructions and pages 49 to 51 for Vacuum Equipment Precautions.



### Handling of the V-Port Assembly

#### ⚠ Caution

1. The construction of the V-port assembly is such that it can be attached or detached at a touch.

When mounting or removing, turn the case completely until it reaches the position where it cannot turn any further. Otherwise, the V port may come off or be damaged.

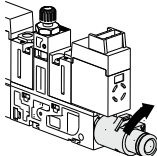

2. If it is mounted on the floor, remove the manifold base once from the installation position and lift the body to perform mounting and removal work so that the mounting and removal work can be performed more easily.

3. If the one-touch fitting is the straight type, a hexagon wrench (width across flats: 2 mm) can be used.

The hexagon hole is resin, so it can be broken if excess torque is applied. Do not apply torque of 0.15 N·m or more. Do not apply any more torque when it reaches the position where it cannot be turned further.

4. When inserting or removing a tube into or out of the one-touch fitting, hold the one-touch fitting body with your fingers.

Otherwise, excessive force can be applied to the V-port assembly or one-touch fitting assembly, causing air leakage or damage, etc.

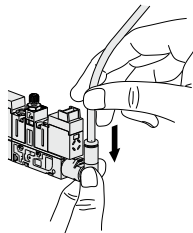

Especially if load is applied in the bending direction against the axial direction of the filter case, the case may be broken.

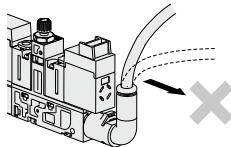

### Operating Supply Pressure

#### ⚠ Caution

1. Use the product within the specified supply pressure range.

Operation over the specified supply pressure range can cause damage to the product. Especially for the vacuum pump system with the adsorption nozzle, the pressure inside the product can increase due to the release pressure. Use the proper pressure and make sure that the adsorption part is not clogged.

### Piping to the Manifold Base

#### ⚠ Caution

1. For the PV port of the manifold base, use a fitting whose maximum bore size of the outside dimension is smaller than 12 mm.

Otherwise, the exterior of the fitting will interfere with the manifold base installation face.

Recommended fittings: KQ2S06-01□S, KQ2S04-01□S

2. When mounting or removing the fittings, etc. to and from the manifold base, hold the manifold base with a wrench.

If the ejector/vacuum pump system is held, it may cause air leakage or damage to the product.

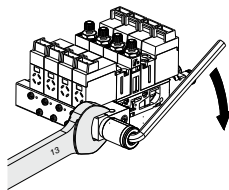

3. The tightening torque for each thread is shown below.

- 1/8 (PV port): 3 to 5 N·m

After tightening by hand, increase the tightening by 2 to 3 turns with a proper tightening tool.

- M5 (PV, PD port): After tightening by hand, increase the tightening by about 1/6 turn with a tightening tool.

### Ejector Exhaust

#### ⚠ Caution

1. The exhaust resistance should be as small as possible to obtain the full ejector performance.

There should be no shield around the exhaust port for the silencer exhaust specification. For the port exhaust specification, the back pressure increase should be 0.005 MPa (5 kPa) at maximum, as exhaust resistance is generated with some piping bore sizes and piping lengths. As a guide, keep the length not more than 1000 mm when the tube inside diameter is 4.

2. If the sound absorbing material is clogged, it will cause a reduction in the ejector performance.

In particular, if it is used in a dusty environment, not only the suction filter, but also the silencer can be clogged. It is recommended to replace the sound absorbing material periodically referring to the figure below.

#### Replacement Procedure

- 1) Turn the body upside down. Apply a watchmaker's screwdriver or your finger to the notch, and slide the silencer cover in the direction indicated by the △ mark.
- 2) It makes a click sound and the hook is disconnected. Put your nail to the part A and remove the cover.
- 3) Catch the sound absorbing material and pull it out using a watchmaker's screwdriver.
- 4) Insert a new sound absorbing material, and mount the cover by the reverse procedure of the disassembly procedure for reassembly. (Refer to page 191 for the replacement parts number.)

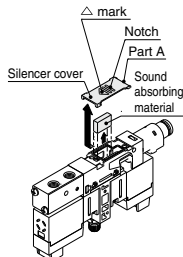

ZK2

ZQ

ZR

ZB

ZA

ZX

ZM

ZL

ZH

ZH

ZH-X267

ZHP

ZU

VQD-V

## Specific Product Precautions 3

Be sure to read this before handling the products.

Refer to back page 50 for Safety Instructions and pages 49 to 51 for Vacuum Equipment Precautions.



### Single Unit

#### ⚠ Caution

1. Do not block the exhaust port of the ejector when the single unit ejector is mounted.

When the product is mounted so that the exhaust port side will be against a wall, use a spacer to secure a clearance of at least 1 mm. (Fig. 1)

For the single unit, PV port and PD port are oriented downward. When it is installed on a working table, use a bracket for single unit (Fig. 2) or secure a space for piping underneath the ports. (Fig. 3)

Bracket part number for single unit: ZB1-BK1-A

\* Two mounting screws (M2 x 14, with washer) and two M2 nuts are included.

Recommended fittings: KQ2H04-M5□, KQ2L04-M5□, KQ2W04-M5□

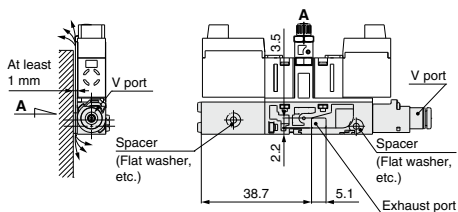

Fig. 1

Recommended fittings when using a bracket for single unit

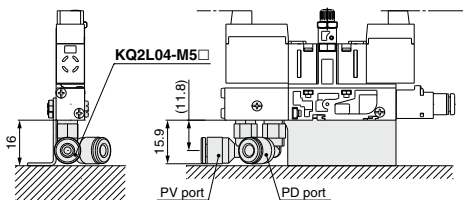

Fig. 2

Recommended fittings when the unit is mounted on the wall and the ports released to the atmosphere at the bottom

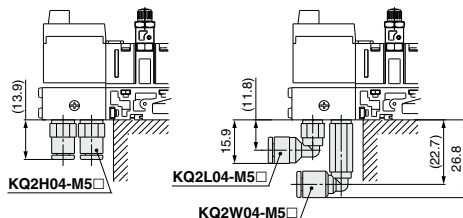

Fig. 3

### Filter Case

#### ⚠ Warning

1. The suction filter case is made using a special clear nylon. Do not use it in an atmosphere where it may come in contact with alcohol or other chemical agents.

### Manifold

#### ⚠ Caution

1. When increasing or decreasing the number of manifold stations, order the manifold base (1) exclusive for the required number of stations and the required number of single units of the body type 3 valve (2).

Refer to "How to Order" (pages from 184 to 186) for the part numbers for placing an order. The part number for the manifold base is different between the sensor/switch mountable base and sensor/switch non-mountable base.

When mounting, check that none of the gaskets, etc. is missing, and tighten the screws to the specified torque shown below.

If the tightening torque is exceeded, the body can be broken.

Proper tightening torque N·m  
0.075 to 0.096

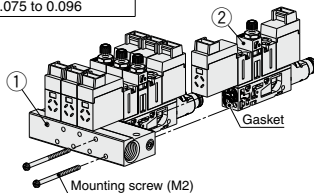

For the manifold with pressure sensor/vacuum pressure switch, order the manifold base (1) exclusive for the required number of stations and the required number of single units of the body type 3 valve (2), pressure sensor (3) or vacuum pressure switch (4).

In this case, the pressure sensor/vacuum pressure switch is tightened together with the single unit (2). (Refer to the figure below.)

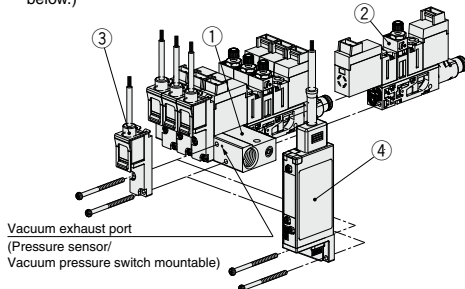

Take care not to drop the O-ring when mounting (3) and (4).

## Specific Product Precautions 4



Be sure to read this before handling the products.

Refer to back page 50 for Safety Instructions and pages 49 to 51 for Vacuum Equipment Precautions.

### Vacuum Break Flow Adjustment Needle

#### ⚠ Caution

1. The flow rate characteristics show the representative values of the product itself.

They may change depending on piping, circuit and pressure conditions, etc. The flow rate characteristics and the number of rotations of the needle vary due to the range of the specifications of the product.

2. The needle has a retaining mechanism, so it will not turn further when it reaches the rotation stop position.

Turning the needle too far may cause damage.

3. Do not tighten the handle with tools such as nippers.

This can result in breakage due to idle turning.

### Blanking Plate Assembly

#### ⚠ Caution

1. When mounting the blanking plate assembly, tighten it with the torque shown below.

2. The blanking plate assembly can be used for either the pressure sensor/vacuum pressure switch mountable base or non-mountable base.

3. Mount the blanking plate assembly so that the gasket does not protrude from the plate.

Proper tightening torque N·m  
0.075 to 0.096

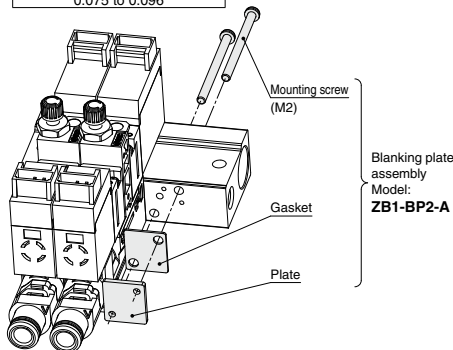

### How to Use Pressure Sensor Assembly

#### Handling

#### ⚠ Caution

1. Do not drop, bump or apply excessive impact (980 m/s<sup>2</sup>) when handling. Even if the switch body is not damaged, the switch may suffer internal damage that will lead to malfunction.

2. The tensile strength of the power cord is within 50 N, and pulling it with a greater force can cause failure. Hold the body when handling the product.

### How to Use Pressure Sensor Assembly

#### Handling

#### ⚠ Caution

3. Refer to the Operation Manual of the pressure sensor PSE540 series for how to connect the connectors for sensor.

#### Environment

#### ⚠ Caution

1. The use of resin piping can cause static electricity to be generated, depending on the fluid. Therefore, when connecting this switch/sensor, take appropriate measures against static electricity at the equipment side to which this product is mounted, and separate the grounding for the product from the grounding for any equipment which generates a strong electromagnetic noise or high frequency.

Otherwise, static electricity can break the switch/sensor.

### How to Use Vacuum Pressure Switch Assembly

#### Handling

#### ⚠ Caution

1. Do not drop, bump or apply excessive impact (100 m/s<sup>2</sup>) when handling. Even if the sensor body is not damaged, the sensor may suffer internal damage that will lead to malfunction.

2. The tensile strength of the power cord is 35 N, and pulling it with a greater force can cause failure. Hold the body when handling the product.

3. Do not allow repeated bending or stretching forces to be applied to lead wires. Wiring arrangements in which repeated bending stress or stretching force is applied to the lead wires can cause broken wires. If the lead wire can move, fix it near the body of the product. The recommended bending radius of the lead wire is 6 times the outside diameter of the sheath, or 33 times the outside diameter of the insulation material, whichever is larger.

#### Connection

#### ⚠ Caution

1. Incorrect wiring can cause the switch to be damaged or malfunction. Connections should only be made when the power supply is turned off.

2. Do not attempt to insert or pull out the connector from the switch while the power is on. Otherwise, it may cause switch output malfunction.

3. Malfunctions stemming from noise may occur if the wire is installed in the same route as that of power or high-voltage cable. Wire the switch independently.

4. Be sure to connect the ground terminal F.G. to ground when using a commercially available switch-mode power supply.

ZK2

ZQ

ZR

ZB

ZA

ZX

ZM

ZL

ZH

ZH

ZH  
-X267

ZHP

ZU

VQD-V



# ZB Series Specific Product Precautions 5

Be sure to read this before handling the products.  
Refer to back page 50 for Safety Instructions and pages 49 to 51 for Vacuum Equipment Precautions.

## How to Use Vacuum Pressure Switch Assembly

### Environment

#### Warning

1. The structure of pressure switches is not intended to prevent explosion. Never use in an atmosphere of flammable gas or explosive gas.

#### Caution

1. The product is CE marked, but not immune to lightning strikes. Take measures against lightning strikes in your system.
2. Do not use the switches in locations where static electricity would be problematic; it may result in the system failure and trouble.

### Assembling/Removing Connectors

#### Caution

- When assembling the connector to the switch housing, push the connector straight onto the pins until the level locks into the housing slot.
- When removing the connector from the switch housing, push the section A (lever) down with your thumb to unlock it from the slot and then withdraw the connector straight off of the pins.

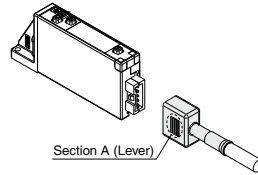

- Do not attempt to insert or pull out the connector from the switch while the power is on. Otherwise, it may cause switch output malfunction.

### Set Pressure Range and Rated Pressure Range

#### Caution

Set the pressure to a value within the rated pressure range.

Set pressure range is the range within which the pressure can be set.

Rated pressure range is the pressure range within which the specifications of the switch (accuracy, linearity, etc.) can be satisfied.

Values outside of this range can be set as long as they are within the set pressure range, but the specifications cannot be guaranteed.

Switch	Pressure range				
	-100 kPa	0	100 kPa	500 kPa	1 MPa
For vacuum ZB1-ZSE	-101 kPa	0	10 kPa		
For compound pressure ZB1-ZSF	-100 kPa		100 kPa		
	-105 kPa		105 kPa		

Rated pressure range of switch  
 Set pressure range of switch