

Direct Operated 3 Port Solenoid Valve

VX31/32/33 Series

For Air, Water, Oil, Steam

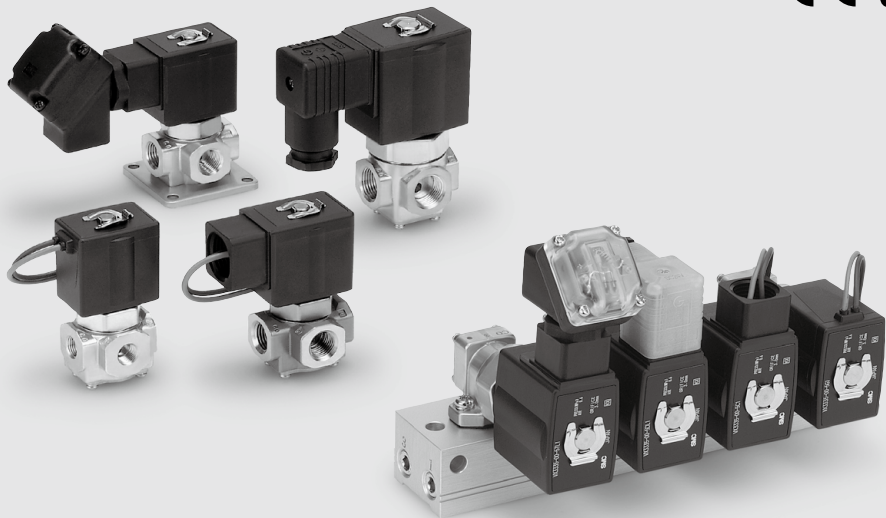

VX2
VXK
VXD
VXZ
VXS
VXB
VXE
VXP
VXR
VXH
VXF
VX3
VXA

Solenoid valves for various fluids used in a wide variety of applications

Improved corrosion resistance

Special magnetic material adopted

Enclosure: Equivalent to IP65

Low-noise construction

Special construction enables to reduce the metal noise.
(DC specification)

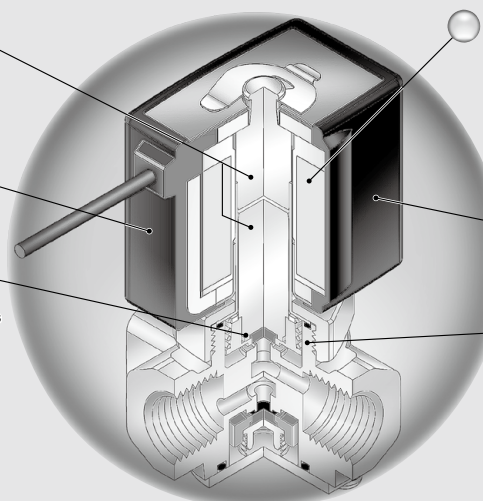

Reduced power consumption (DC specification)

VX31: 6 w → **4.5 w**

VX32: 8 w → **7 w**

VX33: 11.5 w → **10.5 w**

Flame resistance UL94V-0 conformed

Flame resistant mold coil material

Improved maintenance performance

Maintenance is performed easily due to the threaded assembly.

Direct Operated 3 Port Solenoid Valve

VX31/32/33 Series

For Air, Water, Oil, Steam



Single Unit

Valve

Normally closed (N.C.)
Normally open (N.O.)
Common (COM.)

Solenoid Coil

Coil: Class B, Class H

Rated Voltage

100 VAC, 200 VAC, 110 VAC,
220 VAC, 240 VAC, 230 VAC,
48 VAC, 24 VDC, 12 VDC

Material

Body — Brass (C37), Stainless steel
Seal — NBR, FKM, EPDM, PTFE, FFKM

Electrical Entry

- Grommet
- Conduit
- DIN terminal
- Conduit terminal



Normally Closed (N.C.) /
Normally Open (N.O.) /
Common (COM.)

Model	VX31	VX32	VX33
Orifice dia.			
1.5 mm ϕ	●	—	—
2.2 mm ϕ	●	●	●
3 mm ϕ	●	●	●
4 mm ϕ	—	●	●
Port size	1/8 1/4	1/4 3/8	1/4 3/8



Manifold

Valve

Normally closed (N.C.)
Normally open (N.O.)
Common (COM.)

Base

Common SUP/EXH type

Solenoid Coil

Coil: Class B, Class H

Rated Voltage

100 VAC, 200 VAC, 110 VAC,
220 VAC, 240 VAC, 230 VAC,
48 VAC, 24 VDC, 12 VDC

Material

Body — Brass (C37)
Base — Aluminum
Seal — NBR, FKM, EPDM

Electrical Entry

- Grommet
- Conduit
- DIN terminal
- Conduit terminal

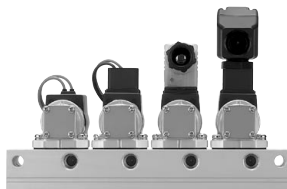

Normally Closed (N.C.) /
Normally Open (N.O.) /
Common (COM.)

Model	VX31	VX32	VX33
Orifice dia.			
1.5 mm ϕ	●	—	—
2.2 mm ϕ	●	●	●
3 mm ϕ	●	●	●
4 mm ϕ	—	●	●
(Common SUP/EXH type) Port size	1/4		
	EXH port	1/8, 1/4	
	OUT port	1/4	

VX31/32/33 Series

Common Specifications

Standard Specifications

Valve specifications	Valve construction		Direct operated poppet
	Withstand pressure (MPa)		3.0
	Body material		Brass (C37), Stainless steel
	Seal material		NBR, FKM, EPDM, PTFE, FFKM
	Enclosure		Dusttight, Low jetproof (equivalent to IP65)*
Environment		Location without the presence of corrosive gases, explosive gases, or constant water adhesion	
Coil specifications	Rated voltage	AC (Class B coil, Built-in full-wave rectifier type)	100 VAC, 200 VAC, 110 VAC, 220 VAC, 230 VAC, 240 VAC, 48 VAC
		AC (Class H coil)	
	DC		24 VDC, 12 VDC
	Allowable voltage fluctuation		±10% of rated voltage
	Allowable leakage voltage	AC (Class B coil, Built-in full-wave rectifier type)	±5% or less of rated voltage
		AC (Class H coil)	±20% or less of rated voltage
DC		±2% or less of rated voltage	
Coil insulation type		Class B, Class H	

* Electrical entry, Grommet with surge voltage suppressor (GS) has a rating of IP40.
For enclosure, refer to "Glossary of Terms" on page 403.

Solenoid Coil Specifications

DC Specification

Model	Power consumption (W)	Temperature rise (°C) ^{Note)}
VX31	4.5	45
VX32	7	45
VX33	10.5	60

Note) The values are for an ambient temperature of 20°C and at the rated voltage.

AC Specification (Class B coil, Built-in full-wave rectifier type)

Model	Apparent power (VA)*	Temperature rise (°C) ^{Note)}
VX31	7	55
VX32	9.5	60
VX33	12	65

* There is no difference in the frequency and the inrush and energized apparent power, since a rectifying circuit is used in the AC (Class B).
Note) The values are for an ambient temperature of 20°C and at the rated voltage.

AC Specification (Class H coil)

Model	Frequency (Hz)	Apparent power (VA)		Temperature rise (°C) ^{Note)}
		Inrush	Energized	
VX31	50	33	14	65
	60	28	12	60
VX32	50	65	33	100
	60	55	27	95
VX33	50	94	50	120
	60	79	41	115

Note) The values are for an ambient temperature of 20°C and at the rated voltage.

Contents

For Air /Single Unit	P.382	For Vacuum Pad /Single Unit	P.394
For Air /Manifold	P.384	For Vacuum Pad /Manifold	P.396
For Water /Single Unit	P.386	Construction	P.398
For Oil /Single Unit	P.388	Dimensions /Single Unit	P.399
For Oil /Manifold	P.390	Dimensions /Manifold	P.400
For Steam /Single Unit	P.392	Replacement Parts	P.401

VX31/32/33 Series

For Air /Single Unit

(Non-leak, Medium vacuum)

Model / Valve Specifications

N.C.

N.O.

COM.

Symbol

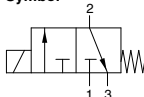

Symbol

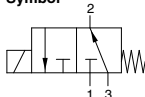

Symbol

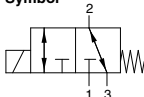

Note) Symbols for N.C. and N.O. types

The symbols show that the N.C. type; port 3 and N.O. type; port 1 are in a blocked state (T).

However, use each port pressure in the state shown below.

N.C. type: Pressure at port 1 ≥ Pressure at port 2 ≥ Pressure at port 3

N.O. type: Pressure at port 3 ≥ Pressure at port 2 ≥ Pressure at port 1

Port size	Orifice diameter (mm)	Model	Max. operating pressure differential ^{Note 3)} (MPa)			Flow rate characteristics ^{Note 1)}			Max. system pressure ^{Note 3)} (MPa)	Weight ^{Note 2)} (g)	
			N.C.	N.O.	COM.	C(dm ³ /(s·bar))	b	Cv			
1/8 (6A)	1.5	VX311□-01	1	1	0.7	0.29	0.32	0.08	2.0	380	
	2.2	VX312□-01	0.7	0.5	0.4	0.60	0.25	0.15			
	3	VX313□-01	0.3	0.3	0.2	0.82	0.20	0.20			
1/4 (8A)	1.5	VX311□-02	1	1	0.7	0.29	0.32	0.08			
		VX312□-02	0.7	0.5	0.4	0.60	0.25	0.15			
		VX322□-02	1.2	1	0.7	0.64	0.40	0.17			
	VX332□-02	1.6	1.6	1							
	2.2	VX313□-02	0.3	0.3	0.2	0.82	0.20	0.20			
		VX323□-02	0.6	0.5	0.3	1.1	0.25	0.27			
		VX333□-02	1	0.9	0.6						
	VX324□-02	0.3	0.25	0.2							
	3	VX334□-02	0.5	0.4	0.3	1.6	0.20	0.38			
4		VX322□-03	1.2	1	0.7				0.64	0.40	0.17
		VX332□-03	1.6	1.6	1						
	VX323□-03	0.6	0.5	0.3							
3/8 (10A)	2.2	VX333□-03	1	0.9	0.6	1.1	0.25	0.27			
		VX324□-03	0.3	0.25	0.2						
		VX334□-03	0.5	0.4	0.3						
	3	VX322□-03	1.2	1	0.7	1.6	0.20	0.38			
		VX332□-03	1.6	1.6	1						
		VX323□-03	0.6	0.5	0.3						
4	VX333□-03	1	0.9	0.6	1.1	0.25	0.27				
	VX324□-03	0.3	0.25	0.2							
	VX334□-03	0.5	0.4	0.3							

Note 1) The flow rate characteristics of this product have variations.

When the highly precise flow control is required according to the system to be used, select an orifice diameter 1.3 times larger than that shown above and install a restrictor on the downstream side of the solenoid valve to make the adjustment.

Note 2) Weight of grommet type. Add 10 g for conduit, 30 g for DIN terminal, and 60 g for conduit terminal type respectively.

Also, add 60 g for VX31□□, 80 g for VX32□□ and VX33□□ respectively for bracket option.

Note 3) Refer to "Glossary of Terms" on page 403, for details on the max. operating pressure differential and the max. system pressure.

Fluid and Ambient Temperature

Power source	Fluid temperature (°C)		Ambient temperature (°C)
	Solenoid valve option (symbol)		
	NII, G	V, M	
AC	-10 ^{Note)} to 60	-10 ^{Note)} to 40	-20 to 60
DC	-10 ^{Note)} to 60	-10 ^{Note)} to 40	-20 to 40

Note) Dew point temperature: -10°C or less

Valve Leakage Rate

Internal Leakage / External Leakage

Seal material	Max. operating pressure differential	Leakage rate	
		Air	Non-leak, Medium vacuum ^{Note)}
NBR, FKM	From 0 to less than 1 MPa	1 cm ³ /min or less	10 ⁻⁶ Pa·m ³ /sec or less
	1 MPa or more	2 cm ³ /min or less	

Note) The leakage amount (10⁻⁶ Pa·m³/sec) for the "V" and "M" option are values when the differential pressure is 0.1 MPa.



How to Order (Single Unit)

DC VX31 1 4 - 01 - 5 G 1 -

AC/Class B coil (Built-in full-wave rectifier type) VX31 1 4 - 01 - 1 GR1 -

Model Refer to Table (1) shown below for availability.

Orifice diameter Refer to Table (1) shown below for availability.

Valve / Body type

0	N.C. / Single unit
2	N.O. / Single unit
4	COM. / Single unit

Solenoid valve option Refer to Table (2) shown below for availability.

Port size Refer to Table (1) shown below for availability.

Bracket

Nil	None
B	With bracket

* Bracket is neither mountable nor removable.

Built-in full-wave rectifier type

Suffix

Nil	—
Z	Oil-free spec.

Thread type

Nil	Rc
T	NPTF
F	G*
N	NPT

* For connection, prepare a fitting compliant with ISO 16030 and JIS B 8674.

Rated voltage

1	100 VAC 50/60 Hz	6	12 VDC
2	200 VAC 50/60 Hz	7	240 VAC 50/60 Hz
3	110 VAC 50/60 Hz	8	48 VAC 50/60 Hz
4	220 VAC 50/60 Hz	J	230 VAC 50/60 Hz
5	24 VDC		

* Refer to Table (3) shown below for availability.

Refer to page 401 for ordering coil only.

Electrical entry

G - Grommet GS - With grommet surge voltage suppressor	C - Conduit
T - With conduit terminal TS - With conduit terminal and surge voltage suppressor	D - DIN terminal DS - DIN terminal with surge voltage suppressor
TL - With conduit terminal and light TZ - With conduit terminal, surge voltage suppressor and light	DL - DIN terminal with light DZ - DIN terminal with surge voltage suppressor and light DO - For DIN terminal (without connector, gasket is included.)

* Refer to Table (3) for available combinations between each electrical option (S, L, Z) and rated voltage.
* Surge voltage suppressor is integrated into the AC/Class B coil, as a standard.

- VX2
- VXK
- VXD
- VXZ
- VXS
- VXB
- VXE
- VXP
- VXR
- VXH
- VXF
- VX3
- VXA

Table (1) Model/Orifice Diameter/Port Size

Model	Solenoid valve model			Orifice symbol (Diameter)			
	VX31	VX32	VX33	1 (1.5 mm)	2 (2.2 mm)	3 (3 mm)	4 (4 mm)
Port symbol (Port size)	01 (1/8)	—	—	●	●	●	—
	02 (1/4)	—	—	●	●	●	—
	—	02 (1/4)	02 (1/4)	—	●	●	●
	—	—	03 (3/8)	—	●	●	●

Table (2) Solenoid Valve Option

Option symbol	Seal material Main valve poppet	Fixed sealant	Body material/ Shading coil material	Guide pin material	Coil insulation type	Note ^(Note)
Nil	NBR	NBR	Brass (C37)	PPS	B	—
G			Stainless steel			
M	FKM	FKM	Stainless steel	PPS	B	Non-leak (10 ⁻⁶ Pa·m ³ /sec), Medium vacuum (0.1 Pa.abs), Oil-free
V			Brass (C37)			

Note) The leakage amount (10⁻⁶ Pa·m³/sec) for the "V" and "M" option are values when the differential pressure is 0.1 MPa.

Table (3) Rated Voltage – Electrical Option

Rated voltage		Class B			
		S	L	Z	
AC/DC	Voltage symbol	Voltage	With surge voltage suppressor	With light	With light and surge voltage suppressor
	1	100 V	●	●	— (Note)
	2	200 V	●	●	— (Note)
	3	110 V	●	●	— (Note)
	4	220 V	— (Note)	●	— (Note)
	7	240 V	— (Note)	●	— (Note)
AC	8	48 V	— (Note)	●	— (Note)
	J	230 V	— (Note)	●	— (Note)
	5	24 V	●	●	●
DC	6	12 V	●	●	—
	6	12 V	●	●	—

Note 1) Option S, Z are not available as surge voltage suppressor is integrated into the AC/Class B coil, as a standard.

* Class H coil is not available.

VVX31/32/33 Series

For Air /Manifold

(Non-leak, Medium vacuum)

Solenoid Valve for Manifold / Valve Specifications



N.C.	N.O.	COM.
-------------	-------------	-------------

Symbol

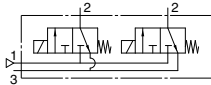

Symbol

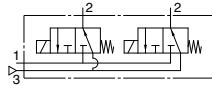

Symbol

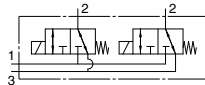

Note) Symbols for N.C. and N.O. types

The symbols show that the N.C. type: port 3 and N.O. type: port 1 are in a blocked state (T).
However, use each port pressure in the state shown below.

N.C. type: Pressure at port 1 \geq Pressure at port 2 \geq Pressure at port 3
N.O. type: Pressure at port 3 \geq Pressure at port 2 \geq Pressure at port 1

Orifice diameter (mm)	Model	Max. operating pressure differential ^{Note 2)} (MPa)			Flow rate characteristics ^{Note 1)}			Max. system pressure ^{Note 2)} (MPa)
		N.C.	N.O.	COM.	Cj[dm ³ /(s·bar)]	b	Cv	
1.5	VX311□-00	1	1	0.7	0.29	0.32	0.08	2.0
	VX312□-00	0.7	0.5	0.4	0.60	0.25	0.15	
2.2	VX322□-00	1.2	1	0.7	0.64	0.40	0.17	
	VX332□-00	1.6	1.6	1				
3	VX313□-00	0.3	0.3	0.2	1.1	0.25	0.27	
	VX323□-00	0.6	0.5	0.3				
	VX333□-00	1	0.9	0.6				
4	VX324□-00	0.3	0.25	0.2	1.6	0.20	0.38	
	VX334□-00	0.5	0.4	0.3				

Note 1) The flow rate characteristics of this product have variations.

When the highly precise flow control is required according to the system to be used, select an orifice diameter 1.3 times larger than that shown above and install a restrictor on the downstream side of the solenoid valve to make the adjustment.

Note 2) Refer to "Glossary of Terms" on page 403 for details on the max. operating pressure differential and the max. system pressure.

Fluid and Ambient Temperature

Power source	Fluid temperature (°C)		Ambient temperature (°C)
	Solenoid valve option (symbol)		
	Nil	V	
AC	-10 ^{Note)} to 60	-10 ^{Note)} to 40	-20 to 60
DC	-10 ^{Note)} to 60	-10 ^{Note)} to 40	-20 to 40

Note) Dew point temperature: -10°C or less

Valve Leakage Rate

Internal Leakage / External Leakage

Seal material	Max. operating pressure differential	Leakage rate	
		Air	Non-leak, Medium vacuum ^{Note)}
NBR, FKM	From 0 to less than 1 MPa 1 MPa or more	1 cm ³ /min or less 2 cm ³ /min or less	10 ⁻⁶ Pa·m ³ /sec or less

Note) The leakage amount (10⁻⁶ Pa·m³/sec) for the "V" option are values when the differential pressure is 0.1 MPa.



How to Order (Solenoid Valve for Manifold)

DC
AC/Class B coil (Built-in full-wave rectifier type)

VX31 1 1 -00-5 G 1

VX31 1 1 -00-1 G R1

Model
Refer to Table (1) shown below for availability.

Orifice diameter
Refer to Table (1) shown below for availability.

Suffix

Built-in full-wave rectifier type

Valve / Body type

1	N.C. / Manifold
3	N.O. / Manifold
5	COM. / Manifold

Solenoid valve option

Refer to Table (2) shown below for availability.

Nil	—
Z	Oil-free spec.

Rated voltage

1	100 VAC 50/60 Hz	6	12 VDC
2	200 VAC 50/60 Hz	7	240 VAC 50/60 Hz
3	110 VAC 50/60 Hz	8	48 VAC 50/60 Hz
4	220 VAC 50/60 Hz	J	230 VAC 50/60 Hz
5	24 VDC		

* Refer to Table (3) shown below for availability.

Refer to page 401 for ordering coil only.

Electrical entry

<p>G - Grommet GS - With grommet surge voltage suppressor</p>	<p>C - Conduit</p>
<p>T - With conduit terminal TS - With conduit terminal and surge voltage suppressor</p> <p>TL - With conduit terminal and light TZ - With conduit terminal, surge voltage suppressor and light</p>	<p>D - DIN terminal DS - DIN terminal with surge voltage suppressor</p> <p>DL - DIN terminal with light DZ - DIN terminal with surge voltage suppressor and light</p> <p>DO - For DIN terminal (without connector, gasket is included.)</p>

* DIN type is available with class B only.

* Refer to Table (3) for available combinations between each electrical option (S, L, Z) and rated voltage.

* Surge voltage suppressor is integrated into the AC/Class B coil, as a standard.

How to Order Manifold Bases

VVX31
VVX32 1 -07-1
VVX33

Port size (Individual port)

1	Rc 1/8
2	Rc 1/4

* Common port sizes are all Rc 1/4.

** Indicating numbers shown below are for common ports.

Type	SUP port	EXH port
N.C.	1	3
N.O.	3	1

Manifold base

Blanking plate part no.

For VX31: **VVX31-4A-**
For VX32/33: **VVX32-4A-**

Seal material

Nil	NBR
F	FKM

Number of manifolds

02	2 stations
:	:
10	10 stations

Suffix

Nil	—
Z	Oil-free spec.

Table (1) Model/Orifice Diameter

Solenoid valve model	Orifice symbol (Diameter)			
	1 (1.5 mmø)	2 (2.2 mmø)	3 (3 mmø)	4 (4 mmø)
VX31	●	●	●	—
VX32	—	●	●	●
VX33	—	●	●	●

Table (2) Solenoid Valve Option

Option symbol	Seal material Main valve poppet	Fixed sealant	Body material	Guide pin material	Coil insulation type	Note (Note)
Nil	NBR	NBR	Brass (C37)	PPS	B	Non-leak (10 ⁻⁶ Pa·m ³ /sec), Medium vacuum (0.1 Pa.abs), Oil-free
V	FKM	FKM				

* Aluminum is only available as a material for the manifold base.

Note) The leakage amount (10⁻⁶ Pa·m³/sec) for the "V" option are values when the differential pressure is 0.1 MPa.

Table (3) Rated Voltage - Electrical Option

AC/DC	Rated voltage		Class B		
	Voltage symbol	Voltage	S With surge voltage suppressor	L With light	Z With light and surge voltage suppressor
AC	1	100 V	— (Note)	●	— (Note)
	2	200 V		●	
	3	110 V		●	
	4	220 V		●	
	7	240 V		—	
	8	48 V		—	
DC	J	230 V	●	●	●
	5	24 V	●	●	●
	6	12 V	●	—	—

* Class H coil is not available.

Note) Option S, Z are not available as surge voltage suppressor is integrated into the AC/Class B coil, as a standard.

How to Order Manifold Assemblies (Example)

Enter the valve and blanking plate to be mounted under the manifold base part number.

Example

VVX311-05-1 1 set

* VX3111-00-1GR1 ... 4 sets

* VVX31-4A 1 set

"*" is the symbol for mounting.
Add an "*" in front of the part numbers for solenoid valves, etc. to be mounted.

① ② ③ ④ ⑤ ⑥ ⑦ ⑧ ⑨ ⑩

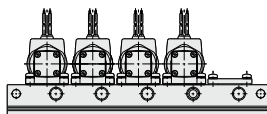

Enter the product's part number in order, counting the 1st station from the left in the manifold arrangement, when viewing the individual port in front.

The common port on the right side is plugged.

VX31/32/33 Series

For Water /Single Unit

Model / Valve Specifications

N.C.

N.O.

COM.

Symbol

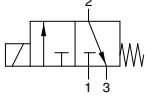

Symbol

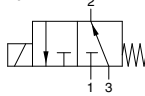

Symbol

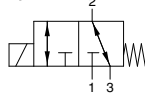

Note) Symbols for N.C. and N.O. types

The symbols show that the N.C. type; port 3 and N.O. type; port 1 are in a blocked state (T). However, use each port pressure in the state shown below.

N.C. type: Pressure at port 1 ≥ Pressure at port 2 ≥ Pressure at port 3
N.O. type: Pressure at port 3 ≥ Pressure at port 2 ≥ Pressure at port 1

Port size	Orifice diameter (mm)	Model	Max. operating pressure differential ^{Note 3)} (MPa)			Flow rate characteristics ^{Note 1)}		Max. system pressure ^{Note 3)} (MPa)	Weight ^{Note 2)} (g)
			N.C.	N.O.	COM.	Kv	Cv converted		
1/8 (6A)	1.5	VX311□-01	1	1	0.7	0.07	0.08	2.0	380
	2.2	VX312□-01	0.7	0.5	0.4	0.14	0.16		
	3	VX313□-01	0.3	0.3	0.2	0.21	0.24		
1/4 (8A)	1.5	VX311□-02	1	1	0.7	0.07	0.08		
	2.2	VX312□-02	0.7	0.5	0.4	0.14	0.16		
		VX322□-02	1.2	1	0.7	0.16	0.19		
		VX332□-02	1.6	1.6	1				
	3	VX313□-02	0.3	0.3	0.2	0.21	0.24		
		VX323□-02	0.6	0.5	0.3	0.28	0.33		
VX333□-02		1	0.9	0.6					
4	VX324□-02	0.3	0.25	0.2	0.43	0.50			
	VX334□-02	0.5	0.4	0.3					
3/8 (10A)	2.2	VX322□-03	1.2	1	0.7	0.16	0.19		
		VX332□-03	1.6	1.6	1				
		VX323□-03	0.6	0.5	0.3				
	3	VX333□-03	1	0.9	0.6	0.28	0.33		
		VX324□-03	0.3	0.25	0.2				
		VX334□-03	0.5	0.4	0.3				

Note 1) The flow rate characteristics of this product have variations.

When the highly precise flow control is required according to the system to be used, select an orifice diameter 1.3 times larger than that shown above and install a restrictor on the downstream side of the solenoid valve to make the adjustment.

Note 2) Weight of grommet type. Add 10 g for conduit, 30 g for DIN terminal, and 60 g for conduit terminal type respectively.

Also, add 60 g for VX31□□, 80 g for VX32□□ and VX33□□ respectively for bracket option.

Note 3) Refer to "Glossary of Terms" on page 403, for details on the max. operating pressure differential and the max. system pressure.

Fluid and Ambient Temperature

Power source	Fluid temperature (°C)		Ambient temperature (°C)
	Solenoid valve option (Symbol)		
	NII, G, H	E, P	
AC	1 to 60	1 to 99	-20 to 60
DC	1 to 40	—	-20 to 40

Note) With no freezing

Valve Leakage Rate

Internal Leakage / External Leakage

Seal material	Max. operating pressure differential	Leakage rate (Water)
NBR, FKM, EPDM	From 0 to less than 1 MPa 1 MPa or more	0.1 cm ³ /min or less 0.2 cm ³ /min or less



How to Order (Single Unit)

DC, AC/Class H coil VX **31** **1** **4** **01** **1** **G** **1** **0**

AC/Class B coil (Built-in full-wave rectifier type) VX **31** **1** **4** **01** **1** **G** **R1** **0**

Model • Refer to Table (1) shown below for availability.

Orifice diameter • Refer to Table (1) shown below for availability.

Valve / Body type

0	N.C. / Single unit
2	N.O. / Single unit
4	COM. / Single unit

Solenoid valve option • Refer to Table (2) shown below for availability.

Port size • Refer to Table (1) shown below for availability.

Thread type

Nil	Rc
T	NPTF
F	G*
N	NPT

* For connection, prepare a fitting compliant with ISO 15030 and JIS B 8674.

Rated voltage

1	100 VAC 50/60 Hz	6	12 VDC
2	200 VAC 50/60 Hz	7	240 VAC 50/60 Hz
3	110 VAC 50/60 Hz	8	48 VAC 50/60 Hz
4	220 VAC 50/60 Hz	J	230 VAC 50/60 Hz
5	24 VDC		

* Refer to Table (3) shown below for availability. Refer to page 401 for ordering coil only.

Suffix

Nil	—
Z	Oil-free spec.

Bracket

Nil	None
B	With bracket

* Bracket is neither mountable nor removable.

Built-in full-wave rectifier type

Electrical entry

G - Grommet GS - With grommet surge voltage suppressor	C - Conduit
T - With conduit terminal TS - With conduit terminal and surge voltage suppressor	D - DIN terminal with surge voltage suppressor DS - DIN terminal with surge voltage suppressor and light
TL - With conduit terminal and light TZ - With conduit terminal, surge voltage suppressor and light	DL - DIN terminal with surge voltage suppressor and light DZ - DIN terminal with surge voltage suppressor and light DO - For DIN terminal (without connector, gasket is included.)

* Refer to Table (3) for available combinations between each electrical option (S, L, Z) and rated voltage.
* Surge voltage suppressor is integrated into the AC/Class B coil, as a standard.

- VX2
- VXK
- VXD
- VXZ
- VXS
- VXB
- VXE
- VXP
- VXR
- VXH
- VXF
- VX3
- VXA

Table (1) Model/Orifice Diameter/Port Size

Model	Solenoid valve model			Orifice symbol (Diameter)			
	VX31	VX32	VX33	1 (1.5 mm)	2 (2.2 mm)	3 (3 mm)	4 (4 mm)
Port symbol (Port size)	01 (1/8)	—	—	●	●	●	—
	02 (1/4)	—	—	●	●	●	—
	—	02 (1/4)	02 (1/4)	—	●	●	●
	—	03 (3/8)	03 (3/8)	—	●	●	●

Table (2) Solenoid Valve Option

Option symbol	Seal material		Body material/ Shading coil material	Guide pin material	Coil insulation type	Note
	Main valve poppet	Fixed sealant				
Nil			Brass (C37)			
G	NBR	NBR	Stainless steel	PPS	B	—
E			Brass (C37)/Cu			
P	EPDM	EPDM	Stainless steel/Ag	Stainless steel	H	Heated water
H	FKM	FKM	Stainless steel	PPS	B	—

Table (3) Rated Voltage – Electrical Option

AC/DC	Rated voltage		Class B		
	Voltage symbol	Voltage	S With surge voltage suppressor	L With light	Z With light and surge voltage suppressor
AC	1	100 V	●	●	— (Note)
	2	200 V	●	●	— (Note)
	3	110 V	●	●	— (Note)
	4	220 V	— (Note)	●	— (Note)
	7	240 V	—	—	—
	8	48 V	—	—	—
	J	230 V	—	—	—
DC	5	24 V	●	●	●
	6	12 V	●	—	—

Note) Option S, Z are not available as surge voltage suppressor is integrated into the AC/Class B coil, as a standard.

AC/DC	Rated voltage		Class H		
	Voltage symbol	Voltage	S With surge voltage suppressor	L With light	Z With light and surge voltage suppressor
AC	1	100 V	●	●	●
	2	200 V	●	●	●
	3	110 V	●	●	●
	4	220 V	●	●	●
	7	240 V	●	—	—
	8	48 V	●	—	—
	J	230 V	●	—	—
DC	5	24 V	—	—	—
	6	12 V	—	—	—

DC specification is not available.

VX31/32/33 Series

For Oil /Single Unit

Model / Valve Specifications

N.C.	N.O.	COM.
------	------	------

Symbol

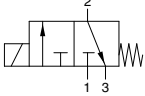

Symbol

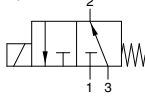

Symbol

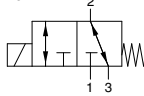

Note) Symbols for N.C. and N.O. types

The symbols show that the N.C. type: port 3 and N.O. type: port 1 are in a blocked state (T).
However, use each port pressure in the state shown below.

N.C. type: Pressure at port 1 ≥ Pressure at port 2 ≥ Pressure at port 3

N.O. type: Pressure at port 3 ≥ Pressure at port 2 ≥ Pressure at port 1

Port size	Orifice diameter (mm)	Model	Max. operating pressure differential ^{Note 3)} (MPa)			Flow rate characteristics ^{Note 1)}		Max. system pressure ^{Note 3)} (MPa)	Weight ^{Note 2)} (g)		
			N.C.	N.O.	COM.	Kv	Cv converted				
1/8 (6A)	1.5	VX311□-01	1	1	0.7	0.07	0.08	2.0	380		
	2.2	VX312□-01	0.7	0.5	0.4	0.14	0.16				
	3	VX313□-01	0.3	0.3	0.2	0.21	0.24				
1/4 (8A)	1.5	VX311□-02	1	1	0.7	0.07	0.08			2.0	380
	2.2	VX312□-02	0.7	0.5	0.4	0.14	0.16				
		VX322□-02	1.2	1	0.7	0.16	0.19				
		VX332□-02	1.6	1.6	1						
	3	VX313□-02	0.3	0.3	0.2	0.21	0.24				
		VX323□-02	0.6	0.5	0.3	0.28	0.33				
		VX333□-02	1	0.9	0.6						
		VX324□-02	0.3	0.25	0.2	0.43	0.50				
	VX334□-02	0.5	0.4	0.3							
	3/8 (10A)	2.2	VX322□-03	1.2	1	0.7	0.16	0.19	2.0		
VX332□-03			1.6	1.6	1						
3		VX323□-03	0.6	0.5	0.3	0.28	0.33				
		VX333□-03	1	0.9	0.6						
4		VX324□-03	0.3	0.25	0.2	0.43	0.50				
		VX334□-03	0.3	0.25	0.2						
4		VX324□-03	0.5	0.4	0.3	0.43	0.50				
		VX334□-03	0.5	0.4	0.3						

Note 1) The flow rate characteristics of this product have variations.

When the highly precise flow control is required according to the system to be used, select an orifice diameter 1.3 times larger than that shown above and install a restrictor on the downstream side of the solenoid valve to make the adjustment.

Note 2) Weight of grommet type. Add 10 g for conduit, 30 g for DIN terminal, and 60 g for conduit terminal type respectively.

Also, add 60 g for VX31□□, 80 g for VX32□□ and VX33□□ respectively for bracket option.

Note 3) Refer to "Glossary of Terms" on page 403, for details on the max. operating pressure differential and the max. system pressure.

Fluid and Ambient Temperature

Power source	Fluid temperature (°C)		Ambient temperature (°C)
	Solenoid valve option (Symbol)		
	A, H	D, N	
AC	-5 ^{Note)} to 60	-5 ^{Note)} to 120	-20 to 60
DC	-5 ^{Note)} to 40	—	-20 to 40

Note) Dynamic viscosity: 50 mm²/s or less

Valve Leakage Rate

Internal Leakage / External Leakage

Seal material	Max. operating pressure differential	Leakage rate (Oil)
FKM	From 0 to less than 1 MPa 1 MPa or more	0.1 cm ³ /min or less 0.2 cm ³ /min or less

Direct Operated 3 Port Solenoid Valve **VX31/32/33 Series**

For Oil / Single Unit



How to Order (Single Unit)

DC, AC/Class H coil

AC/Class B coil (Built-in full-wave rectifier type)

Model
Refer to Table (1) shown below for availability.

Valve / Body type

0	N.C. / Single unit
2	N.O. / Single unit
4	COM. / Single unit

Suffix

Nil	—
Z	Oil-free spec.

VX 31 1 4 A — 01 — 5 G 1 —

VX 31 1 4 A — 01 — 1 GR1 —

Orifice diameter
Refer to Table (1) shown below for availability.

Solenoid valve option
Refer to Table (2) shown below for availability.

Port size
Refer to Table (1) shown below for availability.

Thread type

Nil	Rc
T	NPTF
F	G*
N	NPT

* For connection, prepare a fitting compliant with ISO 16030 and JIS B 8674.

Rated voltage

1	100 VAC 50/60 Hz	6	12 VDC
2	200 VAC 50/60 Hz	7	240 VAC 50/60 Hz
3	110 VAC 50/60 Hz	8	48 VAC 50/60 Hz
4	220 VAC 50/60 Hz	J	230 VAC 50/60 Hz
5	24 VDC		

* Refer to Table (3) shown below for availability.

Refer to page 401 for ordering coil only.

Bracket

Nil	None
B	With bracket

* Bracket is neither mountable nor removable.

Built-in full-wave rectifier type

Electrical entry

G - Grommet GS - With grommet surge voltage suppressor 	C - Conduit
T - With conduit terminal TS - With conduit terminal and surge voltage suppressor TL - With conduit terminal and light TZ - With conduit terminal, surge voltage suppressor and light 	D - DIN terminal DS - DIN terminal with surge voltage suppressor DL - DIN terminal with light DZ - DIN terminal with surge voltage suppressor and light DO - For DIN terminal (without connector, gasket is included.) <p style="font-size: x-small;">* DIN type is available with class B only.</p>

* Refer to Table (3) for available combinations between each electrical option (S, L, Z) and rated voltage.
* Surge voltage suppressor is integrated into the AC/Class B coil, as a standard.

- VX2
- VXK
- VXD
- VXZ
- VXS
- VXB
- VXE
- VXP
- VXR
- VXH
- VXF
- VX3
- VXA

Table (1) Model/Orifice Diameter/Port Size

Model	Solenoid valve model			Orifice symbol (Diameter)			
	VX31	VX32	VX33	1 (1.5 mm)	2 (2.2 mm)	3 (3 mm)	4 (4 mm)
Port symbol (Port size)	01 (1/8)	—	—	●	●	●	—
	02 (1/4)	—	—	●	●	●	—
	—	02 (1/4)	02 (1/4)	—	●	●	●
	—	03 (3/8)	03 (3/8)	—	●	●	●

Table (2) Solenoid Valve Option

Option symbol	Seal material		Body material/ Shading coil material	Guide pin material	Coil insulation type
	Main valve poppet	Fixed sealant			
A	FKM	FKM	Brass (C37)	PPS	B
H			Stainless steel		
D			Brass (C37)/Cu	Stainless steel	H
N			Stainless steel/Ag		

Table (3) Rated Voltage – Electrical Option

AC/DC	Rated voltage		Class B		
	Voltage symbol	Voltage	S With surge voltage suppressor	L With light	Z With light and surge voltage suppressor
AC	1	100 V	●	●	—
	2	200 V	●	●	—
	3	110 V	●	●	—
	4	220 V	— (Note)	●	— (Note)
	7	240 V	—	—	—
	8	48 V	—	—	—
	J	230 V	—	—	—
DC	5	24 V	●	●	●
	6	12 V	●	—	—

(Note) Option S, Z are not available as surge voltage suppressor is integrated into the AC/Class B coil, as a standard.

AC/DC	Rated voltage		Class H		
	Voltage symbol	Voltage	S With surge voltage suppressor	L With light	Z With light and surge voltage suppressor
AC	1	100 V	●	●	●
	2	200 V	●	●	●
	3	110 V	●	●	●
	4	220 V	●	●	—
	7	240 V	●	—	—
	8	48 V	●	—	—
	J	230 V	●	—	—
DC	5	24 V	DC specification is not available.		
	6	12 V	DC specification is not available.		

VVX31/32/33 Series

For Oil / Manifold

Solenoid Valve for Manifold / Valve Specifications

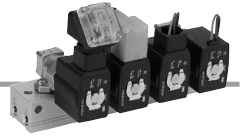

N.C.

N.O.

COM.

Symbol

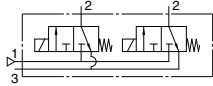

Symbol

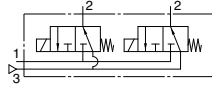

Symbol

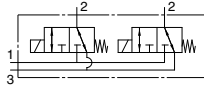

Note) Symbols for N.C. and N.O. types

The symbols show that the N.C. type: port 3 and N.O. type: port 1 are in a blocked state (T).
However, use each port pressure in the state shown below.

N.C. type: Pressure at port 1 \geq Pressure at port 2 \geq Pressure at port 3
N.O. type: Pressure at port 3 \geq Pressure at port 2 \geq Pressure at port 1

Orifice diameter (mm)	Model	Max. operating pressure differential ^{Note 2)} (MPa)			Flow rate characteristics ^{Note 1)}		Max. system pressure ^{Note 2)} (MPa)
		N.C.	N.O.	COM.	Kv	Cv converted	
1.5	VX311□-00	1	1	0.7	0.07	0.08	2.0
	VX312□-00	0.7	0.5	0.4	0.14	0.16	
2.2	VX322□-00	1.2	1	0.7	0.16	0.19	
	VX332□-00	1.6	1.6	1			
3	VX313□-00	0.3	0.3	0.2	0.21	0.24	
	VX323□-00	0.6	0.5	0.3	0.28	0.33	
	VX333□-00	1	0.9	0.6			
4	VX324□-00	0.3	0.25	0.2	0.43	0.50	
	VX334□-00	0.5	0.4	0.3			

Note 1) The flow rate characteristics of this product have variations.

When the highly precise flow control is required according to the system to be used, select an orifice diameter 1.3 times larger than that shown above and install a restrictor on the downstream side of the solenoid valve to make the adjustment.

Note 2) Refer to "Glossary of Terms" on page 403 for details on the max. operating pressure differential and the max. system pressure.

Fluid and Ambient Temperature

Power source	Fluid temperature (°C)		Ambient temperature (°C)
	Solenoid valve option (Symbol)		
	A	D	
AC	-5 ^{Note)} to 60	-5 ^{Note)} to 120	-20 to 60
DC	-5 ^{Note)} to 40	—	-20 to 40

Note) Dynamic viscosity: 50 mm²/s or less

Valve Leakage Rate

Internal Leakage / External Leakage

Seal material	Max. operating pressure differential	Leakage rate (Oil)
FKM	From 0 to less than 1 MPa	0.1 cm ³ /min or less
	1 MPa or more	0.2 cm ³ /min or less



How to Order (Solenoid Valve for Manifold)

DC, AC/Class H coil **VX 31 1 1 A** **00-5 G 1**

AC/Class B coil (Built-in full-wave rectifier type) **VX 31 1 1 A** **00-1 G R 1**

Model Refer to Table (1) shown below for availability.

Orifice diameter Refer to Table (1) shown below for availability.

Valve / Body type

1	N.C. / Manifold
3	N.O. / Manifold
5	COM. / Manifold

Solenoid valve option Refer to Table (2) shown below for availability.

Rated voltage

1	100 VAC 50/60 Hz	6	12 VDC
2	200 VAC 50/60 Hz	7	240 VAC 50/60 Hz
3	110 VAC 50/60 Hz	8	48 VAC 50/60 Hz
4	220 VAC 50/60 Hz	J	230 VAC 50/60 Hz
5	24 VDC		

Suffix

Nil	—
Z	Oil-free spec.

* Refer to Table (3) shown below for availability.
Refer to page 401 for ordering coil only.

Electrical entry

G - Grommet
GS - With grommet surge voltage suppressor

C - Conduit

D - DIN terminal
DS - DIN terminal with surge voltage suppressor
DL - DIN terminal with light surge voltage suppressor and light
DZ - DIN terminal with surge voltage suppressor and light
DO - For DIN terminal (without connector, gasket is included).

T - With conduit terminal
TS - With conduit terminal and surge voltage suppressor
TL - With conduit terminal and light
TZ - With conduit terminal, surge voltage suppressor and light

* DIN type is available with class B only.

- VX2
- VXK
- VXD
- VXZ
- VXS
- VXB
- VXE
- VXP
- VXR
- VXH
- VXF
- VX3
- VXA

How to Order Manifold Bases

VVX31
VVX32 **1** **07-1**
VVX33

Manifold base

Suffix

Nil	—
Z	Oil-free spec.

Number of manifolds

02	2 stations
:	:
10	10 stations

Port size (Individual port)

1	Rc 1/8
2	Rc 1/4

* Common port sizes are all Rc 1/4.
** Indicating numbers shown below are for common ports.

Type	SUP port	EXH port
N.C.	1	3
N.O.	3	1

Blanking plate part no.

For VX31: **VVX31-4A-F**
For VX32/33: **VVX32-4A-F**

Seal material: FKM

How to Order Manifold Assemblies (Example)

Enter the valve and blanking plate to be mounted under the manifold base part number.

Example
VVX311-05-1 1 set
* VX3111A-00-1GR1 .. 4 sets
* VVX31-4A-F 1 set

*" is the symbol for mounting.
Add an "*" in front of the part numbers for solenoid valves, etc. to be mounted.

Enter the product's part number in order, counting the 1st station from the left in the manifold arrangement, when viewing the individual port in front.

The common port on the right side is plugged.

Table (1) Model/Orifice/Diameter

Solenoid valve model	Orifice symbol (Diameter)			
	1 (1.5 mm)	2 (2.2 mm)	3 (3 mm)	4 (4 mm)
VX31	●	●	●	—
VX32	—	●	●	●
VX33	—	●	●	●

Table (2) Solenoid Valve Option

Option symbol	Main valve poppet	Fixed sealant	Body material/ Shading coil material	Guide pin material	Coil insulation type
A	FKM	FKM	Brass (C37)	PPS	B
D			Brass (C37)/Cu	Stainless steel	H

* Aluminum is only available as a material for the manifold base.

Table (3) Rated Voltage – Electrical Entry – Electrical Option

Rated voltage		Class B			Class H			
AC/ DC	Voltage symbol	Voltage	With surge voltage suppressor	With light	With light and surge voltage suppressor	With surge voltage suppressor	With light	With light and surge voltage suppressor
AC	1	100 V	●	●	●	●	●	●
	2	200 V	●	●	●	●	●	
	3	110 V	●	●	●	●	●	
	4	220 V	— (Note)	●	— (Note)	●	●	●
	7	240 V	—	—	—	●	—	—
	8	48 V	—	—	—	●	—	—
DC	J	230 V	—	—	—	—	—	—
	5	24 V	●	●	●	DC specification is not available.		
	6	12 V	—	—	—	DC specification is not available.		

Note) Option S, Z are not available as surge voltage suppressor is integrated into the AC/Class B coil, as a standard.

VX31/32/33 Series

For Steam /Single Unit

Model / Valve Specifications

COM.

Symbol

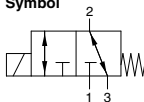

Port size	Orifice diameter (mmø)	Model	Max. operating pressure differential ^{Note 3)} (MPa)		Flow rate characteristics ^{Note 1)}		Max. system pressure ^{Note 3)} (MPa)	Weight ^{Note 2)} (g)
			COM.		Kv	Cv converted		
1/8 (6A)	1.5	VX3114-01	0.7		0.07	0.08	1.0	380
	2.2	VX3124-01	0.4		0.14	0.16		
	3	VX3134-01	0.2		0.21	0.24		
1/4 (8A)	1.5	VX3114-02	0.7		0.07	0.08		
		VX3124-02	0.4		0.14	0.16		
		VX3224-02	0.7		0.16	0.19		
	VX3324-02	1						
	3	VX3134-02	0.2	0.21	0.24			
		VX3234-02	0.3					
VX3334-02		0.6	0.28	0.33				
4	VX3244-02	0.2		0.43	0.50			
	VX3344-02	0.3						
	VX3224-03	0.7				0.16	0.19	
3/8 (10A)	2.2	VX3324-03	1					
		VX3234-03	0.3		0.28			0.33
		VX3334-03	0.6					
4	VX3244-03	0.2		0.43		0.50		
	VX3344-03	0.3						

Note 1) The flow rate characteristics of this product have variations.

When the highly precise flow control is required according to the system to be used, select an orifice diameter 1.3 times larger than that shown above and install a restrictor on the downstream side of the solenoid valve to make the adjustment.

Note 2) Weight of grommet type. Add 10 g for conduit, 30 g for DIN terminal, and 60 g for conduit terminal type respectively.

Also, add 60 g for VX31□□, 80 g for VX32□□ and VX33□□ respectively for bracket option.

Note 3) Refer to "Glossary of Terms" on page 403, for details on the max. operating pressure differential and the max. system pressure.

Fluid and Ambient Temperature

Power source	Fluid temperature (°C)		Ambient temperature (°C)
	Solenoid valve option (Symbol)		
AC	S, Q		-20 to 60
	183		

Valve Leakage Rate

Internal Leakage

Seal material	Leakage rate (Air)
FFKM	150 cm ³ /min or less

External Leakage

Seal material	Leakage rate (Air)
PTFE	1 cm ³ /min or less



How to Order (Single Unit)

VX31 1 4 S - 01 - 1 G 1 -

Model
Refer to Table (1) shown below for availability.

Orifice diameter
Refer to Table (1) shown below for availability.

Valve / Body type
4 COM. / Single unit

Solenoid valve option
Refer to Table (2) shown below for availability.

Port size
Refer to Table (1) shown below for availability.

Thread type

Nil	Rc
T	NPTF
F	G*
N	NPT

* For connection, prepare a fitting compliant with ISO 16030 and JIS B 8674.

Rated voltage

1	100 VAC 50/60 Hz	7	240 VAC 50/60 Hz
2	200 VAC 50/60 Hz	8	48 VAC 50/60 Hz
3	110 VAC 50/60 Hz	J	230 VAC 50/60 Hz
4	220 VAC 50/60 Hz		

* Refer to Table (3) shown below for availability.

Suffix

Nil	—
Z	Oil-free spec.

Bracket

Nil	None
B	With bracket

* Bracket is neither mountable nor removable.

Electrical entry

G - Grommet
GS - With grommet surge voltage suppressor

C - Conduit

T - With conduit terminal
TS - With conduit terminal and surge voltage suppressor
TL - With conduit terminal and light
TZ - With conduit terminal, surge voltage suppressor and light

Refer to page 401 for ordering coil only.

* Refer to Table (3) for available combinations between each electrical option (S, L, Z) and rated voltage.

- VX2
- VXK
- VXD
- VXZ
- VXS
- VXB
- VXE
- VXP
- VXR
- VXH
- VXF
- VX3
- VXA

Table (1) Model/Orifice Diameter/Port Size

Model	Solenoid valve model			Orifice symbol (Diameter)			
	VX31	VX32	VX33	1 (1.5 mm)	2 (2.2 mm)	3 (3 mm)	4 (4 mm)
Port symbol (Port size)	01 (1/8)	—	—	●	●	●	—
	02 (1/4)	—	—	●	●	●	—
	—	02 (1/4)	02 (1/4)	—	—	—	●
—	03 (3/8)	03 (3/8)	—	●	●	●	—

Table (2) Solenoid Valve Option

Option symbol	Seal material		Body material/ Shading coil material	Guide pin material	Coil insulation type
	Main valve poppet	Fixed sealant			
S	FFKM	PTFE	Brass (C37)/Cu	Stainless steel	H
Q			Stainless steel/Ag		

Solenoid coil: AC/Class H only

Table (3) Rated Voltage – Electrical Option

Rated voltage			Class H		
AC/DC	Voltage symbol	Voltage	S	L	Z
			With surge voltage suppressor	With light	With light and surge voltage suppressor
AC	1	100 V	●	●	●
	2	200 V	●	●	●
	3	110 V	●	●	●
	4	220 V	●	●	●
	7	240 V	●	—	—
	8	48 V	●	—	—
DC	J	230 V	●	—	—
	5	24 V	DC specification is not available.		
	6	12 V	DC specification is not available.		

For Vacuum Pad / Single Unit VXV31/32/33 Series

- Vacuum circuit side is suited for a large orifice. Supply pressure side is suited for high pressure and a vacuum pad.
- Construction and dimensions are the same as the VX3 series.

Model / Valve Specifications

N.C.

N.O.

Symbol (example)

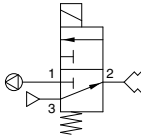

Symbol (example)

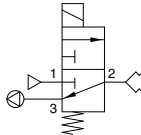

Port size	Orifice diameter (mmø)		Model	Operating pressure*		Flow rate characteristics ^{Note 1)}						Max. system pressure ^{Note 3)} (MPa)	Weight ^{Note 2)} (g)		
	Port 1 side	Port 3 side		Port 1 side	Port 3 side	Passage: 1↔2			Passage: 2↔3						
						C[dm ³ /(s·bar)]	b	Cv	C[dm ³ /(s·bar)]	b	Cv				
1/8 (6A)	3	1.5	VXV3130-01	Low vacuum	0 to 0.5	0.82	0.20	0.20	0.29	0.32	0.08	0.82	0.20	0.20	380
	1.5	3	VXV3132-01	0 to 0.5	Low vacuum	0.29	0.32	0.08	0.82	0.20	0.20				
	3	1.5	VXV3130-02	Low vacuum	0 to 0.5	0.82	0.20	0.20	0.29	0.32	0.08				
1/4 (8A)	1.5	3	VXV3132-02	0 to 0.5	Low vacuum	0.29	0.32	0.08	0.82	0.20	0.20				
	4	2.2	VXV3240-02	Low vacuum	0 to 0.5	1.6	0.20	0.38	0.64	0.40	0.17				
			VXV3340-02	0 to 0.9											
	2.2	4	VXV3242-02	0 to 0.5	Low vacuum	0.64	0.40	0.17	1.6	0.20	0.38				
		VXV3342-02	0 to 0.9												
3/8 (10A)	4	2.2	VXV3240-03	Low vacuum	0 to 0.5	1.6	0.20	0.38	0.64	0.40	0.17				
			VXV3340-03	0 to 0.9											
	2.2	4	VXV3242-03	0 to 0.5	Low vacuum	0.64	0.40	0.17	1.6	0.20	0.38				
			VXV3342-03	0 to 0.9											

Note 1) The flow rate characteristics of this product have variations.

When the highly precise flow control is required according to the system to be used, select an orifice diameter 1.3 times larger than that shown above and install a restrictor on the downstream side of the solenoid valve to make the adjustment.

Note 2) Weight of grommet type. Add 10 g for conduit, 30 g for DIN terminal, and 60 g for conduit terminal type respectively.

Also, add 60 g for VX31□□, 80 g for VX32□□ and VX33□□ respectively for bracket option.

Note 3) Refer to "Glossary of Terms" on page 403, for details on the max. system pressure.

* Low vacuum: Up to 1.3 x 10²Pa-abs

Fluid and Ambient Temperature

Power source	Fluid temperature (°C)	Ambient temperature (°C)
AC	-10 ^{Note)} to 60	-20 to 60
DC	-10 ^{Note)} to 60	-20 to 40

Note 1) Dew point temperature: -10°C or less

Valve Leakage Rate

Internal Leakage / External Leakage

Seal material	Leakage rate ^{Note)}
	Air
NBR, FKM	1 cm ³ /min or less

Note) Value when air pressure is applied.



How to Order (Single Unit)

DC

AC/Class B coil (Built-in full-wave rectifier type)

Model - Refer to Table (1) shown below for availability.

Orifice diameter - Refer to Table (1) shown below for availability.

Valve / Body type

0	N.C. / Single unit
2	N.O. / Single unit

Solenoid valve option - Refer to Table (2) shown below for availability.

Port size - Refer to Table (1) shown below for availability.

Suffix

Nil	—
Z	Oil-free spec.

Thread type

Nil	Rc
T	NPTF
F	G*
N	NPT

* For connection, prepare a fitting compliant with ISO 16030 and JIS B 8674.

Rated voltage

1	100 VAC 50/60 Hz	6	12 VDC
2	200 VAC 50/60 Hz	7	240 VAC 50/60 Hz
3	110 VAC 50/60 Hz	8	48 VAC 50/60 Hz
4	220 VAC 50/60 Hz	J	230 VAC 50/60 Hz
5	24 VDC		

* Refer to Table (3) shown below for availability.

Refer to page 401 for ordering coil only.

Bracket

Nil	None
B	With bracket

* Bracket is neither mountable nor removable.

Built-in full-wave rectifier type

Electrical entry

G - Grommet

GS - With grommet surge voltage suppressor

T - With conduit terminal

TS - With conduit terminal and surge voltage suppressor

TL - With conduit terminal and light

TZ - With conduit terminal, surge voltage suppressor and light

C - Conduit

DS - DIN terminal with surge voltage suppressor

DL - DIN terminal with light

DZ - DIN terminal with surge voltage suppressor and light

DO - For DIN terminal (without connector, gasket is included.)

* DIN type is available with class B only.

- VX2
- VXK
- VXD
- VXZ
- VXS
- VXB
- VXE
- VXP
- VXR
- VXH
- VXF
- VX3
- VXA

Table (1) Model/Orifice Diameter/Port Size

Model	Solenoid valve model			Orifice symbol (Diameter) ^{Note}	
	VXV31	VXV32	VXV33	3 (1.5/3 mm)	4 (2.2/4 mm)
Port symbol (Port size)	01 (1/8)	—	—	●	—
	02 (1/4)	—	—	●	—
	—	02 (1/4)	02 (1/4)	—	●
	—	03 (3/8)	03 (3/8)	—	●

Note) The orifice diameter shown above are for the supply pressure side/vacuum side port.

Table (2) Solenoid Valve Option

Option symbol	Seal material		Body material	Guide pin material	Coil insulation type
	Main valve poppet	Fixed sealant			
Nil	NBR	NBR	Brass (C37)	PPS	B
A	FKM	FKM			
G	NBR	NBR	Stainless steel		
H	FKM	FKM			

Table (3) Rated Voltage – Electrical Option

AC/DC	Rated voltage		Class B		
	Voltage symbol	Voltage	S With surge voltage suppressor	L With light	Z With light and surge voltage suppressor
AC	1	100 V	●	●	—
	2	200 V	●	●	—
	3	110 V	—	●	—
	4	220 V	— (Note)	●	— (Note)
	7	240 V	—	—	—
	8	48 V	—	—	—
DC	J	230 V	—	—	—
	5	24 V	●	●	●
	6	12 V	●	—	—

Note) Option S, Z are not available as surge voltage suppressor is integrated into the AC/Class B coil, as a standard.

* Class H coil is not available.

For Vacuum Pad / Manifold

VVXV31/32/33 Series

- Construction and dimensions are the same as those of the VVX3 series.



Model / Valve Specifications

N.C.

N.O.

Symbol (example)

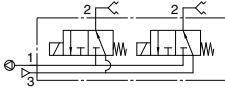

Symbol (example)

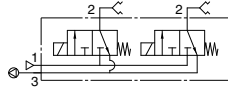

Orifice diameter (mmø)		Model	Operating pressure* (MPa)		Flow rate characteristics						(Note) Max. system pressure (MPa)
Port 1 side	Port 3 side		Port 1 side	Port 3 side	Passage: 1↔2			Passage: 2↔3			
					C[dm ³ /(s·bar)]	b	Cv	C[dm ³ /(s·bar)]	b	Cv	
3	1.5	VVXV3131-00	Low vacuum	0 to 0.5	0.82	0.20	0.20	0.29	0.32	0.08	2.0
1.5	3	VVXV3133-00	0 to 0.5	Low vacuum	0.29	0.32	0.08	0.82	0.20	0.20	
4	2.2	VVXV3241-00	Low vacuum	0 to 0.5	1.6	0.20	0.38	0.64	0.40	0.17	
		VVXV3341-00		0 to 0.9							
2.2	4	VVXV3243-00	0 to 0.5	Low vacuum	0.64	0.40	0.17	1.6	0.20	0.38	
		VVXV3343-00									

(Note) Refer to "Glossary of Terms" on page 403 for details on the max. system pressure.

* Low vacuum: Up to 1.3 x 10²Pa-abs

Fluid and Ambient Temperature

Power source	Fluid temperature (°C)	Ambient temperature (°C)
AC	-10 (Note) to 60	-20 to 60
DC	-10 (Note) to 60	-20 to 40

Note 1) Dew point temperature: -10°C or less

Valve Leakage Rate

Internal Leakage / External Leakage

Seal material	Leakage rate (Note)
	Air
NBR, FKM	1 cm ³ /min or less

(Note) Value when air pressure is applied.



How to Order (Solenoid Valve for Manifold)

DC **VXV 31 3 1** **-00-5 G 1**

AC/Class B coil (Built-in full-wave rectifier type) **VXV 31 3 1** **-00-1 G R 1**

Model Refer to Table (1) shown below for availability.

Orifice diameter Refer to Table (1) shown below for availability.

Valve / Body type

1	N.C. / Manifold
3	N.O. / Manifold

Solenoid valve option Refer to Table (2) shown below for availability.

Nil	—
Z	Oil-free spec.

Rated voltage

1	100 VAC 50/60 Hz	6	12 VDC
2	200 VAC 50/60 Hz	7	240 VAC 50/60 Hz
3	110 VAC 50/60 Hz	8	48 VAC 50/60 Hz
4	220 VAC 50/60 Hz	J	230 VAC 50/60 Hz
5	24 VDC		

Electrical entry

G - Grommet
GS - With grommet surge voltage suppressor

C - Conduit

T - With conduit terminal
TS - With conduit terminal and surge voltage suppressor
TL - With conduit terminal and light
TZ - With conduit terminal, surge voltage suppressor and light

D - DIN terminal
DS - DIN terminal with surge voltage suppressor
DL - DIN terminal with light
DZ - DIN terminal with surge voltage suppressor and light
DO - For DIN terminal (without connector, gasket is included.)

* DIN type is available with class B only.

* Refer to Table (3) shown below for availability.

Refer to page 401 for ordering coil only.

How to Order Manifold Bases

VVX31
VVX32 **1** **-07-1**
VVX33

Number of manifolds

02	2 stations
:	:
10	10 stations

Port size (Individual port)

1	Rc 1/8
2	Rc 1/4

** Common port sizes are all Rc 1/4.

** Indicating numbers shown below are for common ports.

Type	Vacuum side port	SUP side port
N.C.	1	3
N.O.	3	1

Manifold base

Blanking plate part no.

For VVX31: **VVX31-4A-**
For VVX32/33: **VVX32-4A-**

Seal material

Nil	NBR
F	FKM

How to Order Manifold Assemblies (Example)

Enter the valve and blanking plate to be mounted under the manifold base part number.

Example

- VVX311-05-1 1 set
- * VVX3131-00-1GR1.. 4 sets
- * VVX31-4A 1 set

"*" is the symbol for mounting.
Add an "*" in front of the part numbers for solenoid valves, etc. to be mounted.

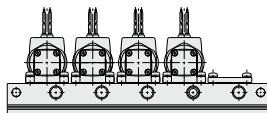

Enter the product's part number in order, counting the 1st station from the left in the manifold arrangement, when viewing the individual port in front.

The common port on the right side is plugged.

- VX2
- VXK
- VXD
- VXZ
- VXS
- VXB
- VXE
- VXP
- VXR
- VXH
- VXF
- VX3
- VXA

G - Grommet
GS - With grommet surge voltage suppressor

C - Conduit

T - With conduit terminal
TS - With conduit terminal and surge voltage suppressor
TL - With conduit terminal and light
TZ - With conduit terminal, surge voltage suppressor and light

D - DIN terminal
DS - DIN terminal with surge voltage suppressor
DL - DIN terminal with light
DZ - DIN terminal with surge voltage suppressor and light
DO - For DIN terminal (without connector, gasket is included.)

* DIN type is available with class B only.

* Refer to Table (3) for available combinations between each electrical option (S, L, Z) and rated voltage.
* Surge voltage suppressor is integrated into the AC/Class B coil, as a standard.

Table (1) Model/Orifice Diameter

Solenoid valve model	Orifice symbol (Diameter) ^(Note)	3 (1.5/3 mmø)	4 (2.2/4 mmø)
VVXV31		●	—
VVXV32		—	●
VVXV33		—	●

(Note) The orifice diameter shows the supply pressure side/vacuum side.

Table (2) Solenoid Valve Option

Option symbol	Seal material		Body material	Guide pin material	Coil insulation type
	Main valve poppet	Fixed sealant			
Nil	NBR	NBR	Brass (C37)	PPS	B
A	FKM	FKM			

* Aluminum is only available as a material for the manifold base.

Table (3) Rated Voltage - Electrical Option

Rated voltage			Class B		
AC/DC	Voltage symbol	Voltage	S With surge voltage suppressor	L With light	Z With surge voltage suppressor
AC	1	100 V	●	—	—
	2	200 V	●	—	—
	3	110 V	●	—	—
	4	220 V	— (Note)	●	— (Note)
	7	240 V	—	—	—
	8	48 V	—	—	—
DC	J	230 V	—	—	—
	5	24 V	●	●	●
	6	12 V	●	—	—

* Class H coil is not available.

(Note) Option S, Z are not available as surge voltage suppressor is integrated into the AC/Class B coil, as a standard.

VX31/32/33 Series

For Air, Water, Oil, Steam

Construction

Single unit

Body material: Brass (C37), Stainless steel

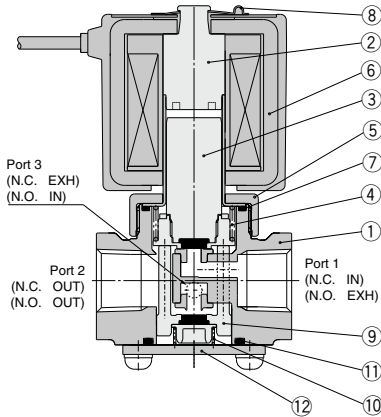

Component Parts

No.	Description	Material	
		Standard	Option
1	Body	Brass (C37)	Stainless steel
2	Tube assembly ^{Note)}	Stainless steel, Cu	Stainless steel, Ag
3	Armature assembly	Stainless steel, C36, PTFE (NBR)	Stainless steel, PTFE (FKM, EPDM, FFKM)
4	Return spring	Stainless steel	
5	Nut	Brass (C37)	Brass (C37)/Ni plated
6	Solenoid coil	Class B molded	Class H molded
7	O-ring	(NBR)	(FKM, EPDM, PTFE)
8	Clip	SK	
9	Guide pin assembly	PPS, C36 (NBR)	Stainless steel (FKM, EPDM, FFKM)
10	Support spring	Stainless steel	
11	O-ring	(NBR)	(FKM, EPDM, PTFE)
12	Plate	Stainless steel	

The materials in parentheses are the seal materials.

Note) Cu and Ag are not applicable to the DC spec and to the AC spec with built-in full-wave rectifier.

Manifold

Base material: Aluminum

Manifold body material: Brass (C37)

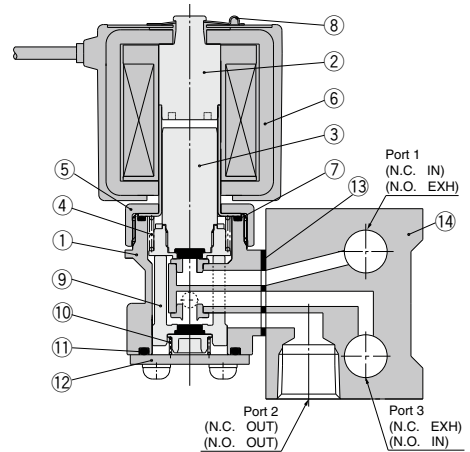

Component Parts

No.	Description	Material	
		Standard	Option
1	Manifold body	Brass (C37)	
2	Tube assembly ^{Note)}	Stainless steel, Cu	
3	Armature assembly	Stainless steel, C36, PTFE (NBR)	Stainless steel, PTFE (FKM, EPDM)
4	Return spring	Stainless steel	
5	Nut	Brass (C37)	Brass (C37)/Ni plated
6	Solenoid coil	Class B molded	Class H molded
7	O-ring	(NBR)	(FKM, EPDM)
8	Clip	SK	
9	Guide pin assembly	PPS, C36 (NBR)	Stainless steel (FKM, EPDM)
10	Support spring	Stainless steel	
11	O-ring	(NBR)	(FKM, EPDM)
12	Plate	Stainless steel	
13	Gasket	(NBR)	(FKM, EPDM)
14	Base	Aluminum	

The materials in parentheses are the seal materials.

Note) Cu is not applicable to the DC spec and to the AC spec with built-in full-wave rectifier.

Dimensions: Single Unit / Body Material: Brass (C37), Stainless Steel

Normally closed (N.C.) : VX31□0/VX32□0/VX33□0

Normally open (N.O.) : VX31□2/VX32□2/VX33□2

Common (COM.) : VX31□4/VX32□4/VX33□4

Grommet: G

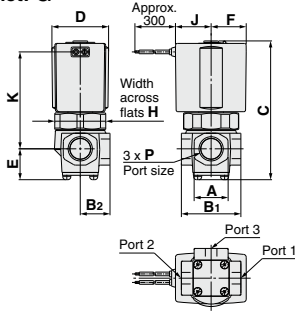

Conduit: C

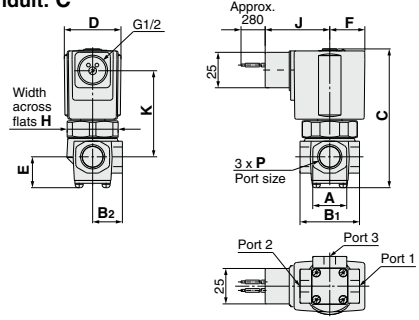

DIN terminal: D

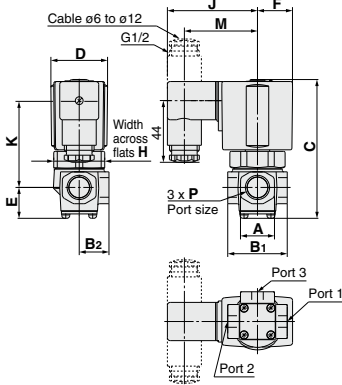

Conduit terminal: T

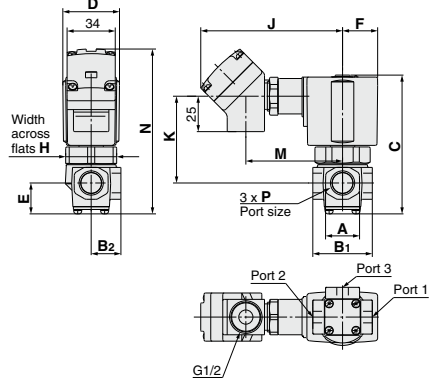

With bracket

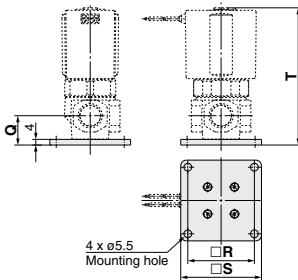

- VX2
- VXK
- VXD
- VXZ
- VXS
- VXB
- VXE
- VXP
- VXR
- VXH
- VXF
- VX3
- VXA

Model	Orifice diameter	Port size P	Electrical entry (AC/Class B)											
			Grommet						Conduit terminal					
			J	K	J	K	M	N	J	K	M	N		
N.C., N.O., COM.			J	K	J	K	M	N	J	K	M	N		
VX31□□	ø1.5, ø2.2, ø3	1/8	30	46	48.5	41	65.5	42	53.5	100.5	41	69.5	91.5	
VX31□□	ø1.5, ø2.2, ø3	1/4	33	56	51.5	51	68.5	52	56.5	103.5	51	72.5	105	
VX32□□	ø2.2, ø3, ø4	1/4, 3/8	36	64.5	54	59.5	71	60.5	59	106	59.5	75	113	
VX33□□	ø2.2, ø3, ø4	1/4, 3/8	36	64.5	54	59.5	71	60.5	59	106	59.5	75	113	

Model	Orifice diameter	Port size P	Electrical entry (DC, AC/Class H)												Bracket mounting								
			Grommet						Conduit terminal						Bracket mounting								
			J	K	J	K	M	N	J	K	M	N	Q	R	S	T							
N.C., N.O., COM.			J	K	J	K	M	N	J	K	M	N	Q	R	S	T							
VX31□□	ø1.5, ø2.2, ø3	1/8	22	36	18	76.5	30	19	19.5	27	40	42.5	58.5	42	46.5	92	42.5	61	93	17.5	40	50	75.5
VX31□□	ø1.5, ø2.2, ø3	1/4	24	41	20.5	90	35	22	22.5	32	43	52.5	61.5	52	49.5	95	52.5	64	106.5	21	47	57	89
VX32□□	ø2.2, ø3, ø4	1/4, 3/8	24	42	21	98	40	22	25	36	46	61	64	60.5	52	98	61	66.5	114.5	21	47	57	97
VX33□□	ø2.2, ø3, ø4	1/4, 3/8	24	42	21	98	40	22	25	36	46	61	64	60.5	52	98	61	66.5	114.5	21	47	57	97

VVX31/32/33 Series

For Air, Oil / Manifold

Dimensions: Manifold / Base Material: Aluminum

Normally closed (N.C.) :

Normally open (N.O.) : VVX31/VVX32/VVX33

Common (COM.) :

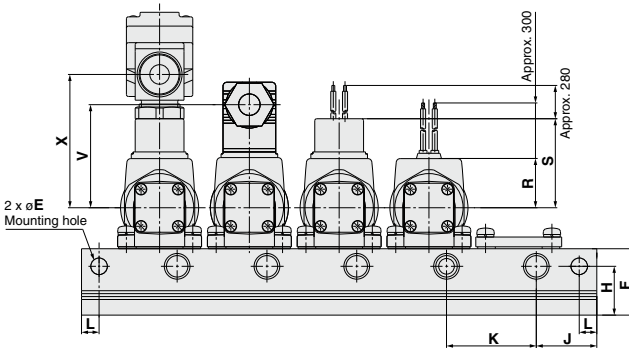
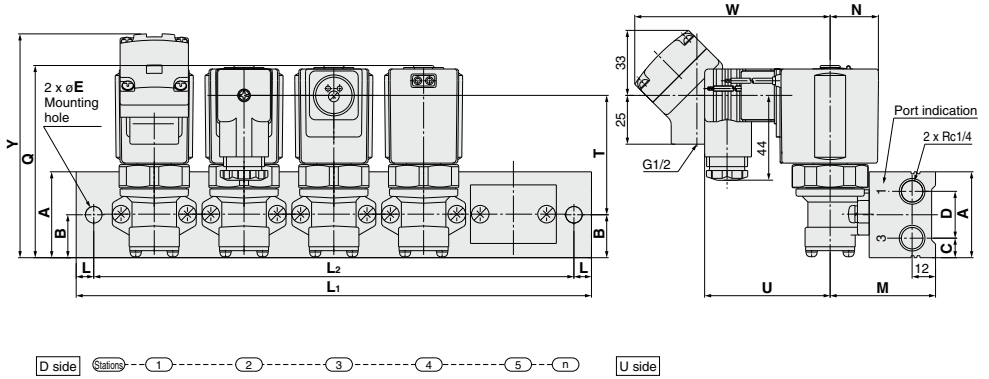

Model	Dimension	n (stations)								
		2	3	4	5	6	7	8	9	10
VVX31	L1	96	132	168	204	240	276	312	348	384
	L2	84	120	156	192	228	264	300	336	372
VVX32	L1	126	172	218	264	310	356	402	448	494
	L2	108	154	200	246	292	338	384	430	476

Model	A	B	C	D	E	F	H	J	K	L	M	N	Q	Electrical entry (DC, AC/Class H)								
														Grommet		Conduit		DIN terminal		Conduit terminal		
														R	S	T	T	U	V	W	X	Y
VVX31	40	20	9	22	6.5	33	24	26	36	6	49	19.5	80.5	19.5	40	45.5	45	58.5	46.5	92	61	97
VVX32	44	22	10	24	8.5	34	25	31	46	9	55	22.5	91	22.5	43	54	53.5	61.5	49.5	95	64	107.5
VVX33	44	22	10	24	8.5	34	25	31	46	9	55	25	99.5	25.5	46	62	61.5	64	52	98	66.5	116

Model	Electrical entry (AC/Class B)					
	Grommet		Conduit		DIN terminal	
	R	S	T	T	U	V
VVX31	30	48.5	44	45	65.5	53.5
VVX32	33	51.5	52.5	53.5	68.5	56.5
VVX33	36	54	60.5	61.5	71	59

Replacement Parts

• Solenoid coil assembly part no.

DC

VX02 1 N - 5 G

Series





1	VX31□□
2	VX32□□
3	VX33□□

Rated voltage (Note)

5	24 VDC
6	12 VDC

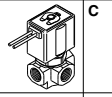
Note 1) Refer to Table (1) for available combinations.

Electrical entry

G - Grommet GS - With grommet surge voltage suppressor 	C - Conduit 
T - With conduit terminal TS - With conduit terminal and surge voltage suppressor TL - With conduit terminal and light TZ - With conduit terminal, surge voltage suppressor and light 	D - DIN terminal DS - DIN terminal with surge voltage suppressor DL - DIN terminal with light DZ - DIN terminal with surge voltage suppressor and light DO - For DIN terminal (without connector) 

* Refer to Table (1) for available combinations between each electrical option and rated voltage.

AC/Class B coil (Built-in full-wave rectifier type)

VX02 1 N - 1 GR

Series



1	VX31□□
2	VX32□□
3	VX33□□

Rated voltage (Note)

1	100 VAC 50/60 Hz
2	200 VAC 50/60 Hz
3	110 VAC 50/60 Hz
4	220 VAC 50/60 Hz
7	240 VAC 50/60 Hz
8	48 VAC 50/60 Hz
J	230 VAC 50/60 Hz

Note 1) Refer to Table (1) for available combinations.

Electrical entry

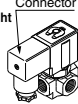
G - Grommet 	C - Conduit 
T - With conduit terminal TL - With conduit terminal and light 	D - DIN terminal DL - DIN terminal with light DO - For DIN terminal (without connector) 

* Refer to Table (1) for available combinations between each electrical option and rated voltage.

* Surge voltage suppressor is integrated into the AC/Class B coil, as a standard.

AC/Class H coil

VX02 1 N - 1 G - H - 2 - Z

Series



1	VX31□□
2	VX32□□
3	VX33□□

Rated voltage (Note)

1	100 VAC 50/60 Hz
2	200 VAC 50/60 Hz
3	110 VAC 50/60 Hz
4	220 VAC 50/60 Hz
7	240 VAC 50/60 Hz
8	48 VAC 50/60 Hz
J	230 VAC 50/60 Hz

Note 1) Refer to Table (1) for available combinations.

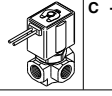
Electrical entry

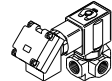
G - Grommet GS - With grommet surge voltage suppressor 	C - Conduit 
T - With conduit terminal TS - With conduit terminal and surge voltage suppressor TL - With conduit terminal and light TZ - With conduit terminal, surge voltage suppressor and light 	

* Refer to Table (1) for available combinations between each electrical option and rated voltage.

Table (1) Rated Voltage - Electrical Option

Rated voltage		Class B			Class H			
AC/DC	Voltage symbol	Voltage	S With surge voltage suppressor	L With light	Z With light and surge voltage suppressor	S With surge voltage suppressor	L With light	Z With light and surge voltage suppressor
AC	1	100 V	●	●	●	●	●	●
	2	200 V	●	●	●	●	●	
	3	110 V	●	●	●	●	●	
	4	220 V	—	—	—	●	●	●
	7	240 V	—	—	—	●	—	—
	8	48 V	—	—	—	●	—	—
	J	230 V	—	—	—	●	—	—
DC	5	24 V	●	●	●	DC specification is not available.		
	6	12 V	●	—	—	DC specification is not available.		

Note) Option S, Z are not available since a surge voltage suppressor is integrated into the AC/Class B coil, as a standard.

* When changing coils, AC/DC are not interchangeable with each other, and Class B and H coils are also not interchangeable with each other.

- VX2
- VXK
- VXD
- VXZ
- VXS
- VXB
- VXE
- VXP
- VXR
- VXH
- VXF
- VX3
- VXA

VX31/32/33 Series

For Air, Water, Oil, Steam

Replacement Parts

- Name plate part no.

AZ-T-VX Valve model
 ↑ Enter by referring to "How to Order".

- Clip part no.

For VX31: **VX021N-10**

For VX32: **VX022N-10**

For VX33: **VX023N-10**

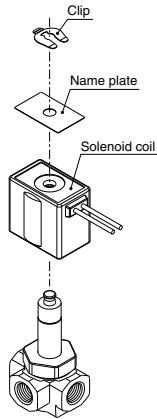

- DIN connector part no.

Without electrical option **3G-GDM2A**

With electrical option **GDM2A -**

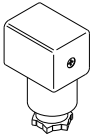

Electrical option

S	With surge voltage suppressor
L	With light
Z	With light and surge voltage suppressor

* Refer to Table (1) for available combinations between each electrical option (S, L, Z) and rated voltage.

Rated voltage

1	100 VAC, 110 VAC
2	200 VAC, 220 VAC, 230 VAC, 240 VAC
5	24 VDC
6	12 VDC
15	48 VAC

- Gasket part no. for DIN connector

VCW20-1-29-1

Glossary of Terms

Pressure Terminology

1. Maximum operating pressure differential

The maximum pressure differential (the difference between the inlet and outlet pressure) which is allowed for operation. When the outlet pressure is 0 MPa, this becomes the maximum operating pressure.

2. Minimum operating pressure differential

The minimum pressure differential (the difference between the inlet pressure and outlet pressure) required to keep the main valve fully opened.

3. Maximum system pressure

The maximum pressure that can be applied inside the pipelines (line pressure).

(The pressure differential of the solenoid valve portion must be less than the maximum operating pressure differential.)

4. Proof pressure

The pressure in which the valve must be withstood without a drop in performance after holding for one minute under prescribed pressure and returning to the operating pressure range. (value under the prescribed conditions)

Electrical Terminology

1. Apparent power (VA)

Volt-ampere is the product of voltage (V) and current (A). Power consumption (W); For AC, $W = V \cdot A \cdot \cos\theta$. For DC, $W = V \cdot A$. Note) $\cos\theta$ shows power factor. $\cos\theta = 0.6$

2. Surge voltage

A high voltage which is momentarily generated by shutting off the power in the shut-off area.

3. Enclosure

A degree of protection defined in the "JIS C 0920: Waterproof test of electric machinery/appliance and the degree of protection against the intrusion of solid foreign objects".

Verify the degree of protection for each product.

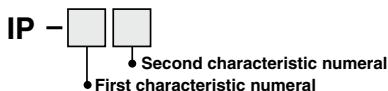

● First Characteristics:

Degrees of protection against solid foreign objects

0	Non-protected
1	Protected against solid foreign objects of 50 mm ϕ and greater
2	Protected against solid foreign objects of 12 mm ϕ and greater
3	Protected against solid foreign objects of 2.5 mm ϕ and greater
4	Protected against solid foreign objects of 1.0 mm ϕ and greater
5	Dust-protected
6	Dusttight

● Second Characteristics:

Degrees of protection against water

0	Non-protected	—
1	Protected against vertically falling water drops	Dripproof type 1
2	Protected against vertically falling water drops when enclosure tilted up to 15°	Dripproof type 2
3	Protected against rainfall when enclosure tilted up to 60°	Rainproof type
4	Protected against splashing water	Splashproof type
5	Protected against water jets	Low jetproof type
6	Protected against powerful water jets	Strong jetproof type
7	Protected against the effects of temporary immersion in water	Immersible type
8	Protected against the effects of continuous immersion in water	Submersible type

Example) IP65: Dusttight, Low jetproof type

"Low jetproof type" means that no water intrudes inside an equipment that could hinder from operating normally by means of applying water for 3 minutes in the prescribed manner. Take appropriate protection measures, since a device is not usable in an environment where a droplet of water is splashed constantly.

Others

1. Material

NBR: Nitrile rubber
FKM: Fluororubber
EPDM: Ethylene propylene rubber
PTFE: Polytetrafluoroethylene resin
FFKM: Perfluoroelastomer

2. Oil-free treatment

The degreasing and washing of wetted parts.

3. Passage symbol

In the symbol ($\frac{\text{IN}}{\text{OUT}}$) Port 1 (IN) and Port 2 (OUT) are shown in a blocked condition ($\frac{\text{---}}{\text{---}}$), but it is not possible to use the valve in cases of reverse pressure, where the Port 2 pressure is higher than the Port 1 pressure.

VX2

VXK

VXD

VXZ

VXS

VXB

VXE

VXP

VXR

VXH

VXF

VX3

VXA



VX3 Series

2/3 Port Solenoid Valves for Fluid Control Specific Product Precautions 1

Be sure to read this before handling the products. For detailed precautions on each series, refer to the main text.

Selection

⚠ Warning

1. Minimum operating pressure differential (VXED, VXP, VXR)

Select an appropriate valve size while referring to the solenoid valve flow rate characteristics.

⚠ Caution

1. Leakage voltage

When the solenoid valve is operated using the controller, etc., the leakage voltage should be the product allowable leakage voltage or less. Particularly when using a resistor in parallel with a switching element and using a C-R element (surge voltage suppressor) to protect the switching element, take note that leakage current will flow through the resistor, C-R element, etc., creating a possible danger that the valve may not turn off.

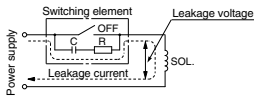

AC/Class B built-in full-wave rectifier coil: 10% or less of rated voltage (VX3: 5% or less)

AC/Class B/H coil: 20% or less of rated voltage

DC coil: 2% or less of rated voltage

2. Selecting options

The fluid handled will differ depending on the valve options. Select optimal options for the fluid.

3. When the fluid is oil.

Generally, FKM is used as seal material, as it is resistant to oil. The resistance of the seal material may deteriorate depending on the type of oil, manufacturer or additives. Check the resistance before using. The kinematic viscosity must not exceed 50 mm²/s. The special construction of the armature adopted in the built-in full-wave rectifier type gives an improvement in OFF response by providing clearance on the absorbed surface when it is switched ON. Select the DC spec. or AC spec. built-in full-wave rectifier type when the dynamic viscosity is higher than water or when the OFF response is prioritized.

Piping

⚠ Caution

1. If a regulator and valve are connected directly, they may vibrate together and cause chattering. Do not connect directly.
2. If the cross-sectional area of piping for the fluid supply side is restricted, operation will become unstable due to inadequate pressure differential during valve operation. Use piping size for the fluid supply side that is suited to the port size.
3. The behavior of the diaphragm valve becomes unstable under the conditions that the circuit flow rate is restricted to 40% or less of the maximum flow rate on the solenoid valve flow rate characteristics. This may cause unstable valve activation. So, select a solenoid valve with an appropriate flow rate size while carefully checking the circuit flow rate.

Wiring

⚠ Caution

1. As a rule, use electrical wire with a cross sectional area of 0.5 to 1.25 mm² for wiring. Furthermore, do not allow excessive force to be applied to the lines.
2. Use electrical circuits which do not generate chattering in their contacts.
3. Use voltage which is within $\pm 10\%$ of the rated voltage. In cases with a DC power supply where importance is placed on responsiveness, stay within $\pm 5\%$ of the rated value. The voltage drop is the value in the lead wire section connecting the coil.
4. When a surge from the solenoid affects the electrical circuitry, install a surge voltage suppressor, etc., in parallel with the solenoid. Or, adopt an option that comes with the surge voltage protection circuit. (However, a surge voltage occurs even if the surge voltage protection circuit is used.)

Operating Precautions

⚠ Warning

1. Make sure when using pilot type 2-port solenoid valves that the flow direction is from 1 (IN) to 2 (OUT). The valve is designed based on a flow direction of 1 (IN) to 2 (OUT) and harnesses the fluid pressure of port 1 (IN) when the valve opens or closes. If reverse pressure (2 (OUT) to 1 (IN)) is applied, it may lead to a reduced service life or cause damage to parts early on due to chattering or pulses from the main valve (diaphragm, piston, etc.). If there is a possibility that reverse pressure will be applied, take countermeasures by installing the check valve, etc. at the downstream side. When installing the check valve, allow ample space between the valve and the check valve. If it is placed near the valve, it may cause chattering and pulses in the main valve.



VX3 Series

2/3 Port Solenoid Valves for Fluid Control Specific Product Precautions 2

Be sure to read this before handling the products. For detailed precautions on each series, refer to the main text.

Electrical Connections

⚠ Caution

Grommet Class H coil: AWG18 Insulator O.D. 2.2 mm
Class B coil: AWG20 Insulator O.D. 2.5 mm

Rated voltage	Lead wire color	
	(1)	(2)
DC (Class B only)	Black	Red
100 VAC	Blue	Blue
200 VAC	Red	Red
Other AC	Gray	Gray

* There is no polarity.

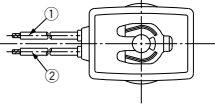

DIN terminal

Internal connections are as shown below. Make connections to the power supply accordingly.

Terminal no.	1	2
DIN terminal	+ (-)	- (+)

* There is no polarity.

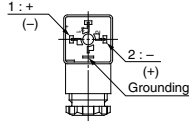

DIN (EN175301-803) Terminal

This DIN terminal corresponds to the Form A DIN connector with an 18 mm terminal pitch, which complies with EN175301-803B.

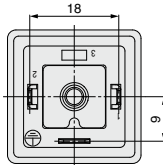

Disassembly

- After loosening the binding head screw with flange, then if the housing is pulled in the direction of the arrow, the connector will be removed from the solenoid valve.
- Pull out the binding head screw with flange from the housing.
- There is a cutout on the bottom of the terminal block. Insert a small flat head screwdriver, etc. into this cutout, and remove the terminal block from the housing. (See figure below.)
- Remove the ground nut, and pull out the washer and the rubber seal.

Wiring

- Pass the cable through the ground nut, washer and rubber seal in this order, and insert these parts into the housing.
- Loosen the binding head screw of the terminal block, then insert the core wire or the crimped terminal of the lead wire into the terminal, and securely fix it with the binding head screw. The binding head screw of the terminal block is M3.
Note 1) Tighten the screw to a torque of between 0.5 and 0.6 N·m.
Note 2) Cable O.D.: $\phi 6$ to $\phi 12$ mm
Note 3) For an outside cable diameter of $\phi 9$ to 12 mm, remove the internal parts of the rubber seal before using.

⚠ Caution

Assembly

- Pass the cable through the ground nut, washer, rubber seal and the housing in this order, and connect to the terminal block. Then, set the terminal block inside the housing. (Push in the terminal block until it snaps into position.)
- Insert the rubber seal and the washer in this order into the cable entry of the housing, and then tighten the ground nut securely.
- Insert the gasket between the bottom part of the terminal block and the plug attached to the equipment, and then insert the binding head screw with flange from the top of the housing, and tighten it.
Note 1) Tighten the screw to a torque of between 0.5 and 0.6 N·m.
Note 2) The orientation of the connector can be changed in steps of 90° by changing the method of assembling the housing and the terminal block.

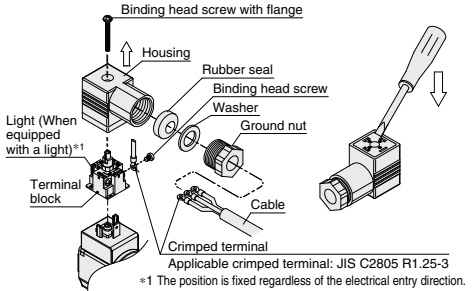

Conduit terminal

Make connections according to the marks shown below.

- Use the tightening torques below for each section.
- Properly seal the terminal connection (G1/2) with the special wiring conduit, etc.

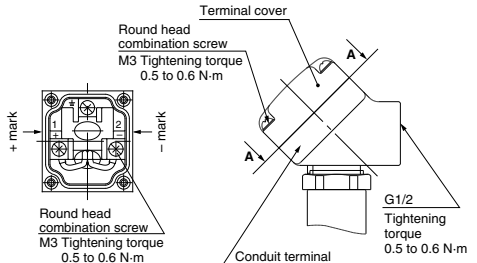

View A-A

(Internal connection diagram)

Disassembly

- Loosen the mounting screw, and remove the terminal cover from the conduit terminal.

Wiring

- Insert the cable into the conduit terminal.
- Loosen the screw with UP terminal of the conduit terminal, then insert the core wire or the crimped terminal of the lead wire into the terminal, and securely fix it with the screw with UP terminal.
Note 1) Tighten the screw to a torque of between 0.5 and 0.6 N·m.

VX2

VXK

VXD

VXZ

VXS

VXB

VXE

VXP

VXR

VXH

VXF

VX3

VXA



VX3 Series

2/3 Port Solenoid Valves for Fluid Control Specific Product Precautions 3

Be sure to read this before handling the products. For detailed precautions on each series, refer to the main text.

Electrical Connections

⚠ Caution

Assembly

1. Insert the gasket into the conduit terminal, and then clamp the terminal cover with the mounting screw.
 Note 1) Tighten the screw to a torque of between 0.5 and 0.6 N·m.
 Note 2) When changing the orientation of the conduit terminal, carry out the following procedure.
 1. Apply a tool (monkey wrench, spanner, etc.) to the width across flats of the conduit terminal, and turn the terminal in the counterclockwise direction.
 2. Loosen the lock nut.
 3. Turn the conduit terminal in the clamping direction (clockwise direction) to about 15° ahead of the desired position.
 4. Turn the lock nut by hand to the coil side until it is lightly tightened.
 5. Apply a tool to the width across flats of the conduit terminal, and turn it to the desired position (through an angle of about 15°) so as to clamp the conduit terminal.
- Note: When changing the orientation by applying additional tightening force to the conduit terminal from the factory-set position, turn no more than one half a turn.

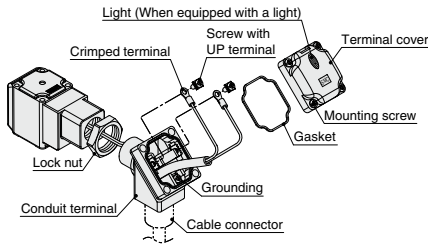

Conduit

When used as an IP65 equivalent, use seal (part no. VCW20-15-6) to install the wiring conduit. Also, use the tightening torque below for the conduit.

Class H coil: AWG18 Insulator O.D. 2.2 mm
 Class B coil: AWG20 Insulator O.D. 2.5 mm

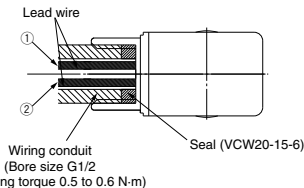

Tightening torque 0.5 to 0.6 N·m)

Rated voltage	Lead wire color	
	①	②
DC	Black	Red
100 VAC	Blue	Blue
200 VAC	Red	Red
Other AC	Gray	Gray

* There is no polarity for DC.

Description	Part no.
Seal	VCW20-15-6

Note) Please order separately.

Electrical Circuits

⚠ Caution

[DC circuit]

Grommet, Conduit, Conduit terminal, DIN type

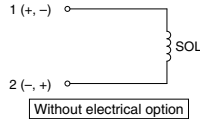

Grommet, Conduit terminal, DIN type

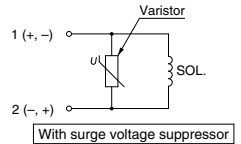

Conduit terminal, DIN type

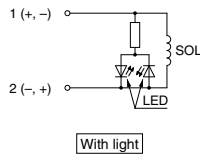

Conduit terminal, DIN type

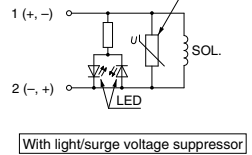

[AC, Class B (Built-in full wave rectifier type) Circuit]

* For AC/Class B, the standard product is equipped with surge voltage suppressor.

Grommet, Conduit, Conduit terminal, DIN type

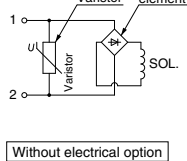

Conduit terminal, DIN type

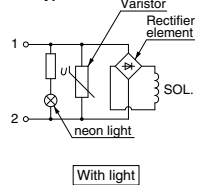

[AC, Class B/H Circuit]

Grommet, Conduit, Conduit terminal

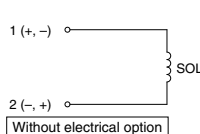

Grommet, Conduit terminal

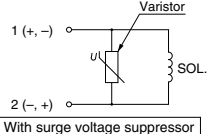

Conduit terminal

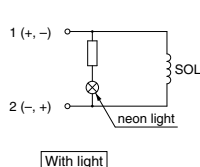

Conduit terminal

