

5 Port Solenoid Valve

SZ3000 Series

Rubber Seal Cassette Type Manifold



The plug-in cassette system makes valve replacement easy.

A plug-in manifold has been created with a height of 43.5 mm (including DIN rail). Valve replacement can be performed easily. Moreover, since spare terminates for wiring (receptacle housings) are contained inside the manifold, terminal changes (additions) can be performed quickly and easily. (The number of additional stations is limited by the manifold specifications. For details, refer to page 263.)

Valves equipped with switches

Adjustment and maintenance of equipment can be performed with greater safety, since the power to each valve can be shut off individually with built-in switches.

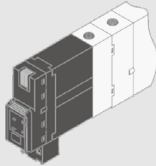

High speed response of 10 ms

(SZ3000 double, 0.5 MPa
24 VDC, Without surge voltage suppressor)

Low power consumption and a faster response time of 10 ms are obtained with a unique pilot valve construction.

Low power consumption: 0.6 W

(Current draw: 25 mA at 24 VDC)

Low power consumption enables direct operation by a PLC. Cost savings are realized through the use of a smaller power supply and the elimination of relay cards.

Easy attaching/detaching of the tubing

The interval between ports A and B is a wide 20.5 mm, allowing easy changes of fittings and tubing.

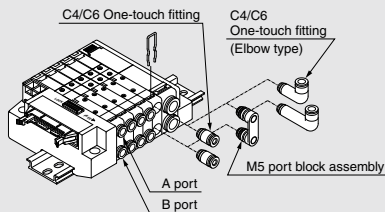

High reliability and long service life exceeding 50 million cycles or more

High reliability and long service life have been achieved with guide ring construction which prevents eccentricity of the main valve, and a return piston with increased return force. (Single and double solenoid type)

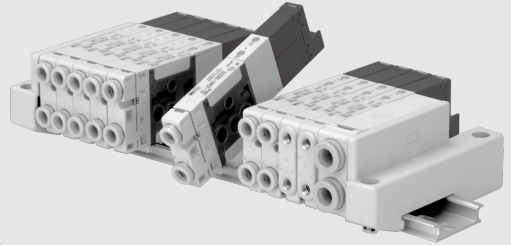

The connector entry direction can be changed from top to side with a simple operation.

Switch for locking a connector

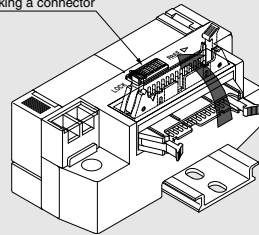

SV
SYJ
SZ
VF
VP4
VQ 1/2
VQ 4/5
VQC 1/2
VQC 4/5
VQZ
SQ
VFS
VFR
VQ7

Plug-in Type		P. 250
Non Plug-in Type		P. 269
EX140/Serial transmission system		P. 276
EX510/Serial transmission system		P. 280
PC Wiring system		P. 284

5 Port Solenoid Valve

SZ3000 Series

Plug-in Type



An order for a manifold base only is not acceptable. Please order the solenoid valves for mounting at the same time while referring to the ordering example.

How to Order

● Plug-in manifold with power supply terminals

SS5Z3 - 60 **F** **D** **1** - **05** **U** **□** **□** - **P** - **□** - **□**

● Connector type

F: D-sub connector (25 pins)

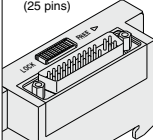

P: Flat ribbon cable (26 pins)

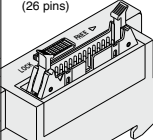

PG: Flat ribbon cable (20 pins)

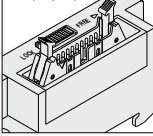

PH: Flat ribbon cable (10 pins)

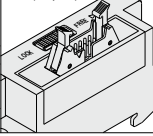

SUP/EXH block mounting position

U	U side (2 to 10 stations)
D	D side (2 to 10 stations)
B	Both sides (2 to 20 stations)
M	Special specifications

* For special specifications, indicate separately by the manifold specification sheet.

Note) A total of up to 3 SUP/EXH blocks can be mounted. Please contact SMC if 4 or more will be mounted.

Pilot type

Nii	Internal pilot
R	External pilot

● CE-compliant

Nii	—
Q	CE-compliant

● Option

When a longer DIN rail is desired than the specified stations, specify the station number to be required.

● Power supply terminals

Symbol	Specifications
P	24 VDC, Positive common
P12	12 VDC, Positive common
N	24 VDC, Negative common
N12	12 VDC, Negative common

● SUP/EXH block fitting specifications

Nii	Straight
L	Elbow fittings (Upward)
B	Elbow fittings (Downward)

● Valve stations

F: D-sub connector

Symbol	Stations	Note
02	2 stations	Double wiring specifications ⁽¹⁾
⋮	⋮	
10	10 stations	
02	2 stations	Specified layout ⁽²⁾ (Up to 21 solenoids possible)
⋮	⋮	
20	20 stations	

P: Flat ribbon cable connector (26 pins)

Symbol	Stations	Note
02	2 stations	Double wiring specifications
⋮	⋮	
11	11 stations	
02	2 stations	Specified layout (Up to 22 solenoids possible)
⋮	⋮	
20	20 stations	

Connector mounting position

Symbol	Mounting position
D	D side

Connector entry direction

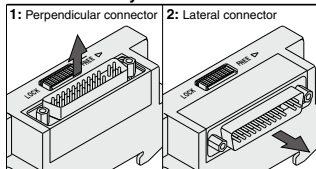

PG: Flat ribbon cable connector (20 pins)

Symbol	Stations	Note
02	2 stations	Double wiring specifications
⋮	⋮	
08	8 stations	
02	2 stations	Specified layout (Up to 16 solenoids possible)
⋮	⋮	
16	16 stations	

PH: Flat ribbon cable connector (10 pins)

Symbol	Stations	Note
02	2 stations	Double wiring specifications
⋮	⋮	
04	4 stations	
02	2 stations	Specified layout (Up to 8 solenoids possible)
⋮	⋮	
08	8 stations	

Note 1) Double wiring specifications: Single, double, 3 position and 4 position solenoid valves can be used at all of the manifold stations.

Note 2) Specified layout: Indicate wiring specifications on a manifold specification sheet.

(Please note that in locations where single solenoid wiring is indicated, it will be impossible to use double or 3 position/4 position valves.)



How to Order

● Plug-in manifold without power supply terminals

SS5Z3 - 60 F D 1 - 05 U □ □ - □ □ - □ □

● Connector type

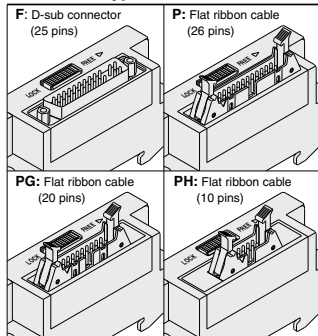

Connector mounting position

Symbol	Mounting position
D	D side

Connector entry direction

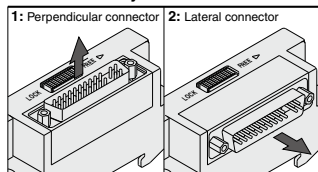

● CE-compliant

Nii	—
Q	CE-compliant

● Option

When a longer DIN rail is desired than the specified stations, specify the station number to be required.

● SUP/EXH block fitting specifications

Nii	Straight
L	Elbow fittings (Upward)
B	Elbow fittings (Downward)

● Pilot type

Nii	Internal pilot
R	External pilot

SUP/EXH block mounting position

U	U side (2 to 10 stations)
D	D side (2 to 10 stations)
B	Both sides (2 to 20 stations)
M*	Special specifications

* For special specifications, indicate separately by the manifold specification sheet.

Note) A total of up to 3 SUP/EXH blocks can be mounted. Please contact SMC if 4 or more will be mounted.

● Valve stations

F: D-sub connector

Symbol	Stations	Note
02	2 stations	Double wiring specifications ⁽¹⁾
⋮	⋮	
12	12 stations	Specified layout ⁽²⁾ (Up to 24 solenoids possible)
02	2 stations	
⋮	⋮	
20	20 stations	

P: Flat ribbon cable connector (26 pins)

Symbol	Stations	Note
02	2 stations	Double wiring specifications
⋮	⋮	
12	12 stations	Specified layout (Up to 25 solenoids possible)
02	2 stations	
⋮	⋮	
20	20 stations	

PG: Flat ribbon cable connector (20 pins)

Symbol	Stations	Note
02	2 stations	Double wiring specifications
⋮	⋮	
09	9 stations	Specified layout (Up to 19 solenoids possible)
02	2 stations	
⋮	⋮	
19	19 stations	

PH: Flat ribbon cable connector (10 pins)

Symbol	Stations	Note
02	2 stations	Double wiring specifications
⋮	⋮	
04	4 stations	Specified layout (Up to 9 solenoids possible)
02	2 stations	
⋮	⋮	
09	9 stations	

Note 1) Double wiring specifications: Single, double, 3 position and 4 position solenoid valves can be used at all of the manifold stations.

Note 2) Specified layout: Indicate wiring specifications on a manifold specification sheet.

(Please note that in locations where single solenoid wiring is indicated, it will be impossible to use double or 3 position/4 position valves.)

SV
SYJ
SZ
VF
VP4
VQ 1/2
VQ 4/5
VQC 1/2
VQC 4/5
VQZ
SQ
VFS
VFR
VQ7

● **How to order solenoid valves** For plug-in (Common for both with and without power supply terminals)

SZ3 **1** **60** **-** **5** **LOZ** **-** **C6** **-** **-** **-**

Type of actuation ●

1	<p>2 position single solenoid</p>
2	<p>2 position double solenoid</p>
3	<p>3 position closed center</p>
4	<p>3 position exhaust center</p>
5	<p>3 position pressure center</p>
A	<p>4 position dual 3 port valve: N.C./N.C.</p>
B	<p>4 position dual 3 port valve: N.O./N.O.</p>
C	<p>4 position dual 3 port valve: N.C./N.O.</p>

● **Rated voltage**

5	24 VDC
6	12 VDC

- When using on a manifold with power supply terminals, be sure to match with the manifold's voltage specifications.

● **Back pressure check valve**

Nil	None
K	Built-in

- The built-in back pressure check valve type has an effective area approximately 20% smaller.
- The 3 position valve is not available with back pressure check valve.

● **Pilot type**

Nil	Internal pilot
R	External pilot

- The 4 position dual 3 port valve is not available with external pilot specifications.

● **Rated voltage**

Nil: Without switch

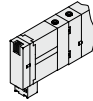

J: With switch

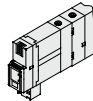

* For switch operation, refer to page 289.

● **Common specifications**

Nil	Positive common
N	Negative common

- When using on a manifold with power supply terminals, be sure to match with the manifold's common specifications.

● **Manual override**

Nil: Non-locking push type

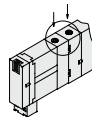

D: Push-turn locking slotted type

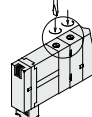

● **CE-compliant**

Nil	—
Q	CE-compliant

● **Made to Order**

Nil	—
X90	Main Valve Fluororubber Specifications (Refer to page 288)

● **A, B port size**

C4: One-touch fitting for ø4
C6: One-touch fitting for ø6



M5: M5 x 0.8



Elbow fitting assembly (Upward)
L4: ø4 elbow fitting assembly
L6: ø6 elbow fitting assembly



Elbow fitting assembly (Downward)
B4: ø4 elbow fitting assembly
B6: ø6 elbow fitting assembly

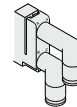

How to Order Valve Manifold Assembly



Ordering example (SZ3000, positive common with power supply terminals)

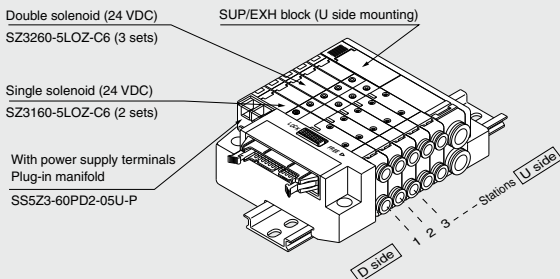

SS5Z3-60PD2-05U-P 1 set (Manifold part number)
 * SZ3160-5LOZ-C6 2 sets (Single solenoid part no.)
 * SZ3260-5LOZ-C6 3 sets (Double solenoid part no.)

The asterisk denotes the symbol for assembly. Prefix it to the part no. of the solenoid valve, etc.

Stations are counted from D side as the 1st one. Indicate the valves to be attached below the manifold part number, in order starting from station 1 as shown in the drawing. When entry of part numbers becomes complicated, indicate on the manifold specification sheet.

Made to Order
 (Refer to page 288 for details.)

Manifold Specifications

Model	D-sub connector Type 60F	Flat ribbon cable type 60P□		
		Type 60P	Type 60PG	Type 60PH
Manifold	Plug-in type			
1 (P: SUP), 3/5 (R: EXH) system	Common SUP, EXH			
Valve stations (With power terminal)	2 to 20 stations		2 to 16 stations	2 to 8 stations
Applicable connector	D-sub connector Conforming to MIL-C-24308 JIS-X-5101	Flat ribbon cable connector Socket: 26 pins MILL type with strain relief Conforming to MIL-C-83503	Flat ribbon cable connector Socket: 20 pins MILL type with strain relief Conforming to MIL-C-83503	Flat ribbon cable connector Socket: 10 pins MILL type with strain relief Conforming to MIL-C-83503
Internal wiring	+ COM, - COM			
4 (A), 2 (B) port	Location	Valve		
Porting specification	Direction	Lateral, Upward, Downward		
Port size	1 (P), 3/5 (R) port	C8		
	4 (A), 2 (B) port	C4, C6, M5		
Weight W (g) ⁽²⁾ (n1: Stations n2: Number of SUP/EXH blocks m: Weight of DIN rail)	W = 3.2n1 + 53n2 + m + 126.5			

Note 1) In cases such as those where many valves are operated simultaneously, use type B (double side SUP/EXH), applying pressure to the 1(P) ports on both sides and exhausting from the 3(R) ports on both sides.

Note 2) The weight W is the value for the D-sub connector manifold with power supply terminals only. To obtain the weight with solenoid valves attached, add the solenoid valve weights given on page 256 for the appropriate number of stations. For DIN rail weight, refer to page 254.

Flow Rate Characteristics

Port size		Flow rate characteristics					
1, 5, 3 (P, EA, EB)	4, 2 (A, B)	1→2/4 (P→A/B)			4/2→3 (A/B→R)		
		C [dm ³ /(s·bar)]	b	Cv	C [dm ³ /(s·bar)]	b	Cv
C8	C4	0.58 [0.49]	0.26 [0.36]	0.14 [0.13]	0.76 [0.65]	0.15 [0.20]	0.18 [0.15]
	C6	0.73 [0.64]	0.24 [0.27]	0.18 [0.16]	0.77 [0.74]	0.19 [0.16]	0.19 [0.19]
	M5	0.60 [0.57]	0.38 [0.35]	0.17 [0.15]	0.67 [0.58]	0.16 [0.39]	0.16 [0.16]

Note) • The value is for manifold base with 5 stations and individually operated 2 position type.

• Values inside [] are for 4 position dual 3 port valves.

SV
 SYJ
SZ
 VF
 VP4
 VQ
 1/2
 VQ
 4/5
 VQC
 1/2
 VQC
 4/5
 VQZ
 SQ
 VFS
 VFR
 VQ7

Solenoid Valve Specifications

Series		SZ3000	
Fluid		Air	
Internal pilot operating pressure range (MPa)	2 position single	0.15 to 0.7	
	2 position double	0.1 to 0.7	
	3 position	0.2 to 0.7	
	4 position dual 3 port valve	0.15 to 0.7	
External pilot operating pressure range (MPa)	Operating pressure range		
	-100 kPa to 0.7		
	Pilot pressure range	2 position single	0.25 to 0.7
		2 position double	0.25 to 0.7
3 position		0.25 to 0.7	
Ambient and fluid temperature (°C)		-10 to 50 (No freezing)	
Max. operating frequency (Hz)	2 position single, double	10	
	4 position dual 3 port valve		
	3 position	3	
Manual override (Manual operation)		Non-locking push type, Push-turn locking slotted type	
Pilot type		Common exhaust type for main and pilot valve	
Lubrication		Not required	
Mounting orientation		Unrestricted	
Impact/Vibration resistance m/s ² (Note)		150/30	
Enclosure		Dust-protected	

Note) Impact resistance: No malfunction occurred when it is tested with a drop tester in the axial direction and at the right angles to the main valve and armature in both energized and de-energized states every once for each condition. (Values at the initial period)

Vibration resistance: No malfunction occurred in a one-sweep test between 45 and 2000 Hz. Test was performed at both energized and de-energized states in the axial direction and at the right angles to the main valve and armature. (Values at the initial period)

Solenoid Specifications

Electrical entry	L type (For plug-in), M type plug connector (M)
Rated coil voltage (V) (Note)	24, 12 VDC
Allowable voltage fluctuation	±10% of rated voltage
Power consumption (W)	0.6 (With light: 0.65)
Surge voltage suppressor	Diode
Indicator light	LED

Note) Only 24 VDC and 12 VDC are available for plug-in use.

Response Time

Note) Based on dynamic performance test, JIS B 8419: 2010. (Coil temperature: 20°C, at rated voltage)

Type of actuation	Response time (ms) (at the pressure of 0.5 MPa)	
	Without surge voltage suppressor	With surge voltage suppressor S, Z type
2 position single	12 or less	15 or less
2 position double	10 or less	13 or less
3 position	15 or less	20 or less
4 position dual 3 port valve	30 or less	35 or less

Weight

Valve model	Type of actuation	Port size	Weight (g)	
		4(A), 2(B)		
SZ3□60□□-C4	2 position	Single	78	
		Double	84	
	3 position	Closed center	C4 (One-touch fitting for ø4)	88
		Exhaust center		
		Pressure center		
4 position	Dual 3 port valve	84		
SZ3□60□□-C6	2 position	Single	74	
		Double	81	
	3 position	Closed center	C6 (One-touch fitting for ø6)	85
		Exhaust center		
		Pressure center		
4 position	Dual 3 port valve	81		
SZ3□60□□-M5	2 position	Single	69	
		Double	75	
	3 position	Closed center	M5 x 0.8	79
		Exhaust center		
		Pressure center		
4 position	Dual 3 port valve	75		

Manifold Options

■ SUP block disk

By installing a SUP block disk in the pressure supply passage of a manifold valve, it is possible to supply two or more different high and low pressures to one manifold. (Use in combination with a pilot port block disk.)



Series	Part no.
SZ3000	SZ3000-114-4A

■ EXH block disk

By installing an EXH block disk in the exhaust passage of a manifold valve, it is possible to divide the valve's exhaust so that it does not affect another valve. (Two block disks are needed to divide both exhausts.)



Series	Part no.
SZ3000	SZ3000-114-4A

■ Pilot port block disk

By installing a pilot port block disk in the pilot passage of a manifold valve, it can function as an internal pilot/external pilot mixed manifold.



Series	Part no.
SZ3000	SZ3000-114-2A

■ Label for block disk

The labels shown below are used on manifold stations containing SUP/EXH block disk(s) to show their location. (3 pcs. each)

SZ3000-155-1A

Label for SUP/EXH block disk



Label for EXH block disk



Label for SUP block disk



Label for pilot port block disk



* When a block disk is concurrently ordered by specifying on the manifold specification sheet, etc., a label will be stuck on the position where block disk is mounted.

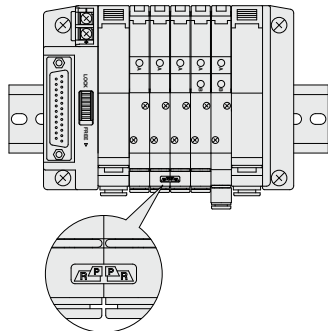

■ Blanking block assembly

SZ3000-55-1A

These are mounted when later addition of valves is planned, etc.

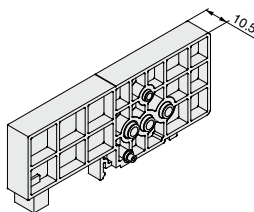

■ Silencer with One-touch fitting

This silencer can be mounted on the manifolds' port R (exhaust) with a single touch.

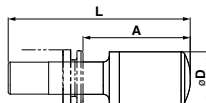

Series	Applicable fittings size ϕd	Model	A	L	D	Effective area mm^2	Noise reduction dB
SZ3000 ($\phi 8$)	8	AN15-C08	26.5	45	13	20	30

■ Plug (White)

These are inserted in cylinder ports or SUP/EXH ports which are not being used.

Purchasing order is available in units of 10 pieces.

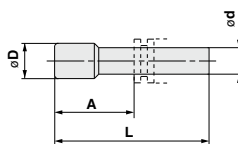

Dimensions

Applicable fittings size ϕd	Model	A	L	D
4	KQ2P-04	16	32	6
6	KQ2P-06	18	35	8
8	KQ2P-08	20.5	39	10

SV

SYJ

SZ

VF

VP4

VQ

1/2

VQ

4/5

VQC

1/2

VQC

4/5

VQZ

SQ

VFS

VFR

VQ7

SZ3000 Series

Manifold Option

■ DIN rail dimensions/Weight

VZ1000-11-1-□

Refer to the L dimension tables

* Enter a number from the DIN rail dimension table below.

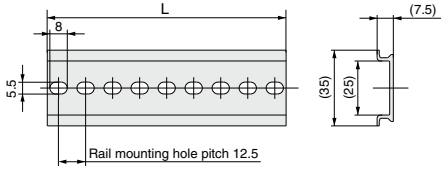

No.	0	1	2	3	4	5	6	7	8	9
L dimension	98	110.5	123	135.5	148	160.5	173	185.5	198	210.5
Weight (g)	17.6	19.9	22.1	24.4	26.6	28.9	31.1	33.4	35.6	37.9

No.	10	11	12	13	14	15	16	17	18	19
L dimension	223	235.5	248	260.5	273	285.5	298	310.5	323	335.5
Weight (g)	40.1	42.4	44.6	46.9	49.1	51.4	53.6	55.9	58.1	60.4

No.	20	21	22	23	24	25	26	27	28	29
L dimension	348	360.5	373	385.5	398	410.5	423	435.5	448	460.5
Weight (g)	62.6	64.9	67.1	69.4	71.6	73.9	76.1	78.4	80.6	82.9

■ Flat ribbon cable type/Cable assembly

AXT100-FC□- $\frac{1}{9}$

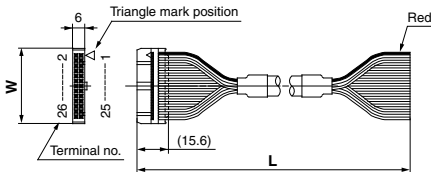

Flat Ribbon Cable Assembly

Cable length (L)	10 pins	20 pins	26 pins
1.5 m	AXT100-FC10-1	AXT100-FC20-1	AXT100-FC26-1
3 m	AXT100-FC10-2	AXT100-FC20-2	AXT100-FC26-2
5 m	AXT100-FC10-3	AXT100-FC20-3	AXT100-FC26-3
Connector width (W)	17.2	30	37.5

* For other commercial connectors, use a type with strain relief conforming to MIL-C-83503.

Connector manufacturers' example

- HIROSE ELECTRIC CO., LTD.
- 3M Japan Limited
- Fujitsu Limited
- Japan Aviation Electronics Industry, Limited.
- J.S.T. Mfg. Co., Ltd.

■ D-sub connector (25 pins)/Cable assembly

AXT100-DS25- $\frac{015}{030}$
050

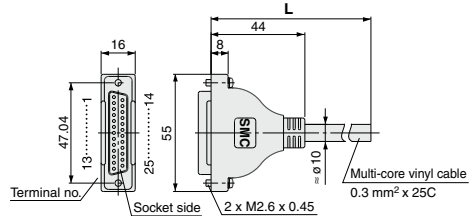

D-sub Connector Cable Assembly Terminal No.

Terminal no.	Lead wire color	Dot marking
1	Black	None
2	Brown	None
3	Red	None
4	Orange	None
5	Yellow	None
6	Pink	None
7	Blue	None
8	Purple	White
9	Gray	Black
10	White	Black
11	White	Red
12	Yellow	Red
13	Orange	Red
14	Yellow	Black
15	Pink	Black
16	Blue	White
17	Purple	None
18	Gray	None
19	Orange	Black
20	Red	White
21	Brown	White
22	Pink	Red
23	Gray	Red
24	Black	White
25	White	None

D-sub Connector Cable Assembly

Cable length (L)	Assembly part no.	Note
1.5 m	AXT100-DS25-015	Cable 25 cores x 24AWG
3 m	AXT100-DS25-030	
5 m	AXT100-DS25-050	

* For other commercial connectors, use a 25 pins type with female connector conforming to MIL-C-24308.

Connector manufacturers' example

- HIROSE ELECTRIC CO., LTD.
- Fujitsu Limited
- Japan Aviation Electronics Industry, Limited.
- J.S.T. Mfg. Co., Ltd.

Electric Characteristics

Item	Characteristics
Conductor resistance Ω /km, 20°C	65 or less
Voltage limit VAC, 1 min.	1000
Insulation resistance $M\Omega$ km, 20°C	5 or less

Note) The minimum bending radius for D-sub connector cables is 20 mm.

Manifold Electrical Wiring

Type 60F D-sub Connector Type (25 pins)

● Without Power Supply Terminal

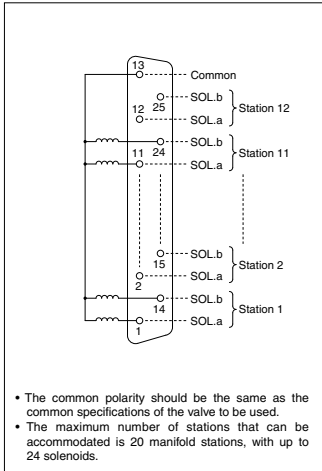

- The common polarity should be the same as the common specifications of the valve to be used.
- The maximum number of stations that can be accommodated is 20 manifold stations, with up to 24 solenoids.

- The circuits above are for the double wiring specifications with up to 10 or 12 stations. Connect to SOL.A in the case of a single solenoid. Moreover, when wiring instructions are given on a manifold specification sheet, the "A" signal for single and the "A, B" signals for double should be wired in order 1, 14, 2, 15.....etc., without skipping or leaving any connectors remaining.
- Stations are counted from D side as the 1st one.

● With Power Supply Terminal

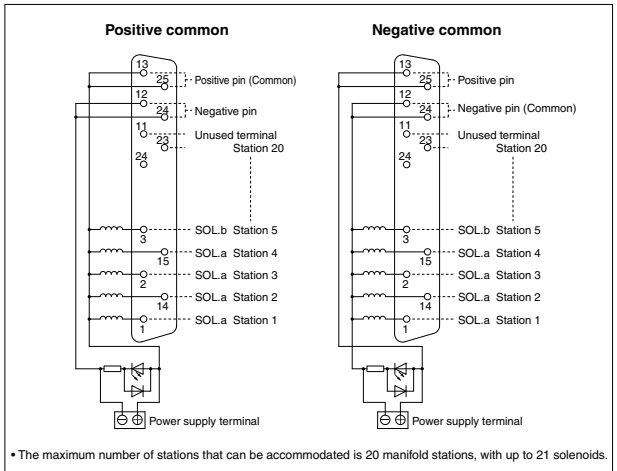

- The maximum number of stations that can be accommodated is 20 manifold stations, with up to 21 solenoids.

Type 60P Flat Ribbon Cable Type (26 pins)

● Without Power Supply Terminal

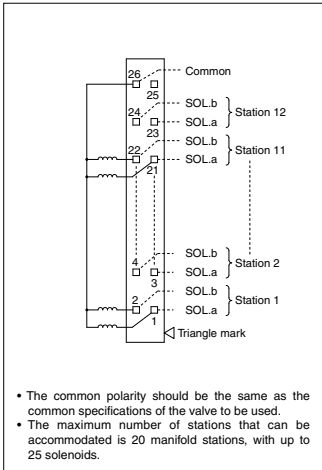

- The common polarity should be the same as the common specifications of the valve to be used.
- The maximum number of stations that can be accommodated is 20 manifold stations, with up to 25 solenoids.

● With Power Supply Terminal

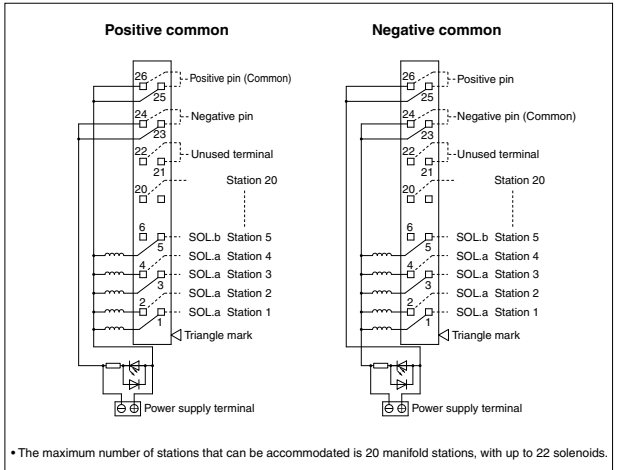

- The maximum number of stations that can be accommodated is 20 manifold stations, with up to 22 solenoids.

- The circuits above are for the double wiring specifications with up to 11 or 12 stations. Connect to SOL.A in the case of a single solenoid. Moreover, when wiring instructions are given on a manifold specification sheet, the "A" signal for single and the "A, B" signals for double should be wired in order 1, 2, 3, 4.....etc., without skipping or leaving any connectors remaining.
- Stations are counted from D side as the 1st one.
- Since terminal numbers are not indicated on the flat cable, use the triangle mark as a reference for wiring.

SV
SYJ
SZ
VF
VP4
VQ 1/2
VQ 4/5
VQC 1/2
VQC 4/5
VQZ
SQ
VFS
VFR
VQ7

SZ3000 Series

Manifold Electrical Wiring

Type 60PG Flat Ribbon Cable Type (20 pins)

● Without Power Supply Terminal

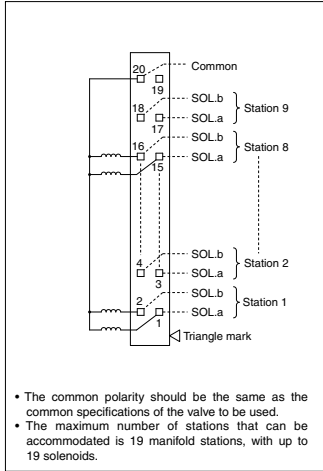

● With Power Supply Terminal

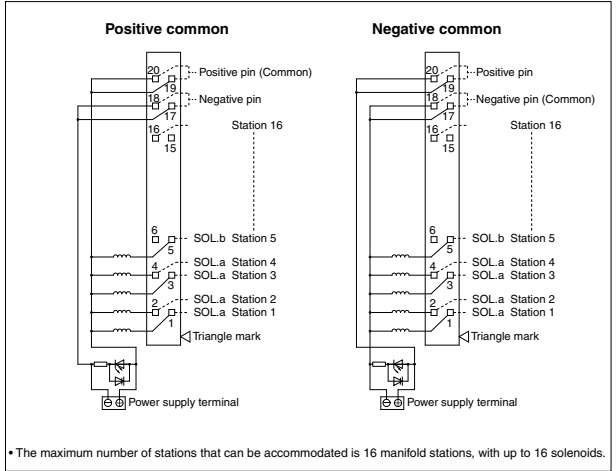

- The circuits above are for the double wiring specifications with up to 8 or 9 stations. Connect to SOL.A in the case of a single solenoid. Moreover, when wiring instructions are given on a manifold specification sheet, the "A" signal for single and the "A, B" signals for double should be wired in order 1, 2, 3, 4.....etc., without skipping or leaving any connectors remaining.
- Stations are counted from D side as the 1st one.
- Since terminal numbers are not indicated on the flat cable, use the triangle mark as a reference for wiring.

Type 60PH Flat Ribbon Cable Type (10 pins)

● Without Power Supply Terminal

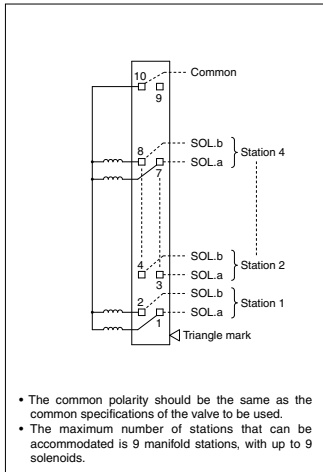

● With Power Supply Terminal

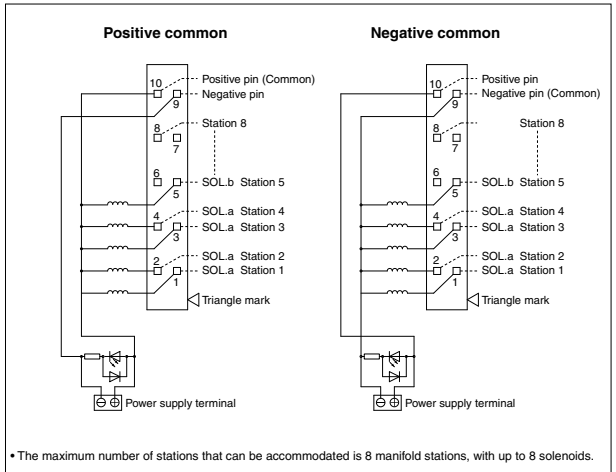

- The circuits above are for the double wiring specifications with up to 4 stations. Connect to SOL.A in the case of a single solenoid. Moreover, when wiring instructions are given on a manifold specification sheet, the "A" signal for single and the "A, B" signals for double should be wired in order 1, 2, 3, 4.....etc., without skipping or leaving any connectors remaining.
- Stations are counted from D side as the 1st one.
- Since terminal numbers are not indicated on the flat cable, use the triangle mark as a reference for wiring.

Wiring of Plug-in Type Manifold with Power Supply Terminal (Example)

- Since the power supply to drive valves with power supply terminals can be supplied from either the control side or the manifold side, these wiring examples should be used for reference when wiring is performed.

1. Wiring example when using manifold power supply terminal

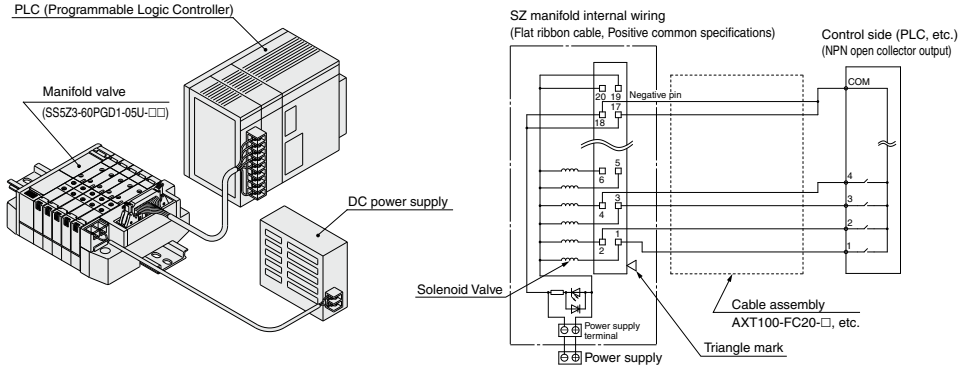

2. Wiring example when not using manifold power supply terminal (Power is supplied to the control side or along the wiring, etc.)

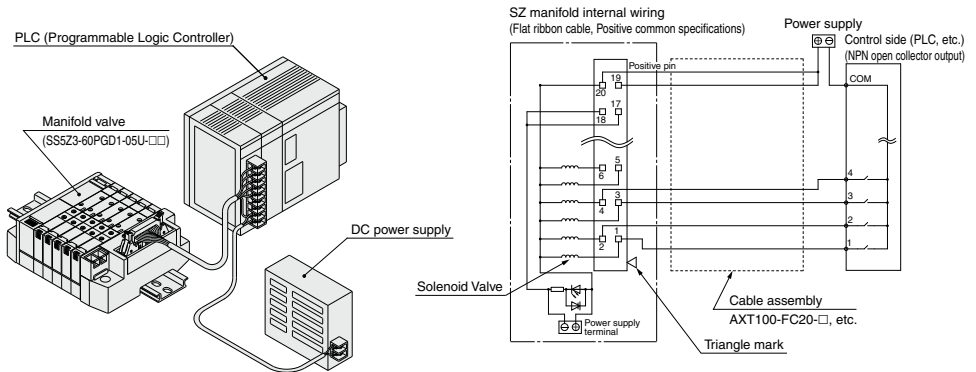

⚠ Caution

- Single wire, COM position, etc. of PLC are different from each manufacturer. When connecting with PLC, read the specifications carefully and understand the electrical circuit. Poor wiring could cause damage to PLC, power source, etc. as well as manifold and valve.

SV
SYJ
SZ
VF
VP4
VQ 1/2
VQ 4/5
VQC 1/2
VQC 4/5
VQZ
SQ
VFS
VFR
VQ7

SZ3000 Series

Construction

Symbol

2 position single

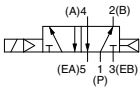

2 position single with back pressure check valve

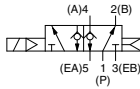

2 position single

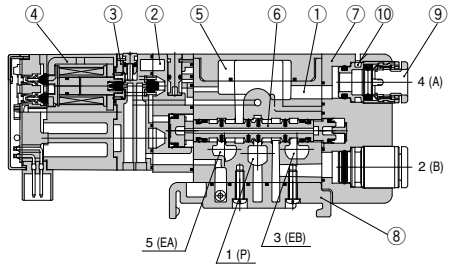

Symbol

2 position double

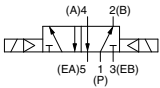

2 position double with back pressure check valve

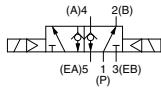

2 position double

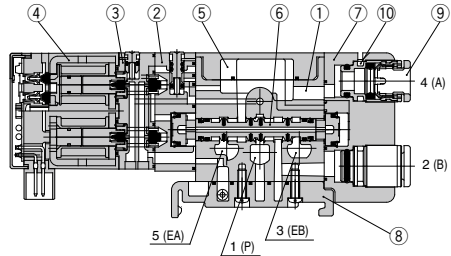

Symbol

3 position closed center

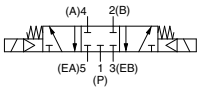

3 position exhaust center

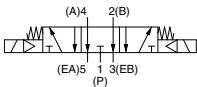

3 position pressure center

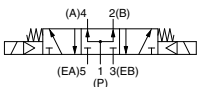

3 position closed center/exhaust center/pressure center

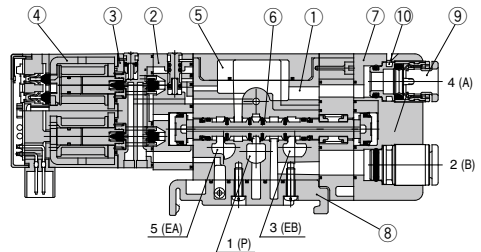

Component Parts

No.	Description	Material	Note
1	Body	Zinc die-casted	—
2	Adapter plate	Resin	Urban white
3	Pilot body	Resin	Urban white
4	Molded coil	—	Urban gray
5	Body cover	Resin	Urban white
6	Spool valve assembly	Aluminum/HNBR	—
7	Port block	Resin	Urban white
8	Bottom cover assembly	—	Urban white

Replacement Parts

No.	Description	Part no.
9	One-touch fitting	Refer to One-touch fitting part number information on page 292.
10	Clip	SX3000-115-2

2 position single with back pressure check valve

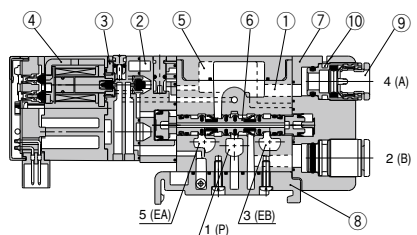

Symbol

4 position dual 3 port valve

SZ3A60 [N.C. valve x 2 pcs.]

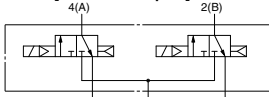

SZ3A60K/With back pressure check valve

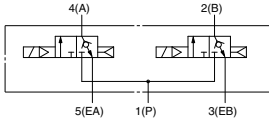

SZ3B60 [N.C. valve x 2 pcs.]

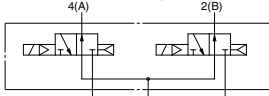

SZ3B60K/With back pressure check valve

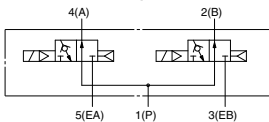

SZ3C60 [N.C. valve, N.O. valve 1 pc. each]

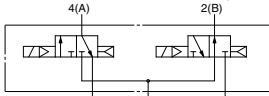

SZ3C60K/With back pressure check valve

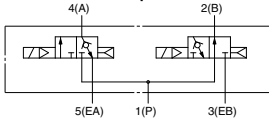

SZ3A60 [N.C. valve x 2 pcs.]

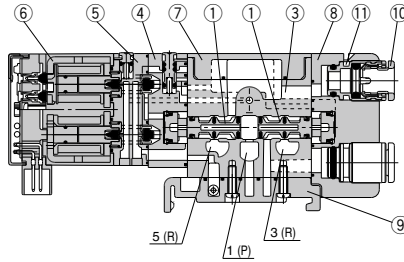

SZ3B60 [N.O. valve x 2 pcs.]

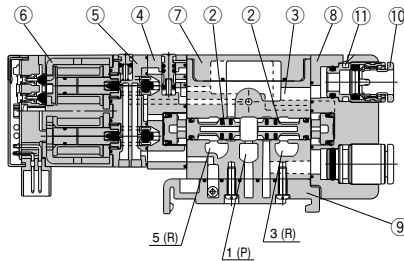

SZ3C60 [N.C. valve, N.O. valve 1 pc. each]

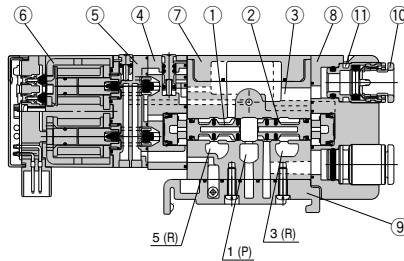

Component Parts

No.	Description	Material	Note
1	Spool valve assembly	Resin/HNBR	For N.C. (Normally closed)
2	Spool valve assembly	Resin/HNBR	For N.O. (Normally open)
3	Body	Zinc die-casted	—
4	Adapter plate	Resin	Urban white
5	Pilot body	Resin	Urban white
6	Molded coil	—	Urban gray
7	Body cover	Resin	Urban white
8	Port block	Resin	Urban white
9	Bottom cover assembly	—	Urban white

Replacement Parts

No.	Description	Part no.
10	One-touch fitting	Refer to One-touch fitting part number information on page 292.
11	Clip	SX3000-115-2

SZ3A60K/With back pressure check valve

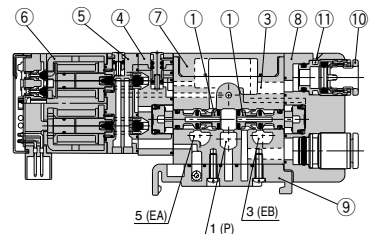

SV
SYJ
SZ
VF
VP4
VQ 1/2
VQ 4/5
VQC 1/2
VQC 4/5
VQZ
SQ
VFS
VFR
VQ7

SZ3000 Series

Manifold Exploded View

Type 60P Manifold (Plug-in, flat ribbon cable type)

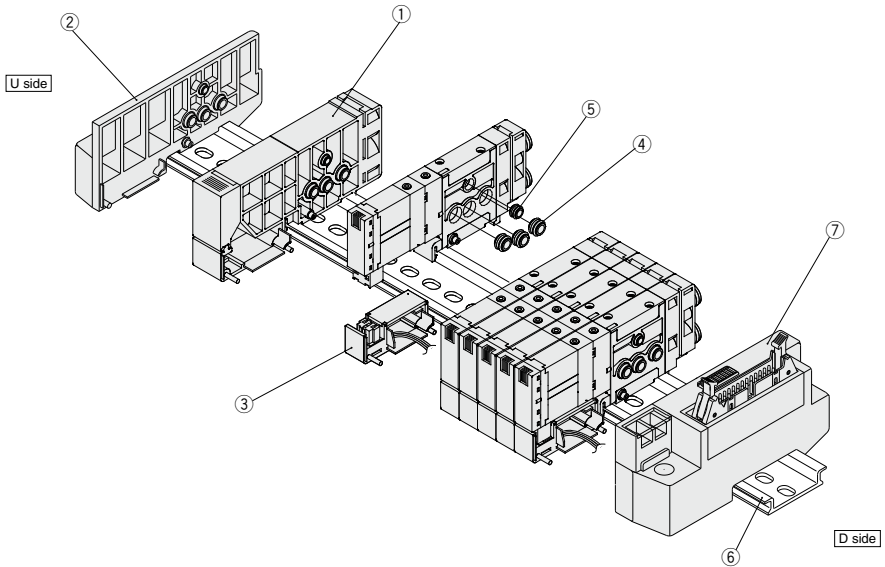

Component Parts

No.	Description	Part no.	Note
1	SUP/EXH block assembly	SZ3000-50-1A-□□	C6: With One-touch fitting for ø6 C8: With One-touch fitting for ø8 L6: With One-touch fitting for ø6 (Elbow fetching upward) L8: With One-touch fitting for ø8 (Elbow fetching upward) B6: With One-touch fitting for ø6 (Elbow fetching downward) B8: With One-touch fitting for ø8 (Elbow fetching downward)
2	End block assembly	SZ3000-53-5A	
3	Housing holder	SX3000-113-1	
4	SUP block bush assembly	SZ3000-114-3A	
5	SUP block bush assembly	SZ3000-114-1A	
6	DIN rail	VZ1000-111-1-□	Refer to page 256.
7	Connector block assembly	SZ3000-42-□□	Refer to connector block assembly part no. table below.

Connector Block Assembly Part No.

Connector specifications	Mounting position	Part no.		Note
		Without power supply terminals	With power supply terminals	
For D-sub connector	D side	SZ3000-42-1A-□□D ₂ ¹	SZ3000-42-2A-□□D ₂ ¹ -P _N	*1: Perpendicular connector *2: Lateral connector P: Positive common N: Negative common
For flat ribbon cable 26 pins	D side	SZ3000-42-3A-□□D ₂ ¹	SZ3000-42-4A-□□D ₂ ¹ -P _N	(Note) The assembly part numbers with power supply terminals are 24 VDC specifications. If 12 VDC specifications are required, enter "12" at the end of the assembly part number.
For flat ribbon cable 20 pins	D side	SZ3000-42-5A-□□D ₂ ¹	SZ3000-42-6A-□□D ₂ ¹ -P _N	
For flat ribbon cable 10 pins	D side	SZ3000-42-7A-□□D ₂ ¹	SZ3000-42-8A-□□D ₂ ¹ -P _N	
For serial	D side	SZ3000-42-10A-□□D	—	

Note) Connector block assembly can be shipped as an assembly only in the case of double wiring. Since the possible number of stations differs depending on the connector type, refer to the valve station section on catalog pages 250, 251, 276 and 280, and enter the number of stations in the □□ section of the assembly part number. Please contact SMC if a connector block assembly is required having a wiring specification other than double wiring.

Plug-in Manifold Station Expansion

⚠ Caution In addition to solenoid valves, housing holders (SX3000-113-1) are necessary for expansion of manifold stations.

- Double wiring specifications manifolds which do not have the maximum number of stations, contain spare receptacle housings for expansion in the housing holder of the last station, or inside the supply/exhaust block assembly (for a maximum of 2 stations). When expanding stations, perform the disassembly and assembly of the manifold while referring to the expansion method shown below.

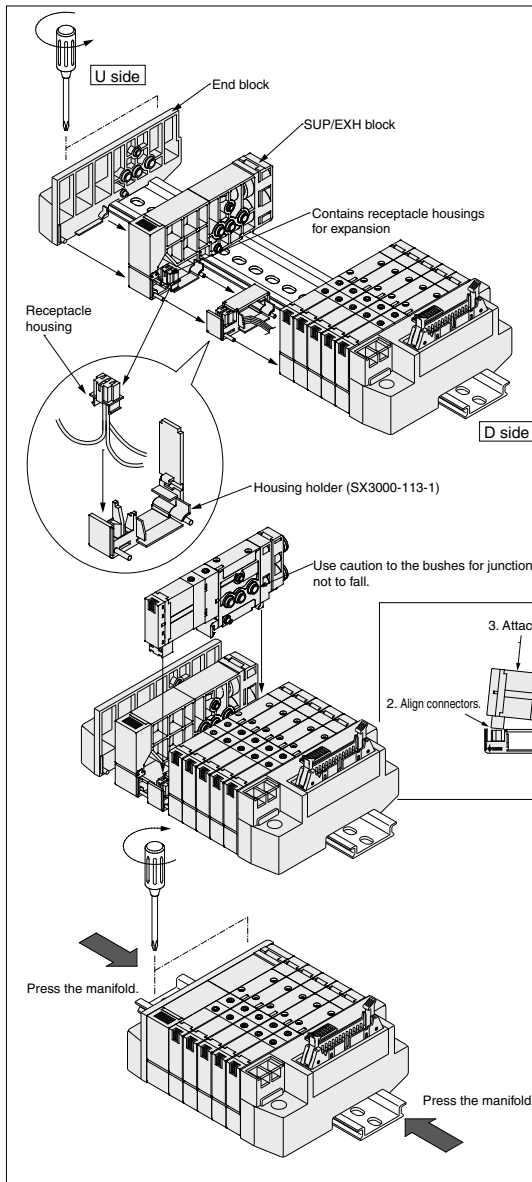

- (1) Loosen the DIN rail holding screw if the end block on the U side.
- (2) Separate the end block and SUP/EXH block.
- (3) Take out the receptacle housing for expansion which is inside the SUP/EXH block, attach it to the newly added housing holder, and attach to the manifold. (Numbers are displayed on the side of the receptacle housings, and they should be used in order from the lowest number.)
- (4) Mount the valve on the DIN rail.
- (5) While pressing the manifold together from both sides, retighten the side U end block's DIN rail holding screw.

⚠ Caution (Tightening torque: 1.4 N·m)

⚠ Caution

1. Be sure to shut off the power and air supplies before disassembly. Furthermore, since air may remain inside the actuator, piping and manifold, confirm that the air is completely exhausted before performing any work.
2. When disassembly and assembly are performed, air leakage may result if connections between blocks and tightening of the end block's holding screw, is inadequate. Before supplying air, confirm that there are no gaps, etc. between blocks, and that manifold blocks are securely fastened to the DIN rail. Then supply air and confirm that there is no air leakage before operating.
3. Note that for manifolds specified with other than double wiring, spare receptacle housings for expansion are not included unless indicated at the time of order.

SV
SYJ
SZ
VF
VP4
VQ 1/2
VQ 4/5
VQC 1/2
VQC 4/5
VQZ
SQ
VFS
VFR
VQ7

SZ3000 Series

Dimensions: SZ3000 Plug-in

SS5Z3-60FD $\frac{1}{2}$ -[Stations]U-□

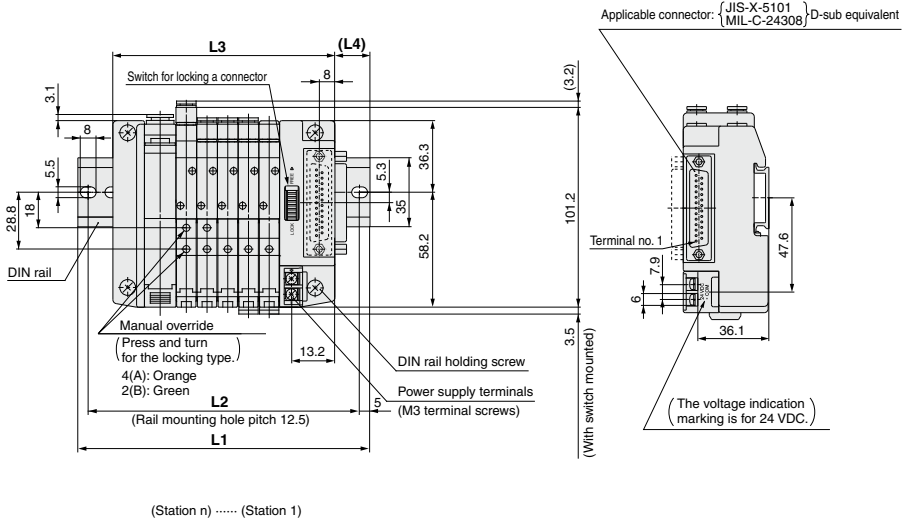
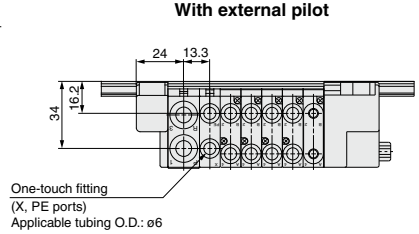
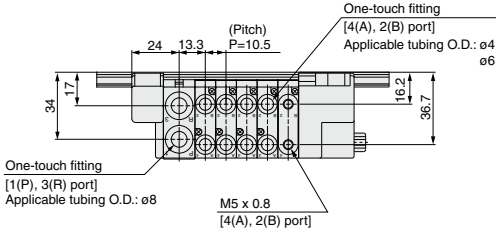

(Station n) (Station 1)

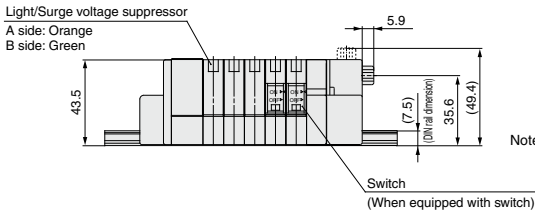

Note) For manifold dimensions with elbow fitting, refer to page 268.

Internal Pilot Manifold L Dimension

L _n	2	3	4	5	6	7	8	9	10
L1	110.5	123	135.5	148	148	160.5	173	185.5	198
L2	100	112.5	125	137.5	137.5	150	162.5	175	187.5
L3	81	91.5	102	112.5	123	133.5	144	154.5	165
L4	15	16	17	18	12.5	13.5	14.5	15.5	16.5

External Pilot Manifold L Dimension

L _n	2	3	4	5	6	7	8	9	10
L1	123	135.5	148	148	160.5	173	185.5	198	210.5
L2	112.5	125	137.5	137.5	150	162.5	175	187.5	200
L3	91.5	102	112.5	123	133.5	144	154.5	165	175.5
L4	16	17	18	12.5	13.5	14.5	15.5	16.5	17.5

Dimensions: SZ3000 Plug-in

SS5Z3-60FD₁ - Stations B-□

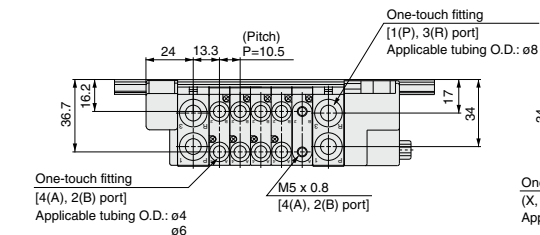

With external pilot

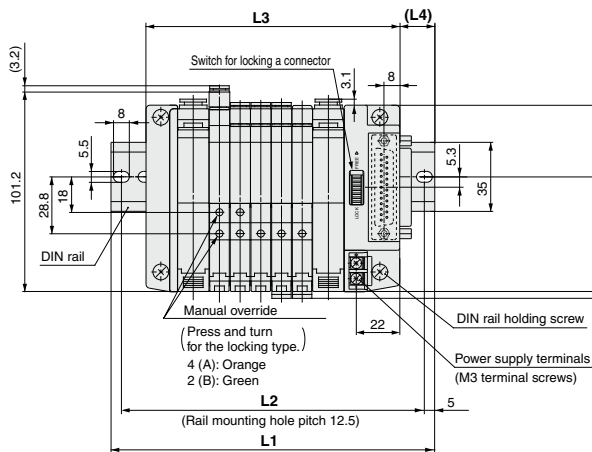
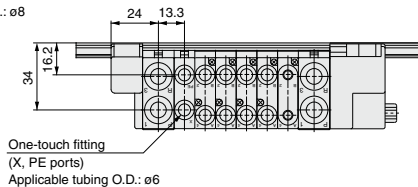

Applicable connector: {JIS-X-5101 } D-sub equivalent
{MIL-C-24308 }

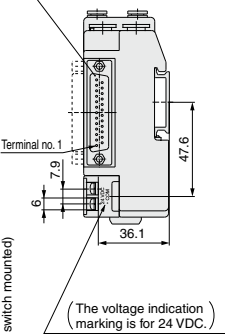

(Station n) (Station 1)

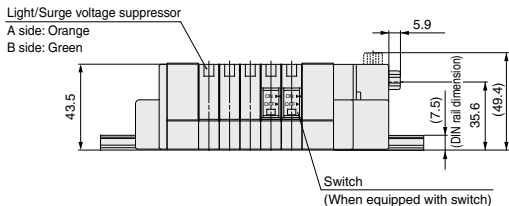

Note) For manifold dimensions with elbow fitting, refer to page 268.

Internal Pilot Manifold L Dimension

L \ n	2	3	4	5	6	7	8	9	10	11	12	13	14	15	16	17	18	19	20
L1	123	135.5	148	160.5	173	173	185.5	198	210.5	223	235.5	248	248	260.5	273	285.5	298	310.5	310.5
L2	112.5	125	137.5	150	162.5	162.5	175	187.5	200	212.5	225	237.5	237.5	250	262.5	275	287.5	300	300
L3	97	107.5	118	128.5	139	149.5	160	170.5	181	191.5	202	212.5	223	233.5	244	254.5	265	275.5	286
L4	13	14	15	16	17	12	13	14	15	16	17	18	12.5	13.5	14.5	15.5	16.5	17.5	12.5

External Pilot Manifold L Dimension

L \ n	2	3	4	5	6	7	8	9	10	11	12	13	14	15	16	17	18	19	20
L1	135.5	148	160.5	173	173	185.5	198	210.5	223	235.5	248	248	260.5	273	285.5	298	310.5	310.5	323
L2	125	137.5	150	162.5	162.5	175	187.5	200	212.5	225	237.5	250	262.5	275	287.5	300	300	312.5	312.5
L3	107.5	118	128.5	139	149.5	160	170.5	181	191.5	202	212.5	223	233.5	244	254.5	265	275.5	286	296.5
L4	14	15	16	17	12	13	14	15	16	17	18	12.5	13.5	14.5	15.5	16.5	17.5	12.5	13.5

SZ3000 Series

Dimensions: SZ3000 Plug-in

SS5Z3-60PD₂-[Stations]U-□ (26 pins)

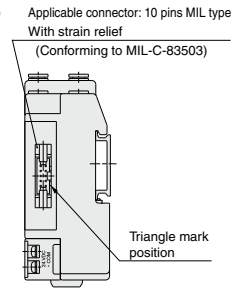
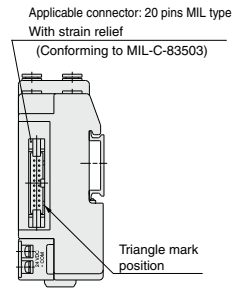
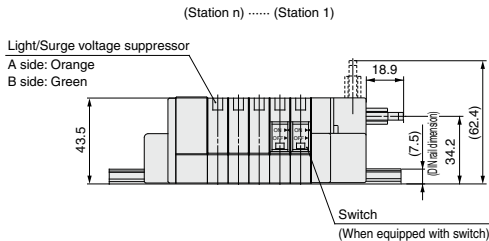
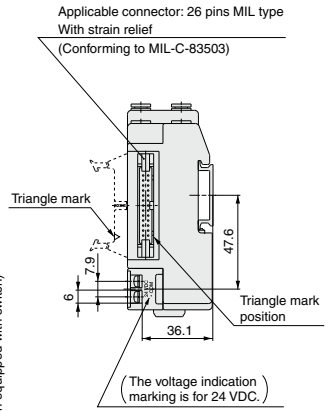
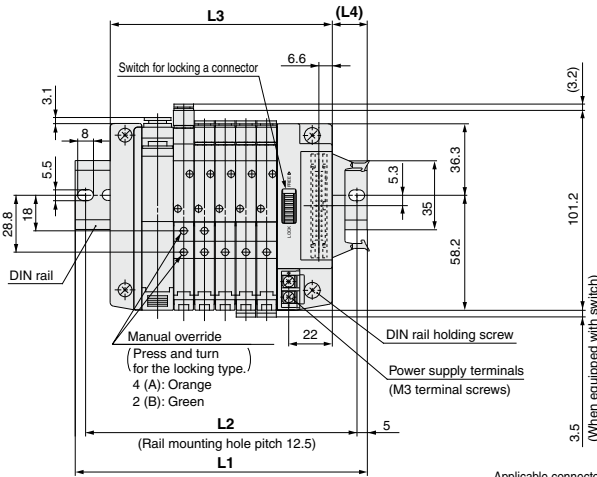
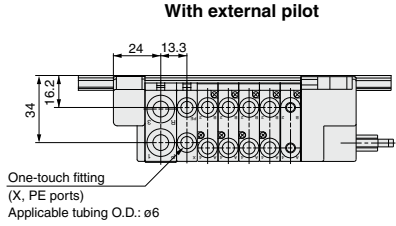
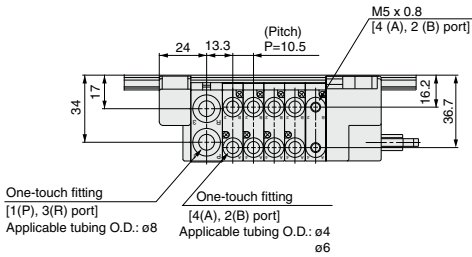

60PG (20 pins)

60PH (10 pins)

Note 1) Types 60PG and 60PH differ only in their connectors, and the L1 through L4 dimensions are the same as type 60P.

Note 2) For manifold dimensions with elbow fitting, refer to page 268.

Internal Pilot Manifold L Dimension

n: Stations

n	2	3	4	5	6	7	8	9	10
L1	110.5	123	135.5	148	148	160.5	173	185.5	198
L2	100	112.5	125	137.5	137.5	150	162.5	175	187.5
L3	81	91.5	102	112.5	123	133.5	144	154.5	165
L4	15	16	17	18	12.5	13.5	14.5	15.5	16.5

External Pilot Manifold L Dimension

n: Stations

n	2	3	4	5	6	7	8	9	10
L1	123	135.5	148	148	160.5	173	185.5	198	210.5
L2	112.5	125	137.5	137.5	150	162.5	175	187.5	200
L3	91.5	102	112.5	123	133.5	144	154.5	165	175.5
L4	16	17	18	12.5	13.5	14.5	15.5	16.5	17.5

Dimensions: SZ3000 Plug-in

SS5Z3-60PD₂- [Stations] B-□ (26 pins)

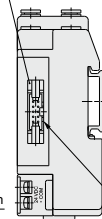
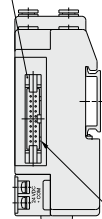
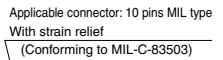
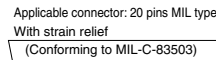
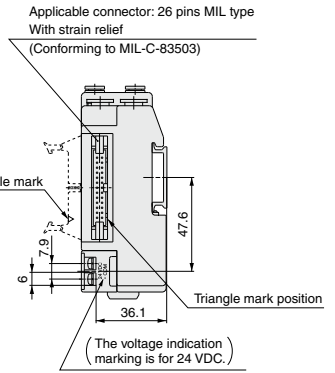
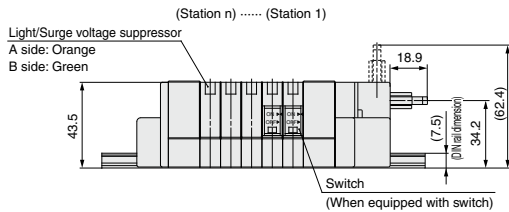
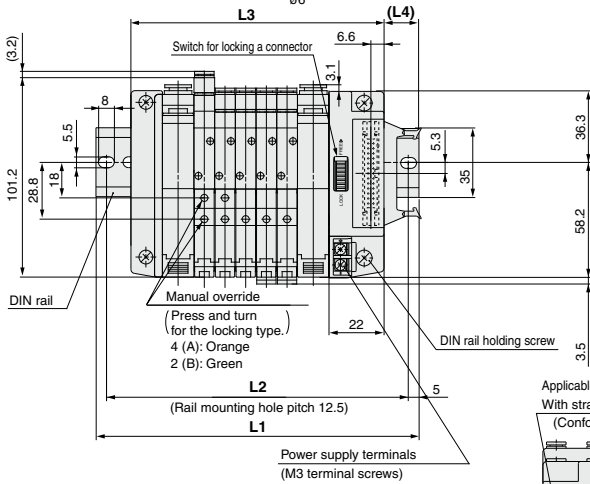
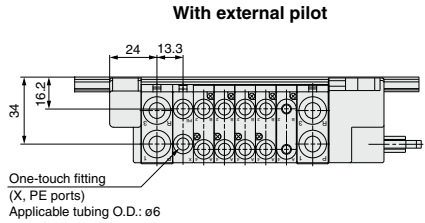
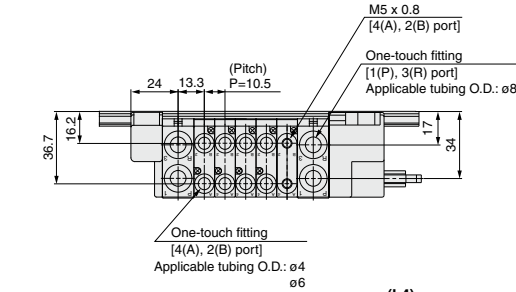

60PG (20 pins)

60PH (10 pins)

Note 1) Types 60PG and 60PH differ only in their connectors, and the L1 through L4 dimensions are the same as type 60P.
 Note 2) For manifold dimensions with elbow fitting, refer to page 268.

Internal Pilot Manifold L Dimension

L	n	2	3	4	5	6	7	8	9	10	11	12	13	14	15	16	17	18	19	20
L1	123	135.5	148	160.5	173	173	185.5	198	210.5	223	235.5	248	248	260.5	273	285.5	298	310.5	310.5	
L2	112.5	125	137.5	150	162.5	162.5	175	187.5	200	212.5	225	237.5	237.5	250	262.5	275	287.5	300	300	
L3	97	107.5	118	128.5	139	149.5	160	170.5	181	191.5	202	212.5	223	233.5	244	254.5	265	275.5	286	
L4	13	14	15	16	17	12	13	14	15	16	17	18	12.5	13.5	14.5	15.5	16.5	17.5	12.5	

External Pilot Manifold L Dimension

L	n	2	3	4	5	6	7	8	9	10	11	12	13	14	15	16	17	18	19	20
L1	135.5	148	160.5	173	173	185.5	198	210.5	223	235.5	248	248	260.5	273	285.5	298	310.5	310.5	323	
L2	125	137.5	150	162.5	162.5	175	187.5	200	212.5	225	237.5	237.5	250	262.5	275	287.5	300	300	312.5	
L3	107.5	118	128.5	139	149.5	160	170.5	181	191.5	202	212.5	223	233.5	244	254.5	265	275.5	286	296.5	
L4	14	15	16	17	12	13	14	15	16	17	18	12.5	13.5	14.5	15.5	16.5	17.5	12.5	13.5	

SV
SYJ
SZ
VF
VP4
VQ 1/2
VQ 4/5
VQC 1/2
VQC 4/5
VQZ
SQ
VFS
VFR
VQ7

SZ3000 Series

Dimensions with Elbow Fitting: SZ3000 Plug-in, D-sub Connector

SS5Z3-60FD₁-[Stations]U_B-□

(The fitting dimension of the flat cable and non plug-in types is the same.)

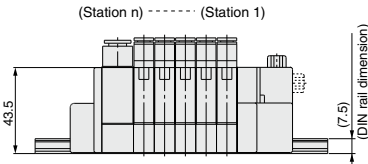
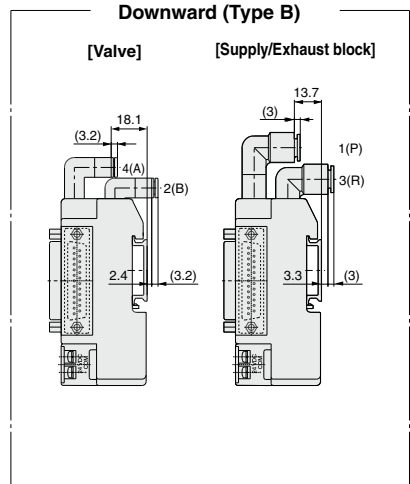
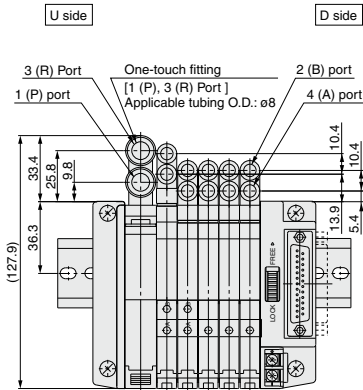
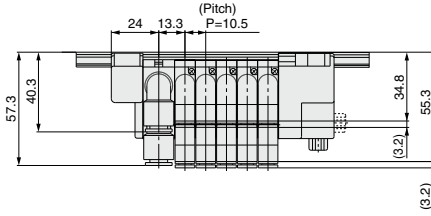

5 Port Solenoid Valve Non Plug-in Type **SZ3000 Series**



How to Order

An order for a manifold base only is not acceptable. Please order the solenoid valves for mounting at the same time while referring to the ordering example.

● Non plug-in manifold

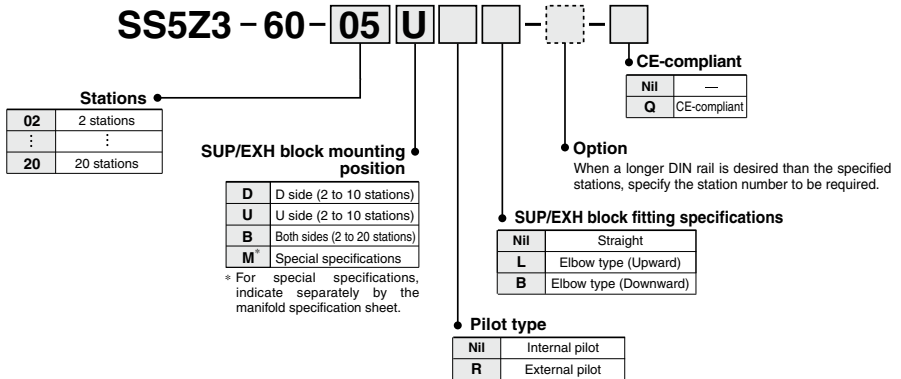

SV
SYJ
SZ
VF
VP4
VQ 1/2
VQ 4/5
VQC 1/2
VQC 4/5
VQZ
SQ
VFS
VFR
VQ7

How to Order Valve Manifold Assembly

Ordering example (SZ3000, Non plug-in)

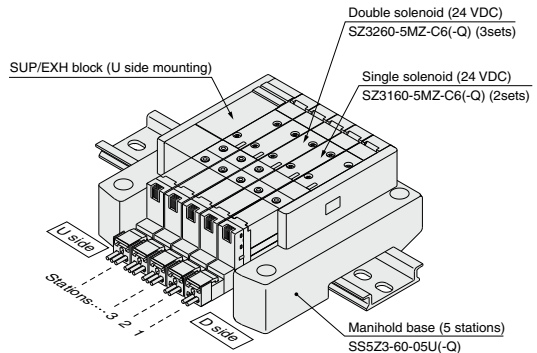

SS5Z3-60-05U (-Q)	1 set (Manifold part number)
* SZ3160-5MZ-C6 (-Q)	2 sets (Single solenoid part no.)
* SZ3260-5MZ-C6 (-Q)	3 sets (Double solenoid part no.)

→ The asterisk denotes the symbol for assembly. Prefix it to the part nos. of the solenoid valve, etc.

Stations are counted from D side as the 1st one. Indicate the valves to be attached below the manifold part number, in order starting from station 1 as shown in the drawing. When entry of part numbers becomes complicated, indicate on the manifold specification sheet.

How to Order

SZ3 1 60 - 5 M - C6

Type of actuation

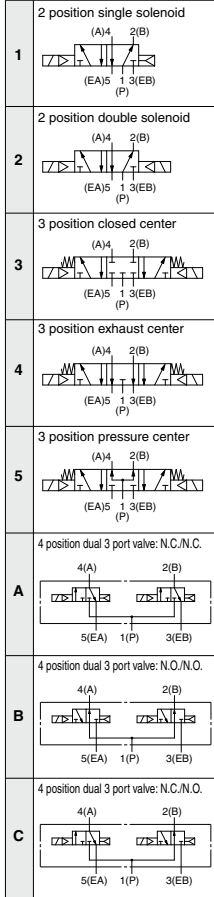

Pilot type

Nil	Internal pilot
R	External pilot

The 4 position dual 3 port valve is not available with external pilot specifications.

Back pressure check valve

Nil	None
K	Built-in

The built-in back pressure check valve type has an effective area approximately 20% smaller.
 The 3 position valve is not available with back pressure check valve.

Rated voltage

5	24 VDC
6	12 VDC

Common specifications

Nil	Positive common
N	Negative common

The symbol is "Nil" when not equipped with light/surge voltage suppressor.

CE-compliant

Nil	—
Q	CE-compliant

Made to Order

Nil	—
X90	Main Valve Fluororubber Specifications (Refer to page 288.)

A, B port size

C4: One-touch fitting for ø4
 C6: One-touch fitting for ø6



M5: M5 x 0.8



Elbow fitting assembly (Upward)
 L4: ø4 elbow fitting assembly
 L6: ø6 elbow fitting assembly



Elbow fitting assembly (Downward)
 B4: ø4 elbow fitting assembly
 B6: ø6 elbow fitting assembly



Manual override

Nil: Non-locking push type

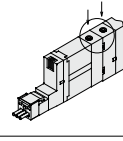

D: Push-turn locking slotted type

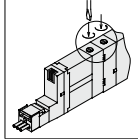

Light/Surge voltage suppressor

Nil	Without light/surge voltage suppressor
S	With surge voltage suppressor
Z	With light/surge voltage suppressor

Electrical entry

M: With lead wire (Length 300 mm)

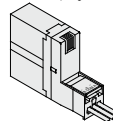

MN: Without lead wire

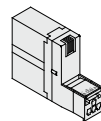

MO: Without connector

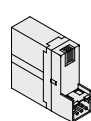

Manifold Specifications



Made to Order Specifications
(For details, refer to page 288.)

Model		Type SS5Z3-60	
Manifold		Non plug-in type	
1 (P: SUP), 3/5 (R: EXH) system		Common SUP, EXH	
Valve stations		2 to 20 stations	
4(A), 2(B) port	Location	Valve	
	Porting specifications	Lateral, Upward, Downward	
Port size	1(P), 3/5(R) port	C8	
	4(A), 2(B) port	C4, C6, M5	
Weight W (g) ⁽²⁾ (n: Number of SUP/EXH blocks) (m: Weight of DIN rail)		W = 34n + m + 89	

Note 1) In cases such as those where many valves are operated simultaneously, use type B (double side SUP/EXH), applying pressure to the 1(P) ports on both sides and exhausting from the 3(R) ports on both sides.

Note 2) The weight W is the value for the D-sub connector manifold with power supply terminals only. To obtain the weight with solenoid valves attached, add the solenoid valve weight given on page 254 for the appropriate number of stations. For DIN rail weight, refer to page 256.

Flow Rate Characteristics

Port size		Flow rate characteristics					
		1→2/4(P→A/B)			4/2→3(A/B→R)		
1, 5, 3 (P, EA, EB)	4, 2 (A, B)	C [dm ³ /(s·bar)]	b	Cv	C [dm ³ /(s·bar)]	b	Cv
C8	C4	0.58 [0.49]	0.26 [0.36]	0.14 [0.13]	0.76 [0.65]	0.15 [0.20]	0.18 [0.15]
	C6	0.73 [0.64]	0.24 [0.27]	0.18 [0.16]	0.77 [0.74]	0.19 [0.16]	0.19 [0.19]
	M5	0.60 [0.57]	0.38 [0.35]	0.17 [0.15]	0.67 [0.58]	0.16 [0.39]	0.16 [0.16]

Note) • The value is for manifold base with 5 stations and individually operated 2 position type.
• Values inside [] are for 4 position dual 3 port valves.

SV

SYJ

SZ

VF

VP4

VQ

1/2

VQ

4/5

VQC

1/2

VQC

4/5

VQZ

SQ

VFS

VFR

VQ7

SZ3000 Series

Manifold Exploded View

Type 60 (Non plug-in) manifold

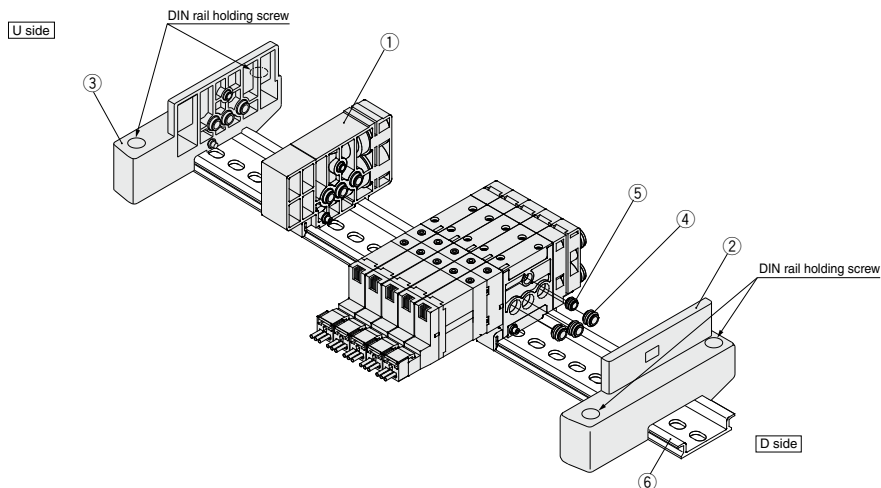

Component Parts

No.	Description	Part no.	Note
1	SUP/EXH block assembly	SZ3000-50-2A-□□	C6: With One-touch fitting for ø6 C8: With One-touch fitting for ø8 L6: With One-touch fitting for ø8 (Elbow fetching upward) L8: With One-touch fitting for ø8 (Elbow fetching upward) B6: With One-touch fitting for ø6 (Elbow fetching downward) B8: With One-touch fitting for ø8 (Elbow fetching downward)
2	End block assembly	SZ3000-53-8A	D side
3	End block assembly	SZ3000-53-7A	U side
4	SUP block bush assembly	SZ3000-114-3A	
5	SUP block bush assembly	SZ3000-114-1A	
6	DIN rail	VZ1000-11-1-□	Refer to page 256.

Manifold Station Expansion Station expansion is possible at any position.

- (1) Loosen one DIN rail holding screw on either U side or D side.
- (2) Separate the blocks at the location where station expansion is desired.
- (3) Mount the valve on the DIN rail.
- (4) While pressing the manifold together from both sides, retighten the DIN rail holding screw of the end block assembly which was loosened.

⚠ Caution (Tightening torque: 1.4 N·m)

⚠ Caution

1. Be sure to shut off the power and air supplies before disassembly. Furthermore, since air may remain inside the actuator, piping and manifold, confirm that the air is completely exhausted before performing any work.
2. When disassembly and assembly are performed, air leakage may result if connections between blocks and tightening of the end block's holding screw, is inadequate. Before supplying air, confirm that there are no gaps, etc. between blocks, and that manifold blocks are securely fastened to the DIN rail. Then supply air and confirm that there is no air leakage before operating.

Dimensions: SZ3000 Non Plug-in

SS5Z3-60- Stations U

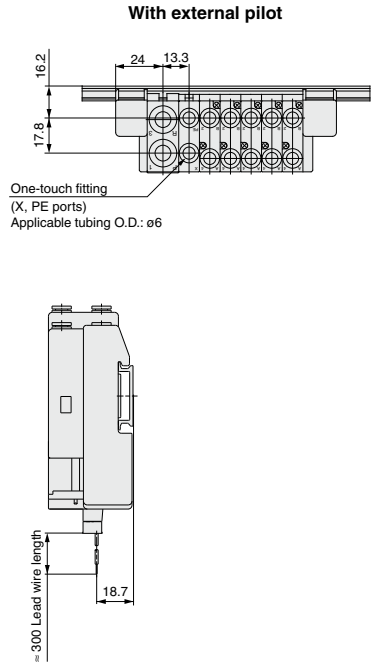
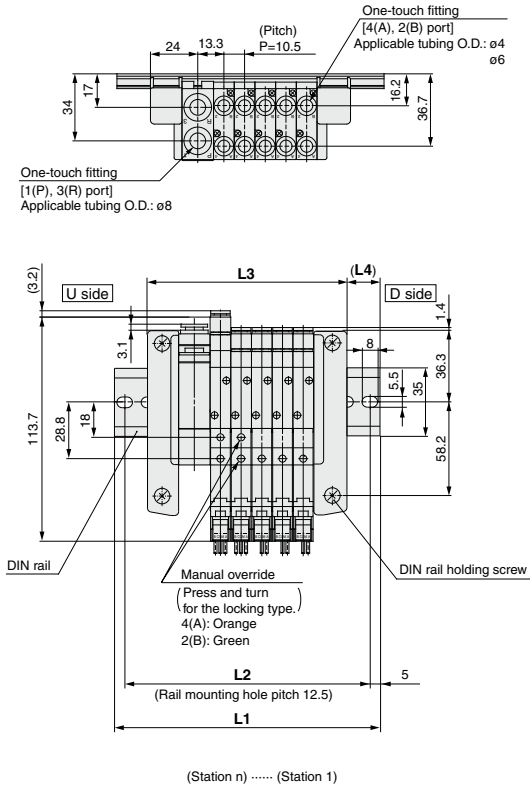

SV
SZY
SZ
VF
VP4
VQ 1/2
VQ 4/5
VQC 1/2
VQC 4/5
VQZ
SQ
VFS
VFR
VQ7

Note) For manifold dimensions with elbow fitting, refer to page 268.

Internal Pilot Manifold L Dimension

L _n	2	3	4	5	6	7	8	9	10
L1	98	110.5	123	135.5	135.5	148	160.5	173	185.5
L2	87.5	100	112.5	125	125	137.5	150	162.5	175
L3	70	80.5	91	101.5	112	122.5	133	143.5	154
L4	14	15	16	17	12	13	14	15	16

External Pilot Manifold L Dimension

L _n	2	3	4	5	6	7	8	9	10
L1	110.5	123	135.5	135.5	148	160.5	173	185.5	198
L2	100	112.5	125	125	137.5	150	162.5	175	187.5
L3	80.5	91	101.5	112	122.5	133	143.5	154	164.5
L4	15	16	17	12	13	14	15	16	17

SZ3000 Series

Dimensions: SZ3000 Non Plug-in

SS5Z3-60- Stations D

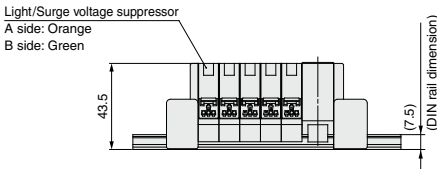
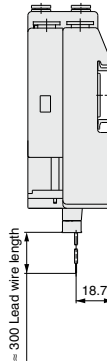
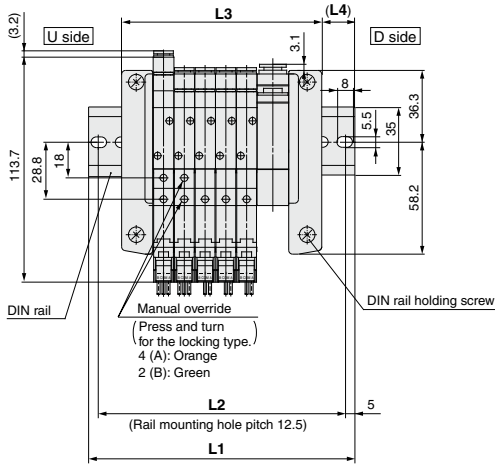
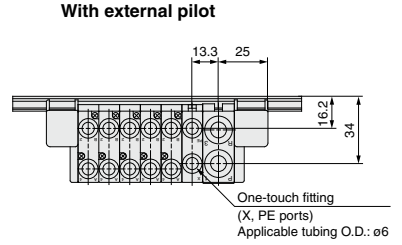
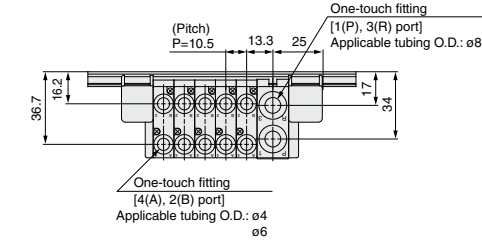

Note) For manifold dimensions with elbow fitting, refer to page 268.

Internal Pilot Manifold L Dimension

L _n	2	3	4	5	6	7	8	9	10
L1	98	110.5	123	135.5	135.5	148	160.5	173	185.5
L2	87.5	100	112.5	125	125	137.5	150	162.5	175
L3	70	80.5	91	101.5	112	122.5	133	143.5	154
L4	14	15	16	17	12	13	14	15	16

External Pilot Manifold L Dimension

L _n	2	3	4	5	6	7	8	9	10
L1	110.5	123	135.5	135.5	148	160.5	173	185.5	198
L2	100	112.5	125	125	137.5	150	162.5	175	187.5
L3	80.5	91	101.5	112	122.5	133	143.5	154	164.5
L4	15	16	17	12	13	14	15	16	17

Dimensions: SZ3000 Non Plug-in

SS5Z3-60- Stations B

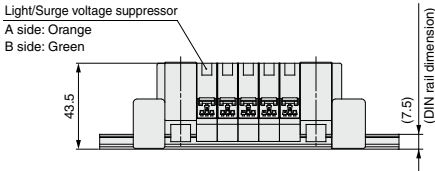
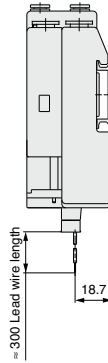
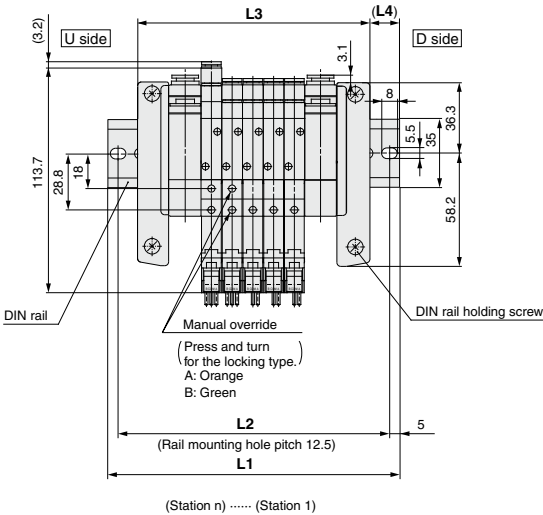
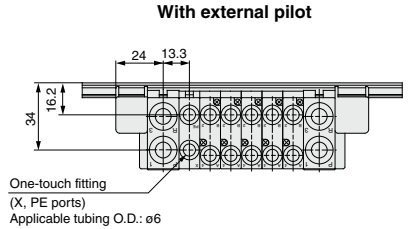
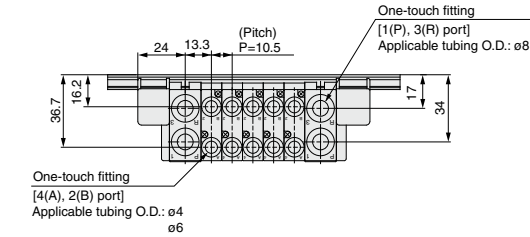

Note) For manifold dimensions with elbow fitting, refer to page 268.

Internal Pilot Manifold L Dimension

n	2	3	4	5	6	7	8	9	10	11	12	13	14	15	16	17	18	19	20
L1	110.5	123	135.5	148	160.5	173	173	185.5	198	210.5	223	235.5	235.5	248	260.5	273	285.5	298	310.5
L2	100	112.5	125	137.5	150	162.5	162.5	175	187.5	200	212.5	225	225	237.5	250	262.5	275	287.5	300
L3	86	96.5	107	117.5	128	138.5	149	159.5	170	180.5	191	201.5	212	222.5	233	243.5	254	264.5	275
L4	12	13	14	15	16	17	12	13	14	15	16	17	12	13	14	15	16	17	18

External Pilot Manifold L Dimension

n	2	3	4	5	6	7	8	9	10	11	12	13	14	15	16	17	18	19	20
L1	123	135.5	148	160.5	173	173	185.5	198	210.5	223	235.5	235.5	248	260.5	273	285.5	298	310.5	310.5
L2	112.5	125	137.5	150	162.5	162.5	175	187.5	200	212.5	225	225	237.5	250	262.5	275	287.5	300	300
L3	96.5	107	117.5	128	138.5	149	159.5	170	180.5	191	201.5	212	222.5	233	243.5	254	264.5	275	285.5
L4	13.5	14.5	15.5	16.5	17.5	12	13	14	15	16	17	12	13	14	15	16	17	18	12.5

5 Port Solenoid Valve

EX140 Integrated-type (For Output) Serial Transmission System

SZ3000 Series

Type **60S**



Note) Refer to the SI unit part no. for the SI unit comparable with CE.

An order for a manifold base only is not acceptable. Please order the solenoid valves for mounting at the same time while referring to the ordering example.

How to Order Manifold

SS5Z3 - 60S Q D - 05 U [] [] - [] - []

SI unit specifications

Symbol	Protocol type
0	Without SI unit
H	NKE Corp.: Fieldbus H System
Q	Device Net
R1	OMRON Corp.: CompoBus/S System (16 output points)
R2	OMRON Corp.: CompoBus/S System (8 output points)
V	CC-LINK

SI unit mounting position

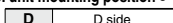

This should be indicated even without SI unit.

Valve stations

Symbol	Stations	Note
02	2 stations	Double wiring specification
08	8 stations	
02	2 stations	Specified layout (Up to 16 solenoids possible.)
16	16 stations	

Note 1) Double wiring specifications: Single, double, 3 position and 4 position solenoid valves can be used at all of the manifold stations.

Note 2) Specified layout: Indicate wiring specifications on the manifold specification sheet. (Note that double, 3 and 4 position valves cannot be used where single solenoid wiring has been specified.)

Note 3) R2 and J2 are available with up to 8 solenoids.

CE-compliant

Nil	—
Q	CE-compliant

Option

When a longer DIN rail is desired than the specified stations, specify the station number to be required.

SUP/EXH block fitting specifications

Nil	Straight
L	Elbow type (Upward)
B	Elbow type (Downward)

Pilot type

Nil	Internal pilot
R	External pilot

SUP/EXH block mounting position

U	U side (2 to 10 stations)
D	D side (2 to 10 stations)
B	Both sides (2 to 16 stations)
M	Special specifications

* For special specifications, indicate separately by the manifold specification sheet.

Note) A total of up to 3 SUP/EXH blocks can be mounted. Please contact SMC if 4 or more will be mounted.

SI unit part no.

Symbol	Protocol type	SI unit part no.	CE-compliant
H	NKE Corp.: Fieldbus H System	EX140-SUH1	—
Q	Device Net	EX140-SDN1	○
R1	OMRON Corp.: CompoBus/S (16 output points)	EX140-SCS1	○
R2	OMRON Corp.: CompoBus/S (8 output points)	EX140-SCS2	○
V	CC-LINK	EX140-SMJ1	○

How to Order Valve Manifold Assembly

Ordering example (Compo Bus/S compatible SI unit)

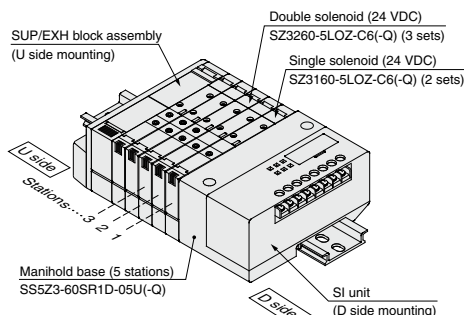

SS5Z3-60SR1D-05U (-Q)1 set (manifold part number)
 * **SZ3160-5LOZ-C6 (-Q)2 sets (Single solenoid part no.)**
 * **SZ3260-5LOZ-C6 (-Q)3 sets (Double solenoid part no.)**

↳ The asterisk denotes the symbol for assembly. Prefix it to the part nos. of the solenoid valve, etc.

Stations are counted from D side as the 1st one. Indicate the valves to be attached below the manifold part number, in order starting from station 1 as shown in the drawing.

When entry of part numbers becomes complicated, indicate on the manifold specification sheet.

Refer to Best Pneumatics No. 1-1 and the Operation Manual for the details of EX140 Integrated-type (For Output) Serial Transmission System. Please download the Operation Manual via our website, <http://www.smcworld.com>

How to Order Solenoid Valves

SZ3 1 60 [] [] - 5LOZ [] [] - C6 - [] - []

● **Type of actuation**

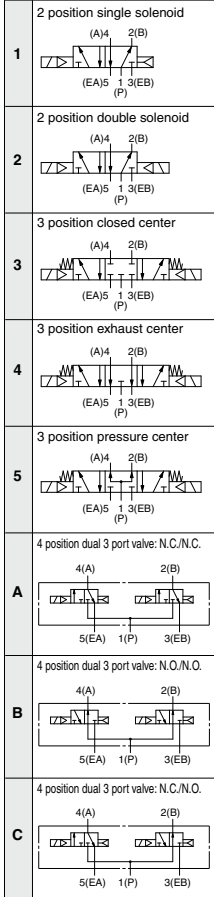

● **Switch specifications**

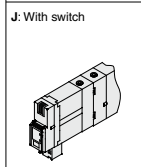
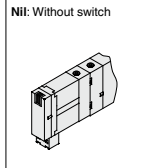

* For switch operation, refer to page 289.

● **Manual override**

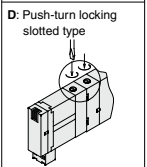
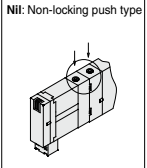

● **Back pressure check valve**

NII	None
K	Built-in

- The built-in back pressure check valve type has an effective area approximately 20% smaller.
- The 3 position valve is not available with back pressure check valve.

● **Pilot type**

NII	Internal pilot
R	External pilot

- Dual 3 port valves are not available with external pilot specifications.

● **CE-compliant**

NII	—
Q	CE-compliant

● **Made to Order**

NII	—
X90	Main Valve Fluororubber Specifications (Refer to page 288)

● **A, B port size**

- C4: One-touch fitting for ø4
- C6: One-touch fitting for ø6



M5: M5 x 0.8



- Elbow fitting assembly (Upward)
- L4: ø4 elbow fitting assembly
- L6: ø6 elbow fitting assembly



- Elbow fitting assembly (Downward)
- B4: ø4 elbow fitting assembly
- B6: ø6 elbow fitting assembly

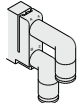

SV
SZY
SZ
VF
VP4
VQ 1/2
VQ 4/5
VQC 1/2
VQC 4/5
VQZ
SQ
VFS
VFR
VQ7

SZ3000 Series

Dimensions : SZ3000 EX140 Integrated-type (For Output) Serial Transmission System

SS5Z3-60S □ D- Stations U

[With external pilot]

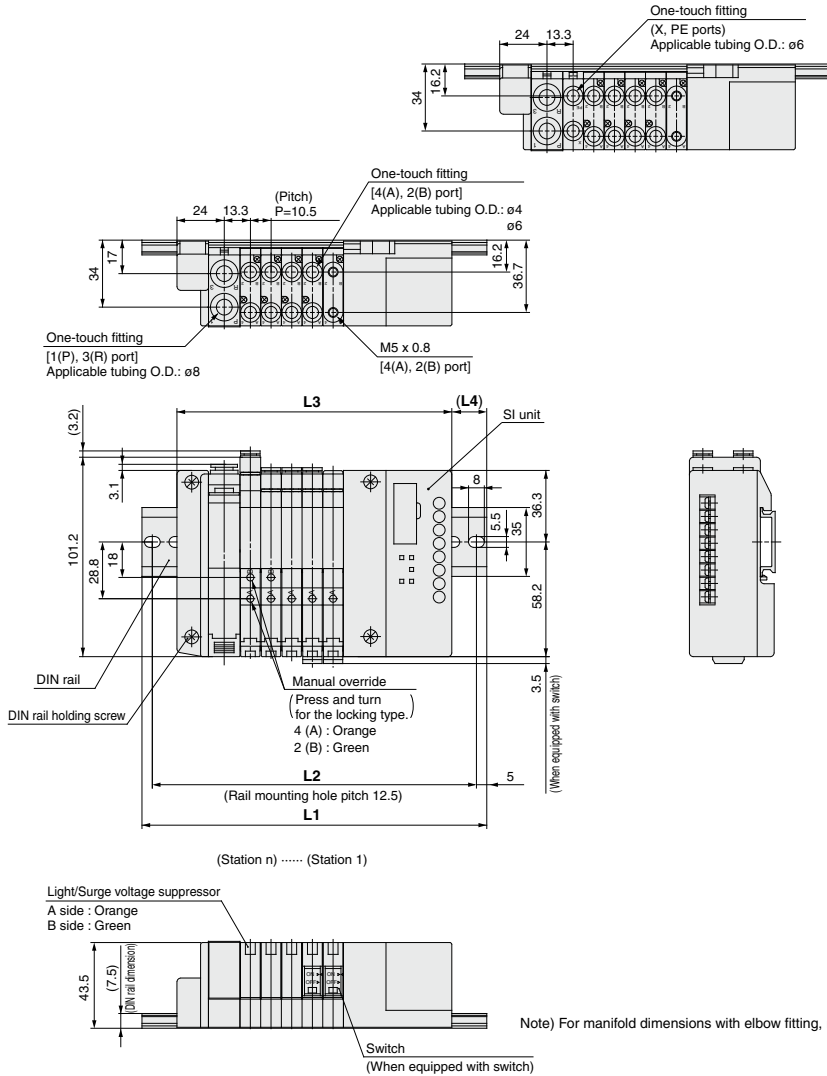

Note) For manifold dimensions with elbow fitting, refer to page 266.

Internal Pilot Manifold L Dimension

n : Stations

L \ n	2	3	4	5	6	7	8	9	10
L1	135.5	148	160.5	173	185.5	185.5	198	210.5	223
L2	125	137.5	150	162.5	175	187.5	200	212.5	225
L3	108	118.5	129	139.5	150	160.5	171	181.5	192
L4	14	15	16	17	18	12.5	13.5	14.5	15.5

External Pilot Manifold L Dimension

n : Stations

L \ n	2	3	4	5	6	7	8	9	10
L1	148	160.5	173	185.5	185.5	198	210.5	223	235.5
L2	137.5	150	162.5	175	175	187.5	200	212.5	225
L3	118.5	129	139.5	150	160.5	171	181.5	192	202.5
L4	15	16	17	18	12.5	13.5	14.5	15.5	16.5

Dimensions : SZ3000 EX140 Integrated-type (For Output) Serial Transmission System

SS5Z3-60S □ D- Stations B

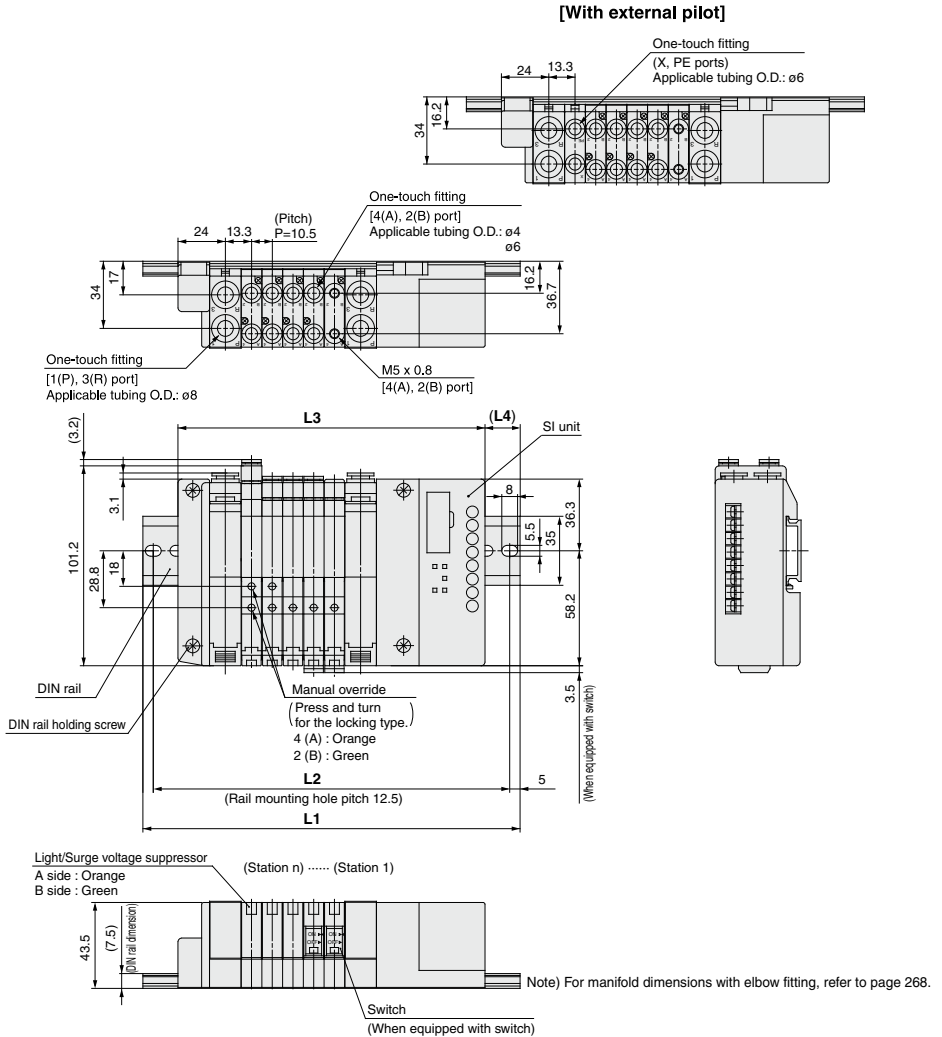

- SV
- SYJ
- SZ**
- VF
- VP4
- VQ 1/2
- VQ 4/5
- VQC 1/2
- VQC 4/5
- VQZ
- SQ
- VFS
- VFR
- VQ7

Internal Pilot Manifold L Dimension n : Stations

L/n	2	3	4	5	6	7	8	9
L1	148	160.5	173	185.5	198	210.5	210.5	223
L2	137.5	150	162.5	175	187.5	200	200	212.5
L3	124	134.5	145	155.5	166	176.5	187	197.5
L4	12	13	14	15	16	17	12	13

L/n	10	11	12	13	14	15	16
L1	235.5	248	260.5	273	285.5	285.5	298
L2	225	237.5	250	262.5	275	275	287.5
L3	208	218.5	229	239.5	250	260.5	271
L4	14	15	16	17	18	12.5	13.5

External Pilot Manifold L Dimension n : Stations

L/n	2	3	4	5	6	7	8	9
L1	160.5	173	185.5	198	210.5	210.5	223	235.5
L2	150	162.5	175	187.5	200	200	212.5	225
L3	134.5	145	155.5	166	176.5	187	197.5	208
L4	13	14	15	16	17	12	13	14

L/n	10	11	12	13	14	15	16
L1	248	260.5	273	285.5	285.5	298	310.5
L2	237.5	250	262.5	275	275	287.5	300
L3	218.5	229	239.5	250	260.5	271	281.5
L4	15	16	17	18	12.5	13.5	14.5

EX510 Gateway-type Serial Transmission System Plug-in Type Cassette Type Manifold **SZ3000 Series**

Type **60S6B**

CE
[Option]

How to Order Manifold

An order for a manifold base only is not acceptable. Please order the solenoid valves for mounting at the same time while referring to the ordering example.

SS5Z3 - 60S6B D - 05 U

SI unit specifications

Nil	NPN output (+ COM)
N	PNP output (- COM)

Unit mounting position

D	D side
---	--------

CE-compliant

Nil	—
Q	CE-compliant

Option

When a longer DIN rail is desired than the specified stations, specify the station number to be required. (Max. 16)

Valve stations

Symbol	Stations	Note
02	2 stations	Double wiring specification ⁽¹⁾
:	:	
08	8 stations	Specified layout ⁽²⁾ (Up to 16 solenoids possible.)
02	2 stations	
:	:	
16	16 stations	

* Including the number of blanking block assembly
Note 1) Double wiring specifications: Single, double, 3 position and 4 position solenoid valves can be used at all of the manifold stations.

Note 2) Specified layout: Indicate wiring specifications on the manifold specification sheet. (Note that double, 3 and 4 position valves cannot be used where single solenoid wiring has been specified.)

SUP/EXH block fitting specifications

Nil	Straight
L	Elbow fittings (Upward)
B	Elbow fittings (Downward)

Pilot type

Nil	Internal pilot
R	External pilot

SUP/EXH block mounting position

U	U side	2 to 10 stations
D	D side	2 to 10 stations
B	Both sides	2 to 16 stations
M	Special specifications	Note

* For special specifications, indicate separately by the manifold specification sheet.

Note) A total of up to 3 SUP/EXH blocks can be mounted. Please contact SMC if 4 or more will be mounted.

How to Order Valve Manifold Assembly

Ordering example

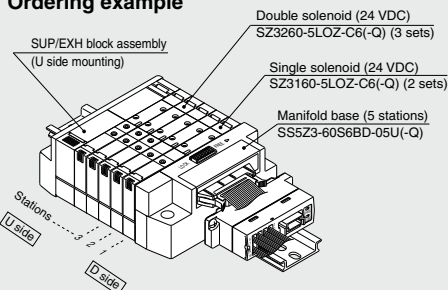

SS5Z3-60S6BD-05U (-Q).....1 set (60S6B type 5-station manifold part no.)
* **SZ3160-5LOZ-C6 (-Q)**.....2 sets (Single solenoid part no.)
* **SZ3260-5LOZ-C6 (-Q)**.....3 sets (Double solenoid part no.)

The asterisk denotes the symbol for assembly. Prefix it to the part nos. of the solenoid valve, etc.

- Valves will be assembled in the order listed starting at the first station at the D side.
 - Indicate the valves to be attached below the manifold part number, in order starting from station 1 as shown in the drawing.
- In the case of complex arrangement, specify them on the manifold specification sheet.

SI unit part no.

Symbol	SI unit specifications	SI unit part no.	Page
Nil	NPN output (+ COM)	EX510-S002B	Best Pneumatics No. 1-1
N	PNP output (- COM)	EX510-S102B	P. 897

Refer to Best Pneumatics No. 1-1 and the Operation Manual for the details of EX510 Gateway-type Serial Transmission System. Please download the Operation Manual via our website, <http://www.smcworld.com>

How to Order

● **How to order solenoid valves** For plug-in (Common for both with and without power supply terminals)

SZ3 **1** **60** **-** **5** **LOZ** **-** **C6** **-** **-** **-**

Type of actuation

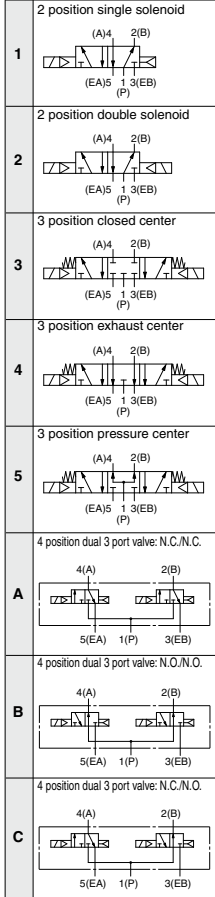

● **Rated voltage**

5	24 VDC
6	12 VDC

● When using on a manifold with power supply terminals, be sure to match with the manifold's voltage specifications.

● **Back pressure check valve**

Nil	None
K	Built-in

● The built-in back pressure check valve type has an effective area approximately 20% smaller.
● The 3 position valve is not available with back pressure check valve.

● **Pilot type**

Nil	Internal pilot
R	External pilot

● The 4 position dual 3 port valve is not available with external pilot specifications.

● **Rated voltage**

Nil: Without switch

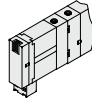

J: With switch



* For switch operation, refer to page 289.

● **Common specifications**

Nil	Positive common
N	Negative common

● When the SI unit specifications are PNP output (-COM), the common specifications of valves should be negative common.

● **Manual override**

Nil: Non-locking push type

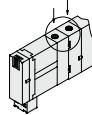

D: Push-turn locking slotted type

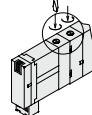

● **CE-compliant**

Nil	—
Q	CE-compliant

● **Made to Order**

Nil	—
X90	Main Valve Fluororubber Specifications (Refer to page 288)

● **A, B port size**

C4: One-touch fitting for ø4
C6: One-touch fitting for ø6



M5: M5 x 0.5



Elbow fitting assembly (Upward)
L4: ø4 elbow fitting assembly
L6: ø6 elbow fitting assembly



Elbow fitting assembly (Downward)
B4: ø4 elbow fitting assembly
B6: ø6 elbow fitting assembly

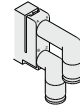

SV

SYJ

SZ

VF

VP4

VQ

1/2

VQ

4/5

VQC

1/2

VQC

4/5

VQZ

SQ

VFS

VFR

VQ7

SZ3000 Series

Dimensions : SZ3000 EX510 Gateway-type Serial Transmission System

SS5Z3-60S6B □ D- Stations U □

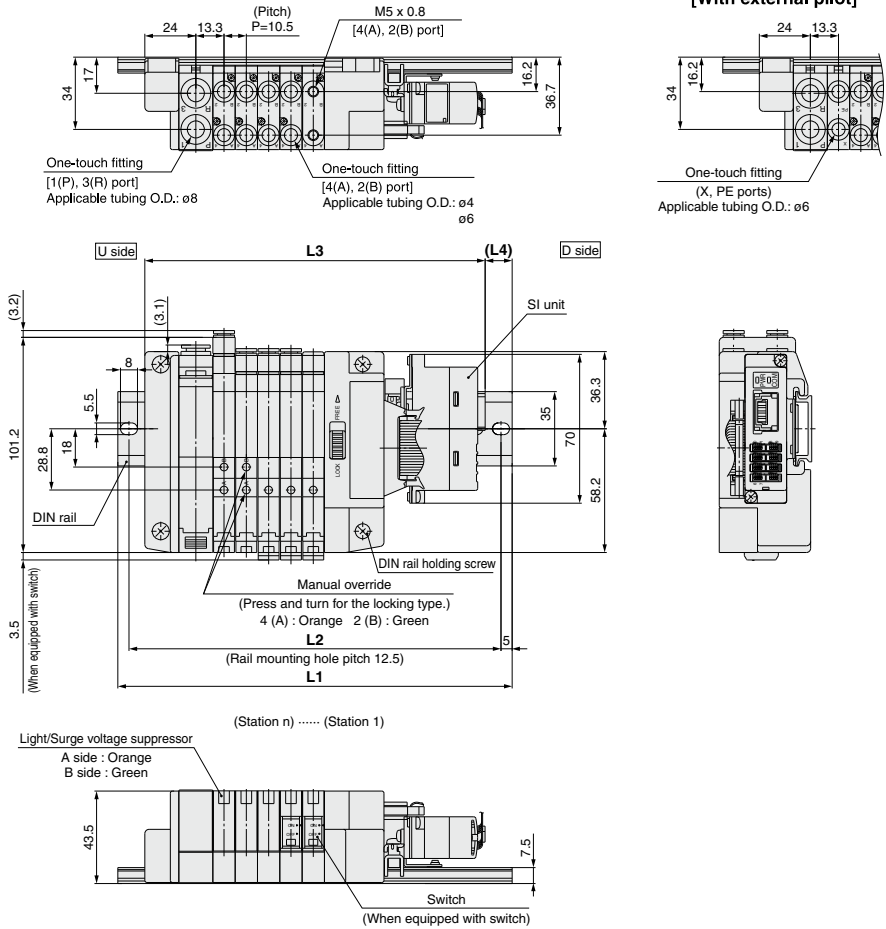

Note) For manifold dimensions with elbow fitting, refer to page 268.

Internal Pilot Manifold L Dimension

n : Stations

L \ n	2	3	4	5	6	7	8	9	10
L1	160.5	173	185.5	185.5	198	210.5	223	235.5	248
L2	150	162.5	175	175	187.5	200	212.5	225	237.5
L3	128.6	139.1	149.6	160.1	170.6	181.1	191.6	202.1	212.6
L4	16	17	18	12.5	13.5	14.5	15.5	16.5	17.5

External Pilot Manifold L Dimension

n : Stations

L \ n	2	3	4	5	6	7	8	9	10
L1	173	185.5	185.5	198	210.5	223	235.5	248	260.5
L2	162.5	175	175	187.5	200	212.5	225	237.5	250
L3	139.1	149.6	160.1	170.6	181.1	191.6	202.1	212.6	223.1
L4	17	18	12.5	13.5	14.5	15.5	16.5	17.5	18.5

Dimensions : SZ3000 EX510 Gateway-type Serial Transmission System

SS5Z3-60S6B□D-**Stations**□B-□

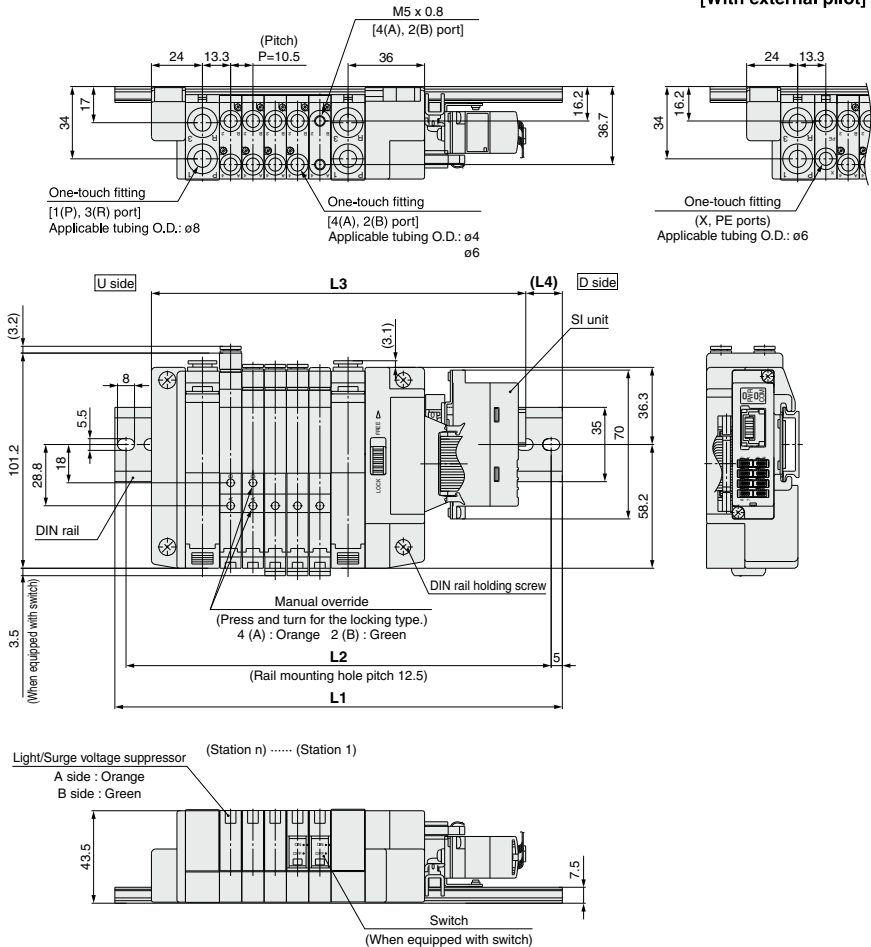

Note) For manifold dimensions with elbow fitting, refer to page 268.

Internal Pilot Manifold L Dimension

		n : Stations														
L	n	2	3	4	5	6	7	8	9	10	11	12	13	14	15	16
L1		173	185.5	198	210.5	223	223	235.5	248	260.5	273	285.5	298	298	310.5	323
L2		162.5	175	187.5	200	212.5	212.5	225	237.5	250	262.5	275	287.5	287.5	300	312.5
L3		144.6	155.1	165.6	176.1	186.6	197.1	207.6	218.1	228.6	239.1	249.6	260.1	270.6	281.1	291.6
L4		14	15	16	17	18	13	14	15	16	17	18	19	13.5	14.5	15.5

External Pilot Manifold L Dimension

		n : Stations														
L	n	2	3	4	5	6	7	8	9	10	11	12	13	14	15	16
L1		185.5	198	210.5	223	223	235.5	248	260.5	273	285.5	298	298	310.5	323	335.5
L2		175	187.5	200	212.5	212.5	225	237.5	250	262.5	275	287.5	287.5	300	312.5	325
L3		155.1	165.6	176.1	186.6	197.1	207.6	218.1	228.6	239.1	249.6	260.1	270.6	281.1	291.6	302.1
L4		15	16	17	18	13	14	15	16	17	18	19	13.5	14.5	15.5	16.5

- SV
- SYJ
- SZ**
- VF
- VP4
- VQ 1/2
- VQ 4/5
- VQC 1/2
- VQC 4/5
- VQZ
- SQ
- VFS
- VFR
- VQ7

Type **60GD**

PC Wiring System Plug-in Type

SZ3000 Series



An order for a manifold base only is not acceptable. Please order the solenoid valves for mounting at the same time while referring to the ordering example.

How to Order Manifold

SS5Z3 — 60GD 1 — 05 U [] [] [] [] [] []

Connector entry direction

1	Upward
2	Lateral

Valve stations

Symbol	Stations	Note
02	2 stations	Double wiring specification
⋮	⋮	
08	8 stations	
02	2 stations	Specified layout (Up to 16 solenoids possible.)
⋮	⋮	
16	16 stations	

Note 1) Double wiring specifications:
Single, double, 3 position and 4 position solenoid valves can be used at all of the manifold stations.
Specified layout:
Indicate wiring specifications on the manifold specification sheet. (Note that double, 3 and 4 position valves cannot be used where single solenoid wiring has been specified.)

Note 2) The number of the blanking block is also included.

SUP/EXH block assembly mounting position

U	U side (2 to 10 stations)
D	D side (2 to 10 stations)
B	Both sides (2 to 16 stations)
*M	Special specifications

* For special specifications, indicate separately by the manifold specification sheet.
Note) A total of up to 3 SUP/EXH blocks can be mounted. Please contact SMC if 4 or more will be mounted.

CE-compliant

Nil	—
Q	CE-compliant

Option
When a longer DIN rail is desired than the specified stations, specify the station number to be required.

SUP/EXH block assembly fitting specifications

Nil	Straight
L	Elbow fittings (Upward)
B	Elbow fittings (Downward)

Pilot type

Nil	Internal pilot
R	External pilot

How to Order Valves

SZ3 1 60 [] [] [] [] **5 LOZ** [] [] [] **C6** [] [] [] []

Type of actuation

1	2 position single solenoid
2	2 position double solenoid
3	3 position closed center
4	3 position exhaust center
5	3 position pressure center
A	4 position dual 3 port valve: N.C./N.C.
B	4 position dual 3 port valve: N.O./N.O.
C	4 position dual 3 port valve: N.C./N.O.

Switch specifications

Nil	Without switch
J	With switch

Rated voltage

5	24 VDC
---	--------

Pilot type

Nil	Internal pilot
R	External pilot

* External pilot spec. is not applicable for 4 position solenoid dual 3 port valves.

Back pressure check valve

Nil	None
K	Built-in

Note 1) The built-in back pressure check valve type has an effective area approximately 20% smaller.
Note 2) Back pressure check valve is not available for 3 position valve.

CE-compliant

Nil	—
Q	CE-compliant

Made to Order

Nil	—
X90	Main valve fluororubber specifications (Refer to page 288)

A, B port size

C4	One-touch fitting for ø4
C6	One-touch fitting for ø6
M5	M5 × 0.5
L4	ø4 Elbow fitting assembly (Upward)
L6	ø6 Elbow fitting assembly (Upward)
B4	ø4 Elbow fitting assembly (Downward)
B6	ø6 Elbow fitting assembly (Downward)

Manual override

Nil	Non-locking push type
D	Push-turn locking slotted type

How to Order Valve Manifold Assembly

Ordering example (SZ3000, positive common with power supply terminals)

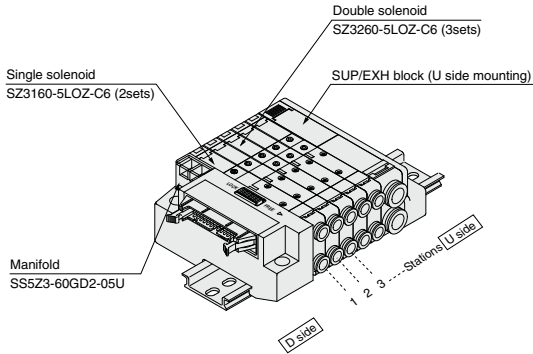

SS5Z3-60GD2-05U.....1set (Manifold part number)
 * SZ3160-5LOZ-C6.....2sets (Single solenoid part no.)
 * SZ3260-5LOZ-C6.....3sets (Double solenoid part no.)

- The asterisk denotes the symbol for assembly. Prefix it to the part nos. of the solenoid valve, etc.
- Stations are counted from D side as the 1st one.
 - Indicate the valves to be attached below the manifold part number, in order starting from station 1 as shown in the drawing. When entry of part numbers becomes complicated, indicate on the manifold specification sheet.

Manifold Specifications

Model		Flat ribbon cable type 60G
Manifold		Plug-in type
P(SUP)/R(EXH) system		Common SUP, EXH
Valve stations ^{Note 1)}		2 to 16 stations
Applicable connector		Flat ribbon cable connector Socket: 20 pins MIL type with strain relief Conforming to MIL-C-83503
A, B port	Location	Valve
Porting specification	Direction	Lateral
	P, R port	C8
Port size	A/B port	C4, C6, M5
	Weight W(g) ^{Note 2)} (n1: Stations n2: Number of SUP/EXH blocks) m: Weight of DIN rail	$W = 3.2n_1 + 53n_2 + m + 126.5$

Note 1) This manifold is applicable to up to 16 solenoid valves. When many valves are operated simultaneously, use B type (SUP/EXH both sides), applying pressure to the P ports on both sides and exhaust from the R ports on both sides.

Note 2) The weight W is the value for the manifold only. To obtain the weight with solenoid valves attached, add the weight of the solenoid valve stations to that of the manifold. For details about the DIN rail weight, refer to the separate catalog CAT.ES11-75.

Manifold Electrical Wiring

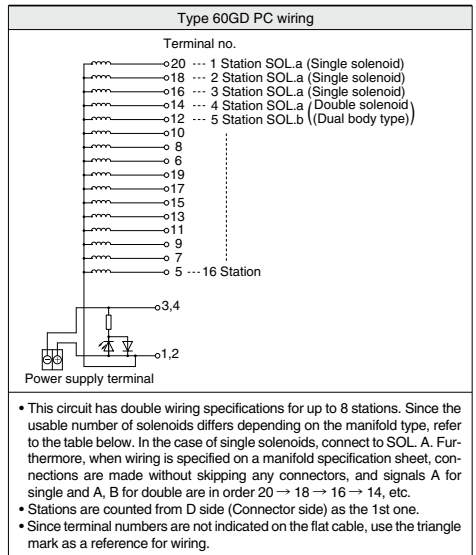

SV
SYJ
SZ
VF
VP4
VQ 1/2
VQ 4/5
VQC 1/2
VQC 4/5
VQZ
SQ
VFS
VFR
VQ7

Dimensions: SZ3000 Series for Plug-in

SS5Z3-60GD₂ - Stations B-□

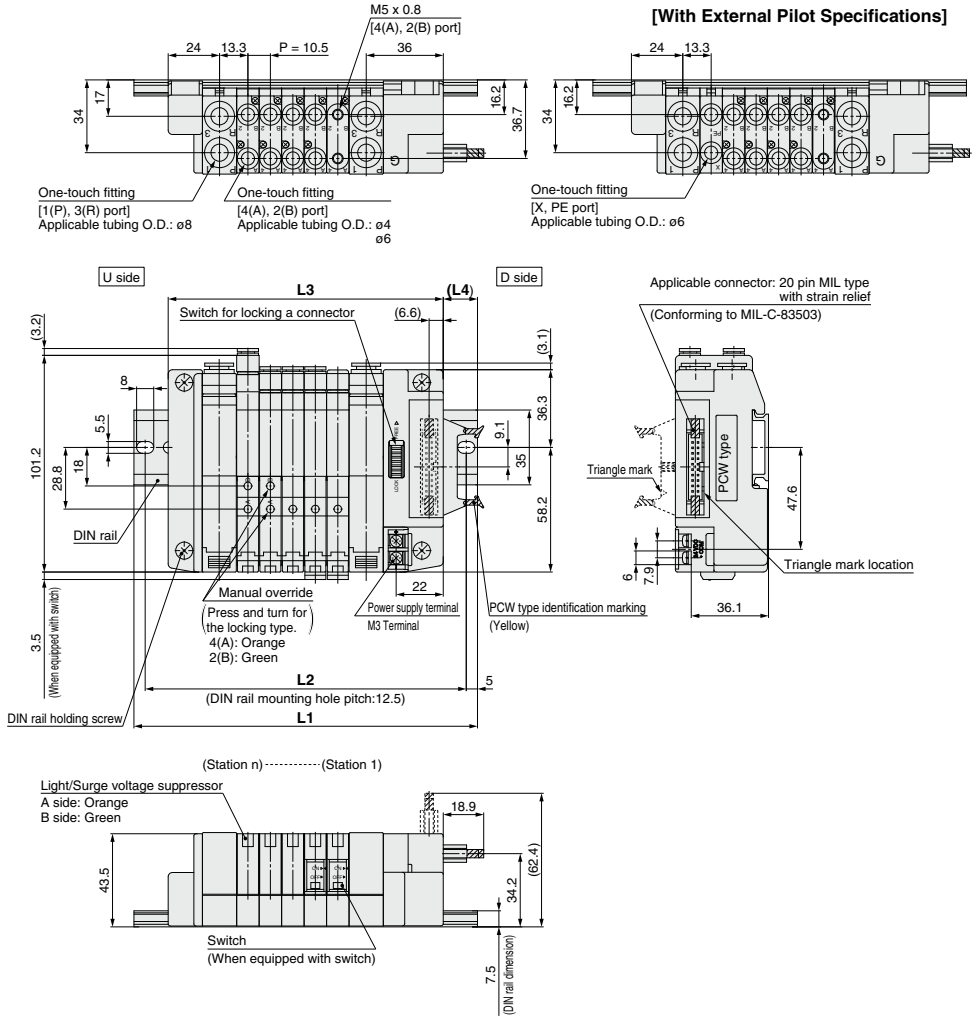

- SV
- SZY
- SZ**
- VF
- VP4
- VQ 1/2
- VQ 4/5
- VQC 1/2
- VQC 4/5
- VQZ
- SQ
- VFS
- VFR
- VQ7

Internal Pilot Manifold L Dimension

n: Stations (n1 + n2)

L	n	2	3	4	5	6	7	8	9	10	11	12	13	14	15	16
L1	123	135.5	148	160.5	173	173	185.5	198	210.5	223	235.5	248	248	260.5	273	
L2	112.5	125	137.5	150	162.5	162.5	175	187.5	200	212.5	225	237.5	237.5	250	262.5	
L3	97	107.5	118	128.5	139	149.5	160	170.5	181	191.5	202	212.5	223	233.5	244	
L4	13	14	15	16	17	12	13	14	15	16	17	18	12.5	13.5	14.5	

External Pilot Manifold L Dimension

n: Stations (n1 + n2)

L	n	2	3	4	5	6	7	8	9	10	11	12	13	14	15	16
L1	135.5	148	160.5	173	173	185.5	198	210.5	223	235.5	248	248	260.5	273	285.5	
L2	125	137.5	150	162.5	162.5	175	187.5	200	212.5	225	237.5	237.5	250	262.5	275	
L3	107.5	118	128.5	139	149.5	160	170.5	181	191.5	202	212.5	223	233.5	244	254.5	
L4	14	15	16	17	12	13	14	15	16	17	18	12.5	13.5	14.5	15.5	

SZ3000 Series

Made to Order Specifications:

Please contact SMC for detailed specifications, delivery and pricing.

1 Main Valve Fluororubber Specifications **-X90**

Symbol

Fluororubber is used for rubber parts of the main valve to allow use in applications such as the following.

1. When using a lubricant other than the recommended turbine oil, and there is a possibility of malfunction due to swelling of the spool valve seals.
2. When ozone enters or is generated in the air supply.

Model no.

SZ3 60(R) - - - -X90 -

• **Entry is the same as standard products.**
Specifications and performance are the same as standard products.

CE-compliant	
Nii	—
Q	CE-compliant

Note) Because in -X90 series fluororubber is used for only main valve, the rubber parts of the application/usage in conditions requiring heat resistance should be avoided.

2 Plug-in Manifold Connector and Serial Unit Mounted on Side U

Products are also available with the plug-in manifold connector mounting position and the serial unit mounting position on the reverse side (U side). For details about part numbers and wiring specifications, etc., please contact SMC.

Standard

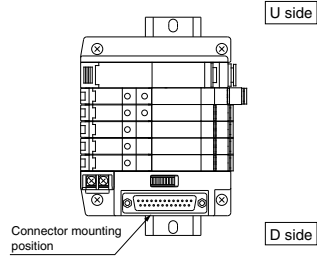

Made to Order

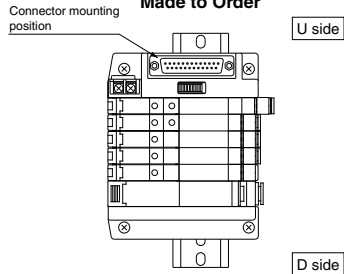



SZ3000 Series

Specific Product Precautions 1

Be sure to read this before handling the products.

Refer to back page 50 for Safety Instructions and pages 3 to 9 for 3/4/5 Port Solenoid Valve Precautions.

Manual Override Operation

Warning

Handle carefully, as connected equipment can be actuated through manual override operation.

■ Non-locking push type

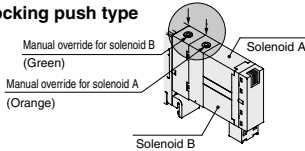

■ Push-turn locking slotted type

After pushing down, turn in the direction of the arrow. If it is not turned, it can be operated the same way as the non-locking type.

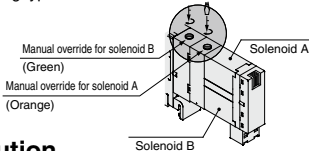

Caution

When locking the manual override with the push-turn locking slotted type, be sure to push it down before turning. Turning without first pushing it down can cause damage to the manual override and other trouble such as air leakage, etc.

Valves with Switches

Warning

When turning OFF with the switch, be sure to move the switch to the locked position. Connected equipment may be actuated if current flow occurs with the switch at an improper position.

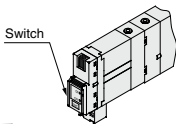

ON position



OFF position



Normal operating condition. Switching of valve is based on an electric signal from the connector.

The valve coil is kept in a de-energized state even when there is an electric signal from the connector.

Electric circuit diagram (With positive common and light/surge voltage suppressor)

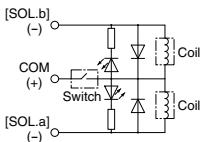

How to Use Plug Connector

Caution

When attaching and detaching a connector, first shut off the electric power and the air supply. Also, crimp the lead wires and sockets securely.

1. Attaching and detaching connectors

- To attach a connector, hold the lever and connector unit between your fingers and insert straight onto the pins of the solenoid valve so that the lever's pawl is pushed into the groove and locks.
- To detach a connector, remove the pawl from the groove by pushing the lever downward with your thumb, and pull the connector straight out.

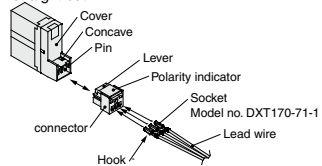

2. Crimping of lead wires and sockets

Peel 3.2 to 3.7 mm of the tip of lead wire, enter the core wires neatly into a socket and crimp it with a special crimp tool. Be careful so that the cover of lead wire does not enter into the crimping part. (Please contact SMC for the dedicated crimping tools.)

Core wire crimping area

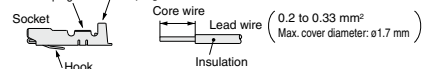

3. Attaching and detaching lead wires with sockets

● Attaching

Insert the sockets into the square holes of the connector (with ⊕ and ⊖ indication), and continue to push the sockets all the way in until the lock by hooking into the seats in the connector. (When they are pushed in, their hooks open and they are locked automatically.) Then confirm that they are locked by pulling lightly on the lead wires.

● Detaching

To detach a socket from a connector, pull out the lead wire while pressing the socket's hook with a stick having a thin tip (approx. 1 mm). If the socket is used again, spread the hook outward.

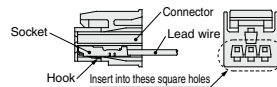

■ Plug connector lead wire lengths

Plug connector lead wires have a standard length of 300 mm, however, the following lengths are also available.

M Type Connector Assembly Part No.

Positive common specifications

For single solenoid **SX100-40-4S-**
For double solenoid **6**
For 3 position type **10**
For 4 position type **15**

Negative common specifications

For single solenoid **SX100-41-4S-**
For double solenoid **25**
For 3 position type **30**
For 4 position type **50**

How to Order

Include the connector assembly part number together with the part number for the plug connector's solenoid valve without connector.

Lead wire length

NH	300mm
6	600mm
10	1000mm
15	1500mm
20	2000mm
25	2500mm
30	3000mm
50	5000mm

<Example>
Lead wire length 2000 mm
SZ3160-5MO-M5
SX100-40-4S-20



SZ3000 Series

Specific Product Precautions 2

Be sure to read this before handling the products.

Refer to back page 50 for Safety Instructions and pages 3 to 9 for 3/4/5 Port Solenoid Valve Precautions.

Common Connector Assembly for Manifold

Caution

By using a common connector assembly for the solenoid valves on a manifold, the common wiring for each solenoid valve is reduced to one line, making it possible to achieve labor savings on wiring work.

Common connector assembly part numbers

Positive common specifications

For single solenoid

SX100-42-4S



For double solenoid, 3 position type, 4 position type

SX100-42-4D



With common lead wire for single solenoid

SX100-40-4S



With common lead wire for double solenoid, 3 position type, 4 position type

SX100-40-4D



(Lead wire length 300 mm)

Negative common specifications

For single solenoid

SX100-43-4S



For double solenoid, 3 position type, 4 position type

SX100-43-4D



With common lead wire for single solenoid

SX100-41-4S



With common lead wire for double solenoid, 3 position type, 4 position type

SX100-41-4D



(Lead wire length 300 mm)

How to Order

Include the common connector assembly part number together with the manifold and solenoid valve part numbers. If the arrangement becomes complicated, then indicate on the manifold specification sheet.

Note 1) Take note that applications with unused connectors or with blanking plates between stations are not possible.

Note 2) For the solenoid valve, specify "without connector" for the plug connector type. The grommet type cannot be used.

Note 3) In places where signals will be sent to the common wiring, use a connector assembly with a common lead wire.
(This is limited to the first station or the last station of a manifold.)

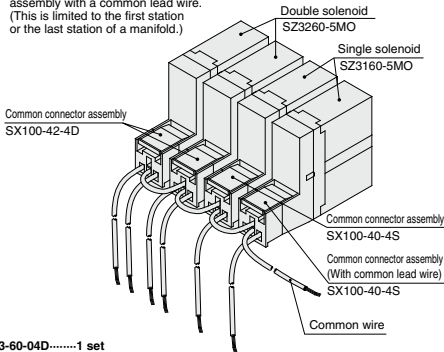

SS5Z3-60-04D.....1 set

*SZ3160-5MO.....2 sets

*SZ3260-5MO.....2 sets

*SX100-40-4S.....1 set (with common Lead wire for single solenoid)

*SX100-42-4S.....1 set (For single solenoid)

*SX100-42-4D.....2 sets (For double solenoid, for 3 position, 4 position)

↳ The * mark denotes the assembling symbol. Prefix "*" to the part nos. of solenoid valves, etc.

Common Connector Assembly for Manifold

Common connector assembly wiring

When ordering common connector assemblies alone, wiring should be performed as outlined in the drawing below. For details on attachment of sockets, refer to the section "How to Use Plug Connectors" on page 289.

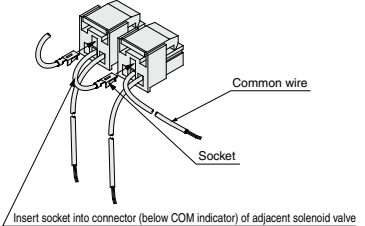

One-touch Fittings

Caution

The pitch of each piping port (P, A, B, etc.) for the SZ series is based on the assumption that the KJ series One-touch fittings will be used. For this reason, when other fittings are used, they may interfere with one another depending on their types and sizes. Therefore, the dimensions of the fittings to be used should first be confirmed in their respective catalogs.

Exhaust Restriction

Caution

Since the SZ series is a type in which the pilot valve exhaust joins the main valve exhaust inside the valve, care must be taken that the piping from the exhaust port is not restricted.

Used as a 3 Port Valve

Caution

SZ3000 series

Using a 5 port valve as a 3 port valve

The SZ3000 series valves can be used as normally closed (N.C.) or normally open (N.O.) 3 port valves by closing one of the cylinder ports (A or B) with a plug. However, they should be used with the exhaust ports kept open. They are convenient at times when a double solenoid type 3 port valve is required.

		B port	A port
		N.C.	N.O.
Type of actuation			
Number of solenoids	Single		
	Double		



SZ3000 Series

Specific Product Precautions 3

Be sure to read this before handling the products.

Refer to back page 50 for Safety Instructions and pages 3 to 9 for 3/4/5 Port Solenoid Valve Precautions.

Light/Surge Voltage Suppressor

⚠ Caution

Pos. common specifications Single solenoid type

Light/Surge voltage suppressor

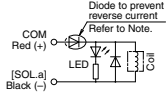

Surge voltage suppressor

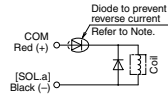

Pos. common specifications

Double solenoid, 3 position type, 4 position type

Light/Surge voltage suppressor

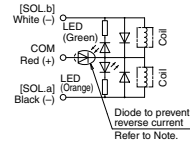

Surge voltage suppressor

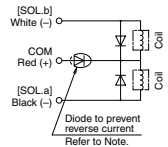

Neg. common specifications Single solenoid type

Light/Surge voltage suppressor

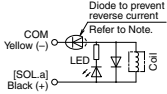

Surge voltage suppressor

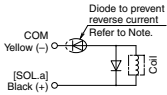

Neg. common specifications

For double solenoid, 3 position type, 4 position type

Light/Surge voltage suppressor

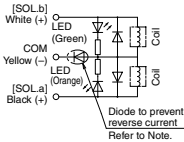

Surge voltage suppressor

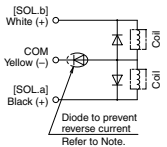

Note) Connect so that polarity is matched to the connector's (+), (-) and A, B and COM indicators. In case of voltage specifications other than 12 or 24 VDC, take care to avoid mistaking polarity, as there is no diode to prevent reverse current. In the event that lead wires are connected in advance, they will be as shown below.

Pos. common specifications

- A (-): Black
- COM (+): Red
- B (-): White (No lead wire in case of single solenoid)

Neg. common specifications

- A (+): Black
- COM (-): Yellow
- B (+): White (No lead wire in case of single solenoid)

Light Indication

⚠ Caution

When equipped with indicator light and surge voltage suppressor, the light window turns orange when solenoid A is energized, and it turns green when solenoid B is energized.

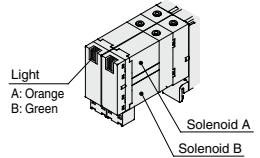

Changing the Connector Entry Direction

⚠ Caution

To change the connector's entry direction, press the levers on both sides of the connector, take it off, and change the direction as shown in the drawing. Since lead wires are attached to the connector, excessive pulling or twisting can cause broken wires or other trouble. Also, take care that lead wires are not pinched when installing the connector.

If an excessive force is applied on the connector in the LOCK position, the connector block may be damaged. Also, using in such a way that the connector floats in the FREE position, it may cause the lead wire, etc. to break. Thus, refrain from using in these ways.

Switch for locking a connector

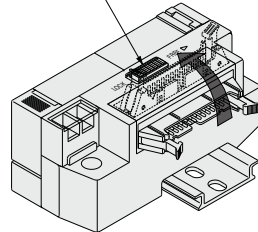

SV

SYJ

SZ

VF

VP4

VQ 1/2

VQ 4/5

VQC 1/2

VQC 4/5

VQZ

SQ

VFS

VFR

VQ7



SZ3000 Series

Specific Product Precautions 4

Be sure to read this before handling the products.

Refer to back page 50 for Safety Instructions and pages 3 to 9 for 3/4/5 Port Solenoid Valve Precautions.

Fitting Assembly Replacement

⚠ Caution

By replacing a valve's fitting assembly, it is possible to change the connection diameter of 4 (A), 2 (B), 1 (P), 3(R) ports. When replacing it, pull out the fitting assembly after removing the clip with a flat head screwdriver, etc. To mount a new fitting assembly, insert it into place and then fully reinset the clip.

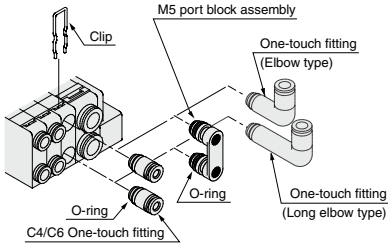

Part No.

	Port size	Part no.
4(A), 2(B) port	One-touch fitting assembly for ø4	VVQ1000-50A-C4
	One-touch fitting assembly for ø6	VVQ1000-50A-C6
	One-touch fitting assembly for ø4 (Elbow type)	SZ3000-73-1A-L4
	One-touch fitting assembly for ø6 (Elbow type)	SZ3000-73-1A-L6
	One-touch fitting assembly for ø4 (Long elbow type)	SZ3000-73-2A-L4
	One-touch fitting assembly for ø6 (Long elbow type)	SZ3000-73-2A-L6
1(P), 3(R) port	M5 port block assembly	SZ3000-56-1A
	One-touch fitting assembly for ø6	VVQ1000-51A-C6
	One-touch fitting assembly for ø8	VVQ1000-51A-C8
	One-touch fitting assembly for ø6 (Elbow type)	SZ3000-74-1A-L6
	One-touch fitting assembly for ø8 (Elbow type)	SZ3000-74-1A-L8
	One-touch fitting assembly for ø6 (Long elbow type)	SZ3000-74-2A-L6
	One-touch fitting assembly for ø8 (Long elbow type)	SZ3000-74-2A-L8

Note 1) When changing the connection diameters for ports 1(P) and 3(R) indicate this on the manifold specification sheets.

Note 2) Be careful to avoid damage or contamination of O-rings, as this can cause air leakage.

Note 3) When removing a straight type fitting assembly from valve, after removing the clip, connect a tube or plug (KQP-□□) to the One-touch fitting and pull it out by holding the tube (or plug). If the fitting assembly is pulled out by holding its release button (resin part), the release bushing may be damaged.

Note 4) Be sure to shut off the power and air supplies before disassembly. Furthermore, since air may remain inside the actuator, piping and manifold, confirm that the air is completely exhausted before performing any work.

Note 5) When inserting tubing into an elbow type fitting assembly, insert the tubing while holding the elbow fitting assembly body with your hand. If the tubing is inserted without holding the elbow, excessive force can be applied to the valve and fitting assembly, causing air leakage or damage, etc.

How to Calculate the Flow Rate

For obtaining the flow rate, refer to front matters.

One-touch Fittings

⚠ Caution

1. Tube attachment/detachment for One-touch fittings

1) Attaching of tube

(1) Take a tube having no flaws on its periphery and cut it off at a right angle. When cutting the tube, use tube cutters TK-1, 2 or 3. Do not use pinchers, nippers or scissors, etc. If cutting is done with tools other than tube cutter, the tube may be cut diagonally or become flattened, etc. This can make a secure installation impossible, and cause problems such as the tube pulling out after installation or air leakage.

Also allow some extra length in the tube.

(2) Grasp the tube and push it in slowly, inserting it securely all the way into the fitting.

(3) After inserting the tube, pull on it lightly to confirm that it will not come out. If it is not installed securely all the way into the fitting, this can cause problems such as air leakage or the tube pulling out.

2) Detaching of tube

(1) Push in the release button sufficiently, pushing the collar evenly.

(2) Pull out the tube while holding down the release button so that it does not come out. If the release button is not pressed down sufficiently, there will be increased bite on the tube and it will become more difficult to pull it out.

(3) When the removed tube is to be used again, cut off the portion which has been chewed before reusing it. If the chewed portion of the tube is used as is, this can cause trouble such as air leakage or difficulty in removing the tube.

Other Tube Brands

⚠ Caution

1. When using other tubing than SMC brand, confirm that the following specifications are satisfied with respect to the outside diameter tolerance of the tube.

- 1) Nylon tubing within ±0.1 mm
- 2) Soft nylon tubing within ±0.1 mm
- 3) Polyurethane tubing within +0.15 mm, within -0.2 mm

Do not use tubes which do not meet these outside diameter tolerances. It may not be possible to connect them, or they may cause other trouble, such as air leakage or the tube pulling out after connection.

Built-in Back Pressure Check Valve

⚠ Caution

1. Valves with built-in back pressure check valve is to protect the back pressure inside a valve. For this reason, use caution that the valves with external pilot specification cannot be pressurized from exhaust port [3(R)]. As compared with the types which do not integrate the back pressure check valve, C value of the flow rate characteristics goes down. For details, please contact SMC.

2. Do not switch valves when A or B port is open to the atmosphere, or while the actuators and air operated equipment are in operation. The back pressure prevention seal may be peeled off, which may cause air leakage or malfunctions. Use caution especially when performing a trial operation or maintenance work.