

# 5 Port Solenoid Valve

## *SV1000/2000/3000/4000 Series*

Rubber Seal

The connection cable and various units for PLC connection in PC wiring systems have been discontinued by the manufacturer. Therefore, while they can no longer be provided, the valve manifold (manifold with built-in valves) can still be ordered. For details, refer to the **Web Catalog**.

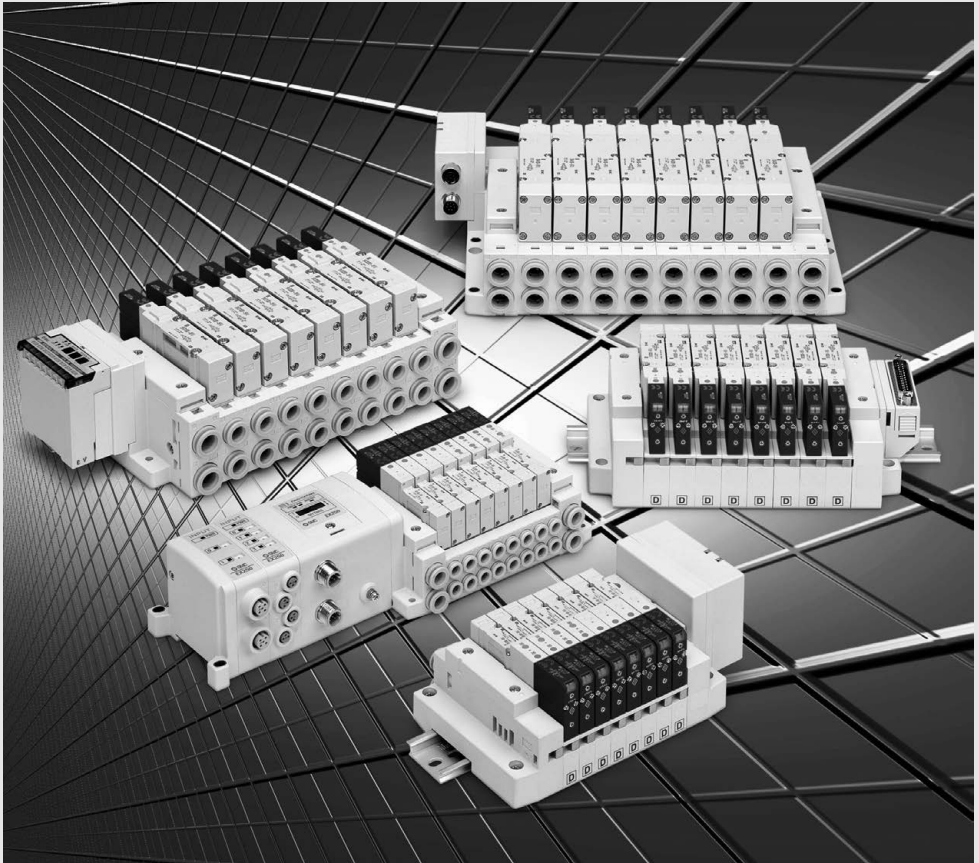

**Connector Type Manifold**

# Connector Type Manifold SV1000/2000/3000/4000 Series

- The use of multi-pin connectors to replace wiring inside manifold blocks provides flexibility when adding stations or changing manifold configuration.

The SV Series employs a multi-connector instead of the current lead wires for internal. By connecting each block with a connector, changes to manifold stations are greatly simplified.

## Connector wiring diagram

For both serial and parallel wiring, additional manifold blocks are sequentially assigned pins on the connector. This makes it completely unnecessary to disassemble the connector unit.

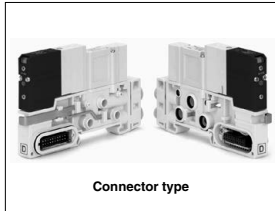
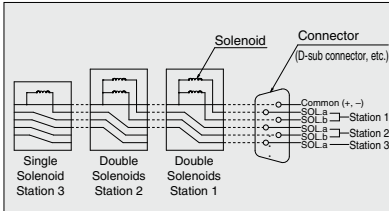

**Service life of 50 million cycles or more**  
(Based on SMC life test conditions)

## ■ Cassette base type manifold (For SV1000/2000)

Cassette base type manifolds offer the ultimate in flexibility. Manifold sections can be added using a simple release mechanism.

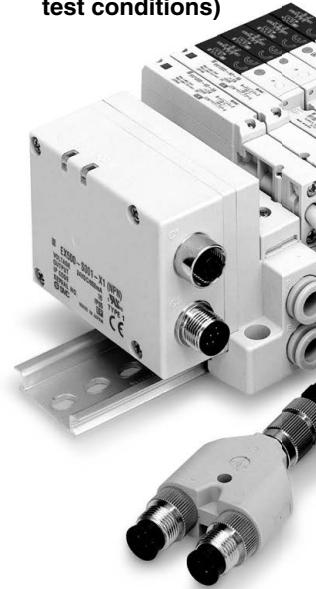
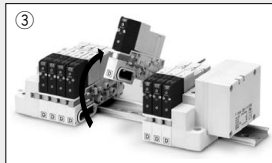
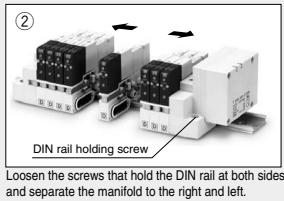
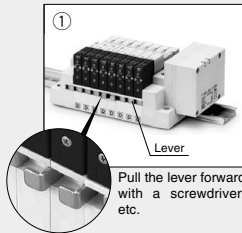

**Power consumption: 0.6 W**  
(Current: 25 mA, 24 VDC)

## ■ Tie-rod base manifold (For SV1000/2000/3000/4000)

Current tie-rod base type manifolds are also available. 34 pins connector allows up to 16 stations with double solenoids. (Refer to the tie-rod base manifold exploded view on page 114.)

- A relay output module control of devices up to 110 VAC, 3 A.

■ The standard product is CE/UKCA-compliant and UL-standard.

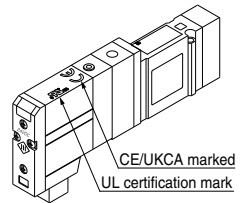

■ **EX500 Series: Gateway-type, serial transmission system**

- IP67 compliant (Gateway unit and input manifold are compliant with IP65.)
- No. of input/output point: 128 points (Output 64 points, Input 64 points)
- Controls up to 4 branches with 32 I/O per branch
- A single cable from the gateway provides both signal and power for each branch, eliminating the need for separate power connections for each manifold.

■ **EX250 Series: Integrated-type (for I/O), serial transmission system**

- IP67 compliant (compliant with IP40.)
- No. of input/output point: 64 points (Output 32 points, Input 32 points)
- Double solenoid allows up to 16 stations (up to 32 solenoids).

■ **Interface regulator SV1000, 2000, 3000, 4000 series**

- P port regulation, A port regulation and B port regulation are selectable, depending on an application. Able to set the pressure arbitrarily for each station of the manifold just by inserting between manifold base and valve.



■ **Increased moisture and dust resistance.**

- Enclosure against foreign matters and water is conforming to IP67\*. Can be used in an atmosphere where the valve or manifold is exposed by water, etc. directly. (\* Based on IEC60529) (Refer to the catalog contents for details, as some types of connectors do not meet these standards.)

■ **4 position dual 3 port valves available for the SV1000/2000 series**

- Two 3 port valves built into a single valve body.
- A and B ports can be individually controlled.
- Three combinations are available: [N.C./N.C.], [N.O./N.O.], and [N.C./N.O.].
- Mixed mounting with 5 port valves is also possible.
- Labels are attached to indicate A and B side functions, using the same color as the manual override.

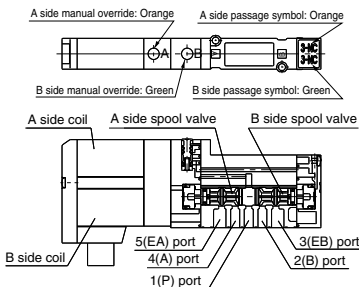

Model	A side	B side	Symbol	
			SV1000 series	SV2000 series
SV1A00	N.C. valve	N.C. valve		
SV1B00	N.O. valve	N.O. valve		
SV1C00	N.C. valve	N.O. valve		

\* External pilot specifications is not available for 4 position dual 3 port valves.





# INDEX

## SV Series Manifold Variations

### Serial Wiring

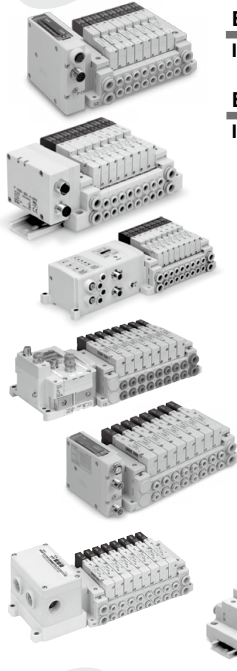

**Valve Manifold Common Specifications** P. 24

**EX500 Gateway Decentralized System 2** P. 28

**IP67 compliant** P. 33

	Applicable series	<b>Manifold specifications</b> <b>Tie-rod base manifold</b> <b>SV1000/SV2000/SV3000</b> • Number of output points: 32 points • Connected to the SI unit of the EX500
--	-------------------	---

**EX500 Gateway Decentralized System** P. 33

**IP67 compliant** P. 41

	Applicable series	<b>Cassette base manifold</b> <b>SV1000/SV2000</b> <b>Tie-rod base manifold</b> <b>SV1000/SV2000/SV3000/SV4000</b> • Number of output points: 16 points • Connected to the SI unit of the EX500
--	-------------------	---

**EX250 Integrated-type (For I/O) Serial Transmission System** P. 41

**IP67 (partly IP40) compliant** P. 47

	Applicable series	<b>Tie-rod base manifold</b> <b>SV1000/SV2000/SV3000</b> • Number of input/output points: Each 32 points
--	-------------------	--

**EX600 Integrated-type (For I/O) Serial Transmission System** P. 47

**IP67 compliant** P. 57

	Applicable series	<b>Tie-rod base manifold</b> <b>SV1000/SV2000/SV3000</b> • Digital input/output: Max. 144 inputs/144 outputs • Analog input: Max. 18 channels • Valve output: 32 outputs
--	-------------------	--

**EX260 Integrated-type (For Output) Serial Transmission System** P. 57

**IP67 (partly IP40) compliant** P. 63

	Applicable series	<b>Tie-rod base manifold</b> <b>SV1000/SV2000/SV3000</b> • Number of output points: 16 points
--	-------------------	---

**EX126 Integrated-type (For Output) Serial Transmission System** P. 63

**IP67 compliant** P. 69

	Applicable series	<b>Tie-rod base manifold</b> <b>SV1000/SV2000/SV3000</b> • Number of output points: 16, 32 points
--	-------------------	---

**EX120 Integrated-type (For Output) Serial Transmission System** P. 69

**IP67 compliant** P. 79

	Applicable series	<b>Cassette base manifold</b> <b>SV1000/SV2000</b> <b>Tie-rod base manifold</b> <b>SV1000/SV2000/SV3000/SV4000</b> • Number of output points: 16 points
--	-------------------	---

### Parallel Wiring

**For Circular Connector**

**IP67 compliant** P. 89

	Applicable series	<b>Cassette base manifold</b> <b>SV1000/SV2000</b> <b>Tie-rod base manifold</b> <b>SV1000/SV2000/SV3000/SV4000</b> • Number of connectors: 26 pins
--	-------------------	--

**D-sub Connector** P. 89

	Applicable series	<b>Cassette base manifold</b> <b>SV1000/SV2000</b> <b>Tie-rod base manifold</b> <b>SV1000/SV2000/SV3000/SV4000</b> • Number of connectors: 25 pins • MIL-C-24308 Conforming to JIS-X-5101
--	-------------------	--

**Flat Ribbon Cable Connector** P. 99

	Applicable series	<b>Cassette base manifold</b> <b>SV1000/SV2000</b> <b>Tie-rod base manifold</b> <b>SV1000/SV2000/SV3000/SV4000</b> • Number of connectors: 26, 20, 10 pins • With strain relief Conforming to MIL-C-83503
--	-------------------	--

**Single Valve/Sub-plate [IP67 compliant]** P. 126

**IP67 compliant** P. 134

	Applicable series	<b>SV1000/SV2000/SV3000/SV4000</b> • With waterproof M12 connector
--	-------------------	---

**Made to Order Specifications** P. 134



# Valve Manifold Common Specifications

# SV Series



## Cassette base manifold

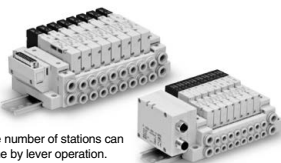

• Changing the number of stations can be easily done by lever operation.

## Manifold Specifications

Applicable series		SV1000	SV2000
<b>Manifold type</b>		Stacking type cassette base manifold	
<b>1 (P: SUP), 3/5 (E: EXH) type</b>		Common SUP, EXH	
<b>Valve stations (maximum)</b>		18 stations	20 stations
<b>Max. number of solenoids</b>		18 points	26 points
<b>Port size</b>	<b>1(P), 3/5(E) port</b>	C8, N9	C10, N11
	<b>4(A), 2(B) port</b>	C3, C4, C6 N1, N3, N7	C4, C6, C8 N3, N7, N9

## Flow Rate Characteristics

Model	Port size		Flow rate characteristics					
	1, 5, 3 (P, EA, EB)	4, 2 (A, B)	1→4/2 (P→A/B)			4/2→3/5 (A/B→E)		
			C [dm <sup>3</sup> /(s·bar)]	b	Cv	C [dm <sup>3</sup> /(s·bar)]	b	Cv
SS5V1-16	C8	C6	0.89	0.22	0.22	0.98	0.21	0.23
SS5V2-16	C10	C8	2.3	0.28	0.50	2.7	0.18	0.56

Note) The value is for manifold base with 5 stations and individually operated 2 position type.

## Tie-rod base manifold



• 34 pins connector allows up to 16 stations with double solenoids.

## Manifold Specifications

Applicable series		SV1000	SV2000	SV3000	SV4000
<b>Manifold type</b>		Tie-rod base manifold			
<b>1 (P: SUP), 3/5 (E: EXH) type</b>		Common SUP, EXH			
<b>Valve stations (maximum)</b>		20 stations			
<b>Max. number of solenoids</b>		32 points			
<b>Port size</b>	<b>1(P), 3/5(E) port</b>	C8, N9	C10, N11	C12, N11	C12, N11, 03
	<b>4(A), 2(B) port</b>	C3, C4, C6 N1, N3, N7	C4, C6, C8 N3, N7, N9	C6, C8, C10 N7, N9, N11	C8, C10, C12 N9, N11, 02, 03

## Flow Rate Characteristics

Model	Port size		Flow rate characteristics					
	1, 5, 3 (P, EA, EB)	4, 2 (A, B)	1→4/2 (P→A/B)			4/2→3/5 (A/B→E)		
			C [dm <sup>3</sup> /(s·bar)]	b	Cv	C [dm <sup>3</sup> /(s·bar)]	b	Cv
SS5V1-10	C8	C6	0.98	0.26	0.24	1.1	0.35	0.28
SS5V2-10	C10	C8	2.1	0.20	0.46	2.4	0.18	0.48
SS5V3-10	C12	C10	4.2	0.22	0.91	4.3	0.21	0.93
SS5V4-10	C12	C12	6.2	0.19	1.3	7.0	0.18	1.6

Note) The value is for manifold base with 5 stations and individually operated 2 position type.

## Enclosure of Manifold Variations (Common for cassette base and tie-rod base)

Series	Enclosure (Based on IEC60529)
EX500 (Gateway Decentralized System 2 (128 points)) Serial Transmission System	IP67 Note 1)
EX500 (Gateway Decentralized System (64 points)) Serial Transmission System	IP67 Note 2)
EX250 Serial Transmission System	IP67 (partly IP40)
EX600 Serial Transmission System	IP67
EX260 Serial Transmission System	IP67 (partly IP40)
EX126 Serial Transmission System	IP67
EX120 Serial Transmission System	IP20
Circular connector	IP67
D-sub connector	Dusttight (IP40)
Flat ribbon cable	Dusttight (IP40)

Note 1) Enclosure of a gateway unit is IP65.

Note 2) Enclosure of a gateway unit and input manifold is IP65.

**SV Series Solenoid Valve Specifications**

**Made to Order Specifications**  
(For details, refer to page 134.)

**Symbol**

**SV1000/2000/3000/4000**

2 position single solenoid

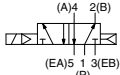

2 position double solenoid

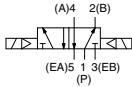

**SV1000/2000/3000**

3 position closed center

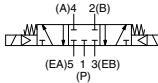

**SV4000**

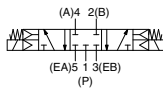

3 position exhaust center

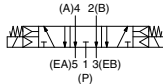

3 position pressure center

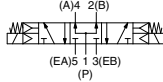
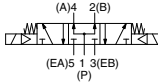

**SV1000**

4 position dual 3 port valve

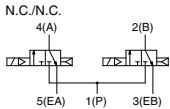

N.O./N.O.

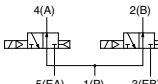

N.C./N.O.

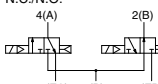

**SV2000**

N.C./N.C.

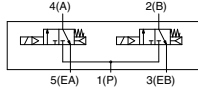

N.O./N.O.

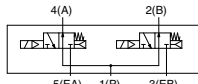

N.C./N.O.

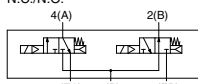

\* SV3000 and 4000 are not available with 4 position dual 3 port valve.

<b>Fluid</b>		Air
<b>Internal pilot Operating pressure range (MPa)</b>	2 position single 4 position dual 3 port valve	0.15 to 0.7
<b>External pilot Operating pressure range (MPa)</b>	2 position double	0.1 to 0.7
	3 position	0.2 to 0.7
<b>Ambient and fluid temperature (°C)</b>	<b>Operating pressure range</b>	-100 kPa to 0.7
	2 position single, double 3 position	0.25 to 0.7
<b>Max. operating frequency (Hz)</b>	2 position single, double 4 position dual 3 port valve	5
<b>Manual override</b>	3 position	3
		Non-locking push type Push-turn locking slotted type
<b>Pilot exhaust method</b>	<b>Internal pilot</b>	Common exhaust type for main and pilot valve
	<b>External pilot</b>	Pilot valve individual exhaust
<b>Lubrication</b>		Not required
<b>Mounting orientation</b>		Unrestricted
<b>Impact/Vibration resistance (ms<sup>2</sup>)</b>		150/30
<b>Enclosure</b>		IP67 (Based on IEC60529)
<b>Coil rated voltage</b>		24 VDC, 12 VDC
<b>Allowable voltage fluctuation</b>		±10% of rated voltage
<b>Power consumption</b>		0.6 (With indicator light: 0.65)
<b>Surge voltage suppressor</b>		Zener diode
<b>Indicator light</b>		LED

Note) Impact resistance: No malfunction occurred when it is tested with a drop tester in the axial direction and at the right angles to the main valve and armature in both energized and de-energized states every once for each condition. (Values at the initial period)

Vibration resistance: No malfunction occurred in a one-sweep test between 45 and 2000 Hz. Test was performed at both energized and de-energized states in the axial direction and at the right angles to the main valve and armature. (Values at the initial period)

**Response Time**

Type of actuation	Response time (ms) (at the pressure of 0.5 MPa)			
	SV1000	SV2000	SV3000	SV4000
2 position single	11 or less	25 or less	28 or less	40 or less
2 position double	10 or less	17 or less	26 or less	40 or less
3 position	18 or less	29 or less	32 or less	82 or less
4 position dual 3 port valve	15 or less	33 or less	—	—

Note) Based on dynamic performance test, JIS B 8419: 2010.  
(Coil temperature: 20°C, at rated voltage)

**Weight**

Series	Type of actuation	Weight (g)
SV1000	Single solenoid	66
	Double solenoid	71
	3 position	73
	4 position dual 3 port	71
SV2000	Single solenoid	74
	Double solenoid	78
	3 position	83
	4 position dual 3 port	78
SV3000	Single solenoid	99
	Double solenoid	102
	3 position	110
SV4000	Single solenoid	186
	Double solenoid	190
	3 position	211

Note) Weight of solenoid valve only.



# Gateway-type Serial Transmission System

## EX500 Series

IP67 compliant

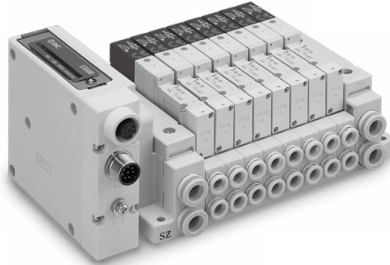

### EX500 Gateway Decentralized System 2 **P.28**

Applicable series	<b>Tie-rod base manifold</b> <b>SV1000/SV2000/SV3000</b>
	<ul style="list-style-type: none"><li>• Number of output points: 32 points</li><li>• Connected to the SI unit of the EX500</li></ul>

IP67 compliant

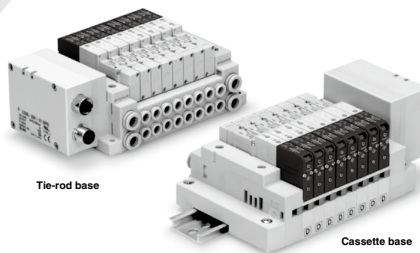

### EX500 Gateway Decentralized System **P.33**

Applicable series	<b>Cassette base manifold</b> <b>SV1000/SV2000</b>
	<b>Tie-rod base manifold</b> <b>SV1000/SV2000/SV3000/SV4000</b>
	<ul style="list-style-type: none"><li>• Number of output points: 16 points</li><li>• Connected to the SI unit of the EX500</li></ul>

# EX500 (Gateway Decentralized System 2 (128 Points)) Serial Transmission System



## SV Series

### How to Order Manifold

#### ● Tie-rod base

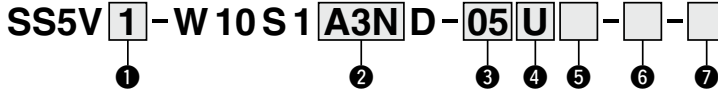

#### ① Series

1	SV1000
2	SV2000
3	SV3000

#### ② SI unit (Number of outputs, Output polarity, Max. number of valve stations, Protocol)

0	Without SI unit
A3N	32 outputs <sup>Note 1) 3)</sup> , 2 to 16 stations <sup>(20 stations <sup>Note 2)</sup>)</sup>

- Note 1) 16 outputs can be set by switching the built-in setting switch.
- Note 2) ( ): Maximum number of stations for mixed single and double wiring.
- Note 3) When using the SI unit with 32 outputs, use the GW unit compatible with the EX500 Gateway Decentralized System 2 (128 points).

#### ③ Valve stations

Symbol	Stations	Note
02	2 stations	Double wiring <sup>Note 1)</sup>
⋮	⋮	
16	16 stations	
02	2 stations	Specified layout <sup>Note 2)</sup> (Available up to 32 solenoids)
⋮	⋮	
20	20 stations	

- Note 1) Double wiring: single, double, 3-position and 4-position valves can be used on all manifold stations.
- Use of a single solenoid will result in an unused control signal. If this is not desired, order with a specified layout.
- Note 2) Specified layout: Indicate the wiring specifications on the manifold specification sheet. (Note that double, 3-position and 4-position valves cannot be used where single wiring has been specified.)

#### SI unit part no. EX500-S103

#### ④ P, E port entry

U	U side (2 to 10 stations)
D	D side (2 to 10 stations)
B	Both sides (2 to 20 stations)

#### ⑤ SUP/EXH block assembly

Nil	Internal pilot
S	Internal pilot, Built-in silencer <sup>Note)</sup>
R	External pilot
RS	External pilot, Built-in silencer <sup>Note)</sup>

Note) When the built-in silencer type is used, keep the exhaust port from coming in direct contact with water or other liquids.

#### ⑦ Mounting

Nil	Direct mounting
D	With DIN bracket, DIN rail with standard length
D0	With DIN bracket, without DIN rail
D3 <sup>Note)</sup>	With DIN bracket, DIN rail for 3 stations
⋮	⋮
D20 <sup>Note)</sup>	With DIN bracket, DIN rail for 20 stations

Note) Specify a longer rail than the length of valve stations.

\* If the DIN rail must be mounted without an SI unit, select "D0" and order the DIN rail separately. Refer to L3 of the dimensions for the DIN rail length. For the DIN rail part number, refer to page 123.

#### ⑥ A, B port size

##### Metric size

Symbol	A, B port	P, E port	Applicable series
C3	ø3.2 One-touch fitting	ø8 One-touch fitting	SV1000
C4	ø4 One-touch fitting		
C6	ø6 One-touch fitting		
C4	ø4 One-touch fitting	ø10 One-touch fitting	SV2000
C6	ø6 One-touch fitting		
C8	ø8 One-touch fitting		
C6	ø6 One-touch fitting	ø12 One-touch fitting	SV3000
C8	ø8 One-touch fitting		
C10	ø10 One-touch fitting		
M <sup>Note)</sup>	A, B port mixed		

##### Inch size

Symbol	A, B port	P, E port	Applicable series
N1	ø1/8" One-touch fitting	ø5/16" One-touch fitting	SV1000
N3	ø5/32" One-touch fitting		
N7	ø1/4" One-touch fitting		
N3	ø5/32" One-touch fitting	ø3/8" One-touch fitting	SV2000
N7	ø1/4" One-touch fitting		
N9	ø5/16" One-touch fitting		
N7	ø1/4" One-touch fitting	ø3/8" One-touch fitting	SV3000
N9	ø5/16" One-touch fitting		
N11	ø3/8" One-touch fitting		
M <sup>Note)</sup>	A, B port mixed		

Note) Indicate the sizes on the manifold specification sheet.

\* The X and PE port size of external pilot type [R, RS] are ø4 (mm) or ø5/32" (inch) for the SV1000/2000 series, and ø6 (mm) or ø1/4" (inch) for the SV3000 series.

\* A separate GW unit and communication cable are required.

For details about the EX500 series, refer to the [Web Catalog](#).

## How to Order Manifold Assembly

### Example

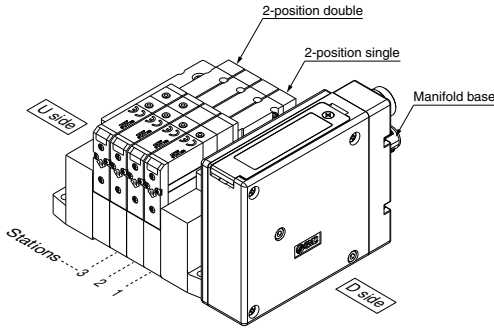

SS5V1-W10S1A3ND-04B-C6.....1 set (Manifold base part number)  
 \* SV1100-5FU.....2 sets (2-position single part number)  
 \* SV1200-5FU.....2 sets (2-position double part number)

The asterisk denotes the symbol for assembly.  
 Prefix it to the part numbers of the valve etc.

- The valve arrangement is numbered as the 1st station from the D side.
- Under the manifold base part number, state the valves to be mounted in order from the 1st station as shown in the figure above. If the arrangement becomes complicated, specify on the manifold specification sheet.

## How to Order Valves

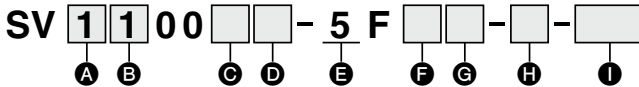

### A Series

1	SV1000
2	SV2000
3	SV3000

### B Type of actuation

1	2-position single
2	2-position double
3	3-position closed center
4	3-position exhaust center
5	3-position pressure center

**A Note)** 4-position dual 3-port valve (N.C./N.O.)

**B Note)** 4-position dual 3-port valve (N.O./N.O.)

**C Note)** 4-position dual 3-port valve (N.C./N.O.)

Note) Select the SV1000 or SV2000 series for the 4-position dual 3-port valve.

\* Select the internal pilot type for the 4-position dual 3-port valve.

### C Pilot type

Nii	Internal pilot
R	External pilot

### D Back pressure check valve

Nii	None
K	Built-in

\* Built-in back pressure check valve type is applicable to the SV1000 series only.

\* The product with a back pressure check valve is not available for 3-position valves.

Note) Refer to Specific Product Precautions 2 on page 136.

### E Rated voltage

5	24 VDC
---	--------

### F Light/surge voltage suppressor

U	With light/surge voltage suppressor
R	Without light, with surge voltage suppressor

### G Manual override

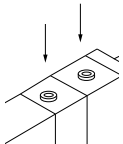
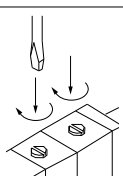
<p><b>Nii</b></p> <p>Non-locking push</p> 
<p><b>D</b></p> <p>Push-turn locking (slotted)</p> 

### H Manifold block

If stations are to be added, order the product with manifold block.  
 (For details, refer to page 119.)

### I Made to Order

Nii	—
X90	Main valve fluororubber specification (For details, refer to page 134.)



## Dimensions: SV1000 Series for EX500 Gateway Decentralized System 2 (128 points)

### ● Tie-rod base manifold

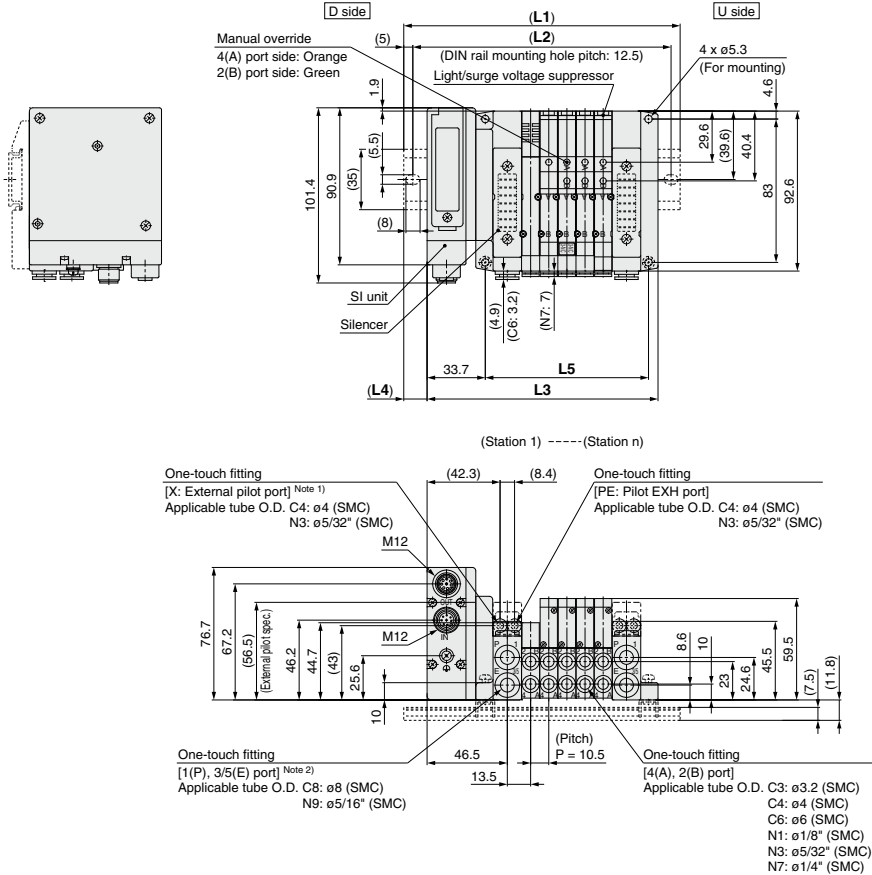

Note 1) External pilot port positions and silencer discharge port positions are the same as P, E port outlet positions.  
Note 2) When P, E port outlets are indicated on the U side or D side, the P, E ports on the opposite side are plugged.

### L: DIN Rail Overall Length

n: Stations

L \ n	2	3	4	5	6	7	8	9	10	11	12	13	14	15	16	17	18	19	20
L1	135.5	148	148	160.5	173	185.5	198	210.5	210.5	223	235.5	248	260.5	273	273	285.5	298	310.5	323
L2	125	137.5	137.5	150	162.5	175	187.5	200	200	212.5	225	237.5	250	262.5	262.5	275	287.5	300	312.5
L3	102.2	112.7	123.2	133.7	144.2	154.7	165.2	175.7	186.2	196.7	207.2	217.7	228.2	238.7	249.2	259.7	270.2	280.7	291.2
L4	16.5	17.5	12.5	13.5	14.5	15.5	16.5	17.5	12	13	14	15	16	17	12	13	14	15	16
L5	63	73.5	84	94.5	105	115.5	126	136.5	147	157.5	168	178.5	189	199.5	210	220.5	231	241.5	252

**Dimensions: SV2000 Series for EX500 Gateway Decentralized System 2 (128 Points)**

● Tie-rod base manifold

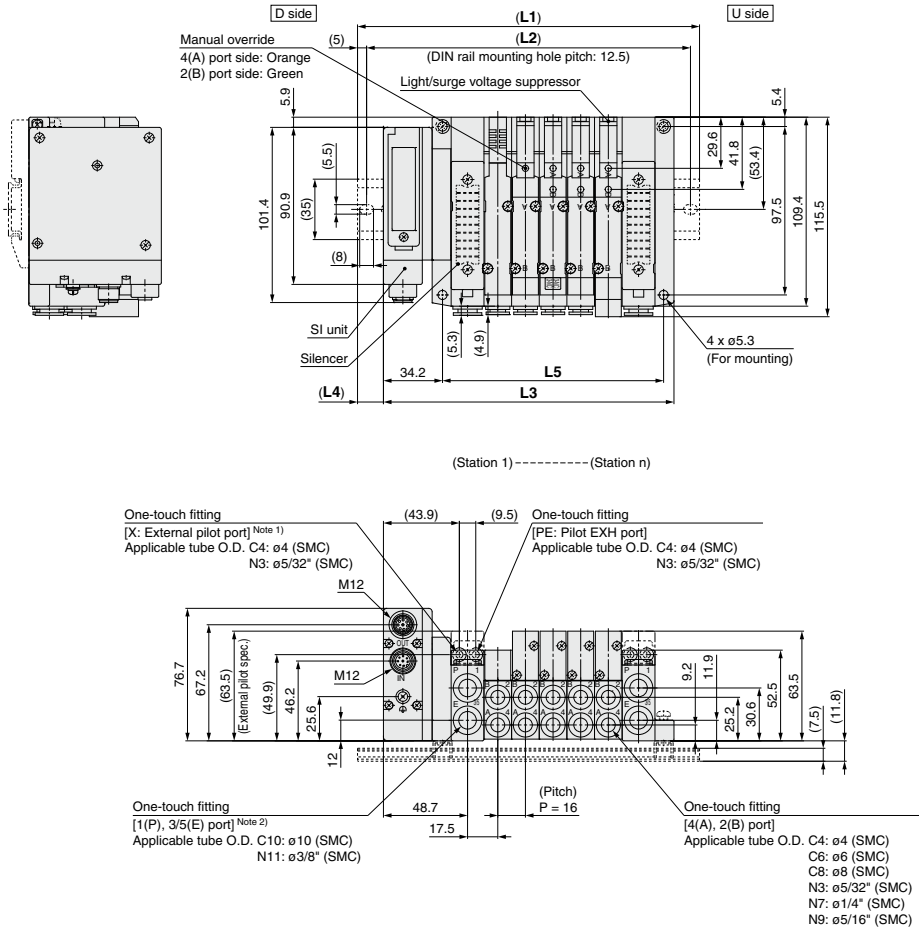

Note 1) External pilot port positions and silencer discharge port positions are the same as P, E port outlet positions.  
 Note 2) When P, E port outlets are indicated on the U side or D side, the P, E ports on the opposite side are plugged.

**L: DIN Rail Overall Length**

L \ n	2	3	4	5	6	7	8	9	10	11	12	13	14	15	16	17	18	19	20
L1	148	160.5	185.5	198	210.5	235.5	248	260.5	273	298	310.5	323	335.5	360.5	373	385.5	410.5	423	435.5
L2	137.5	150	175	187.5	200	225	237.5	250	262.5	287.5	300	312.5	325	350	362.5	375	400	412.5	425
L3	120.2	136.2	152.2	168.2	184.2	200.2	216.2	232.2	248.2	264.2	280.2	296.2	312.2	328.2	344.2	360.2	376.2	392.2	408.2
L4	14	12	16.5	15	13	17.5	16	14	12.5	17	15	13.5	11.5	16	14.5	12.5	17	15.5	13.5
L5	80	96	112	128	144	160	176	192	208	224	240	256	272	288	304	320	336	352	368

n: Stations

# SV Series

## Dimensions: SV3000 Series for EX500 Gateway Decentralized System 2 (128 points)

### ● Tie-rod base manifold

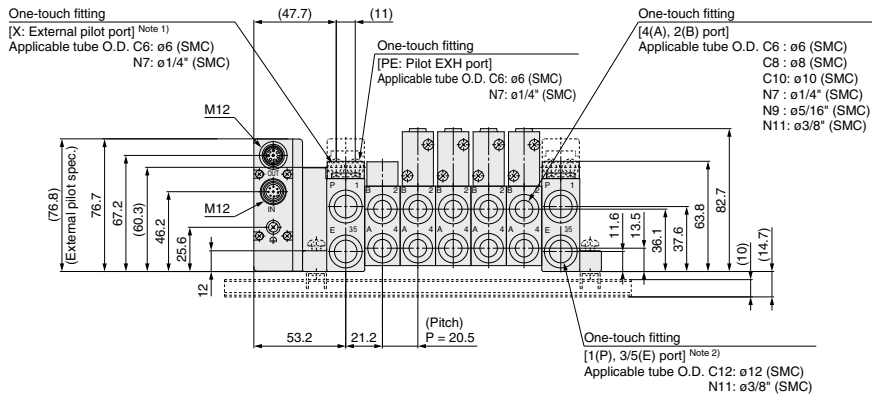
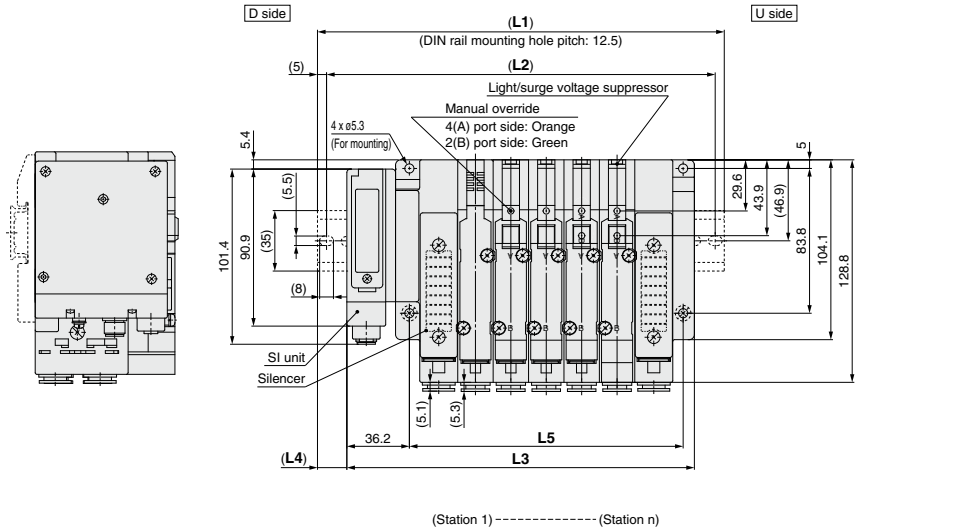

### L: DIN Rail Overall Length

L \ n	2	3	4	5	6	7	8	9	10	11	12	13	14	15	16	17	18	19	20
L1	173	185.5	210.5	235.5	248	273	298	310.5	335.5	348	373	398	410.5	435.5	460.5	473	498	523	535.5
L2	162.5	175	200	225	237.5	262.5	287.5	300	325	337.5	362.5	387.5	400	425	450	462.5	487.5	512.5	525
L3	139.7	160.2	180.7	201.2	221.7	242.2	262.7	283.2	303.7	324.2	344.7	365.2	385.7	406.2	426.7	447.2	467.7	488.2	508.7
L4	16.5	12.5	15	17	13	15.5	17.5	13.5	16	12	14	16.5	12.5	14.5	17	13	15	17.5	13.5
L5	97	117.5	138	158.5	179	199.5	220	240.5	261	281.5	302	322.5	343	363.5	384	404.5	425	445.5	466

# EX500 (Gateway Decentralized System (64 Points)) Serial Transmission System

## SV Series



### How to Order Manifold

**Series**

1	SV1000
2	SV2000
3	SV3000
4	SV4000

**● Tie-rod base**  
**● Cassette base**

SS5V **1** - W 10S **A2W** D - **05** U [ ] - [ ] - [ ]

SS5V **1** - W 16S **A2W** D - **05** U [ ] - [ ] - [ ]

**Series**

1	SV1000
2	SV2000

**● Enclosure IP67 specifications**

**SI unit (Number of outputs, Output polarity, Max. number of valve stations, Protocol)**

0	Without SI unit
A2W	16 outputs, 2 to 8 stations (16 stations) (Note)

(Note) ( ): Maximum number of stations for mixed single and double wiring.

**Valve stations**

Symbol	Stations	Note
02	2 stations	Double wiring specifications (1)
⋮	⋮	
08	8 stations	Specified layout (2) (up to 16 solenoids possible.)
02	2 stations	
⋮	⋮	
16	16 stations	

Note 1) Double wiring specifications: Single, double, 3 position and 4 position solenoid valves can be used on all manifold stations. Use of a single solenoid will result in an unused control signal. If this is not desired, order with a specified layout.

Note 2) Specified layout: Indicate wiring specifications on the manifold specification sheet. (Note that double, 3 position and 4 position valves cannot be used where single solenoid wiring has been specified.)

**SI unit part no. EX500-S001**

**● Mounting**

Nil	Direct mounting
D	DIN rail mounting (With DIN rail)
D0	DIN rail mounting (Without DIN rail)
D3	For 3 stations   When a longer DIN rail is desired than the specified
⋮	⋮
D16	For 16 stations   stations. (Specify a longer rail than the standard length.)

\* In the case of D0, only DIN rail fittings are attached.

**● DIN rail length specified**

Symbol	Standard length
3	For 3 stations   Specify a longer rail than the standard length.
⋮	⋮
16	For 16 stations

**P, E port location**

U	U side (2 to 10 stations)
D	D side (2 to 10 stations)
B	Both sides (2 to 16 stations)

**SUP/EXH block assembly specifications**

Nil	Internal pilot
S	Internal pilot/Built-in silencer
R	External pilot
RS	External pilot/Built-in silencer

(Note) When the built-in silencer type is used, keep the exhaust port from coming in direct contact with water or other liquids.

**A, B port size (metric)**

Symbol	A, B port	P, E port	Applicable series
C3	One-touch fitting for ø3.2	One-touch fitting for ø8	SV1000
C4	One-touch fitting for ø4		
C6	One-touch fitting for ø6		
C4	One-touch fitting for ø4	One-touch fitting for ø10	SV2000
C6	One-touch fitting for ø6		
C8	One-touch fitting for ø8	One-touch fitting for ø12	SV3000
C6	One-touch fitting for ø6		
C8	One-touch fitting for ø8	One-touch fitting for ø12	SV4000
C10	One-touch fitting for ø10		
C12	One-touch fitting for ø12	Rc 3/8	SV4000
02	Rc 1/4		
03	Rc 3/8		
02F	G 1/4		
03F	G 3/8		
M	A, B ports mixed		

**A, B port size (inch)**

Symbol	A, B port	P, E port	Applicable series
N1	One-touch fitting for ø1/8"	One-touch fitting for ø5/16"	SV1000
N3	One-touch fitting for ø5/32"		
N7	One-touch fitting for ø1/4"		
N3	One-touch fitting for ø5/32"	One-touch fitting for ø3/8"	SV2000
N7	One-touch fitting for ø1/4"		
N9	One-touch fitting for ø5/16"	One-touch fitting for ø3/8"	SV3000
N7	One-touch fitting for ø1/4"		
N9	One-touch fitting for ø5/16"	One-touch fitting for ø3/8"	SV4000
N11	One-touch fitting for ø3/8"		
N11	One-touch fitting for ø5/16"	NPTF 3/8	SV4000
N11	One-touch fitting for ø3/8"		
N2N	NPT 1/4		
03N	NPT 3/8	NPTF 3/8	SV4000
02T	NPTF 1/4		
03T	NPTF 3/8		
M	A, B ports mixed		

\* A separate GW unit and communication cable are required.

For details about the EX500 series, refer to the **Web Catalog** and the Operation Manual. Please download the Operation Manual via SMC website, <https://www.smworld.com>

\* In the case of mixed specifications (M), indicate separately on the manifold specification sheet.  
 \* Port sizes of X, PE port for external pilot specifications (R, RS) are ø4 (metric), ø5/32" (inch) for SV1000/2000 and ø6 (metric) and ø1/4" (inch) for SV3000/4000.



## How to Order Manifold Assembly

### Ordering example (SV1000)

#### Manifold

SS5V1-W16SA2WD-06B-C6 (1 set)

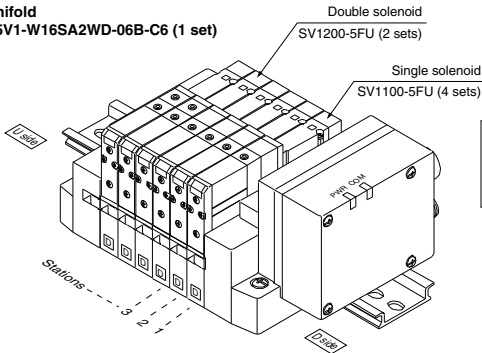

SS5V1-W16SA2WD-06B-C6.....1 set (Manifold part no.)  
 \* SV1100-5FU.....4 sets (Single solenoid part no.)  
 \* SV1200-5FU.....2 sets (Double solenoid part no.)

## How to Order Valve

SV 1 1 00 - 5 F - - -

#### Series

1	SV1000
2	SV2000
3	SV3000
4	SV4000

#### Type of actuation

1	2 position single
2	2 position double
3	3 position closed center
4	3 position exhaust center
5	3 position pressure center
A	4 position dual 3 port valve: N.C./N.C.
B	4 position dual 3 port valve: N.O./N.O.
C	4 position dual 3 port valve: N.C./N.O.

\* 4 position dual 3 port valves are applicable to the SV1000 and SV2000 series only.

#### Pilot type

Nil	Internal pilot
R	External pilot

\* External pilot specifications is not available for 4 position dual 3 port valves.

#### Back pressure check valve

Nil	None
K	Built-in

\* Built-in back pressure check valve type is applicable to the SV1000 series only.

\* Back pressure check valve is not available for 3 position valve.

#### Rated voltage

5	24 VDC
---	--------

Note) Available with manifold block for station additions. Refer to pages 113 and 119.

#### Made to Order

Nil	-
X90	Main valve fluororubber (Refer to page 134.)

#### Manual override

Nil: Non-locking push type

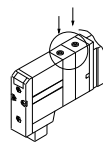

D: Push-turn locking slotted type

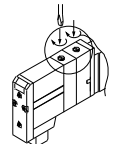

#### Light/Surge voltage suppressor

U	With light/surge voltage suppressor
R	With surge voltage suppressor

Note) Refer to Specific Product Precautions 2 on page 136.

**Dimensions: SV1000 Series for EX500 Gateway Decentralized System (64 points)**

● **Cassette base manifold: SS5V1-W16SA2WD-** $\begin{matrix} \text{U} \\ \text{S, R, RS} \end{matrix}$  $\begin{matrix} \text{C3, N1} \\ \text{C4, N3} \\ \text{C5, N7} \end{matrix}$

- When P, E port outlets are indicated on the U side or D side, the P, E ports on the opposite side are plugged.
- External pilot port positions and silencer discharge port positions are the same as P, E port outlet positions.

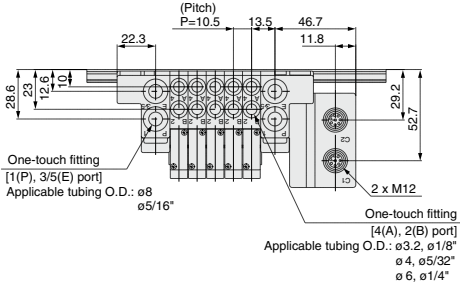

**With External Pilot Specifications**

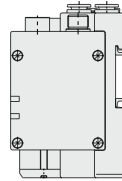
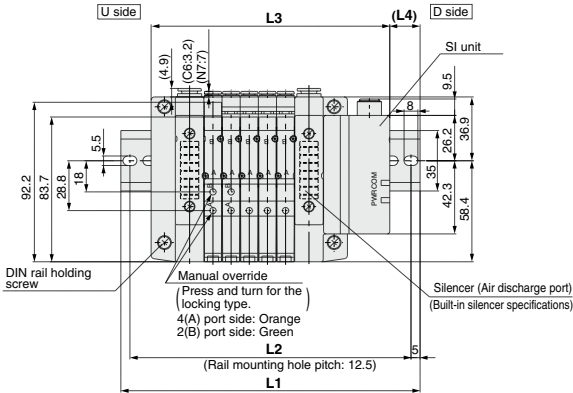
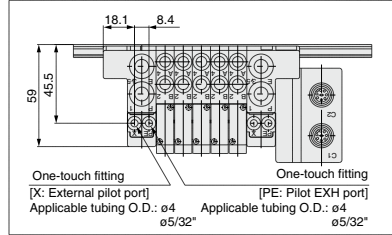

**With option**

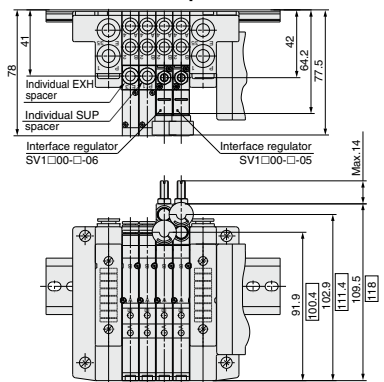

□ Dimensions are the ones for SV1300-□□□□.

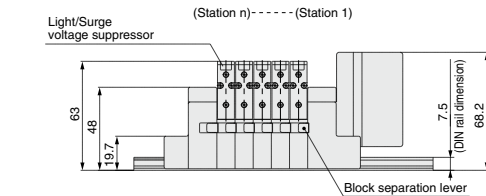

**L Dimension**

n	2	3	4	5	6	7	8	9	10	11	12	13	14	15	16
L1	135.5	148	160.5	173	173	185.5	198	210.5	223	235.5	235.5	248	260.5	273	285.5
L2	125	137.5	150	162.5	162.5	175	187.5	200	212.5	225	225	237.5	250	262.5	275
L3	106.5	117	127.5	138	148.5	159	169.5	180	190.5	201	211.5	222	232.5	243	253.5
L4	14.5	15.5	16.5	17.5	12.5	13.5	14.5	15.5	16.5	17.5	12	13	14	15	16

n: Stations

# SV Series

## Dimensions: SV2000 Series for EX500 Gateway Decentralized System (64 points)

### ● Cassette base manifold: SS5V2-W16SA2WD-Stations<sub>U</sub> (S, R, RS) <sup>C4, N3</sup><sub>C6, N7</sub><sup>C4, N3</sup><sub>C6, N7</sub>

- When P, E port outlets are indicated on the U side or D side, the P, E ports on the opposite side are plugged.
- External pilot port positions and silencer discharge port positions are the same as P, E port outlet positions.

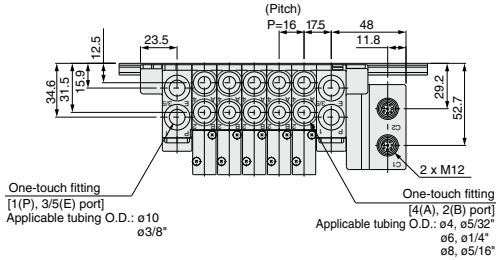

### With External Pilot Specifications

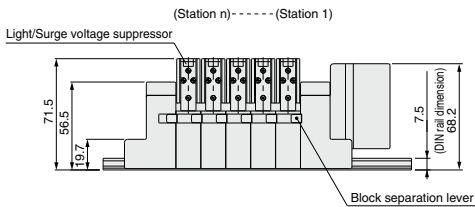
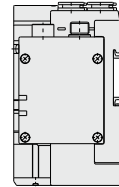
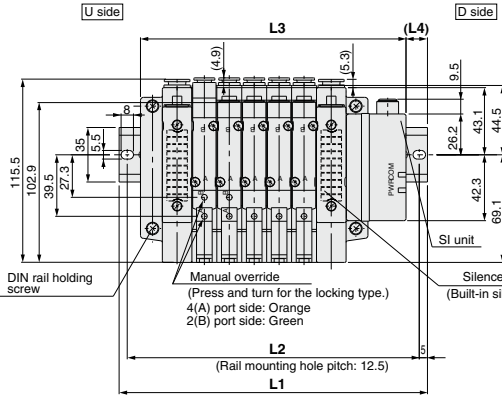
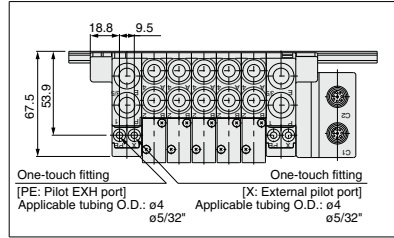

### With option

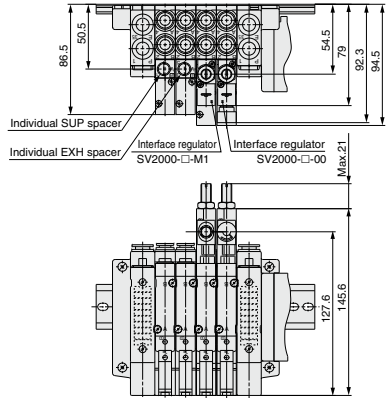

### L Dimension

n	2	3	4	5	6	7	8	9	10	11	12	13	14	15	16
L1	148	173	185.5	198	210.5	235.5	248	260.5	285.5	298	310.5	323	348	360.5	373
L2	137.5	162.5	175	187.5	200	225	237.5	250	275	287.5	300	312.5	337.5	350	362.5
L3	122.5	138.5	154.5	170.5	186.5	202.5	218.5	234.5	250.5	266.5	282.5	298.5	314.5	330.5	346.5
L4	13	17.5	15.5	14	12	16.5	15	13	17.5	16	14	12.5	17	15	13.5



**Dimensions: SV1000 Series for EX500 Gateway Decentralized System (64 points)**

● Tie-rod base manifold: SS5V1-W10SA2WD- $\frac{U}{D}$ (S, R, RS) $\frac{C3, N1}{C4, N5}$ / $\frac{C6, N6}{C8, N8}$ (-D)

- When P, E port outlets are indicated on the U side or D side, the P, E ports on the opposite side are plugged.
- External pilot port positions and silencer discharge port positions are the same as P, E port outlet positions.

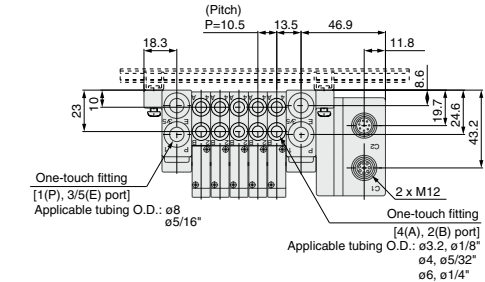

**With External Pilot Specifications**

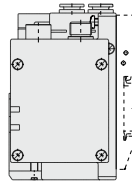
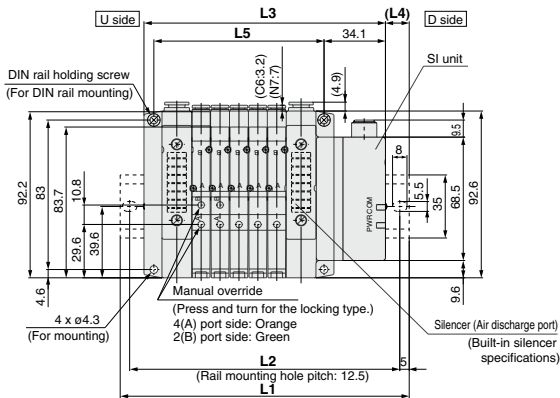
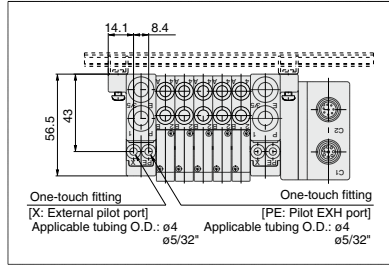

**With option**

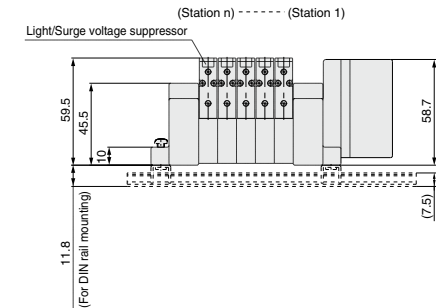
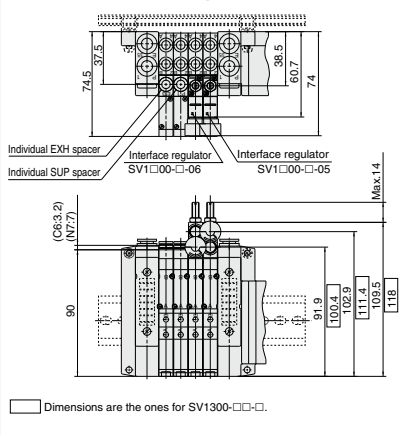

**L Dimension**

n	2	3	4	5	6	7	8	9	10	11	12	13	14	15	16
L1	135.5	148	148	160.5	173	185.5	198	210.5	210.5	223	235.5	248	260.5	273	273
L2	125	137.5	137.5	150	162.5	175	187.5	200	200	212.5	225	237.5	250	262.5	262.5
L3	102.6	113.1	123.6	134.1	144.6	155.1	165.6	176.1	186.6	197.1	207.6	218.1	228.6	239.1	249.6
L4	16.5	17.5	12	13	14	15	16	17	12	13	14	15	16	17	11.5
L5	63	73.5	84	94.5	105	115.5	126	136.5	147	157.5	168	178.5	189	199.5	210

# SV Series

## Dimensions: SV2000 Series for EX500 Gateway Decentralized System (64 points)

### ● Tie-rod base manifold: SS5V2-W10SA2WD-~~Stations~~<sub>U</sub>(S, R, RS)-<sup>C4, N3</sup><sub>D</sub>(-D) <sup>C6, N7</sup> <sup>C8, N8</sup>

- When P, E port outlets are indicated on the U side or D side, the P, E ports on the opposite side are plugged.
- External pilot port positions and silencer discharge port positions are the same as P, E port outlet positions.

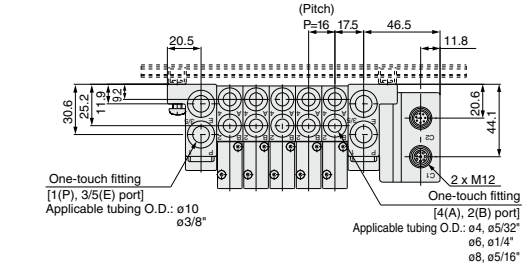

### With External Pilot Specifications

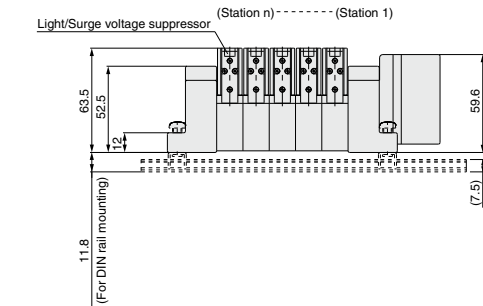
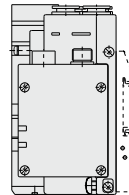
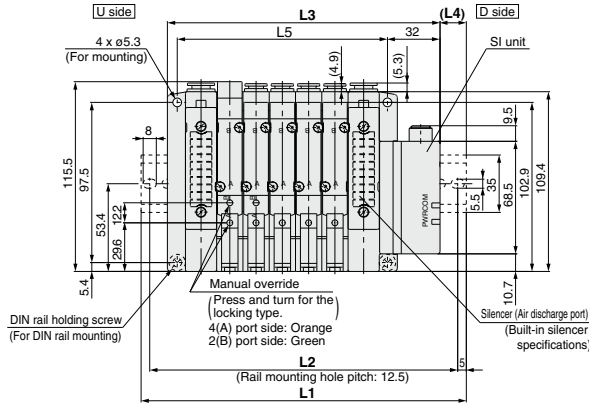
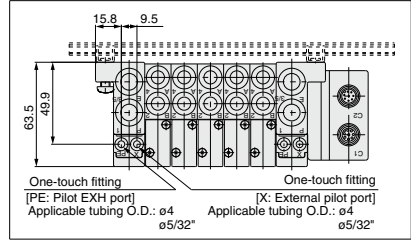

### With option

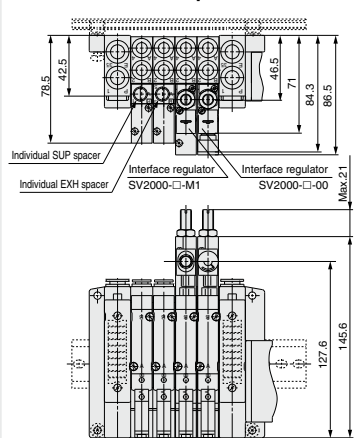

### L Dimension

n: Stations

n	2	3	4	5	6	7	8	9	10	11	12	13	14	15	16
L1	148	160.5	185.5	198	210.5	223	248	260.5	273	285.5	310.5	323	335.5	360.5	373
L2	137.5	150	175	187.5	200	212.5	237.5	250	262.5	275	300	312.5	325	350	362.5
L3	118	134	150	166	182	198	214	230	246	262	278	294	310	326	342
L4	15	13.5	18	16	14.5	12.5	17	15.5	13.5	12	16.5	14.5	13	17.5	15.5
L5	80	96	112	128	144	160	176	192	208	224	240	256	272	288	304

**Dimensions: SV3000 Series for EX500 Gateway Decentralized System (64 Points)**

● Tie-rod base manifold: SS5V3-W10SA2WD- $\frac{U}{S}$ (S, R, RS) $\frac{C6, N7}{C8, N9}$ (-D)

- When P, E port outlets are indicated on the U side or D side, the P, E ports on the opposite side are plugged.
- External pilot port positions and silencer discharge port positions are the same as P, E port outlet positions.

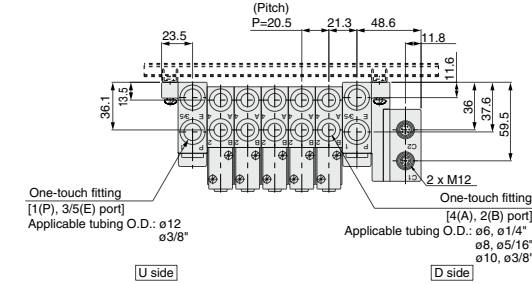

**With External Pilot Specifications**

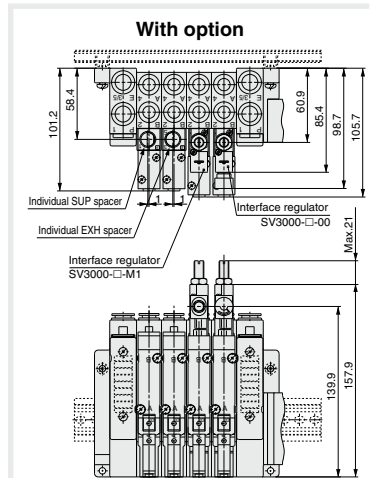
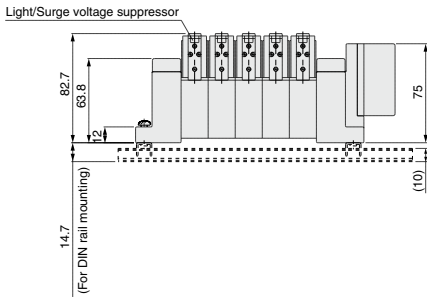
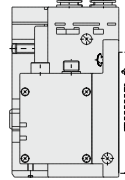
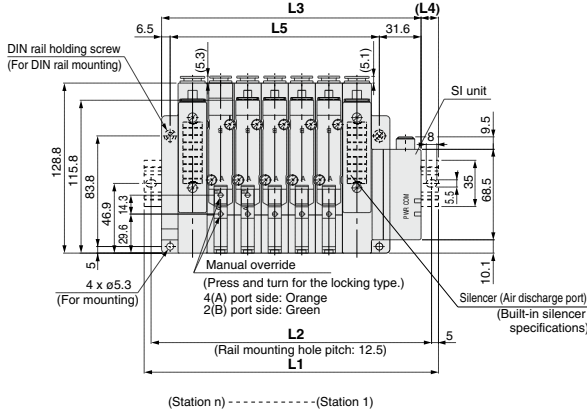
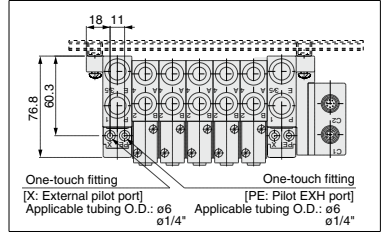

**L Dimension**

n: Stations

n	2	3	4	5	6	7	8	9	10	11	12	13	14	15	16
L1	160.5	185.5	210.5	223	248	273	285.5	310.5	323	348	373	385.5	410.5	435.5	448
L2	150	175	200	212.5	237.5	262.5	275	300	312.5	337.5	362.5	375	400	425	437.5
L3	135.1	155.6	176.1	196.6	217.1	237.6	258.1	278.6	299.1	319.6	340.1	360.6	381.1	401.6	422.1
L4	12.5	15	17	13	15.5	17.5	13.5	16	12	14	16.5	12.5	14.5	17	13
L5	97	117.5	138	158.5	179	199.5	220	240.5	261	281.5	302	322.5	343	363.5	384

# SV Series

## Dimensions: SV4000 Series for EX500 Gateway Decentralized System (64 points)

### ● Tie-rod base manifold: SS5V4-W10SA2WD-Stations (S, R, RS) (C8, C10, N8, N11) (-D)

- When P, E port outlets are indicated on the U side or D side, the P, E ports on the opposite side are plugged.
- External pilot port positions and silencer discharge port positions are the same as P, E port outlet positions.

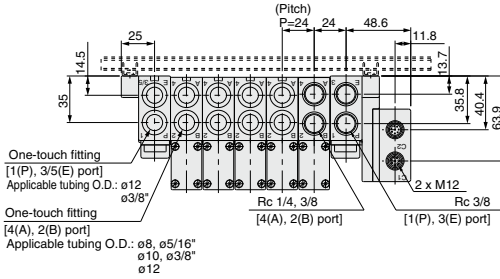

### With External Pilot Specifications

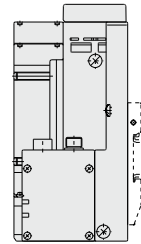
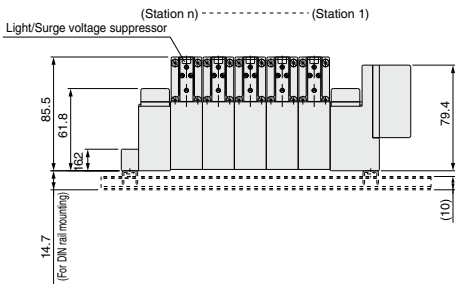
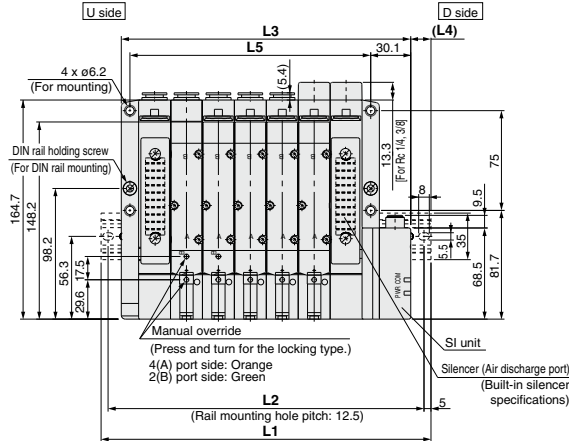
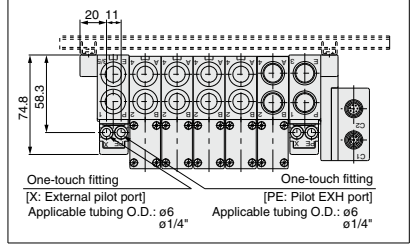

### With option

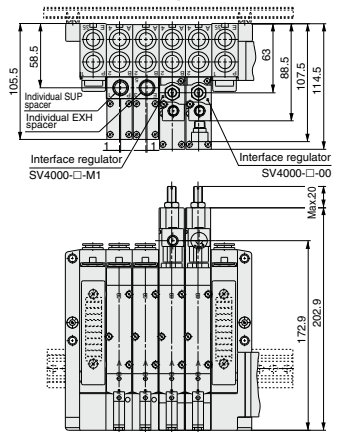

n: Stations

### L Dimension

n	2	3	4	5	6	7	8	9	10	11	12	13	14	15	16
L1	173	198	223	248	273	298	323	348	373	385.5	410.5	435.5	460.5	485.5	510.5
L2	162.5	187.5	212.5	237.5	262.5	287.5	312.5	337.5	362.5	375	400	425	450	475	500
L3	145.6	169.6	193.6	217.6	241.6	265.6	289.6	313.6	337.6	361.6	385.6	409.6	433.6	457.6	481.6
L4	13.5	14	14.5	15	15.5	16	16.5	17	17.5	12	12.5	13	13.5	14	14.5
L5	109	133	157	181	205	229	253	277	301	325	349	373	397	421	445

# Integrated-type (For I/O) Serial Transmission System

## EX250 Series

IP67 (partly IP40) compliant

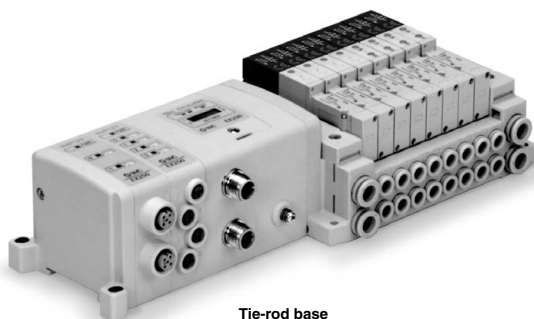

Tie-rod base

Applicable series	<b>Tie-rod base manifold</b> <b>SV1000/SV2000/SV3000</b>
-------------------	---

- Number of inputs/outputs points: 32 points each

# EX250 Integrated-type (For I/O) Serial Transmission System

# SV Series



## How to Order Manifold

### ● Tie-rod base

SS5V 1 - W10S1 QW [ ] [ ] [ ] D - 05 U [ ] - [ ] - [ ]

#### Series

1	SV1000
2	SV2000
3	SV3000

#### Enclosure IP67

#### SI unit

Symbol	Protocol type
0	Without SI unit
QW	DeviceNet®
TAW	AS-Interface (8in/8out 2 power supply systems)
TBW	AS-Interface (4in/4out 2 power supply systems)
TCW <sup>(1)</sup>	AS-Interface (8in/8out 1 power supply systems)
TDW <sup>(1)</sup>	AS-Interface (4in/4out 1 power supply systems)
ZEN	EtherNet/IP

- \*Input blocks cannot be mounted without SI unit.
- \*When the DIN rail is included without an SI unit, the DIN rail length will accommodate an SI unit and one input block.

Note 1) There is a limit to the supply current to the input block and valve from SI units that have AS-Interface-compliant 1 power supply systems. Refer to the **Web Catalog** for details.

#### Mounting

Nil	Direct mounting
D	DIN rail mounting (With DIN rail)
D0	DIN rail mounting (Without DIN rail)
D3	For 3 stations
:	:
:	:
D20	For 20 stations

\* In the case of D0, only DIN rail fittings are attached.

#### ● SUP/EXH block assembly specifications

Nil	Internal pilot
S	Internal pilot/Built-in silencer
R	External pilot
RS	External pilot/Built-in silencer

Note) When the built-in silencer type is used, keep the exhaust port from coming in direct contact with water or other liquids.

#### ● P, E port location

U	U side (2 to 10 stations)
D	D side (2 to 10 stations)
B	Both sides (2 to 20 stations)

### Input block stations

Nil	None
1	1 station
:	:
:	:
8	8 stations

Note) Without SI unit, the symbol is nil. When the SI unit is AS Interface compliant, the maximum number of stations is limited. Refer to the **Web Catalog** for details.

#### Input block type

Nil	Without input block
1	M12: 2 inputs EX250-IE1
2	M12: 4 inputs EX250-IE2
3	M8: 4 inputs EX250-IE3

Note) Without SI unit, the symbol is nil.

#### Input block specifications

Nil	PNP sensor input (Positive common) or without input block
N	NPN sensor input (Negative common)

### ● Valve stations

Symbol	Stations	Note
02	2 stations	Double wiring specifications <sup>(1)</sup>
:	:	
:	:	
16	16 stations	Specified layout <sup>(2)</sup> (up to 32 solenoids possible.)
02	2 stations	
:	:	
:	:	
20	20 stations	

\* When the SI unit is AS-Interface compliant, the maximum number of solenoids is as shown below, so please be careful of the number of stations.

- 8in/8out: Max. 8 solenoids
- 4in/4out: Max. 4 solenoids
- Note 1) Double wiring specifications: Single, double, 3 position and 4 position solenoid valves can be used on all manifold stations. Use of a single solenoid will result in an unused control signal. If this is not desired, order with a specified layout.
- Note 2) Specified layout: Indicate wiring specifications on the manifold specification sheet. (Note that double, 3 and 4 position valves cannot be used where single solenoid wiring has been specified.)

### SI Unit Part No.

Symbol	Protocol type	Solenoid part no.
QW	DeviceNet®	EX250-SDN1
TAW	AS-Interface (8in/8out 2 power supply systems)	EX250-SAS3
TBW	AS-Interface (4in/4out 2 power supply systems)	EX250-SAS5
TCW	AS-Interface (8in/8out 1 power supply systems)	EX250-SAS7
TDW	AS-Interface (4in/4out 1 power supply systems)	EX250-SAS9
ZEN	EtherNet/IP	EX250-SEN1

### A, B port size (metric)

Symbol	A, B port	P, E port	Applicable series
C3	One-touch fitting for ø3.2	One-touch fitting for ø8	SV1000
C4	One-touch fitting for ø4		
C6	One-touch fitting for ø6		
C4	One-touch fitting for ø4	One-touch fitting for ø10	SV2000
C6	One-touch fitting for ø6		
C8	One-touch fitting for ø8		
C6	One-touch fitting for ø6	One-touch fitting for ø12	SV3000
C8	One-touch fitting for ø8		
C10	One-touch fitting for ø10		
M	A, B ports mixed		

### A, B port size (inch)

Symbol	A, B port	P, E port	Applicable series
N1	One-touch fitting for ø1/8"	One-touch fitting for ø5/16"	SV1000
N3	One-touch fitting for ø5/32"		
N7	One-touch fitting for ø1/4"		
N3	One-touch fitting for ø5/32"	One-touch fitting for ø3/8"	SV2000
N7	One-touch fitting for ø1/4"		
N9	One-touch fitting for ø5/16"		
N7	One-touch fitting for ø1/4"	One-touch fitting for ø3/8"	SV3000
N9	One-touch fitting for ø5/16"		
N11	One-touch fitting for ø3/8"		
M	A, B ports mixed		

\* In the case of mixed specifications (M), indicate separately on the manifold specification sheet.

\* Port sizes of X, PE port for external pilot specifications (R, RS) are ø4 (metric), ø5/32" (inch) for SV1000/2000 and ø6 (metric) and ø1/4" (inch) for SV3000.

Refer to the **Web Catalog** and the Operation Manual for the details of EX250 Integrated-type Serial Transmission System. Please download the Operation Manual via our website, <https://www.smccworld.com>.

## How to Order Manifold Assembly

### Ordering example (SV1000)

#### Manifold

SS5V1-W10S1QW11ND-05B-C6 (1 set)

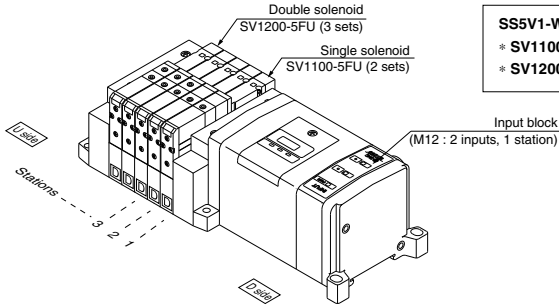

SS5V1-W10S1QW11ND-05B-C6...1 set (manifold part no.)

\* SV1100-5FU.....2 sets (Single solenoid part no.)

\* SV1200-5FU.....3 sets (Double solenoid part no.)

## How to Order Valve

SV 1 1 0 0 - 5 F - - - (Note)

#### Series

1	SV1000
2	SV2000
3	SV3000

#### Type of actuation

1	2 position single
2	2 position double
3	3 position closed center
4	3 position exhaust center
5	3 position pressure center
A	4 position dual 3 port valve: N.C./N.C.
B	4 position dual 3 port valve: N.O./N.O.
C	4 position dual 3 port valve: N.C./N.O.

\* 4 position dual 3 port valves are applicable to the SV1000 and SV2000 series only.

#### Pilot type

Nil	Internal pilot
R	External pilot

\* External pilot specifications is not available for 4 position dual 3 port valves.

#### Back pressure check valve

Nil	None
K	Built-in

\* Built-in back pressure check valve type is applicable to the SV1000 series only.  
\* Back pressure check valve is not available for 3 position valve.

Note) Available with manifold block for station additions. Refer to page 119.

#### Made to Order

Nil	-
X90	Main valve fluororubber (Refer to page 134.)

#### Manual override

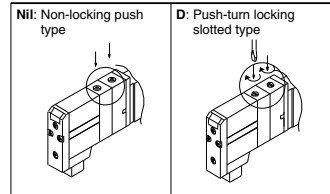

#### Light/Surge voltage suppressor

U	With light/surge voltage suppressor
R	With surge voltage suppressor

#### Rated voltage

5	24 VDC
---	--------

Note) Refer to Specific Product Precautions 2 on page 136.



# SV Series

## Dimensions: SV1000 Series for EX250 Integrated-type (For I/O) Serial Transmission System

● Tie-rod base manifold: SS5V1-W10S1□□□□□□-Stations  $\frac{U}{D}$  (S, R, RS)-C3, N1  
C4, N3 (-D)  
C6, N7

- When P, E port outlets are indicated on the U side or D side, the P, E ports on the opposite side are plugged.
- External pilot port positions and silencer discharge port positions are the same as P, E port outlet positions.

(With 2 input blocks)

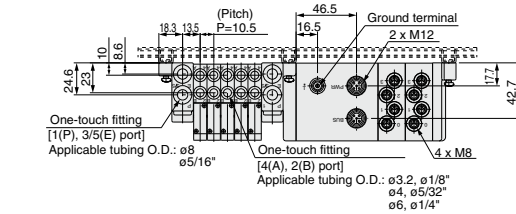

### With External Pilot Specifications

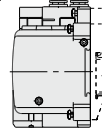
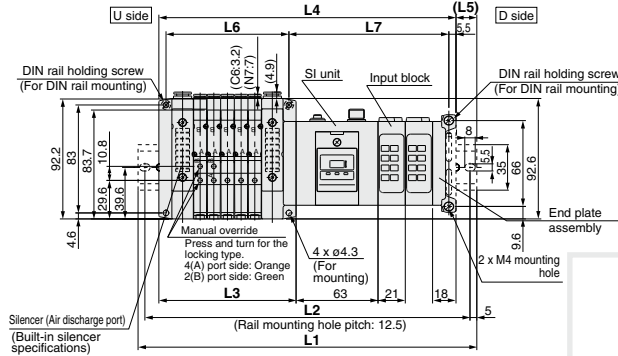
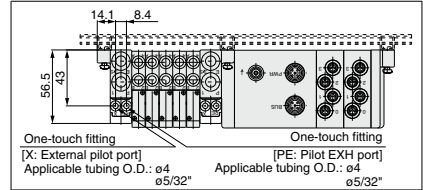

### With option

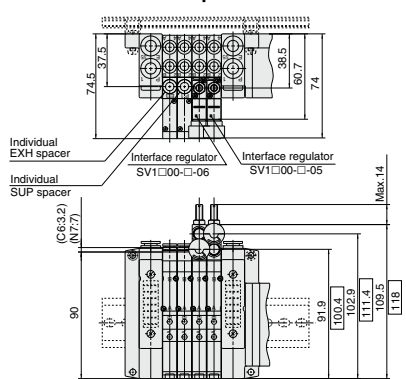

□ Dimensions are the ones for SV1300-□□-□.

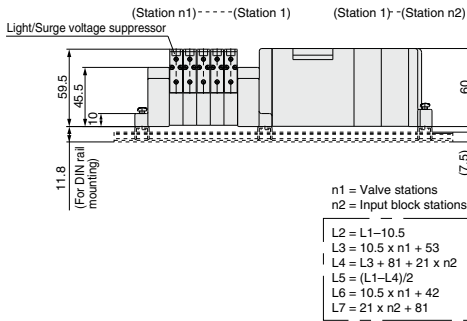

### L1: DIN Rail Overall Length

Valve stations (n1) Input block Stations (n2)	2	3	4	5	6	7	8	9	10	11	12	13	14	15	16	17	18	19	20
0	185.5	198	210.5	210.5	223	235.5	248	260.5	273	273	285.5	298	310.5	323	335.5	348	348	360.5	373
1	210.5	210.5	223	235.5	248	260.5	273	273	285.5	298	310.5	323	335.5	348	348	360.5	373	385.5	398
2	223	235.5	248	260.5	273	273	285.5	298	310.5	323	335.5	348	348	360.5	373	385.5	398	410.5	410.5
3	248	260.5	273	273	285.5	298	310.5	323	335.5	348	348	360.5	373	385.5	398	410.5	410.5	423	435.5
4	273	273	285.5	298	310.5	323	335.5	348	348	360.5	373	385.5	398	410.5	410.5	423	435.5	448	460.5
5	285.5	298	310.5	323	335.5	348	348	360.5	373	385.5	398	410.5	410.5	423	435.5	448	460.5	473	473
6	310.5	323	335.5	348	348	360.5	373	385.5	398	410.5	410.5	423	435.5	448	460.5	473	473	485.5	498
7	335.5	348	348	360.5	373	385.5	398	410.5	410.5	423	435.5	448	460.5	473	473	485.5	498	510.5	523
8	348	360.5	373	385.5	398	410.5	410.5	423	435.5	448	460.5	473	473	485.5	498	510.5	523	535.5	535.5

**Dimensions: SV2000 Series for EX250 Integrated-type (For I/O) Serial Transmission System**

● Tie-rod base manifold: SS5V2-W10S1□□□□D-**Stations**  $\frac{U}{B}$  (S, R, RS)-  $\frac{C4, N3}{C8, N1}$   $\frac{C6, N9}{C8, N9}$  (-D)

(With 2 input blocks)

- When P, E port outlets are indicated on the U side or D side, the P, E ports on the opposite side are plugged.
- External pilot port positions and silencer discharge port positions are the same as P, E port outlet positions.

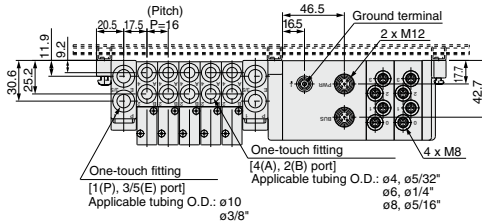

**With External Pilot Specifications**

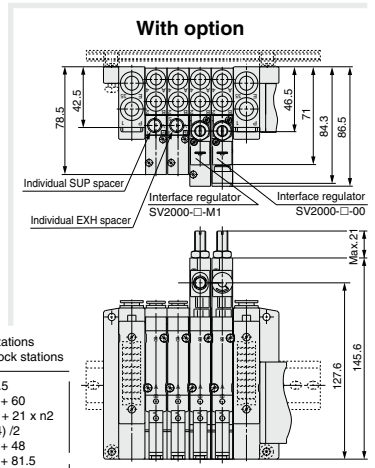
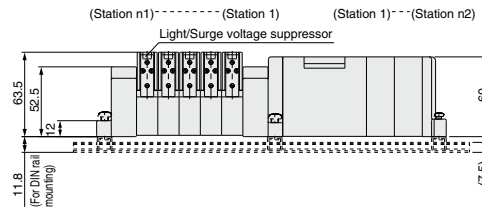
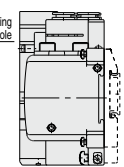
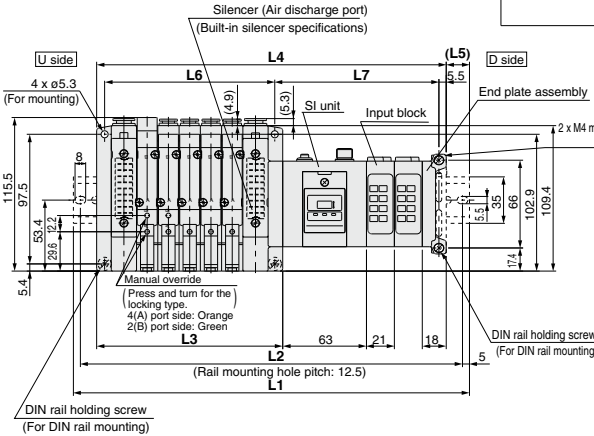
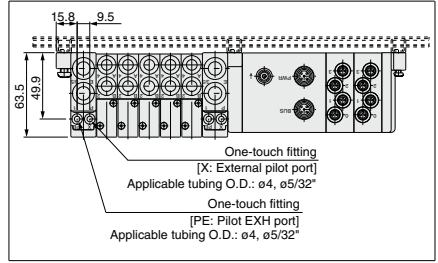

n1 = Valve stations  
n2 = Input block stations

- L2 = L1 - 10.5
- L3 = 16 x n1 + 60
- L4 = L3 + 81 + 21 x n2
- L5 = (L1 - L4) / 2
- L6 = 16 x n1 + 48
- L7 = 21 x n2 + 81.5

**L1: DIN Rail Overall Length**

Valve stations (n1) Input block Stations (n2)	2	3	4	5	6	7	8	9	10	11	12	13	14	15	16	17	18	19	20
0	198	223	235.5	248	260.5	285.5	298	310.5	335.5	348	360.5	373	398	410.5	423	448	460.5	473	485.5
1	223	235.5	260.5	273	285.5	298	323	335.5	348	373	385.5	398	410.5	435.5	448	460.5	485.5	498	510.5
2	248	260.5	273	298	310.5	323	335.5	360.5	373	385.5	410.5	423	435.5	448	473	485.5	498	510.5	535.5
3	260.5	285.5	298	310.5	335.5	348	360.5	373	398	410.5	423	435.5	460.5	473	485.5	510.5	523	535.5	548
4	285.5	298	323	335.5	348	360.5	385.5	398	410.5	435.5	448	460.5	473	498	510.5	523	548	560.5	573
5	310.5	323	335.5	360.5	373	385.5	398	423	435.5	448	473	485.5	498	510.5	535.5	548	560.5	585.5	598
6	323	348	360.5	373	398	410.5	423	435.5	460.5	473	485.5	510.5	523	535.5	548	573	585.5	598	610.5
7	348	360.5	385.5	398	410.5	435.5	448	460.5	473	498	510.5	523	535.5	560.5	573	585.5	610.5	623	635.5
8	373	385.5	398	423	435.5	448	460.5	485.5	498	510.5	535.5	548	560.5	573	598	610.5	623	648	660.5

# SV Series

## Dimensions: SV3000 Series for EX250 Integrated-type (For I/O) Serial Transmission System

● Tie-rod base manifold: SS5V3-W10S1□□□□D-**Stations**  $\frac{U}{D}$  (S, R, RS)-  $\frac{C6, N7}{C8, N9}$  (C10, N11) (-D)

(With 2 input blocks)

- When P, E port outlets are indicated on the U side or D side, the P, E ports on the opposite side are plugged.
- External pilot port positions and silencer discharge port positions are the same as P, E port outlet positions.

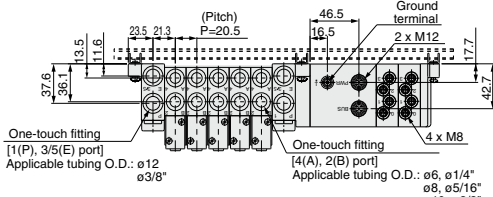

### With External Pilot Specifications

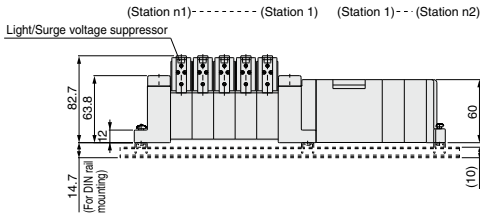
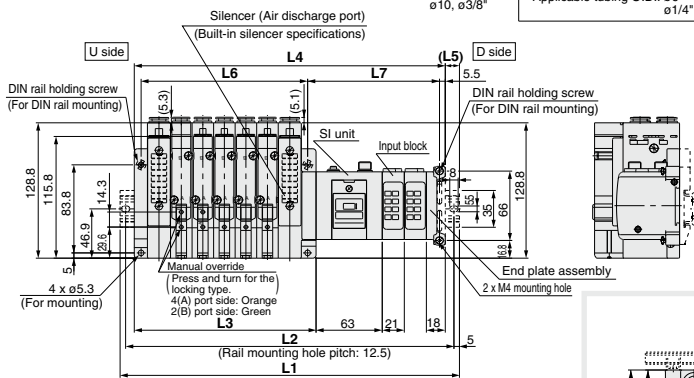
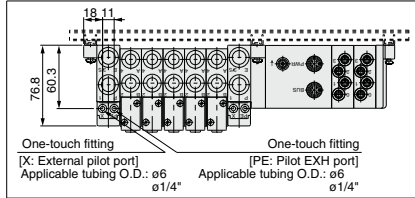

n1 = Valve stations  
n2 = Input block stations

- L2 = L1 - 10.5
- L3 = 20.5 x n1 + 70.5
- L4 = L3 + 81 + 21 x n2
- L5 = (L1 - L4) / 2
- L6 = 20.5 x n1 + 56
- L7 = 21 x n2 + 83.5

### With option

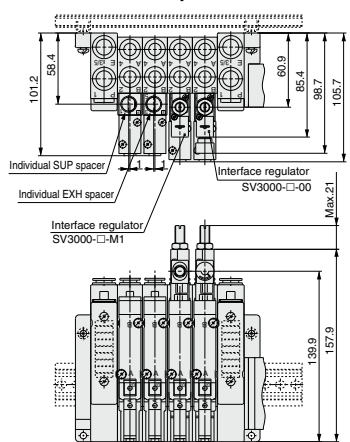

### L1: DIN Rail Overall Length

Valve stations (n1) Input block Stations (n2)	2	3	4	5	6	7	8	9	10	11	12	13	14	15	16	17	18	19	20
0	223	248	260.5	285.5	298	323	348	360.5	385.5	410.5	423	448	473	485.5	510.5	535.5	548	573	585.5
1	248	260.5	285.5	310.5	323	348	360.5	385.5	410.5	423	448	473	485.5	510.5	535.5	548	573	585.5	610.5
2	260.5	285.5	310.5	323	348	360.5	385.5	410.5	423	448	473	485.5	510.5	535.5	548	573	598	610.5	635.5
3	285.5	310.5	323	348	373	385.5	410.5	423	448	473	485.5	510.5	535.5	548	573	598	610.5	635.5	648
4	310.5	323	348	373	385.5	410.5	423	448	473	485.5	510.5	535.5	548	573	598	610.5	635.5	660.5	673
5	323	348	373	385.5	410.5	435.5	448	473	485.5	510.5	535.5	548	573	598	610.5	635.5	660.5	673	698
6	348	373	385.5	410.5	435.5	448	473	485.5	510.5	535.5	548	573	598	610.5	635.5	660.5	673	698	723
7	373	385.5	410.5	435.5	448	473	498	510.5	535.5	548	573	598	610.5	635.5	660.5	673	698	723	735.5
8	385.5	410.5	435.5	448	473	498	510.5	535.5	548	573	598	610.5	635.5	660.5	673	698	723	735.5	760.5

# Integrated-type (For I/O) Serial Transmission System

## **EX600 Series**

IP67 compliant

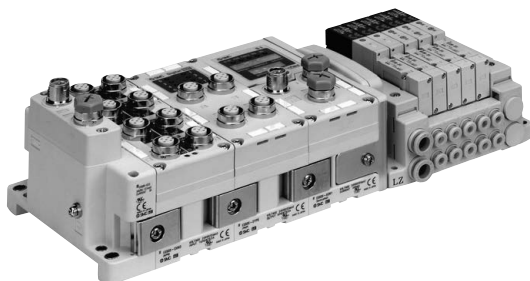

Tie-rod base

Applicable series **Tie-rod base manifold**  
**SV1000/SV2000/SV3000**

- Digital input/output: Max. 144 inputs/144 outputs
- Analog input: Max. 18 channels
- Valve output: 32 outputs

Refer to the **Web Catalog** and the Operation Manual for the details of EX600 Integrated-type (For I/O) Serial Transmission System.  
Please download the Operation Manual via our website, <https://www.smcworld.com>

# EX600 Series



# SV1000/2000/3000 Series

When I/O Unit EX600-D□□E or EX600-D□□F are selected, enclosure is IP40.  
Refer to page 141 for details.

## How to Order

### ● Tie-rod Base

**SS5V** **1** - **10S6** **Q** **□** **□** **□** **D** - **05** **U** **□** - **C6** - **□**

**Series**

1	SV1000
2	SV2000
3	SV3000

**Enclosure**

Nil	IP40
W (Note)	IP67

Note) When selecting an EX600-D□□E or EX600-D□□F I/O unit, option W (IP67) cannot be selected.

**SI Unit**

0	Without SI Unit
Q	DeviceNet® type (Version A)
N	PROFIBUS DP type (Version A)
V	CC-Link type
EA	EtherNet/IP™ (2 port)
F	PROFINET type
WE	EtherNet/IP™ compatible wireless base (Note 3)
WF	PROFINET compatible wireless base (Note 3)
WS	Wireless remote (Note 3)

**Mounting**

Nil	Direct mounting
D	DIN rail mounting (With DIN rail)
D0 (Note 1)	DIN rail mounting (Without DIN rail)
D3	For 3 sta. When a longer DIN rail is desired than the specified stations. (Specify a longer rail than the standard length.)
:	:
D20	For 20 sta.

**SI Unit**

0	Without SI Unit
Q	DeviceNet® type (Version A)
N	PROFIBUS DP type (Version A)
V	CC-Link type
EA	EtherNet/IP™ (2 port)
F	PROFINET type
WE	EtherNet/IP™ compatible wireless base (Note 3)
WF	PROFINET compatible wireless base (Note 3)
WS	Wireless remote (Note 3)

Note 1) I/O units cannot be chosen without SI Unit.  
Note 2) When "Without SI Unit" is specified, the valve plate to connect the manifold and SI unit is not mounted. For mounting method, refer to Specific Product Precautions of the **Web Catalog**.  
Note 3) The wireless system is suitable for use only in a country where it is in accordance with the Radio Act and regulations of that country.

**End plate type**

Nil	No end plate
2	M12 power supply connector B-coded
3	7/8 inch power supply connector
4	M12 power supply connector IN/OUT, A-coded, Pin arrangement 1
5	M12 power supply connector IN/OUT, A-coded, Pin arrangement 2

**SI Unit COM.**

Nil	Positive common
N	Negative common

Note) Without SI Unit, the symbol is nil.

**I/O unit sta. number**

Nil	None
1	1 sta.
:	:
9	9 sta.

Note 1) Without SI Unit, the symbol is nil.  
Note 2) SI Unit is not included in I/O unit station number.  
Note 3) When I/O unit is selected, it is shipped separately, and assembled by customer. Refer to the attached operation manual for mounting method.

**Valve stations**

Symbol	Stations	Note
02	2 sta.	Double wiring specification (Note 1)
:	:	
16	16 sta.	
02	2 sta.	Specified layout (Note 2) (Up to 32 solenoids possible)
:	:	
20	20 sta.	

### ● SUP/EXH block assembly

Nil	Internal pilot
S (Note)	Internal pilot, Built-in silencer
R	External pilot
RS (Note)	External pilot, Built-in silencer

Note) When the built-in silencer type is used, keep the exhaust port from coming in direct contact with water or other liquids.

### ● P, E port entry

U	U side (2 sta. to 10 sta.)
D	D side (2 sta. to 10 sta.)
B	B side (2 sta. to 20 sta.)

Note 1) Double wiring specifications: Single, double, 3 position and 4 position solenoid valves can be used at all of the manifold stations. When single solenoid is used, control signal which is not assigned to any number is ignored. If empty signal is not wanted, please order with signal layout specified.  
Note 2) Specified layout: Indicate wiring specifications with the manifold specification sheet. (Note that double, 3 position and 4 position valves cannot be used where single solenoid wiring has been specified.)

### A, B port size (Metric)

Symbol	A, B port	P, E port	Applicable series
C3	ø3.2 One-touch fitting	ø8 One-touch fitting	SV1000
C4	ø4 One-touch fitting		
C6	ø6 One-touch fitting		
C4	ø4 One-touch fitting		
C6	ø6 One-touch fitting	ø10 One-touch fitting	SV2000
C8	ø8 One-touch fitting		
C8	ø6 One-touch fitting		
C6	ø8 One-touch fitting		
C10	ø10 One-touch fitting	ø12 One-touch fitting	SV3000
M	A, B port mixed		

### A, B port size (Inch)

Symbol	A, B port	P, E port	Applicable series
N1	ø1/8" One-touch fitting	ø5/16" One-touch fitting	SV1000
N3	ø5/32" One-touch fitting		
N7	ø1/4" One-touch fitting		
N3	ø5/32" One-touch fitting		
N7	ø1/4" One-touch fitting	ø3/8" One-touch fitting	SV2000
N9	ø5/16" One-touch fitting		
N7	ø1/4" One-touch fitting		
N9	ø5/16" One-touch fitting		
N11	ø3/8" One-touch fitting	ø3/8" One-touch fitting	SV3000
M	A, B port mixed		

\* In the case of Mixed specifications (M), indicate separately with the manifold specification sheet.

\* Regarding the X and PE port size of External pilot (P), and X port size of External pilot/Built-in silencer type (RS), ø4 (mm) and ø5/32" (inch) for the SV1000/2000 series, ø6 (mm) and, ø1/4" (inch) for the SV3000 series.

## How to Order Manifold Assembly (Example)

### Example (SS5V1)

**Manifold**  
Power supply with  
M12 connector

For the I/O unit part number mounted, refer to the **Web Catalog**.

- Digital Input Unit
- Digital Output Unit
- Digital Input/Output Unit
- Analog Input Unit
- Analog Output Unit
- Analog Input/Output Unit

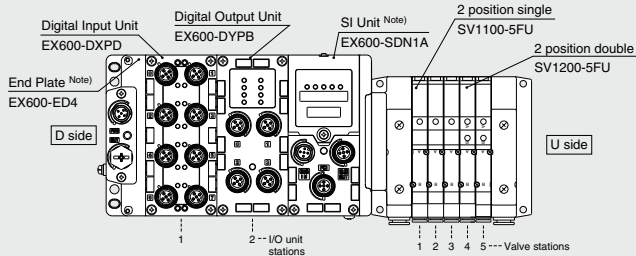

#### Serial transmission kit

- SS5V1-W10S6Q4N2D-05B-C6 ..... 1 set    **Manifold base part number**
- \* SV1100-5FU ..... 3 sets    **Valve part number (Stations 1 to 3)**
- \* SV1200-5FU ..... 2 sets    **Valve part number (Stations 4 to 5)**
- \* EX600-DXPD ..... 1 set    **I/O unit part number (Station 1)**
- \* EX600-DYPB ..... 1 set    **I/O unit part number (Station 2)**

Enter in order starting from the first station on the D side.  
When entry of part numbers becomes complicated, indicate with the manifold specification sheet.

Enter in order starting from the first station on the D side.  
When entry of part numbers becomes complicated, indicate with the manifold specification sheet.

→ The asterisk denotes the symbol for assembly.  
Prefix it to the part nos. of the solenoid valve, etc.

Note) Do not enter the SI Unit part number and the End Plate part number together.

## How to Order Valves

SV **1** **1** 00 **5** FU **U** **5**

#### Series

1	SV1000
2	SV2000
3	SV3000

#### Type of actuation

1	2 position single solenoid
2	2 position double solenoid
3	3 position closed center
4	3 position exhaust center
5	3 position pressure center
A	4 position dual 3 port valve: N.C./N.C.
B	4 position dual 3 port valve: N.O./N.O.
C	4 position dual 3 port valve: N.C./N.O.

\* 4 position dual 3 port valves are applicable to the SV1000/2000 series only.

#### Pilot specifications

NII	Internal pilot
R	External pilot

\* External pilot specification is not available for 4 position dual 3 port valves.

#### Back pressure check valve

NII	None
K	Built-in

\* Built-in back pressure check valve type is applicable to the SV1000 series only.  
\* The 3 position valve is not available with the back pressure check valve.

#### Made to Order

NII	—
X90	Fluororubber specification

#### Manual override

NII: Non-locking push type    D: Push-turn locking slotted type

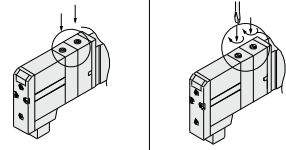

#### Light/Surge voltage suppressor

U	With light/surge voltage suppressor
R	With surge voltage suppressor

#### Coil voltage

5	24 VDC
---	--------

## Dimensions: SV1000 Series

### Power supply with M12 connector

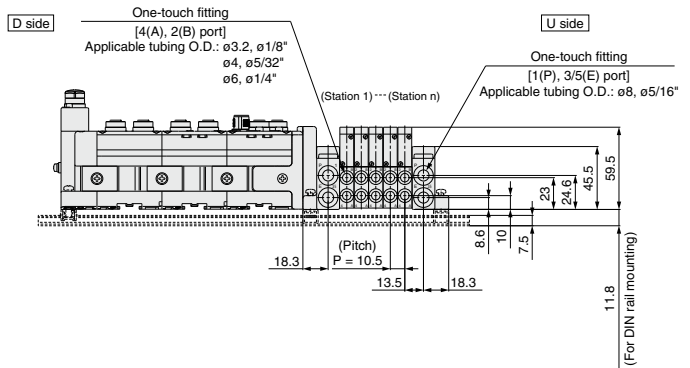
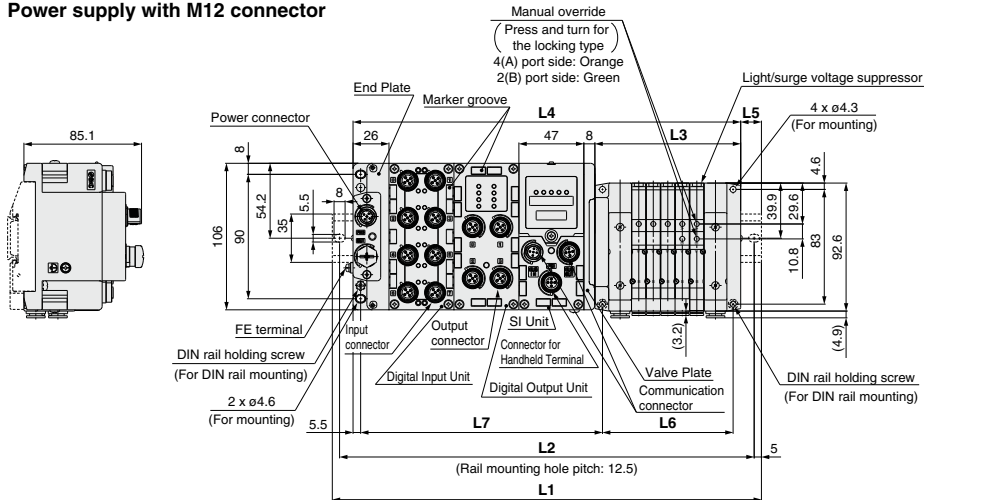

L2 = L1 - 10.5
L3 = 10.5 x n1 + 53
L4 = L3 + 81 + 47 x n2
L5 = (L1 - L4)/2
L6 = 10.5 x n1 + 42
L7 = 47 x n2 + 81

### L1: DIN Rail Overall Length

I/O unit stations (n2) \ Valve stations (n1)	2	3	4	5	6	7	8	9	10	11	12	13	14	15	16	17	18	19	20
0	185.5	198	210.5	210.5	223	235.5	248	260.5	273	273	285.5	298	310.5	323	335.5	348	348	360.5	373
1	235.5	248	248	260.5	273	285.5	298	310.5	310.5	323	335.5	348	360.5	373	373	385.5	398	410.5	423
2	273	285.5	298	310.5	323	335.5	335.5	348	360.5	373	385.5	398	410.5	410.5	423	435.5	448	460.5	473
3	323	335.5	348	360.5	373	373	385.5	398	410.5	423	435.5	435.5	448	460.5	473	485.5	498	498	510.5
4	373	385.5	398	398	410.5	423	435.5	448	460.5	473	473	485.5	498	510.5	523	535.5	535.5	548	560.5
5	423	435.5	435.5	448	460.5	473	485.5	498	498	510.5	523	535.5	548	560.5	560.5	573	585.5	598	610.5
6	460.5	473	485.5	498	510.5	523	535.5	535.5	548	560.5	573	585.5	598	598	610.5	623	635.5	648	660.5
7	510.5	523	535.5	548	560.5	560.5	573	585.5	598	610.5	623	623	635.5	648	660.5	673	685.5	698	698
8	560.5	573	585.5	598	598	610.5	623	635.5	648	660.5	660.5	673	685.5	698	710.5	723	723	735.5	748
9	610.5	623	623	635.5	648	660.5	673	685.5	685.5	698	710.5	723	735.5	748	760.5	760.5	773	785.5	798



**Dimensions: SV1000 Series**

**Power supply with 7/8 inch connector**

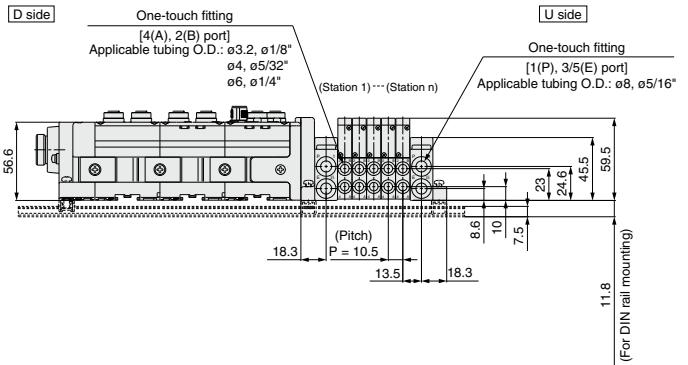
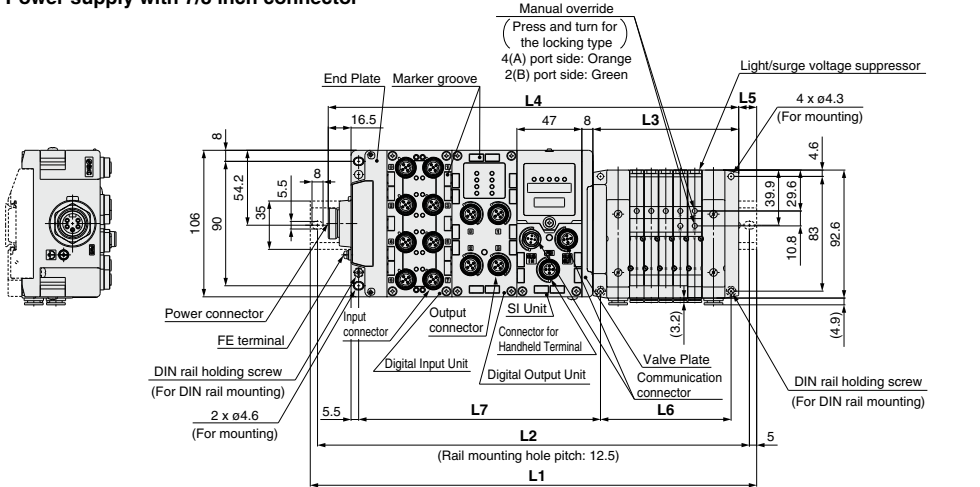

$L2 = L1 - 10.5$   
 $L3 = 10.5 \times n1 + 53$   
 $L4 = L3 + 97.5 + 47 \times n2$   
 $L5 = (L1 - L4) / 2$   
 $L6 = 10.5 \times n1 + 42$   
 $L7 = 47 \times n2 + 81$

**L1: DIN Rail Overall Length**

I/O unit stations (n2) \ Valve stations (n1)	2	3	4	5	6	7	8	9	10	11	12	13	14	15	16	17	18	19	20
0	198	210.5	223	235.5	248	248	260.5	273	285.5	298	310.5	310.5	323	335.5	348	360.5	373	385.5	385.5
1	248	260.5	273	285.5	285.5	298	310.5	323	335.5	348	348	360.5	373	385.5	398	410.5	410.5	423	435.5
2	298	310.5	310.5	323	335.5	348	360.5	373	373	385.5	398	410.5	423	435.5	448	448	460.5	473	485.5
3	348	348	360.5	373	385.5	398	410.5	410.5	423	435.5	448	460.5	473	473	485.5	498	510.5	523	535.5
4	385.5	398	410.5	423	435.5	435.5	448	460.5	473	485.5	498	510.5	510.5	523	535.5	548	560.5	573	573
5	435.5	448	460.5	473	473	485.5	498	510.5	523	535.5	535.5	548	560.5	573	585.5	598	598	610.5	623
6	485.5	498	498	510.5	523	535.5	548	560.5	573	573	585.5	598	610.5	623	635.5	635.5	648	660.5	673
7	535.5	535.5	548	560.5	573	585.5	598	598	610.5	623	635.5	648	660.5	660.5	673	685.5	698	710.5	723
8	573	585.5	598	610.5	623	635.5	635.5	648	660.5	673	685.5	698	698	710.5	723	735.5	748	760.5	760.5
9	623	635.5	648	660.5	660.5	673	685.5	698	710.5	723	723	735.5	748	760.5	773	785.5	798	798	810.5

## Dimensions: SV2000 Series

### Power supply with M12 connector

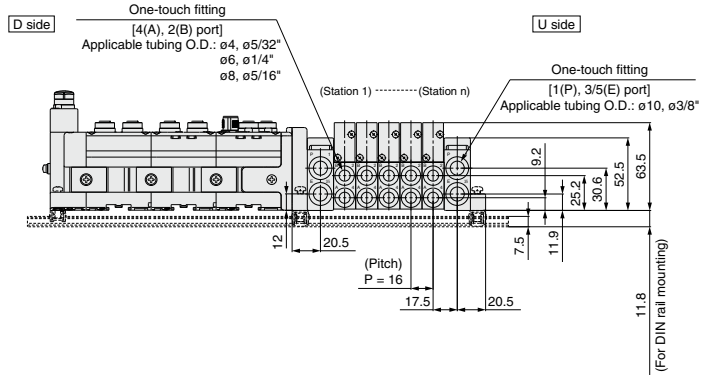
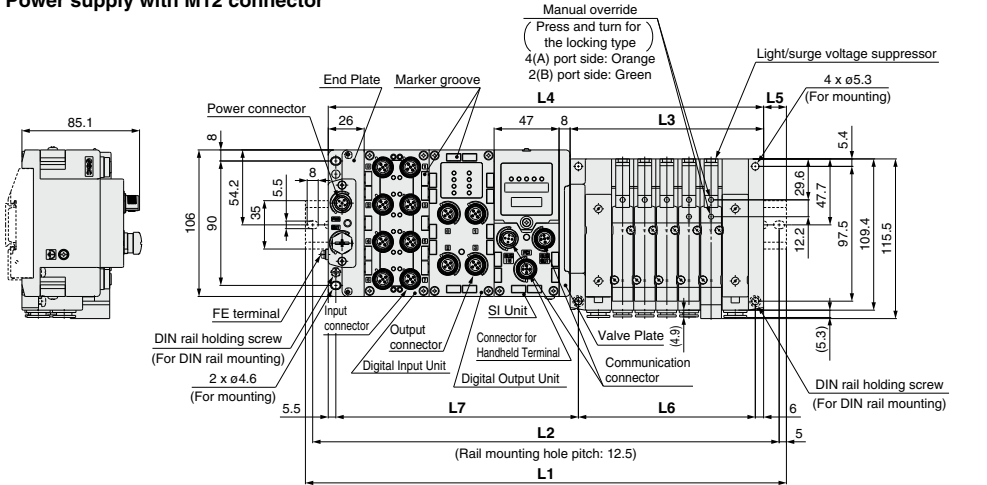

$$\begin{aligned}
 L2 &= L1 - 10.5 \\
 L3 &= 16 \times n1 + 60 \\
 L4 &= L3 + 81 + 47 \times n2 \\
 L5 &= (L1 - L4)/2 \\
 L6 &= 16 \times n1 + 48 \\
 L7 &= 47 \times n2 + 81.5
 \end{aligned}$$

### L1: DIN Rail Overall Length

I/O unit stations (n2) \ Valve stations (n1)	2	3	4	5	6	7	8	9	10	11	12	13	14	15	16	17	18	19	20
0	198	223	235.5	248	260.5	285.5	298	310.5	335.5	348	360.5	373	398	410.5	423	448	460.5	473	485.5
1	248	260.5	285.5	298	310.5	335.5	348	360.5	373	398	410.5	423	435.5	460.5	473	485.5	510.5	523	535.5
2	298	310.5	323	348	360.5	373	398	410.5	423	435.5	460.5	473	485.5	510.5	523	535.5	548	573	585.5
3	348	360.5	373	385.5	410.5	423	435.5	460.5	473	485.5	498	523	535.5	548	573	585.5	598	610.5	635.5
4	385.5	410.5	423	435.5	460.5	473	485.5	498	523	535.5	548	560.5	585.5	598	610.5	635.5	648	660.5	673
5	435.5	448	473	485.5	498	523	535.5	548	560.5	585.5	598	610.5	635.5	648	660.5	673	698	710.5	723
6	485.5	498	510.5	535.5	548	560.5	585.5	598	610.5	623	648	660.5	673	698	710.5	723	735.5	760.5	773
7	535.5	548	560.5	585.5	598	610.5	623	648	660.5	673	685.5	710.5	723	735.5	760.5	773	785.5	798	823
8	573	598	610.5	623	648	660.5	673	685.5	710.5	723	735.5	760.5	773	785.5	798	823	835.5	848	860.5
9	623	635.5	660.5	673	685.5	710.5	723	735.5	748	773	785.5	798	823	835.5	848	860.5	885.5	898	910.5

**Dimensions: SV2000 Series**

**Power supply with 7/8 inch connector**

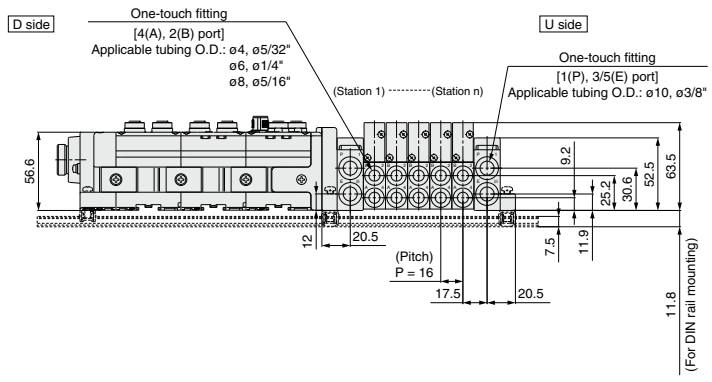
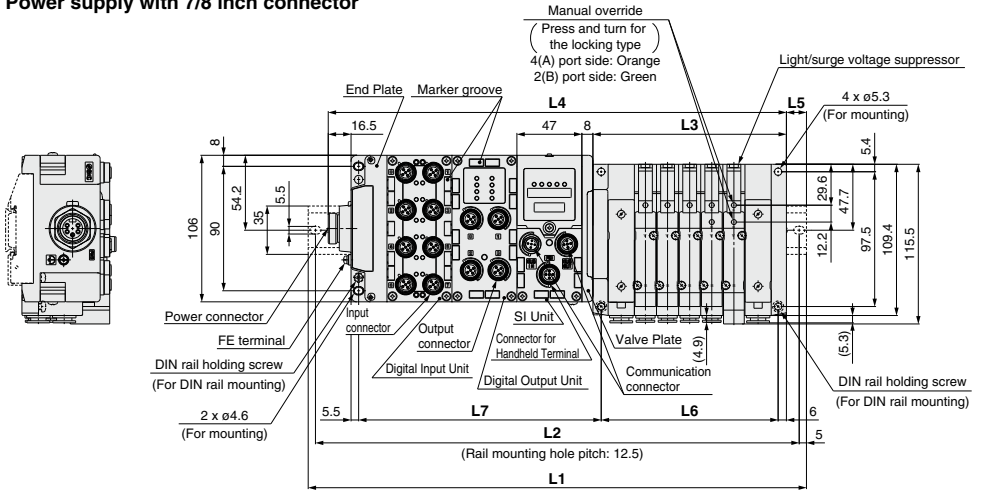

- L2 = L1 - 10.5
- L3 = 16 x n1 + 60
- L4 = L3 + 97.5 + 47 x n2
- L5 = (L1 - L4)/2
- L6 = 16 x n1 + 48
- L7 = 47 x n2 + 81.5

**L1: DIN Rail Overall Length**

I/O unit stations (n2) \ Valve stations (n1)	2	3	4	5	6	7	8	9	10	11	12	13	14	15	16	17	18	19	20
0	223	235.5	248	273	285.5	298	310.5	335.5	348	360.5	373	398	410.5	423	448	460.5	473	485.5	510.5
1	260.5	285.5	298	310.5	335.5	348	360.5	373	398	410.5	423	448	460.5	473	485.5	510.5	523	535.5	548
2	310.5	323	348	360.5	373	398	410.5	423	435.5	460.5	473	485.5	510.5	523	535.5	548	573	585.5	598
3	360.5	373	398	410.5	423	435.5	460.5	473	485.5	498	523	535.5	548	573	585.5	598	610.5	635.5	648
4	410.5	423	435.5	460.5	473	485.5	498	523	535.5	548	573	585.5	598	610.5	635.5	648	660.5	673	698
5	448	473	485.5	498	523	535.5	548	560.5	585.5	598	610.5	635.5	648	660.5	673	698	710.5	723	748
6	498	523	535.5	548	560.5	585.5	598	610.5	623	648	660.5	673	698	710.5	723	735.5	760.5	773	785.5
7	548	560.5	585.5	598	610.5	623	648	660.5	673	698	710.5	723	735.5	760.5	773	785.5	798	823	835.5
8	598	610.5	623	648	660.5	673	685.5	710.5	723	735.5	760.5	773	785.5	798	823	835.5	848	873	885.5
9	648	660.5	673	685.5	710.5	723	735.5	748	773	785.5	798	823	835.5	848	860.5	885.5	898	910.5	935.5

## Dimensions: SV3000 Series

### Power supply with M12 connector

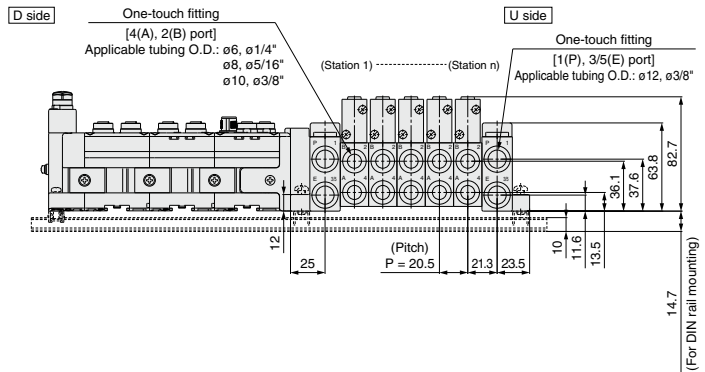
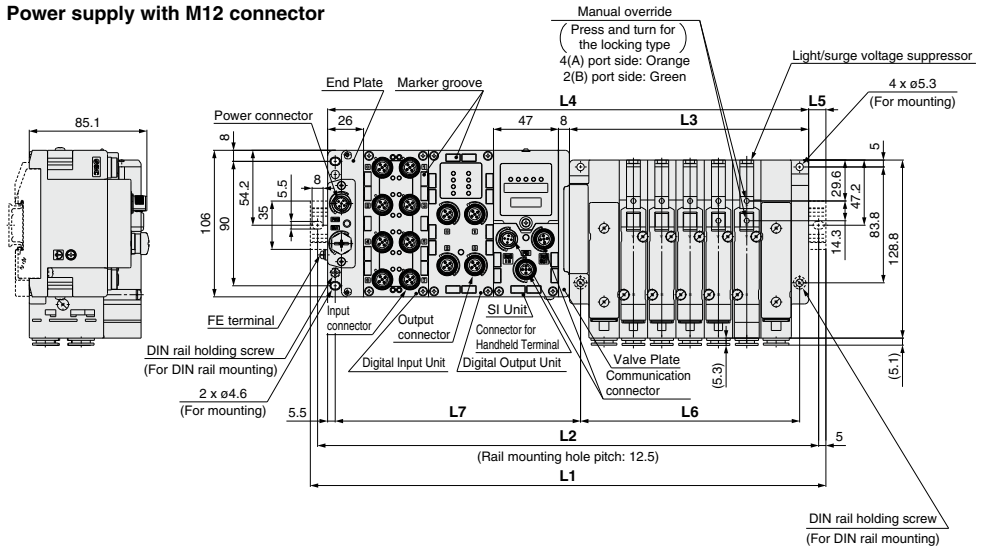

L2 = L1 - 10.5
L3 = 20.5 x n1 + 70.5
L4 = L3 + 81 + 47 x n2
L5 = (L1 - L4)/2
L6 = 20.5 x n1 + 56
L7 = 47 x n2 + 83.5

### L1: DIN Rail Overall Length

I/O unit stations (n2) \ Valve stations (n1)	2	3	4	5	6	7	8	9	10	11	12	13	14	15	16	17	18	19	20
0	223	248	260.5	285.5	298	323	348	360.5	385.5	410.5	423	448	473	485.5	510.5	535.5	548	573	585.5
1	273	285.5	310.5	335.5	348	373	398	410.5	435.5	448	473	498	510.5	535.5	560.5	573	598	623	635.5
2	310.5	335.5	360.5	373	398	423	435.5	460.5	485.5	498	523	535.5	560.5	585.5	598	623	648	660.5	685.5
3	360.5	385.5	398	423	448	460.5	485.5	510.5	523	548	573	585.5	610.5	635.5	648	673	685.5	710.5	735.5
4	410.5	435.5	448	473	498	510.5	535.5	548	573	598	610.5	635.5	660.5	673	698	723	735.5	760.5	773
5	460.5	473	498	523	535.5	560.5	585.5	598	623	635.5	660.5	685.5	698	723	748	760.5	785.5	810.5	823
6	498	523	548	560.5	585.5	610.5	623	648	673	685.5	710.5	735.5	748	773	785.5	810.5	835.5	848	873
7	548	573	598	610.5	635.5	648	673	698	710.5	735.5	760.5	773	798	823	835.5	860.5	873	898	923
8	598	623	635.5	660.5	685.5	698	723	735.5	760.5	785.5	798	823	848	860.5	885.5	910.5	923	948	973
9	648	660.5	685.5	710.5	723	748	773	785.5	810.5	835.5	848	873	885.5	910.5	935.5	948	973	—	—

**Dimensions: SV3000 Series**

**Power supply with 7/8 inch connector**

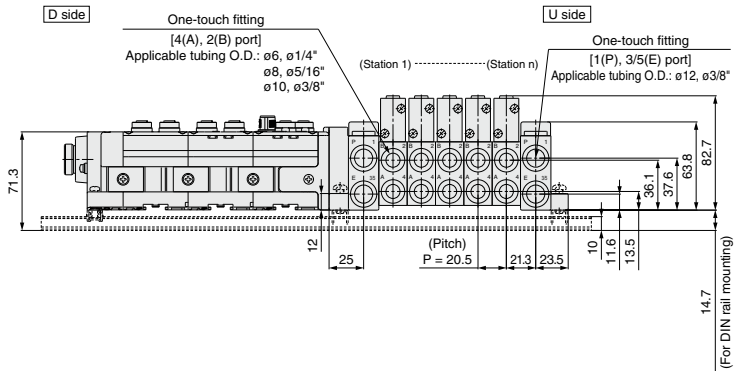
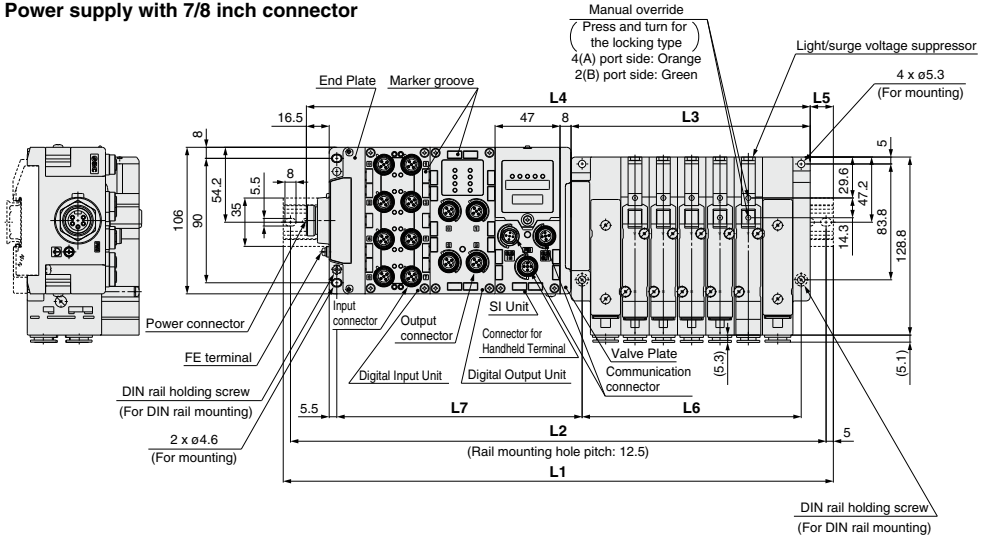

- L2 = L1 - 10.5
- L3 = 20.5 x n1 + 70.5
- L4 = L3 + 97.5 + 47 x n2
- L5 = (L1 - L4)/2
- L6 = 20.5 x n1 + 56
- L7 = 47 x n2 + 83.5

**L1: DIN Rail Overall Length**

I/O unit stations (n2) \ Valve stations (n1)	2	3	4	5	6	7	8	9	10	11	12	13	14	15	16	17	18	19	20
0	235.5	260.5	285.5	298	323	335.5	360.5	385.5	398	423	448	460.5	485.5	510.5	523	548	560.5	585.5	610.5
1	285.5	310.5	323	348	373	385.5	410.5	423	448	473	485.5	510.5	535.5	548	573	598	610.5	635.5	660.5
2	335.5	348	373	398	410.5	435.5	460.5	473	498	523	535.5	560.5	573	598	623	635.5	660.5	685.5	698
3	385.5	398	423	435.5	460.5	485.5	498	523	548	560.5	585.5	610.5	623	648	660.5	685.5	710.5	723	748
4	423	448	473	485.5	510.5	523	548	573	585.5	610.5	635.5	648	673	698	710.5	735.5	760.5	773	798
5	473	498	510.5	535.5	560.5	573	598	623	635.5	660.5	673	698	723	735.5	760.5	785.5	798	823	848
6	523	535.5	560.5	585.5	598	623	648	660.5	685.5	710.5	723	748	760.5	785.5	810.5	823	848	873	885.5
7	573	585.5	610.5	623	648	673	685.5	710.5	735.5	748	773	798	810.5	835.5	860.5	873	898	910.5	935.5
8	610.5	635.5	660.5	673	698	723	735.5	760.5	773	798	823	835.5	860.5	885.5	898	923	948	960.5	985.5
9	660.5	685.5	698	723	748	760.5	785.5	810.5	823	848	860.5	885.5	910.5	923	948	973	985.5	—	—



# Integrated-type (For Output) Serial Transmission System

## EX260 Series

IP67 (partly IP40) compliant

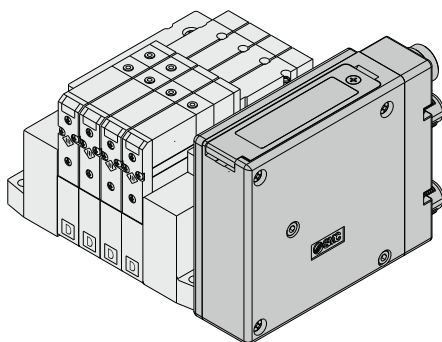

Tie-rod base

Applicable series	<b>Tie-rod base manifold</b> <b>SV1000/SV2000/SV3000</b>
-------------------	---

• Number of outputs points: 16, 32 points each

# Tie-rod Base: EX260 Integrated-type (For Output) Serial Transmission System

# SV Series





## How to Order Manifold

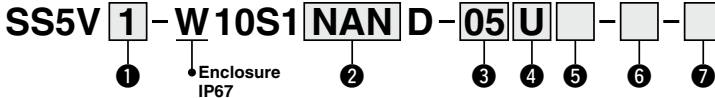

### ① Series

1	SV1000
2	SV2000
3	SV3000

### ② SI Unit specifications

(output polarity, protocol, number of outputs, communication connector)

Symbol (output polarity)	Protocol	Number of outputs	Communication connector
Positive common (NPN)	Negative common (NPN)		
0 Without SI Unit			
QA	QAN	32	M12
QB	QBN	16	
NA	NAN	32	
NB	NBN	16	M12
NC	NCN	32	
ND	NDN	16	
VA	VAN	32	M12
VB	VBN	16	
DA	DAN	32	
DB	DBN	16	M12
FA	FAN	32	
FB	FBN	16	
EA	EAN	32	M12
EB	EBN	16	
GA	GAN	32	
GB	GBN	16	
— (Note 2)		Ethernet	32
— (Note 2)		POWERLINK	16

Note 1) DIN rail cannot be mounted without SI Unit.  
 Note 2) Positive common (NPN) type is not applicable.  
 Note 3) IP40 for the D-sub applicable communication connector specification.  
 (The manifold part number is "SS5V□-10S1NC/ND□.")  
 Note 4) For SI unit part number, refer to the table below.

### ③ Valve stations

In case of the 32 Outputs SI unit

Symbol	Stations	Note
02	2 stations	Double wiring (Note 1)
⋮	⋮	
16	16 stations	
02	2 stations	Specified layout (Note 2) (Available up to 32 solenoids)
⋮	⋮	
20	20 stations	

In case of the 16 Outputs SI unit

Symbol	Stations	Note
02	2 stations	Double wiring (Note 1)
⋮	⋮	
08	8 stations	
02	2 stations	Specified layout (Note 2) (Available up to 16 solenoids)
⋮	⋮	
16	16 stations	

Note 1) Double wiring: single, double, 3-position and 4-position solenoid valves can be used on all manifold stations.  
 Use of a single solenoid will result in an unused control signal. If this is not desired, order with a specified layout.  
 Note 2) Specified layout: Indicate the wiring specifications with the manifold specification sheet.  
 (Note that double, 3-position and 4-position valves cannot be used where single solenoid wiring has been specified.)

### ④ P, E port location

U	U side (2 to 10 stations)
D	D side (2 to 10 stations)
B	Both sides (2 to 20 stations)

### ⑤ SUP/EXH block assembly specifications

NII	Internal pilot
S (Note)	Internal pilot/Built-in silencer
R	External pilot
RS (Note)	External pilot/Built-in silencer

Note) When the built-in silencer type is used, keep the air outlet from coming in direct contact with water or other liquids.

### ⑦ Mounting

NII	Direct mounting
D	DIN rail mounting (With DIN rail)
D0	DIN rail mounting (Without DIN rail)
D3	For 3 stations
⋮	⋮
D20	For 20 stations

When a longer DIN rail is desired than the specified stations.  
(Specify a longer rail than the standard length.)

\* If the DIN rail must be mounted without an SI Unit, select "D0" and order the DIN rail separately. Refer to L3 of the dimensions for the DIN rail length. For the DIN rail part number, refer to page 123.

### ⑥ A, B port size (Metric size)

Symbol	A, B port	P, E port	Applicable series
C3	ø3.2 One-touch fitting	ø8	SV1000
C4	ø4 One-touch fitting		
C6	ø6 One-touch fitting		
C4	ø4 One-touch fitting	ø10	SV2000
C6	ø6 One-touch fitting		
C8	ø8 One-touch fitting		
C6	ø6 One-touch fitting	ø12	SV3000
C8	ø8 One-touch fitting		
C10	ø10 One-touch fitting		
M	A, B ports mixed		

\* In the case of mixed specifications (M), indicate separately on the manifold specification sheet.

\* The port sizes of X, PE ports for external pilot specifications (R, RS) are ø4 (millimeters) or ø5/32" (inches) for the SV1000/2000 series, and ø6 (millimeters) or ø1/4" (inches) for the SV3000 series.

### EX260 SI unit part no.

Symbol	Protocol	Number of outputs	Communication connector	SI unit part no.	
				+COM.	-COM.
QA	DeviceNet®	32	M12	EX260-SDN2	EX260-SDN1
QB		16		EX260-SDN4	EX260-SDN3
NA	PROFIBUS	32	M12	EX260-SPR2	EX260-SPR1
NB		16		EX260-SPR4	EX260-SPR3
NC		32		EX260-SPR6	EX260-SPR5
ND	D-sub	16	D-sub	EX260-SPR8	EX260-SPR7
VA		32		EX260-SMJ2	EX260-SMJ1
VB	CC-Link	16	M12	EX260-SMJ4	EX260-SMJ3

### A, B port size (Inch size)

Symbol	A, B port	P, E port	Applicable series
N1	ø1/8" One-touch fitting	ø5/16"	SV1000
N3	ø5/32" One-touch fitting		
N7	ø1/4" One-touch fitting		
N3	ø5/32" One-touch fitting	ø3/8"	SV2000
N7	ø1/4" One-touch fitting		
N9	ø5/16" One-touch fitting		
N7	ø1/4" One-touch fitting	ø3/8"	SV3000
N9	ø5/16" One-touch fitting		
N11	ø3/8" One-touch fitting		
M	A, B ports mixed		

### EX260 SI unit part no.

Symbol	Protocol	Number of outputs	Communication connector	SI unit part no.	
				+COM.	-COM.
DA	EtherCAT	32	M12	EX260-SEC2	EX260-SEC1
DB		16		EX260-SEC4	EX260-SEC3
FA	PROFINET	32	M12	EX260-SPN2	EX260-SPN1
FB		16		EX260-SPN4	EX260-SPN3
EA		32		EX260-SEN2	EX260-SEN1
EB	EtherNet/IP™	16	M12	EX260-SEN4	EX260-SEN3
GA	Ethernet	32	M12	—	EX260-SPL1
GB	POWERLINK	16		—	EX260-SPL3



## How to Order Manifold Assembly

### Example (SV1000)

Manifold

SS5V1-W10S1NAND-04B-C6 (1 set)

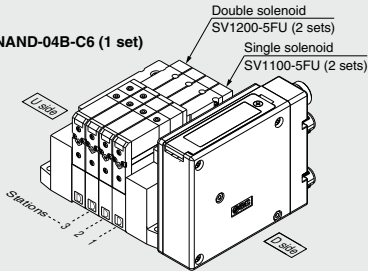

SS5V1-W10S1NAND-04B-C6 ..... 1 set (Manifold part no.)  
 \*SV1100-5FU ..... 2 sets (Single solenoid part no.)  
 \*SV1200-5FU ..... 2 sets (Double solenoid part no.)

## How to Order Valves

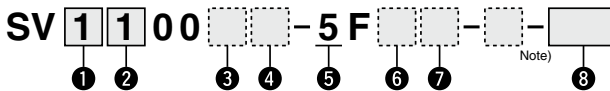

### 1 Series

1	SV1000
2	SV2000
3	SV3000

### 2 Type of actuation

1	2-position single
2	2-position double
3	3-position closed center
4	3-position exhaust center
5	3-position pressure center
A	4-position dual 3-port valve: N.C./N.C.
B	4-position dual 3-port valve: N.O./N.O.
C	4-position dual 3-port valve: N.C./N.O.

\* 4-position dual 3-port valves are applicable to the SV1000 and SV2000 series only.

### 3 Pilot type

NII	Internal pilot
R	External pilot

\* External pilot specifications is not available for 4-position dual 3-port valves.

### 4 Back pressure check valve

NII	None
K	Built-in

\* Built-in back pressure check valve type is applicable to the SV1000 series only.  
 \* Back pressure check valve is not available for 3-position valve.

Note) Refer to Specific Product Precautions 2 on page 136.

### 5 Rated voltage

5	24 VDC
---	--------

### 6 Light/Surge voltage suppressor

U	With light/surge voltage suppressor
R	With surge voltage suppressor

### 7 Manual override

NII: Non-locking push type

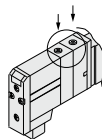

D: Push-turn locking slotted type

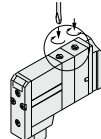

Note) Available with manifold block for station additions. Refer to page 119.

### 8 Made to Order

NII	—
X90	Main valve fluororubber (Refer to page 134.)

- Refer to the **Web Catalog** for the dimensions of single SI unit.
- Refer to the technical operation manual for details of SI unit.

## Dimensions: SV1000 Series for EX260 Integrated-type (For Output) Serial Transmission System

● Tie-rod base manifold: SS5V1-W10S1□□D-**Stations**  $\frac{U}{D}$  (S, R, RS)- $\frac{C3, N1}{C4, N3}$  (-D)  
 $\frac{C6, N7}{C6, N7}$

- When P, E port outlets are indicated on the U side or D side, the P, E ports on the opposite side are plugged.
- External pilot port positions and silencer discharge port positions are the same as P, E port outlet positions.

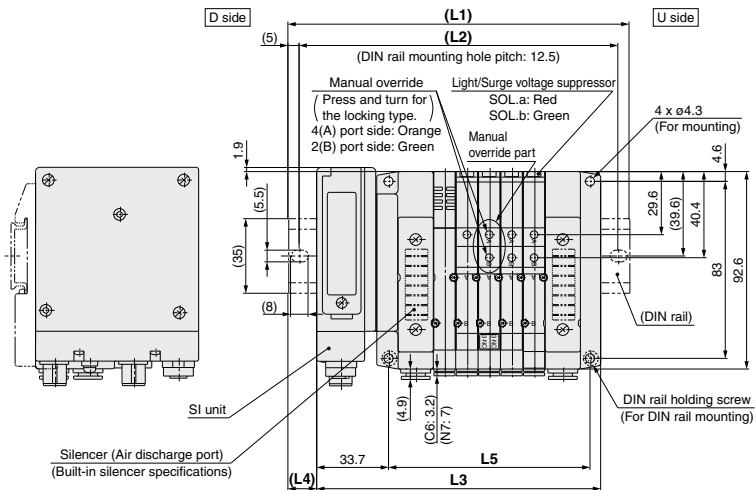

### [Communication connector D-sub]

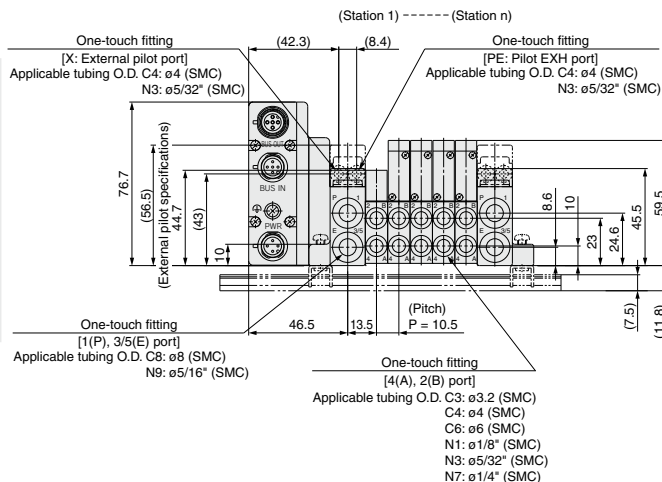
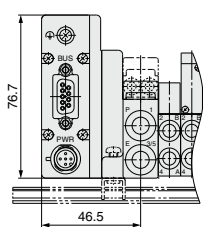

### L: DIN Rail Overall Length

L	n: Stations																			
	2	3	4	5	6	7	8	9	10	11	12	13	14	15	16	17	18	19	20	
L1	135.5	148	148	160.5	173	185.5	198	210.5	210.5	223	235.5	248	260.5	273	273	285.5	298	310.5	323	
L2	125	137.5	137.5	150	162.5	175	187.5	200	200	212.5	225	237.5	250	262.5	262.5	275	287.5	300	312.5	
L3	102.2	112.7	123.2	133.7	144.2	154.7	165.2	175.7	186.2	196.7	207.2	217.7	228.2	238.7	249.2	259.7	270.2	280.7	291.2	
L4	16.5	17.5	12.5	13.5	14.5	15.5	16.5	17.5	12	13	14	15	16	17	12	13	14	15	16	
L5	63	73.5	84	94.5	105	115.5	126	136.5	147	157.5	168	178.5	189	199.5	210	220.5	231	241.5	252	

**Dimensions: SV2000 Series for EX260 Integrated-type (For Output) Serial Transmission System**

● Tie-rod base manifold: SS5V2-W10S1□□D-**Stations**  $\frac{U}{D}$  (S, R, RS)- $\frac{C3, N3}{C6, N6}$  (-D)

- When P, E port outlets are indicated on the U side or D side, the P, E ports on the opposite side are plugged.
- External pilot port positions and silencer discharge port positions are the same as P, E port outlet positions.

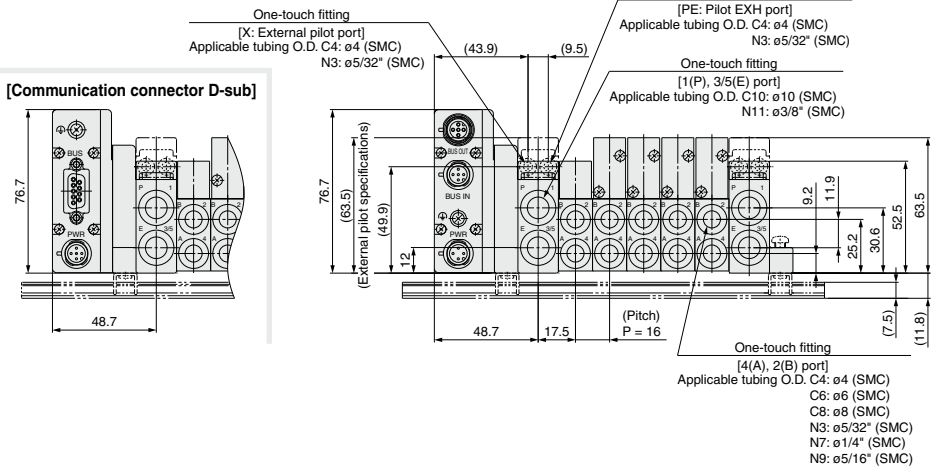
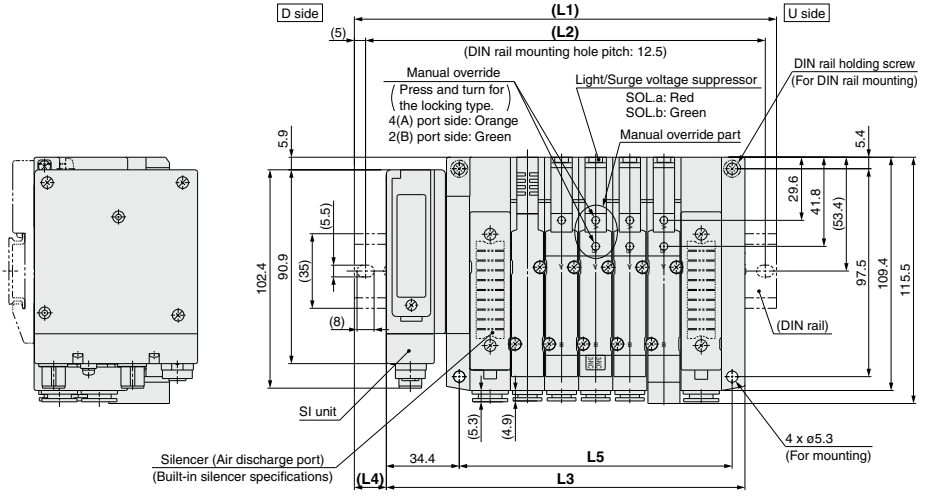

**L: DIN Rail Overall Length**

L	n: Stations																			
	2	3	4	5	6	7	8	9	10	11	12	13	14	15	16	17	18	19	20	
L1	148	160.5	185.5	198	210.5	235.5	248	260.5	273	298	310.5	323	335.5	360.5	373	385.5	410.5	423	435.5	
L2	137.5	150	175	187.5	200	225	237.5	250	262.5	287.5	300	312.5	325	350	362.5	375	400	412.5	425	
L3	120.2	136.2	152.2	168.2	184.2	200.2	216.2	232.2	248.2	264.2	280.2	296.2	312.2	328.2	344.2	360.2	376.2	392.2	408.2	
L4	14	12	16.5	15	13	17.5	16	14	12.5	17	15	13.5	11.5	16	14.5	12.5	17	15.5	13.5	
L5	80	96	112	128	144	160	176	192	208	224	240	256	272	288	304	320	336	352	368	

## Dimensions: SV3000 Series for EX260 Integrated-type (For Output) Serial Transmission System

### ● Tie-rod base manifold: SS5V3-W10S1□□□□D- $\frac{U}{D}$ Stations $\frac{U}{D}$ (S, R, RS)-C6, N7 C8, N9 C10, N11 (-D)

- When P, E port outlets are indicated on the U side or D side, the P, E ports on the opposite side are plugged.
- External pilot port positions and silencer discharge port positions are the same as P, E port outlet positions.

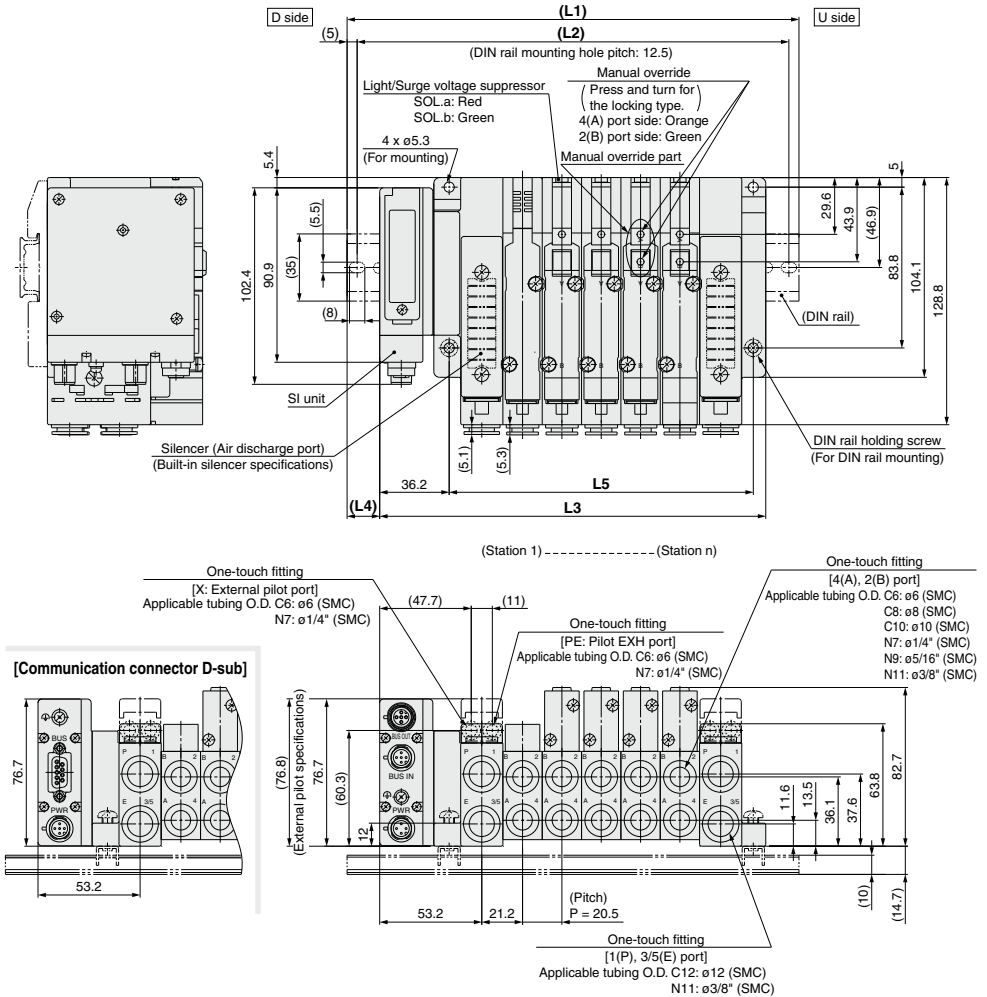

### L: DIN Rail Overall Length

L	n	2	3	4	5	6	7	8	9	10	11	12	13	14	15	16	17	18	19	20	n: Stations
L1	173	185.5	210.5	235.5	248	273	298	310.5	335.5	348	373	398	410.5	435.5	460.5	473	498	523	535.5		
L2	162.5	175	200	225	237.5	262.5	287.5	300	325	337.5	362.5	387.5	400	425	450	462.5	487.5	512.5	525		
L3	139.7	160.2	180.7	201.2	221.7	242.2	262.7	283.2	303.7	324.2	344.7	365.2	385.7	406.2	426.7	447.2	467.7	488.2	508.7		
L4	16.5	12.5	15	17	13	15.5	17.5	13.5	16	12	14	16.5	12.5	14.5	17	13	15	17.5	13.5		
L5	97	117.5	138	158.5	179	199.5	220	240.5	261	281.5	302	322.5	343	363.5	384	404.5	425	445.5	466		

# Integrated-type (For Output) Serial Transmission System

## **EX126 Series**

IP67 compliant

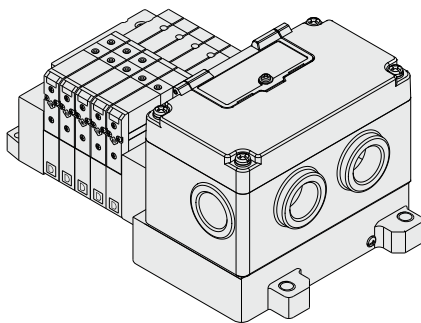

Applicable series	<b>Tie-rod base manifold</b> <b>SV1000/SV2000/SV3000</b>
-------------------	---

• Number of outputs points: 16 points
---------------------------------------

# EX126 Integrated-type (For Output) Serial Transmission System

# SV Series



## How to Order

### Tie-rod base

SS5V **1** - W 10S4   D-05 **U**   -   -  

#### Series

1	SV1000
2	SV2000
3	SV3000

#### Enclosure IP67 specifications

#### SI unit

0	Without SI unit and end plate
VW	CC-Link

- When the SI unit is not included, only the terminal block plate is included.

#### Mounting

Nil	Direct mounting
D	DIN rail mounting (With DIN rail)
D0*	DIN rail mounting (Without DIN rail)
D3	For 3 stations When a longer DIN rail is desired than the specified stations. (Specify a longer rail than the standard length.)
:	:
:	:
D16	For 16 stations

- \* In the case of D0, only DIN rail fittings are attached.

#### Valve stations

Symbol	Stations	Note
02	2 stations	Double wiring specifications (1)
:	:	
08	8 stations	
02	2 stations	Specified layout (2) (up to 16 solenoids possible.)
:	:	
16	16 stations	

Note 1) Double wiring specifications: Single, double, 3 position and 4 position solenoid valves can be used on all manifold stations. Use of a single solenoid will result in an unused control signal. If this is not desired, order with a specified layout.

Note 2) Specified layout: Indicate wiring specifications on a manifold specificationsheet. (Note that double, 3 and 4 position valves cannot be used where single solenoid wiring has been specified.)

#### SUP/EXH block assembly specifications

Nil	Internal pilot
S*	Internal pilot/Built-in silencer
R	External pilot
RS*	External pilot/Built-in silencer

Note) When the built-in silencer type is used, keep the exhaust port from coming in direct contact with water or other liquids.

#### SI Unit Part No.

Symbol	Protocol type	SI unit part no.
VW	CC-Link	EX126D-SMJ1

Refer to the **Web Catalog** and the Operation Manual for the details of the EX126 Integrated-type (For Output) Serial Transmission System.  
Please download the Operation Manual via our website, <https://www.smworld.com>.

#### P, E port location

U	U side (2 to 10 stations)
D	D side (2 to 10 stations)
B	Both sides (2 to 16 stations)

#### A, B port size (Metric)

Symbol	A, B port	P, E port	Applicable series
C3	One-touch fitting for ø3.2	One-touch fitting for ø4	SV1000
C4	One-touch fitting for ø4		
C6	One-touch fitting for ø6		
C4	One-touch fitting for ø4	One-touch fitting for ø10	SV2000
C6	One-touch fitting for ø6		
C8	One-touch fitting for ø8		
C6	One-touch fitting for ø6	One-touch fitting for ø12	SV3000
C8	One-touch fitting for ø8		
C10	One-touch fitting for ø10		
M	A, B ports mixed		

#### A, B port size (Inch)

Symbol	A, B port	P, E port	Applicable series
N1	One-touch fitting for ø1/8"	One-touch fitting for ø5/16"	SV1000
N3	One-touch fitting for ø5/32"		
N7	One-touch fitting for ø1/4"		
N3	One-touch fitting for ø5/32"	One-touch fitting for ø3/8"	SV2000
N7	One-touch fitting for ø1/4"		
N9	One-touch fitting for ø5/16"		
N7	One-touch fitting for ø1/4"	One-touch fitting for ø3/8"	SV3000
N9	One-touch fitting for ø5/16"		
N11	One-touch fitting for ø3/8"		
M	A, B ports mixed		

\* In the case of mixed specifications (M), indicate separately on the manifold specification sheet.

\* Port sizes of X, PE port for external pilot specification (R, RS) are ø4 (metric), ø5/32" (inch) for SV1000/2000 and ø6 (metric) and ø1/4" (inch) for SV3000.

## How to Order Manifold Assembly

### Ordering example (SV1000)

Manifold

SS5V1-W10S4VVD-05B-C6 (1 set)

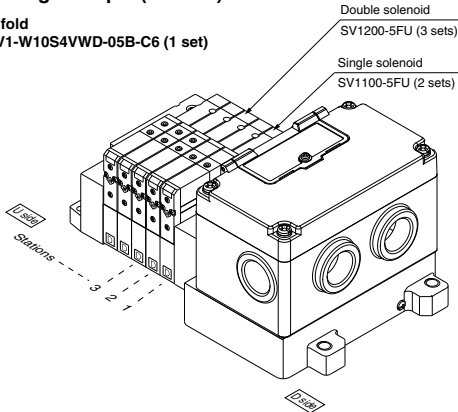

SS5V1-W10S4VVD-05B-C6 ..... 1 set (manifold part no.)  
\* SV1100-5FU ..... 2 sets (manifold part no.)  
\* SV1200-5FU ..... 3 sets (manifold part no.)

## How to Order Valve

SV 1 1 0 0 - 5 F - - -

**Series**

1	SV1000
2	SV2000
3	SV3000

**Type of actuation**

1	2 position single
2	2 position double
3	3 position closed center
4	3 position exhaust center
5	3 position pressure center
A	4 position dual 3 port valve: N.C./N.C.
B	4 position dual 3 port valve: N.O./N.O.
C	4 position dual 3 port valve: N.C./N.O.

\* 4 position dual 3 port valves are applicable to the SV1000 and SV2000 series only.

**Pilot type**

Nil	Internal pilot
R	External pilot

\* External pilot specifications is not available for 4 position dual 3 port valves.

**Back pressure check valve**

Nil	None
K	Built-in

\* Built-in back pressure check valve type is applicable to the SV1000 series only.  
\* Back pressure check valve is not available for 3 position valve.

**Rated voltage**

5	24 VDC
---	--------

Note) Available with manifold block for station additions. Refer to page 119.

**Made to Order**

Nil	-
X90	Main valve fluororubber (Refer to page 134.)

**Manual override**

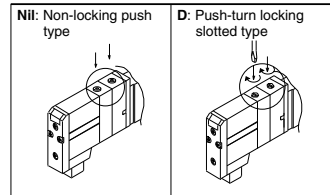

**Light/Surge voltage suppressor**

U	With light/surge voltage suppressor
R	With surge voltage suppressor

Note) Refer to Specific Product Precautions 2 on page 136.

## Dimensions: SV1000 Series for EX126 Integrated-type (For Output) Serial Transmission System

● Tie-rod base manifold : SS5V1-W10S4 □ D-<sup>U</sup>Stations<sub>0</sub>(S, R, RS)-<sup>C3, N1</sup><sub>C4, N3</sub><sup>C6, N7</sup>(-D)

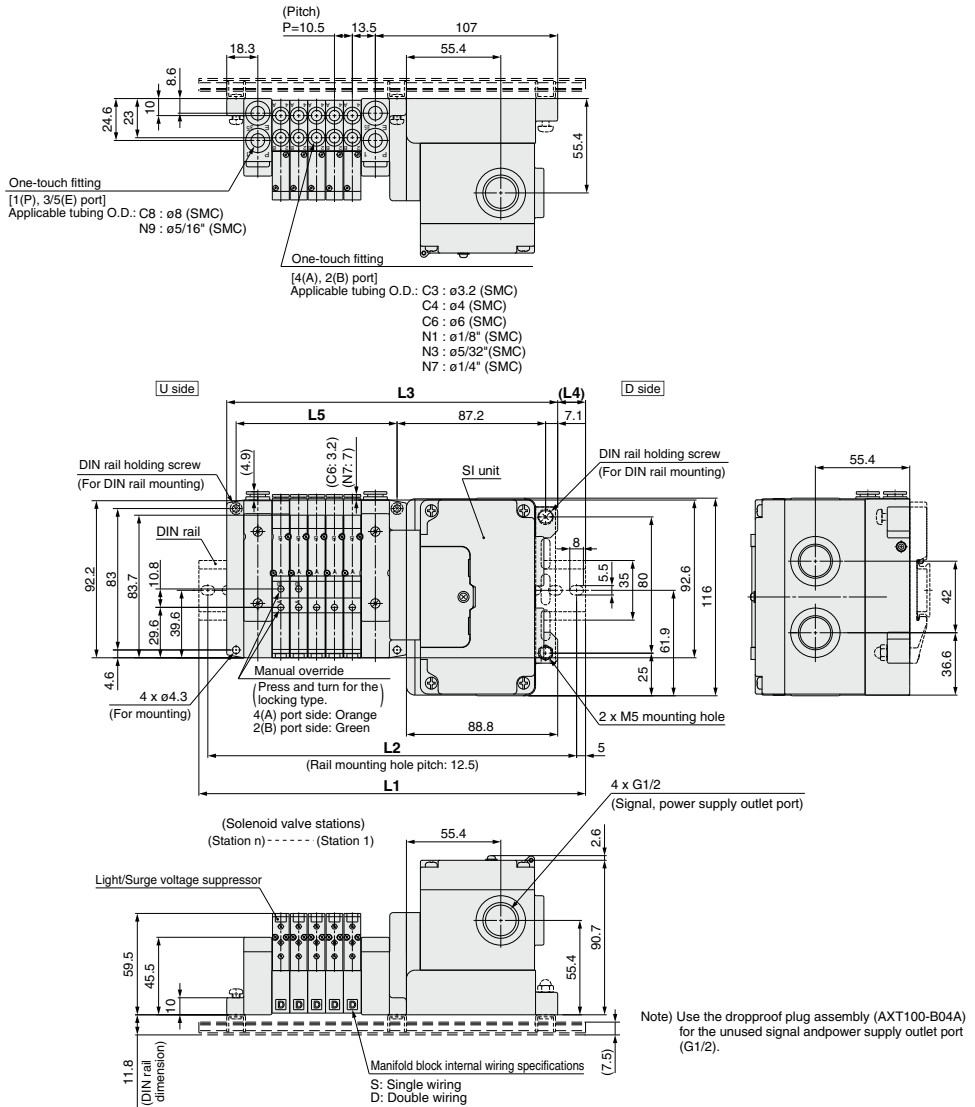

### L Dimension

n	2	3	4	5	6	7	8	9	10	11	12	13	14	15	16
L1	198	198	210.5	223	235.5	248	260.5	260.5	273	285.5	298	310.5	323	323	335.5
L2	187.5	187.5	200	212.5	225	237.5	250	250	262.5	275	287.5	300	312.5	312.5	325
L3	162.8	173.3	183.8	194.3	204.8	215.3	225.8	236.3	246.8	257.3	267.8	278.3	288.8	299.3	309.8
L4	17.5	12.5	13.5	14.5	15.5	16.5	17.5	12	13	14	15	16	17	12	13
L5	63	73.5	84	94.5	105	115.5	126	136.5	147	157.5	168	178.5	189	199.5	210



**Dimensions: SV2000 Series for EX126 Integrated-type (For Output) Serial Transmission System**

● Tie-rod base manifold : SS5V2-W10S4 □ D- Stations  $\frac{U}{D}$  (S, R, RS)  $\frac{C4, N3}{C6, N7}$  (N7, N9) (-D)

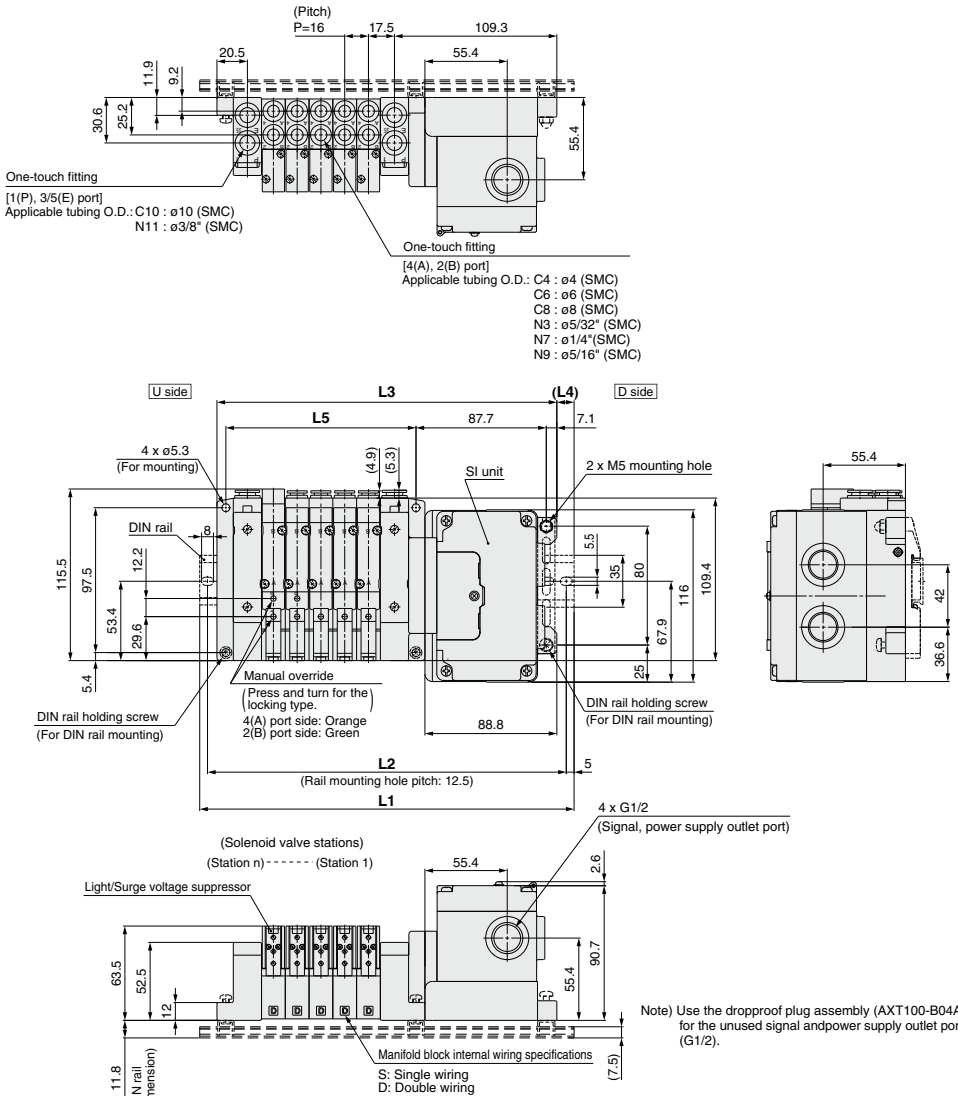

**L Dimension**

n	2	3	4	5	6	7	8	9	10	11	12	13	14	15	16
L1	210.5	223	248	260.5	273	285.5	310.5	323	335.5	348	373	385.5	398	423	435.5
L2	200	212.5	237.5	250	262.5	275	300	312.5	325	337.5	362.5	375	387.5	412.5	425
L3	180.8	196.8	212.8	228.8	244.8	260.8	276.8	292.8	308.8	324.8	340.8	356.8	372.8	388.8	404.8
L4	15	13	17.5	16	14	12.5	17	15	13.5	11.5	16	14.5	12.5	17	15.5
L5	80	96	112	128	144	160	176	192	208	224	240	256	272	288	304

n : Stations

## Dimensions: SV3000 Series for EX126 Integrated-type (For Output) Serial Transmission System

● Tie-rod base manifold : SS5V3-W10S4 □ D- $\frac{U}{B}$ -(Stations) $\frac{U}{B}$ (S, R, RS)- $\frac{C6, N7}{C8, N9}$ / $\frac{C10, N11}{C10, N11}$  (-D)

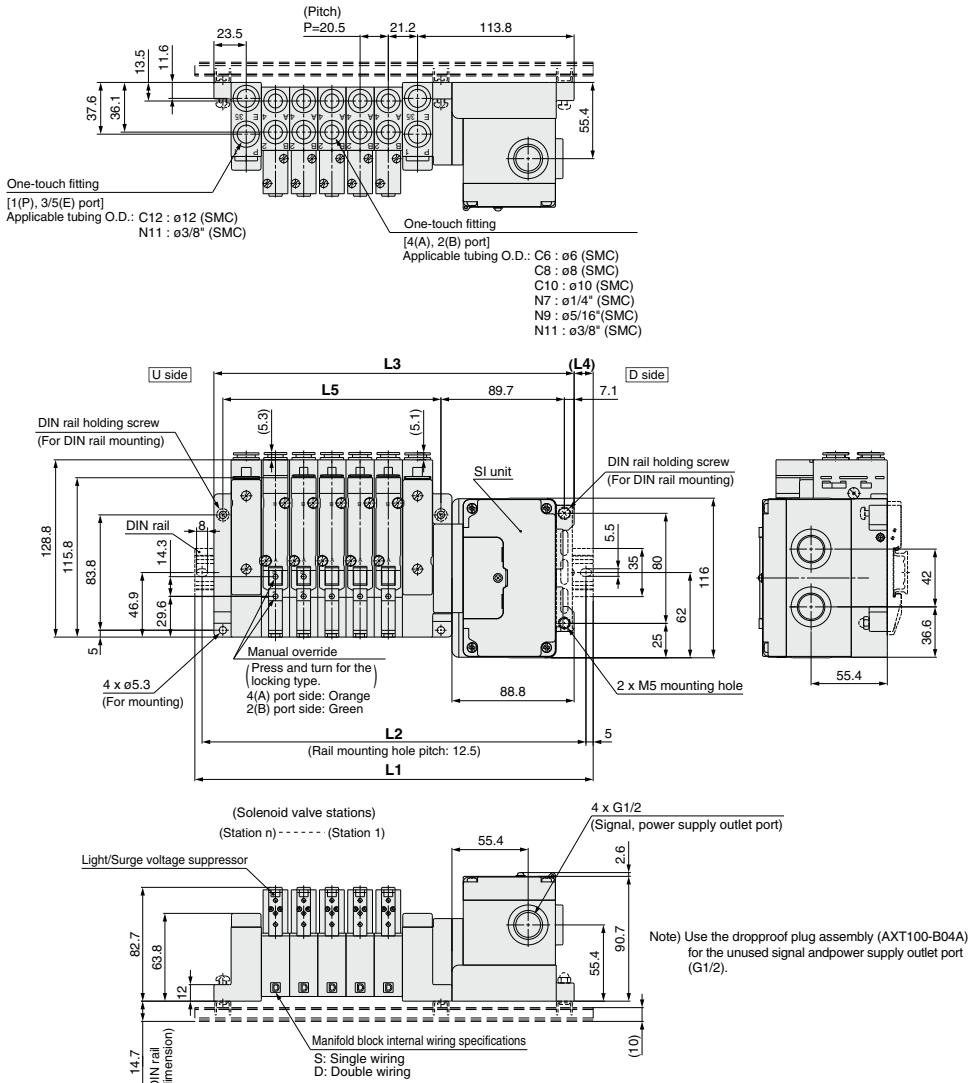

### L Dimension

n : Stations

n	2	3	4	5	6	7	8	9	10	11	12	13	14	15	16
L1	235.5	248	273	285.5	310.5	335.5	348	373	398	410.5	435.5	460.5	473	498	510.5
L2	225	237.5	262.5	275	300	325	337.5	362.5	387.5	400	425	450	462.5	487.5	500
L3	200.3	220.8	241.3	261.8	282.3	302.8	323.3	343.8	364.3	384.8	405.3	425.8	446.3	466.8	487.3
L4	17.5	13.5	16	12	14	16.5	12.5	14.5	17	13	15	17.5	13.5	15.5	11.5
L5	97	117.5	138	158.5	179	199.5	220	240.5	261	281.5	302	322.5	343	363.5	384

# Integrated-type (For Output) Serial Transmission System

## EX120 Series

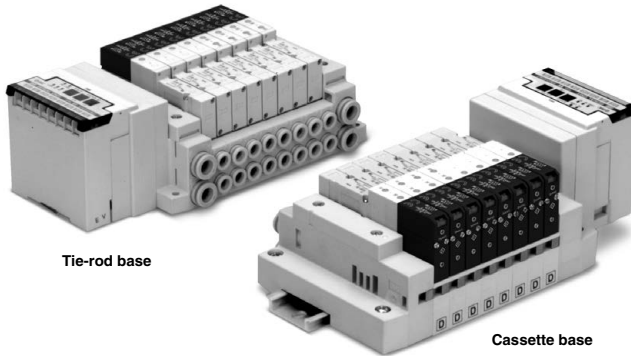

Tie-rod base

Cassette base

Applicable series

**Cassette base manifold  
SV1000/SV2000**

**Tie-rod base manifold  
SV1000/SV2000/SV3000/SV4000**

• Number of outputs points: 16 points

# EX120 Integrated-type (For Output) Serial Transmission System

# SV Series



## How to Order Manifold

### ● Tie-rod base

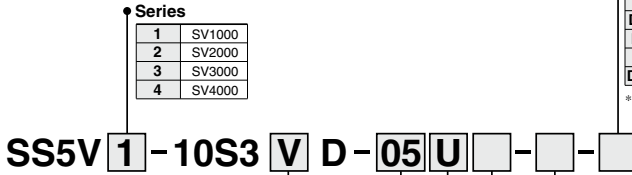

### ● Cassette base



Series

1	SV1000
2	SV2000

### SI Unit

Symbol	Specifications
0	Without SI unit
Q	DeviceNet®
R1	OMRON Corp.: CompoBus/S (16 output points)
R2	OMRON Corp.: CompoBus/S (8 output points)
V	CC-LINK
ZB (Note)	CompoNet® (Positive common)
ZBN (Note)	CompoNet® (Negative common)

Note) Communication connector (for the opposite side) is not provided, order it separately.

Symbol	Stations	Note
02	2 stations	(1) Double wiring specifications
∴	∴	
08	8 stations	
02	2 stations	(2) Specified layout (up to 16 solenoids possible.)
∴	∴	
16	16 stations	

● Since R2 type SI units have 8 outputs note that up to 8 solenoids can be accommodated.  
● This also includes the number of blanking plate assemblies.

Note 1) Double wiring specifications: Single, double, 3 position and 4 position solenoid valves can be used on all manifold stations. Use of a single solenoid will result in an unused control signal. If this is not desired, order with a specified layout.

Note 2) Specified layout: Indicate wiring specifications on a manifold specificationsheet. (Note that double, 3 and 4 position valves cannot be used where single solenoid wiring has been specified.)

### Valve stations

### Mounting

Nil	Direct mounting
D	DIN rail mounting (With DIN rail)
D0	DIN rail mounting (Without DIN rail)
D3	For 3 stations (When a longer DIN rail is desired than the specified stations. (Specify a longer rail than the standard length.)
D16	For 16 stations (Specify a longer rail than the standard length.)

\* In the case of D0, only DIN rail fittings are attached.

### DIN rail length specified

Nil	Standard length
3	For 3 stations (Specify a longer rail length.)
∴	∴
16	For 16 stations (Specify a longer rail length.)

### SUP/EXH block assembly specifications

Nil	Internal pilot
S	Internal pilot/Built-in silencer
R	External pilot
RS	External pilot/Built-in silencer

### P, E port location

U	U side (2 to 10 stations)
D	D side (2 to 10 stations)
B	Both sides (2 to 16 stations)

### SI Unit Part No.

Symbol	Protocol type	SI unit part no.
Q	DeviceNet®	EX120-SDN1
R1	OMRON Corp.: CompoBus/S (16 output points)	EX120-SCS1
R2	OMRON Corp.: CompoBus/S (8 output points)	EX120-SCS2
V	CC-LINK	EX120-SMJ1
ZB	CompoNet® (Positive common)	EX120-SCM1
ZBN	CompoNet® (Negative common)	EX120-SCM3

Refer to the **Web Catalog** and the Operation Manual for the details of EX120 Integrated-type (For Output) Serial Transmission System. Please download the Operation Manual via our website, <https://www.smcworld.com>.

### A, B port size (Metric)

Symbol	A, B port	P, E port	Applicable series
C3	One-touch fitting for ø3.2	One-touch fitting for ø8	SV1000
C4	One-touch fitting for ø4		
C6	One-touch fitting for ø6	One-touch fitting for ø10	SV2000
C8	One-touch fitting for ø8		
C8	One-touch fitting for ø8	One-touch fitting for ø12	SV3000
C10	One-touch fitting for ø10		
C10	One-touch fitting for ø10	One-touch fitting for ø12	SV4000
C12	One-touch fitting for ø12		
02	Rc 1/4	Rc 3/8	
03	Rc 3/8		
02F	G 1/4	G 3/8	
03F	G 3/8		
M	A, B ports mixed		

### A, B port size (Inch)

Symbol	A, B port	P, E port	Applicable series
N1	One-touch fitting for ø1/8"	One-touch fitting for ø5/16"	SV1000
N3	One-touch fitting for ø5/32"		
N7	One-touch fitting for ø1/4"	One-touch fitting for ø3/8"	SV2000
N3	One-touch fitting for ø5/32"		
N7	One-touch fitting for ø1/4"	One-touch fitting for ø3/8"	SV3000
N9	One-touch fitting for ø5/16"		
N7	One-touch fitting for ø1/4"	One-touch fitting for ø3/8"	SV4000
N9	One-touch fitting for ø5/16"		
N11	One-touch fitting for ø3/8"	One-touch fitting for ø3/8"	
N11	One-touch fitting for ø3/8"		
02N	NPT 1/4	NPT 3/8	
03N	NPT 3/8		
02T	NPTF 1/4	NPTF 3/8	
03T	NPTF 3/8		
M	A, B ports mixed		

\* In the case of mixed specifications (M), indicate separately on the manifold specification sheet.

\* Port sizes of X, PE port for external pilot specification (R, RS) are ø4 (metric), ø5/32" (inch) for SV1000/2000 and ø6 (metric) and ø1/4" (inch) for SV3000/4000.

## How to Order Manifold Assembly

### Ordering example (SV1000)

Manifold  
SS5V1-16S3AD-06B-C6 (1 set)

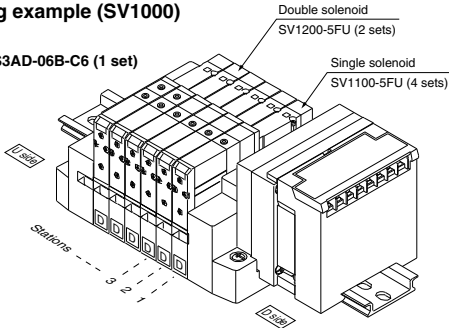

SS5V1-16S3CD-06B-C6 ..... 1 set (manifold part no.)  
 \* SV1100-5FU ..... 4 sets (Single solenoid part no.)  
 \* SV1200-5FU ..... 2 sets (Double solenoid part no.)

## How to Order Solenoid Valves

SV 1 1 00 - 5 F - [ ] - [ ] (Note)

### Series

1	SV1000
2	SV2000
3	SV3000
4	SV4000

### Type of actuation

1	2 position single
2	2 position double
3	3 position closed center
4	3 position exhaust center
5	3 position pressure center
A	4 position dual 3 port valve: N.C./N.C.
B	4 position dual 3 port valve: N.O./N.O.
C	4 position dual 3 port valve: N.C./N.O.

\* 4 position dual 3 port valves are applicable to the SV1000 and SV2000 series only.

### Pilot type

Nil	Internal pilot
R	External pilot

\* External pilot specifications is not available for 4 position dual 3 port valves.

Note) Available with manifold block for station additions. Refer to pages 113 and 119.

### Made to Order

Nil	—
X90	Main valve fluoro rubber (Refer to page 134.)

### Manual override

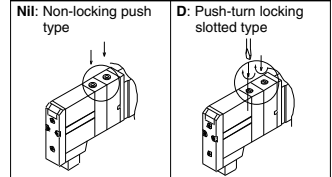

### Light/Surge voltage suppressor

U	With light/surge voltage suppressor
R	With surge voltage suppressor

### Rated voltage

5	24 VDC
---	--------

### Back pressure check valve

Nil	None
K	Built-in

\* Built-in back pressure check valve type is applicable to the SV1000 series only.  
 \* Back pressure check valve is not available for 3 position Valve.

Note) Refer to Specific Product Precautions 2 on page 136.

## Dimensions: SV1000 Series for EX120 Integrated-type (For Output) Serial Transmission System

● Cassette base manifold : SS5V1-16S3 □ D- Stations  $\frac{U}{D}$  (S, R, RS)  $\frac{C3, N1}{C4, N3}$   $\frac{C6, N7}{C6, N7}$

- When P, E port outlets are indicated on the U side or D side, the P, E ports on the opposite side are plugged.
- External pilot port positions and silencer discharge port positions are the same as P, E port outlet positions.

### With External Pilot Specifications

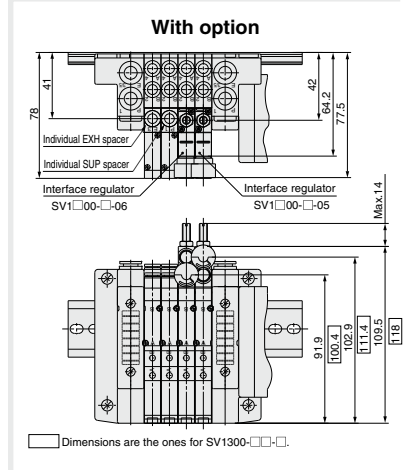
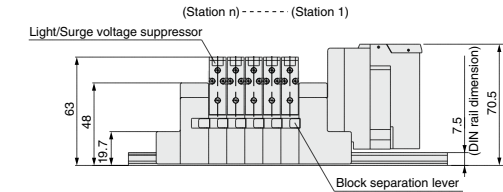
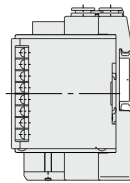
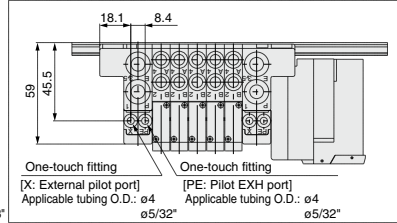
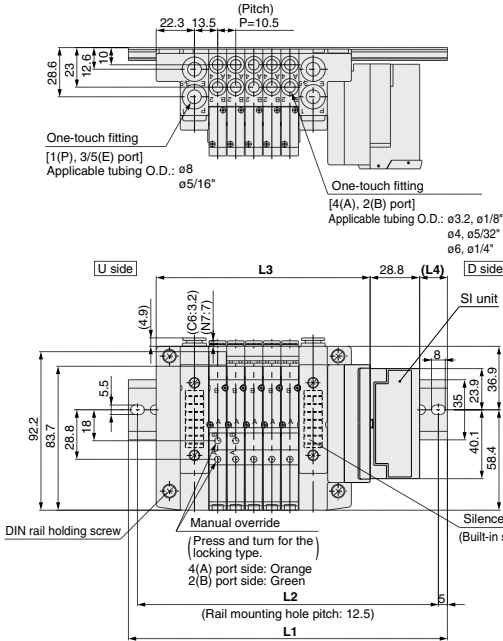

### L Dimension

	n : Stations															
$\frac{L}{n}$	2	3	4	5	6	7	8	9	10	11	12	13	14	15	16	
L1	148	160.5	173	185.5	198	198	210.5	223	235.5	248	260.5	260.5	273	285.5	298	
L2	137.5	150	162.5	175	187.5	187.5	200	212.5	225	237.5	250	250	262.5	275	287.5	
L3	92.9	103.4	113.9	124.4	134.9	145.4	155.9	166.4	176.9	187.4	197.9	208.4	218.9	229.4	239.9	
L4	13	14	15	16	17	12	13	14	15	16	17	11.5	12.5	13.5	14.5	

**Dimensions: SV2000 Series for EX120 Integrated-type (For Output) Serial Transmission System**

● Cassette base manifold : SS5V2-16S3 □ D- Stations  $\frac{U}{D}$  (S, R, RS)  $\frac{C4, N3}{C6, N7}$   $\frac{C8, N9}{C8, N9}$

- When P, E port outlets are indicated on the U side or D side, the P, E ports on the opposite side are plugged.
- External pilot port positions and silencer discharge port positions are the same as P, E port outlet positions.

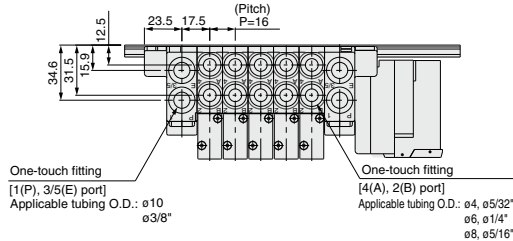

**With External Pilot Specifications**

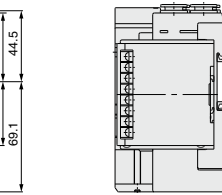
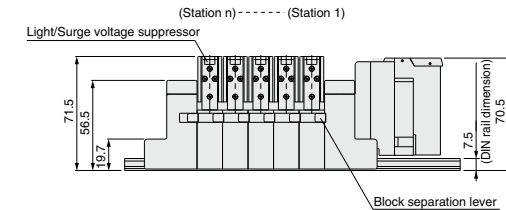
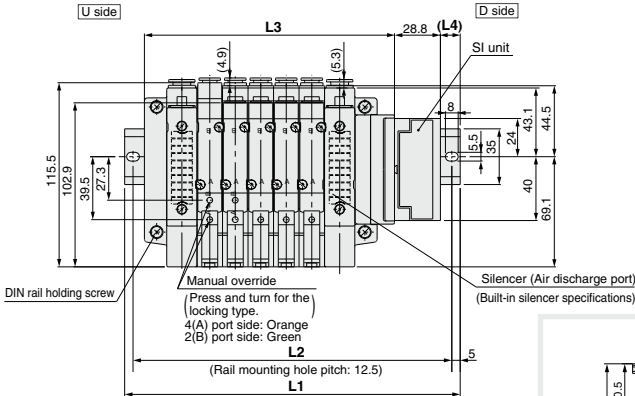
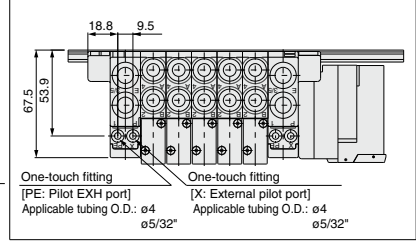

**With option**

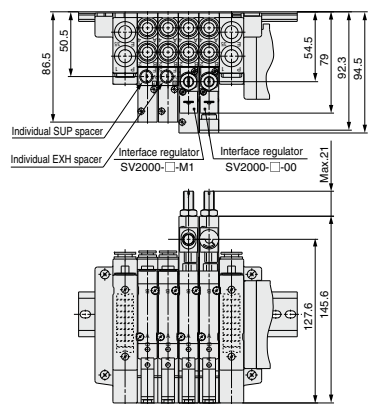

**L Dimension**

n : Stations

n	2	3	4	5	6	7	8	9	10	11	12	13	14	15	16
L1	173	185.5	198	210.5	235.5	248	260.5	273	298	310.5	323	348	360.5	373	385.5
L2	162.5	175	187.5	200	225	237.5	250	262.5	287.5	300	312.5	337.5	350	362.5	375
L3	108.9	124.9	140.9	156.9	172.9	188.9	204.9	220.9	236.9	252.9	268.9	284.9	300.9	316.9	332.9
L4	17.5	16	14	12.5	17	15	13.5	11.5	16	14.5	12.5	17	15.5	13.5	12

# SV Series

## Dimensions: SV1000 Series for EX120 Integrated-type (For Output) Serial Transmission System

### ● Tie-rod base manifold : SS5V1-10S3 □ D- Stations $\frac{U}{D}$ (S, R, RS)- $\frac{C3, N1}{C6, N7}$ (-D)

- When P, E port outlets are indicated on the U side or D side, the P, E ports on the opposite side are plugged.
- External pilot port positions and silencer discharge port positions are the same as P, E port outlet positions.

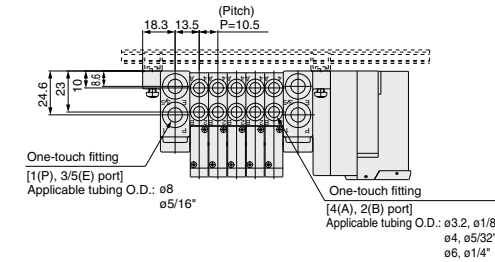

### With External Pilot Specifications

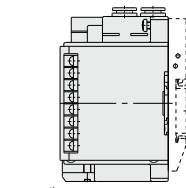
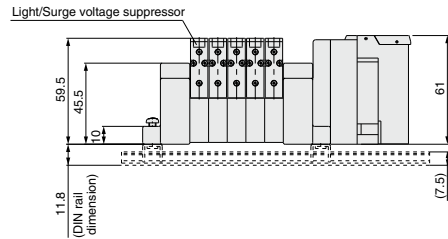
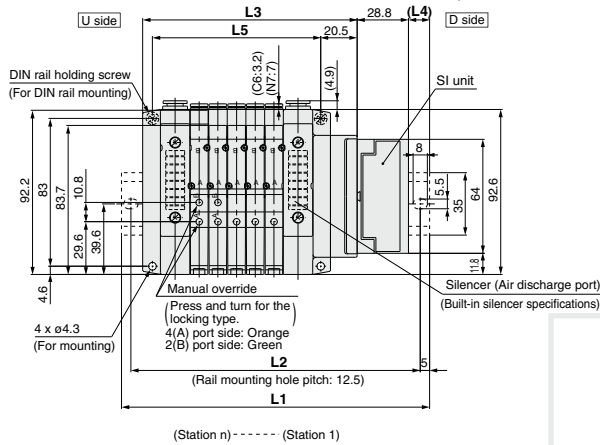
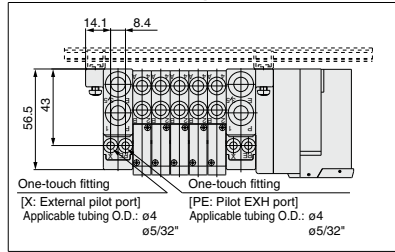

### With option

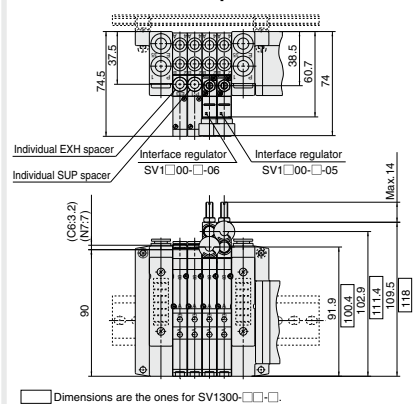

### L Dimension

n : Stations

L \ n	2	3	4	5	6	7	8	9	10	11	12	13	14	15	16
L1	148	160.5	173	173	185.5	198	210.5	223	235.5	235.5	248	260.5	273	285.5	298
L2	137.5	150	162.5	162.5	175	187.5	200	212.5	225	225	237.5	250	262.5	275	287.5
L3	89	99.5	110	120.5	131	141.5	152	162.5	173	183.5	194	204.5	215	225.5	236
L4	15	16	17	12	13	14	15	16	17	11.5	12.5	13.5	14.5	15.5	16.5
L5	63	73.5	84	94.5	105	115.5	126	136.5	147	157.5	168	178.5	189	199.5	210



**Dimensions: SV2000 Series for EX120 Integrated-type (For Output) Serial Transmission System**

● Tie-rod base manifold : SS5V2-10S3□D-(Stations)<sub>U</sub><sub>B</sub>(S, R, RS)<sup>C4, N3</sup><sub>C8, N7</sub><sup>C4, N3</sup><sub>C8, N9</sub>(-D)

- When P, E port outlets are indicated on the U side or D side, the P, E ports on the opposite side are plugged.
- External pilot port positions and silencer discharge port positions are the same as P, E port outlet positions.

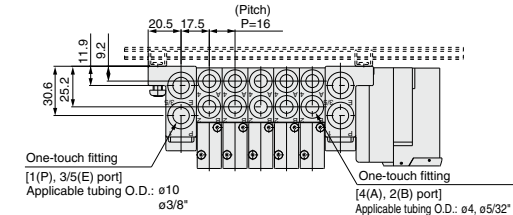

**With External Pilot Specifications**

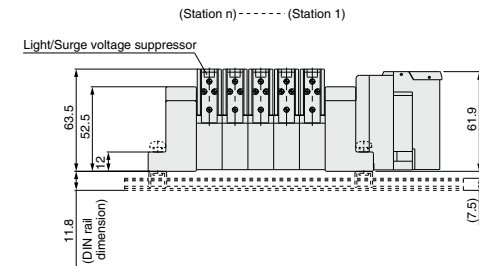
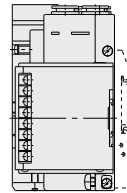
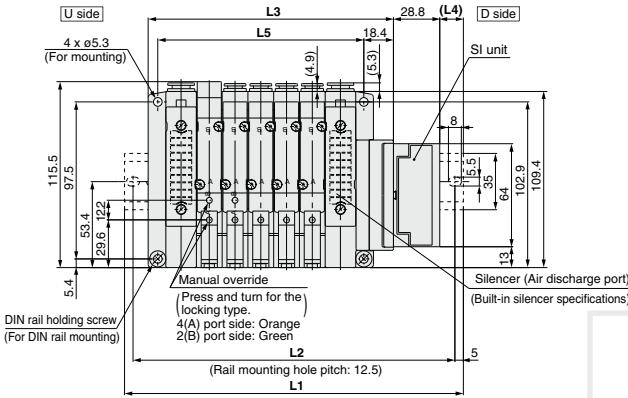
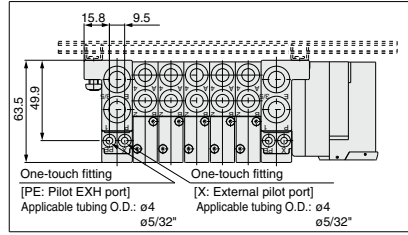

**With option**

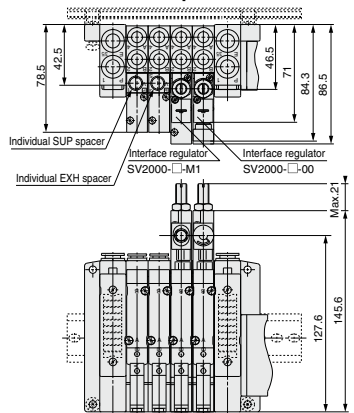

**L Dimension**

n : Stations

L \ n	2	3	4	5	6	7	8	9	10	11	12	13	14	15	16
L1	160.5	173	198	210.5	223	248	260.5	273	285.5	310.5	323	335.5	360.5	373	385.5
L2	150	162.5	187.5	200	212.5	237.5	250	262.5	275	300	312.5	325	350	362.5	375
L3	104.4	120.4	136.4	152.4	168.4	184.4	200.4	216.4	232.4	248.4	264.4	280.4	296.4	312.4	328.4
L4	13.5	12	16.5	14.5	13	17.5	15.5	14	12	16.5	15	13	17.5	16	14
L5	80	96	112	128	144	160	176	192	208	224	240	256	272	288	304

# SV Series

## Dimensions: SV3000 Series for EX120 Integrated-type (For Output) Serial Transmission System

### ● Tie-rod base manifold : SS5V3-10S3 □ D- Stations $\frac{U}{D}$ (S, R, RS) $\frac{C6, N7}{C10, N6, N11}$ (-D)

- When P, E port outlets are indicated on the U side or D side, the P, E ports on the opposite side are plugged.
- External pilot port positions and silencer discharge port positions are the same as P, E port outlet positions.

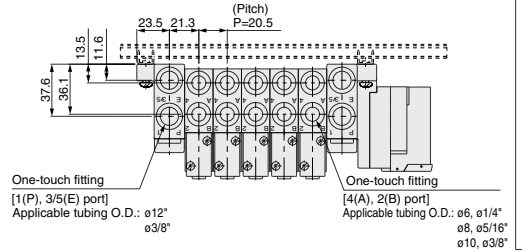

### With External Pilot Specifications

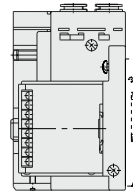
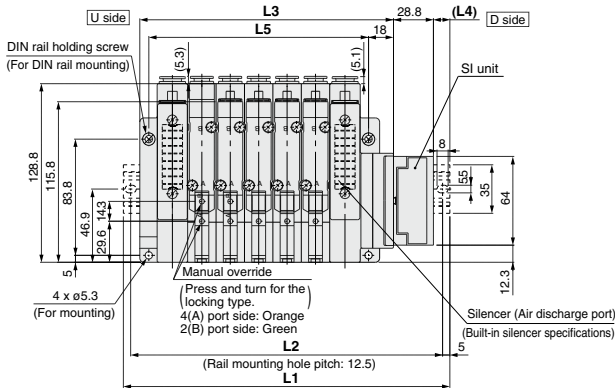
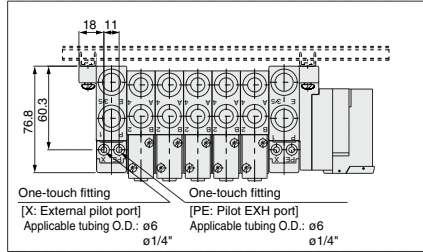

### With option

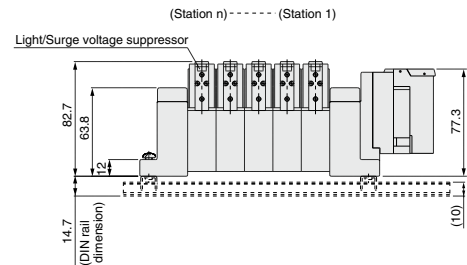
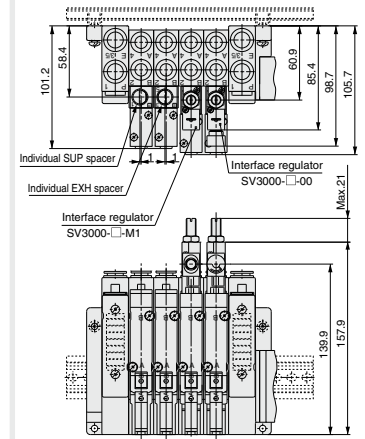

### L Dimension

L	2	3	4	5	6	7	8	9	10	11	12	13	14	15	16
L1	185.5	198	223	235.5	260.5	285.5	298	323	348	360.5	385.5	410.5	423	448	460.5
L2	175	187.5	212.5	225	250	275	287.5	312.5	337.5	350	375	400	412.5	437.5	450
L3	121.5	142	162.5	183	203.5	224	244.5	265	285.5	306	326.5	347	367.5	388	408.5
L4	17.5	13.5	16	12	14	16.5	12.5	14.5	17	13	15	17.5	13.5	15.5	11.5
L5	97	117.5	138	158.5	179	199.5	220	240.5	261	281.5	302	322.5	343	363.5	384

n : Stations

**Dimensions: SV4000 Series for EX120 Integrated-type (For Output) Serial Transmission System**

● Tie-rod base manifold : SS5V4-10S3 □ D- $\left[ \begin{matrix} \text{Stations} \\ \text{S, R, RS} \end{matrix} \right]_{\text{B}}^{\text{U}}$  (S, R, RS)  $\left[ \begin{matrix} \text{C8, N8, C10, N11} \\ \text{C12} \end{matrix} \right]_{\text{B}}^{\text{U}}$  (-D)

- When P, E port outlets are indicated on the U side or D side, the P, E ports on the opposite side are plugged.
- External pilot port positions and silencer discharge port positions are the same as P, E port outlet positions.

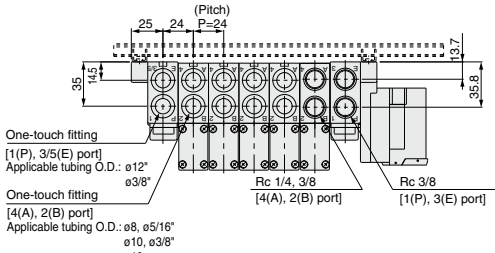

**With External Pilot Specifications**

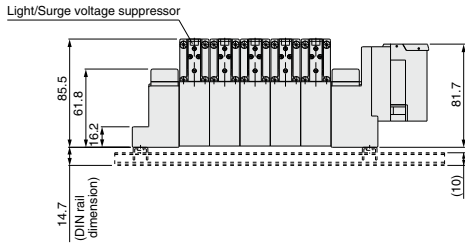
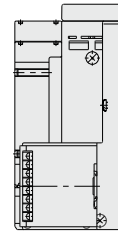
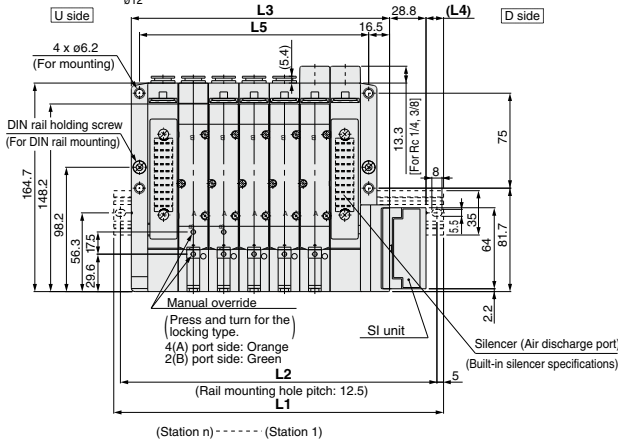
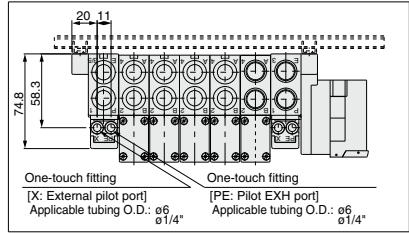

**With option**

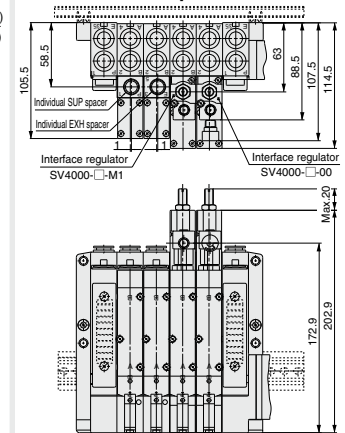

**L Dimension**

n : Stations

L \ n	2	3	4	5	6	7	8	9	10	11	12	13	14	15	16
L1	185.5	210.5	235.5	260.5	285.5	310.5	335.5	360.5	385.5	410.5	435.5	448	473	498	523
L2	175	200	225	250	275	300	325	350	375	400	425	437.5	462.5	487.5	512.5
L3	132	156	180	204	228	252	276	300	324	348	372	396	420	444	468
L4	12.5	13	13.5	14	14.5	15	15.5	16	16.5	17	17.5	11.5	12	12.5	13
L5	109	133	157	181	205	229	253	277	301	325	349	373	397	421	445



# Circular Connector

IP67 compliant

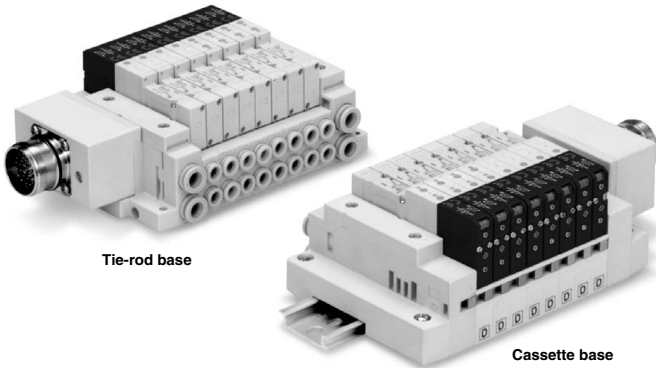

Applicable series	<b>Cassette base manifold SV1000/SV2000</b>
	<b>Tie-rod base manifold SV1000/SV2000/SV3000/SV4000</b>
• Number of connectors: 26 pins	

# Circular Connector SV Series



## How to Order Manifold

Note 1) Double wiring specifications: Single, double, 3 position and 4 position solenoid valves can be used at all of the manifold stations. Use of a single solenoid will result in an unused control signal. If this is not desired, order with a specified layout.  
 Note 2) Specified layout: Indicate wiring specifications on the manifold specification sheet. (Note that double, 3 and 4 position valves cannot be used where single solenoid wiring has been specified.)

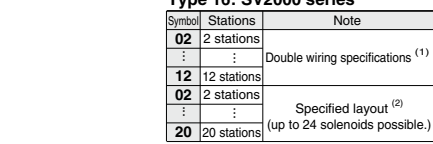
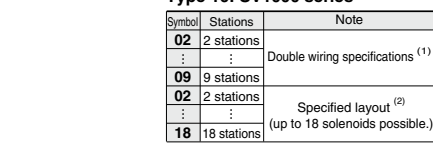
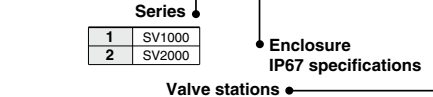
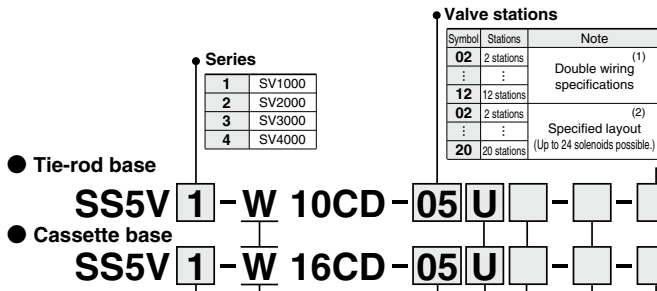

Note 1) Double wiring specifications: Single, double, 3 position and 4 position solenoid valves can be used at all of the manifold stations. Use of a single solenoid will result in an unused control signal. If this is not desired, order with a specified layout.  
 Note 2) Specified layout: Indicate wiring specifications on the manifold specification sheet. (Note that double, 3 and 4 position valves cannot be used where single solenoid wiring has been specified.)

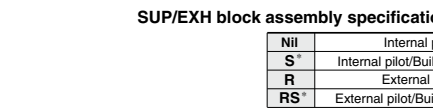

Note) When the built-in silencer type is used, keep the exhaust port from coming in direct contact with water or other liquids.

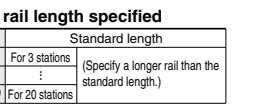
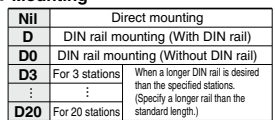

**A, B port size (Metric)**

Symbol	Specifications	P, E port	Applicable series
C3	One-touch fitting for ø3.2	One-touch fitting for ø8	SV1000
C4	One-touch fitting for ø4		
C6	One-touch fitting for ø6		
C4	One-touch fitting for ø4	One-touch fitting for ø10	SV2000
C6	One-touch fitting for ø6		
C8	One-touch fitting for ø8		
C6	One-touch fitting for ø6	One-touch fitting for ø12	SV3000
C8	One-touch fitting for ø8		
C10	One-touch fitting for ø10		
C8	One-touch fitting for ø8	One-touch fitting for ø12	SV4000
C10	One-touch fitting for ø10		
C12	One-touch fitting for ø12		
02	Rc 1/4	Rc 3/8	SV4000
03	Rc 3/8		
02F	G 1/4		
03F	G 3/8	G 3/8	
M	A, B ports mixed		

**A, B port size (Inch)**

Symbol	Specifications	P, E port	Applicable series
N1	One-touch fitting for ø1/8"	One-touch fitting for ø5/16"	SV1000
N3	One-touch fitting for ø5/32"		
N7	One-touch fitting for ø1/4"		
N3	One-touch fitting for ø5/32"	One-touch fitting for ø3/8"	SV2000
N7	One-touch fitting for ø1/4"		
N9	One-touch fitting for ø5/16"		
N7	One-touch fitting for ø1/4"	One-touch fitting for ø3/8"	SV3000
N9	One-touch fitting for ø5/16"		
N11	One-touch fitting for ø3/8"		
N9	One-touch fitting for ø5/16"	One-touch fitting for ø3/8"	SV4000
N11	One-touch fitting for ø3/8"		
02N	NPT 1/4		
03N	NPT 3/8	NPT 3/8	
02T	NPTF 1/4	NPTF 3/8	
03T	NPTF 3/8		
M	A, B ports mixed		

\* In the case of mixed specifications (M), indicate separately on the manifold specification sheet.  
 \* Port sizes of X, PE port for external pilot specification (R, RS) are ø4(metric), ø5/32"(inch) for SV1000/2000 and ø6 (metric) and ø1/4"(inch) for SV3000/4000.

## How to Order Manifold Assembly

### Ordering example (SV1000)

Manifold  
SS5V1-W16CD-06B-C6 (1 set)

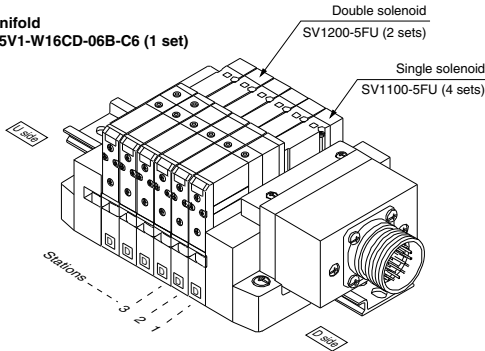

SS5V1-W16CD-06B-C6.....1 set (Manifold part no.)  
\* SV1100-5FU.....4 sets (Single solenoid part no.)  
\* SV1200-5FU.....2 sets (Double solenoid part no.)

## How to Order Solenoid Valves

SV 1 1 0 0 - 5 F - - -

Series ●

1	SV1000
2	SV2000
3	SV3000
4	SV4000

Type of actuation ●

1	2 position single
2	2 position double
3	3 position closed center
4	3 position exhaust center
5	3 position pressure center
A	4 position dual 3 port valve: N.C./N.C.
B	4 position dual 3 port valve: N.O./N.O.
C	4 position dual 3 port valve: N.C./N.O.

\* 4 position dual 3 port valves are applicable to the SV1000 and SV2000 series only.

Pilot type ●

Nil	Internal pilot
R	External pilot

\* External pilot specifications is not available for 4 position dual 3 port valves.

Back pressure check valve ●

Nil	None
K	Built-in

\* Built-in back pressure check valve type is applicable to the SV1000 series only.  
\* Back pressure check valve is not available for 3 position valve.

Rated voltage ●

5	24 VDC
6	12 VDC

Note)

Note) Available with manifold block for station additions. Refer to pages 113 and 119.

Made to Order ●

Nil	—
X90	Main valve fluororubber (Refer to page 134.)

Manual override ●

Nil: Non-locking push type

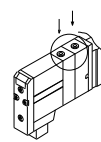

D: Push-turn locking slotted type

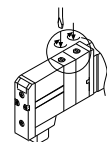

Light/Surge voltage suppressor ●

U	With light/surge voltage suppressor
R	With surge voltage suppressor

Note) Refer to Specific Product Precautions 2 on page 136.

## Manifold Electrical Wiring

10C/16C Circular Connector Type (26 pins)		
	Terminal no.	Polarity
Station 1	SOL_01	(-) (+)
	SOL_02	(-) (+)
Station 2	SOL_03	(-) (+)
	SOL_04	(-) (+)
Station 3	SOL_05	(-) (+)
	SOL_06	(-) (+)
Station 4	SOL_07	(-) (+)
	SOL_08	(-) (+)
Station 5	SOL_09	(-) (+)
	SOL_10	(-) (+)
Station 6	SOL_11	(-) (+)
	SOL_12	(-) (+)
Station 7	SOL_13	(-) (+)
	SOL_14	(-) (+)
Station 8	SOL_15	(-) (+)
	SOL_16	(-) (+)
Station 9	SOL_17	(-) (+)
	SOL_18	(-) (+)
Station 10	SOL_19	(-) (+)
	SOL_20	(-) (+)
Station 11	SOL_21	(-) (+)
	SOL_22	(-) (+)
Station 12	SOL_23	(-) (+)
	SOL_24	(-) (+)
	COM_25	(+) (-)
	COM_26	(+) (-)

Positive common specification      Negative common specification

- This circuit has double wiring specifications for up to 12 stations. Since the usable number of solenoids differs depending on the manifold type, refer to the table below. In the case of single solenoids, connect to SOL\_ A. Furthermore, when wiring is specified on a manifold specification sheet, connections are made without skipping any connectors, and connections are made without skipping any connectors, and signals A for single and A, B for double are in order 1→2 → 3 → 4, etc.
- Stations are counted from D side (connector side) as the 1st.
- Since solenoid valves do not have polarity, either the +COM or -COM can be used.

### Usable No. of Solenoids

Model		Max. no. of solenoids
Tie-rod base type 10	SV1000	24
	to SV4000	
Cassette base type 16	SV1000	18
	SV2000	24



**Dimensions: SV1000 Series for Circular Connector**

● **Cassette base manifold: SS5V1-W16CD-(Stations)  $\frac{U}{D}$  (S, R, RS)-** C3, N1  
C4, N3  
C5, N7

- When P, E port outlets are indicated on the U side or D side, the P, E ports on the opposite side are plugged.
- External pilot port positions and silencer discharge port positions are the same as P, E port outlet positions.

**With External Pilot Specifications**

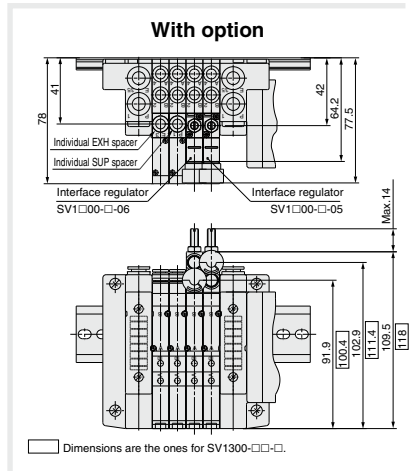
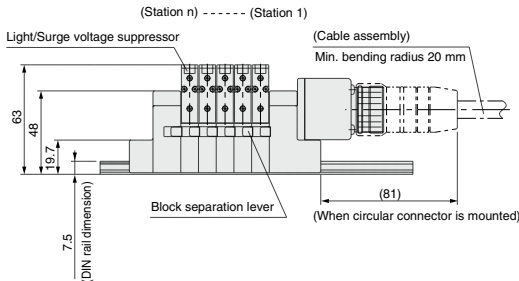
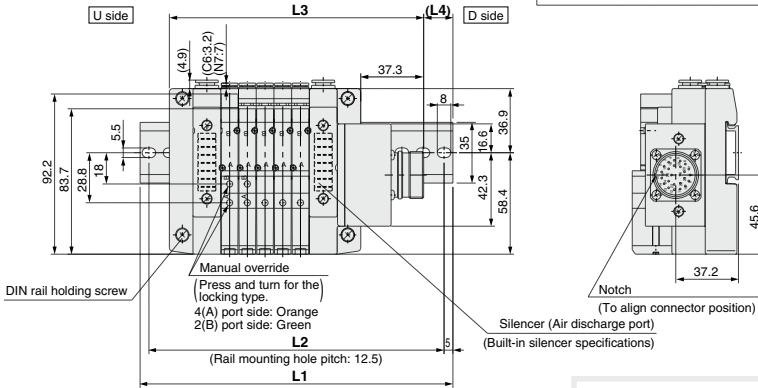
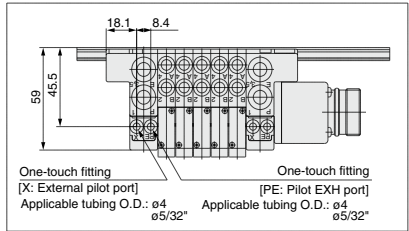
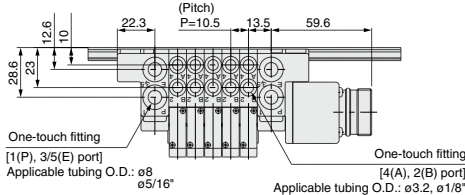

**L Dimension**

n	2	3	4	5	6	7	8	9	10	11	12	13	14	15	16	17	18
L1	148	160.5	173	185.5	185.5	198	210.5	223	235.5	248	248	260.5	273	285.5	298	310.5	310.5
L2	137.5	150	162.5	175	175	187.5	200	212.5	225	237.5	237.5	250	262.5	275	287.5	300	300
L3	119.3	129.8	140.3	150.8	161.3	171.8	182.3	192.8	203.3	213.8	224.3	234.8	245.3	255.8	266.3	276.8	287.3
L4	14.5	15.5	16.5	17.5	12	13	14	15	16	17	12	13	14	15	16	17	11.5

## Dimensions: SV2000 Series for Circular Connector

### ● Cassette base manifold: SS5V2-W16CD-(Stations) $\frac{U}{D}$ (S, R, RS)- C4, N3 C6, N7 C8, N9

- When P, E port outlets are indicated on the U side or D side, the P, E ports on the opposite side are plugged.
- External pilot port positions and silencer discharge port positions are the same as P, E port outlet positions.

#### With External Pilot Specifications

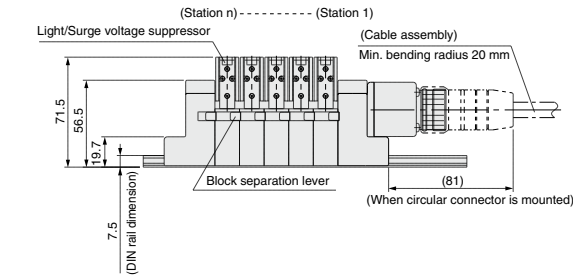
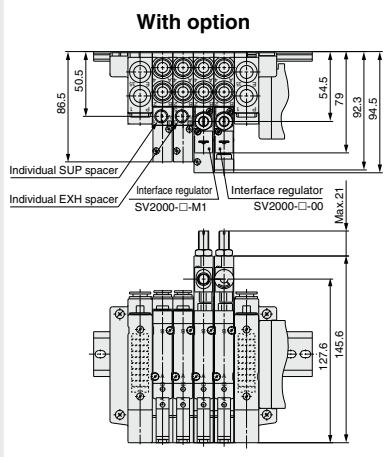
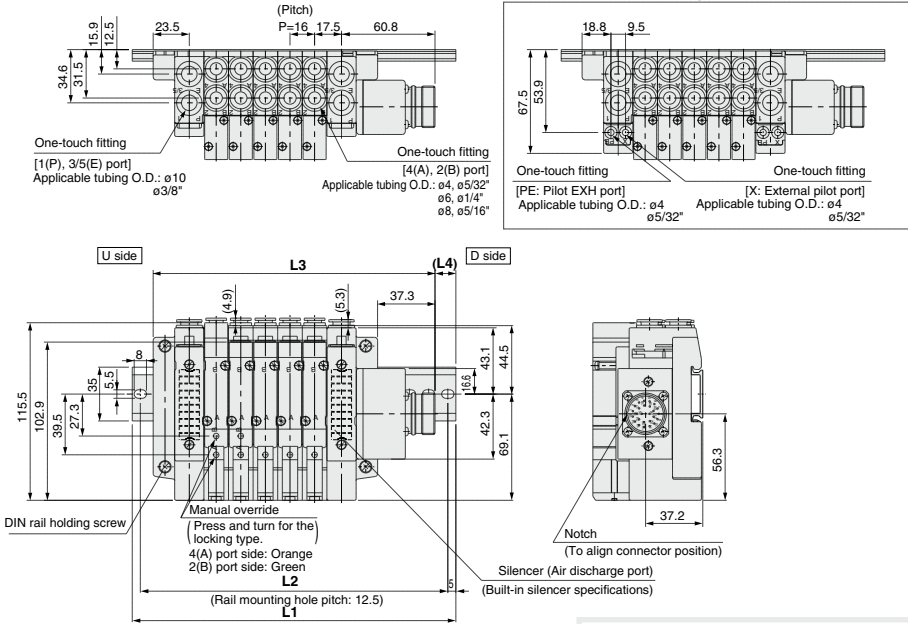

#### L Dimension

n	2	3	4	5	6	7	8	9	10	11	12	13	14	15	16	17	18	19	20
L1	160.5	185.5	198	210.5	223	248	260.5	273	298	310.5	323	335.5	360.5	373	385.5	410.5	423	435.5	448
L2	150	175	187.5	200	212.5	237.5	250	262.5	287.5	300	312.5	325	350	362.5	375	400	412.5	425	437.5
L3	135.3	151.3	167.3	183.3	199.3	215.3	231.3	247.3	263.3	279.3	295.3	311.3	327.3	343.3	359.3	375.3	391.3	407.3	423.3
L4	12.5	17	15.5	13.5	12	16.5	14.5	13	17.5	15.5	14	12	16.5	15	13	17.5	16	14	12.5

n: Stations

**Dimensions: SV1000 Series for Circular Connector**

● Tie-rod base manifold: SS5V1-W10CD-(Stations)  $\frac{U}{D}$  (S, R, RS) C3, N1  
C4, N3 (-D) C6, N7

- When P, E port outlets are indicated on the U side or D side, the P, E ports on the opposite side are plugged.
- External pilot port positions and silencer discharge port positions are the same as P, E port outlet positions.

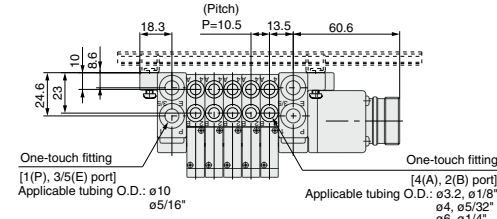

**With External Pilot Specifications**

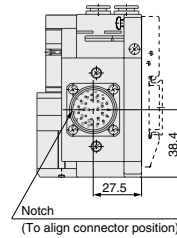
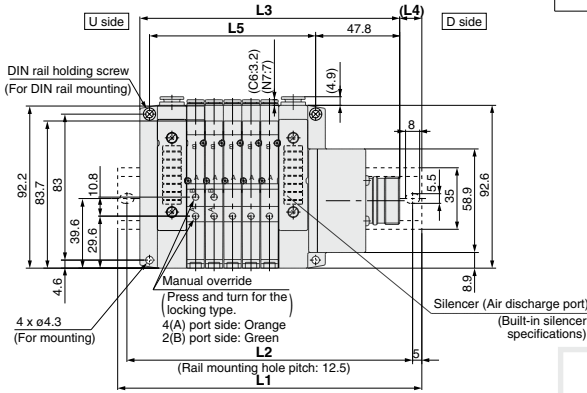
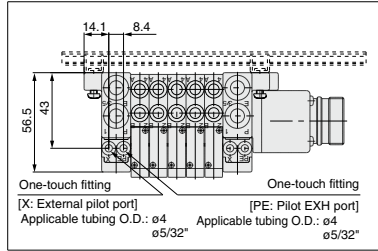

**With option**

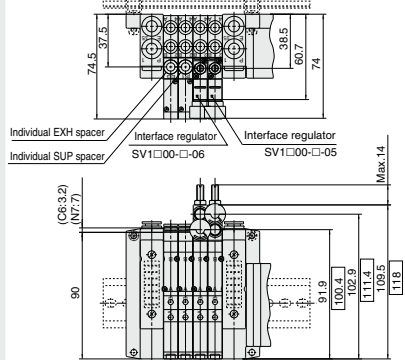
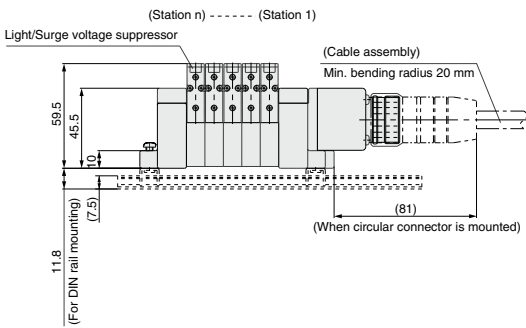

□ Dimensions are the ones for SV1300-□-□.

**L Dimension**

n	2	3	4	5	6	7	8	9	10	11	12	13	14	15	16	17	18	19	20
L1	148	160.5	160.5	173	185.5	198	210.5	223	235.5	235.5	248	260.5	273	285.5	298	298	310.5	323	335.5
L2	137.5	150	150	162.5	175	187.5	200	212.5	225	225	237.5	250	262.5	275	287.5	287.5	300	312.5	325
L3	116.3	128.8	137.3	147.8	158.3	168.8	179.3	189.8	200.3	210.8	221.3	231.8	242.3	252.8	263.3	273.8	284.3	294.8	305.3
L4	16	17	11.5	12.5	13.5	14.5	15.5	16.5	17.5	12.5	13.5	14.5	15.5	16.5	17.5	12	13	14	15
L5	63	73.5	84	94.5	105	115.5	126	136.5	147	157.5	168	178.5	189	199.5	210	220.5	231	241.5	252

n: Stations

# SV Series

## Dimensions: SV2000 Series for Circular Connector

### ● Tie-rod base manifold: SS5V2-W10CD-Stations U (S, R, RS) D (S, R, RS) C4, N3 C6, N7 C8, N6 (-D)

- When P, E port outlets are indicated on the U side or D side, the P, E ports on the opposite side are plugged.
- External pilot port positions and silencer discharge port positions are the same as P, E port outlet positions.

#### With External Pilot Specifications

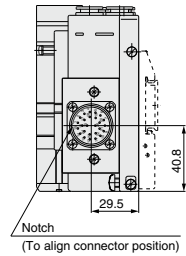
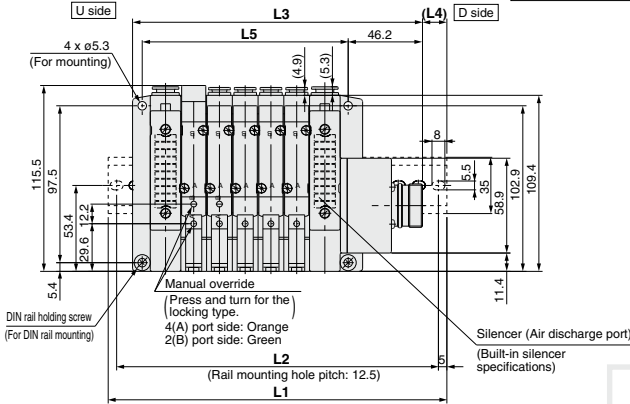
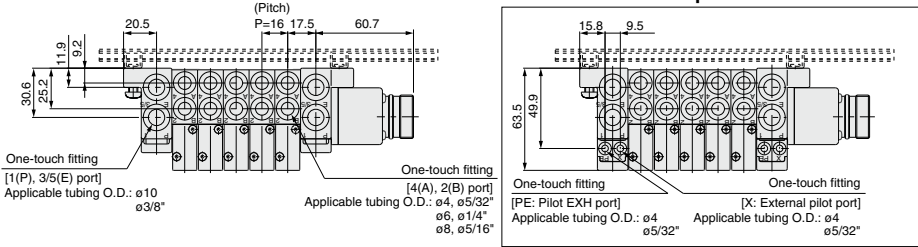

#### With option

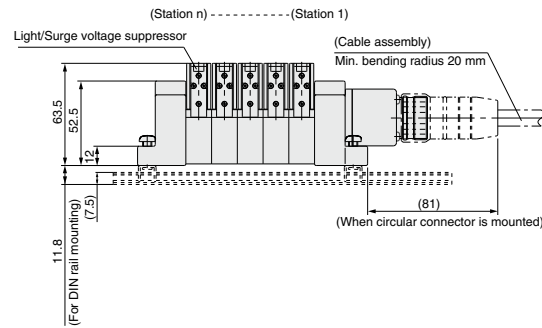
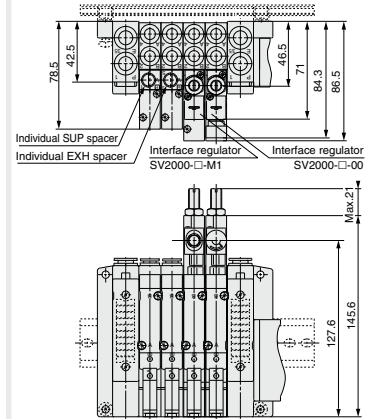

#### L Dimension

n	2	3	4	5	6	7	8	9	10	11	12	13	14	15	16	17	18	19	20
L1	160.5	173	198	210.5	223	235.5	260.5	273	285.5	310.5	323	335.5	348	373	385.5	398	423	435.5	448
L2	150	162.5	187.5	200	212.5	225	250	262.5	275	300	312.5	325	337.5	362.5	375	387.5	412.5	425	437.5
L3	132.2	148.2	164.2	180.2	196.2	212.2	228.2	244.2	260.2	276.2	302.2	308.2	324.2	340.2	356.2	372.2	388.2	404.2	420.2
L4	14	12.5	17	15	13.5	11.5	16	14.5	12.5	17	15.5	13.5	12	16.5	14.5	13	17.5	15.5	14
L5	80	96	112	128	144	160	176	192	208	224	240	256	272	288	304	320	336	352	368

## Dimensions: SV3000 Series for Circular Connector

### ● Tie-rod base manifold: SS5V3-W10CD-Stations U D (S, R, RS) C6, N7 C8, N9 C10, N11 (-D)

- When P, E port outlets are indicated on the U side or D side, the P, E ports on the opposite side are plugged.
- External pilot port positions and silencer discharge port positions are the same as P, E port outlet positions.

#### With External Pilot Specifications

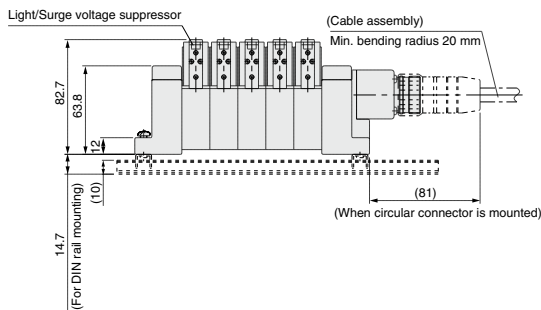
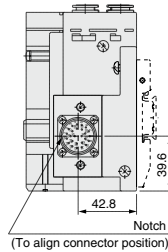
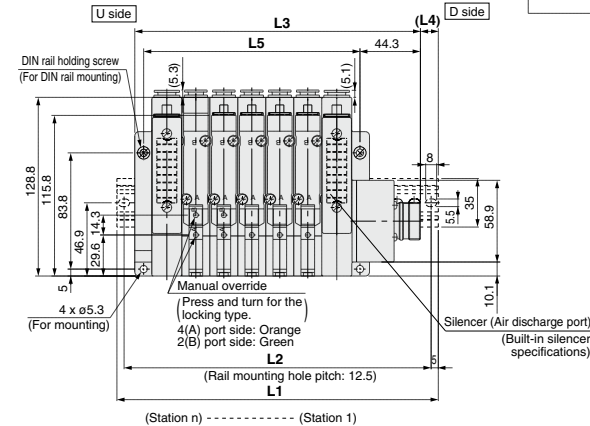
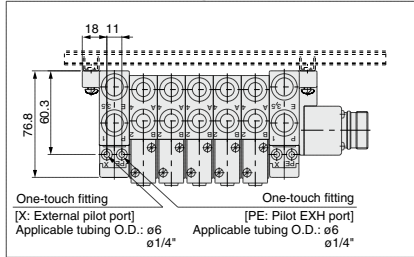
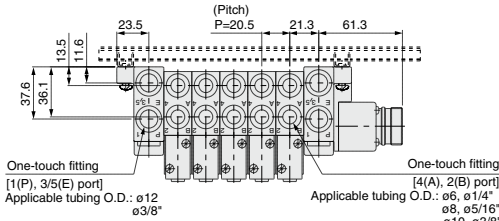

#### With option

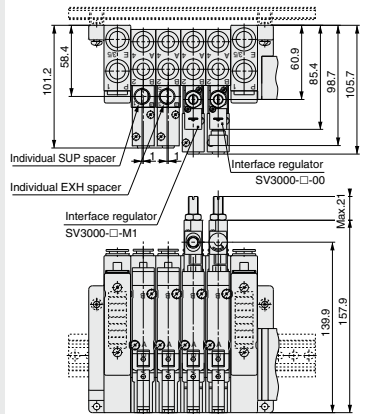

#### L Dimension

n	2	3	4	5	6	7	8	9	10	11	12	13	14	15	16	17	18	19	20
L1	173	198	223	235.5	260.5	285.5	298	323	335.5	360.5	385.5	398	423	448	460.5	485.5	510.5	523	548
L2	162.5	187.5	212.5	225	250	275	287.5	312.5	325	350	375	387.5	412.5	437.5	450	475	500	512.5	537.5
L3	147.8	168.3	188.8	209.3	229.8	250.3	270.8	291.3	311.8	332.3	352.8	373.3	393.8	414.3	434.8	455.3	475.8	496.3	516.8
L4	12.5	15	17	13	15.5	17.5	13.5	16	12	14	16.5	12.5	14.5	17	13	15	17.5	13.5	15.5
L5	97	117.5	138	158.5	179	199.5	220	240.5	261	281.5	302	322.5	343	363.5	384	404.5	425	445.5	466

n: Stations

# SV Series

## Dimensions: SV4000 Series for Circular Connector

### ● Tie-rod base manifold: SS5V4-W10CD- $\left[ \begin{matrix} \text{U} \\ \text{D} \end{matrix} \right]$ (S, R, RS)- $\left[ \begin{matrix} \text{O}8 \\ \text{O}3, \text{C}10, \text{N}9 \\ \text{C}12, \text{N}11 \end{matrix} \right]$ (-D)

- When P, E port outlets are indicated on the U side or D side, the P, E ports on the opposite side are plugged.
- External pilot port positions and silencer discharge port positions are the same as P, E port outlet positions.

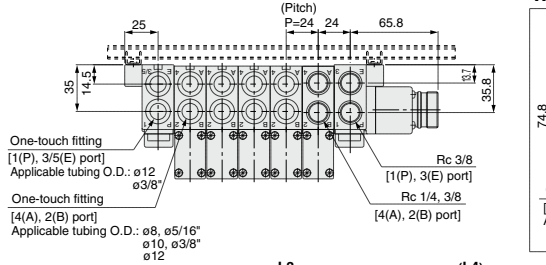

### With External Pilot Specifications

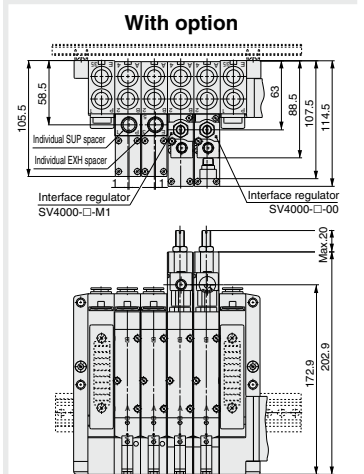
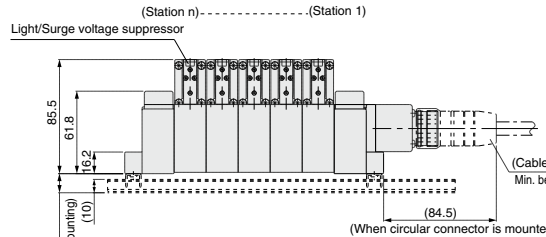
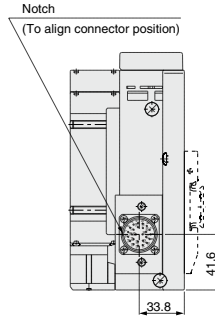
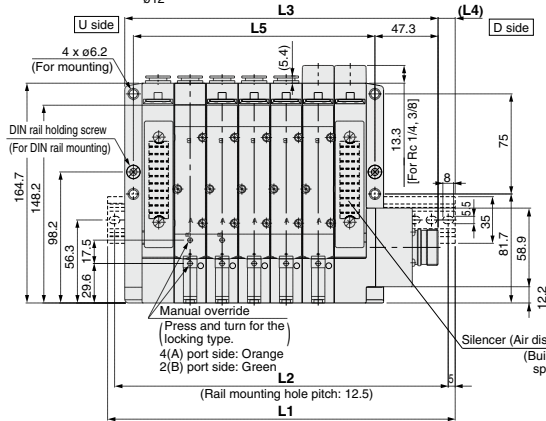
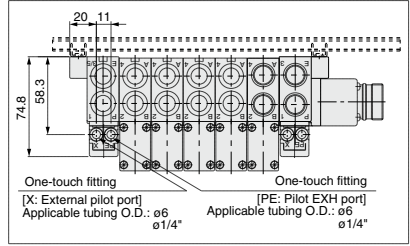

### L Dimension

n	2	3	4	5	6	7	8	9	10	11	12	13	14	15	16	17	18	19	20
L1	198	210.5	235.5	260.5	285.5	310.5	335.5	360.5	385.5	410.5	435.5	460.5	485.5	498	523	548	573	598	623
L2	187.5	200	225	250	275	300	325	350	375	400	425	450	475	487.5	512.5	537.5	562.5	587.5	612.5
L3	162.8	186.8	210.8	234.8	258.8	282.8	306.8	330.8	354.8	378.8	402.8	426.8	450.8	474.8	498.8	522.8	546.8	570.8	594.8
L4	17.5	12	12.5	13	13.5	14	14.5	15	15.5	16	16.5	17	17.5	11.5	12	12.5	13	13.5	14
L5	109	133	157	181	205	229	253	277	301	325	349	373	397	421	445	469	493	517	541

# D-sub Connector

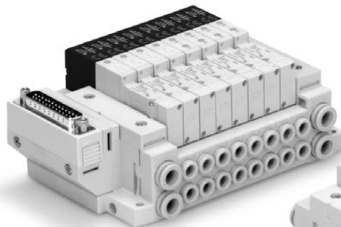

Tie-rod base

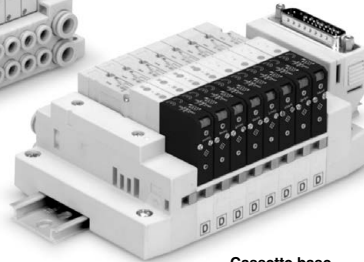

Cassette base

Applicable series	Cassette base manifold <b>SV1000/SV2000</b>
	Tie-rod base manifold <b>SV1000/SV2000/SV3000/SV4000</b>
<ul style="list-style-type: none"><li>• Number of connectors: 25 pins</li><li>• MIL-C-24308</li></ul> Conforming to JIS-X-5101	

# D-sub Connector SV Series



## How to Order Manifold

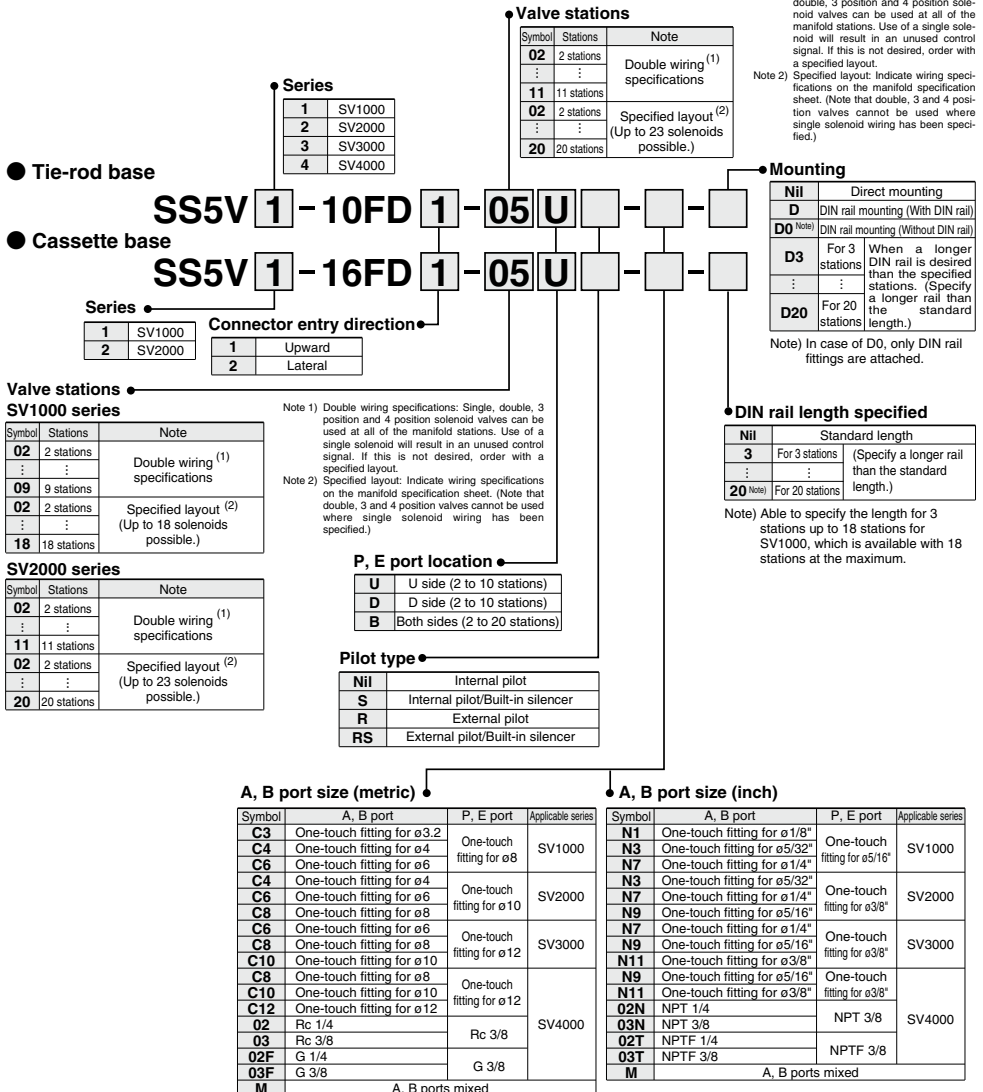

\* In the case of mixed specifications (M), indicate separately on the manifold specification sheet.

\* Port sizes of X, PE port for external pilot specifications (R, RS) are ø4 (metric), ø5/32" (inch) for SV1000/2000 and ø6 (metric) and ø1/4" (inch) for SV3000/4000.



## How to Order Manifold Assembly

### Ordering example (SV1000)

**Manifold**

SS5V1-16FD1-06B-C6 (1 set)

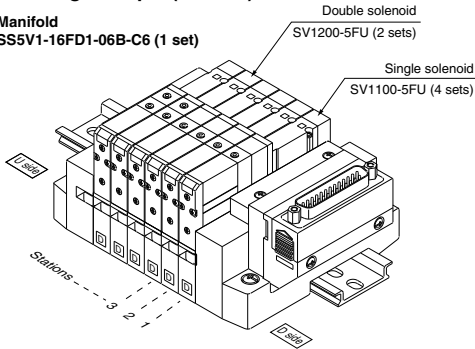

SS5V1-16FD1-06B-C6.....1 set (Manifold part no.)  
 \* SV1100-5FU.....4 sets (Single solenoid part no.)  
 \* SV1200-5FU.....2 sets (Double solenoid part no.)

## How to Order Solenoid Valves

SV 1 1 0 0 - 5 F - [ ] - [ ]

**Series**

1	SV1000
2	SV2000
3	SV3000
4	SV4000

**Type of actuation**

1	2 position single
2	2 position double
3	3 position closed center
4	3 position exhaust center
5	3 position pressure center
A	4 position dual 3 port valve: N.C./N.C.
B	4 position dual 3 port valve: N.O./N.O.
C	4 position dual 3 port valve: N.C./N.O.

\* 4 position dual 3 port valves are applicable to the SV1000 and SV2000 series only.

**Pilot type**

Nil	Internal pilot
R	External pilot

\* External pilot specifications is not available for 4 position dual 3 port valves.

Note) Available with manifold block for station additions. Refer to pages 113 and 119.

**Made to Order**

Nil	—
X90	Main valve fluororubber (Refer to page 134.)

**Manual override**

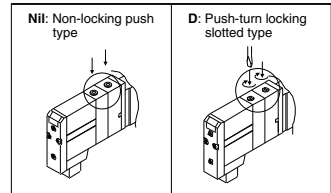

**Light/Surge voltage suppressor**

U	With light/surge voltage suppressor
R	With surge voltage suppressor

**Rated voltage**

5	24 VDC
6	12 VDC

**Back pressure check valve**

Nil	None
K	Built-in

\* Built-in back pressure check valve type is applicable to the SV1000 series only.

\* Back pressure check valve is not available for 3 position valve.

Note) Refer to Specific Product Precautions 2 on page 136.

## Manifold Electrical Wiring

10F/16F D-sub Connector Type (25 pins)

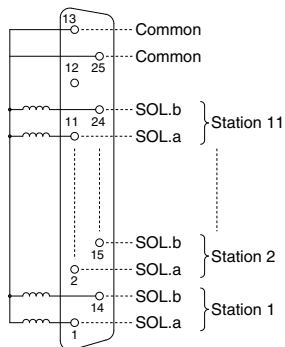

- This circuit has double wiring specifications for up to 11 stations. Since the usable number of solenoids differs depending on the manifold type, refer to the table below.  
In the case of single solenoids, connect to SOL.A. Furthermore, when wiring is specified on the manifold specification sheet, connections are made without skipping any connectors, and signals A for single and A, B for double are in order 1 → 14 → 2 → 15, etc.
- Stations are counted from D side (connector side) as the 1st.
- Since solenoid valves do not have polarity, either the +COM or -COM can be used.

### Usable No. of Solenoids

Model	Max. no. of solenoids
Tie-rod base type 10	23
Cassette base type 16	18
	23

## Dimensions: SV1000 Series for D-sub Connector

### ● Cassette base manifold: SS5V1-16FD<sub>2</sub><sup>1</sup> - Stations $\frac{U}{D}$ (S, R, RS) - C3, N1 C4, N3 C6, N7

- When P, E port outlets are indicated on the U side or D side, the P, E ports on the opposite side are plugged.
- External pilot port positions and silencer discharge port positions are the same as P, E port outlet positions.

#### With External Pilot Specifications

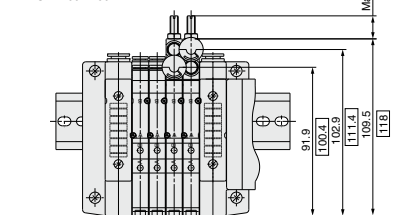
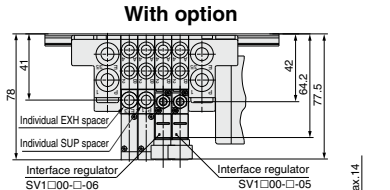
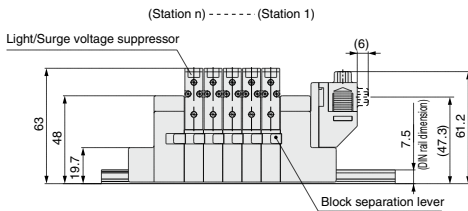
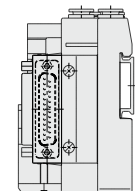
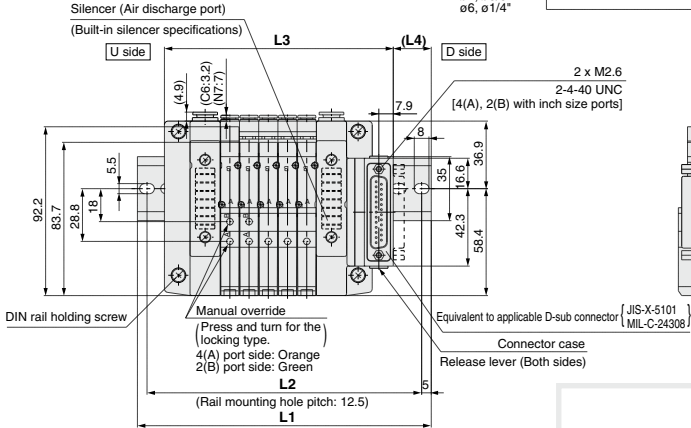
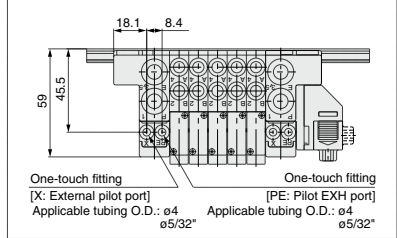
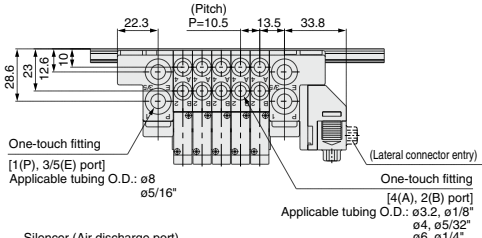

□ Dimensions are the ones for SV1300-□-□.

#### L Dimension

L	n: Stations																
	2	3	4	5	6	7	8	9	10	11	12	13	14	15	16	17	18
L1	123	135.5	148	160.5	173	185.5	198	198	210.5	223	235.5	248	260.5	260.5	273	285.5	298
L2	112.5	125	137.5	150	162.5	175	187.5	187.5	200	212.5	225	237.5	250	250	262.5	275	287.5
L3	93.5	104	114.5	125	135.5	146	156.5	167	177.5	188	198.5	209	219.5	230	240.5	251	261.5
L4	18	19	20	21	22	23	24	18.5	19.5	20.5	21.5	22.5	23.5	18.5	19.5	20.5	21.5

## Dimensions: SV2000 Series for D-sub Connector

### ● Cassette base manifold: SS5V2-16FD<sub>2</sub> - Stations $\frac{U}{D}$ (S, R, RS) C4, N3 C5, N7 C8, N9

- When P, E port outlets are indicated on the U side or D side, the P, E ports on the opposite side are plugged.
- External pilot port positions and silencer discharge port positions are the same as P, E port outlet positions.

#### With External Pilot Specifications

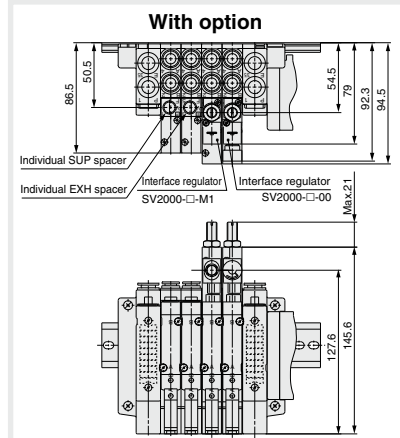
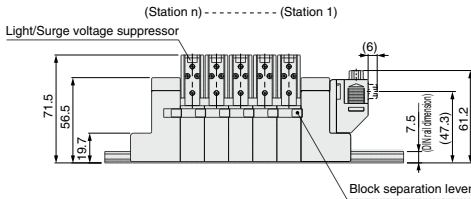
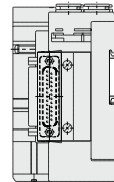
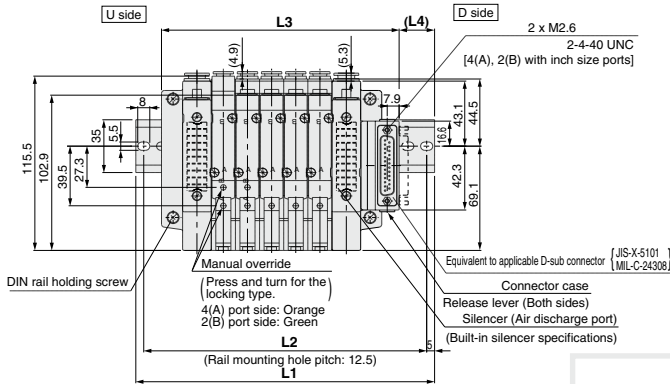
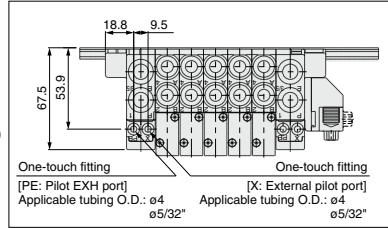
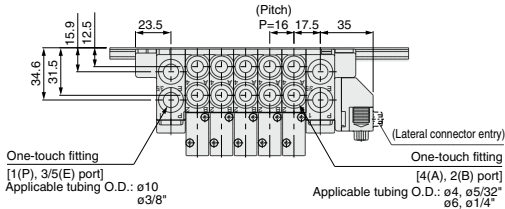

#### L Dimension

n	2	3	4	5	6	7	8	9	10	11	12	13	14	15	16	17	18	19	20
L1	148	160.5	173	198	210.5	223	235.5	260.5	273	285.5	310.5	323	335.5	348	373	385.5	398	423	435.5
L2	137.5	150	162.5	187.5	200	212.5	225	250	262.5	275	300	312.5	325	337.5	362.5	375	387.5	412.5	425
L3	109.5	125.5	141.5	157.5	173.5	189.5	205.5	221.5	237.5	253.5	269.5	285.5	301.5	317.5	333.5	349.5	365.5	381.5	397.5
L4	22.5	20.5	19	23.5	21.5	20	18	22.5	21	19	23.5	22	20	18.5	23	21	19.5	24	22

## Dimensions: SV1000 Series for D-sub Connector

● Tie-rod base manifold: SS5V1-10FD<sub>2</sub> -  $\frac{U}{D}$  (Stations)  $\frac{C3, N1}{C4, N3}$  (S, R, RS)  $\frac{C6, N7}{C6, N7}$  (-D)

- When P, E port outlets are indicated on the U side or D side, the P, E ports on the opposite side are plugged.
- External pilot port positions and silencer discharge port positions are the same as P, E port outlet positions.

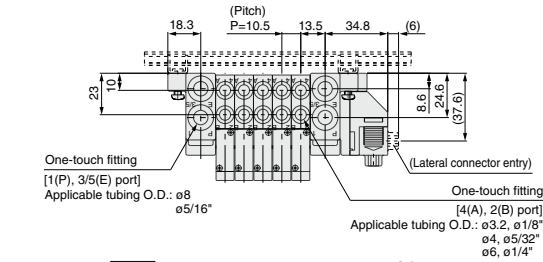

### With External Pilot Specifications

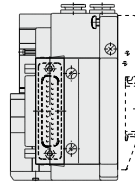
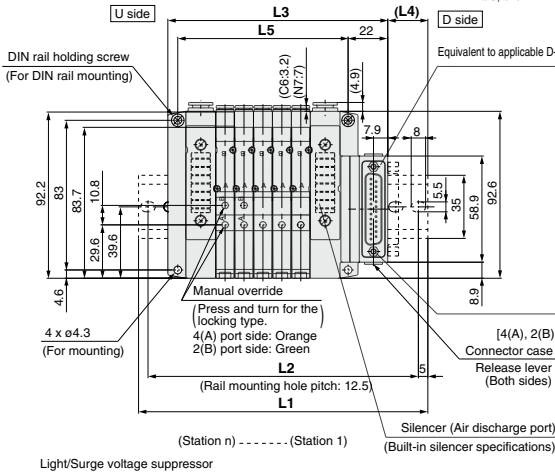
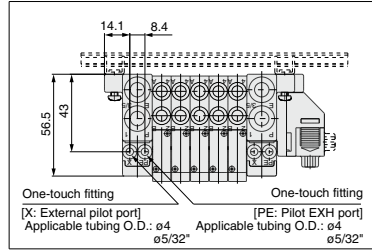

### With option

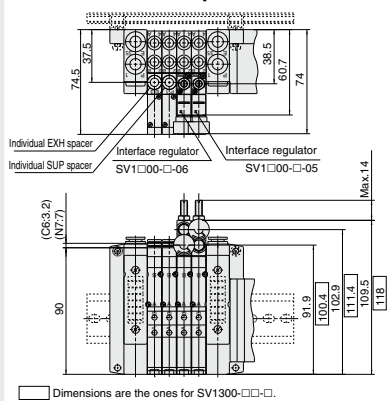

### L Dimension

n	2	3	4	5	6	7	8	9	10	11	12	13	14	15	16	17	18	19	20
L1	123	135.5	148	160.5	173	173	185.5	198	210.5	223	235.5	248	260.5	273	285.5	298	310.5	310.5	310.5
L2	112.5	125	137.5	150	162.5	162.5	175	187.5	200	212.5	225	225	237.5	250	262.5	275	287.5	300	300
L3	90.5	101	111.5	122	132.5	143	153.5	164	174.5	185	195.5	206	216.5	227	237.5	248	258.5	269	279.5
L4	19.5	20.5	21.5	22.5	23.5	18	19	20	21	22	23	18	19	20	21	22	23	24	18.5
L5	63	73.5	84	94.5	105	115.5	126	136.5	147	157.5	168	178.9	189	199.5	210	220.5	231	241.5	252

n: Stations

# SV Series

## Dimensions: SV2000 Series for D-sub Connector

● Tie-rod base manifold: SS5V2-10FD<sub>2</sub><sup>1</sup> =  $\left[ \begin{array}{c} \text{Stations} \\ \text{D} \end{array} \right] \left( \begin{array}{c} \text{U} \\ \text{B} \end{array} \right) (\text{S, R, RS}) - \left( \begin{array}{c} \text{C4, N3} \\ \text{C5, N7} \\ \text{C6, N9} \end{array} \right) (-\text{D})$

- When P, E port outlets are indicated on the U side or D side, the P, E ports on the opposite side are plugged.
- External pilot port positions and silencer discharge port positions are the same as P, E port outlet positions.

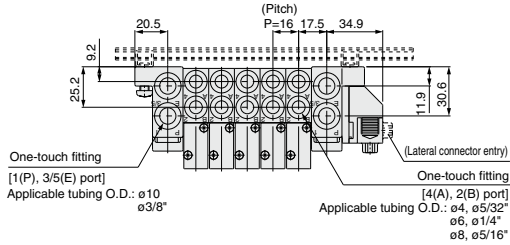

### With External Pilot Specifications

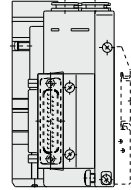
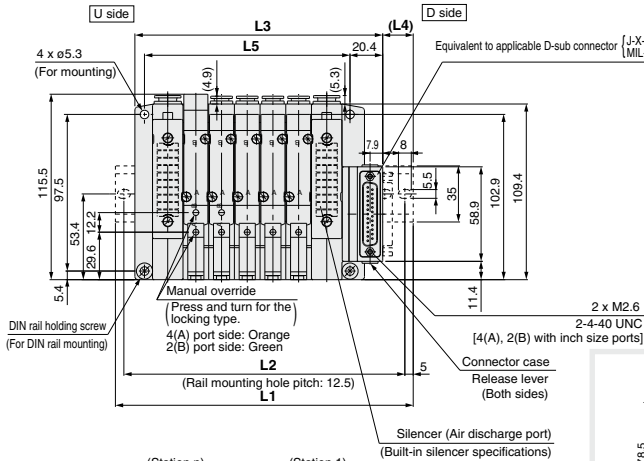
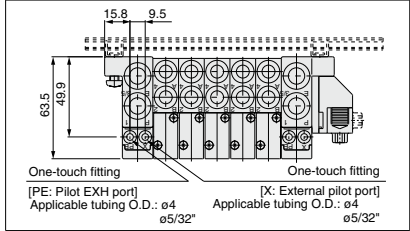

### With option

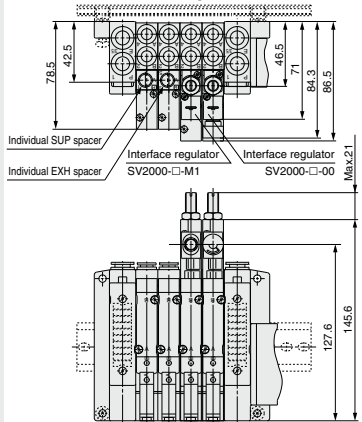

### L Dimension

n	2	3	4	5	6	7	8	9	10	11	12	13	14	15	16	17	18	19	20
L1	135.5	160.5	173	185.5	210.5	223	235.5	248	273	285.5	298	323	335.5	348	360.5	385.5	398	410.5	435.5
L2	125	150	162.5	175	200	212.5	225	237.5	262.5	275	287.5	312.5	325	337.5	350	375	387.5	400	425
L3	106.4	122.4	138.4	154.4	170.4	186.4	202.4	218.4	234.4	250.4	266.4	282.4	298.4	314.4	330.4	346.4	362.4	378.4	394.4
L4	17.5	22	20.5	18.5	23	21.5	19.5	18	23.4	20.5	19	23.5	21.5	20	18	22.5	21	19	23.5
L5	80	96	112	128	144	160	176	192	208	224	240	256	272	288	304	320	336	352	368

## Dimensions: SV3000 Series for D-sub Connector

● Tie-rod base manifold: SS5V3-10FD<sub>2</sub><sup>1</sup> [Stations]  $\frac{U}{D}$  (S, R, RS) C6, N7 C8, N9 C10, N11 (-D)

- When P, E port outlets are indicated on the U side or D side, the P, E ports on the opposite side are plugged.
- External pilot port positions and silencer discharge port positions are the same as P, E port outlet positions.

### With External Pilot Specifications

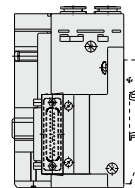
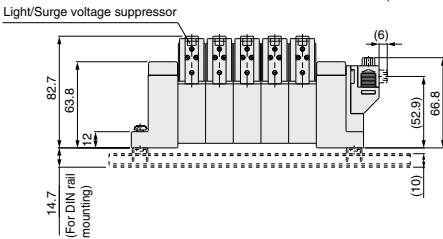
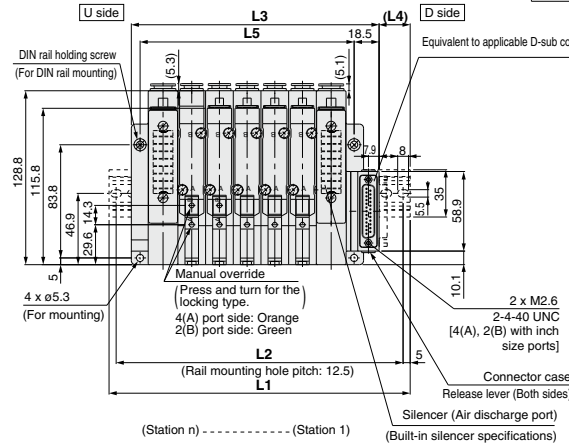
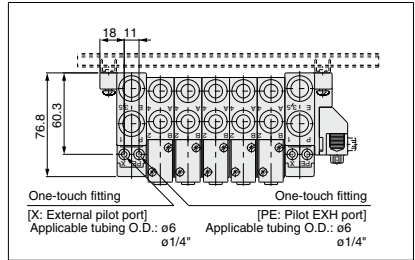
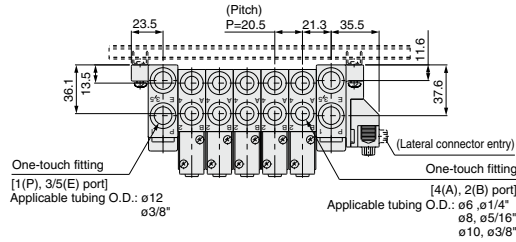

### With option

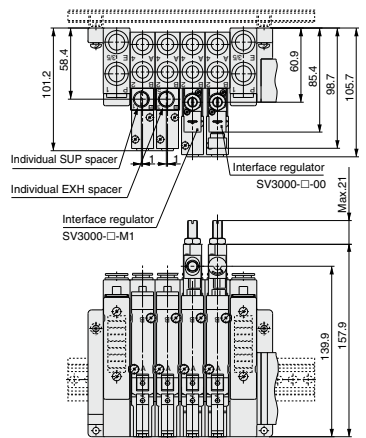

### L Dimension

n	1	2	3	4	5	6	7	8	9	10	11	12	13	14	15	16	17	18	19	20
L1	160.5	173	198	223	235.5	260.5	285.5	298	323	348	360.5	385.5	398	423	448	460.5	485.5	510.5	523	
L2	150	162.5	187.5	212.5	225	250	275	287.5	312.5	337.5	350	375	387.5	412.5	437.5	450	475	500	512.5	
L3	122	142.5	163	183.5	204	224.5	245	265.5	286	306.5	327	347.5	368	388.5	409	429.5	450	470.5	491	
L4	22.5	18.5	20.5	23	19	21	23.5	19.5	21.5	24	20	22	18	20.5	22.5	18.5	21	23	19	
L5	97	117.5	138	158.5	179	199.5	220	240.5	261	281.5	302	322.5	343	363.5	384	404.5	425	445.5	466	

n: Stations

# SV Series

## Dimensions: SV4000 Series for D-sub Connector

● Tie-rod base manifold: SS5V4-10FD<sub>2</sub> = Stations  $\frac{U}{D}$  (S, R, RS) 02, C8, N9, 03, C10, N11 (-D)

- When P, E port outlets are indicated on the U side or D side, the P, E ports on the opposite side are plugged.
- External pilot port positions and silencer discharge port positions are the same as P, E port outlet positions.

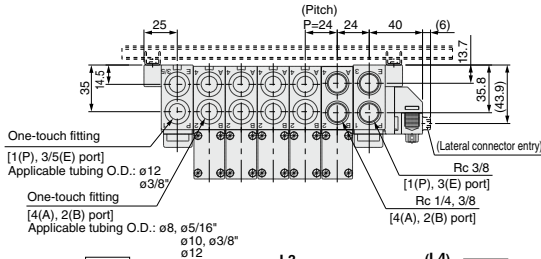

### With External Pilot Specifications

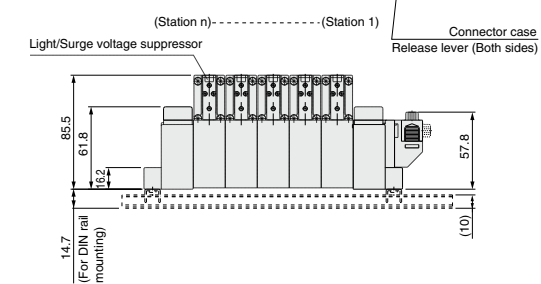
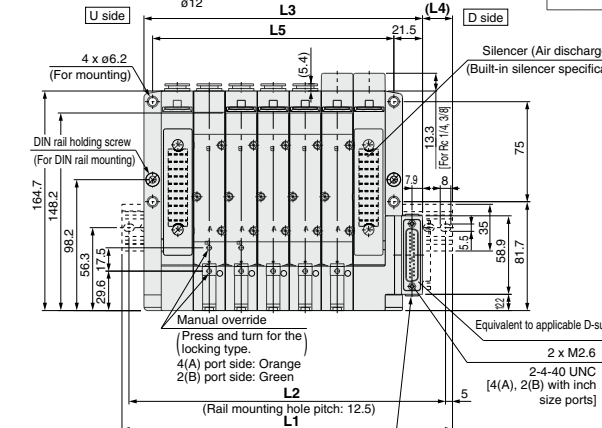
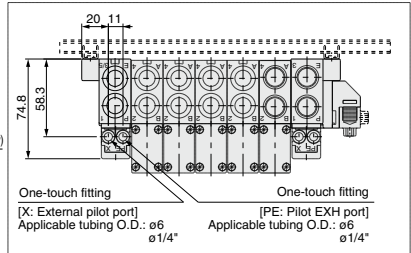

### L Dimension

n	1	2	3	4	5	6	7	8	9	10	11	12	13	14	15	16	17	18	19	20
L1	173	198	223	248	273	298	310.5	335.5	360.5	385.5	410.5	435.5	460.5	485.5	510.5	535.5	560.5	585.5	610.5	
L2	162.5	187.5	212.5	237.5	262.5	287.5	300	325	350	375	400	425	450	475	500	525	550	575	600	
L3	137	161	185	209	233	257	281	305	329	353	377	401	425	449	473	497	521	545	569	
L4	21	21.5	22	22.5	23	23.5	18	18.5	19	19.5	20	20.5	21	21.5	22	22.5	23	23.5	24	
L5	109	133	157	181	205	229	253	277	301	325	349	373	397	421	445	469	493	517	541	



# Flat Ribbon Cable Connector



Tie-rod base

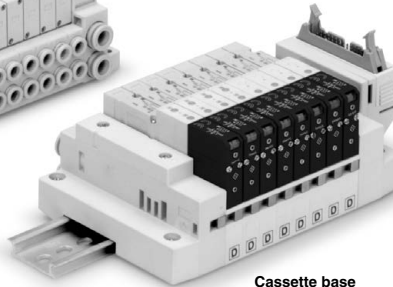

Cassette base

Applicable series

Cassette base manifold  
**SV1000/SV2000**

Tie-rod base manifold  
**SV1000/SV2000/SV3000/SV4000**

- Number of connectors: 26, 20, 10 pins
- With strain relief
- Conforming to MIL-C-83503

# Flat Ribbon Cable Connector

# SV Series



## How to Order Manifold

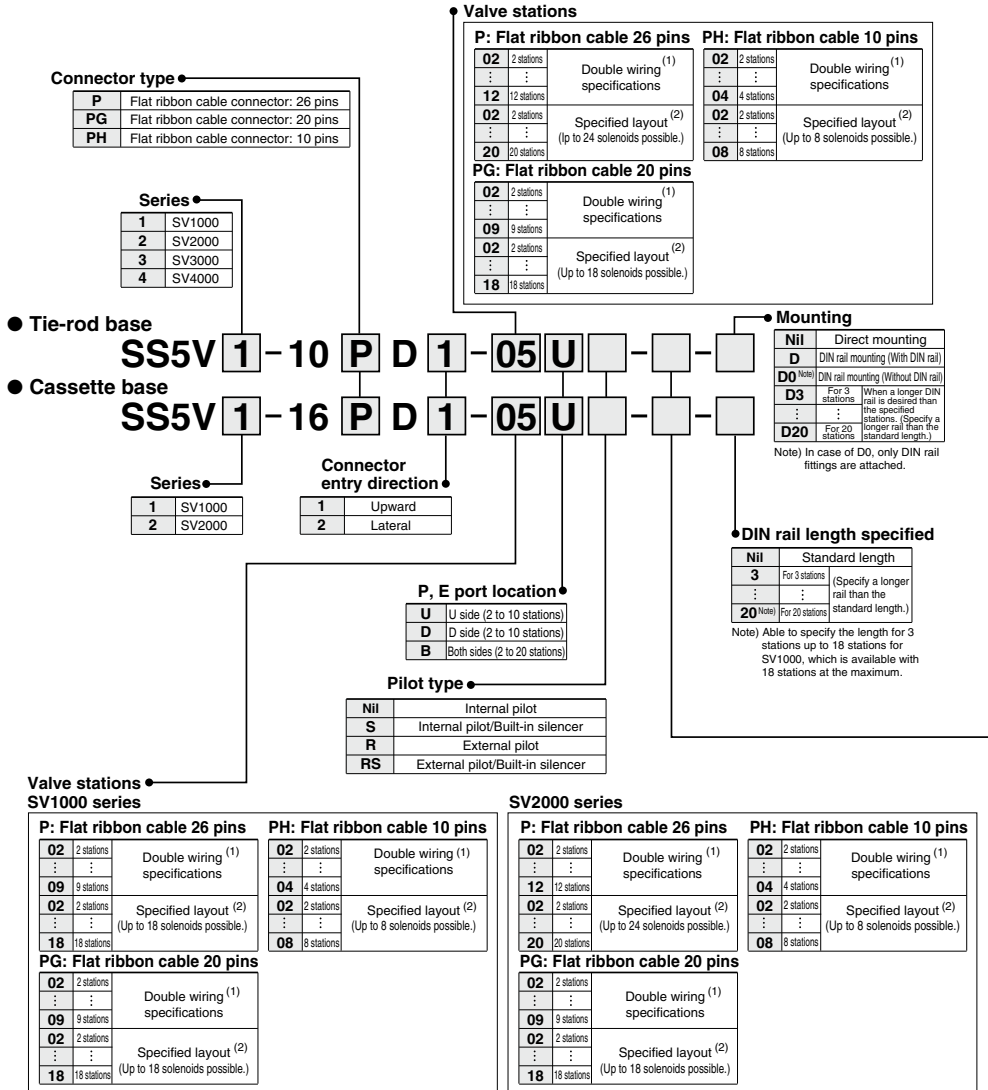

Note 1) Double wiring specifications: Single, double, 3 and 4 position solenoid valves can be used on all manifold stations. Use of a single solenoid will result in an unused control signal. If this is not desired, order with a specified layout.

Note 2) Specified layout: Indicate wiring specifications on a manifold specification sheet. (Note that double, 3 and 4 position valves cannot be used where single solenoid wiring has been specified.)

## How to Order Valve Manifold Assembly

### Ordering example (SV1000)

Manifold

SS5V1-16PD1-06B-C6 (1 set)

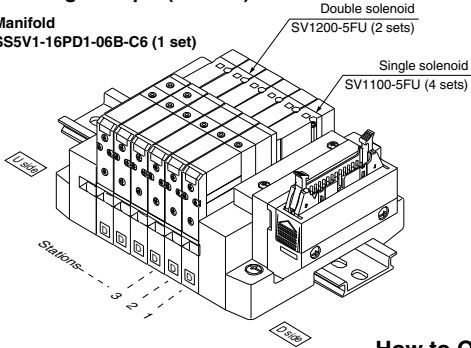

SS5V1-16PD1-06B-C6.....1 set (manifold part no.)  
 \* SV1100-5FU.....4 sets (Single solenoid part no.)  
 \* SV1200-5FU.....2 sets (Double solenoid part no.)

## How to Order Valve

SV 1 1 0 0 - 5 F

Series ●

1	SV1000
2	SV2000
3	SV3000
4	SV4000

### Type of actuation ●

1	2 position single
2	2 position double
3	3 position closed center
4	3 position exhaust center
5	3 position pressure center
A	4 position dual 3 port valve: N.C./N.C.
B	4 position dual 3 port valve: N.O./N.O.
C	4 position dual 3 port valve: N.C./N.O.

\* 4 position dual 3 port valves are applicable to the SV1000 and SV2000 series only.

### Pilot type ●

Nil	Internal pilot
R	External pilot

\* External pilot specifications is not available for 4 position dual 3 port valves.

### Rated voltage

5	24 VDC
6	12 VDC

### Back pressure check valve

Nil	None
K	Built-in

\* Built-in back pressure check valve type is applicable to the SV1000 series only.  
 \* Back pressure check valve is not available for 3 position valve.

Note) Refer to Specific Product Precautions 2 on page 136.

Note) [ ]

Note) Available with manifold block for station additions. Refer to pages 113 and 119.

### Made to Order ●

Nil	—
X90	Main valve fluororubber (Refer to page 134.)

### Manual override

Nil: Non-locking push type

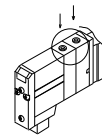

D: Push-turn locking slotted type

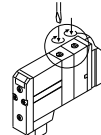

### Light/Surge voltage suppressor

U	With light/surge voltage suppressor
R	With surge voltage suppressor

### A, B port size (Metric)

Symbol	A, B port	P, E port	Applicable series
C3	One-touch fitting for ø3.2	One-touch fitting for ø6	SV1000
C4	One-touch fitting for ø4		
C6	One-touch fitting for ø6	One-touch fitting for ø10	SV2000
C4	One-touch fitting for ø4		
C6	One-touch fitting for ø6	One-touch fitting for ø12	SV3000
C8	One-touch fitting for ø8		
C10	One-touch fitting for ø10	One-touch fitting for ø12	SV4000
C12	One-touch fitting for ø12		
02	Rc 1/4	Rc 3/8	
03	Rc 3/8		
02F	G 1/4	G 3/8	
03F	G 3/8		
M	A, B ports mixed		

### A, B port size (Inch)

Symbol	A, B port	P, E port	Applicable series
N1	One-touch fitting for ø1/8"	One-touch fitting for ø5/16"	SV1000
N3	One-touch fitting for ø5/32"		
N7	One-touch fitting for ø1/4"	One-touch fitting for ø3/8"	SV2000
N3	One-touch fitting for ø5/32"		
N7	One-touch fitting for ø1/4"	One-touch fitting for ø3/8"	SV3000
N9	One-touch fitting for ø5/16"		
N7	One-touch fitting for ø1/4"	One-touch fitting for ø3/8"	SV4000
N9	One-touch fitting for ø5/16"		
N11	One-touch fitting for ø3/8"	One-touch fitting for ø3/8"	
N9	One-touch fitting for ø5/16"		
N11	One-touch fitting for ø3/8"	NPT 3/8	
02N	NPT 1/4		
03N	NPT 3/8	NPTF 3/8	
02T	NPTF 1/4		
03T	NPTF 3/8		
M	A, B ports mixed		

\* In the case of mixed specifications (M), indicate separately on the manifold specification sheet.

\* Port sizes of X, PE port for external pilot specification (R, RS) are ø4 (metric), ø5/32" (inch) for SV1000/2000 and ø6 (metric) and ø1/4" (inch) for SV3000/4000.

## Manifold Electrical Wiring

10P/16P Flat Ribbon Cable Type (26 pins)

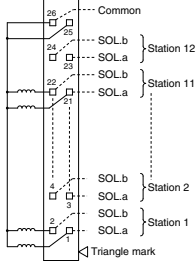

- This circuit has double wiring specifications for up to 12 stations. Since the usable number of solenoids differs depending on the manifold type, refer to the table below. In the case of single solenoids, connect to SOL. A. Furthermore, when wiring is specified on a manifold specification sheet, connections are made without skipping any connectors, and connectors are made without skipping any connectors, and signals A for single and A, B for double are in order 1 → 2 → 3 → 4, etc.
- Stations are counted from D side (connector side) as the 1st one.
- Since terminal numbers are not indicated on the flat cable, use the triangle mark as a reference for wiring.
- Since solenoid valves do not have polarity, either the +COM or -COM can be used.

### Usable No. of Solenoids

Model	SV1000 to SV4000	Max. no. of solenoids
Tie-rod base type 10		24
Cassette base type 16	SV1000	18
	SV2000	24

10PG/16PG Flat Ribbon Cable Type (20 pins)

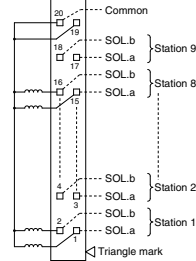

- This circuit has double wiring specifications for up to 9 stations. Since the usable number of solenoids differs depending on the manifold type, refer to the table below. In the case of single solenoids, connect to SOL. A. Furthermore, when wiring is specified on a manifold specification sheet, connections are made without skipping any connectors, and connectors are made without skipping any connectors, and signals A for single and A, B for double are in order 1 → 2 → 3 → 4, etc.
- Stations are counted from D side (connector side) as the 1st one.
- Since terminal numbers are not indicated on the flat cable, use the triangle mark as a reference for wiring.
- Since solenoid valves do not have polarity, either the +COM or -COM can be used.

### Usable No. of Solenoids

Model	SV1000 to SV4000	Max. no. of solenoids
Tie-rod base type 10		18
Cassette base type 16	SV1000	
	SV2000	

10PH/16PH Flat Ribbon Cable Type (10 pins)

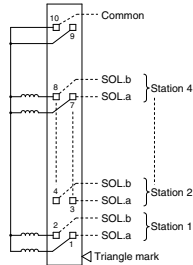

- This circuit has double wiring specifications for up to 4 stations. Since the usable number of solenoids differs depending on the manifold type, refer to the table below. In the case of single solenoids, connect to SOL. A. Furthermore, when wiring is specified on a manifold specification sheet, connections are made without skipping any connectors, and connectors are made without skipping any connectors, and signals A for single and A, B for double are in order 1 → 2 → 3 → 4, etc.
- Stations are counted from D side (connector side) as the 1st one.
- Since terminal numbers are not indicated on the flat cable, use the triangle mark as a reference for wiring.
- Since solenoid valves do not have polarity, either the +COM or -COM can be used.

### Usable No. of Solenoids

Model	SV1000 to SV4000	Max. no. of solenoids
Tie-rod base type 10		8
Cassette base type 16	SV1000	
	SV2000	

## Dimensions: SV1000 Series for Flat Ribbon Cable

● Cassette base manifold : **SS5V1-16** <sup>P</sup> PG <sup>D</sup> D<sub>2</sub> - [Stations] <sup>U</sup> (S, R, RS) <sup>C3, N1</sup> <sup>C4, N3</sup> <sup>C6, N7</sup>

- When P, E port outlets are indicated on the U side or D side, the P, E ports on the opposite side are plugged.
- External pilot port positions and silencer discharge port positions are the same as P, E port outlet positions.

### With External Pilot Specifications

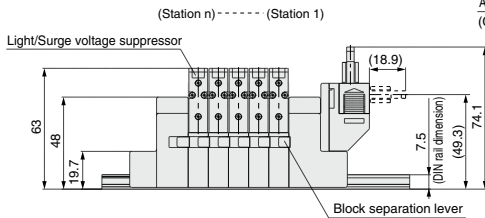
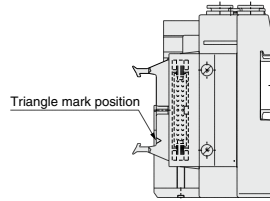
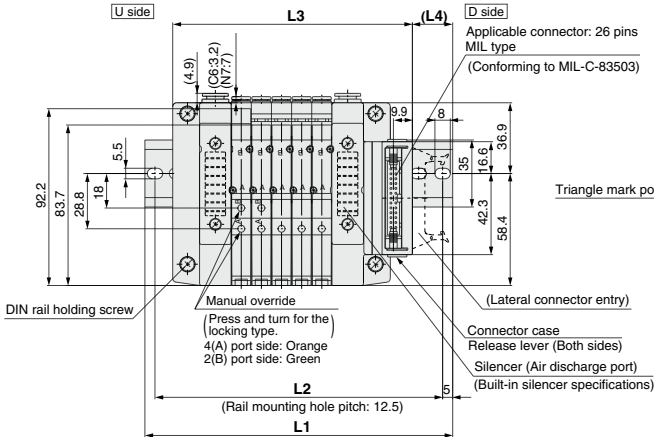
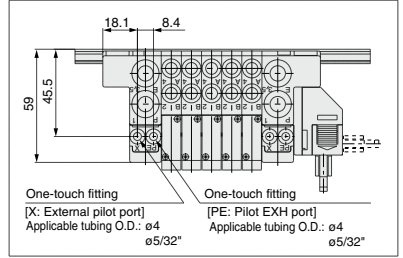
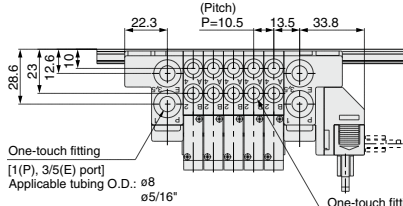

Applicable connector: 20 pins MIL type (Conforming to MIL-C-83503)

Applicable connector: 10 pins MIL type (Conforming to MIL-C-83503)

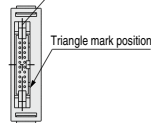

16PG (20 pins)

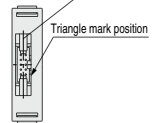

16PH (10 pins)

Refer to page 93 (compliant for D-sub connector) for dimensions with interface regulator and individual SUP/EXH spacer.

### L Dimension

	n : Stations																
n	2	3	4	5	6	7	8	9	10	11	12	13	14	15	16	17	18
L1	135.5	135.5	148	160.5	173	185.5	198	198	210.5	223	235.5	248	260.5	260.5	273	285.5	298
L2	125	125	137.5	150	162.5	175	187.5	187.5	200	212.5	225	237.5	250	250	262.5	275	287.5
L3	93.5	104	114.5	125	135.5	146	156.5	167	177.5	188	198.5	209	219.5	230	240.5	251	261.5
L4	24.5	19	20	21	22	23	24	19	20	21	22	23	24	18.5	19.5	20.5	21.5

# SV Series

## Dimensions: SV2000 Series for Flat Ribbon Cable

● Cassette base manifold : SS5V2-16 <sup>P</sup><sub>PH</sub> D<sub>2</sub> - [Stations] <sub>B</sub> (S, R, RS) <sup>C4, N3</sup><sub>C6, N7</sub> <sup>C8, N9</sup>

- When P, E port outlets are indicated on the U side or D side, the P, E ports on the opposite side are plugged.
- External pilot port positions and silencer discharge port positions are the same as P, E port outlet positions.

### With External Pilot Specifications

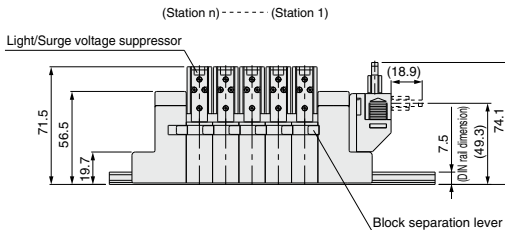
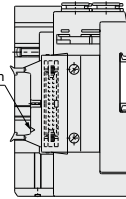
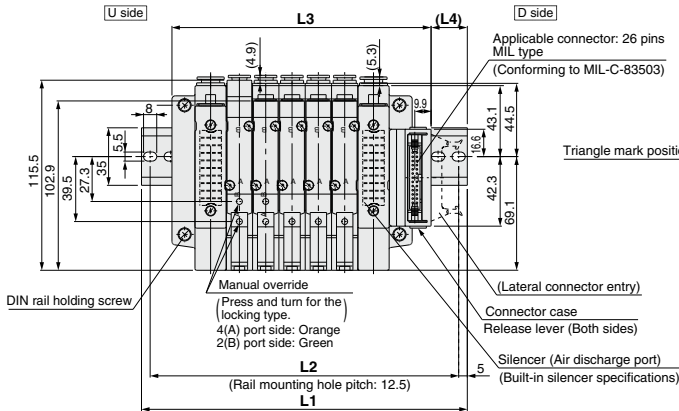
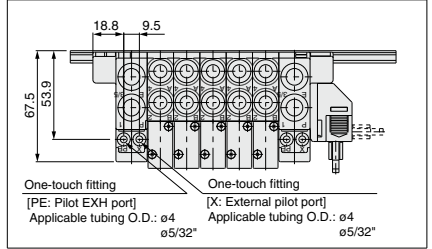
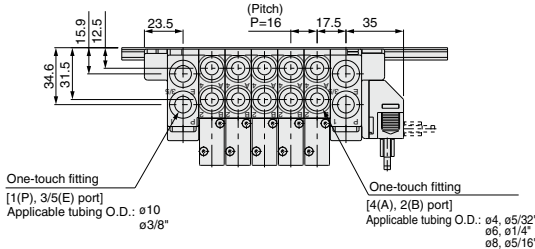

Applicable connector: 20 pins MIL type (Conforming to MIL-C-83503)

Applicable connector: 10 pins MIL type (Conforming to MIL-C-83503)

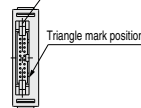

16PG (20 pins)

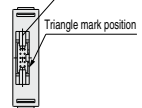

16PH (10 pins)

Refer to page 93 (compliant for D-sub connector) for dimensions with interface regulator and individual SUP/EXH spacer.

### L Dimension

n	2	3	4	5	6	7	8	9	10	11	12	13	14	15	16	17	18	19	20
L1	148	160.5	173	198	210.5	223	235.5	260.5	273	285.5	310.5	323	335.5	348	373	385.5	398	423	435.5
L2	137.5	150	162.5	187.5	200	212.5	225	250	262.5	275	300	312.5	325	337.5	362.5	375	387.5	412.5	425
L3	109.5	125.5	141.5	157.5	173.5	189.5	205.5	221.5	237.5	253.5	269.5	285.5	301.5	317.5	333.5	349.5	365.5	381.5	397.5
L4	22.5	21	19	23.5	22	20	18.5	23	21	19.5	24	22	20.5	18.5	23	21.5	19.5	24	22.5

## Dimensions: SV1000 Series for Flat Ribbon Cable

● Tie-rod base manifold : SS5V1-10<sup>P</sup><sub>PH</sub>D<sub>2</sub>-(Stations)<sup>U</sup><sub>B</sub>(S, R, RS)<sup>C3, N1</sup><sub>C6, N7</sub>(-D)

- When P, E port outlets are indicated on the U side or D side, the P, E ports on the opposite side are plugged.
- External pilot port positions and silencer discharge port positions are the same as P, E port outlet positions.

### With External Pilot Specifications

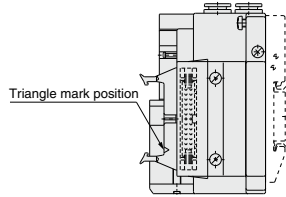
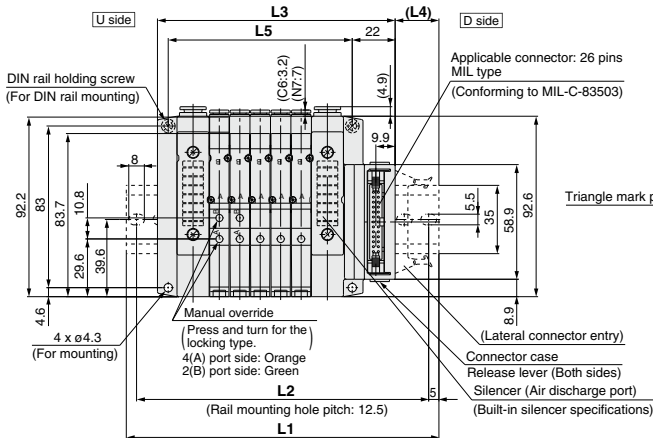
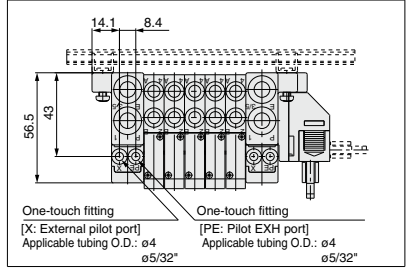
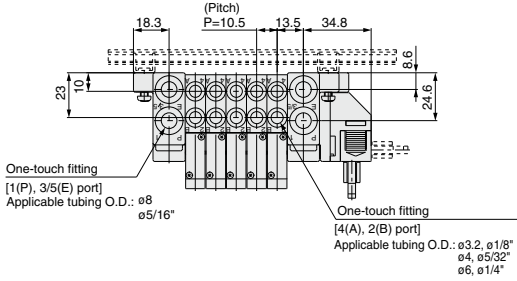

Applicable connector: 20 pins MIL type (Conforming to MIL-C-83503)      Applicable connector: 10 pins MIL type (Conforming to MIL-C-83503)

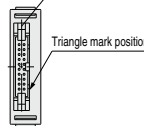

10PG (20 pins)

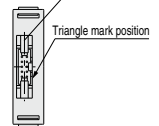

10PH (10 pins)

Refer to page 93 (compliant for D-sub connector) for dimensions with interface regulator and individual SUP/EXH spacer.

### L Dimension

	n : Stations																			
L <sub>n</sub>	2	3	4	5	6	7	8	9	10	11	12	13	14	15	16	17	18	19	20	
L1	123	135.5	148	160.5	173	173	185.5	198	210.5	223	235.5	248	248	260.5	273	285.5	298	310.5	310.5	
L2	112.5	125	137.5	150	162.5	162.5	175	187.5	200	212.5	225	237.5	237.5	250	262.5	275	287.5	300	300	
L3	90.5	101	111.5	122	132.5	143	153.5	164	174.5	185	195.5	206	216.5	227	237.5	248	258.5	269	279.5	
L4	19.5	20.5	21.5	22.5	23.5	18.5	19.5	20.5	21.5	22.5	23.5	24.5	19	20	21	22	23	24	19	
L5	63	73.5	84	94.5	105	115.5	126	136.5	147	157.5	168	178.5	189	199.5	210	220.5	231	241.5	252	

# SV Series

## Dimensions: SV2000 Series for Flat Ribbon Cable

● Tie-rod base manifold : SS5V2-10 <sup>P</sup> PG D<sub>2</sub> - [Stations] <sub>B</sub> (S, R, RS) <sup>C4, N3</sup> - C6, N7 / ( -D) <sub>C8, N9</sub>

- When P, E port outlets are indicated on the U side or D side, the P, E ports on the opposite side are plugged.
- External pilot port positions and silencer discharge port positions are the same as P, E port outlet positions.

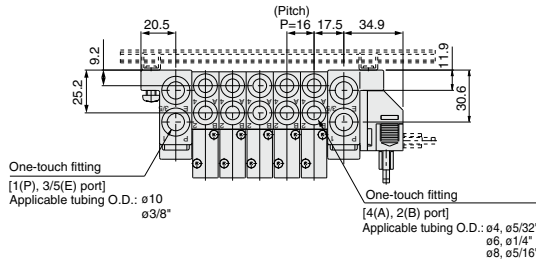

### With External Pilot Specifications

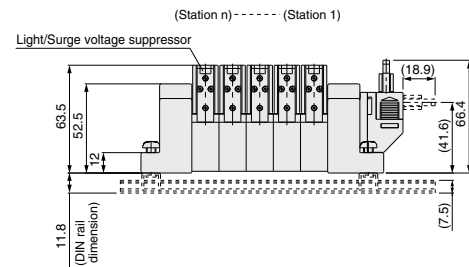
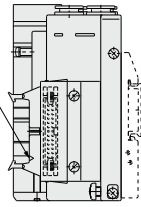
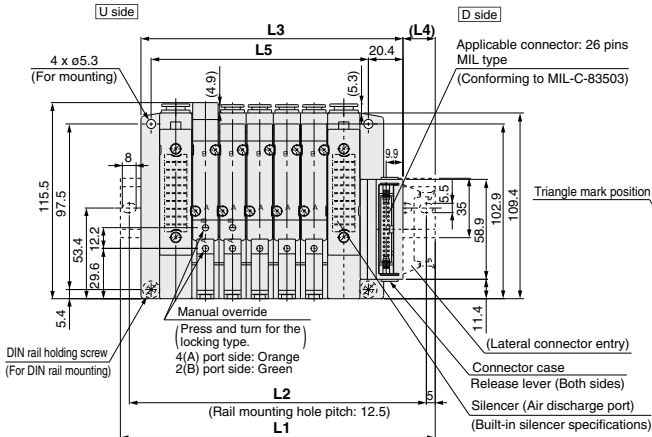
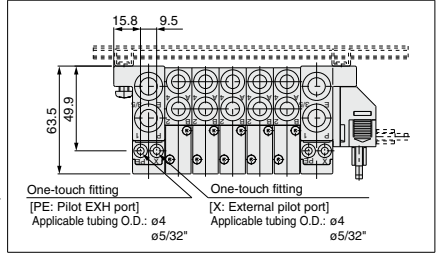

Applicable connector: 20 pins MIL type (Conforming to MIL-C-83503)

Applicable connector: 10 pins MIL type (Conforming to MIL-C-83503)

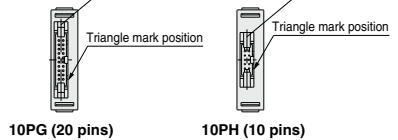

Refer to page 96 (compliant for D-sub connector) for dimensions with interface regulator and individual SUP/EXH spacer.

### L Dimension

L	n : Stations																			
	1	2	3	4	5	6	7	8	9	10	11	12	13	14	15	16	17	18	19	20
L1	148	160.5	173	185.5	210.5	223	235.5	248	273	285.5	298	323	335.5	348	360.5	385.5	398	410.5	435.5	
L2	137.5	150	162.5	175	200	212.5	225	237.5	262.5	275	287.5	312.5	325	337.5	350	375	387.5	400	425	
L3	106.4	122.4	138.4	154.4	170.4	186.4	202.4	218.4	234.4	250.4	266.4	282.4	298.4	314.4	330.4	346.4	362.4	378.4	394.4	
L4	24	22.5	20.5	19	23.5	21.5	20	18	23.5	21	19	23.5	22	20	18.5	23	21	19.5	24	
L5	80	96	112	128	144	160	176	192	208	224	240	256	272	288	304	320	336	352	368	



## Dimensions: SV3000 Series for Flat Ribbon Cable

● Tie-rod base manifold :  $SS5V3-10 \frac{P}{PH} \frac{D}{D_2} - [Stations] \frac{U}{B} (S, R, RS) \frac{C_6, N7}{C_8, N_9} \frac{C_{10}, N_{11}}{(-)}$

- When P, E port outlets are indicated on the U side or D side, the P, E ports on the opposite side are plugged.
- External pilot port positions and silencer discharge port positions are the same as P, E port outlet positions.

### With External Pilot Specifications

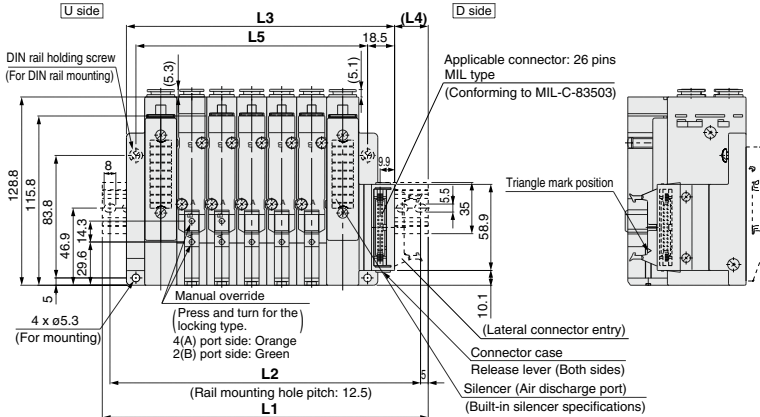
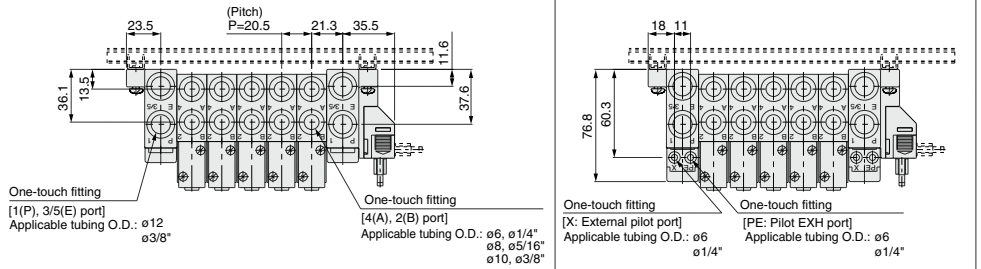

(Station n) ----- (Station 1)

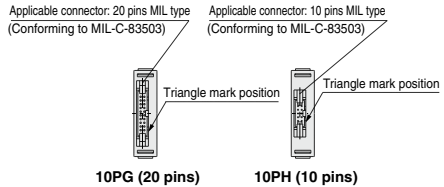
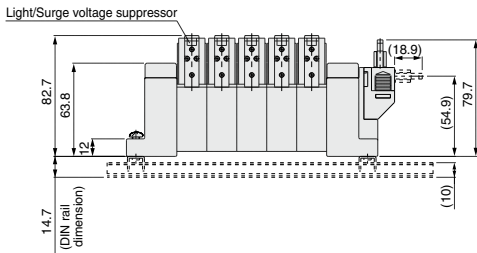

Refer to page 97 (compliant for D-sub connector) for dimensions with interface regulator and individual SUP/EXH spacer.

### L Dimension

		n : Stations																			
L <sub>n</sub>	1	2	3	4	5	6	7	8	9	10	11	12	13	14	15	16	17	18	19	20	
L <sub>1</sub>	160.5	173	198	223	235.5	260.5	285.5	298	323	348	360.5	385.5	398	423	448	460.5	485.5	510.5	523		
L <sub>2</sub>	150	162.5	187.5	212.5	225	250	275	287.5	312.5	337.5	350	375	387.5	412.5	437.5	450	475	500	512.5		
L <sub>3</sub>	122	142.5	163	183.5	204	224.5	245	265.5	286	306.5	327	347.5	368	388.5	409	429.5	450	470.5	491		
L <sub>4</sub>	22.5	18.5	21	23	19	21.5	23.5	19.5	22	24	22.5	18.5	20.5	23	19	21	23.5	19.5			
L <sub>5</sub>	97	117.5	138	158.5	179	199.5	220	240.5	261	281.5	302	322.5	343	363.5	384	404.5	425	445.5	466		

# SV Series

## Dimensions: SV4000 Series for Flat Ribbon Cable

### ● Tie-rod base manifold : SS5V4-10<sup>P</sup><sub>PH</sub> D<sub>2</sub> - (Stations)<sub>B</sub> (S, R, RS) 0<sub>2</sub><sup>C8</sup>, 0<sub>3</sub><sup>C8</sup>, 0<sub>3</sub><sup>N8</sup>, 0<sub>3</sub><sup>C10</sup>, 0<sub>3</sub><sup>N11</sup> (-D)

- When P, E port outlets are indicated on the U side or D side, the P, E ports on the opposite side are plugged.
- External pilot port positions and silencer discharge port positions are the same as P, E port outlet positions.

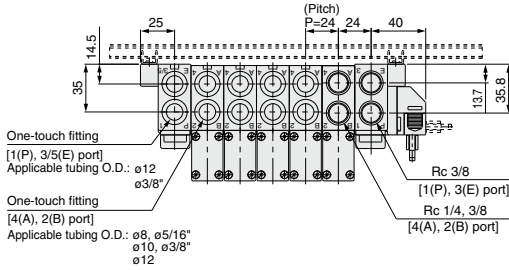

### With External Pilot Specifications

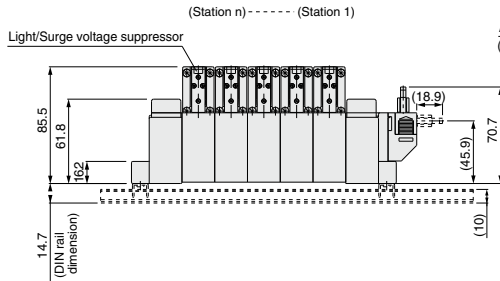
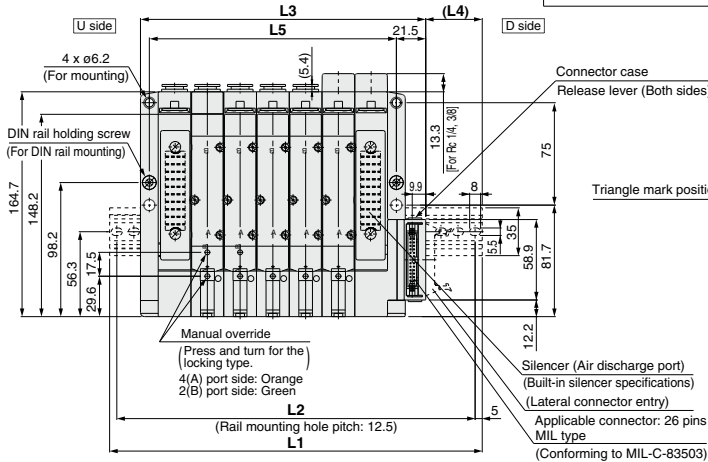
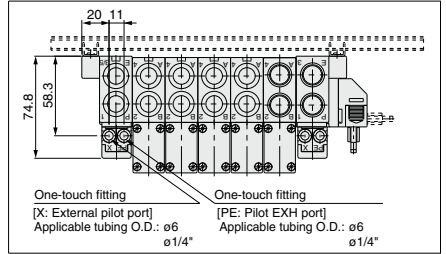

Applicable connector: 20 pins MIL type (Conforming to MIL-C-83503)

Applicable connector: 10 pins MIL type (Conforming to MIL-C-83503)

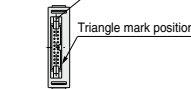

10PG (20 pins)

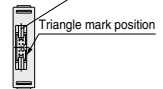

10PH (10 pins)

Refer to page 98 (compliant for D-sub connector) for dimensions with interface regulator and individual SUP/EXH spacer.

### L Dimension

n	2	3	4	5	6	7	8	9	10	11	12	13	14	15	16	17	18	19	20
L1	185.5	210.5	235.5	260.5	285.5	310.5	335.5	348	373	398	423	448	473	498	523	548	573	598	623
L2	175	200	225	250	275	300	325	337.5	362.5	387.5	412.5	437.5	462.5	487.5	512.5	537.5	562.5	587.5	612.5
L3	137	161	185	209	233	257	281	305	329	353	377	401	425	449	473	497	521	545	569
L4	31.5	31.5	31.5	31.5	31.5	31.5	31.5	31.5	31.5	31.5	31.5	31.5	31.5	31.5	31.5	31.5	31.5	31.5	31.5
L5	109	133	157	181	205	229	253	277	301	325	349	373	397	421	445	469	493	517	541

n : Stations



## Type 16: Cassette Base Manifold Exploded View

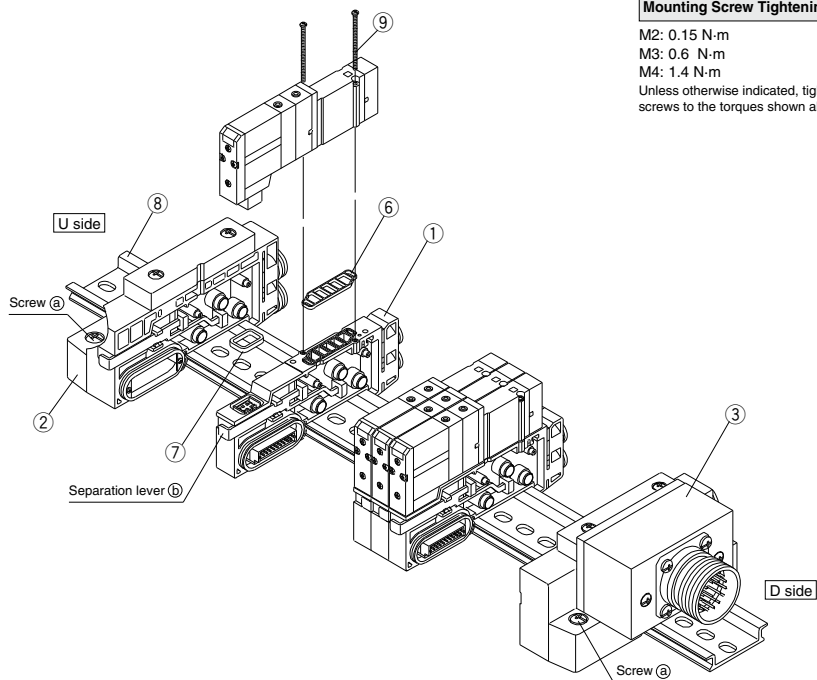

### ⚠ Caution

#### Mounting Screw Tightening Torques

M2: 0.15 N·m

M3: 0.6 N·m

M4: 1.4 N·m

Unless otherwise indicated, tighten mounting screws to the torques shown above.

③ SUP/EXH block assembly		
<p>EX500 (Type 16SA2W)</p>	<p>EX120 (Type 16S3□)</p>	
<p>Circular connector (Type 16C)</p>	<p>D-sub connector (Type 16F□)</p>	<p>For Flat ribbon cable connector (Type 16P□)</p>

① **Manifold Block Assembly Part No.**

Series	Wiring specifications	Manifold block assembly part no.	Note
SV1000	Single	SV1000-50-3A-□□	C3: With One-touch fitting for ø3.2 N1: One-touch fitting for ø1/8" C4: With One-touch fitting for ø4 N3: One-touch fitting for ø5/32" C6: With One-touch fitting for ø6 N7: One-touch fitting for ø1/4" (Gaskets ⑥ and ⑦ are included.)
	Double	SV1000-50-4A-□□	
SV2000	Single	SV2000-50-3A-□□	C4: With One-touch fitting for ø4 N3: One-touch fitting for ø5/32" C6: With One-touch fitting for ø6 N7: One-touch fitting for ø1/4" C8: With One-touch fitting for ø8 N9: One-touch fitting for ø5/16" (Gaskets ⑥ and ⑦ are included.)
	Double	SV2000-50-4A-□□	

② **SUP/EXH end block assembly** SV □ 000 – 52U – 2 A □ – □

③ **SUP/EXH block assembly** SV □ 000 – 51D □ – □ A □ – □

Series	
1	SV1000
2	SV2000

Connector entry direction  
(D-sub, flat types only)

1	Upward
2	Lateral

SUP/EXH block assembly specifications

30	For EX500 (decentralized serial)
32	For circular connector
33	D-sub connector
34	For flat ribbon cable connector (26 pins)
35	For flat ribbon cable connector (20 pins)
36	For flat ribbon cable connector (10 pins)
38	For EX120 (dedicated output serial)

\* Since EX500 and EX120 type SI units are not included, order them separately.

● **P, E port size**

C8	One-touch fitting for ø8	SV1000
N9	One-touch fitting for ø5/16"	
C10	One-touch fitting for ø10	SV2000
N11	One-touch fitting for ø3/8"	
00 <sup>Note 1)</sup>	Plug	All series
00U <sup>Note 2)</sup>		

Note 1) "00" (Plug) is not available for S, R and RS types.

Note 2) "00U" is available only for D-sub connectors and the lock bracket size is in inches.

● **Pilot specifications**

NII	Internal pilot specifications
S	Internal pilot/Built-in silencer
R	External pilot specifications
RS	External pilot/Built-in silencer

No.	Description	Part no.		Note
		SV1000	SV2000	
④	EX500 series SI unit	EX500-S0001		
⑤	EX120 series SI unit	Refer to page 70.		
⑥	Gasket	SX3000-57-4	SX5000-57-6	
⑦	Connector gasket	SX3000-146-2		
⑧	DIN rail	VZ1000-11-1-□		Refer to DIN rail dimension tables on page 123.
⑨	Round head combination screw	SX3000-22-2 (M2 x 24)	SV2000-21-1 (M3 x 30)	
		Tightening torque: 0.16 N·m	Tightening torque: 0.8 N·m	

## Type 16: Cassette Base Manifold

### How to increase manifold bases (Type 16)

- (1) Loosen the screws (a) (2 pcs. on one side) that hold the manifold base onto the DIN rail.  
(When removing the manifold base from the DIN rail, loosen the holding screws at four locations.)
- (2) Using a flat head screwdriver, etc., pull the lever (b) forward on the manifold block assembly where a station is to be added, and disconnect the manifold block assemblies.
- (3) Attach the manifold block assembly to be added to the DIN rail as shown in the figure.
- (4) Connect the block assemblies by pressing them together, and push the lever (b) in firmly until it stops.  
Then secure them to the DIN rail by tightening the screws (a).

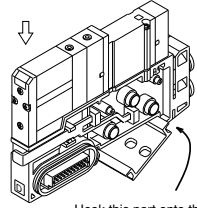

Hook this part onto the DIN rail, and press down in the direction of the arrow.

Figure. Block mounting procedure

**⚠ Caution** (Tightening torque: 1.4 N·m)

### ⚠ Caution

#### Fitting assembly replacement

By replacing manifold fitting assemblies, it is possible to change the size of the A, B ports and P, E ports. To replace them, Remove the clip with a flat head screwdriver, etc., and pull out the fitting assembly. Mount the new fitting assembly by inserting it and then replacing the clip to its fully inserted position.

#### Fitting Assembly Part No.

		Port size	SV1000	SV2000
A, B Port		One-touch fitting for ø3.2	VVQ1000-50A-C3	—
		One-touch fitting for ø4	VVQ1000-50A-C4	VVQ1000-51A-C4
		One-touch fitting for ø6	VVQ1000-50A-C6	VVQ1000-51A-C6
		One-touch fitting for ø8	—	VVQ1000-51A-C8
		One-touch fitting for ø1/8"	VVQ1000-50A-N1	—
		One-touch fitting for ø5/32"	VVQ1000-50A-N3	VVQ1000-51A-N3
		One-touch fitting for ø1/4"	VVQ1000-50A-N7	VVQ1000-51A-N7
		One-touch fitting for ø5/16"	—	VVQ1000-51A-N9
P, E Port		One-touch fitting for ø8	VVQ1000-51A-C8	—
		One-touch fitting for ø10	—	VVQ2000-51A-C10
		One-touch fitting for ø5/16"	VVQ1000-51A-N9	—
		One-touch fitting for ø3/8"	—	VVQ2000-51A-N11

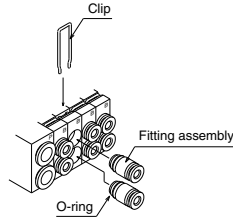

Note 1) Be careful to avoid damage or contamination of O-rings, as this can cause air leakage.

Note 2) When removing a fitting assembly from a valve, after removing the clip, attach tubing or a plug (KQ2P-□□) to the One-touch fitting, and pull it out while holding the tubing (or plug). If it is pulled out while holding the release button of the fitting assembly (resin part), the release button may be damaged.

Note 3) Be sure to shut off the power and air supplies before disassembly. Furthermore, since air may remain inside the actuator, piping and manifold, confirm that the air is completely exhausted before performing any work.

■ How to order cassette base type 16 solenoid valves with manifold block

[SV1000/SV2000 Series]

• Type with manifold block is used when adding stations, etc.

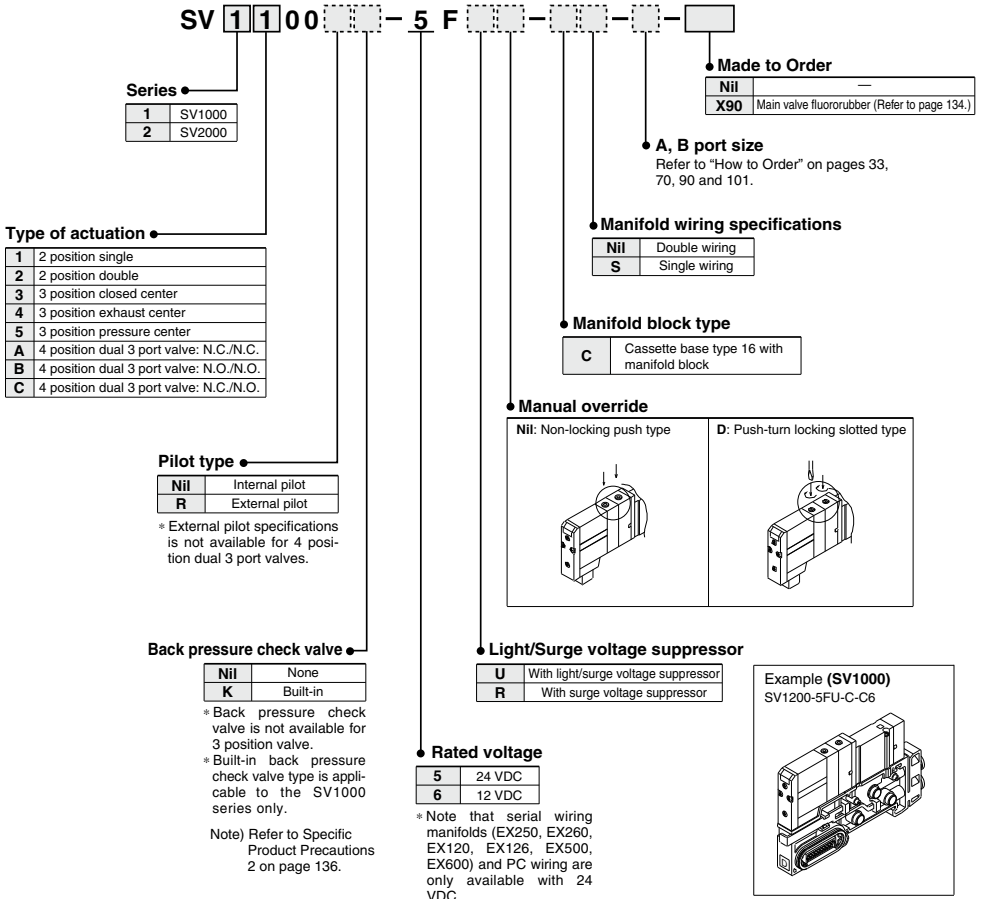

## Type 10: Tie-rod Base Manifold Exploded View

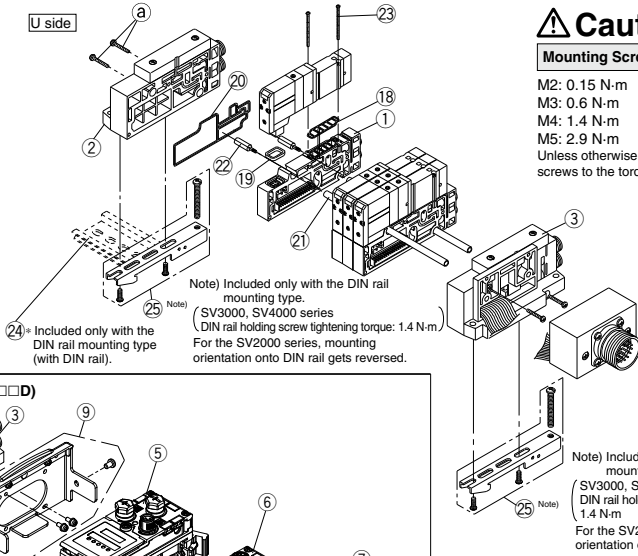

### EX600 (Type 10S6□□□D)

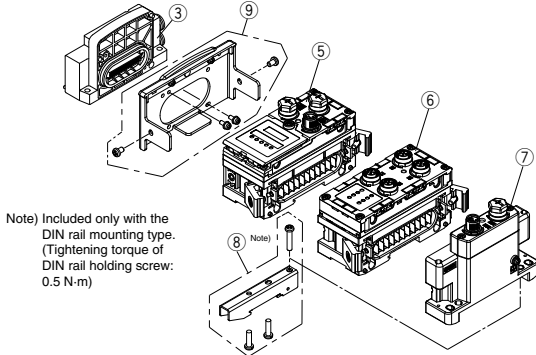

### EX500 (Type 10S1□□D)

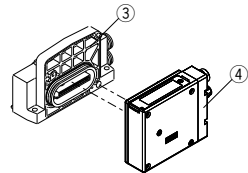

### EX250 (Type 10S1□W)

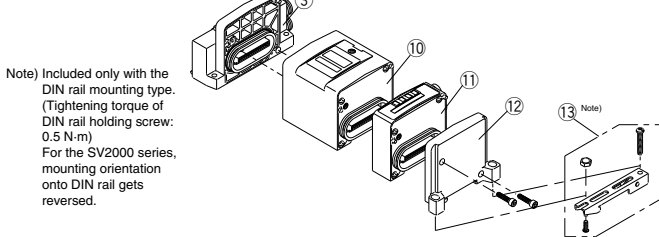

### Circular connector (Type 10C)

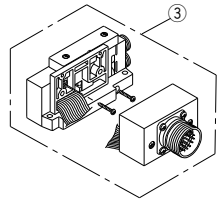

### EX500 (Type 10SA□W)

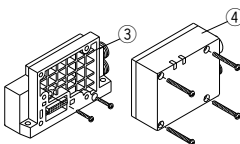

### EX260 (Type 10S1□□D)

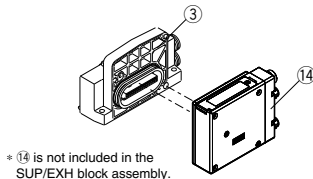

### D-sub connector (Type 10F)

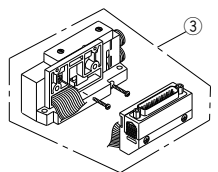



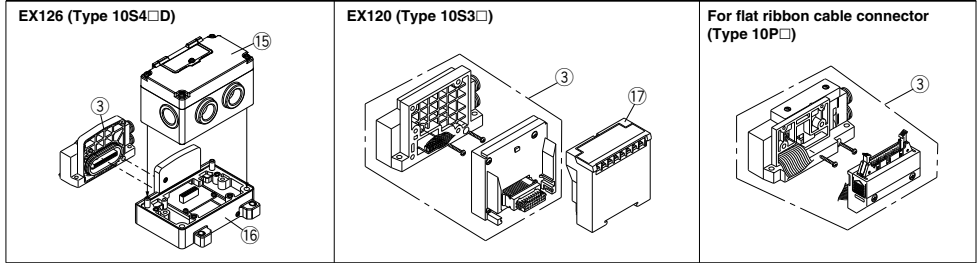

① Manifold Block Assembly Part No.

Series	Wiring specifications	Manifold block assembly part no.	Note
SV1000	Single	SV1000-50-1A-□□	C3: With ø3.2 One-touch fitting N1: ø1/8" One-touch fitting
	Double	SV1000-50-2A-□□	C4: With ø4 One-touch fitting N3: ø5/32" One-touch fitting C6: With ø6 One-touch fitting N7: ø1/4" One-touch fitting (Tie-rod for station additions ② and gaskets ⑬, ⑭, and ⑯ are included.)
SV2000	Single	SV2000-50-1A-□□	C4: With ø4 One-touch fitting N3: ø5/32" One-touch fitting
	Double	SV2000-50-2A-□□	C6: With ø6 One-touch fitting N7: ø1/4" One-touch fitting C8: With ø8 One-touch fitting N9: ø5/16" One-touch fitting (Tie-rod for station additions ② and gaskets ⑬, ⑭, and ⑯ are included.)
SV3000	Single	SV3000-50-1A-□□	C6: With ø6 One-touch fitting N7: ø1/4" One-touch fitting
	Double	SV3000-50-2A-□□	C8: With ø8 One-touch fitting N9: ø5/16" One-touch fitting C10: With ø10 One-touch fitting N11: ø3/8" One-touch fitting (Tie-rod for station additions ② and gaskets ⑬, ⑭, and ⑯ are included.)
SV4000	Single	SV4000-50-1A-□□	C8: With ø8 One-touch fitting N9: ø5/16" One-touch fitting
	Double	SV4000-50-2A-□□	C10: With ø10 One-touch fitting N11: ø3/8" One-touch fitting C12: With ø12 One-touch fitting O2: Rc 1/4 O2N: NPT 1/4 O3: Rc 3/8 O3N: NPT 3/8 O2F: G1/4 O2T: NPTF 1/4 O3F: G3/8 O3T: NPTF 3/8 (Tie-rod for station additions ② and gaskets ⑬, ⑭, and ⑯ are included.)

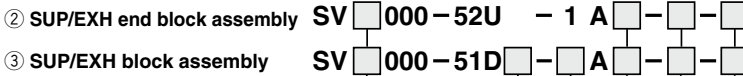

Series

1	SV1000
2	SV2000
3	SV3000
4	SV4000

Connector entry direction  
(D-sub, flat types only)

1	Upward
2	Lateral

Mounting

Nil	Direct mounting
DO	DIN rail mounting

SUP/EXH block assembly specifications

10	For EX600 (Gateway Decentralized System) For EX500 (Gateway Decentralized System 2) For EX600
11	For EX250 For EX260 For EX126
12	For circular connector
13	D-sub connector
14	For flat ribbon cable connector (26 pins)
15	For flat ribbon cable connector (20 pins)
16	For flat ribbon cable connector (10 pins)
18	For EX120 (dedicated output serial)

Pilot type

Nil	Internal pilot
S	Internal pilot/Built-in silencer
R	External pilot
RS	External pilot/Built-in silencer

P, E port size

C8	ø8 One-touch fitting	SV1000
N9	ø5/16" One-touch fitting	
C10	ø10 One-touch fitting	SV2000
N11	ø3/8" One-touch fitting	
C12	ø12 One-touch fitting	SV3000
N11	ø3/8" One-touch fitting	SV4000
O3	Rc 3/8	
O3F	G 3/8	SV4000
O3N	NPT 3/8	
O3T	NPTF 3/8	
00	Note 1) Plug	
00U	Note 2) Plug	All series

Note 1) "00" (Plug) is not available for S, R and RS types.  
Note 2) "00U" is available only for D-sub connectors and the lock bracket size is in inches.

\* Since EX500, EX600, EX250, EX260, EX126 and EX120 type SI units are not included, order them separately.

## Type 10: Tie-rod Base Manifold Exploded View

No.	Description	Part no.				Note	
		SV1000	SV2000	SV3000	SV4000		
4	EX500 series SI unit		Refer to page 28.			Gateway Decentralized System 2 (128 points)	
			Refer to page 33.			Gateway Decentralized System (64 points)	
			EX600-SDN1A			DeviceNet® PNP (Negative common)	
			EX600-SDN2A			DeviceNet® NPN (Positive common)	
			EX600-SMJ1			CC-Link PNP (Negative common)	
			EX600-SMJ2			CC-Link NPN (Positive common)	
			EX600-SPR1A			PROFIBUS DP PNP (Negative common)	
			EX600-SPR2A			PROFIBUS DP NPN (Positive common)	
			EX600-SEN3			EtherNet/IP™ (2 port) PNP (Negative common)	
			EX600-SEN4			EtherNet/IP™ (2 port) NPN (Positive common)	
			EX600-SPN1			PROFINET PNP (Negative common)	
			EX600-SPN2			PROFINET NPN (Positive common)	
			EX600-WEN1 <sup>Note 2)</sup>			Wireless base module EtherNet/IP™ PNP (Negative common)	
			EX600-WEN2 <sup>Note 2)</sup>			Wireless base module EtherNet/IP™ NPN (Positive common)	
			EX600-WPN1 <sup>Note 2)</sup>			Wireless base module PROFINET PNP (Negative common)	
			EX600-WPN2 <sup>Note 2)</sup>			Wireless base module PROFINET NPN (Positive common)	
			EX600-WSV1 <sup>Note 2)</sup>			Wireless remote module PNP (Negative common)	
			EX600-WSV2 <sup>Note 2)</sup>			Wireless remote module NPN (Positive common)	
	EX600 series digital input unit		EX600-DXNB			NPN input M12 connector 5 pins (4 pcs.) 8 inputs	
			EX600-DXPB			PNP input M12 connector 5 pins (4 pcs.) 8 inputs	
			EX600-DXNC			NPN input M8 connector 3 pins (8 pcs.) 8 inputs	
			EX600-DXNC1			NPN input M8 connector 3 pins (8 pcs.) 8 inputs, with open circuit detection	
			EX600-DXPC			PNP input M8 connector 3 pins (8 pcs.) 8 inputs	
			EX600-DXPC1			PNP input M8 connector 3 pins (8 pcs.) 8 inputs, with open circuit detection	
			EX600-DXND			NPN input M12 connector 5 pins (8 pcs.) 16 inputs	
			EX600-DXPD			PNP input M12 connector 5 pins (8 pcs.) 16 inputs	
			EX600-DXNE			NPN input D-sub connector 25 pins 16 inputs	
			EX600-DXPE			PNP input D-sub connector 25 pins 16 inputs	
			EX600-DXNF			NPN input spring type terminal block 32 pins 16 inputs	
			EX600-DXPF			PNP input spring type terminal block 32 pins 16 inputs	
			EX600-DYNB			NPN output M12 connector 5 pins (4 pcs.) 8 outputs	
			EX600-DYPB			PNP output M12 connector 5 pins (4 pcs.) 8 outputs	
			EX600-DYNE			NPN output D-sub connector 25 pins 16 outputs	
			EX600-DYPE			PNP output D-sub connector 25 pins 16 outputs	
			EX600-DYNF			NPN output spring type terminal block 32 pins 16 outputs	
			EX600-DYPE			PNP output spring type terminal block 32 pins 16 outputs	
		EX600 series digital input/output unit		EX600-DMNE			NPN input/output D-sub connector 25 pins 8 inputs/outputs
				EX600-DMPE			PNP input/output D-sub connector 25 pins 8 inputs/outputs
				EX600-DMNF			NPN input/output spring type terminal block 32 pins 8 inputs/outputs
	EX600 series analog input unit		EX600-AXA			M12 connector 5 pins (2 pcs.), 2-channel input	
		EX600 series analog output unit		EX600-AYA			M12 connector 5 pins (2 pcs.), 2-channel output
	EX600 series analog input/output unit			EX600-AMB			M12 connector 5 pins (4 pcs.), 2-channel input/output
		7 End plate for EX600 series		EX600-ED2			M12 power supply connector, B-coded
			EX600-ED2-2			M12 power supply connector, B-coded, with DIN rail mounting bracket	
			EX600-ED3			7/8 inch power supply connector	
			EX600-ED3-2			7/8 inch power supply connector, with DIN rail mounting bracket	
			EX600-ED4			M12 power supply connector IN/OUT, A-coded, Pin arrangement 1	
			EX600-ED4-2			M12 power supply connector IN/OUT, A-coded, Pin arrangement 1, with DIN rail mounting bracket	
			EX600-ED5			M12 power supply connector IN/OUT, A-coded, Pin arrangement 2	
			EX600-ED5-2			M12 power supply connector IN/OUT, A-coded, Pin arrangement 2, with DIN rail mounting bracket	
8	Clamp assembly for EX600		EX600-ZMA2			With mounting screws (M4 x 20 1 pc., M4 x 12 2 pcs.)	
9	Valve plate for EX600		EX600-ZMV1			Enclosed parts: round head screws (M4 x 6) 2 pcs., round head screws (M3 x 8) 4 pcs.	
10	EX250 series SI unit		Refer to page 42.			M12, 2 inputs	
			EX250-IE1			M12, 4 inputs	
			EX250-IE2			M8, 4 inputs (3 pins)	
			EX250-IE3			With mounting screws (M3 x 10, 2 pcs.)	
12	EX250 series end plate assembly		EX250-EA1				
13	For EX250 clamp assembly		SV1000-78A				
14	EX260 series SI unit		Refer to page 58.				
15	EX126 series SI unit		Refer to page 64.				
16	Terminal block plate		VVQC1000-74A-2			For mounting EX126 SI unit	
17	EX120 series SI unit		Refer to page 70.				
18	Gasket	SX3000-57-4	SX5000-57-6	SX7000-57-5	SY9000-11-2		
19	Connector gasket	SX3000-146-2	SX3000-146-2	SX3000-146-2	SX3000-146-2		
20	Manifold block gasket	SV3000-181-1	SX5000-138-1	SV3000-65-1	SV4000-65-2		
21	Tie-rod	SV1000-55-1-□□	SV2000-55-1-□□	SV3000-55-1-□□	SV4000-55-1-□□	□□: Manifold stations	
22	Tie-rod for station addition	SV1000-55-2-1	SV2000-55-2A	SV3000-55-2A	SV4000-55-2A		
23	Round head combination screw (Valve mounting screw)	SX3000-22-2 (M2 x 24)	SV2000-21-1 (M3 x 30)	SV3000-21-1 (M4 x 35)	SV2000-21-2 (M3 x 40)		
24	DIN rail	VZ1000-11-1-□	VZ1000-11-1-□	VZ1000-11-4-□	VZ1000-11-4-□	Refer to DIN rail dimension tables on page 123.	
25	Clamp assembly	SV1000-69A	SV1000-69A	SV3000-69A			
	Clamp assembly for EX600	SV1000-69A	SV2000-75A	SV3000-69A			

Note 1) Two pieces of □ and □□ (tie-rod) are required for the SV1000 series, and three pieces are required for the SV2000, 3000 and 4000 series.  
Two pieces of □□ (valve mounting screw) are required for the SV1000, 2000 and 3000 series, and three pieces are required for the SV4000 series.

Note 2) The wireless system is suitable for use only in a country where it is in accordance with the Radio Act and regulations of that country.



## Type 10: Tie-rod Base Manifold

### How to increase manifold bases (Type 10)

- (1) Loosen the U side screws (a), and remove the SUP/EXH end block assembly (2).

- (2) Screw in the tie-rods (14) for station addition.  
(Screw them in until there is no gap between the tie-rods.)

- (3) Connect the manifold assembly (1) and supply/exhaust end block assembly (2) to be added, and tighten the screws (a).

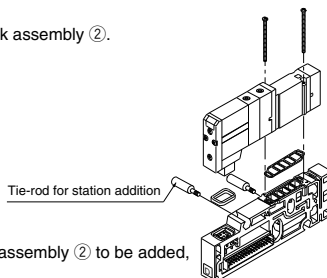

**⚠ Caution** Tightening torques (a)

SV1000, SV2000	0.6 N·m
SV3000	1.4 N·m
SV4000	2.9 N·m

Note) When eliminating manifold stations, the appropriate tie-rods (13) for the desired change should be ordered separately.  
(When equipped with a DIN rail, be sure to tighten the DIN rail holding screws after tightening the tension bolts.)

### ⚠ Caution

#### Fitting Assembly Replacement

By replacing manifold fitting assemblies, it is possible to change the size of the A, B ports and P, E ports. To replace them, remove the clip with a flat head screwdriver, etc., and pull out the fitting assembly. Mount the new fitting assembly by inserting it and then replacing the clip to its fully inserted position.

#### Fitting Assembly Part No.

Port size		SV1000	SV2000	SV3000	SV4000
A, B Port	One-touch fitting for ø3.2	VVQ1000-50A-C3	—	—	—
	One-touch fitting for ø4	VVQ1000-50A-C4	VVQ1000-51A-C4	—	—
	One-touch fitting for ø6	VVQ1000-50A-C6	VVQ1000-51A-C6	VVQ2000-51A-C6	—
	One-touch fitting for ø8	—	VVQ1000-51A-C8	VVQ2000-51A-C8	VVQ4000-50B-C8
	One-touch fitting for ø10	—	—	VVQ2000-51A-C10	VVQ4000-50B-C10
	One-touch fitting for ø12	—	—	—	VVQ4000-50B-C12
	One-touch fitting for ø1/8"	VVQ1000-50A-N1	—	—	—
	One-touch fitting for ø5/32"	VVQ1000-50A-N3	VVQ1000-51A-N3	—	—
	One-touch fitting for ø1/4"	VVQ1000-50A-N7	VVQ1000-51A-N7	VVQ2000-51A-N7	—
	One-touch fitting for ø5/16"	—	VVQ1000-51A-N9	VVQ2000-51A-N9	VVQ4000-50B-N9
One-touch fitting for ø3/8"	—	—	VVQ2000-51A-N11	VVQ4000-50B-N11	
1/4 threaded type port block assembly	—	—	—	SY9000-58A-02□	
3/8 threaded type port block assembly	—	—	—	SY9000-58A-03□	
P, E Port	One-touch fitting for ø8	VVQ1000-51A-C8	—	—	—
	One-touch fitting for ø10	—	VVQ2000-51A-C10	—	—
	One-touch fitting for ø12	—	—	VVQ4000-50B-C12	VVQ4000-50B-C12
	One-touch fitting for ø5/16"	VVQ1000-51A-N9	—	—	—
	One-touch fitting for ø3/8"	—	VVQ2000-51A-N11	VVQ4000-50B-N11	VVQ4000-50B-N11
3/8 threaded type port block assembly	—	—	—	SY9000-58B-03□	

■ 1/4, 3/8 thread type port block assembly

For A, B port

**SY9000-58A-02** 

For P, E port

**SY9000-58B-03** 



● Thread type

Nil	Rc
F	G
N	NPT
T	NPTF

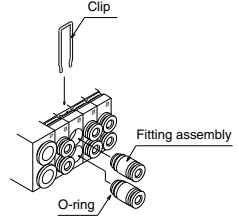

- Note 1) Be careful to avoid damage or contamination of O-rings, as this can cause air leakage.  
 Note 2) When removing a fitting assembly from a valve, after removing the clip, attach tubing or a plug (KQP-□□) to the One-touch fitting, and pull it out while holding the tubing (or plug). If it is pulled out while holding the release button of the fitting assembly (resin part), the release button may be damaged. However, 02 and 03 port block assemblies should be pulled out as they are.  
 Note 3) Be sure to shut off the power and air supplies before disassembly. Furthermore, since air may remain inside the actuator, piping and manifold, confirm that the air is completely exhausted before performing any work.

■ How to order tie-rod type 10 solenoid valves with manifold block

[SV1000 to SV4000 series]

● Type with manifold block is used when adding stations, etc.

SV **1** **1** 00  - 5 F  -  -  -  - 

Series ●

1	SV1000
2	SV2000
3	SV3000
4	SV4000

Type of actuation ●

1	2 position single
2	2 position double
3	3 position closed center
4	3 position exhaust center
5	3 position pressure center
A	4 position dual 3 port valve: N.C./N.C.
B	4 position dual 3 port valve: N.O./N.O.
C	4 position dual 3 port valve: N.C./N.O.

\*4 position dual 3 port valves are applicable to the SV1000 and SV2000 series only.

Pilot type ●

Nil	Internal pilot
R	External pilot

\* External pilot specifications is not available for 4 position dual 3 port valves.

Back pressure check valve ●

Nil	None
K	Built-in

- \* Built-in back pressure check valve type is applicable to the SV1000 series only.
- \* Back pressure check valve is not available for 3 position valve.

(Note) Refer to Specific Product Precautions 2 on page 136.

● A, B port size

Refer to "How to Order" on pages 33, 42, 64, 70, 90 and 101.

● Manifold wiring specifications

Nil	Double wiring
S	Single wiring

Made to Order ●

Nil	—
X90	Main valve fluororubber (Refer to page 134.)

● Manifold block type

T	For Tie-rod base type 10 with manifold block
---	--

Note) Tie-rod type 10 includes tie-rods for station additions.

● Manual override

Nil: Non-locking push type

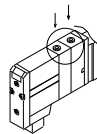

D: Push-turn locking slotted type

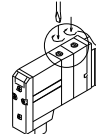

● Light/Surge voltage suppressor

U	With light/surge voltage suppressor
R	With surge voltage suppressor

● Rated voltage

5	24 VDC
6	12 VDC

\* Note that serial wiring (EX500, EX250 and EX12□) are only available with 24 VDC.

Example (SV1000)  
SV1200-5FU-T-C6

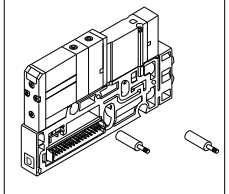

# Manifold Options (Common for Type 16 and 10)

## Relay output module

By adding a relay output module to a SV series manifold, devices up to 110 VAC, 3 A (large type solenoid valves, etc.) can be controlled together with the SV series valves.

### How to Order

SV    000-60-5 A-1A

Series ●

1	SV1000
2	SV2000
3	SV3000
4	SV4000

● No. of output point

A	1 output
B	2 outputs

● Rated voltage

5	24 VDC
6	12 VDC

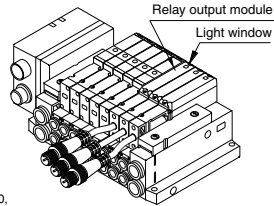

\* Note that serial wiring manifolds (EX500, EX250 and EX12□) are available with 24 VDC only.

## Relay Output Module Specifications

Item	Specifications			
No. of output points	1 output [connector with lead wire (M12)]		2 outputs [connector with lead wire (M12)]	
Output type	<p>Contact type ("a" contact)</p>		<p>Contact type ("a" contact)</p>	
Load voltage	110 VAC	30 VDC	110 VAC	30 VDC
Load current	3 A	3 A	0.3 A	1 A
Indicator light	Red			
Enclosure	Based on IP67 (IEC60529)			
Current consumption	20 mA or less			
Polarity	Non-polar			
weight (g)	48			

## Connection Destination (Female Side) Connector Cable

Connector size	pin	Manufacturer	Applicable series
M12	4	Correns Corp.	VA-4D
		OMRON Corp.	XS2
		Azbil Corp.	PA5-41
		HIROSE ELECTRIC CO., LTD.	HR24
		DDK Ltd.	CM01-8DP4S

\* This connector is a female connector for ① relay output module and ② single unit/sub-plate.

## Manifold Options

### ■ Blanking plate assembly

Used in situations where valves will be added in the future or for maintenance.

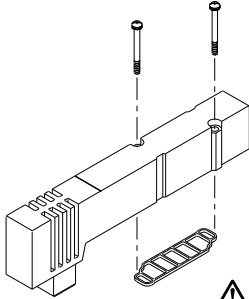

Series	Blanking plate assembly part no.
SV1000	SV1000-67-1A
SV2000	SV2000-67-1A
SV3000	SV3000-67-1A
SV4000	SV4000-67-1A

### ⚠ Caution

**Mounting screw  
tightening torques**

M2: 0.16 N·m  
M3: 0.8 N·m  
M4: 1.4 N·m

### ■ SUP/EXH block disk

[SUP block disk]

By placing a SUP block disk in a manifold valve's pressure supply passage, two different high and low pressures can be supplied to one manifold.

[EXH block disk]

By installing an EXH block disk in a manifold valve's exhaust passage, the valve's exhaust can be separated so that it will not affect other valves. It can also be used on a manifold with mixed positive pressure and vacuum.

(Two pieces are required to block EXH on both sides. However, the SV1000 and 2000 series type 10 manifolds require only one piece.)

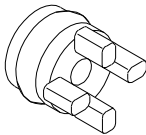

Cassette base type 16

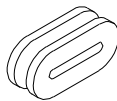

Tie-rod base type 10

Series	Manifold Model	SUP block disk	EXH block disk
SV1000	10	SV1000-59-1A	SV1000-59-2A
	16	SX3000-77-1A	SX3000-77-1A
SV2000	10	SV2000-59-1A	SV2000-59-2A
	16	SV2000-59-3A	SV2000-59-3A
SV3000	10	SV3000-59-1A	SV3000-59-1A
SV4000	10	SY9000-57-1A	SY9000-57-1A

### ■ Label for block disk

These labels are attached to manifolds in which SUP and EXH block disks have been installed, in order to identify the installed locations. (Three sheets each included.)

#### SV1000-74-1A

Label for SUP  
block disk



Label for EXH  
block disk



Label for SUP/EXH  
block disk



\* When a block disk is concurrently ordered by specifying on the manifold specification sheet, etc., a label will be stuck on the position where block disk is mounted.

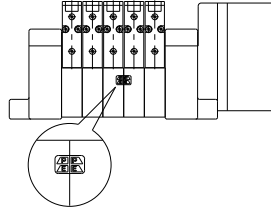

### ■ Silencer (Compact resin type/One-touch fitting connection)

#### AN10-C to AN30-C

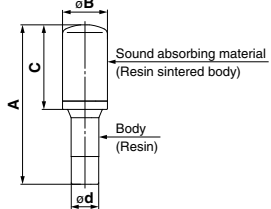

#### Dimensions

Series	Model	A	B	C	$\phi d$
SV1000 (For $\phi 8$ )	AN15-C08	4.5	13	20	$\phi 8$
SV2000 (For $\phi 10$ )	AN20-C10	57.5	16.5	30.5	$\phi 10$
SV3000, SV4000 (For $\phi 12$ )	AN30-C12	71.5	20	43.5	$\phi 12$

### ■ Plug

These are inserted in unused cylinder ports and P, E ports.

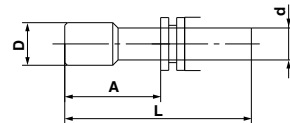

Applicable fitting size d	Model	A	L	D
$\phi 4$	KQ2P-04	16	32	$\phi 6$
$\phi 6$	KQ2P-06	18	35	$\phi 8$
$\phi 8$	KQ2P-08	20.5	39	$\phi 10$
$\phi 10$	KQ2P-10	22	43	$\phi 12$
$\phi 12$	KQ2P-12	24	44.5	$\phi 14$
$\phi 1/8"$	KQ2P-01	16	31.5	$\phi 5$
$\phi 5/32"$	KQ2P-03	16	32	$\phi 6$
$\phi 1/4"$	KQ2P-07	18	35	$\phi 8.5$
$\phi 5/16"$	KQ2P-09	20.5	39	$\phi 10$
$\phi 3/8"$	KQ2P-11	22	43	$\phi 11.5$

## Manifold Options

### ■ Circular connector/Cable assembly (26 pins)

#### AXT100 – MC26 – □

##### Lead Wire Length

Part no.	L dimension
AXT100-MC26-015	1.5 m
AXT100-MC26-030	3 m
AXT100-MC26-050	5 m

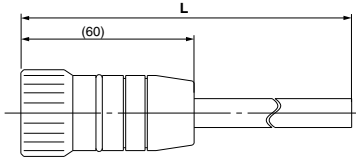

Plug terminal no.  
(arrangement as seen from lead wire side)

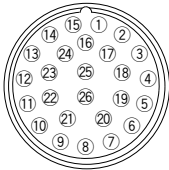

### Circular Connector Cable Assembly Terminal No.

Terminal no.	Lead wire color	Dot marking
①	Black	None
②	Brown	None
③	Red	None
④	Orange	None
⑤	Yellow	None
⑥	Pink	None
⑦	Blue	None
⑧	Purple	White
⑨	Gray	Black
⑩	White	Black
⑪	White	Red
⑫	Yellow	Red
⑬	Orange	Red
⑭	Yellow	Black
⑮	Pink	Black
⑯	Blue	White
⑰	Purple	None
⑱	Gray	None
⑲	Orange	Black
⑳	Red	White
㉑	Brown	White
㉒	Pink	Red
㉓	Gray	Red
㉔	Black	White
㉕	White	None

Note) Terminal no. ㉕ is connected to ㉓ inside the connector.

### ■ D-sub connector/Cable assembly (25 pins)

#### AXT100 – DS25 – □

##### Lead Wire Length

Part no.	L dimension
AXT100-DS25-015	1.5 m
AXT100-DS25-030	3 m
AXT100-DS25-050	5 m

When a commercially available connector is required, use a 25 pin female connector conforming to MIL-C24308.

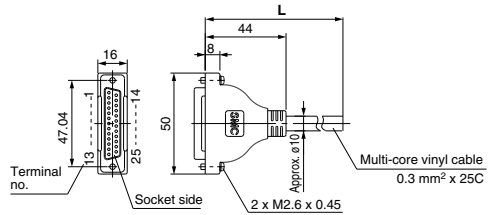

### D-sub Connector Cable Assembly Terminal No.

Terminal no.	Lead wire color	Dot marking
①	Black	None
②	Brown	None
③	Red	None
④	Orange	None
⑤	Yellow	None
⑥	Pink	None
⑦	Blue	None
⑧	Purple	White
⑨	Gray	Black
⑩	White	Black
⑪	White	Red
⑫	Yellow	Red
⑬	Orange	Red
⑭	Yellow	Black
⑮	Pink	Black
⑯	Blue	White
⑰	Purple	None
⑱	Gray	None
⑲	Orange	Black
⑳	Red	White
㉑	Brown	White
㉒	Pink	Red
㉓	Gray	Red
㉔	Black	White
㉕	White	None

### Circular Connector, D-sub Connector Cable Assembly Electric Characteristics

Item	Characteristics
Conductor resistance $\Omega/\text{km}$ , 20°C	65 or less
Withstand voltage VAC, 1 min.	1000
Insulation resistance, M $\Omega/\text{km}$ , 20°C	5 or less

Note) The minimum inside bending radius for each cable is 20 mm.



## Manifold Options

### ■ Flat ribbon cable/Cable assembly

**AXT100 – FC** □ – □

Cable length (L)	10 pins	20 pins	26 pins
1.5 m	AXT100-FC10-1	AXT100-FC20-1	AXT100-FC26-1
3 m	AXT100-FC10-2	AXT100-FC20-2	AXT100-FC26-2
5 m	AXT100-FC10-3	AXT100-FC20-3	AXT100-FC26-3
Connector width (W)	17.2	30	37.5

\* For other commercial connectors, use a type with strain relief conforming to MIL-C-83503.

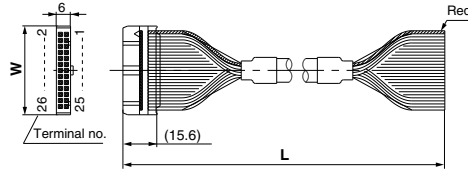

Connector manufacturers' example

- HIROSE ELECTRIC CO., LTD.
- 3M Japan Limited
- Fujitsu Limited
- Japan Aviation Electronics Industry, Limited
- J.S.T. Mfg. Co., Ltd.

### ■ Connector cable for M12 waterproof connector (Female side)

Connector manufacturers' example  
Correns Corp.  
OMRON Corp.  
Azbil Corp.  
HIROSE ELECTRIC CO., LTD.  
DDK Ltd.

### ■ SV1000/2000 and the EX500 series input unit DIN rail dimensions and mass

**VZ1000 – 11 – 1 –** □

\* As for □, enter the number from the DIN rail dimensions table.

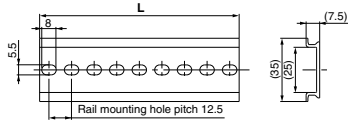

No.	0	1	2	3	4	5	6	7	8	9
L dimension	98	110.5	123	135.5	148	160.5	173	185.5	198	210.5
Mass (g)	17.6	19.9	22.1	24.4	26.6	28.9	31.1	33.4	35.6	37.9
No.	10	11	12	13	14	15	16	17	18	19
L dimension	223	235.5	248	260.5	273	285.5	298	310.5	323	335.5
Mass (g)	40.1	42.4	44.6	46.9	49.1	51.4	53.6	55.9	58.1	60.4
No.	20	21	22	23	24	25	26	27	28	29
L dimension	348	360.5	373	385.5	398	410.5	423	435.5	448	460.5
Mass (g)	62.5	64.9	67.1	69.4	71.6	73.9	76.1	78.4	80.6	82.9
No.	30	31	32	33	34	35	36	37	38	39
L dimension	473	485.5	498	510.5	523	535.5	548	560.5	573	585.5
Mass (g)	85.1	87.4	89.6	91.9	94.1	96.4	98.6	100.9	103.1	105.4
No.	40	41	42	43	44	45	46	47	48	49
L dimension	598	610.5	623	635.5	648	660.5	673	685.5	698	710.5
Mass (g)	107.6	109.9	112.1	114.4	116.6	118.9	121.1	123.4	125.6	127.9
No.	50	51	52	53	54	55	56	57	58	59
L dimension	723	735.5	748	760.5	773	785.5	798	810.5	823	835.5
Mass (g)	130.1	132.4	134.6	136.9	139.1	141.4	143.6	145.9	148.1	150.4
No.	60	61	62	63	64	65	66	67	68	69
L dimension	848	860.5	873	885.5	898	910.5	923	935.5	948	960.5
Mass (g)	152.6	154.9	157.1	159.4	161.6	163.9	166.1	168.4	170.6	172.9
No.	70	71								
L dimension	973	985.5								
Mass (g)	175.1	177.4								

### ■ SV3000 and 4000 DIN rail dimensions and mass

**VZ1000 – 11 – 4 –** □

\* As for □, enter the number from the DIN rail dimensions table.

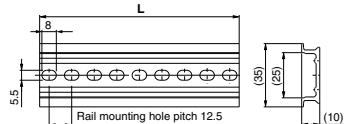

No.	0	1	2	3	4	5	6	7	8	9	10	11	12	13	14	15	16	17	18	19	20
L dimension	98	110.5	123	135.5	148	160.5	173	185.5	198	210.5	223	235.5	248	260.5	273	285.5	298	310.5	323	335.5	348
Mass (g)	24.8	28	31.1	34.3	37.4	40.6	43.8	46.9	50.1	53.3	56.4	59.6	62.7	65.9	69.1	72.2	75.4	78.6	81.7	84.9	88
No.	21	22	23	24	25	26	27	28	29	30	31	32	33	34	35	36	37	38	39	40	41
L dimension	360.5	373	385.5	398	410.5	423	435.5	448	460.5	473	485.5	498	510.5	523	535.5	548	560.5	573	585.5	598	610.5
Mass (g)	91.2	94.4	97.5	100.7	103.9	107	110.2	113.3	116.5	119.7	122.8	126	129.2	132.3	135.5	138.6	141.8	145	148.1	151.3	154.5
No.	42	43	44	45	46	47	48	49	50	51	52	53	54	55	56	57	58	59	60	61	62
L dimension	623	635.5	648	660.5	673	685.5	698	710.5	723	735.5	748	760.5	773	785.5	798	810.5	823	835.5	848	860.5	873
Mass (g)	157.6	160.8	163.9	167.1	170.3	173.4	176.6	179.8	182.9	186.1	189.2	192.4	195.6	198.7	201.9	205.1	208.2	211.4	214.5	217.7	220.9
No.	63	64	65	66	67	68	69	70	71												
L dimension	885.5	898	910.5	923	935.5	948	960.5	973	985.5												
Mass (g)	224	227.2	230.4	233.5	236.7	239.8	243	246.2	249.3												

# SV Series

## Manifold Options

### Interface Regulator How to Order Interface Regulator

#### SV1000 Series

SV1 0 00 - 05 - P

#### Applicable valve Note 3)

0	For single, double, 4 position
3	For 3 position

#### Pressure gauge option Note 1)

M1	Without pressure gauge
05	With MPa indication pressure gauge [For odd number station]
06	With MPa indication pressure gauge [For even number station]
N5	With psi indication pressure gauge [For odd number station]
N6	With psi indication pressure gauge [For even number station]

Note 2)

Note 2)

#### Regulating port

P	P port
A1	A port (P controlled type, A port regulation)
B1	B port (P controlled type, B port regulation)

#### SV2000/3000/4000 Series

SV 2 000 - 00 - P

#### Series

2	SV2000
3	SV3000
4	SV4000

#### Regulating port

P	P port
A1	A port (P controlled type, A port regulation)
B1	B port (P controlled type, B port regulation)

Note 1) 1(P) port pressure regulation is only available for 3-position closed center and pressure closed center, and 4-position dual 3-port valves.

#### Pressure gauge option

M1	Without pressure gauge
00	With MPa indication pressure gauge
N0	With psi indication pressure gauge

Note 2)

Note 1) In the case of the SV1000 series with a pressure gauge when mounting on the manifold, use caution that the part numbers are different between the odd no. stations and the even no. stations to avoid pressure gauges from interfering from each others.

Note 2) The units with the psi indication are sold only overseas according to the new measurement law in Japan.

Note 3) Use caution that the part numbers will differ depending on the one for single/double and 4- and 3-position due to the different length of solenoid valves. Also, if the one for 3 position is included in the same manifold, use all the ones for 3-position.

SV1000-05/N5-□  
(For mounting odd number stations)

SV1000-06/N6-□  
(For mounting even number stations)

SV1000-M1-□

SV2000-00/N0-□

SV2000-M1-□

SV3000-00/N0-□

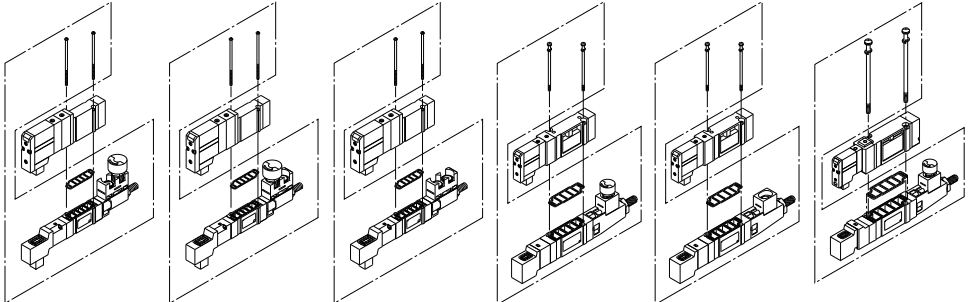

SV3000-M1-□

SV4000-00/N0-□

SV4000-M1-□

#### Symbol

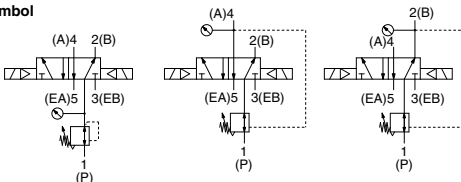

#### Accessory

Series	Round head combination screw	Gasket
SV1000	SX3000-22-9 (M2 x 39.5)	SX3000-57-4
SV2000	SV2000-21-7 (M3 x 53)	SX5000-57-6
SV3000	SV3000-21-4 (M4 x 57)	SX7000-57-5
SV4000	SV2000-21-8 (M3 x 69.5)	SY9000-11-2

### ⚠ Caution

#### Mounting Screw Tightening Torques

M2: 0.16 N·m  
M3: 0.8 N·m  
M4: 1.4 N·m

## Manifold Option

### ■ Individual SUP spacer assembly

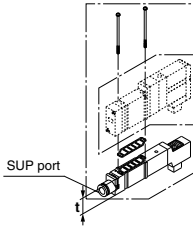

### ■ Individual EXH spacer assembly

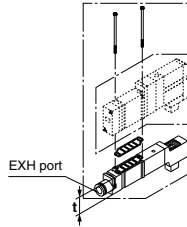

## How to order individual SUP/EXH spacer assembly

SV1000 Series

SV1000 - **38** - 1A - **C6**

\* t: 15

#### ● Port size

<b>C3</b>	One-touch fitting for $\phi 3.2$
<b>C4</b>	One-touch fitting for $\phi 4$
<b>C6</b>	One-touch fitting for $\phi 6$
<b>N1</b>	One-touch fitting for $\phi 1/8"$
<b>N3</b>	One-touch fitting for $\phi 5/32"$
<b>N7</b>	One-touch fitting for $\phi 1/4"$

#### ● Spacer type

<b>38</b>	Individual SUP spacer
<b>39</b>	Individual EXH spacer
<b>88</b>	Individual SUP + Individual EXH spacers (Double-stack)

\* In the SV3000 series, only type 10 is compatible with the double-stack spacers.  
The SV4000 series is not compatible with the double-stack spacers.  
Individual SUP and EXH spacers can be mounted either on the top or the bottom.

SV2000/SV3000/SV4000 Series

SV **2** 000 - **38** - 1 **A**

#### ● Series

Symbol	Series	t
<b>2</b>	SV2000	15
<b>3</b>	SV3000	18.5
<b>4</b>	SV4000	20

#### ● Thread type (Note)

NH	Rc
<b>F</b>	G
<b>N</b>	NPT
<b>T</b>	NPTF

Note) SV2000/3000/4000 port size

Series	Port size
<b>SV2000</b>	1/8
<b>SV3000</b>	
<b>SV4000</b>	1/4

## Accessory

Series	Round head combination screw	Gasket
<b>SV1000</b>	SX3000-22-9 (M2 x 39.5)	SX3000-57-4
<b>SV2000</b>	SV2000-21-6 (M3 x 46)	SY5000-11-15
<b>SV3000</b>	SV3000-21-3 (M4 x 53)	SY7000-11-11
<b>SV4000</b>	SV2000-21-5 (M3 x 60)	SY9000-11-2

### ■ Individual SUP/EXH spacer assembly (Double-stack)

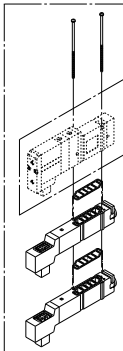

# Single Valve/Sub-plate Type IP67 Compliant SV1000/2000/3000/4000 Series



## How to Order

SV 1 1 00 - 5 W1 U D - - -

**Series**

1	SV1000
2	SV2000
3	SV3000
4	SV4000

**Made to order**

Nil	—
X90	Main valve fluororubber (Refer to page 134.)

**Type of actuation**

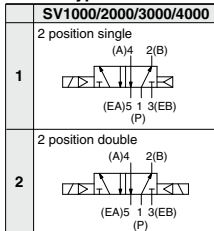

**Pilot type**

Nil	Internal pilot
R	External pilot

\* External pilot specifications is not available for 4 position dual 3 port valves.

**Thread type**

Nil	Rc
F	G
N	NPT
T	NPTF

**Port size**

Symbol	Port size	Applicable series
Nil	Without sub-plate	
01	1/8	SV1000
02	1/4	SV2000 SV3000
03	3/8	SV3000 SV4000
04	1/2	SV4000

**Manual override**

Nil	Non-locking push type
D	Push-turn locking slotted type

**Light/Surge voltage suppressor**

U	With light/surge voltage suppressor
R	With surge voltage suppressor

**M12 waterproof connector**

Symbol	Cable length (mm)
W1	300
W2	500
W3	1000
W4	2000
W7	5000

**Rated voltage**

5	24 VDC
6	12 VDC

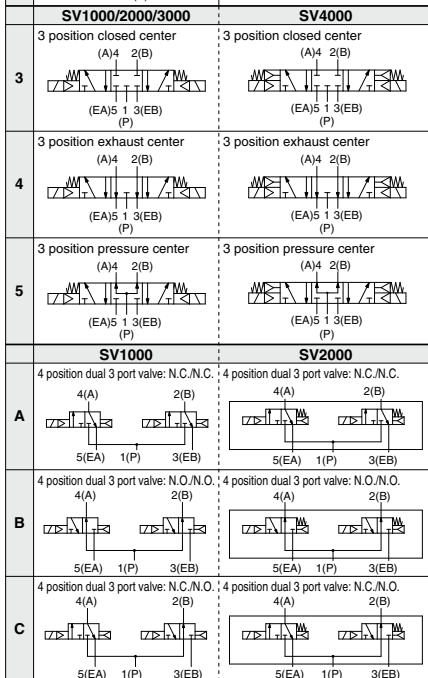

\* SV3000 and 4000 are not available with 4 position dual 3 port valve.

## SV Series Solenoid Valve Specifications



<b>Fluid</b>		Air
<b>Internal pilot operating pressure range (MPa)</b>	2 position single	0.15 to 0.7
	4 position dual 3 port valve	
	2 position double	0.1 to 0.7
<b>External pilot operating pressure range (MPa)</b>	3 position	0.2 to 0.7
	Operating pressure range	-100 kPa to 0.7
<b>Ambient and fluid temperature (°C)</b>	2 position single, double	0.25 to 0.7
	4 position dual 3 port valve	
	3 position	-10 to 50 (No freezing)
<b>Max. operating frequency (Hz)</b>	2 position single, double	5
	4 position dual 3 port valve	
	3 position	3
<b>Manual override</b>		Non-locking push type
		Push-turn locking slotted type
<b>Pilot exhaust method</b>	Internal pilot	Common exhaust type for main and pilot valve
	External pilot	
<b>Lubrication</b>		Not required
<b>Mounting orientation</b>		Unrestricted
<b>Impact/Vibration resistance (ms<sup>2</sup>)</b>		150/30 (8.3 to 2000 Hz)
<b>Enclosure</b>		IP67 (Based on IEC60529)
<b>Electrical entry</b>		M12 waterproof connector
<b>Coil rated voltage</b>		24 VDC, 12 VDC
<b>Allowable voltage fluctuation</b>		±10% of rated voltage
<b>Power consumption (W)</b>		0.6 (With indicator light: 0.65)
<b>Surge voltage suppressor</b>		Zener diode
<b>Indicator light</b>		LED

Note) Impact resistance: No malfunction occurred when it is tested with a drop tester in the axial direction and at the right angles to the main valve and armature in both energized and de-energized states every once for each condition. (Values at the initial period)

Vibration resistance: No malfunction occurred in a one-sweep test between 45 and 2000 Hz. Test was performed at both energized and de-energized states in the axial direction and at the right angles to the main valve and armature. (Values at the initial period)

### Response Time

Type of actuation	Response time (ms) (at the pressure of 0.5 MPa)			
	SV1000	SV2000	SV3000	SV4000
2 position single	11 or less	25 or less	28 or less	40 or less
2 position double	10 or less	17 or less	26 or less	40 or less
3 position	18 or less	29 or less	32 or less	82 or less
4 position dual 3 port valve	15 or less	33 or less	—	—

Note) Based on dynamic performance test, JIS B 8375-1981. (Coil temperature: 20°C, at rated voltage)

### M12 Waterproof Connector Wiring Specifications

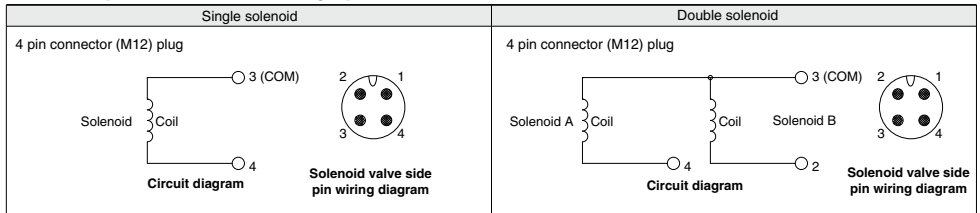

Note) Solenoid valves have no polarity.

### Connection Destination (Female Side) Connector Cable

Connector size	pin	Manufacturer	Applicable series
M12	4	Correns Corp.	VA-4D
		OMRON Corp.	XS2
		Azbil Corp.	PA5-41
		HIROSE ELECTRIC CO., LTD.	HR24
		DDK Ltd.	CM01-8DP4S

\* This connector is a female connector for ① relay output module and ② single unit/sub-plate.

## Flow Rate Characteristics/Weight

### SV1000 Series

Valve model	Type of actuation		Port size	Flow rate characteristics <sup>(1)</sup>						Weight (g) <sup>(2)</sup>
				1 → 4/2 (P → A/B)			4/2 → 5/3 (A/B → EA/EB)			
				C [dm <sup>3</sup> /(s·bar)]	b	Cv	C [dm <sup>3</sup> /(s·bar)]	b	Cv	
SV1□00-□-01	2 position	Single	Rc 1/8	1.0	0.30	0.24	1.1	0.30	0.26	123 (88)
		Double								128 (93)
	3 position	Closed center		0.77	0.28	0.18	0.85	0.30	0.19	130 (95)
		Exhaust center		0.73	0.31	0.18	1.1 [0.55]	0.26 [0.52]	0.24 [0.16]	
		Pressure center		1.2 [0.51]	0.24 [0.45]	0.29 [0.14]	0.89	0.47	0.24	
	4 position dual	N.C./N.C.		0.68	0.35	0.18	1.1	0.39	0.29	128 (93)
		N.O./N.O.		0.87	0.31	0.23	0.77	0.44	0.21	

Note 1) [ ]: Denotes the normal position. Note 2) ( ): Denotes without sub-plate.

### SV2000 Series

Valve model	Type of actuation		Port size	Flow rate characteristics <sup>(1)</sup>						Weight (g) <sup>(2)</sup>
				1 → 4/2 (P → A/B)			4/2 → 5/3 (A/B → EA/EB)			
				C [dm <sup>3</sup> /(s·bar)]	b	Cv	C [dm <sup>3</sup> /(s·bar)]	b	Cv	
SV2□00-□-02	2 position	Single	Rc 1/4	2.4	0.41	0.64	2.8	0.29	0.66	159 (96)
		Double								163 (100)
	3 position	Closed center		1.8	0.47	0.50	1.8	0.40	0.47	168 (105)
		Exhaust center		1.4	0.55	0.44	3.0 [1.2]	0.33 [0.48]	0.72 [0.37]	
		Pressure center		3.3 [0.84]	0.36 [0.60]	0.85 [0.28]	1.8	0.40	0.48	
	4 position dual	N.C./N.C.		2.2	0.40	0.55	2.6	0.31	0.60	163 (100)
		N.O./N.O.		2.7	0.24	0.57	2.3	0.36	0.54	

Note 1) [ ]: Denotes the normal position. Note 2) ( ): Denotes without sub-plate.

### SV3000 Series

Valve model	Type of actuation		Port size	Flow rate characteristics <sup>(1)</sup>						Weight (g) <sup>(2)</sup>
				1 → 4/2 (P → A/B)			4/2 → 5/3 (A/B → EA/EB)			
				C [dm <sup>3</sup> /(s·bar)]	b	Cv	C [dm <sup>3</sup> /(s·bar)]	b	Cv	
SV3□00-□-02	2 position	Single	Rc 1/4	4.1	0.41	1.1	4.1	0.29	1.0	250 (121)
		Double								253 (124)
	3 position	Closed center		3.0	0.43	0.80	2.6	0.41	0.72	26 (132)
		Exhaust center		2.6	0.42	0.71	4.7 [1.7]	0.35 [0.48]	1.1 [0.49]	
		Pressure center		5.3 [2.3]	0.39 [0.49]	1.3 [0.65]	2.2	0.49	0.63	
SV3□00-□-03	2 position	Single	Rc 3/8	4.9	0.29	1.2	4.5	0.27	1.1	235
		Double								238
	3 position	Closed center		3.0	0.40	0.80	2.6	0.45	0.73	246
		Exhaust center		2.6	0.42	0.71	4.8 [1.7]	0.35 [0.48]	1.1 [0.34]	
		Pressure center		5.3 [2.3]	0.31 [0.51]	1.3 [0.64]	2.3	0.45	0.66	

Note 1) [ ]: Denotes the normal position. Note 2) ( ): Denotes without sub-plate.

### SV4000 Series

Valve model	Type of actuation		Port size	Flow rate characteristics <sup>(1)</sup>						Weight (g) <sup>(2)</sup>
				1 → 4/2 (P → A/B)			4/2 → 5/3 (A/B → EA/EB)			
				C [dm <sup>3</sup> /(s·bar)]	b	Cv	C [dm <sup>3</sup> /(s·bar)]	b	Cv	
SV4□00-□-03	2 position	Single	Rc 3/8	7.9	0.34	2.0	9.6	0.43	2.5	505 (208)
		Double								509 (212)
	3 position	Closed center		7.5	0.33	1.8	7.3	0.30	1.7	530 (233)
		Exhaust center		7.2	0.34	1.7	13 [4.0]	0.23 [0.41]	2.8 [0.95]	
		Pressure center		12 [3.3]	0.26 [0.41]	2.8 [0.84]	6.7	0.40	1.9	
SV4□00-□-04	2 position	Single	Rc 1/2	8.0	0.48	2.2	10	0.29	2.5	484
		Double								488
	3 position	Closed center		7.6	0.32	1.8	7.3	0.32	1.8	509
		Exhaust center		7.3	0.42	2.0	13 [4.7]	0.32 [0.54]	3.6 [1.5]	
		Pressure center		12 [3.3]	0.33 [0.51]	3.3 [0.94]	7.4	0.33	1.9	

Note 1) [ ]: Denotes the normal position. Note 2) ( ): Denotes without sub-plate.

**Construction: SV1000/2000/3000/4000 Single Valve/Sub-plate Type**

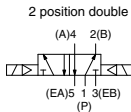
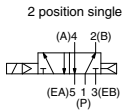

**SV1000/2000/3000**

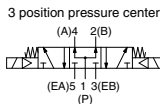
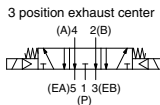
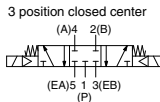

**SV4000**

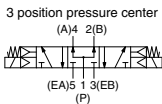
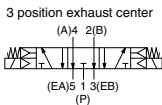
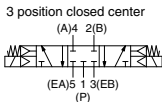

**2 position single**

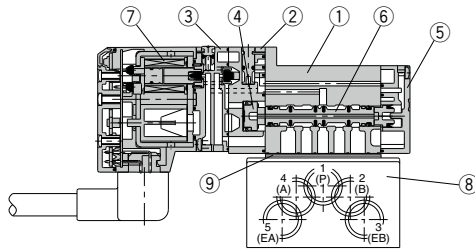

**2 position double**

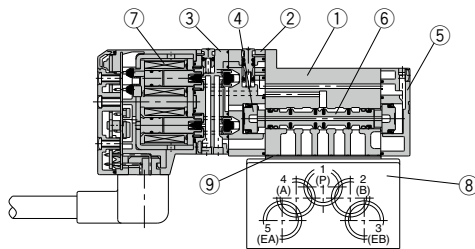

**3 position closed center/exhaust center/pressure center**

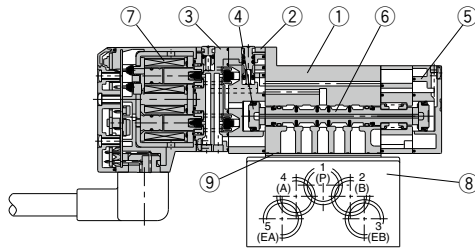

**Component Parts**

No.	Description	Material	Note
①	<b>Body</b>	Aluminum die-casted (SV1000 is zinc die-casted)	White
②	<b>Adapter plate</b>	Resin	White
③	<b>Pilot body</b>	Resin	White
④	<b>Piston</b>	Resin	—
⑤	<b>End plate</b>	Resin	White
⑥	<b>Spool valve assembly</b>	Aluminum/HNBR	—
⑦	<b>Molded coil</b>	—	Gray

**Caution**

**Mounting screw tightening torques**

M2: 0.16 N·m  
M3: 0.8 N·m  
M4: 1.4 N·m

**Replacement Parts**

No.	Description	Part no.				Note
		SV1□00	SV2□00	SV3□00	SV4□00	
⑧	<b>Sub-plate</b>	SY3000-27-1□	SY5000-27-1□	1/4: SY7000-27-1□ 3/8: SY7000-27-2□	3/8: SY9000-27-1□ 1/2: SY9000-27-2□	Aluminum die-casted Refer to thread types on page 126 for □.
⑨	<b>Gasket</b>	SY3000-11-25	SY5000-11-18	SY7000-11-14	SY9000-11-2	
—	<b>Round head combination screw</b>	SX3000-22-2 (M2 x 24)	SV2000-21-1 (M3 x 30)	SV3000-21-1 (M4 x 35)	SV2000-21-2 (M3 x 40)	For valve mounting (Matt nickel plated)

Note) Round head combination screw requires 2 pcs. per one valve for the SV1000, SV2000 and SV3000 series. For the SV4000 series, it requires 3 pcs.

## Dimensions: SV1000 Series

### 2 position single/double, 4 position dual 3 port [M12 waterproof connector type]

SV1□00(R)-□W□□-01□

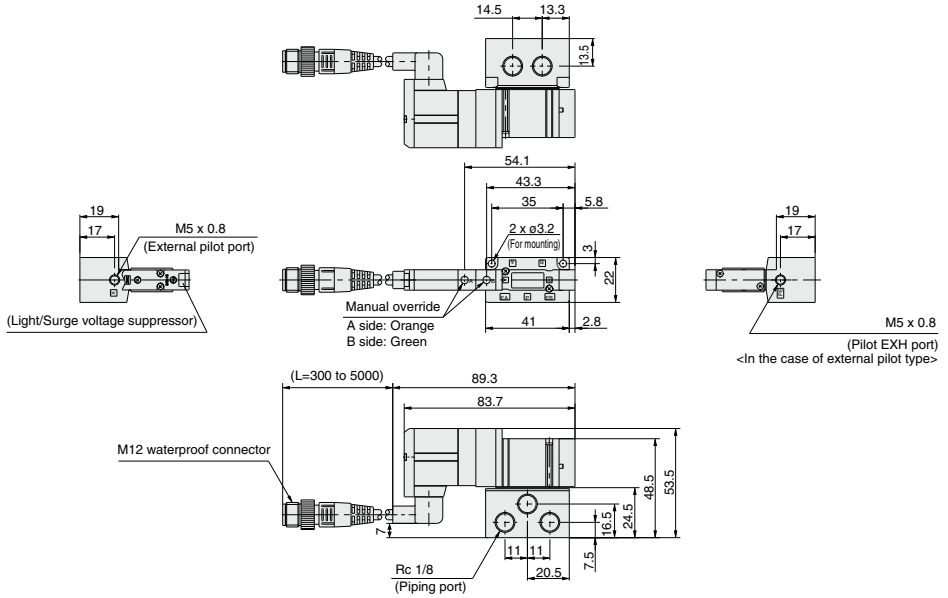

### 3 position closed center/exhaust center/pressure center [M12 waterproof connector type]

SV1□00(R)-□W□□-01□

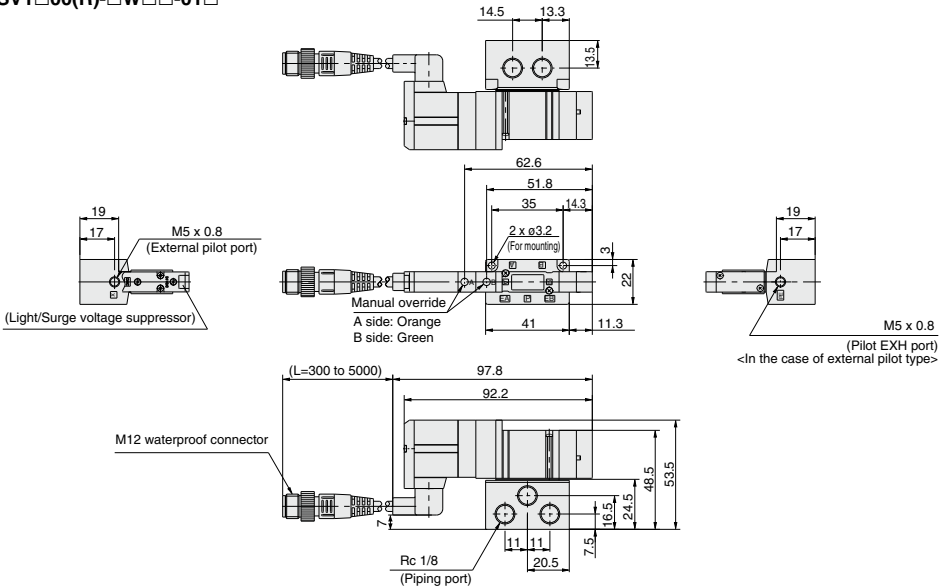



**Dimensions: SV2000 Series**

**2 position single/double, 4 position dual 3 port [M12 waterproof connector type]**  
SV2□00(R)-□W□□-02□

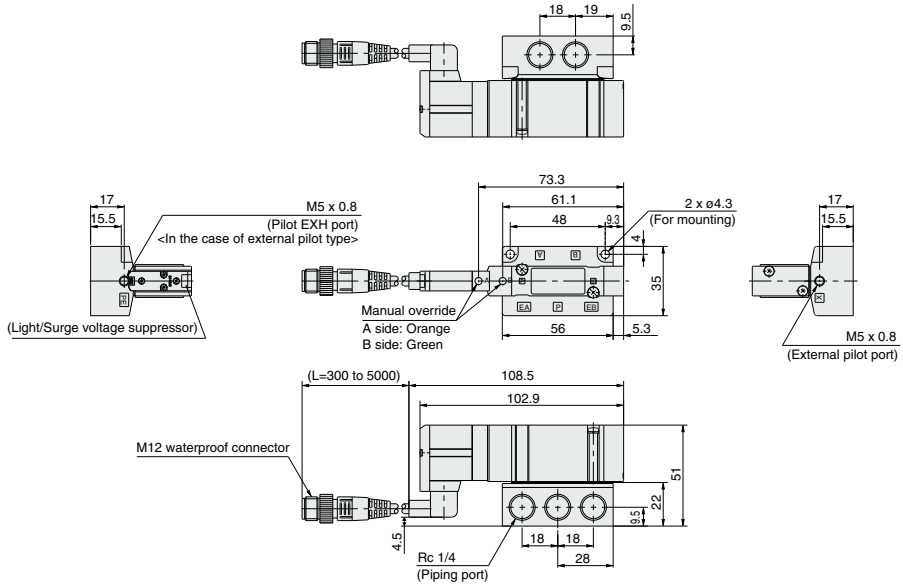

**3 position closed center/exhaust center/pressure center [M12 waterproof connector type]**  
SV2□00(R)-□W□□-02□

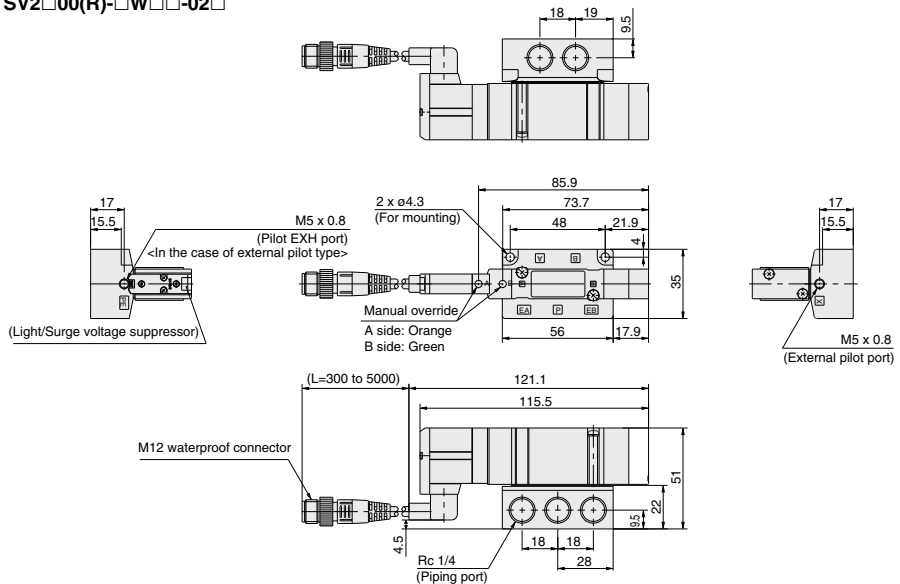

## Dimensions: SV3000 Series

### 2 position single/double [M12 waterproof connector type]

SV3□00(R)-□W□□-02, 03□

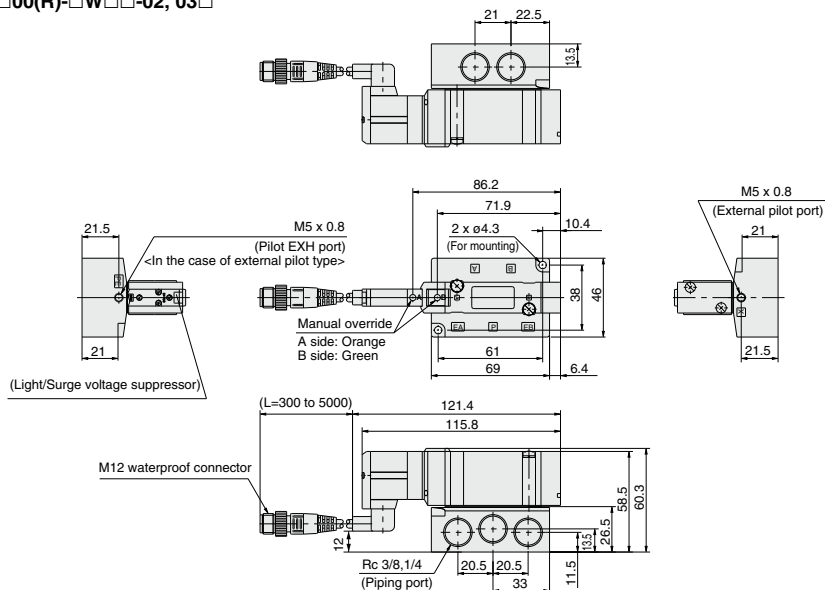

### 3 position closed center/exhaust center/pressure center [M12 waterproof connector type]

SV3□00(R)-□W□□-02, 03□

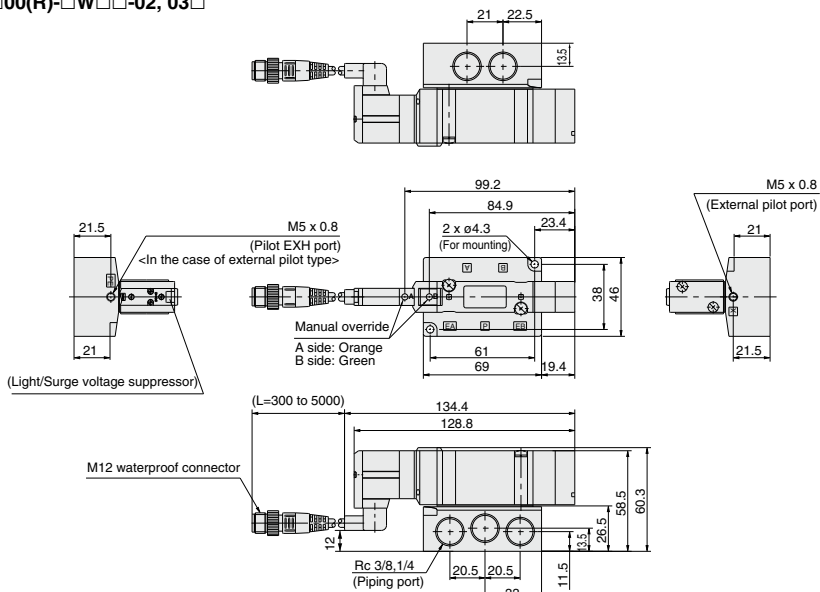

**Dimensions: SV4000 Series**

**2 position single/double [M12 waterproof connector type]**

SV4□00(R)-□W□□-03, 04□

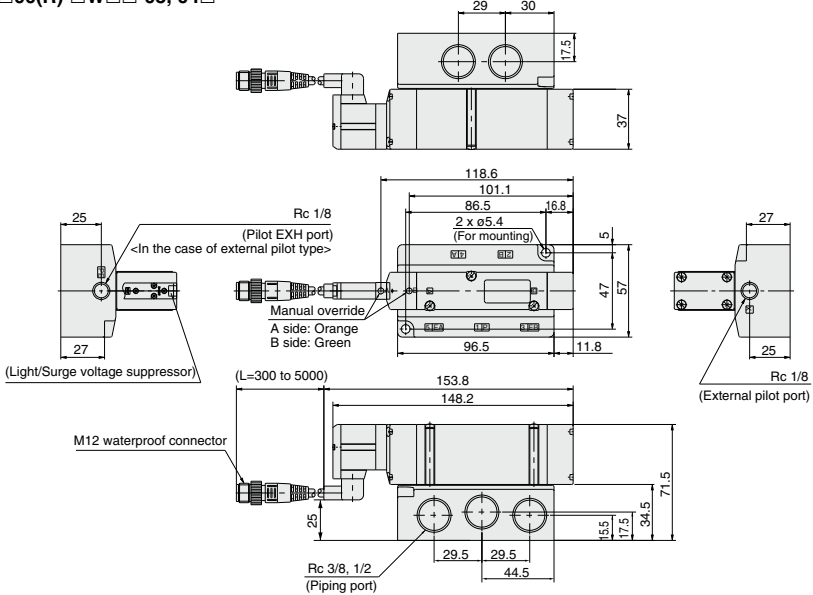

**3 position closed center/exhaust center/pressure center [M12 waterproof connector type]**

SV4□00(R)-□W□□-03, 04□

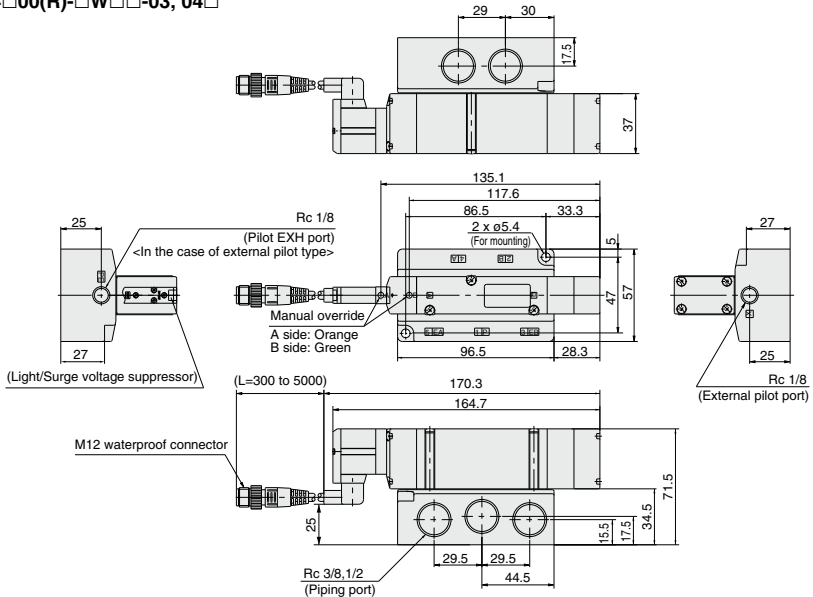



Please contact SMC for detailed dimensions, specifications and lead times.

## 1 Main Valve Fluororubber Specifications

Symbol  
**-X90**

Fluororubber is used for rubber parts of the main valve to allow use in applications such as the following.

1. When using a lubricant other than the recommended turbine oil, and there is a possibility of malfunction due to swelling of the spool valve seals.
2. When ozone enters or is generated in the air supply.

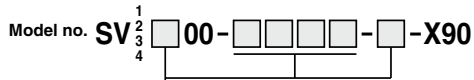

• Entry is the same as standard products.

Note) Because in the -X90 series fluororubber is used for only main valve, the rubber parts of the application/usage in conditions requiring heat resistance should be avoided.



# SV Series

## Specific Product Precautions 1

Be sure to read this before handling the products.

Refer to page 8 for safety instructions and pages 9 to 15 for 3/4/5 port solenoid valve precautions.

### Environment

#### Warning

- Do not use valves in atmospheres of corrosive gases, chemicals, salt water, water, steam, or where there is direct contact with any of these.
- Products compliant with IP65 and IP67 enclosures (Based on IEC60529) are protected against dust and water, however, these products cannot be used in water.
- Products compliant with IP65 and IP67 enclosures satisfy the specifications by mounting each product properly. Be sure to read the Specific Product Precautions for each product.
- When using built-in silencer type manifold with an IP67 enclosure, keep the exhaust port of the silencer from coming in direct contact with water or other liquids. Liquid filtration through the exhaust port of the silencer can cause damage to the valve.

### Manual Override Operation

#### Warning

Handle carefully, as connected equipment can be actuated through manual override operation.

#### Non-locking push type

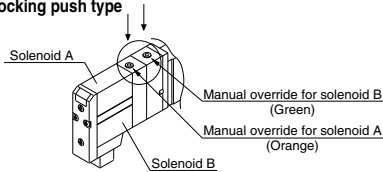

#### Push-turn locking slotted type

After pushing down, turn in the direction of the arrow. If it is not turned, it can be operated the same way as the non-locking type.

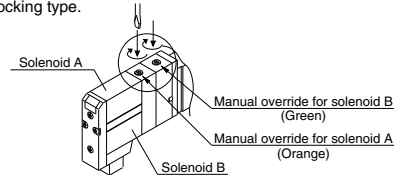

#### Caution

When locking the manual override with the push-turn locking slotted type, be sure to push it down before turning. Turning without first pushing it down can cause damage to the manual override and other trouble such as air leakage, etc.

### Exhaust Restriction

#### Caution

Since Series SV is a type in which the pilot valve exhaust joins the main valve exhaust inside the valve, use caution, so that the piping from the exhaust port is not restricted.

### SV Series Used as a 3 Port Valve

#### Caution

In the case of using a 5 port valve (as a 3 port valve)

The SV series can be used as normally closed (N.C.) or normally open (N.O.) 3 port valves by closing one of the cylinder ports (A or B) with a plug. However, they should be used with the exhaust ports kept open. They are convenient at times when a double solenoid type 3 port valve is required.

Plug position		B port	A port
Actuation		N.C.	N.O.
Number of solenoids	Single		
	Double		

### Light/Surge Voltage Suppressor

#### Caution

Solenoid valves have no polarity. Light/Surge voltage suppressor

#### Single solenoid

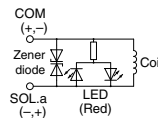

#### Double solenoid, 3 position type

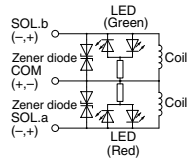

#### Surge voltage suppressor

#### Single solenoid

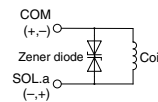

#### Double solenoid, 3 position type

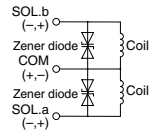

### Light Indication

#### Caution

When equipped with indicator light and surge voltage suppressor, the light window turns red when solenoid A is energized, and it turns green when solenoid B is energized.

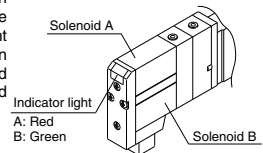



# SV Series

## Specific Product Precautions 2

Be sure to read this before handling the products.

Refer to page 8 for safety instructions and pages 9 to 15 for 3/4/5 port solenoid valve precautions.

### Connector Entry Directions

#### ⚠ Caution

Connector entry directions for D-sub connectors and flat ribbon cables can be changed. To change the connector's entry direction, press the levers on both sides of the connector, take it off, and change the direction as shown in the drawing. Since lead wire assemblies are attached to the connector, excessive pulling or twisting can cause broken wires or other trouble. Also, take precautions so that lead wires are not caught and pinched when installing the connector.

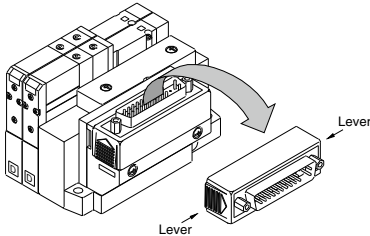

### Manifold Mounting

#### ⚠ Caution

There will be slight variations in the width of manifold blocks due to tolerance for the stacking manifold type. As the manifold is made up of a combination of manifold blocks, there will be an error due to accumulated tolerance between the actual pitch dimensions of the mounting holes used to secure the manifold and the values stated in the catalog. Keep this in mind when increasing the number of stations.

#### Manifold Block Width Tolerance Chart

Series	Block width tolerance
SS5V1-(W)10□ series	±0.15 mm
SS5V2-(W)10□ series	±0.2 mm
SS5V3-(W)10□ series	±0.15 mm
SS5V4-(W)10□ series	±0.15 mm

### How to Order Manifold

#### ⚠ Caution

The letter "S" or "D" is indicated on manifold blocks for the SV series as shown below. This indication refers to the type of substrate assembly (single wiring or double wiring) inside the manifold blocks. When the manifold specification sheet does not include a wiring specification, all stations will be double wiring specification (D). In this case, single and double solenoid valves can be mounted in any position, but when a single valve is used, there will be an unused control signal. To avoid this, indicate positions of manifold blocks for a single wiring specification (S) and double wiring specification (D) on a manifold specification sheet. (Note that double, 3 or 4 position valves cannot be used for manifolds blocks with single wiring specification (S).)

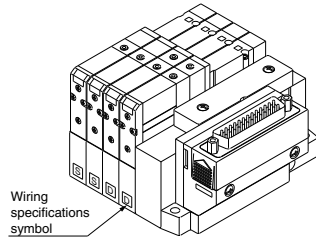

### Substrate Assemblies inside Manifolds

#### ⚠ Caution

Substrate assemblies inside of manifolds cannot be taken apart. Attempting to do so may damage parts.

### One-touch Fittings

#### ⚠ Caution

##### 1. Tube attachment/detachment for One-touch fittings

###### 1) Attaching of tube

- (1) Take a tube having no flaws on its periphery and cut it off at a right angle. When cutting the tube, use tube cutters TK-1, 2 or 3. Do not use pinchers, nippers or scissors, etc. If cutting is done with tools other than tube cutters, there is the danger that the tube may be cut diagonally or become flattened, etc., making a secure installation impossible, and causing problems such as the tube pulling out after installation or air leakage. Also allow some extra length in the tube.
- (2) Grasp the tube and push it in slowly, inserting it securely all the way into the fitting.
- (3) After inserting the tube, pull on it lightly to confirm that it will not come out. If it is not installed securely all the way into the fitting, this can cause problems such as air leakage or the tube pulling out.

###### 2) Detaching of tube

- (1) Push in the release button sufficiently, and push the collar evenly at the same time.
- (2) Pull out the tube while holding down the release button so that it does not come out. If the release button is not pressed down sufficiently, there will be increased bite on the tube and it will become more difficult to pull it out.
- (3) When the removed tube is to be used again, cut off the portion which has been chewed before reusing it. If the chewed portion of the tube is used as is, this can cause trouble such as air leakage or difficulty in removing the tube.



## SV Series

# Specific Product Precautions 3

Be sure to read this before handling the products.

Refer to page 8 for safety instructions and pages 9 to 15 for 3/4/5 port solenoid valve precautions.

### Other Tubing Brands

#### Caution

1. When using tube other than SMC brand, confirm that the following specifications are satisfied with respect to the outside diameter tolerance of the tube.

- |                        |                     |
|------------------------|---------------------|
| 1) Nylon tubing        | within $\pm 0.1$ mm |
| 2) Soft nylon tubing   | within $\pm 0.1$ mm |
| 3) Polyurethane tubing | within $+0.15$ mm   |
|                        | within $-0.2$ mm    |

Do not use tubing which does not meet these outside diameter tolerances. It may not be possible to connect them, or they may cause other trouble, such as air leakage or the tube pulling out after connection.

### Back Pressure Check Valve Built-in Type

#### Caution

1. Valves with built-in back pressure check valve is to protect the back pressure inside a valve. For this reason, use caution the valves with external pilot specification cannot be pressurized from exhaust port [3/5(E)]. As compared with the types which do not integrate the back pressure check valve, C value of the flow rate characteristics goes down. For details, please contact SMC.
2. Do not switch valves when A or B port is open to the atmosphere, or while the actuators and air operated equipment are in operation. The back pressure prevention seal may be peeled off, which may cause air leakage or malfunctions. Use caution especially when performing a trial operation or maintenance work.



# SV Series

## Specific Product Precautions 4

Be sure to read this before handling the products.

Refer to page 8 for safety instructions and pages 9 to 15 for 3/4/5 port solenoid valve precautions.

### Interface Regulator

### Caution

#### Specifications

Interface regulator		SV1□00-□-□	SV2000-□-□	SV3000-□-□	SV4000-□-□
Applicable model		SV1000	SV2000	SV3000	SV4000
Regulating port		P, A, B			
Set pressure range		0.1 to 0.7 MPa			
Maximum operating pressure		0.7 MPa			
Fluid		Air			
Ambient and fluid temp.		Maximum at 50°C			
Weight	With pressure gauge	38.4 g (43.4 g)	86.5 g	103.8 g	178.2 g
	Without pressure gauge	32 g (37 g)	80.3 g	97.6 g	171.8 g

Note 1) Apply pressure from P port in the base for interface regulator.

Note 2) P port pressure regulation is only available for closed center, pressure center and 4-position dual 3-port valve.

Note 3) Gasket and mounting screws are included in the weight.

Note 4) ( ) : Denotes the values of SV1300.

### Flow Rate Characteristics

**SV1000** P Reduced pressure (P → A,B)

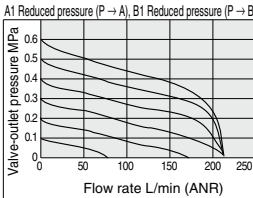
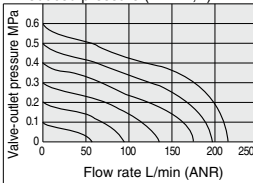

**SV2000** P Reduced pressure (P → A,B)

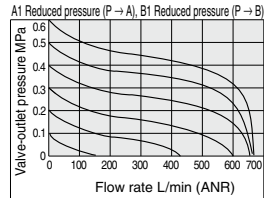
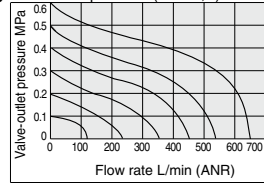

**SV3000** P Reduced pressure (P → A,B)

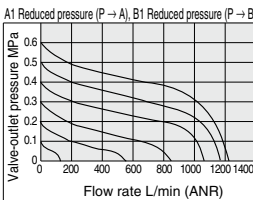
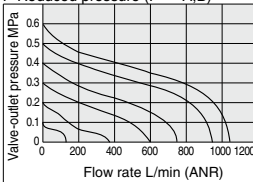

### How to Calculate the Flow Rate

For obtaining the flow rate, refer to the [Web Catalog](#).





# SV Series

## Specific Product Precautions 5

Be sure to read this before handling the products.

Refer to page 8 for safety instructions and pages 9 to 15 for 3/4/5 port solenoid valve precautions.

### Serial Wiring EX500/EX250/EX260/EX120 Precautions

#### Warning

- These products are intended for use in general factory automation equipment.  
Avoid using these products in machinery/equipment which affects human safety, and in cases where malfunction or failure can result in extensive damage.
- Do not use in an explosive atmosphere, environment with inflammable gases, or corrosive atmosphere.  
This can cause injury or fire, etc.
- Work such as transporting, installing, piping, wiring, operation, control and maintenance should be performed by personnel with specialized knowledge.  
There is a danger of electrocution, injury or fire, etc.
- Install an external emergency stop circuit that can promptly stop operation and shut off the power supply.
- Do not remodel these products, as there is a danger of injury and damage.
- Do not wipe the product with chemicals, etc.

#### Caution

- Read the operation manual carefully, strictly observe the precautions and operate within the range of the specifications.
- Do not drop these products or submit them to strong impacts. This can cause damage, failure or malfunction, etc.
- In locations with poor electrical conditions, take steps to ensure a steady flow of the rated power supply. Use of a voltage outside of the specifications can cause malfunction, damage to the unit, electrocution or fire, etc.
- Do not touch connector terminals or internal substrates when current is being supplied. There is a danger of malfunction, damage to the unit or electrocution if connector terminals or internal substrates are touched when current is being supplied.  
Be sure that the power supply is OFF when adding or removing manifold valves or input blocks, etc., or when connecting or disconnecting connectors.
- Operate at an ambient temperature that is within the specifications. Even when the ambient temperature range is within the specifications, do not use in locations where there are rapid temperature changes.
- Keep wire scraps and other extraneous material from getting inside these products. This can cause fire, failure or malfunction, etc.
- Give consideration to the operating environment depending on the type of enclosure being used.  
To achieve IP65 or IP67 protection, provide appropriate wiring between all units using electrical wiring cables, communication connectors and cables with M12 connectors. Also, provide waterproof caps when there are unused ports, and perform proper mounting of input units, input blocks, SI units and manifold valves, etc. Provide a cover or other protection for applications in which there is constant exposure to water.
- Obey the proper tightening torque.  
There is a possibility of damaging threads if tightening exceeds the tightening torque range.
- Provide adequate protection when operating in locations such as the following:
  - Where noise is generated by static electricity, etc.
  - Where there is a strong electric field
  - Where there is a danger of exposure to radiation
  - When in close proximity to power supply lines

#### Caution

- When these products are installed in equipment, provide adequate protection against noise by using noise filters, etc.
- Since these products are components that are used after installation in other equipment, the customer should confirm conformity to EMC directives for the finished product.
- Do not remove the name plate.
- Perform periodic inspections and confirm normal operation. It may otherwise be impossible to guarantee safety due to unexpected malfunction or erroneous operation.
- Do not use in places where there are cyclic temperature changes.  
In case that the cyclic temperature is beyond normal temperature changes, the inside the product is likely to be adversely effected.
- Do not use in direct sunlight.  
Do not use in direct sunlight. It may cause malfunction or damage.
- Do not use in places where there is radiated heat around it.  
Such a place is likely to cause malfunction.

### Power Supply Safety Instructions

#### Caution

- Operation is possible with a single power supply or a separate power supply. However, be sure to provide two wiring systems (one for solenoid valves, and one for input and control units).
- Use the following UL approved products for DC power supply combinations.
  - Controlled voltage current circuit conforming to UL508  
Circuit uses the secondary coil of an isolated transformer as the power supply, satisfying the following conditions.
    - Max. voltage (with no load): 30 Vrms (42.4 V peak) or less
    - Max. current: (1) 8 A or less (including shorts), and (2) When controlled by a circuit protector (fuse, etc.) with the following rating

No-load voltage (V peak)	Max. current rating
0 to 20 [V]	5.0
Over 20 [V] to 30 [V]	100
	Peak voltage value

- A circuit (class 2 circuit) with maximum 30 Vrms (42.4 V peak) or less, and a power supply consisting of a class 2 power supply unit conforming to UL1310, or a class 2 transformer conforming to UL1585

### Safety Instructions for Cable

#### Caution

- Be careful of mis-wiring. This can cause malfunction, damage and fire in the unit.
- To prevent noise and surge in signal lines, keep all wiring separate from power lines and high voltage lines. Otherwise, this can cause malfunction.
- Check wiring insulation, as defective insulation can cause damage to the unit due to excessive voltage or current.
- Do not bend or pull cables repeatedly, and do not place heavy objects on them or allow them to be pinched. This can cause broken lines.



# SV Series

## Specific Product Precautions 6

Be sure to read this before handling the products.

Refer to page 8 for safety instructions and pages 9 to 15 for 3/4/5 port solenoid valve precautions.

### EX600 Precautions

#### Design/Selection

#### ⚠ Warning

- Use this product within the specification range.**  
Using beyond the specified specifications range can cause fire, malfunction, or damage to the system.  
Confirm the specifications when operating.
- When using for an interlock circuit:**
  - Provide a multiple interlock system which is operated by another system (such as mechanical protection function).
  - Perform an inspection to check that it is working properly.

This may cause possible injury due to malfunction.

#### ⚠ Caution

- When applicable to UL, use a Class 2 power supply unit conforming to UL1310 for direct current power supply.**
- Use this product within the specified voltage range.**  
Using beyond the specified voltage range is likely to cause the units and connecting devices to be damaged or to malfunction.
- The power supply for the unit should be 0 V as the standard for both power supply for output as well as power supply for control/input.**

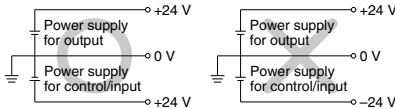

- Do not install a unit in a place where it can be used as a foothold.**  
Applying any excessive load such as stepping on the unit by mistake or placing a foot on it, will cause it to break.
- Keep the surrounding space free for maintenance.**  
When designing a system, take into consideration the amount of free space needed for performing maintenance.
- Do not remove the name plate.**  
Improper maintenance or incorrect use of operation manual can cause failure and malfunction. Also, there is a risk of losing conformity with safety standards.
- Beware of inrush current when the power supply is turned on.**  
Some connected loads can apply an initial charge current which will trigger the over current protection function, causing the unit to malfunction.

#### Mounting

#### ⚠ Caution

- When handling and assembling units:**
  - Do not touch the sharp metal parts of the connector or plug.
  - Do not apply excessive force to the unit when disassembling.

The connecting portions of the unit are firmly joined with seals.
- When joining units, take care not to get fingers caught between units.**  
Injury can result.

#### Mounting

#### ⚠ Caution

- Do not drop, bump, or apply excessive impact.**  
Otherwise, the unit can become damaged, malfunction, or fail to function.
- Observe the tightening torque range.**  
Tightening outside of the allowable torque range will likely damage the screw.  
IP67 cannot be guaranteed if the screws are not tightened to the specified torque.
- When lifting a large size manifold solenoid valve unit, take care to avoid causing stress to the valve connection joint.**  
The connection parts of the unit may be damaged.  
Because the unit may be heavy, carrying and installation should be performed by more than one operator to avoid strain or injury.
- When placing a manifold, mount it on a flat surface.**  
Torsion in the whole manifold can lead to trouble such as air leakage or defective insulation.

#### Wiring

#### ⚠ Caution

- Confirm grounding to maintain the safety of the reduced wiring system and for anti-noise performance.**  
Provide a specific grounding as close to the unit as possible to minimize the distance to grounding.
- Avoid repeatedly bending or stretching the cable and applying a heavy object or force to it.**  
Wiring applying repeated bending and tensile stress to the cable can break the circuit.
- Avoid miswiring.**  
If miswired, there is a danger of malfunction or damage to the reduced wiring system.
- Do not wire while energizing the product.**  
There is a danger of malfunction or damage to the reduced wiring system or input/output equipment.
- Avoid wiring the power line and high pressure line in parallel.**  
Noise or surge produced by signal line resulting from the power line or high pressure line could cause malfunction.  
Wiring of the reduced wiring system or input/output device and the power line or high pressure line should be separated from each other.
- Confirm the wiring insulation.**  
Defective insulation (contact with other circuits, improper insulation between terminals, etc.) may cause damage to the reduced wiring system or input/output device due to excessive voltage or current.



## SV Series

# Specific Product Precautions 7

Be sure to read this before handling the products.

Refer to page 8 for safety instructions and pages 9 to 15 for 3/4/5 port solenoid valve precautions.

### EX600 Precautions

#### Wiring

#### Caution

- When a reduced wiring system is installed in machinery/equipment, provide adequate protection against noise by using noise filters, etc.**  
Noise in signal lines may cause malfunction.
- When connecting wires of input/output device or Handheld Terminal, prevent water, solvent or oil from entering inside from the connector section.**  
This can cause damage, equipment failure or malfunction.
- Avoid wiring patterns in which excessive stress is applied to the connector.**  
This may cause malfunction or damage to the unit due to contact failure.

#### Operating Environment

#### Warning

- Do not use in an atmosphere containing an inflammable gas or explosive gas.**  
Use in such an atmosphere is likely to cause a fire or explosion. This system is not explosion-proof.

#### Caution

- Select the proper type of enclosure according to the environment of operation.**  
IP65/67 is achieved when the following conditions are met.
  - Provide appropriate wiring between all units using electrical wiring cables, communication connectors and cables with M12 connectors.
  - Suitable mounting of each unit and manifold valve.
  - Be sure to mount a seal cap on any unused connectors.If using in an environment that is exposed to water splashes, please take measures such as using a cover.  
When the enclosure is IP40, do not use in an operating environment or atmosphere where it may come in contact with corrosive gas, chemical agents, seawater, water, or water vapor. When connected to EX600-D□□E or EX600-D□□F, manifold enclosure is IP40.  
Also, the Handheld Terminal conforms to IP20, so prevent foreign matter from entering inside, and water, solvent or oil from coming in direct contact with it.
- Provide adequate protection when operating in locations such as the following.**  
Failure to do so may cause damage or malfunction. The effect of countermeasures should be checked in individual equipment and machine.
  - Where noise is generated by static electricity, etc.
  - Where there is a strong electric field
  - Where there is a danger of exposure to radiation
  - When in close proximity to power supply lines

#### Operating Environment

#### Caution

- Do not use in an environment where oil and chemicals are used.**  
Operating in environments with coolants, cleaning solvents, various oils or chemicals may cause adverse effects (damage, malfunction) to the unit even in a short period of time.
- Do not use in an environment where the product could be exposed to corrosive gas or liquid.**  
This may damage the unit and cause it to malfunction.
- Do not use in locations with sources of surge generation.**  
Installation of the unit in an area around the equipment (electromagnetic lifters, high frequency induction furnaces, welding machine, motors, etc.), which generates the large surge voltage could cause to deteriorate an internal circuitry element of the unit or result in damage. Implement countermeasures against the surge from the generating source, and avoid touching the lines with each other.
- Use the product type that has an integrated surge absorption element when directly driving a load which generates surge voltage by relay, solenoid valves or lamp.**  
When a surge generating load is directly driven, the unit may be damaged.
- The product is CE/UKCA marked, but not immune to lightning strikes. Take measures against lightning strikes in your system.**
- Keep dust, wire scraps and other extraneous material from getting inside the product.**  
This may cause malfunction or damage.
- Mount the unit in such locations, where no vibration or shock is affected.**  
This may cause malfunction or damage.
- Do not use in places where there are cyclic temperature changes.**  
In case that the cyclic temperature is beyond normal temperature changes, the internal unit is likely to be adversely effected.
- Do not use in direct sunlight.**  
Do not use in direct sunlight. It may cause malfunction or damage.
- Use this product within the specified ambient temperature range.**  
This may cause malfunction.
- Do not use in places where there is radiated heat around it.**  
Such a place is likely to cause malfunction.



# SV Series

## Specific Product Precautions 8

Be sure to read this before handling the products.

Refer to page 8 for safety instructions and pages 9 to 15 for 3/4/5 port solenoid valve precautions.

### EX600 Precautions

#### Adjustment/Operation

##### ⚠ Warning

1. Do not perform operation or setting with wet hands.

There is a risk of electrical shock.

##### <Handheld Terminal>

2. Do not apply pressure to the LCD.

There is a possibility of the crack of LCD and injuring.

3. The forced input/output function is used to change the signal status forcibly. When operating this function, be sure to check the safety of the surroundings and installation.

Otherwise, injury or equipment damage could result.

4. Incorrect setting of parameters can cause malfunction. Be sure to check the settings before use.

This may cause injury or equipment damage.

##### ⚠ Caution

1. Use a watchmaker's screwdriver with thin blade for the setting of each switch of the SI Unit.

When setting the switch, do not touch other unrelated parts.

This may cause parts damage or malfunction due to a short circuit.

2. Provide adequate setting for the operating conditions.

Failure to do so could result in malfunction.

Refer to the operation manual for setting of the switches.

3. For the details of programming and address setting, refer to the manual from the PLC manufacturer.

The content of programming related to protocol is designed by the manufacturer of the PLC used.

##### <Handheld Terminal>

4. Do not press the setting buttons with a sharp pointed object.

This may cause damage or malfunction.

5. Do not apply excessive load and impact to the setting buttons.

This may cause damage, equipment failure or malfunction.

When the order does not include the SI Unit, the Valve Plate to connect the manifold and SI Unit is not mounted. Use attached valve fixing screws and mount the Valve Plate.

(Tightening torque: 0.6 to 0.7 N·m)

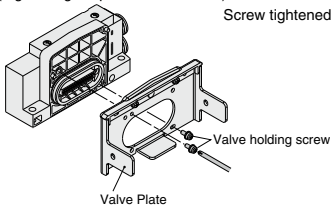

#### Maintenance

##### ⚠ Warning

1. Do not disassemble, modify (including circuit board replacement) or repair this product.

Such actions are likely to cause injuries or breakage.

2. When an inspection is performed,

- Turn off the power supply.
- Stop the air supply, exhaust the residual pressure in piping and verify that the air is released before performing maintenance work.

Unexpected malfunction of system components and injury can result.

##### ⚠ Caution

1. When handling and replacing the unit:

- Do not touch the sharp metal parts of the connector or plug.
- Do not apply excessive force to the unit when disassembling.

The connecting portions of the unit are firmly joined with seals.

- When joining units, take care not to get fingers caught between units.

Injury can result.

2. Perform periodic inspection.

Unexpected malfunction in the system composition devices is likely to occur due to malfunction of machinery or equipment.

3. After maintenance, make sure to perform an appropriate functionality inspection.

In cases of abnormality such as faulty operation, stop operation. Unexpected malfunction in the system composition devices is likely to occur.

4. Do not use benzene and thinner for cleaning units.

Damage to the surface or erasure of the display can result. Wipe off any stains with a soft cloth.

If the stain is persistent, wipe off with a cloth soaked in a dilute solution of neutral detergent and wrung out tightly, and then finish with a dry cloth.

#### Other

##### ⚠ Caution

1. Refer to the catalog of each series for Common Precautions and Specific Product Precautions on manifold solenoid valves.

#### ■ Trademark

DeviceNet® is a registered trademark of ODVA, Inc. EtherNet/IP® is a registered trademark of ODVA, Inc. CompoNet® is a registered trademark of ODVA, Inc. EtherCAT® is registered trademark and patented technology, licensed by Beckhoff Automation GmbH, Germany.