

Mechanically Jointed Rodless Cylinder

MY1 Series

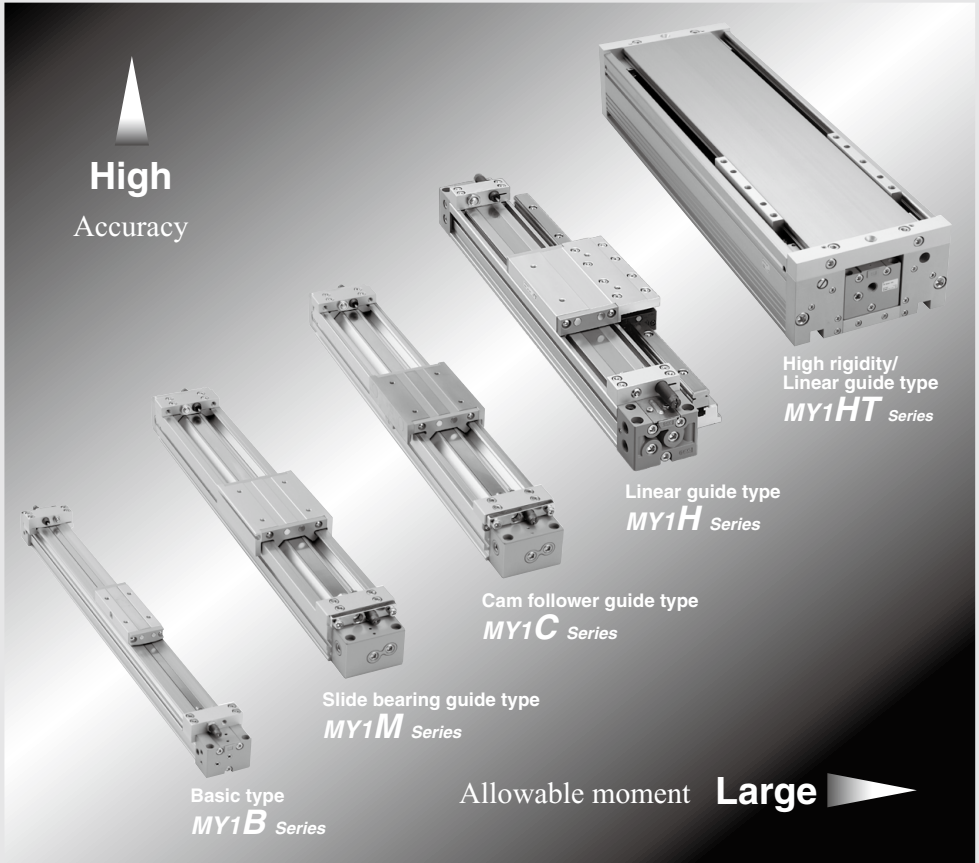

Five types of guide allow a wide range of selections.

Series Variations		Bore size (mm)								Air cushion	Stroke adjustment Unit	Side support	Floating bracket	End lock	Made to Order ⁽³⁾		
Series	Guide type	Piping type ⁽¹⁾	10	16	20	25	32	40	50	63	80	100					
MY1B	Basic type	Centralized piping Standard piping	●	●	●	●	●	●	●	●	●	●	● ⁽²⁾	● ⁽⁴⁾	●	●	P. 1233
MY1M	Slide bearing guide type		●	●	●	●	●	●	●	●	●	●	●	●	●	●	P. 1257
MY1C	Cam follower guide type		●	●	●	●	●	●	●	●	●	●	●	●	●	●	P. 1277
MY1H	Linear guide type		●	●	●	●	●	●	●	●	●	●	● ⁽³⁾	●	●	●	P. 1297
MY1HT	High rigidity/Linear guide type		●	●	●	●	●	●	●	●	●	●	●	●	●	● ⁽⁵⁾	P. 1319

Note 1) $\phi 10$ is available with central piping only. Note 2) $\phi 10$ is available with rubber bumper only.
 Note 3) Availability for Made-to-Order differs, depending on the size and the model.
 Note 4) Except $\phi 50$ to $\phi 100$. Note 5) Except $\phi 10$.

With 5 standardized guide types

Basic Type

MY1B Series

Wide variations from $\varnothing 10$ to $\varnothing 100$

Can be combined with a variety of guides to accommodate conditions.

Simple design without guide facilitates space savings.

Basic type

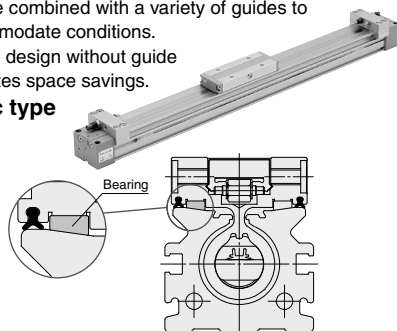

Slide Bearing Type

MY1M Series

Simple guide type that can mount a workpiece directly.

Integrated guide allows use in a wide range of conveyor systems.

Moderate type

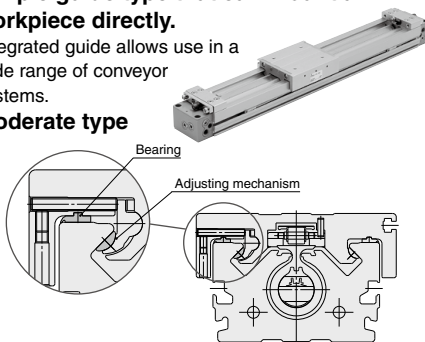

Cam Follower Guide Type

MY1C Series

Strong against moment, compatible with long strokes

Makes smooth operation possible even with an off-set load.

Cam follower type

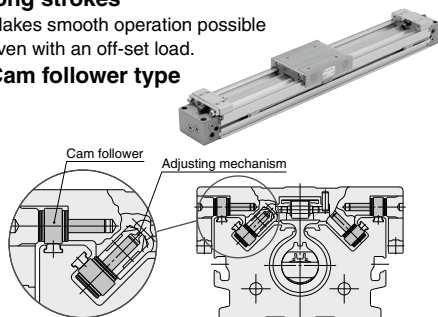

Linear Guide Type

MY1H Series

Uses a linear guide to achieve high repeatability

Small and medium sizes 10 to 40 are ideal for pick & place.

Linear guide type

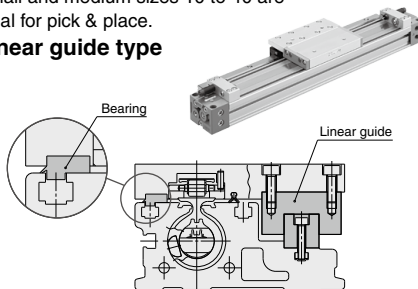

High Rigidity/Linear Guide Type

MY1HT Series

Linear guide heavy loaded workpieces can be accommodated by using two linear guides.

Linear guide twin guide type

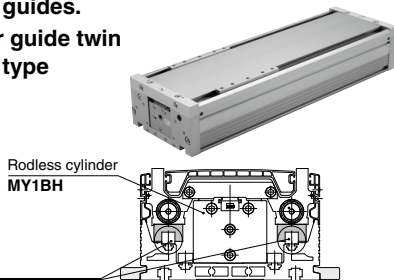

2 linear guides

Minimal leakage seal construction

- The flexible material of the seal belt allows for improved adherence to the cylinder tube, resulting in a reduced leakage amount. (50% reduction compared with the current product)

Applicable models

MY1□16 to 50

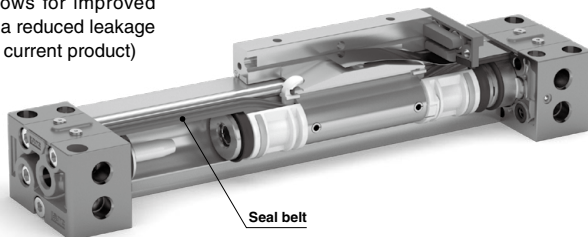

Dust seal band with improved holding force

- The seal magnet on the cylinder tube adsorbs the dust seal band with magnetic force, resulting in improved holding force.

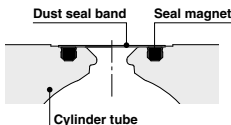

- The dust seal band can be easily removed for replacement by simply loosening the two holding screws. Easier maintenance

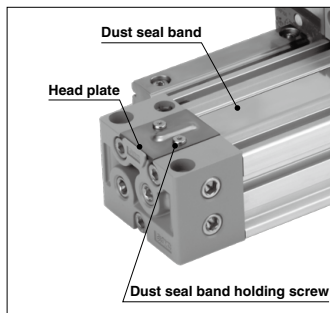

Applicable models

MY1B10, 25 to 40, 80, 100
MY1H10, 25 to 40

Allows for piping to be connected according to installation conditions. Centralized piping type for increased piping freedom

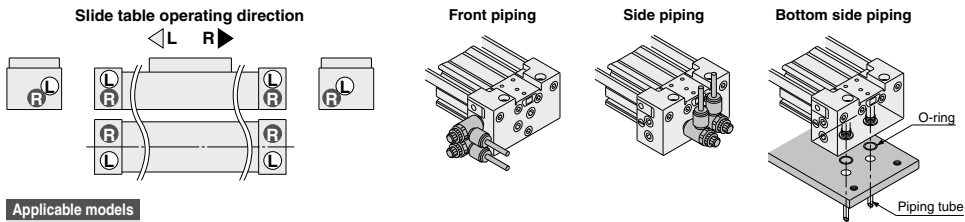

Applicable models

All models

MY1M and MY1C compatibility guaranteed

- With the same outer dimensions and workpiece mounting dimensions, both series are compatible with stroke adjustment units, side supports, auto switches, etc.

Applicable models

MY1M16 to 63
MY1C16 to 63

Built-in adjustment bolt and shock absorber, 3 stroke adjustment unit types

- The shock absorber softens the impact of workpieces at the stroke end, and the adjustment bolt increases the repeatability of the stopping position.
- The following 3 unit types each meet the specification requirements.
- An intermediate fixing spacer for stopping slide tables in the middle of the stroke is available as well.

A unit

With adjustment bolt

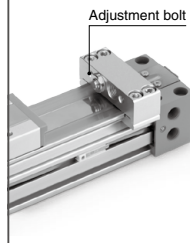

L unit

With adjustment bolt
+
low load shock absorber

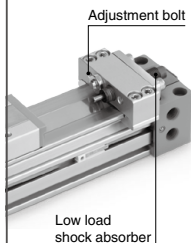

H unit

With adjustment bolt
+
high load shock absorber

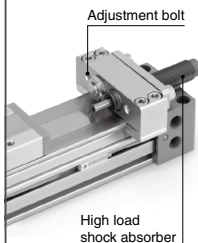

Intermediate fixing spacer as standard

Fixture can be selected to hold the stroke adjustment unit at the intermediate stroke position.

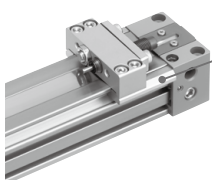

Applicable models

All models

Except MY1B50 to 100

Standardized end lock

- The end lock type has been standardized for bore sizes $\varnothing 16$ to $\varnothing 40$ of the MY1H series. Mountable at any position on one or both sides

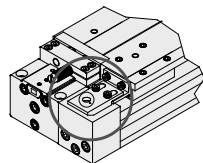

Applicable models

MY1H16 to 40

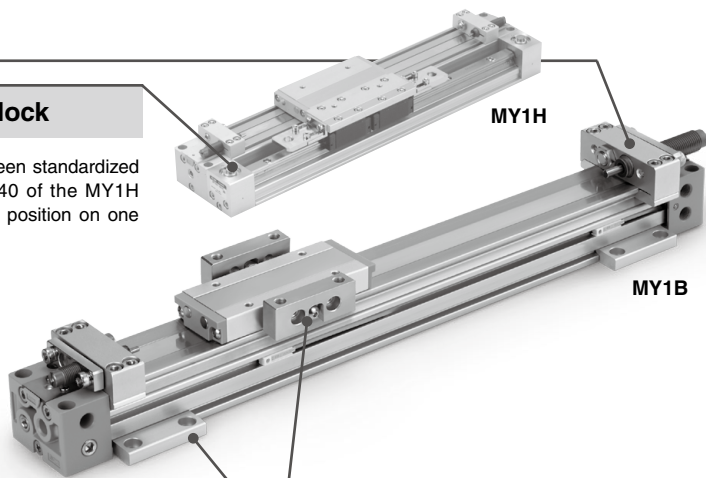

Side support

- Prevents deflection of the cylinder tube at a long stroke. Makes linear operation possible
- Now with 2 selectable mounting options in order to support mounting frames

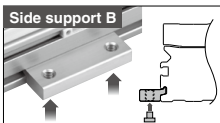
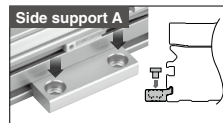

Applicable models

All models

Floating Bracket

- 2 connection types can be selected. ($\varnothing 25$ to $\varnothing 40$)
Easier to connect to other guide types.



Applicable models

MY1B10 to 100

Auto switch wiring storage system

To increase safety, auto switch lead wires can be stored to prevent accidental contact with slide tables.

- Improved safety and accuracy of the entire system can be achieved by storing auto switch lead wires in the product's designated lead wire containment grooves.

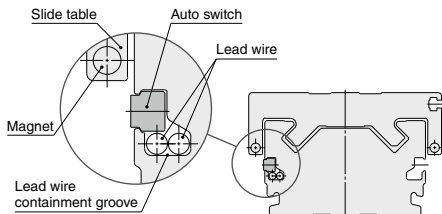

Applicable models

MY1M16 to 63
MY1C16 to 63

Auto switches can be mounted from the front. Contributes to reduction in mounting time.

- Auto switches can be mounted from the front at any position on the mounting groove.

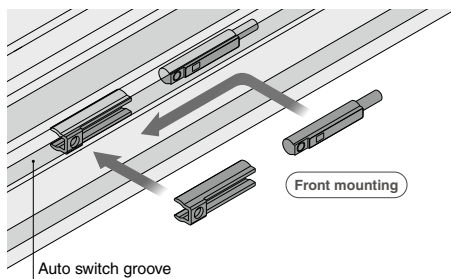

Applicable models

MY1B25 to 40
MY1H25 to 40
MY1HT50, 63

Extremely easy to maintain

- It is possible to replace cylinders with a workpiece being mounted.

For details, refer to page 1337.

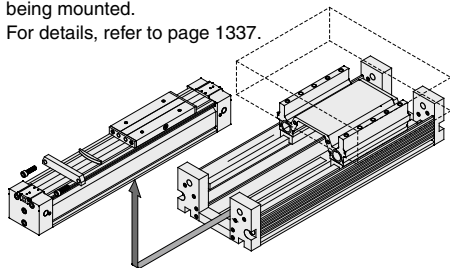

Applicable models

MY1HT50, 63

Two mounting types, Space saving



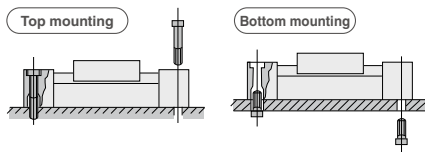



- The cylinder body can be secured directly from the top or bottom without the use of mounting brackets. This does not change the overall length dimension.

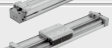

Applicable models

MY1□16 to 63

MY1 Series Variations

Series	Bore size (mm)										Page
	10	16	20	25	32	40	50	63	80	100	
 MY1B	●	●	●	●	●	●	●	●	●	●	P. 1233
 MY1M		●	●	●	●	●	●	●	●	●	P. 1257
 MY1C		●	●	●	●	●	●	●	●	●	P. 1277
 MY1H	●										P. 1297
 MY1H End lock		●	●	●	●	●	●	●	●	●	
 MY1HT							●	●			P. 1319

CONTENTS

Mechanically Jointed Rodless Cylinder *MY1 Series*



MY1B Series

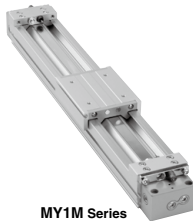

MY1M Series



MY1C Series

MY1 Series/Model Selection	P. 1228
● MY1B Series/Basic Type	P. 1233
Prior to Use	P. 1234
Model Selection	P. 1236
How to Order	P. 1238
Specifications, Piston Speed, Stroke Adjustment Unit	P. 1239
Theoretical Output, Weight	P. 1240
Cushion Capacity	P. 1241
Construction: $\phi 10$	P. 1243
Construction: $\phi 16, \phi 20, \phi 50$ to $\phi 100$	P. 1244
Construction: $\phi 25, \phi 32, \phi 40$	P. 1245-1
Dimensions/Centralized Piping Type: $\phi 10$	P. 1246
Dimensions/Standard Type, Centralized Piping Type: $\phi 16, \phi 20$	P. 1247
Dimensions/Standard Type, Centralized Piping Type: $\phi 25, \phi 32, \phi 40$	P. 1247-1
Dimensions/Standard Type, Centralized Piping Type: $\phi 50, \phi 63$	P. 1248
Dimensions/Standard Type, Centralized Piping Type: $\phi 80, \phi 100$	P. 1249
Stroke adjustment unit	P. 1250
Accessory Bracket (Option)	P. 1251-1
Side Supports, Guide to Side Support Application	P. 1252
Floating Brackets	P. 1254
● MY1M Series/Slide Bearing Guide Type	P. 1257
Prior to Use	P. 1258
Model Selection	P. 1260
How to Order	P. 1262
Specifications, Piston Speed, Stroke Adjustment Unit	P. 1263
Theoretical Output, Weight	P. 1264
Cushion Capacity	P. 1266
Construction: $\phi 16$ to $\phi 63$	P. 1268
Dimensions/Standard Type, Centralized Piping Type: $\phi 16, \phi 20$	P. 1270
Dimensions/Standard Type, Centralized Piping Type: $\phi 25, \phi 32, \phi 40$	P. 1271
Dimensions/Standard Type, Centralized Piping Type: $\phi 50, \phi 63$	P. 1272
Stroke adjustment unit	P. 1273
Accessory Bracket (Option)	P. 1274-1
Side Supports, Guide to Side Support Application	P. 1275
● MY1C Series/Cam Follower Guide Type	P. 1277
Prior to Use	P. 1278
Model Selection	P. 1280
How to Order	P. 1282
Specifications, Piston Speed, Stroke Adjustment Unit	P. 1283
Theoretical Output, Weight	P. 1284
Cushion Capacity	P. 1286
Construction: $\phi 16$ to $\phi 63$	P. 1288
Dimensions/Standard Type, Centralized Piping Type: $\phi 16, \phi 20$	P. 1290
Dimensions/Standard Type, Centralized Piping Type: $\phi 25, \phi 32, \phi 40$	P. 1291
Dimensions/Standard Type, Centralized Piping Type: $\phi 50, \phi 63$	P. 1292
Side Supports, Guide to Side Support Application	P. 1295

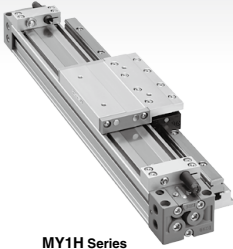

MY1H Series



MY1HT Series

● MY1H Series/Linear Guide Type	P. 1297
Prior to Use	P. 1298
Model Selection	P. 1300
How to Order	P. 1302
Specifications, Piston Speed, Stroke Adjustment Unit	P. 1303
Theoretical Output, Weight, With End Lock	P. 1304
Cushion Capacity	P. 1306
Construction: $\phi 10$	P. 1307
Construction: $\phi 16, \phi 20$	P. 1308
Construction: $\phi 25, \phi 32, \phi 40$	P. 1309-1
Construction (End Lock): $\phi 16, \phi 20$	P. 1310
Construction (End Lock): $\phi 25, \phi 32, \phi 40$	P. 1310-1
Dimensions/Centralized Piping Type: $\phi 10$	P. 1311
Dimensions/Standard Type, Centralized Piping Type: $\phi 16, \phi 20$	P. 1312
Dimensions/Standard Type, Centralized Piping Type: $\phi 25, \phi 32, \phi 40$	P. 1312-1
Dimensions/End Lock: $\phi 16, \phi 20$	P. 1312-2
Dimensions/End Lock: $\phi 25, \phi 32, \phi 40$	P. 1312-3
Stroke adjustment unit	P. 1313
Accessory Bracket (Option)	P. 1315
Side Supports, Guide to Side Support Application	P. 1316
● MY1HT Series/High Rigidity/Linear Guide Type	P. 1319
Prior to Use	P. 1320
Model Selection	P. 1322
How to Order	P. 1324
Specifications, Stroke Adjustment Unit	P. 1325
Theoretical Output, Standard Stroke, Weight	P. 1325
Cushion Capacity	P. 1326
Construction	P. 1328
Dimensions/Standard Type, Centralized Piping Type: $\phi 50, \phi 63$	P. 1329
Side Supports, Guide to Side Support Application	P. 1330
Auto Switch Mounting	P. 1331
Made to Order: Individual Specifications	P. 1334
Specific Product Precautions	P. 1335

MY1 Series Model Selection 1

Following are the steps for selecting the most suitable MY1 series to your application.

Standards for Tentative Model Selection

Cylinder model	Guide type	Standards for guide selection	Graphs for related allowable values
MY1B	Basic type	Guaranteed accuracy not required, generally combined with separate guide	Refer to P. 1234.
MY1M	Slide bearing guide type	Slide table accuracy approx. ± 0.12 mm ⁽²⁾	Refer to P. 1258.
MY1C	Cam follower guide type	Slide table accuracy approx. ± 0.05 mm ⁽²⁾	Refer to P. 1278.
MY1H	Linear guide type	Slide table accuracy of ± 0.05 mm or less required ⁽²⁾	Refer to P. 1298.
MY1HT	High rigidity/Linear guide type	Slide table accuracy of ± 0.05 mm or less required ⁽²⁾	Refer to P. 1320.

Note 1) These accuracy values for each guide should be used only as a guide during selection. Please contact SMC when guaranteed accuracy for MY1C/MY1H is required.

Note 2) "Accuracy" here means displacement of the slide table (at stroke end) when 50% of the allowable moment shown in the catalog is applied. (reference value).

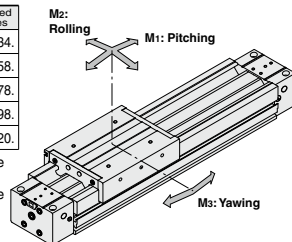

Selection Flow Chart

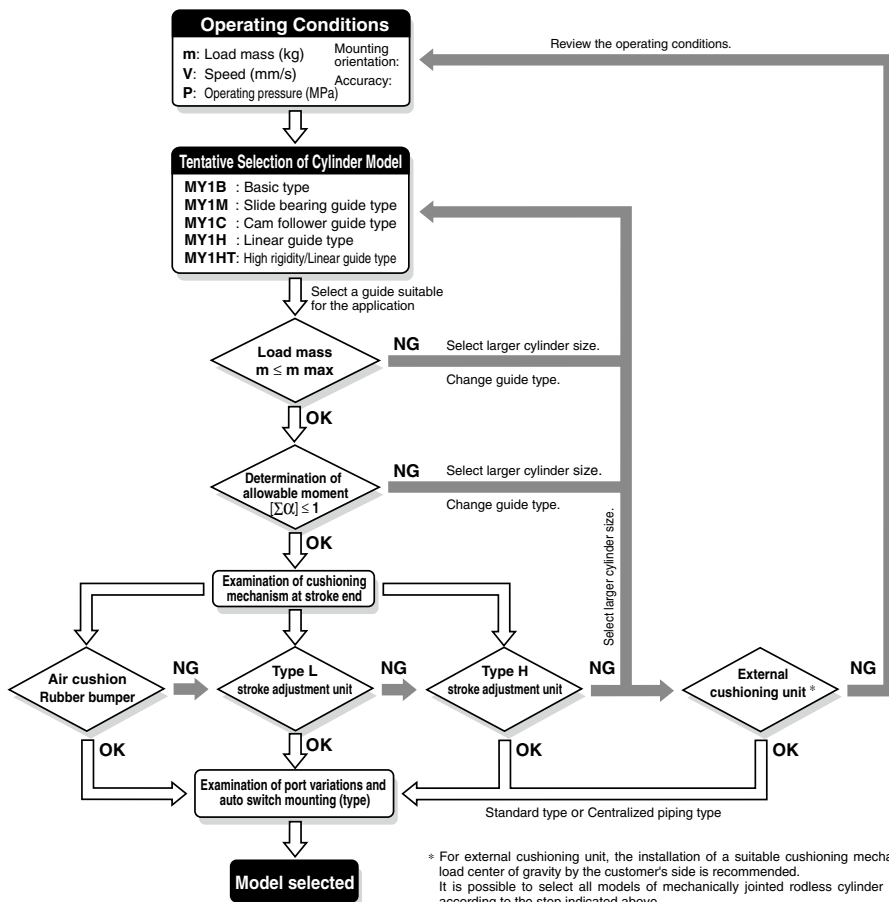

Types of Moment Applied to Rodless Cylinders

Multiple moments may be generated depending on the mounting orientation, load, and position of the center of gravity.

Coordinates and Moments

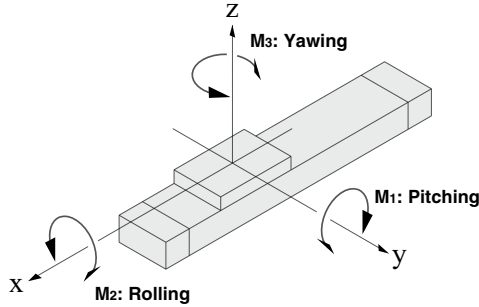

Static Moment

Horizontal mounting

Ceiling mounting

Wall mounting

Vertical mounting

g: Gravitational acceleration

Mounting orientation	Horizontal mounting	Ceiling mounting	Wall mounting	Vertical mounting
Static load (m)	m_1	m_2	m_3	m_4 <small>(Note)</small>
M_1	$m_1 \times g \times X$	$m_2 \times g \times X$	—	$m_4 \times g \times Z$
M_2	$m_1 \times g \times Y$	$m_2 \times g \times Y$	$m_3 \times g \times Z$	—
M_3	—	—	$m_3 \times g \times X$	$m_4 \times g \times Y$

Note) m_4 is a mass movable by thrust. Use 0.3 to 0.7 times the thrust (differs depending on the operating speed) as a guide for actual use.

Dynamic Moment

Mounting orientation	Horizontal mounting	Ceiling mounting	Wall mounting	Vertical mounting
Dynamic load (Fe)	$1.4 \times \nu_a \times \delta \times m_n \times g$			
M_{1e}	$\frac{1}{3} \times F_e \times Z$			
M_{2e}	Dynamic moment M_{2e} is not generated.			
M_{3e}	$\frac{1}{3} \times F_e \times Y$			

Note) Regardless of the mounting orientation, dynamic moment is calculated with the formulae above.

g: Gravitational acceleration, ν_a : Average speed, δ : Damper coefficient

MY1 Series Model Selection 2

Following are the steps for selecting the most suitable MY1 series to your application.

Calculation of Guide Load Factor

1. Operating Conditions

Operating cylinder MY1H40-500
Average operating speed v_a ... 300 mm/s
Mounting orientation Wall mounting
Cushion Air cushion
($\dot{\phi} = 1/100$)

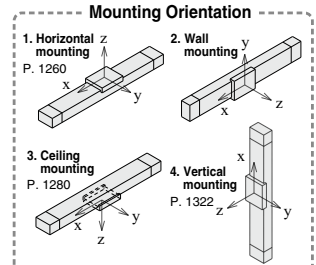
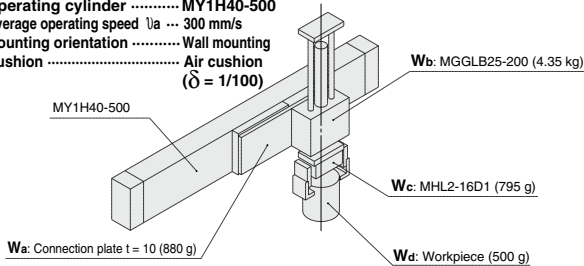

For actual examples of calculation for each orientation, refer to the pages above.

2. Load Blocking

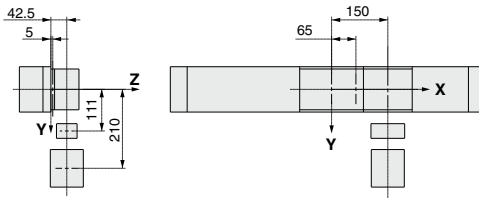

Mass and Center of Gravity for Each Workpiece

Workpiece no. W_n	Mass m_n	Center of gravity		
		X-axis X_n	Y-axis Y_n	Z-axis Z_n
W_a	0.88 kg	65 mm	0 mm	5 mm
W_b	4.35 kg	150 mm	0 mm	42.5 mm
W_c	0.795 kg	150 mm	111 mm	42.5 mm
W_d	0.5 kg	150 mm	210 mm	42.5 mm

$n = a, b, c, d$

3. Composite Center of Gravity Calculation

$$m_3 = \sum m_n \\ = 0.88 + 4.35 + 0.795 + 0.5 = 6.525 \text{ kg}$$

$$X = \frac{1}{m_3} \times \sum (m_n \times X_n) \\ = \frac{1}{6.525} (0.88 \times 65 + 4.35 \times 150 + 0.795 \times 150 + 0.5 \times 150) = 138.5 \text{ mm}$$

$$Y = \frac{1}{m_3} \times \sum (m_n \times Y_n) \\ = \frac{1}{6.525} (0.88 \times 0 + 4.35 \times 0 + 0.795 \times 111 + 0.5 \times 210) = 29.6 \text{ mm}$$

$$Z = \frac{1}{m_3} \times \sum (m_n \times Z_n) \\ = \frac{1}{6.525} (0.88 \times 5 + 4.35 \times 42.5 + 0.795 \times 42.5 + 0.5 \times 42.5) = 37.4 \text{ mm}$$

4. Calculation of Load Factor for Static Load

m_3 : Mass

$m_3 \text{ max}$ (from (1) of graph MY1H/ m_3) = 50 (kg)
Load factor $\alpha_1 = m_3 / m_3 \text{ max} = 6.525 / 50 = 0.13$

M_2 : Moment

$M_2 \text{ max}$ (from (2) of graph MY1H/ M_2) = 50 (N·m)
 $M_2 = m_3 \times g \times Z = 6.525 \times 9.8 \times 37.4 \times 10^{-3} = 2.39$ (N·m)
Load factor $\alpha_2 = M_2 / M_2 \text{ max} = 2.39 / 50 = 0.05$

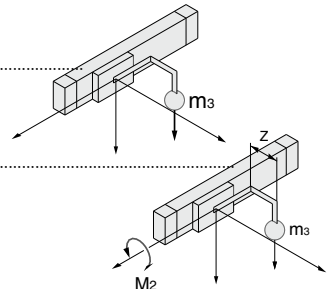

M₃: Moment

M₃ max (from (3) of graph MY1H/M₃) = 38.7 (N·m)

$$M_3 = m_3 \times g \times X = 6.525 \times 9.8 \times 138.5 \times 10^{-3} = 8.86 \text{ (N·m)}$$

$$\text{Load factor } \alpha_3 = M_3/M_3 \text{ max} = 8.86/38.7 = 0.23$$

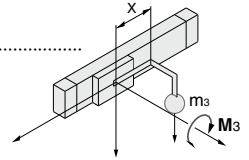

5. Calculation of Load Factor for Dynamic Moment

Equivalent load F_E at impact

$$F_E = 1.4Ua \times \delta \times m \times g = 1.4 \times 300 \times \frac{1}{100} \times 6.525 \times 9.8 = 268.6 \text{ (N)}$$

M_{1E}: Moment

M_{1E} max (from (4) of graph MY1H/M₁ where 1.4Ua = 420 mm/s) = 35.9 (N·m)

$$M_{1E} = \frac{1}{3} \times F_E \times Z = \frac{1}{3} \times 268.6 \times 37.4 \times 10^{-3} = 3.35 \text{ (N·m)}$$

$$\text{Load factor } \alpha_4 = M_{1E}/M_{1E} \text{ max} = 3.35/35.9 = 0.09$$

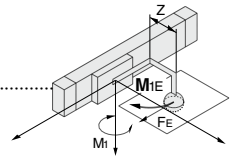

M_{3E}: Moment

M_{3E} max (from (5) of graph MY1H/M₃ where 1.4Ua = 420 mm/s) = 27.6 (N·m)

$$M_{3E} = \frac{1}{3} \times F_E \times Y = \frac{1}{3} \times 268.6 \times 29.6 \times 10^{-3} = 2.65 \text{ (N·m)}$$

$$\text{Load factor } \alpha_5 = M_{3E}/M_{3E} \text{ max} = 2.65/27.6 = 0.10$$

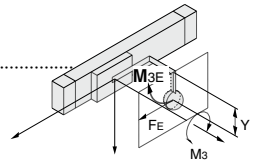

6. Sum and Examination of Guide Load Factors

$$\Sigma \alpha = \alpha_1 + \alpha_2 + \alpha_3 + \alpha_4 + \alpha_5 = 0.60 \leq 1$$

The above calculation is within the allowable value, and therefore the selected model can be used.

Select a shock absorber separately.

In an actual calculation, when the sum of guide load factors α in the formula above is more than 1, consider decreasing the speed, increasing the bore size, or changing the product series.

This calculation can be easily made using the “SMC Pneumatics CAD System”.

Load Mass

MY1H/m₃

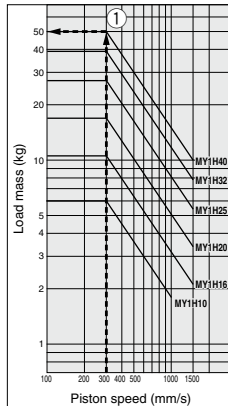

Allowable Moment

MY1H/M₁

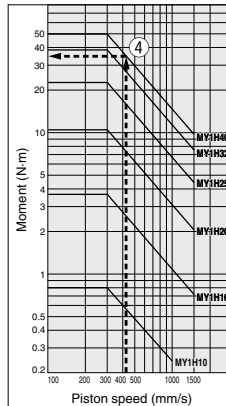

MY1H/M₂

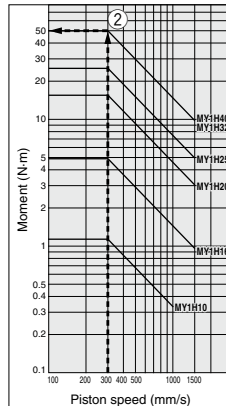

MY1H/M₃

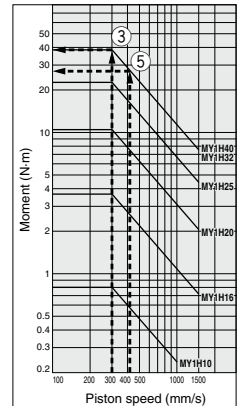

MY1B Series

Basic Type

ø10, ø16, ø20, ø25, ø32, ø40, ø50, ø63, ø80, ø100

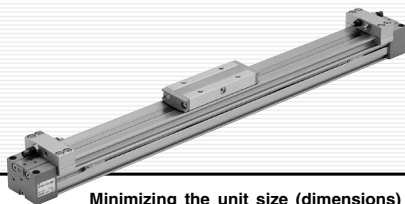

Minimizing the unit size (dimensions) and combination with other guides is possible.

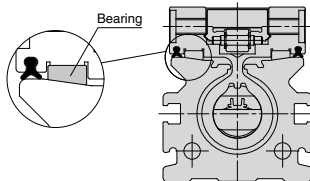

INDEX

MY1B Series Prior to Use	P. 1234
Model Selection	P. 1236
How to Order	P. 1238
Specifications	P. 1239
Cushion Capacity	P. 1241
Construction	P. 1243
Dimensions	P. 1246
Stroke Adjustment Unit	P. 1250
Accessory Bracket (Option)	P. 1251-1
Floating Bracket	P. 1254

MY1B Series Prior to Use

Maximum Allowable Moment/Maximum Load Mass

Model	Bore size (mm)	Maximum allowable moment (N·m)			Maximum load mass (kg)		
		M ₁	M ₂	M ₃	m ₁	m ₂	m ₃
MY1B	10	0.8	0.1	0.3	5.0	1.0	0.5
	16	2.5	0.3	0.8	15	3.0	1.7
	20	5.0	0.6	1.5	21	4.2	3.0
	25	10	1.2	3.0	29	5.8	5.4
	32	20	2.4	6.0	40	8.0	8.8
	40	40	4.8	12	53	10.6	14
	50	78	9.3	23	70	14	20
	63	160	19	48	83	16.6	29
	80	315	37	95	120	24	42
	100	615	73	184	150	30	60

The above values are the maximum allowable values for moment and load. Refer to each graph regarding the maximum allowable moment and maximum allowable load for a particular piston speed.

Caution on Design

We recommend installing an external shock absorber when the cylinder is combined with another guide (connection with floating bracket, etc.) and the maximum allowable load is exceeded, or when the operating speed is 1000 to 1500 mm/s for bore sizes ø16, ø50, ø63, ø80 and ø100.

Load mass (kg)

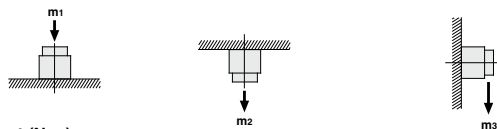

Moment (N·m)

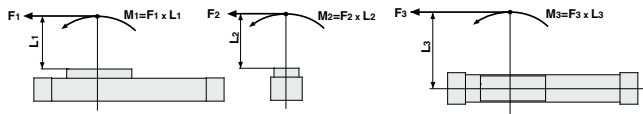

<Calculation of guide load factor>

1. Maximum allowable load (1), static moment (2), and dynamic moment (3) (at the time of impact with stopper) must be examined for the selection calculations.

* To evaluate, use \bar{U}_a (average speed) for (1) and (2), and U (collision speed $U = 1.4 \bar{U}_a$) for (3). Calculate m_{max} for (1) from the maximum allowable load graph (m_1, m_2, m_3) and M_{max} for (2) and (3) from the maximum allowable moment graph (M_1, M_2, M_3).

$$\sum \alpha = \frac{\text{Load mass [m]}}{\text{Maximum allowable load [m}_{max}\text{]}} + \frac{\text{Static moment [M]}^{(1)}}{\text{Allowable static moment [M}_{max}\text{]}} + \frac{\text{Dynamic moment [M}_E\text{]}^{(2)}}{\text{Allowable dynamic moment [M}_{Emax}\text{]}} \leq 1$$

Note 1) Moment caused by the load, etc., with cylinder in resting condition.

Note 2) Moment caused by the impact load equivalent at the stroke end (at the time of impact with stopper).

Note 3) Depending on the shape of the workpiece, multiple moments may occur. When this happens, the sum of the load factors ($\sum \alpha$) is the total of all such moments.

2. Reference formula [Dynamic moment at impact]

Use the following formulae to calculate dynamic moment when taking stopper impact into consideration.

m: Load mass (kg)

F: Load (N)

F_E: Load equivalent to impact (at impact with stopper) (N)

\bar{U}_a : Average speed (mm/s)

M: Static moment (N·m)

$U = 1.4 \bar{U}_a$ (mm/s) $F_E = 1.4 U a \cdot \delta \cdot m \cdot g$

$\therefore M_E = \frac{1}{3} F_E \cdot L = 4.57 U a \delta m L$

U: Collision speed (mm/s)

L: Distance to the load's center of gravity (m)

M_E: Dynamic moment (N·m)

δ : Damper coefficient

With rubber bumper = 4/100

(MY1B10, MY1H10)

With air cushion = 1/100

With shock absorber = 1/100

g: Gravitational acceleration (9.8 m/s²)

Note 4) $1.4 U a \delta$ is a dimensionless coefficient for calculating impact force.

Note 5) Average load coefficient ($= \frac{1}{3}$): This coefficient is for averaging the maximum load moment at the time of stopper impact according to service life calculations.

3. For detail selection procedures, refer to pages 1236 and 1237.

Maximum Allowable Moment

Select the moment from within the range of operating limits shown in the graphs. Note that the maximum allowable load value may sometimes be exceeded even within the operating limits shown in the graphs. Therefore, also check the allowable load for the selected conditions.

Maximum Load Mass

Select the load from within the range of limits shown in the graphs. Note that the maximum allowable moment value may sometimes be exceeded even within the operating limits shown in the graphs. Therefore, also check the allowable moment for the selected conditions.

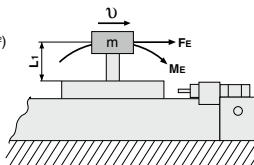

MY1B/M₁

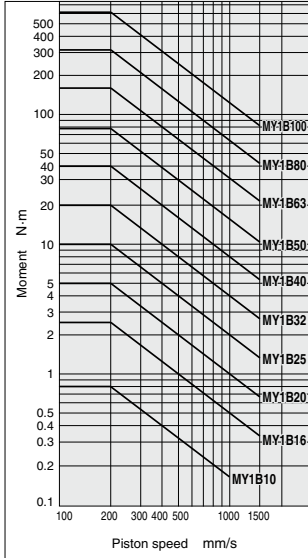

MY1B/M₂

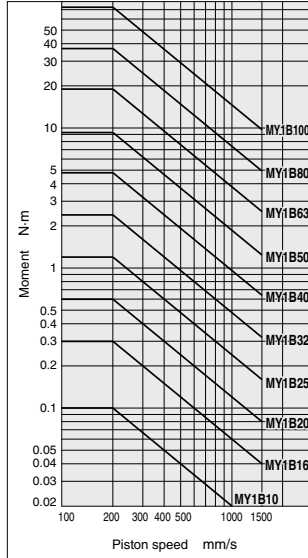

MY1B/M₃

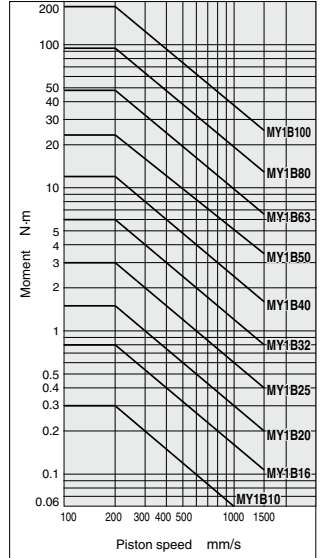

MY1B/m₁

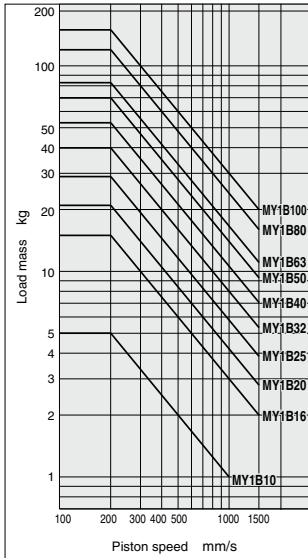

MY1B/m₂

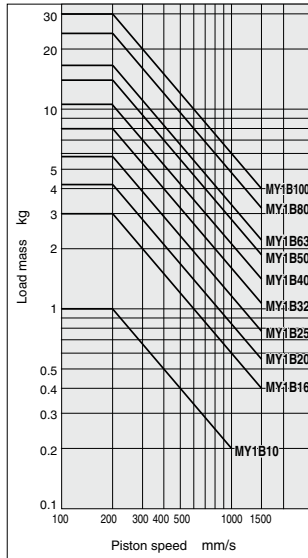

MY1B/m₃

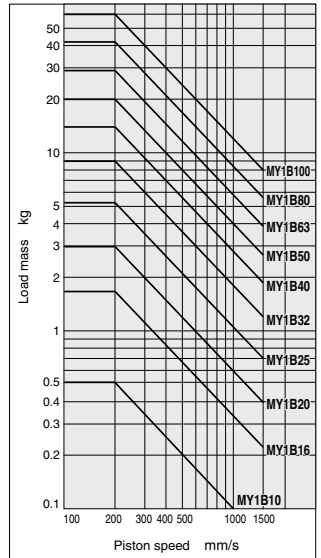

MY1B Series Model Selection

Following are the steps for selecting the most suitable MY1B series to your application.

Calculation of Guide Load Factor

1. Operating Conditions

Cylinder MY1B50-500
 Average operating speed \bar{v}_a ... 300 mm/s
 Mounting orientation Horizontal mounting
 Cushion Air cushion
 ($\bar{\delta} = 1/100$)

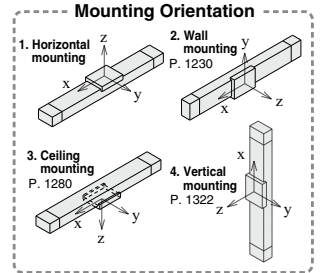
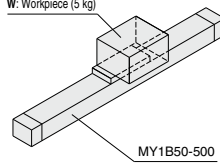

For actual examples of calculation for each orientation, refer to the pages above.

2. Load Blocking

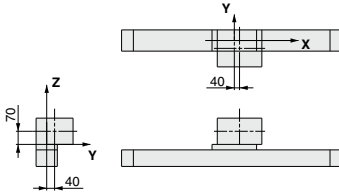

Mass and Center of Gravity for Workpiece

Workpiece no.	Mass m	Center of gravity		
		X-axis	Y-axis	Z-axis
W	5 kg	40 mm	40 mm	70 mm

3. Calculation of Load Factor for Static Load

m₁: Mass

m₁ max (from (1) of graph MY1B/**m₁**) = 47 (kg).....

Load factor $\alpha_1 = m_1 / m_1 \text{ max} = 5/47 = 0.11$

M₁: Moment

M₁ max (from (2) of graph MY1B/**M₁**) = 52 (N·m).....

M₁ = **m₁** × **g** × **X** = 5 × 9.8 × 40 × 10⁻³ = 1.96 (N·m)

Load factor $\alpha_2 = M_1 / M_1 \text{ max} = 1.96/52 = 0.04$

M₂: Moment

M₂ max (from (3) of graph MY1B/**M₂**) = 6.2 (N·m).....

M₂ = **m₁** × **g** × **Y** = 5 × 9.8 × 40 × 10⁻³ = 1.96 (N·m)

Load factor $\alpha_3 = M_2 / M_2 \text{ max} = 1.96/6.2 = 0.32$

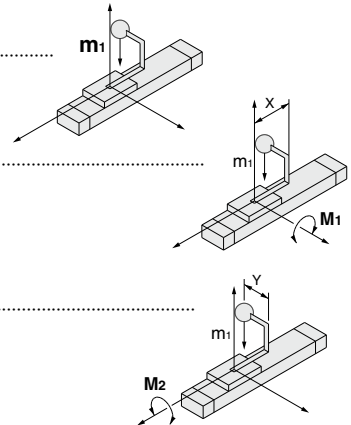

4. Calculation of Load Factor for Dynamic Moment

Equivalent load F_E at impact

$$F_E = 1.4U_a \times \delta \times m \times g = 1.4 \times 300 \times \frac{1}{100} \times 5 \times 9.8 = 205.8 \text{ (N)}$$

M_{1E} : Moment

$M_{1E} \text{ max}$ (from (4) of graph MY1B/ M_1 where $1.4U_a = 420 \text{ mm/s}$) = 37 (N·m).....

$$M_{1E} = \frac{1}{3} \times F_E \times Z = \frac{1}{3} \times 205.8 \times 70 \times 10^{-3} = 4.81 \text{ (N·m)}$$

Load factor $\alpha_4 = M_{1E}/M_{1E} \text{ max} = 4.81/37 = 0.13$

M_{3E} : Moment

$M_{3E} \text{ max}$ (from (5) of graph MY1B/ M_3 where $1.4U_a = 420 \text{ mm/s}$) = 11.0 (N·m).....

$$M_{3E} = \frac{1}{3} \times F_E \times Y = \frac{1}{3} \times 205.8 \times 40 \times 10^{-3} = 2.75 \text{ (N·m)}$$

Load factor $\alpha_5 = M_{3E}/M_{3E} \text{ max} = 2.75/11.0 = 0.25$

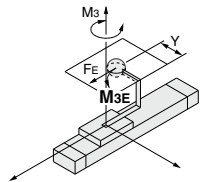
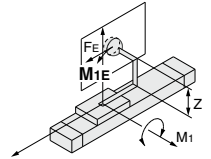

5. Sum and Examination of Guide Load Factors

$$\Sigma \alpha = \alpha_1 + \alpha_2 + \alpha_3 + \alpha_4 + \alpha_5 = 0.85 \leq 1$$

The above calculation is within the allowable value, and therefore the selected model can be used. Select a shock absorber separately.

In an actual calculation, when the total sum of guide load factors α in the formula above is more than 1, consider either decreasing the speed, increasing the bore size, or changing the product series. This calculation can be easily made using the "SMC Pneumatics CAD System".

Load Mass

MY1B/ m_1

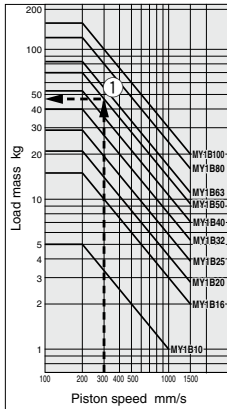

Allowable Moment

MY1B/ M_1

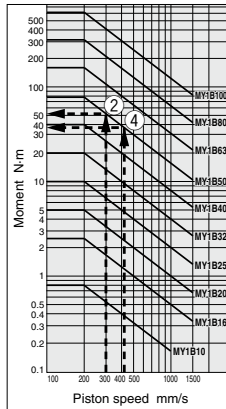

MY1B/ M_2

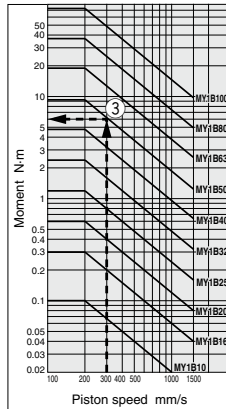

MY1B/ M_3

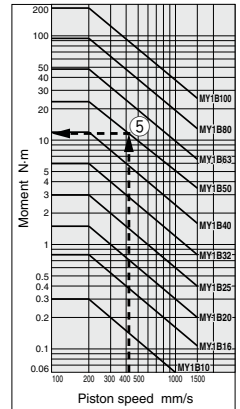

Mechanically Jointed Rodless Cylinder Basic Type

MY1B Series

ø10, ø16, ø20, ø25, ø32, ø40, ø50, ø63, ø80, ø100

How to Order

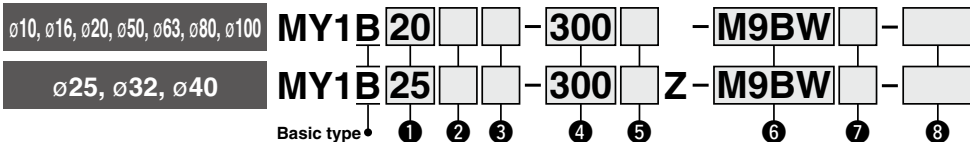

① Bore size

10	10 mm
16	16 mm
20	20 mm
25	25 mm
32	32 mm
40	40 mm
50	50 mm
63	63 mm
80	80 mm
100	100 mm

② Port thread type

Symbol	Type	Bore size
Nil	M thread	ø10, ø16, ø20
	Pc	ø25, ø32, ø40,
TN	NPT	ø50, ø63, ø80,
TF	G	ø100

③ Piping

Nil	Standard type
G	Centralized piping type

Note) For ø10, only G is available.

④ Cylinder stroke (mm)

Bore size	Standard stroke*1	Long stroke (-XB11)	Maximum manufacturable stroke
10, 16	100, 200, 300, 400 500, 600, 700, 800 900, 1000, 1200, 1400	Strokes of 2001 to 3000 mm (1 mm increments) exceeding the standard stroke	3000
	1600, 1800, 2000 *1 The stroke can be manufactured in 1 mm increments from 1 mm stroke.	Strokes of 2001 to 5000 mm (1 mm increments) exceeding the standard stroke	5000

Ordering example

* Add "-XB11" to the end of the part number for long strokes. MY1B20-3000L-M9BW-XB11

Note) Please be advised that with stroke 49 or less, there are cases where auto switch mounting is not possible and the performance of the air cushion may decline.

⑤ Stroke adjustment unit symbol

Refer to "Stroke adjustment unit" on page 1239.

⑥ Auto switch

Nil	ø10	Without auto switch (Built-in magnet for reed switch)
		Without auto switch (Built-in magnet for solid state switch) (Made to Order: -X1810)
	ø16 to ø100	Without auto switch (Built-in magnet)

* Refer to the table below for the applicable auto switch model.

Applicable auto switches vary depending on the bore size. Select an applicable one referring to the table below.

⑦ Number of auto switches

Nil	2 pcs.
S	1 pc.
n	"n" pcs.

Made to Order
Made to Order: Individual Specifications
(For details, refer to page 1334.)

Symbol	Specifications
-X168	Helical insert thread specifications
-X1810	Magnet for ø10 solid state auto switch specifications

Made to Order Specifications

[Click here for details](#)

Symbol	Specifications
-XB11	Long stroke type
-XB22	Shock absorber soft type RJ series type
-XC67*	NBR rubber lining in dust seal band

* Only ø16, ø20, ø50, and ø63 are available for the -XC67.

Applicable Auto Switches

Refer to pages 1575 to 1701 for further information on auto switches.

Type	Special function	Electrical entry	Release light	Wiring (Output)	Load voltage		Auto switch model				Lead wire length (m)					Pre-wired connector	Applicable load
					DC	AC	Perpendicular		In-line		0.5 (Nil)	1 (M)	3 (L)	5 (Z)			
							ø10 to ø40	ø50 to ø100	ø10 to ø40	ø50 to ø100							
Solid state auto switch	Diagnostic indication (2-color indicator)	Grommet	Yes	3-wire (NPN)	24 V	—	M9NV(Y69A)**	M9N(Y59A)**	●	●	○	○	○	○	IC circuit	Relay, PLC	
				3-wire (PNP)			M9PV(Y7PV)**	M9P(Y7P)**	●	●	○	○	○	○	IC circuit		
				2-wire			M9BV(Y69B)**	M9B(Y59B)**	●	●	○	○	○	○	—		
				3-wire (NPN)			M9NW(Y7NWV)**	M9NW(Y7NV)**	●	●	○	○	○	○	IC circuit		
	Water resistant (2-color indicator)	Grommet	Yes	3-wire (PNP)	24 V	—	M9PW(Y7PWV)**	M9PW(Y7PW)**	●	●	○	○	○	○	IC circuit		
				2-wire			M9BW(Y7B WV)**	M9BW(Y7B W)**	●	●	○	○	○	○	—		
				3-wire (NPN)			M9NAV(—)**	M9NA(—)**	○	○	●	○	○	○	IC circuit		
				3-wire (PNP)			M9PAV(—)**	M9PA(—)**	○	○	●	○	○	○	IC circuit		
Reed auto switch	—	Grommet	Yes	3-wire (NPN equivalent)	24 V	12 V	M9BAV(—)**	M9BA(Y7BA)**	○	○	●	○	○	—	IC circuit		
				2-wire			M9BAV(—)**	M9BA(Y7BA)**	○	○	●	○	○	○	—	IC circuit	
Reed auto switch	—	Grommet	No	3-wire	24 V	12 V	A96V	A96	Z76	●	—	—	—	—	IC circuit		
				2-wire			A93V*3	A93	Z73	●	●	●	—	—	—	Relay, PLC	
						100 V or less	A90V	A90	Z80	●	—	—	—	—	IC circuit		

*1 Water resistant type auto switches can be mounted on the above models, but in such case SMC cannot guarantee water resistance.

Consult with SMC regarding water resistant types with the above model numbers.

*2 For details on switch mounting brackets and part numbers, refer to "Switch Mounting Bracket; Part No." on page 1333-1.

*3 1 m type lead wire is only applicable to D-A93.

* Lead wire length symbols: 0.5 m Nil (Example) M9NW
1 m M (Example) M9NW
3 m L (Example) M9NW
5 m Z (Example) M9NW

* Solid state auto switches marked with "○" are produced upon receipt of order.

** D-M9□□□ type cannot be mounted on ø50. Select auto switches in brackets.

* There are other applicable auto switches than listed above. For details, refer to page 1333-1.

* Auto switches are shipped together (not assembled).

Mechanically Jointed Rodless Cylinder **MY1B Series**

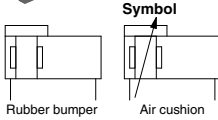
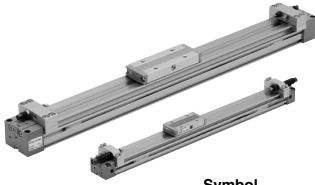

Specifications

Bore size (mm)	10	16	20	25	32	40	50	63	80	100
Fluid	Air									
Action	Double acting									
Operating pressure range	0.2 to 0.8 MPa	0.15 to 0.8 MPa	0.1 to 0.8 MPa							
Proof pressure	1.2 MPa									
Ambient and fluid temperature	5 to 60°C									
Cushion	Rubber bumper	Air cushion								
Lubrication	Non-lube									
Stroke length tolerance	1000 or less $+1.8$ 1001 to 3000 $+2.8$ -0			2700 or less $+1.8$ 2701 to 5000 $+2.8$ -0						
Piping Port size	Front/Side port	M5 x 0.8			1/8	1/4	3/8	1/2		
	Bottom port	ø4			ø6	ø8	ø10	ø18		

Piston Speed

Bore size (mm)	10	16	20 to 40	50 to 100
Without stroke adjustment unit	100 to 500 mm/s	100 to 1000 mm/s		
Stroke adjustment unit	A unit	100 to 200 mm/s	100 to 1000 mm/s ⁽¹⁾	
	L unit and H unit	100 to 1000 mm/s	—	100 to 1500 mm/s ⁽¹⁾

Note 1) Be aware that when the stroke adjustment range is increased by manipulating the adjustment bolt, the air cushion capacity decreases.

Also, when exceeding the air cushion stroke ranges on page 1241, the piston speed should be 100 to 200 mm per second.

Note 2) The piston speed is 100 to 1000 mm/s for centralized piping.

Note 3) Use at a speed within the absorption capacity range. Refer to page 1241.

Note 4) Due to the construction of this product, it may have more fluctuation in operating speed compared to a rod type air cylinder. For applications that require constant speed, select the equipment corresponding to the required level.

Stroke Adjustment Unit Specifications

Bore size (mm)	10	16	20	25	32	40
Unit symbol	A	H	A	A	L	H
Configuration Shock absorber model	With adjustment bolt		With adjustment bolt		With adjustment bolt	
	RB 0805 + with adjustment bolt	RB 0806 + with adjustment bolt	RB 1007 + with adjustment bolt	RB 1007 + with adjustment bolt	RB 1412 + with adjustment bolt	RB 2015 + with adjustment bolt
Stroke adjustment range by intermediate fixing spacer (mm)	Without spacer	0 to -5	0 to -5.6	0 to -6	0 to -11.5	0 to -12
	With short spacer	—	-5.6 to -11.2	-6 to -12	-11.5 to -23	-12 to -24
	With long spacer	—	-11.2 to -16.8	-12 to -18	-23 to -34.5	-24 to -36
						0 to -16
						-16 to -32
						-32 to -48

Note) Intermediate fixing spacer is not available for ø10.

* Stroke adjustment range is applicable for one side when mounted on a cylinder.

Stroke Adjustment Unit Symbol

		Right side stroke adjustment unit													
		Without unit	A: With adjustment bolt					L: With low load shock absorber + Adjustment bolt				H: With high load shock absorber + Adjustment bolt			
Left side stroke adjustment unit	Without unit	Nil	SA	SA6	SA7	SL	SL6	SL7	SH	SH6	SH7				
	A: With adjustment bolt	AS	A	AA6	AA7	AL	AL6	AL7	AH	AH6	AH7				
	With short spacer	A6S	A6A	A6	A6A7	A6L	A6L6	A6L7	A6H	A6H6	A6H7				
	With long spacer	A7S	A7A	A7A6	A7	A7L	A7L6	A7L7	A7H	A7H6	A7H7				
	L: With low load shock absorber + Adjustment bolt	LS	LA	LA6	LA7	L	LL6	LL7	LH	LH6	LH7				
	With short spacer	L6S	L6A	L6A6	L6A7	L6L	L6	L6L7	L6H	L6H6	L6H7				
	With long spacer	L7S	L7A	L7A6	L7A7	L7L	L7L6	L7	L7H	L7H6	L7H7				
	H: With high load shock absorber + Adjustment bolt	HS	HA	HA6	HA7	HL	HL6	HL7	H	HH6	HH7				
With short spacer	H6S	H6A	H6A6	H6A7	H6L	H6L6	H6L7	H6H	H6	H6H7					
With long spacer	H7S	H7A	H7A6	H7A7	H7L	H7L6	H7L7	H7H	H7H6	H7					

* Spacers are used to fix the stroke adjustment unit at an intermediate stroke position.

For details on spacers and stroke adjustment units, refer to "Accessory Bracket (Option)" on page 1251-1.

Stroke adjustment unit mounting diagram

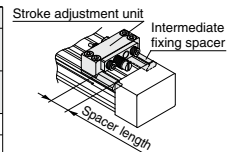

Example of H6H7 attachment

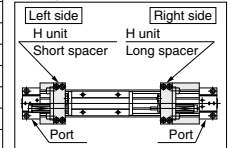

Refer to pages 1331 to 1333-1 for the specifications with auto switch.

MY1B Series

Shock Absorbers for L and H Units

Model	Stroke adjustment unit	Bore size (mm)				
		10	20	25	32	40
Standard (Shock absorber/RB series)	L	—	RB0806	RB1007	RB1412	
	H	RB0805	RB1007	RB1412	RB2015	
Shock absorber/soft type RJ series mounted (-XB22)	L	—	RJ0806H	RJ1007H	RJ1412H	
	H	RJ0805	RJ1007H	RJ1412H	—	—

* The shock absorber service life is different from that of the MY1B cylinder depending on operating conditions. Refer to the RB Series Specific Product Precautions for the replacement period.

* Mounted shock absorber soft type RJ series (-XB22) is made to order specifications. For details, refer to page 1752.

Shock Absorber Specifications

Model		RB 0805	RB 0806	RB 1007	RB 1412	RB 2015
Max. energy absorption (J)		1.0	2.9	5.9	19.6	58.8
Stroke absorption (mm)		5	6	7	12	15
Max. collision speed (mm/s)		1000	1500	1500	1500	1500
Max. operating frequency (cycle/min)		80	80	70	45	25
Spring force (N)	Extended	1.96	1.96	4.22	6.86	8.34
	Retracted	3.83	4.22	6.86	15.98	20.50
Operating temperature range (°C)		5 to 60				

* The shock absorber service life is different from that of the MY1B cylinder depending on operating conditions. Refer to the RB series Specific Product Precautions for the replacement period.

Theoretical Output

Bore size (mm)	Piston area (mm ²)	Operating pressure (MPa)							
		0.2	0.3	0.4	0.5	0.6	0.7	0.8	
10	78	15	23	31	39	46	54	62	
16	200	40	60	80	100	120	140	160	
20	314	62	94	125	157	188	219	251	
25	490	98	147	196	245	294	343	392	
32	804	161	241	322	402	483	563	643	
40	1256	251	377	502	628	754	879	1005	
50	1962	392	588	784	981	1177	1373	1569	
63	3115	623	934	1246	1557	1869	2180	2492	
80	5024	1004	1507	2009	2512	3014	3516	4019	
100	7850	1570	2355	3140	3925	4710	5495	6280	

Note) Theoretical output (N) = Pressure (MPa) x Piston area (mm²)

Weight

Bore size (mm)	Basic weight	Additional weight per each 50 mm of stroke	Weight of moving parts	Side support bracket weight (per set)	Stroke adjustment unit weight (per unit)		
					Type A and B	A unit weight	L unit weight
10	0.15	0.04	0.03	0.003	0.01	—	0.02
16	0.61	0.06	0.07	0.01	0.04	—	—
20	1.06	0.10	0.14	0.02	0.05	0.05	0.10
25	1.14	0.11	0.21	0.02	0.06	0.10	0.18
32	2.28	0.17	0.47	0.02	0.12	0.21	0.40
40	3.11	0.25	0.91	0.04	0.23	0.32	0.49
50	7.78	0.44	1.40	0.04	—	—	—
63	13.10	0.70	2.20	0.08	—	—	—
80	20.70	1.18	4.80	0.17	—	—	—
100	35.70	1.97	8.20	0.17	—	—	—

Calculation: (Example) **MY1B20-300A**

- Basic weight 1.06 kg
- Cylinder stroke 300 stroke
- Additional weight 0.10/50 stroke
- 1.06 + 0.10 x 300/50 + 0.05 x 2 ≒ 2.17 kg
- Weight of A unit 1.76 kg

⚠ Precautions

For details on the MY1B Series Mechanically Jointed Rodless Cylinder, refer to "Specific Product Precautions" on pages 1335 to 1336-2.

Cushion Capacity

Cushion Selection

<Rubber bumper>

Rubber bumpers are a standard feature on MY1B10. Since the stroke absorption of rubber bumpers is short, when adjusting the stroke with an A unit, install an external shock absorber.

The load and speed range which can be absorbed by a rubber bumper is inside the rubber bumper limit line of the graph.

<Air cushion>

Air cushions are a standard feature on mechanically jointed rodless cylinders. (Except $\phi 10$.) The air cushion mechanism is incorporated to prevent excessive impact of the piston at the stroke end during high speed operation. The purpose of air cushion, thus, is not to decelerate the piston near the stroke end.

The ranges of load and speed that air cushions can absorb are within the air cushion limit lines shown in the graphs.

<Stroke adjustment unit with shock absorber>

Use this unit when operating with a load or speed exceeding the air cushion limit line, or when cushioning is required outside of the effective air cushion stroke range due to stroke adjustment.

L unit

Use this unit when cushioning is necessary outside of the effective air cushion range even if the load and speed are within the air cushion limit line, or when the cylinder is operated in a load and speed range above the air cushion limit line and below the L unit limit line.

H unit

Use this unit when the cylinder is operated in a load and speed range above the L unit limit line and below the H unit limit line.

* For details on stroke adjustment using the adjustment bolt, refer to page 1336.

Air Cushion Stroke

(mm)

Bore size (mm)	Cushion stroke
16	12
20	15
25	15
32	19
40	24
50	30
63	37
80	40
100	40

Rubber Bumper ($\phi 10$ only) Positive Stroke from One End Due to Pressure

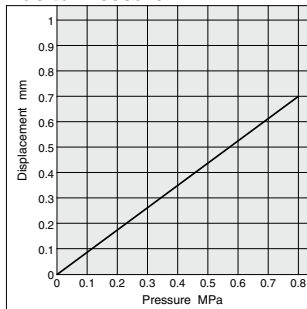

Absorption Capacity of Rubber Bumper, Air Cushion and Stroke Adjustment Units

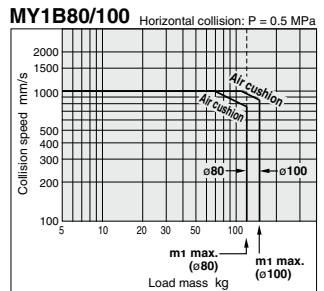
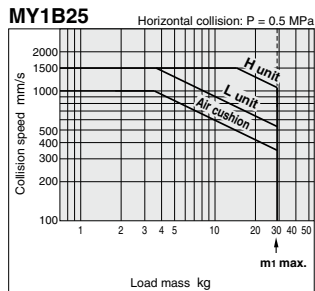
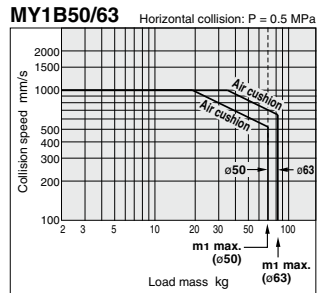
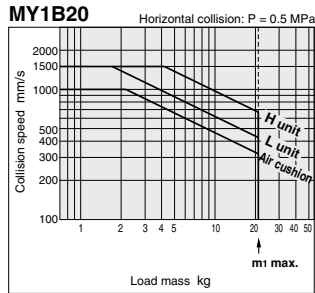
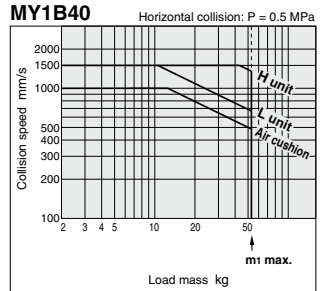
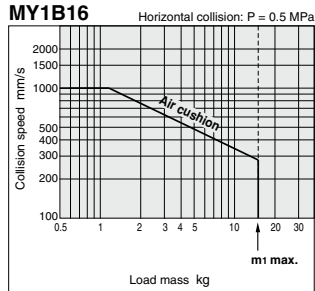
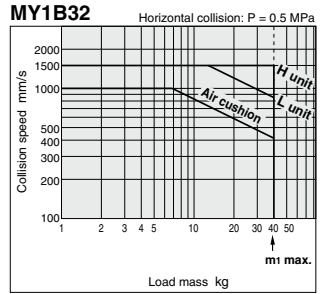
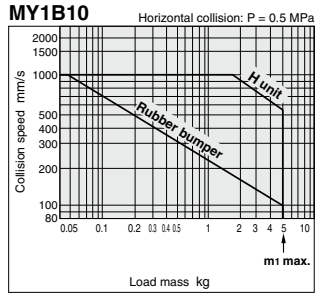

Construction: $\varnothing 10$

Centralized piping type: MY1B10G

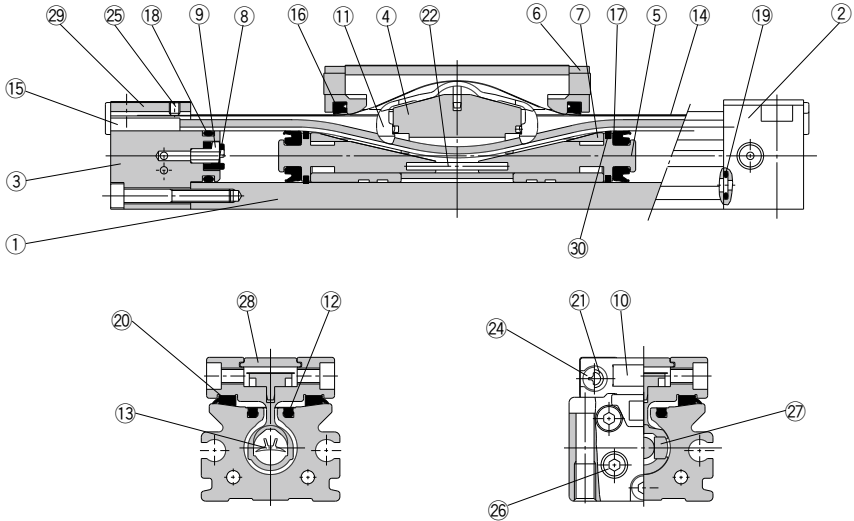

Component Parts

No.	Description	Material	Note
1	Cylinder tube	Aluminum alloy	Hard anodized
2	Head cover WR	Aluminum alloy	Painted
3	Head cover WL	Aluminum alloy	Painted
4	Piston yoke	Aluminum alloy	Hard anodized
5	Piston	Aluminum alloy	Chromated
6	End Cover	Special resin	
7	Wear ring	Special resin	
8	Bumper	Polyurethane rubber	
9	Holder	Stainless steel	
10	Stopper	Carbon steel	Nickel plated
11	Belt separator	Special resin	
12	Seal magnet	Rubber magnet	

No.	Description	Material	Note
15	Belt clamp	Special resin	
20	Bearing	Special resin	
21	Spacer	Chromium molybdenum steel	Nickel plated
22	Spring pin	Stainless steel	
23	Hexagon socket head cap screw	Chromium molybdenum steel	Chromated
24	Round binding head screw	Carbon steel	Chromated
25	Slotted set screw	Carbon steel	Black zinc chromated
26	Hexagon socket head plug	Carbon steel	Chromated
27	Magnet	—	
28	Top plate	Stainless steel	
29	Head plate	Stainless steel	
30	Lube-retainer	Special resin	

Replacement Part: Seal Kit

No.	Description	Qty.	MY1B10
13	Seal belt	1	MY10-16A-Stroke
14	Dust seal band	1	MY10-16B-Stroke
16	Scraper	2	MY1B10-PS
17	Piston seal	2	
18	Tube gasket	2	
19	O-ring	4	

* Seal kit includes 15, 17, 18 and 19.

Seal kit includes a grease pack (10 g).

When 13 and 14 are shipped independently, a grease pack is included. (10 g per 1000 strokes)

Order with the following part number when only the grease pack is needed.

Grease pack part number: GR-S-010 (10 g), GR-S-020 (20 g)

MY1B Series

Construction: $\varnothing 16$, $\varnothing 20$, $\varnothing 50$ to $\varnothing 100$

MY1B16, 20, 50 to 100

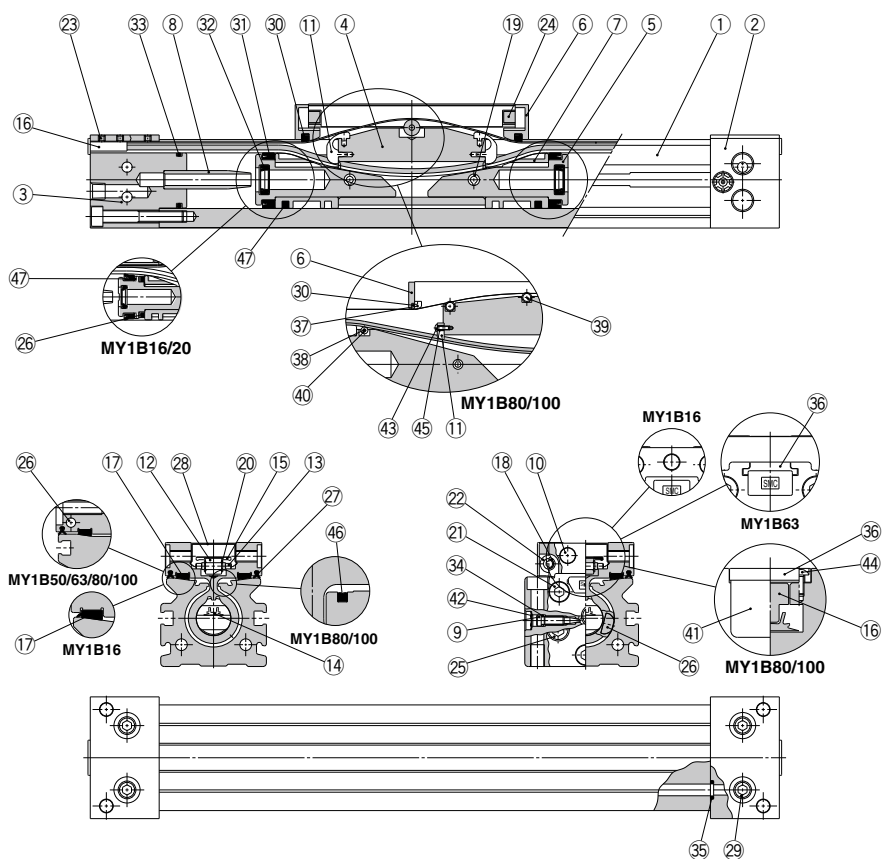

MY1B16, 20, 50 to 100

Component Parts

No.	Description	Material	Note
1	Cylinder tube	Aluminum alloy	Hard anodized
2	Head cover WR	Aluminum alloy	Painted
3	Head cover WL	Aluminum alloy	Painted
4	Piston yoke	Aluminum alloy	Anodized
5	Piston	Aluminum alloy	Chromated
6	End cover	Special resin	
		Carbon steel	Nickel plated (ø80, ø100)
7	Wear ring	Special resin	
8	Cushion ring	Aluminum alloy	Anodized
9	Cushion needle	Rolled steel	Nickel plated
10	Stopper	Carbon steel	Nickel plated
11	Belt separator	Special resin	
12	Guide roller	Special resin	(ø16, ø20, ø50, ø63)
13	Guide roller shaft	Stainless steel	(ø16, ø20, ø50, ø63)
16	Belt clamp	Special resin	
		Aluminum alloy	Chromated (ø80, ø100)
17	Bearing	Special resin	
18	Spacer	Stainless steel	(ø16, ø20, ø50, ø63)
19	Spring pin	Carbon tool steel	
20	Type E retaining ring	Cold rolled special steel strip	(ø50, ø63)
21	Hexagon socket head cap screw	Chromium molybdenum steel	Chromated
22	Hexagon socket button head screw	Chromium molybdenum steel	Chromated
23	Hexagon socket head set screw	Chromium molybdenum steel	Black zinc chromated/ Chromated
24	Double round parallel key	Carbon steel	(ø16, ø20)
25	Hexagon socket head taper plug	Carbon steel	Chromated

No.	Description	Material	Note
26	Magnet	—	
28	Top cover	Stainless steel	
29	Hexagon socket head taper plug	Carbon steel	Chromated
36	Head plate	Aluminum alloy	Painted (ø63 to ø100)
37	Backup plate	Special resin	(ø80, ø100)
38	Guide roller B	Special resin	(ø80, ø100)
39	Guide roller A	Stainless steel	(ø80, ø100)
40	Guide roller shaft B	Stainless steel	(ø80, ø100)
41	Side cover	Aluminum alloy	Hard anodized (ø80, ø100)
42	Type CR retaining ring	Spring steel	
43	Hexagon socket button head screw	Chromium molybdenum steel	Chromated (ø80, ø100)
44	Hexagon socket button head screw	Chromium molybdenum steel	Chromated (ø80, ø100)
45	Spacer B	Stainless steel	(ø80, ø100)
46	Seal magnet	Rubber magnet	(ø80, ø100)
47	Lube-retainer	Special resin	(ø16, ø20, ø50, ø63)

Replacement Part: Seal Kit

No.	Description	Qty.	MY1B16	MY1B20
14	Seal belt	1	MY16-16C-Stroke	MY20-16C-Stroke
15	Dust seal band	1	MY16-16B-Stroke	MY20-16B-Stroke
27	Side scraper	2	—	MYB20-15CA7164B
34	O-ring	2	KA00309 (ø4 x ø1.8 x ø1.1)	KA00309 (ø4 x ø1.8 x ø1.1)
30	Scraper	2		
31	Piston seal	2		
32	Cushion seal	2	MY1B16-PS	MY1B20-PS
33	Tube gasket	2		
35	O-ring	4		

No.	Description	Qty.	MY1B50	MY1B63	MY1B80	MY1B100
14	Seal belt	1	MY50-16C-Stroke	MY63-16A-Stroke	MY80-16A-Stroke	MY100-16A-Stroke
15	Dust seal band	1	MY50-16B-Stroke	MY63-16B-Stroke	MY80-16B-Stroke	MY100-16B-Stroke
27	Side scraper	2	MYB50-15CA7165B	MYB63-15CA7166B	MYB80-15CK2470B	MYB100-15CK2471B
34	O-ring	2	KA00402 (ø8.3 x ø4.5 x ø1.9)	KA00777	KA00050	KA00050
30	Scraper	2				
31	Piston seal	2				
32	Cushion seal	2	MY1B50-PS	MY1B63-PS	MY1B80-PS	MY1B100-PS
33	Tube gasket	2				
35	O-ring	4				

* Seal kit includes ③, ④, ⑤, ⑥ and ⑦. Order the seal kit based on each bore size.

* Seal kit includes a grease pack (10 g).

When ⑭ and ⑮ are shipped independently, a grease pack is included. (10 g per 1000 strokes)

Order with the following part number when only the grease pack is needed.

Grease pack part number: GR-S-010 (10 g), GR-S-020 (20 g)

Note) Two kinds of dust seal bands are available for the MY1B16, 20, 50, 63. Since the part number varies depending on the treatment of the hexagon socket head set screw ⑬, please check a proper dust seal band carefully.

A: Black zinc chromated→MY□□-16B-stroke, B: Chromated→MY□□-16BW-stroke

MY1B Series

Construction $\phi 25, \phi 32, \phi 40$

MY1B25 to 40

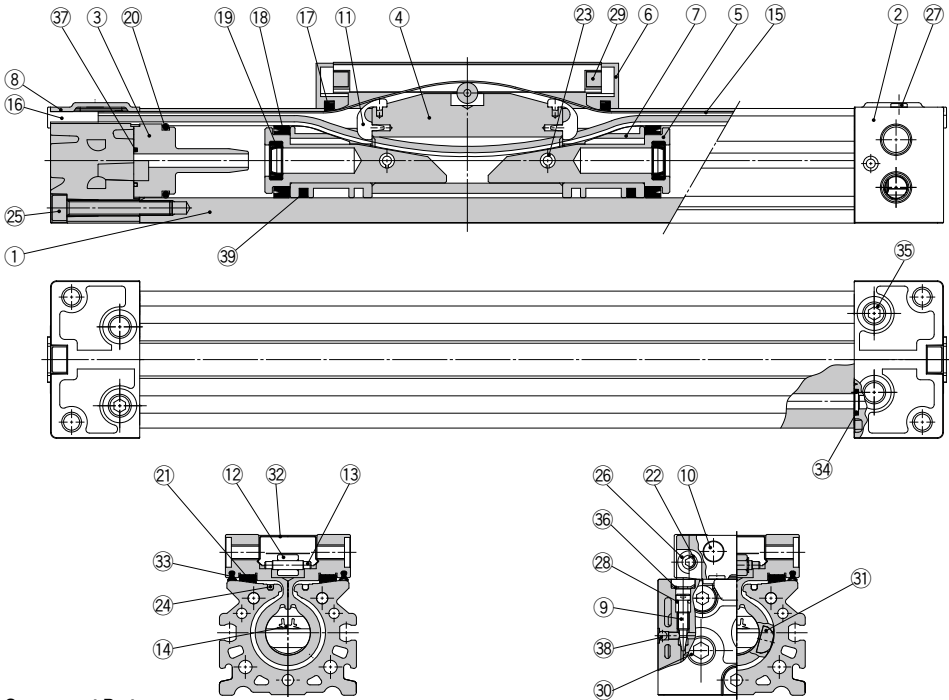

Component Parts

No.	Description	Material	Note
1	Cylinder tube	Aluminum alloy	Hard anodized
2	Head cover	Aluminum alloy	Painted
3	Cushion boss	Polyacetal	
4	Piston yoke	Aluminum alloy	Anodized
5	Piston	Aluminum alloy	Chromated
6	End cover	Polyacetal	
7	Wear ring	Polyacetal	
8	Head plate	Stainless steel	
9	Cushion needle	Rolled steel	Nickel plated
10	Stopper	Carbon steel	Nickel plated
11	Belt separator	Polyacetal	
12	Guide roller	Polyacetal	
13	Parallel pin	Carbon steel	
16	Belt clamp	Polybutylene terephthalate	
21	Bearing	Polyacetal	
22	Spacer	Stainless steel	

No.	Description	Material	Note
23	Spring pin	Carbon tool steel	
24	Seal magnet	Rubber magnet	
25	Hexagon socket head cap screw	Chromium molybdenum steel	Chromated
26	Hexagon socket button head screw	Chromium molybdenum steel	Chromated
27	Thin head screw	Chromium molybdenum steel	Chromated
29	Double round parallel key	Carbon steel	
30	Hexagon socket head taper plug	Carbon steel	Chromated (Centralized piping: 7 pcs.)
31	Magnet	Rare earth magnet	
32	Top cover	Stainless steel	
35	Hexagon socket head taper plug	Carbon steel	Chromated (Centralized piping: 3 pcs.)
36	Type CR retaining ring	Spring steel	
38	Steel ball	Spring steel	
39	Lube retainer	Special resin	

Seal List

No.	Description	Material	Qty.	Stroke		
				MY1B25	MY1B32	MY1B40
14	Seal belt	Urethane	1	MY25-16C-Stroke	MY32-16C-Stroke	MY40-16C-Stroke
15	Dust seal band	Stainless steel	1	MY1B25-16B-Stroke	MY1B32-16B-Stroke	MY1B40-16B-Stroke
33	Side scraper	Polyamide	2	MYB25-15BA5900B	MYB32-15BA5901B	MYB40-15BA5902B
28	O-ring	NBR	2	KA00311 ($\phi 5.1 \times \phi 3 \times \phi 1.05$)	KA00320 ($\phi 7.15 \times \phi 3.75 \times \phi 1.7$)	KA00320 ($\phi 7.15 \times \phi 3.75 \times \phi 1.7$)
37	Cushion boss gasket	NBR	2	MYB25-16GA5900	MYB32-16GA5901	MYB40-16GA5902
17	Scraper	NBR	2			
18	Piston seal	NBR	2			
19	Cushion seal	NBR	2	MY1B25-PS	MY1B32-PS	MY1B40-PS
20	Tube gasket	NBR	2			
34	O-ring	NBR	2			

* Seal kit includes 17, 18, 19, 20 and 34.
Order the seal kit based on each bore size.

* Seal kit includes a grease pack (10 g).
When 14 and 15 are shipped independently, a grease pack is included. (10 g/1000 mm stroke)
Order with the following part number when only the grease pack is needed.
Grease pack part number:
GR-S-010 (10 g), **GR-S-020** (20 g)

Centralized Piping Type $\phi 10$

MY1B10G — **Stroke**

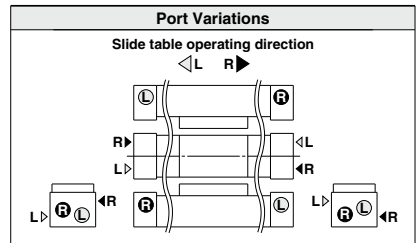
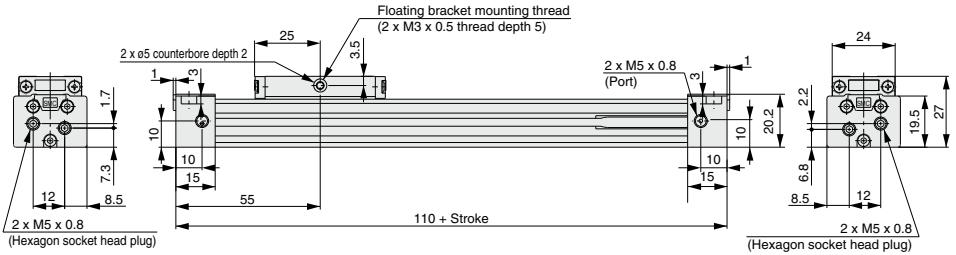
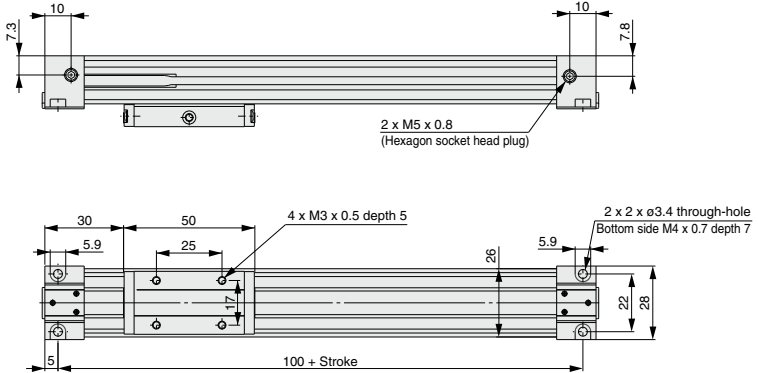

MY1B Series

Standard Type/Centralized Piping Type $\phi 16, \phi 20$

MY1B16□/20□ — Stroke

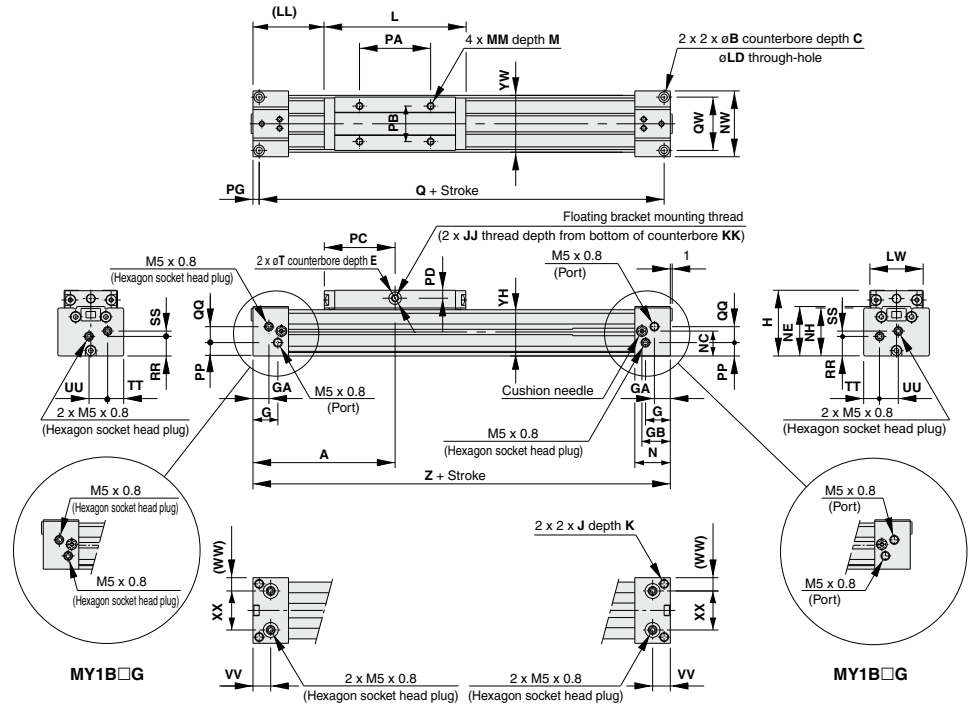

Model	A	B	C	E	G	GA	GB	H	J	JJ	K	KK	L	LD	LL	LW	M	MM	N	NC	NE
MY1B16□	80	6	3.5	2	14	9	16	37	M5 x 0.8	M4 x 0.7	10	6.5	80	3.5	40	30	6	M4 x 0.7	20	14	27.8
MY1B20□	100	7.5	4.5	2	12.5	12.5	20.5	46	M6 x 1	M4 x 0.7	12	10	100	4.5	50	37	8	M5 x 0.8	25	17.5	34

Model	NH	NW	PA	PB	PC	PD	PG	PP	Q	QQ	QW	RR	SS	T	TT	UU	VV	WW	XX	YH	YW	Z
MY1B16□	27	37	40	20	40	4.5	3.5	7.5	153	9	30	11	3	7	9	10.5	10	7.5	22	26	32	160
MY1B20□	33.5	45	50	25	50	5	4.5	11.5	191	11	36	14.5	5	8	10.5	12	12.5	10.5	24	32.5	40	200

Centralized Piping on the Bottom

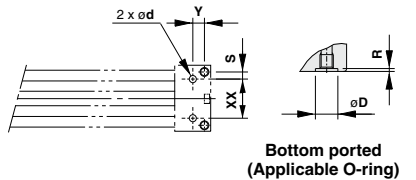
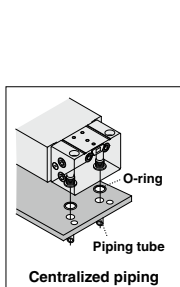

Model	WX	Y	S	d	D	R	Applicable O-ring
MY1B16□	22	6.5	4	4	8.4	1.1	C6
MY1B20□	24	8	6	4	8.4	1.1	

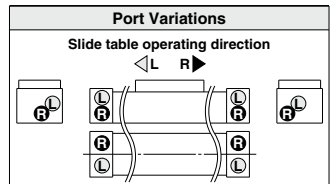

Standard/Centralized Piping Type $\varnothing 25, \varnothing 32, \varnothing 40$

MY1B25□/32□/40□ - Stroke Z

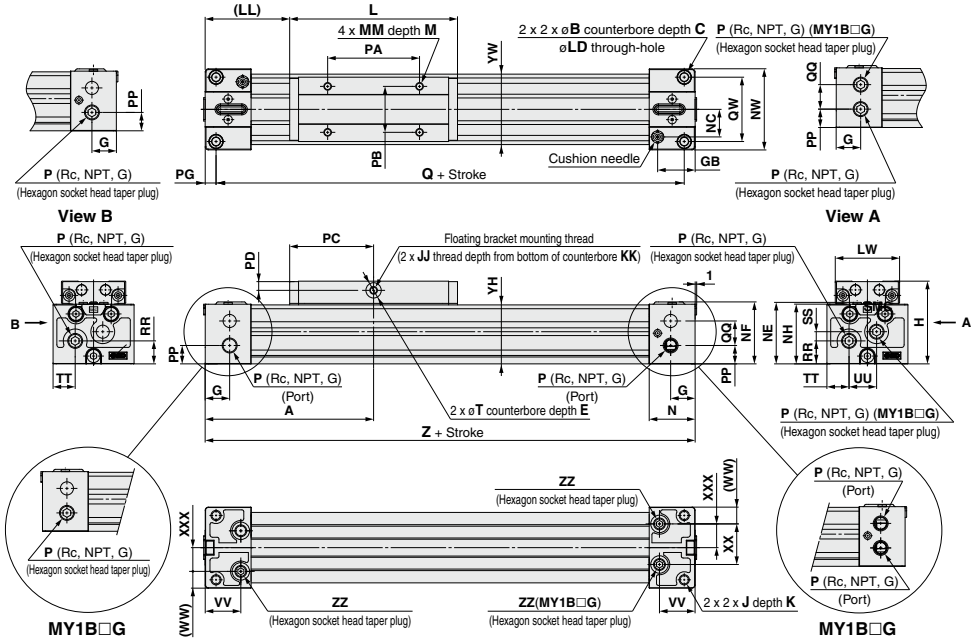

Standard piping/Centralized piping

Model	A	B	C	E	G	GB	H	J	JJ	K	KK	L	LD	LL	LW	M	MM	N	NC	NE	NF	NH	NW
MY1B25□	110	9	5.5	2	16	24.5	54	M6 x 1	M5 x 0.8	9.5	9	110	5.6	55	42	9	M5 x 0.8	30	18	40.2	40.5	39	53
MY1B32□	140	11	6.6	2	19	28.5	68	M8 x 1.25	M5 x 0.8	16	10	140	6.8	70	52	12	M6 x 1	37	22	50.2	50	49	64
MY1B40□	170	14	8.5	2	23	35	84	M10 x 1.5	M6 x 1	15	13	170	8.6	85	64	12	M6 x 1	45	26.5	62.7	62	61.5	75

Model	P	PA	PB	PC	PD	PP	PG	Q	QW	RR	T	TT	VV	WW	XXX	YH	YW	Z	ZZ
MY1B25□	1/8	60	30	55	6	12	7	206	42	15	10	14.5	23.3	11	15.5	38.5	46	220	Rc1/16
MY1B32□	1/8	80	35	70	10	16	8	264	51	16	10	16	28.5	12	20	48	55	280	Rc1/16
MY1B40□	1/4	100	40	85	12	18.5	9	322	59	23.5	14	20	35	14	23.5	60.5	67	340	Rc1/8

Centralized piping

Model	QQ	SS	UU	XX
MY1B25□	16	6	18	26.5
MY1B32□	16	11	32	40
MY1B40□	24	12	35	47

Centralized Piping on the Bottom

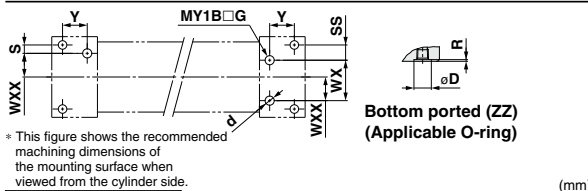

* This figure shows the recommended machining dimensions of the mounting surface when viewed from the cylinder side.

Model	WXX	Y	S	d	D	R	Applicable O-ring
MY1B25□	15.5	16.2	5.5	6	11.4	1.1	C9
MY1B32□	20	20.4	5.5	6	11.4	1.1	
MY1B40□	23.5	25.9	6	8	13.4	1.1	

Model	WX	SS
MY1B25□	26.5	10
MY1B32□	40	5.5
MY1B40□	47	6

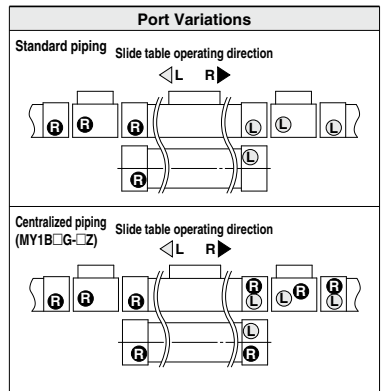
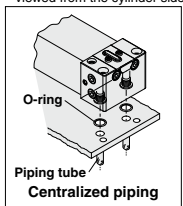

MY1B Series

Standard Type/Centralized Piping Type $\phi 50, \phi 63$

MY1B50□/63□ — Stroke

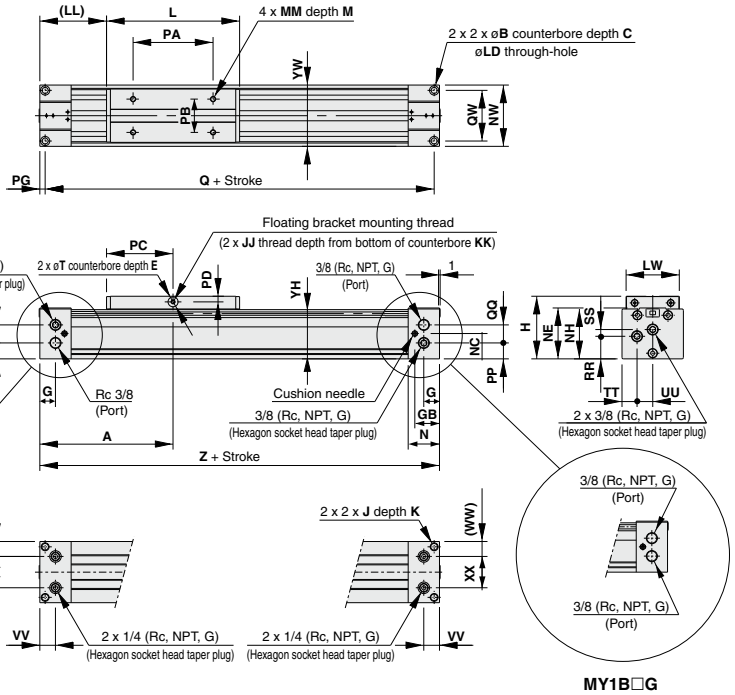

MY1B□G

MY1B□G

(mm)

Model	A	B	C	E	G	GB	H	J	JJ	K	KK	L	LD	LL	LW	M	MM	N	NC	NE
MY1B50□	200	14	8.5	3	23.5	37	94	M12 x 1.75	M6 x 1	25	17	200	9	100	80	14	M8 x 1.25	47	38	76.5
MY1B63□	230	17	10.5	3	25	39	116	M14 x 2	M8 x 1.25	28	24	230	11	115	96	16	M8 x 1.25	50	51	100

(mm)

Model	NH	NW	PA	PB	PC	PD	PG	PP	Q	QQ	QW	RR	SS	T	TT	UU	VV	WW	XX	YH	YW	Z
MY1B50□	75	92	120	50	100	8.5	8	24	384	27	76	34	10	15	22.5	23.5	23.5	22.5	47	74	92	400
MY1B63□	95	112	140	60	115	9.5	10	37.5	440	29.5	92	45.5	13.5	16	27	29	25	28	56	94	112	460

Centralized Piping on the Bottom

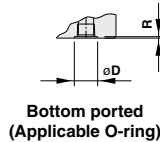
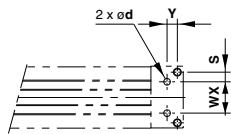
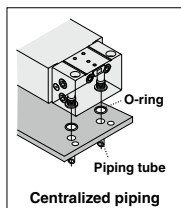

Model	WX	Y	S	d	D	R	Applicable O-ring
MY1B50□	47	15.5	14.5	10	17.5	1.1	C15
MY1B63□	56	15	18	10	17.5	1.1	

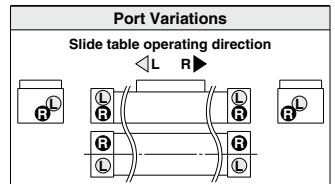

Mechanically Jointed Rodless Cylinder Basic Type **MY1B Series**

Standard Type/Centralized Piping Type $\phi 80, \phi 100$

MY1B80□/100□ — Stroke

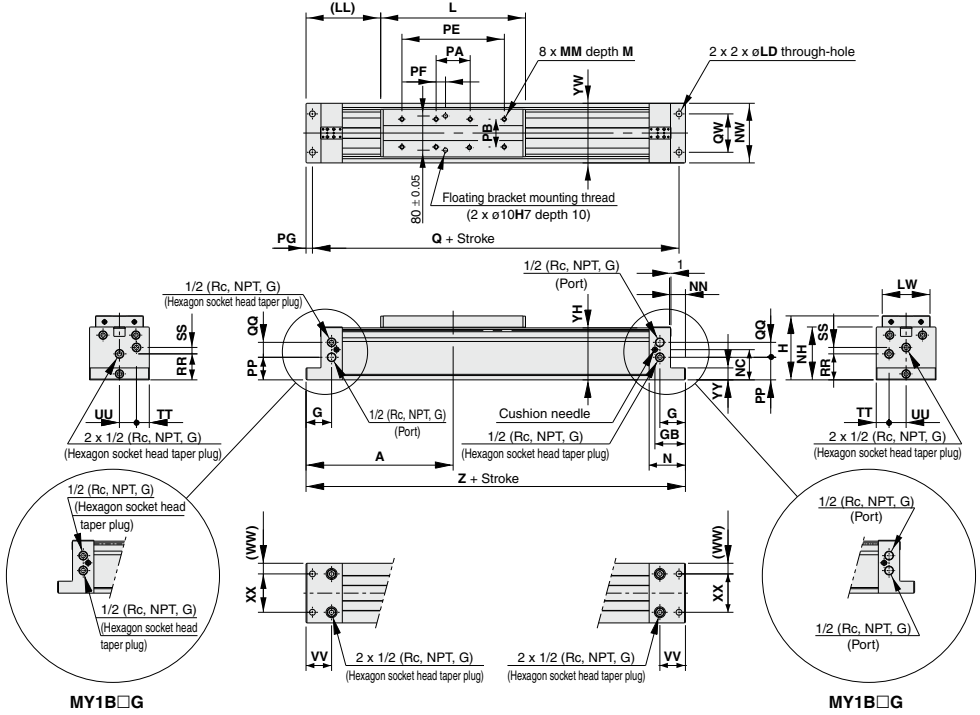

Model	A	G	GB	H	L	LD	LL	LW	M	MM	N	NC	NH	NN	NW	PA	PB	PE
MY1B 80□	345	60	71.5	150	340	14	175	112	20	M10 x 1.5	85	71	124	35	140	80	65	240
MY1B 100□	400	70	79.5	190	400	18	200	140	25	M12 x 1.75	95	85	157	45	176	120	85	280

Model	PF	PG	PP	Q	QQ	QW	RR	SS	TT	UU	VV	WW	XX	YH	YW	YY	Z
MY1B 80□	22	15	53	660	35	90	61	15	30	40	60	25	90	122	140	28	690
MY1B 100□	42	20	69	760	38	120	75	20	40	48	70	28	120	155	176	35	800

Centralized Piping on the Bottom

O-ring

Piping tube

Centralized piping

**Bottom ported
(Applicable O-ring)**

Port Variations

Slide table operating direction
◀ L R ▶

Model	WX	Y	d	D	R	Applicable O-ring
MY1B 80□	90	45	18	26	1.8	P22
MY1B 100□	120	50	18	26	1.8	



MY1B Series

Stroke Adjustment Unit

With adjustment bolt

MY1B — A (Z)

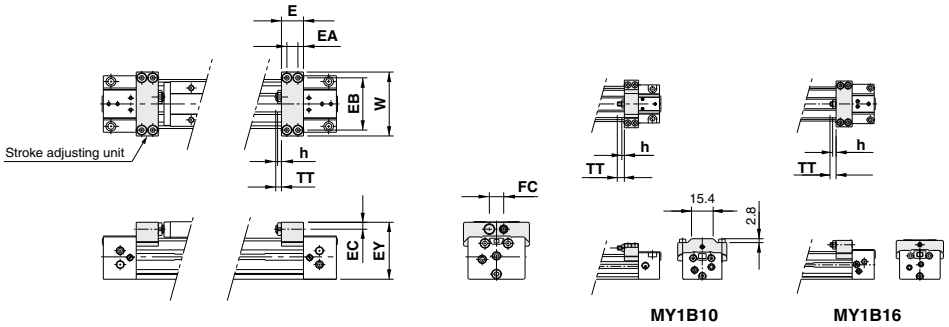

Applicable bore size	E	EA	EB	EC	EY	FC	h	TT	W
MY1B10	10	5	28	3.3	26.3	—	1.8	5 (Max. 10)	35
MY1B16	14.6	7	34.4	4.2	36.5	—	2.4	5.4 (Max. 11)	43
MY1B20	19	9	43	5.8	45.6	13	3.2	6 (Max. 12)	53
MY1B25	20	10	49	6.5	53.5	13	3.5	5 (Max. 16.5)	60
MY1B32	25	12	61	8.5	67	17	4.5	8 (Max. 20)	74
MY1B40	31	15	76	9.5	81.5	17	4.5	9 (Max. 25)	94

(mm)

With low load shock absorber + Adjustment bolt

MY1B — L (Z)

ø20

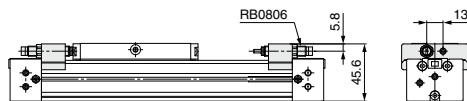
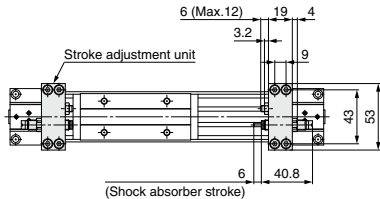

ø25 to ø40

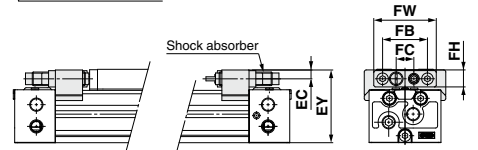
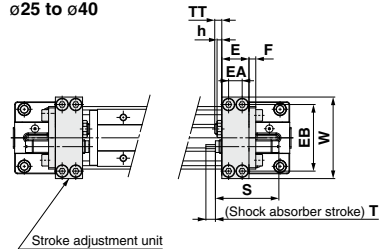

Applicable cylinder	E	EA	EB	EC	EY	F	FB	FC	FH	FW
MY1B25	20	10	49	6.5	53.5	6	33	13	12	46
MY1B32	25	12	61	8.5	67	6	43	17	16	56
MY1B40	31	15	76	9.5	81.5	6	43	17	16	56

(mm)

Applicable cylinder	h	S	T	TT	W	Shock absorber model
MY1B25	3.5	46.7	7	5 (Max. 16.5)	60	RB1007
MY1B32	4.5	67.3	12	8 (Max. 20)	74	RB1412
MY1B40	4.5	67.3	12	9 (Max. 25)	94	RB1412

Stroke Adjustment Unit

With high load shock absorber + Adjustment bolt

MY1B Bore size — Stroke H (Z)

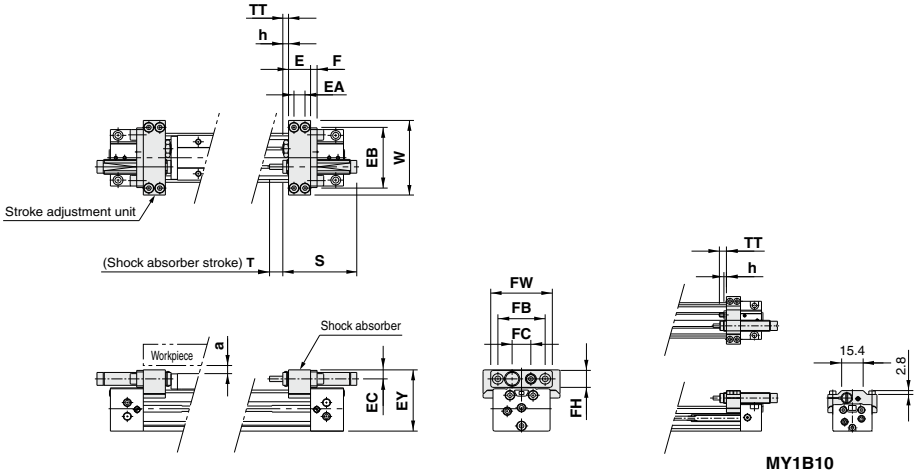

* Since the dimension EY of H unit is greater than the table top height (dimension H), when a workpiece is loaded that is larger than the full length (dimension L) of the slide table allow a clearance of size "a" or larger at the workpiece side. (mm)

Applicable bore size	E	EA	EB	EC	EY	F	FB	FC	FH	FW	h	S	T	TT	W	Shock absorber model	a
MY1B10	10	5	28	5.5	29.8	—	—	8	—	—	1.8	40.8	5	5 (Max. 10)	35	RB0805	3.5
MY1B20	20	10	49	6.5	47.5	6	33	13	12	46	3.5	46.7	7	5 (Max. 11)	60	RB1007	2.5
MY1B25	20	10	57	8.5	57.5	6	43	17	16	56	4.5	67.3	12	5 (Max. 16.5)	70	RB1412	4.5
MY1B32	25	12	74	11.5	73	8	57	22	22	74	5.5	73.2	15	8 (Max. 20)	90	RB2015	6
MY1B40	31	15	82	12	87	8	57	22	22	74	5.5	73.2	15	9 (Max. 25)	100	RB2015	4

MY1B Series

Accessory Bracket (option)

Stroke Adjustment Unit

MY - A 20 H2 - 6N

Stroke adjustment unit

Bore size

10	10 mm
16	16 mm
20	20 mm
25	25 mm
32	32 mm
40	40 mm

Note) Stroke adjusting unit is not available for ø50, ø63, ø80 and ø100.

Intermediate fixing spacer

Nil	Without spacer
6	Short spacer
7	Long spacer

Spacer delivery type

Nil	Unit installed
N	Spacer only

* Spacers are used to fix the stroke adjustment unit at an intermediate stroke position.

* Spacers are shipped for a set of two.

Note) Intermediate fixing spacer is not available for ø10.

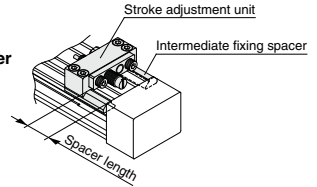

Unit no.

Symbol	Stroke adjustment unit	Mounting position
A1	A unit	Left
A2		Right
L1	L unit	Left
L2		Right
H1	H unit	Left
H2		Right

Note 1) A and H unit only for ø10, A unit only for ø16

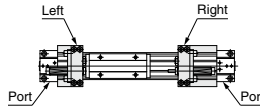

Stroke adjustment range

(mm)

Bore size	10			16			20			25			32			40		
Unit symbol	A	H		A		H	A	L	H	A	L	H	A	L	H	A	L	H
Without spacer	0 to -5			0 to -5.6			0 to -6			0 to -11.5			0 to -12			0 to -16		
With short spacer	—	—		-5.6 to -11.2			-6 to -12			-11.5 to -23			-12 to -24			-16 to -32		
With long spacer	—	—		-11.2 to -16.8			-12 to -18			-23 to -34.5			-24 to -36			-32 to -48		

Spacer length

(mm)

Bore size	16	20	25	32	40
Short spacer	5.6	6	11.5	12	16
Long spacer	11.2	12	23	24	32

Component Parts

<p>MY-A20H2 (Without spacer)</p>	<p>MY-A20H2-6 (With short spacer)</p>	<p>MY-A20H2-7 (With long spacer)</p>	<p>MY-A20H2-6N (Short spacer only)</p>
			<p>MY-A20H2-7N (Long spacer only)</p>

Side Support

Side support A MY-S□A

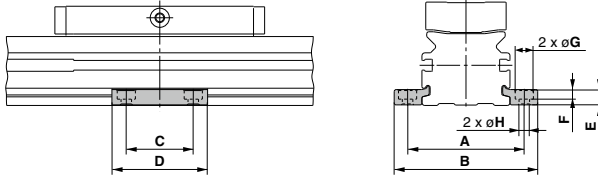

Side support B MY-S□B

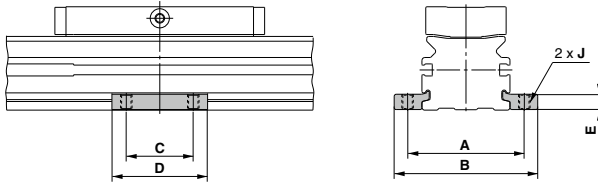

Model	Applicable bore size	A	B	C	D	E	F	G	H	J
MY-S10 ^A	MY1B 10	35	43.6	12	21	3	1.2	6.5	3.4	M4 x 0.7
MY-S16 ^A	MY1B 16	43	53.6	15	26	4.9	3	6.5	3.4	M4 x 0.7
MY-S20 ^A	MY1B 20	53	65.6	25	38	6.4	4	8	4.5	M5 x 0.8
MY-S25 ^A	MY1B 25	61	75	35	50	8	5	9.5	5.5	M6 x 1
	MY1B 32	70	84							
MY-S32 ^A	MY1B 40	87	105	45	64	11.7	6	11	6.6	M8 x 1.25
	MY1B 50	113	131							
MY-S50 ^A	MY1B 63	136	158	55	80	14.8	8.5	14	9	M10 x 1.5
MY-S63 ^A	MY1B 80	170	200	70	100	18.3	10.5	17.5	11.5	M12 x 1.75
	MY1B100	206	236							

= A set of side supports consists of a left support and a right support.

Guide for Side Support Application

For long stroke operation, the cylinder tube may be deflected depending on its own weight and the load mass. In such a case, use a side support in the middle section. The spacing (L) of the support must be no more than the values shown in the graph on the right.

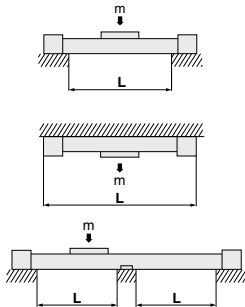

⚠ Caution

- If the cylinder mounting surfaces are not measured accurately, using a side support may cause poor operation. Therefore, be sure to level the cylinder tube when mounting. Also, for long stroke operation involving vibration and impact, use of a side support is recommended even if the spacing value is within the allowable limits shown in the graph.
- Support brackets are not for mounting; use them solely for providing support.

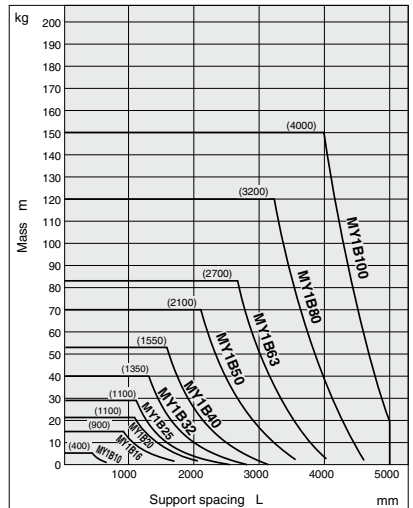

MY1B Series

Floating Bracket

Facilitates connection to other guide systems.

Applicable bore size

ø10

MY-J10

Application Example

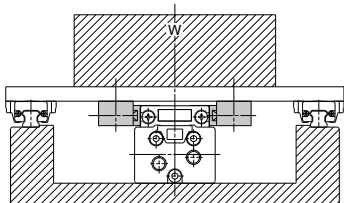

Mounting Example

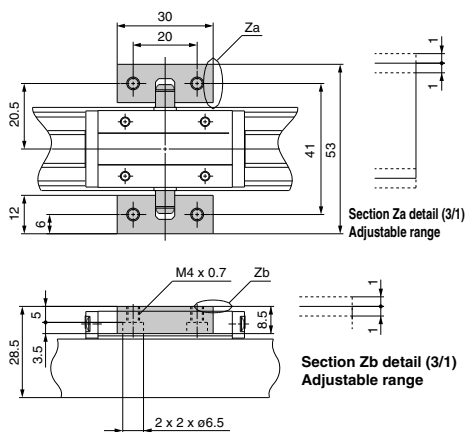

Note) A set of brackets with floating mechanism consists of a left bracket and a right bracket.

* For details on how to secure the holding bolt, refer to page 1336.

Applicable bore size

ø16, ø20

MY-J16/MY-J20

Application Example

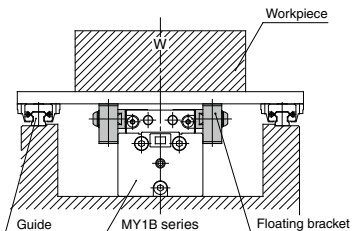

Mounting Example

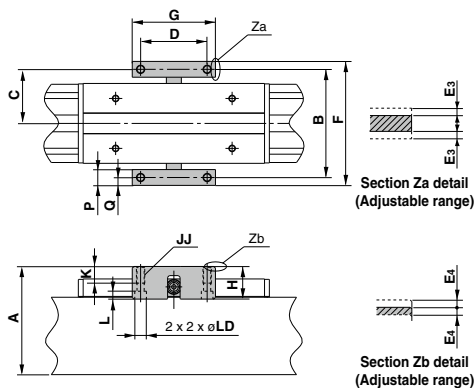

Model	Applicable bore size	A	B	C	D	F	G	H
MY-J16	MY1B16□	45	45	22.5	30	52	38	18
MY-J20	MY1B20□	55	52	26	35	59	50	21

Model	Applicable bore size	JJ	K	L	P	Q	Ea	E4	LD
MY-J16	MY1B16□	M4 x 0.7	10	4	7	3.5	1	1	6
MY-J20	MY1B20□	M4 x 0.7	10	4	7	3.5	1	1	6

Note) A set of brackets with floating mechanism consists of a left bracket and a right bracket.

MY-J10 to 20 (1 set) Component Parts

Description	Qty.	Material
Bracket	2	Carbon steel
Pin	2	Carbon steel
Conical spring washer	2	Carbon steel
Holding bolt	2	Chromium molybdenum steel

Floating Bracket

Facilitates connection to other guide systems.

Applicable bore size

ø25, ø32, ø40

MY□J25/MY□J32/MY□J40

L Type

Application Example

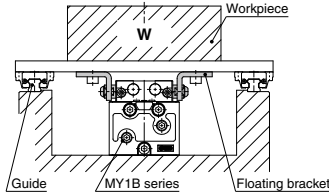

Mounting dimension

One set of brackets can be mounted in two directions for compact combinations.

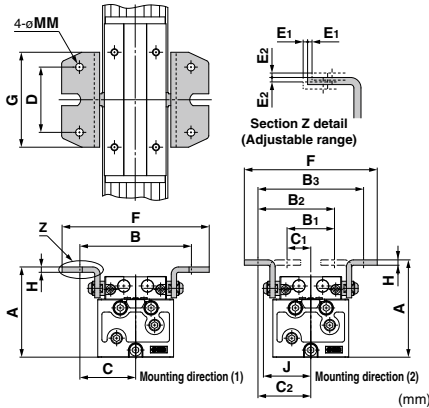

Part no.	Applicable cylinder	Common						Mounting direction (1)			
		D	G	H	J	MM	A	B	C	F	
MY-J25	MY1B25□	40	60	3.2	35	5.5	63	78	39	100	
MY-J32	MY1B32□	55	80	4.5	40	6.5	76	94	47	124	
MY-J40	MY1B40□	74	100	4.5	47	6.5	92	112	56	144	

Part no.	Applicable cylinder	Mounting direction (2)						Adjustable range		
		A	B1	B2	B3	C1	C2	F	E1	E2
MY-J25	MY1B25□	65	28	53	78	14	39	96	1	1
MY-J32	MY1B32□	82	40	64	88	20	44	111	1	1
MY-J40	MY1B40□	98	44	76	108	22	54	131	1	1

Note) Floating brackets consist of a set of right and left bracket.

* For details on how to secure the holding bolt, refer to page 1336.

MY-J25 (1 set) Component Parts

Description	Qty.	Material
Bracket	2	Carbon steel
Pin	2	Carbon steel
Conical spring washer	2	Carbon steel
Holding bolt	2	Chromium molybdenum steel

Block Type

Application Example

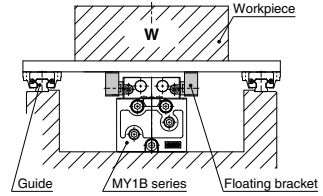

Mounting dimension

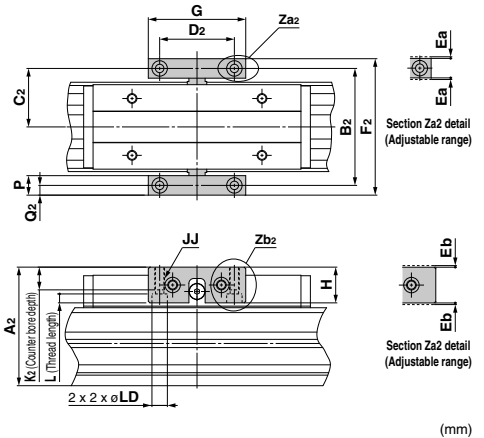

Part no.	Applicable cylinder	G	H	JJ	L	P	LD	Adjustable range	
								Ea	Eb
MYAJ25	MY1B25□	55	22	M6 x 1	5.5	12	9.5	1	1
MYAJ32	MY1B32□	60	22	M6 x 1	5.5	12	9.5	1	1
MYAJ40	MY1B40□	72	32	M8 x 1.25	6.5	16	11	1	1

Part no.	Applicable cylinder	A2	B2	C2	D2	F2	K2	Q2
MYAJ32	MY1B32□	73	72	36	46	84	14	6
MYAJ40	MY1B40□	93.5	88	44	55	104	19	8

* For details on how to secure the holding bolt, refer to page 1336.

MYAJ25 to 40 (1 set) Component Parts

Description	Qty.	Material
Bracket	2	Rolled steel
Pin	2	Carbon steel
Conical spring washer	2	Carbon steel
Holding bolt	2	Chromium molybdenum steel

MY1B Series

Floating Bracket

Facilitates connection to other guide systems.

Applicable bore size

ø50, ø63

MY-J50/MY-J63

Application Example

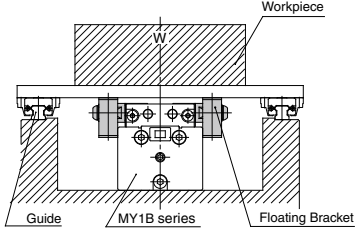

Mounting Example

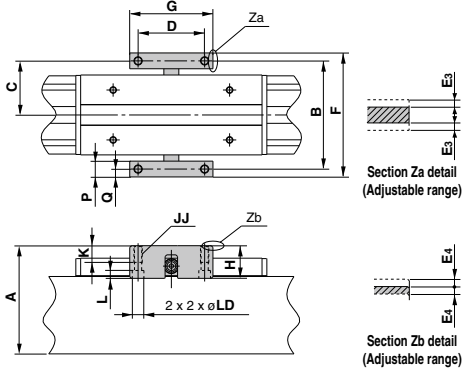

Model	Applicable bore size	A	B	C	D	F	G	H
MY-J50	MY1B50□	110	110	55	70	126	90	37
MY-J63	MY1B63□	131	130	65	80	149	100	37

Model	Applicable bore size	JJ	K	L	P	Q	E3	E4	LD
MY-J50	MY1B50□	M8 x 1.25	20	7.5	16	8	2.5	2.5	11
MY-J63	MY1B63□	M10 x 1.5	20	9.5	19	9.5	2.5	2.5	14

Note) A set of brackets with floating mechanism consists of a left bracket and a right bracket.

* For details on how to secure the holding bolt, refer to page 1336.

MY-J50, 63 (1 set) Component Parts

Description	Qty.	Material
Bracket	2	Carbon steel
Pin	2	Carbon steel
Conical spring washer	2	Carbon steel
Holding bolt	2	Chromium molybdenum steel

Applicable bore size

ø80, ø100

MY-J80/MY-J100

Application Example

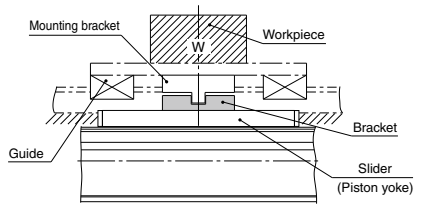

Mounting Example

Support bracket mounting area is heat treated at Hrc40 or above.

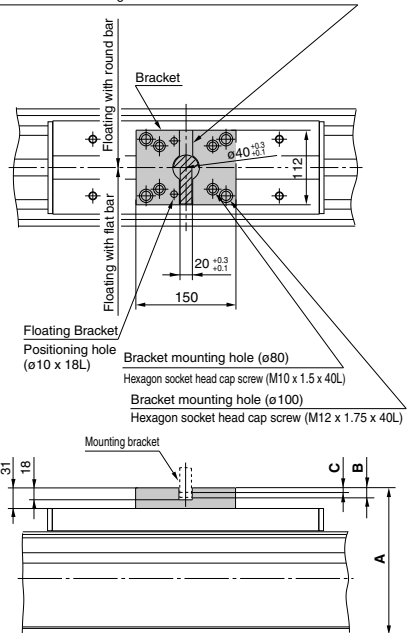

Model	Applicable bore size	A	B (max.)	C (min.)
MY-J80	MY1B 80□	181	15	9
MY-J100	MY1B100□	221	15	9

Note) * Flat bar or round bar mounting are possible for the support bracket (slanted lines) mounted by the customer.

- "B" and "C" indicate the allowable mounting dimensions for the support bracket (flat bar or round bar).
- Consider support brackets with dimensions that allow the floating mechanism to function properly.

MY-J80, 100 (1 set) Component Parts

Description	Qty.	Material
Bracket	1	Rolled steel
Pin	2	Carbon steel
Holding bolt	4	Chromium molybdenum steel

MY1M Series

Slide Bearing Guide Type

∅16, ∅20, ∅25, ∅32, ∅40, ∅50, ∅63

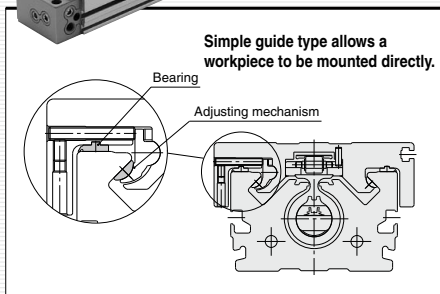
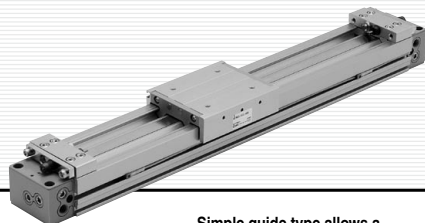

INDEX

MY1M Series Prior to Use	P. 1258
Model Selection	P. 1260
How to Order	P. 1262
Specifications	P. 1263
Cushion Capacity	P. 1266
Construction	P. 1268
Dimensions	P. 1270
Stroke Adjustment Unit	P. 1273
Accessory Bracket (Option)	P. 1274-1

MY1M Series Prior to Use

Maximum Allowable Moment/Maximum Load Mass

Model	Bore size (mm)	Maximum allowable moment (N·m)			Maximum load mass (kg)		
		M ₁	M ₂	M ₃	m ₁	m ₂	m ₃
MY1M	16	6.0	3.0	1.0	18	7	2.1
	20	10	5.2	1.7	26	10.4	3
	25	15	9.0	2.4	38	15	4.5
	32	30	15	5.0	57	23	6.6
	40	59	24	8.0	84	33	10
	50	115	38	15	120	48	14
	63	140	60	19	180	72	21

The above values are the maximum allowable values for moment and load. Refer to each graph regarding the maximum allowable moment and maximum allowable load for a particular piston speed.

Maximum Allowable Moment

Select the moment from within the range of operating limits shown in the graphs. Note that the maximum allowable load value may sometimes be exceeded even within the operating limits shown in the graphs. Therefore, also check the allowable load for the selected conditions.

Load mass (kg)

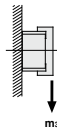

Moment (N·m)

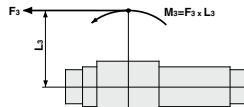
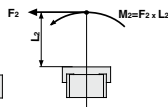
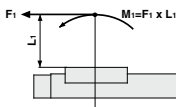

<Calculation of guide load factor>

1. Maximum allowable load (1), static moment (2), and dynamic moment (3) (at the time of impact with stopper) must be examined for the selection calculations.

* To evaluate, use \bar{v}_a (average speed) for (1) and (2), and v (collision speed $v = 1.4\bar{v}_a$) for (3). Calculate m_{max} for (1) from the maximum allowable load graph (m_1, m_2, m_3) and M_{max} for (2) and (3) from the maximum allowable moment graph (M_1, M_2, M_3).

$$\text{Sum of guide load factors } \Sigma \alpha = \frac{\text{Load mass [m]}}{\text{Maximum allowable load [mmax]}} + \frac{\text{Static moment [M]}^{(1)}}{\text{Allowable static moment [Mmax]}} + \frac{\text{Dynamic moment [Me]}^{(2)}}{\text{Allowable dynamic moment [MEmax]}} \leq 1$$

Note 1) Moment caused by the load, etc., with cylinder in resting condition.

Note 2) Moment caused by the impact load equivalent at the stroke end (at the time of impact with stopper).

Note 3) Depending on the shape of the workpiece, multiple moments may occur. When this happens, the sum of the load factors (α) is the total of all such moments.

Maximum Load Mass

Select the load from within the range of limits shown in the graphs. Note that the maximum allowable moment value may sometimes be exceeded even within the operating limits shown in the graphs. Therefore, also check the allowable moment for the selected conditions.

2. Reference formula [Dynamic moment at impact]

Use the following formulae to calculate dynamic moment when taking stopper impact into consideration.

m: Load mass (kg)

F: Load (N)

F_E: Load equivalent to impact (at impact with stopper) (N)

\bar{v}_a : Average speed (mm/s)

M: Static moment (N·m)

$$v = 1.4\bar{v}_a \text{ (mm/s)} \quad F_E = 1.4\bar{v}_a \cdot \delta \cdot m \cdot g$$

$$\therefore M_E = \frac{1}{3} \cdot F_E \cdot L_1 = 4.57\bar{v}_a \delta m L_1 \text{ (N·m)}$$

v: Collision speed (mm/s)

L₁: Distance to the load's center of gravity (m)

M_E: Dynamic moment (N·m)

δ : Damper coefficient

With rubber bumper = 4/100

(MY1B10, MY1H10)

With air cushion = 1/100

With shock absorber = 1/100

g: Gravitational acceleration (9.8 mm/s²)

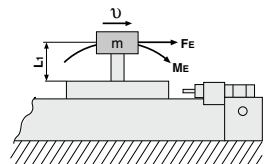

Note 4) $1.4\bar{v}_a\delta$ is a dimensionless coefficient for calculating impact force.

Note 5) Average load coefficient ($= \frac{1}{3}$): This coefficient is for averaging the maximum load moment at the time of stopper impact according to service life calculations.

3. For detailed selection procedures, refer to pages 1260 and 1261.

MY1M/M₁

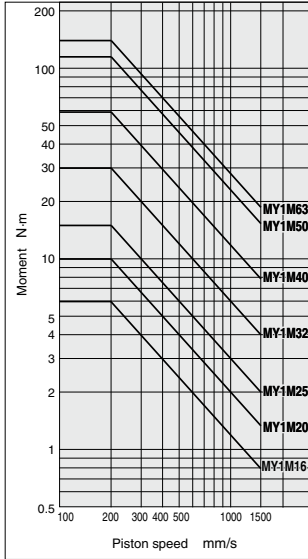

MY1M/M₂

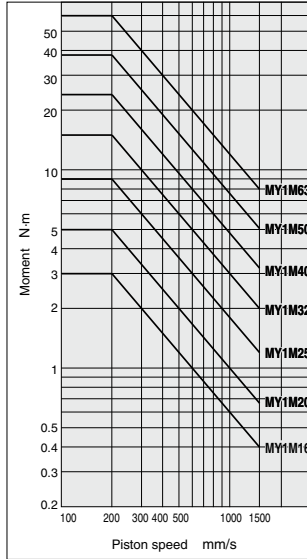

MY1M/M₃

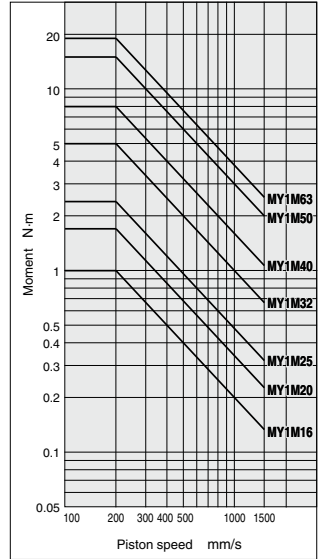

MY1M/m₁

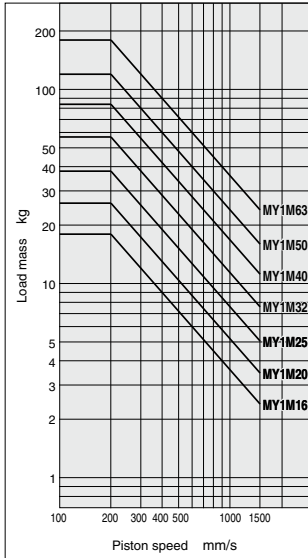

MY1M/m₂

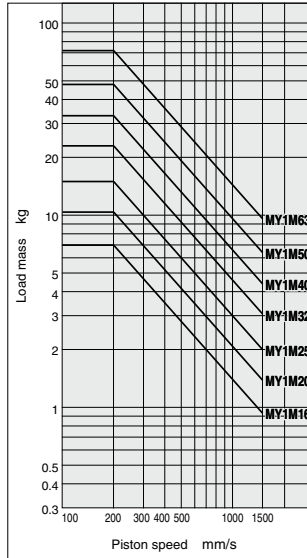

MY1M/m₃

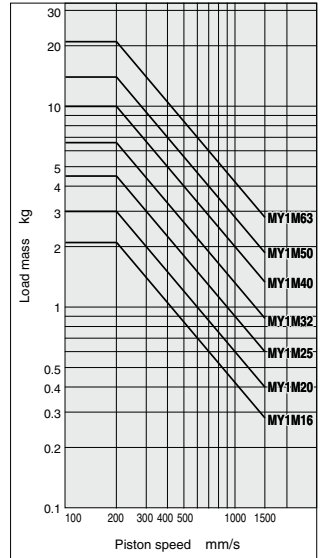

Model Selection

Following are the steps for selecting the most suitable MY1M series to your application.

Calculation of Guide Load Factor

1. Operating Conditions

Cylinder MY1M40-500

Average operating speed v_a ...200 mm/s

Mounting orientationHorizontal mounting

Cushion Air cushion
($\delta = 1/100$)

W_a: Connection plate t = 10 (880 g)

W_a: Workpiece (500 g)

W_c: MHL2-16D1 (795 g)

MY1M40-500

W_b: MGGLB25-200 (4.35 kg)

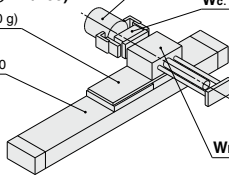

Mounting Orientation

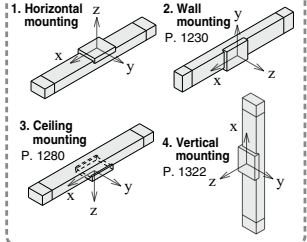

For actual examples of calculation for each orientation, refer to the pages above.

2. Load Blocking

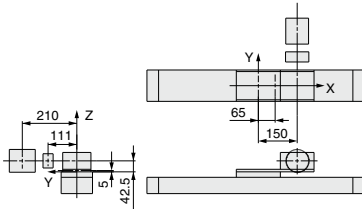

Mass and Center of Gravity for Each Workpiece

Workpiece no.	Mass m _n	Center of gravity		
		X-axis X _n	Y-axis Y _n	Z-axis Z _n
W _a	0.88 kg	65 mm	0 mm	5 mm
W _b	4.35 kg	150 mm	0 mm	42.5 mm
W _c	0.795 kg	150 mm	111 mm	42.5 mm
W _d	0.5 kg	150 mm	210 mm	42.5 mm

n=a, b, c, d

3. Composite center of Gravity Calculation

$$m_1 = \sum m_n = 0.88 + 4.35 + 0.795 + 0.5 = 6.525 \text{ kg}$$

$$X = \frac{1}{m_1} \times \sum (m_n \times x_n) = \frac{1}{6.525} (0.88 \times 65 + 4.35 \times 150 + 0.795 \times 150 + 0.5 \times 150) = 138.5 \text{ mm}$$

$$Y = \frac{1}{m_1} \times \sum (m_n \times y_n) = \frac{1}{6.525} (0.88 \times 0 + 4.35 \times 0 + 0.795 \times 111 + 0.5 \times 210) = 29.6 \text{ mm}$$

$$Z = \frac{1}{m_1} \times \sum (m_n \times z_n) = \frac{1}{6.525} (0.88 \times 5 + 4.35 \times 42.5 + 0.795 \times 42.5 + 0.5 \times 42.5) = 37.4 \text{ mm}$$

4. Calculation of load factor for static load

m₁: Mass

m₁ max (from (1) of graph MY1M/m₁) = 84 (kg).....

Load factor $\alpha_1 = m_1/m_1 \text{ max} = 6.525/84 = 0.08$

M₁: Moment

M₁ max (from (2) of graph MY1M/M₁) = 59 (N·m).....

M₁ = m₁ × g × X = 6.525 × 9.8 × 138.5 × 10⁻³ = 8.86 (N·m)

Load factor $\alpha_2 = M_1/M_1 \text{ max} = 8.86/59 = 0.15$

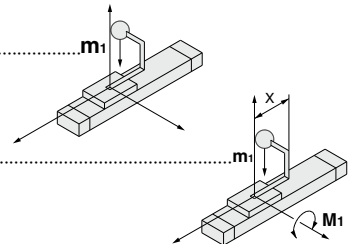

M_2 : Moment

$M_2 \text{ max}$ (from (3) of graph MY1M/ M_2) = 24 (N·m).....

$M_3 = m_1 \times g \times Y = 6.525 \times 9.8 \times 29.6 \times 10^{-3} = 1.89$ (N·m)

Load factor $\alpha_3 = M_2/M_2 \text{ max} = 1.89/24 = 0.08$

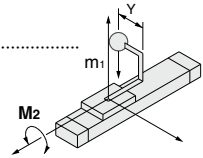

5. Calculation of Load Factor for Dynamic Moment

Equivalent load F_E at impact

$$F_E = 1.40a \times \delta \times m \times g = 1.4 \times 200 \times \frac{1}{100} \times 6.525 \times 9.8 = 179.1 \text{ (N)}$$

M_{1E} : Moment

$M_{1E} \text{ max}$ (from (4) of graph MY1M/ M_1 where $1.40a = 280 \text{ mm/s}$) = 42.1 (N·m).....

$$M_{1E} = \frac{1}{3} \times F_E \times Z = \frac{1}{3} \times 179.1 \times 37.4 \times 10^{-3} = 2.23 \text{ (N·m)}$$

Load factor $\alpha_4 = M_{1E}/M_{1E} \text{ max} = 2.23/42.1 = 0.05$

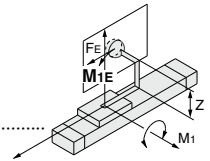

M_{3E} : Moment

$M_{3E} \text{ max}$ (from (5) of graph MY1M/ M_3 where $1.40a = 280 \text{ mm/s}$) = 5.7 (N·m).....

$$M_{3E} = \frac{1}{3} \times F_E \times Y = \frac{1}{3} \times 179.1 \times 29.6 \times 10^{-3} = 1.77 \text{ (N·m)}$$

Load factor $\alpha_5 = M_{3E}/M_{3E} \text{ max} = 1.77/5.7 = 0.31$

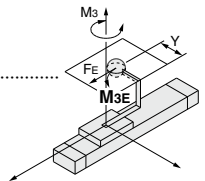

6. Sum and Examination of Guide Load Factors

$$\Sigma \alpha = \alpha_1 + \alpha_2 + \alpha_3 + \alpha_4 + \alpha_5 = 0.67 \leq 1$$

The above calculation is within the allowable value, and therefore the selected model can be used.

Select a shock absorber separately.

In an actual calculation, when the total sum of guide load factors α in the formula above is more than 1, consider either decreasing the speed, increasing the bore size, or changing the product series. This calculation can be easily made using the "SMC Pneumatics CAD System".

Load Mass

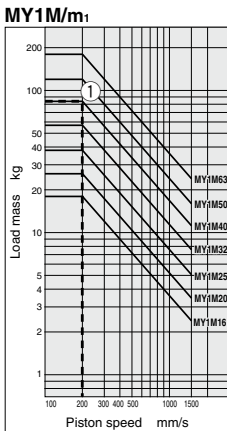

Allowable Moment

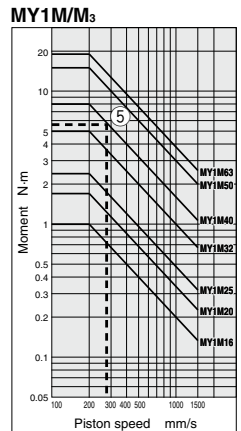
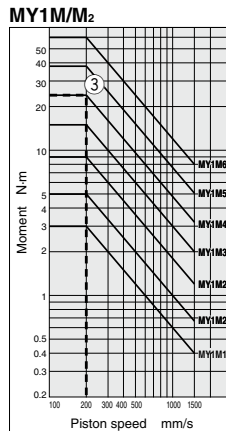
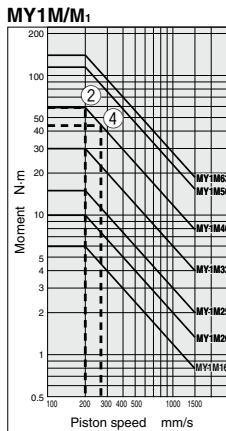

Mechanically Jointed Rodless Cylinder Slide Bearing Guide Type

MY1M Series

ø16, ø20, ø25, ø32, ø40, ø50, ø63

How to Order

Slide bearing guide type

MY1M 20 G - 300 - M9BW -

Slide bearing guide type

1 2 3 4 5 6 7 8

1 Bore size

16	16 mm
20	20 mm
25	25 mm
32	32 mm
40	40 mm
50	50 mm
63	63 mm

2 Port thread type

Symbol	Type	Bore size
Nil	M thread	ø16, ø20
	Rc	ø25, ø32,
TN	NPT	ø40, ø50,
TF	G	ø63

3 Piping

Nil	Standard type
G	Centralized piping type

4 Cylinder stroke (mm)

Bore size	Standard stroke*1	Long stroke (-XB11)	Maximum manufacturable stroke
20, 25, 32 40, 50, 63	*1 The stroke can be manufactured in 1 mm increments from 1 mm stroke.	Strokes of 2001 to 5000 mm (1 mm increments) exceeding the standard stroke	5000

Ordering example

* Add "-XB11" to the end of the part number for long strokes. MY1M20-3000L-M9BW-XB11

Note) Please be advised that with stroke 49 or less, there are cases where auto switch mounting is not possible and the performance of the air cushion may decline.

5 Stroke adjustment unit symbol

Refer to "Stroke adjustment unit" on page 1263.

6 Auto switch

Nil	Without auto switch (Built-in magnet)
Applicable auto switches vary depending on the bore size. Select an applicable one referring to the table below.	

7 Number of auto switches

Nil	2 pcs.
S	1 pc.
n	"n" pcs.

8 Made to Order

Refer to page 1263 for details.

Applicable Auto Switches

Refer to pages 1575 to 1701 for further information on auto switches.

Type	Special function	Electrical entry	Indicator light	Wiring (Output)	Load voltage		Auto switch model			Lead wire length (m)			Pre-wired connector	Applicable load		
					DC	AC	Perpendicular	In-line	0.5 (Nil)	1 (M)	3 (L)	5 (Z)				
															ø16, ø20	ø25 to ø63
Solid state auto switch	—	Grommet	Yes	3-wire (NPN)	24 V	5 V, 12 V	—	M9NV	M9N	●	●	○	○	IC circuit	Relay, PLC	
				3-wire (PNP)				M9PV	M9P	●	●	○	○			
				2-wire				M9BV	M9B	●	●	○	○			
				3-wire (NPN)				M9NVV	M9NV	●	●	○	○			
	Diagnostic indication (2-color indicator)			3-wire (PNP)	M9PVV	M9PV	●	●	○	○	IC circuit					
				2-wire	M9BVV	M9BV	●	●	○	○	—					
				3-wire (NPN)	M9NAV*1	M9NA*1	○	○	○	○	IC circuit					
				3-wire (PNP)	M9PAV*1	M9PA*1	○	○	○	○	IC circuit					
Water resistant (2-color indicator)	2-wire	M9BAV*1	M9BA*1	○	○	○	○	—								
	Red auto switch	Grommet	Yes	3-wire (NPN equivalent)	24 V	12 V	100 V or less	A96V	A96	Z76	●	—	—	—	IC circuit	Relay, PLC
				2-wire				A93V*3	A93	Z73	●	●	●	—	—	
	—	No	No	No	2-wire	24 V	12 V	100 V or less	A90V	A90	Z70	●	—	—	—	IC circuit
—									—	—	—	—	—	—	—	—

*1 Water resistant type auto switches can be mounted on the above models, but in such case SMC cannot guarantee water resistance.

Consult with SMC regarding water resistant types with the above model numbers.

*2 For details on switch mounting brackets and part numbers, refer to "Switch Mounting Bracket: Part No." on page 1333-1.

*3 1 m type lead wire is only applicable to D-A93.

* Lead wire length symbols: 0.5 m Nil (Example) M9NV
1 m M (Example) M9NVM
3 m L (Example) M9NWL
5 m Z (Example) M9NVZ

* Solid state auto switches marked with "○" are produced upon receipt of order.

* There are other applicable auto switches than listed above. For details, refer to page 1333-1.

* Auto switches are shipped together (not assembled). (Refer to page 1331 for the details of auto switch mounting.)

Mechanically Jointed Rodless Cylinder Slide Bearing Guide Type **MY1M Series**

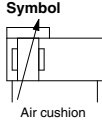
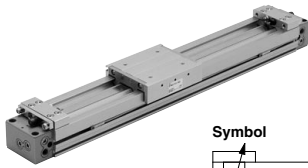

Made to Order: Individual Specifications
(For details, refer to page 1334.)

Symbol	Specifications
-X168	Helical insert thread specifications

Made to Order Specifications

[Click here for details](#)

Symbol	Specifications
-XB11	Long stroke
-XB22	Shock absorber soft type RJ series type
-XC67	NBR rubber lining in dust seal band

Specifications

Bore size (mm)	16	20	25	32	40	50	63
Fluid	Air						
Action	Double acting						
Operating pressure range	0.2 to 0.8 MPa			0.15 to 0.8 MPa			
Proof pressure	1.2 MPa						
Ambient and fluid temperature	5 to 60°C						
Cushion	Air cushion						
Lubrication	Non-lube						
Stroke length tolerance	1000 or less $^{+1.8}_0$ 1001 to 3000 $^{+2.8}_0$		2700 or less $^{+1.8}_0$, 2701 to 5000 $^{+2.8}_0$				
Piping port size	Front/Side port Bottom port		M5 x 0.8 ø4		1/8 ø6	1/4 ø8	3/8 ø10

Piston Speed

Bore size (mm)	16 to 63
Without stroke adjustment unit	100 to 1000 mm/s
Stroke adjustment unit	A unit L unit and H unit
	100 to 1000 mm/s ⁽¹⁾ 100 to 1500 mm/s ⁽²⁾

Note 1) Be aware that when the stroke adjustment range is increased by manipulating the adjustment bolt, the air cushion capacity decreases. Also, when exceeding the air cushion stroke ranges on page 1266, the piston speed should be 100 to 200 mm per second.

Note 2) The piston speed is 100 to 1000 mm/s for centralized piping.

Note 3) Use a speed at the upper absorption capacity range. Refer to page 1266.

Note 4) Due to the construction of this product, it may have more fluctuation in operating speed compared to a rod type air cylinder. For applications that require constant speed, select the equipment corresponding to the required level.

Stroke Adjustment Unit Specifications

Bore size (mm)	16			20			25			32			40			50			63					
Unit symbol	A	L	H	A	L	H	A	L	H	A	L	H	A	L	H	A	L	H	A	L	H			
Configuration	With adjustment bolt			With adjustment bolt			With adjustment bolt			With adjustment bolt			With adjustment bolt			With adjustment bolt			With adjustment bolt			With adjustment bolt		
Shock absorber model	RB 0806 + with adjustment bolt			RB 0806 + with adjustment bolt			RB 1007 + with adjustment bolt			RB 1007 + with adjustment bolt			RB 1412 + with adjustment bolt			RB 2015 + with adjustment bolt			RB 2015 + with adjustment bolt			RB 2725 + with adjustment bolt		
Stroke adjustment range by intermediate fixing spacer (mm)	Without spacer			Without spacer			Without spacer			Without spacer			Without spacer			Without spacer			Without spacer			Without spacer		
	0 to -5.6			0 to -6			0 to -11.5			0 to -12			0 to -16			0 to -20			0 to -25			0 to -25		
	With short spacer			With short spacer			With short spacer			With short spacer			With short spacer			With short spacer			With short spacer			With short spacer		
	-5.6 to -11.2			-6 to -12			-11.5 to -23			-12 to -24			-16 to -32			-20 to -40			-25 to -50			-25 to -50		
	With long spacer			With long spacer			With long spacer			With long spacer			With long spacer			With long spacer			With long spacer			With long spacer		
	-11.2 to -16.8			-12 to -18			-23 to -34.5			-24 to -36			-32 to -48			-40 to -60			-50 to -75			-50 to -75		

* Stroke adjustment range is applicable for one side when mounted on a cylinder.

Stroke Adjustment Unit Symbol

Left side stroke adjustment unit	Without unit	Right side stroke adjustment unit																		
		A: With adjustment bolt					L: With low load shock absorber + Adjustment bolt					H: With high load shock absorber + Adjustment bolt								
		With short spacer		With long spacer			With short spacer		With long spacer			With short spacer		With long spacer						
Without unit	Nil	SA	SA6	SA7	SL	SL6	SL7	SH	SH6	SH7										
A: With adjustment bolt	AS	A	AA6	AA7	AL	AL6	AL7	AH	AH6	AH7										
With short spacer	A6S	A6A	A6	A6A7	A6L	A6L6	A6L7	A6H	A6H6	A6H7										
With long spacer	A7S	A7A	A7A6	A7	A7L	A7L6	A7L7	A7H	A7H6	A7H7										
L: With low load shock absorber + Adjustment bolt	LS	LA	LA6	LA7	L	LL6	LL7	LH	LH6	LH7										
With short spacer	L6S	L6A	L6A6	L6A7	L6L	L6	L6L6	L6H	L6H6	L6H7										
With long spacer	L7S	L7A	L7A6	L7A7	L7L	L7L6	L7L7	L7H	L7H6	L7H7										
H: With high load shock absorber + Adjustment bolt	HS	HA	HA6	HA7	HL	HL6	HL7	H	HH6	HH7										
With short spacer	H6S	H6A	H6A6	H6A7	H6L	H6L6	H6L7	H6H	H6	H6H7										
With long spacer	H7S	H7A	H7A6	H7A7	H7L	H7L6	H7L7	H7H	H7H6	H7										

* Spacers are used to fix the stroke adjustment unit at an intermediate stroke position.

For details on spacers and stroke adjustment units, refer to "Accessory Bracket (Option)" on page 1274-1.

Stroke adjustment unit mounting diagram

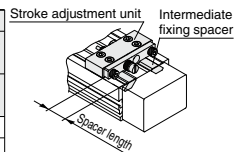

Example of L6L7 attachment

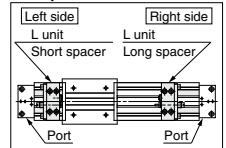

Refer to pages 1331 to 1333-1 for the specifications with auto switch.

MY1M Series

Shock Absorbers for L and H Units

Type	Stroke adjustment unit	Bore size (mm)					
		16	20	25	32	40	50
Standard (Shock absorber/RB series)	L	RB0806	RB1007	RB1412	RB2015		
	H	—	RB1007	RB1412	RB2015	RB2725	
Shock absorber/soft type RJ series mounted (-XB22)	L	RJ0806H	RJ1007H	RJ1412H		—	—
	H	—	RJ1007H	RJ1412H	—	—	—

* The shock absorber service life is different from that of the MY1M cylinder depending on operating conditions. Refer to the RB Series Specific Product Precautions for the replacement period.

* Mounted shock absorber soft type RJ series (-XB22) is made to order specifications. For details, refer to page 1752.

Shock Absorber Specifications

Model	RB 0806	RB 1007	RB 1412	RB 2015	RB 2725	
	Max. energy absorption (J)	2.9	5.9	19.6	58.8	147
Stroke absorption (mm)	6	7	12	15	25	
Max. collision speed (mm/s)	1500					
Max. operating frequency (cycle/min)	80	70	45	25	10	
Spring force (N)	Extended	1.96	4.22	6.86	8.34	8.83
	Retracted	4.22	6.86	15.98	20.50	20.01
Operating temperature range (°C)	5 to 60					

* The shock absorber service life is different from that of the MY1M cylinder depending on operating conditions. Refer to the RB Series Specific Product Precautions for the replacement period.

Theoretical Output

Bore size (mm)	Piston area (mm ²)	Operating pressure (MPa)							
		0.2	0.3	0.4	0.5	0.6	0.7	0.8	
16	200	40	60	80	100	120	140	160	
20	314	62	94	125	157	188	219	251	
25	490	98	147	196	245	294	343	392	
32	804	161	241	322	402	483	563	643	
40	1256	251	377	502	628	754	879	1005	
50	1962	392	588	784	981	1177	1373	1569	
63	3115	623	934	1246	1557	1869	2180	2492	

Note) Theoretical output (N) = Pressure (MPa) x Piston area (mm²)

Weight

Bore size (mm)	Basic weight	Additional weight per each 50 mm of stroke	Weight of moving parts	Side support bracket weight (per set)	Stroke adjustment unit weight (per unit)		
					Type A and B	A unit weight	L unit weight
16	0.67	0.12	0.19	0.01	0.03	0.04	—
20	1.11	0.16	0.28	0.02	0.04	0.05	0.08
25	1.64	0.24	0.39	0.02	0.07	0.11	0.18
32	3.27	0.38	0.81	0.04	0.14	0.23	0.39
40	5.88	0.56	1.41	0.08	0.25	0.34	0.48
50	10.06	0.77	2.51	0.08	0.36	0.51	0.81
63	16.57	1.11	3.99	0.17	0.68	0.83	1.08

Calculation: (Example) **MY1M25-300A**

- Basic weight..... 1.64 kg
- Cylinder stroke..... 300 stroke
- Additional weight..... 0.24/50 stroke
1.64 + 0.24 x 300/50 + 0.07 x 2 ≒ 3.22 kg
- Weight of A unit..... 0.07 kg

⚠ Precautions

For details on the MY1M Series Mechanically Jointed Rodless Cylinder, refer to "Specific Product Precautions" on pages 1335 to 1336-2.

MY1M Series

Cushion Capacity

Cushion Selection

<Air cushion>

Air cushions are a standard feature on mechanically jointed rodless cylinders. The air cushion mechanism is incorporated to prevent excessive impact of the piston at the stroke end during high speed operation. The purpose of air cushion, thus, is not to decelerate the piston near the stroke end. The ranges of load and speed that air cushions can absorb are within the air cushion limit lines shown in the graphs.

<Stroke adjustment unit with shock absorber>

Use this unit when operating with a load or speed exceeding the air cushion limit line, or when cushioning is required outside of the effective air cushion stroke range due to stroke adjustment.

<L unit>

Use this unit when the cylinder stroke is outside of the effective air cushion range even if the load and speed are within the air cushion limit line, or when the cylinder is operated in a load and speed range above the air cushion limit line or below the L unit limit line.

<H unit>

Use this unit when the cylinder is operated in a load and speed range above the L unit limit line and below the H unit limit line.

* For details on stroke adjustment using the adjustment bolt, refer to page 1336.

Air Cushion Stroke

Bore size (mm)	Cushion stroke (mm)
16	12
20	15
25	15
32	19
40	24
50	30
63	37

Absorption Capacity of Air Cushion and Stroke Adjustment Units

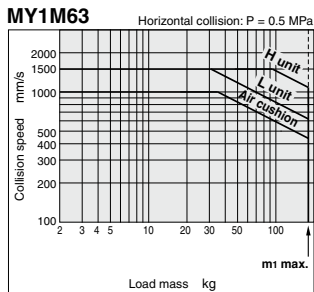
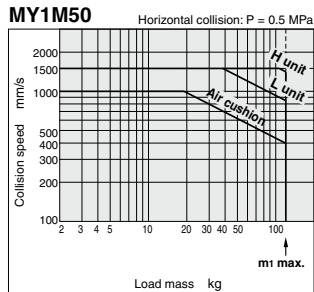
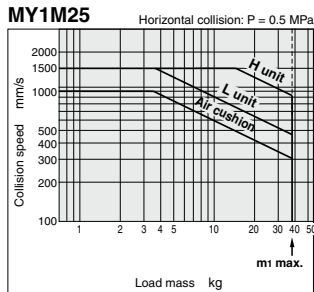
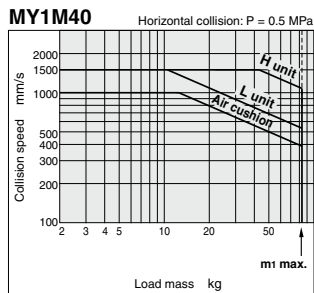
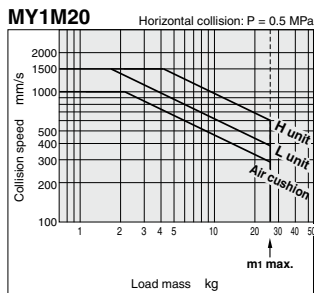
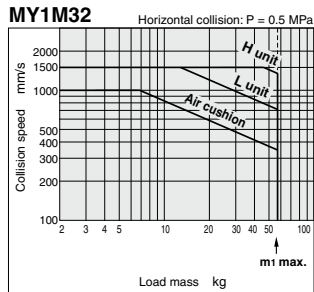
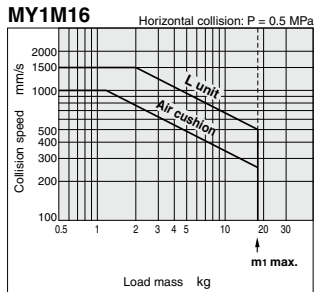

MY1M Series

Construction: $\varnothing 16$ to $\varnothing 63$

MY1M16 to 63

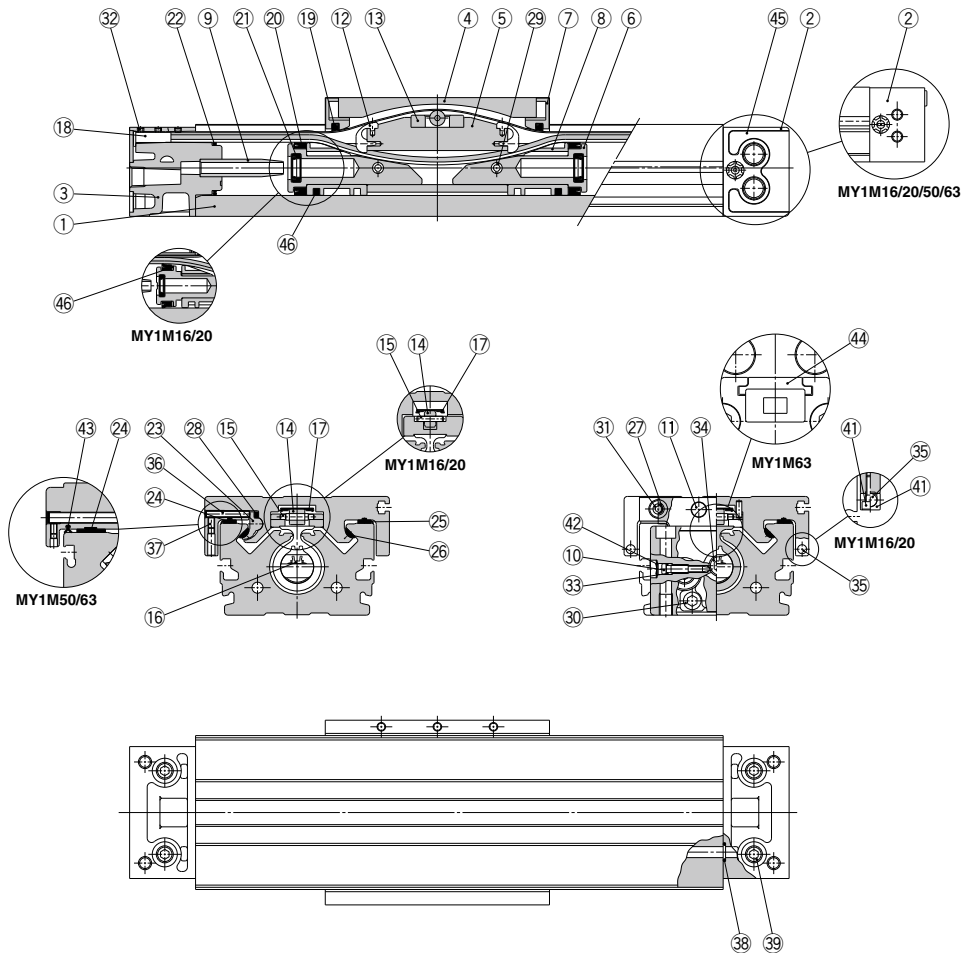

MY1M16 to 63

Component Parts

No.	Description	Material	Note
1	Cylinder tube	Aluminum alloy	Hard anodized
2	Head cover WR	Aluminum alloy	Painted
3	Head cover WL	Aluminum alloy	Painted
4	Slide table	Aluminum alloy	Hard anodized
5	Piston yoke	Aluminum alloy	Chromated
6	Piston	Aluminum alloy	Chromated
7	End cover	Special resin	
8	Wear ring	Special resin	
9	Cushion ring	Aluminum alloy	Anodized
10	Cushion needle	Rolled steel	Nickel plated
11	Stopper	Carbon steel	Nickel plated
12	Belt separator	Special resin	
13	Coupler	Sintered iron material	
14	Guide roller	Special resin	
15	Guide roller shaft	Stainless steel	
18	Belt clamp	Special resin	
23	Adjusting arm	Aluminum alloy	Chromated
24	Bearing R	Special resin	
25	Bearing L	Special resin	
26	Bearing S	Special resin	

No.	Description	Material	Note
27	Spacer	Stainless steel	
28	Backup spring	Stainless steel	
29	Spring pin	Carbon tool steel	
30	Hexagon socket head cap screw	Chromium molybdenum steel	Chromated
31	Hexagon socket button head screw	Chromium molybdenum steel	Chromated
32	Hexagon socket head set screw	Chromium molybdenum steel	Black zinc chromated/Chromated
34	Hexagon socket head taper plug	Carbon steel	Chromated
35	Magnet	—	
36	Hexagon socket head set screw	Chromium molybdenum steel	Black zinc chromated
37	Hexagon socket head set screw	Chromium molybdenum steel	Black zinc chromated
39	Hexagon socket head taper plug	Carbon steel	Chromated
40	Magnet holder	Special resin	($\phi 16, \phi 20$)
41	Hexagon socket head cap screw	Chromium molybdenum steel	Nickel plated
42	Type CR retaining ring	Spring steel	
44	Head plate	Aluminum alloy	Hard anodized ($\phi 63$)
45	Port cover	Special resin	($\phi 25$ to $\phi 40$)
46	Lube-retainer	Special resin	

Replacement Part: Seal Kit

No.	Description	Qty.	MY1M16	MY1M20	MY1M25	MY1M32	MY1M40	MY1M50	MY1M63
16	Seal belt	1	MY16-16C-Stroke	MY20-16C-Stroke	MY25-16C-Stroke	MY32-16C-Stroke	MY40-16C-Stroke	MY50-16C-Stroke	MY63-16A-Stroke
17	Dust seal band	1	MY16-16B-Stroke	MY20-16B-Stroke	MY25-16B-Stroke	MY32-16B-Stroke	MY40-16B-Stroke	MY50-16B-Stroke	MY63-16B-Stroke
33	O-ring	2	KA00309 ($\phi 4 \times \phi 1.8 \times \phi 1.1$)	KA00311 ($\phi 5.1 \times \phi 3 \times \phi 1.05$)	KA00311 ($\phi 5.1 \times \phi 3 \times \phi 1.05$)	KA00320 ($\phi 7.15 \times \phi 3.75 \times \phi 1.7$)	KA00402 ($\phi 8.3 \times \phi 4.5 \times \phi 1.9$)	KA00777 —	KA00777 —
43	Side scraper	2	—	—	—	—	—	MYM50-15CK0502B	MYM63-15CK0503B
19	Scraper	2	—	—	—	—	—	—	—
20	Piston seal	2	—	—	—	—	—	—	—
21	Cushion seal	2	MY1M16-PS	MY1M20-PS	MY1M25-PS	MY1M32-PS	MY1M40-PS	MY1M50-PS	MY1M63-PS
22	Tube gasket	2	—	—	—	—	—	—	—
38	O-ring	4	—	—	—	—	—	—	—

* Seal kit includes 19, 20, 21, 22 and 38. Order the seal kit based on each bore size.

* Seal kit includes a grease pack (10 g).

When 16 and 17 are shipped independently, a grease pack is included. (10 g per 1000 strokes)

Order with the following part number when only the grease pack is needed.

Grease pack part number: GR-S-010 (10 g), GR-S-020 (20 g)

Note) Two kinds of dust seal bands are available. Verify the type to use, since the part number varies

depending on the treatment of the hexagon socket head set screw 32.

A: Black zinc chromated→MY□□-16B-stroke, B: Chromated→MY□□-16BW-stroke

MY1M Series

Standard Type/Centralized Piping Type $\phi 16, \phi 20$

MY1M16□/20□ — Stroke

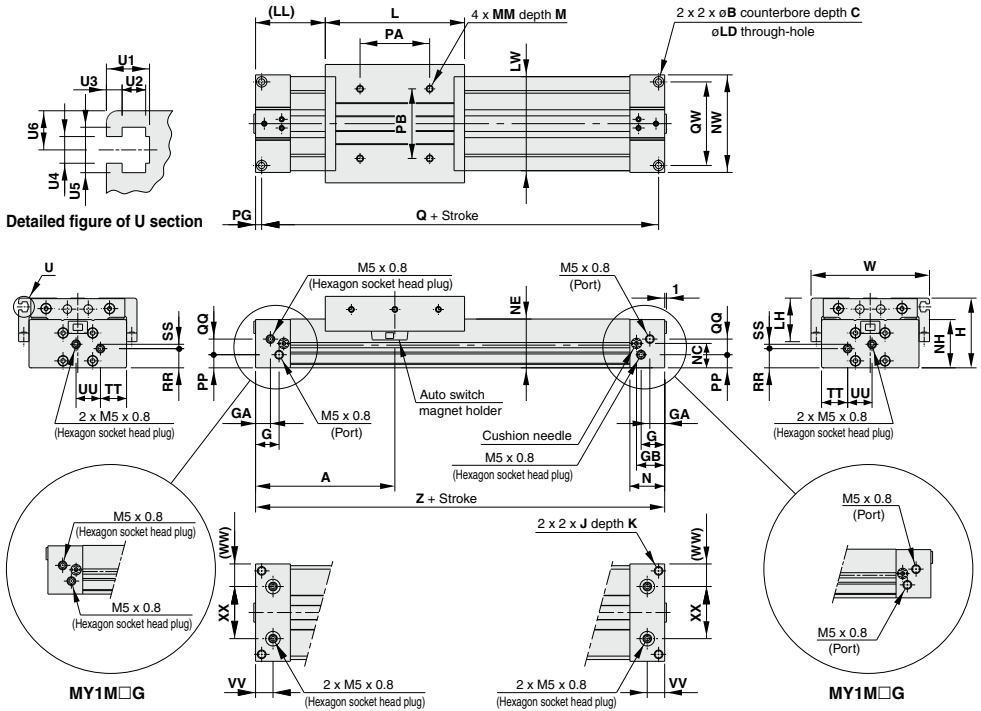

Model	A	B	C	G	GA	GB	H	J	K	L	LD	LH	LL	LW	M	MM	N	NC	NE	NH	NW	PA
MY1M16□	80	6	3.5	13.5	8.5	16.2	40	M5 x 0.8	10	80	3.6	22.5	40	54	6	M4 x 0.7	20	14	28	27.7	56	40
MY1M20□	100	7.5	4.5	12.5	12.5	20	46	M6 x 1	12	100	4.8	23	50	58	7.5	M5 x 0.8	25	17	34	33.7	60	50

Model	PB	PG	PP	Q	QQ	QW	RR	SS	TT	UU	VV	W	WW	XX	Z
MY1M16□	40	3.5	7.5	153	9	48	11	2.5	15	14	10	68	13	30	160
MY1M20□	40	4.5	11.5	191	10	45	14.5	5	18	12	12.5	72	14	32	200

Detailed Dimensions of U Section (mm)

Model	U1	U2	U3	U4	U5	U6
MY1M16□	5.5	3	2	3.4	5.8	5
MY1M20□	5.5	3	2	3.4	5.8	5.5

Centralized Piping on the Bottom

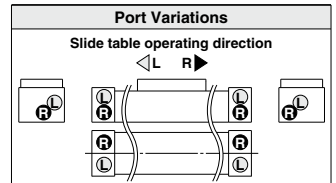
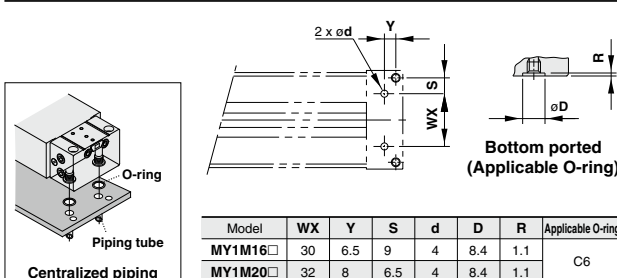

Mechanically Jointed Rodless Cylinder Slide Bearing Guide Type **MY1M Series**

Standard Type/Centralized Piping Type $\phi 25, \phi 32, \phi 40$

MY1M25□/32□/40□ — Stroke

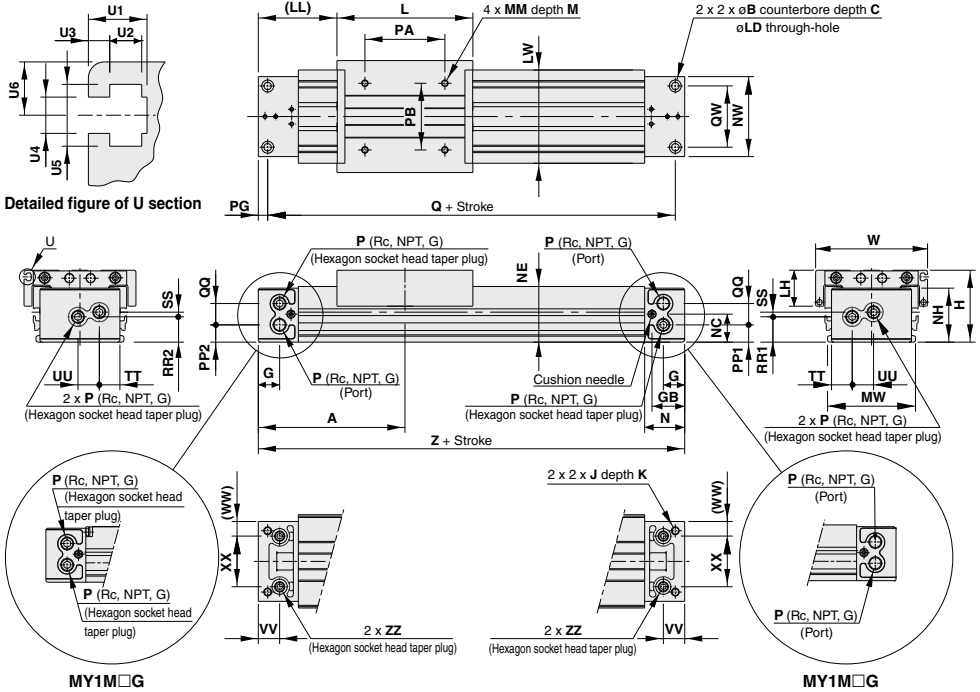

Model	A	B	C	G	GB	H	J	K	L	LD	LH	LL	LW	M	MM	MW	N	NC	NE	NH	NW	P	PA
MY1M25□	110	9	5.5	17	24.5	54	M6 x 1	9.5	102	5.6	27	59	70	10	M5 x 0.8	66	30	21	41.8	40.5	60	1/8	60
MY1M32□	140	11	6.5	19	30	68	M6 x 1.25	16	132	6.8	35	74	88	13	M6 x 1	80	37	26	52.3	50	74	1/8	80
MY1M40□	170	14	8.5	23	36.5	84	M10 x 1.5	15	162	8.6	38	89	104	13	M6 x 1	96	45	32	65.3	63.5	94	1/4	100

"P" indicates cylinder supply ports.

Detailed Dimensions of U Section

Model	PB	PG	PP1	PP2	Q	QQ	QW	RR1	RR2	SS	TT	UU	VV	W	WW	XX	Z	ZZ
MY1M25□	50	7	12.7	12.7	206	15.5	46	18.9	17.9	4.1	15.5	16	16	84	11	38	220	Rc 1/16
MY1M32□	60	8	15.5	18.5	264	16	60	22	24	4	21	16	19	102	13	48	280	Rc 1/16
MY1M40□	80	9	17.5	20	322	26	72	25.5	29	9	26	21	23	118	20	54	340	Rc 1/8

Centralized Piping on the Bottom

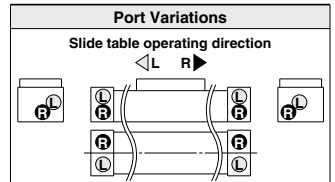
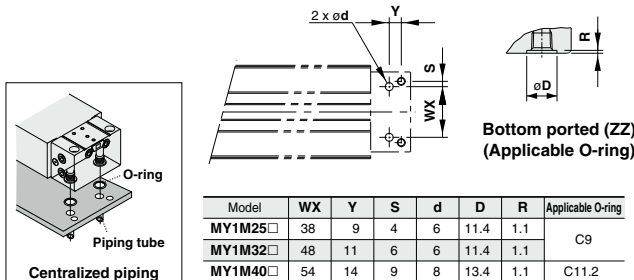

MY1M Series

Standard Type/Centralized Piping Type $\phi 50, \phi 63$

Refer to page 1337 regarding centralized piping port variations.

MY1M50□/60□ — Stroke

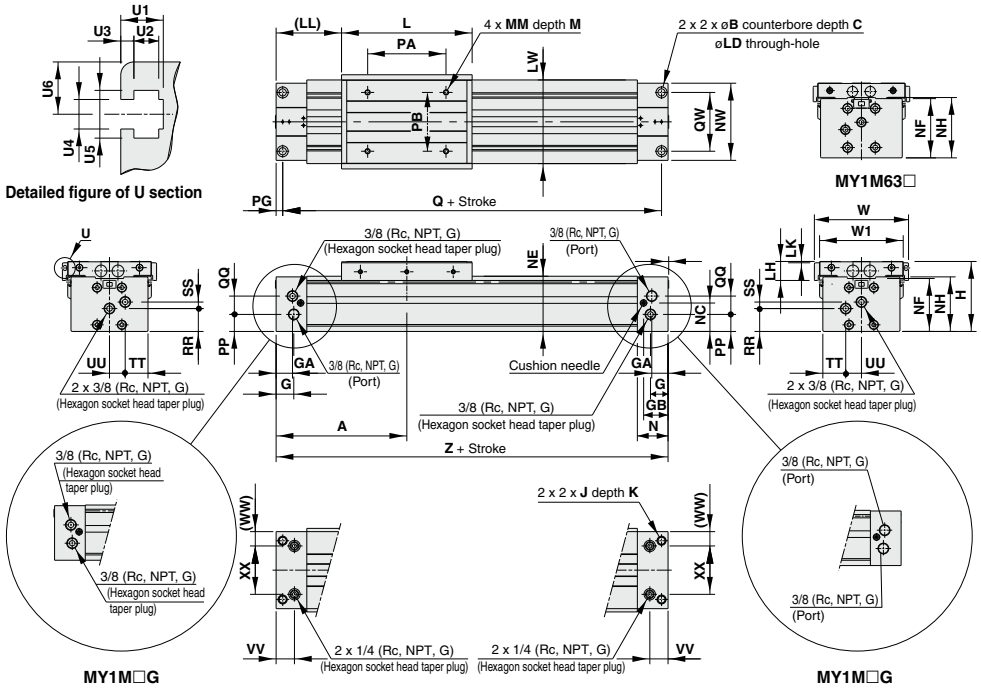

Model	A	B	C	G	GA	GB	H	J	K	L	LD	LH	LK	LL	LW	M	MM	N	NC	NE	NF	NH	NW	PA
MY1M50□	200	17	10.5	27	25	37.5	107	M14 x 2	28	200	11	29	2	100	128	15	M8 x 1.25	47	43.5	84.5	81	83.5	118	120
MY1M63□	230	19	12.5	29.5	27.5	39.5	130	M16 x 2	32	230	13.5	32.5	5.5	115	152	16	M10 x 1.5	50	56	104	103	105	142	140

Model	PB	PG	PP	Q	QQ	QW	RR	SS	TT	UU	VV	W	W1	WW	XX	Z
MY1M50□	90	10	26	380	28	90	35	10	35	24	28	144	128	22	74	400
MY1M63□	110	12	42	436	30	110	49	13	43	28	30	168	152	25	92	460

Detailed Dimensions of U Section

Model	U1	U2	U3	U4	U5	U6
MY1M50□	6.5	3.8	2	4.5	7.3	8
MY1M63□	8.5	5	2.5	5.5	8.4	8

Centralized Piping on the Bottom

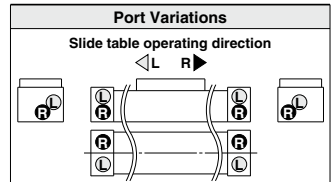
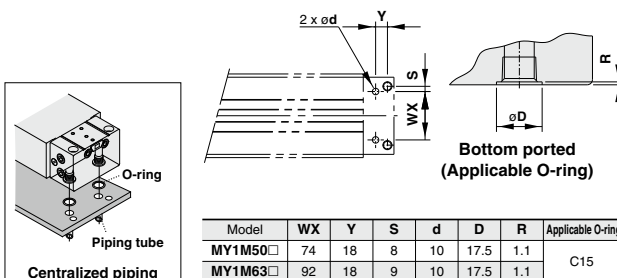

Stroke Adjustment Unit

With adjustment bolt

MY1M [Bore size] □ — Stroke A

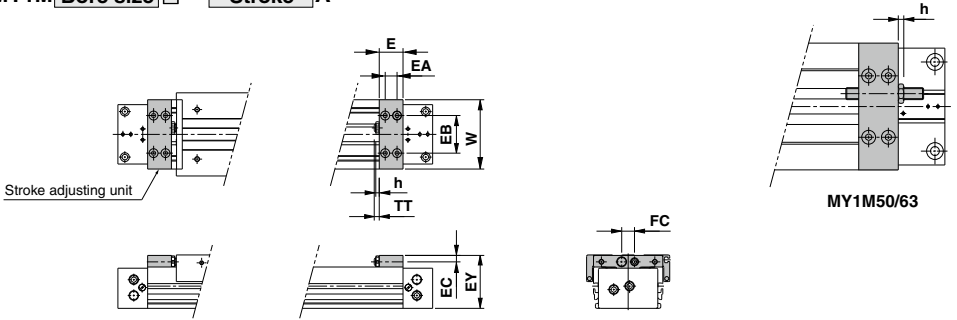

Applicable bore size	E	EA	EB	EC	EY	FC	h	TT	W
MY1M16	14.6	7	30	5.8	39.5	14	3.6	5.4 (Max. 11)	58
MY1M20	20	10	32	5.8	45.5	14	3.6	5 (Max. 11)	58
MY1M25	24	12	38	6.5	53.5	13	3.5	5 (Max. 16.5)	70
MY1M32	29	14	50	8.5	67	17	4.5	8 (Max. 20)	88
MY1M40	35	17	57	10	83	17	4.5	9 (Max. 25)	104
MY1M50	40	20	66	14	106	26	5.5	13 (Max. 33)	128
MY1M63	52	26	77	14	129	31	5.5	13 (Max. 38)	152

With low load shock absorber + Adjustment bolt

MY1M [Bore size] □ — Stroke L

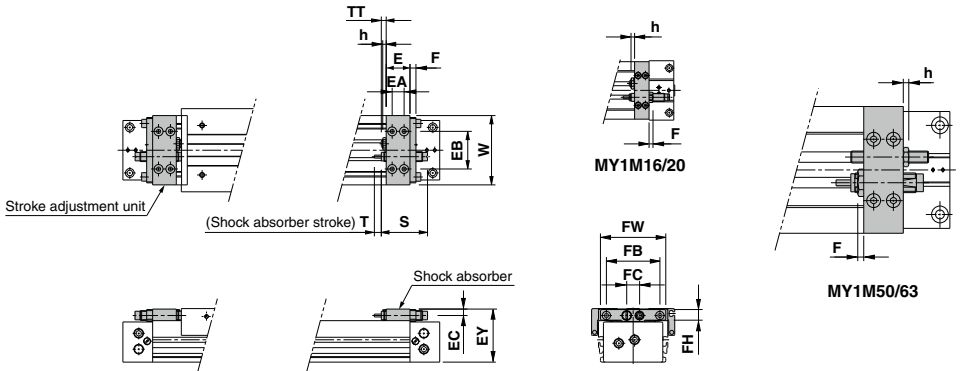

Applicable size	E	EA	EB	EC	EY	F	FB	FC	FH	FW	h	S	T	TT	W	Shock absorber model
MY1M16	14.6	7	30	5.8	39.5	4	—	14	—	—	3.6	40.8	6	5.4 (Max. 11)	58	RB0806
MY1M20	20	10	32	5.8	45.5	4	—	14	—	—	3.6	40.8	6	5 (Max. 11)	58	RB0806
MY1M25	24	12	38	6.5	53.5	6	54	13	13	66	3.5	46.7	7	5 (Max. 16.5)	70	RB1007
MY1M32	29	14	50	8.5	67	6	67	17	16	80	4.5	67.3	12	8 (Max. 20)	88	RB1412
MY1M40	35	17	57	10	83	6	78	17	17.5	91	4.5	67.3	12	9 (Max. 25)	104	RB1412
MY1M50	40	20	66	14	106	6	—	26	—	—	5.5	73.2	15	13 (Max. 33)	128	RB2015
MY1M63	52	26	77	14	129	6	—	31	—	—	5.5	73.2	15	13 (Max. 38)	152	RB2015

(mm)

MY1M Series

Stroke Adjustment Unit

With high load shock absorber + Adjustment bolt

MY1M — H

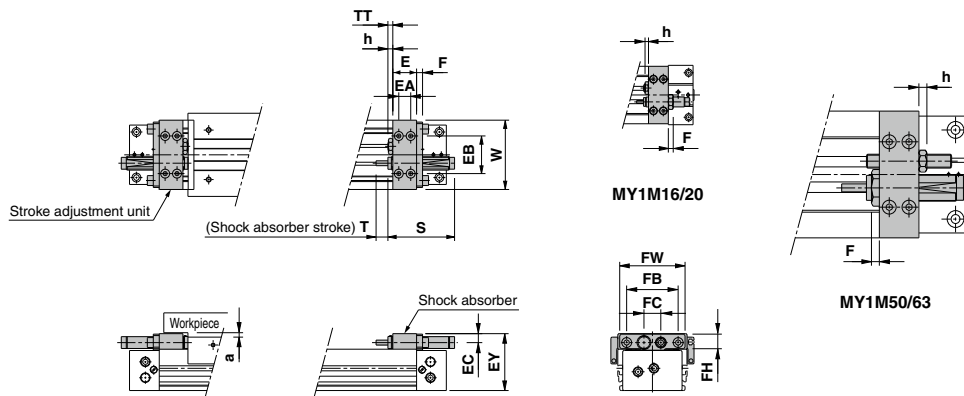

* Since dimension EY of the H type unit is greater than the table top height (dimension H), when mounting a workpiece that exceeds the overall length (dimension L) of the slide table, allow a clearance of dimension "a" or larger on the workpiece side.

Applicable bore size	E	EA	EB	EC	EY	F	FB	FC	FH	FW	h	S	T	TT	W	Shock absorber model	a
MY1M20	20	10	32	7.7	50	5	—	14	—	—	3.5	46.7	7	5 (Max. 11)	58	RB1007	5
MY1M25	24	12	38	9	57.5	6	52	17	16	66	4.5	67.3	12	5 (Max. 16.5)	70	RB1412	4.5
MY1M32	29	14	50	11.5	73	8	67	22	22	82	5.5	73.2	15	8 (Max. 20)	88	RB2015	6
MY1M40	35	17	57	12	87	8	78	22	22	95	5.5	73.2	15	9 (Max. 25)	104	RB2015	4
MY1M50	40	20	66	18.5	115	8	—	30	—	—	11	99	25	13 (Max. 33)	128	RB2725	9
MY1M63	52	26	77	19	138.5	8	—	35	—	—	11	99	25	13 (Max. 38)	152	RB2725	9.5

MY1M Series

Accessory Bracket (option)

Stroke Adjustment Unit

MYM-A 25 L2-6N

Stroke adjustment unit

Bore size

16	16 mm
20	20 mm
25	25 mm
32	32 mm
40	40 mm
50	50 mm
63	63 mm

Intermediate fixing spacer

Nil	Without spacer
6	Short spacer
7	Long spacer

Spacer delivery type

Nil	Unit installed
N	Spacer only

- Spacers are used to fix the stroke adjustment unit at an intermediate stroke position.
- Spacers are shipped for a set of two.

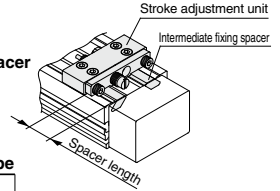

Symbol	Stroke adjustment unit	Mounting position
A1	A unit	Left
A2		Right
L1	L unit	Left
L2		Right
H1	H unit	Left
H2		Right

Note 1) A and L unit only for ø16

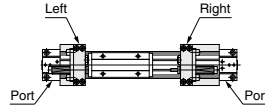

Stroke adjustment range

Bore size	16		20		25		32		40		50		63	
Unit symbol	A	L	A	L	A	L	A	L	A	L	A	L	A	L
Without spacer	0 to -5.6		0 to -6		0 to -11.5		0 to -12		0 to -16		0 to -20		0 to -25	
With short spacer	-5.6 to -11.2		-6 to -12		-11.5 to -23		-12 to -24		-16 to -32		-20 to -40		-25 to -50	
With long spacer	-11.2 to -16.8		-12 to -18		-23 to -34.5		-24 to -36		-32 to -48		-40 to -60		-50 to -75	

Spacer length

Bore size	16	20	25	32	40	50	63
Short spacer	5.6	6	11.5	12	16	20	25
Long spacer	11.2	12	23	24	32	40	50

Component Parts

MYM-A25L2
(Without spacer)

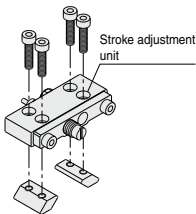

MYM-A25L2-6
(With short spacer)

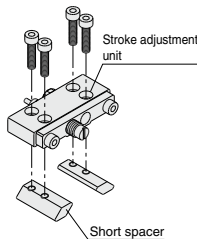

MYM-A25L2-7
(With long spacer)

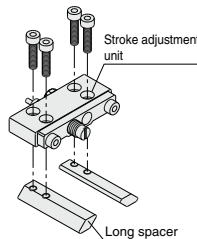

MYM-A25L2-6N
(Short spacer only)

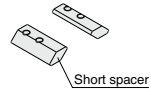

MYM-A25L2-7N
(Long spacer only)

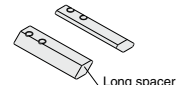

MY1M Series

Side Support

Side support A MY-S□A

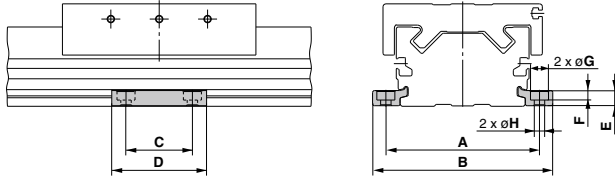

Side support B MY-S□B

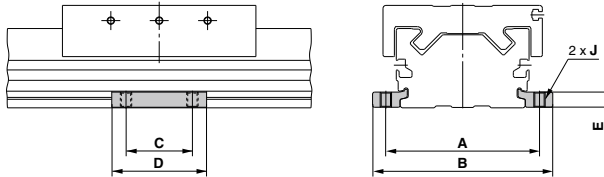

Model	Applicable bore size	A	B	C	D	E	F	G	H	J
MY-S16 _A	MY1M16	61	71.6	15	26	4.9	3	6.5	3.4	M4 x 0.7
MY-S20 _A	MY1M20	67	79.6	25	38	6.4	4	8	4.5	M5 x 0.8
MY-S25 _A	MY1M25	81	95	35	50	8	5	9.5	5.5	M6 x 1
MY-S32 _A	MY1M32	100	118	45	64	11.7	6	11	6.6	M8 x 1.25
MY-S40 _A	MY1M40	120	142	55	80	14.8	8.5	14	9	M10 x 1.5
	MY1M50	142	164							
MY-S63 _A	MY1M63	172	202	70	100	18.3	10.5	17.5	11.5	M12 x 1.75

* A set of side supports consists of a left support and a right support.

Guide for Side Support Application

For long stroke operation, the cylinder tube may be deflected depending on its own weight and the load mass. In such a case, use a side support in the middle section. The spacing (L) of the support must be no more than the values shown in the graph on the right.

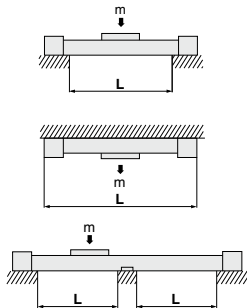

Caution

1. If the cylinder mounting surfaces are not measured accurately, using a side support may cause poor operation. Therefore, be sure to level the cylinder tube when mounting. Also, for long stroke operation involving vibration and impact, use of a side support is recommended even if the spacing value is within the allowable limits shown in the graph.
2. Support brackets are not for mounting; use them solely for providing support.

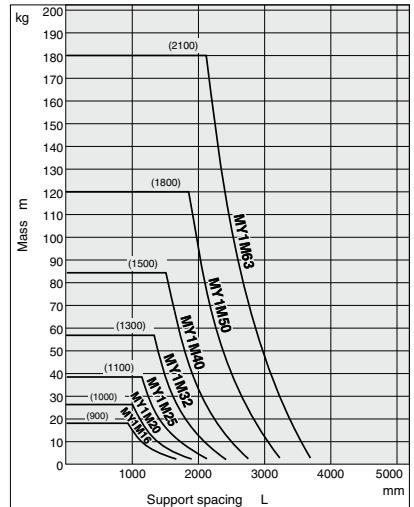

MY1C Series

Cam Follower Guide Type

ø16, ø20, ø25, ø32, ø40, ø50, ø63

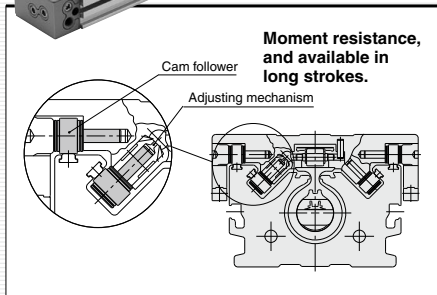
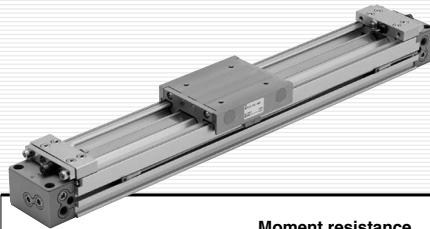

INDEX

MY1C Series Prior to Use	P. 1278
Model Selection	P. 1280
How to Order	P. 1282
Specifications	P. 1283
Cushion Capacity	P. 1286
Construction	P. 1288
Dimensions	P. 1290
Side Support	P. 1295

MY1C series Prior to Use

Maximum Allowable Moment/Maximum Load Mass

Model	Bore size (mm)	Maximum allowable moment (N·m)			Maximum load mass (kg)		
		M1	M2	M3	m1	m2	m3
MY1C	16	6.0	3.0	2.0	18	7	2.1
	20	10	5.0	3.0	25	10	3
	25	15	8.5	5.0	35	14	4.2
	32	30	14	10	49	21	6
	40	60	23	20	68	30	8.2
	50	115	35	35	93	42	11.5
	63	150	50	50	130	60	16

The above values are the maximum allowable values for moment and load. Refer to each graph regarding the maximum allowable moment and maximum allowable load for a particular piston speed.

Load mass (kg)

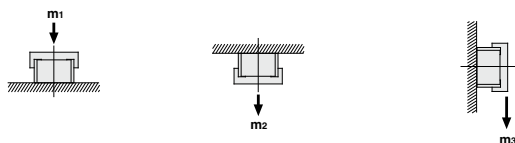

Moment (N·m)

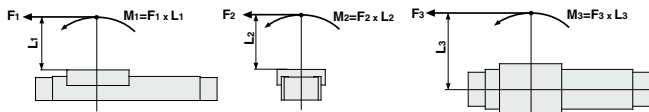

<Calculation of guide load factor>

- Maximum allowable load (1), static moment (2), and dynamic moment (3) (at the time of impact with stopper) must be examined for the selection calculations.
 ※ To evaluate, use \bar{v}_a (average speed) for (1) and (2), and v (collision speed $v = 1.4\bar{v}_a$) for (3). Calculate m_{max} for (1) from the maximum allowable load graph (m_1, m_2, m_3) and M_{max} for (2) and (3) from the maximum allowable moment graph (M_1, M_2, M_3).

$$\text{Sum of guide load factors } \Sigma \alpha = \frac{\text{Load mass [m]}}{\text{Maximum allowable load [m}_{max}\text{]}} + \frac{\text{Static moment [M]}^{(1)}}{\text{Allowable static moment [M}_{max}\text{]}} + \frac{\text{Dynamic moment [M}\epsilon\text{]}^{(2)}}{\text{Allowable dynamic moment [M}\epsilon_{max}\text{]}} \leq 1$$

Note 1) Moment caused by the load, etc., with cylinder in resting condition.

Note 2) Moment caused by the impact load equivalent at the stroke end (at the time of impact with stopper).

Note 3) Depending on the shape of the workpiece, multiple moments may occur. When this happens, the sum of the load factors ($\Sigma \alpha$) is the total of all such moments.

2. Reference formula [Dynamic moment at impact]

Use the following formulae to calculate dynamic moment when taking stopper impact into consideration.

m: Load mass (kg)

F: Load (N)

F ϵ : Load equivalent to impact (at impact with stopper) (N)

\bar{v}_a : Average speed (mm/s)

M: Static moment (N·m)

$v = 1.4\bar{v}_a$ (mm/s) $F\epsilon = 1.4\bar{v}_a \cdot \delta \cdot m$ (Note 4)

$\therefore M\epsilon = \frac{1}{3} \cdot F\epsilon \cdot L_1 = 4.57\bar{v}_a \delta m L_1$ (N·m) (Note 5)

v : Collision speed (mm/s)

L_1 : Distance to the load's center of gravity (m)

M ϵ : Dynamic moment (N·m)

δ : Damper coefficient At collision: $v = 1.4\bar{v}_a$

With rubber bumper = 4/100

(MY1B10, MY1H10)

With air cushion = 1/100

With shock absorber = 1/100

g: Gravitational acceleration (9.8 m/s²)

Note 4) $1.4\bar{v}_a \delta$ is a dimensionless coefficient for calculating impact force.

Note 5) Average load coefficient ($= \frac{1}{3}$). This coefficient is for averaging the maximum load moment at the time of stopper impact according to service life calculations.

- For detailed selection procedures, refer to pages 1280 and 1281.

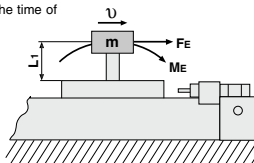

Maximum Allowable Moment

Select the moment from within the range of operating limits shown in the graphs. Note that the maximum allowable load value may sometimes be exceeded even within the operating limits shown in the graphs. Therefore, also check the allowable load for the selected conditions.

Maximum Load Mass

Select the load from within the range of limits shown in the graphs. Note that the maximum allowable moment value may sometimes be exceeded even within the operating limits shown in the graphs. Therefore, also check the allowable moment for the selected conditions.

MY1C/M₁

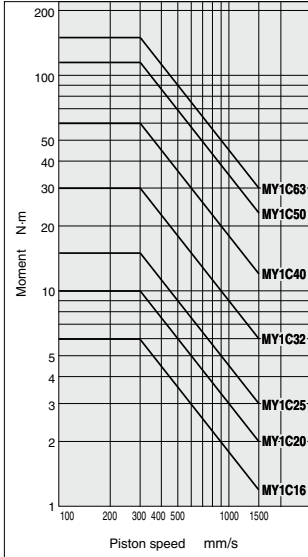

MY1C/M₂

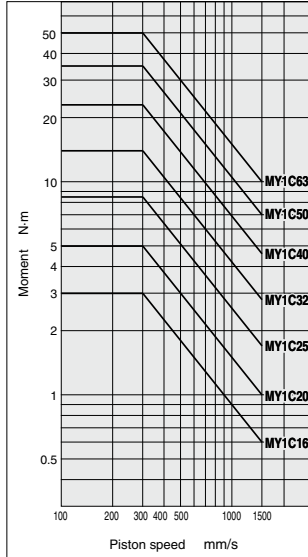

MY1C/M₃

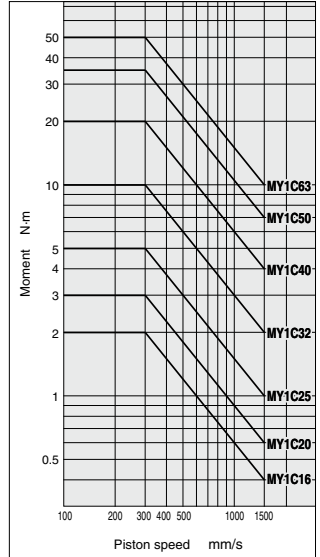

MY1C/m₁

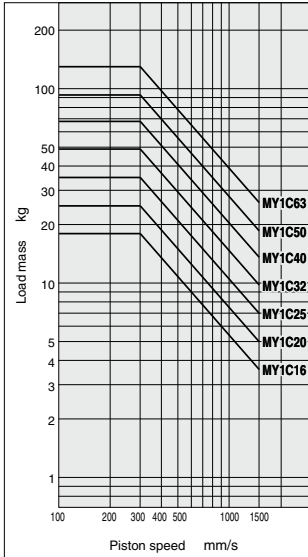

MY1C/m₂

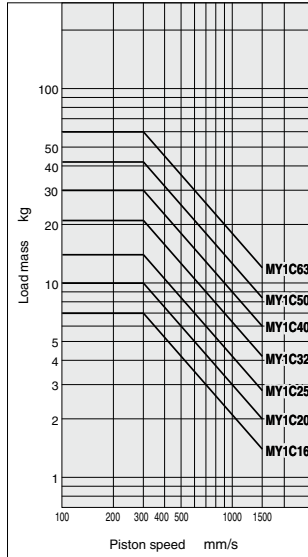

MY1C/m₃

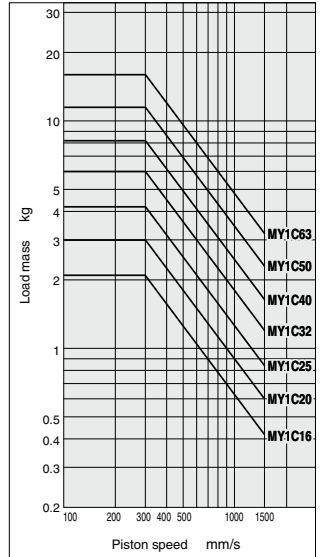

MY1C Series Model Selection

Following are the steps for selecting the most suitable MY1C series to your application.

Calculation of Guide Load Factor

1. Operating Conditions

Cylinder..... MY1C40-500
Average operating speed v_a ... 300 mm/s
Mounting orientation..... Ceiling mounting
Cushion..... Air cushion
($\delta = 1/100$)

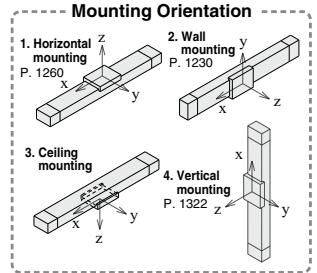
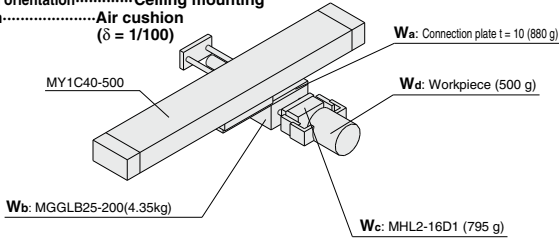

For actual examples of calculation for each orientation, refer to the pages above.

2. Load Blocking

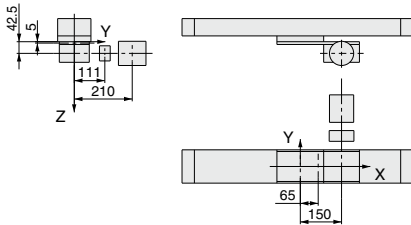

Mass and Center of Gravity for Each Workpiece

Workpiece no.	Mass m_n	Center of gravity		
		X-axis X_n	Y-axis Y_n	Z-axis Z_n
Wa	0.88 kg	65 mm	0 mm	5 mm
Wb	4.35 kg	150 mm	0 mm	42.5 mm
Wc	0.795 kg	150 mm	111 mm	42.5 mm
Wd	0.5 kg	150 mm	210 mm	42.5 mm

$n=a, b, c, d$

3. Composite Center of Gravity Calculation

$$m_2 = \sum m_n \\ = 0.88 + 4.35 + 0.795 + 0.5 = 6.525 \text{ kg}$$

$$X = \frac{1}{m_2} \times \sum (m_n \times X_n) \\ = \frac{1}{6.525} (0.88 \times 65 + 4.35 \times 150 + 0.795 \times 150 + 0.5 \times 150) = 138.5 \text{ mm}$$

$$Y = \frac{1}{m_2} \times \sum (m_n \times Y_n) \\ = \frac{1}{6.525} (0.88 \times 0 + 4.35 \times 0 + 0.795 \times 111 + 0.5 \times 210) = 29.6 \text{ mm}$$

$$Z = \frac{1}{m_2} \times \sum (m_n \times Z_n) \\ = \frac{1}{6.525} (0.88 \times 5 + 4.35 \times 42.5 + 0.795 \times 42.5 + 0.5 \times 42.5) = 37.4 \text{ mm}$$

4. Calculation of Load Factor for Static Load

m_2 : Mass

$$m_2 \text{ max (from (1) of graph MY1C}/m_2) = 30 \text{ (kg)}$$

$$\text{Load factor } \alpha_1 = m_2/m_2 \text{ max} = 6.525/30 = 0.22$$

M_1 : Moment

$$M_1 \text{ max (from (2) of graph MY1C}/M_1) = 60 \text{ (N}\cdot\text{m)}$$

$$M_1 = m_2 \times g \times X = 6.525 \times 9.8 \times 138.5 \times 10^{-3} = 8.86 \text{ (N}\cdot\text{m)}$$

$$\text{Load factor } \alpha_2 = M_1/M_1 \text{ max} = 8.86/60 = 0.15$$

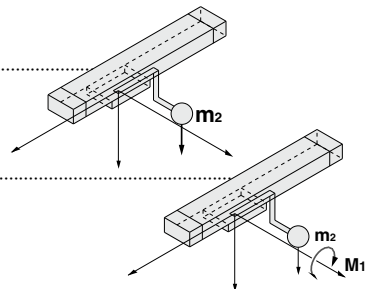

M₂: Moment

M₂ max (from (3) of graph MY1C/M₂) = 23.0 (N·m).....

M₂ = m₂ × g × Y = 6.525 × 9.8 × 29.6 × 10⁻³ = 1.89 (N·m)

Load factor **α₃ = M₂/M₂ max** = 1.89/23.0 = **0.08**

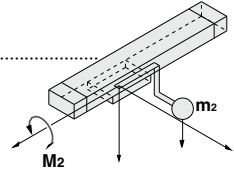

5. Calculation of Load Factor for Dynamic Moment

Equivalent load F_E at impact

F_E = 1.4v_a × δ × m × g = 1.4 × 300 × $\frac{1}{100}$ × 6.525 × 9.8 = 268.6 (N)

M_{1E}: Moment

M_{1E} max (from (4) of graph MY1C/M₁ where 1.4v_a = 420 mm/s) = 42.9 (N·m).....

M_{1E} = $\frac{1}{3}$ × F_E × Z = $\frac{1}{3}$ × 268.6 × 37.4 × 10⁻³ = 3.35 (N·m)

Load factor **α₄ = M_{1E}/M_{1E} max** = 3.35/42.9 = **0.08**

M_{3E}: Moment

M_{3E} max (from (5) of graph MY1C/M₃ where 1.4v_a = 420 mm/s) = 14.3 (N·m).....

M_{3E} = $\frac{1}{3}$ × F_E × Y = $\frac{1}{3}$ × 268.6 × 29.6 × 10⁻³ = 2.65 (N·m)

Load factor **α₅ = M_{3E}/M_{3E} max** = 2.65/14.3 = **0.19**

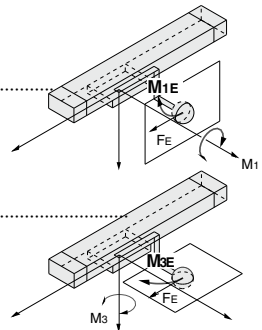

6. Sum and Examination of Guide Load Factors

Σα = α₁ + α₂ + α₃ + α₄ + α₅ = 0.72 ≤ 1

The above calculation is within the allowable value, and therefore the selected model can be used.

Select a shock absorber separately.

In an actual calculation, when the total sum of guide load factors α in the formula above is more than 1, consider either decreasing the speed, increasing the bore size, or changing the product series. This calculation can be easily made using the "SMC Pneumatics CAD System".

Load Mass

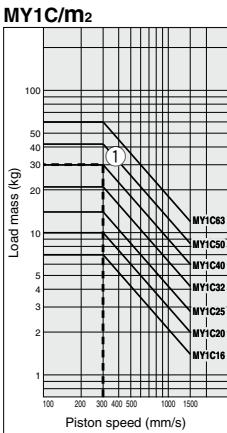

Allowable Moment

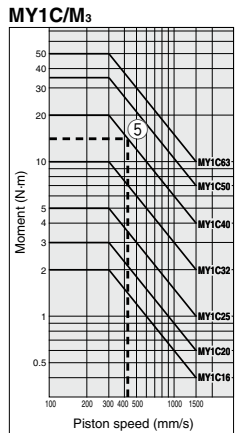
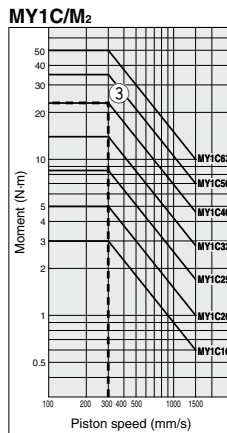
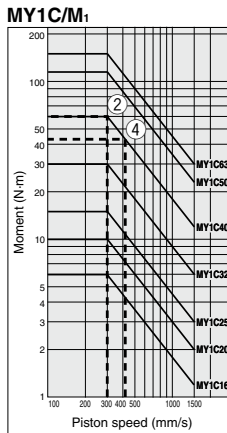

Mechanically Jointed Rodless Cylinder Cam Follower Guide Type

MY1C Series

ø16, ø20, ø25, ø32, ø40, ø50, ø63

How to Order

Cam follower guide type **MY1C** **25** **300** **M9BW**

Cam follower guide type • ① ② ③ ④ ⑤ ⑥ ⑦ ⑧

① Bore size

16	16 mm
20	20 mm
25	25 mm
32	32 mm
40	40 mm
50	50 mm
63	63 mm

② Port thread type

Symbol	Type	Bore size
Nil	M thread	ø16, ø20
	Rc	ø25, ø32,
TN	NPT	ø40, ø50,
TF	G	ø63

③ Piping

Nil	Standard type
G	Centralized piping type

④ Cylinder stroke (mm)

Bore size	Standard stroke* ¹	Long stroke (-XB11)	Maximum manufacturable stroke
16	100, 200, 300, 400, 500 600, 700, 800, 900 1000, 1200, 1400 1600, 1800, 2000	Strokes of 2001 to 3000 mm (1 mm increments) exceeding the standard stroke	3000
	20, 25, 32 40, 50, 63	Strokes of 2001 to 5000 mm (1 mm increments) exceeding the standard stroke	5000

Ordering example

* Add "-XB11" to the end of the part number for long strokes. MY1C20-3000L-M9BW-XB11

Note) Please be advised that with stroke 49 or less, there are cases where auto switch mounting is not possible and the performance of the air cushion may decline.

⑤ Stroke adjustment unit symbol

Refer to "Stroke adjustment unit" on page 1283.

⑥ Auto switch

Nil	Without auto switch (Built-in magnet)
-----	---------------------------------------

Applicable auto switches vary depending on the bore size. Select an applicable one referring to the table below.

⑦ Number of auto switches

Nil	2 pcs.
S	1 pc.
n	"n" pcs.

⑧ Made to Order

Refer to page 1283 for details.

Applicable Auto Switches

Refer to pages 1575 to 1701 for further information on auto switches.

Type	Special function	Electrical entry	Indicator/light	Wiring (Output)	Load voltage		Auto switch model				Lead wire length (m)				Pre-wired connector	Applicable load
					DC	AC	Perpendicular		In-line		0.5 (Nil)	1 (M)	3 (L)	5 (Z)		
							ø16, ø20	ø25 to ø63	ø16, ø20	ø25 to ø63						
Solid state auto switch	—	Grommet	Yes	3-wire (NPN)	5 V, 12 V	—	M9NV	M9N	●	●	○	○	IC circuit	Relay, PLC		
							M9PV	M9P	●	●	○	○				
				2-wire	M9BV	M9B	●	●	○	○	—					
					M9NVV	M9NV	●	●	○	○	IC circuit					
	3-wire (PNP)			M9PVV	M9PV	●	●	○	○	—						
				M9BVV	M9BV	●	●	○	○	—						
	Water resistant (2-color indicator)			3-wire (NPN)	5 V, 12 V	M9NAV* ¹	M9NA* ¹	○	○	●	○	○	IC circuit			
				3-wire (PNP)	5 V, 12 V	M9PAV* ¹	M9PA* ¹	○	○	○	○	○	—			
	2-wire	M9BAV* ¹	M9BA* ¹	○	○	●	○	○	○	—						
		3-wire (NPN equivalent)	—	5 V	—	A96V	—	A96	Z76	●	—	—	IC circuit	—		
2-wire	24 V		12 V	100 V	A93V* ³	—	A93	Z73	●	●	●	—	—	Relay, PLC		
		100 V or less		A90V	—	A90	Z80	●	—	—	—	—	IC circuit	—		

*1 Water resistant type auto switches can be mounted on the above models, but in such case SMC cannot guarantee water resistance.

Consult with SMC regarding water resistant types with the above model numbers.

*2 For details on switch mounting brackets and part numbers, refer to "Switch Mounting Bracket: Part No." on page 1333-1.

*3 1 m type lead wire is only applicable to A-D93.

* Lead wire length symbols: 0.5 m Nil (Example) M9NV
1 m M (Example) M9NVW
3 m L (Example) M9NWL
5 m Z (Example) M9NVZ

* Solid state auto switches marked with "○" are produced upon receipt of order.
* Separate switch spacers (BMG2-012) are required to retrofit auto switches (M9 type) on cylinders ø25 to ø63.

* There are other applicable auto switches than listed above. For details, refer to page 1333-1.

* Auto switches are shipped together (not assembled). (Refer to page 1331 for the details of auto switch mounting.)

Mechanically Jointed Rodless Cylinder Cam Follower Guide Type **MY1C Series**

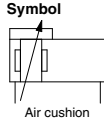
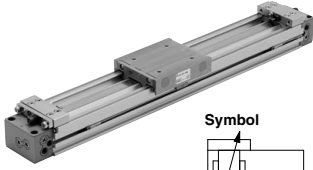

Made to Order; Individual Specifications
(For details, refer to page 1334.)

Symbol	Specifications
-X168	Helical insert thread specifications

Made to Order Specifications

[Click here for details](#)

Symbol	Specifications
-XB11	Long stroke
-XB22	Shock absorber soft type RJ series type
-XC56	With knock pin hole
-XC67	NBR rubber lining in dust seal band

Specifications

Bore size (mm)	16	20	25	32	40	50	63
Fluid	Air						
Action	Double acting						
Operating pressure range	0.15 to 0.8 MPa			0.1 to 0.8 MPa			
Proof pressure	1.2 MPa						
Ambient and fluid temperature	5 to 60°C						
Cushion	Air cushion						
Lubrication	Non-lube						
Stroke length tolerance	1000 or less $^{+1.8}_0$ 1001 to 3000 $^{+2.8}_0$			2700 or less $^{+1.8}_0$; 2701 to 5000 $^{+2.8}_0$			
Piping port size	Front/Side port	M5 x 0.8		1/8	1/4	3/8	
	Bottom port	ø4		ø6	ø8	ø10	

Piston Speed

Bore size (mm)	16 to 63	
Without stroke adjustment unit	100 to 1000 mm/s	
Stroke adjustment unit	A unit	100 to 1000 mm/s ⁽¹⁾
	L unit and H unit	100 to 1500 mm/s ⁽²⁾

Note 1) Be aware that when the stroke adjustment range is increased by manipulating the adjustment bolt, the air cushion capacity decreases. Also, when exceeding the air cushion stroke ranges on page 1286, **the piston speed should be 100 to 200 mm per second.**

Note 2) The piston speed is 100 to 1000 mm/s for centralized piping.

Note 3) Use at a speed within the absorption capacity range. Refer to page 1286.

Note 4) Due to the construction of this product, it may have more fluctuation in operating speed compared to a rod type air cylinder. For applications that require constant speed, select the equipment corresponding to the required level.

Stroke Adjustment Unit Specifications

Bore size (mm)	16			20			25			32			40			50			63					
Unit symbol	A	L	H	A	L	H	A	L	H	A	L	H	A	L	H	A	L	H	A	L	H			
Configuration	With adjustment bolt			With adjustment bolt			With adjustment bolt			With adjustment bolt			With adjustment bolt			With adjustment bolt			With adjustment bolt			With adjustment bolt		
Shock absorber model	RB 0806 + with adjustment bolt			RB 0806 + with adjustment bolt			RB 1007 + with adjustment bolt			RB 1007 + with adjustment bolt			RB 1412 + with adjustment bolt			RB 1412 + with adjustment bolt			RB 2015 + with adjustment bolt			RB 2015 + with adjustment bolt		
Stroke adjustment range by intermediate fixing spacer (mm)	Without spacer	0 to -5.6		0 to -6		0 to -11.5		0 to -12		0 to -16		0 to -16		0 to -20		0 to -20		0 to -25		0 to -25				
	With short spacer	-5.6 to -11.2		-6 to -12		-11.5 to -23		-12 to -24		-16 to -32		-16 to -32		-20 to -40		-20 to -40		-25 to -50		-25 to -50				
	With long spacer	-11.2 to -16.8		-12 to -18		-23 to -34.5		-24 to -36		-32 to -48		-32 to -48		-40 to -60		-40 to -60		-50 to -75		-50 to -75				

* Stroke adjustment range is applicable for one side when mounted on a cylinder.

Stroke Adjustment Unit Symbol

		Right side stroke adjustment unit																				
		Without unit	A: With adjustment bolt			L: With low load shock absorber + Adjustment bolt			H: With high load shock absorber + Adjustment bolt													
			With short spacer	With long spacer		With short spacer	With long spacer		With short spacer	With long spacer		With short spacer	With long spacer									
Left side stroke adjustment unit	Without unit	Nil	SA	SA6	SA7	SL	SL6	SL7	SH	SH6	SH7											
	A: With adjustment bolt	AS	A	AA6	AA7	AL	AL6	AL7	AH	AH6	AH7											
	With short spacer	A6S	A6A	A6	A6A7	A6L	A6L6	A6L7	A6H	A6H6	A6H7											
	With long spacer	A7S	A7A	A7A6	A7	A7L	A7L6	A7L7	A7H	A7H6	A7H7											
	L: With low load shock absorber + Adjustment bolt	LS	LA	LA6	LA7	L	LL6	LL7	LH	LH6	LH7											
	With short spacer	L6S	L6A	L6A6	L6A7	L6L	L6L6	L6L7	L6H	L6H6	L6H7											
With long spacer	L7S	L7A	L7A6	L7A7	L7L	L7L6	L7L7	L7H	L7H6	L7H7												
H: With high load shock absorber + Adjustment bolt	HS	HA	HA6	HA7	HL	HL6	HL7	H	HH6	HH7												
With short spacer	H6S	H6A	H6A6	H6A7	H6L	H6L6	H6L7	H6H	H6H6	H6H7												
With long spacer	H7S	H7A	H7A6	H7A7	H7L	H7L6	H7L7	H7H	H7H6	H7H7												

* Spacers are used to fix the stroke adjustment unit at an intermediate stroke position.

For details on spacers and stroke adjustment units, refer to "Accessory Bracket (Option)" on page 1274-1.

Stroke adjustment unit mounting diagram

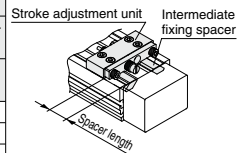

Example of H6H7 attachment

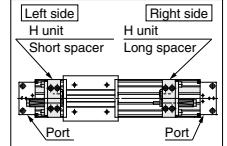

Refer to pages 1331 to 1333-1 for the specifications with auto switch.

MY1C Series

Shock Absorbers for L and H Units

Type	Stroke adjustment unit	Bore size (mm)					
		16	20	25	32	40	50
Standard (Shock absorber/RB series)	L	RB0806	RB1007	RB1412	RB2015		
	H	—	RB1007	RB1412	RB2015	RB2725	
Shock absorber/soft type RJ series mounted (-XB22)	L	RJ0806H	RJ1007H	RJ1412H		—	—
	H	—	RJ1007H	RJ1412H	—	—	—

* The shock absorber service life is different from that of the MY1C cylinder depending on operating conditions. Refer to the RB Series Specific Product Precautions for the replacement period.

* Mounted shock absorber soft type RJ series (-XB22) is made to order specifications. For details, refer to page 1752.

Shock Absorber Specifications

Model	RB 0806	RB 1007	RB 1412	RB 2015	RB 2725	
	Max. energy absorption (J)	2.9	5.9	19.6	58.8	147
Stroke absorption (mm)	6	7	12	15	25	
Max. collision speed (mm/s)	1500					
Max. operating frequency (cycle/min)	80	70	45	25	10	
Spring force (N)	Extended	1.96	4.22	6.86	8.34	8.83
	Retracted	4.22	6.86	15.98	20.50	20.01
Operating temperature range (°C)	5 to 60					

* The shock absorber service life is different from that of the MY1C cylinder depending on operating conditions. Refer to the RB Series Specific Product Precautions for the replacement period.

Theoretical Output

Bore size (mm)	Piston area (mm ²)	Operating pressure (MPa)						(N)
		0.2	0.3	0.4	0.5	0.6	0.7	
16	200	40	60	80	100	120	140	160
20	314	62	94	125	157	188	219	251
25	490	98	147	196	245	294	343	392
32	804	161	241	322	402	483	563	643
40	1256	251	377	502	628	754	879	1005
50	1962	392	588	784	981	1177	1373	1569
63	3115	623	934	1246	1557	1869	2180	2492

Note) Theoretical output (N) = Pressure (MPa) x Piston area (mm²)

Weight

Bore size (mm)	Basic weight	Additional weight per each 50 mm of stroke	Weight of moving parts	Side support bracket weight (per set)	Stroke adjustment unit weight (per unit)			(kg)
				Type A and B	A unit weight	L unit weight	H unit weight	
16	0.67	0.12	0.22	0.01	0.03	0.04	—	
20	1.06	0.15	0.31	0.02	0.04	0.05	0.08	
25	1.58	0.24	0.41	0.02	0.07	0.11	0.18	
32	3.14	0.37	0.86	0.04	0.14	0.23	0.39	
40	5.60	0.52	1.49	0.08	0.25	0.34	0.48	
50	10.14	0.76	2.59	0.08	0.36	0.51	0.81	
63	16.67	1.10	4.26	0.17	0.68	0.83	1.08	

Calculation: (Example) **MY1C25-300A**

- Basic weight..... 1.58 kg
- Cylinder stroke..... 300 stroke
- Additional weight..... 0.24/50 stroke
1.58 + 0.24 x 300/50 + 0.07 x 2 ≒ 3.16 kg
- Weight of A unit..... 0.07 kg

⚠ Precautions

For details on the MY1C Series Mechanically Jointed Rodless Cylinder, refer to "Specific Product Precautions" on pages 1335 to 1336-2.

MY1C Series

Cushion Capacity

Cushion Selection

<Air cushion>

Air cushions are a standard feature on mechanically jointed rodless cylinders.

The air cushion mechanism is incorporated to prevent excessive impact of the piston at the stroke end during high speed operation. The purpose of air cushion, thus, is not to decelerate the piston near the stroke end.

The ranges of load and speed that air cushions can absorb are within the air cushion limit lines shown in the graphs.

<Stroke adjustment unit with shock absorber>

Use this unit when operating with a load or speed exceeding the air cushion limit line, or when cushioning is necessary because the cylinder stroke is outside of the effective air cushion stroke range due to stroke adjustment.

L unit

Use this unit when the cylinder stroke is outside of the effective air cushion range even if the load and speed are within the air cushion limit line, or when the cylinder is operated in a load and speed range above the air cushion limit line or below the L unit limit line.

H unit

Use this unit when the cylinder is operated in a load and speed range above the L unit limit line and below the H unit limit line.

* For details on stroke adjustment using the adjustment bolt, refer to page 1336.

Air Cushion Stroke

(mm)

Bore size (mm)	Cushion stroke
16	12
20	15
25	15
32	19
40	24
50	30
63	37

Absorption Capacity of Air Cushion and Stroke Adjustment Units

MY1C16

Horizontal collision: P = 0.5 MPa

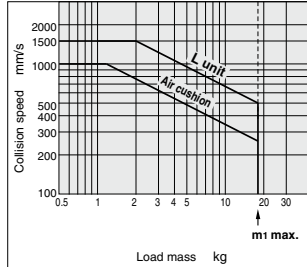

MY1C32

Horizontal collision: P = 0.5 MPa

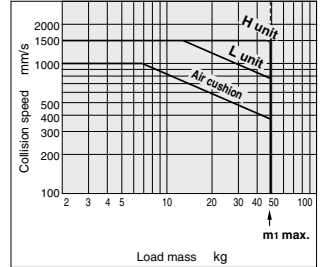

MY1C20

Horizontal collision: P = 0.5 MPa

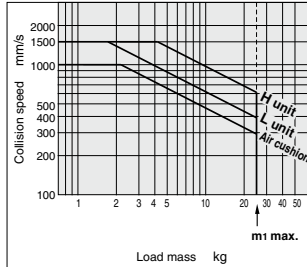

MY1C40

Horizontal collision: P = 0.5 MPa

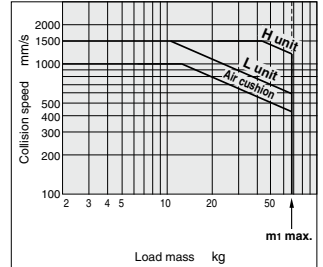

MY1C25

Horizontal collision: P = 0.5 MPa

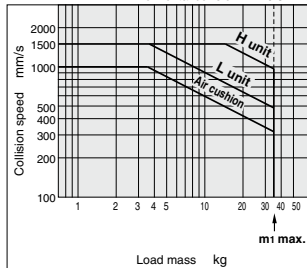

MY1C50

Horizontal collision: P = 0.5 MPa

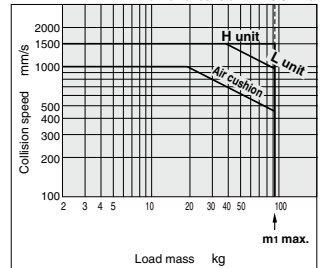

MY1C63

Horizontal collision: P = 0.5 MPa

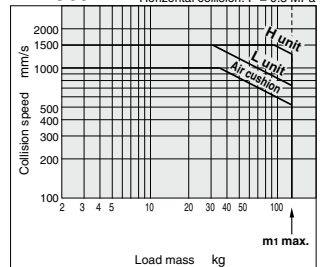

MY1C Series

Construction: $\varnothing 16$ to $\varnothing 63$

MY1C16 to 63

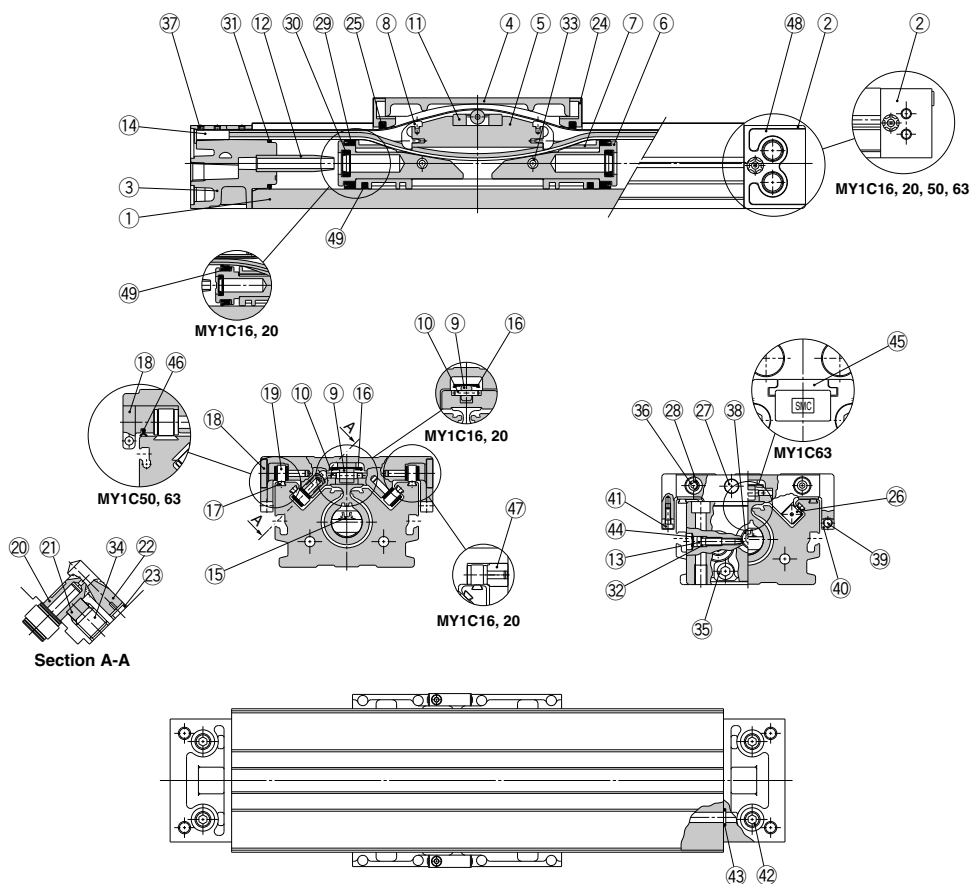

MY1C16 to 63

Component Parts

No.	Description	Material	Note
1	Cylinder tube	Aluminum alloy	Hard anodized
2	Head cover WR	Aluminum alloy	Painted
3	Head cover WL	Aluminum alloy	Painted
4	Slide table	Aluminum alloy	Electroless nickel plated
5	Piston yoke	Aluminum alloy	Chromated
6	Piston	Aluminum alloy	Chromated
7	Wear ring	Special resin	
8	Belt separator	Special resin	
9	Guide roller	Special resin	
10	Guide roller shaft	Stainless steel	
11	Coupler	Sintered iron material	
12	Cushion ring	Aluminum alloy	Anodized
13	Cushion needle	Rolled steel	Nickel plated
14	Belt clamp	Special resin	
17	Rail	Hard steel wire	
18	Cam follower cap	Special resin	(ø25 to ø40)
19	Cam follower	—	
20	Eccentric gear	Stainless steel	
21	Gear bracket	Stainless steel	
22	Adjustment gear	Stainless steel	
23	Retaining ring	Stainless steel	

No.	Description	Material	Note
24	End Cover	Special resin	
26	Backup plate	Special resin	
27	Stopper	Carbon steel	Nickel plated
28	Spacer	Stainless steel	
33	Spring pin	Carbon tool steel	
34	Hexagon socket head set screw	Chromium molybdenum steel	Black zinc chromated
35	Hexagon socket head cap screw	Chromium molybdenum steel	Chromated
36	Hexagon socket button head screw	Chromium molybdenum steel	Chromated
37	Hexagon socket head set screw	Chromium molybdenum steel	Black zinc chromated/Chromated
38	Hexagon socket head taper plug	Carbon steel	Chromated
39	Magnet		
40	Magnet holder	Special resin	
41	Hexagon socket head cap screw	Chromium molybdenum steel	Chromated
42	Hexagon socket head taper plug	Carbon steel	Chromated
44	Type CR retaining ring	Spring steel	
45	Head plate	Aluminum alloy	Hard anodized (ø63)
46	Side scraper	Special resin	(ø50 to ø63)
47	Bushing	Aluminum alloy	(ø16 to ø20)
48	Port cover	Special resin	(ø25 to ø40)
49	Lube-retainer	Special resin	

Replacement Part: Seal Kit

No.	Description	Qty.	MY1C16	MY1C20	MY1C25	MY1C32	MY1C40	MY1C50	MY1C63
15	Seal belt	1	MY16-16C-Stroke	MY20-16C-Stroke	MY25-16C-Stroke	MY32-16C-Stroke	MY40-16C-Stroke	MY50-16C-Stroke	MY63-16A-Stroke
16	Dust seal band	1	MY16-16B-Stroke	MY20-16B-Stroke	MY25-16B-Stroke	MY32-16B-Stroke	MY40-16B-Stroke	MY50-16B-Stroke	MY63-16B-Stroke
32	O-ring	2	KA00309 (ø4 x ø1.8 x ø1.1)	KA00311 (ø5.1 x ø3 x ø1.05)	KA00311 (ø5.1 x ø3 x ø1.05)	KA00320 (ø7.15 x ø3.75 x ø1.7)	KA00402 (ø8.3 x ø4.5 x ø1.9)	KA00777	KA00777
46	Side scraper	2	—	—	—	—	—	MYM50-15CK0502B	MYM63-15CK0503B
25	Scraper	2							
29	Piston seal	2							
30	Cushion seal	2	MY1M16-PS	MY1M20-PS	MY1M25-PS	MY1M32-PS	MY1M40-PS	MY1M50-PS	MY1M63-PS
31	Tube gasket	2							
43	O-ring	4							

* Seal kit includes 25, 29, 30, 31 and 43. Order the seal kit based on each bore size.

* Seal kit includes a grease pack (10 g).

When 15 and 16 are shipped independently, a grease pack is included. (10 g per 1000 strokes)

Order with the following part number when only the grease pack is needed.

Grease pack part number: GR-S-010 (10 g), **GR-S-020** (20 g)

Note) Two kinds of dust seal bands are available. Verify the type to use, since the part number varies depending on the treatment of the hexagon socket head set screw 37.

A: Black zinc chromated → MY□□-16B-stroke, B: Nickel plated → MY□□-16BW-stroke

MY1C Series

Standard Type/Centralized Piping Type $\phi 16, \phi 20$

The stroke adjustment unit for the MY1C is the same as that of the MY1M.
For models and external dimensions, refer to pages 1273 to 1274-1.

MY1C16□/20□ — Stroke

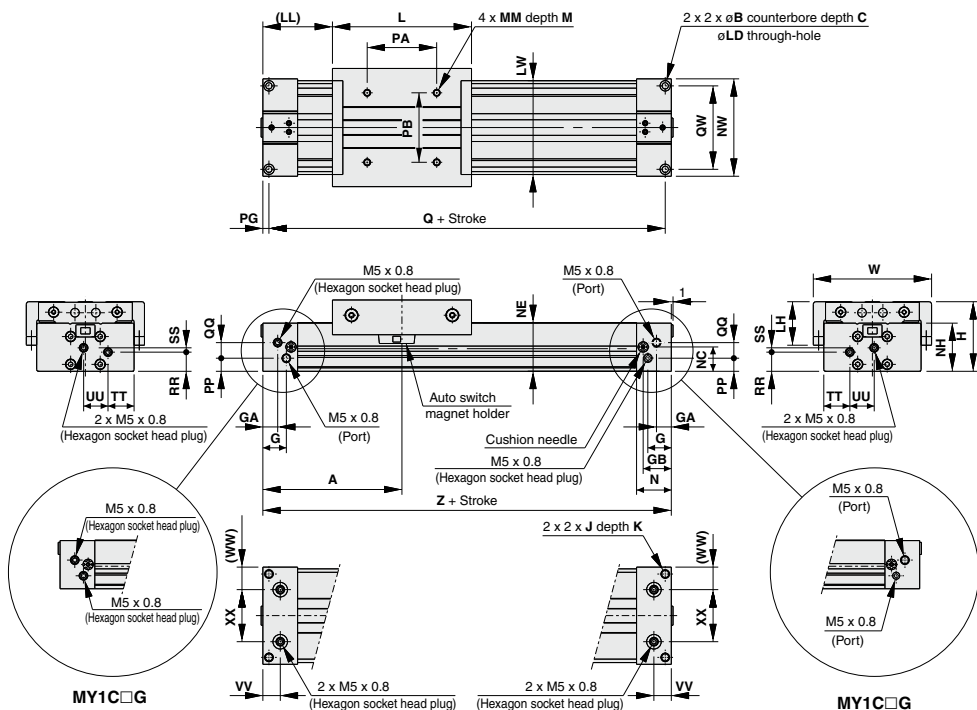

Model	A	B	C	G	GA	GB	H	J	K	L	LD	LH	LL	LW	M	MM	N	NC
MY1C16□	80	6	3.5	13.5	8.5	16.2	40	M5 x 0.8	10	80	3.6	22.5	40	54	6	M4 x 0.7	20	14
MY1C20□	100	7.5	4.5	12.5	12.5	20	46	M6 x 1	12	100	4.8	23	50	58	7.5	M5 x 0.8	25	17

Model	NE	NH	NW	PA	PB	PG	PP	Q	QQ	QW	RR	SS	TT	UU	VV	W	WW	XX	Z
MY1C16□	28	27.7	56	40	40	3.5	7.5	153	9	48	11	2.5	15	14	10	68	13	30	160
MY1C20□	34	33.7	60	50	40	4.5	11.5	191	10	45	14.5	5	18	12	12.5	72	14	32	200

Centralized Piping on the Bottom

Centralized piping

Bottom ported (Applicable O-ring)

Port Variations

Slide table operating direction
◀ L ▶ R

Model	WX	Y	S	d	D	R	Applicable O-ring
MY1C16□	30	6.5	9	4	8.4	1.1	C6
MY1C20□	32	8	6.5	4	8.4	1.1	

Mechanically Jointed Rodless Cylinder Cam Follower Guide Type **MY1C Series**

The stroke adjustment unit for the MY1C is the same as that of the MY1M.
For models and external dimensions, refer to pages 1273 to 1274-1.

Standard Type/Centralized Piping Type $\varnothing 25, \varnothing 32, \varnothing 40$

MY1C25□/32□/40□ — Stroke

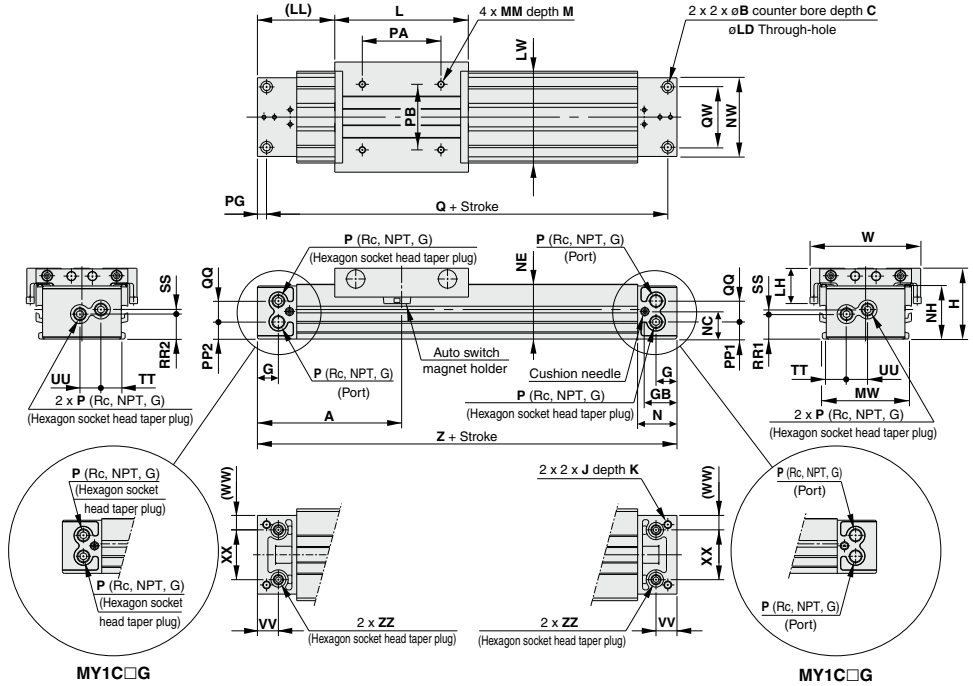

MY1C□G

MY1C□G

Model	A	B	C	G	GB	H	J	K	L	LD	LH	LL	LW	M	MM	MW	N	NC	NE	NH	NW	P	PA
MY1C25□	110	9	5.5	17	24.5	54	M6 x 1	9.5	102	5.6	27	59	70	10	M5 x 0.8	66	30	21	41.8	40.5	60	Rc 1/8	60
MY1C32□	140	11	6.5	19	30	68	M8 x 1.25	16	132	6.8	35	74	88	13	M6 x 1	80	37	26	52.3	50	74	Rc 1/8	80
MY1C40□	170	14	8.5	23	36.5	84	M10 x 1.5	15	162	8.6	38	89	104	13	M6 x 1	96	45	32	65.3	63.5	94	Rc 1/4	100

P indicates cylinder supply ports.

Model	PB	PG	PP1	PP2	Q	QQ	QW	RR1	RR2	SS	TT	UU	VV	W	WW	XX	Z	ZZ
MY1C25□	50	7	12.7	12.7	206	15.5	46	18.9	17.9	4.1	15.5	16	16	84	11	38	220	Rc 1/16
MY1C32□	60	8	15.5	18.5	264	16	60	22	24	4	21	16	19	102	13	48	280	Rc 1/16
MY1C40□	80	9	17.5	20	322	26	72	25.5	29	9	26	21	23	118	20	54	340	Rc 1/8

Centralized Piping on the Bottom

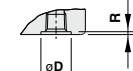
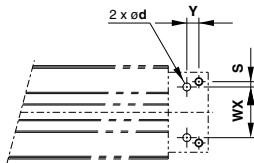
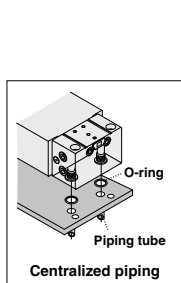

Bottom ported (ZZ)
(Applicable O-ring)

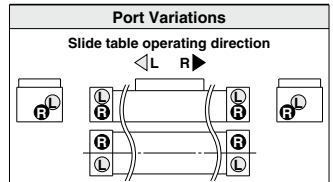

Model	WX	Y	S	d	D	R	Applicable O-ring
MY1C25□	38	9	4	6	11.4	1.1	C9
MY1C32□	48	11	6	6	11.4	1.1	
MY1C40□	54	14	9	8	13.4	1.1	C11.2

MY1C Series

Standard Type/Centralized Piping Type $\phi 50, \phi 63$

The stroke adjustment unit for the MY1C is the same as that of the MY1M.
For models and external dimensions, refer to pages 1273 to 1274-1.

MY1C50□/63□ — Stroke

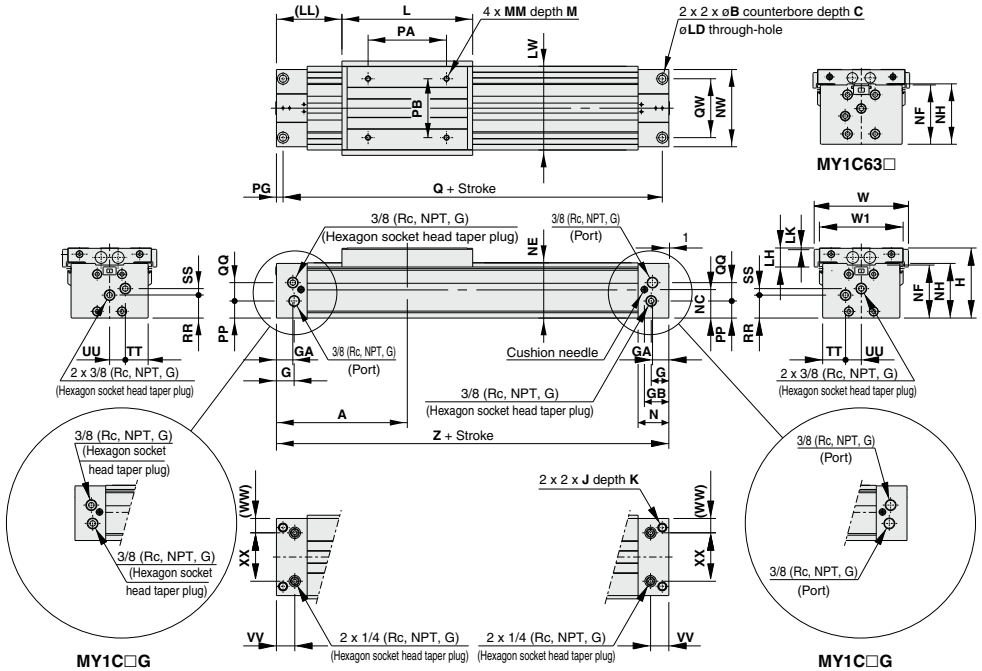

Model	A	B	C	G	GA	GB	H	J	K	L	LD	LH	LK	LL	LW	M	MM	N	NC	NE
MY1C50□	200	17	10.5	27	25	37.5	107	M14 x 2	28	200	11	29	2	100	128	15	M8 x 1.25	47	43.5	84.5
MY1C63□	230	19	12.5	29.5	27.5	39.5	130	M16 x 2	32	230	13.5	32.5	5.5	115	152	16	M10 x 1.5	50	60	104

Model	NF	NH	NW	PA	PB	PG	PP	Q	QQ	QW	RR	SS	TT	UU	VV	W	W1	WW	XX	Z
MY1C50□	81	83.5	118	120	90	10	26	380	28	90	35	10	35	24	28	144	128	22	74	400
MY1C63□	103	105	142	140	110	12	42	436	30	110	49	13	43	28	30	168	152	25	92	460

Centralized Piping on the Bottom

O-ring
Piping tube
Centralized piping

2 x ϕd
Y
S
WX
 ϕD
R

Bottom ported (ZZ)
(Applicable O-ring)

Port Variations

Slide table operating direction
◀ L R ▶

Model	WX	Y	S	d	D	R	Applicable O-ring
MY1C50□	74	18	8	10	17.5	1.1	C15
MY1C63□	92	18	9	10	17.5	1.1	

Side Support

Side support A MY-S□A

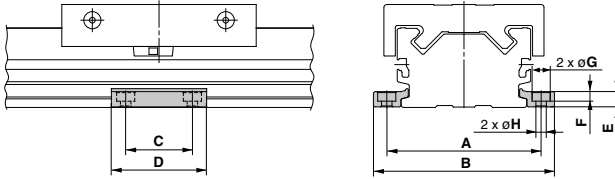

Side support B MY-S□B

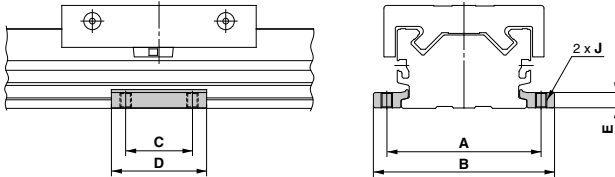

(mm)

Model	Applicable bore size	A	B	C	D	E	F	G	H	J
MY-S16 ^{1/2}	MY1C16	61	71.6	15	26	4.9	3	6.5	3.4	M4 x 0.7
MY-S20 ^{1/2}	MY1C20	67	79.6	25	38	6.4	4	8	4.5	M5 x 0.8
MY-S25 ^{1/2}	MY1C25	81	95	35	50	8	5	9.5	5.5	M6 x 1
MY-S32 ^{1/2}	MY1C32	100	118	45	64	11.7	6	11	6.6	M8 x 1.25
MY-S40 ^{1/2}	MY1C40	120	142	55	80	14.8	8.5	14	9	M10 x 1.5
	MY1C50	142	164							
MY-S63 ^{1/2}	MY1C63	172	202	70	100	18.3	10.5	17.5	11.5	M12 x 1.75

* A set of side supports consists of a left support and a right support.

Guide for Side Support Application

For long stroke operation, the cylinder tube may be deflected depending on its own weight and the load weight. In such a case, use a side support in the middle section. The spacing (L) of the support must be no more than the values shown in the graph on the right.

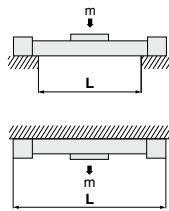

Caution

1. If the cylinder mounting surfaces are not measured accurately, using a side support may cause poor operation. Therefore, be sure to level the cylinder tube when mounting. Also, for long stroke operation involving vibration and impact, use of a side support is recommended even if the spacing value is within the allowable limits shown in the graph.
2. Support brackets are not for mounting; use them solely for providing support.

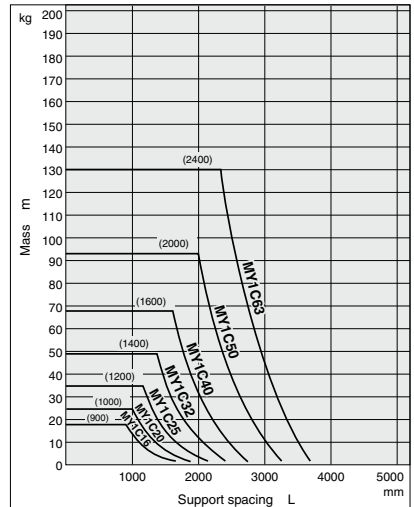
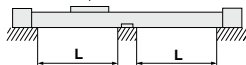

MY1H Series

Linear Guide Type

ø10, ø16, ø20, ø25, ø32, ø40

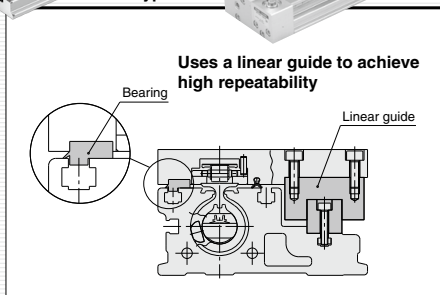
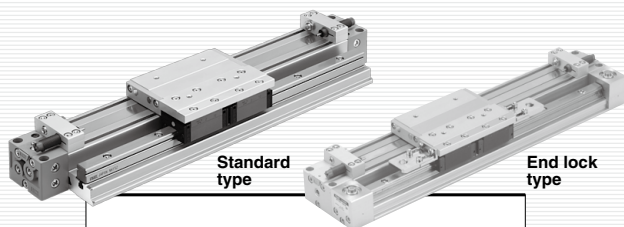

INDEX

MY1H Series Prior to Use	P. 1298
Model Selection	P. 1300
How to Order	P. 1302
Specifications	P. 1303
Cushion Capacity	P. 1306
Construction	P. 1307
Dimensions	P. 1311
Stroke Adjustment Unit	P. 1313
Accessory Bracket (Option)	P. 1315

MY1H Series Prior to Use

Maximum Allowable Moment/Maximum Load Mass

Model	Bore size (mm)	Maximum allowable moment (N·m)			Maximum load mass (kg)		
		M ₁	M ₂	M ₃	m ₁	m ₂	m ₃
MY1H	10	0.8	1.1	0.8	6.1	6.1	6.1
	16	3.7	4.9	3.7	10.8	10.8	10.8
	20	11	16	11	17.6	17.6	17.6
	25	23	26	23	27.5	27.5	27.5
	32	39	50	39	39.2	39.2	39.2
	40	50	50	39	50	50	50

The above values are the maximum allowable values for moment and load. Refer to each graph regarding the maximum allowable moment and maximum allowable load for a particular piston speed.

Maximum Allowable Moment

Select the moment from within the range of operating limits shown in the graphs. Note that the maximum allowable load value may sometimes be exceeded even within the operating limits shown in the graphs. Therefore, also check the allowable load for the selected conditions.

Load mass (kg)

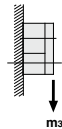

Moment (N·m)

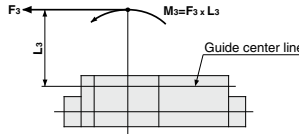
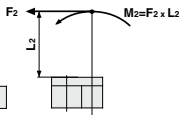
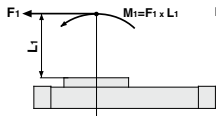

<Calculation of guide load factor>

- Maximum allowable load (1), static moment (2), and dynamic moment (3) (at the time of impact with stopper) must be examined for the selection calculations.
 * To evaluate, use \bar{v}_a (average speed) for (1) and (2), and v (collision speed $v = 1.4v_a$) for (3). Calculate m_{max} for (1) from the maximum allowable load graph (m_1, m_2, m_3) and M_{max} for (2) and (3) from the maximum allowable moment graph (M_1, M_2, M_3).

$$\text{Sum of guide load factors } \Sigma \alpha = \frac{\text{Load mass [m]}}{\text{Maximum allowable load [m}_{max}]} + \frac{\text{Static moment [M]}^{(1)}}{\text{Allowable static moment [M}_{max}]} + \frac{\text{Dynamic moment [Me]}^{(2)}}{\text{Allowable dynamic moment [Me}_{max}]} \leq 1$$

- Note 1) Moment caused by the load, etc., with cylinder in resting condition.
 Note 2) Moment caused by the impact load equivalent at the stroke end (at the time of impact with stopper).
 Note 3) Depending on the shape of the workpiece, multiple moments may occur. When this happens, the sum of the load factors ($\Sigma \alpha$) is the total of all such moments.

2. Reference formula [Dynamic moment at impact]

Use the following formulae to calculate dynamic moment when taking stopper impact into consideration.

- m**: Load mass (kg)
- F**: Load (N)
- F_E**: Load equivalent to impact (at impact with stopper) (N)
- \bar{v}_a** : Average speed (mm/s)
- M**: Static moment (N·m)
- v** : Collision speed (mm/s)
- L₁**: Distance to the load's center of gravity (m)
- Me**: Dynamic moment (N·m)
- δ** : Damper coefficient
 With rubber bumper = 4/100
 (MY1B10, MY1H10)
 With air cushion = 1/100
 With shock absorber = 1/100
- g**: Gravitational acceleration (9.8 m/s²)

$$v = 1.4\bar{v}_a \text{ (mm/s)} \quad F_E = 1.4\bar{v}_a \cdot \delta \cdot m \cdot g$$

$$\therefore Me = \frac{1}{3} \cdot F_E \cdot L_1 = 4.57\bar{v}_a \delta m L_1 \text{ (N·m)}$$

- Note 4) $1.4\bar{v}_a \delta$ is a dimensionless coefficient for calculating impact force.
 Note 5) Average load coefficient (= \bar{v}): This coefficient is for averaging the maximum load moment at the time of stopper impact according to service life calculations.

- For detailed selection procedures, refer to pages 1300 and 1301.

Maximum Load Mass

Select the load from within the range of limits shown in the graphs. Note that the maximum allowable moment value may sometimes be exceeded even within the operating limits shown in the graphs. Therefore, also check the allowable moment for the selected conditions.

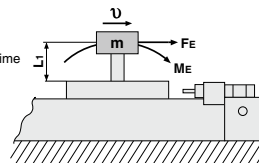

MY1H/M1

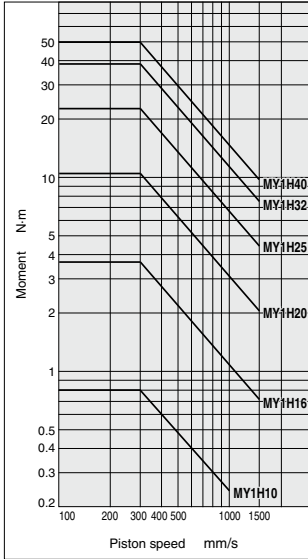

MY1H/M2

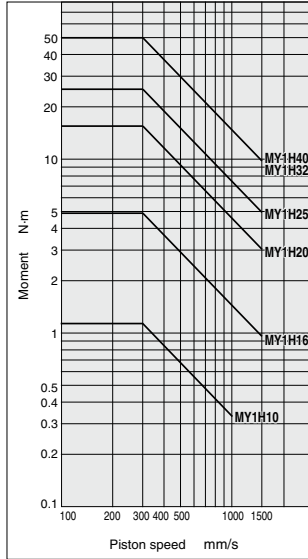

MY1H/M3

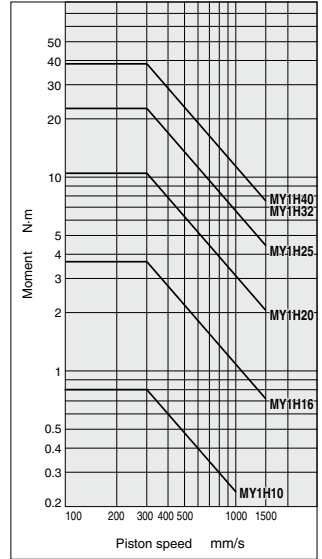

MY1H/m1

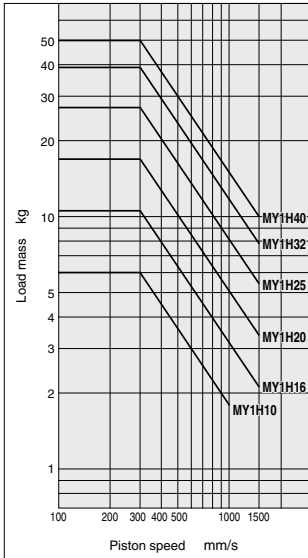

MY1H/m2

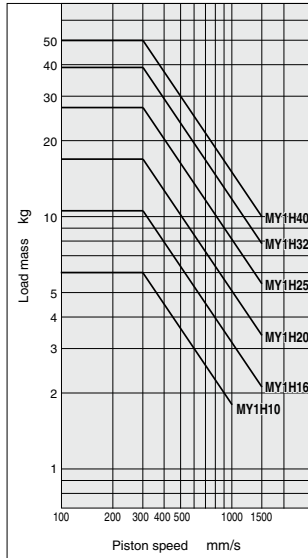

MY1H/m3

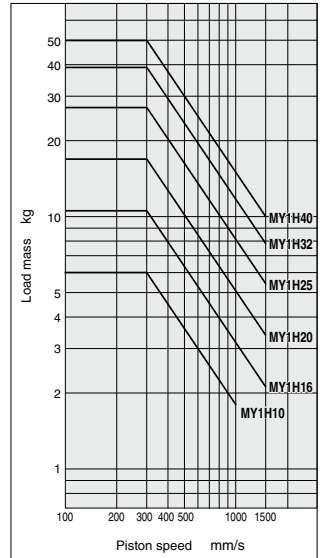

MY1H Series Model Selection

Following are the steps for selecting the most suitable MY1H series to your application.

Calculation of Guide Load Factor

1. Operating Conditions

- Operating cylinder MY1H20-500
- Average operating speed v_a ... 300 mm/s
- Mounting orientation Wall mounting
- Cushion Air cushion ($\delta = 1/100$)

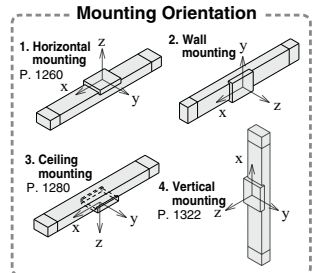
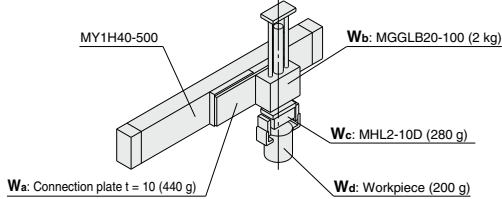

For actual examples of calculation for each orientation, refer to the pages above.

2. Load Blocking

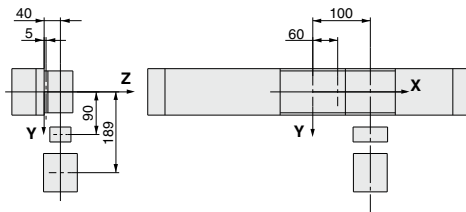

Mass and Center of Gravity for Each Workpiece

Workpiece no.	Mass m_n	Center of gravity		
		X-axis X_n	Y-axis Y_n	Z-axis Z_n
Wa	0.44 kg	60 mm	0 mm	5 mm
Wb	2.0 kg	100 mm	0 mm	40 mm
Wc	0.280 kg	100 mm	90 mm	40 mm
Wd	0.2 kg	100 mm	189 mm	40 mm

n=a, b, c, d

3. Composite Center of Gravity Calculation

$$m_3 = \sum m_n = 0.44 + 2.0 + 0.280 + 0.2 = \mathbf{2.92 \text{ kg}}$$

$$X = \frac{1}{m_3} \times \sum (m_n \times X_n) = \frac{1}{2.95} (0.44 \times 60 + 2.0 \times 100 + 0.280 \times 100 + 0.2 \times 100) = \mathbf{94.0 \text{ mm}}$$

$$Y = \frac{1}{m_3} \times \sum (m_n \times Y_n) = \frac{1}{2.95} (0.44 \times 0 + 2.0 \times 0 + 0.280 \times 90 + 0.2 \times 189) = \mathbf{21.6 \text{ mm}}$$

$$Z = \frac{1}{m_3} \times \sum (m_n \times Z_n) = \frac{1}{2.95} (0.44 \times 5 + 2.0 \times 40 + 0.280 \times 40 + 0.2 \times 40) = \mathbf{34.8 \text{ mm}}$$

4. Calculation of Load Factor for Static Load

m_3 : Mass

$m_3 \text{ max}$ (from (1) of graph MY1H/ m_3) = 17.6 (kg).....

Load factor $\alpha_1 = m_3/m_3 \text{ max} = 2.92/17.6 = \mathbf{0.17}$

M_2 : Moment

$m_2 \text{ max}$ (from (2) of graph MY1H/ M_2) = 16.0 (N·m).....

$M_2 = m_3 \times g \times Z = 2.92 \times 9.8 \times 34.8 \times 10^{-3} = 1.00$ (N·m)

Load factor $\alpha_2 = M_2/M_2 \text{ max} = 1.00/16.0 = \mathbf{0.07}$

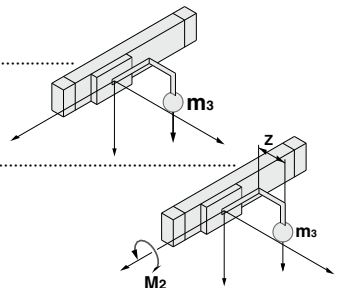

M₃: Moment

M₃ max (from (3) of graph MY1H/M₃) = 11.0 (N·m).....

M₃ = m₃ × g × X = 2.92 × 9.8 × 94.0 × 10⁻³ = 2.69 (N·m)

Load factor **α₃ = M₃/M₃ max = 2.69/11.0 = 0.25**

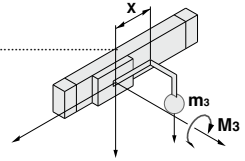

5. Calculation of Load Factor for Dynamic Moment

Equivalent load F_E at impact

F_E = 1.4U_a × δ × m × g = 1.4 × 300 × $\frac{1}{100}$ × 2.92 × 9.8 = 120.2 (N)

M_{1E}: Moment

M_{1E} max (from (4) of graph MY1H/M₁ where 1.4U_a = 420 mm/s) = 7.9 (N·m).....

M_{1E} = $\frac{1}{3}$ × F_E × Z = $\frac{1}{3}$ × 120.2 × 34.8 × 10⁻³ = 1.40 (N·m)

Load factor **α₄ = M_{1E}/M_{1E} max = 1.40/7.9 = 0.18**

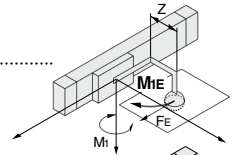

M_{3E}: Moment

M_{3E} max (from (5) of graph MY1H/M₃ where 1.4U_a = 420 mm/s) = 7.9 (N·m).....

M_{3E} = $\frac{1}{3}$ × F_E × Y = $\frac{1}{3}$ × 120.2 × 21.6 × 10⁻³ = 0.87 (N·m)

Load factor **α₅ = M_{3E}/M_{3E} max = 0.87/7.9 = 0.12**

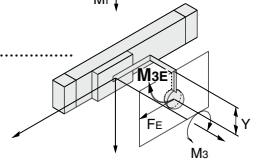

6. Sum and Examination of Guide Load Factors

Σα = α₁ + α₂ + α₃ + α₄ + α₅ = 0.79 ≤ 1

The above calculation is within the allowable value, and therefore the selected model can be used.

Select a shock absorber separately.

In an actual calculation, when the total sum of guide load factors Σα in the formula above is more than 1, consider either decreasing the speed, increasing the bore size, or changing the product series.

This calculation can be easily made using the "SMC Pneumatics CAD System".

Load Mass

MY1H/m₃

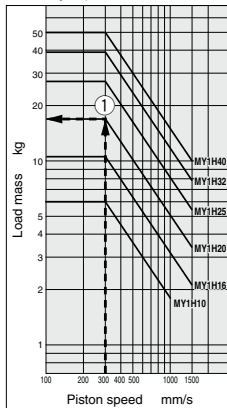

Allowable Moment

MY1H/M₁

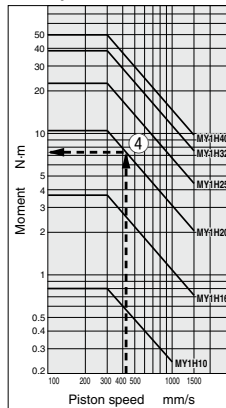

MY1H/M₂

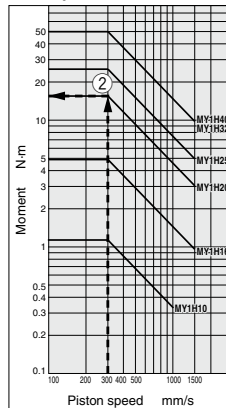

MY1H/M₃

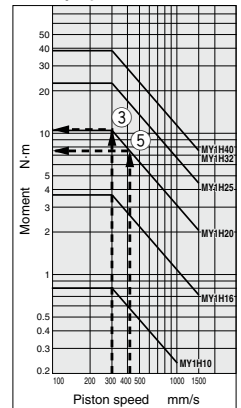

Mechanically Jointed Rodless Cylinder Linear Guide Type

MY1H Series

ø10, ø16, ø20, ø25, ø32, ø40

How to Order

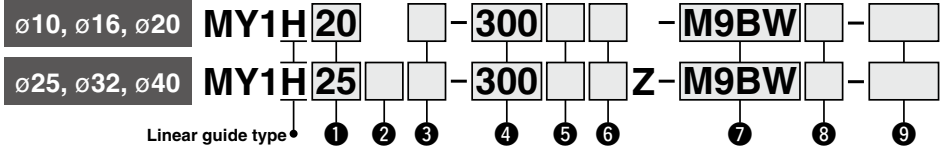

① Bore size

10	10 mm
16	16 mm
20	20 mm
25	25 mm
32	32 mm
40	40 mm

② Port thread type

Symbol	Type	Bore size
Nil	M thread	ø10, ø16, ø20
	Rc	ø25, ø32 ø40
TN	NPT	
TF	G	ø40

④ Cylinder stroke (mm)

Bore size	Standard stroke	Intermediate stroke (-XB10)	Long stroke (-XB11)	Maximum manufacturable stroke
10	50, 100, 150 200, 250, 300 350, 400, 450 500, 550, 600	Intermediate strokes of 60 to 590 mm (10 mm increments) other than standard strokes	—	—
		Intermediate strokes of 51 to 599 mm (1 mm increments) other than standard strokes	Strokes of 601 to 1000 mm (1 mm increments) exceeding the standard stroke	1000
25, 32, 40	500, 550, 600	Intermediate strokes of 51 to 599 mm (1 mm increments) other than standard strokes	Strokes of 601 to 1500 mm (1 mm increments) exceeding the standard stroke	1500

③ Piping

Nil	Standard type
G	Centralized piping type

Note) For ø10, only G is available.

⑤ Stroke adjustment unit symbol

Refer to "Stroke adjustment unit" on page 1303.
Intermediate fixing spacer is not available for end lock mounting side.

⑥ End lock position

Nil	Without end lock
E	Right end
F	Left end
W	Both ends

* MY1H10 is not available with end lock.
* For end lock positions, refer to page 1312-2.

⑧ Number of auto switches

Nil	2 pcs.
S	1 pc.
n	"n" pcs.

⑨ Made to Order

Refer to page 1303 for details.

⑦ Auto switch

Nil	ø10	Without auto switch (Built-in magnet for reed switch)
		Without auto switch (Built-in magnet for solid state switch) (Made to Order: -X1610)
	ø16 to ø100	Without auto switch (Built-in magnet)

* Refer to the table below for the applicable auto switch model.

Applicable Auto Switches

Refer to pages 1575 to 1701 for further information on auto switches.

Type	Special function	Electrical entry	Wiring (Output)	Load voltage		Auto switch model		Lead wire length (m)					Pre-wired connector	Applicable load	
				DC	AC	Perpendicular	In-line	0.5 (Nil)	1 (M)	3 (Z)	5 (L)	None (N)			
Solid state auto switch	—	Grommet	3-wire (NPN)	24 V	5 V, 12 V	—	M9NV	M9N	●	●	●	○	○	○	IC circuit
			3-wire (PNP)				M9PV	M9P	●	●	●	○	○		
			2-wire				M9BV	M9B	●	●	●	○	○	○	
			3-wire (NPN)				M9NVW	M9NW	●	●	●	○	○	○	
	3-wire (PNP)	M9PVW	M9PW	●	●	●	○	○	○						
	2-wire	M9BWW	M9BW	●	●	●	○	○	○						
	3-wire (NPN)	M9NAV ^{*1}	M9NA ^{*1}	○	○	○	○	○	○	IC circuit					
	3-wire (PNP)	M9PAV ^{*1}	M9PA ^{*1}	○	○	○	○	○	○						
2-wire	M9BAV ^{*1}	M9BA ^{*1}	○	○	○	○	○	○							
—	Grommet	3-wire (NPN equivalent)	24 V	12 V	100 V 100 V or less	A96V	A96	●	●		—	—	—	—	IC circuit
2-wire		A93V ^{*3}				A93	●	●	●	—	—	—	Relay, PLC		
Reed auto switch	—	Grommet	—	24 V	12 V	100 V 100 V or less	A90V	A90	●	●	●	—		—	—

*1 Water resistant type auto switches can be mounted on the above models, but in such case SMC cannot guarantee water resistance.

Consult with SMC regarding water resistant types with the above model numbers.

*2 For details on switch mounting brackets and part numbers, refer to "Switch Mounting Bracket: Part No." on page 1333-1.

*3 1 m type lead wire is only applicable to D-A93.

* Lead wire length symbols: 0.5 m Nil (Example) M9NV
1 m M (Example) M9NVW
3 m L (Example) M9NWL
5 m Z (Example) M9NWZ

* Solid state auto switches marked with "○" are produced upon receipt of order.

* There are other applicable auto switches than listed above. For details, refer to page 1333-1.

* Auto switches are shipped together (not assembled). (Refer to page 1331 for the details of auto switch mounting.)

Mechanically Jointed Rodless Cylinder Linear Guide Type **MY1H Series**

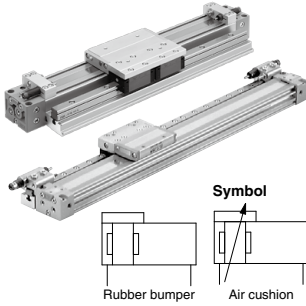

Specifications

Bore size (mm)	10	16	20	25	32	40
Fluid	Air					
Action	Double acting					
Operating pressure range	0.2 to 0.8 MPa	0.15 to 0.8 MPa		0.1 to 0.8 MPa		
Proof pressure	1.2 MPa					
Ambient and fluid temperatures	5 to 60°C					
Cushion	Rubber bumper		Air cushion			
Lubrication	Non-lube					
Stroke length tolerance	+1.8 0					
Piping port size	Front/Side port	M5 x 0.8			1/8	1/4
Bottom port	ø4			ø6		ø8

Piston Speed

Bore size (mm)	10	16 to 40
Without stroke adjustment unit	100 to 500 mm/s	100 to 1000 mm/s
Stroke adjustment unit	A unit	100 to 1000 mm/s ⁽¹⁾
	L unit and H unit	100 to 1500 mm/s ⁽²⁾

Note 1) Be aware that when the stroke adjustment range is increased by manipulating the adjustment bolt, the air cushion capacity decreases. Also, when exceeding the air cushion stroke ranges on page 1306, the **piston speed should be 100 to 200 mm per second**.

Note 2) The piston speed is 100 to 1000 mm/s for centralized piping.

Note 3) Use at a speed within the absorption capacity range. Refer to page 1306.

Made to Order

Made to Order: Individual Specifications

(For details, refer to page 1334.)

Symbol	Specifications
-X168	Helical insert thread specifications
-X1810	Magnet for i10 solid state auto switch specifications

Made to Order Specifications

[Click here for details](#)

Symbol	Specifications
-XB10	Intermediate stroke (Using exclusive body)
-XB11 ⁽¹⁾	Long stroke
-XB22	Shock absorber soft type RJ series type
-XC56	With knock pin hole
-XC67 ⁽²⁾	NBR rubber lining in dust seal band

Note 1) Excludes ø10 for the -XB11

Note 2) Only bore sizes ø10 to ø20 are available for the -XC67.

Stroke Adjustment Unit Specifications

Bore size (mm)	10			16			20			25			32			40		
Unit symbol	H	A	L	A	L	H	A	L	H	A	L	H	A	L	H			
Configuration	RB 0805	With adjustment bolt	RB 0806	With adjustment bolt	RB 0806	With adjustment bolt	RB 1007	With adjustment bolt	RB 1007	With adjustment bolt	RB 1412	With adjustment bolt	RB 1412	With adjustment bolt	RB 2015	With adjustment bolt		
Shock absorber model	+ with adjustment bolt		+ with adjustment bolt		+ with adjustment bolt		+ with adjustment bolt		+ with adjustment bolt		+ with adjustment bolt		+ with adjustment bolt		+ with adjustment bolt			
Stroke adjustment range by intermediate fixing spacer (mm)	Without spacer 0 to -10	With short spacer —*1	With long spacer —*1	0 to -5.6	With short spacer -5.6 to -11.2	With long spacer -11.2 to -16.8	0 to -6	With short spacer -6 to -12	With long spacer -12 to -18	0 to -11.5	With short spacer -11.5 to -23	With long spacer -23 to -34.5	0 to -12	With short spacer -12 to -24	With long spacer -24 to -36	0 to -16	With short spacer -16 to -32	With long spacer -32 to -48

*1) For ø10, stroke adjustment is available. Refer to page 1336-2 for details.

*2) Stroke adjustment range is applicable for one side when mounted on a cylinder.

Stroke Adjustment Unit Symbol

		Right side stroke adjustment unit														
		Without unit	A: With adjustment bolt			L: With low load shock absorber + Adjustment bolt			H: With high load shock absorber + Adjustment bolt							
			With short spacer	With long spacer	With short spacer	With long spacer	With short spacer	With long spacer	With short spacer	With long spacer	With short spacer	With long spacer	With short spacer	With long spacer	With short spacer	With long spacer
Left side stroke adjustment unit	Without unit	Nil	SA	SA6	SA7	SL	SL6	SL7	SH	SH6	SH7					
	A: With adjustment bolt	AS	A	AA6	AA7	AL	AL6	AL7	AH	AH6	AH7					
	With short spacer	A6S	A6A	A6	A6A7	A6L	A6L6	A6L7	A6H	A6H6	A6H7					
	With long spacer	A7S	A7A	A7A6	A7	A7L	A7L6	A7L7	A7H	A7H6	A7H7					
	L: With low load shock absorber + Adjustment bolt	LS	LA	LA6	LA7	L	LL6	LL7	LH	LH6	LH7					
	With short spacer	L6S	L6A	L6A6	L6A7	L6L	L6L6	L6L7	L6H	L6H6	L6H7					
	With long spacer	L7S	L7A	L7A6	L7A7	L7L	L7L6	L7L7	L7H	L7H6	L7H7					
	H: With high load shock absorber + Adjustment bolt	HS	HA	HA6	HA7	HL	HL6	HL7	H	HH6	HH7					
	With short spacer	H6S	H6A	H6A6	H6A7	H6L	H6L6	H6L7	H6H	H6H6	H6H7					
	With long spacer	H7S	H7A	H7A6	H7A7	H7L	H7L6	H7L7	H7H	H7H6	H7H7					

* Intermediate fixing spacer is not available for end lock mounting side.

* Spacers are used to fix the stroke adjustment unit at an intermediate stroke position.

For details on spacers and stroke adjustment units, refer to "Accessory Bracket (Option)" on page 1315.

Stroke adjustment unit mounting diagram

Stroke adjustment unit Intermediate fixing spacer

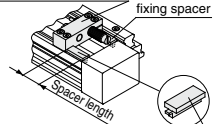

Place the protruding section on the stroke adjusting unit side.

Example of L6L7 attachment

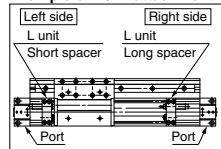

Refer to pages 1331 to 1333-1 for the specifications with auto switch.

MY1H Series

Shock Absorbers for L and H Units

Type	Stroke adjustment unit	Bore size (mm)					
		10	16	20	25	32	40
Standard (Shock absorber/RB series)	L	—	RB0806	RB1007	RB1412		
	H	RB0805	—	RB1007	RB1412	RB2015	
Shock absorber/soft type RJ series mounted (-XB22)	L	—	RJ0806H	RJ1007H	RJ1412H		
	H	RJ0805	—	RJ1007H	RJ1412H	—	—

* The shock absorber service life is different from that of the MY1H cylinder depending on operating conditions. Refer to the RB Series Specific Product Precautions for the replacement period.

* Mounted shock absorber soft type RJ series (-XB22) is made to order specifications. For details, refer to page 1752.

Shock Absorber Specifications

Model	RB 0805	RB 0806	RB 1007	RB 1412	RB 2015	
	Max. energy absorption (J)	1.0	2.9	5.9	19.6	58.8
Stroke absorption (mm)	5	6	7	12	15	
Max. collision speed (mm/s)	1000	1500	1500	1500	1500	
Max. operating frequency (cycle/min)	80	80	70	45	25	
Spring force (N)	Extended	1.96	1.96	4.22	6.86	8.34
	Retracted	3.83	4.22	6.86	15.98	20.50
Operating temperature range (°C)	5 to 60					

* The shock absorber service life is different from that of the MY1H cylinder depending on operating conditions. Refer to the RB Series Specific Product Precautions for the replacement period.

Theoretical Output

Bore size (mm)	Piston area (mm ²)	Operating pressure (MPa)							(N)
		0.2	0.3	0.4	0.5	0.6	0.7	0.8	
10	78	15	23	31	39	46	54	62	
16	200	40	60	80	100	120	140	160	
20	314	62	94	125	157	188	219	251	
25	490	98	147	196	245	294	343	392	
32	804	161	241	322	402	483	563	643	
40	1256	251	377	502	628	754	879	1005	

Note) Theoretical output (N) = Pressure (MPa) x Piston area (mm²)

Weight

Bore size (mm)	Basic weight	Additional weight per each 50 mm of stroke	Weight of moving parts	Side support bracket weight (per set)	Stroke adjustment unit weight (per unit)			(kg)
					Type A and B			
					A unit weight	L unit weight	H unit weight	
10	0.26	0.08	0.05	0.003	—	—	0.02	
16	0.74	0.14	0.19	0.01	0.02	0.04	—	
20	1.35	0.25	0.40	0.02	0.03	0.05	0.07	
25	2.17	0.30	0.73	0.02	0.04	0.07	0.11	
32	4.37	0.46	1.30	0.04	0.08	0.14	0.23	
40	5.84	0.55	1.89	0.08	0.12	0.19	0.28	

Calculation: (Example) MY1H20-300A

- Basic weight 1.35 kg
- Cylinder stroke 300 stroke
- Additional weight 0.25/50 stroke
- 1.35 + 0.25 x 300/50 + 0.03 x 2 = 2.19 kg
- Weight of A unit 0.03 kg

With End Locks

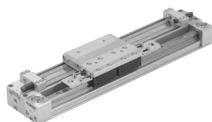

Specifications

Bore size (mm)	16	20	25	32	40
Lock position	One end (Selectable), Both ends				
Holding force (Max.) (N)	110	170	270	450	700
Fine stroke adjustment range (mm)	0 to -5.6	0 to -6	0 to -11.5	0 to -12	0 to -16
Backlash	1 mm or less				
Manual release	Possible (Non-lock type)				

⚠ Precautions

For details on the MY1H Series Mechanically Jointed Rodless Cylinder, refer to "Specific Product Precautions" on pages 1335 to 1336-3.

MY1H Series

Cushion Capacity

Cushion Selection

<Rubber bumper>

Rubber bumpers are a standard feature on MY1H10.

Since the stroke absorption of rubber bumpers is short, when adjusting the stroke with an A unit, install an external shock absorber.

The load and speed range which can be absorbed by a rubber bumper is inside the rubber bumper limit line of the graph.

<Air cushion>

Air cushions are a standard feature on mechanically jointed rodless cylinders.

The air cushion mechanism is incorporated to prevent excessive impact of the piston at the stroke end during high speed operation. The purpose of air cushion, thus, is not to decelerate the piston near the stroke end.

The ranges of load and speed that air cushions can absorb are within the air cushion limit lines shown in the graphs.

<Stroke adjustment unit with shock absorber>

Use this unit when operating with a load or speed exceeding the air cushion limit line, or when cushioning is required outside of the effective air cushion stroke range due to stroke adjustment.

L unit

Use this unit when the cylinder stroke is outside of the effective air cushion range even if the load and speed are within the air cushion limit line, or when the cylinder is operated in a load and speed range above the air cushion limit line or below the L unit limit line.

H unit

Use this unit when the cylinder is operated in a load and speed range above the L unit limit line and below the H unit limit line.

* For details on stroke adjustment using the adjustment bolt, refer to page 1336.

Air Cushion Stroke

(mm)

Bore size (mm)	Cushion stroke
16	12
20	15
25	15
32	19
40	24

Rubber Bumper (ø10 only) Positive Stroke from One End Due to Pressure

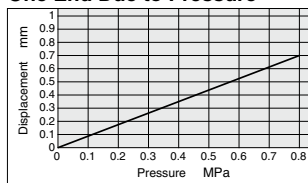

Absorption Capacity of Rubber Bumper, Air cushion and Stroke Adjustment Units

MY1H10

Horizontal collision: P = 0.5 MPa

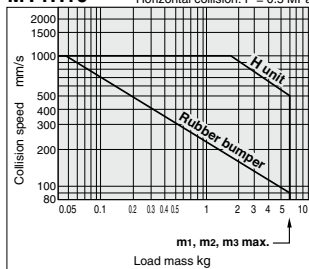

MY1H25

Horizontal collision: P = 0.5 MPa

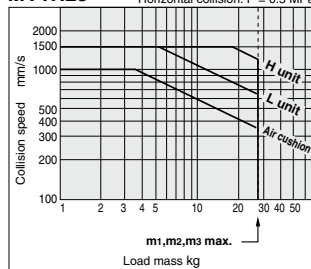

MY1H16

Horizontal collision: P = 0.5 MPa

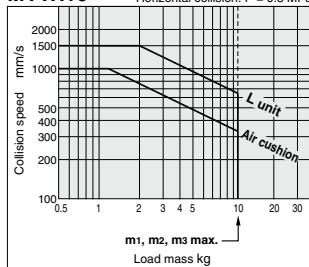

MY1H32

Horizontal collision: P = 0.5 MPa

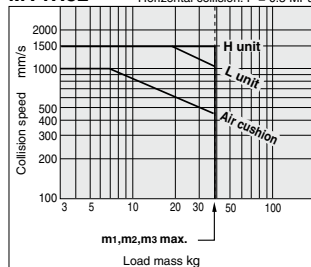

MY1H20

Horizontal collision: P = 0.5 MPa

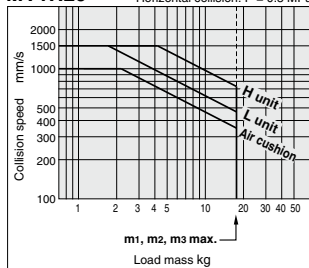

MY1H40

Horizontal collision: P = 0.5 MPa

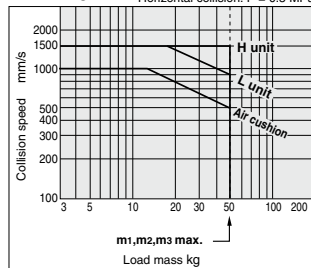

Construction: $\varnothing 10$

Centralized piping type

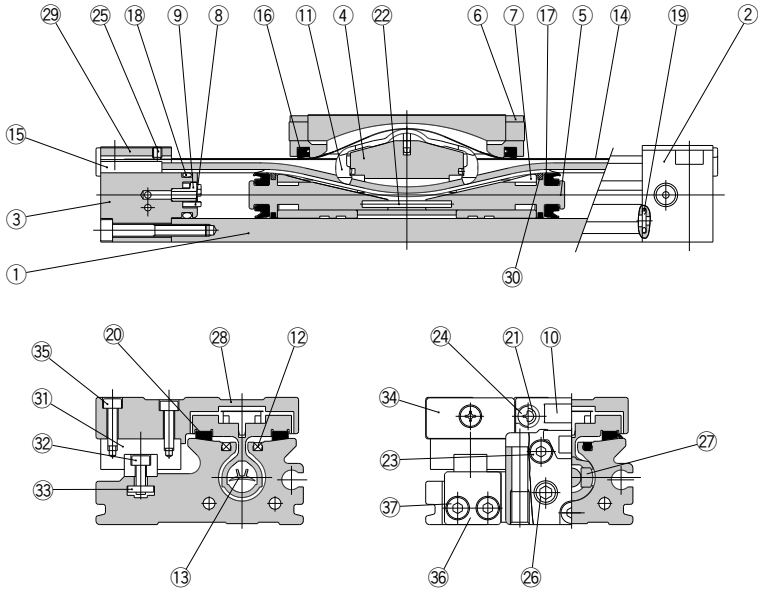

Component Parts

No.	Description	Material	Note
1	Cylinder tube	Aluminum alloy	Hard anodized
2	Head cover WR	Aluminum alloy	Painted
3	Head cover WL	Aluminum alloy	Painted
4	Piston yoke	Aluminum alloy	Hard anodized
5	Piston	Aluminum alloy	Chromated
6	End cover	Special resin	
7	Wear ring	Special resin	
8	Bumper	Polyurethane rubber	
9	Holder	Stainless steel	
10	Stopper	Carbon steel	Nickel plated
11	Belt separator	Special resin	
12	Seal magnet	Rubber magnet	
15	Belt clamp	Special resin	
20	Bearing	Special resin	
21	Spacer	Chromium molybdenum steel	Nickel plated

No.	Description	Material	Note
22	Spring pin	Stainless steel	
23	Hexagon socket head cap screw	Chromium molybdenum steel	Chromated
24	Round binding head screw	Carbon steel	Chromated
25	Hexagon socket head set screw	Carbon steel	Black zinc chromated
26	Hexagon socket head plug	Carbon steel	Chromated
27	Magnet	—	
28	Slide table	Aluminum alloy	Hard anodized
29	Head plate	Stainless steel	
30	Lube-retainer	Special resin	
31	Linear guide	—	
32	Hexagon socket head cap screw	Chromium molybdenum steel	Chromated
33	Square nut	Carbon steel	Chromated
34	Stopper plate	Carbon steel	Chromated
35	Hexagon socket head cap screw	Chromium molybdenum steel	Chromated
36	Guide stopper	Carbon steel	Nickel plated
37	Hexagon socket head cap screw	Chromium molybdenum steel	Chromated

Replacement Part: Seal Kit

No.	Description	Qty.	MY1H10
13	Seal belt	1	MY10-16A-Stroke
14	Dust seal band	1	MY10-16B-Stroke
16	Scraper	2	MY1B10-PS
17	Piston seal	2	
18	Tube gasket	2	
19	O-ring	4	

* Seal kit includes 16, 17, 18 and 19.

Seal kit includes a grease pack (10 g).

When 13 and 14 are shipped independently, a grease pack is included.

Order with the following part number when only the grease pack is needed.

Grease pack part number: GR-S-010 (10 g), GR-S-020 (20 g)

MY1H Series

Construction: $\varnothing 16$, $\varnothing 20$

MY1H16, 20

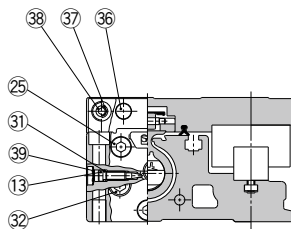
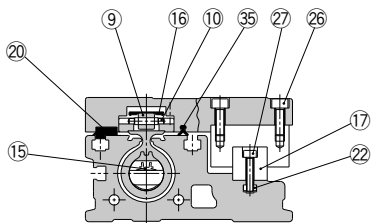
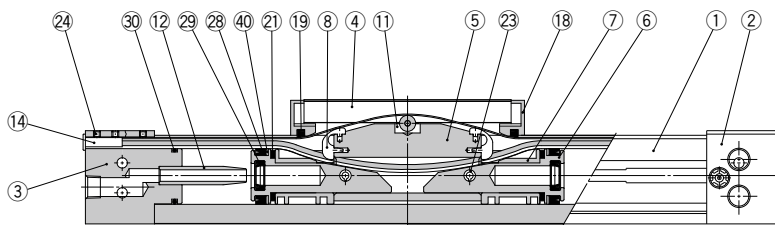

MY1H16, 20

Component Parts

No.	Description	Material	Note
1	Cylinder tube	Aluminum alloy	Hard anodized
2	Head cover WR	Aluminum alloy	Painted
3	Head cover WL	Aluminum alloy	Painted
4	Slide table	Aluminum alloy	Hard anodized
5	Piston yoke	Aluminum alloy	Chromated
6	Piston	Aluminum alloy	Chromated
7	Wear ring	Special resin	
8	Belt separator	Special resin	
9	Guide roller	Special resin	
10	Guide roller shaft	Stainless steel	
11	Coupler	Sintered iron material	
12	Cushion ring	Aluminum alloy	Anodized
13	Cushion needle	Rolled steel	Nickel plated
14	Belt clamp	Special resin	
17	Guide		
18	End cover	Special resin	
20	Bearing	Special resin	

No.	Description	Material	Note
21	Magnet	—	
22	Square nut	Carbon steel	Chromated
23	Spring pin	Carbon tool steel	
24	Hexagon socket head set screw	Chromium molybdenum steel	Black zinc chromated/Chromated
25	Hexagon socket head cap screw	Chromium molybdenum steel	Chromated
26	Hexagon socket head cap screw	Chromium molybdenum steel	Chromated
27	Hexagon socket head cap screw	Chromium molybdenum steel	Chromated
32	Hexagon socket head taper plug	Carbon steel	Chromated
34	Hexagon socket head taper plug	Carbon steel	Chromated
36	Stopper	Carbon steel	Nickel plated
37	Spacer	Stainless steel	
38	Hexagon socket button head screw	Chromium molybdenum steel	Chromated
39	Type CR retaining ring	Spring steel	
40	Lube-retainer	Special resin	

Replacement Part: Seal Kit

No.	Description	Qty.	MY1H16	MY1H20
15	Seal belt	1	MY16-16C- <u>Stroke</u>	MY20-16C- <u>Stroke</u>
16	Dust seal band	1	MY16-16B- <u>Stroke</u>	MY20-16B- <u>Stroke</u>
31	O-ring	2	KA00309 (ø4 x ø1.8 x ø1.1)	KA00309 (ø4 x ø1.8 x ø1.1)
35	Side scraper	1	MYH16-15BK2900B	MYH20-15BK2901B
19	Scraper	2		
28	Piston seal	2	MY1H16-PS	MY1H20-PS
29	Cushion seal	2		
30	Tube gasket	2		
33	O-ring	4		

* Seal kit includes 19, 28, 29, 30 and 33. Order the seal kit based on each bore size.

* Seal kit includes a grease pack (10 g).

When 15 and 16 are shipped independently, a grease pack (20 g) is included.

Order with the following part number when only the grease pack is needed.

Grease pack part number: GR-S-010 (10 g), **GR-S-020** (20 g)

Note) Two kinds of dust seal bands are available. Verify the type to use, since the part number varies depending on the treatment of the hexagon socket head set screw 24.

A: Black zinc chromated → MY□□-16B-stroke, B: Chromated → MY□□-16BW-stroke

MY1H Series

Construction: $\varnothing 25$, $\varnothing 32$, $\varnothing 40$

MY1H25, 32, 40

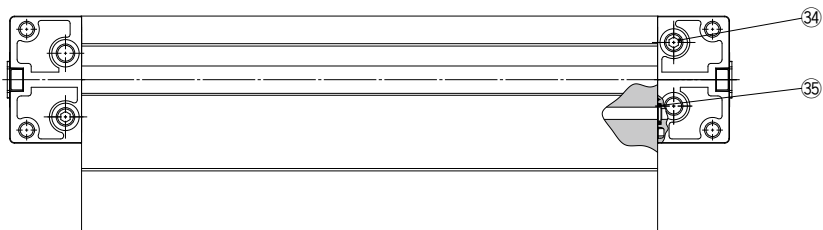
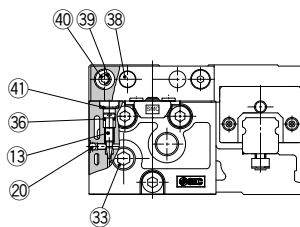
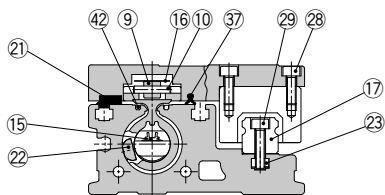
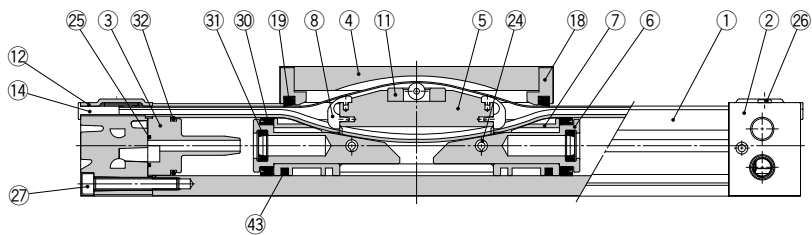

MY1H25, 32, 40

Component Parts

No.	Description	Material	Note
1	Cylinder tube	Aluminum alloy	Hard anodized
2	Head cover	Aluminum alloy	Painted
3	Cushion boss	Special resin	
4	Slide table	Aluminum alloy	Hard anodized
5	Piston yoke	Aluminum alloy	Chromated
6	Piston	Aluminum alloy	Chromated
7	Wear ring	Special resin	
8	Belt separator	Special resin	
9	Guide roller	Special resin	
10	Parallel pin	Stainless steel	
11	Coupler	Sintered iron material	
12	Head plate	Stainless steel	
13	Cushion needle	Rolled steel	Nickel plated
14	Belt clamp	Special resin	
17	Guide	—	
18	End cover	Special resin	
20	Steel ball	Carbon tool steel	
21	Bearing	Special resin	
22	Magnet	Rare earth magnet	
23	Square nut	Carbon steel	Chromated
24	Spring pin	Bearing steel	
26	Thin head screw	Chromium molybdenum steel	Chromated
27	Hexagon socket head cap screw	Chromium molybdenum steel	Chromated
28	Hexagon socket head cap screw	Chromium molybdenum steel	Chromated
29	Hexagon socket head cap screw	Chromium molybdenum steel	Chromated
33	Hexagon socket head taper plug	Carbon steel	Chromated (Centralized piping: 10 pcs.)
34	Hexagon socket head taper plug	Carbon steel	Chromated (Centralized piping: 4 pcs.)
38	Stopper	Carbon steel	
39	Spacer	Stainless steel	
40	Hexagon socket button head screw	Chromium molybdenum steel	Chromated
41	CR retaining ring	Spring steel	
42	Seal magnet	Rubber magnet	
43	Lube retainer	Special resin	

Replacement Parts: Seal Kit

No.	Description	Material	Qty.	MY1H25	MY1H32	MY1H40
15	Seal belt	Urethane	1	MY25-16C-[Stroke]	MY32-16C-[Stroke]	MY40-16C-[Stroke]
16	Dust seal band	Stainless steel	1	MY1B25-16B-[Stroke]	MY1B32-16B-[Stroke]	MY1B40-16B-[Stroke]
25	Cushion boss gasket	NBR	2	MYB25-16GA5900	MYB32-16GA5901	MYB40-16GA5902
36	O-ring	NBR	2	KA00311 (ø5.1 x ø3 x ø1.05)	KA00320 (ø7.15 x ø3.75 x ø1.7)	KA00320 (ø7.15 x ø3.75 x ø1.7)
37	Side scraper	Special resin	2	MYH25-15BK2902B	MYH32-15BK2903B	MYH40-15BK2904B
19	Scraper	NBR	2	MY1H25-PS	MY1H32-PS	MY1H40-PS
30	Piston seal	NBR	2			
31	Cushion seal	NBR	2			
32	Tube gasket	NBR	2			
35	O-ring	NBR	4			

* Seal kit includes ⑱, ⑳, ㉑, ㉒ and ㉓. Order the seal kit based on each bore size.

* Seal kit includes a grease pack (10 g). When ⑮ or ⑯ is shipped independently, a grease pack (20 g) is included. Order with the following part number when only the grease pack is needed.

Grease pack part number: GR-S-010 (10 g), GR-S-020 (20 g)

MY1H Series

Construction: $\varnothing 16$, $\varnothing 20$

With End Lock

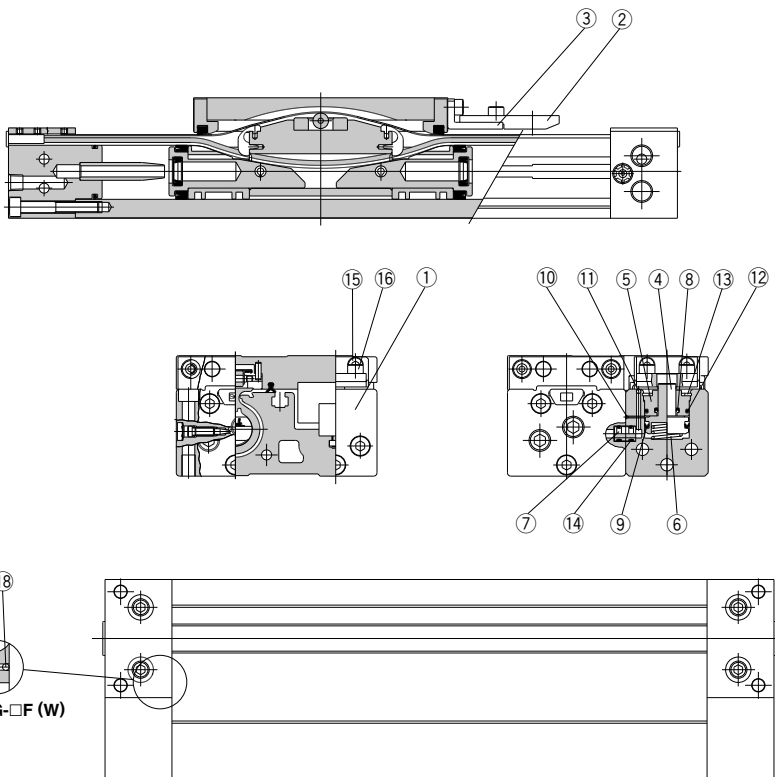

Component Parts

No.	Description	Material	Note
1	Locking body	Aluminum alloy	Painted
2	Lock finger	Carbon steel	After quenching, nickel plated
3	Lock finger bracket	Rolled steel	Nickel plated
4	Lock piston	Carbon tool steel	After quenching, electroless nickel plated
5	Rod cover	Aluminum alloy	Hard anodized
6	Return spring	Spring steel	Zinc chromated
7	Bypass pipe	Aluminum alloy	Chromated
10	Steel ball	High carbon chrome bearing steel	
11	Steel ball	High carbon chrome bearing steel	
13	Round type R retaining ring	Carbon tool steel	Nickel plated
14	O-ring	NBR	
15	Hexagon socket head cap screw	Chromium molybdenum steel	Nickel plated
16	Hexagon socket head cap screw	Chromium molybdenum steel	Nickel plated
17	Steel ball	High carbon chrome bearing steel	
18	Steel ball	High carbon chrome bearing steel	

Replacement Part: Seal Kit

No.	Description	Material	Qty.	MY1H16	MY1H20
8	Rod seal	NBR	1	KB00257	KB00257
9	Piston seal	NBR	1	KB00202	KB00202
12	O-ring	NBR	1	KA00057	KA00057

** Since the seal kit does not include a grease pack, order it separately.

Grease pack part no.: GR-S-010 (10 g)

Construction: $\varnothing 25$, $\varnothing 32$, $\varnothing 40$

End lock

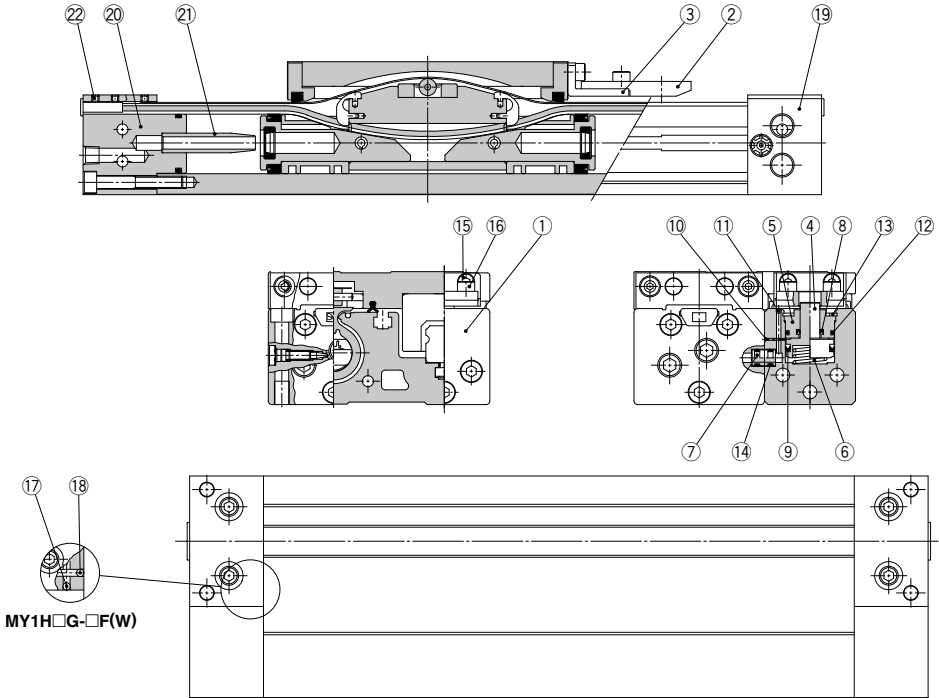

Component Parts

No.	Description	Material	Note
1	Locking body	Aluminum alloy	Painted
2	Lock finger	Carbon steel	After quenching, nickel plated
3	Lock finger bracket	Rolled steel	Nickel plated
4	Lock piston	Carbon tool steel	After quenching, electroless nickel plated
5	Rod cover	Aluminum alloy	Hard anodized
6	Return spring	Spring steel	Zinc chromated
7	Bypass pipe	Aluminum alloy	Hard anodized
10	Steel ball	High carbon chromium bearing steel	
11	Steel ball	High carbon chromium bearing steel	
13	Inverted internal retaining ring	Carbon tool steel	Nickel plated
15	Hexagon socket head cap screw	Chromium molybdenum steel	Chromated
16	Hexagon socket head cap screw	Chromium molybdenum steel	Chromated
17	Steel ball	High carbon chromium bearing steel	
18	Steel ball	High carbon chromium bearing steel	
19	Head cover WR	Aluminum alloy	Painted
20	Head cover WL	Aluminum alloy	Painted
21	Cushion ring	Aluminum alloy	
22	Hexagon socket head set screw	Chromium molybdenum steel	Chromated

Replacement Parts: Seal Kit

No.	Description	Material	Qty.	MY1H25	MY1H32	MY1H40
8	Rod seal	NBR	1	KB00267	KB00267	KB00267
9	Piston seal	NBR	1	KB00217	KB00217	KB00217
12	O-ring	NBR	1	KB00037	KB00037	KB00037
14	O-ring	NBR	2	KA00048	KA00048	KA00048

* Since the seal kit does not include a grease pack, order it separately.

Grease pack part no.: GR-S-010 (10 g)

MY1H Series

Centralized Piping Type $\phi 10$

MY1H10G — Stroke

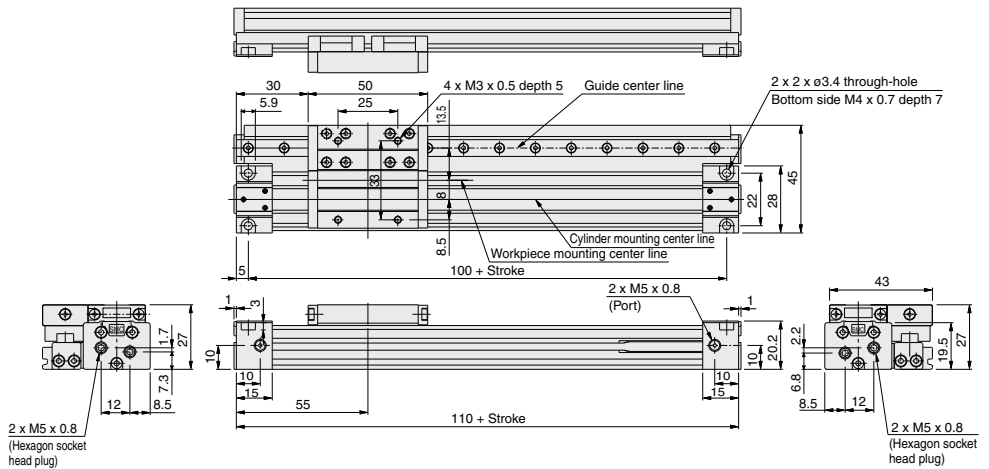

With shock absorber + Adjustment bolt

MY1H10G — Stroke H

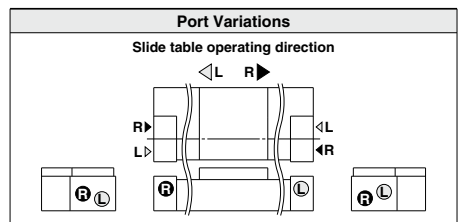
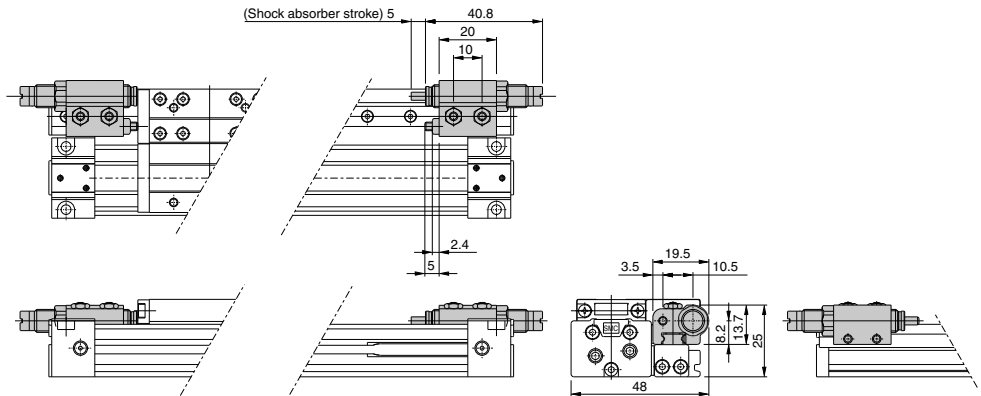

Mechanically Jointed Rodless Cylinder Linear Guide Type **MY1H Series**

Standard Type/Centralized Piping Type $\phi 16, \phi 20$

MY1H16□/20□ – Stroke

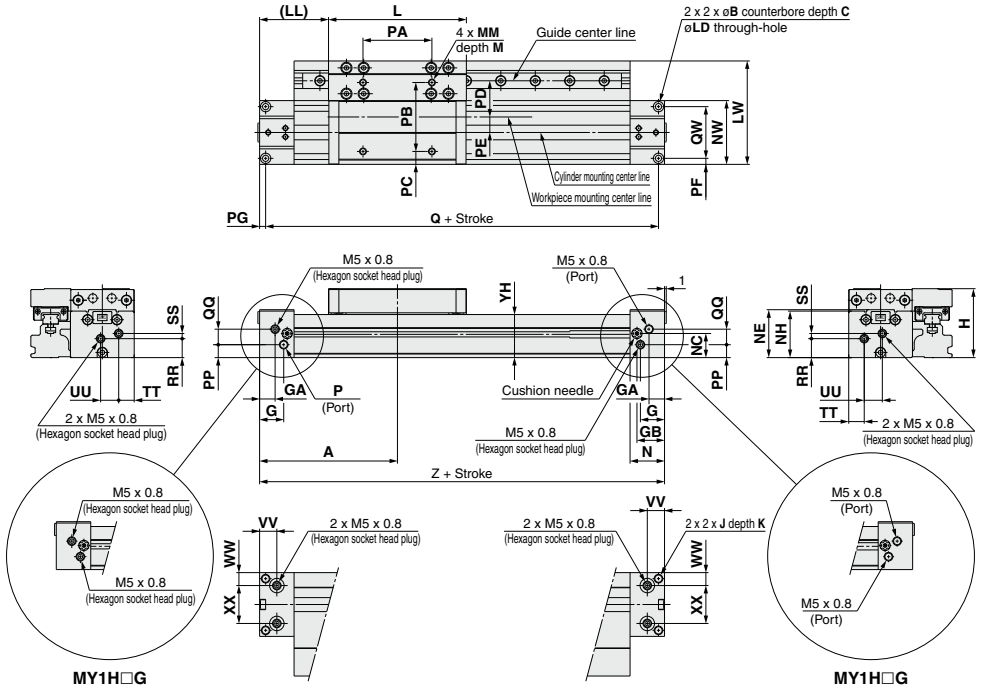

Model	A	B	C	G	GA	GB	H	J	K	L	LD	LL	LW	M	MM	N	NC	NE	NH	NW
MY1H16□	80	6	3.5	14	9	16	40	M5 x 0.8	10	80	3.5	40	60	7	M4 x 0.7	20	14	27.8	27	37
MY1H20□	100	7.5	4.5	12.5	12.5	20.5	46	M6 x 1	12	100	4.5	50	78	8	M5 x 0.8	25	17.5	34	33.5	45

Model	PA	PB	PC	PD	PE	PF	PG	PP	Q	QQ	QW	RR	SS	TT	UU	VV	WW	XX	YH	Z
MY1H16□	40	40	7.5	21	9	3.5	3.5	7.5	153	9	30	11	3	9	10.5	10	7.5	22	25	160
MY1H20□	50	40	14.5	27	12	4.5	4.5	11.5	191	11	36	14.5	5	10.5	12	12.5	10.5	24	31.5	200

Centralized Piping on the Bottom

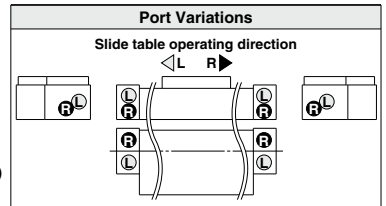
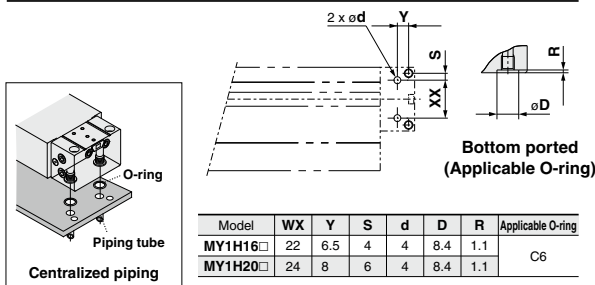

MY1H Series

Standard Type/Centralized Piping Type: $\phi 25$, $\phi 32$, $\phi 40$

MY1H25 □ /32 □ /40 □ - Stroke Z

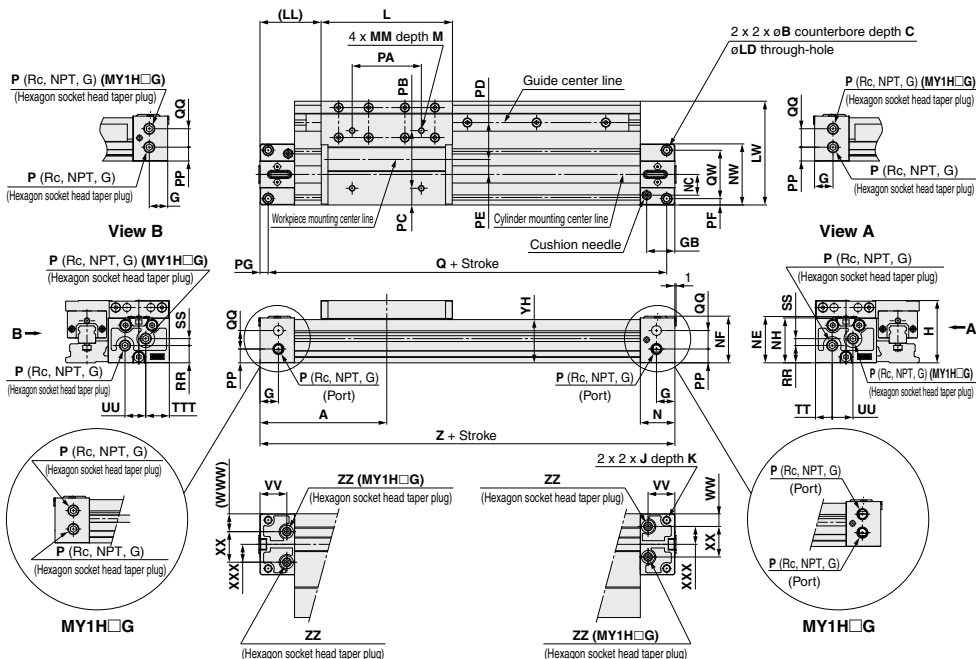

Standard piping/Centralized piping

Model	A	B	C	G	GB	H	J	K	L	LD	LL	LW	M	MM	N	NC	NE	NF	NH	NW	P	PA	PB	PC
MY1H25	110	9	5.5	16	24.5	54	M6 x 1	9.5	114	5.6	53	90	9	M5 x 0.8	30	18	40.2	40.5	39	53	Rc1/8	60	50	14.5
MY1H32	140	11	6.6	19	28.5	68	M8 x 1.25	16	140	6.8	70	110	13	M6 x 1	37	22	50.2	50	49	64	Rc1/8	80	60	15
MY1H40	170	14	8.5	23	35	84	M10 x 1.5	15	170	8.6	85	121	13	M6 x 1	45	26.5	62.7	62	61.5	75	Rc1/4	100	80	20.5

Model	PD	PE	PF	PG	PP	Q	QR	TT	TTT	VV	WW	WWW	XXX	YH	Z	ZZ	
MY1H25	32	13	5.5	7	12	206	42	15	14.5	20.5	23.3	11	15.5	15.5	37.5	220	Rc1/16
MY1H32	42	13	6.5	8	16	264	51	16	16	28.5	12	12	20	47	280	Rc1/16	
MY1H40	37.5	23	8	9	18.5	322	59	23.5	20	20	35	14	14	23.5	59.5	340	Rc1/8

Centralized piping (mm)					
Model	QQ	SS	UU	XX	
MY1H25	16	6	18	26.5	
MY1H32	16	11	32	40	
MY1H40	24	12	35	47	

Centralized Piping on the Bottom

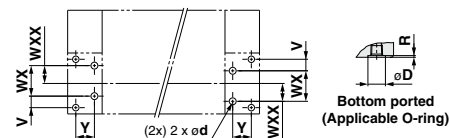

* This figure shows the recommended machining dimensions of the mounting surface when viewed from the cylinder side.

* Values inside the parentheses are those for MY1H□G.

Model	WX	Y	d	D	R	Applicable O-ring
MY1H25	15.5	16.2	6	11.4	1.1	C9
MY1H32	20	20.4	6	11.4	1.1	
MY1H40	23.5	25.9	8	13.4	1.1	

Model	WX	V
MY1H25	26.5	10
MY1H32	40	5.5
MY1H40	47	6

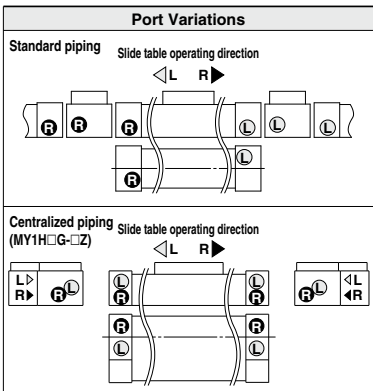
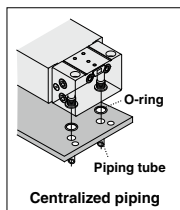

Mechanically Jointed Rodless Cylinder Linear Guide Type **MY1H Series**

With End Lock $\phi 16, \phi 20$

Dimensions for types other than end lock are identical to the standard type dimensions. For details about dimensions, etc., refer to page 1312.

**MY1H□—□E
(Right end)**

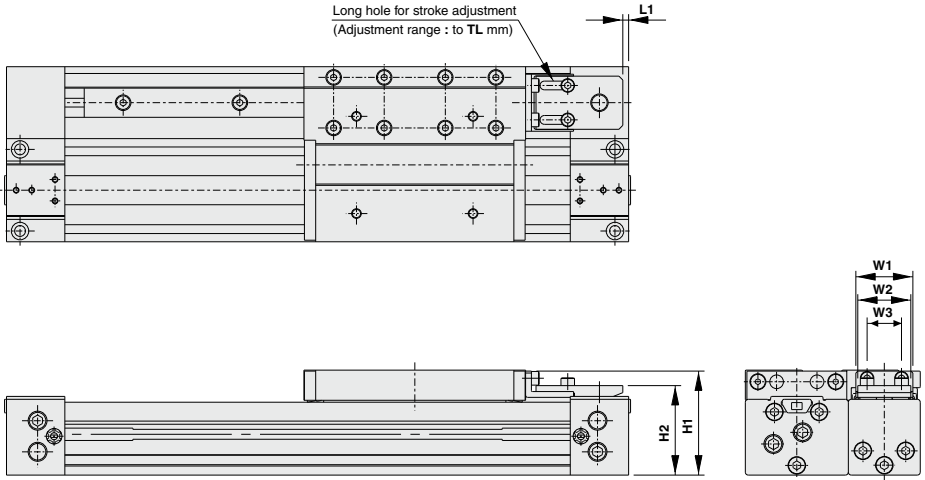

**MY1H□—□F
(Left end)**

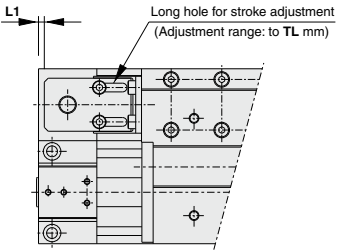

**MY1H□—□W
(Both ends)**

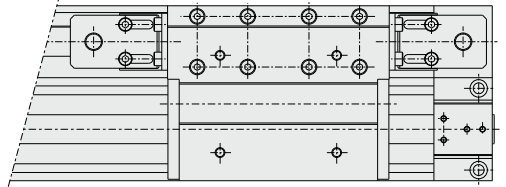

(mm)

Model	H1	H2	L1	TL	W1	W2	W3
MY1H16□	39.2	33	0.5	5.6	18	16	10.4
MY1H20□	45.7	39.5	3	6	18	16	10.4

MY1H Series

With End Lock: $\varnothing 25$, $\varnothing 32$, $\varnothing 40$

Dimensions for types other than end lock are identical to the standard type dimensions. For details about dimensions, etc., refer to page 1312-1.

MY1H□-□WZ (Both ends)

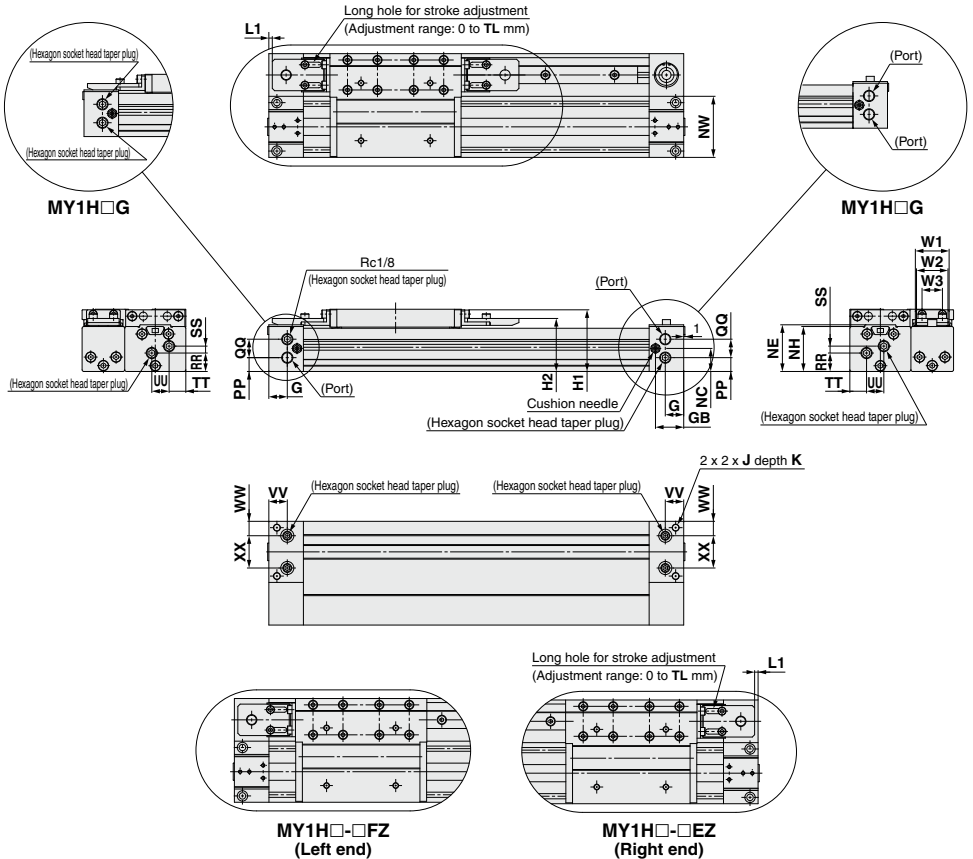

Standard piping/Centralized piping

Model	NC	NE	PP	RR	SS	UU	VV	WW	XX
MY1H25	20	40.5	12	16	6	15	16	12.5	28
MY1H32	25	50	17	23	4	16	19	16	32
MY1H40	30.5	63	8.5	27	10.5	22	23	19.5	36

* The dimensions of the TT, G, GB, and NA are the same as those of the standard product.

End lock mechanism (Standard piping/Centralized piping) (mm)

Model	H1	H2	L1	TL	W1	W2	W3
MY1H25	53.5	46	3	11.5	29.3	27.3	17.7
MY1H32	67	56	6.5	12	29.3	27.3	17.7
MY1H40	83	68.5	10.5	16	38	35	24.4

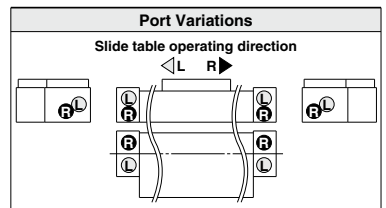

Stroke Adjustment Unit

With adjustment bolt

MY1H Bore size – Stroke A(Z)

ø16, ø20

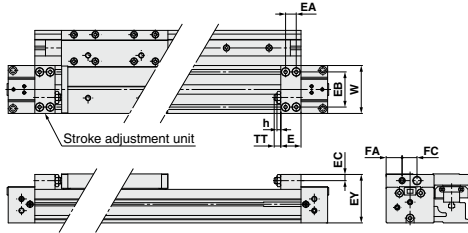

ø25, ø32, ø40

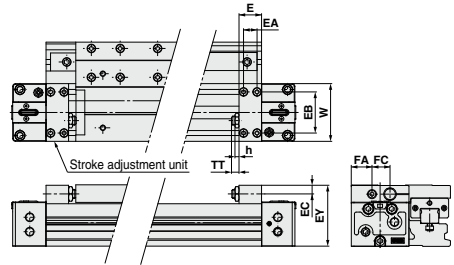

Applicable bore size	E	EA	EB	EC	EY	FA	FC	h	TT	W
MY1H16	14.6	7	28	5.8	39.5	11.5	13	3.6	5.4 (Max. 11)	37
MY1H20	19	10	33	5.8	45.5	15	14	3.6	6 (Max. 12)	45
MY1H25	18	9	40	7.5	53.5	16	21	3.5	5 (Max. 16.5)	53
MY1H32	25	14	45.6	9.5	67.5	23	20	4.5	8 (Max. 20)	64
MY1H40	31	19	55	11	82	24.5	26	4.5	9 (Max. 25)	75

With low load shock absorber + Adjustment bolt

MY1H Bore size – Stroke L(Z)

ø16, ø20

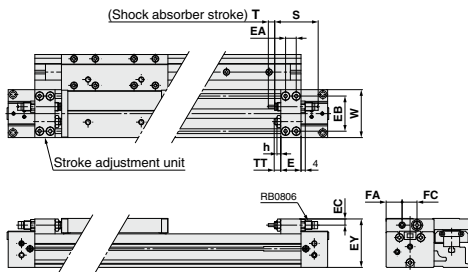

ø25, ø32, ø40

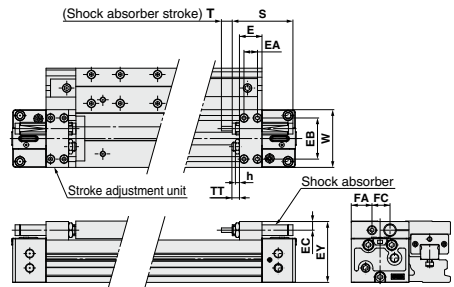

Applicable bore size	E	EA	EB	EC	EY	FA	FC	h	S	T	TT	W	Shock absorber model
MY1H16	14.6	7	28	5.8	39.5	11.5	13	3.6	40.8	6	5.4 (Max. 11)	37	RB0806
MY1H20	19	10	33	5.8	45.5	15	14	3.6	40.8	6	6 (Max. 12)	45	RB0806
MY1H25	18	9	40	7.5	53.5	16	21	3.5	46.7	7	5 (Max. 16.5)	53	RB1007
MY1H32	25	14	45.6	9.5	67.5	23	20	4.5	67.3	12	8 (Max. 20)	64	RB1412
MY1H40	31	19	55	11	82	24.5	26	4.5	67.3	12	9 (Max. 25)	75	RB1412

MY1H Series

Stroke Adjustment Unit

With high load shock absorber + Adjustment bolt

MY1H [Bore size] □ - [Stroke] H(Z)

ø20

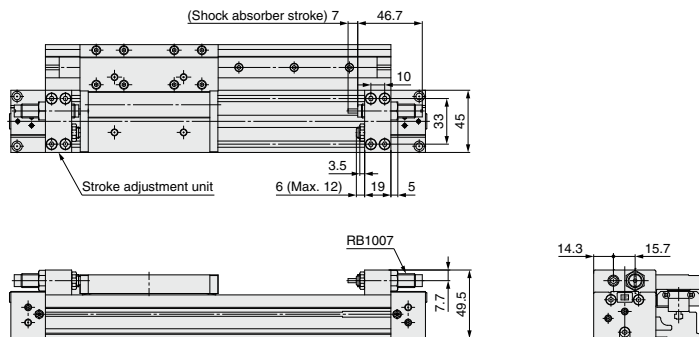

ø25, ø32, ø40

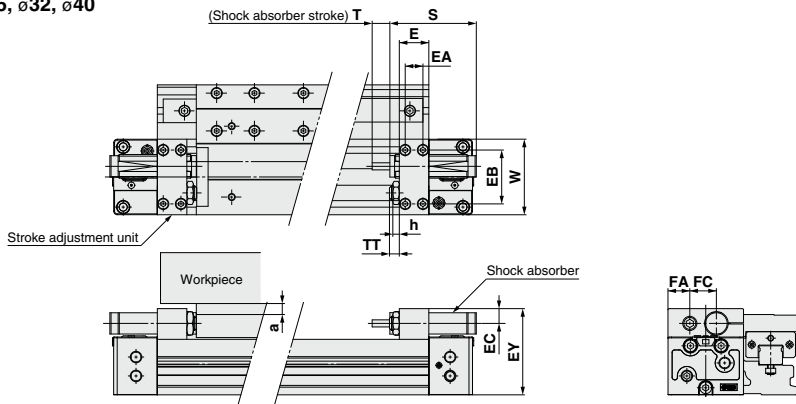

* Since the EY dimension of H unit is greater than the table top height (H dimension), when a work piece exceeding the full length (L dimension) of the slide table is mounted, allow a clearance of size "a" or larger at the work piece side.

Applicable bore size	E	EA	EB	EC	EY	F	FA	FC	h	S	T	TT	W	Shock absorber model	a
MY1H25	18	9	40	9	57	—	18	17.5	4.5	67.3	12	5 (Max. 16.5)	53	RB1412	3.5
MY1H32	25	14	45.6	12.4	73	—	18.5	22.5	5.5	73.2	15	8 (Max. 20)	64	RB2015	5.5
MY1H40	31	19	55	12.4	86	—	26.5	22	5.5	73.2	15	9 (Max. 25)	75	RB2015	2.5

MY1H Series Accessory Bracket (option)

Stroke Adjustment Unit

MYH-A 25 L2-6N

Stroke adjustment unit

Bore size

10	10 mm
16	16 mm
20	20 mm
25	25 mm
32	32 mm
40	40 mm

Unit no.

Symbol	Stroke adjustment unit	Mounting position
A1	A unit	Left
A2		Right
L1	L unit	Left
L2		Right
H1	H unit	Left
H2		Right

Intermediate fixing spacer

Nil	Without spacer
6	Short spacer
7	Long spacer

Spacer delivery type

Nil	Unit installed
N	Spacer only

- * Spacers are used to fix the stroke adjustment unit at an intermediate stroke position.
- * Spacers are shipped for a set of two.

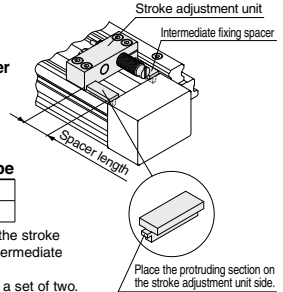

* When ordering the intermediate fixing spacer for the stroke adjustment unit, the intermediate fixing spacer is shipped together.

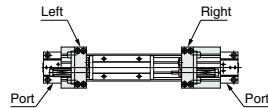

Stroke adjustment range

Bore size	10	16		20			25		32			40			
Unit symbol	H	A	L	A	L	H	A	L	H	A	L	H	A	L	H
Without spacer	0 to -10	0 to -5.6		0 to -6			0 to -11.5		0 to -12			0 to -16			
With short spacer	—*	-5.6 to -11.2		-6 to -12			-11.5 to -23		-12 to -24			-16 to -32			
With long spacer	—*	-11.2 to -16.8		-12 to -18			-23 to -34.5		-24 to -36			-32 to -48			

* For ø10, stroke adjustment is available. Refer to page 1336-2 for details.

Spacer length

Bore size	16	20	25	32	40
Short spacer	5.6	6	11.5	12	16
Long spacer	11.2	12	23	24	32

Component Parts

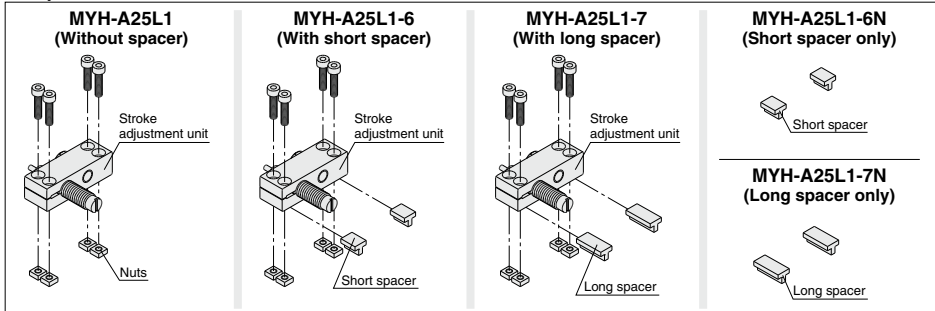

* Nuts are equipped on the cylinder body.

MY1H Series

Side Support

Side support A MY-S□A

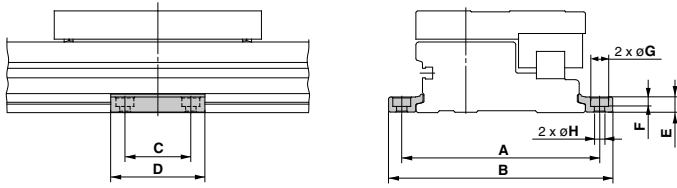

Side support B MY-S□B

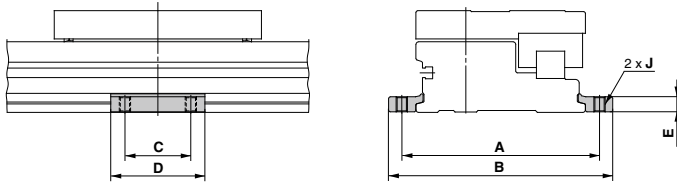

Model	Applicable bore size	A	B	C	D	E	F	G	H	J
MY-S10 _B	MY1H10	53	61.6	12	21	3	1.2	6.5	3.4	M4 x 0.7
MY-S16 _B	MY1H16	71	81.6	15	26	4.9	3	6.5	3.4	M4 x 0.7
MY-S20 _B	MY1H20	91	103.6	25	38	6.4	4	8	4.5	M5 x 0.8
MY-S25 _B	MY1H25	105	119	35	50	8	5	9.5	5.5	M6 x 1
MY-S32 _B	MY1H32	130	148	45	64	11.7	6	11	6.6	M8 x 1.25
MY-S40 _B	MY1H40	145	167	55	80	14.8	8.5	14	9	M10 x 1.5

* A set of side supports consists of a left support and a right support.

Guide for Side Support Application

For long stroke operation, the cylinder tube may be deflected depending on its own weight and the load mass. In such a case, use a side support in the middle section. The spacing (L) of the support must be no more than the values shown in the graph on the right.

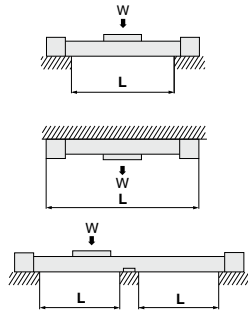

⚠ Caution

1. If the cylinder mounting surfaces are not measured accurately, using a side support may cause poor operation. Therefore, be sure to level the cylinder tube when mounting. Also, for long stroke operation involving vibration and impact, use of a side support is recommended even if the spacing value is within the allowable limits shown in the graph.
2. Support brackets are not for mounting; use them solely for providing support.

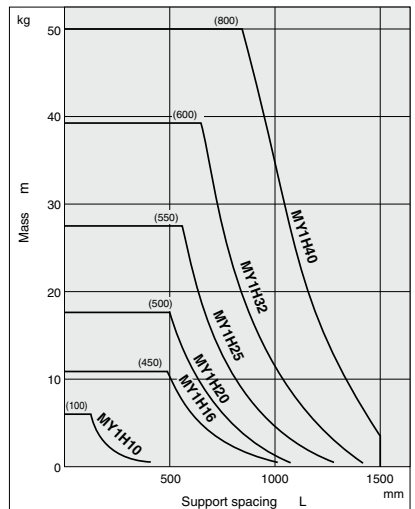

MY1HT Series

High Rigidity/Linear Guide Type

ø50, ø63



The use of two linear guides allows a maximum load of 320 kg. (ø63)

Rodless cylinder
MY1BH

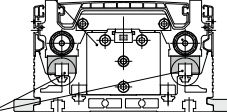

2 linear guides

INDEX

MY1HT Series Prior to Use	P. 1320
Model Selection	P. 1322
How to Order	P. 1324
Specifications	P. 1325
Cushion Capacity	P. 1326
Construction	P. 1328
Dimensions	P. 1329
Side Support	P. 1330

MY1HT Series Prior to Use

Maximum Allowable Moment/Maximum Load Mass

Model	Bore size (mm)	Maximum allowable moment (N-m)			Maximum load mass (kg)		
		M ₁	M ₂	M ₃	m ₁	m ₂	m ₃
MY1HT	50	140	180	140	200	140	200
	63	240	300	240	320	220	320

The above values are the maximum allowable values for moment and load. Refer to each graph regarding the maximum allowable moment and maximum allowable load for a particular piston speed.

Maximum Allowable Moment

Select the moment from within the range of operating limits shown in the graphs. Note that the maximum allowable load value may sometimes be exceeded even within the operating limits shown in the graphs. Therefore, also check the allowable load for the selected conditions.

Load mass (kg)

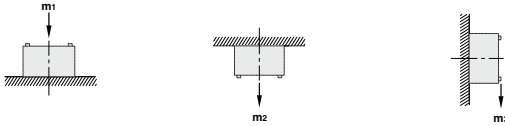

Moment (N-m)

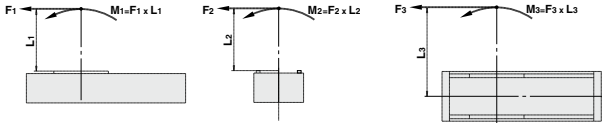

<Calculation of guide load factor>

- Maximum allowable load (1), static moment (2), and dynamic moment (3) (at the time of impact with stopper) must be examined for the selection calculations.
 * To evaluate, use \bar{v}_a (average speed) for (1) and (2), and v (collision speed $v = 1.4\bar{v}_a$) for (3). Calculate m_{max} for (1) from the maximum allowable load graph (m_1, m_2, m_3) and M_{max} for (2) and (3) from the maximum allowable moment graph (M_1, M_2, M_3).

Maximum Load Mass

Select the load from within the range of limits shown in the graphs. Note that the maximum allowable moment value may sometimes be exceeded even within the operating limits shown in the graphs. Therefore, also check the allowable moment for the selected conditions.

$$\text{Sum of guide load factors } \Sigma\alpha = \frac{\text{Load mass [m]}}{\text{Maximum allowable load [m max]}} + \frac{\text{Static moment [M] }^{(1)}}{\text{Allowable static moment [Mmax]}} + \frac{\text{Dynamic moment [Me] }^{(2)}}{\text{Allowable dynamic moment [MEmax]}} \leq 1$$

- Note 1) Moment caused by the load, etc., with cylinder in resting condition.
 Note 2) Moment caused by the impact load equivalent at the stroke end (at the time of impact with stopper).
 Note 3) Depending on the shape of the workpiece, multiple moments may occur. When this happens, the sum of the load factors ($\Sigma\alpha$) is the total of all such moments.

- Reference formula [Dynamic moment at impact]
 Use the following formulae to calculate dynamic moment when taking stopper impact into consideration.

- m:** Load mass (kg)
F: Load (N)
F_E: Load equivalent to impact (at impact with stopper) (N)
 \bar{v}_a : Average speed (mm/s)
M: Static moment (N-m)
 $v = 1.4\bar{v}_a$ (mm/s) $F_E = 1.4\bar{v}_a \cdot \delta \cdot m \cdot g$ (Note 4)
 $\therefore M_E = \frac{1}{3} \cdot F_E \cdot L = 4.57\bar{v}_a \delta m L$ (Note 5)
 \bar{v} : Collision speed (mm/s)
L: Distance to the load's center of gravity (m)
M_E: Dynamic moment (N-m)
 δ : Damper coefficient
 With rubber bumper = 4/100 (MY1B10, MY1H10)
 With air cushion = 1/100
 With shock absorber = 1/100
g: Gravitational acceleration (9.8 m/s²)

- Note 4) $1.4\bar{v}_a\delta$ is a dimensionless coefficient for calculating impact force.
 Note 5) Average load coefficient ($= \frac{1}{3}$): This coefficient is for averaging the maximum load moment at the time of stopper impact according to service life calculations.

- For detailed selection procedures, refer to pages 1322 and 1323.

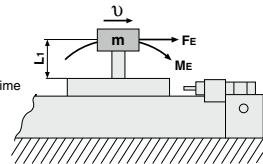

MY1HT/M₁

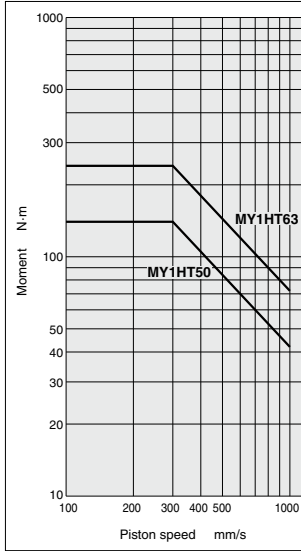

MY1HT/M₂

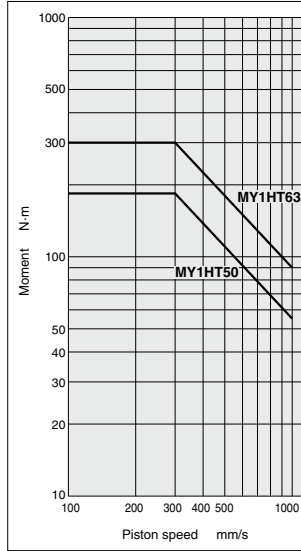

MY1HT/M₃

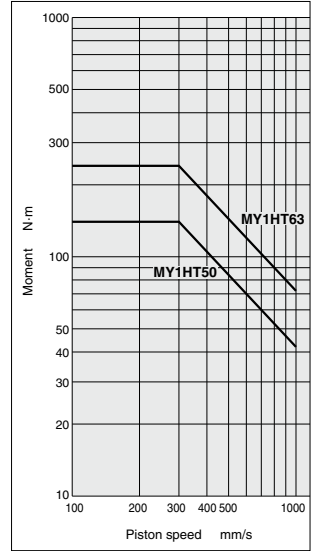

MY1HT/m₁

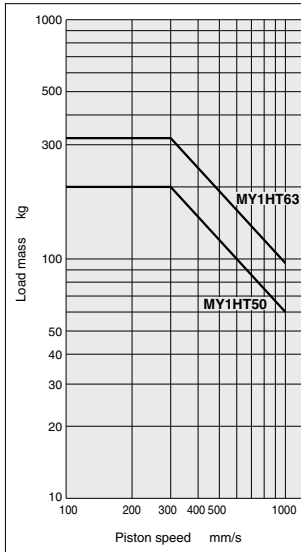

MY1HT/m₂

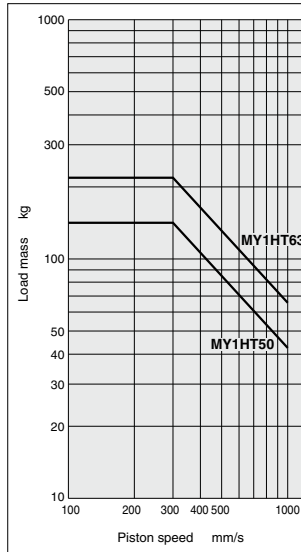

MY1HT/m₃

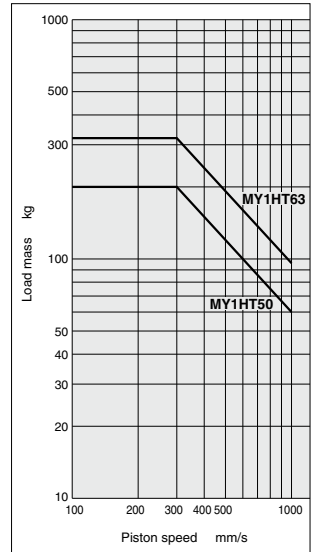

MY1HT Series Model Selection

Following are the steps for selecting the most suitable MY1HT series to your application.

Calculation of Guide Load Factor

1. Operating Conditions

Cylinder MY1HT50-600
 Average operating speed v_a ... 700 mm/s
 Mounting orientation Vertical mounting
 Cushion Shock absorber
 ($\delta = 1/100$)

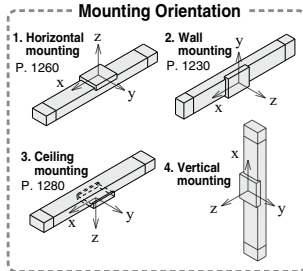
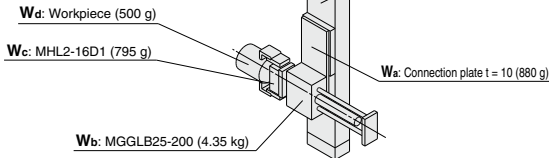

For actual examples of calculation for each orientation, refer to the pages above.

2. Load Blocking

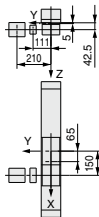

Mass and Center of Gravity for Each Workpiece

Workpiece no. W _n	Mass m _n	Center of gravity		
		X-axis X _n	Y-axis Y _n	Z-axis Z _n
W _a	0.88 kg	65 mm	0 mm	5 mm
W _b	4.35 kg	150 mm	0 mm	42.5 mm
W _c	0.795 kg	150 mm	111 mm	42.5 mm
W _d	0.5 kg	150 mm	210 mm	42.5 mm

n=a, b, c, d

3. Composite Center of Gravity Calculation

$$m_t = \sum m_n$$

$$= 0.88 + 4.35 + 0.795 + 0.5 = \mathbf{6.525 \text{ kg}}$$

$$X = \frac{1}{m_t} \times \sum (m_n \times x_n)$$

$$= \frac{1}{6.525} (0.88 \times 65 + 4.35 \times 150 + 0.795 \times 150 + 0.5 \times 150) = \mathbf{138.5 \text{ mm}}$$

$$Y = \frac{1}{m_t} \times \sum (m_n \times y_n)$$

$$= \frac{1}{6.525} (0.88 \times 0 + 4.35 \times 0 + 0.795 \times 111 + 0.5 \times 210) = \mathbf{29.6 \text{ mm}}$$

$$Z = \frac{1}{m_t} \times \sum (m_n \times z_n)$$

$$= \frac{1}{6.525} (0.88 \times 5 + 4.35 \times 42.5 + 0.795 \times 42.5 + 0.5 \times 42.5) = \mathbf{37.4 \text{ mm}}$$

4. Calculation of Load Factor for Static Load

m_t: Mass

m_t is the mass which can be transferred by the thrust, and as a rule, is actually

about 0.3 to 0.7 of the thrust. (This differs depending on the operating speed.)

M_t: Moment

M_t max (from (1) of graph MY1HT/M_t) = 60 (N·m)

$$M_t = m_t \times g \times Z = 6.525 \times 9.8 \times 37.4 \times 10^{-3} = 2.39 \text{ (N·m)}$$

$$\text{Load factor } \alpha_1 = M_t / M_{t \text{ max}} = 2.39 / 60 = \mathbf{0.04}$$

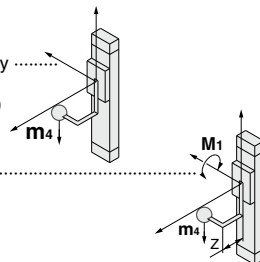

M₃ : Moment

M₃ max (from (2) of graph MY1HT/M₃) = 60 (N·m)

M₃ = **m₄** × **g** × **Y** = 6.525 × 9.8 × 29.6 × 10⁻³ = 1.89 (N·m)

Load factor **α₂** = **M₃**/**M₃ max** = 1.89/60 = **0.03**

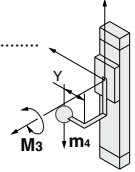

5. Calculation of Load Factor for Dynamic Moment

Equivalent load F_E at impact

F_E = 1.4U_a × δ × m × g = 1.4 × 700 × $\frac{1}{100}$ × 6.525 × 9.8 = 626.7 (N)

M_{1E} : Moment

M_{1E} max (from (3) of graph MY1HT/M₁ where 1.4U_a = 980 mm/s) = 42.9 (N·m)

M_{1E} = $\frac{1}{3}$ × **F_E** × **Z** = $\frac{1}{3}$ × 626.7 × 37.4 × 10⁻³ = 7.82 (N·m)

Load factor **α₃** = **M_{1E}**/**M_{1E} max** = 7.82/42.9 = **0.18**

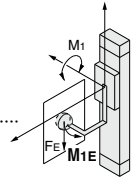

M_{3E} : Moment

M_{3E} max (from (4) of graph MY1HT/M₃ where 1.4U_a = 980 mm/s) = 42.9 (N·m)

M_{3E} = $\frac{1}{3}$ × **F_E** × **Y** = $\frac{1}{3}$ × 626.7 × 29.6 × 10⁻³ = 6.19 (N·m)

Load factor **α₄** = **M_{3E}**/**M_{3E} max** = 6.19/42.9 = **0.14**

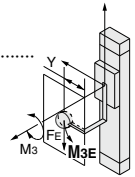

6. Sum and Examination of Guide Load Factors

$\Sigma\alpha = \alpha_1 + \alpha_2 + \alpha_3 + \alpha_4 = 0.39 \leq 1$

The above calculation is within the allowable value, and therefore the selected model can be used.

Select a shock absorber separately.

In an actual calculation, when the total sum of guide load factors $\Sigma\alpha$ in the formula above is more than 1, consider either decreasing the speed, increasing the bore size, or changing the product series.

This calculation can be easily made using the "SMC Pneumatics CAD System".

Allowable Moment

MY1HT/M₁

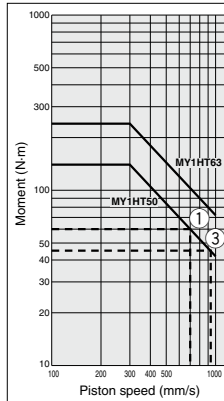

MY1HT/M₃

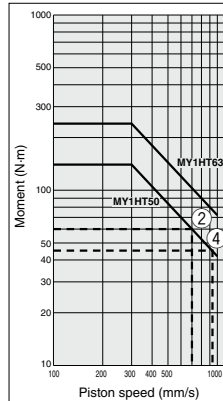

Mechanically Jointed Rodless Cylinder

High Rigidity/Linear Guide Type

MY1HT Series

ø50, ø63

How to Order

High Rigidity/
Linear Guide Type

MY1HT 50 [] [] - 400 L - Y7BW [] - []

High rigidity/Linear guide type
(2 linear guides)

1 2 3 4 5 6 7 8

1 Bore size

50	50 mm
63	63 mm

2 Port thread type

Symbol	Type	Bore size
Nil	Rc	ø50, ø63
TN	NPT	
TF	G	

3 Piping

Nil	Standard type
G	Centralized piping type

4 Stroke

Refer to "Standard Stroke" on page 1325.

5 Stroke adjustment unit

L	One shock absorber at each stroke end
H	Two shock absorbers at each stroke end
LH	One shock absorber at left side, two shock absorbers at right side
HL	Two shock absorbers at left side, one shock absorber at right side

* The positions right and left are for when the label is on the front side. Refer to the figure below for details.

Two shock absorbers at left side One shock absorber at right side

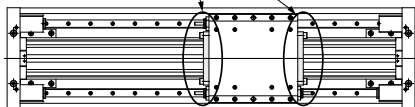

Note) With top cover removed

Label position

6 Auto switch

Nil	Without auto switch (Built-in magnet)
-----	---------------------------------------

* For the applicable auto switch model, refer to the table below.

7 Number of auto switches

Nil	2 pcs.
S	1 pc.
n	"n" pcs.

8 Made to Order

Refer to page 1325 for details.

Option

Stroke Adjustment Unit Part No.

Bore size (mm)	50	63
Unit type	MYT-A50L	MYT-A63L

Side Support Part No.

Type	Bore size (mm)	50	63
Side support A		MY-S63A	
Side support B		MY-S63B	

For details about dimensions, etc., refer to page 1330.

A set of side supports consists of a left support and a right support.

Applicable Auto Switches

Refer to pages 1575 to 1701 for further information on auto switches.

Type	Special function	Electrical entry	Indicator light	Wiring (Output)	Load voltage		Auto switch model		Lead wire length (m)			Pre-wired connector	Applicable load	
					DC	AC	Perpendicular	In-line	0.5 (Nil)	3 (L)	5 (Z)			
Solid state auto switch	—	Grommet	Yes	3-wire (NPN)	24 V	5 V, 12 V	—	Y69A	Y59A	●	●	○	IC circuit	Relay, PLC
				3-wire (PNP)				Y7PV	Y7P	●	○	○		
				2-wire				Y69B	Y59B	●	●	○		
				3-wire (NPN)				Y7NWV	Y7NW	●	○	○		
	3-wire (PNP)	Y7PWV	Y7PW	●	○	○								
Water resistant (2-color indicator)	—	Grommet	Yes	2-wire	24 V	12 V	—	Y7BWW	Y7BW	●	●	○	—	—
				3-wire (NPN equivalent)				—	Z76	●	●	—		
				2-wire				24 V	12 V	100 V	—	Z73		
Reed auto switch	—	Grommet	No	3-wire (NPN equivalent)	24 V	12 V	100 V or less	—	Z80	●	●	●	IC circuit	Relay, PLC
				2-wire				—	Z80	●	●	●		

*1 Water resistant type auto switches can be mounted on the above models, but in such case SMC cannot guarantee water resistance.

*2 Consult with SMC regarding water resistant types with the above model numbers.

*3 For details on switch mounting brackets and part numbers, refer to "Switch Mounting Bracket: Part No." on page 1333-1.

*4 Lead wire length symbols: 0.5 m Nil (Example) Y7BW

3 m L (Example) Y7BWL

5 m Z (Example) Y7BWZ

* There are other applicable auto switches than listed above. For details, refer to page 1333-1.

* Auto switches are shipped together (not assembled). (For details about auto switch mounting, etc., refer to page 1332.)

* Solid state auto switches marked with "○" are produced upon receipt of order.

* Separate switch spacers (BMP1-032) are required for retrofitting of auto switches.

Mechanically Jointed Rodless Cylinder High Rigidity/Linear Guide Type **MY1HT Series**

Specifications

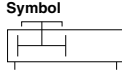

Bore size (mm)	50	63
Fluid	Air	
Action	Double acting	
Operating pressure range	0.1 to 0.8 MPa	
Proof pressure	1.2 MPa	
Ambient and fluid temperature	5 to 60°C	
Piston speed	100 to 1000 mm/s	
Cushion	Shock absorbers on both ends (Standard)	
Lubrication	Non-lube	
Stroke length tolerance	2700 or less $^{+1.8}_0$, 2701 to 5000 $^{+2.8}_0$	
Port size	Side port	3/8

Note) Use at a speed within the absorption capacity range. Refer to page 1326.

Stroke Adjustment Unit Specifications

Applicable bore size (mm)	50		63	
Unit symbol, contents	L	H	L	H
	RB2015 and adjustment bolt: 1 set each	RB2015 and adjustment bolt: 2 sets each	RB2725 and adjustment bolt: 1 set each	RB2725 and adjustment bolt: 2 sets each
Fine stroke adjustment range (mm)	0 to -20		0 to -25	
Stroke adjustment range	For adjustment method, refer to page 1337.			

* Stroke adjustment range is applicable for one side when mounted on a cylinder.

Shock absorber model	RB2015 x 1 pc.	RB2015 x 2 pcs.	RB2725 x 1 pc.	RB2725 x 2 pcs.
Maximum energy absorption (J)	58.8	88.2 ^{Note)}	147	220.5 ^{Note)}
Stroke absorption (mm)	15	15	25	25
Maximum collision speed (mm/s)	1000		1000	
Maximum operating frequency (cycle/min)	25	25	10	10
Spring force (N)	Extended	8.34	16.68	8.83
	Retracted	20.50	41.00	20.01
Operating temperature range (°C)	5 to 60			

Note) Maximum energy absorption for 2 pcs. is calculated by multiplying the value for 1 pc. by 1.5.

* The shock absorber service life is different from that of the MY1HT cylinder depending on operating conditions. Refer to the RB Series Specific Product Precautions for the replacement period.

Theoretical Output

Bore size (mm)	Piston area (mm ²)	Operating pressure (MPa)						
		0.2	0.3	0.4	0.5	0.6	0.7	0.8
50	1962	392	588	784	981	1177	1373	1569
63	3115	623	934	1246	1557	1869	2180	2492

Note) Theoretical output (N) = Pressure (MPa) x Piston area (mm²)



Made to Order Specifications
Click here for details

Symbol	Specifications
-XB10	Intermediate stroke (Using exclusive body)
-XC67	NBR rubber lining in dust seal band

Standard Stroke

Bore size (mm)	Standard stroke (mm)	Intermediate stroke (-XB10)	Long stroke (-XB11)	Maximum manufacturable stroke
50, 63	200, 400, 600 800, 1000 1500, 2000	Intermediate strokes of 201 to 1999 mm (1 mm increments) other than standard strokes	—	5000

Note) Ordering example

* Add "-XB10" to the end of the part number for intermediate strokes. MY1HT50-500L-Y7BW-XB10

Weight

Bore size (mm)	Basic weight	Additional weight per each 25 mm of stroke	Weight of moving parts	Side support weight (per set)	Stroke adjustment unit weight		
				Type A and B	L unit weight	LH unit weight	H unit weight
50	30.62	0.87	5.80	0.17	0.62	0.93	1.24
63	41.69	1.13	8.10	0.17	1.08	1.62	2.16

Calculation: (Example) **MY1HT50-400L**

- Basic weight30.62 kg
 - Additional weight0.87/25 st
 - L unit weight0.62 kg
 - Cylinder stroke..... 400 st
- 30.62 + 0.87 x 400 + 25 + 0.62 x 2 = 45.8

Refer to pages 1331 to 1333-1 for the specifications with auto switch.

MY1HT Series

Cushion Capacity

Cushion Selection

<Stroke adjustment unit with built-in shock absorber>

L unit

Use this unit when the cylinder stroke is outside of the effective air cushion range even if the load and speed are within the air cushion limit line, or when the cylinder is operated in a load and speed range above the air cushion limit line or below the L unit limit line.

H unit

Use this unit when the cylinder is operated in a load and speed range above the L unit limit line and below the H unit limit line.

Stroke Adjustment Unit Absorption Capacity

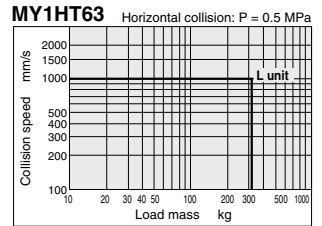
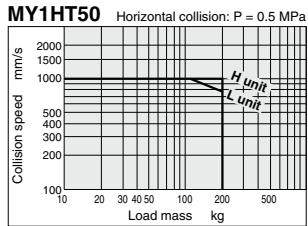

Precautions

For details on the MY1HT Series Mechanically Jointed Rodless Cylinder, refer to "Specific Product Precautions" on pages 1335 to 1337.

MY1HT Series

Construction

Standard type

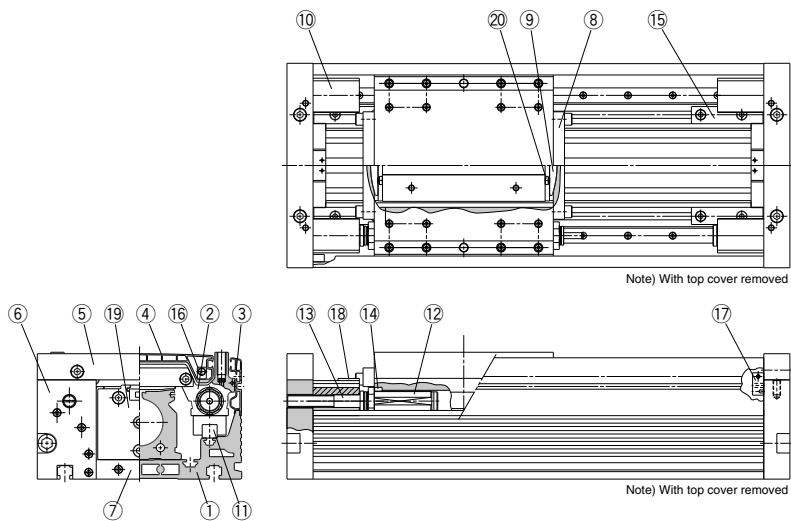

Component Parts

No.	Description	Material	Note
1	Guide frame	Aluminum alloy	Hard anodized
2	Slide table	Aluminum alloy	Hard anodized
3	Side cover	Aluminum alloy	Hard anodized
4	Top cover	Aluminum alloy	Hard anodized
5	Upper plate	Aluminum alloy	Hard anodized
6	End plate	Aluminum alloy	Hard anodized
7	Bottom plate	Aluminum alloy	Hard anodized
8	End cover	Aluminum alloy	Chromated
9	Coupler	Aluminum alloy	Chromated
10	Adjuster holder	Aluminum alloy	Hard anodized
11	Guide	—	
12	Shock absorber	—	
13	Stopper bolt	Carbon steel	Nickel plated
14	Absorber ring	Rolled steel	Nickel plated
15	End support	Aluminum alloy	Hard anodized
16	Top block	Aluminum alloy	Chromated
17	Side block	Aluminum alloy	Chromated
18	Slide plate	Special resin	
19	Rodless cylinder	—	MY1BH
20	Stopper	Carbon steel	Nickel plated

Mechanically Jointed Rodless Cylinder High Rigidity/Linear Guide Type **MY1HT Series**

Standard Type/Centralized Piping Type $\varnothing 50, \varnothing 63$

MY1HT50□/63□ — **Stroke**

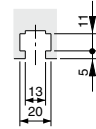
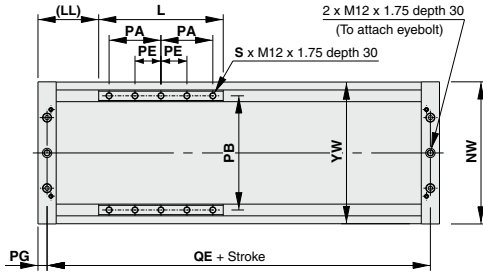

Applicable nut JIS B 1163
Square nut M12

Dimensions of T-slot for mounting

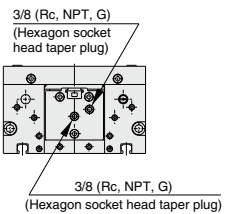
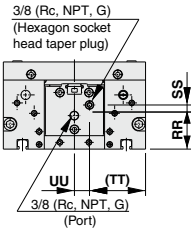

MY1HT□G

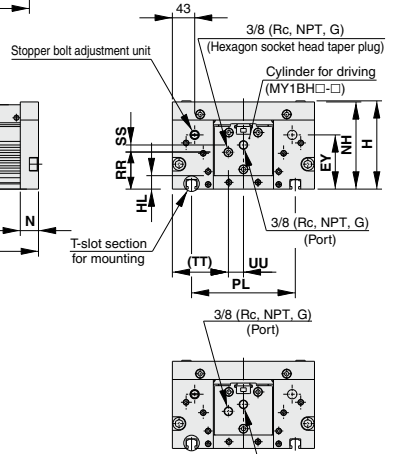

MY1HT□G

Model	A	EY	H	HL	L	LL	N	NH	NW	PA	PB	PE	PG
MY1HT50□	207	97.5	145	23	210	102	30	143	254	90	200	-	15
MY1HT63□	237	104.5	170	26	240	117	35	168	274	100	220	50	17.5

Model	PL	QE	RR	S	SS	TT	UU	YH	YW	Z
MY1HT50□	180	384	57	6	10	103.5	23.5	136.4	253	414
MY1HT63□	200	439	71.5	10	13.5	108	29	162.6	273	474

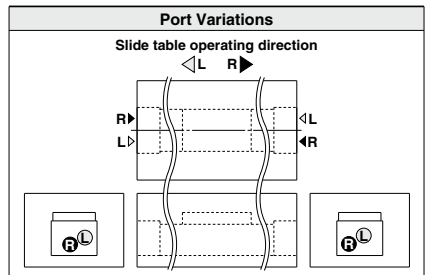

MY1HT Series

Side Support

Side support A MY-S63A

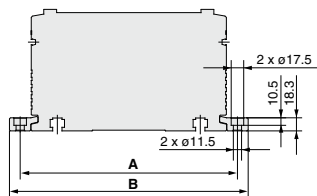
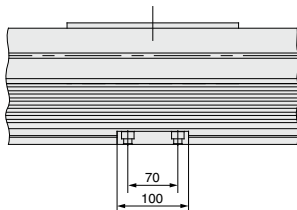

Side support B MY-S63B

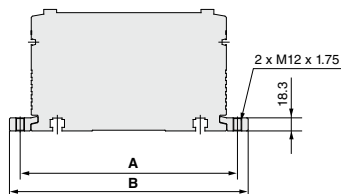
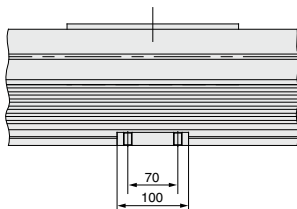

Dimensions

		(mm)	
Model	Applicable bore size	A	B
MY-S63 ^A _B	MY1HT50	284	314
	MY1HT63	304	334

* A set of side supports consists of a left support and a right support.

Guide for Side Support Application

For long stroke operation, the cylinder tube may be deflected depending on its own weight and the load mass. In such a case, use a side support in the middle section. The spacing (L) of the support must be no more than the values shown in the graph on the right.

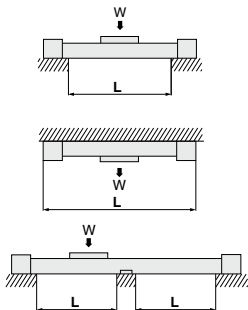

⚠ Caution

1. If the cylinder mounting surfaces are not measured accurately, using a side support may cause poor operation. Therefore, be sure to level the cylinder tube when mounting. Also, for long stroke operation involving vibration and impact, use of a side support is recommended even if the spacing value is within the allowable limits shown in the graph.
2. Support brackets are not for mounting; use them solely for providing support.

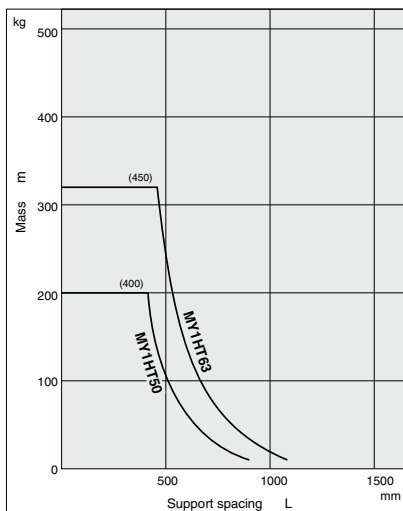

MY1 Series

Auto Switch Mounting

Proper Auto Switch Mounting Position (Detection at stroke end)

MY1B (Basic type)

ø10 to 20

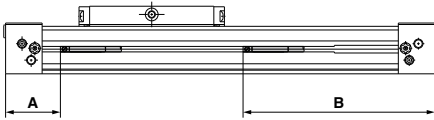

ø25 to ø100

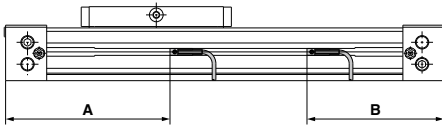

MY1M (Slide bearing guide type)

ø16, ø20

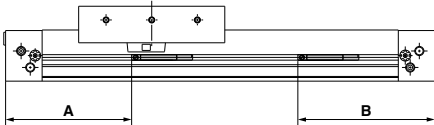

ø25 to ø63

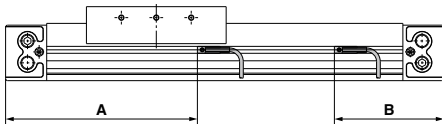

MY1C (Cam follower guide type)

ø16, ø20

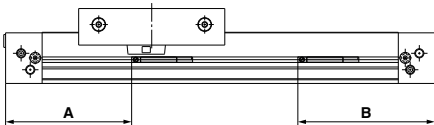

ø25 to ø63

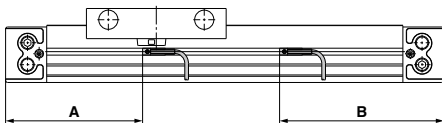

Proper Auto Switch Mounting Position (mm)

Auto switch model	D-M9□		D-A9□		D-Y59□/Y7P	
	A	B	A	B	A	B
Bore size						
10	24	86	20	90	—	—
16	31.5	128.5	27.5	132.5	—	—
20	39	161	35	165	—	—
25	138	82	107	82	—	—
32	186.5	93.5	159	93.5	—	—
40	222.5	170	186	170	—	—
50	—	—	—	—	272.5	127.5
63	322.5	137.5	—	—	317.5	142.5
80	489.5	200.5	—	—	484.5	205.5
100	574.5	225.5	—	—	569.5	230.5

Note 1) D-M9□□□ type cannot be mounted on ø50.

Note 2) Adjust the auto switch after confirming the operating condition in the actual setting.

Proper Auto Switch Mounting Position (mm)

Auto switch model	D-M9□		D-A9□		D-Y59□/Y7P	
	A	B	A	B	A	B
Bore size						
16	74	86	70	90	—	—
20	94	106	90	110	—	—
25	143.5	75.5	—	—	139.5	80.5
32	189.5	90.5	—	—	184.5	95.5
40	234.5	105.5	—	—	229.5	110.5
50	283.5	116.5	—	—	278.5	121.5
63	328.5	131.5	—	—	323.5	136.5

Note) Adjust the auto switch after confirming the operating condition in the actual setting.

Proper Auto Switch Mounting Position (mm)

Auto switch model	D-M9□		D-A9□		D-Y59□/Y7P	
	A	B	A	B	A	B
Bore size						
16	74	86	70	90	—	—
20	94	106	90	110	—	—
25	102	118	—	—	97	123
32	132	148	—	—	127	153
40	162.5	175.5	—	—	157.5	182.5
50	283.5	116.5	—	—	278.5	121.5
63	328.5	131.5	—	—	323.5	136.5

Note) Adjust the auto switch after confirming the operating condition in the actual setting.

MY1 Series

Proper Auto Switch Mounting Position (Detection at stroke end)

MY1H (Linear guide type)

ø10 to ø20

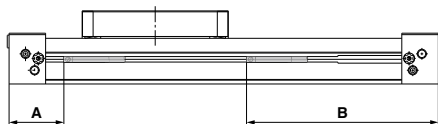

Proper Auto Switch Mounting Position (mm)

Auto switch model	D-M9□ D-M9□V D-M9□W D-M9□WV D-M9□A D-M9□AV		D-A9□ D-A9□V		D-Y59□/Y7P D-Y69□/Y7PV D-Y7□W D-Y7□WV D-Z7□/Z80	
	A	B	A	B	A	B
Bore size 10	24	86	20	90	—	—
16	31.5	128.5	27.5	132.5	—	—
20	39	161	35	165	—	—
25	46.5	99.5	42.5	95.5	—	—
32	54	124	50	120	—	—
40	61.5	146.5	57.5	142.5	—	—

Note) Adjust the auto switch after confirming the operating condition in the actual setting.

MY1HT (High rigidity/Linear guide type)

ø50, ø63

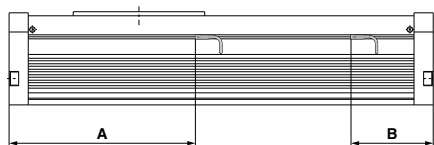

Proper Auto Switch Mounting Position (mm)

Auto switch model	D-Y59□/Y7P D-Y69□/Y7PV D-Y7□W D-Y7□WV D-Y7BA D-Z7□/Z80	
	A	B
Bore size 50	290.5	123.5
63	335.5	138.5

Note) Adjust the auto switch after confirming the operating condition in the actual setting.

Operating Range

(Note) Since this is a guideline including hysteresis, not meant to be guaranteed. (Assuming approximately ±30% dispersion.)
There may be the case it will vary substantially depending on an ambient environment.

MY1B (Basic type) (mm)

Auto switch model	Bore size									
	10	16	20	25	32	40	50	63	80	100
D-M9□/M9□V										
D-M9□W/M9□WV	3.5	4	5.5	5.0	5.5	5.5	—	12	12	11.5
D-M9□A/M9□AV										
D-A9□/A9□V	6	6.5	8.5	7.0	10.0	9.0	—	—	—	—
D-Z7□/Z80	—	—	—	—	—	—	11.5	11.5	11.5	11.5
D-Y59□/Y69□	—	—	—	—	—	—	3.5	3.5	3.5	3.5
D-Y7□/Y7□V	—	—	—	—	—	—	—	—	—	—

D-M9□□ type cannot be mounted on ø50.

MY1M (Slide bearing guide type) (mm)

Auto switch model	Bore size						
	16	20	25	32	40	50	63
D-M9□/M9□V							
D-M9□W/M9□WV	7.5	7.5	8.5	8.5	9.5	7	6
D-M9□A/M9□AV							
D-A9□/A9□V	11	7.5	—	—	—	—	—
D-Z7□/Z80	—	—	12	12	12	11.5	11.5
D-Y59□/Y69□	—	—	5	5	5	5.5	5.5
D-Y7P/Y7PV	—	—	—	—	—	—	—
D-Y7□W/Y7□WV	—	—	—	—	—	—	—

MY1C (Cam follower guide type) (mm)

Auto switch model	Bore size						
	16	20	25	32	40	50	63
D-M9□/M9□V							
D-M9□W/M9□WV	7.5	7.5	7	8	8.5	7	6
D-M9□A/M9□AV							
D-A9□/A9□V	11	7.5	—	—	—	—	—
D-Z7□/Z80	—	—	12	12	12	11.5	11.5
D-Y59□/Y69□	—	—	5	5	5	5.5	5.5
D-Y7P/Y7PV	—	—	—	—	—	—	—
D-Y7□W/Y7□WV	—	—	—	—	—	—	—

MY1H (Linear guide type) (mm)

Auto switch model	Bore size					
	10	16	20	25	32	40
D-M9□/M9□V						
D-M9□W/M9□WV	3	4.5	5	5.0	5.5	5.5
D-M9□A/M9□AV						
D-A9□/A9□V	11	6.5	8.5	7.0	10.0	9.0
D-Z7□/Z80	—	—	—	—	—	—
D-Y59□/Y69□	—	—	—	—	—	—
D-Y7P/Y7PV	—	—	—	—	—	—
D-Y7□W/Y7□WV	—	—	—	—	—	—

MY1HT

(High rigidity/Linear guide type) (mm)

Auto switch model	Bore size	
	50	63
D-Z7□/Z80	11	11
D-Y59□/Y69□	5	5
D-Y7P/Y7PV		
D-Y7□W/Y7□WV		
D-Y7BA		

MY1 Series

Auto Switch Mounting Bracket/Part No.

Auto switch model	Bore size (mm)	
	MY1B, MY1M, MY1C, MY1H	
	ø10 to ø20	ø25 to ø100
D-A9□/A9□V D-M9□/M9□V D-M9□W/M9□WV D-M9□A/M9□AV	—	BMG2-012

Note) D-A9□□ type cannot be mounted on ø50 to ø100 of the MY1B, and ø25 to ø63 of the MY1C and MY1M. D-M9□□□ type cannot be mounted on ø50 of the MY1B series.

Auto switch model	Bore size (mm)	
	MY1B-Z, MY1H-Z	
	ø25 to ø40	
D-A9□/A9□V D-M9□/M9□V D-M9□W/M9□WV D-M9□A/M9□AV	BMY3-016	

ø25 to ø100: M9□(V)/M9□W(V)/M9□A(V)

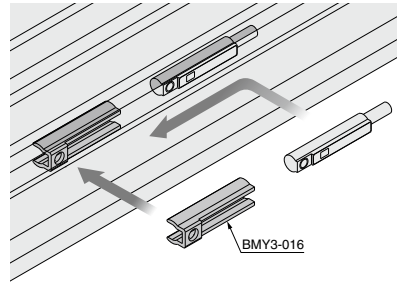
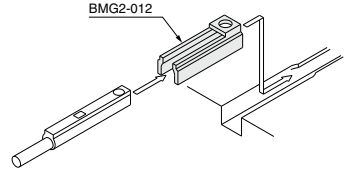

Switch Spacer No.

Cylinder series	Applicable bore size (mm)	
	50	63
MY1HT	BMP1-032	

When attaching an auto switch, first take a switch spacer between your fingers and press it into a switch mounting groove. When doing this, confirm that it is set in the correct mounting orientation, or reattach if necessary.

Next, insert an auto switch into the groove and slide it until it is positioned under the switch spacer.

After establishing the mounting position, use a watchmaker's flat head screwdriver to tighten the auto switch mounting screw which is included.

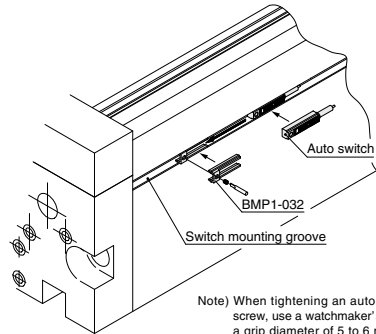
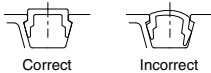

Note) When tightening an auto switch mounting screw, use a watchmaker's screwdriver with a grip diameter of 5 to 6 mm. Also, tighten with a torque of about 0.05 to 0.1 N·m. As a guide, it should be turned about 90° past the point at which tightening can be felt.

Besides the models listed in How to Order, the following auto switches are applicable.

For detailed specifications, refer to pages 1575 to 1701.

Type	Model	Electrical entry (Fetching direction)	Features	Applicable bore size
Solid state auto switch	D-Y69A, Y69B, Y7PV	Grommet (Perpendicular)	—	ø25 to ø100
	D-Y7NWV, Y7PWV, Y7BWV		Diagnostic indication (2-color indicator)	
	D-Y59A, Y59B, Y7P	Grommet (In-line)	—	
	D-Y7NW, Y7PW, Y7BW		Diagnostic indication (2-color indicator)	

* For solid state auto switches, auto switches with a pre-wired connector are also available. Refer to pages 1648 and 1649 for details.

* Normally closed (NC = b contact) solid state auto switches (D-F9G/F9H/Y7G/Y7H types) are also available. Refer to pages 1593 and 1595 for details.



MY1 Series

Specific Product Precautions 1

Be sure to read this before handling the products.

Refer to back page 50 for Safety Instructions and pages 3 to 12 for Actuator and Auto Switch Precautions.

Selection

⚠ Caution

1. When using a cylinder with long strokes, implement an intermediate support.

When using a cylinder with long strokes, implement an intermediate support to prevent the tube from sagging and being deflected by vibration or an external load.

Refer to the Guide for Side Support Application on pages 1252, 1275, 1295, 1316 and 1330.

2. For intermediate stops, use a dual-side pressure control circuit.

Since the mechanically jointed rodless cylinders have a unique seal structure, slight external leakage may occur. Controlling intermediate stops with a 3 position valve cannot hold the stopping position of the slide table (slider). The speed at the restarting state also may not be controllable. Use the dual-side pressure control circuit with a PAB-connected 3 position valve for intermediate stops.

3. Constant speed.

Since the mechanically jointed rodless cylinders have a unique seal structure, a slight speed change may occur. For applications that require constant speed, select an applicable equipment for the level of demand.

4. Load factor of 0.5 or less

When the load factor is high against the cylinder output, it may adversely affect the cylinder (condensation, etc.) and cause malfunctions. Select a cylinder to make the load factor less than 0.5. (Mainly when using an external guide)

5. Cautions on less frequent operation

When the cylinder is used extremely infrequently, operation may be interrupted in order for anchoring and a change lubrication to be performed or service life may be reduced.

6. Consider uncalculated loads such as piping, cableveyor, etc., when selecting a load moment

Calculation does not include the external acting force of piping, cableveyor, etc. Select load factors taking into account the external acting force of piping, cableveyor, etc.

7. Accuracy

The mechanical jointed rodless cylinder does not guarantee traveling parallelism. When accuracy in traveling parallelism and a middle position of stroke is required, please consult SMC.

Mounting

⚠ Caution

1. Do not apply strong impacts or excessive moment to the slide table (slider).

• The slide table (slider) is supported by precision bearings (MY1C, MY1H) or resin bearings. Therefore, do not apply strong impacts or excessive moment, etc., when mounting workpieces.

Mounting

⚠ Caution

2. When connecting to a load which has an external guide mechanism, use a discrepancy absorption mechanism.

• Mechanically jointed rodless cylinders can be used with a direct load within the allowable range for each type of guide. Please note that careful alignment is necessary when connecting to a load having an external guide mechanism. Mount the external guide mounting brackets and floating brackets in a place where the required degree of freedom for the floating Y and Z axes can be secured.

The thrust transmission area of the floating bracket must be fixed so that it does not partially contact the body.

* Refer to the Coordinates and Moment in Model Selection on page 1229 for the details of floating Y and Z axes.

3. Do not mount cylinders as they are twisted.

When mounting, be sure for a cylinder tube not to be twisted. The flatness of the mounting surface is not appropriate, the cylinder tube is twisted, which may cause air leakage due to the detachment of a seal belt, damage a dust seal band, and cause malfunctions.

4. Do not mount a slide table on the fixed equipment surface.

It may cause damage or malfunctions since an excessive load is applied to the bearing.

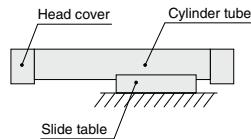

Mounting with a slide table (slider)

5. Consult SMC when mounting in a cantilevered way.

Since the cylinder body deflects, it may cause malfunctions. Please consult SMC when using it this way.

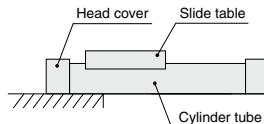

Mounting in a cantilevered way

6. Fixed parts of the cylinder on both ends must have at least 5 mm of contact between where the end of the cylinder tube and the equipment surface.

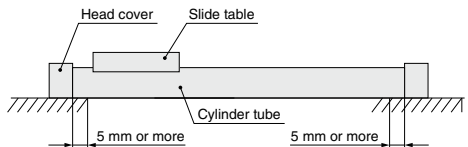



MY1 Series

Specific Product Precautions 2

Be sure to read this before handling the products.

Refer to back page 50 for Safety Instructions and pages 3 to 12 for Actuator and Auto Switch Precautions.

Mounting

⚠ Caution

7. Do not generate negative pressure in the cylinder tube.

When the cylinder is in a non-pressurized state, such as during a test run, maintenance, etc., external or inertial force may cause negative pressure to be generated inside the cylinder. In such cases, the seal belt may come off, resulting in a temporary air leak.

• Examples:

- 1) When external force is used to move a slide table all at once during installation, a test run, etc.
- 2) When a vertically-mounted slide table carrying a load drops due to self-weight
(In either case, the smaller the speed controller's opening is set, the more likely negative pressure is to be generated.)

• For negative pressure prevention

When using external force to move a slide table, move it slowly and steadily at about 20 mm/s. (If the speed controller's opening is set extremely small, increase the opening only during manual operation.)

• If the seal belt comes off

If the seal belt comes off due to negative pressure and air is leaking, manually move the slide table from the beginning to the end of the cylinder's full stroke slowly and steadily at about 20 mm/s.

(If the speed controller's opening is set extremely small, increase the opening only during manual operation.)

If air continues to leak even after the above mentioned restoration methods have been tried, please contact your nearest sales office.

8. Do not unnecessarily alter the guide adjustment setting.

• The adjustment of the guide is preset and does not require readjustment under normal operating conditions. Therefore, do not unnecessarily alter the guide adjustment setting. However, series other than the MY1H Series can be readjusted and their bearings can be replaced.

To perform these operations, refer to the bearing replacement procedure given in the operation manual.

9. Do not get your hands caught during cylinder operation.

For the cylinder with a stroke adjustment unit, the space between the slide table and stroke adjustment unit is very small, and your hands may get caught. When operating without a protective cover, be careful not to get your hands caught.

10. Do not use a shock absorber together with air cushion.

11. Secure the holding bolt as shown in the diagram below.

<ø10 to ø63>

Installation of Holding Bolts

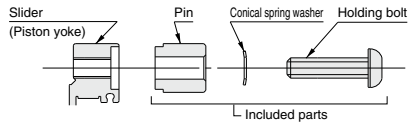

Tightening Torque for Holding Bolts (N·m)

Part no.	Tightening torque	Part no.	Tightening torque	Part no.	Tightening torque
MY-J10	0.6	MY-J25	3	MY-J50	5
MY-J16	1.5	MY-J32	5	MY-J63	13
MY-J20	1.5	MY-J40	5		

<ø80 to ø100>

Installation of Hexagon Socket Head Cap Screw

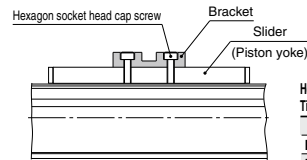

Hexagon Socket Head Cap Screw

Part no.	Tightening torque
MY-J 80	25
MY-J100	44

12. Refer to the figure below when using the adjustment bolt to perform stroke adjustment.

When the effective stroke of the shock absorber decreases as a result of stroke adjustment, the absorption capacity decreases dramatically. Secure the adjustment bolt at the position where it protrudes approximately 0.5 mm from the shock absorber.

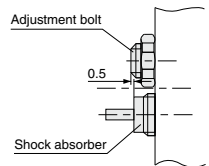



MY1 Series

Specific Product Precautions 3

Be sure to read this before handling the products.

Refer to back page 50 for Safety Instructions and pages 3 to 12 for Actuator and Auto Switch Precautions.

Mounting

⚠ Caution

13. Tightening Torque for Stroke Adjustment Unit (Lock Plate) Holding Bolts

Use caution not to get your hands caught in the unit.

When using a product with stroke adjustment unit, the space between the slide table (slider) and the stroke adjustment unit becomes narrow at the stroke end, causing a danger of hands getting caught. Install a protective cover to prevent direct contact with the human body.

<Fastening of unit>

The unit can be secured by evenly tightening the four unit holding bolts.

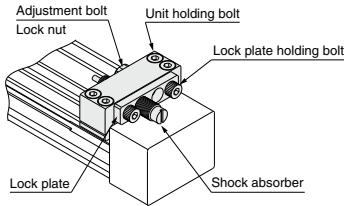

Caution

Do not operate with the stroke adjustment unit fixed in an intermediate position. When the stroke adjustment unit is fix in an intermediate position, slippage can occur depending on the amount of energy released at the time of an impact. In such cases, as a stroke adjustment unit with the spacer for intermediate securing is available, it is recommended to use it. (MY1B: Excludes $\sigma 10$)

For other lengths, please consult with SMC (Refer to "Tightening Torque for Stroke Adjustment Unit Holding Bolts".)

<Stroke adjustment with adjustment bolt>

Loosen the adjustment bolt lock nut, and adjust the stroke from the lock plate side using a hexagon wrench. Retighten the lock nut.

<Stroke adjustment with shock absorber>

Loosen the two lock plate holding bolts, turn the shock absorber and adjust the stroke. Then, uniformly tighten the lock plate holding bolts to secure the shock absorber.

Take care not to over-tighten the holding bolts. (MY1B: Excludes $\sigma 10$, $\sigma 20$ L unit, MY1M/C: Excludes $\sigma 16$, $\sigma 20$, $\sigma 50$, and $\sigma 63$) (Refer to "Tightening Torque for Stroke Adjustment Unit Lock Plate Holding Bolts".)

Note) Although the lock plate may slightly bend due to tightening of the lock plate holding bolt, this does not affect the shock absorber and locking function.

<MY1B>

Tightening Torque for Stroke Adjustment Unit Holding Bolts (N·m)

Bore size (mm)	Unit	Tightening torque
10	A	0.4
	H	
25	A	3.5
	L	
	H	
32	A	5.8
	L	
	H	
40	A	13.8
	L	
	H	
	H	

Tightening Torque for Stroke Adjustment Unit Lock Plate Holding Bolts (N·m)

Bore size (mm)	Unit	Tightening torque
20	H	1.2
	L	1.2
25	L	3.3
	H	3.3
32	L	3.3
	H	10
40	L	3.3
	H	10

<MY1M, MY1C>

Tightening Torque for Stroke Adjustment Unit Holding Bolts (N·m)

Bore size (mm)	Unit	Tightening torque
16	A	0.7
	L	
20	A	1.8
	L	
	H	
25	A	3.5
	L	
	H	
32	A	5.8
	L	
	H	
40	A	13.8
	L	
	H	
50	A	13.8
	L	
	H	
63	A	27.5
	L	
	H	

Tightening Torque for Stroke Adjustment Unit Lock Plate Holding Bolts (N·m)

Bore size (mm)	Unit	Tightening torque
25	L	1.2
	H	3.3
32	L	3.3
	H	10
40	L	3.3
	H	10



MY1 Series

Specific Product Precautions 4

Be sure to read this before handling the products.

Refer to back page 50 for Safety Instructions and pages 3 to 12 for Actuator and Auto Switch Precautions.

Mounting

⚠ Caution

<MY1H>

To adjust the stroke adjustment unit of the MY1H10, follow the step shown below.

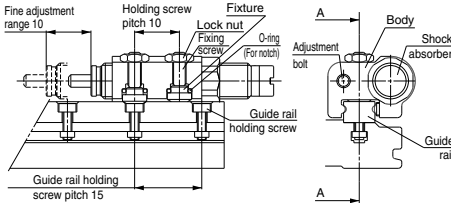

Section A-A

Adjusting Procedure

1. Loosen the two lock nuts, and then loosen the holding screws by turning them approximately two turns.
2. Move the body to the notch just before the desired stroke. (The notches are found in alternating increments of 5 mm and 10 mm.)
3. Tighten the holding screw to 0.3 N·m. Make sure that the tightening does not cause excessive torque.

The fixture fits into the fastening hole in the guide rail to prevent slippage, which enables fastening with low torque.

4. Tighten the lock nut to 0.6 N·m.
5. Make fine adjustments with the adjustment bolt and shock absorber.

Tightening Torque for Stroke Adjustment Unit Holding Bolts (N·m)

Bore size (mm)	Tightening torque
10	Refer to "Adjusting Procedure" above.
16	0.7
20	1.8
25	1.8
32	3.5
40	5.8

14. Use the formula below to calculate the absorbed energy of the stroke adjustment unit with shock absorber.

(N·m)

Type of impact	Horizontal collision	Vertical (Downward)	Vertical (Upward)
Kinetic energy E_1	$\frac{1}{2} m \cdot v^2$		
Thrust energy E_2	$F \cdot s$	$F \cdot s + m \cdot g \cdot s$	$F \cdot s - m \cdot g \cdot s$
Absorbed energy E	$E_1 + E_2$		

Symbol

v: Speed of impact object (m/s)

F: Cylinder thrust (N)

s: Shock absorber stroke (m)

m: Mass of impact object (kg)

g: Gravitational acceleration (9.8 m/s²)

Note) The speed of the impact object is measured at the time of impact with the shock absorber.

Operating Environment

⚠ Warning

1. Do not use in an environment where the cylinder is exposed to coolant, cutting oil, water drops, adhesive foreign particles, dust, etc. and avoid use with compressed air containing drainage and foreign particles.

• Foreign matter or liquids on the cylinder's interior or exterior can wash out the lubricating grease, which can lead to deterioration and damage of dust seal band and seal materials, causing a danger of malfunction.

When operating in locations with exposure to water and oil, or in dusty locations, provide protection such as a cover to prevent direct contact with the cylinder, or mount so that the dust seal band surface faces downward, and operate with clean compressed air.

2. Carry out cleaning and grease application suitable for the operating environment.

Carry out cleaning regularly when using in an operating environment in which the product is likely to get dirty.

After cleaning, be sure to apply grease to the top side of the cylinder tube and the rotating part of the dust seal band. Apply grease to these parts regularly even if not after cleaning. Please consult SMC for the cleaning of the slide table (slider) interior and grease application.

3. The product is not designed for clean room usage.

If clean room usage is considered, please consult with SMC.

Service Life and Replacement Period of Shock Absorber

⚠ Caution

1. Allowable operating cycle under the specifications set in this catalog is shown below.

1.2 million times RB08□□

2 million times RB10□□ to RB2725

Note) Specified service life (suitable replacement period) is the value at room temperature (20 to 25°C). The period may vary depending on the temperature and other conditions. In some cases the absorber may need to be replaced before the allowable operating cycle above.



MY1H Series

Specific Product Precautions 5

Be sure to read this before handling the products. Refer to back page 50 for Safety Instructions and pages 3 to 12 for Actuator and Auto Switch Precautions.

MY1H: With End Lock

Recommended Pneumatic Circuit

⚠ Caution

This is necessary for the correct locking and unlocking actions.

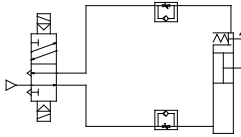

Operating Precautions

⚠ Caution

1. Do not use 3-position solenoid valves.

Avoid use in combination with 3-position solenoid valves (especially closed center metal seal types). If pressure is trapped in the port on the lock mechanism side, the cylinder cannot be locked.

Furthermore, even after being locked, the lock may be released after some time due to air leaking from the solenoid valve and entering the cylinder.

2. Back pressure is required when releasing the lock.

Before starting operation, be sure to control the system so that air is supplied to the side without the lock mechanism (in case of locks on both ends, the side where the slide table is not locked) as shown in the figure above. There is a possibility that the lock may not be released. (Refer to "Lock Release.")

3. Release the lock when mounting or adjusting the cylinder.

If mounting or other work is performed when the cylinder is locked, the lock unit may be damaged.

4. Operate at 50% or less of the theoretical output.

If the load exceeds 50% of the theoretical output, this may cause problems such as failure of the lock to release, or damage to the lock unit.

5. Do not operate multiple cylinders in synchronization.

Avoid applications in which two or more end lock cylinders are synchronized to move one workpiece, as one of the cylinder locks may not be able to release when required.

6. Use a speed controller with meter-out control.

Lock cannot be released occasionally by meter-in control.

7. Be sure to operate completely to the cylinder stroke end on the side with the lock.

If the cylinder piston does not reach the end of the stroke, locking and unlocking may not be possible. (Refer to "End Lock Mechanism Adjustment.")

Operating Pressure

⚠ Caution

1. Supply air pressure of 0.15 MPa or higher to the port on the side that has the lock mechanism, as it is necessary for disengaging the lock.

Exhaust Speed

⚠ Caution

1. Locking will occur automatically if the pressure applied to the port on the lock mechanism side falls to 0.05 MPa or less. In the cases where the piping on the lock mechanism side is long and thin, or the speed controller is separated at some distance from the cylinder port, the exhaust speed will be reduced. Take note that some time may be required for the lock to engage. In addition, clogging of a silencer mounted on the solenoid valve exhaust port can produce the same effect.

Relation to Cushion

⚠ Caution

1. When the air cushion on the lock mechanism side is in a fully closed or nearly closed state, there is a possibility that the slide table will not reach the stroke end, in which case locking will not occur.

End Lock Mechanism Adjustment

⚠ Caution

1. The end lock mechanism is adjusted at the time of shipping. Therefore, adjustment for operation at the stroke end is unnecessary.
2. Adjust the end lock mechanism after the stroke adjustment unit has been adjusted. The adjustment bolt and shock absorber of the stroke adjustment unit must be adjusted and secured first. Locking and unlocking may not occur otherwise.
3. Perform fine adjustment of the end lock mechanism as follows. Loosen the lock finger holding bolts, and then adjust by aligning the center of the lock piston with the center of the lock finger hole. Secure the lock finger.

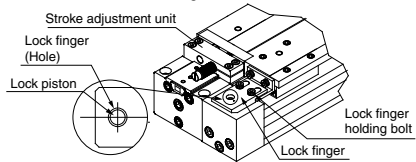

Lock Release

⚠ Warning

1. Before releasing the lock, be sure to supply air to the side without the lock mechanism, so that there is no load applied to the lock mechanism when it is released. (Refer to "Recommended Pneumatic Circuit.") If the lock is released when the port on the side without the lock is in an exhaust state, and with a load applied to the lock unit, the lock unit may be subjected to an excessive force and be damaged. Furthermore, sudden movement of the slide table is very dangerous.

Manual Release

⚠ Caution

1. When manually releasing the end lock, be sure to release the pressure.

If it is unlocked while the air pressure still remains, it will lead to damage a workpiece, etc. due to unexpected lurching.

2. Perform manual release of the end lock mechanism as follows.

Push the lock piston down with a screwdriver, etc., and move the slide table.

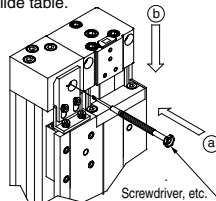

Other handling precautions regarding mounting, piping and environment are the same as the standard series.



MY1HT Series

Specific Product Precautions 6

Be sure to read this before handling the products.

Refer to back page 50 for Safety Instructions and pages 3 to 12 for Actuator and Auto Switch Precautions.

MY1HT

Mounting

⚠ Caution

- Do not put hands or fingers inside when the body is suspended. Since the body is heavy, use eye bolts when suspending it. (The eye bolts are not included with the body.)

Stroke Adjustment Method

⚠ Caution

- As shown in Figure (1), to adjust the stopper bolt within the adjustment range A, insert a hexagon wrench from the top to loosen the hexagon socket head set screw by approximately one turn, and then adjust the stopper bolt with a flat head screwdriver.

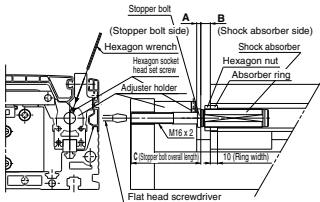

Figure (1) Stroke adjusting section detail

Stopper Bolt Holding Screw Tightening Torque

Stopper Bolt

Tightening Torque for Stroke Adjustment Unit Lock Plate Holding Bolts (N·m)

Bore size (mm)	Tightening torque
50	0.6
63	1.5

- When the adjustment described in 1 above is insufficient, the shock absorber can be adjusted. Remove the covers as shown in Figure (2) and make further adjustment by loosening the hexagon nut.

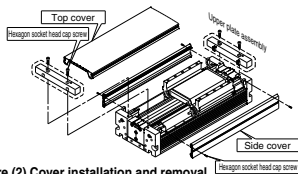

Figure (2) Cover installation and removal

- Various dimensions are indicated in Table (1). Never make an adjustment that exceeds the dimensions in the table, as it may cause an accident and/or damage.

Bore size (mm)	50	63
A to A _{MAX}	6 to 26	6 to 31
B to B _{MAX}	14 to 54	14 to 74
C	87	102
Max adjustment range	60	85

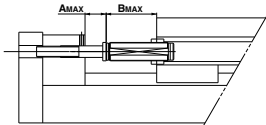

Figure (3) Maximum stroke adjustment detail

Disassembly and Assembly Procedure

⚠ Caution

Disassembly step

- Remove the hexagon socket head cap screws 1, and remove the upper plates.
- Remove the top cover.
- Remove the hexagon socket head cap screws 2, and remove the end covers and couplers.
- Remove the hexagon socket head cap screws 3.
- Remove the hexagon socket head cap screws 4, and remove the end supports.
- Remove the cylinder.

Assembly step

- Insert the MY1BH cylinder.
- Temporarily fasten the end supports with the hexagon socket head cap screws 4.
- With two hexagon socket head cap screws 3 on the L or R side, pull the end support and the cylinder.
- Tighten the hexagon socket head cap screws 3 on the other side to eliminate the looseness in the axial direction. (At this point, a space is created between the end support and the end plate on one side, but this is not a problem.)
- Re-tighten the hexagon socket head cap screws 4.
- Fasten the end cover with the hexagon head cap screws 2, while making sure that the coupler is in the right direction.
- Place the top cover on the body.
- Insert the holding blocks into the top cover and fasten the upper plates with the hexagon socket head cap screws 1.

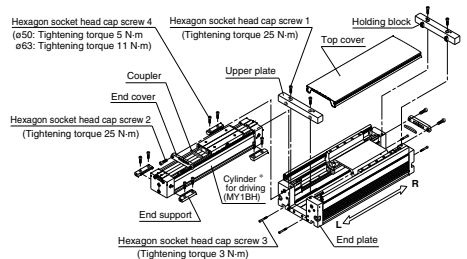

* Cylinder For Driving (MY1BH Series)

Since the MY1BH series is a cylinder for driving for the MY1HT series, its construction is different from the MY1B series. Do not use the MY1B series as a cylinder for driving, since it will lead to damage.

How to Order

High rigidity/Linear guide type MY1HT 50 □ □ □ - 300 L - Z73 □ □

Cylinder for driving MY1BH 50 □ □ □ - 300

Bore size ↓ Stroke (mm)

50	50 mm	Piping	Nil Standard type
63	63 mm		

Symbol	Type	Bore size
Nil	Rc	
TN	NPT	ø50, ø63
TF	G	