

Low Torque Rotary Joint

MQR Series

Metal Seal Type

RoHS

Long service life

1 billion rotations

MQR1 : 1 billion rotations

MQR2 : 0.5 billion rotations

MQR4 : 0.3 billion rotations

MQR8 : 0.2 billion rotations

MQR12: 0.1 billion rotations

MQR16: 0.1 billion rotations

※ Under SMC's life test conditions.

Low rotational torque

0.003 to 0.50 N·m or less

Allowable RPM

200 to 3000 min⁻¹ (rpm)

Operating temperature

-10 to 80°C

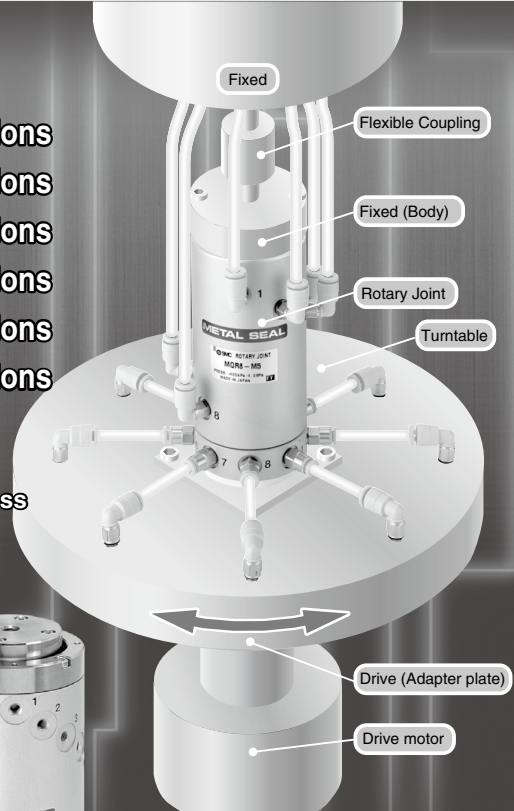

Application of adapter plate drive

※ Not suitable for transmission of drive



KQ2
KQB2
KS
KX
KM
KF
M
H/DL
L/LL
KC
KK
KK130
DM
KDM
KB
KR
KA
KQG2
KG
KFG2
MS
KKA
KP
LQ
MQR
T
IDK

Low Torque Metal Seal Type
Rotary Joint

MQR Series



Rotational torque unaffected by supply pressure and temperature fluctuations

Use of metal seals prevents the spool from sticking to the rotating surface even after a long period of non-operation.

Operating pressure **-100 kPa to 1 MPa**

Piping ports are aligned in a spiral line for easy piping

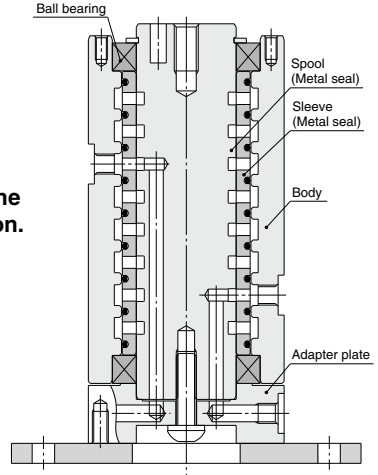

Applications: Air supply to rotary/pivot shafts of turntables and robot arms

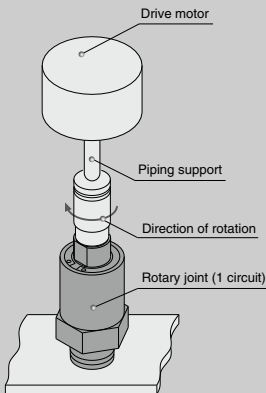

Example of 1 circuit

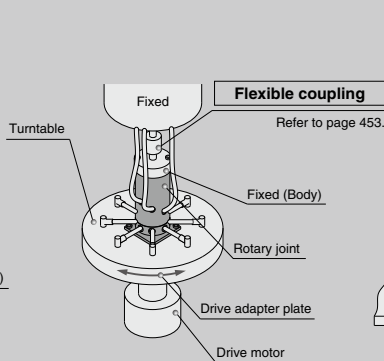

Example of adapter plate drive

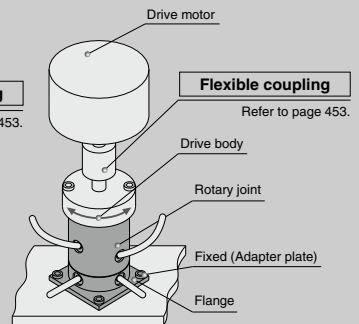

Example of body drive

* This series cannot be used for drive transmission. (Refer to page 453.)

Made to Order

- Contact SMC if you wish to use rotary joints at temperatures outside the range of -10°C to 80°C or to have joints made with 20 circuits or more or a through hole specification.

Metal Seal Type

Low Torque Rotary Joint

MQR Series

RoHS

1 circuit, 2 circuits, 4 circuits, 8 circuits, 12 circuits, 16 circuits

How to Order

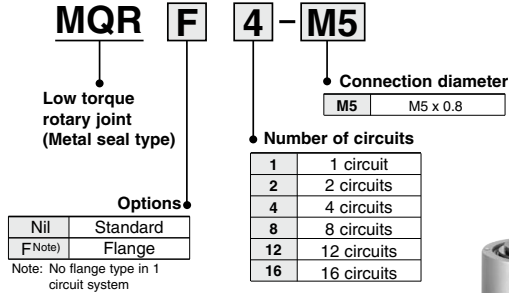

Options/Mounting Bracket

Number of circuits	Flange part number
2 circuits	MQR2-F
4 circuits	MQR4-F
8 circuits	MQR8-F
12 circuits	MQR12-F
16 circuits	MQR16-F



Specifications

Model	MQR1-M5	MQR2-M5	MQR4-M5	MQR8-M5	MQR12-M5	MQR16-M5
Number of circuits (Number of ports)	1	2	4	8	12	16
Fluid	Air					
Seal structure	Metal seal					
Guide structure	Bearing supported	Bearing supported at both ends				
Port size	Male R 1/8		M5 x 0.8			
	Female M5 x 0.8					
Flow rate characteristics	C	0.50 [dm ³ /(s·bar)]				
	b	0.40				
	Cv	0.17				
Lubrication	Not required					
Min. operating pressure	-100 kPa					
Max. operating pressure	1.0 MPa					
Ambient temperature and operating fluid temperature ^{Note 1)}	-10 to 80°C					
Maximum start-up rotation torque ^{Note 2)}	0.003 N·m or less	0.03 N·m or less	0.05 N·m or less	0.10 N·m or less	0.20 N·m or less	0.50 N·m or less
Allowable rotation number ^{Note 5)}	3000 min ⁻¹ (rpm) or less ^{Note 3)}	2000 min ⁻¹ (rpm) or less	1500 min ⁻¹ (rpm) or less	900 min ⁻¹ (rpm) or less	600 min ⁻¹ (rpm) or less	200 min ⁻¹ (rpm) or less
Allowable radial load (allowable coupling axis reaction) ^{Note 4)}	1 N or less	15 N or less	30 N or less	40 N or less	50 N or less	50 N or less
Allowable axial load						
Weight	0.025 kg	0.16 kg	0.39 kg	0.76 kg	1.26 kg	2.80 kg

Note 1) The temperature 80°C includes temperature rise during rotation.

Note 2) The start-up torque does not change with the supply pressure or with non-use (remains within the maximum start-up rotation torque), but it does change with the rotation number. (Refer to page 450).

Note 3) If using at a speed above 600 min⁻¹ (r.p.m.), ensure rotation is in the direction in which the joint is fastened.

Note 4) Rubber / resin couplings are recommended due to their excellent absorption of off center, shocks, and vibrations.

Note 5) min⁻¹: Number of rotations per 1 minute

KQ2
KQB2
KS
KX
KM
KF
M
H/DL
L/LL
KC
KK
KK130
DM
KDM
KB
KR
KA
KQG2
KG
KFG2
MS
KKA
KP
LQ
MQR
T
IDK

MQR Series

Construction

MQR1-M5

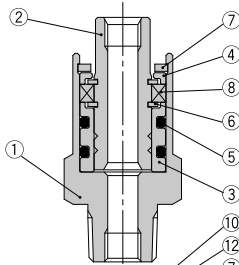

MQR2 to 16-M5

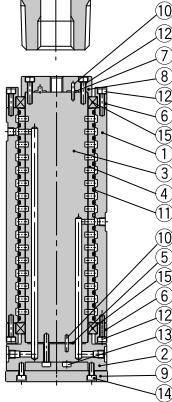

Leakage according to differential pressure

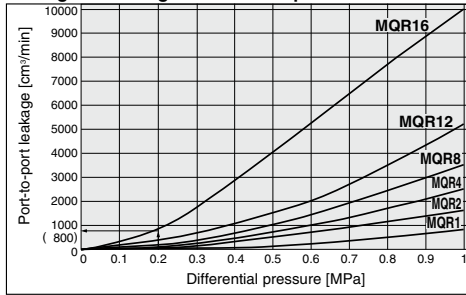

Note) These values show reference values and are not guaranteed.

Temperature rise with rotation number

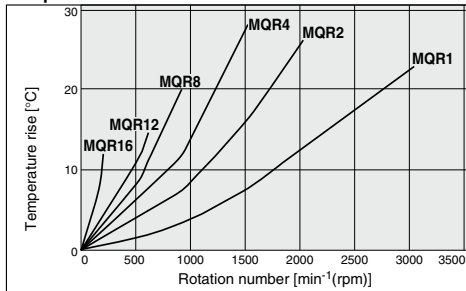

Note: Value when no pressure applied. Temperature rise is reduced by supply of air.

Note: These values show reference values and are not guaranteed.

450

Component Parts/(MQR1 - M5, 1 circuit)

No.	Name	Material	Remarks
1	Body	Stainless steel	
2	Spool	Special stainless steel	
3	Sleeve	Special stainless steel	
4	Plate	Aluminium	
5	O-ring	H-NBR	
6	Retaining ring	Carbon steel	
7	Retaining ring	Carbon steel	
8	Radial bearing		

Component Parts/(MQR2 to 16 - M5, 2 to 16 circuits)

No.	Name	Material	Remarks
1	Body	Aluminum	
2	Adapter plate	Aluminum	
3	Spool	Special stainless steel	
4	Sleeve	Special stainless steel	
5	Gasket	H-NBR	
6	Bearing holder	Stainless steel	16 circuits only
7	Gasket	H-NBR	16 circuits only
8	Plate	Aluminum	16 circuits only
9	Flange	Aluminum	
10	Parallel pin	Carbon steel	Except for 2 circuits
11	O-ring	H-NBR	
12	Bolt	Carbon steel	16 circuits only
13	Bolt	Carbon steel	
14	Bolt	Carbon steel	
15	Radial bearing	—	

e.g.: If adjacent ports are connected to vacuum pressure of -0.1 MPa and positive pressure of 0.1 MPa in MQR16, then differential pressure is 0.2 MPa, and leakage is 800 (cm³/min).

Change in rotational torque with rotation number

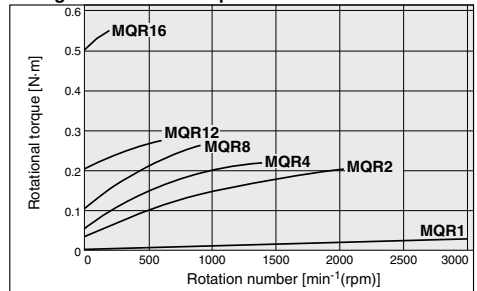

Note) These values show reference values and are not guaranteed.



MQR Series Rotary Joint/Precautions 1

Be sure to read this before handling the products.

Design

⚠ Warning

- A protective cover is recommended to minimize the risk of human injury.**
If a moving part poses a risk of human injury and/or damage to machinery/equipment, then a structure which prevents direct contact with that part should be adopted.
- Securely tighten all stationary parts and connected parts so that they will not become loose.**
Secure fastening is particularly important when the rotary joint has a high operating frequency.
- Provide safety devices in drive circuit.**
Collisions, or foreign material introduced by the air source, may cause scuffing or burning of rotating parts, which in turn leads to increased rotational torque. Install safety devices in the drive circuit accordingly.
- Pressure**
Air leakage occurs in these products. They cannot be used for pressure holding in pressure vessels, etc.
- Do not use in an emergency shutdown air circuit.**
These products are not designed for use in a safety circuit performing emergency shutdown. Other reliable safety protection means should be adopted for such systems.
- Ensure room for maintenance.**
Leave sufficient space for maintenance work.
- Releasing residual pressure.**
Provide a residual pressure release function in order to carry out maintenance work.
- Using vacuum supply.**
When using a vacuum air supply, install a suction filter, or equivalent, to prevent infiltration of dirt and foreign material via the absorption pad or exhaust port.

Selection

⚠ Warning

- Confirm the specifications.**
The products advertised in this catalog are designed according to use in industrial compressed air systems. If the products are used in conditions where pressure, temperature, etc., are out of specification, damage and/or malfunction may be caused. Do not use in these conditions. (Refer to specifications.)
- Do not use for power transmission.**
These products are not designed to be used as bearings for transmitting power from a drive source, such as a motor. Such use may lead to rotation faults, or damage.

Mounting

⚠ Warning

- Prevent impacts on shaft when drive source is started.**
If excessive offset load is applied to the product, it may cause malfunction, breakdown, or personal injury or damage to machinery and equipment. Use a flexible coupling as illustrated below, to avoid direct radial load or axial load on the shaft. A rubber/resin coupling is recommended, due to its excellent absorption of off center, shocks, and vibrations. Please consult the coupling manufacturer to discuss the detailed operating conditions.

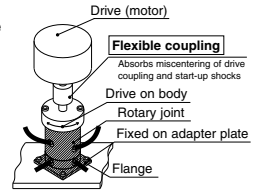

- Do not make additions to this product.**
Any additions made to this product will weaken it and may cause product failure, leading to human injury and/or damage to machinery/equipment.
- Allow freedom of movement when securing the shaft.**
If you do not allow some freedom of movement when fixing the shaft, then any eccentricity will cause abnormal wear, leading to malfunction, breakdown, and possible human injury and/or damage to machinery/equipment.
- When the top is fixed, install a relief port (ø1 or more).**
This product leaks air to the outside. When the top is made airtight, an excessively large load may occur. This may lead to malfunction.

⚠ Caution

- Confirm the model and size before installation. Check that there are no scratches, impact marks, cracks, or the like, on the product.**
- When connecting tubes, take account of variations in pressure according to tube length.**
- Do not wipe model designation on nameplate with organic solvents, etc.**
This will cause designation to disappear.
- Do not knock rotary shaft when main unit is fixed, or knock main unit when rotary shaft is fixed.**
This may bend the rotary shaft and cause damage to the bearings. The rotary shaft should be fixed when attaching a load, etc. to it.

KQ2

KQB2

KS
KX

KM

KF

M

H/DL
L/LL

KC

KK

KK130

DM

KDM

KB

KR

KA

KQG2

KG

KFG2

MS

KKA

KP

LQ

MQR

T

IDK



MQR Series Rotary Joint/Precautions 2

Be sure to read this before handling the products.

Piping

Caution

1. Preparation before piping.

Before piping is connected, it should be thoroughly blown out with air (flushed), to remove chips, cutting oil and other debris from inside the piping.

2. Winding of sealant tape.

When screwing together pipes and fittings, etc., be certain that chips from the pipe threads and sealant material do not get inside the piping. Also, when sealant tape is used, leave approximately 2 thread ridges exposed at the end of the threads.

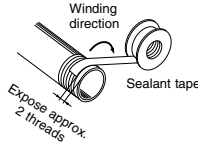

3. Screw tightening and tightening torque.

Use the tightening torques in the table below, when screwing a fitting onto a piping port. Particular attention is required in the case of MQR1 (1 circuit), as this joint supports the piping.

Tightening Torque for Piping

Connecting threads	Suitable tightening torque
M5	1.5 to 2 N·m
Rc 1/8	7 to 9 N·m

* Comments

Fastening M5 thread fittings

Tighten manually, and then tighten a further quarter-turn using the fastening tool. If using miniature fittings, tighten manually, and then tighten a further quarter-turn using the fastening tool. If there are two gaskets, such as a universal elbow or universal tee, the final tightening should be doubled to a half-turn.

Note: Over-tightening of fittings may cause fracturing of the thread sections or deformation of the gaskets, leading to air leaks. If the fittings are under-tightened, the loosening of thread and air leaks may occur.

Lubrication

Caution

1. Lubrication

- Due to the initial lubricant provided, the product can be used without lubrication.
- Do not lubricate if using the product at low torque. Lubrication may cause an increase in the rotational torque, due to the viscosity and surface tension of the oil.
- In the event that lubrication is applied, use turbine oil class 1 (without additives) ISO VG32.

Refer to the brands of each turbine oil class 1 (without additives) ISO VG32 manufacturer shown below.

Air Supply

Warning

1. Use clean air.

Do not use compressed air containing chemicals, synthetic oils containing organic solvents, salts, or corrosive gases, etc., as these can cause damage or malfunction.

Caution

1. Use the product within the range of specifications for fluid and ambient temperature.

Take measures to prevent freezing when used at 5°C or less, since moisture in circuits can freeze, causing malfunction.

2. Install air filters.

Install air filters near valves on their upstream side. The filtration degree should be 5 µm or less. Furthermore, when using at low friction, it is also recommended to use clean air (atmospheric pressure dew point temperature of -10°C) and install mist separator AM series (filtration degree 0.3 µm or less) or AM + AMD series (filtration degree 0.01 µm or less).

3. Install an after-cooler, air dryer or water separator (Drain Catch), etc.

Air containing excessive drainage can cause malfunction of valves and other pneumatic equipment. To prevent this, install an after-cooler, air dryer or water separator, etc.

Refer to the SMC's "Air Cleaning Equipment" catalog for further details on compressed air quality.

Operating Environment

Warning

1. Do not use in environments where there is a danger of corrosion.

Refer to the construction drawings regarding rotary joint materials.

2. Do not use in dusty locations or where water, oil, etc., will splash on the equipment.

Maintenance

Warning

1. Perform maintenance according to the procedures indicated in the operation manual.

If handled improperly, malfunction and damage of machinery or equipment may occur.

2. During maintenance, do not perform any disassembly or assembly whilst the air supply is connected.

Caution

1. Drain flushing

Remove condensate from air filters at regular intervals.

Disassembly

Caution

- The component parts of these products are manufactured to precision tolerances, and therefore cannot be disassembled.



MQR Series Specific Product Precautions 1

Be sure to read this before handling the products.
Refer to back page 50 for Safety Instructions.

Operation

⚠ Caution

- The metal seal structure means that port-to-port leaking occurs. Therefore, please note the following points when using different pressures at neighbouring ports.

When using different pressures at normal pressure

Use relieving type regulators.

Leaks between ports are to be exhausted via the relief port of the regulator on the lower pressure side.

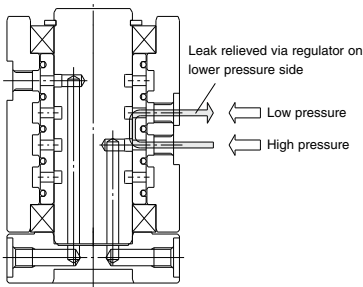

When combination of vacuum and normal pressures

When using a compact vacuum ejector (suction flow rate approx. 10 L/min), the vacuum pressure drop is several kPa or so, depending on the supply source characteristics and the piping conditions. For more details, please refer to the flow rate characteristics graph provided in the vacuum pump catalogue, operation manual, etc.

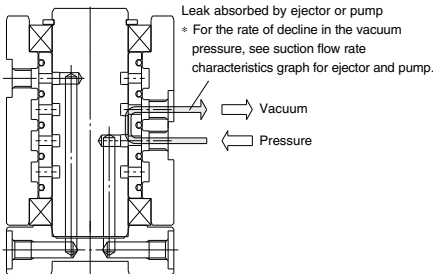

Using different pressures in vacuum

As neither the ejector nor the vacuum pump has a relief function, pressure interference may occur. Install an atmospheric release port (blanking port) or normal pressure circuit between the pressure ports having different vacuum pressures.

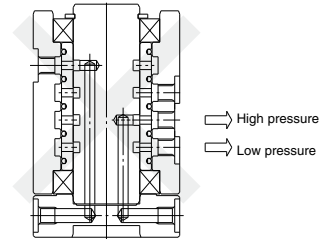

- * If neighbouring ports are used at different vacuum pressures, the vacuum pressure on the lower vacuum side will increase and hence it cannot be used.

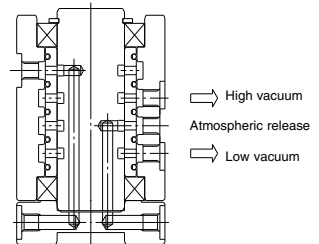

Using atmospheric release port

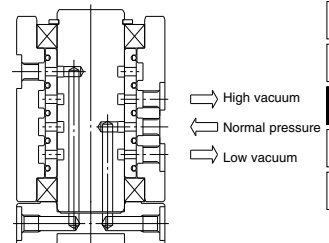

Using normal pressure port

- * If using two or more ports at different vacuum pressures, an atmospheric release port or a normal pressure supply should be provided between the ports.

KQ2

KQB2

**KS
KX**

KM

KF

M

**H/DL
L/LL**

KC

KK

KK130

DM

KDM

KB

KR

KA

KQG2

KG

KFG2

MS

KKA

KP

LQ

MQR

T

IDK



MQR Series

Specific Product Precautions 2

Be sure to read this before handling the products.
Refer to back page 50 for Safety Instructions.

Mounting

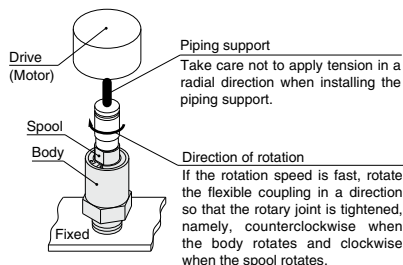

Example of 1 circuit

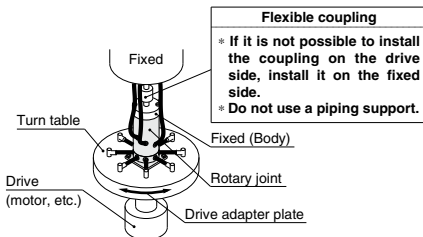

Example of adapter plate drive

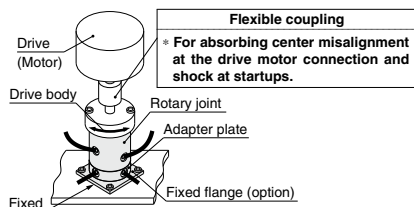

Example of body drive

⚠ Caution

- Although the center misalignment of the drive shaft and fixed shaft is different due to the flexible coupling type and size, keep adjustments to 0.3 mm or less as a guide.
Do not use piping support for 2 or more circuits. If used for 2 or more circuits, excessive radial load may occur momentarily (particularly at the start) due to piping tension and deflection, and it may cause excessive abrasion.
- This product has a floating mechanism on the sleeve in order to keep the surface pressure of the metal seal part at a lower level even when rotating with the accumulated center misalignment of parts. If instantaneous shock occurs when starting and stopping rotation, the surface pressure may rise without working the floating mechanism and excessive abrasion may occur. Flexible coupling should be installed at the drive motor connection in order to protect the rotary joint from direct shocks. The recommended coupling is made by rubber or resin. These are excellent in center misalignment and adsorption of impact and vibration.
(Reference coupling: Bellow Flex (Plastic bellows coupling) CHP model produced by Miki Pulley Co., Ltd.)
For applicable reaction force of the coupling, refer to specifications on page 449.
Select coupling with twice the safety factor against the value supplied by the coupling maker as the reaction force may be applied as a drive load especially with intermittent operation.
- When the rotary joint is secured, align the drive shaft and the fixed shaft using the slip fit of the body adapter plate. Using the slip fit facilitates alignment of the axes. Relief port over $\phi 1$ should be installed when securing the top side. Since this product has slight air leakage, offset load may occur if sealing top side when mounting, and excessive abrasion may occur.

Reference coupling/Bellow Flex (Plastic bellows coupling) CHP Model produced by Miki Pulley Co., Ltd.

Rotary joint type	MQR2	MQR4	MQR8	MQR12	MQR16
Coupling part no.	CHP-20	CHP-20	CHP-20 CHP-26	CHP-26 CHP-34	CHP-34

