

Parallel Type Air Gripper

MHZ Series

ø6, ø10, ø16, ø20, ø25, ø32, ø40

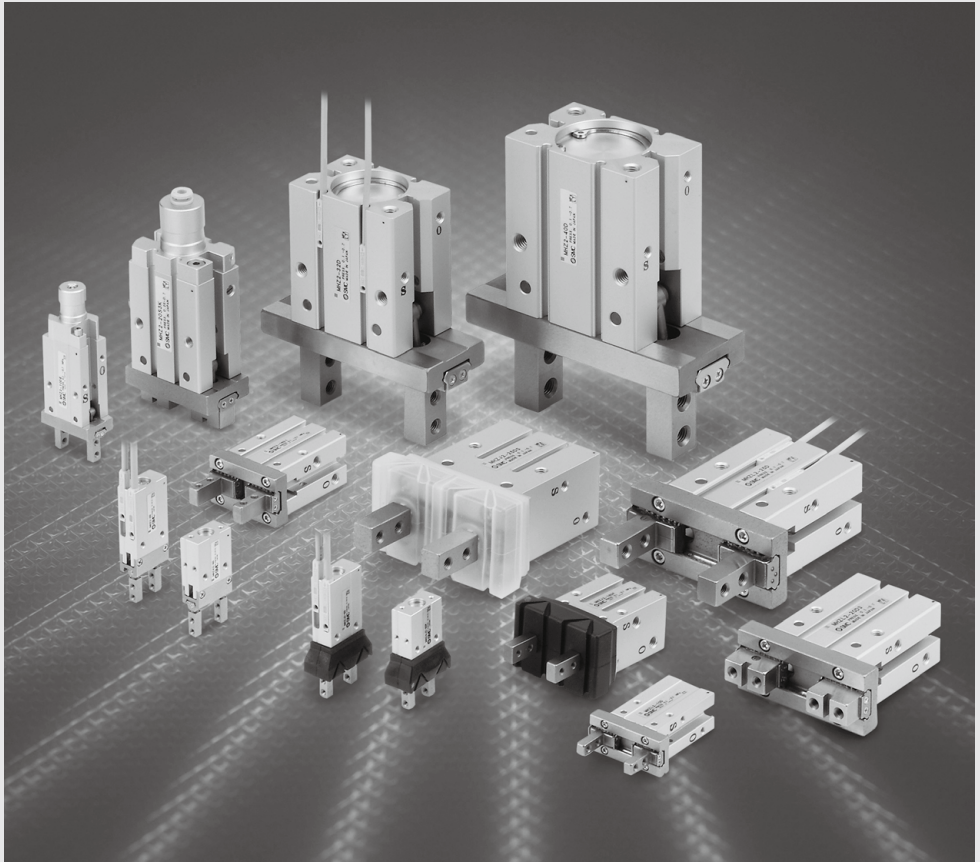

MHZ

MHF

MHL

MHR

MHK

MHS

MHC

MHT

MHY

MHW

-X□

MRHQ

MA

D-□

Integral linear guide used for high rigidity

• Repeatability: ± 0.01 mm

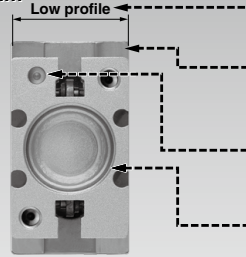
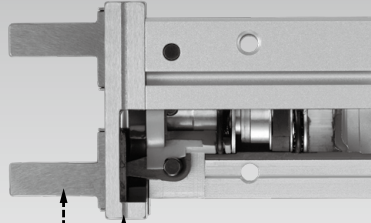
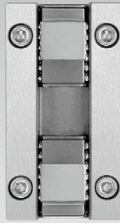

• Martensitic stainless steel

High degree of mounting flexibility

Can be mounted five ways from three directions.

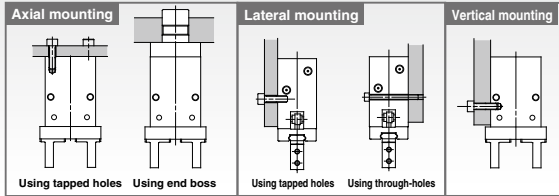

Finger positions can be selected.

(Standard type/MHZ2)

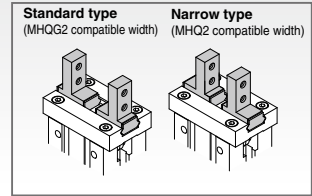

Body option/Piping port location

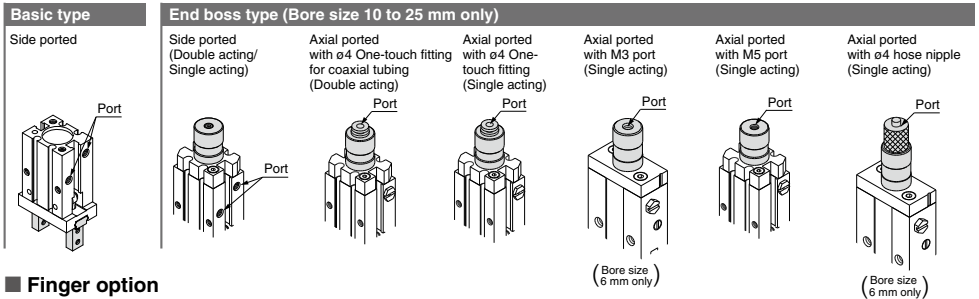

Finger option

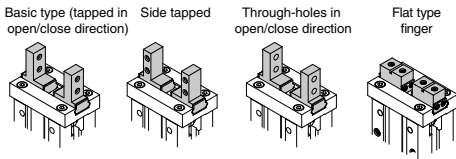

Compact Series (Without auto switch) **Page 398**

MHZJ2-6/MHZAJ2-6 (With dust cover)

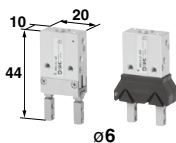

Standard Type **Page 408**

MHZ2 Series

$\phi 6$ $\phi 10$ to $\phi 25$ $\phi 32$, $\phi 40$

and high precision

● **Body thickness tolerance:**
±0.05 mm

● **No guide protrusion in direction of body thickness**

● **Improved remounting accuracy**

Positioning dowel pin holes provided

● **Top mounting centering location**

Mounting is more secure with a depth 0.5 to 2 mm greater than current types.

Integral guide rail construction

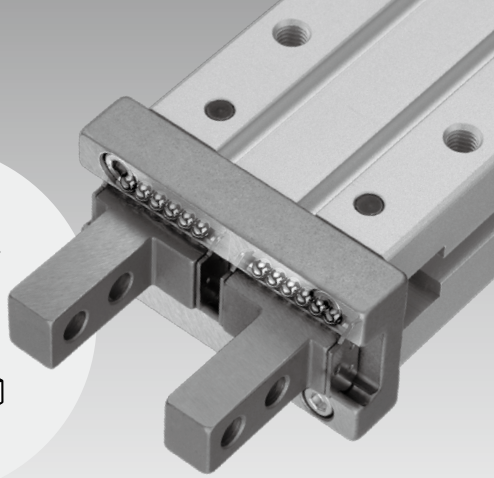
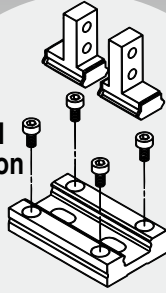

Long Stroke **Page 426**

MHZL2 Series

Accommodates diverse workpiece diameters with a single unit

- Nearly double the standard stroke
- Long stroke are also compact and lightweight

Series	Opening/Closing stroke (mm) (Open-Closed)	Weight (g)	Body thickness (mm)
MHZL2-10	8 (4)	60	16.4
MHZL2-16	12 (6)	135	23.6
MHZL2-20	18 (10)	270	27.6
MHZL2-25	22 (14)	470	33.6

Values inside () are for standard MHZ2 series.



ø10 to ø25



With dust cover

Made to Order

ø10 to ø20

Page 436

With Dust Cover **Page 440**

MHZJ2 Series

- Prevents entry of chips, dust, water, etc.
- Prevents dispersion of grease and external leakage of dust.

Cover materials

- Chloroprene rubber (Black)
- Fluororubber (Black)
- Silicone rubber (White)



ø6

ø10 to ø25



ø32, ø40

Made to Order

Page 451

· Dust cover adhesion (Powerful adhesive used): -X77□

· Dust cover caulking (Silicone caulking agent used): -X78□

MHZ

MHF

MHL

MHR

MHK

MHS

MHC

MHT

MHY

MHW







-X□





MRHQ

MA

D-□

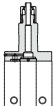
Series Variations

Series	Bore size (mm)	Action	Body option					
			Basic type		End boss type			
			Side ported	Side ported	With One-touch fitting for coaxial tubing	With One-touch fitting	With M3 port	With M5 port
Standard MHZA2-6  Page 398	6	Double acting	●	●				
		Single acting (Normally open)	●	●		●	●	
		Single acting (Normally closed)	●	●		●	●	
With dust cover MHZAJ2-6  Page 398	6	Double acting	●	●				
		Single acting (Normally open)	●	●		●	●	
		Single acting (Normally closed)	●	●		●	●	
Standard MHZ2  Page 408	6	Double acting	●					
		Single acting (Normally open)	●					
		Single acting (Normally closed)	●					
	10, 16 20, 25	Double acting	●	●	●			
		Single acting (Normally open)	●	●		●		●
		Single acting (Normally closed)	●	●		●		●
	32, 40	Double acting	●					
		Single acting (Normally open)	●					
		Single acting (Normally closed)	●					
Long stroke MHZL2  Page 426	10, 16 20, 25	Double acting	●	●	●			
		Single acting (Normally open)	●	●		●		●
		Single acting (Normally closed)	●	●		●		●
Long stroke With dust cover MHZL2  Page 436	10, 16 20	Double acting	●					
With dust cover MHZJ2  Page 440 Page 451	6	Double acting	●					
		Single acting (Normally open)	●					
		Single acting (Normally closed)	●					
	10, 16 20, 25	Double acting	●	●	●			
		Single acting (Normally open)	●	●		●		●
		Single acting (Normally closed)	●	●		●		●
32, 40	Double acting	●						

		Finger option			
With hose nipple		Basic type (tapped in open/close direction)	Side tapped	Through-holes in open/close direction	Flat type finger
					

Made to Order common specifications	Page
-------------------------------------	------

		●	●	●	●
	●	●	●	●	●
	●	●	●	●	●

Page 398

* Availability varies depending on the model.
For details, refer to "Made to Order" on pages 725 to 748.

		●	●	●	●
		●	●	●	●
		●	●	●	●

Page 408

- X4 Heat resistance (-10 to 100 °C)
- X5 Fluororubber seal
- X7 Closing direction spring assist
- X12 Opening direction spring assist
- X46 Built-in needle valve for finger speed control
- X50 Without magnet
- X51 MHQ2/MHQG2 compatible flat type fingers
- X53 Ethylene propylene rubber seal (EPDM)
- X56 Axial ported
- X63 Fluorine grease
- X64 Finger: Side tapped
- X65 Finger: Through-holes in opening/closing directions
- X77A Dust cover adhesion
- X77B Dust cover adhesion/Finger part only
- X78A Dust cover caulking
- X78B Dust cover caulking/Finger part only
- X79 Grease for food processing machines/Fluorine grease
- X79A Grease for food processing machines/Aluminum complex soap base grease
- X81A Special black chromium treatment is made on only the finger.
- X81B Special black chromium treatment is made on the finger and guide.

Page 426

		●	●	●	●
		●	●	●	●
		●	●	●	●

Page 436

		●			
		●			
		●			

Page 440

		●			
		●			
		●			

Page 451

MHZ

MHF

MHL

MHR

MHK

MHS

MHC

MHT

MHY

MHW

-X□

MRHQ

MA

D-□

MHZ Series Model Selection

Model Selection

Selection Procedure



Step 1 Confirmation of Gripping Force



Example

Workpiece mass:
0.1 kg

Gripping method:
External gripping

Gripping point distance:
L = 30 mm

Operating pressure:
0.4 MPa

Guidelines for the selection of the gripper with respect to workpiece mass

- Although conditions differ according to the workpiece shape and the coefficient of friction between the attachments and the workpiece, select a model that can provide a gripping force of 10 to 20 times the workpiece weight, or more. (Note) For further details, refer to the model selection illustration.

- If high acceleration, deceleration or impact forces are encountered during motion, a further margin of safety should be considered.

Example) When it is desired to set the gripping force at 20 times or more above the workpiece weight.
Required gripping force = 0.1 kg x 20 x 9.8 m/s² = 19.6 N or more

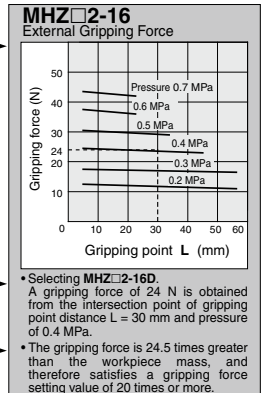

Model Selection Illustration

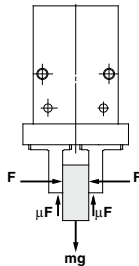

“Gripping force at least 10 to 20 times the workpiece weight”

The “10 to 20 times or more of the workpiece weight” recommended by SMC is calculated with a safety margin of a = 4, which allows for impacts that occur during normal transportation, etc.

When $\mu = 0.2$	When $\mu = 0.1$
$F = \frac{mg}{2 \times 0.2} \times 4$ $= 10 \times mg$	$F = \frac{mg}{2 \times 0.1} \times 4$ $= 20 \times mg$

10 x Workpiece weight

20 x Workpiece weight

Note) • Even in cases where the coefficient of friction is greater than $\mu = 0.2$, for reasons of safety, select a gripping force which is at least 10 to 20 times greater than the workpiece weight, as recommended by SMC.

• If high acceleration, deceleration or impact forces are encountered during motion, a further margin of safety should be considered.

When gripping a workpiece as in the figure to the left, and with the following definitions,

F: Gripping force (N)

μ : Coefficient of friction between the attachments and the workpiece

m: Workpiece mass (kg)

g: Gravitational acceleration (= 9.8 m/s²)

mg: Workpiece weight (N)

the conditions under which the workpiece will not drop are

$$2 \times \mu F > mg$$

↑ Number of fingers

and therefore,

$$F > \frac{mg}{2 \times \mu}$$

With “a” representing the extra margin, “F” is determined by the following formula:

$$F = \frac{mg}{2 \times \mu} \times a$$

Step 1 Effective Gripping Force: MHZ□2 Series/Double Acting/External Gripping Force

- Indication of effective gripping force

The effective gripping force shown in the graphs to the right is expressed as F, which is the thrust of one finger, when both fingers and attachments are in full contact with the workpiece as shown in the figure below.

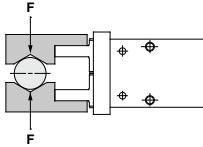

External Grip

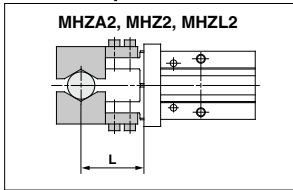

External Gripping Force

MHZ2-6D/MHZA2-6D

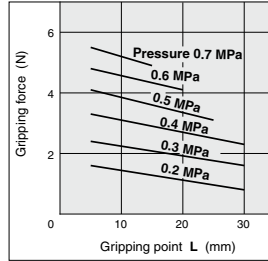

External Gripping Force

MHZ2-25D/MHZL2-25D

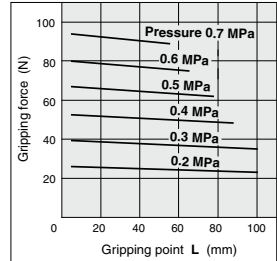

MHZ2-10D/MHZL2-10D

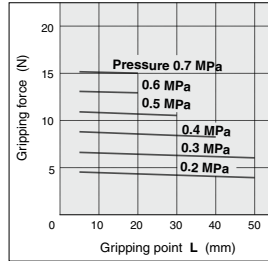

MHZ2-32D

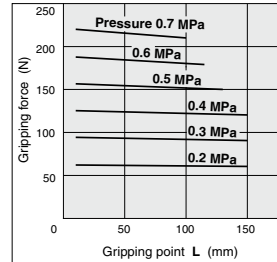

MHZ2-16D/MHZL2-16D

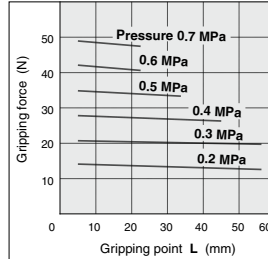

MHZ2-40D

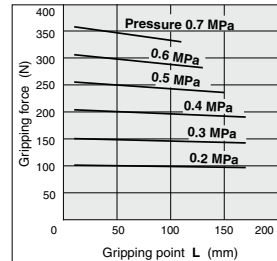

MHZ2-20D/MHZL2-20D

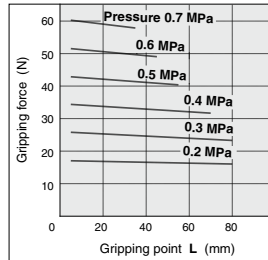

MHZ

MHF

MHL

MHR

MHK

MHS

MHC

MHT

MHY

MHW

-X□

MRHQ

MA

D-□

Model Selection

Step 1 Effective Gripping Force: MHZ□2 Series/Double Acting/Internal Gripping Force

- Indication of effective gripping force

The effective gripping force shown in the graphs to the right is expressed as F, which is the thrust of one finger, when both fingers and attachments are in full contact with the workpiece as shown in the figure below.

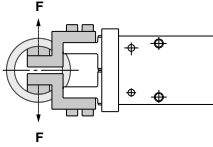

Internal Grip

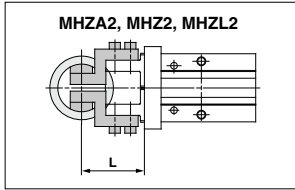

Internal Gripping Force

MHZ2-6D/MHZA2-6D

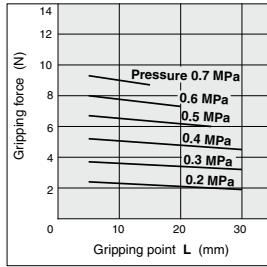

MHZ2-10D/MHZA2-10D

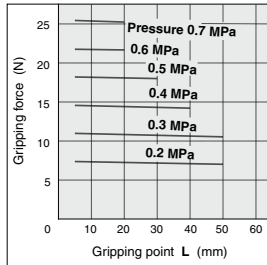

MHZ2-16D/MHZA2-16D

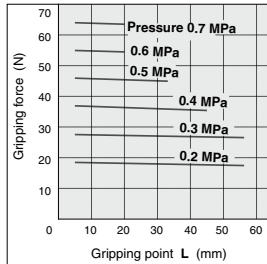

MHZ2-20D/MHZA2-20D

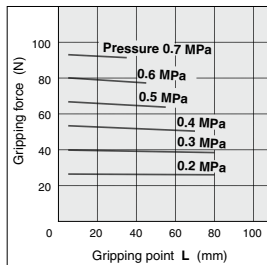

Internal Gripping Force

MHZ2-25D/MHZA2-25D

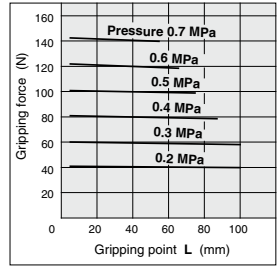

MHZ2-32D

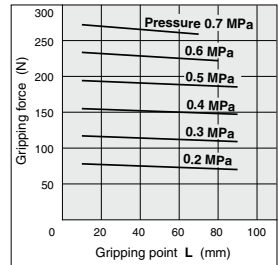

MHZ2-40D

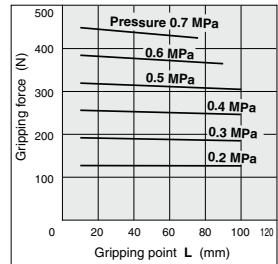

Step 1 Effective Gripping Force: MHZ□2 Series/Single Acting/External Gripping Force

- Indication of effective gripping force

The effective gripping force shown in the graphs to the right is expressed as F, which is the thrust of one finger, when both fingers and attachments are in full contact with the workpiece as shown in the figure below.

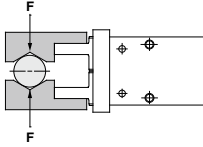

External Grip

MHZA2, MHZ2, MHZL2

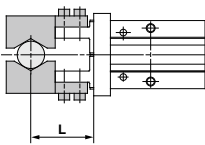

External Gripping Force

MHZ2-6S/MHZA2-6S

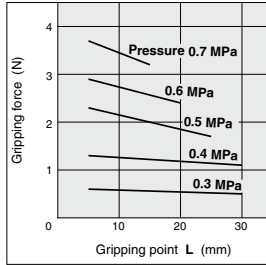

External Gripping Force

MHZ2-25S/MHZL2-25S

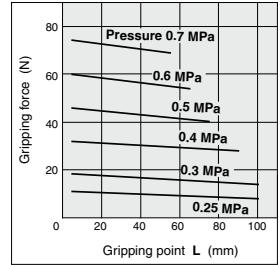

MHZ2-10S/MHZL2-10S

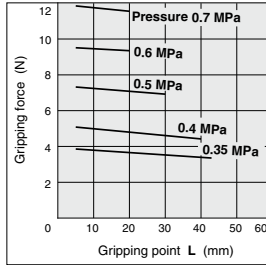

MHZ2-32S

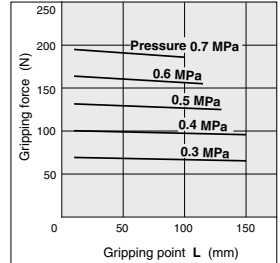

MHZ2-16S/MHZL2-16S

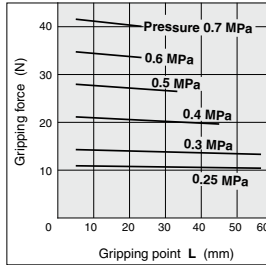

MHZ2-40S

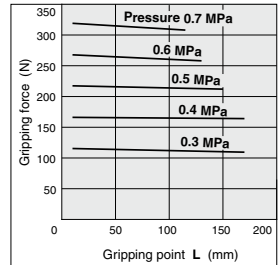

MHZ2-20S/MHZL2-20S

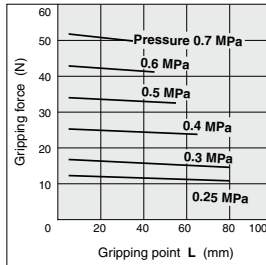

MHZ

MHF

MHL

MHR

MHK

MHS

MHC

MHT

MHY

MHW

-X□

MRHQ

MA

D-□

Model Selection

Step 1 Effective Gripping Force: MHZ□2 Series/Single Acting/Internal Gripping Force

- Indication of effective gripping force

The effective gripping force shown in the graphs to the right is expressed as F, which is the thrust of one finger, when both fingers and attachments are in full contact with the workpiece as shown in the figure below.

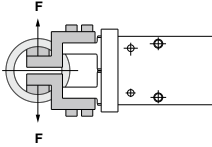

Internal Grip

MHA2, MHZ2, MHZL2

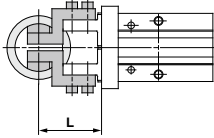

Internal Gripping Force

MHZ2-6C/MHZA2-6C

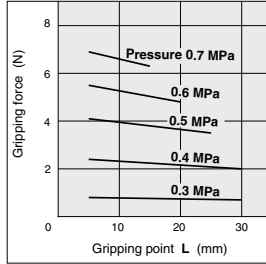

MHZ2-10C/MHZA2-10C

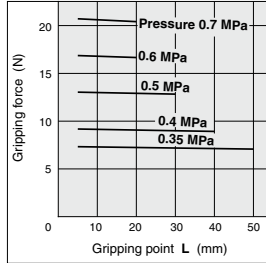

MHZ2-16C/MHZA2-16C

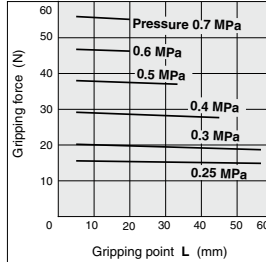

MHZ2-20C/MHZA2-20C

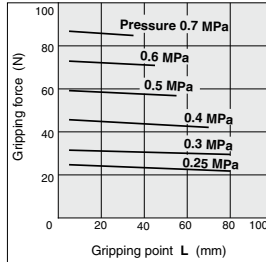

Internal Gripping Force

MHZ2-25C/MHZA2-25C

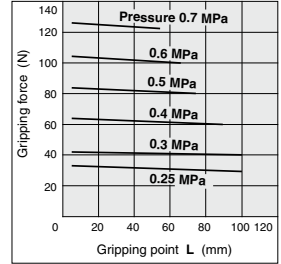

MHZ2-32C

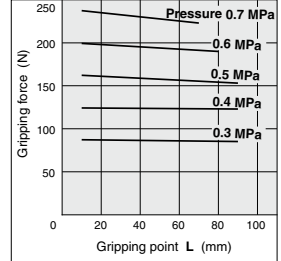

MHZ2-40C

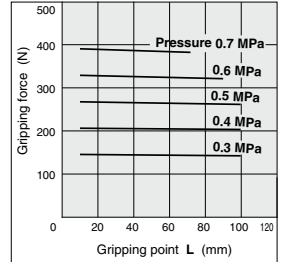

Step 1 Effective Gripping Force: MHZ□2 Series/Double Acting/External Gripping Force

- Indication of effective gripping force

The effective gripping force shown in the graphs to the right is expressed as F, which is the thrust of one finger, when both fingers and attachments are in full contact with the workpiece as shown in the figure below.

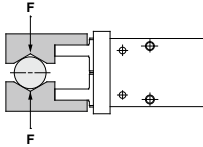

External Grip

MHZAJ2, MHZJ2, 11-MHZ2

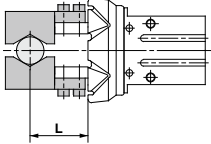

External Gripping Force

MHZJ2-6D/MHZAJ2-6D

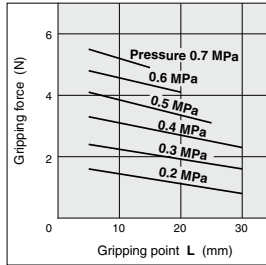

External Gripping Force

MHZJ2-25D/11-MHZ2-25D

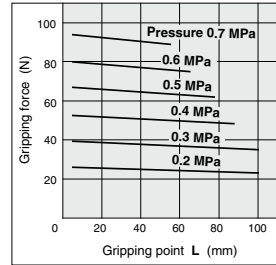

MHZJ2-10D/11-MHZ2-10D

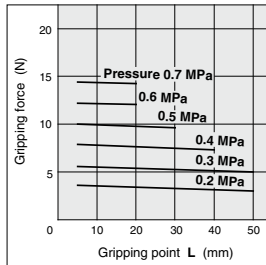

MHZJ2-16D/11-MHZ2-16D

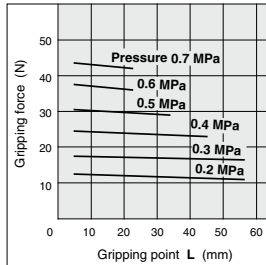

MHZJ2-20D/11-MHZ2-20D

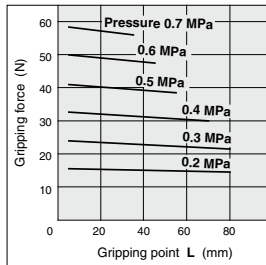

MHZ

MHF

MHL

MHR

MHK

MHS

MHC

MHT

MHY

MHW

-X□

MRHQ

MA

D-□

Model Selection

Step 1 Effective Gripping Force: MHZ□2 Series/Double Acting/Internal Gripping Force

- Indication of effective gripping force

The effective gripping force shown in the graphs to the right is expressed as F, which is the thrust of one finger, when both fingers and attachments are in full contact with the workpiece as shown in the figure below.

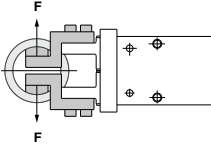

Internal Grip

MHZAJ2, MHZJ2, 11-MHZ2

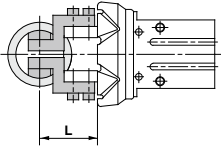

Internal Gripping Force

MHZJ2-6D/MHZAJ2-6D

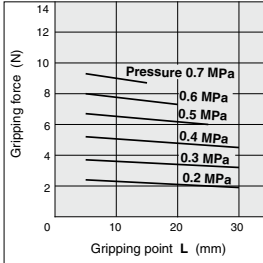

Internal Gripping Force

MHZJ2-25D/11-MHZ2-25D

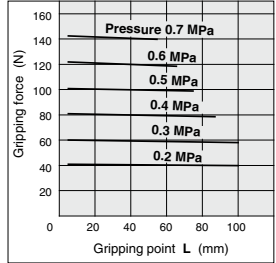

MHZJ2-10D/11-MHZ2-10D

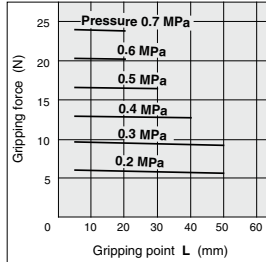

MHZJ2-16D/11-MHZ2-16D

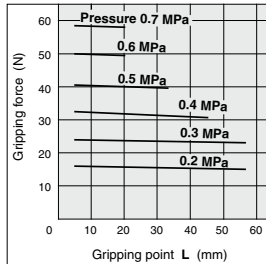

MHZJ2-20D/11-MHZ2-20D

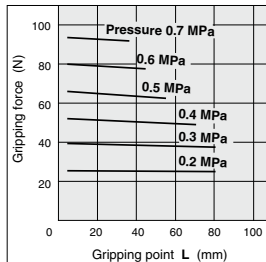

Step 1 Effective Gripping Force: MHZ□2 Series/Single Acting/External Gripping Force

- Indication of effective gripping force

The effective gripping force shown in the graphs to the right is expressed as F, which is the thrust of one finger, when both fingers and attachments are in full contact with the workpiece as shown in the figure below.

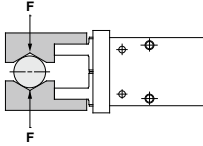

External Grip

MHZAJ2, MHZJ2

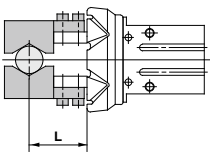

External Gripping Force

MHZJ2-6S/MHZAJ2-6S

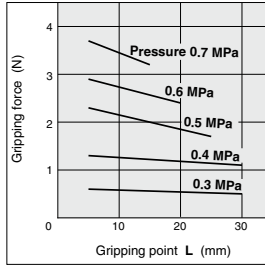

External Gripping Force

MHZJ2-25S

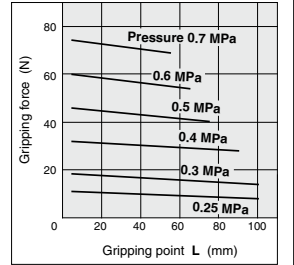

MHZJ2-10S

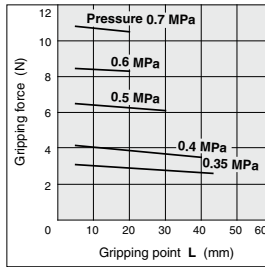

MHZJ2-16S

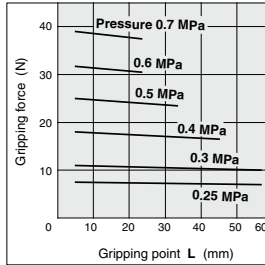

MHZJ2-20S

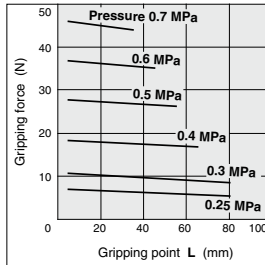

MHZ

MHF

MHL

MHR

MHK

MHS

MHC

MHT

MHY

MHW

-X□

MRHQ

MA

D-□

Model Selection

Step 1 Effective Gripping Force: MHZ□2 Series/Single Acting/Internal Gripping Force

- Indication of effective gripping force

The effective gripping force shown in the graphs to the right is expressed as F, which is the thrust of one finger, when both fingers and attachments are in full contact with the workpiece as shown in the figure below.

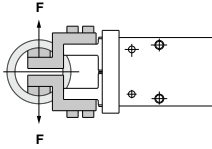

Internal Grip

MHZAJ2, MHZJ2

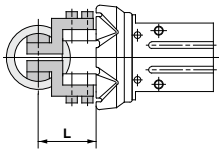

Internal Gripping Force

MHZJ2-6C/MHZAJ2-6C

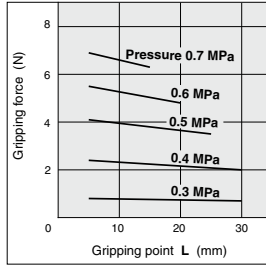

Internal Gripping Force

MHZJ2-25C

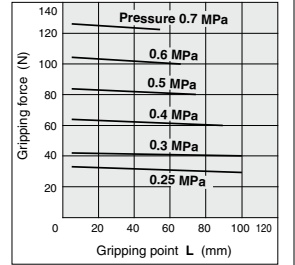

MHZJ2-10C

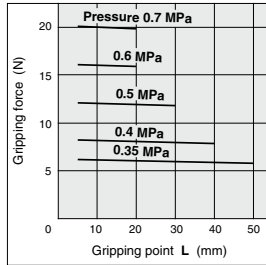

MHZJ2-16C

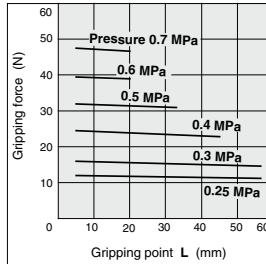

MHZJ2-20C

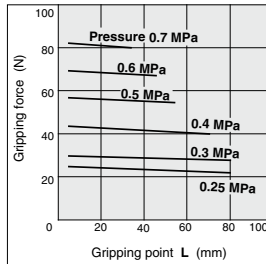

Step 2 Confirmation of Gripping Point: MHZ□ Series/External Grip

External Grip

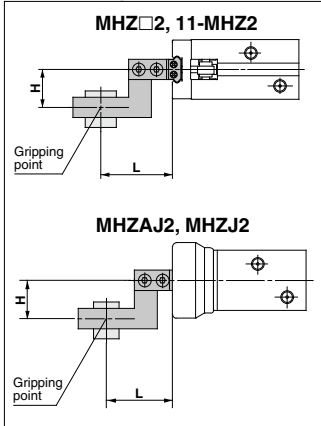

- The air gripper should be operated so that the workpiece gripping point "L" and the amount of overhang "H" stay within the range shown for each operating pressure given in the graphs to the right.
- If the workpiece gripping point goes beyond the range limits, this will have an adverse effect on the life of the air gripper.

External Grip

MHZ□2-6□

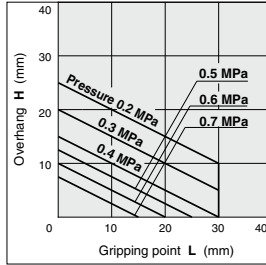

MHZ□2-10□/11-MHZ2-10□

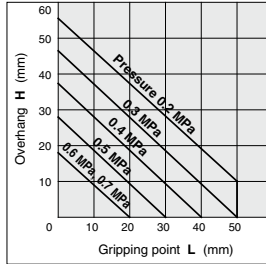

MHZ□2-16□/11-MHZ2-16□

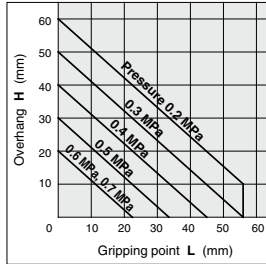

MHZ□2-20□/11-MHZ2-20□

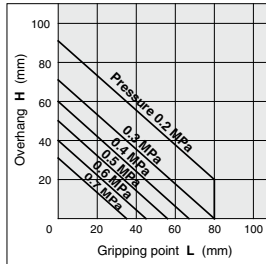

External Grip

MHZ□2-25□/11-MHZ2-25□

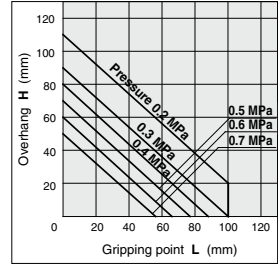

MHZ2-32□

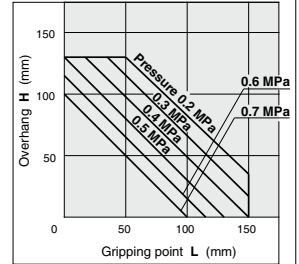

MHZ2-40□

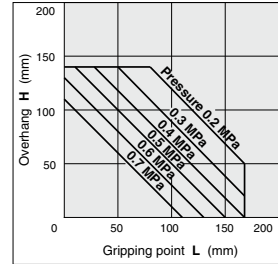

- MHZ**
- MHF**
- MHL**
- MHR**
- MHK**
- MHS**
- MHC**
- MHT**
- MHY**
- MHW**
- X□**
- MRHQ**
- MA**
- D-□**

Model Selection

Step 2 Confirmation of Gripping Point: MHZ□ Series/Internal Grip

Internal Grip

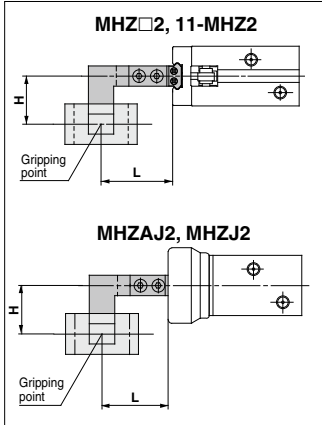

- The air gripper should be operated so that the workpiece gripping point "L" and the amount of overhang "H" stay within the range shown for each operating pressure given in the graphs to the right.
- If the workpiece gripping point goes beyond the range limits, this will have an adverse effect on the life of the air gripper.

Internal Grip

MHZ□2-6□

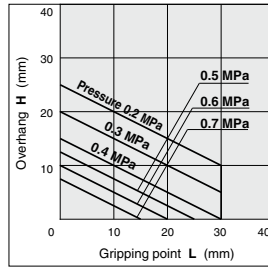

MHZ□2-10□/11-MHZ2-10□

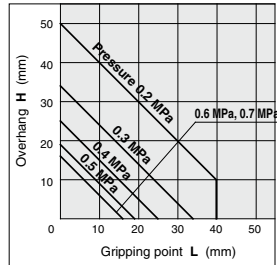

MHZ□2-16□/11-MHZ2-16□

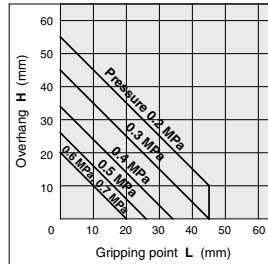

MHZ□2-20□/11-MHZ2-20□

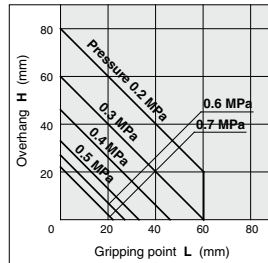

Internal Grip

MHZ□2-25□/11-MHZ2-25□

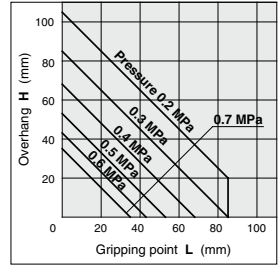

MHZ2-32□

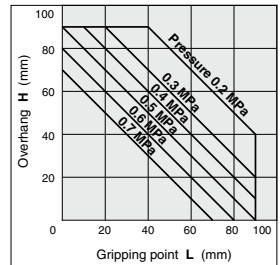

MHZ2-40□

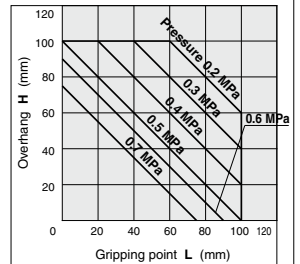

Step 3 Confirmation of External Force on Fingers: MHZ□2 Series

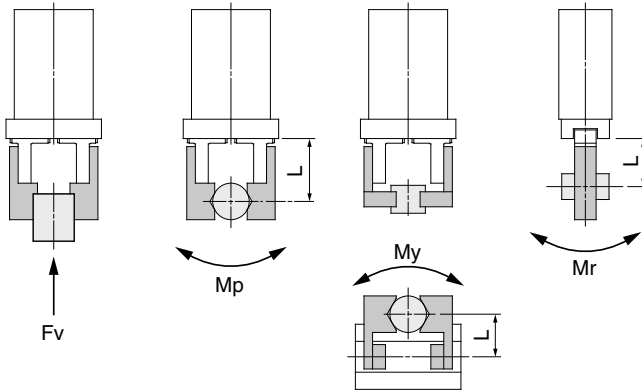

L: Distance to the point at which the load is applied (mm)

Model	Allowable vertical load Fv (N)	Maximum allowable moment		
		Pitch moment: Mp (N·m)	Yaw moment: My (N·m)	Roll moment: Mr (N·m)
MHZ□2-6	10	0.04	0.04	0.08
MHZ□2-10	58	0.26	0.26	0.53
MHZ□2-16	98	0.68	0.68	1.36
MHZ□2-20	147	1.32	1.32	2.65
MHZ□2-25	255	1.94	1.94	3.88
MHZ□2-32	343	3	3	6
MHZ□2-40	490	4.5	4.5	9

Note) Values for load and moment in the table indicate static values.

Calculation of allowable external force (when moment load is applied)	Calculation example
$\text{Allowable load } F \text{ (N)} = \frac{M \text{ (maximum allowable moment)(N·m)}}{L \times 10^{-3}}$ <p>(*: Constant for unit conversion)</p>	<p>When a static load of $f = 10 \text{ N}$ is operating, which applies pitch moment to point $L = 30 \text{ mm}$ from the MHZ□2-16D guide. Therefore, it can be used.</p> $\text{Allowable load } F = \frac{0.68}{30 \times 10^{-3}} = 22.7 \text{ (N)}$ <p>Load $f = 10 \text{ (N)} < 22.7 \text{ (N)}$</p>

MHZ

MHF

MHL

MHR

MHK

MHS

MHC

MHT

MHY

MHW

-X□

MRHQ

MA

D-□

Specifications



		Fluid	Air
Operating pressure	Double acting		0.15 to 0.7 MPa
	Single acting	Normally open	0.3 to 0.7 MPa
		Normally closed	
Ambient and fluid temperature			-10 to 60°C
Repeatability			±0.01 mm
Max. operating frequency			180 c.p.m.
Lubrication			Not required
Action			Double acting/Single acting

* Use the gripper with dust cover when used in a place where there may be dust.

Symbol

Double acting:
Internal grip

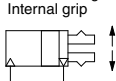

Double acting:
External grip

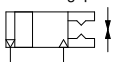

Single acting/
Normally closed:
Internal grip

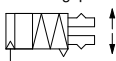

Single acting/
Normally open:
External grip

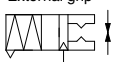

Model

Action	Model	Bore size (mm)	Gripping force ^{Note)}		Opening/ Closing (Both sides) (mm)	Weight (g)
			Gripping force per finger Effective value (N)			
			External	Internal		
Double acting	MHZA2-6D	6	3.3	6.1	4	26
	MHZAJ2-6D	6			4	27
Single acting Normally Normally closed	MHZA2-6S	6	1.9	—	4	26
	MHZAJ2-6S	6			4	27
	MHZA2-6C	6	—	3.7	4	26
	MHZAJ2-6C	6			4	27

Note) Values based on pressure of 0.5 MPa, gripping point L = 20 mm, at center of stroke.

Option

● Body Option/End Boss Type

Symbol	Piping port location	Type of piping port	Applicable model	
		MHZA2-6/MHZAJ2-6	Double acting	Single acting
Nil	Basic type	M3 x 0.5	●	●
E	Side ported	M3 x 0.5	●	●
K	Axial ported	With ø4 One-touch fitting	—	●
H		With ø4 hose nipple	—	●
M		M3 x 0.5	—	●



Made to Order
[Click here for details](#)

Symbol	Specifications/Description
-X4	Heat resistance (100°C)
-X5	Fluororubber seal
-X12	Opening direction spring assist
-X53	EPDM seal/Fluorine grease
-X56	Axial ported type
-X63	Fluorine grease
-X64	Finger: Side tapped mounting
-X65	Finger: Through-hole mounting
-X79	Grease for food processing machines, Fluorine grease
-X79A	Grease for food processing machines
-X81A	Anti-corrosive treatment of finger
-X81B	Anti-corrosive treatment of finger and guide

Moisture Control Tube IDK Series



When operating an actuator with a small diameter and a short stroke at a high frequency, the dew condensation (water droplet) may occur inside the piping depending on the conditions.

Simply connecting the moisture control tube to the actuator will prevent dew condensation from occurring. For details, refer to [the IDK series in the Best Pneumatics No. 6](#).

MHZ

MHF

MHL

MHR

MHK

MHS

MHC

MHT

MHY

MHW

-X□

MRHQ

MA

D-□

MHZA2-6/MHZAJ2-6 Series

Construction: Standard Type MHZA2-6

Double acting/With fingers open

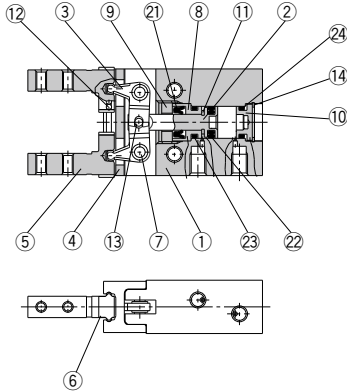

Double acting/With fingers closed

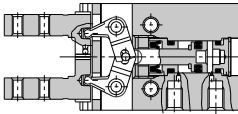

Single acting/Normally open

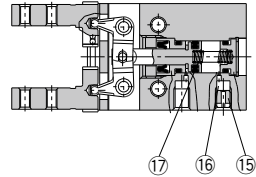

Single acting/Normally closed

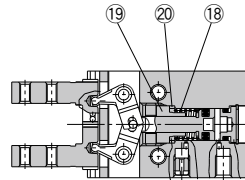

Component Parts

No.	Description	Material	Note
1	Body	Aluminum alloy	Hard anodized
2	Piston	Stainless steel	
3	Lever	Stainless steel	Heat treated
4	Guide	Stainless steel	Heat treated
5	Finger	Stainless steel	Heat treated
6	Roller stopper	Stainless steel	
7	Lever shaft	Stainless steel	Nitriding
8	Holder	Brass	Electroless nickel plated
9	Holder lock	Stainless steel	
10	Cap	Aluminum alloy	Clear anodized
11	Bumper	Urethane rubber	
12	Steel balls	High carbon chrome bearing steel	
13	Needle roller	High carbon chrome bearing steel	

Component Parts

No.	Description	Material	Note
14	Type C retaining ring	Carbon steel	Phosphate coated
15	Exhaust plug	Brass	Electroless nickel plated
16	Exhaust filter	Polyvinyl formal	
17	N.O. spring	Stainless steel spring wire	
18	N.C. spring	Stainless steel spring wire	
19	N.C. holder	Brass	Electroless nickel plated
20	N.C. spacer	Stainless steel	
21	Rod seal	NBR	
22	Piston seal	NBR	
23	Gasket	NBR	
24	Gasket	NBR	

Replacement Parts

Description		MHZA2-6□	Main parts
Finger assembly		Please contact SMC to replace the seal kit and finger assembly.	
End boss assembly	MHZA2-6□□H	MHZA-A0607	Main body of adaptor Mounting screw for adaptor Seal
	MHZA2-6□□K	MHZA-A0608	
	MHZA2-6□□M	MHZA-A0609	
	MHZA2-6□□E	MHZA-A0610	

* The end boss assembly other than type E should be mounted on the special body.

Replacement part/Grease pack part no.: GR-S-010 (10 g)

Construction: With Dust Cover MHZAJ2-6

Double acting/With fingers open

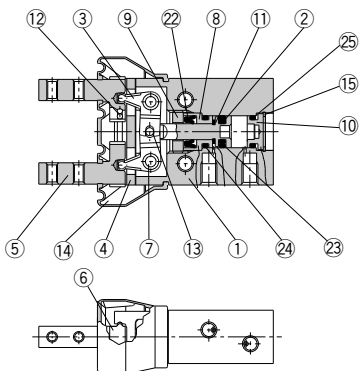

Double acting/With fingers closed

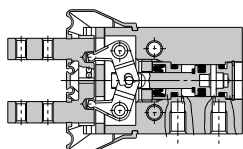

Single acting/Normally open

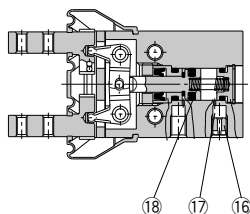

Single acting/Normally closed

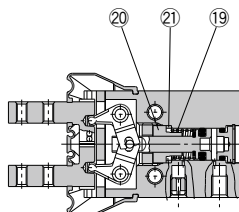

Component Parts

No.	Description	Material	Note
1	Body	Aluminum alloy	Hard anodized
2	Piston	Stainless steel	
3	Lever	Stainless steel	Heat treated
4	Guide	Stainless steel	Heat treated
5	Finger	Stainless steel	Heat treated
6	Roller stopper	Stainless steel	
7	Lever shaft	Stainless steel	Nitriding
8	Holder	Brass	Electroless nickel plated
9	Holder lock	Stainless steel	
10	Cap	Aluminum alloy	Clear anodized
11	Bumper	Urethane rubber	
12	Steel balls	High carbon chrome bearing steel	
13	Needle roller	High carbon chrome bearing steel	

Component Parts

No.	Description	Material	Note
14	Dust cover	CR	Chloroprene rubber
		FKM	Fluororubber
		Silicone rubber	
15	Type C retaining ring	Carbon steel	Phosphate coated
16	Exhaust plug	Brass	Electroless nickel plated
17	Exhaust filter	Polyvinyl formal	
18	N.O. spring	Stainless steel spring wire	
19	N.C. spring	Stainless steel spring wire	
20	N.C. holder	Brass	Electroless nickel plated
21	N.C. spacer	Stainless steel	
22	Rod seal	NBR	
23	Piston seal	NBR	
24	Gasket	NBR	
25	Gasket	NBR	

Replacement Parts

Description		MHZAJ2-6	Main parts
Seal kit		Please contact SMC to replace the seal kit.	
Dust cover	Material	MHZAJ2-J6	(14)
	CR	MHZAJ2-J6F	
	FKM	MHZAJ2-J6S	
Finger assembly		Please contact SMC to replace the finger assembly.	
End boss assembly	MHZA2-6□□H	MHZA-A0607	Main body of adaptor Mounting screw for adaptor Seal
	MHZA2-6□□K	MHZA-A0608	
	MHZA2-6□□M	MHZA-A0609	
	MHZA2-6□□E	MHZA-A0610	

* End boss type

H = With hose nipple, K = With One-touch fitting, M = With M3 port, E = Side port

* The end boss assembly other than type E should be mounted on the special body.

Replacement part/Grease pack part no.: GR-S-010 (10 g)

MHZ

MHF

MHL

MHR

MHK

MHS

MHC

MHT

MHY

MHW

-X□

MRHQ

MA

D-□

MHZA2-6/MHZAJ2-6 Series

Dimensions: Standard Type

MHZA2-6□ Double acting/Single acting Basic type

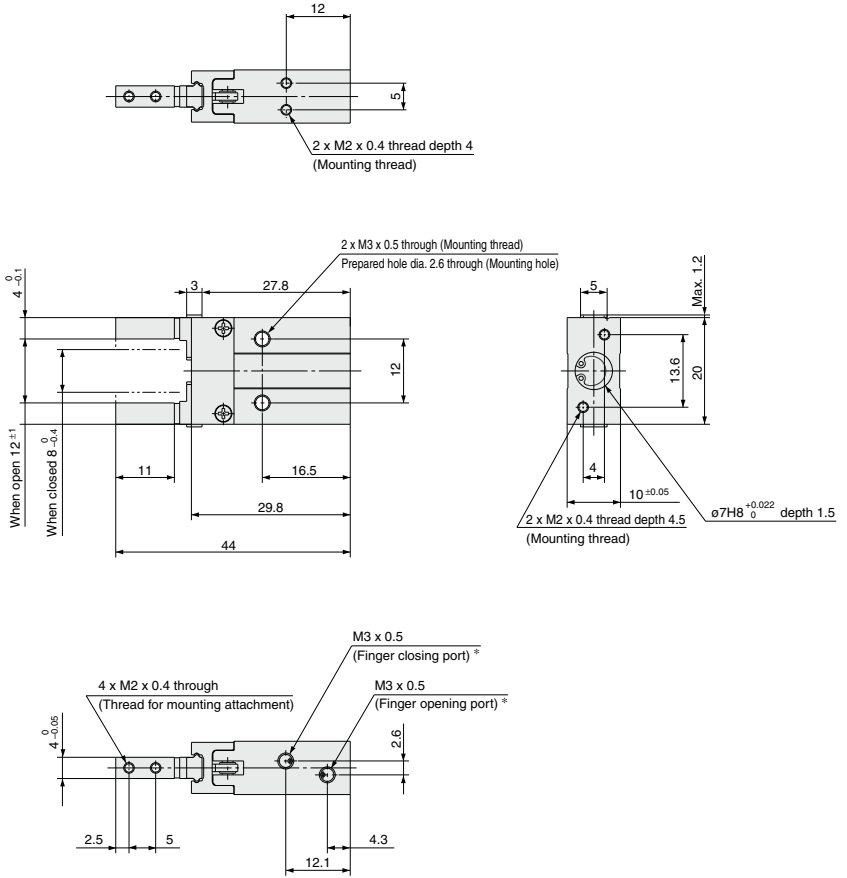

* For single action, the port on one side is a breathing hole.

MHZA2-6 Series Finger Option

Side Tapped Mounting [1]

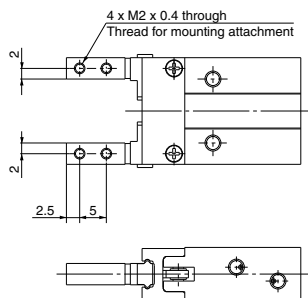

* Specifications and dimensions other than the above are the same as the basic type.

Through-holes in Opening/Closing Direction [2]

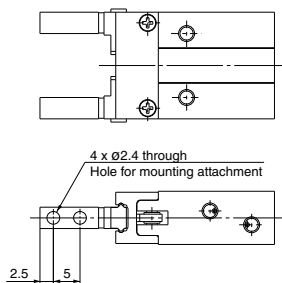

* Specifications and dimensions other than the above are the same as the basic type.

Flat Type Fingers [3]

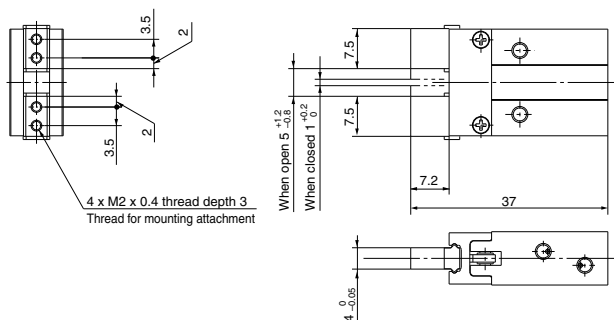

Weight: 25 g

Note) To mount attachments, use JISB1101 type M2 round head screws. Be careful not to use commercially available M2 hexagon socket head cap bolt as its top diameter is large.

* Specifications and dimensions other than the above are the same as the basic type.

MHZA2-6/MHZAJ2-6 Series

Body Option: End Boss Type

Applicable Model

Symbol	Piping port location	Type of piping port		Applicable model	
		MHZA2	MHZAJ2	Double acting	Single acting
E	Side ported	M3 x 0.5	—	●	●
H	Axial ported	With ø4 hose nipple	—	—	●
K		With ø4 One-touch fitting	—	—	●
M		M3 x 0.5	—	—	●

Side Ported [E]

MHZA2-6□□E

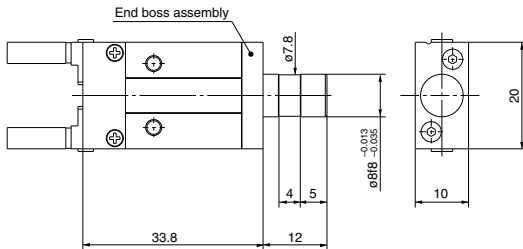

* Specifications and dimensions other than the above are the same as the basic type.

MHZAJ2-6□E□

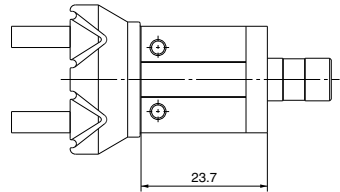

* Specifications and dimensions other than the above are the same as the basic type or the end boss dimensions of the MHZA type.

Axial Ported (with hose nipple) [H]

MHZA2-6^S□H

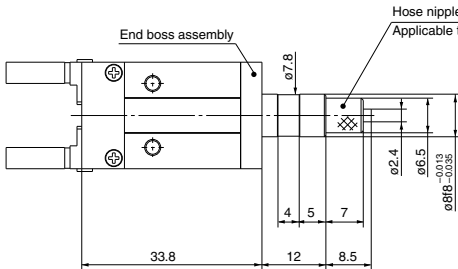

* Specifications and dimensions other than the above are the same as the basic type.

MHZAJ2-6^SH□

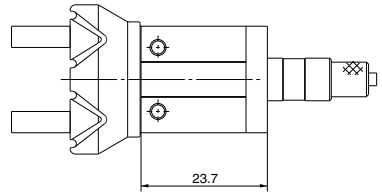

* Specifications and dimensions other than the above are the same as the basic type or the end boss dimensions of the MHZA type.

Applicable Tubing

Specifications	Description/Model	Nylon tubing	Soft nylon tubing	Polyurethane tubing	Polyurethane coil tubing
		T0425	TS0425	TU0425	TCU0425B-1
Outside diameter (mm)		4	4	4	4
Max. operating pressure (MPa)		1.0	0.8	0.5	0.5
Min. bending radius (mm)		13	12	10	—
Operating temperature (°C)		-20 to 60	-20 to 60	-20 to 60	-20 to 60
Material		Nylon 12	Nylon 12	Polyurethane	Polyurethane

Refer to "Pneumatic Piping Equipment (CAT. E50)" regarding One-touch fittings and tubing.

MHZ

MHF

MHL

MHR

MHK

MHS

MHC

MHT

MHY

MHW

-X□

MRHQ

MA

D-□

MHZA2-6/MHZAJ2-6 Series

Axial Ported (with One-touch fitting) [K]

MHZA2-6[□]K

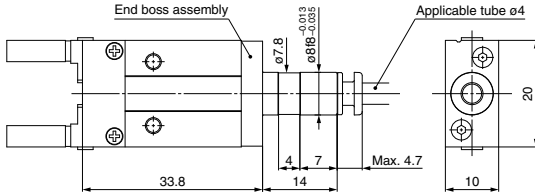

* Specifications and dimensions other than the above are the same as the basic type.

MHZAJ2-6[□]K

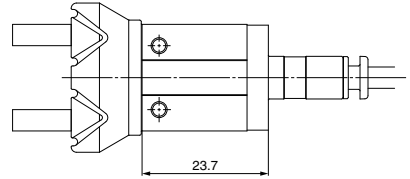

* Specifications and dimensions other than the above are the same as the basic type or the end boss dimensions of the MHZA type.

Applicable Tubing

Description/Model	Nylon tubing	Soft nylon tubing	Polyurethane tubing	Polyurethane coil tubing
Specifications	T0425	TS0425	TU0425	TCU0425B-1
Outside diameter (mm)	4	4	4	4
Max. operating pressure (MPa)	1.0	0.8	0.5	0.5
Min. bending radius (mm)	13	12	10	—
Operating temperature (°C)	-20 to 60	-20 to 60	-20 to 60	-20 to 60
Material	Nylon 12	Nylon 12	Polyurethane	Polyurethane

Refer to "Pneumatic Piping Equipment (CAT. E50)" regarding One-touch fittings and tubing.

Axial Ported (with M3 port) [M]

MHZA2-6[□]M

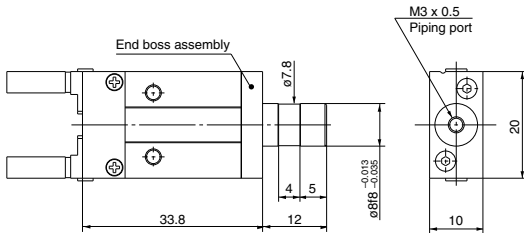

* Specifications and dimensions other than the above are the same as the basic type.

MHZAJ2-6[□]M

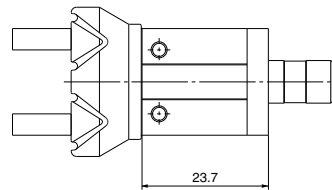

* Specifications and dimensions other than the above are the same as the basic type or the end boss dimensions of the MHZA type.

Weight

Model	End boss type (Symbol)			
	E	H	K	M
MHZA2-6 [□]	28	28	28	28
MHZAJ2-6 [□]	29	29	29	29

(g)

MHZ

MHF

MHL

MHR

MHK

MHS

MHC

MHT

MHY

MHW

-X□

MRHQ

MA

D-□

Parallel Type Air Gripper/Standard Type

MHZ2 Series

ø6, ø10, ø16, ø20, ø25, ø32, ø40

How to Order

Bore size

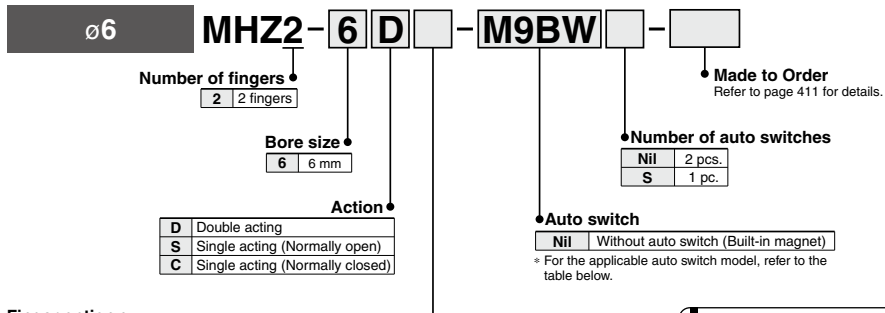

Finger option

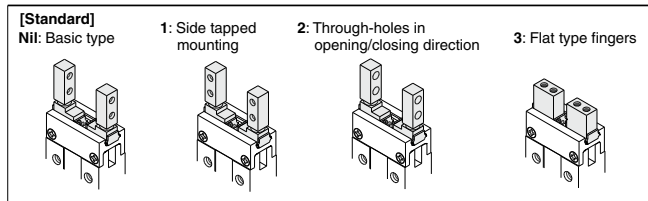

Moisture Control Tube IDK Series

When operating an actuator with a small diameter and a short stroke at a high frequency, the dew condensation (water droplet) may occur inside the piping depending on the conditions. Simply connecting the moisture control tube to the actuator will prevent dew condensation from occurring. For details, refer to [the IDK series in the Best Pneumatics No. 6](#).

Applicable Auto Switches

Refer to pages 797 to 850 for further information on the auto switch.

Type	Special function	Electrical entry	Indicator light	Wiring (Output)	Load voltage		Auto switch model		Lead wire length (m) *				Pre-wired connector	Applicable load	
					DC	AC	Electrical entry direction	Perpendicular	In-line	0.5 (Nil)	1 (M)	3 (L)			5 (Z)
Solid state auto switch	—	Grommet	Yes	3-wire (NPN)	5 V, 12 V	—	M9NV	M9N	●	●	●	○	○	IC circuit	
				3-wire (PNP)					F8N	—	●	—	○		—
				2-wire	M9PV		M9P	●	●	●	○	○			
					F8P		—	●	—	●	○	—			
				3-wire (NPN)	M9BV		M9B	●	●	●	○	○	—		
					F8B		—	●	—	●	○	—			
	Diagnosis (2-color indicator)			Water resistant (2-color indicator)	3-wire (NPN)		5 V, 12 V	M9NWV	M9NW	●	●	●	○	○	IC circuit
					3-wire (PNP)			M9PWV	M9PW	●	●	●	○	○	
					2-wire		M9BWW	M9BW	●	●	●	○	○	—	
							M9NAV**	M9NA**	○	○	●	○	○		IC circuit
					3-wire (PNP)		M9PAV**	M9PA**	○	○	○	○	○	—	
					2-wire		M9BAV**	M9BA**	○	○	●	○	○		

** Water resistant type auto switches can be mounted on the above models, but in such case SMC cannot guarantee water resistance.

* Lead wire length symbols: 0.5 m..... Nil (Example) M9NW

1 m..... M (Example) M9NWV

3 m..... L (Example) M9NWL

5 m..... Z (Example) M9NWZ

* Solid state auto switches marked with ○ are produced upon receipt of order.

Note 1) When using a D-F8□ switch, mount it at a distance of 10 mm or more from magnetic substances such as iron, etc.

Note 2) When using the 2-color indicator type, please make the setting so that the indicator is lit in red to ensure the detection at the proper position of the air gripper.

How to Order

Bore size

ø10 to ø25

MH2-16 D **M9BW**

Number of fingers
2 2 fingers

10	10 mm
16	16 mm
20	20 mm
25	25 mm

D	Double acting
S	Single acting (Normally open)
C	Single acting (Normally closed)

Action

Auto switch

Nil | Without auto switch (Built-in magnet)

* For the applicable auto switch model, refer to the table below.

Number of auto switches

Nil	2 pcs.
S	1 pc.
n	n pc.

Finger position/option

Standard (MHQ2 compatible type)

Nil: Basic type



1: Side tapped mounting



2: Through-holes in opening/closing direction



3: Flat type fingers

The flat type fingers do not have standard and narrow options. When MHQ2/MH2 compatible types are required, see the -X51 made-to-order specifications on page 460.



Narrow type (MHQ2 compatible type)

N: Basic type



N1: Side tapped mounting



N2: Through-holes in opening/closing direction



Body option

Nil: Basic type

E: End boss type Side ported (Double acting/Single acting)

W: End boss type Axial ported ø4 One-touch fitting for coaxial tubing (Double acting)

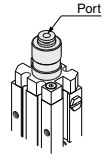
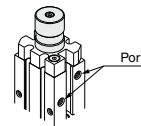
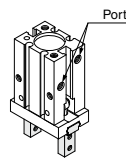

K: End boss type Axial ported with ø4 One-touch fitting (Single acting)



M: End boss type Axial ported with M5 port (Single acting)

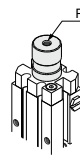

Applicable Auto Switches/Refer to pages 797 to 850 for further information on the auto switch.

Type	Special function	Electrical entry	Indicator light	Wiring (Output)	Load voltage		Auto switch model		Lead wire length (m) *					Applicable model	Pre-wired connector	Applicable load			
					DC	AC	Electrical entry direction		0.5 (Nil)	1 (M)	3 (L)	5 (Z)	ø10				ø16	ø20	ø25
							Perpendicular	In-line											
Solid state auto switch	—	Grommet	Yes	3-wire (NPN)	5 V, 12 V	—	M9NV	M9N	●	●	●	○	●	●	●	○	IC circuit	Relay, PLC	
				3-wire (PNP)			F8N	—	—	—	—	—	—	—	—	—			
				2-wire	12 V	—	—	—	—	—	—	—	—	—	—	—			
				3-wire (NPN)	5 V, 12 V	—	M9BV	M9B	●	●	●	○	●	●	●	○			
				3-wire (PNP)			F8P	—	—	—	—	—	—	—	—	—			
				2-wire	12 V	—	—	—	—	—	—	—	—	—	—	—			
	Diagnosis (2-color indicator)	Grommet	Yes	3-wire (NPN)	5 V, 12 V	—	M9NVV	M9NW	●	●	●	○	●	●	●	○	IC circuit	Relay, PLC	
	3-wire (PNP)			M9PWW			M9PW	●	●	●	○	●	●	●	○				
	2-wire			12 V	—	—	—	—	—	—	—	—	—	—	—				
	3-wire (NPN)			5 V, 12 V	—	M9NAV**	M9NA**	○	○	○	○	○	○	○	○				
	3-wire (PNP)					M9PAV**	M9PA**	○	○	○	○	○	○	○	○				
	2-wire			12 V	—	—	—	—	—	—	—	—	—	—	—				
Water resistant (2-color indicator)	Grommet	Yes	3-wire (NPN)	5 V, 12 V	—	M9NAV**	M9NA**	○	○	○	○	○	○	○	○	IC circuit	Relay, PLC		
3-wire (PNP)			M9PAV**			M9PA**	○	○	○	○	○	○	○	○					
2-wire	12 V	—	—	—	—	—	—	—	—	—	—	—	—						

** Water resistant type auto switches can be mounted on the above models, but in such case SMC cannot guarantee water resistance.

* Lead wire length symbols: 0.5 m..... Nil (Example) M9NW
1 m..... M (Example) M9NWM
3 m..... L (Example) M9NWL
5 m..... Z (Example) M9NWZ

* Solid state auto switches marked with ○ are produced upon receipt of order.

- Note 1) When using the 2-color indicator type, please make the setting so that the indicator is lit in red to ensure the detection at the proper position of the air gripper.
 Note 2) Through-hole mounting is not possible when using the auto switch at the square groove on the side.
 Note 3) When the product is ordered with auto switch, only MH22-10 is shipped with the auto switch mounting brackets. When the auto switch is used at the square groove on the side with MH22-16 to 25, mounting brackets (BMG2-012) are required. Please order them separately. Refer to page 457 for the auto switch mounting brackets.

Moisture Control Tube IDK Series



When operating an actuator with a small diameter and a short stroke at a high frequency, the dew condensation (water droplet) may occur inside the piping depending on the conditions.

Simply connecting the moisture control tube to the actuator will prevent dew condensation from occurring. For details, refer to [the IDK series in the Best Pneumatics No. 6](#).

MHZ2 Series

How to Order

Bore size

ø32 to ø40 **MHZ2-32 D** - **M9BW** - **□**

- Number of fingers**
 - 2 2 fingers
- Bore size**
 - 32 32 mm
 - 40 40 mm
- Action**
 - D Double acting
 - S Single acting (Normally open)
 - C Single acting (Normally closed)
- Number of auto switches**

Nil	2 pcs.
S	1 pc.
n	n pc.
- Auto switch**

Nil	Without auto switch (Built-in magnet)
-----	---------------------------------------

Made to Order
Refer to page 411 for details.

* For the applicable auto switch model, refer to the table below.

Finger option

[Standard] Nil: Basic type

- Side tapped mounting
- Through-holes in opening/closing direction
- Flat type fingers

Applicable Auto Switches

Refer to pages 797 to 850 for further information on the auto switch.

Type	Special function	Electrical entry	Indicator light	Wiring (Output)	Load voltage		Auto switch model		Lead wire length (m) *				Pre-wired connector	Applicable load		
					DC	AC	Electrical entry direction		0.5 (Nil)	1 (M)	3 (L)	5 (Z)				
							Perpendicular	In-line								
Solid state auto switch	—	Grommet	Yes	3-wire (NPN)	5 V, 12 V	—	M9NV	M9N	●	●	●	○	○	IC circuit	Relay, PLC	
				3-wire (PNP)			F8N	—	●	—	●	○	—			
				2-wire	M9PV		M9P	●	●	●	○	○	—			
					F8P		—	●	—	●	○	—	—			
				3-wire (NPN)	M9BV		M9B	●	●	●	○	○	—			—
					F8B		—	●	—	●	○	—	—			—
	Diagnosis (2-color indicator)	Grommet	Yes	3-wire (NPN)	12 V	—	M9NVV	M9NV	●	●	●	○	○	IC circuit		
				3-wire (PNP)			M9PWW	M9PW	●	●	●	○	○	—		
				2-wire	M9BWW		M9BW	●	●	●	○	○	—			
					M9NAV**		M9NA**	○	○	●	○	○	○	IC circuit		
				3-wire (NPN)	M9PAV**		M9PA**	○	○	●	○	○	○	—		
					3-wire (PNP)		M9BAV**	M9BA**	○	○	●	○	○	—		
Water resistant (2-color indicator)	Grommet	Yes	3-wire (NPN)	5 V, 12 V	—	M9NAV**	M9NA**	○	○	●	○	○	IC circuit			
			3-wire (PNP)			M9PAV**	M9PA**	○	○	●	○	○	—			
2-wire	M9NAV**	M9NA**	○	○		●	○	○	○	—						
	M9PAV**	M9PA**	○	○		●	○	○	○	—						

** Water resistant type auto switches can be mounted on the above models, but in such case SMC cannot guarantee water resistance.

* Lead wire length symbols: 0.5 m..... Nil (Example) M9NW

* Solid state auto switches marked with ○ are produced upon receipt of order.

1 m..... M (Example) M9NWM

3 m..... L (Example) M9NWL

5 m..... Z (Example) M9NWX

Note 1) When using the 2-color indicator type, please make the setting so that the indicator is lit in red to ensure the detection at the proper position of the air gripper.

Note 2) Through-hole mounting is not possible when using the auto switch at the square groove on the side.

Note 3) When the auto switch is used at the square groove on the side with MHZ2-32 and 40, mounting brackets (BMG2-012) are required. Please order them separately. Refer to page 457 for the auto switch mounting brackets.

ø6



ø10 to ø25



ø32, ø40



Symbol

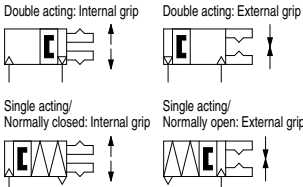

Refer to pages 454 to 458 for the specifications with auto switch.

- Auto switch installation examples and mounting positions
- Auto switch hysteresis
- Auto switch mounting
- Protrusion of auto switch from edge of body



Made to Order: Individual Specifications
(For details, refer to pages 459 and 460.)

Symbol	Specifications/Description
-X46	Built-in needle valve for finger speed control
-X51	MHQ2/MHQG2-compliant flat type fingers



Made to Order
[Click here for details](#)

Symbol	Specifications/Description
-X4	Heat resistance (100°C)
-X5	Fluororubber seal
-X7	Closing direction spring assist
-X12	Opening direction spring assist
-X50	Without magnet
-X53	EPDM seal/Fluorine grease
-X56	Axial ported type
-X63	Fluorine grease
-X79	Grease for food processing machines, Fluorine grease
-X79A	Grease for food processing machines
-X81A	Anti-corrosive treatment of finger
-X81B	Anti-corrosive treatment of finger and guide

Specifications

		Fluid	Air
Operating pressure	Double acting	ø6: 0.15 to 0.7 MPa ø10: 0.2 to 0.7 MPa ø16 to ø40: 0.1 to 0.7 MPa	
	Single acting	Normally open	ø6: 0.3 to 0.7 MPa ø10: 0.35 to 0.7 MPa ø16 to ø40: 0.25 to 0.7 MPa
		Normally closed	
Ambient and fluid temperature		-10 to 60°C	
Repeatability		ø6 to ø25: ±0.01 mm ø32, ø40: ±0.02 mm	
Max. operating frequency		ø6 to ø25: 180 c.p.m. ø32, ø40: 60 c.p.m.	
Lubrication		Not required	
Action		Double acting/Single acting	
Auto switch (Option) ^{Note)}		Solid state auto switch (3-wire, 2-wire)	

Note) Refer to pages 797 to 850 for further information on auto switches.

* Use the gripper with dust cover when used in a place where there may be dust.

Model

Action	Model	Bore size (mm)	Gripping force ^{Note 1)}		Opening/Closing stroke (Both sides) (mm)	Weight ^{Note 2)} (g)	
			Gripping force per finger Effective value (N)				
			External	Internal			
Double acting	MHZ2-6D	6	3.3	6.1	4	27	
	MHZ2-10D(N)	10	11	17	4	55	
	MHZ2-16D(N)	16	34	45	6	115	
	MHZ2-20D(N)	20	42	66	10	230	
	MHZ2-25D(N)	25	65	104	14	420	
	MHZ2-32D	32	158	193	22	715	
Single acting	Normally open	MHZ2-40D	40	254	318	30	1275
		MHZ2-6S	6	1.9	—	4	27
		MHZ2-10S(N)	10	7.1	—	4	55
		MHZ2-16S(N)	16	27	—	6	115
		MHZ2-20S(N)	20	33	—	10	235
		MHZ2-25S(N)	25	45	—	14	425
	Normally closed	MHZ2-32S	32	131	—	22	760
		MHZ2-40S	40	217	—	30	1370
		MHZ2-6C	6	—	3.7	4	27
		MHZ2-10C(N)	10	—	13	4	55
		MHZ2-16C(N)	16	—	38	6	115
		MHZ2-20C(N)	20	—	57	10	235
		MHZ2-25C(N)	25	—	83	14	425
		MHZ2-32C	32	—	161	22	760
MHZ2-40C	40	—	267	30	1370		

Note 1) Values based on pressure of 0.5 MPa, gripping point L = 20 mm, at center of stroke.

Note 2) Values excluding weight of auto switch.

Option

● Body Option/End Boss Type

Symbol	Piping port location	Type of piping port						Applicable model		
		MHZ2-6	MHZ2-10	MHZ2-16	MHZ2-20	MHZ2-25	MHZ2-32	MHZ2-40	Double acting	Single acting
Nil	Basic type	M3 x 0.5	M5 x 0.8					●	●	
E	Side ported	—	M3 x 0.5	M5 x 0.8					●	●
W	Axial ported	—	With ø4 One-touch fitting for coaxial tubing			—		●	—	
K	Axial ported	—	With ø4 One-touch fitting			—		—	●	
M	Axial ported	—	M5 x 0.8			—		—	●	

* For detailed body option specifications, refer to option specifications on pages 424 and 425.

MHZ

MHF

MHL

MHR

MHK

MHS

MHC

MHT

MHY

MHW

-X□

MRHQ

MA

D-□

MHZ2 Series

Clean Series: Air Gripper

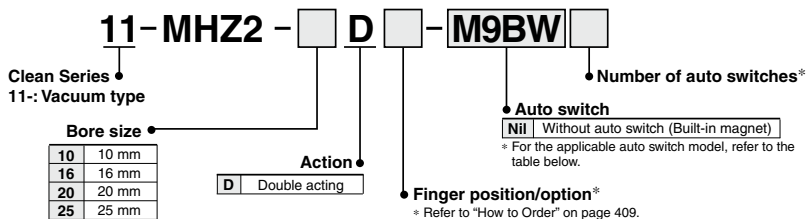

Applicable Auto Switches

Refer to pages 797 to 850 for further information on the auto switch.

Type	Special function	Electrical entry	Indicator light	Wiring (Output)	Load voltage		Auto switch model		Lead wire length (m) *				Pre-wired connector	Applicable load		
					DC	AC	Electrical entry direction	In-line	0.5 (Nil)	1 (M)	3 (L)	5 (Z)				
Solid state auto switch	—	Grommet	Yes	3-wire (NPN)	24 V	5 V, 12 V	M9NV	M9N	●	●	●	○	○	IC circuit	Relay, PLC	
				3-wire (PNP)			F8N	—	●	●	●	○	—			
				2-wire			M9PV	M9P	●	●	●	○	○			
				3-wire (NPN)			F8P	—	●	●	●	○	—			
				3-wire (PNP)			M9BV	M9B	●	●	●	○	○			
				2-wire			F8B	—	●	●	●	○	—			
	Diagnosis (2-color indicator) Water resistant (2-color indicator)	Grommet	Yes	3-wire (NPN)	24 V	5 V, 12 V	M9NWV	M9NW	●	●	●	○	○	○	IC circuit	Relay, PLC
				3-wire (PNP)			M9PWV	M9PW	●	●	●	○	○			
				2-wire			M9BWW	M9BW	●	●	●	○	○			
				3-wire (NPN)			M9NAV**	M9NA**	○	○	●	○	○			
				3-wire (PNP)			M9PAV**	M9PA**	○	○	●	○	○			
				2-wire			M9BAV**	M9BA**	○	○	●	○	○			

- * Water resistant type auto switches can be mounted on the above models, but in such case SMC cannot guarantee water resistance.
- * Lead wire length symbols: 0.5 m..... Nil (Example) M9NW
1 m..... M (Example) M9NWM
3 m..... L (Example) M9NWL
5 m..... Z (Example) M9NWZ
- * Solid state auto switches marked with ○ are produced upon receipt of order.

- Note 1) When using the 2-color indicator type, please make the setting so that the indicator is lit in red to ensure the detection at the proper position of the air gripper.
- Note 2) When using a D-F8□ switch, mount it at a distance of 10 mm or more from magnetic substances such as iron, etc.
- Note 3) For 11-MHZ2-10D□, the through-hole mounting cannot be made when using the auto switch.
- Note 4) Two extension fitting assemblies (P331176A) are supplied with 11-MHZ2-10D□. Please use them if the fitting interferes with the auto switch.

Specifications

Fluid	Air
Operating pressure	ø10: 0.2 to 0.7 MPa ø16 to ø25: 0.1 to 0.7 MPa
Ambient and fluid temperature	-10 to 60°C
Repeatability	±0.01 mm
Max. operating frequency	180 c.p.m.
Lubrication	Not required
Action	Double acting
Cleanliness class (ISO class)	Class 4
Auto switch (Option)	Solid state auto switch (3-wire, 2-wire)

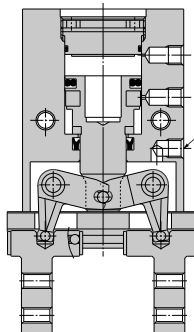
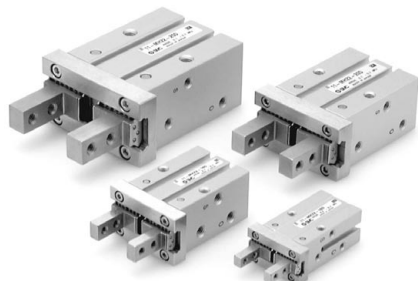

Vacuum port
The concentrated vacuuming of internally generated particulates prevents them from spreading into the clean room.

For details, refer to "Pneumatic Clean Series (CAT. E02-23)" catalog.

Construction: MHZ2-6□

Double acting/With fingers open

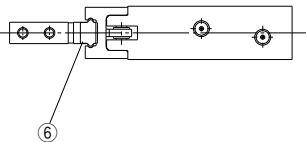
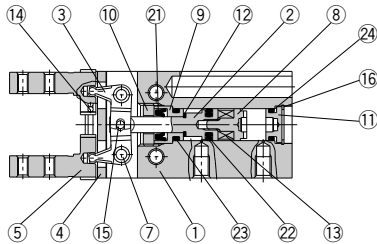

Double acting/With fingers closed

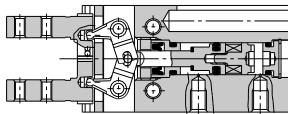

Single acting/Normally open

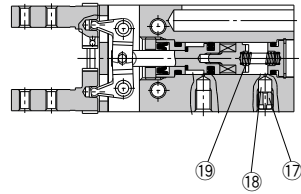

Single acting/Normally closed

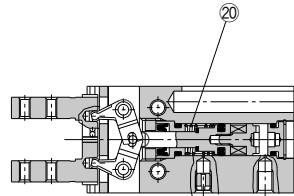

Component Parts

No.	Description	Material	Note
1	Body	Aluminum alloy	Hard anodized
2	Piston	Stainless steel	
3	Lever	Stainless steel	Heat treated
4	Guide	Stainless steel	Heat treated
5	Finger	Stainless steel	Heat treated
6	Roller stopper	Stainless steel	
7	Lever shaft	Stainless steel	Nitriding
8	Magnet holder	Stainless steel	
9	Holder	Brass	Electroless nicked plated
10	Holder lock	Stainless steel	
11	Cap	Aluminum alloy	Clear anodized
12	Bumper	Urethane rubber	
13	Magnet	—	Nickel plated

Component Parts

No.	Description	Material	Note
14	Steel balls	High carbon chrome bearing steel	
15	Needle roller	High carbon chrome bearing steel	
16	Type C retaining ring	Carbon steel	Phosphate coated
17	Exhaust plug	Brass	Electroless nickel plated
18	Exhaust filter	Polyvinyl formal	
19	N.O. spring	Stainless steel spring wire	
20	N.C. spring	Stainless steel spring wire	
21	Rod seal	NBR	
22	Piston seal	NBR	
23	Gasket	NBR	
24	Gasket	NBR	

Replacement Parts

Description		MHZ2-6	Main parts
Finger assembly		Please contact SMC to replace the seal kit and finger assembly.	
Piston assembly	MHZ2-6D□	MHZ-A0603	②⑧⑨⑩⑫⑬⑮⑰⑱⑲
	MHZ2-6S□		
	MHZ2-6C□		

Replacement part/Grease pack part no.: GR-S-010 (10 g)

MHZ

MHF

MHL

MHR

MHK

MHS

MHC

MHT

MHY

MHW

-X□

MRHQ

MA

D-□

MHZ2 Series

Construction: MHZ2-10□ to 25□

Double acting/With fingers open

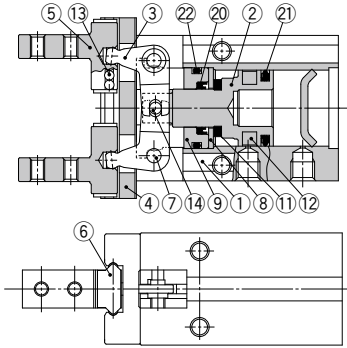

Single acting/Normally open

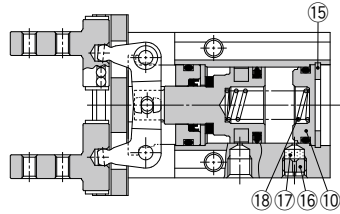

Double acting/With fingers closed

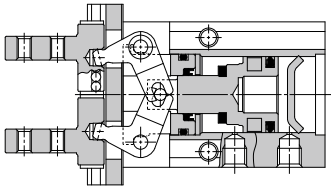

Single acting/Normally closed

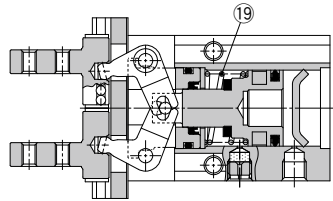

Component Parts

No.	Description	Material	Note
1	Body	Aluminum alloy	Hard anodized
2	Piston	ø10, ø16: Stainless steel ø20, ø25: Aluminum alloy	ø20, ø25: Hard anodized
3	Lever	Stainless steel	Nitriding
4	Guide	Stainless steel	Heat treated
5	Finger	Stainless steel	Heat treated
6	Roller stopper	Stainless steel	
7	Lever shaft	Stainless steel	Nitriding
8	Seal support	Stainless steel	
9	Rod cover	Synthetic resin	
10	Cap	Synthetic resin	Single acting/Normally open only
11	Bumper	Urethane rubber	

Component Parts

No.	Description	Material	Note
12	Rubber magnet	Synthetic rubber	
13	Steel balls	High carbon chrome bearing steel	
14	Needle roller	High carbon chrome bearing steel	
15	Type C retaining ring	Carbon steel	Phosphate coated Single acting/Normally open only
16	Exhaust plug A	Brass	Electroless nickel plated
17	Exhaust filter A	Polyvinyl formal	
18	N.O. spring	Stainless steel spring wire	
19	N.C. spring	Stainless steel spring wire	
20	Rod seal	NBR	
21	Piston seal	NBR	
22	Gasket	NBR	

Replacement Parts

Description	MHZ2-10	MHZ2-16	MHZ2-20	MHZ2-25	Main parts	
Seal kit	MHZ2-□□□□	MHZ10-PS	MHZ16-PS	MHZ20-PS	MHZ25-PS	⑳㉑㉒
	MHZ2-□□□□	MHZ10S-PS	MHZ16S-PS	MHZ20S-PS	MHZ25S-PS	
Finger assembly	MHZ2-□□□(N)	MHZ-AA1002(N)	MHZ-AA1602(N)	MHZ-AA2002(N)	MHZ-AA2502(N)	④⑤⑥⑬
	MHZ2-□□□(N)1	MHZ-AA1002(N)-1	MHZ-AA1602(N)-1	MHZ-AA2002(N)-1	MHZ-AA2502(N)-1	
	MHZ2-□□□(N)2	MHZ-AA1002(N)-2	MHZ-AA1602(N)-2	MHZ-AA2002(N)-2	MHZ-AA2502(N)-2	
Piston assembly	MHZ2-□□□3	MHZ-AA1002-3	MHZ-AA1602-3	MHZ-AA2002-3	MHZ-AA2502-3	②①⑫⑭
	MHZ2-□□□□	MHZ-AA1003	MHZ-AA1603	MHZ-AA2003	MHZ-AA2503	
	MHZ2-□□□□					
End boss assembly	MHZ2-□□□□W	MHZ-A1007	MHZ-A1607	MHZ-A2007	MHZ-A2507	Main body of adaptor Mounting screw for adaptor Seal
	MHZ2-□□□□K	MHZ-A1008	MHZ-A1608	MHZ-A2008	MHZ-A2508	
	MHZ2-□□□□M	MHZ-A1009	MHZ-A1609	MHZ-A2009	MHZ-A2509	
	MHZ2-□□□□E	MHZ-A1010	MHZ-A1610	MHZ-A2010	MHZ-A2510	
Lever assembly	MHZ-AA1004	MHZ-AA1604	MHZ-AA2004	MHZ-AA2504	③	

* Finger option

1 = Side tapped, 2 = Through-hole, 3 = Flat type fingers

* End boss type

W = One-touch-fitting for coaxial tubing, K = With One-touch fitting, M = With M5 port, E = Side ported

* The end boss assembly other than type E should be mounted on the special body.

Replacement part/Grease pack part no.: GR-S-010 (10 g)

Construction: MHZ2-32□ to 40□

Double acting/With fingers open

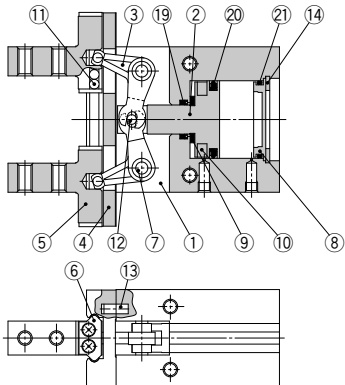

Single acting/Normally open

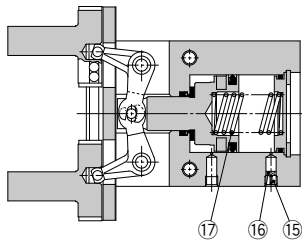

Single acting/Normally closed

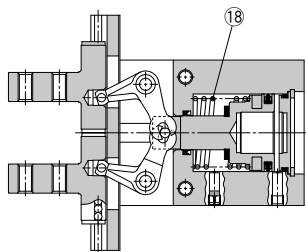

Double acting/With fingers closed

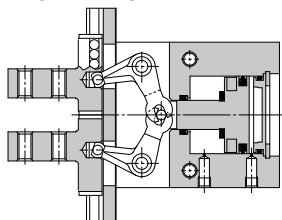

Component Parts

No.	Description	Material	Note
1	Body	Aluminum alloy	Hard anodized
2	Piston	Aluminum alloy	Hard anodized
3	Lever	Stainless steel	Heat treated
4	Guide	Stainless steel	Heat treated
5	Finger	Stainless steel	Heat treated
6	Roller stopper	Stainless steel	
7	Lever shaft	Stainless steel	Nitriding
8	Cap	Aluminum alloy	Clear anodized
9	Bumper	Urethane rubber	
10	Rubber magnet	Synthetic rubber	
11	Steel balls	High carbon chrome bearing steel	

Component Parts

No.	Description	Material	Note
12	Needle roller	High carbon chrome bearing steel	
13	Parallel pin	Stainless steel	
14	Type C retaining ring	Carbon steel	Phosphate coated
15	Exhaust plug A	Brass	Electroless nickel plated
16	Exhaust filter A	Polyvinyl formal	
17	N.O. spring	Stainless steel spring wire	
18	N.C. spring	Stainless steel spring wire	
19	Rod seal	NBR	
20	Piston seal	NBR	
21	Gasket	NBR	

Replacement Parts

Description		MHZ2-32	MHZ2-40	Main parts
Seal kit		MHZ32-PS	MHZ40-PS	(19)(20)(21)
Finger assembly	MHZ2-□□□(N)	MHZ-A3202	MHZ-A4002	(4)(5)(6)(11)(13) Mounting screw
	MHZ2-□□□(N)1	MHZ-A3202-1	MHZ-A4002-1	
	MHZ2-□□□(N)2	MHZ-A3202-2	MHZ-A4002-2	
Piston assembly	MHZ2-□□□3	MHZ-A3202-3	MHZ-A4002-3	(2)(9)(10)(12)
	MHZ2-□□□□	MHZ-A3203	MHZ-A4003	
	MHZ2-□□□□	MHZ-A3203S	MHZ-A4003S	
Lever assembly		MHZ-A3204	MHZ-A4004	(3)

* Finger option

1 = Side tapped, 2 = Through-hole, 3 = Flat type fingers

Replacement part/Grease pack part no.: GR-S-010 (10 g)

MHZ

MHF

MHL

MHR

MHK

MHS

MHC

MHT

MHY

MHW

-X□

MRHQ

MA

D-□

MHZ2 Series

Dimensions

MHZ2-6□ Double acting/Single acting Basic type

Use the MHZJ2 series with a dust cover when used in a place where there may be dust.

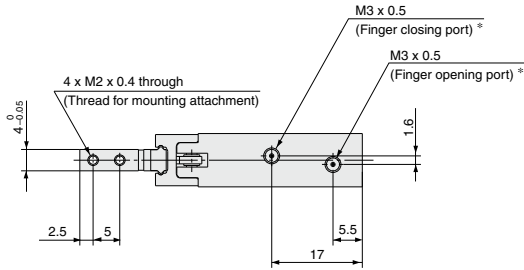
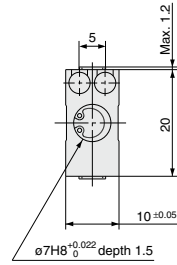
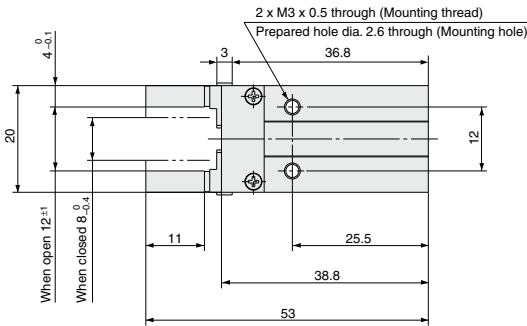

* For single action, the port on one side is a breathing hole.

Auto Switch Mounting Groove Dimensions

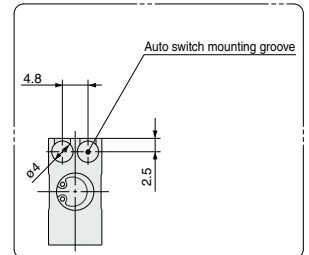

MHZ2-10 □ Double acting/Single acting Basic type

Use the MHZJ2 series with a dust cover when used in a place where there may be dust.

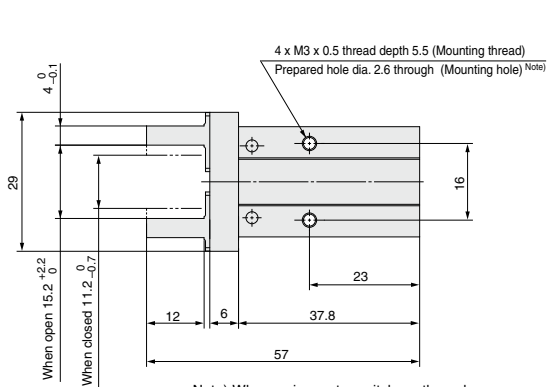
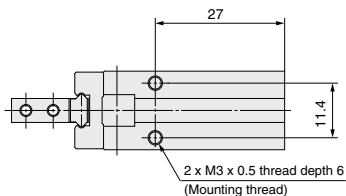

Note) When using auto switches, through-hole mounting is not possible.

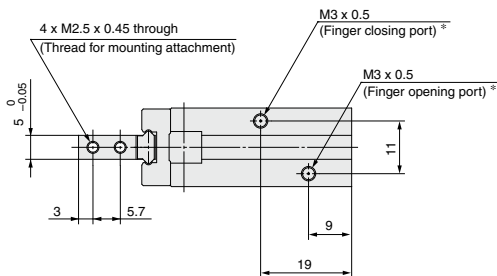
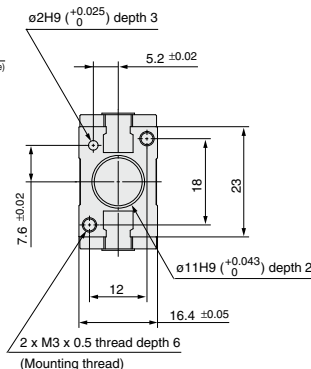

* For single action, the port on one side is a breathing hole.

Finger Position/Narrow Type

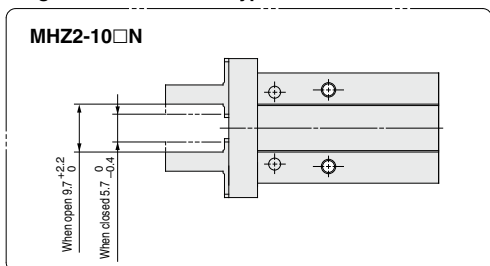

Auto Switch Mounting Groove Dimensions

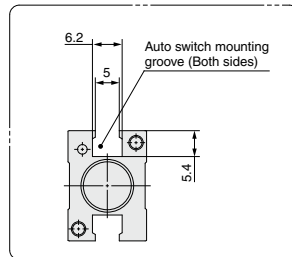

Note) When using auto switches, through-hole mounting is not possible.

- MHZ
- MHF
- MHL
- MHR
- MHK
- MHS
- MHC
- MHT
- MHY
- MHW
- X □
- MRHQ
- MA
- D- □

MHZ2 Series

Dimensions

MHZ2-16□ Double acting/Single acting Basic type

Use the MHZJ2 series with a dust cover when used in a place where there may be dust.

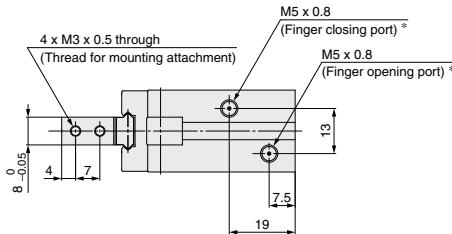
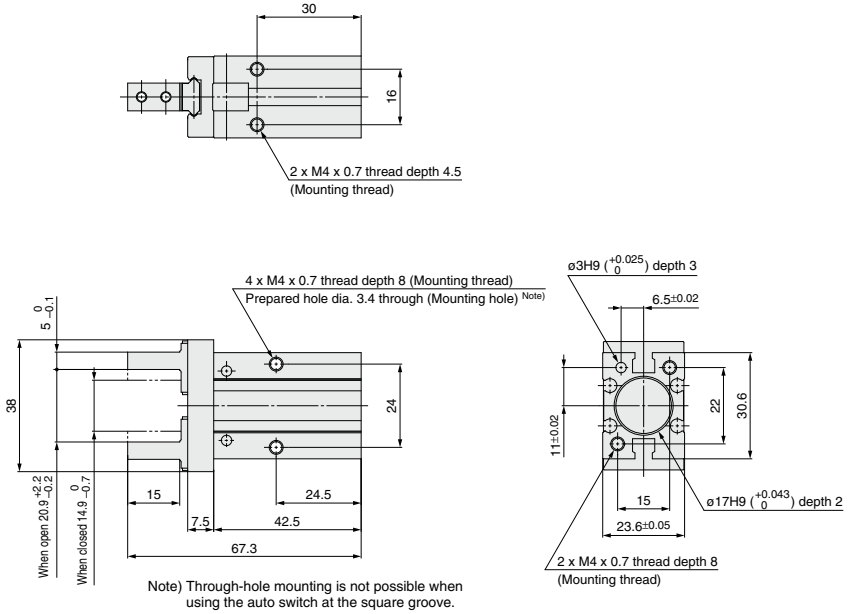

* For single action, the port on one side is a breathing hole.

Finger Position/Narrow Type

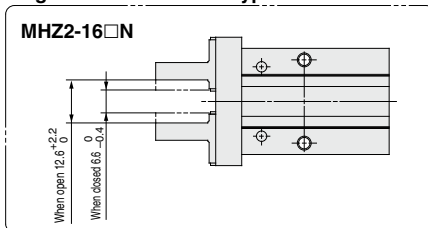

Auto Switch Mounting Groove Dimensions

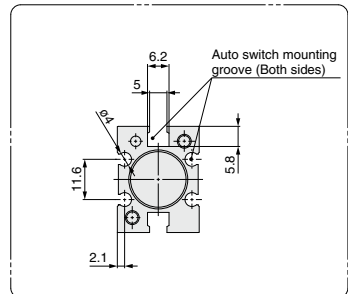

Note: Through-hole mounting is not possible when using the auto switch at the square groove.

MHZ2-20□ Double acting/Single acting Basic type

Use the MHZJ2 series with a dust cover when used in a place where there may be dust.

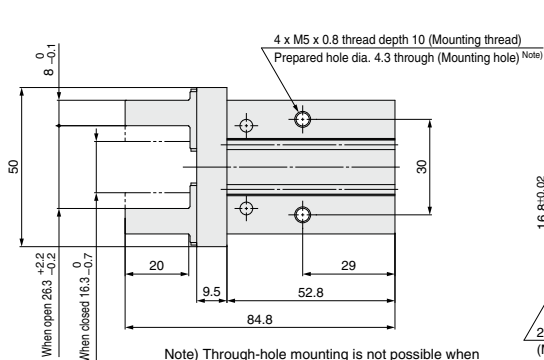
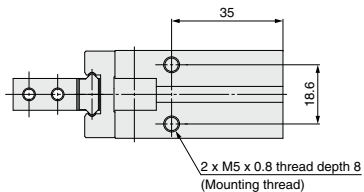

Note) Through-hole mounting is not possible when using the auto switch at the square groove.

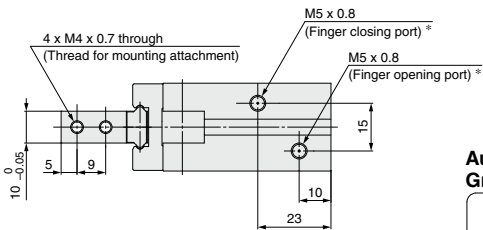
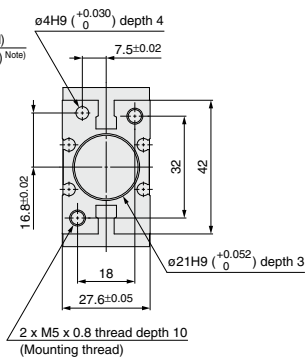

* For single action, the port on one side is a breathing hole.

Finger Position/Narrow Type

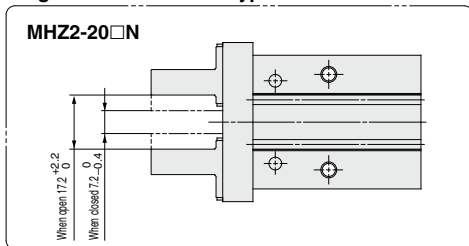

Auto Switch Mounting Groove Dimensions

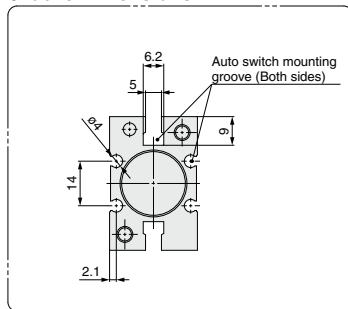

Note) Through-hole mounting is not possible when using the auto switch at the square groove.

MHZ

MHF

MHL

MHR

MHK

MHS

MHC

MHT

MHY

MHW

-X□

MRHQ

MA

D-□

MHZ2-32 □ Double acting/Single acting Basic type

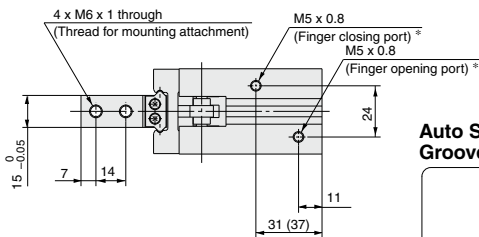
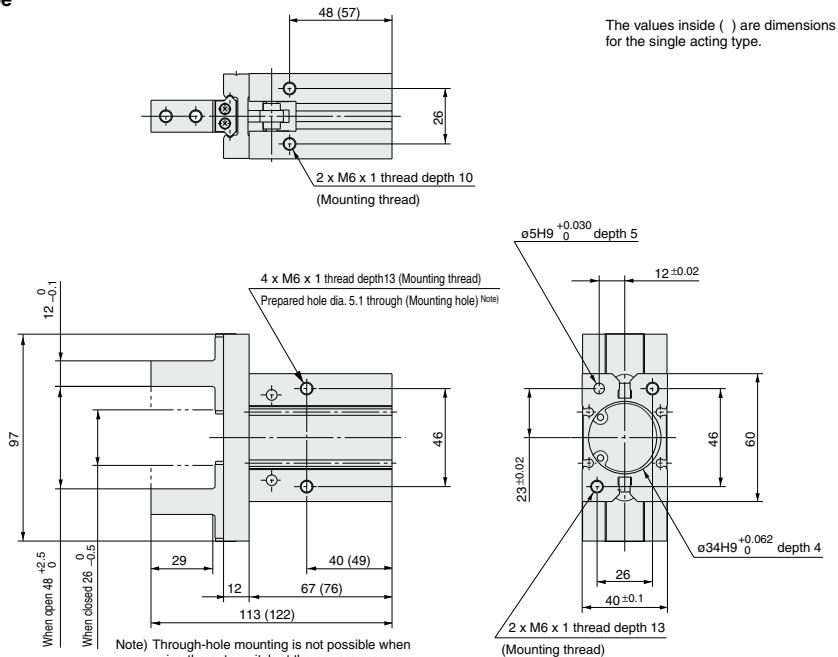

* For single action, the port on one side is a breathing hole.

Auto Switch Mounting Groove Dimensions

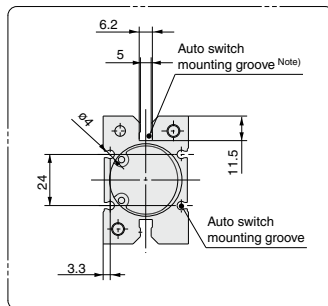

Note) Through-hole mounting is not possible when using the auto switch at the square groove.

- MHZ
- MHF
- MHL
- MHR
- MHK
- MHS
- MHC
- MHT
- MHY
- MHW
- X □
- MRHQ
- MA
- D- □

MHZ2 Series

Dimensions

MHZ2-40 □ Double acting/Single acting

Basic type

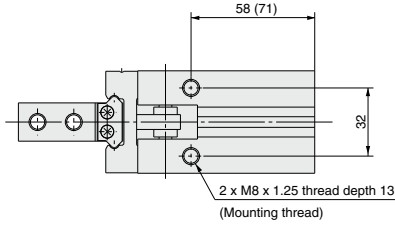

The values inside () are dimensions for the single acting type.

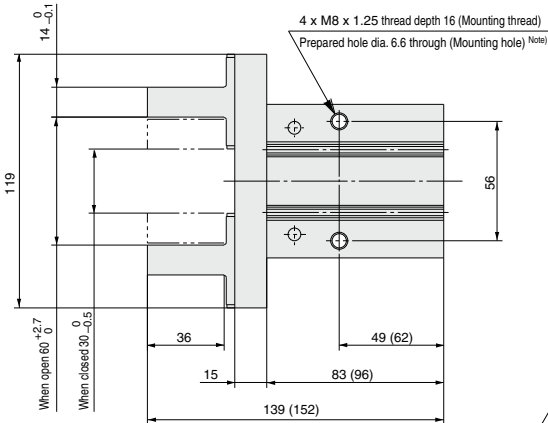

Note) Through-hole mounting is not possible when using the auto switch at the square groove.

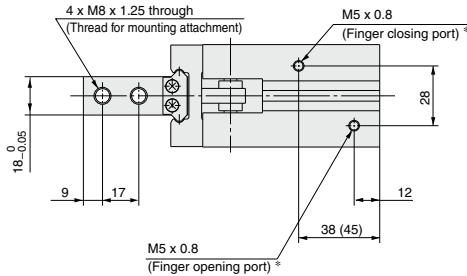
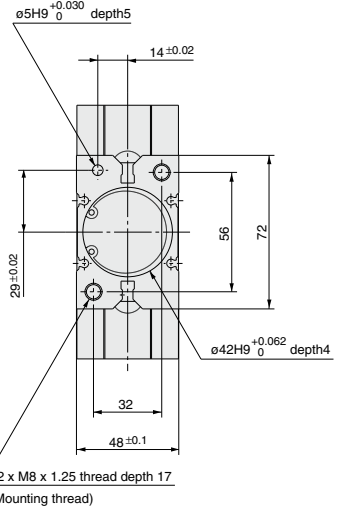

* For single action, the port on one side is a breathing hole.

Auto Switch Mounting Groove Dimensions

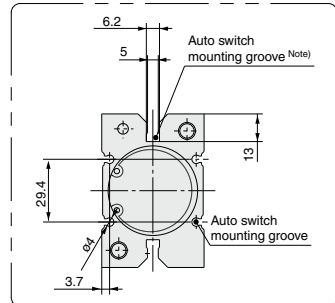

Note) Through-hole mounting is not possible when using the auto switch at the square groove.

Standard Type/MHZ2 Series Finger Option

Side Tapped Mounting [1/N1]

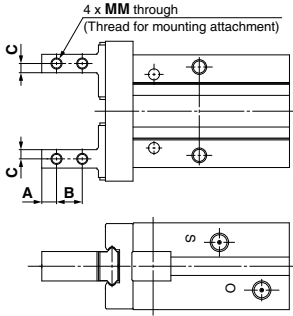

(mm)

Model	A	B	C	MM
MHZ2-6□1	2.5	5	2	M2 x 0.4
MHZ2-10□ _{N1} □	3	5.7	2	M2.5 x 0.45
MHZ2-16□ _{N1} □	4	7	2.5	M3 x 0.5
MHZ2-20□ _{N1} □	5	9	4	M4 x 0.7
MHZ2-25□ _{N1} □	6	12	5	M5 x 0.8
MHZ2-32□1□	7	14	6	M6 x 1
MHZ2-40□1□	9	17	7	M8 x 1.25

* Specifications and dimensions other than the above are the same as the basic type (including narrow type).

Through-holes in Opening/ Closing Direction [2/N2]

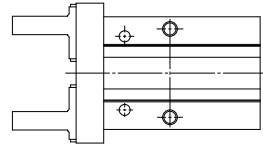

4 x øH through
(Hole for mounting attachment)

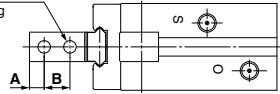

(mm)

Model	A	B	H
MHZ2-6□2	2.5	5	2.4
MHZ2-10□ _{N2} □	3	5.7	2.9
MHZ2-16□ _{N2} □	4	7	3.4
MHZ2-20□ _{N2} □	5	9	4.5
MHZ2-25□ _{N2} □	6	12	5.5
MHZ2-32□2□	7	14	6.6
MHZ2-40□2□	9	17	9

* Specifications and dimensions other than the above are the same as the basic type (including narrow type).

Flat Type Fingers [3]

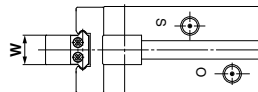
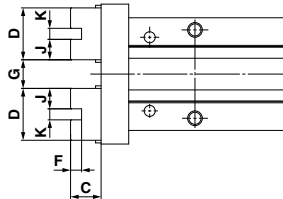
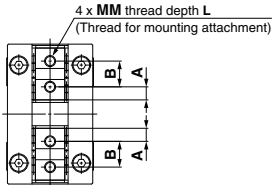

(mm)

Model	A	B	C	D	F	G		J	K	MM	L	W	Weight (g)
						Open	Closed						
MHZ2-6□3 ⁽¹⁾	2	3.5	7.2	7.5	—	5 ^{+1.2} _{-0.8}	1 ^{+0.2} ₀	—	—	M2 x 0.4	3	4 ⁰ _{-0.05}	26
MHZ2-10□3□ ⁽²⁾⁽³⁾	2.45	6	5.2	10.9	2	5.4 ^{+2.2} ₀	1.4 ⁰ _{-0.2}	4.45	2H9 ^{+0.025} ₀	M2.5 x 0.45	5	5 ⁰ _{-0.05}	55
MHZ2-16□3□ ⁽²⁾⁽³⁾	3.05	8	8.3	14.1	2.5	7.4 ^{+2.2} ₀	1.4 ⁰ _{-0.2}	5.8	2.5H9 ^{+0.025} ₀	M3 x 0.5	6	8 ⁰ _{-0.05}	115
MHZ2-20□3□ ⁽²⁾⁽³⁾	3.95	10	10.5	17.9	3	11.6 ^{+2.3} ₀	1.6 ⁰ _{-0.2}	7.45	3H9 ^{+0.025} ₀	M4 x 0.7	8	10 ⁰ _{-0.05}	225 (230)
MHZ2-25□3□ ⁽²⁾⁽³⁾	4.9	12	13.1	21.8	4	16 ^{+2.5} ₀	2 ⁰ _{-0.2}	8.9	4H9 ^{+0.030} ₀	M5 x 0.8	10	12 ⁰ _{-0.05}	410 (415)
MHZ2-32□3□	7.3	20	18	34.6	5	25 ^{+2.7} ₀	3 ⁰ _{-0.2}	14.8	5H9 ^{+0.030} ₀	M6 x 1	12	15 ⁰ _{-0.05}	740 (785)
MHZ2-40□3□	8.7	24	22	41.4	6	33 ^{+2.9} ₀	3 ⁰ _{-0.2}	17.7	6H9 ^{+0.030} ₀	M8 x 1.25	16	18 ⁰ _{-0.05}	1335 (1430)

Note 1) To mount attachments, use JISB1101 type M2 round head screws. Be careful not to use commercially available M2 hexagon socket head cap bolt as its top diameter is large.

Note 2) Specifications and dimensions other than the above are the same as the basic type (including narrow type).

Note 3) The overall length is the same as the MHQ(G) flat finger type.

Note 4) The values inside () are for the single acting type.

Standard Type/MHZ2 Series

Body Option: End Boss Type

Applicable Model

Symbol	Piping port location	Type of piping port				Applicable model		
		MHZ2-10	MHZ2-16	MHZ2-20	MHZ2-25	Double acting	Single acting	
E	Side ported	M3 x 0.5		M5 x 0.8		●	●	●
W	Axial ported	With $\phi 4$ One-touch fitting for coaxial tubing				●	—	—
K		With $\phi 4$ One-touch fitting				—	●	●
M		M5 x 0.8				—	●	●

Side Ported [E]

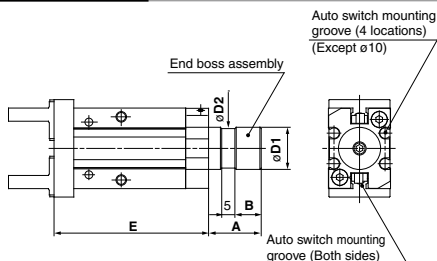

Model	A	B	D1	D2	E
MHZ2-10□□E	15	7	12f8 ^{-0.016} _{-0.043}	11	52.8
MHZ2-16□□E	20	10	16f8 ^{-0.016} _{-0.043}	15	58.7
MHZ2-20□□E	22	12	20f8 ^{-0.020} _{-0.053}	19	70.5
MHZ2-25□□E	25	15	25f8 ^{-0.020} _{-0.053}	24	82.9

Other dimensions and specifications correspond to the standard type.

* Refer to the dimension table.

* When auto switches are used at the square groove on the side, side mounting with through-holes is not possible.

Axial Ported (with One-touch fitting for coaxial tubing) [W]

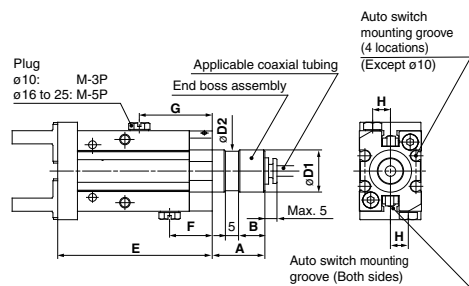

Model	A	B	D1	D2	E	F	G	H
MHZ2-10D□W	15	7	12f8 ^{-0.016} _{-0.043}	11	52.8	18	28.3	5.5
MHZ2-16D□W	20	10	16f8 ^{-0.016} _{-0.043}	15	58.7	16.2	27.7	6.5
MHZ2-20D□W	22	12	20f8 ^{-0.020} _{-0.053}	19	70.5	18.2	31.2	7.5
MHZ2-25D□W	25	15	25f8 ^{-0.020} _{-0.053}	24	82.9	19	31.8	10

Other dimensions and specifications correspond to the standard type.

* Refer to the dimension table.

* When auto switches are used at the square groove on the side, side mounting with through-holes is not possible.

Applicable Coaxial Tubing

Reference symbol

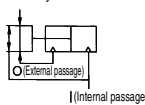

Model	TW04B-20
Specifications	
Outside diameter	4 mm
Max. operating pressure	0.6 MPa
Min. bending radius	10 mm
Operating temperature	-20 to 60°C
Material	Nylon 12

Changing from Coaxial to Single Tubing

Changing to single tubing is possible by using a branch "Y" or branch tee fitting. In this case particularly, single tube fittings and tube for $\phi 3.2$ will be necessary.

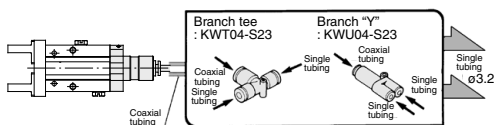

Branch Tee, Different Diameter Tee, Branch "Y", Male Run Tee

Please contact your SMC sales representative for details of the coaxial fittings and tubing.

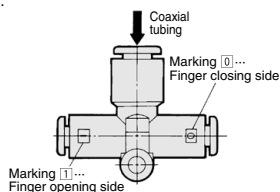

Axial Ported (with One-touch fitting) [K]

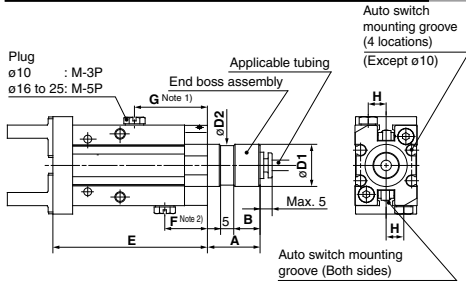

- * Refer to the dimension table.
- * When auto switches are used at the square groove on the side, side mounting with through-holes is not possible.

Note 1) Normally open type plug position.
 Note 2) Normally closed type plug position.
 The plug is mounted on only one side for the single acting type.

		(mm)							
Model		A	B	D1	D2	E	F	G	H
MHZ2-10	$\frac{S}{C}$ □ K	15	7	12f8 ^{-0.016} _{-0.043}	11	52.8	18	28.3	5.5
MHZ2-16	$\frac{S}{C}$ □ K	20	10	16f8 ^{-0.016} _{-0.043}	15	58.7	16.2	27.7	6.5
MHZ2-20	$\frac{S}{C}$ □ K	22	12	20f8 ^{-0.020} _{-0.053}	19	70.5	18.2	31.2	7.5
MHZ2-25	$\frac{S}{C}$ □ K	25	15	25f8 ^{-0.020} _{-0.053}	24	82.9	19	31.8	10

Other dimensions and specifications correspond to the standard type.

Applicable Tubing

Description/Model	Nylon tubing	Soft nylon tubing	Polyurethane tubing	Polyurethane coil tubing
	T0425	TS0425	TU0425	TCU0425B-1
Outside diameter (mm)	4	4	4	4
Max. operating pressure (MPa)	1.0	0.8	0.5	0.5
Min. bending radius (mm)	13	12	10	—
Operating temperature (°C)	-20 to 60	-20 to 60	-20 to 60	-20 to 60
Material	Nylon 12	Nylon 12	Polyurethane	Polyurethane

Refer to "Best Pneumatics No. 7" regarding One-touch fittings and tubing.

Axial Ported (with M5 Port) [M]

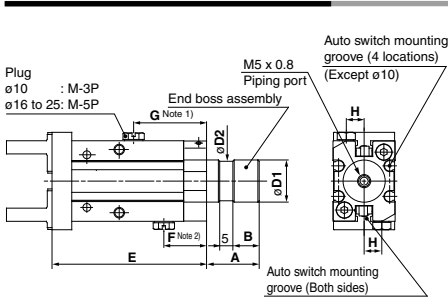

- * Refer to the dimension table.
- * When auto switches are used at the square groove on the side, side mounting with through-holes is not possible.

Note 1) Normally open type plug position.
 Note 2) Normally closed type plug position.
 The plug is mounted on only one side for the single acting type.

		(mm)							
Model		A	B	D1	D2	E	F	G	H
MHZ2-10	$\frac{S}{C}$ □ M	15	7	12f8 ^{-0.016} _{-0.043}	11	52.8	18	28.3	5.5
MHZ2-16	$\frac{S}{C}$ □ M	20	10	16f8 ^{-0.016} _{-0.043}	15	58.7	16.2	27.7	6.5
MHZ2-20	$\frac{S}{C}$ □ M	22	12	20f8 ^{-0.020} _{-0.053}	19	70.5	18.2	31.2	7.5
MHZ2-25	$\frac{S}{C}$ □ M	25	15	25f8 ^{-0.020} _{-0.053}	24	82.9	19	31.8	10

Other dimensions and specifications correspond to the standard type.

Weight

Model	End boss type (Symbol)			
	E	W	K	M
MHZ2-10 □ □	65	64	66	65
MHZ2-16 □ □	148	147	148	147
MHZ2-20 □ □	272	277	277	277
MHZ2-25 □ □	485	495	496	494

MHZ

MHF

MHL

MHR

MHK

MHS

MHC

MHT

MHY

MHW

-X □

MRHQ

MA

D-□

Parallel Type Air Gripper/Long Stroke Type

MHZL2 Series

ø10, ø16, ø20, ø25

How to Order

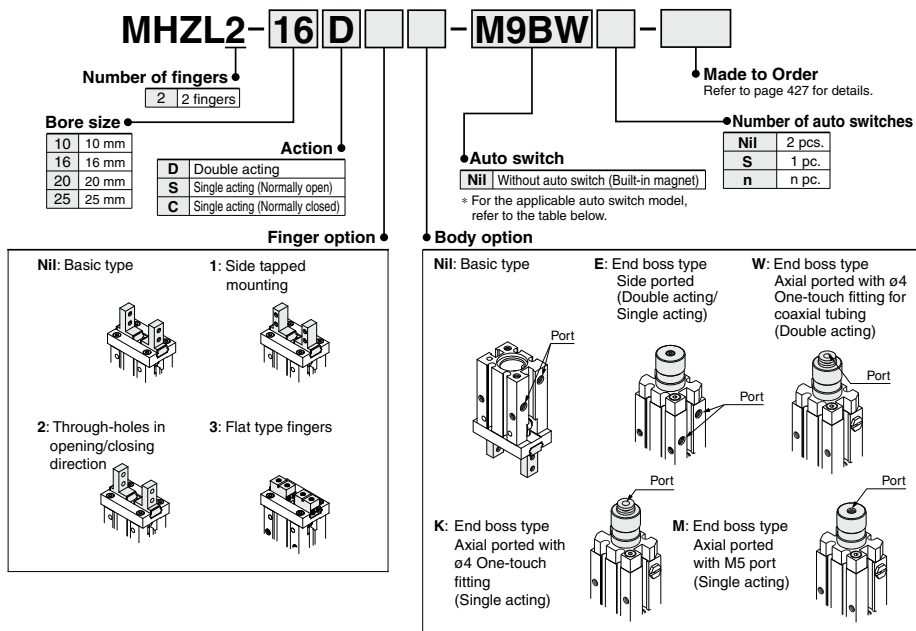

Applicable Auto Switches

Refer to pages 797 to 850 for further information on the auto switch.

Type	Special function	Electrical entry	Indicator light	Wiring (Output)	Load voltage		Auto switch model		Lead wire length (m) *					Applicable model	Pre-wired connector	Applicable load			
					DC	AC	Electrical entry direction		0.5 (Nil)	1 (M)	3 (L)	5 (Z)	ø10				ø16	ø20	ø25
							Perpendicular	In-line											
Solid state auto switch	—	Grommet	Yes	3-wire (NPN)	5V, 12 V	24 V	—	M9NV	M9N	●	●	○	●	●	●	○	IC circuit		
				F8N				M9P	—	—	—	—	●	●	●	—			
				M9PV				M9P	●	●	●	○	●	●	●	●		○	
				F8P				M9B	●	—	●	○	—	—	●	●		—	
				M9BV				M9B	●	—	●	○	—	—	●	●		○	
				F8B				M9NW	●	—	●	○	—	—	●	●		—	
	Diagnosis (2-color indicator)	Grommet	Yes	3-wire (NPN)	5V, 12 V	24 V	—	M9NWV	M9NW	●	●	○	●	●	●	○	IC circuit		
				M9PVV				M9PW	●	●	○	●	●	●	○				
				M9BWW				M9BW	●	●	○	●	●	●	○				
				M9NAV**				M9NA**	○	○	●	○	●	●	●	○			
				M9PAV**				M9PA**	○	○	○	○	●	●	●	○			
				M9BAV**				M9BA**	○	○	●	○	●	●	●	○			

** Water resistant type auto switches can be mounted on the above models, but in such case SMC cannot guarantee water resistance.

* Lead wire length symbols: 0.5 m..... Nil (Example) M9NW

1 m..... M (Example) M9NW

3 m..... L (Example) M9NL

5 m..... Z (Example) M9NZ

* Solid state auto switches marked with ○ are produced upon receipt of order.

Note 1) When using the 2-color indicator type, please make the setting so that the indicator is lit in red to ensure the detection at the proper position of the air gripper.

Note 2) Through-hole mounting is not possible when using the auto switch at the square groove on the side.

Note 3) When the product is ordered with auto switch, only MHZL2-10 is shipped with the auto switch mounting brackets. When the auto switch is used at the square groove on the side with MHZL2-16 to 25, mounting brackets (BMG2-012) are required. Order them separately. Refer to page 457 for the auto switch mounting brackets.

Specifications



Fluid		Air
Operating pressure	Double acting	ø10: 0.2 to 0.7 MPa ø16 to ø25: 0.1 to 0.7 MPa
	Single acting Normally open acting Normally closed	ø10: 0.35 to 0.7 MPa ø16 to ø25: 0.25 to 0.7 MPa
Ambient and fluid temperature		-10 to 60°C
Repeatability		±0.01 mm
Max. operating frequency		120 c.p.m.
Lubrication		Not required
Action		Double acting/Single acting
Auto switch (Option) ^{Note)}		Solid state auto switch (3-wire, 2-wire)

Note) Refer to pages 797 to 850 for further information on auto switches.

Symbol

Double acting:
Internal grip

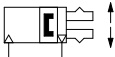

Double acting:
External grip

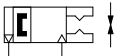

Single acting/
Normally closed: Internal grip

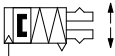

Single acting/
Normally open: External grip



Refer to pages 454 to 458 for the specifications with auto switch.

- Auto switch installation examples and mounting positions
- Auto switch hysteresis
- Auto switch mounting
- Protrusion of auto switch from edge of body



Made to Order Individual Specifications
(Refer to pages 436 to 439 for details.)

Symbol	Specifications/Description
-X6110	With dust cover

Made to Order

[Click here for details](#)

Symbol	Specifications/Description
-X4	Heat resistance (100°C)
-X5	Fluororubber seal
-X7	Closing direction spring assist
-X12	Opening direction spring assist
-X50	Without magnet
-X53	EPDM seal/Fluorine grease
-X56	Axial ported type
-X63	Fluorine grease
-X79	Grease for food processing machines, Fluorine grease
-X79A	Grease for food processing machines
-X81A	Anti-corrosive treatment of finger
-X81B	Anti-corrosive treatment of finger and guide

Model

Action	Model	Bore size (mm)	Gripping force ^{Note 1)}		Opening/Closing stroke (Both sides) (mm)	Weight ^{Note 2)} (g)	
			Gripping force per finger Effective value (N)				
			External	Internal			
Double acting	MHZL2-10D	10	11	17	8	60	
	MHZL2-16D	16	34	45	12	135	
	MHZL2-20D	20	42	66	18	270	
	MHZL2-25D	25	65	104	22	470	
Single acting	Normally open	MHZL2-10S	10	7.1	—	8	70
		MHZL2-16S	16	27		12	145
		MHZL2-20S	20	33		18	290
		MHZL2-25S	25	50		22	515
	Normally closed	MHZL2-10C	10	—	13	8	70
		MHZL2-16C	16		38	12	145
		MHZL2-20C	20		57	18	290
		MHZL2-25C	25		85	22	515

Note 1) Values based on pressure of 0.5 MPa, gripping point L = 20 mm, at center of stroke.
Note 2) Values excluding weight of auto switch.

Option

● Body Option/End Boss Type

Symbol	Piping port location	Type of piping port				Applicable model		
		MHZL2-10	MHZL2-16	MHZL2-20	MHZL2-25	Double acting	Single acting	
Nil	Basic type	M3 x 0.5	M5 x 0.8			●	●	
E	Side ported	M3 x 0.5	M5 x 0.8			●	●	
W	Axial ported	With ø4 One-touch fitting for coaxial tubing					●	—
K	Axial ported	With ø4 One-touch fitting					—	●
M	Axial ported	M5 x 0.8					—	●

* For detailed body option specifications, refer to option specifications on pages 434 and 435.

Moisture Control Tube IDK Series



When operating an actuator with a small diameter and a short stroke at a high frequency, the dew condensation (water droplet) may occur inside the piping depending on the conditions. Simply connecting the moisture control tube to the actuator will prevent dew condensation from occurring. For details, refer to [the IDK series in the Best Pneumatics No. 6](#).

MHZL2 Series

Construction: MHZL2-10□ to 25□

Double acting/With fingers open

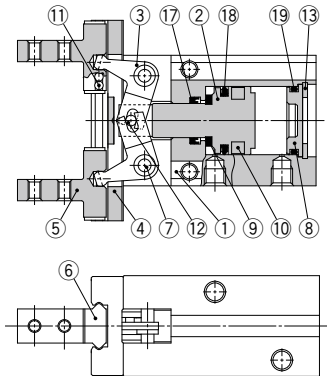

Single acting/Normally open

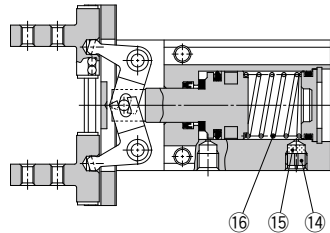

Double acting/With fingers closed

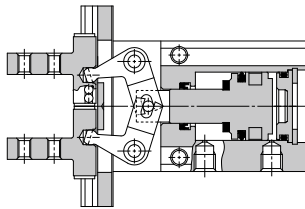

Single acting/Normally closed

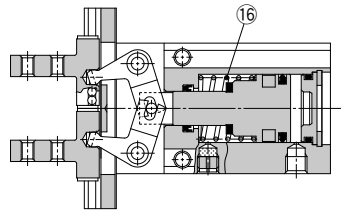

Component Parts

No.	Description	Material	Note
1	Body	Aluminum alloy	Hard anodized
2	Piston	ø10, ø16: Stainless steel ø20, ø25: Aluminum alloy	Hard anodized
3	Lever	Stainless steel	Nitriding
4	Guide	Stainless steel	Heat treated
5	Finger	Stainless steel	Heat treated
6	Roller stopper	Stainless steel	
7	Lever shaft	Stainless steel	Nitriding
8	Cap	Aluminum alloy	Clear anodized
9	Bumper	Urethane rubber	

Component Parts

No.	Description	Material	Note
10	Rubber magnet	Synthetic rubber	
11	Steel balls	High carbon chrome bearing steel	
12	Needle roller	High carbon chrome bearing steel	
13	Type C retaining ring	Carbon steel	Phosphate coated
14	Exhaust plug A	Brass	Electroless nickel plated
15	Exhaust filter A	Polyvinyl formal	
16	Spring	Stainless steel spring wire	
17	Rod seal	NBR	
18	Piston seal	NBR	
19	Gasket	NBR	

Replacement Parts

Description		MHZL2-10	MHZL2-16	MHZL2-20	MHZL2-25	Main parts
Seal kit		MHZL10-PS	MHZL16-PS	MHZL20-PS	MHZL25-PS	⑰⑱⑲
Finger assembly	MHZL2-□□□	MHZL-AA1002	MHZL-AA1602	MHZL-AA2002	MHZL-AA2502	④⑤⑥⑱
	MHZL2-□□□1	MHZL-AA1002-1	MHZL-AA1602-1	MHZL-AA2002-1	MHZL-AA2502-1	
	MHZL2-□□□2	MHZL-AA1002-2	MHZL-AA1602-2	MHZL-AA2002-2	MHZL-AA2502-2	
Piston assembly	MHZL2-□□□3	MHZL-AA1002-3	MHZL-AA1602-3	MHZL-AA2002-3	MHZL-AA2502-3	②⑨⑩⑫
	MHZL2-□□□D	MHZL-A1003	MHZL-A1603	MHZL-A2003	MHZL-A2503	
	MHZL2-□□□S	MHZL-A1003C	MHZL-A1603C	MHZL-A2003C	MHZL-A2503C	
End boss assembly	MHZL2-□□□CW	MHZ-A1007	MHZ-A1607	MHZ-A2007	MHZ-A2507	Main body of adaptor Mounting screw for adaptor Seal kit
	MHZL2-□□□K	MHZ-A1008	MHZ-A1608	MHZ-A2008	MHZ-A2508	
	MHZL2-□□□CM	MHZ-A1009	MHZ-A1609	MHZ-A2009	MHZ-A2509	
	MHZL2-□□□E	MHZ-A1010	MHZ-A1610	MHZ-A2010	MHZ-A2510	
Lever assembly		MHZL-A1004	MHZL-A1604	MHZL-A2004	MHZL-A2504	③⑦

* Finger option

1 = Side tapped, 2 = Through-hole, 3 = Flat type fingers

* End boss type

W = One-touch-fitting for coaxial tubing, K = With One-touch fitting, M = With M5 port, E = Side ported

* The end boss assembly other than type E should be mounted on the special body.

Replacement part/Grease pack part no.: GR-S-010 (10 g)

Dimensions

MHZL2-10 □ Double acting/Single acting

Basic type

The values inside () are dimensions for the single acting type.

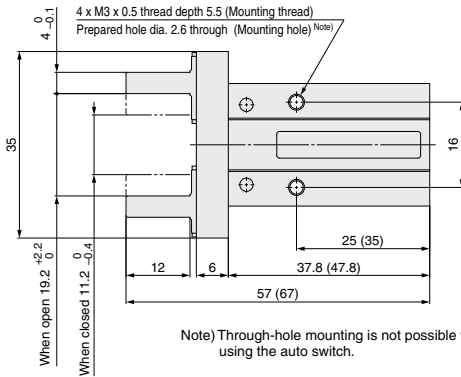
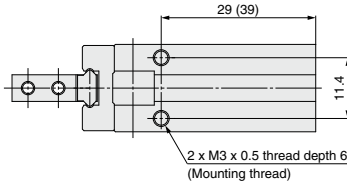

Note) Through-hole mounting is not possible when using the auto switch.

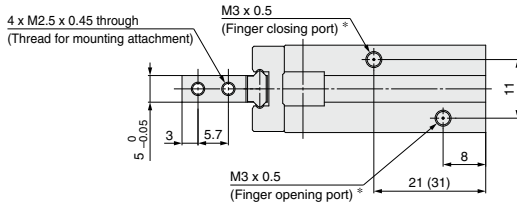
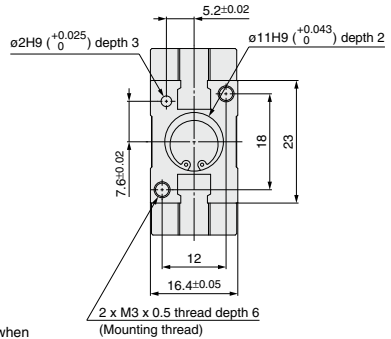

* For single action, the port on one side is a breathing hole.

Auto Switch Mounting Groove Dimensions

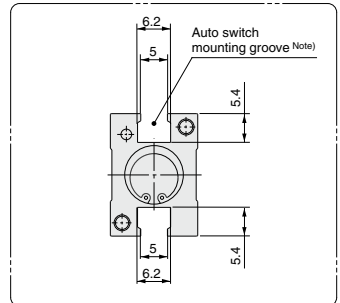

Note) Through-hole mounting is not possible when using the auto switch at the square groove.

MHZ

MHF

MHL

MHR

MHK

MHS

MHC

MHT

MHY

MHW

-X □

MRHQ

MA

D- □

MHZL2 Series

Dimensions

MHZL2-16 □ Double acting/Single acting Basic type

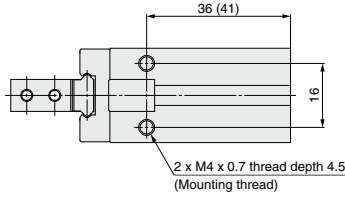

The values inside () are dimensions for the single acting type.

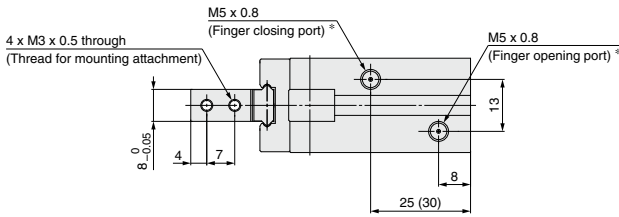
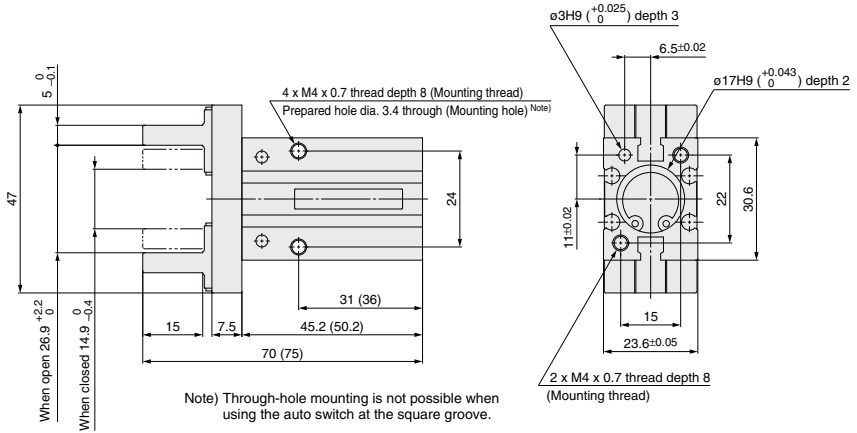

*For single action, the port on one side is a breathing hole.

Auto Switch Mounting Groove Dimensions

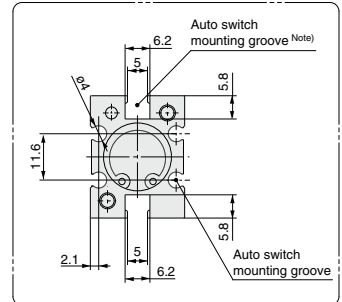

Note) Through-hole mounting is not possible when using the auto switch at the square groove.

MHZL2-20□ Double acting/Single acting Basic type

The values inside () are dimensions for the single acting type.

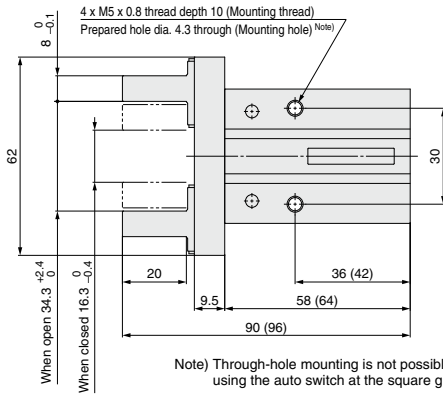
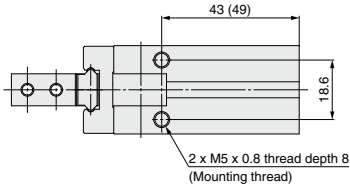

Note) Through-hole mounting is not possible when using the auto switch at the square groove.

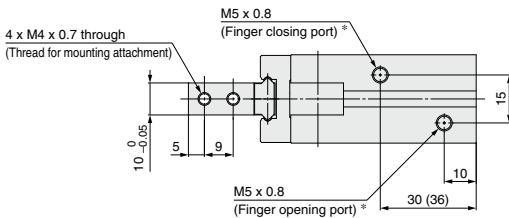
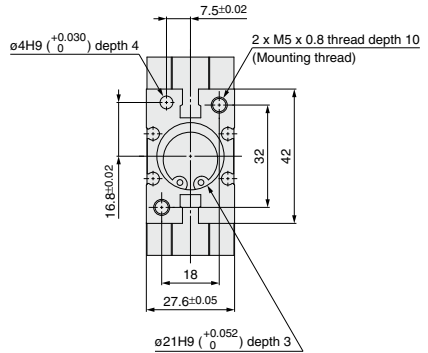

* For single action, the port on one side is a breathing hole.

Auto Switch Mounting Groove Dimensions

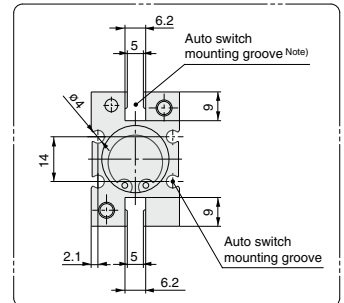

Note) Through-hole mounting is not possible when using the auto switch at the square groove.

MHZ

MHF

MHL

MHR

MHK

MHS

MHC

MHT

MHY

MHW

-X□

MRHQ

MA

D-□

MHZL2 Series

Dimensions

MHZL2-25 □ Double acting/Single acting Basic type

The values inside () are dimensions for the single acting type.

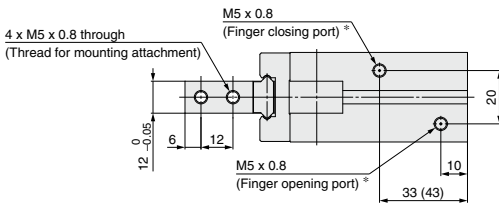
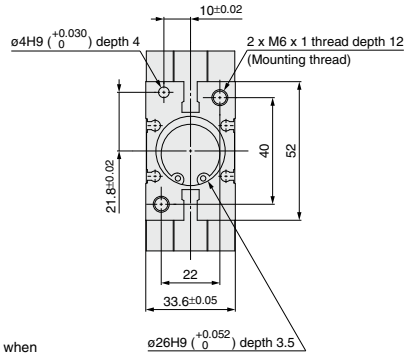
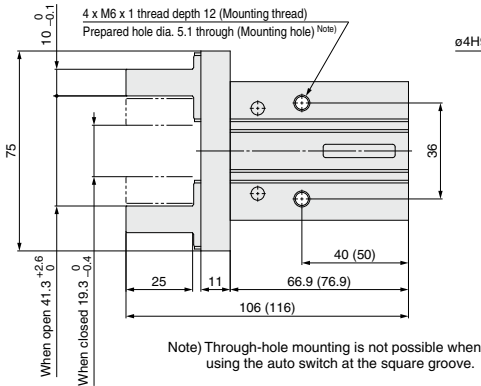
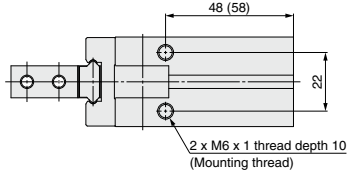

* For single action, the port on one side is a breathing hole.

Auto Switch Mounting Groove Dimensions

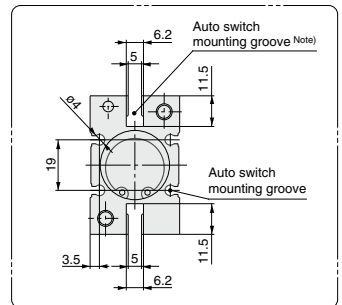

Note) Through-hole mounting is not possible when using the auto switch at the square groove.

Long Stroke Type/MHZL2 Series Finger Option

Side Tapped Mounting [1]

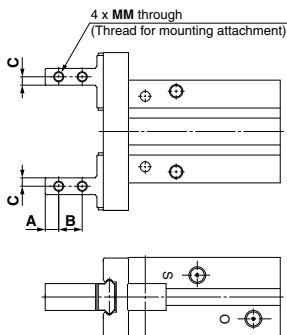

(mm)

Model	A	B	C	MM
MHZL2-10□1□	3	5.7	2	M2.5 x 0.45
MHZL2-16□1□	4	7	2.5	M3 x 0.5
MHZL2-20□1□	5	9	4	M4 x 0.7
MHZL2-25□1□	6	12	5	M5 x 0.8

* Specifications and dimensions other than the above are the same as the basic type.

Through-holes in Opening/ Closing Direction [2]

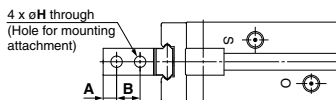
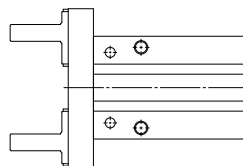

(mm)

Model	A	B	H
MHZL2-10□2□	3	5.7	2.9
MHZL2-16□2□	4	7	3.4
MHZL2-20□2□	5	9	4.5
MHZL2-25□2□	6	12	5.5

* Specifications and dimensions other than the above are the same as the basic type.

Flat Type Fingers [3]

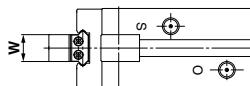
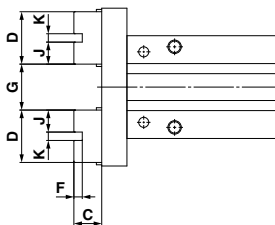
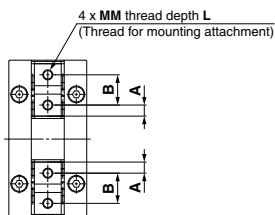

(mm)

Model	A	B	C	D	F	G		J	K	MM	L	W	Weight (g)	
						Open	Closed						Double acting	Single acting
MHZL2-10□3□	2.45	7	5.2	11.9	2	9.4 ^{+2.2} ₀	1.4 ⁰ _{-0.2}	4.95	2H9 ^{+0.025} ₀	M2.5 x 0.45	5	5 ⁰ _{-0.05}	60	70
MHZL2-16□3□	3.3	9	8.3	15.7	2.5	13.4 ^{+2.2} ₀	1.4 ⁰ _{-0.2}	6.55	2.5H9 ^{+0.025} ₀	M3 x 0.5	6	8 ⁰ _{-0.05}	135	145
MHZL2-20□3□	3.95	12	10.5	19.9	3	19.6 ^{+2.4} ₀	1.6 ⁰ _{-0.2}	8.45	3H9 ^{+0.025} ₀	M4 x 0.7	8	10 ⁰ _{-0.05}	270	290
MHZL2-25□3□	4.9	14	13.1	23.8	4	24 ^{+2.6} ₀	2 ⁰ _{-0.2}	9.9	4H9 ^{+0.030} ₀	M5 x 0.8	10	12 ⁰ _{-0.05}	460	505

* Specifications and dimensions other than the above are the same as the basic type.

MHZ

MHF

MHL

MHR

MHK

MHS

MHC

MHT

MHY

MHW

-X□

MRHQ

MA

D-□

Long Stroke Type/MHZL2 Series

Body Option: End Boss Type

Applicable Model

Symbol	Piping port location	Type of piping port				Applicable model		
		MHZL2-10	MHZL2-16	MHZL2-20	MHZL2-25	Double acting	Single acting	
E	Side ported	M3 x 0.5		M5 x 0.8		●	●	●
W	Axial ported	With $\phi 4$ One-touch fitting for coaxial tubing				●	—	—
K		With $\phi 4$ One-touch fitting				—	●	●
M		M5 x 0.8				—	●	●

Side Ported [E]

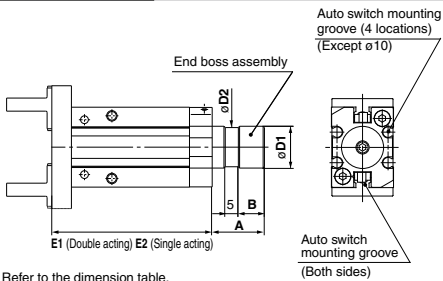

- * Refer to the dimension table.
- * When auto switches are used at the square groove on the side, side mounting with through-holes is not possible.

Model	A	B	D1	D2	E1	E2
MHZL2-10□□E	15	7	12f8 ^{-0.016} _{-0.043}	11	52.8	62.8
MHZL2-16□□E	20	10	16f8 ^{-0.016} _{-0.043}	15	61.4	66.4
MHZL2-20□□E	22	12	20f8 ^{-0.020} _{-0.053}	19	75.7	81.7
MHZL2-25□□E	25	15	25f8 ^{-0.020} _{-0.053}	24	86.2	96.2

Other dimensions and specifications correspond to the standard type.

Axial Ported (with One-touch fitting for coaxial tubing) [W]

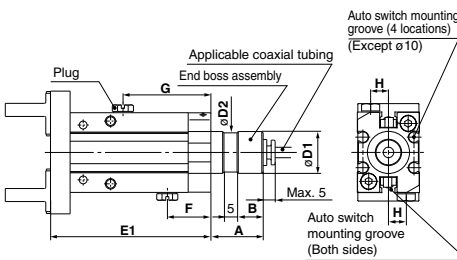

- * Refer to the dimension table.
- * When auto switches are used at the square groove on the side, side mounting with through-holes is not possible.

Model	A	B	D1	D2	E1
MHZL2-10D□W	15	7	12f8 ^{-0.016} _{-0.043}	11	52.8
MHZL2-16D□W	20	10	16f8 ^{-0.016} _{-0.043}	15	61.4
MHZL2-20D□W	22	12	20f8 ^{-0.020} _{-0.053}	19	75.7
MHZL2-25D□W	25	15	25f8 ^{-0.020} _{-0.053}	24	86.2

Other dimensions and specifications correspond to the standard type.

Applicable Coaxial Tubing Type W

Model	TW04B-20		
Specifications			
Outside diameter	4 mm		
Max. operating pressure	0.6 MPa		
Min. bending radius	10 mm		
Operating temperature	-20 to 60°C		
Material	Nylon 12		

	F	G	H
$\phi 10$	17	30	5.5
$\phi 16$	16.7	33.7	6.5
$\phi 20$	18.2	38.2	7.5
$\phi 25$	18.3	41.3	10

Changing from Coaxial to Single Tubing

Changing to single tubing is possible by using a branch "Y" or branch tee fitting. In this case particularly, single tube fittings and tubing for $\phi 3.2$ will be necessary.

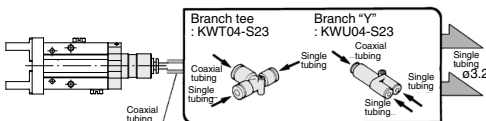

Branch tee, Different diameter tee, Branch "Y", Male run tee

Please contact your SMC sales representative for details of the coaxial fittings and tubing.

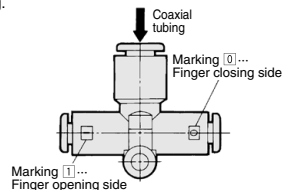

Axial Ported (with One-touch fitting) [K]

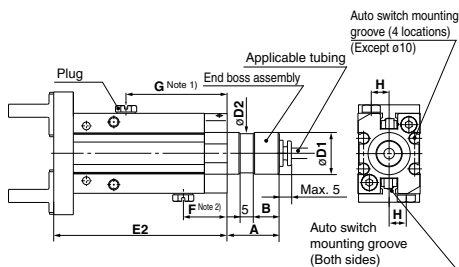

* Refer to the dimension table.
 * When auto switches are used at the square groove on the side, side mounting with through-holes is not possible.

Note 1) Normally open type plug position.

Note 2) Normally closed type plug position.

The plug is mounted on only one side for the single acting type.

Model	A	B	D1	D2	E2
MHZL2-10 ^S □K	15	7	12f8 ^{-0.016} _{-0.043}	11	62.8
MHZL2-16 ^S □K	20	10	16f8 ^{-0.016} _{-0.043}	15	66.4
MHZL2-20 ^S □K	22	12	20f8 ^{-0.020} _{-0.053}	19	81.7
MHZL2-25 ^S □K	25	15	25f8 ^{-0.020} _{-0.053}	24	96.2

Other dimensions and specifications correspond to the standard type.

Applicable Tubing

Description/ Model	Nylon tubing	Soft nylon tubing	Polyurethane tubing	Polyurethane coil tubing
	T0425	TS0425	TU0425	TCU0425B4
Outside diameter (mm)	4	4	4	4
Max. operating pressure (MPa)	1.0	0.8	0.5	0.5
Min. bending radius (mm)	13	12	10	—
Operating temperature (°C)	-20 to 60	-20 to 60	-20 to 60	-20 to 60
Material	Nylon 12	Nylon 12	Polyurethane	Polyurethane

Refer to "Pneumatic Piping Equipment (CAT. E50)" regarding One-touch fittings and tubing.

Type K

	F	G	H
ø10	17	40	5.5
ø16	16.7	38.7	6.5
ø20	18.2	44.2	7.5
ø25	18.3	51.3	10

Axial Ported (with M5 port) [M]

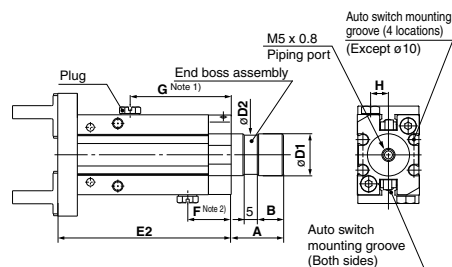

* Refer to the dimension table.
 * When auto switches are used at the square groove on the side, side mounting with through-holes is not possible.

Note 1) Normally open type plug position.

Note 2) Normally closed type plug position.

The plug is mounted on only one side for the single acting type.

Model	A	B	D1	D2	E2
MHZL2-10 ^S □M	15	7	12f8 ^{-0.016} _{-0.043}	11	62.8
MHZL2-16 ^S □M	20	10	16f8 ^{-0.016} _{-0.043}	15	66.4
MHZL2-20 ^S □M	22	12	20f8 ^{-0.020} _{-0.053}	19	81.7
MHZL2-25 ^S □M	25	15	25f8 ^{-0.020} _{-0.053}	24	96.2

Other dimensions and specifications correspond to the standard type.

Type M

	F	G	H
ø10	17	40	5.5
ø16	16.7	38.7	6.5
ø20	18.2	44.2	7.5
ø25	18.3	51.3	10

Weight

Model	End boss type (Symbol)				
	E		W	K	M
	Double acting	Single acting			
MHZL2□-10□□	70	80	70	80	80
MHZL2□-16□□	170	180	170	180	180
MHZL2□-20□□	310	330	310	330	330
MHZL2□-25□□	535	580	535	580	580

MHZL2 Series

Made to Order Individual Specifications

Please contact SMC for detailed dimensions, specifications and lead times.



1 With dust cover (For MHZL10, 16, 20)

Symbol
-X6110

Long stroke type (size 10, 16, 20) with dust cover

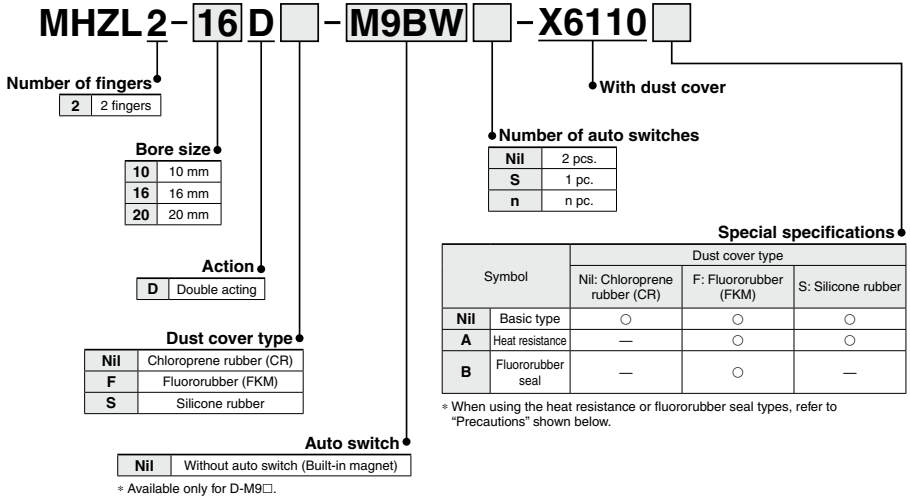

Specifications

Model	Basic type	Heat resistance	Fluororubber seal
Ambient and fluid temperature	-10 to 60°C	-10 to 100°C	-10 to 60°C
Specifications other than the above	Same as the standard type		

Model

Action	Model	Bore size (mm)	Gripping force ^{Note 1)}		Opening/Closing stroke (Both sides) (mm)	^{Note 2)} Weight (g)
			Gripping force per finger Effective value (N)			
			External	Internal		
Double acting	MHZL2-10D-X6110□	10	11	17	8	85
	MHZL2-16D-X6110□	16	34	45	12	150
	MHZL2-20D-X6110□	20	42	66	18	385

Note 1) Values based on pressure of 0.5 MPa, gripping point L = 20 mm, at center of stroke.

Note 2) Values excluding weight of auto switch.

⚠ Precautions

For heat resistance

⚠ Warning

Be aware that smoking cigarettes after your hands have come into contact with the grease used for this air gripper can create a gas that is hazardous to humans.

⚠ Caution

- Note 1) Magnet is built-in, but when using an auto switch, the acceptable temperature range becomes -10 to 60°C.
- Note 2) For the dust cover option part number, only fluororubber (F) or silicone rubber (S) can be selected.
- Note 3) For lubrication, specialized grease GR-F is recommended.

For fluororubber seal

⚠ Caution

- Note 1) Consult with SMC, since the type of chemical and the operating temperature may not allow the use of this product.
- Note 2) Since the standard-type magnet is built-in, consult with SMC for the product's adaptability to the operating environment.
- Note 3) The dust cover material is also fluororubber. Thus, enter (F) for the fluororubber dust cover in the part number.



Dimensions

MHZL2-10D□-X6110
Basic type/Double acting

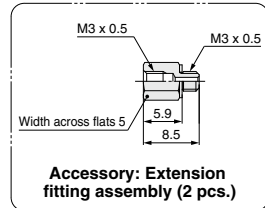
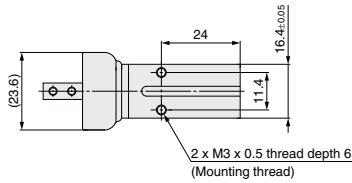

* When using the perpendicular type (D-M9□V) switch, use an extension fitting since the switch interferes with the One-touch fitting.

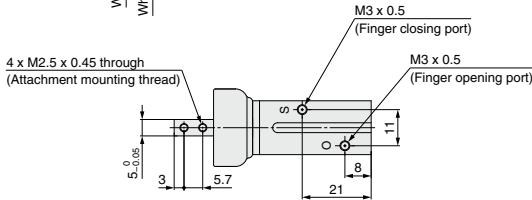
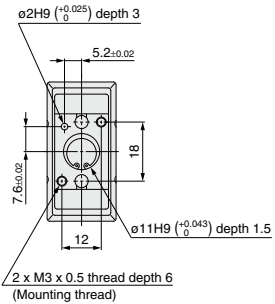
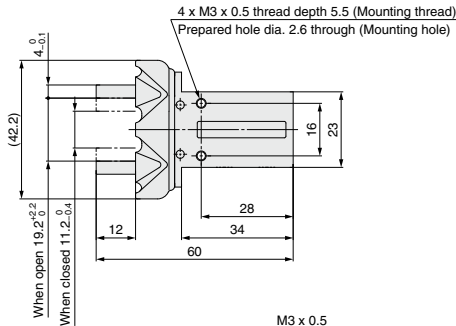

Auto Switch Mounting Groove Dimensions

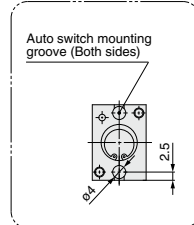

* The dimensions of the heat resistance or fluororubber seal types are the same as those shown above.

MHZ

MHF

MHL

MHR

MHK

MHS

MHC

MHT

MHY

MHW

-X□

MRHQ

MA

D-□

Dimensions

MHZL2-20D□-X6110
Basic type/Double acting

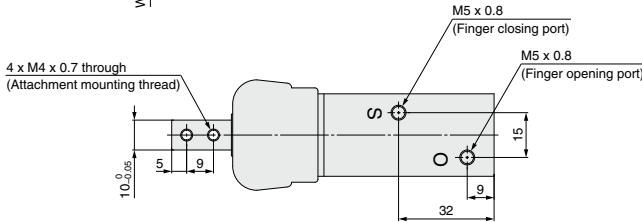
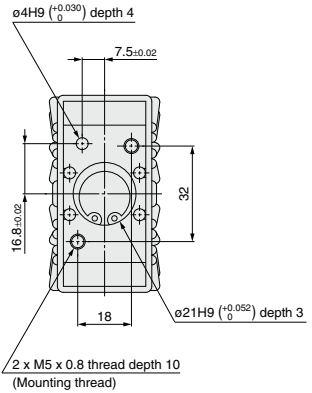
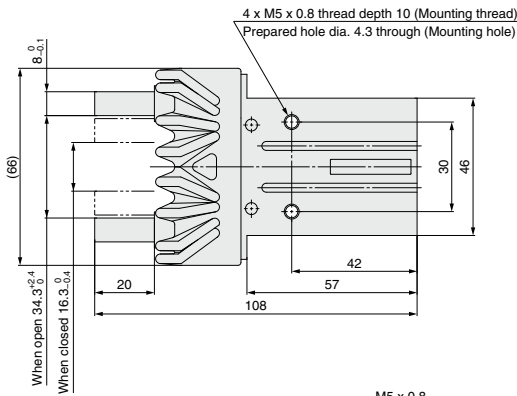
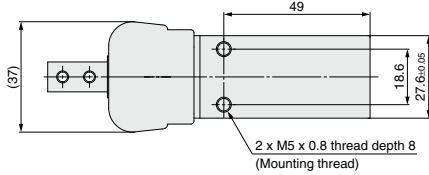

Auto Switch Mounting Groove Dimensions

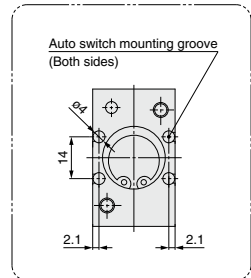

* The dimensions of the heat resistance or fluororubber seal types are the same as those shown above.

MHZ

MHF

MHL

MHR

MHK

MHS

MHC

MHT

MHY

MHW

-X□

MRHQ

MA

D-□

Parallel Type Air Gripper with Dust Cover

MHZJ2 Series

ø6, ø10, ø16, ø20, ø25, ø32, ø40

How to Order

MHZJ2-16 D □ □ - M9BW □ - □

Number of fingers
 2 | 2 fingers

Bore size

6	6 mm
10	10 mm
16	16 mm
20	20 mm
25	25 mm

Action

D	Double acting
S	Single acting (Normally open)
C	Single acting (Normally closed)

Body option

* ø32, ø40: Made to Order (For details, refer to page 451.) * ø6 is only applicable with basic type.

Made to Order
Refer to page 441 for details.

Number of auto switches

Nil	2 pcs.
S	1 pc.
n	n pc.

Auto switch

Nil	Without auto switch (Built-in magnet)
-----	---------------------------------------

* For the applicable auto switch model, refer to the table below.

Dust cover type

Nil	Chloroprene rubber (CR)
F	Fluororubber (FKM)
S	Silicone rubber (Si)

Nil: Basic type

E: End boss type Side ported (Double acting /Single acting)

W: End boss type Axial ported with ø4 One-touch fitting for coaxial tubing (Double acting)

K: End boss type Axial ported with ø4 One-touch fitting for coaxial tubing (Single acting)

M: End boss type Axial ported with M5 port (Single acting)

Applicable Auto Switches

Refer to pages 797 to 850 for further information on the auto switch.

Type	Special function	Electrical entry	Indicator light	Wiring (Output)	Load voltage		Auto switch model		Lead wire length (m) *					Applicable model					Pre-wired connector	Applicable load
					DC	AC	Electrical entry direction		0.5 (Nil)	1 (M)	3 (L)	5 (Z)	ø6	ø10	ø16	ø20	ø25			
							Perpendicular	In-line												
Solid state auto switch	—	Grommet	Yes	3-wire (NPN)	5 V, 12 V	—	M9NV	M9N	●	●	○	●	●	●	●	●	○	IC circuit	Relay, PLC	
							F8N	—	●	—	○	●	—	●	●	●	○			
				3-wire (PNP)	M9PV	M9P	●	●	○	●	●	●	●	●	○	—				
					F8P	—	●	—	○	●	—	●	●	●	—	—				
				2-wire	M9BV	M9B	●	●	○	●	●	●	●	●	○	—				
					F8B	—	●	—	○	●	—	●	●	●	—	—				
	Diagnosis (2-color indicator)	Grommet	Yes	3-wire (NPN)	5 V, 12 V	—	M9NVV	M9NW	●	●	○	●	●	●	●	●	○	IC circuit	Relay, PLC	
							M9PWW	M9PW	●	●	○	●	●	●	●	●	○			
				3-wire (PNP)	M9BWW	M9BW	●	●	○	●	●	●	●	●	○	—				
					M9NAV**	M9NA**	○	○	○	○	●	●	●	●	○	○				
				2-wire	M9PAV**	M9PA**	○	○	○	○	●	●	●	●	○	○				
					M9BAV**	M9BA**	○	○	○	○	●	●	●	●	○	○				

** Water resistant type auto switches can be mounted on the above models, but in such case SMC cannot guarantee water resistance.
 * Lead wire length symbols: 0.5 m..... Nil (Example) M9NW
 1 m..... M (Example) M9NWM
 3 m..... L (Example) M9NWL
 5 m..... Z (Example) M9NZW
 * Solid state auto switches marked with ○ are produced upon receipt of order.

Note 1) When using the 2-color indicator type, please make the setting so that the indicator is lit in red to ensure the detection at the proper position of the air gripper.
 Note 2) When using a D-F8□ switch on sizes ø6, mount it at a distance of 10 mm or more from magnetic substances such as iron, etc.



Symbol

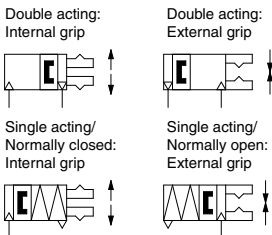

Made to Order Individual Specifications
(Refer to pages 451 to 453 for details.)

Symbol	Specifications/Description
-X6100	With dust cover (ø32, ø40)

Made to Order

[Click here for details](#)

Symbol	Specifications/Description
-X4	Heat resistance (100°C)
-X5	Fluororubber seal
-X7	Closing direction spring assist
-X12	Opening direction spring assist
-X50	Without magnet
-X53	EPDM seal/Fluorine grease
-X56	Axial ported type
-X63	Fluorine grease
-X64	Finger: Side tapped mounting
-X65	Finger: Through-hole mounting
-X77A	Dust cover adhesion
-X77B	Dust cover adhesion (Finger part only)
-X78A	Dust cover caulking
-X78B	Dust cover caulking (Finger part only)
-X79	Grease for food processing machines, Fluorine grease
-X79A	Grease for food processing machines
-X81A	Anti-corrosive treatment of finger

Moisture Control Tube IDK Series



When operating an actuator with a small diameter and a short stroke at a high frequency, the dew condensation (water droplet) may occur inside the piping depending on the conditions.

Simply connecting the moisture control tube to the actuator will prevent dew condensation from occurring. For details, refer to [the IDK series in the Best Pneumatics No. 6](#).

Specifications

		Fluid	Air
Operating pressure	Double acting	Normally open	ø6: 0.15 to 0.7 MPa
			ø10: 0.2 to 0.7 MPa
	Single acting	Normally closed	ø6: 0.3 to 0.7 MPa
Normally open		ø10: 0.35 to 0.7 MPa	
Ambient and fluid temperature		-10 to 60°C	
Repeatability		±0.01 mm	
Max. operating frequency		180 c.p.m.	
Lubrication		Not required	
Action		Double acting, Single acting	
Auto switch (option) ^(Note)		Solid state auto switch (3-wire, 2-wire)	

(Note) Refer to pages 797 to 850 for further information on auto switches.

Model

Action	Model	Bore size (mm)	Gripping force ^(Note 1)		Opening/Closing stroke (Both sides) (mm)	Weight ^(Note 2) (g)	
			Gripping force per finger Effective value (N)				
			External	Internal			
Double acting	MHZJ2- 6D	6	3.3	6.1	4	28	
	MHZJ2-10D	10	9.8	17	4	60	
	MHZJ2-16D	16	30	40	6	130	
	MHZJ2-20D	20	42	66	10	250	
	MHZJ2-25D	25	65	104	14	460	
Single acting	Normally closed	MHZJ2- 6S	6	1.9	—	4	28
		MHZJ2-10S	10	6.3	—	4	60
		MHZJ2-16S	16	24	—	6	130
		MHZJ2-20S	20	28	—	10	255
		MHZJ2-25S	25	45	—	14	465
	Normally open	MHZJ2- 6C	6	—	3.7	4	28
		MHZJ2-10C	10	—	12	4	60
		MHZJ2-16C	16	—	31	6	130
		MHZJ2-20C	20	—	56	10	255
MHZJ2-25C	25	—	83	14	465		

Note 1) Values based on pressure of 0.5 MPa, gripping point L = 20 mm, at center of stroke.

Note 2) Values excluding weight of auto switch.

Option

● Body Option/End Boss Type

Symbol	Piping port location	Type of piping port				Applicable model	
		MHZJ2-10	MHZJ2-16	MHZJ2-20	MHZJ2-25	Double acting	Single acting
Nil	Basic type	M3 x 0.5	M5 x 0.8		●	●	
E	Side ported	M3 x 0.5	M5 x 0.8		●	●	
W	Axial ported	With ø4 One-touch fitting for coaxial tubing				●	—
K	Axial ported	With ø4 One-touch fitting				—	●
M	Axial ported	M5 x 0.8				—	●

* For detailed body option specifications, refer to option specifications on pages 449 and 450.

Refer to pages 454 to 458 for the specifications with auto switch.

- Auto switch installation examples and mounting positions
- Auto switch hysteresis
- Auto switch mounting
- Protrusion of auto switch from edge of body

MHZJ2 Series

Construction: MHZJ2-6□

Double acting/With fingers open

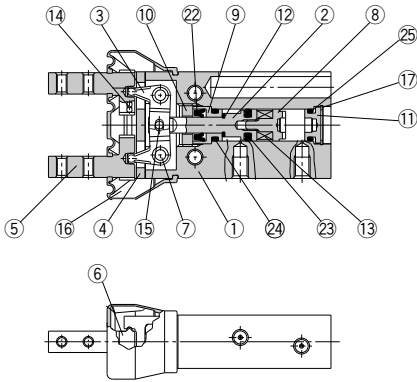

Double acting/With fingers closed

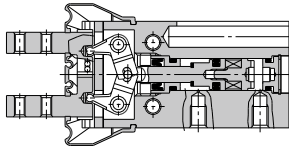

Single acting/Normally open

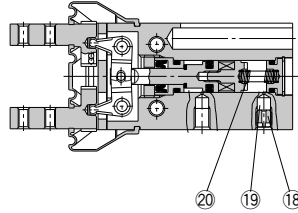

Single acting/Normally closed

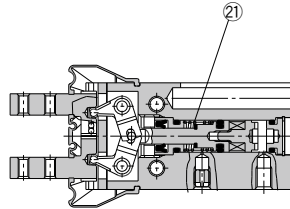

Component Parts

No.	Description	Material	Note
1	Body	Aluminum alloy	Hard anodized
2	Piston	Stainless steel	
3	Lever	Stainless steel	Heat treated
4	Guide	Stainless steel	Heat treated
5	Finger	Stainless steel	Heat treated
6	Roller stopper	Stainless steel	
7	Lever shaft	Stainless steel	Nitriding
8	Magnet holder	Stainless steel	
9	Holder	Brass	Electroless nickel plated
10	Holder lock	Stainless steel	
11	Cap	Aluminum alloy	Clear anodized
12	Bumper	Urethane rubber	
13	Magnet	—	Nickel plated
14	Steel balls	High carbon chrome bearing steel	
15	Needle roller	High carbon chrome bearing steel	
16	Dust cover	CR	Chloroprene rubber
		FKM	Fluororubber
		Silicone rubber	
17	Type C retaining ring	Carbon steel	Nickel plated
18	Exhaust plug	Brass	Electroless nickel plated
19	Exhaust filter	Polyvinyl formal	
20	N.O. spring	Stainless steel spring wire	
21	N.C. spring	Stainless steel spring wire	
22	Rod seal	NBR	
23	Piston seal	NBR	
24	Gasket	NBR	
25	Gasket	NBR	

Replacement Parts

Description		MHZJ2-6	Main parts
Seal kit		Please contact SMC to replace the seal kit.	
Dust cover	Material	CR	MHZJ2-J6
		FKM	MHZJ2-J6F
		Silicone rubber	MHZJ2-J6S
Finger assembly		Please contact SMC to replace the finger assembly.	
Piston assembly		MHZJ2-6D□	MHZJ-A0603
		MHZJ2-6S□	
		MHZJ2-6C□	
			② ⑧ ⑨ ⑩ ⑫ ⑬ ⑮ ⑰ ⑲ ⑳ ㉓ ㉔
			② ⑧ ⑨ ⑩ ⑫ ⑬ ⑮ ⑰ ⑲ ⑳ ㉓ ㉔

Replacement part/Grease pack part no.: GR-S-010 (5 g)

Construction: MHZJ2-10□ to 25□

Double acting/With fingers open

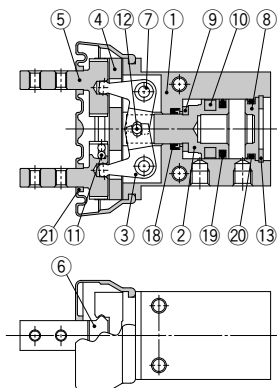

Single acting/Normally open

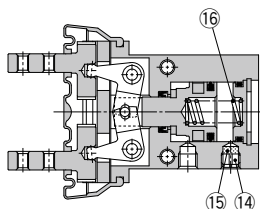

Double acting/With fingers closed

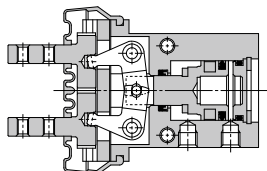

Single acting/Normally closed

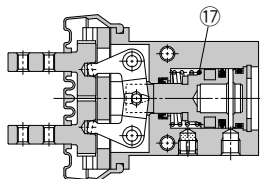

Component Parts

No.	Description	Material	Note
1	Body	Aluminum alloy	Hard anodized
2	Piston	ø10, ø16: Stainless steel ø20, ø25: Aluminum alloy	Hard anodized
3	Lever	Stainless steel	Nitriding
4	Guide	Stainless steel	Heat treated
5	Finger	Stainless steel	Heat treated
6	Roller stopper	Stainless steel	
7	Lever shaft	Stainless steel	Nitriding
8	Cap	Aluminum alloy	Clear anodized
9	Bumper	Urethane rubber	
10	Rubber magnet	Synthetic rubber	
11	Steel balls	High carbon chrome bearing steel	

No.	Description	Material	Note
12	Needle roller	High carbon chrome bearing steel	
13	Type C retaining ring	Carbon steel	Nickel plated
14	Exhaust plug A	Brass	Electroless nickel plated
15	Exhaust filter A	Polyvinyl formal	
16	N.O. spring	Stainless steel spring wire	
17	N.O. spring	Stainless steel spring wire	
18	Rod seal	NBR	
19	Piston seal	NBR	
20	Gasket	NBR	
21	Dust cover	CR	Chloroprene rubber
		FKM	Fluororubber
		Silicone rubber	

Replacement Parts

Description		MHZJ2-10	MHZJ2-16	MHZJ2-20	MHZJ2-25	Main parts
Seal kit		MHZJ10-PS	MHZJ16-PS	MHZJ20-PS	MHZJ25-PS	⑱⑲⑳
Dust cover	Material					
	CR	MHZJ2-J10	MHZJ2-J16	MHZJ2-J20	MHZJ2-J25	
	FKM	MHZJ2-J10F	MHZJ2-J16F	MHZJ2-J20F	MHZJ2-J25F	㉑
	Silicone rubber	MHZJ2-J10S	MHZJ2-J16S	MHZJ2-J20S	MHZJ2-J25S	㉒⑲⑳⑳
Finger assembly		MHZJ-AA1002	MHZJ-AA1602	MHZJ-AA2002	MHZJ-AA2502	④⑤⑥⑪⑩ Mounting thread
Piston assembly		MHZJ-A1003	MHZJ-A1603	MHZJ-A2003	MHZJ-A2503	②⑨⑩⑫
End boss assembly	MHZJ2-□□□□W	MHZ-A1007	MHZ-A1607	MHZ-A2007	MHZ-A2507	Main body of adaptor Mounting screw for adaptor Seal kit
	MHZJ2-□□□□K	MHZ-A1008	MHZ-A1608	MHZ-A2008	MHZ-A2508	
	MHZJ2-□□□□M	MHZ-A1009	MHZ-A1609	MHZ-A2009	MHZ-A2509	
	MHZJ2-□□□□E	MHZ-A1010	MHZ-A1610	MHZ-A2010	MHZ-A2510	
Lever assembly		MHZJ-A1004	MHZJ-A1604	MHZJ-A2004	MHZJ-A2504	③

* Material of packing
NBR = Nitrile rubber, FKM = Fluororubber

* Material of dust cover

CR = Chloroprene rubber, FKM = Fluororubber, Silicone rubber

* End boss type

W = One-touch fitting for coaxial tubing, K = With One-touch fitting, M = With M5 port, E = Side ported

* The end boss assembly other than type E should be mounted on the special body.

Replacement part/Grease pack part no.: GR-S-010 (10 g)

MHZ

MHF

MHL

MHR

MHK

MHS

MHC

MHT

MHY

MHW

-X□

MRHQ

MA

D-□

MHZJ2 Series

Dimensions

MHZJ2-6□ Double acting/Single acting Basic type

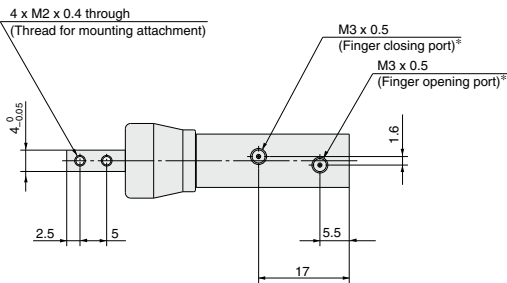
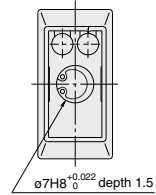
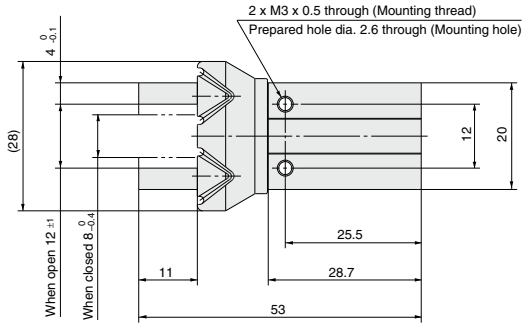
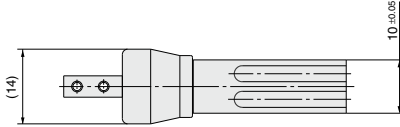

* For single action, the port on one side is a breathing hole.

Auto Switch Mounting Groove Dimensions

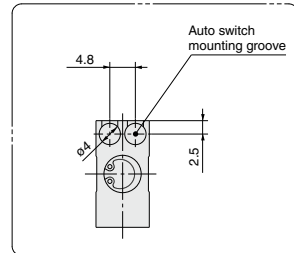

MHZJ2-10□ Double acting/Single acting
Basic type

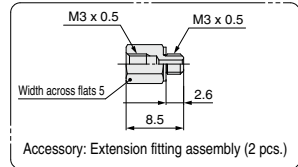
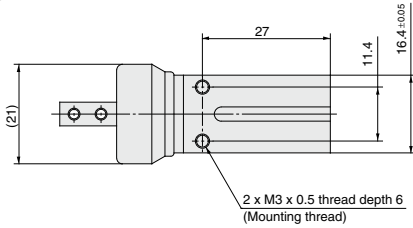

Note) If the fitting attached to the port interferes with the auto switch, please use the extension fitting assembly supplied with the air gripper.

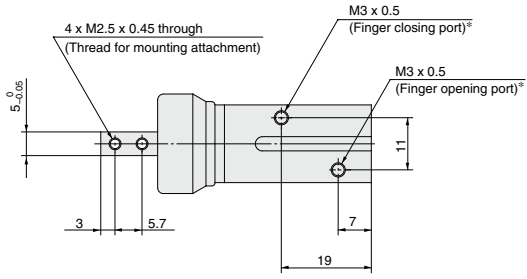
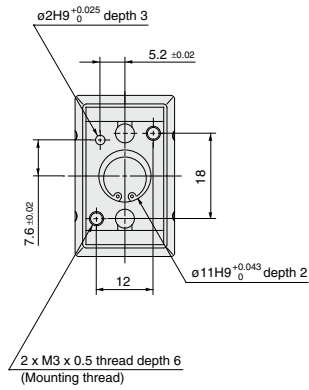
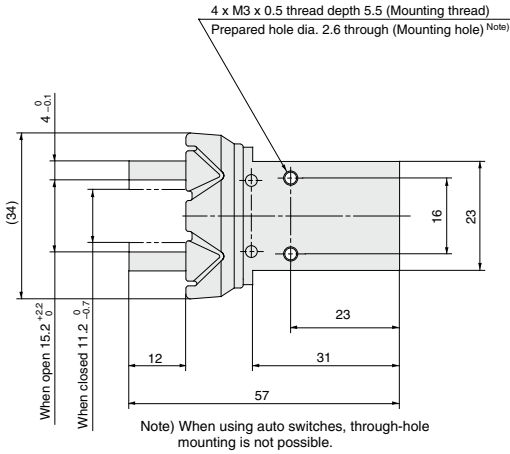

* For single action, the port on one side is a breathing hole.

Auto Switch Mounting Groove Dimensions

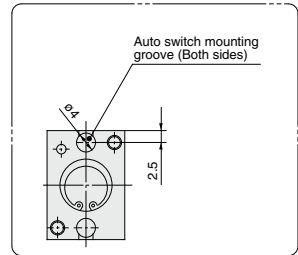

Note) When using auto switches, through-hole mounting is not possible.

- MHZ
- MHF
- MHL
- MHR
- MHK
- MHS
- MHC
- MHT
- MHY
- MHW
- X□
- MRHQ
- MA
- D-□

MHZJ2 Series

Dimensions

MHZJ2-16 □ Double acting/Single acting Basic type

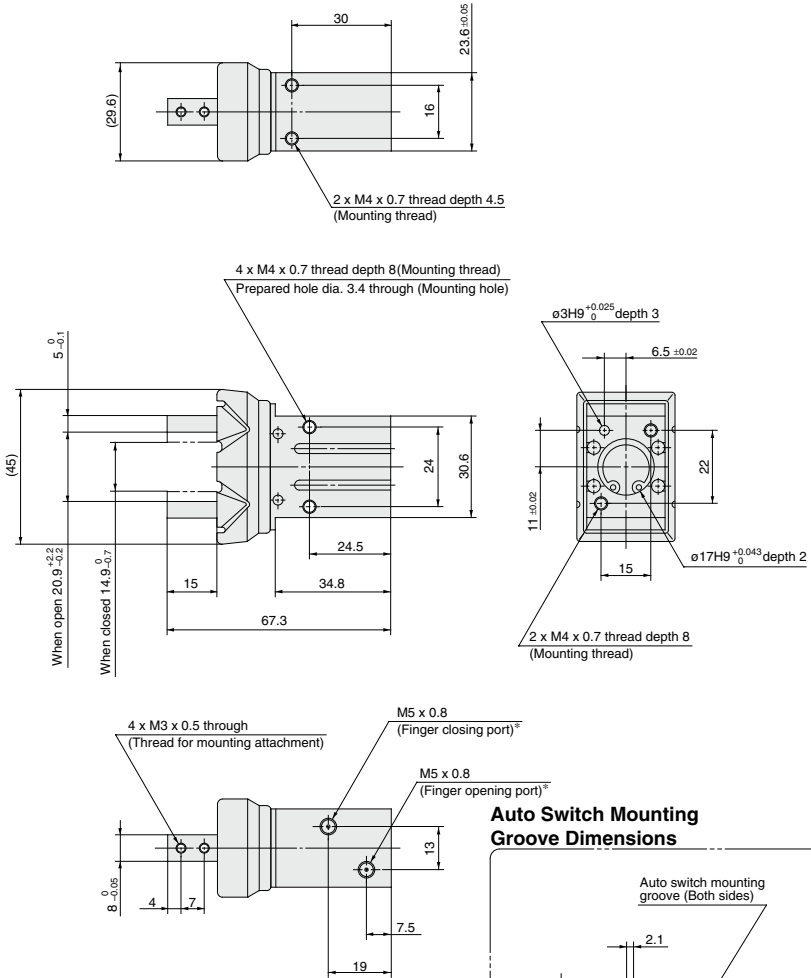

* For single action, the port on one side is a breathing hole.

MHZJ2-20 □ Double acting/Single acting
Basic type

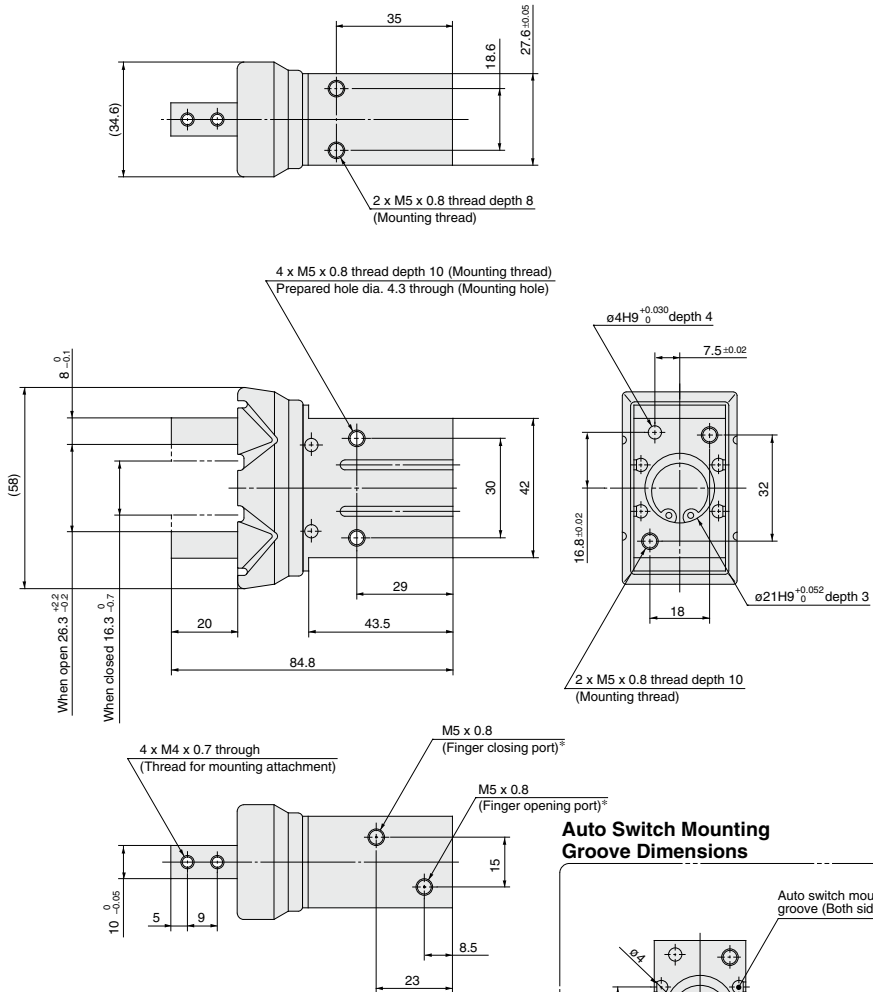

* For single action, the port on one side is a breathing hole.

MHZ
MHF
MHL
MHR
MHK
MHS
MHC
MHT
MHY
MHW
-X □
MRHQ
MA
D- □

MHZJ2 Series

Dimensions

MHZJ2-25 □ Double acting/Single acting

Basic type

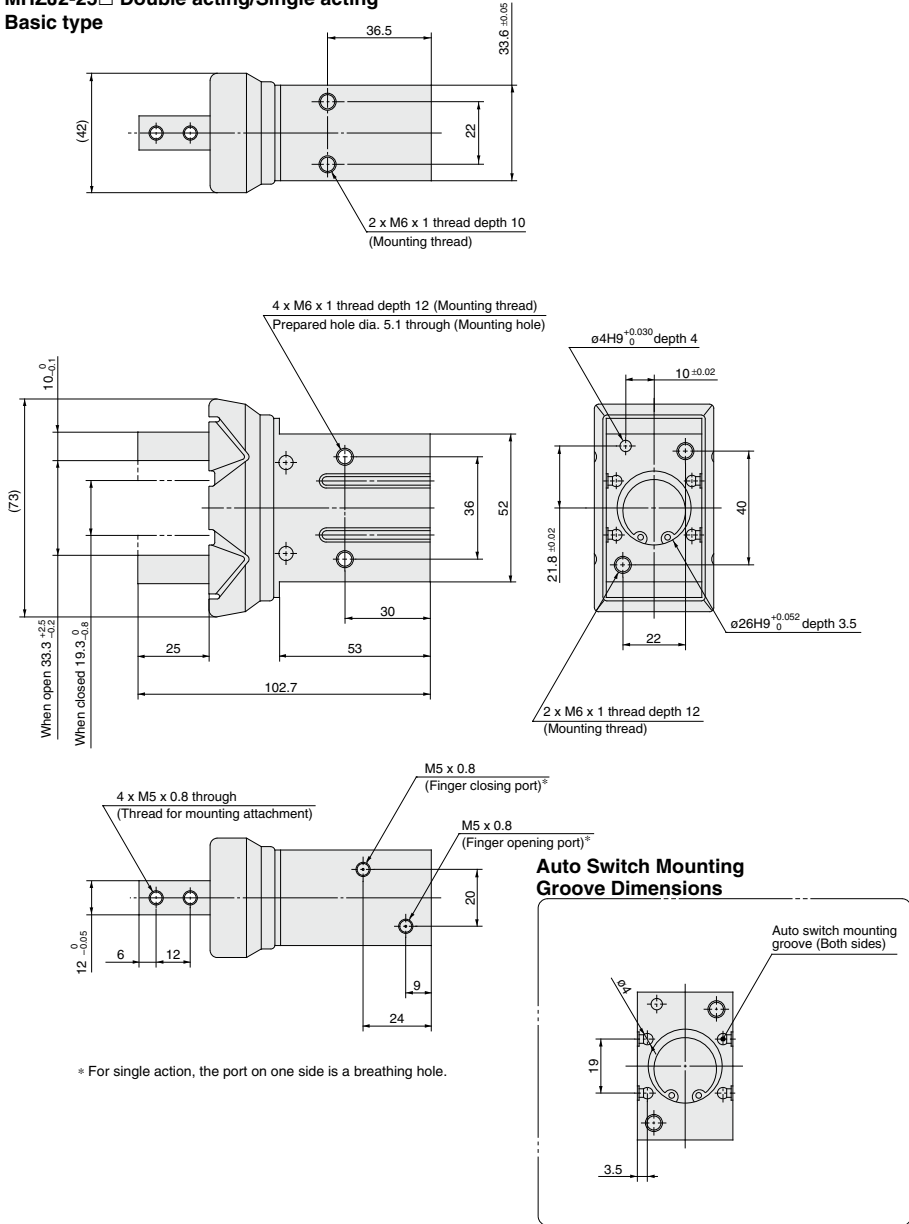

* For single action, the port on one side is a breathing hole.

With Dust Cover/MHZJ2 Series Body Option: End Boss Type

Applicable Model

Symbol	Piping port location	Type of piping port				Applicable model		
		MHZJ2-10	MHZJ2-16	MHZJ2-20	MHZJ2-25	Double acting	Single acting	
							Normally open	Normally closed
E	Side ported	M3 x 0.5	M5 x 0.8		●	●	●	
W	Axial ported	With ø4 One-touch fitting for coaxial tubing				●	—	—
K		With ø4 One-touch fitting				—	●	●
M		M5 x 0.8				—	●	●

Side Ported [E]

Auto switch mounting groove (4 locations) (Except ø10)

Auto switch mounting groove (Both sides) (ø10 only: Round groove)

Model	A	B	D1	D2	E
MHZJ2-10□□E	15	7	12f8 ^{-0.016} _{-0.043}	11	40
MHZJ2-16□□E	20	10	16f8 ^{-0.016} _{-0.043}	15	43.5
MHZJ2-20□□E	22	12	20f8 ^{-0.020} _{-0.053}	19	51.7
MHZJ2-25□□E	25	15	25f8 ^{-0.020} _{-0.053}	24	61.3

Other dimensions and specifications correspond to the standard type.

* Refer to the dimension table.
* When auto switches are used on ø10, side mounting with through-holes is not possible.

Axial Ported (with One-touch fitting for coaxial tubing) [W]

Plug ø10: M-3P ø16 to 25: M-5P

Applicable coaxial tubing

Auto switch mounting groove (4 locations) (Except ø10)

Auto switch mounting groove (Both sides) (ø10 only: Round groove)

Model	A	B	D1	D2	E	F	G	H
MHZJ2-10D□W	15	7	12f8 ^{-0.016} _{-0.043}	11	40	16	28	5.5
MHZJ2-16D□W	20	10	16f8 ^{-0.016} _{-0.043}	15	43.5	16.2	27.7	6.5
MHZJ2-20D□W	22	12	20f8 ^{-0.020} _{-0.053}	19	51.7	16.7	31.2	7.5
MHZJ2-25D□W	25	15	25f8 ^{-0.020} _{-0.053}	24	61.3	17.3	32.3	10

Other dimensions and specifications correspond to the standard type.

Applicable Coaxial Tubing

Model	TW04B-20
Specifications	
Outside diameter	4 mm
Max. operating pressure	0.6 MPa
Min. bending radius	10 mm
Operating temperature	-20 to 60°C
Material	Nylon 12

Reference symbol

○ [External passage]
| [Internal passage]

* Refer to the dimension table.
* When auto switches are used on ø10, side mounting with through-holes is not possible.

Changing from Coaxial to Single Tubing

Changing to single tubing is possible by using a branch "Y" or branch tee fitting. In this case particularly, single tube fittings and tubing for ø3.2 will be necessary.

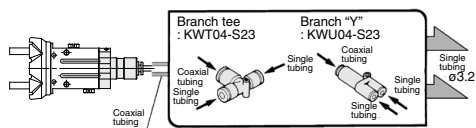

Branch Tee, Different Diameter Tee, Branch "Y", Male Run Tee

Please contact your SMC sales representative for details of the coaxial fittings and tubing.

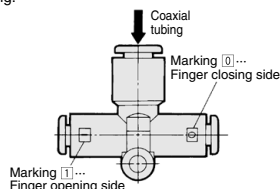

MHZJ2 Series

Axial Ported (with One-touch fitting) [K]

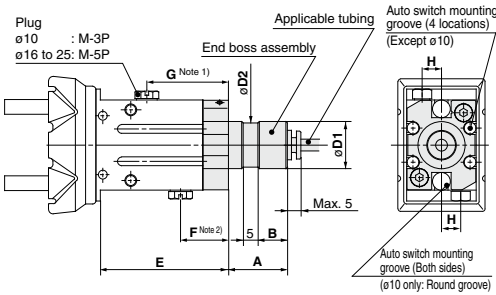

- * Refer to the dimension table.
 - * When auto switches are used on $\phi 10$, side mounting with through-holes is not possible.
 - Note 1) Normally open type plug position.
 - Note 2) Normally closed type plug position.
- The plug is mounted on only one side for the single acting type.

Model	A	B	D1	D2	E	F	G	H
MHZJ2-10 ^S □K	15	7	12f8 ^{-0.016} _{-0.043}	11	40	16	28	5.5
MHZJ2-16 ^S □K	20	10	16f8 ^{-0.016} _{-0.043}	15	43.5	16.2	27.7	6.5
MHZJ2-20 ^S □K	22	12	20f8 ^{-0.020} _{-0.053}	19	51.7	16.7	31.2	7.5
MHZJ2-25 ^S □K	25	15	25f8 ^{-0.020} _{-0.053}	24	61.3	17.3	32.3	10

Other dimensions and specifications correspond to the standard type.

Applicable Tubing

Description/Model	Nylon tubing	Soft nylon tubing	Polyurethane tubing	Polyurethane coil tubing
	T0425	TS0425	TU0425	TCU0425B-1
Outside diameter (mm)	4	4	4	4
Max. operating pressure (MPa)	1.0	0.8	0.5	0.5
Min. bending radius (mm)	13	12	10	—
Operating temperature (°C)	-20 to 60	-20 to 60	-20 to 60	-20 to 60
Material	Nylon 12	Nylon 12	Polyurethane	Polyurethane

Refer to "Pneumatic Piping Equipment (CAT. E50)" regarding One-touch fittings and tubing.

Axial Ported (with M5 port) [M]

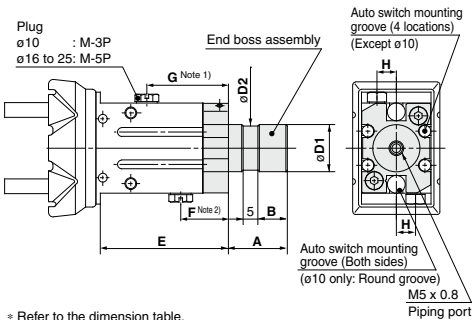

- * Refer to the dimension table.
 - * When auto switches are used on $\phi 10$, side mounting with through-holes is not possible.
 - Note 1) Normally open type plug position.
 - Note 2) Normally closed type plug position.
- The plug is mounted on only one side for the single acting type.

Model	A	B	D1	D2	E	F	G	H
MHZJ2-10 ^S □M	15	7	12f8 ^{-0.016} _{-0.043}	11	40	16	28	5.5
MHZJ2-16 ^S □M	20	10	16f8 ^{-0.016} _{-0.043}	15	43.5	16.2	27.7	6.5
MHZJ2-20 ^S □M	22	12	20f8 ^{-0.020} _{-0.053}	19	51.7	16.7	31.2	7.5
MHZJ2-25 ^S □M	25	15	25f8 ^{-0.020} _{-0.053}	24	61.3	17.3	32.3	10

Other dimensions and specifications correspond to the standard type.

Weight

Model	End boss type (Symbol)			
	E	W	K	M
MHZJ2-10□□	70	70	70	70
MHZJ2-16□□	165	165	165	165
MHZJ2-20□□	290	290	290	290
MHZJ2-25□□	525	525	525	525

MHZJ2 Series

Made to Order Individual Specifications

Please contact SMC for detailed dimensions, specifications and lead times.



1 With dust cover (For MHZJ 32, 40)

Symbol
-X6100

With dust cover type (size 32, 40)

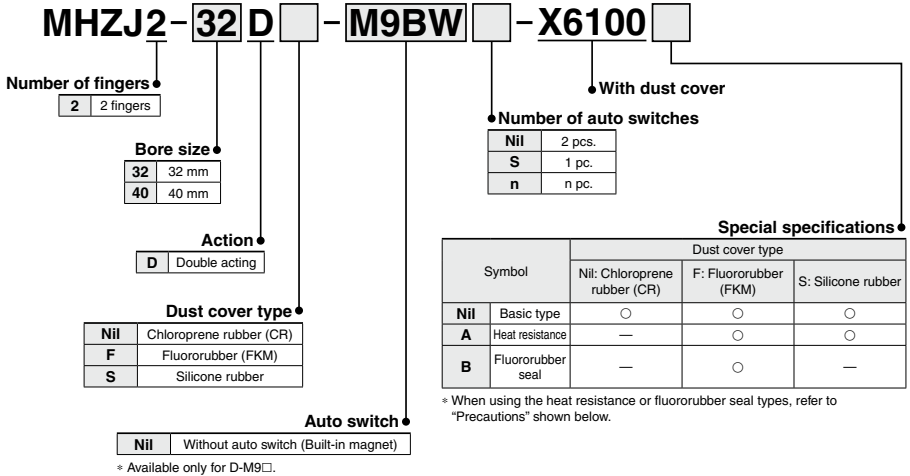

* Available only for D-M9□.

Specifications

Model		Basic type	Heat resistance	Fluororubber seal
Fluid		Air		
Operating pressure	Double acting	0.1 to 0.7 MPa		
Ambient and fluid temperature		-10 to 60°C	-10 to 100°C	-10 to 60°C
Repeatability		±0.01 mm		
Max. operating frequency		60 c.P/m		
Lubrication		Not required		
Action		Double acting		

Model

Action	Model	Bore size (mm)	Gripping force ^{Note 1)}		Opening/ Closing stroke (Both sides) (mm)	Weight ^{Note 2)} (g)
			Gripping force per finger Effective value (N)			
			External	Internal		
Double acting	MHZJ2-32D-X6100 □	32	158	193	22	760
	MHZJ2-40D-X6100 □	40	254	318	30	1325

Note 1) Values based on pressure of 0.5 MPa, gripping point L = 20 mm, at center of stroke.

Note 2) Values excluding weight of auto switch.

⚠ Handling Precautions

Heat resistance

⚠ Warning

Be aware that smoking cigarettes after your hands have come into contact with the grease used for this air gripper can create a gas that is hazardous to humans.

⚠ Caution

- Note 1) Magnet is built-in, but when using an auto switch, the acceptable temperature range becomes -10 to 60°C.
- Note 2) With the part number for the dust cover option, only fluororubber (F) or silicone rubber (S) options may be selected.
- Note 3) For lubrication, specialized grease GR-F is recommended.

Fluororubber seal

⚠ Caution

- Note 1) Please contact SMC, since the type of chemical and the operating temperature may not allow the use of this product.
- Note 2) Since the standard-type magnet is built-in, please contact SMC for the product's adaptability to the operating environment.
- Note 3) For the air gripper with a dust cover, the dust cover material is also fluororubber. Thus, enter (F) for the fluororubber dust cover in the part number.

MHZ

MHF

MHL

MHR

MHK

MHS

MHC

MHT

MHY

MHW

-X□

MHRQ

MA

D-□

Dimensions (Dimensions other than specified below are the same as the standard type.)

MHZJ2-40D□-X6100
Basic type/Double acting

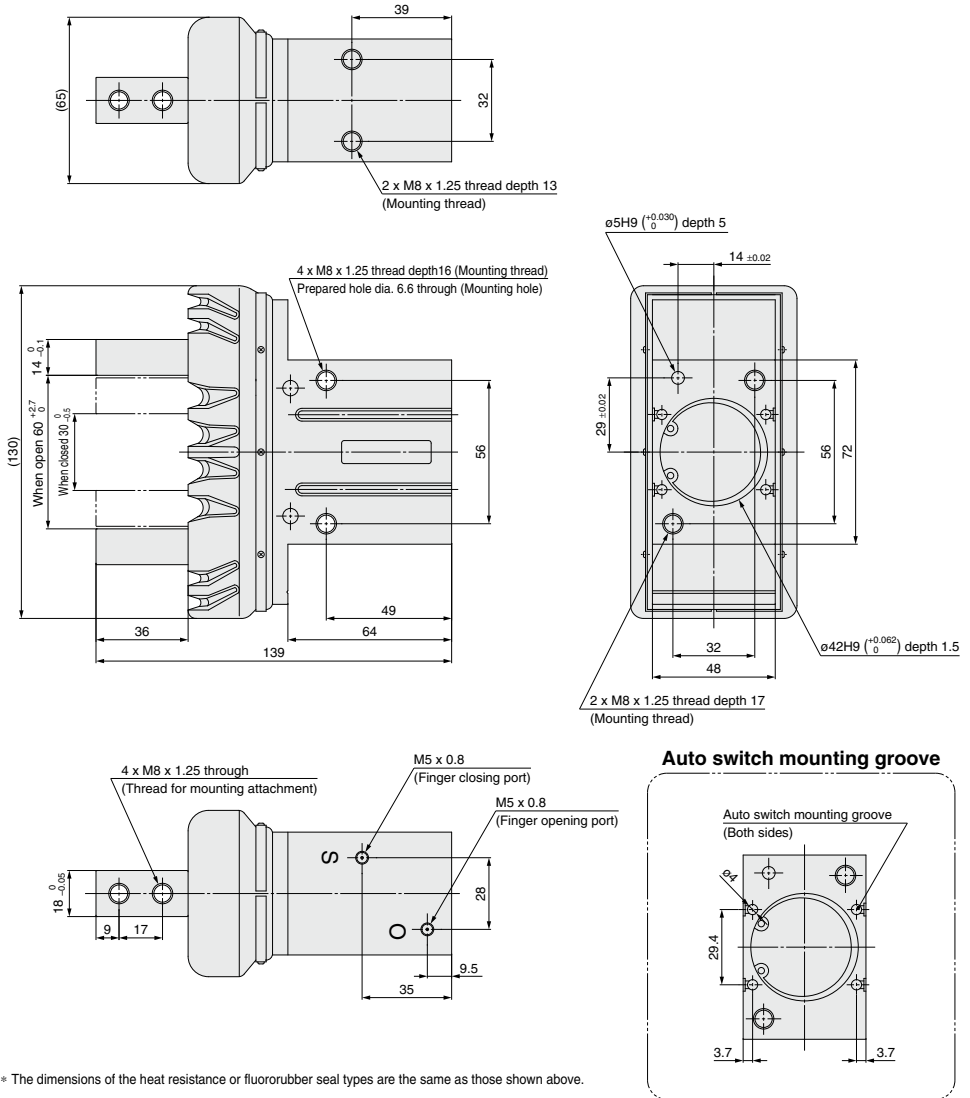

* The dimensions of the heat resistance or fluororubber seal types are the same as those shown above.



MHZ
MHF
MHL
MHR
MHK
MHS
MHC
MHT
MHY
MHW
-X□
MRHQ
MA
D-□

MHZ2/MHZ□2 Series

Auto Switch Installation Examples and Mounting Position

Various auto switch applications are possible through different combinations of auto switch quantities and detecting positions.

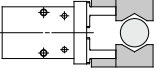
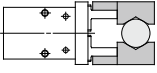
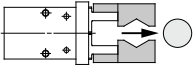
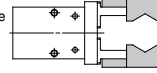
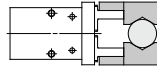
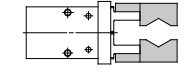
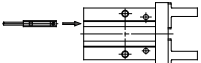
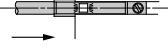
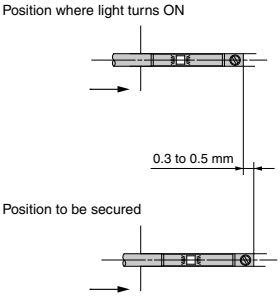
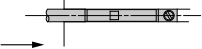
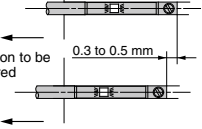
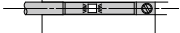
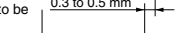
1) Detection when Gripping Exterior of Workpiece

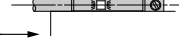

Detection example		1. Confirmation of fingers in reset position	2. Confirmation of workpiece held	3. Confirmation of workpiece released
Position to be detected	Position of fingers fully opened 	Position when gripping workpiece 	Position of fingers fully closed 	
Operation of auto switch	Auto switch turned on when fingers return. (Light ON)	Auto switch turned on when gripping a workpiece. (Light ON)	When a workpiece is not held (Abnormal operation): Auto switch to turn ON (Light ON)	
Detection combinations	One auto switch *One position, any of ①, ②, and ③ can be detected.	●	●	●
	Two auto switches *Two positions of ①, ②, and ③ can be detected.	●	●	—
	Pattern	—	●	●
Pattern	●	—	●	
How to determine auto switch installation position	Step 1) Fully open the fingers. 	Step 1) Position fingers for gripping a workpiece. 	Step 1) Fully close the fingers. 	
At no pressure or low pressure, connect the auto switch to a power supply, and follow the directions.	Step 2) Insert the auto switch into the switch installation groove in the direction shown in the following drawing.0 			
	Step 3) Slide the auto switch in the direction of the arrow until the indicator light illuminates. 	Step 3) Slide the auto switch in the direction of the arrow until the light illuminates and fasten it at a position 0.3 to 0.5 mm in the direction of the arrow beyond the position where the indicator light illuminates. 		
	Step 4) Slide the auto switch further in the direction of the arrow until the indicator light goes out. 			
	Step 5) Move the auto switch in the opposite direction and fasten it at a position 0.3 to 0.5 mm beyond the position where the indicator light illuminates. 			
	Position where light turns ON  Position to be secured 0.3 to 0.5 mm 	Position where light turns ON  Position to be secured 0.3 to 0.5 mm 		

Note 1) It is recommended that gripping of a workpiece be performed close to the center of the finger stroke.

Note 2) When holding a workpiece close at the end of open/close stroke of fingers, detecting performance of the combinations listed in the above table may be limited, depending on the hysteresis of an auto switch, etc.

Various auto switch applications are possible through different combinations of auto switch quantities and detecting positions.

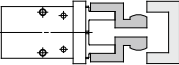
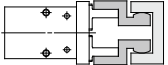
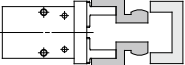
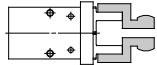
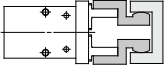
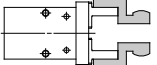
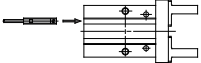
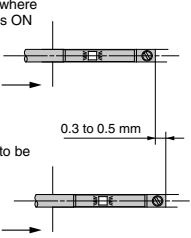
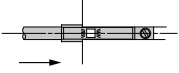
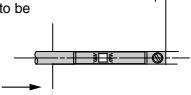
2) Detection when Gripping Interior of Workpiece

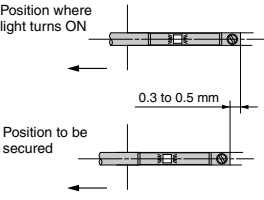
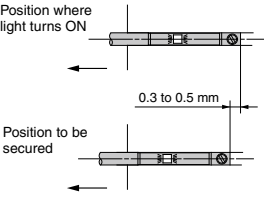
Detection example		1. Confirmation of fingers in reset position	2. Confirmation of workpiece held	3. Confirmation of workpiece released
Position to be detected		Position of fingers fully closed 	Position when gripping workpiece 	Position of fingers fully opened 
Operation of auto switch		Auto switch turned ON when fingers return. (Light ON)	Auto switch turned ON when gripping a workpiece. (Light ON)	When a workpiece is not held (Abnormal operation): Auto switch to turn ON (Light ON)
Detection combinations	One auto switch *One position, any of ①, ②, and ③ can be detected.	●	●	●
	Two auto switches *Two positions of ①, ②, and ③ can be detected.	●	●	—
		●	●	●
Pattern	A	—	●	●
B	—	●	—	●
C	●	—	●	●
How to determine auto switch installation position		Step 1) Fully close the fingers. 	Step 1) Position fingers for gripping a workpiece. 	Step 1) Fully open the fingers. 
At no pressure or low pressure, connect the auto switch to a power supply, and follow the directions.		Step 2) Insert the auto switch into the switch installation groove in the direction shown in the following drawing.		
				
		Step 3) Move the auto switch in the direction of the arrow and fasten it at a position 0.3 to 0.5 mm beyond the position where the indicator light illuminates.	Step 3) Slide the auto switch in the direction of the arrow until the indicator light illuminates.	
				
			Step 4) Slide the auto switch further in the direction of the arrow until the indicator light goes out.	
	Step 5) Move the auto switch in the opposite direction 0.3 to 0.5 mm in the direction indicated by the arrow from its location when the indicator light comes on again.			
				

Note 1) It is recommended that gripping of a workpiece be performed close to the center of the finger stroke.

Note 2) When holding a workpiece close at the end of open/close stroke of fingers, detecting performance of the combinations listed in the above table may be limited, depending on the hysteresis of an auto switch, etc.

MHZ2, MHZ□2 Series

Auto Switch Hysteresis

Auto switches have hysteresis similar to micro switches.
Use the table below as a guide when adjusting auto switch positions, etc.

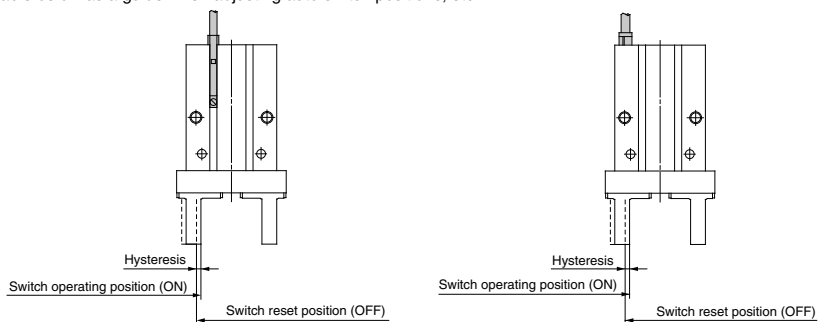

Hysteresis

Auto switch model	D-Y59A/Y59B D-Y69A/Y69B D-Y7P(V) D-Y7□W(V)	D-F8□	D-M9□(V) D-M9□W(V) D-M9□A(V)
Air gripper model			
MHZ2-6□	No setting	0.5	0.5
MHZ2-10□, MHZL2-10□	0.5	No setting	0.5 <small>Note</small>
MHZ2-16□, MHZL2-16□	0.5	0.5	0.5
MHZ2-20□, MHZL2-20□	0.5	0.5	0.8
MHZ2-25□, MHZL2-25□	0.5	0.5	0.5
MHZ2-32□	0.5	0.5	0.7
MHZ2-40□	0.5	0.5	0.9
MHZJ2-6□	No setting	0.5	0.5
MHZJ2-10□		0.5	0.5
MHZJ2-16□		0.5	0.5
MHZJ2-20□		0.5	0.8
MHZJ2-25□		0.5	0.5

Note) When mounting D-M9□(V), M9□W(V) and M9□A(V) on MHZ2-10□ and MHZL2-10, mounting brackets (BMG2-012) are required.

Auto Switch Mounting

Applicable models:

- MHZ2-6
- MHZJ2 Series
- Round groove of the MHZ2 series
- Round groove of the MHZL2 series

To set the auto switch, insert the auto switch into the auto switch installation groove of the gripper from the direction indicated in the following drawing. After setting the position, tighten the attached auto switch mounting screw with a flat head watchmaker's screwdriver.

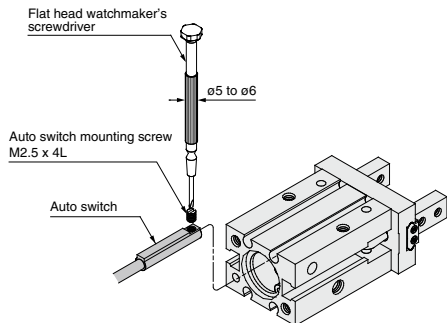

Note) Use a watchmaker's screwdriver with a grip diameter of 5 to 6 mm to tighten the auto switch mounting screw.
Also, tighten with a torque of about 0.05 to 0.15 N·m, or about 0.05 to 0.10 N·m for D-M9□A(V).

[Mounting of Auto Switch: Precautions]

When mounting an auto switch on the piping top surface of the MHZJ2-10□, the auto switch may not be mountable due to interference with the fitting. Use an extension fitting included with the product for the combinations in the table below.

Auto switch model	One-touch Mini Fittings (KQ2H/KQ2S/KQ2L/KQ2W) KJH/KJS/KJL/KJW
D-M9□(V)	×
D-M9□W(V)	×
D-F8□	×
D-M9□A(V)	×

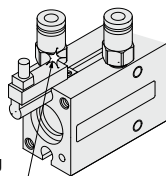

Interference between the auto switch and the fitting

Mounting dimensions of extension fitting

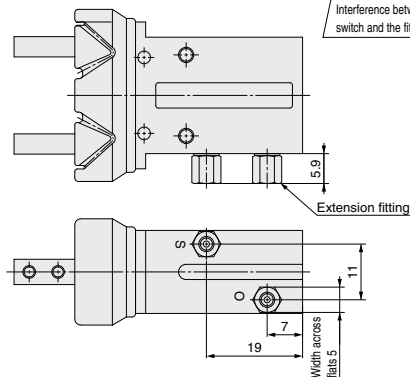

* When mounting extension fittings, first, tighten it by hand, then give it an additional 1/4 turn with a wrench.

Applicable models:

- Square groove on the side of the MHZ2 series
- Square groove on the side of the MHZL2 series

- (1) To set the auto switch, insert the auto switch into the installation groove of the cylinder as shown below and set it roughly.
- (2) Insert the auto switch into the auto switch bracket installation groove.
- (3) After confirming the detecting position, tighten the set screws (M2.5) attached to the auto switch and set it.
- (4) Be sure to change the detecting position in the state of (2).

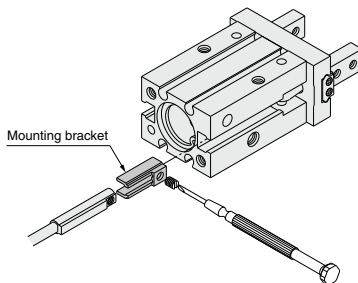

Auto Switch Mounting Bracket: Part No.

Auto switch part no.	Auto switch mounting bracket part no.
D-M9□(V)	BMG2-012
D-M9□W(V)	
D-F8□	
D-M9□A(V)	

Note) Use a watchmaker's screwdriver with a grip diameter of 5 to 6 mm to tighten the set screws (M2.5).
The tightening torque should be 0.05 to 0.1 N·m.
As a guide, it should be turned about 90° beyond the point at which tightening can be felt.

Note) D-F8□ cannot be mounted on MHZ2-10□, MHZJ2-10□ and MHZL2-10□

[Handling of Mounting Brackets: Precautions]

When auto switch is set on the mounting side as shown below, allow at least 2 mm run off space on mounting plate since the auto switch is protruded from the gripper edge.

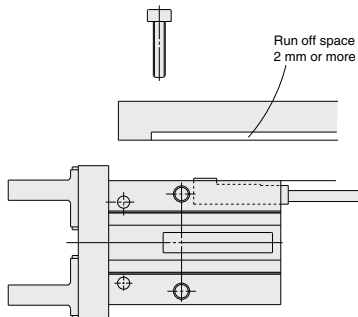

MHZ
MHF
MHL
MHR
MHK
MHS
MHC
MHT
MHY
MHW
-X□
MRHQ
MA
D-□

MHZ2, MHZ□2 Series

Protrusion of Auto Switch from Edge of Body

The amount of auto switch protrusion from the body's end surface is as shown in the table below.

Use this as a standard when mounting, etc.

D-F8□ has no protrusion from the body's end surface.

The end boss type has no protrusion either.

Standard Body

Lead wire type		In-line electrical entry type			Perpendicular electrical entry type				
		Explanatory drawing			Explanatory drawing				
Auto switch model		Finger position			Finger position				
Air gripper model		D-Y59□ D-Y7P D-Y7□W	D-M9□ D-M9□W	D-M9□A	D-Y69□ D-Y7PV D-Y7□WV	D-M9□V D-M9□WV	D-M9□AV		
Standard	MHZ2-6□	Open	No setting		No setting		9	11	
		Close					11	13	
	MHZ2-10□	Open	1	3.5 <small>Note 3)</small>	5.5 <small>Note 3)</small>	—	1.5 <small>Note 3)</small>	3.5 <small>Note 3)</small>	
		Close	7.5	6.5 <small>Note 3)</small>	8.5 <small>Note 3)</small>	6.5	4.5 <small>Note 3)</small>	6.5 <small>Note 3)</small>	
	MHZ2-16□	Open	—	1	3	—	—	—	
		Close	6	4	6	5	2	4	
	MHZ2-20□	Open	—	—	—	—	—	—	
		Close	4	2	4	3	—	—	
	MHZ2-25□	Open	—	—	—	—	—	—	
		Close	1	—	—	—	—	—	
	MHZ2-32□	Open	—	—	—	—	—	—	
		Close	3	—	—	2	—	—	
	MHZ2-40□	Open	—	—	—	—	—	—	
		Close	2	—	—	1	—	—	
	With dust cover	MHZJ2-6□	Open	11		13		9	11
			Close	13		15		11	13
MHZJ2-10□		Open	5		7		3	5	
		Close	7		9		5	7	
MHZJ2-16□		Open	2		4		—	—	
		Close	5		7		3	5	
MHZJ2-20□		Open	—		—		—	—	
		Close	3		5		1	3	
MHZJ2-25□		Open	—		—		—	—	
		Close	2		4		—	—	
Long stroke	Double acting	MHZL2-10D	Open	0.5	1.5 <small>Note 3)</small>	3.5 <small>Note 3)</small>	—	—	
			Close	8.5	8 <small>Note 3)</small>	10 <small>Note 3)</small>	7.5	6 <small>Note 3)</small>	8 <small>Note 3)</small>
		MHZL2-16D	Open	—	—	—	—	—	—
			Close	8	6	8	7	4	6
		MHZL2-20D	Open	—	—	—	—	—	—
			Close	7	5	7	6	3	5
	MHZL2-25D	Open	—	—	—	—	—	—	
		Close	5.5	3.5	5.5	4.5	1.5	3.5	
	Single acting (Normally open)	MHZL2-10S	Open	—	—	—	—	—	
			Close	—	—	—	—	—	
		MHZL2-16S	Open	—	—	—	—	—	
			Close	3	1	3	2	—	
		MHZL2-20S	Open	—	—	—	—	—	
			Close	1	—	—	—	—	
		MHZL2-25S	Open	—	—	—	—	—	
			Close	—	—	—	—	—	
		MHZL2-10C	Open	—	—	—	—	—	
			Close	5.5	5 <small>Note 3)</small>	7 <small>Note 3)</small>	4.5	3 <small>Note 3)</small>	5 <small>Note 3)</small>
MHZL2-16C		Open	—	—	—	—	—		
		Close	5.5	3.5	5.5	4.5	1.5	3.5	
MHZL2-20C	Open	—	—	—	—	—			
	Close	3.5	1.5	3.5	2.5	—			
MHZL2-25C	Open	—	—	—	—	—			
	Close	1.5	—	—	0.5	—			

Note 1) There is no protrusion if no values are entered in the table.

Note 2) The actual mounting position should be adjusted after confirming the auto switch operating conditions.

Note 3) When mounting D-M9□(V), M9□W(V) and M9□A(V) on MHZ2-10□ and MHZL2-10□, mounting brackets (BMG2-012) are required.

1 Built-in needle valve for finger speed control

Symbol
-X46

Installation of a variable throttle allows adjustment of the finger opening/closing speed.

How to Order

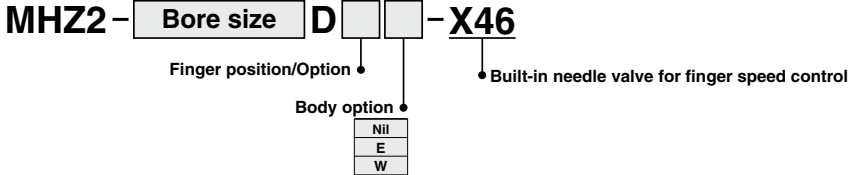

Specifications

Bore size (mm)	10, 16, 20, 25
Action	Double acting
Needle position	Refer to the dimensions and figures below.
Specifications/dimensions other than the above	Same as the standard type

Note) Not available for ø6, ø32 and ø40.

Dimensions (Dimensions other than specified below are the same as the standard type.)

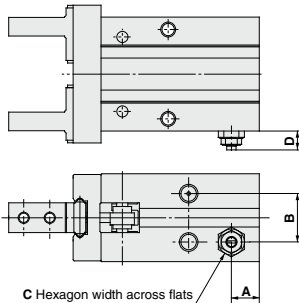

Model	A	B	C	D* (mm)
MHZ2-10D <input type="checkbox"/> <input type="checkbox"/> - X46	9	11	4.5	5.2
MHZ2-16D <input type="checkbox"/> <input type="checkbox"/> - X46	7.5	13	7	5.8
MHZ2-20D <input type="checkbox"/> <input type="checkbox"/> - X46	10	15	7	6
MHZ2-25D <input type="checkbox"/> <input type="checkbox"/> - X46	10.7	20	7	6.2

Dimensions other than the above are identical to the standard type; refer to pages 417 to 420.

* Reference values to establish criteria for needle adjustment.

Adjust so that the finger opening/closing speed will be no greater than necessary. If the finger opening/closing speed is greater than necessary, impact forces acting on the fingers and other parts will increase. This can cause a loss of repeatability when gripping workpieces and have an adverse effect on the life of the unit.

This needle is used to adjust the finger closing speed. When adjusting the opening speed (attenuating impact during operation, etc.), use a meter-out control speed controller AS series.

Guide for Internal Needle Adjustment

Model	Number of rotations from fully closed needle condition <small>(Note)</small>
MHZ2-10D <input type="checkbox"/> <input type="checkbox"/> - X46	1/4 to 1/2
MHZ2-16D <input type="checkbox"/> <input type="checkbox"/> - X46	1/2 to 1
MHZ2-20D <input type="checkbox"/> <input type="checkbox"/> - X46	1 to 1 1/2
MHZ2-25D <input type="checkbox"/> <input type="checkbox"/> - X46	1 1/2 to 2

Note) The condition in which the needle is tightened gently until it stops.

MHZ

MHF

MHL

MHR

MHK

MHS

MHC

MHT

MHY

MHW

-X

MRHQ

MA

D-



2 MHQ2/MHQG2 Compatible Flat Type Fingers

Symbol
-X51

Previous MHQ2/MHQG2 series compatible flat type finger is selectable for the MHZ2 series.

How to Order

MHZ2 – **Bore size** [] [] [] – **X51**

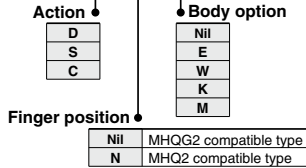

Specifications

Bore size (mm)	10, 16, 20, 25
Action	Double acting, Single acting (normally open, normally closed)
Finger dimensions	Refer to the dimensions and figures below.
Specifications/dimensions other than the above	Same as the standard type

Note 1) Not available for ø6, ø32 and ø40.

Note 2) An option symbol (3) for the flat finger type is not specified.

Dimensions (Dimensions other than specified below are the same as the standard type.)

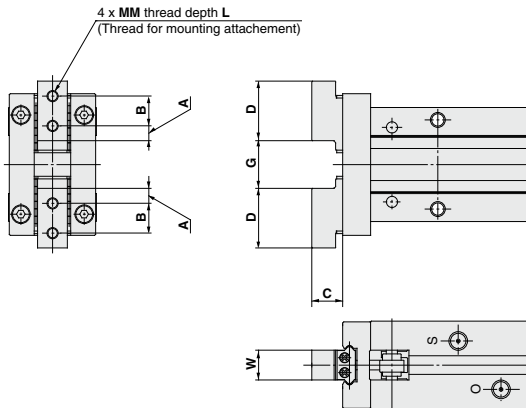

Model		A	B	C	D	G		MM	L	W
						Open	Closed			
MHZ2-10□□□-X51	MHQG2 compatible	3	6	5.2	12	9.7 ^{+0.2} _{-0.2}	5.7 ⁰ _{-0.4}	M2 x 0.4	3.6	5 ⁰ _{-0.05}
	MHQ2 compatible	2	5	5.2	9	9.7 ^{+0.2} _{-0.2}	5.7 ⁰ _{-0.4}	M2 x 0.4	3.6	5 ⁰ _{-0.05}
MHZ2-16□□□-X51	MHQG2 compatible	4	8	8.3	16	12.6 ^{+0.2} _{-0.2}	6.6 ⁰ _{-0.4}	M3 x 0.5	6	8 ⁰ _{-0.05}
	MHQ2 compatible	2.5	7	8.3	12	12.6 ^{+0.2} _{-0.2}	6.6 ⁰ _{-0.4}	M3 x 0.5	6	8 ⁰ _{-0.05}
MHZ2-20□□□-X51	MHQG2 compatible	5	10	10.5	20.8	17.2 ^{+0.2} _{-0.2}	7.2 ⁰ _{-0.4}	M4 x 0.7	8	10 ⁰ _{-0.05}
	MHQ2 compatible	3.3	9	10.5	15.5	17.2 ^{+0.2} _{-0.2}	7.2 ⁰ _{-0.4}	M4 x 0.7	8	10 ⁰ _{-0.05}
MHZ2-25□□□-X51	MHQG2 compatible	6.5	12	13.1	25	22.8 ^{+0.5} _{-0.5}	8.8 ⁰ _{-0.4}	M5 x 0.8	10	12 ⁰ _{-0.05}
	MHQ2 compatible	3.5	12	13.1	19	22.8 ^{+0.5} _{-0.5}	8.8 ⁰ _{-0.4}	M5 x 0.8	10	12 ⁰ _{-0.05}



MHZ Series Specific Product Precautions

Be sure to read this before handling the products.

Mounting Air Grippers/MHZ□2 Series

Possible to mount from 3 directions.

How to mount air grippers

Axial mounting (Body tapped)

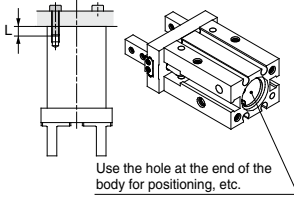

Model	Applicable bolts	Max. tightening torque (N·m)	Max. screw-in depth (L, mm)
MHZ□2-6 ^(max)	M2 x 0.4	0.15	4.5
MHZ□2-10	M3 x 0.5	0.88	6
MHZ□2-16	M4 x 0.7	2.1	8
MHZ□2-20	M5 x 0.8	4.3	10
MHZ□2-25	M6 x 1	7.3	12
MHZ□2-32	M6 x 1	7.9	13
MHZ□2-40	M8 x 1.25	17.7	17

Note) Axial mounting type is not available for MHZ2-6 and MHZJ2-6.

Model	Hole diameter (mm)	Hole depth (mm)
MHZ□2-6	ø7H8 ^{+0.022} ₀	1.5
MHZ□2-10	ø11H9 ^{+0.043} ₀	2
MHZ□2-16	ø17H9 ^{+0.043} ₀	2
MHZ□2-20	ø21H9 ^{+0.052} ₀	3
MHZ□2-25	ø26H9 ^{+0.052} ₀	3.5
MHZ□2-32	ø34H9 ^{+0.062} ₀	4
MHZ□2-40	ø42H9 ^{+0.062} ₀	4

Perpendicular mounting (Body tapping)

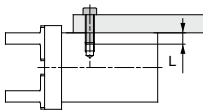

Model	Applicable bolts	Max. tightening torque (N·m)	Max. screw-in depth (L, mm)
MHZ□2-6 ^(max)	M2 x 0.4	0.15	4
MHZ□2-10	M3 x 0.5	0.9	6
MHZ□2-16	M4 x 0.7	1.6	4.5
MHZ□2-20	M5 x 0.8	3.3	8
MHZ□2-25	M6 x 1	5.9	10
MHZ□2-32	M6 x 1	5.9	10
MHZ□2-40	M8 x 1.25	13.7	13

Note) Except MHZ2-6 and MHZJ2-6.

How to mount air grippers

Lateral mounting (Body tapped and through-hole)

●Body tapped

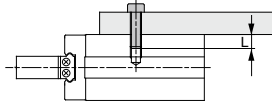

Model	Applicable bolts	Max. tightening torque (N·m)	Max. screw-in depth (L, mm)
MHZ□2-6	M3 x 0.5	0.88	10
MHZ□2-10	M3 x 0.5	0.69	5
MHZ□2-16	M4 x 0.7	2.1	8
MHZ□2-20	M5 x 0.8	4.3	10
MHZ□2-25	M6 x 1	7.3	12
MHZ□2-32	M6 x 1	7.9	13
MHZ□2-40	M8 x 1.25	17.7	16

●Body through-holes

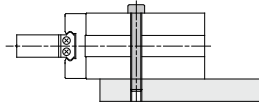

Model	Applicable bolts	Max. tightening torque (N·m)
MHZ□2-6	M2.5 x 0.45	0.49
MHZ□2-10	M2.5 x 0.45	0.49
MHZ□2-16	M3 x 0.5	0.88
MHZ□2-20	M4 x 0.7	2.1
MHZ□2-25	M5 x 0.8	4.3
MHZ□2-32	M5 x 0.8	4.3
MHZ□2-40	M6 x 1	7.3

Note) Use body tapped for D-Y59, D-Y69, D-Y7P with auto switch types. Make sure that the bolt's screw-in depth is less than those shown in the table below to prevent the tip of the bolt from pressing the switch body.

Model	Max. screw-in depth (L, mm)
MHZ□2-6	—
MHZ□2-10	5
MHZ□2-16	8
MHZ□2-20	10
MHZ□2-25	12
MHZ□2-32	13
MHZ□2-40	16

How to mount the attachment to the finger

The attachment must be mounted on fingers using bolts such as finger mounting female threads, etc., which should be tightened with the tightening torque in the table below.

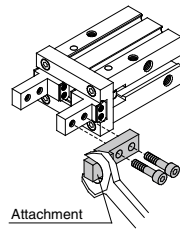

Model	Applicable bolts	Max. tightening torque (N·m)
MHZ□2-6	M2 x 0.4	0.15
MHZ□2-10	M2.5 x 0.45	0.31
MHZ□2-16	M3 x 0.5	0.59
MHZ□2-20	M4 x 0.7	1.4
MHZ□2-25	M5 x 0.8	2.8
MHZ□2-32	M6 x 1	4.9
MHZ□2-40	M8 x 1.25	11.8

MHZ

MHF

MHL

MHR

MHK

MHS

MHC

MHT

MHY

MHW

-X□

MRHQ

MA

D-□

Operating Environment

⚠ Caution

Use caution for the anti-corrosiveness of linear guide section.

Martensitic stainless steel is used for the finger guide. But, use caution that anti-corrosiveness is inferior to the austenitic stainless steel. Especially, in an environment where waterdrops are adhered by condensation, etc., rust might be generated.

High Rigidity

MHQG2 Series

ø32, ø40

With guide holder

Possible to mount the solid state auto switch with indicator light.



Specifications

Fluid		Air	
Operating pressure	Double acting		0.1 to 0.6 MPa
	Single acting	Normally open	0.25 to 0.6 MPa
Normally closed			
Ambient and fluid temperature			-10 to 60°C
Repeatability			ø32, 40: ±0.02 mm
Max. operating frequency			ø32, 40: 60 c.p.m
Lubrication			Not required
Operating system			Double acting, Single acting
Auto switch (Option) *			Solid state auto switch: D-M9N(V), D-M9P(V), D-M9B(V), D-Y59 _ø , D-Y69 _ø

* Refer to pages 797 to 850 for the detailed specifications of auto switches.

Model

Operating system	Model	Cylinder bore (mm)	Gripping force ^{Note 1)} (Effective value) N	Opening/Closing stroke (mm)	Weight ^{Note 2)} (g)	
Double acting	MHQG2-32D	32	External grip: 88 Internal grip: 139	20	1100	
	MHQG2-40D	40	External grip: 158 Internal grip: 247	28	1940	
Single acting	Normally open	MHQG2-32S	32	69	20	1110
		MHQG2-40S	40	130	28	1960
	Normally closed	MHQG2-32C	32	127	20	1110
		MHQG2-40C	40	227	28	1960

Note 1) Values at the pressure of 0.5 MPa. Double acting is compatible with both external and internal gripping forces, while single acting and normally open external gripping force, and single acting and normally closed internal gripping force.

Note 2) Values excluding weight of auto switch.

Symbol

Double acting: Internal grip

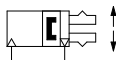

Double acting: External grip

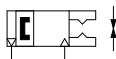

Single acting/Normally closed: Internal grip

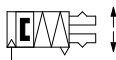

Single acting/Normally open: External grip



With Dust Cover

MHQJ2 Series

ø10, ø16, ø20, ø25

Air gripper with dustproof and dripproof construction

Enclosure to prevent accumulation of dust.

Sealed construction with a dust cover

Possible to mount the solid state auto switch with indicator light.

Three-type dust cover variations for diversified applications



Symbol

Double acting: Internal grip

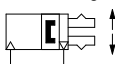

Double acting: External grip

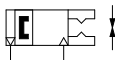

Single acting/Normally closed: Internal grip

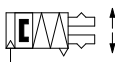

Single acting/Normally open: External grip



Specifications

Fluid		Air	
Operating pressure	Double acting		0.1 to 0.6 MPa
	Single acting	Normally open	0.25 to 0.6 MPa
Normally closed			
Ambient and fluid temperature			-10 to 60°C
Repeatability			±0.01 mm
Max. operating frequency			180 c.p.m
Lubrication			Not required
Operating system			Double acting, Single acting
Auto switch (Option) *			Solid state auto switch: D-M9N(V), D-M9P(V), D-M9B(V)

* Refer to pages 797 to 850 for the detailed specifications of auto switches.

Model

Operating system	Model	Cylinder bore (mm)	Gripping force ^{Note 1)} (Effective value) N	Opening/Closing stroke (mm)	Weight ^{Note 2)} (g)	
Double acting	MHQJ2-10D	10	11	4	90	
	MHQJ2-16D	16	34	6	180	
	MHQJ2-20D	20	42	10	340	
	MHQJ2-25D	25	63	14	640	
Single acting	Normally open	MHQJ2-10S	10	7.8	4	90
		MHQJ2-16S	16	26	6	181
		MHQJ2-20S	20	33	10	342
		MHQJ2-25S	25	49	14	643
	Normally closed	MHQJ2-10C	10	7.8	4	90
		MHQJ2-16C	16	26	6	181
		MHQJ2-20C	20	33	10	342
		MHQJ2-25C	25	49	14	643

Note 1) Values at the pressure of 0.5 MPa. Double acting is compatible with both external and internal gripping forces, while single acting and normally open external gripping force, and single acting and normally closed internal gripping force.

Note 2) Values excluding weight of auto switch.

MHZ

MHF

MHL

MHR

MHK

MHS

MHC

MHT

MHY

MHW

-X□

MRHQ

MA

D-□