

# Precision Regulator

## IR1000-A/2000-A/3000-A Series

RoHS

Air consumption

Reduced by Up to approx. **90%**\*  
[L/min (ANR)]

IR	Current model	Series
1 or less	4.4	IR1000-A/IR2000-A
1 or less	11.5	IR3000-A

\* Compared with the current IR1000/2000/3000

High flow rate

Up to approx. **twice**\*  
[L/min (ANR)]

IR	Current model	Series
720	320	IR1000-A
1900	940	IR2000-A

\* Compared with the current IR1000/2000

Lightweight

Reduced by up to approx. **27%**\*  
[kg]

IR	Current model	Series
0.13	0.14	IR1000-A
0.23	0.30	IR2000-A
0.47	0.64	IR3000-A

\* Compared with the current IR1000/2000/3000

Sensitivity: **0.2%** (Full span)  
Repeatability: **±0.5%** (Full span)

### Space saving

New structure without fixed throttle does not require a mist separator.

Reduced by **71 mm**

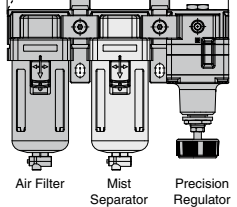
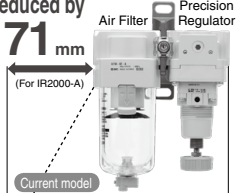

Digital pressure switch standardized

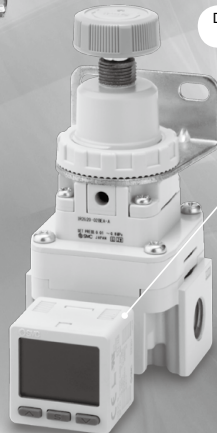
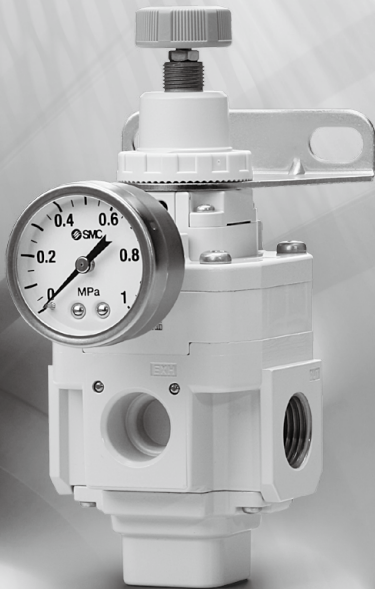

ARJ

AR425 to 935

ARX

AMR

ARM

ARP

IR□-A

IR

IRV

VEX

SRH

SRP

SRF

ITV

IC

ITVH

ITVX

PVQ

VY1

VBA

VBAT

AP100

# Reduction in air consumption

## ● Air consumption is reduced with a new original structure.

With this new original structure, running costs are reduced.

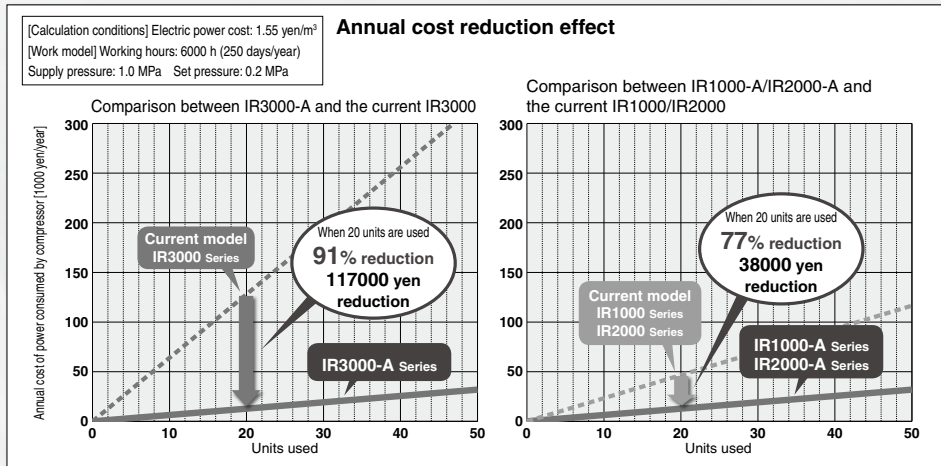

## ● No fixed throttle in the new design.

\* Poor quality of air may cause operation failure. Select a model that is suitable for the desired air cleanliness by referring to "Air Preparation Equipment Model Selection Guide" (pages 2 and 3) for air quality.

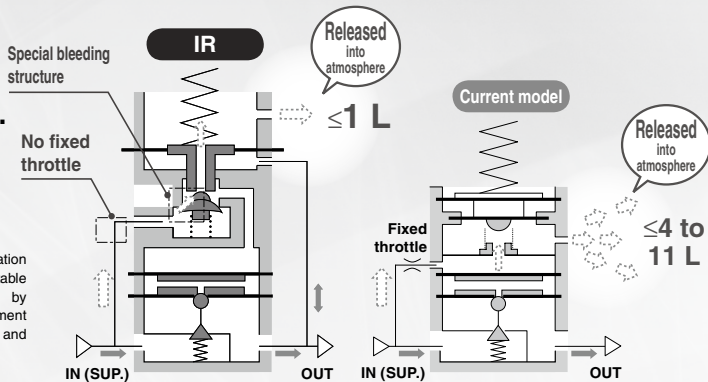

## ● Flow rate: Up to approx. twice

(Compared to the current SMC product) [L/min(ANR)]

IR	Current model	Series
720	320	IR1000-A
1900	940	IR2000-A

Supply pressure: 0.7 MPa

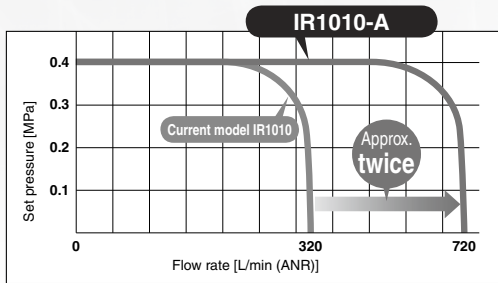

Supply pressure: 0.7 MPa

**Weight**

Reduced by up to approx. **27%** [kg]

IR	Current model	Series
0.13	0.14	IR1000-A
0.23	0.30	IR2000-A
0.47	0.64	IR3000-A

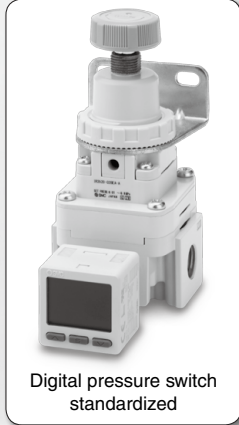

**Hexagon panel nut mounting**

\* Interchangeable with the current SMC product

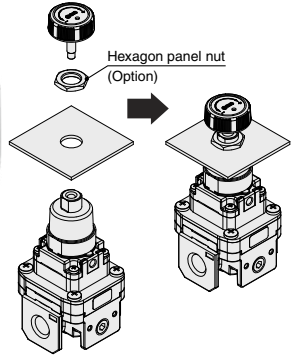

**Sensitivity: 0.2%** (Full span)

**Repeatability: ±0.5%** (Full span)

**Mounting is interchangeable with the current SMC model.**

**New IR can be used between a cylinder and solenoid valve.**

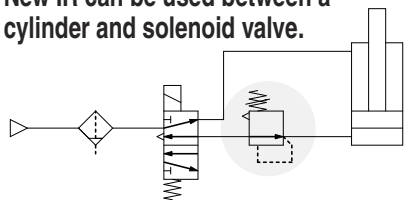

Note) The set pressure may vary depending on the elapsed time and change in ambient temperature after pressure setting. If the setting value varies, adjust the pressure with the knob.

**Exhaust (EXH) directions can be selected.** (IR3000-A series)

**Bottom and front exhaust added.**

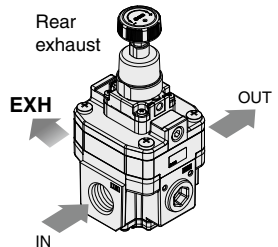
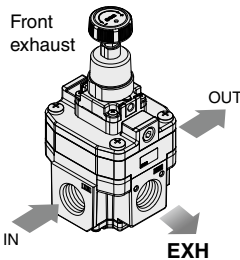
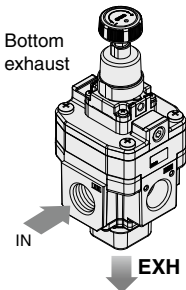

- ARJ
- AR425 to 935
- ARX
- AMR
- ARM
- ARP
- IR0-A
- IR
- IRV
- VEV
- SRH
- SRP
- SRF
- ITV
- IC
- ITVH
- ITVX
- PVQ
- VY1
- VBA
- VBAT
- AP100

## ● Application Examples

### Constant fluid pressure Note)

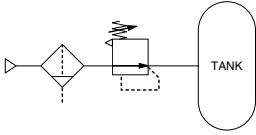

- Since there is a large effective area for supply and exhaust pressure, setting can be done quickly.

### Balance and drive Note) Accurate balance pressure setting

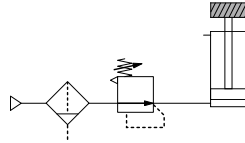

- Limits pressure fluctuation when driving a cylinder, maintaining excellent static and dynamic balance.

### Accurate pressure setting Note) Sensitivity within 0.2% F.S. (Full Span) Tension control

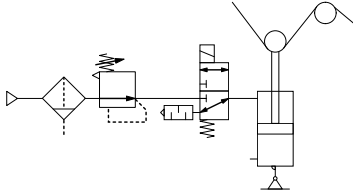

### Contact pressure control Note)

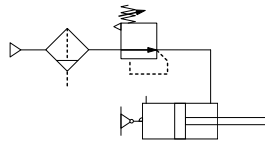

- Adapts to the cylinder's piston displacement, maintaining a constant pressure.

### Multistage control of pressing force for workpiece Note) (Wrapping machine)

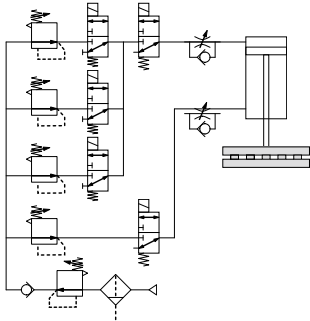

### Leak test circuit Note)

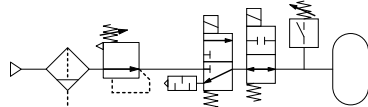

### Residual pressure relief Note)

Ex.) Backflow from the tank

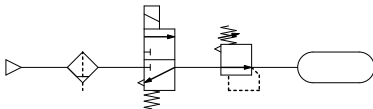

- Residual pressure is exhausted by relief function.

### Usage between a cylinder and solenoid valve Note)

Ex.) Between a cylinder and solenoid valve

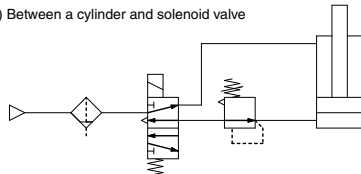

- It can be used between a cylinder and solenoid valve. (Refer to the Specific Product Precautions on page 806.)

**Adjustment of blow-line pressure** Note)

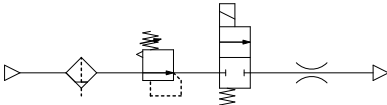



•Outlet pressure is less affected by fluctuation of inlet pressure. New IR offers consistent pressure control.

Note) The set pressure may vary depending on the elapsed time and change in ambient temperature after pressure setting. If the setting value varies, adjust the pressure with the knob.



**Series Variations**

Series	Model	Set pressure range (MPa)	Port size
IR1000-A 	IR1000-A	0.005 to 0.2	1/8
	IR1010-A	0.01 to 0.4	
	IR1020-A	0.01 to 0.8	
IR2000-A 	IR2000-A	0.005 to 0.2	1/4
	IR2010-A	0.01 to 0.4	
	IR2020-A	0.01 to 0.8	
IR3000-A 	IR3000-A	0.01 to 0.2	1/4, 3/8, 1/2
	IR3010-A	0.01 to 0.4	
	IR3020-A	0.01 to 0.8	

Basic Type (Knob)

ARJ
AR425 to 935
ARX
AMR
ARM
ARP
IR□-A
IR
IRV
VEV
SRH
SRP
SRF
ITV
IC
ITVH
ITVX
PVQ
VY1
VBA
VBAT
AP100

# Precision Regulator

## IR1000-A/2000-A/3000-A Series

RoHS

Symbol



Basic type  
(Knob)

### Standard Specifications

Model	Basic type (Knob)		
	IR10□0-A	IR2000-A	IR30□0-A
<b>Fluid</b>	Air		
<b>Proof pressure</b>	1.5 MPa		
<b>Max. supply pressure</b>	1.0 MPa		
<b>Min. supply pressure</b> <sup>Note 1)</sup>	Set pressure + 0.05 MPa		
<b>Set pressure range</b>	IR1000-A: 0.005 to 0.2 MPa	IR2000-A: 0.005 to 0.2 MPa	IR3000-A: 0.01 to 0.2 MPa
	IR1010-A: 0.01 to 0.4 MPa	IR2010-A: 0.01 to 0.4 MPa	IR3010-A: 0.01 to 0.4 MPa
	IR1020-A: 0.01 to 0.8 MPa	IR2020-A: 0.01 to 0.8 MPa	IR3020-A: 0.01 to 0.8 MPa
<b>Sensitivity</b>	Within 0.2% of full span		
<b>Repeatability</b> <sup>Note 2)</sup>	Within ±0.5% of full span		
<b>Air consumption</b> <sup>Note 3)</sup>	1 L/min (ANR) or less		
<b>Port size</b>	1/8	1/4	1/4, 3/8, 1/2
<b>Pressure gauge port</b>	1/8 (2 locations)		
<b>Ambient and fluid temperature</b> <sup>Note 4)</sup>	-5 to 60°C (No freezing)		
<b>Weight (kg)</b> <sup>Note 5)</sup>	0.13	0.23	0.47

Note 1) When there is no flow rate on the outlet. (Refer to Operation 13 on page 806.)

Note 2) Other characteristics such as aging deterioration and temperature characteristics are not included.

Note 3) Measuring conditions: supply pressure 1.0 MPa, set pressure 0.2 MPa

Note 4) -5 to 50°C for the products with the digital pressure switch

Note 5) Without accessories

### Accessories (Option)/Part No.

Description	IR10□0-A	IR20□0-A	IR30□0-A
<b>Bracket assembly</b> <sup>Note 1)</sup>	IR10P-501AS	IR20P-501AS	IR30P-501AS
<b>Hexagon panel nut</b>	IR10P-600S	IR20P-600S	IR20P-600S
<b>Round type pressure gauge</b> <sup>Note 2)</sup>	<b>0.2 MPa setting</b>	G33-2-□01	G43-2-□01
	<b>0.4 MPa setting</b>	G33-4-□01	G43-4-□01
<b>Digital pressure switch</b> <sup>Note 3)</sup>	<b>0.8 MPa setting</b>	G33-10-□01	G43-4-□01
	<b>NPN 1 output</b>	ISE20-N-M-□01-L	
	<b>PNP 1 output</b>	ISE20-P-M-□01-L	
<b>NPN 2 outputs/ Voltage output</b>	ISE20A-R-M-□01-J		
	<b>NPN 2 outputs/ Current output</b>	ISE20A-S-M-□01-J	

Note 1) This is an assembly of the bracket and set nut.

Note 2) □ in part numbers for a round type pressure gauge indicates a type of connection thread. No indication is necessary for R; however, indicate N for NPT.

A 1.0 MPa pressure gauge is fitted for 0.8 MPa setting. Please contact SMC regarding the supply of pressure gauge with psi unit specifications.

Note 3) □ in part numbers for a digital pressure switch indicates a type of connection thread. No indication is necessary for R; however, indicate N for NPT. For details on handling digital pressure switch and specifications, refer to the Best Pneumatics No. 8. Please contact SMC regarding the supply of digital pressure switch with unit conversion function.

### Modular Products and Accessories

Applicable products and accessories	Applicable size		
	IR1000-A series	IR2000-A series	IR3000-A series
<b>Filter</b>	AF20-A	AF30-A	AF40-A
<b>Spacer</b>	Y200-A	Y300-A	Y400-A
<b>Spacer with bracket</b>	Y200T-A	Y300T-A	Y400T-A

Refer to pages 427 and 430 for details of the modular applicable products and accessories. The former modular and mounting brackets can be used.

# Precision Regulator IR1000-A/2000-A/3000-A Series

## How to Order

IR 1 0 0 0 -   01 BG -   - A

1
2
3
4
5
6
7



- Option/Semi-standard: Select one each for a to e.
- Option/Semi-standard symbol: When more than one specification is required, indicate in alphanumeric order.

Made to Order (Refer to page 804-1)

Symbol	Specifications/Content
10-	Clean series
25A-	Secondary battery compatible
-X1155	Fluororubber specification
-X1	Non-grease specifications
IRM□-	Manifold specifications

	Symbol	Description	①					
			Body size					
			1	2	3			
②	Set pressure range	0	0.005 to 0.2 MPa	●	●	—		
		1	0.01 to 0.2 MPa	—	—	●		
		2	0.01 to 0.4 MPa	●	●	●		
		2	0.01 to 0.8 MPa	●	●	●		
③	Exhaust direction	0	Bottom exhaust	●	●	●		
		1	Front exhaust	—	—	●		
		2	Rear exhaust	—	—	●		
		+						
④	Pipe thread type	Nil	Rc	●	●	●		
		N	NPT	●	●	●		
		F	G	●	●	●		
		+						
⑤	Port size	01	1/8	●	—	—		
		02	1/4	—	●	●		
		03	3/8	—	—	●		
		04	1/2	—	—	●		
⑥	a	Mounting	Nil	Without mounting option	●	●	●	
			B <sup>Note 2)</sup>	With bracket	●	●	●	
			H	With hexagon panel nut (for panel mount)	●	●	●	
	b	Pressure gauge	Nil	Without pressure gauge	●	●	●	
			G	Round type pressure gauge	●	●	●	
		With digital pressure switch	EA	NPN open collector 1 output	●	●	●	
			EB	PNP open collector 1 output	●	●	●	
			EC	NPN open collector 1 output + Analog voltage output	●	●	●	
	ED	NPN open collector 1 output + Analog current output	●	●	●			
	⑦	c	Flow direction	Nil	Flow direction: Left to right	●	●	●
				R	Flow direction: Right to left	●	●	●
		d	Knob	Nil	Upward	●	●	●
V				Downward	●	●	●	
e	Pressure unit <sup>Note 3)</sup>	Nil	Name plate and pressure gauge in imperial units: MPa	●	●	●		
		Z	Name plate and pressure gauge in imperial units: psi	●	●	●		
		ZA	Digital pressure switch: With unit conversion function	●	●	●		

Note 1) Options are shipped together with the product, but not assembled. B and H cannot be selected at the same time. The current bracket cannot be used for this product.  
 Note 2) Assembly of a bracket and set nuts.  
 Note 3) See pressure unit table below.

	Pipe thread type	Name plate in imperial units	Pressure gauge in imperial units		Sales <sup>Note 6)</sup>
			G	EA, EB, EC, ED	
Nil	Rc	MPa	MPa	Fixed SI unit	Japan, Overseas
	NPT				
	G				
Z <sup>Note 4)</sup>	Rc	psi	psi	With unit conversion function (Initial value psi)	Only overseas
	NPT				
	G				
ZA <sup>Note 5)</sup>	Rc	MPa	—	With unit conversion function	Only overseas
	NPT				
	G				

Note 4) For pipe thread type: NPT  
 Note 5) For options: EA, EB, EC, ED  
 Note 6) According to the new Measurement Law, only the SI unit type is provided for use in Japan.

# IR1000-A/2000-A/3000-A Series

## IR1000-A Series

\* The data shown below are representative values, and are not guaranteed.

### Flow Rate Characteristics

#### IR1020-01-A

Supply pressure: 0.7 MPa

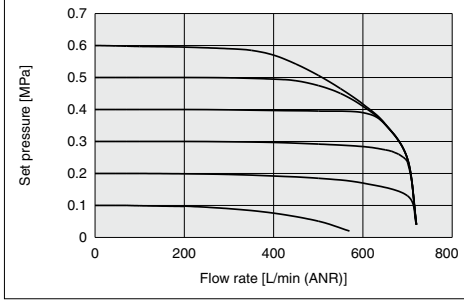

### Relief Characteristics

#### IR1020-01-A

Back pressure: 0.7 MPa

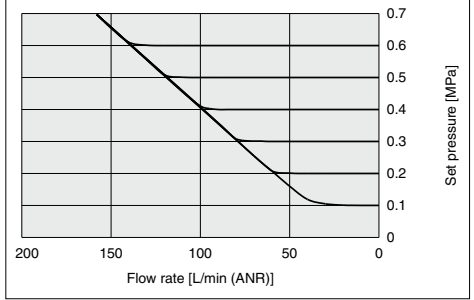

### Pressure Characteristics

#### IR1000-A

Supply pressure: 0.3 to 1.0 MPa  
Set pressure: 0.2 MPa  
Flow rate: 0 L/min (ANR)

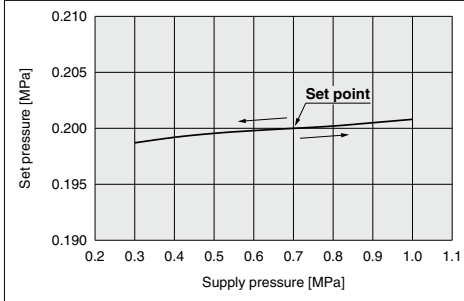

#### IR1020-A

Supply pressure: 0.3 to 1.0 MPa  
Set pressure: 0.2 MPa  
Flow rate: 0 L/min (ANR)

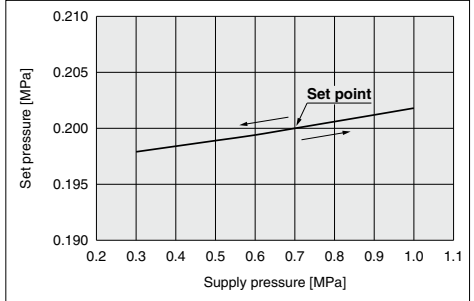

#### IR1010-A

Supply pressure: 0.3 to 1.0 MPa  
Set pressure: 0.2 MPa  
Flow rate: 0 L/min (ANR)

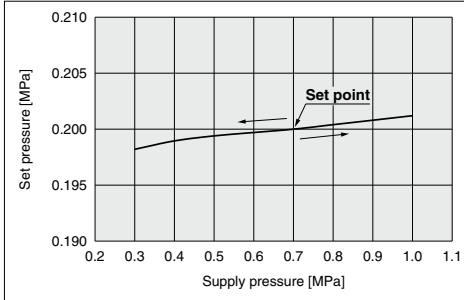



# Precision Regulator *IR1000-A/2000-A/3000-A Series*

## IR2000-A Series

\* The data shown below are representative values, and are not guaranteed.

### Flow Rate Characteristics

#### IR2020-02-A

Supply pressure: 0.7 MPa

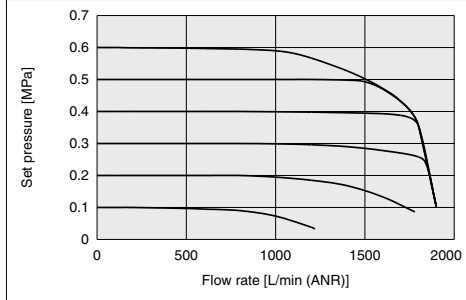

### Relief Characteristics

#### IR2020-02-A

Back pressure: 0.7 MPa

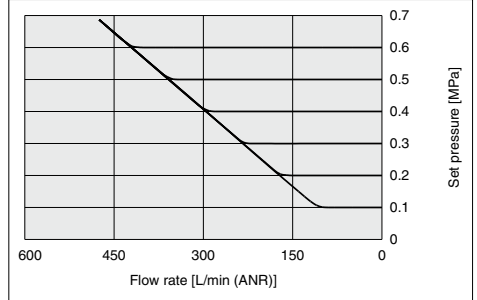

### Pressure Characteristics

#### IR2000-A

Supply pressure: 0.3 to 1.0 MPa  
Set pressure: 0.2 MPa  
Flow rate: 0 L/min (ANR)

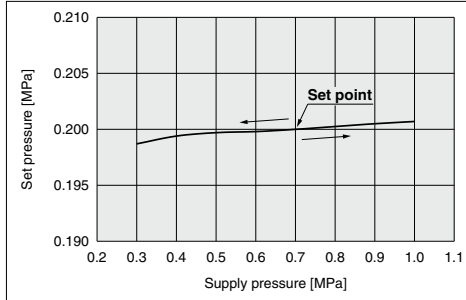

#### IR2020-A

Supply pressure: 0.3 to 1.0 MPa  
Set pressure: 0.2 MPa  
Flow rate: 0 L/min (ANR)

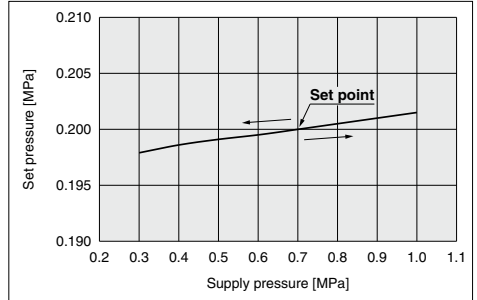

#### IR2010-A

Supply pressure: 0.3 to 1.0 MPa  
Set pressure: 0.2 MPa  
Flow rate: 0 L/min (ANR)

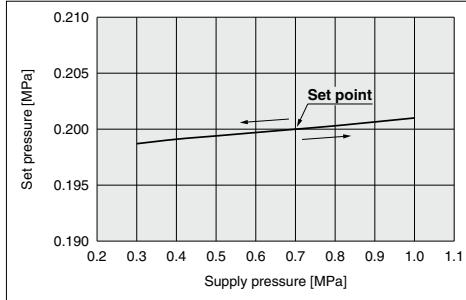

ARJ

AR425  
to 935

ARX

AMR

ARM

ARP

IR□-A

IR

IRV

IVX

SRH

SRP

SRF

ITV

IC

ITVH

ITVX

PVQ

VY1

VBA  
VBAT

AP100

# IR1000-A/2000-A/3000-A Series

## IR3000-A Series

\* The data shown below are representative values, and are not guaranteed.

### Flow Rate Characteristics

#### IR3020-04-A

Supply pressure: 0.7 MPa

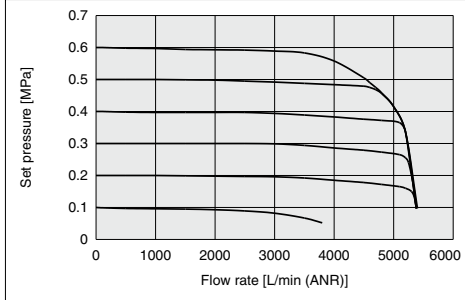

### Relief Characteristics

#### IR3020-04-A

Back pressure: 0.7 MPa

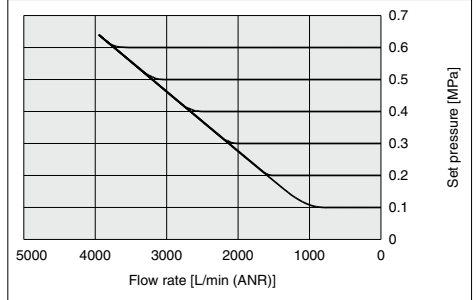

### Pressure Characteristics

#### IR3000-A

Supply pressure: 0.3 to 1.0 MPa  
Set pressure: 0.2 MPa  
Flow rate: 0 L/min (ANR)

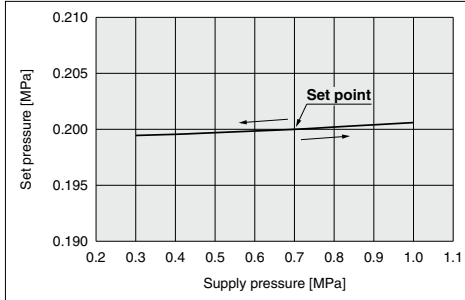

#### IR3020-A

Supply pressure: 0.3 to 1.0 MPa  
Set pressure: 0.2 MPa  
Flow rate: 0 L/min (ANR)

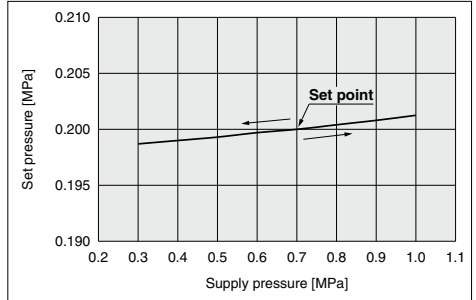

#### IR3010-A

Supply pressure: 0.3 to 1.0 MPa  
Set pressure: 0.2 MPa  
Flow rate: 0 L/min (ANR)

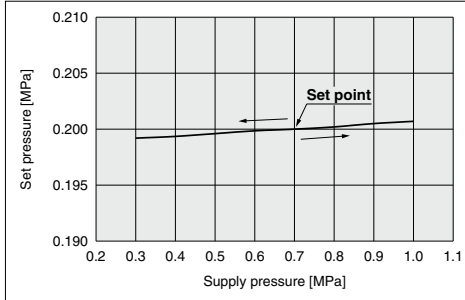

# Precision Regulator *IR1000-A/2000-A/3000-A Series*

## Construction

### Basic type (Knob): IR20□0-A

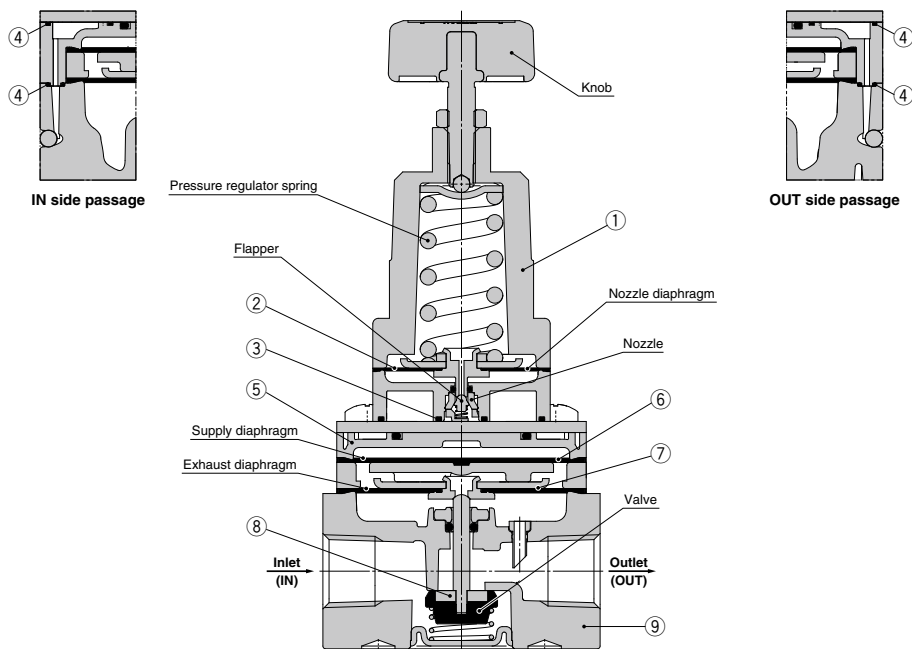

### Working principle

When the knob is rotated, the flapper is pushed through the spring, and a gap is generated between the nozzle and flapper. The supply pressure flows to the inlet passes through the path between the nozzle and flapper and acts on the supply diaphragm as nozzle back pressure. The force generated by the diaphragm pushes down the valve, and the supply pressure flows to the outlet. The discharged air pressure acts on the exhaust diaphragm, and counteracts against the force generated by the supply diaphragm. The air pressure acts on the nozzle diaphragm at the same time, and counteracts against the compression force of the spring to adjust the set pressure. When the set pressure increases too much, the nozzle diaphragm is pushed up, and a gap is generated between the flapper and nozzle diaphragm after the flapper is closed. The balance of the supply diaphragm and exhaust diaphragm is lost when the nozzle back pressure flows into the atmosphere. The exhaust valve is open after the valve is closed, and excess pressure on the outlet is released to the air. Due to this pilot mechanism, fine pressure variations are detected and precise pressure adjustment is possible.

### Component Parts

No.	Description	Material		
		IR1000-A	IR2000-A	IR3000-A
1	Bonnet	Aluminum die-casted		
2	Nozzle diaphragm assembly	Aluminum, Weather resistant NBR		
3	Seal	HNBR		
4	Seal	NBR		
5	Diaphragm spacer	Polyacetal		
6	Supply diaphragm	Weather resistant NBR		—
7	Exhaust diaphragm assembly	Steel, Aluminum, Weather resistant NBR		Aluminum, Weather resistant NBR, HNBR
8	Valve assembly	Stainless steel, Aluminum, HNBR		Aluminum, HNBR
9	Body	Aluminum die-casted		

ARJ

AR425  
to 935

ARX

AMR

ARM

ARP

IR□-A

IR

IRV

VEV

SRH

SRP

SRF

ITV

IC

ITVH

ITVX

PVQ

VY1

VBA

VBAT

AP100

# IR1000-A/2000-A/3000-A Series

## Construction

### Basic type (Knob): IR10□0-A

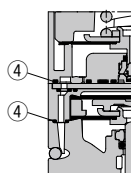

IN side passage

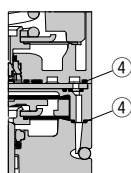
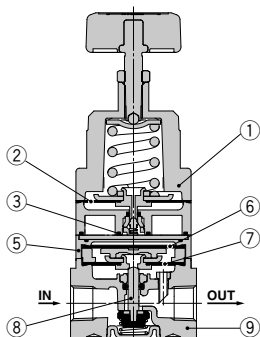

OUT side passage

### Basic type (Knob): IR30□0-A

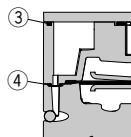

IN side passage

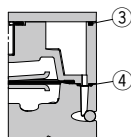
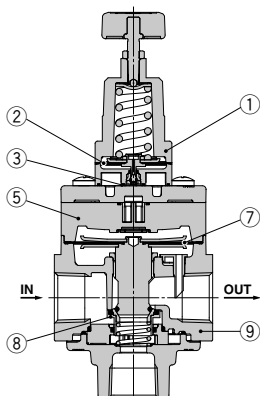

OUT side passage

### Basic type (Knob): IR30□ $\frac{1}{2}$ -A

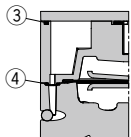

IN side passage

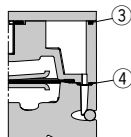
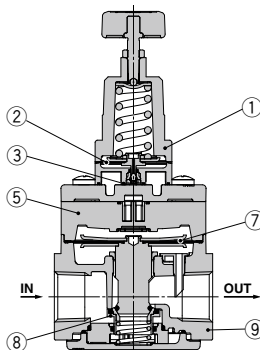

OUT side passage

# Precision Regulator IR1000-A/2000-A/3000-A Series



## Dimensions

### Basic type (Knob): IR10□0-□01□-A

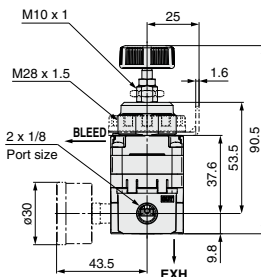
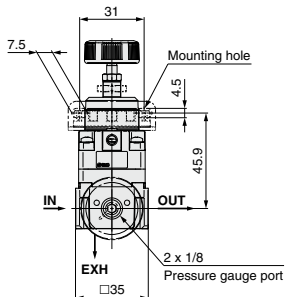
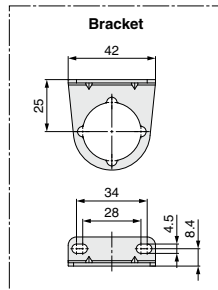
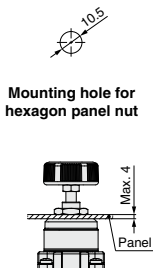
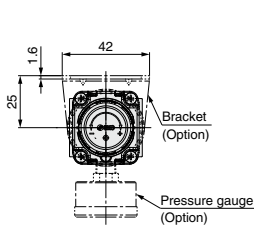

When connecting to the EXH port, contact your SMC sales representative separately.

### With digital pressure switch: IR10□0-□01□E□-A

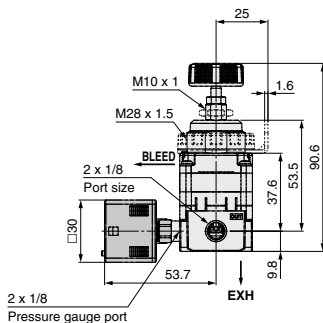
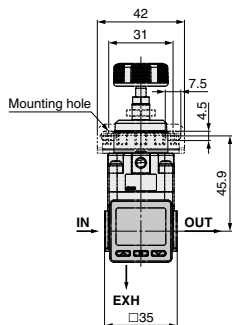

ARJ

AR425  
to 935

ARX

AMR

ARM

ARP

IR□-A

IR

IRV

VEV

SRH

SRP

SRF

ITV

IC

ITVH

ITVX

PVQ

VY1

VBA

VBAT

AP100

# IR1000-A/2000-A/3000-A Series

## Dimensions

Basic type (Knob): IR20□0-□02□-A

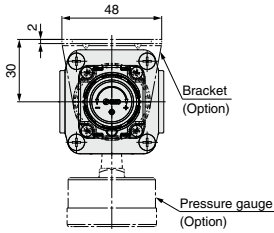

Mounting hole for hexagon panel nut

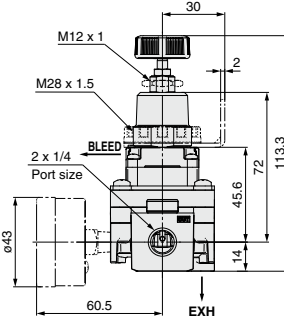
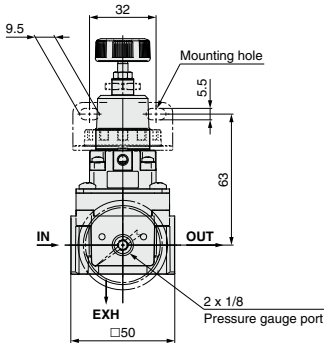
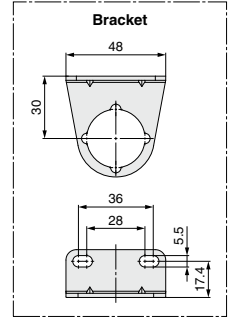
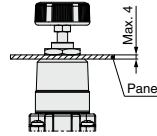

When connecting to the EXH port, contact your SMC sales representative separately.

With digital pressure switch: IR20□0-□02□E□-A

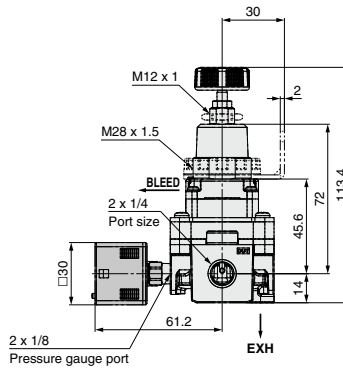
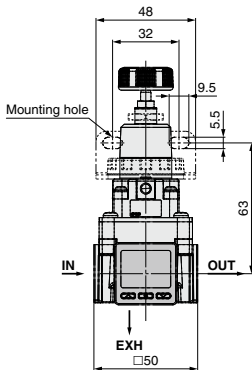

# Precision Regulator *IR1000-A/2000-A/3000-A Series*

## Dimensions

### Basic type (Knob): IR30□0-□0□□-A

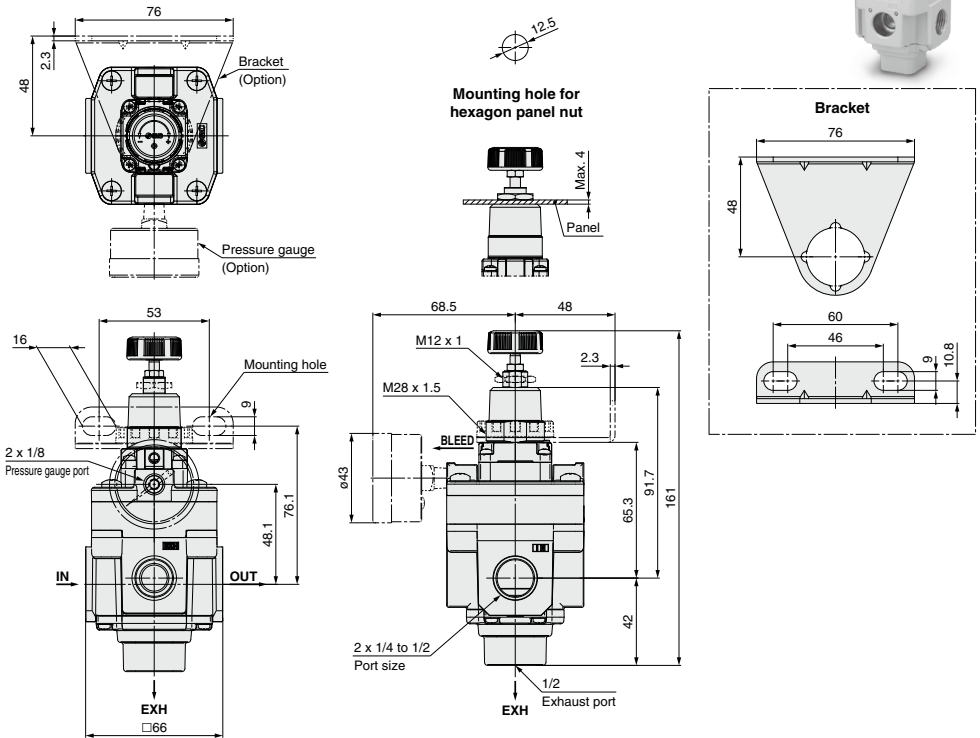

### With digital pressure switch: IR30□0-□0□□E□-A

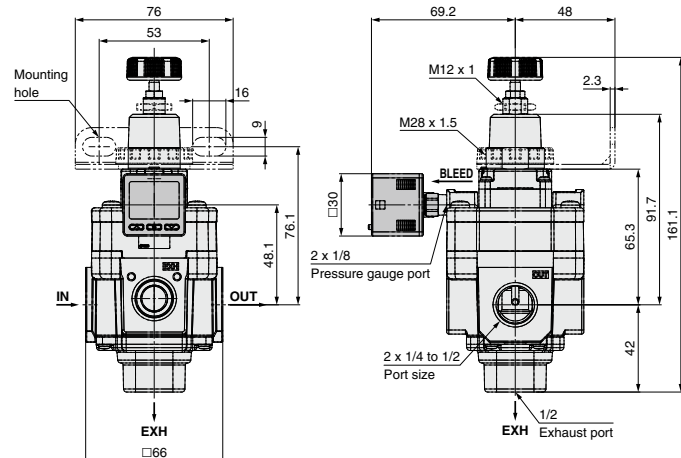

ARJ

AR425  
to 935

ARX

AMR

ARM

ARP

IR□-A

IR

IRV

VEX

SRH

SRP

SRF

ITV

IC

ITVH

ITVX

PVQ

VY1

VBA

VBAT

AP100

# IR1000-A/2000-A/3000-A Series

## Dimensions

Basic type (Knob): IR30□ $\frac{1}{2}$ -□0□□-A

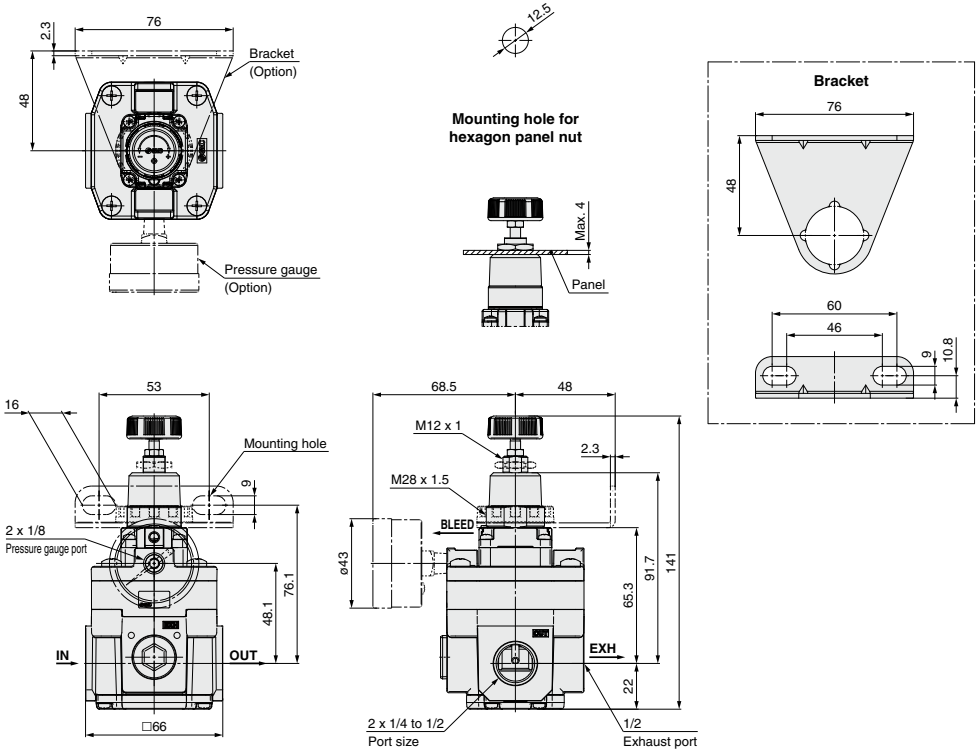

With digital pressure switch: IR30□ $\frac{1}{2}$ -□0□□E□-A

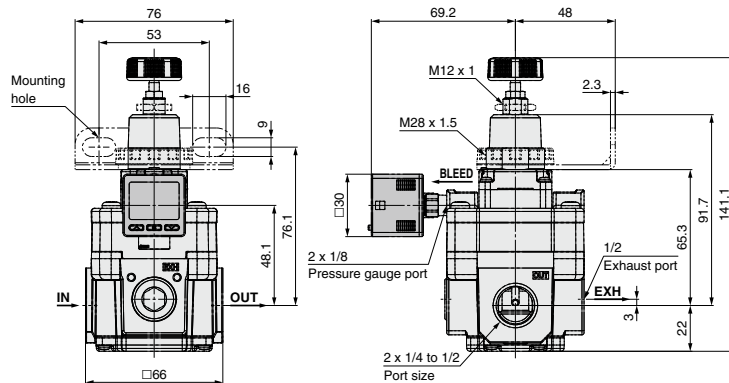



# IR1000-A/2000-A/3000-A Series

## Made to Order

Please contact SMC for detailed dimensions, specifications, each part number and lead times.



### 1 Clean Series

10 - IR  0  0 -    - A

• Clean series

#### Specifications

Cleanliness	ISO Class 3
Bleed hole	With M5 fitting (Applicable tubing O.D. ø6)
EXH port	IR1000-A series: With M5 fitting (Applicable tubing O.D. ø6) IR2000-A series: With R1/8 fitting (Applicable tubing O.D. ø6) IR3000-A series: 1/2 female thread
Pressure gauge	Oil-free + Stud parts nickle plated
Grease	Fluorine grease

### 2 Secondary Battery Compatible

25A - IR  0  0 -    - A

• Secondary battery compatible

#### Specifications

Parts material	Material mainly composed of copper or zinc is not used.
Parts surface treatment	Zinc chromate or copper-based plating is not used.
Grease	Grease compatible with low dew point

Note 1) Electroless nickel plating is used.

Note 2) Combinations with the pressure gauge are not available.

### 3 Fluororubber Specification

Fluororubber is used for rubber seal materials.

IR  0  0 -    - A - X1155

• Fluororubber specification

### 4 Non-grease Specifications

IR  0  0 -    - A - X1

• Non-grease specifications

Note 1) Assembly is performed in a general assembly environment.

Note 2) Parts are not washed.

Note 3) Fluorine grease is used on some of the wetted parts (sliding parts) and non-wetted parts (threaded part on the setting knob).

### 5 Manifold Specifications (Except IR3000-A series)

2 to 8 station manifold type regulators.

(Please contact SMC regarding 9 or more stations.)

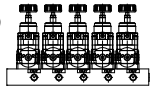

IRM  10 -    G -    - A

• Blanking plate and quantity

Blanking plate  
1 to n pcs.

• Set pressure and quantity

0.2 MPa setting 1 to n pcs.  
 1 0.4 MPa setting 1 to n pcs.  
 2 0.8 MPa setting 1 to n pcs.

Example 1) 0.4 MPa setting with 6 stations

IRM10-6G-1G-A

Example 2) 0.2 MPa setting 2 pcs.

0.4 MPa setting 2 pcs.

0.8 MPa setting 1 pc. with 5 stations

IRM20-5G-021221-A

• Accessory (Pressure gauge)

Nil	None
G	IR1000-A series: G33-□-01 IR2000-A series: G43-□-01

• Stations

2	2 stations
⋮	⋮
8	8 stations

• Thread type (Thread on the manifold base)

Nil	Rc
N	NPT
F	G

• Body size

10	IR1000-A series
20	IR2000-A series

• Manifold type regulator

#### Specifications

Stations	2 to 8 stations	
Port	Common SUP	IR1000-A series: 1/4, IR2000-A series: 1/2
	Individual OUT	IR1000-A series: 1/8, IR2000-A series: 1/4
	Individual EXH (From IR body)	
Set pressure	0.2 MPa, 0.4 MPa and 0.8 MPa settings can be combined.	
Accessory (Pressure gauge)	G33-□-01 (IR1000-A series), G43-□-01 (IR2000-A series)	

Note 1) Regulators to be manifolded are counted starting from stations 1 on the left side with the OUT ports in front.

Note 2) When regulators with a different set pressure are manifolded, viewing OUT ports from front, the low pressure range is installed on the left side and high pressure range is on the right side. In case of the Example 2) above mentioned, stations 1 and 2 are of 0.2 MPa setting, stations 3 and 4 are of 0.4 MPa setting, and station 5 is of 0.8 MPa setting.

Note 3) For the model with pressure gauge (G), the pressure gauge is shipped together, but not assembled.

ARJ

AR425 to 935

ARX

AMR

ARM

ARP

IR□-A

IR

IRV

IVX

SRH

SRP

SRF

ITV

IC

ITVH

ITVX

PVQ

VY1

VBA

VBAT

AP100





# IR1000-A/2000-A/3000-A Series Specific Product Precautions 1

Be sure to read this before handling the products.

Refer to back page 50 for Safety Instructions and pages 387 to 391 for F.R.L. Precautions.

## Piping

### ⚠ Warning

1. Screw piping together with the recommended proper torque while holding the side with the female threads.

Looseness or faulty sealing will occur if tightening torque is insufficient, while thread damage will result if the torque is excessive.

Furthermore, if the side with the female threads is not held while tightening, excessive force will be applied directly to piping brackets, etc., causing damage or other problems.

#### Recommended Proper Torque [N·m]

Connection thread	1/8	1/4	3/8	1/2 (Note)
Torque	7 to 9	12 to 14	22 to 24	28 to 30

(Note) Tightening force for connecting to the EXH port of IR30□<sub>2</sub>-A is 8 to 10 N·m.

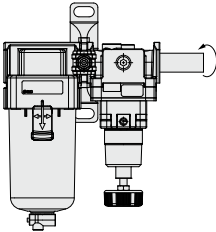

2. Do not allow twisting or bending moment to be applied other than the weight of the equipment.

Provide separate support for external piping, as damage may otherwise occur.

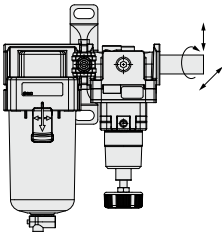

3. Piping materials without flexibility such as steel tube piping are prone to be effected by excess moment load and vibration from the piping side. Use flexible tubing in between to avoid such an effect.

### ⚠ Caution

1. Preparation before piping

Before piping is connected, it should be thoroughly blown out with air (flushing) or washed to remove chips, cutting oil and other debris from inside the pipe.

## Piping

### ⚠ Caution

2. Winding of sealant tape

When screwing piping or fittings into ports, ensure that metal chips from the pipe threads or sealing material do not enter the piping. Also, when the sealant tape is used, leave 1.5 to 2 thread ridges exposed at the end of the threads.

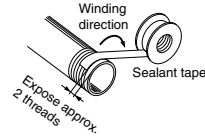

## Operating Environment

### ⚠ Warning

1. Do not use in an atmosphere having corrosive gases, chemicals, sea water, water, water steam, or where there is direct contact with any of these.
2. Do not operate in locations where vibration or impact occurs.
3. In locations which receive direct sunlight, provide a protective cover, etc.
4. In locations near heat sources, block off any radiated heat.
5. In locations where there is contact with spatter from water, oil or solder, etc., implement suitable protective measures.

## Air Supply

### ⚠ Warning

1. Please consult with SMC when using the product in applications other than compressed air.
2. Do not use compressed air which includes chemicals, synthetic oils containing organic solvents, salt or corrosive gases, etc., as this can cause damage or malfunction.
3. If condensate in the drain bowl is not emptied on a regular basis, the bowl will overflow and allow the condensate to enter the outlet side. This will cause a malfunction of pneumatic equipment.

When removing drain is difficult, use of a filter with an auto drain is recommended.

### ⚠ Caution

1. Condensate or dust, etc. in the supply pressure line can cause malfunctions. In addition to an air filter (SMC AF series, etc.), please use a mist separator (SMC AM, AFM series) depending on the conditions. Refer to "Air Preparation Equipment Model Selection Guide" (pages 2 and 3) for air quality.
2. When a lubricator is used at the supply side of the product, it can cause malfunctions. Do not use a lubricator at the supply side of the product.

If lubrication is required for terminal devices, connect a lubricator on the output side of the regulator.

ARJ

AR425  
to 935

ARX

AMR

ARM

ARP

IR□-A

IR

IRV

VEV

SRH

SRP

SRF

ITV

IC

ITVH

ITVX

PVQ

VY1

VBA

VBAT

AP100



# IR1000-A/2000-A/3000-A Series Specific Product Precautions 2

Be sure to read this before handling the products.

Refer to back page 50 for Safety Instructions and pages 387 to 391 for F.R.L. Precautions.

## Maintenance

### ⚠ Warning

- When the product is removed for maintenance, reduce the set pressure to "0" and shut off the supply pressure completely beforehand.
- When a pressure gauge is to be mounted, remove the plug after reducing the set pressure to "0".
- When using the regulator between a solenoid valve and an actuator, check the pressure gauge periodically. Sudden pressure fluctuations may shorten the durability of the pressure gauge.  
A digital pressure gauge is recommended for such situation or as deemed necessary.

## Handling

### ⚠ Caution

- When the precision regulator with pressure gauge is used, do not apply impact to the product by dropping it, etc. during transportation or installation.  
This may cause misalignment of the pressure gauge pointer.

## Operation

### ⚠ Caution

- Do not use a precision regulator outside the range of its specifications as this can cause failure. (Refer to the specifications.)
- When mounting is performed, make connections while confirming port indications.
- When mounting the bracket or tightening the hexagon panel nut on the panel, tighten them to the recommended proper torque.

Looseness or faulty sealing will occur if tightening torque is insufficient, while thread damage will result if the torque is excessive.

#### Recommended Proper Torque (N·m)

Set nut (for bracket)

IR10□0-A	IR20□0-A	IR30□□-A
2.0±0.2		

Hexagon panel nut (for knob type only)

IR10□0-A	IR20□0-A	IR30□□-A
3.5±0.5		

- After pressure adjustment, be sure to tighten the lock nut. When tightening the nut, tighten so that the knob does not move due to friction caused by tightening.
- When pressure is applied to the inlet of a regulator, make sure that the output is connected to the circuit. Air blow occurs from the outlet and it depends on the operating conditions.
- The set pressure may vary depending on the elapsed time and change in ambient temperature after pressure setting. If the setting value varies, adjust with the knob.

## Operation

### ⚠ Caution

- If the directional control valve (solenoid valve, mechanical valve, etc.) is mounted and ON-OFF is repeated for a long time, the set pressure may vary. If the setting value varies, adjust with the knob.
- There may be pulsation or noise depending on the pressure conditions, piping conditions and ambient environment. In this case, it is possible to improve the problem by changing the pressure conditions and piping conditions.  
If the problem is not improved, contact your SMC sales representative.

- The capacity of the output side is large, and when used for the purpose of a relief function, the exhaust sound will be loud when being relieved. Therefore, operate with a silencer (SMC AN series, etc.) mounted on the exhaust port (EXH port).  
When using the IR1000-A and 2000-A series, contact your SMC sales representative.

- When installing a pressure gauge to the product, do not apply pressure more than the maximum display pressure. This will cause a malfunction.

- When using a precision regulator between a solenoid valve and cylinder, caution should be taken regarding the following points.

- The residual pressure of the cylinder will be exhausted from the regulator's exhaust port. (Depending on the conditions, partial backflow may occur.)

- When holding pressure at the intermediate position of a closed center solenoid valve, due to reduced pilot pressure the pressure inside the cylinder will not be able to be held because the regulator will perform an exhaust operation. If it is necessary for the pressure inside the cylinder to be held, please consider using in combination with a separate shut-off valve.

- When releasing pressure at the intermediate position of an exhaust center solenoid valve, depending on the conditions, vacuum pressure may remain inside the cylinder. If the introduction of atmospheric pressure is required, please consider using in combination with a separate atmospheric pressure introduction valve.

- When using the IR3000-A series in balancing applications, abnormal noises may occur depending on the pressure and circuit conditions. In such cases, the noise will often cease if changes are made to the pressure or piping conditions or if a high noise reduction type silencer (such as SMC's ANA1 series, etc.) is installed.

- The min. supply pressure is the min. required supply pressure for when there is no flow on the output side. If flow is to be used, or if the volume on the outlet side is large, supply pressure with sufficient margins in regards to the set pressure if responsiveness is required.

- When a precision regulator is used in applications in which back pressure is frequently applied or when it is used in environments where vibration is present or pulsations are present in the set pressure, wear of the exhaust valve may be accelerated, resulting in increased premature exhaust leakage.