



# Air Cylinder

## CS1 Series

ø125, ø140, ø160, ø180, ø200, ø250, ø300

### Series Variations

Series	Action	Type	Basic	Standard variations With rod boot	Bore size (mm)	Page
<b>Standard CS1 Series</b>  CS1 Series  CS1W Series	Double acting	Single rod CS1 series	Lube	•	•	125 140 160 180 200 250 300
			Non-lube	•	•	
			Air-hydro	•	•	
		Double rod CS1W series	Lube	•	•	125 140 160 180 200 250 300
			Non-lube	•	•	
			Air-hydro	•	•	
<b>Low Friction CS1□Q Series</b> 	Double acting	Single rod CS1□Q series	Non-lube	•	•	125 140 160

For the aluminum tubing of bore sizes 125, 140 and 160, a new "CS2 series"(P.565) model is now available with reduced weight and self weight deflection. Please consider using the CS2 series.

CJ1
CJP
CJ2
JCM
CM2
CM3
CG1
CG3
JMB
MB
MB1
CA2
CS1
CS2

D-□
-X□
Technical Data

# Combinations of Standard Products and Made

## CS1 Series

- : Standard
- : Made to Order specifications
- : Special product (Contact SMC for details.)
- : Not available

Symbol	Specification	Applicable bore size	CS1 (Standard)			
			Double acting			
			Single rod		Air-hydro	
		Lube	Non-lube			
		ø125 to ø300		ø125 to ø160		
Standard	Standard	ø125 to ø300	●	●	●	
CDS1	Built-in magnet	ø125 to ø200	●	●	●	
CS1□-□ <sup>J</sup> <sub>K</sub>	With rod boot	ø125 to ø300	●	●	●	
20-	Copper <sup>Note 2)</sup> and Fluorine-free	ø125 to ø160	—	●	—	
XA□	Change of rod end shape	ø125 to ø300	○	○	○	
XB5	Oversized rod cylinder	ø125 to ø200	○	○	○	
XB6	Heat-resistant cylinder (-10 to 150°C)	—	—	○	—	
XB7	Cold-resistant cylinder	ø125 to ø300	○	○	—	
XB16	Large-bore air-hydro cylinder	ø180 to ø200	—	—	○	
XC3	Special port location	ø125 to ø300	○	○	○	
XC4	With heavy duty scraper		○	○	○	
XC5	Heat-resistant cylinder (-10 to 110°C)		○	○ <sup>Note 1)</sup>	—	
XC6	Stainless steel		○	○	○	
XC7	Tie-rod, cushion valve, tie-rod nut and similar parts made of stainless steel		○	○	○	
XC8	Adjustable stroke cylinder/Adjustable extension type		○	○	○	
XC9	Adjustable stroke cylinder/Adjustable retraction type		ø125 to ø160	○	○	○
XC10	Dual stroke cylinder/Double rod type		ø125 to ø300	○	○	○
XC11	Dual stroke cylinder/Single rod type			○	○	○
XC12	Tandem cylinder			○	○	○
XC14	Change of trunnion bracket mounting position	○		○	○	
XC15	Change of tie-rod length	○		○	○	
XC22	Fluororubber seal	○		○ <sup>Note 1)</sup>	○	
XC26	Clevis pins with flat washer	○		○	○	
XC27	Double clevis pins made of stainless steel (Stainless steel 304)	○		○	○	
XC30	Rod side trunnion mounted on the rod cover front	○		○	○	
XC35	With coil scraper	○		○	○	
XC39	Special trunnion axis	○	○	○		
XC40	Clevis hole with bushing	○	○	○		
XC50	Knuckle fixed with nuts	○	○	○		
XC68	Hard chrome plated stainless steel rod	○	○	○		
XC86	With rod end bracket	○	○	○		

Note 1) Applicable I.D.: ø125 to ø200, ø250 and ø300 are available upon request for special order.

Note 2) Copper-free for the externally exposed part. For details, refer to the **Web Catalog**.

	CS1 (Standard)			CS1Q (Low friction)
Double acting				
	Double rod			Single rod
	Lube	Non-lube	Air-hydro	Non-lube
	ø125 to ø300		ø125 to ø160	
	●	●	●	●
	●	●	●	●
	●	●	●	●
	—	●	—	—
	○	○	○	○
	○	○	○	○
	—	○	—	—
	○	○	○	○
	○	○	○	○
	○	○	○	○
	○	○	○	○
	○	○	○	○
	○	○	○	○
	○	○	○	○
	○	○	○	○
	○	○	○	○
	○	○	○	○
	○	○	○	○
	○	○	○	○
	○	○	○	○
	○	○	○	○
	○	○	○	○
	○	○	○	○
	○	○	○	○
	○	○	○	○
	○	○	○	○
	○	○	○	○
	○	○	○	○
	○	○	○	○
	○	○	○	○
	○	○	○	○
	○	○	○	○
	○	○	○	○
	○	○	○	○
	○	○	○	○
	○	○	○	○
	○	○	○	○
	○	○	○	○
	○	○	○	○

- CJ1**
- CJP**
- CJ2**
- JCM**
- CM2**
- CM3**
- CG1**
- CG3**
- JMB**
- MB**
- MB1**
- CA2**
- CS1**
- CS2**

- D-□**
- X□**
- Technical Data

# Air Cylinder: Standard Type Lube/Non-lube Type, Air-hydro Type

## CS1 Series

Lube/Non-lube:  $\varnothing 125, \varnothing 140, \varnothing 160, \varnothing 180, \varnothing 200, \varnothing 250, \varnothing 300$   
Air-hydro:  $\varnothing 125, \varnothing 140, \varnothing 160$

For the aluminum tubing of bore sizes 125, 140 and 160, a new "CS2 series" (P.565) model is now available with reduced weight and self weight deflection. Please consider using the CS2 series.

### How to Order

CS1 **L**    **160**  - **300**  -  - **V**

#### Mounting

<b>B</b>	Basic type
<b>L</b>	Foot type
<b>F</b>	Rod side flange type
<b>G</b>	Head side flange type
<b>C</b>	Single clevis type
<b>D</b>	Double clevis type
<b>T</b>	Center trunnion type

#### Tubing material

Symbol	Bore size (mm)	Tubing material	Stroke range (mm)
Nil	125, 140	Aluminum tube	1000 or less
	160		1200 or less
	125, 140	Steel tube	1001 or more
	160		1201 or more
F	180 to 300		All stroke <sup>(Note)</sup>
	125, 140	Steel tube	1000 or less
160	1200 or less		

\* Refer to page 531 for the maximum strokes.

Note) The tubing material of items with a bore size of 180 and 200 corresponding to the Class 2 Pressure Vessel Act is aluminum tubing.

#### Type

Nil	Lube
<b>N</b>	Non-lube
<b>H</b>	Air-hydro

#### Class 2 Pressure Vessel

(Subject to or not subject to)

Nil	Applicable
<b>V</b>	Not applicable

\* This indicates whether or not the cylinder stroke is applicable to the Class 2 Pressure Vessel Act and whether or not the product is made in Japan.

\* "-V" is not put on a product with a stroke not applicable to the Class 2 Pressure Vessel Act. For details, refer to page 532.

#### Made to Order

(Refer to page 531 for details.)

#### Suffix for cylinder

Rod boot	<b>J</b>	Nylon tarpaulin
	<b>K</b>	Heat resistant tarpaulin
	<b>N</b>	Without cushion
	<b>R</b>	With cushion in rod side
	<b>H</b>	With cushion in head side
	Cushion	Nil

\* If specifying more than one symbol, indicate them in alphabetically

\*\* Air-hydro type has no cushion. No symbol indicates no cushion.

#### Cylinder stroke (mm)

(Refer to "Maximum Stroke" on page 531.)

#### Bore size

Lube, Non-lube		Air-hydro	
<b>125</b>	125 mm	<b>125</b>	125 mm
<b>140</b>	140 mm	<b>140</b>	140 mm
<b>160</b>	160 mm	<b>160</b>	160 mm
<b>180</b>	180 mm		
<b>200</b>	200 mm		
<b>250</b>	250 mm		
<b>300</b>	300 mm		

#### Port thread type

Nil	Rc
<b>TN</b>	NPT
<b>TF</b>	G

### Mounting Bracket Part No.

Bore size (mm)	125	140	160	180	200	250	300
Foot type*	CS1-L12	CS1-L14	CS1-L16	CS1-L18	CS1-L20	CS1-L25	CS1-L30
Flange type	CS1-F12	CS1-F14	CS1-F16	CS1-F18	CS1-F20	CS1-F25	CS1-F30
Single clevis type	CS1-C12	CS1-C14	CS1-C16	CS1-C18	CS1-C20	CS1-C25	CS1-C30
Double clevis type**	CS1-D12	CS1-D14	CS1-D16	CS1-D18	CS1-D20	CS1-D25	CS1-D30

\* Order two foot brackets per cylinder.

\*\* When ordering the double clevis, the clevis pin and the cotter pin (2 pcs.) are attached.

For "How to Order" with auto switch, refer to page 535.

# Air Cylinder: Standard Type Lube/Non-lube Type, Air-hydro Type **CS1 Series**



### Symbol

Double acting, Air cushion

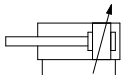

**Made to Order Specifications**  
(For details, refer to pages 1703 to 1896.)

Symbol	Specifications
-XA□	Change of rod end shape
-XB5	Oversized rod cylinder
-XB6	Heat-resistant cylinder (-10 to 150°C)
-XC3	Special port location
-XC4	With heavy duty scraper
-XC5	Heat resistant cylinder (110°C)
-XC6	Made of stainless steel
-XC8	Adjustable stroke cylinder/Adjustable extension type
-XC9	Adjustable stroke cylinder/Adjustable retraction type
-XC10	Dual stroke cylinder/Double rod type
-XC11	Dual stroke cylinder/Single rod type
-XC14	Change of trunnion bracket mounting position
-XC15	Change of tie-rod length
-XC22	Fluororubber seal
-XC26	Clevis pins with flat washer
-XC27	Double clevis pin and double knuckle pin made of stainless steel
-XC30	Rod side trunnion
-XC35	With coil scraper
-XC68	Hard chrome plated stainless steel rod
-XC86	With rod end bracket

### Rod Boot Material

Symbol	Material	Maximum ambient temperature
<b>J</b>	Nylon tarpaulin	70°C
<b>K</b>	Heat resistant tarpaulin	110°C *

\* Maximum ambient temperature for the rod boot itself.

### Specifications

Type	Lube, Non-lube	Air-hydro
Bore size (mm)	ø125 to ø300	ø125, ø140, ø160
Fluid	Air	Turbine oil
Proof pressure	1.57 MPa <sup>(Note)</sup>	
Maximum operating pressure	0.97 MPa	
Minimum operating pressure	0.05 MPa	0.06 MPa
Piston speed	50 to 500 mm/s	0.5 to 200 mm/s
Cushion	Interchangeable	None
Ambient and fluid temperature	0 to 70°C (No freezing), Air-hydro type: 5 to 60°C	
Stroke length tolerance (mm)	250 or less <sup>st: +1.0, -0</sup> , 251 to 1,000 <sup>st: +1.4, -0</sup> , 1,001 to 1,500 <sup>st: +1.8, -0</sup> 1501 to 2000 <sup>st: +2.2, -0</sup> , 2001 to 2400 <sup>st: +2.6, -0</sup>	
Mounting	Basic type, Foot type, Rod side flange type, Head side flange type, Single clevis type, Double clevis type, Center trunnion type	

(Note) Item corresponding to Class 2 Pressure Vessel Act is 1.46 MPa.

### Maximum Stroke

Tubing material	Aluminum tube		Steel tube	
	Basic type, Head side flange type Single clevis type, Double clevis type Center trunnion type, Foot type Rod side flange type	Basic type Head side flange type Single clevis type Double clevis type Center trunnion type	Foot type Rod side flange type	
125	1000 or less	1000 or less	1600 or less	
140	1000 or less	1000 or less	1600 or less	
160	1200 or less	1200 or less	1600 or less	
180	—	1200 or less	2000 or less <sup>(Note)</sup>	
200	—	1200 or less <sup>(Note)</sup>	2000 or less <sup>(Note)</sup>	
250	—	1200 or less	2400 or less	
300	—	1200 or less	2400 or less	

(Note) The tubing material of items with a bore size of 180 and 200 corresponding to the Class 2 Pressure Vessel Act is aluminum tubing.

### Accessory

Mounting	Basic type	Foot type	Rod side flange type	Head side flange type	Single clevis type	Double clevis type	Center trunnion type
	Standard equipment	—	—	—	—	●	—
Option	Rod end nut	●	●	●	●	●	●
	Single knuckle joint	●	●	●	●	●	●
	Double knuckle joint (Clevis pin, Cotter pin)	●	●	●	●	●	●
	Rod boot	●	●	●	●	●	●

\* In the case of using the rod end nut together with the single knuckle joint or double knuckle joint, refer to page 547.

### Principal Parts Material and Surface Treatment

Description	Material	Note	
Cover	Rolled steel plate	Black painted	
Tube	ø125, ø140, ø160	Aluminum alloy Hard anodized	
	ø180, ø200, ø250, ø300	Carbon steel tube Inside: Hard chrome plated	
Sliding part seal	Lube	Carbon steel tube <sup>(Note)</sup> Inside: Hard chrome plated <sup>(Note)</sup>	
	Non-lube	NBR	
	Air-hydro	NBR	
Piston rod	Carbon steel	Hard chrome plated	
Piston	Lube	Cast iron	
	Non-lube	Aluminum alloy casted (Iron tube: Cast iron)	Chromated (In the case of aluminum alloy casted)
	Air-hydro	Aluminum alloy casted (Iron tube: Cast iron)	Chromated (In the case of aluminum alloy casted)

(Note) For items with a bore size of ø180 and ø200 corresponding to the Class 2 Pressure Vessel Act, the material is "Aluminum alloy" and the note should state "Hard anodized".

CJ1

CJP

CJ2

JCM

CM2

CM3

CG1

CG3

JMB

MB

MB1

CA2

CS1

CS2

D-□

-X□

Technical Data

# CS1 Series

## Weight/Aluminum Tube: Lube (Non-lube, Air-hydro) (kg)

Bore size (mm)		125	140	160	180 <sup>*2</sup>	200 <sup>*2</sup>
Basic weight	Basic type	14.85 (13.73)	17.98 (16.57)	24.77 (23.03)	33.44	41.86
	Foot type	16.48 (15.36)	20.50 (19.09)	27.57 (25.83)	37.64	46.74
	Rod side flange type	17.53 (16.41)	22.98 (21.57)	31.16 (29.42)	43.27	53.77
	Head side flange type	17.53 (16.41)	22.98 (21.57)	31.16 (29.42)	43.27	53.77
	Single clevis type	17.92 (16.80)	22.27 (20.86)	30.26 (28.52)	41.83	51.76
	Double clevis type (Clevis pin, Cotter pin)	18.38 (17.26)	23.02 (21.61)	31.11 (29.37)	43.51	53.79
	Trunnion type	18.98 (17.86)	23.71 (22.30)	32.17 (30.43)	44.06	55.85
	Additional weight per each 100 mm of stroke	1.77	1.96	2.39	3.24	3.87
Accessory bracket	Single knuckle	0.91	1.16	1.56	3.07	2.90
	Double knuckle (Knuckle pin, Cotter pin)	1.37	1.81	2.48	4.74	4.59
	Rod end nut	0.16	0.16	0.23	0.32	0.85

\*1 ( ): Denotes the non-lube and air-hydro type.

\*2 The aluminum tubes with a bore size of 180 or 200 are subject to the Class 2 Pressure Vessel Act. (Common to lube and non-lube types)

Calculation example: **CS1L160-500**

- Basic weight.....27.57 (Foot type, σ160)
- Additional weight.....2.39/100 stroke
- Cylinder stroke.....500 stroke  
27.57 + 2.39 x 500/100 = 39.52 kg

## Weight/Steel Tube (kg)

Bore size (mm)		125	140	160	180	200	250	300
Standard weight	Basic type	15.20	18.38	25.24	34.16	42.66	79.78	115.94
	Foot type	16.83	20.90	28.04	38.36	47.54	89.28	133.22
	Rod side flange type	17.88	23.38	31.63	43.99	54.57	101.62	146.14
	Head side flange type	17.88	23.38	31.63	43.99	54.57	101.62	146.14
	Single clevis type	18.27	22.67	30.73	42.55	52.56	98.17	149.22
	Double clevis (Clevis pin, Cotter pin)	18.73	23.42	31.58	44.23	54.59	101.36	154.96
	Trunnion type	19.33	24.11	32.64	44.78	56.65	107.62	156.37
Additional weight per each 100 mm of stroke	2.66	3.01	3.58	4.95	5.75	9.08	12.15	
Accessory bracket	Single knuckle	0.91	1.16	1.56	3.07	2.90	5.38	10.82
	Double knuckle (Knuckle pin, Cotter pin)	1.37	1.81	2.48	4.74	4.59	9.22	17.17
	Rod end nut	0.16	0.16	0.23	0.32	0.85	1.26	1.43

## ⚠ Precautions

Be sure to read this before handling the products.  
Refer to back page 50 for Safety Instructions and pages 3 to 12 for Actuator and Auto Switch Precautions.

### ⚠ Warning

**Do not use the cylinder as a shock absorber.**

- Using the cylinder as a shock absorber may cause damage.

### ⚠ Caution

**Do not open the cushion valve excessively.**

- If the cushion valve is rotated excessively in the opening direction (counterclockwise), it could be damaged. Be aware that the valve could slip out, or the threads becomes too short.

**Regarding the installation of a knuckle joint**

- Please contact SMC if a knuckle joint must be installed on the piston rod by using the rod end nut.

**Do not place tape or other objects onto the painted surface of the unit.**

- The paint of the CS cylinder is dried naturally, so it may peel off if tape or another object is placed onto it.

## Regulations/Class 2 Pressure Vessel Act

The air cylinder uses the compressed air, but may become applicable to the regulations depending on the cylinder size.

So, please fully understand the regulations before using the cylinder.

### Regulations regarding Class 2 Pressure Vessel

1. As specified in Articles 42 and 44 of the Industrial Safety and Health Act, the individual examination shall be conducted in conformity with the Class 2 Pressure Vessel Act. If the pressure vessel structure does not satisfy the Class 2 Pressure Vessel Act, it shall not be transferred, leased or installed.

#### 2. About Class 2 Pressure Vessel

The Class 2 Pressure Vessel is a vessel (except for Class 1 Pressure Vessel) that contains the gas with a gauge pressure of 0.2 MPa or more and satisfies the conditions shown below.

- ① Vessel with an inside capacity of 0.04 m<sup>3</sup> or more
- ② Vessel with a shell inside diameter of 200 mm or more and a length of 1000 mm or more (extracted from Article 1-7 of the Industrial Safety and Health Act.)

The following shows SMC products that are applicable to the Class 2 Pressure Vessel Act.

### Products applicable to the Class 2 Pressure Vessel Act

If the stroke exceeds the level shown below, the cylinder is applicable to the Class 2 Pressure Vessel Act.

Bore size (mm)	Cylinder stroke (mm)
180	1569
200	998
250	813
300	564

### 3 Periodical Self Inspection

As specified in Article 45 of the Industrial Safety and Health Act, it is obligated to conduct the periodical self inspection of the product applicable to the Class 2 Pressure Vessel Act and keep the inspection records when using it. (Related laws: Articles 88 and 89 of the Ordinance on Safety of Boilers and Pressure Vessels) After the use of the product applicable to the Class 2 Pressure Vessel Act has been started, the self inspection of the following points is conducted once a year and the inspection results are recorded.

- 1 Check the main body for damage.
- 2 Check the lid tightening bolt for wear.
- 3 Check the pipe and valve for damage.

### 4 Products not applicable to the Class 2 Pressure Vessel Act

According to Articles 13 and 14 of the Industrial Safety and Health Act, when it is obvious that the product is not used in Japan, it is not necessary to examine the product in conformity with the Class 2 Pressure Vessel Act. Additionally, when it is obvious that the product is not used in Japan, the product is exempted from the machine applicable to Articles 42 and 44 of the Industrial Safety and Health Act.

Please order the air cylinder with “-V” put at the end of the part number.

(The symbol “-V” is not put on a product with a stroke not applicable to the Class 2 Pressure Vessel Act.)

The cylinders manufactured in SMC overseas factories are not examined in conformity with the Class 2 Pressure Vessel Act. When using the cylinder in Japan, be sure to use the cylinder made in Japan that has been examined in conformity with the Class 2 Pressure Vessel Act.

- 5 A safety valve is installed on the upstream side of the piping so that any pressure exceeding the maximum operating pressure of the cylinder applicable to the Class 2 Pressure Vessel Act is not applied.

# Air Cylinder: Standard Type Lube/Non-lube Type, Air-hydro Type **CS1 Series**

## Construction

### Lube

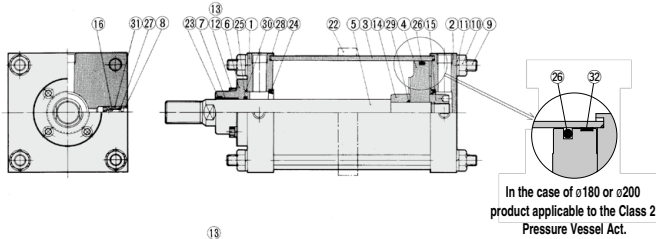

### Non-lube

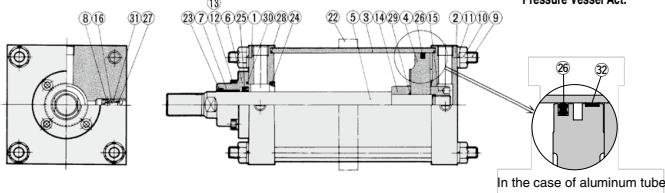

### Air-hydro

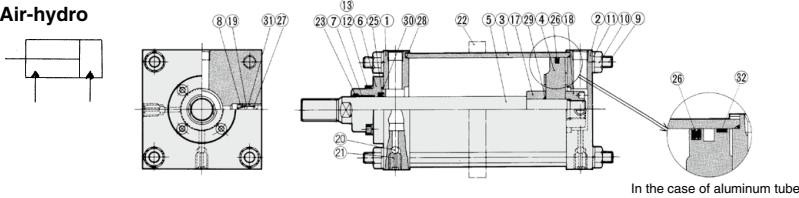

CJ1

CJP

CJ2

JCM

CM2

CM3

CG1

CG3

JMB

MB

MB1

CA2

**CS1**

CS2

### Component Parts

No.	Description	Material	Note
1	Rod cover	Rolled steel plate	Black painted
2	Head cover	Rolled steel plate	Black painted
3	Cylinder tube	ø125 to ø160	Aluminum alloy Hard anodized
		ø125 to ø300	Carbon steel tube Inside: Hard chrome plated
4	Piston	Cast iron **	
5	Piston rod	Carbon steel	Hard chrome plated
6	Retaining plate	Cast iron	Black painted
7	Bushing	Bearing alloy	
8	Valve guide	Brass	
9	Tie-rod	Carbon steel	Chromated
10	Tie-rod nut	Rolled steel	Black zinc chromated
11	Spring washer	Steel wire	Black zinc chromated
12	Retaining plate bolt	Chromium molybdenum steel	Black zinc chromated
13	Spring washer	Steel wire	Black zinc chromated
14	Cushion ring A	Rolled steel	Zinc chromated
15	Cushion ring B	Rolled steel	Zinc chromated
16	Cushion valve	Rolled steel	Electroless nickel plated
17	Spacer A	Rolled steel	Zinc chromated
18	Spacer B	Rolled steel	Zinc chromated
19	Air releasing B	Rolled steel	Zinc chromated
20	Air releasing A	Chromium molybdenum steel	
21	Check ball	Chrome bearing steel	
22	Tie-rod reinforcement ring *	Rolled steel	Black painted
32	Wear ring	Resin	

\* In the case of long strokes

\*\* Aluminum tubing material of non-lube and air-hydro type is an aluminum alloy casted.

### Seal List

No.	Description	Material	Note
<b>Lube</b>			
23	Wiper ring		
24	Cushion seal		
25	Rod seal	NBR	
26	Piston seal		
27	Valve seal		
28	Tube gasket		
29	Piston gasket		
30	Retaining plate gasket		
31	Guide gasket		
<b>Non-lube</b>			
Seals except 25 and 26 are the same as for the lube-type.			
25	Rod seal	NBR	
26	Piston seal	NBR	
<b>Air-hydro</b>			
Seals except 25 and 26 are the same as for the lube-type. (Except cushion seal)			
No.	Description	Material	Note
25	Rod seal	NBR	
26	Piston seal		

### Replacement Parts (Seal kit)

- For replacement parts no. (seal kit) for air cylinder standard type CS1 series, refer to page 534.
- \*\* Seal kits does not include cushion seal, piston seal and guide gasket because those are not replaceable parts.

D-□

-X□

Technical Data

# CS1 Series

## Standard/Replacement Parts/Seal Kit

When ordering the replacement parts (seal kits) for standard type CS1 series air cylinders, indicate the order number listed in the table on the right.

Each set of replacement parts contains the following: Wiper ring, rod seal, piston seal, valve seal, tube gasket, and push plate gasket (for 1 cylinder).

### Standard (Lube)

Bore size(mm)	Kit no.	Description
125	CS1-125A-PS	Component part numbers: 23, 25, 26, 27, 28, 30
140	CS1-140A-PS	
160	CS1-160A-PS	
180	CS1-180A-PS	
200	CS1-200A-PS	
250	CS1-250A-PS	
300	CS1-300A-PS	

\* Seal kit includes a grease pack (ø125 to 160: 40 g, ø180 and 200: 50 g, ø250 and 300: 60 g).  
Order with the following part number when only the grease pack is needed.

**Grease pack part no.:** GR-S-010 (10 g), GR-S-020 (20 g)

### Standard (Non-lube)

Bore size(mm)	Kit no.	Description
125	CS1N125A-PS	Component part numbers: 23, 25, 26, 27, 28, 30
140	CS1N140A-PS	
160	CS1N160A-PS	
180	CS1N180A-PS	
200	CS1N200A-PS	
250	CS1N250A-PS	
300	CS1N300A-PS	

\* Seal kit includes a grease pack (ø125 to 160: 40 g, ø180 and 200: 50 g, ø250 and 300: 60 g).  
Order with the following part number when only the grease pack is needed.

**Grease pack part no.:** GR-S-010 (10 g), GR-S-020 (20 g)

### Air-hydro

Bore size(mm)	Kit no.	Description
125	CS1H125A-PS	Component part numbers: 23, 25, 26, 27, 28, 30
140	CS1H140A-PS	
160	CS1H160A-PS	



# Air Cylinder CDS1 Series

ø125, ø140, ø160, ø180, ø200

## How to Order

**With auto switch** CDS1 **L** **160** - **300** - **M9BW**

**With auto switch** (Built-in magnet)

**Mounting**

B	Basic type
L	Foot type
F	Rod side flange type
G	Head side flange type
C	Single clevis type
D	Double clevis type
T	Center trunnion type

**Type**

Nil	Lube
N	Non-lube
H	Air-hydro

**Bore size**

Lube, Non-lube		Air-hydro	
125	125 mm	125	125 mm
140	140 mm	140	140 mm
160	160 mm	160	160 mm
180	180 mm		
200	200 mm		

**Port thread type**

Nil	Rc
TN	NPT
TF	G

**Built-in Magnet Cylinder Model**

If a built-in magnet cylinder without auto switch is required, there is no need to enter the symbol for auto switch.  
Example: CDS1B125-200

**Cylinder stroke (mm)**  
(Refer to Maximum Stroke on page 536.)

**Number of auto switches**

Nil	2 pcs.
3	3 pcs.
S	1 pc.
n	"n" pcs.

**Auto switch**

Nil	Without auto switch
-----	---------------------

\* Refer to the table below for the applicable auto switch model.

**Suffix for cylinder**

Rod boot	J	Nylon tarpaulin
	K	Heat resistant tarpaulin
	N	Without cushion
	R	With cushion in rod side
Cushion	H	With cushion in head side
	Nil	With cushion in both sides (Air-hydro type has no cushion.)

\* If specifying more than one symbol, indicate them alphabetically.  
\*\* Air-hydro type has no cushion. No symbol indicates no cushion.

## Applicable Auto Switches

Refer to pages 1575 to 1701 for further information on auto switches.

Type	Special function	Electrical entry	Indicator light	Wiring (Output)	Load voltage		Auto switch model		Lead wire length (m)					Pre-wired connector	Applicable load				
					DC	AC	Tie-rod mounting	Band mounting	0.5 (Nil)	1 (M)	3 (L)	5 (Z)							
Solid state auto switch	—	Grommet	Yes	3-wire (NPN)	24 V	5 V, 12 V	—	M9N	●	●	●	○	○	—	IC circuit				
				3-wire (PNP)				M9P	●	●	●	○	○						
		2-wire		12 V	M9B	●	●	●	○	○	—								
		3-wire (NPN)			—	G39	—	—	—	—	—	IC circuit							
	Diagnostic indication (2-color indicator)	Terminal conduit	Yes	2-wire	24 V	5 V, 12 V	—	M9NW	●	●	●	○	○	—	IC circuit				
				3-wire (PNP)				M9PW	●	●	●	○	○						
	Water resistant (2-color indicator)	Grommet	Yes	3-wire (NPN)	24 V	5 V, 12 V	—	M9BW	●	●	●	○	○	—	—				
				3-wire (PNP)				M9NA**	—	○	○	●	○			○			
				2-wire	M9PA**	—	○	○	○	○	○	—	IC circuit						
				4-wire (NPN)	M9BA**	—	○	○	●	○	○								
With diagnostic output (2-color indicator)	Terminal conduit	Yes	2-wire (Non-polar)	24 V	5 V, 12 V	—	F59F	—	○	—	○	○	—	IC circuit					
Magnetic field resistant (2-color indicator)			P3DWA				—	●	—	●	—	—							
Reed auto switch	—	Grommet	Yes	3-wire (NPN equivalent)	24 V	12 V	100 V	A96	—	●	—	●	—	—	IC circuit				
				2-wire				A93	—	●	●	●	—			—	IC circuit		
				—				A90	—	●	—	●	—						
		Terminal conduit	Yes	No/Yes/No	2-wire	24 V	12 V	100 V, 200 V or less	A54	—	●	—	●	—	—	PLC			
									—	A64	—	●	—	●			—		
									—	A33	—	—	—	—			—	—	Relay, PLC
									—	A34	—	—	—	—			—		
Diagnostic indication (2-color indicator)	Grommet	Yes	2-wire	24 V	100 V, 200 V	200 V or less	A44	—	—	—	—	—	—	Relay, PLC					
							—	A59W	—	●	—	●			—				

\*1 Water resistant type auto switches can be mounted on the above models, but in such case SMC cannot guarantee water resistance. Consult with SMC regarding water resistant types with the above model numbers.

\* Lead wire length symbols: 0.5 m ..... Nil (Example) M9NW  
1 m ..... M (Example) M9NWM  
3 m ..... L (Example) M9NWL  
5 m ..... Z (Example) M9NWLZ

\* Solid state auto switches marked with "○" are produced upon receipt of order.

\* Since there are other applicable auto switches than listed above, refer to page 563 for details.

\* For details about auto switches with pre-wired connector, refer to pages 1648 and 1649.

\* D-A9□/M9□/M9□W/M9□A/P3DWA□ auto switches are shipped together (not assembled). (Only auto switch mounting brackets are assembled before shipped.)

CJ1

CJP

CJ2

JCM

CM2

CM3

CG1

CG3

JMB

MB

MB1

CA2

CS1

CS2

D-□

-X□

Technical Data



## Symbol

Double acting, Air cushion

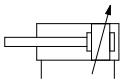

**Made to Order Specifications**  
(For details, refer to pages 1703 to 1896.)

Symbol	Specifications
-XA□	Change of rod end shape
-XB5	Oversized rod cylinder
-XC3	Special port location
-XC4	With heavy duty scraper
-XC6	Piston rod and rod end nut made of stainless steel
-XC8	Adjustable stroke cylinder/Adjustable extension type
-XC9	Adjustable stroke cylinder/Adjustable retraction type
-XC10	Dual stroke cylinder/Double rod type
-XC11	Dual stroke cylinder/Single rod type
-XC14	Change of trunnio bracket mounting position
-XC15	Change of tie-rod length
-XC22	Fluororubber seal
-XC26	Clevis pins with flat washer
-XC27	Double clevis pin and double knuckle pin made of stainless steel
-XC30	Rod side trunnion
-XC35	With coil scraper
-XC68	Hard chrome plated stainless steel rod
-XC86	With rod end bracket

Refer to pages 561 to 563 for auto switch specifications.

- Minimum auto switch mounting stroke
- Proper auto switch mounting position (detection at stroke end) and mounting height
- Operating range
- Switch mounting bracket: Part no.

## Specifications

Type	Lube, Non-lube	Air-hydro	
<b>Fluid</b>	Air	Turbine oil	
<b>Bore size (mm)</b>	125, 140, 160	180, 200	125, 140, 160
<b>Proof pressure</b>	1.57 MPa	1.2 MPa	1.57 MPa
<b>Maximum operating pressure</b>	0.97 MPa	0.7 MPa	0.97 MPa
<b>Minimum operating pressure</b>	0.05 MPa		0.06 MPa
<b>Piston speed</b>	50 to 500 mm/s		0.5 to 200 mm/s
<b>Cushion</b>	Interchangeable		None
<b>Ambient and fluid temperature</b>	0 to 60°C (No freezing), Air-hydro type: 5 to 60°C		
<b>Stroke length tolerance (mm)</b>	250 or less <sup>+0.1</sup> / <sub>0</sub> , 251 to 1,000 <sup>+0.1</sup> / <sub>0</sub> , 1,001 to 1,500 <sup>+0.15</sup> / <sub>0</sub>		
<b>Mounting</b>	Basic type, Foot type, Rod side flange type, Head side flange type, Single clevis type, Double clevis type, Center trunnion type		

## Maximum Stroke

(mm)

Bore size (mm)	Maximum stroke	
	Basic type, Head side flange type, Single clevis type, Double clevis type, Center trunnion type	Foot type, Rod side flange type
<b>125, 140</b>	1000 or less	1400 or less
<b>160</b>	1200 or less	1400 or less
<b>180</b>	1200 or less	1500 or less
<b>200</b>	998 or less	998 or less
Note	ø200: Cylinders of the stroke range of 998 to 1200 are special products.	ø200: Cylinders of the stroke range of 998 to 1500 are special products.

**Principal Parts Material and Surface Treatment**

Description		Material	Note
Cover		Rolled steel plate	Black painted
Tube	ø125, ø140, ø160 ø180, ø200	Aluminum alloy	Hard anodized
Sliding part seal	Lube type	NBR	JIS B 2401 O-ring *
	Non-lube type	NBR	
	Air-hydro type	NBR	
Piston rod		Carbon steel	Hard chrome plated
Piston		Aluminum alloy casted	Chromated

\* Foot type, Rod side flange type: In the case of bore size of ø125 and ø140, the stroke range is 1001 to 1400.

In the case of ø160, piston seals of the stroke range 1200 to 1400 are NLP.

\* In the case of bore size ø180 and ø200, piston seals are NLP.

**Weight**

(kg)

Bore size (mm)		125	140	160	180	200
Basic weight	Basic type	13.79	16.64	23.11	27.55	36.11
	Foot type	15.42	19.16	25.91	31.75	40.99
	Rod side flange type	16.47	21.64	29.50	37.38	48.02
	Head side flange type	16.47	21.64	29.50	37.38	48.02
	Single clevis type	16.86	20.93	28.60	35.94	46.01
	Double clevis (Clevis pin, Cotter pin)	17.32	21.68	29.45	37.62	48.04
	Trunnion type	17.92	22.37	30.51	38.71	50.10
Additional weight per each 100 stroke		1.77	1.96	2.39	2.85	3.42
Accessory bracket	Single knuckle	0.91	1.16	1.56	3.07	2.90
	Double knuckle (Knuckle pin, Cotter pin)	1.37	1.81	2.48	4.74	4.59
	Rod end nut	0.16	0.16	0.23	0.32	0.85

**Mounting Bracket Part No.**

Bore size (mm)	125	140	160	180	200
Foot type *	CS1-L12	CS1-L14	CS1-L16	CS1-L18	CS1-L20
Flange type	CS1-F12	CS1-F14	CS1-F16	CS1-F18	CS1-F20
Single clevis type	CS1-C12	CS1-C14	CS1-C16	CS1-C18	CS1-C20
Double clevis type **	CS1-D12	CS1-D14	CS1-D16	CS1-D18	CS1-D20

\* Order two foot brackets per cylinder.

\*\* When ordering the double clevis, the clevis pin and the cotter pin (2 pcs.) are attached.

**Accessory**

\* For details about the single knuckle joint, double knuckle joint, knuckle pin, clevis pin, and rod end nut, refer to page 547.

**CJ1**
**CJP**
**CJ2**
**JCM**
**CM2**
**CM3**
**CG1**
**CG3**
**JMB**
**MB**
**MB1**
**CA2**
**CS1**
**CS2**
**D-□**
**-X□**

 Technical  
Data

# CDS1 Series

## Construction

### Lube

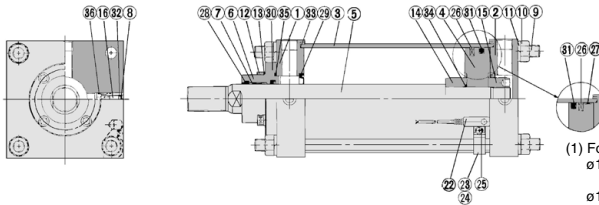

- (1) Foot type: Rod side flange type  
 $\phi 125$ ,  $\phi 140$ :  
 In the case of 1001 to 1400 st  
 $\phi 160$ :  
 In the case of 1201 to 1400 st  
 (2) In the case of  $\phi 180$ ,  $\phi 200$

### Non-lube

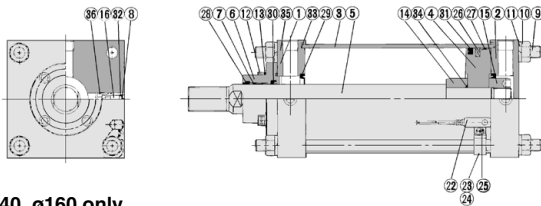

### Air-hydro: $\phi 125$ , $\phi 140$ , $\phi 160$ only

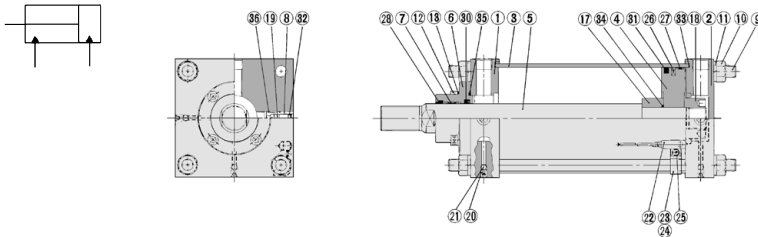

### Component Parts

No.	Description	Material	Note
1	Rod cover	Rolled steel plate	Black painted
2	Head cover	Rolled steel plate	Black painted
3	Cylinder tube	Aluminum alloy	Hard anodized
4	Piston	Aluminum alloy casted	Chromated
5	Piston rod	Carbon steel	Hard chrome plated
6	Retaining plate	Cast iron	Black painted
7	Bushing	Bearing alloy	
8	Valve guide	Brass	
9	Tie-rod	Carbon steel	Chromated
10	Tie-rod nut	Rolled steel	Black zinc chromated
11	Spring washer	Steel wire	Black zinc chromated
12	Retaining plate bolt	Chromium molybdenum steel	Black zinc chromated
13	Spring washer	Steel wire	Black zinc chromated
14	Cushion ring A	Rolled steel	Zinc chromated
15	Cushion ring B	Rolled steel	Zinc chromated
16	Cushion valve	Rolled steel	Electroless nickel plated
17	Spacer A	Rolled steel	Zinc chromated
18	Spacer B	Rolled steel	Zinc chromated
19	Air releasing B	Rolled steel	Zinc chromated
20	Air releasing A	Chromium molybdenum steel	
21	Check ball	Chrome bearing steel	
22	Auto switch	—	
23	Set screw	Chromium molybdenum steel	Zinc chromated
24	Switch mounting bracket	Aluminum alloy	
25	Switch mounting screw	Copper wire	Nickel plated
26	Magnet	—	
27	Wear ring	Resin	

### Seal List

No.	Description	Material	Note
28	Wiper ring		
29*	Cushion seal		
30	Rod seal		
31	Piston seal	NBR	
32	Valve seal		
33	Tube gasket		
34*	Piston gasket		
35	Retaining plate gasket		
36*	Guide gasket		

Lube (1) (For lube-type 2, refer to page 539.)

Non-lube Seals except ⑩ and ⑪ are the same as lube type.

30	Rod seal	NBR	
31	Piston seal		

Air-hydro Seals except ⑩ and ⑪ are the same as lube type.

No.	Description	Material	Note
30	Rod seal		
31	Piston seal	NBR	

### Replacement Parts (Seal kit)

• For replacement part no. (seal kits) of cylinder with auto switch CDS1 series, refer to page 539.  
 \*\* Seal kits does not include cushion seal, piston seal and guide gasket because those are not replaceable parts.

**With Auto Switch/Replacement Parts/Seal Kit**

When ordering the replacement parts (seal kits) for the CDS1 series cylinder with auto switches, indicate the order number listed in the table on the right.

Each set of replacement parts contains the following: wiper ring, rod seal, piston seal, valve seal, tube gasket, and push plate gasket (for 1 cylinder).

**Lube (1)**

Bore size (mm)	Kit no.	Description
<b>125</b>	CS1-125A-PS	Component part numbers: ㉘, ㉙, ㉚, ㉛, ㉜, ㉝
<b>140</b>	CS1-140A-PS	
<b>160</b>	CS1-160A-PS	
<b>180</b>	CDS1-180A-PS	
<b>200</b>	CDS1-200A-PS	

\* Seal kit includes a grease pack (ø125 to 160: 40 g, ø180 and 200: 50 g). Order with the following part number when only the grease pack is needed.

**Grease pack part no.:** GR-S-010 (10 g), GR-S-020 (20 g)

**Non-lube**

Bore size (mm)	Kit no.	Description
<b>125</b>	CS1N125A-PS	Component part numbers: ㉘, ㉙, ㉚, ㉛, ㉜, ㉝
<b>140</b>	CS1N140A-PS	
<b>160</b>	CS1N160A-PS	
<b>180</b>	CS1N180A-PS	
<b>200</b>	CS1N200A-PS	

\* Seal kit includes a grease pack (ø125 to 160: 40 g, ø180 and 200: 50 g). Order with the following part number when only the grease pack is needed.

**Grease pack part no.:** GR-S-010 (10 g), GR-S-020 (20 g)

**Lube (2)\***

Bore size (mm)	Kit no.	Description
<b>125</b>	CDS1L125A-PS	Component part numbers: ㉘, ㉙, ㉚, ㉛, ㉜, ㉝
<b>140</b>	CDS1L140A-PS	
<b>160</b>	CDS1L160A-PS	

\* Foot type, Rod side flange type: ø125, ø140—1001 to 1400 stroke, ø160—1201 to 1400 stroke

\* Seal kit includes a grease pack (ø125 to 160: 40 g, ø180 and 200: 50 g). Order with the following part number when only the grease pack is needed.

**Grease pack part no.:** GR-S-010 (10 g), GR-S-020 (20 g)

**Air-hydro**

Bore size (mm)	Kit no.	Description
<b>125</b>	CS1H125A-PS	Component part numbers: ㉘, ㉙, ㉚, ㉛, ㉜, ㉝
<b>140</b>	CS1H140A-PS	
<b>160</b>	CS1H160A-PS	

CJ1

CJP

CJ2

JCM

CM2

CM3

CG1

CG3

JMB

MB

MB1

CA2

CS1

CS2

D-□

-X□

Technical  
Data

# C□S1 Series

## Basic Type: CS1B

Lube type (CS1B), Non-lube type (CS1BN), Air-hydro type (CS1BH)

With rod boot

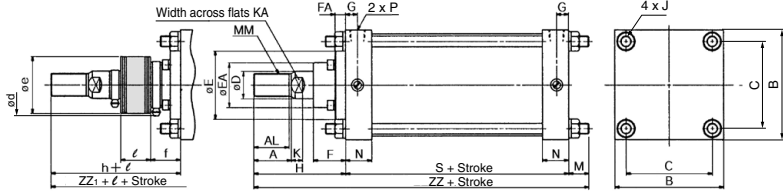

## With auto switch: CDS1B

With rod boot

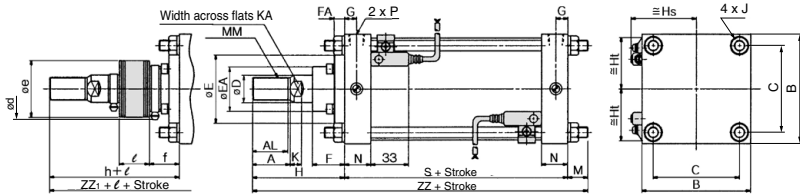

Type	Bore size (mm)	Stroke range* (mm)	A	AL	B	C	D	E	EA	F	FA	G	J	K	KA	M	MM	N	P	S
Lube	125	to 1000	50	47	145	115	36	90	59	43	14	16	M14 x 1.5	15	31	27	M30 x 1.5	35	1/2	98
Non-lube	140	to 1000	50	47	161	128	36	90	59	43	14	16	M14 x 1.5	15	31	27	M30 x 1.5	35	1/2	98
Air-hydro	160	to 1200	56	53	182	144	40	90	59	43	14	18.5	M16 x 1.5	17	36	30.5	M36 x 1.5	39	3/4	106
	180	to 1200	63	60	204	162	45	115	70	48	17	18.5	M18 x 1.5	20	41	35	M40 x 1.5	39	3/4	111
Lube	200	to 1200	63	60	226	182	50	115	74	48	17	18.5	M20 x 1.5	20	46	35	M45 x 1.5	39	3/4	111
Non-lube	250	to 1200	71	67	277	225	60	140	86	60	20	23	M24 x 1.5	25	56	41.5	M56 x 2	49	1	141
	300	to 1200	80	76	330	270	70	140	96	60	20	23	M30 x 1.5	30	65	51.5	M64 x 2	49	1	146

Type	Bore size (mm)	Without rod boot		With rod boot						
		H	ZZ	d	e	f	h	l	ZZ <sub>1</sub>	
Lube	125	110	235	82	75	40	133	0.2 stroke	258	
Non-lube	140	110	235	82	75	40	133	0.2 stroke	258	
Air-hydro	160	120	256.5	82	75	40	141	0.2 stroke	277.5	
	180	135	281	92	85	45	153	0.2 stroke	299	
Lube	200	135	281	96	90	45	153	0.2 stroke	299	
Non-lube	250	160	342.5	108	105	55	176	0.17 stroke	358.5	
	300	175	372.5	118	115	55	190	0.17 stroke	387.5	

\* The minimum stroke with rod boot is 30 mm or more.

## With Auto Switch: $\phi 125$ to $\phi 200$ Only

Type	Bore size (mm)	Stroke range (mm)	S	Without rod boot		With rod boot	
				ZZ	ZZ <sub>1</sub>		
Lube	125	Up to 1000	98	235	258		
Non-lube	140	Up to 1000	98	235	258		
Air-hydro	160	Up to 1200	106	256.5	277.5		
Lube	180	Up to 1200	115	285	303		
Non-lube	200	Up to 998	120	290	308		

\* Dimensions except mentioned above are the same as standard type.

\*\* For the auto switch mounting position and its mounting height, refer to page 561.

\*\*\*Refer to "Minimum Stroke for Auto Switch Mounting" on page 562.

**Foot Type: CS1L**

Lube type (CS1L), Non-lube type (CS1LN), Air-hydro type (CS1LH)

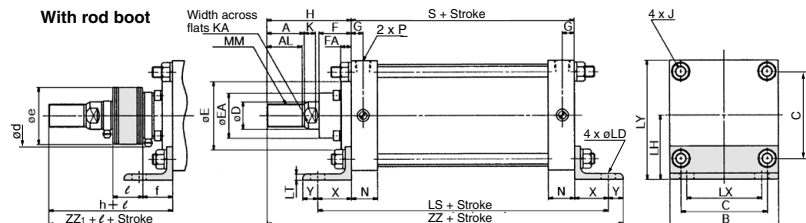

**Long stroke**

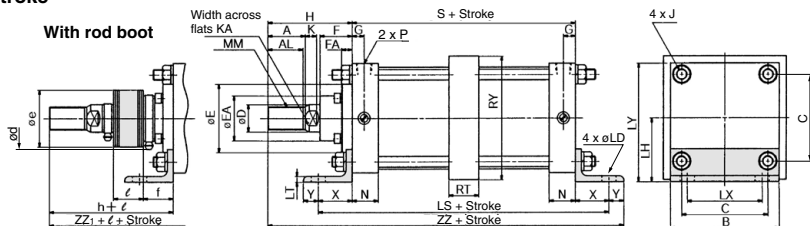

**With auto switch: CDS1L**

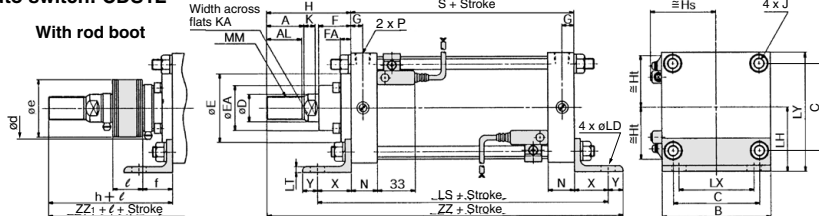

Type	Bore size (mm)	Stroke range (mm)	Long stroke range (mm)	A	AL	B	C	D	E	EA	F	FA	G	J	K	KA	LD	LH	LS	LT	LX	LY	MM	N	P	RT
Lube	<b>125</b>	Up to 1400	1401 to 1600	50	47	145	115	36	90	59	43	14	16	M14 x 1.5	15	31	19	85	188	8	100	157.5	M30 x 1.5	35	1/2	36
Non-lube	<b>140</b>	Up to 1400	1401 to 1600	50	47	161	128	36	90	59	43	14	16	M14 x 1.5	15	31	19	100	188	9	112	180.5	M30 x 1.5	35	1/2	36
Air-hydro	<b>160</b>	Up to 1400	1401 to 1600	56	53	182	144	40	90	59	43	14	18.5	M16 x 1.5	17	36	19	106	206	9	118	197	M36 x 1.5	39	3/4	45
	<b>180</b>	Up to 1800	1801 to 2000	63	60	204	162	45	115	70	48	17	18.5	M18 x 1.5	20	41	24	125	231	10	132	227	M40 x 1.5	39	3/4	45
Lube	<b>200</b>	Up to 1800	1801 to 2000	60	60	226	182	50	115	74	48	17	18.5	M20 x 1.5	20	46	24	132	231	10	150	245	M45 x 1.5	39	3/4	45
Non-lube	<b>250</b>	Up to 2000	2001 to 2400	71	67	277	225	60	140	86	60	20	23	M24 x 1.5	25	56	29	160	301	12	180	298.5	M56 x 2	49	1	55
	<b>300</b>	Up to 2000	2001 to 2400	80	76	330	270	70	140	96	60	20	23	M30 x 1.5	30	65	33	200	326	15	212	365	M64 x 2	49	1	55

Type	Bore size (mm)	RY	S	X	Y	Without rod boot		With rod boot						
						H	ZZ	d	e	f	h	ℓ	ZZ1	
Lube	<b>125</b>	164	98	45	20	110	273	82	75	40	133	0.2 stroke	296	
Non-lube	<b>140</b>	184	98	45	30	110	283	82	75	40	133	0.2 stroke	306	
Air-hydro	<b>160</b>	204	106	50	25	120	301	82	75	40	141	0.2 stroke	322	
	<b>180</b>	228	111	60	30	135	336	92	85	45	153	0.2 stroke	354	
Lube	<b>200</b>	257	111	60	30	135	336	96	90	45	153	0.2 stroke	354	
Non-lube	<b>250</b>	325	141	80	40	160	421	108	105	55	176	0.17 stroke	437	
	<b>300</b>	390	146	90	40	175	451	118	115	55	190	0.17 stroke	466	

\* The minimum stroke with rod boot is 30 mm or more.

**With Auto Switch: ø125 to ø200 Only** (mm)

Type	Bore size (mm)	Stroke range (mm)	S	LS	Without rod boot ZZ	With rod boot ZZ1
Lube	<b>125</b>	Up to 1400	98	188	273	296
Non-lube	<b>140</b>	Up to 1400	98	188	283	306
Air-hydro	<b>160</b>	Up to 1400	106	206	301	322
Lube	<b>180</b>	Up to 1500	115	235	340	358
Non-lube	<b>200</b>	Up to 998	120	240	345	363

\* Dimensions except mentioned above are the same as standard type.

\*\* For the auto switch mounting position and its mounting height, refer to page 561.

\*\*\* Refer to "Minimum Stroke for Auto Switch Mounting" on page 562.

- CJ1
- CJP
- CJ2
- JCM
- CM2
- CM3
- CG1
- CG3
- JMB
- MB
- MB1
- CA2
- CS1**
- CS2

- D-□
- X□
- Technical Data

# C□S1 Series

## Rod Side Flange Type: CS1F

Lube type (CS1F), Non-lube type (CS1FN), Air-hydro type (CS1FH)

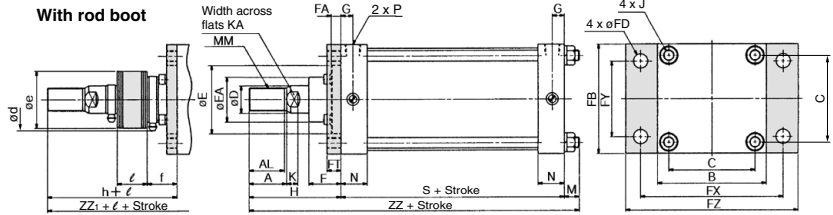

### Long stroke

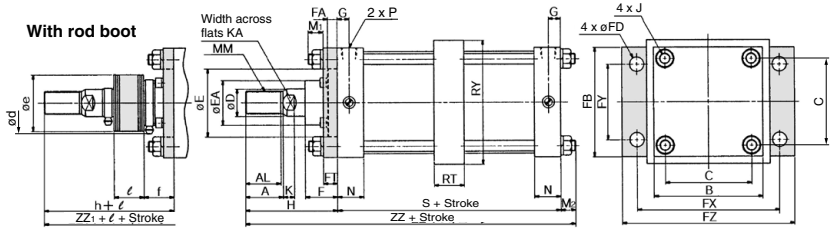

### With auto switch: CDS1F

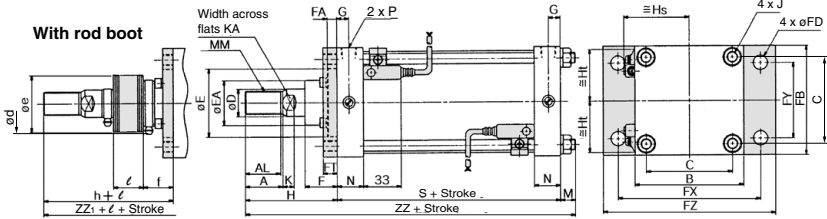

Type	Bore size (mm)	Stroke* range (mm)	Without rod boot																	With rod boot													
			A	AL	B	C	D	E	EA	F	FA	FB	FD	FT	FX	FY	FZ	G	J	K	KA	M	S	N	P	MM	H	ZZ	d	e	f	h	ℓ
Lube	125	Up to 1400	50	47	145	115	36	90	59	43	14	145	19	14	190	100	230	16	M14 x 1.5	15	31	30	98	35	1/2	M30 x 1.5	110	238	82	75	40	133	261
Non-lube	140	Up to 1400	50	47	161	128	36	90	59	43	14	160	19	20	212	112	255	16	M14 x 1.5	15	31	24	98	35	1/2	M30 x 1.5	110	232	82	75	40	133	255
Air-hydro	160	Up to 1400	56	53	182	144	40	90	59	43	14	180	19	20	236	118	275	18.5	M16 x 1.5	17	36	26	106	39	3/4	M36 x 1.5	120	252	82	75	40	141	273
	180	Up to 1800	63	60	204	162	45	115	70	48	17	200	24	25	265	132	320	18.5	M18 x 1.5	20	41	31	111	39	3/4	M40 x 1.5	135	277	92	85	45	153	295
Lube	200	Up to 1800	63	60	226	182	50	115	74	48	17	225	24	25	280	150	335	18.5	M20 x 1.5	20	46	31	111	39	3/4	M45 x 1.5	135	277	96	90	45	153	295
Non-lube	250	Up to 2000	71	67	277	225	60	140	86	60	20	275	29	30	355	180	420	23	M24 x 1.5	25	56	35	141	49	1	M56 x 2	160	336	108	105	55	176	352
	300	Up to 2000	80	76	330	270	70	140	96	60	20	330	33	30	400	212	475	23	M30 x 1.5	30	65	48	146	49	1	M64 x 2	175	369	118	115	55	190	384

### Long Stroke

Type	Bore size (mm)	Long stroke range (mm)	Without rod boot		With rod boot			
			M1	M2	RT	RY	ZZ	ZZ1
Lube	125	1401 to 1600	22	22	36	164	230	253
Non-lube	140	1401 to 1600	19	19	36	184	227	250
Air-hydro	160	1401 to 1600	22	22	45	204	248	269
	180	1801 to 2000	26	26	45	228	272	290
Lube	200	1801 to 2000	26	26	45	257	272	290
Non-lube	250	2001 to 2400	30	30	55	325	331	347
	300	2001 to 2400	36	36	55	390	357	372

\* The minimum stroke with rod boot is 30 mm or more.

### With Auto Switch: ø125 to ø200 Only

Type	Bore size (mm)	Stroke range (mm)	Without rod boot		With rod boot	
			S	ZZ	ZZ1	
Lube	125	Up to 1400	98	238	261	
Non-lube	140	Up to 1400	98	232	255	
Air-hydro	160	Up to 1400	106	252	273	
Lube	180	Up to 1500	115	281	299	
Non-lube	200	Up to 998	120	286	304	

\* Dimensions except mentioned above are the same as standard type.

\*\* For the auto switch mounting position and its mounting height, refer to page 561.

\*\*\*Refer to "Minimum Stroke for Auto Switch Mounting" on page 562.



**Head Side Flange Type: CS1G**

Lube type (CS1G), Non-lube type (CS1GN), Air-hydro type (CS1GH)

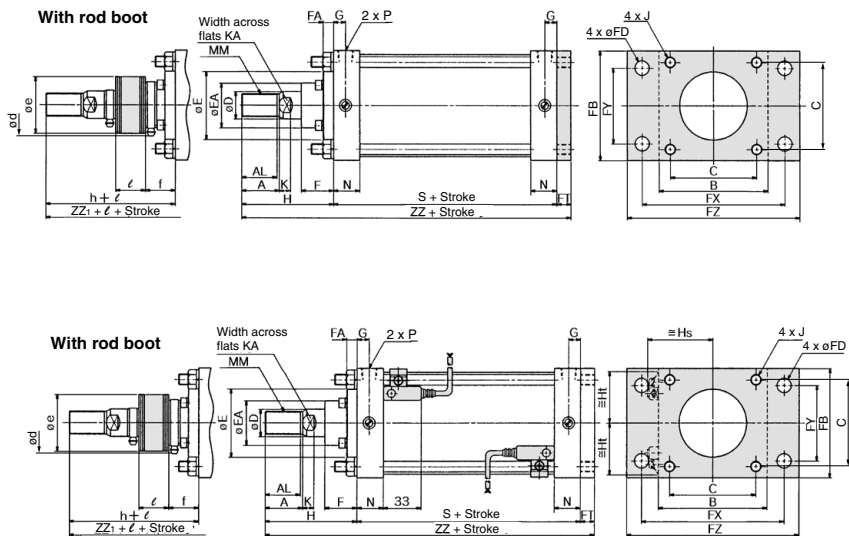

- CJ1**
- CJP**
- CJ2**
- JCM**
- CM2**
- CM3**
- CG1**
- CG3**
- JMB**
- MB**
- MB1**
- CA2**
- CS1**
- CS2**

Type	Bore size (mm)	Stroke range* (mm)	A	AL	B	C	D	E	EA	F	FA	FB	FD	FT	FX	FY	FZ	G	J	K	KA	MM	N	P
Lube	<b>125</b>	Up to 1000	50	47	145	115	36	90	59	43	14	145	19	14	190	100	230	16	M14 x 1.5	15	31	M30 x 1.5	35	1/2
Non-lube	<b>140</b>	Up to 1000	50	47	161	128	36	90	59	43	14	160	19	20	212	112	255	16	M14 x 1.5	15	31	M30 x 1.5	35	1/2
Air-hydro	<b>160</b>	Up to 1200	56	53	182	144	40	90	59	43	14	180	19	20	236	118	275	18.5	M16 x 1.5	17	36	M36 x 1.5	39	3/4
	<b>180</b>	Up to 1200	63	60	204	162	45	115	70	48	17	200	24	25	265	132	320	18.5	M18 x 1.5	20	41	M40 x 1.5	39	3/4
Lube	<b>200</b>	Up to 1200	63	60	226	182	50	115	74	48	17	225	24	25	280	150	335	18.5	M20 x 1.5	20	46	M45 x 1.5	39	3/4
Non-lube	<b>250</b>	Up to 1200	71	67	277	225	60	140	86	60	20	275	29	30	355	180	420	23	M24 x 1.5	25	56	M56 x 2	49	1
	<b>300</b>	Up to 1200	80	76	330	270	70	140	96	60	20	330	33	30	400	212	475	25	M30 x 1.5	30	65	M64 x 2	49	1

Type	Bore size (mm)	S	Without rod boot		With rod boot						
			H	ZZ	d	e	f	h	ℓ	ZZ <sub>1</sub>	
Lube	<b>125</b>	98	110	222	82	75	40	133	0.2 stroke	245	
Non-lube	<b>140</b>	98	110	228	82	75	40	133	0.2 stroke	251	
Air-hydro	<b>160</b>	106	120	246	82	75	40	141	0.2 stroke	267	
	<b>180</b>	111	135	271	92	85	45	153	0.2 stroke	289	
Lube	<b>200</b>	111	135	271	96	90	45	153	0.2 stroke	289	
Non-lube	<b>250</b>	141	160	331	108	105	55	176	0.17 stroke	347	
	<b>300</b>	146	175	351	118	115	55	190	0.17 stroke	366	

\* The minimum stroke with rod boot is 30 mm or more.

**With Auto Switch: ø125 to ø200 Only (mm)**

Type	Bore size (mm)	Stroke range (mm)	S	Without rod boot		With rod boot	
				ZZ	ZZ <sub>1</sub>		
Lube	<b>125</b>	Up to 1000	98	222	245		
Non-lube	<b>140</b>	Up to 1000	98	228	251		
Air-hydro	<b>160</b>	Up to 1200	106	246	267		
Lube	<b>180</b>	Up to 1200	115	275	293		
Non-lube	<b>200</b>	Up to 998	120	280	298		

\* Dimensions except mentioned above are the same as standard type.  
 \*\* For the auto switch mounting position and its mounting height, refer to page 561.  
 \*\*\* Refer to "Minimum Stroke for Auto Switch Mounting" on page 562.

- D-□**
- X□**
- Technical Data

# C□S1 Series

## Single Clevis Type: CS1C

Lube type (CS1C), Non-lube type (CS1CN), Air-hydro type (CS1CH)

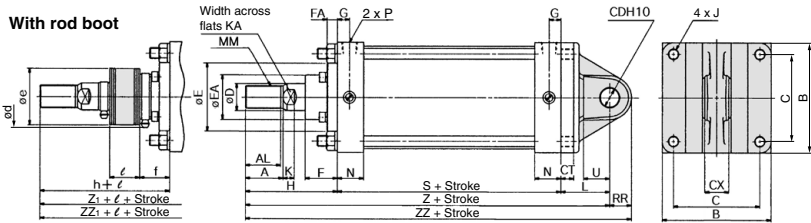

## With auto switch: CDS1C

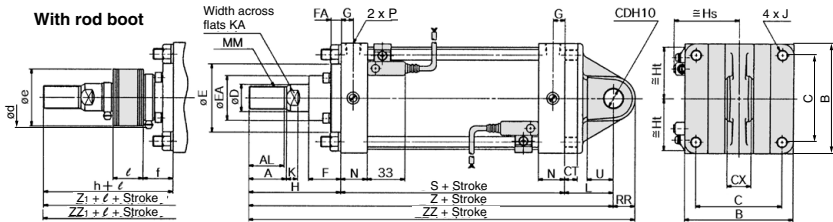

Type	Bore size (mm)	Stroke range <sup>a</sup> (mm)	A	AL	B	C	CDH10	CT	CX	D	E	EA	F	FA	G	J	K	KA	L	MM	N	P	RR
Lube	125	Up to 1000	50	47	145	115	25 <sup>+0.084</sup> <sub>0</sub>	17	32 <sup>-0.1</sup> <sub>-0.3</sub>	36	90	59	43	14	16	M14 x 1.5	15	31	65	M30 x 1.5	35	1/2	29
Non-lube	140	Up to 1000	50	47	161	128	28 <sup>+0.084</sup> <sub>0</sub>	17	36 <sup>-0.1</sup> <sub>-0.3</sub>	36	90	59	43	14	16	M14 x 1.5	15	31	75	M30 x 1.5	35	1/2	32
Air-hydro	160	Up to 1200	56	53	182	144	32 <sup>+0.100</sup> <sub>0</sub>	20	40 <sup>-0.1</sup> <sub>-0.3</sub>	40	90	59	43	14	18.5	M16 x 1.5	17	36	80	M36 x 1.5	39	3/4	36
Lube	180	Up to 1200	63	60	204	162	40 <sup>+0.100</sup> <sub>0</sub>	23	50 <sup>-0.1</sup> <sub>-0.3</sub>	45	115	70	48	17	18.5	M18 x 1.5	20	41	90	M40 x 1.5	39	3/4	44
Non-lube	200	Up to 1200	63	60	226	182	40 <sup>+0.100</sup> <sub>0</sub>	25	50 <sup>-0.1</sup> <sub>-0.3</sub>	50	115	74	48	17	18.5	M20 x 1.5	20	46	90	M45 x 1.5	39	3/4	44
Lube	250	Up to 1200	71	67	277	225	50 <sup>+0.100</sup> <sub>0</sub>	30	63 <sup>-0.1</sup> <sub>-0.3</sub>	60	140	86	60	20	23	M24 x 1.5	25	56	110	M56 x 2	49	1	55
Non-lube	300	Up to 1200	80	76	330	270	63 <sup>+0.120</sup> <sub>0</sub>	37	80 <sup>-0.1</sup> <sub>-0.3</sub>	70	140	96	60	20	23	M30 x 1.5	30	65	130	M64 x 2	49	1	68

Type	Bore size (mm)	S	U	(mm)									
				Without rod boot				With rod boot					
				H	Z	ZZ	d	e	f	h	l	Z <sub>1</sub>	ZZ <sub>1</sub>
Lube	125	98	35	110	273	302	82	75	40	133	0.2 stroke	296	325
Non-lube	140	98	40	110	283	315	82	75	40	133	0.2 stroke	306	338
Air-hydro	160	106	45	120	306	342	82	75	40	141	0.2 stroke	327	363
Lube	180	111	50	135	336	380	92	85	45	153	0.2 stroke	354	398
Non-lube	200	111	50	135	336	380	96	90	45	153	0.2 stroke	354	398
Lube	250	141	65	160	411	466	108	105	55	176	0.17 stroke	427	482
Non-lube	300	146	80	175	451	519	118	115	55	190	0.17 stroke	466	534

\* The minimum stroke with rod boot is 30 mm or more.

## With Auto Switch: ø125 to ø200 Only (mm)

Type	Bore size (mm)	Stroke range (mm)	S	(mm)			
				Without rod boot		With rod boot	
				Z	ZZ	Z <sub>1</sub>	ZZ <sub>1</sub>
Lube	125	Up to 1000	98	273	302	296	325
Non-lube	140	Up to 1000	98	283	315	306	338
Air-hydro	160	Up to 1200	106	306	342	327	363
Lube	180	Up to 1200	115	340	384	358	402
Non-lube	200	Up to 998	120	345	389	363	407

\* Dimensions except mentioned above are the same as standard type.

\*\* For the auto switch mounting position and its mounting height, refer to page 561.

\*\*\* Refer to "Minimum Stroke for Auto Switch Mounting" on page 562.

**Double Clevis Type: CS1D**

Lube type (CS1D), Non-lube type (CS1DN), Air-hydro type (CS1DH)

With rod boot

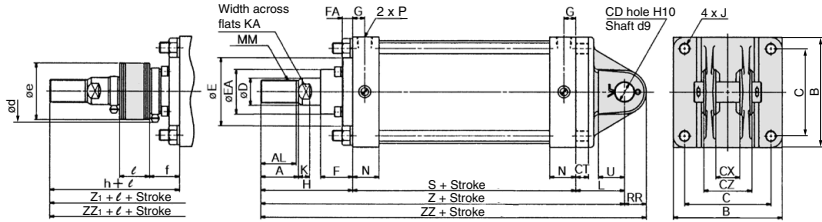

With auto switch: CDS1D

With rod boot

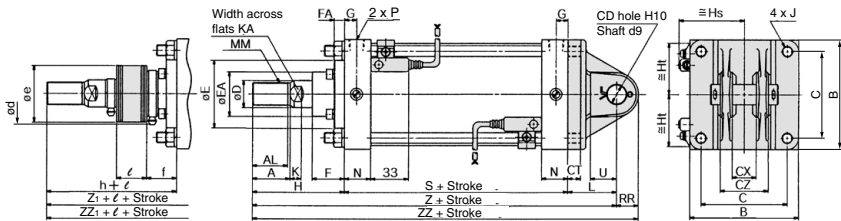

Note) Clevis pin and cotter pin are shipped together.

- CJ1
- CJP
- CJ2
- JCM
- CM2
- CM3
- CG1
- CG3
- JMB
- MB
- MB1
- CA2
- CS1**
- CS2

Type	Bore size (mm)	Stroke range <sup>a)</sup> (mm)	A	AL	B	C	CD <sub>H10</sub>	CT	CX	CZ	D	E	EA	F	FA	G	J	K	KA	L	MM	N	P	RR
Lube	125	Up to 1000	50	47	145	115	25 <sup>+0.084</sup>	17	32 <sup>+0.3</sup>	64 <sup>0</sup>	36	90	59	43	14	16	M14 x 1.5	15	31	65	M30 x 1.5	35	1/2	29
Non-lube	140	Up to 1000	50	47	161	128	28 <sup>+0.084</sup>	17	36 <sup>+0.3</sup>	72 <sup>0</sup>	36	90	59	43	14	16	M14 x 1.5	15	31	75	M30 x 1.5	35	1/2	32
Air-hydro	160	Up to 1200	56	53	182	144	32 <sup>+0.100</sup>	20	40 <sup>+0.3</sup>	80 <sup>0</sup>	40	90	59	43	14	18.5	M16 x 1.5	17	36	80	M36 x 1.5	39	3/4	36
	180	Up to 1200	63	60	204	162	40 <sup>+0.100</sup>	23	50 <sup>+0.3</sup>	100 <sup>0</sup>	45	115	70	48	17	18.5	M18 x 1.5	20	41	90	M40 x 1.5	39	3/4	44
Lube	200	Up to 1200	63	60	226	182	40 <sup>+0.100</sup>	25	50 <sup>+0.3</sup>	100 <sup>0</sup>	50	115	74	48	17	18.5	M20 x 1.5	20	46	90	M45 x 1.5	39	3/4	44
Non-lube	250	Up to 1200	71	67	277	225	50 <sup>+0.100</sup>	30	63 <sup>+0.3</sup>	126 <sup>0</sup>	60	140	86	60	20	23	M24 x 1.5	25	56	110	M56 x 2	49	1	55
	300	Up to 1200	80	76	330	270	63 <sup>+0.120</sup>	37	80 <sup>+0.3</sup>	160 <sup>0</sup>	70	140	96	60	20	23	M30 x 1.5	30	65	130	M64 x 2	49	1	68

Type	Bore size (mm)	S	U	Without rod boot										With rod boot			
				H	Z	ZZ	d	e	f	h	$\ell$	Z <sub>1</sub>	ZZ <sub>1</sub>				
Lube	125	98	35	110	273	302	82	75	40	133	0.2 stroke	296	325				
Non-lube	140	98	40	110	283	315	82	75	40	133	0.2 stroke	306	338				
Air-hydro	160	106	45	120	306	342	82	75	40	141	0.2 stroke	327	363				
	180	111	50	135	336	380	92	85	45	153	0.2 stroke	354	398				
Lube	200	111	50	135	336	380	96	90	45	153	0.2 stroke	354	398				
Non-lube	250	141	65	160	411	466	108	105	55	176	0.17 stroke	427	482				
	300	146	80	175	451	519	118	115	55	190	0.17 stroke	466	534				

\* The minimum stroke with rod boot is 30 mm or more.

With Auto Switch:  $\phi 125$  to  $\phi 200$  Only (mm)

Type	Bore size (mm)	Stroke range (mm)	S	Without rod boot		With rod boot	
				Z	ZZ	Z <sub>1</sub>	ZZ <sub>1</sub>
Lube	125	Up to 1000	98	273	302	296	325
Non-lube	140	Up to 1000	98	283	315	306	338
Air-hydro	160	Up to 1200	106	306	342	327	363
Lube	180	Up to 1200	115	340	384	358	402
Non-lube	200	Up to 998	120	345	389	363	407

\* Dimensions except mentioned above are the same as standard type.

\*\* For the auto switch mounting position and its mounting height, refer to page 561.

\*\*\* Refer to "Minimum Stroke for Auto Switch Mounting" on page 562.

- D-□
- X□
- Technical Data

## Center Trunnion Type: CS1T

Lube type (CS1T), Non-lube type (CS1TN), Air-hydro type (CS1TH)

With rod boot

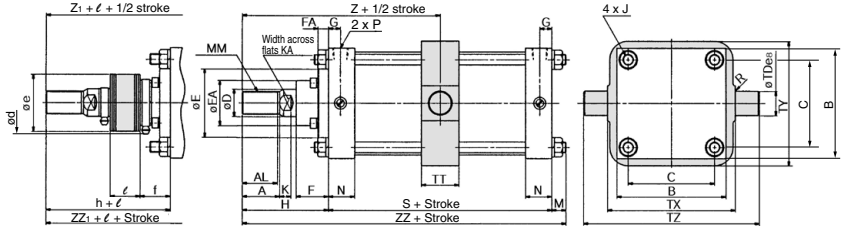

With auto switch: CDS1T

With rod boot

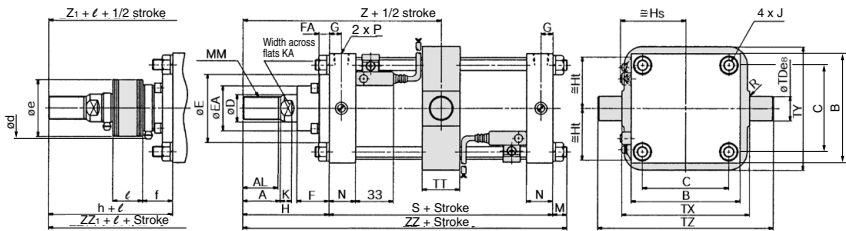

Type	Bore size (mm)	Stroke range* (mm)	A	AL	B	C	D	E	EA	F	FA	G	J	K	KA	M	MM	N	P	R	S	TDes	TT	TX
Lube	125	25 to 1000	50	47	145	115	36	90	59	43	14	16	M14 x 1.5	15	31	19	M30 x 1.5	35	1/2	1	98	32 <sup>-0.050</sup> -0.089	50	170
	140	30 to 1000	50	47	161	128	36	90	59	43	14	16	M14 x 1.5	15	31	19	M30 x 1.5	35	1/2	1.5	98	36 <sup>-0.050</sup> -0.089	55	190
Air-hydro	160	35 to 1200	56	53	182	144	40	90	59	43	14	18.5	M16 x 1.5	17	36	22	M36 x 1.5	39	3/4	1.5	106	40 <sup>-0.050</sup> -0.089	60	212
	180	30 to 1200	63	60	204	162	45	115	70	48	17	18.5	M18 x 1.5	20	41	26	M40 x 1.5	39	3/4	2	111	45 <sup>-0.050</sup> -0.089	59	236
Lube	200	30 to 1200	63	60	226	182	50	115	74	48	17	18.5	M20 x 1.5	20	46	26	M45 x 1.5	39	3/4	2	111	45 <sup>-0.050</sup> -0.089	59	265
	250	30 to 1200	71	67	277	225	60	140	86	60	20	23	M24 x 1.5	25	56	30	M56 x 2	49	1	3	141	56 <sup>-0.060</sup> -0.106	69	335
Non-lube	300	35 to 1200	80	76	330	270	70	140	96	60	20	23	M30 x 1.5	30	65	36	M64 x 2	49	1	4	146	67 <sup>-0.060</sup> -0.136	79	400

Type	Bore size (mm)	TV	TZ	Without rod boot				With rod boot						
				H	Z	ZZ	d	e	f	h	ℓ	Z <sub>1</sub>	ZZ <sub>1</sub>	
Lube	125	164	234	110	159	227	82	75	40	133	0.2 stroke	182	250	
	140	184	262	110	159	227	82	75	40	133	0.2 stroke	182	250	
Non-lube	160	204	292	120	173	248	82	75	40	141	0.2 stroke	194	269	
	180	228	326	135	190.5	272	92	85	45	153	0.2 stroke	203.5	290	
Lube	200	257	355	135	190.5	272	96	90	45	153	0.2 stroke	203.5	290	
	250	325	447	160	230.5	331	108	105	55	176	0.17 stroke	265	347	
Non-lube	300	390	534	175	248	357	118	115	55	190	0.17 stroke	263	372	

\* The minimum stroke with rod boot is 30 mm or more.  
 (The minimum stroke with rod boot, but for bore size ø160 and ø300 is 23 mm or more.)

With Auto Switch: ø125 to ø200 Only (mm)

Type	Bore size (mm)	Stroke range (mm)	S	Without rod boot		With rod boot	
				Z	ZZ	Z <sub>1</sub>	ZZ <sub>1</sub>
Lube	125	UP to 1000	98	159	227	182	250
	140	UP to 1000	98	159	227	182	250
Non-lube	160	UP to 1200	106	173	248	194	269
	180	UP to 1200	115	192.5	276	210.5	294
Lube	200	UP to 998	120	195	281	213	299
	250	UP to 998	120	195	281	213	299

\* Dimensions except mentioned above are the same as standard type.

\*\* For the auto switch mounting position and its mounting height, refer to page 561.

\*\*\* Refer to "Minimum Stroke for Auto Switch Mounting" on page 562.

# CS1 Series

# Accessory Bracket Dimensions

## I Type Single Knuckle Joint\*

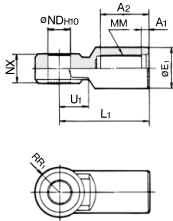

Material: Cast iron

Part no.	Applicable bore size (mm)	A1	A2	E1	L1	MM	ND <sub>H10</sub>	NX	RR	U1
I-12	125	8	54	46	100	M30 x 1.5	25 <sup>+0.084</sup> <sub>0</sub>	32 <sup>+0.1</sup> <sub>-0.3</sub>	27	33
I-14	140	8	54	48	105	M30 x 1.5	28 <sup>+0.084</sup> <sub>0</sub>	36 <sup>+0.1</sup> <sub>-0.3</sub>	30	39
I-16	160	8	60	55	110	M36 x 1.5	32 <sup>+0.1</sup> <sub>0</sub>	40 <sup>+0.1</sup> <sub>-0.3</sub>	34	39
I-18	180	8	67	70	125	M40 x 1.5	40 <sup>+0.1</sup> <sub>0</sub>	50 <sup>+0.1</sup> <sub>-0.3</sub>	42.5	44
I-20	200	8	67	70	125	M45 x 1.5	40 <sup>+0.1</sup> <sub>0</sub>	50 <sup>+0.1</sup> <sub>-0.3</sub>	42.5	44
I-25	250	9	75.5	86	160	M56 x 2	50 <sup>+0.1</sup> <sub>0</sub>	63 <sup>+0.1</sup> <sub>-0.3</sub>	53	66
I-30	300	9	84.5	105	175	M64 x 2	63 <sup>+0.12</sup> <sub>0</sub>	80 <sup>+0.1</sup> <sub>-0.3</sub>	66	71

## Knuckle Pin, Clevis Pin

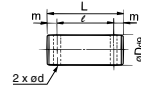

Material: Carbon steel

Part no.	Applicable bore size (mm)	Dd9	L	ℓ	m	d (Drill/through)	Applicable cotter pin
IY-12	125	25 <sup>-0.065</sup> <sub>-0.117</sub>	79.5	69.5	5	4	ø4 x 40
IY-14	140	28 <sup>-0.065</sup> <sub>-0.117</sub>	86.5	76.5	5	4	ø4 x 40
IY-16	160	32 <sup>-0.080</sup> <sub>-0.142</sub>	94.5	84.5	5	4	ø4 x 40
IY-18	180, 200	40 <sup>-0.080</sup> <sub>-0.142</sub>	115	105	5	4	ø4 x 55
IY-25	250	50 <sup>-0.080</sup> <sub>-0.142</sub>	144	132	6	5	ø5 x 65
IY-30	300	63 <sup>-0.100</sup> <sub>-0.174</sub>	178	166	6	5	ø5 x 80

\* IY-□ includes a pin and 2 cotter pins.

## Y Type Double Knuckle Joint\*

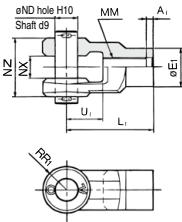

Material: Cast iron

Part no.	Applicable bore size (mm)	A1	E1	L1	MM	ND <sub>H10</sub>	NX	NZ	RR	U1
Y-12	125	8	46	100	M30 x 1.5	25 <sup>+0.084</sup> <sub>0</sub>	32 <sup>+0.3</sup> <sub>-0.1</sub>	64 <sup>-0.1</sup> <sub>-0.3</sub>	27	42
Y-14	140	8	48	105	M30 x 1.5	28 <sup>+0.084</sup> <sub>0</sub>	36 <sup>+0.3</sup> <sub>-0.1</sub>	72 <sup>-0.1</sup> <sub>-0.3</sub>	30	47
Y-16	160	8	55	110	M36 x 1.5	32 <sup>+0.1</sup> <sub>0</sub>	40 <sup>+0.3</sup> <sub>-0.1</sub>	80 <sup>-0.1</sup> <sub>-0.3</sub>	34	46
Y-18	180	8	70	125	M40 x 1.5	40 <sup>+0.1</sup> <sub>0</sub>	50 <sup>+0.3</sup> <sub>-0.1</sub>	100 <sup>-0.1</sup> <sub>-0.3</sub>	42.5	54
Y-20	200	8	70	125	M45 x 1.5	40 <sup>+0.1</sup> <sub>0</sub>	50 <sup>+0.3</sup> <sub>-0.1</sub>	100 <sup>-0.1</sup> <sub>-0.3</sub>	42.5	54
Y-25	250	9	86	160	M56 x 2	50 <sup>+0.1</sup> <sub>0</sub>	63 <sup>+0.3</sup> <sub>-0.1</sub>	126 <sup>-0.1</sup> <sub>-0.3</sub>	53	81
Y-30	300	9	105	175	M64 x 2	63 <sup>+0.12</sup> <sub>0</sub>	80 <sup>+0.3</sup> <sub>-0.1</sub>	160 <sup>-0.1</sup> <sub>-0.3</sub>	66	87

\* Use a single knuckle joint or a double knuckle joint individually.

(Screw it entirely over the rod end threads and tighten it.)

\* Extend the dimensions of A, H, when using a single/double knuckle joint together with a rod end nut.

\* Pin and cotter pin are attached for double knuckle joint.

● The rod end bracket type is available as Made to Order "XC86" when ordering the cylinder and attached mounting brackets. Refer to page 1855.

## Rod End Nut

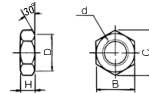

Material: Rolled steel

Part no.	Applicable bore size (mm)	d	H	B	C	D
NT-12	125, 140	M30 x 1.5	18	46	53.1	44
NT-16	160	M36 x 1.5	21	55	63.5	53
NT-18	180	M40 x 1.5	23	60	69.3	57
NT-20	200	M45 x 1.5	27	70	80.8	67
NT-25	250	M56 x 2	34	85	98.1	82
NT-30	300	M64 x 2	38	95	110.0	92

CG1

CJP

CG2

JCM

CM2

CM3

CG1

CG3

JMB

MB

MB1

CA2

CS1

CS2

D-□

-X□

Technical Data

# Air Cylinder: Double Rod Type

# CS1W Series

Lube/Non-lube:  $\varnothing 125, \varnothing 140, \varnothing 160, \varnothing 180, \varnothing 200, \varnothing 250, \varnothing 300$

Air-hydro:  $\varnothing 125, \varnothing 140, \varnothing 160$

For the aluminum tubing of bore sizes 125, 140 and 160, a new "CS2 series"(P.565) model is now available with reduced weight and self weight deflection. Please consider using the CS2 series.

## How to Order

**CS1W L**    **125**   **100**   **V**

**With auto switch CDS1W L**    **125**   **100**   **M9BW**

**Built in magnet** (σ125 to σ200) (Built-in magnet) **Double rod type**

**Mounting**

<b>B</b>	Basic type
<b>L</b>	Foot type
<b>F</b>	Rod side flange type
<b>T</b>	Center trunnion type

**Port thread type**

<b>NI</b>	Rc
<b>TF</b>	NPT
<b>n</b>	G

**Bore size**

Lube, Non-lube		Air-hydro	
125	125 mm	125	125 mm
140	140 mm	140	140 mm
160	160 mm	160	160 mm
180	180 mm		
200	200 mm		
250*	250 mm		
300*	300 mm		

\* It is not available with auto switch.

**Type**

<b>NI</b>	Lube
<b>N</b>	Non-lube
<b>H</b>	Air-hydro

**Number of auto switches**

<b>NI</b>	2 pcs.
<b>3</b>	3 pcs.
<b>S</b>	1 pc.
<b>n</b>	"n" pcs.

**Auto switch**

<b>NI</b>	Without auto switch
-----------	---------------------

\* Refer to the table below for the applicable auto switch model.

**Suffix for cylinder**

Rod boot in one side	<b>J</b>	Nylon tarpaulin
	<b>K</b>	Heat resistant tarpaulin
Rod boot in both sides	<b>JJ</b>	Nylon tarpaulin
	<b>KK</b>	Heat resistant tarpaulin
	<b>N</b>	Without cushion
	<b>R</b>	With cushion in rod side
	<b>H</b>	With cushion in head side
Cushion	<b>NI</b>	With cushion in both sides (Air-hydro type has no cushion.)

**Made to Order** (Refer to page 549 for details.)

**Class 2 Pressure Vessel** (Subject to or not subject to)

<b>NI</b>	Applicable
<b>V</b>	Not applicable

**Tubing material**

Symbol	Bore size (mm)	Tubing material	Stroke range (mm)	
			Without switch	With switch
<b>NI</b>	<b>125, 140</b>	Aluminum tube	1000 or less	1000 or less
	<b>160</b>		1200 or less	1200 or less
	<b>180</b>		1200 or less	1200 or less
	<b>200</b>	Steel tube	1200 or less <sup>Note)</sup>	998 or less
<b>F</b>	<b>250, 300</b>		1200 or less	—
	<b>125, 140</b>	Steel tube	1000 or less	1000 or less
	<b>160</b>		1200 or less	1200 or less

\* Refer to page 549 for the maximum strokes.  
Note) For items corresponding to the Class 2 Pressure Vessel Act, the material is aluminum alloy.

**Built-in magnet cylinder model**

If a built-in magnet cylinder without auto switch is required, there is no need to enter the symbol for auto switch. (Example) CDS1WB125-100

**Cylinder stroke (mm)** (Refer to "Maximum Stroke" on page 549.)

\* If specifying more than one symbol, indicate them in alphabetically.  
\*\* Air-hydro type has no cushion. No symbol indicates no cushion.

## Applicable Auto Switches

Refer to pages 1575 to 1701 for further information on auto switches.

Type	Special function	Electrical entry	Indicator light	Wiring (Output)	Load voltage		Auto switch model		Lead wire length (m)					Pre-wired connector	Applicable load			
					DC	AC	Tie-rod mounting	Band mounting	0.5 (NI)	1 (M)	3 (L)	5 (Z)						
Solid state auto switch	—	Grommet	No	3-wire (NPN)	24 V	5 V, 12 V	—	<b>M9N</b>	●	●	●	○	○	IC circuit	Relay, PLC			
				3-wire (PNP)				<b>M9P</b>	●	●	●	○	○					
		Terminal conduit	Yes	2-wire	24 V	5 V, 12 V	—	<b>M9B</b>	●	●	●	○	○	IC circuit				
				3-wire (NPN)				<b>G39</b>	—	—	—	—	—			IC circuit		
	Diagnostic indication (2-color indicator)	Grommet	Yes	2-wire	24 V	5 V, 12 V	—	<b>K39</b>	—	—	—	—	—	IC circuit				
				3-wire (NPN)				<b>M9NW</b>	●	●	●	○	○					
				3-wire (PNP)				<b>M9PW</b>	●	●	●	○	○					
				2-wire				<b>M9BW</b>	●	●	●	○	○					
				3-wire (NPN)				<b>M9NA</b> *1	○	○	●	○	○			IC circuit		
				3-wire (PNP)				<b>M9PA</b> *1	○	○	●	○	○					
Water resistant (2-color indicator)	Grommet	No	2-wire	24 V	5 V, 12 V	—	<b>M9BA</b> *1	○	○	○	○	○	IC circuit					
			4-wire (NPN)				<b>F59F</b>	—	—	●	●	●		IC circuit				
			2-wire (Non-polar)				<b>P3DWA</b>	—	—	●	●	●			IC circuit			
			3-wire (PN equivalent)				<b>A96</b>	—	—	●	●	●		IC circuit				
Reed auto switch	—	Grommet	No	2-wire	24 V	12 V	100 V	<b>A93</b>	●	●	●	—	IC circuit		Relay, PLC			
								Terminal conduit	Yes	12 V	100 V or less	<b>A90</b>		●		●	●	—
												DIN terminal		Yes		100 V, 200 V	<b>A54</b>	●
		<b>A64</b>	●										—				●	—
		Grommet	No					100 V, 200 V	<b>A33</b>	—	—	—	—	—		—	PLC	
									<b>A34</b>	—	—	—	—	—				
<b>A44</b>	—			—	—	—	—											
Diagnostic indication (2-color indicator)	Grommet	Yes	—	—	—	—	—	<b>A59W</b>	●	●	●	—	—	Relay, PLC				

\*1 Water resistant type auto switches can be mounted on the above models, but in such case SMC cannot guarantee water resistance. Consult with SMC regarding water resistant types with the above model numbers.

\* Lead wire length symbols: 0.5 m ..... NI (Example) M9NW 3 m ..... L (Example) M9NWL  
1 m ..... M (Example) M9NWM 5 m ..... Z (Example) M9NWZ

\* Solid state auto switches marked with "O" are produced upon receipt of order.  
\* Since there are other applicable auto switches than listed above, refer to page 563 for details.

\* For details about auto switches with pre-wired connector, refer to pages 1648 and 1649.

\* D-A9C/M9C/M9CWA/P3DWA□ auto switches are shipped together (not assembled). (Only auto switch mounting brackets are assembled before shipped.)

# Air Cylinder: Double Rod Type **CS1W Series**



## Symbol

Air cushion

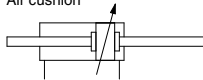

**Made to Order Specifications**  
(For details, refer to pages 1703 to 1896.)

Symbol	Specifications
-XA□	Change of rod end shape
-XB6	Heat-resistant cylinder (-10 to 150°C)
-XC4	With heavy duty scraper
-XC5	Heat resistant cylinder (110°C)
-XC6	Piston rod and rod end nut made of stainless steel
-XC14	Change of trunnion bracket mounting position
-XC15	Change of tie-rod length
-XC30	Rod side trunnion
-XC35	With coil scraper

Refer to pages 561 to 563 for auto switch specifications.

- Minimum auto switch mounting stroke
- Proper auto switch mounting position (detection at stroke end) and mounting height
- Operating range
- Switch mounting bracket: Part no.

## Specifications

Type	Lube, Non-lube	Air-hydro
<b>Fluid</b>	Air	Turbine oil
<b>Proof pressure</b>	1.57 MPa <sup>Note)</sup>	
<b>Max. operating pressure</b>	0.97 MPa	0.97 MPa
<b>Min. operating pressure</b>	0.05 MPa	0.06 MPa
<b>Piston speed</b>	50 to 500 mm/s	0.5 to 200 mm/s
<b>Cushion</b>	Interchangeable	
<b>Ambient and fluid temperature</b>	Without switch 0 to 70°C (No freezing) With switch 0 to 60°C (No freezing)	Air-hydro 5 to 60°C
<b>Stroke length tolerance</b>	250 <sup>st</sup> or less: $+1.0$ <sub>0</sub> 251 to 1,000 <sup>st</sup> : $+1.4$ <sub>0</sub> 1,001 to 1,200 <sup>st</sup> : $+1.8$ <sub>0</sub>	
<b>Mounting</b>	Basic type, Foot type, Rod side flange type, Center trunnion type	

Note) Item corresponding to Class 2 Pressure Vessel Act is 1.46 MPa.

## Maximum Stroke

Bore size (mm)	Aluminum tube		Steel tube
	Without switch	With switch	Without switch
<b>125, 140</b>	1000 or less	1000 or less	1000 or less
<b>160</b>	1200 or less	1200 or less	1200 or less
<b>180</b>	—	1200 or less	1200 or less
<b>200</b>	—	998 or less <sup>Note 1)</sup>	1200 or less <sup>Note 2)</sup>
<b>250, 300</b>	—	—	1200 or less

Note 1) For models with a bore size of 200 with auto switches, strokes of 999 to 1200 are available as special orders.

Note 2) The tubing material of items with a bore size of 180 and 200 corresponding to the Class 2 Pressure Vessel Act is aluminum tubing.

## Accessory

Mounting		Basic type	Foot type	Rod side flange type	Center trunnion type
Option	Rod end nut	●	●	●	●
	Single knuckle joint	●	●	●	●
	Double knuckle joint (Clevis pin, Cotter pin)	●	●	●	●
	Rod boot	●	●	●	●

\* For details about part numbers and dimensions, refer to page 547.  
(For rod boots, refer to page 553.)

## Mounting Bracket Part No.

Bore size (mm)	125	140	160	180	200	250	300
Foot type*	CS1W-L12	CS1W-L14	CS1W-L16	CS1W-L18	CS1W-L20	CS1W-L25	CS1W-L30
Flange type	CS1-F12	CS1-F12	CS1-F16	CS1-F18	CS1-F20	CS1-F25	CS1-F30

\* Order two foot brackets per cylinder.

## Rod Boot Material

Symbol	Material	Maximum ambient temperature
<b>J</b>	Nylon tarpaulin	70°C
<b>K</b>	Heat resistant tarpaulin	110°C*

\* Maximum ambient temperature for the rod boot itself.

CJ1

CJP

CJ2

JCM

CM2

CM3

CG1

CG3

JMB

MB

MB1

CA2

CS1

CS2

D-□

-X□

Technical Data

# CS1W Series

## Principal Parts Material and Surface Treatment

Description	Material	Note
Cover	Rolled steel plate	Black painted
Tube *	Aluminum alloy	Hard anodized
	Carbon steel tube	Hard chrome plated
	Carbon steel tube <sup>Note)</sup>	Hard chrome plated <sup>Note)</sup>
Sliding seal	Lube	NBR
	Non-lube	NBR
	Air-hydro	NBR
Piston rod	Carbon steel	Hard chrome plated
Piston	Lube	Cast iron (With auto switch: Aluminum alloy casted)
	Non-lube	Aluminum alloy casted (Iron tube: Cast iron)
	Air-hydro	Aluminum alloy casted (Iron tube: Cast iron)

\* In the case of an auto switch with bore sizes  $\phi 180$  and  $\phi 200$ , tubing material is aluminum alloy (hard anodized). Piston seal is NLP.

Note) For items with a bore size of  $\phi 180$  and  $\phi 200$  corresponding to the Class 2 Pressure Vessel Act, the material is "Aluminum alloy" and the note should state "Hard anodized".

## Weight/Aluminum Tube: Lube Type (Non-lube, Air-hydro) (kg)

Bore size (mm)		$\phi 125$	$\phi 140$	$\phi 160$
Basic weight	Basic type	16.51 (15.28)	19.62 (18.12)	26.65 (24.79)
	Foot type	18.14 (16.91)	22.14 (20.64)	29.45 (27.59)
	Rod side flange type	19.19 (17.96)	24.62 (23.12)	33.04 (31.18)
	Trunnion type	20.64 (19.41)	25.35 (23.85)	34.05 (32.19)
Add'l weight per each 100 mm stroke		2.57	2.76	3.38
Accessory bracket	Single knuckle	0.91	1.16	1.56
	Double knuckle (Knuckle pin, Cotter pin)	1.37	1.81	2.48
	Rod end nut	0.16	0.16	0.23

\* ( ): Denotes the non-lube and air-hydro type.

Calculation: (Example) **CS1WL125-500**

- Basic weight .....18.14 (Foot type,  $\phi 125$ )
  - Additional weight .....2.57/100 stroke
  - Cylinder stroke .....500 stroke
- 18.14 + 2.57 x 500/100 = 30.99 kg

## Weight/Steel Tube (kg)

Bore size (mm)		$\phi 125$	$\phi 140$	$\phi 160$	$\phi 180$	$\phi 200$	$\phi 250$	$\phi 300$
Basic weight	Basic type	16.85	20.03	27.12	36.90	45.79	85.36	122.39
	Foot type	18.48	22.55	29.92	41.10	50.67	94.86	139.67
	Rod side flange type	19.53	25.03	33.51	46.73	57.70	107.20	152.59
	Trunnion type	20.98	25.76	34.52	47.52	59.78	113.20	162.82
Add'l weight per each 100 mm stroke		3.46	3.81	4.57	6.20	7.29	11.30	15.17
Accessory bracket	Single knuckle	0.91	1.16	1.56	3.07	2.90	5.38	10.82
	Double knuckle (Knuckle pin, Cotter pin)	1.37	1.81	2.48	4.74	4.59	9.22	17.17
	Rod end nut	0.16	0.16	0.23	0.32	0.85	1.26	1.43



## Construction

### Lube, Non-lube With auto switch

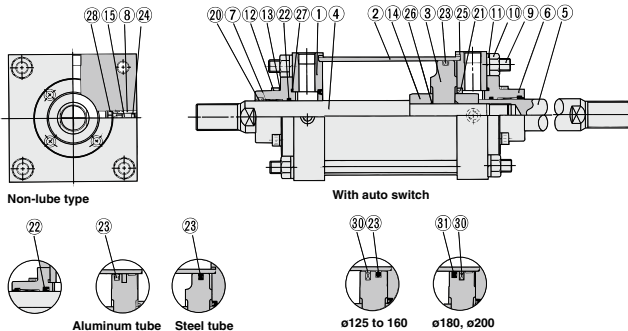

### Air-hydro

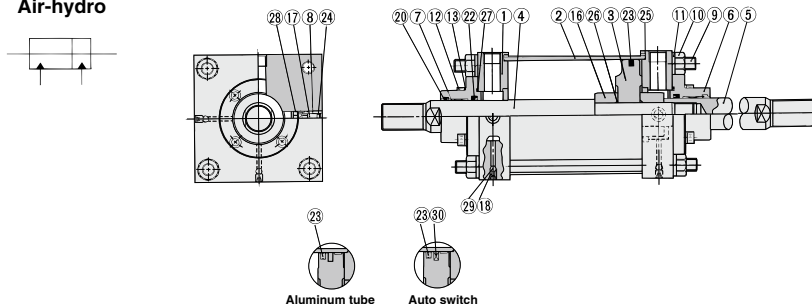

### Component Parts

No.	Description	Material	Note
1	Rod cover	Rolled steel	Black painted
2	Cylinder tube	ø125 to ø160 Aluminum alloy	Hard anodized
		ø125 to ø300* Carbon steel tube	Inside: Hard chrome plated
3	Piston	Cast iron*	
4	Piston rod A	Carbon steel	Hard chrome plated
5	Piston rod B	Carbon steel	Hard chrome plated
6	Retaining plate	Cast iron	Black painted
7	Bushing	Bearing alloy	
8	Valve guide	Brass	
9	Tie-rod	Carbon steel	Chromated
10	Tie-rod nut	Rolled steel	Black zinc chromated
11	Spring washer	Steel wire	Black zinc chromated
12	Retaining plate bolt	Chromium molybdenum steel	Black zinc chromated
13	Spring washer	Steel wire	Black zinc chromated
14	Cushion ring A	Rolled steel	Zinc chromated
15	Cushion valve	Rolled steel	Electroless nickel plated
16	Spacer A	Rolled steel	
17	Air releasing B	Rolled steel	Zinc chromated
18	Air releasing A	Chromium molybdenum steel	
29	Check ball	Chrome bearing steel	
30	Magnet	—	

\* In the case of the aluminum tube of non-lube and air-hydro type, piston material is an aluminum alloy casted. In the case of auto switch bore size ø180 and ø200, piston material is aluminum alloy casted and tubing material is aluminum alloy (hard anodized).  
For items with a bore size of ø180 and ø200 corresponding to the Class 2 Pressure Vessel Act, the material is "Aluminum alloy" and the note should state "Hard anodized".

### Seal List

No.	Description	Material	Note
<b>Lube</b>			
20	Wiper ring	NBR	
21	Cushion seal		
22	Rod seal		
23	Piston seal		
24	Valve seal		
25	Tube gasket		
26*	Piston gasket		
27	Retaining plate gasket		
28*	Guide gasket		

### Non-lube

Seals except 22 and 23 are the same as lube type.

22	Rod seal	NBR	
23	Piston seal	NBR	

### Air-hydro

Seals except 22 and 23 are the same as lube type.

No.	Description	Material	Note
22	Rod seal	NBR	
23	Piston seal		

### Lube (With switch)

Seals except 31 are the same as lube type.

No.	Description	Material	Note
31	Piston seal	NBR	

### Replacement Parts (Seal kit)

- For replacement parts no. (seal kits) of double rod type cylinder for the CS1W series, refer to page 552.
- \* Seal kits does not include cushion seal, piston seal and guide gasket because those are not replaceable parts.

CJ1

CJP

CJ2

JCM

CM2

CM3

CG1

CG3

JMB

MB

MB1

CA2

**CS1**

CS2

D-□

-X□

Technical Data

# CS1W Series

## Double Acting, Double Rod/Replacement Parts /Seal kit

When ordering the replacement parts (seal kits) for the CS1W series double rod type cylinder, indicate the order number listed in the table at right.

Each set of replacement parts contains the following: wiper ring, rod seal, piston seal, valve seal, tube gasket, and push plate gasket (for 1 cylinder).

### Lube

Bore size (mm)	Kit no.	Description
125	CS1W-125A-PS	Component part numbers: ⑳, ㉑, ㉒, ㉓, ㉔, ㉕, ㉖
140	CS1W-140A-PS	
160	CS1W-160A-PS	
180	CS1W-180A-PS	
200	CS1W-200A-PS	
300	CS1W-300A-PS	

\* Seal kit includes a grease pack (ø125 to 160: 40 g, ø180 and 200: 50 g, ø250 and 300: 60 g). Order with the following part number when only the grease pack is needed.

**Grease pack part no.:** GR-S-010 (10 g), GR-S-020 (20 g)

### Non-lube with Auto Switch

Bore size (mm)	Kit no.	Description
125	CS1WN125A-PS	Component part numbers: ⑳, ㉑, ㉒, ㉓, ㉔, ㉕, ㉖
140	CS1WN140A-PS	
160	CS1WN160A-PS	
180	CS1WN180A-PS	
200	CS1WN200A-PS	
250*	CS1WN250A-PS	
300*	CS1WN300A-PS	

\* It is not available with auto switch.

\* Seal kit includes a grease pack (ø125 to 160: 40 g, ø180 and 200: 50 g, ø250 and 300: 60 g). Order with the following part number when only the grease pack is needed.

**Grease pack part no.:** GR-S-010 (10 g), GR-S-020 (20 g)

### Lube with Auto Switch

Bore size (mm)	Kit no.	Description
125	CS1W125A-PS	Component part numbers: ⑳, ㉑, ㉒, ㉓, ㉔, ㉕, ㉖
140	CS1W140A-PS	
160	CS1W160A-PS	
180	CDS1W180A-PS	
200	CDS1W200A-PS	

\* Seal kit includes a grease pack (ø125 to 160: 40 g, ø180 and 200: 50 g). Order with the following part number when only the grease pack is needed.

**Grease pack part no.:** GR-S-010 (10 g), GR-S-020 (20 g)

### Air-hydro

Bore size (mm)	Kit no.	Description
125	CS1WH125A-PS	Component part numbers: ⑳, ㉑, ㉒, ㉓, ㉔, ㉕, ㉖
140	CS1WH140A-PS	
160	CS1WH160A-PS	

## Basic Type: CS1WB

Lube type (CS1WB), Non-lube type (CS1WBN), Air-hydro type (CS1WBH)

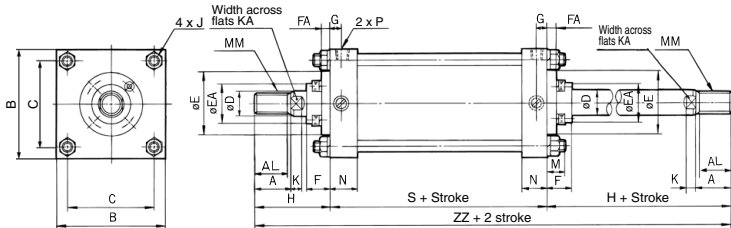

**With rod boot (One side)**

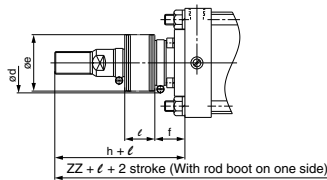

$ZZ + \ell + 2 \text{ stroke}$  (With rod boot on one side)

**With rod boot (Both sides)**

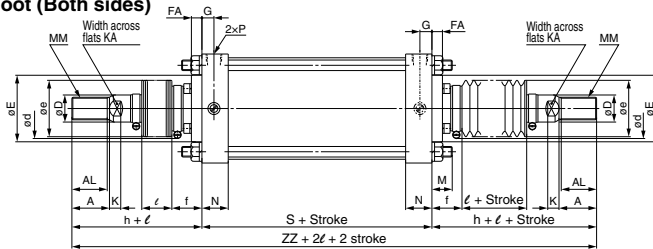

Type	Bore size (mm)	Stroke range (mm)																			
		Without rod boot	With rod boot	A	AL	B	C	D	E	EA	F	FA	G	J	K	KA	M	MM	N	P	S
Lube Non-lube Air-hydro	<b>125</b>	Up to 1000	30 to 1000	50	47	145	115	36	90	59	43	14	16	M14 x 1.5	15	31	27	M30 x 1.5	35	1/2	98
	<b>140</b>	Up to 1000	30 to 1000	50	47	161	128	36	90	59	43	14	16	M14 x 1.5	15	31	27	M30 x 1.5	35	1/2	98
	<b>160</b>	Up to 1200	30 to 1200	56	53	182	144	40	90	59	43	14	18.5	M16 x 1.5	17	36	30.5	M36 x 1.5	39	3/4	106
Lube Non-lube	<b>180</b>	Up to 1200	30 to 1200	63	60	204	162	45	115	70	48	17	18.5	M18 x 1.5	20	41	35	M40 x 1.5	39	3/4	111
	<b>200</b>	Up to 1200	30 to 1200	63	60	226	182	50	115	74	48	17	18.5	M20 x 1.5	20	46	35	M45 x 1.5	39	3/4	111
	<b>250</b>	Up to 1200	30 to 1200	71	67	277	225	60	140	86	60	20	23	M24 x 1.5	25	56	41.5	M56 x 2	49	1	141
	<b>300</b>	Up to 1200	30 to 1200	80	76	330	270	70	140	96	60	20	23	M30 x 1.5	30	65	51.5	M64 x 2	49	1	146

Type	Bore size (mm)	Stroke range (mm)										Both sides	
		Without rod boot		With rod boot (Single side)						Both sides		ZZ	ZZ
		H	ZZ	d	e	f	h	ℓ	ZZ	ZZ			
Lube Non-lube Air-hydro	<b>125</b>	110	318	82	75	40	133	0.2 stroke	341	364			
	<b>140</b>	110	318	82	75	40	133	0.2 stroke	341	364			
	<b>160</b>	120	346	82	75	40	141	0.2 stroke	367	388			
Lube Non-lube	<b>180</b>	135	381	92	85	45	153	0.2 stroke	399	417			
	<b>200</b>	135	381	96	90	45	153	0.2 stroke	399	417			
	<b>250</b>	160	461	108	105	55	176	0.17 stroke	477	493			
	<b>300</b>	175	496	118	115	55	190	0.17 stroke	511	526			

### With Auto Switch: ø125 to ø200 Only

Type	Bore size (mm)	Stroke range (mm)		Mounting dimensions (mm)			
		Without rod boot	With rod boot	S	ZZ	ZZ	
Lube Non-lube Air-hydro	<b>125</b>	Up to 1000	30 to 1000	98	318	341	364
	<b>140</b>	Up to 1000	30 to 1000	98	318	341	364
	<b>160</b>	Up to 1200	30 to 1200	106	346	367	388
Lube Non-lube	<b>180</b>	Up to 1200	30 to 1200	115	385	403	421
	<b>200</b>	Up to 998	30 to 998	120	390	408	426

\*\*\* Refer to "Minimum Stroke for Auto Switch Mounting" on page 562.

- CJ1**
- CJP**
- CJ2**
- JCM**
- CM2**
- CM3**
- CG1**
- CG3**
- JMB**
- MB**
- MB1**
- CA2**
- CS1**
- CS2**

# CS1W Series

## Foot Type: CS1WL

### Lube type (CS1WL), Non-lube type (CS1WLN), Air-hydro type (CS1WLH)

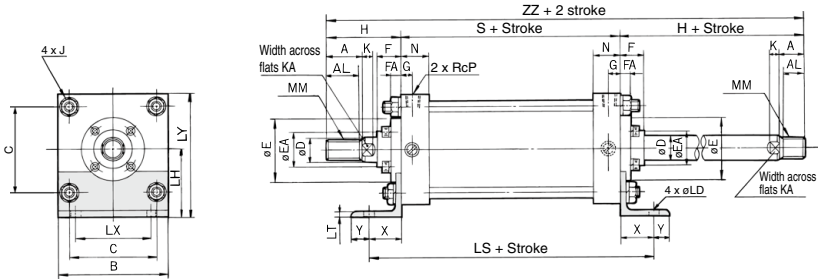

#### With rod boot

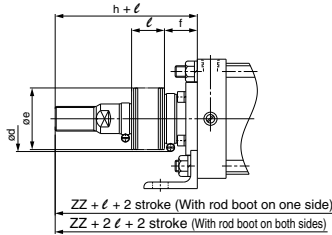

Type	Bore size (mm)	Stroke range (mm)		(mm)																
		Without rod boot	With rod boot	A	AL	B	C	D	E	EA	F	FA	G	J	K	KA	LD	LH	LS	LT
		Lube	<b>125</b>	Up to 1000	30 to 1000	50	47	145	115	36	90	59	43	14	16	M14 x 1.5	15	31	19	85
Non-lube	<b>140</b>	Up to 1000	30 to 1000	50	47	161	128	36	90	59	43	14	16	M14 x 1.5	15	31	19	100	188	9
Air-hydro	<b>160</b>	Up to 1200	30 to 1200	56	53	182	144	40	90	59	43	14	18.5	M16 x 1.5	17	36	19	106	206	9
Lube Non-lube	<b>180</b>	Up to 1200	30 to 1200	63	60	204	162	45	115	70	48	17	18.5	M18 x 1.5	20	41	24	125	231	10
	<b>200</b>	Up to 1200	30 to 1200	63	60	226	182	50	115	74	48	17	18.5	M20 x 1.5	20	46	24	132	231	10
	<b>250</b>	Up to 1200	30 to 1200	71	67	277	225	60	140	86	60	20	23	M24 x 1.5	25	56	29	160	301	12
	<b>300</b>	Up to 1200	30 to 1200	80	76	330	270	70	140	96	60	20	23	M30 x 1.5	30	65	33	200	326	15

Type	Bore size (mm)	LX	LY	MM	N	P	S	X	Y	(mm)											
										Without rod boot					With rod boot (Single side)					With rod boot (Both sides)	
										H	ZZ	d	e	f	h	l	ZZ	ZZ			
Lube	<b>125</b>	100	157.5	M30 x 1.5	35	1/2	98	45	20	110	318	82	75	40	133	0.2 stroke	341	364			
Non-lube	<b>140</b>	112	180.5	M30 x 1.5	35	1/2	98	45	30	110	318	82	75	40	133	0.2 stroke	341	364			
Air-hydro	<b>160</b>	118	197	M36 x 1.5	39	3/4	106	50	25	120	346	82	75	40	141	0.2 stroke	367	388			
Lube Non-lube	<b>180</b>	132	227	M40 x 1.5	39	3/4	111	60	30	135	381	92	85	45	153	0.2 stroke	399	417			
	<b>200</b>	150	245	M45 x 1.5	39	3/4	111	60	30	135	381	96	90	45	153	0.2 stroke	399	417			
	<b>250</b>	180	298.5	M56 x 2	49	1	141	80	40	160	461	108	105	55	176	0.17 stroke	477	493			
	<b>300</b>	212	365	M64 x 2	49	1	146	90	40	175	496	118	115	55	190	0.17 stroke	511	526			

#### With Auto Switch: ø125 to ø200 Only

Type	Bore size (mm)	Stroke range (mm)		(mm)						
		Without rod boot	With rod boot	S	LS	Without rod boot			With rod boot (Both sides)	
		ZZ	ZZ	ZZ	ZZ	ZZ	ZZ			
Lube	<b>125</b>	Up to 1000	30 to 1000	98	188	318	341	364		
Non-lube	<b>140</b>	Up to 1000	30 to 1000	98	188	318	341	364		
Air-hydro	<b>160</b>	Up to 1200	30 to 1200	106	206	346	367	388		
Lube Non-lube	<b>180</b>	Up to 1200	30 to 1200	115	235	385	403	421		
	<b>200</b>	Up to 998	30 to 998	120	240	390	408	426		

\*\*\* Refer to "Minimum Stroke for Auto Switch Mounting" on page 562.

## Rod Side Flange Type: CS1WF

Lube type (CS1WF), Non-lube type (CS1WFN), Air-hydro type (CS1WFH)

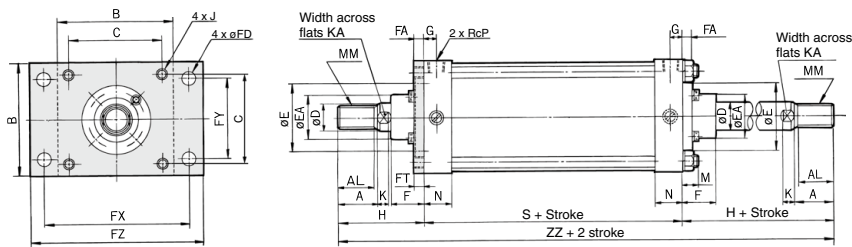

### With rod boot

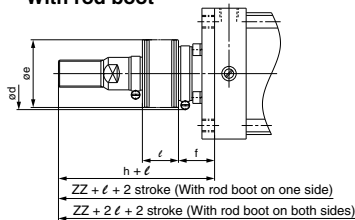

Type	Bore size (mm)	Stroke range (mm)		A	AL	B	B	C	D	E	EA	F	FA	FD	FT	FT	FX	FY	FZ	G	J
		Without rod boot	With rod boot																		
Lube Non-lube Air-hydro	125	Up to 1000	30 to 1000	50	47	145	145	115	36	90	59	43	14	19	14	190	100	230	16	M14 x 1.5	
	140	Up to 1000	30 to 1000	50	47	160	161	128	36	90	59	43	14	19	20	212	112	255	16	M14 x 1.5	
	160	Up to 1200	30 to 1200	56	53	180	182	144	40	90	59	43	14	19	20	236	118	275	18.5	M16 x 1.5	
Lube Non-lube	180	Up to 1200	30 to 1200	63	60	200	204	162	45	115	70	48	17	24	25	265	132	320	18.5	M18 x 1.5	
	200	Up to 1200	30 to 1200	63	60	225	226	182	50	115	74	48	17	24	25	280	150	335	18.5	M20 x 1.5	
	250	Up to 1200	30 to 1200	71	67	275	277	225	60	140	86	60	20	29	30	355	180	420	23	M24 x 1.5	
	300	Up to 1200	30 to 1200	80	76	330	330	270	70	140	96	60	20	33	30	400	212	475	23	M30 x 1.5	

Type	Bore size (mm)	K	KA	M	MM	N	P	S	Without rod boot		With rod boot (Single side)							Both sides	
									H	ZZ	d	e	f	h	ℓ	ZZ	ZZ		
Lube Non-lube Air-hydro	125	15	31	30	M30 x 1.5	35	1/2	98	110	318	82	75	40	133	0.2 stroke	341	364		
	140	15	31	24	M30 x 1.5	35	1/2	98	110	318	82	75	40	133	0.2 stroke	341	364		
	160	17	36	26	M36 x 1.5	39	3/4	106	120	346	82	75	40	141	0.2 stroke	367	388		
Lube Non-lube	180	20	41	31	M40 x 1.5	39	3/4	111	135	381	92	85	45	153	0.2 stroke	399	417		
	200	20	46	31	M45 x 1.5	39	3/4	111	135	381	96	90	45	153	0.2 stroke	399	417		
	250	25	56	35	M56 x 2	49	1	141	160	461	108	105	55	176	0.17 stroke	477	493		
	300	30	65	48	M64 x 2	49	1	146	175	496	118	115	55	190	0.17 stroke	511	526		

### With Auto Switch: ø125 to ø200 Only (mm)

Type	Bore size (mm)	Stroke range (mm)		S	Without rod boot	With rod boot (Single side)	With rod boot (Both sides)
		Without rod boot	With rod boot		ZZ	ZZ	ZZ
Lube Non-lube Air-hydro	125	Up to 1000	30 to 1000	98	318	341	364
	140	Up to 1000	30 to 1000	98	318	341	364
	160	Up to 1200	30 to 1200	106	346	367	388
Lube Non-lube	180	Up to 1200	30 to 1200	115	385	403	421
	200	Up to 998	30 to 998	120	390	408	426

\*\*\* Refer to "Minimum Stroke for Auto Switch Mounting" on page 562.

- CJ1**
- CJP**
- CJ2**
- JCM**
- CM2**
- CM3**
- CG1**
- CG3**
- JMB**
- MB**
- MB1**
- CA2**
- CS1**
- CS2**

- D-□**
- X□**
- Technical Data

# CS1W Series

## Center Trunnion Type: CS1WT

Lube type (CS1WT), Non-lube type (CS1WTN), Air-hydro type (CS1WTH)

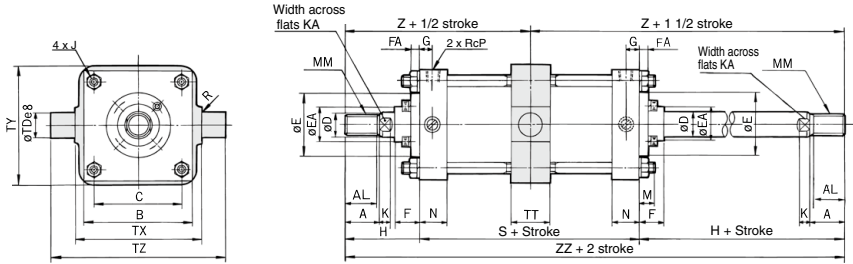

### With rod boot

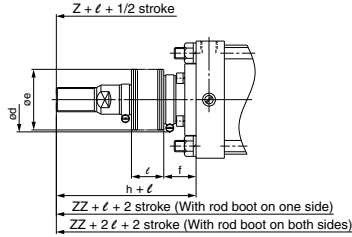

Type	Bore size (mm)	Stroke range (mm)																				
		Without rod boot	With rod boot	A	AL	B	C	D	E	EA	F	FA	G	J	K	KA	M	MM	N	P	R	S
		Lube	<b>125</b>	25 to 1000	30 to 1000	50	47	145	115	36	90	59	43	14	16	M14 x 1.5	15	31	19	M30 x 1.5	35	1/2
Non-lube	<b>140</b>	30 to 1000	30 to 1000	50	47	161	128	36	90	59	43	14	16	M14 x 1.5	15	31	19	M30 x 1.5	35	1/2	1.5	98
Air-hydro	<b>160</b>	35 to 1200	35 to 1200	56	53	182	144	40	90	59	43	14	18.5	M16 x 1.5	17	36	22	M36 x 1.5	39	3/4	1.5	106
	<b>180</b>	30 to 1200	30 to 1200	63	60	204	162	45	115	70	48	17	18.5	M18 x 1.5	20	41	26	M40 x 1.5	39	3/4	2	111
Lube	<b>200</b>	30 to 1200	30 to 1200	63	60	226	182	50	115	74	48	17	18.5	M20 x 1.5	20	46	26	M45 x 1.5	39	3/4	2	111
	<b>250</b>	30 to 1200	30 to 1200	71	67	277	225	60	140	86	60	20	23	M24 x 1.5	25	56	30	M56 x 2	49	1	3	141
Non-lube	<b>300</b>	35 to 1200	35 to 1200	80	76	330	270	70	140	96	60	20	23	M30 x 1.5	30	65	36	M64 x 2	49	1	4	146

Type	Bore size (mm)	TDes	TT	TX	TY	TZ	H	Without rod boot												With rod boot (Single side)				With rod boot (Both sides)			
								Z		ZZ		d	e	f	h	l	Z	ZZ	Z	ZZ	Z	ZZ					
								Z	ZZ	d	e	f	h	l	Z	ZZ	Z	ZZ	Z	ZZ	Z	ZZ					
Lube	<b>125</b>	32 <sup>+0.050</sup> <sub>-0.089</sub>	50	170	164	234	110	159	318	82	75	40	133	0.2 stroke	182	341	182	364									
Non-lube	<b>140</b>	36 <sup>+0.050</sup> <sub>-0.089</sub>	55	190	184	262	110	159	318	82	75	40	133	0.2 stroke	182	341	182	364									
Air-hydro	<b>160</b>	40 <sup>+0.050</sup> <sub>-0.089</sub>	60	212	204	292	120	173	346	82	75	40	141	0.2 stroke	194	367	194	388									
	<b>180</b>	45 <sup>+0.050</sup> <sub>-0.089</sub>	59	236	228	326	135	190.5	381	92	85	45	153	0.2 stroke	208.5	399	208.5	417									
Lube	<b>200</b>	45 <sup>+0.050</sup> <sub>-0.089</sub>	59	265	257	355	135	190.5	381	96	90	45	153	0.2 stroke	208.5	399	208.5	417									
	<b>250</b>	56 <sup>+0.060</sup> <sub>-0.106</sub>	69	335	325	447	160	230.5	461	108	105	55	176	0.17 stroke	246.5	477	246.5	493									
Non-lube	<b>300</b>	67 <sup>+0.060</sup> <sub>-0.106</sub>	79	400	390	534	175	248	496	118	115	55	190	0.17 stroke	263	511	263	526									

### With Auto Switch: ø125 to ø200 Only

Type	Bore size (mm)	Stroke range (mm)		S	Without rod boot				With rod boot (Single side)				With rod boot (Both sides)			
		Without rod boot	With rod boot		Z	ZZ	Z	ZZ	Z	ZZ	Z	ZZ				
		Lube	<b>125</b>		25 to 1000	30 to 1000	98	159	318	182	341	364				
Non-lube	<b>140</b>	30 to 1000	30 to 1000	98	159	318	182	341	364							
Air-hydro	<b>160</b>	35 to 1200	35 to 1200	106	173	346	194	367	388							
	<b>180</b>	30 to 1200	30 to 1200	115	192.5	385	210.5	403	421							
Lube	<b>200</b>	30 to 998	30 to 998	120	195	390	213	408	426							

\*\*\* Refer to "Minimum Stroke for Auto Switch Mounting" on page 562.

# Air Cylinder: Low Friction Type Non-lube Type

## CS1□Q Series

ø125, ø140, ø160

For the aluminum tubing of bore sizes 125, 140 and 160, a new "CS2 series"(P.565) model is now available with reduced weight and self weight deflection. Please consider using the CS2 series.

### How to Order

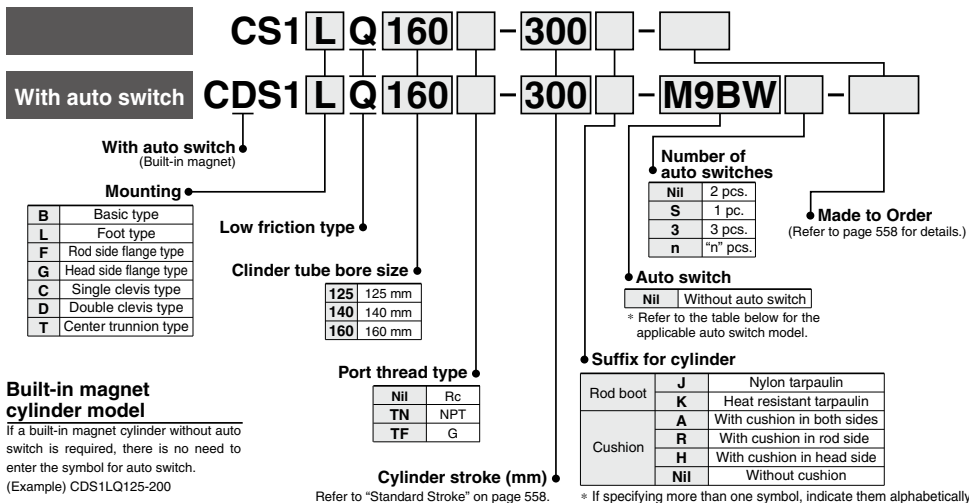

### Built-in magnet cylinder model

If a built-in magnet cylinder without auto switch is required, there is no need to enter the symbol for auto switch. (Example) CDS1LQ125-200

Refer to "Standard Stroke" on page 558.

\* If specifying more than one symbol, indicate them alphabetically.

### Applicable Auto Switches

Refer to pages 1575 to 1701 for further information on auto switches.

Type	Special function	Electrical entry	Indicator light	Wiring (Output)	Load voltage		Auto switch model		Lead wire length (m)					Pre-wired connector	Applicable load			
					DC	AC	Tie-rod mounting	Band mounting	0.5 (Nil)	1 (M)	3 (L)	5 (Z)						
Solid state auto switch	—	Grommet	No	3-wire (NPN)	24 V	5 V, 12 V	—	M9N	●	●	○	○	○	—	—			
				3-wire (PNP)				M9P	●	●	○	○	○					
		2-wire	M9B	●	●	○	○	○	—	—								
		3-wire (NPN)	24 V	5 V, 12 V	—	G39	—	—			—	—	—	—	—			
	2-wire	K39				—	—	—	—	—								
	Diagnostic indication (2-color indicator)	Terminal conduit	Yes	3-wire (NPN)	24 V	5 V, 12 V	—	M9NW	●	●	○	○	○	—	—			
				3-wire (PNP)				M9PW	●	●	○	○	○					
	Water resistant (2-color indicator)	Grommet	Yes	2-wire	24 V	12 V	—	M9BW	●	●	○	○	○	—	—			
				3-wire (NPN)				5 V, 12 V	—	M9NA*1	●	●	○			○	○	
	With diagnostic output (2-color indicator)	Grommet	Yes	3-wire (PNP)	24 V	12 V	—			M9PA*1	—	○	●	○	○	—	—	
2-wire				M9BA*1				—	○	●	○	○						
Magnetic field resistant (2-color indicator)	Terminal conduit	Yes	4-wire (NPN)	24 V	5 V, 12 V	—	F59F	—	●	—	○	○	—	—				
			2-wire (Non-polar)				P3DWA	—	●	●	○	○						
Reed auto switch	—	Grommet	Yes	3-wire (NPN equivalent)	24 V	5 V	—	A96	●	—	—	—	—	—	—			
								12 V	A93	—	●	●	●			—		
								5 V, 12 V	A90	—	●	—	—			—		
								100 V or less	A90	—	●	—	—			—		
								100 V, 200 V	A54	—	●	—	—			—		
		Terminal conduit	No	Yes	2-wire	24 V	12 V	—	—	A33	—	—	—	—	—	—	—	
										A34	—	—	—	—	—			
										200 V or less	A64	—	●	—	—			—
										100 V, 200 V	A44	—	—	—	—			—
										—	A59W	—	●	—	●			—

\*1 Water resistant type auto switches can be mounted on the above models, but in such case SMC cannot guarantee water resistance.

Consult with SMC regarding water resistant types with the above model numbers.

\* Lead wire length symbols: 0.5 m ..... Nil (Example) M9NW \* Solid state auto switches marked with "○" are pre-cuppled upon receipt of order.

1 m ..... M (Example) M9NWM  
3 m ..... L (Example) M9NWL  
5 m ..... Z (Example) M9NWZ

\* Since there are other applicable auto switches than listed above, refer to page 563 for details.

\* For details about auto switches with pre-wired connector, refer to pages 1648 and 1649.

\* D-A9□/M9□/M9□W/M9□A/P3DWA□ auto switches are shipped together (not assembled). (Only auto switch mounting brackets are assembled before shipped.)

CJ1

CJP

CJ2

JCM

CM2

CM3

CG1

CG3

JMB

MB

MB1

CA2

CS1

CS2

D-□

-X□

Technical Data

# CS1□Q Series

**Designed with a low sliding resistance of the piston, this air cylinder is ideal for applications such as contact pressure control, which requires smooth movements at low pressures.**

## Low sliding resistance

Min. operating pressure –0.005 MPa

**Auto switch mounting is possible.**



### Symbol

Double acting, Without cushion

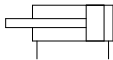

**Made to Order** **Made to Order Specifications**  
(For details, refer to pages 1703 to 1896.)

Symbol	Specifications
-XA□	Change of rod end shape
-XC3	Special port location
-XC14	Change of trunnion bracket mounting position
-XC15	Change of tie-rod length
-XC26	Clevis pins with flat washer
-XC27	Double clevis pins made of stainless steel (Stainless steel 304)
-XC30	Rod side trunnion

## Application Example

Low friction cylinder is used in combination with precision regulator (IR series).

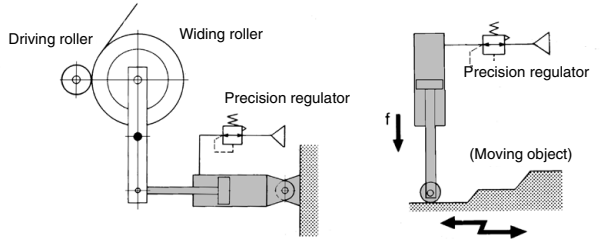

## Specifications

<b>Action</b>	Double acting, Single rod
<b>Direction of low friction</b>	Both directions
<b>Fluid</b>	Air
<b>Proof pressure</b>	1.05 MPa
<b>Maximum operating pressure</b>	0.7 MPa
<b>Minimum operating pressure</b>	0.005 MPa *
<b>Ambient and fluid temperature</b>	Without auto switch: 0 to 70°C (No freezing) With auto switch: 0 to 60°C (No freezing)
<b>Allowable leakage</b>	0.5L/min (ANR) or less
<b>Cushion</b>	None (With cushion is available.)
<b>Lubrication</b>	Not required (Non-lube)
<b>Bore size (mm)</b>	125, 140, 160
<b>Mounting</b>	Basic type, Foot type, Rod side flange type, Head side flange type, Single clevis type, Double clevis type, Center trunnion type

\* In the case of w/ cushion, pressure inside cushion stroke is not included.

## Maximum Stroke

(mm)

Mounting bracket	Aluminum tube (with auto switch)	Iron tube (without auto switch)	
	Basic type, Head side flange type Single clevis type, Double clevis type Center trunnion type Rod side flange type	Basic type, Head side flange type Single clevis type Double clevis type Center trunnion type	Foot type Rod side flange type
Bore size (mm)			
125	1000 or less	1000 or less	1600 or less
140	1000 or less	1000 or less	1600 or less
160	1200 or less	1200 or less	1600 or less

Refer to pages 561 to 563 for auto switch specifications.

- Minimum auto switch mounting stroke
- Proper auto switch mounting position (detection at stroke end) and mounting height
- Operating range
- Switch mounting bracket: Part no.



## Mounting Bracket Part No.

Bore size (mm)	125	140	160
Foot type *	CS1-L12	CS1-L14	CS1-L16
Flange type	CS1-F12	CS1-F14	CS1-F16
Single clevis type	CS1-C12	CS1-C14	CS1-C16
Double clevis type	CS1-D12	CS1-D14	CS1-D16

\* Order two foot brackets per cylinder.

## Rod Boot Material

Symbol	Material	Max. ambient temperature
<b>J</b>	Nylon tarpaulin	70°C
<b>K</b>	Heat resistant tarpaulin	110°C *

\* Maximum ambient temperature for the rod boot itself.

## Accessory

Mounting type		Basic type	Foot type	Rod side flange type	Head side flange type	Single clevis type	Double clevis type	Center trunnion type
Standard equipment	Clevis pin	—	—	—	—	—	●	—
Option	Rod end nut	●	●	●	●	●	●	●
	Single knuckle joint	●	●	●	●	●	●	●
	Double knuckle joint (Knuckle pin, Cotter pin)	●	●	●	●	●	●	●
	Rod boot	●	●	●	●	●	●	●

## Principal Parts Material and Surface Treatment

Description	Material	Note
Cover	Rolled steel plate	Black painted
Tube	Aluminum alloy (with auto switch)	Hard anodized
	Carbon steel tube (without auto switch)	Inside: Hard chrome plated
Sliding part seal	NBR	
Piston rod	Carbon steel	Hard chrome plated
Piston	Aluminum alloy casted	Chromated

## Weight/Steel Tube (For aluminum tube [with auto switch], refer to page 537.) (kg)

Bore size (mm)		125	140	160
Basic weight	Basic type	15.20	18.38	25.24
	Foot type	16.83	20.90	28.04
	Rod side flange type	17.88	23.38	31.63
	Head side flange type	17.88	23.38	31.63
	Single clevis type	18.27	22.67	30.73
	Double clevis type	18.73	23.42	31.58
	Trunnion type	19.33	24.11	32.64
Additional weight per each 100 mm of stroke		2.66	3.01	3.58
Accessory bracket	Single knuckle	0.91	1.16	1.56
	Double knuckle (With pin)	1.37	1.81	2.48

Calculation: (Example) **CS1LQ160, 500**

- Basic weight..... 28.04 (Foot type, ø160)
- Additional weight..... 3.58/100 stroke
- Cylinder stroke..... 500 stroke, 28.04 + 3.58 x 500/100 = 45.94 kg

## Sliding Resistance

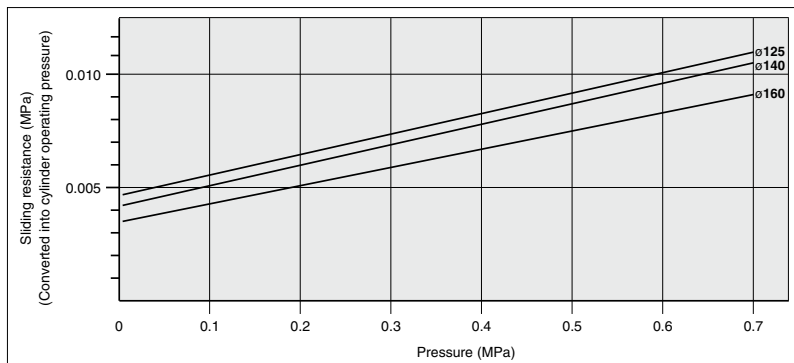

**CJ1**

**CJP**

**CJ2**

**JCM**

**CM2**

**CM3**

**CG1**

**CG3**

**JMB**

**MB**

**MB1**

**CA2**

**CS1**

**CS2**

**D-□**

**-X□**

Technical Data

# CS1□Q Series

## Construction

### Non-lube

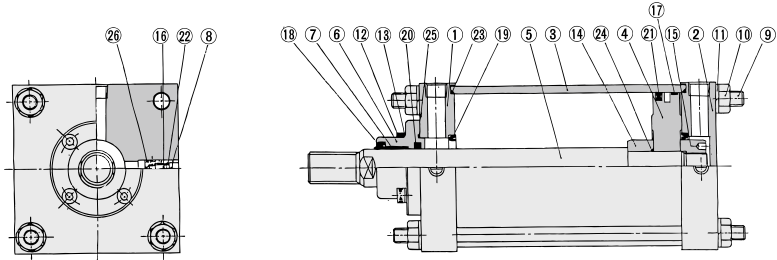

### Component Parts

No.	Description	Material	Note
1	Rod cover	Rolled steel plate	Black painted
2	Head cover	Rolled steel plate	Black painted
3	Cylinder tube	Aluminum alloy*	Hard anodized
		Carbon steel tube	Hard chrome plated
4	Piston	Aluminum alloy casted	Chromated
5	Piston rod	Carbon steel	Hard chrome plated
6	Retaining plate	Cast iron	Black painted
7	Bushing	Bearing alloy	
8	Valve guide	Brass	
9	Tie-rod	Carbon steel	Chromated
10	Tie-rod nut	Rolled steel	Black zinc chromated
11	Spring washer	Steel wire	Black zinc chromated
12	Retaining plate bolt	Chromium molybdenum steel	Black zinc chromated
13	Spring washer	Steel wire	Black zinc chromated
14	Cushion ring A	Rolled steel	Zinc chromated
15	Cushion ring B	Rolled steel	Zinc chromated
16	Cushion valve	Rolled steel	Electroless nickel plated
17	Wear ring	Resin	

\* With auto switch

### Seal List

No.	Description	Material	Note
18	Wiper ring	NBR	
19	Cushion seal*		
20	Rod seal		
21	Piston seal		
22	Valve seal		
23	Tube gasket		
24	Piston gasket		
25	Retaining plate gasket		
26	Guide gasket		

\* It is used only in the case of w/ cushion type.

### Low Friction Type

Bore size (mm)	Kit no.	Description
125	CS1Q125A-PS	Component part numbers: 18, 20, 21, 22, 23, 25
140	CS1Q140A-PS	
160	CS1Q160A-PS	

\* Since the seal kit does not include a grease pack, order it separately.  
Grease pack part no.: GR-L-005(5g), GR-L-010(10g), GR-L-150(150g)

\*\* Seal kits does not include cushion seal, piston seal and guide gasket because those are not replaceable parts.

### Dimensions: According to Mounting Brackets

External dimensions for each mounting bracket other than basic type are the same as standard type. Refer to pages 540 to 546.

### Basic Type: CS1BQ

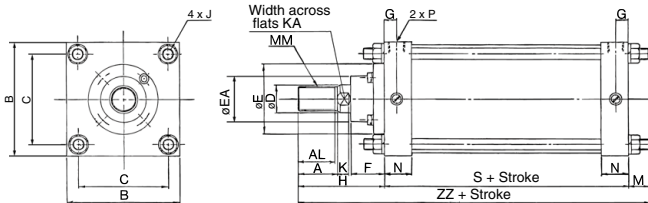

Bore size (mm)	Stroke range (mm)	A	AL	B	C	D	E	EA	F	G	J	K	KA	M	MM	N	P	S	H	ZZ
125	Up to 1000	50	47	145	115	36	90	59	43	16	M14 x 1.5	15	31	27	M30 x 1.5	35	1/2	98	110	235
140	Up to 1000	50	47	161	128	36	90	59	43	16	M14 x 1.5	15	31	27	M30 x 1.5	35	1/2	98	110	235
160	Up to 1200	56	53	182	144	40	90	59	43	18.5	M16 x 1.5	17	36	30.5	M36 x 1.5	39	3/4	106	120	256.5

# CS1 Series

# Auto Switch Mounting 1

## Proper Auto Switch Mounting Position (Detection at stroke end) and Mounting Height

### Band mounting type

D-A3□  
D-G3/K3

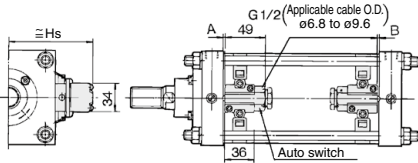

D-A44

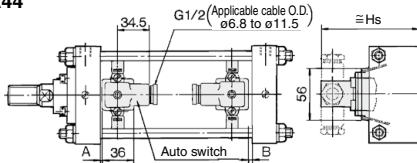

D-F5□/J59/D-F5NT  
D-F5BA/F59F  
D-F5□W/J59W

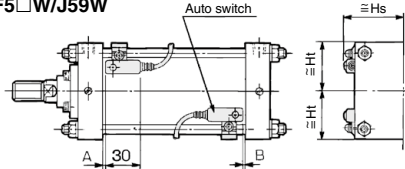

### Tie-rod mounting type

D-M9□/M9□V      D-Z7□/Z80  
D-M9□W/M9□WV      D-Y59□/Y69□/Y7P/Y7PV  
D-M9□A/M9□AV      D-Y7□W/Y7□WV  
D-A9□/A9□V      D-Y7BA

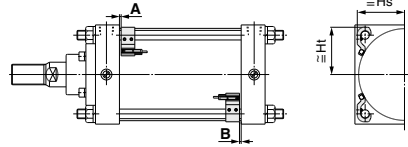

D-A5□/A6□

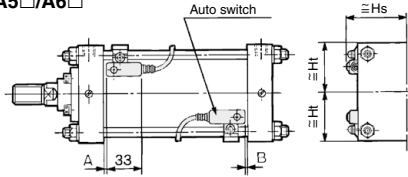

D-P3DWA

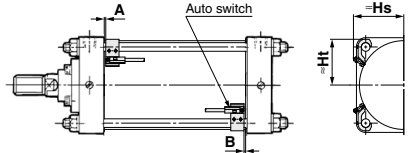

### Proper Auto Switch Mounting Position

Auto switch model	D-M9□ D-M9□V D-M9□W D-M9□WV D-M9□A D-M9□AV		D-A9□ D-A9□V		D-Z7□/Z80 D-Y5□/Y6□ D-Y7P/Y7PV D-Y7□W D-Y7□WV D-Y7BA		D-A5□ D-A6□ D-A3□ D-A44 D-G39 D-K39		D-A59W		D-F5□W D-J59W D-F5BA D-F5□ D-J59 D-F59F		D-F5NT		D-P3DWA	
	A	B	A	B	A	B	A	B	A	B	A	B	A	B	A	B
125	8	8	4	4	1.5	1.5	0	0	2	2	4.5	4.5	9.5	9.5	3.5	3.5
140	8	8	4	4	1.5	1.5	0	0	2	2	4.5	4.5	9.5	9.5	3.5	3.5
160	8	8	4	4	1.5	1.5	0	0	2	2	4.5	4.5	9.5	9.5	3.5	3.5
180	13.5	12.5	9.5	7.5	7	5	3.5	1.5	7.5	5.5	10	8	15	13	9	7
200	16	14	12	10	9.5	7.5	6	4	10	8	12.5	10.5	17.5	15.5	11.5	9.5

\* The mounting position should be referred for reference only for the auto switch mounting position at the stroke end detection.

\* Adjust the auto switch after confirming the operation to set actually.

\* Low friction type (CDS1□Q): ø125, ø140, ø160

### Auto Switch Mounting Height

Auto switch model	D-M9□ D-M9□W D-M9□A D-A9□ D-A9□V		D-M9□WV D-M9□AV D-M9□V		D-Z7□/Z80 D-Y5□/Y6□ D-Y7P D-Y7PV D-Y7□W D-Y7□WV D-Y7BA		D-A3□ D-G39 D-K39		D-A44		D-A5□ D-A6□ D-A59W		D-F5□ D-J59 D-F5□W D-J59W D-F5BA D-F59F D-F5NT		D-P3DWA	
	Hs	Ht	Hs	Ht	Hs	Ht	Hs	Ht	Hs	Ht	Hs	Ht	Hs	Ht	Hs	Ht
125	69	69.5	71.5	69.5	69	69.5	116	116	126	75.5	69.5	74.5	70	76	69.5	69.5
140	76	76	77.5	76	76	76	124	124	134	81	76.5	80	76.5	82	76	76
160	85	85	86	85	85	85	134.5	134.5	144.5	89	87.5	88	87.5	91	85	85
180	95	95	95.5	95	95	95	144	144	154	97	97.5	96	97.5	100	95	95
200	106	106	106	106	106	106	154	154	164	107	108	107.5	108	111	106	106

\* Low friction type (CDS1□Q): ø125, ø140, ø160

- CJ1
- CJP
- CJ2
- JCM
- CM2
- CM3
- CG1
- CG3
- JMB
- MB
- MB1
- CA2
- CS1**
- CS2

- D-□
- X□
- Technical Data

## Minimum Stroke for Auto Switch Mounting

n: No. of auto switch (mm)

Auto switch model No.	No. of auto switch mounted	Bracket other than center trunnion	Center trunnion type			
			φ125	φ140	φ160	φ180
D-M9□ D-M9□W	2 (Different surfaces, Same surface)	15	105	110		115
	n	$15 + 40 \frac{(n-2)}{2}$ (n = 2, 4, 6, 8, ...) Note 1	$105 + 40 \frac{(n-4)}{2}$ (n = 4, 8, 12, 16, ...) Note 2	$110 + 40 \frac{(n-4)}{2}$ (n = 4, 8, 12, 16, ...) Note 2		$115 + 40 \frac{(n-4)}{2}$ (n = 4, 8, 12, 16, ...) Note 2
D-M9□V D-M9□WV	2 (Different surfaces, Same surface)	10	80	85		90
	n	$10 + 30 \frac{(n-2)}{2}$ (n = 2, 4, 6, 8, ...) Note 1	$80 + 30 \frac{(n-4)}{2}$ (n = 4, 8, 12, 16, ...) Note 2	$85 + 30 \frac{(n-4)}{2}$ (n = 4, 8, 12, 16, ...) Note 2		$90 + 30 \frac{(n-4)}{2}$ (n = 4, 8, 12, 16, ...) Note 2
D-M9□A	2 (Different surfaces, Same surface)	20	115		120	
	n	$20 + 40 \frac{(n-2)}{2}$ (n = 2, 4, 6, 8, ...) Note 1	$115 + 40 \frac{(n-2)}{2}$ (n = 4, 8, 12, 16, ...) Note 2		$120 + 40 \frac{(n-2)}{2}$ (n = 4, 8, 12, 16, ...) Note 2	
D-M9□AV	2 (Different surfaces, Same surface)	15	90		95	
	n	$15 + 30 \frac{(n-2)}{2}$ (n = 2, 4, 6, 8, ...) Note 1	$90 + 30 \frac{(n-2)}{2}$ (n = 4, 8, 12, 16, ...) Note 2		$95 + 30 \frac{(n-2)}{2}$ (n = 4, 8, 12, 16, ...) Note 2	
D-A9□	2 (Different surfaces, Same surface)	15	100	105		110
	n	$15 + 40 \frac{(n-2)}{2}$ (n = 2, 4, 6, 8, ...) Note 1	$100 + 40 \frac{(n-4)}{2}$ (n = 4, 8, 12, 16, ...) Note 2	$105 + 40 \frac{(n-4)}{2}$ (n = 4, 8, 12, 16, ...) Note 2		$110 + 40 \frac{(n-4)}{2}$ (n = 4, 8, 12, 16, ...) Note 2
D-A9□V	2 (Different surfaces, Same surface)	10	75	80		85
	n	$10 + 30 \frac{(n-2)}{2}$ (n = 2, 4, 6, 8, ...) Note 1	$75 + 30 \frac{(n-4)}{2}$ (n = 4, 8, 12, 16, ...) Note 2	$80 + 30 \frac{(n-4)}{2}$ (n = 4, 8, 12, 16, ...) Note 2		$85 + 30 \frac{(n-4)}{2}$ (n = 4, 8, 12, 16, ...) Note 2
D-A5□/A6□ D-A59W D-F5□/J59 D-F59W D-F5EA D-F59F	2 (Different surfaces, Same surface)	25	125	135		150
	n (Same surface)	$25 + 55 \frac{(n-2)}{2}$ (n = 2, 4, 6, 8, ...) Note 1	$125 + 55 \frac{(n-4)}{2}$ (n = 4, 8, 12, 16, ...) Note 2	$135 + 55 \frac{(n-4)}{2}$ (n = 4, 8, 12, 16, ...) Note 2		$150 + 55 \frac{(n-4)}{2}$ (n = 4, 8, 12, 16, ...) Note 2
D-F5NT	2 (Different surfaces, Same surface)	35	145	155		170
	n (Same surface)	$35 + 55 \frac{(n-2)}{2}$ (n = 2, 4, 6, 8, ...) Note 1	$145 + 55 \frac{(n-4)}{2}$ (n = 4, 8, 12, 16, ...) Note 2	$155 + 55 \frac{(n-4)}{2}$ (n = 4, 8, 12, 16, ...) Note 2		$170 + 55 \frac{(n-4)}{2}$ (n = 4, 8, 12, 16, ...) Note 2
D-A3□ D-G39 D-K39	2	Different surfaces	35		110	150
		Same surface	100			
	n	Different surfaces	$35 + 30(n-2)$ (n = 2, 3, 4, 5, ...)		$110 + 30(n-2)$ (n = 2, 4, 6, 8, ...) Note 1	$150 + 100(n-2)$ (n = 2, 4, 6, 8, ...) Note 1
		Same surface	$100 + 100(n-2)$ (n = 2, 3, 4, 5, ...)		$110 + 100(n-2)$ (n = 2, 4, 6, 8, ...) Note 1	$150 + 30(n-2)$ (n = 2, 4, 6, 8, ...) Note 1
D-A44	2	Different surfaces	35		110	150
		Same surface	55			
	n	Different surfaces	$35 + 30(n-2)$ (n = 2, 3, 4, 5, ...)		$110 + 30(n-2)$ (n = 2, 4, 6, 8, ...) Note 1	$150 + 30(n-2)$ (n = 2, 4, 6, 8, ...) Note 1
		Same surface	$55 + 55(n-2)$ (n = 2, 3, 4, 5, ...)		$110 + 50(n-2)$ (n = 2, 4, 6, 8, ...) Note 1	$150 + 50(n-2)$ (n = 2, 4, 6, 8, ...) Note 1
1	15		110	150		
D-Z7□ D-Z80 D-Y59□ D-Y7P D-Y7□W	2 (Different surfaces, Same surface)	15	105	110		115
	n	$15 + 40 \frac{(n-2)}{2}$ (n = 2, 4, 6, 8, ...) Note 1	$105 + 40 \frac{(n-4)}{2}$ (n = 4, 8, 12, 16, ...) Note 2	$110 + 40 \frac{(n-4)}{2}$ (n = 4, 8, 12, 16, ...) Note 2		$115 + 40 \frac{(n-4)}{2}$ (n = 4, 8, 12, 16, ...) Note 2
D-Y69□ D-Y7PV D-Y7□WV	2 (Different surfaces, Same surface)	10	90	95		100
	n	$10 + 30 \frac{(n-2)}{2}$ (n = 2, 4, 6, 8, ...) Note 1	$90 + 30 \frac{(n-4)}{2}$ (n = 4, 8, 12, 16, ...) Note 2	$95 + 30 \frac{(n-4)}{2}$ (n = 4, 8, 12, 16, ...) Note 2		$100 + 30 \frac{(n-4)}{2}$ (n = 4, 8, 12, 16, ...) Note 2
D-Y7BA	2 (Different surfaces, Same surface)	20	115	120	125	130
	n	$20 + 45 \frac{(n-2)}{2}$ (n = 2, 4, 6, 8, ...) Note 1	$115 + 45 \frac{(n-4)}{2}$ (n = 4, 8, 12, 16, ...) Note 2	$120 + 45 \frac{(n-4)}{2}$ (n = 4, 8, 12, 16, ...) Note 2	$125 + 45 \frac{(n-4)}{2}$ (n = 4, 8, 12, 16, ...) Note 2	$130 + 45 \frac{(n-4)}{2}$ (n = 4, 8, 12, 16, ...) Note 2
D-P3DWA	2 (Different surfaces, Same surface)	20	110	115		120
	n	$20 + 50 \frac{(n-2)}{2}$ (n = 2, 4, 6, 8, ...) Note 1	$110 + 50 \frac{(n-4)}{2}$ (n = 4, 8, 12, 16, ...) Note 2	$115 + 50 \frac{(n-4)}{2}$ (n = 4, 8, 12, 16, ...) Note 2		$120 + 50 \frac{(n-4)}{2}$ (n = 4, 8, 12, 16, ...) Note 2

\* Low friction type (CDS□□): φ125, φ140, φ160

Note 1) When "n" is an odd number, an even number that is one larger than this odd number is used for the calculation.  
Note 2) When "n" is an odd number, a multiple of 4 that is larger than this odd number is used for the calculation.

**Operating range**

Auto switch model	Bore size (mm)				
	125	140	160	180	200
D-M9□/M9□V D-M9□W/M9□WV D-M9□A/M9□AV	6	6.5	6.5	6.5	7
D-A9□/A9□V	12	12.5	11.5	12	12.5
D-Z7□/Z80	14	14.5	13	14	14.5
D-A3□/A44 D-A5□/A6□	10	10	10	10	10
D-A59W	17	17	17	17	17
D-Y59□/Y69□ D-Y7P/Y7PV D-Y7□W/Y7□WV D-Y7BA	12	13	7	7.5	8
D-F5□/J59/F5□W D-J59W/F5BA D-F5NT/F59F	5	5	5.5	6	6
D-G39/K39	11	11	10	10	10
D-P3DWA	6	6.5	6.5	6.5	7

- \* Since this is a guideline including hysteresis, not meant to be guaranteed. (Assuming approximately ±30% dispersion.)  
There may be the case it will vary substantially depending on an ambient environment.
- \* Low friction type (CDS1□□): ø125, ø140, ø160

**Auto Switch Mounting Bracket: Part No.**

Auto switch model	Bore size (mm)				
	ø125	ø140	ø160	ø180	ø200
D-M9□/M9□V D-M9□W/M9□WV D-M9□A/M9□AV D-A9□/A9□V	BS5-125	BS5-125	BS5-160	BS5-180	BS5-200
D-A5□/A6□ D-A59W D-F5□/J59 D-F5NT D-F5□W/J59W D-F5BA/F59F	BT-12	BT-12	BT-16	BT-18A	BT-20
D-A3□/A44 D-G39/K39	BS1-125	BS1-140	BS1-160	BS1-180	BS1-200
D-Z7□/Z80 D-Y59□/Y69□ D-Y7P/Y7PV D-Y7□W/Y7□WV D-Y7BA	BS4-125	BS4-125	BS4-160	BS4-180	BS4-200
D-P3DWA	BS7-125S	BS7-125S	BS7-160S	BS7-180S	BS7-200S

**[Stainless Steel Mounting Screw Kit]**

The following set of stainless steel mounting screws is available. Use them in accordance with the operating environment. (Since auto switch brackets are not included, order them separately.)

BBA1: For D-A5/A6/F5/J5 types

The above stainless steel screws are used when a cylinder is shipped with D-F5BA-type auto switches.

When only a switch is shipped independently, BBA1 screws are attached.

Note) When D-M9□A/M9□AV/Y7BA auto switches are used, do not use steel set screws included in the auto switch mounting brackets above (BS5-□□□ and BS4-□□□). Order the stainless steel screw set BBA1 separately, and use M4 x 8L stainless steel set screws included in BBA1 instead.

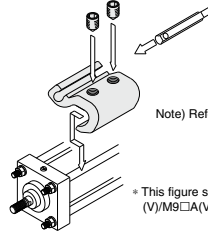

Note) Refer to page 1689 for the details of BBA1 screws.

\* This figure shows how to mount D-A9□(V)/M9□(V)/M9□V(V)/M9□A(V).

- CG1
- CGP
- CG2
- JCM
- CM2
- CM3
- CG1
- CG3
- JMB
- MB
- MB1
- CA2
- CS1
- CS2

Besides the models listed in How to Order, the following auto switches are applicable. Refer to pages 1575 to 1701 for the detailed specifications.

Auto switch type	Part no.	Electrical entry (Fetching direction)	Features
Reed	D-A90V	Grommet (perpendicular)	Without indicator light
	D-A93V, A96V		
	D-Z73, Z76		—
	D-A53, A56	Grommet (in-line)	Without indicator light
	D-A67		
	D-Z80		
Solid state	D-F59, F5P, J59	Grommet (in-line)	—
	D-Y59A, Y59B, Y7P		
	D-F59W, F5PW, J59W		2-color display
	D-Y7NW, Y7PW, Y7BW		Water resistant (2 colors)
	D-F5BA, Y7BA		With timer
	D-F5NT		
	D-M9NV, M9PV, M9BV	Grommet (perpendicular)	—
	D-Y69A, Y69B, Y7PV		
	D-M9NWV, M9PWV, M9BWW		2-color display
	D-Y7NWV, Y7PWV, Y7BWW		
	D-M9NAV, M9PAV, M9BAV		Water resistant (2 colors)

- \* For solid state auto switches, auto switches with a pre-wired connector are also available. Refer to pages 1648 and 1649 for details.
- \* Normally closed (NC = b contact) solid state auto switches (D-F9G/F9H/Y7G/Y7H types) are also available. Refer to page 1593 and 1595 for details.

- D-□
- X□
- Technical Data