

Series CKZN

Slim Line Power Clamp Arm -X6013



②

How to Order 6013 Arms

③

50mm Bore Dimensions

④⑤

63mm Bore Dimensions

⑥⑦

CKZN Clamp Reference

⑧

Actuator Precautions 1

⑨

Actuator Precautions 2

⑩

Specific Product Precautions

X6013 Arms

Bore Size	Part Number	Code	NAAMS Ref No.
50	CKZ-50A401-X6013	A401	ACA401M
	CKZ-50A402-X6013	A402	ACA402M
	CKZ-50A403-X6013	A403	ACA403M
	CKZ-50A411-X6013	A411	ACA411M
	CKZ-50A412-X6013	A412	ACA412M
	CKZ-50A413-X6013	A413	ACA413M
	CKZ-50A421-X6013	A421	ACA421M
	CKZ-50A422-X6013	A422	ACA422M
63	CKZ-50A423-X6013	A423	ACA423M
	CKZ-63A507-X6013	A507	ACA507M
	CKZ-63A508-X6013	A508	ACA508M
	CKZ-63A509-X6013	A509	ACA509M
	CKZ-63A510-X6013	A510	ACA510M
	CKZ-63A511-X6013	A511	ACA511M
	CKZ-63A512-X6013	A512	ACA512M
	CKZ-63A513-X6013	A513	ACA513M
	CKZ-63A514-X6013	A514	ACA514M
	CKZ-63A515-X6013	A515	ACA515M
	CKZ-63A516-X6013	A516	ACA516M
	CKZ-63A517-X6013	A517	ACA517M
	CKZ-63A518-X6013	A518	ACA518M
	CKZ-63A519-X6013	A519	ACA519M
	CKZ-63A520-X6013	A520	ACA520M
	CKZ-63A521-X6013	A521	ACA521M
	CKZ-63A522-X6013	A522	ACA522M
	CKZ-63A523-X6013	A523	ACA523M
	CKZ-63A524-X6013	A524	ACA524M
	CKZ-63A525-X6013	A525	ACA525M
CKZ-63A526-X6013	A526	ACA526M	
CKZ-63A527-X6013	A527	ACA527M	

Bore Size	Part Number	Code	NAAMS Ref No.
63	CKZ-63A528-X6013	A528	ACA528M
	CKZ-63A529-X6013	A529	ACA529M
	CKZ-63A530-X6013	A530	ACA530M
	CKZ-63A531-X6013	A531	ACA531M
	CKZ-63A532-X6013	A532	ACA532M
	CKZ-63A533-X6013	A533	ACA533M
	CKZ-63A534-X6013	A534	ACA534M
	CKZ-63A535-X6013	A535	ACA535M
	CKZ-63A536-X6013	A536	ACA536M
	CKZ-63A537-X6013	A537	ACA537M
	CKZ-63A538-X6013	A538	ACA538M
	CKZ-63A539-X6013	A539	ACA539M
	CKZ-63A540-X6013	A540	ACA540M
	CKZ-63A541-X6013	A541	ACA541M
	CKZ-63A542-X6013	A542	ACA542M
	CKZ-63A543-X6013	A543	ACA543M
	CKZ-63A544-X6013	A544	ACA544M
	CKZ-63A545-X6013	A545	ACA545M
	CKZ-63A546-X6013	A546	ACA546M
	CKZ-63A547-X6013	A547	ACA547M
	CKZ-63A548-X6013	A548	ACA548M
	CKZ-63A549-X6013	A549	ACA549M
	CKZ-63A550-X6013	A550	ACA550M
	CKZ-63A551-X6013	A551	ACA551M
	CKZ-63A552-X6013	A552	ACA552M
	CKZ-63A553-X6013	A553	ACA553M
	CKZ-63A554-X6013	A554	ACA554M

How to Order

ARM PART NUMBER **P** - X6013

● **Arm style**

Nil	Standard arm (not painted)
P	Painted

Painted clamp arms are safety orange per NAAMS specification color munsell no. 3.75YR6/14

50mm Bore Dimensions

50mm Bore Straight-Machined

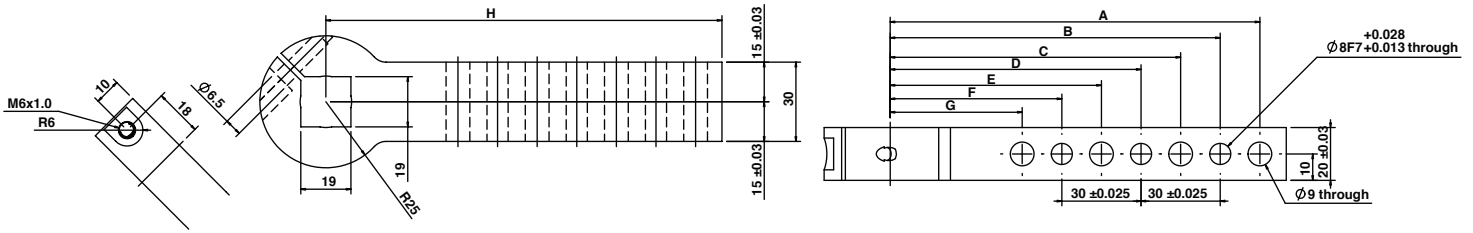

Part Number	NAAMS	A	B	C	D	E	F	G	H	I	Weight kg(lbs)
CKZ-50A401-X6013	ACA401M	80.0	65.0	50.0	-	-	-	-	90.0	-	0.5 (1.11)
CKZ-50A402-X6013	ACA402M	110.0	95.0	80.0	65.0	50.0	-	-	120.0	-	0.6 (1.36)
CKZ-50A403-X6013	ACA403M	140.0	125.0	110.0	95.0	80.0	65.0	50.0	150.0	-	0.7 (1.61)

50mm Bore 25mm Offset-Machined

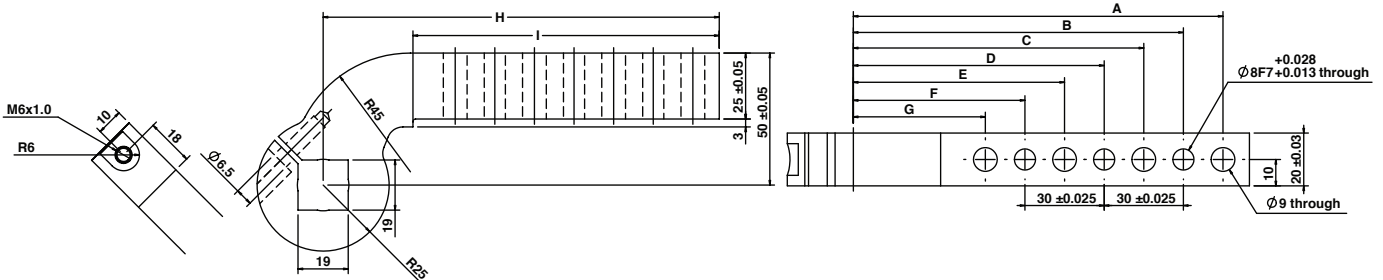

Part Number	NAAMS	A	B	C	D	E	F	G	H	I	Weight kg(lbs)
CKZ-50A411-X6013	ACA411M	80.0	65.0	50.0	-	-	-	-	90.0	56.0	0.6 (1.22)
CKZ-50A412-X6013	ACA412M	110.0	95.0	80.0	65.0	50.0	-	-	120.0	86.0	0.6 (1.43)
CKZ-50A413-X6013	ACA413M	140.0	125.0	110.0	95.0	80.0	65.0	50.0	150.0	116.0	0.7 (1.64)

50mm Bore 50mm Offset-Machined

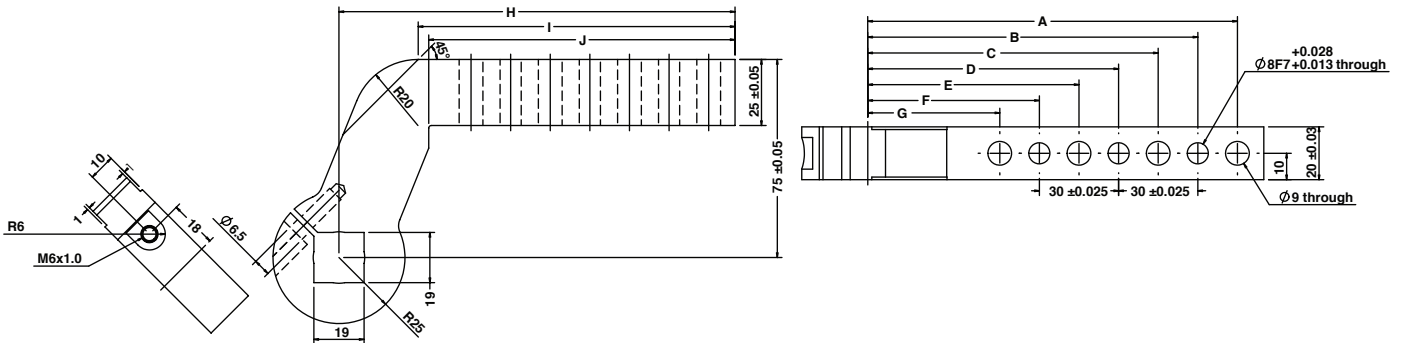

Part Number	NAAMS	A	B	C	D	E	F	G	H	I	Weight kg(lbs)
CKZ-50A421-X6013	ACA421M	80.0	65.0	50.0	-	-	-	-	90.0	56.0	0.7 (1.45)
CKZ-50A422-X6013	ACA422M	110.0	95.0	80.0	65.0	50.0	-	-	120.0	86.0	0.8 (1.66)
CKZ-50A423-X6013	ACA423M	140.0	125.0	110.0	95.0	80.0	65.0	50.0	150.0	116.0	0.8 (1.87)

63mm Bore Dimensions

63mm Bore Straight-Machined

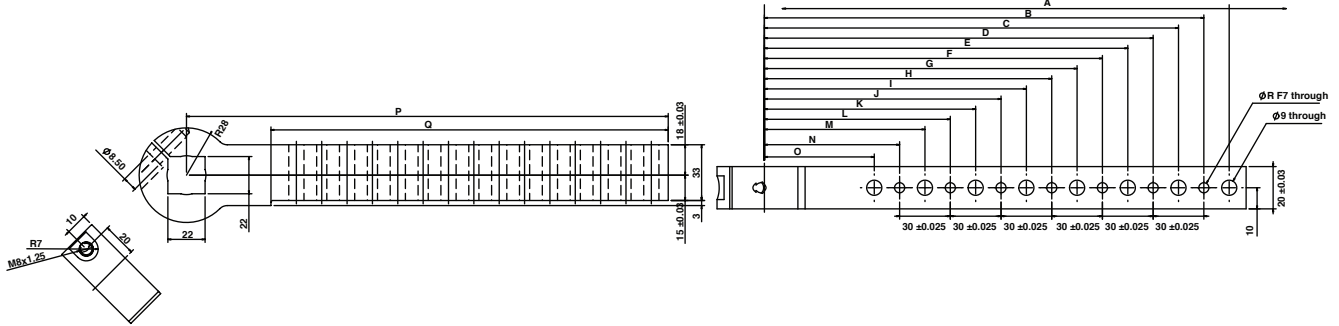

Part Number	NAAMS	A	B	C	D	E	F	G	H	I	J	K	L	M	N	O	P	Q	R (DWL)	Weight kg(lbs)
CKZ-63A507-X6013	ACA507M	125.0	110.0	95.0	80.0	65.0	-	-	-	-	-	-	-	-	-	-	135.0	85.0	6.0	0.8 (1.76)
CKZ-63A508-X6013	ACA508M	155.0	140.0	125.0	110.0	95.0	80.0	65.0	-	-	-	-	-	-	-	-	165.0	115.0	6.0	0.9 (2.1)
CKZ-63A509-X6013	ACA509M	185.0	170.0	155.0	140.0	125.0	110.0	95.0	80.0	65.0	-	-	-	-	-	-	195.0	145.0	6.0	1.1 (2.47)
CKZ-63A510-X6013	ACA510M	215.0	200.0	185.0	170.0	155.0	140.0	125.0	110.0	95.0	80.0	65.0	-	-	-	-	225.0	175.0	6.0	1.2 (2.65)
CKZ-63A511-X6013	ACA511M	245.0	230.0	215.0	200.0	185.0	170.0	155.0	140.0	125.0	110.0	95.0	80.0	65.0	-	-	255.0	205.0	6.0	1.3 (3)
CKZ-63A512-X6013	ACA512M	275.0	260.0	245.0	230.0	215.0	200.0	185.0	170.0	155.0	140.0	125.0	110.0	95.0	80.0	65.0	285.0	235.0	6.0	1.5 (3.35)
CKZ-63A513-X6013	ACA513M	125.0	110.0	95.0	80.0	65.0	-	-	-	-	-	-	-	-	-	-	135.0	85.0	8.0	0.8 (1.76)
CKZ-63A514-X6013	ACA514M	155.0	140.0	125.0	110.0	95.0	80.0	65.0	-	-	-	-	-	-	-	-	165.0	115.0	8.0	0.9 (2.1)
CKZ-63A515-X6013	ACA515M	185.0	170.0	155.0	140.0	125.0	110.0	95.0	80.0	65.0	-	-	-	-	-	-	195.0	145.0	8.0	1.1 (2.47)
CKZ-63A516-X6013	ACA516M	215.0	200.0	185.0	170.0	155.0	140.0	125.0	110.0	95.0	80.0	65.0	-	-	-	-	225.0	175.0	8.0	1.2 (2.65)
CKZ-63A517-X6013	ACA517M	245.0	230.0	215.0	200.0	185.0	170.0	155.0	140.0	125.0	110.0	95.0	80.0	65.0	-	-	255.0	205.0	8.0	1.3 (3)
CKZ-63A518-X6013	ACA518M	275.0	260.0	245.0	230.0	215.0	200.0	185.0	170.0	155.0	140.0	125.0	110.0	95.0	80.0	65.0	285.0	235.0	8.0	1.5 (3.35)

63mm Bore 25mm Offset-Machined

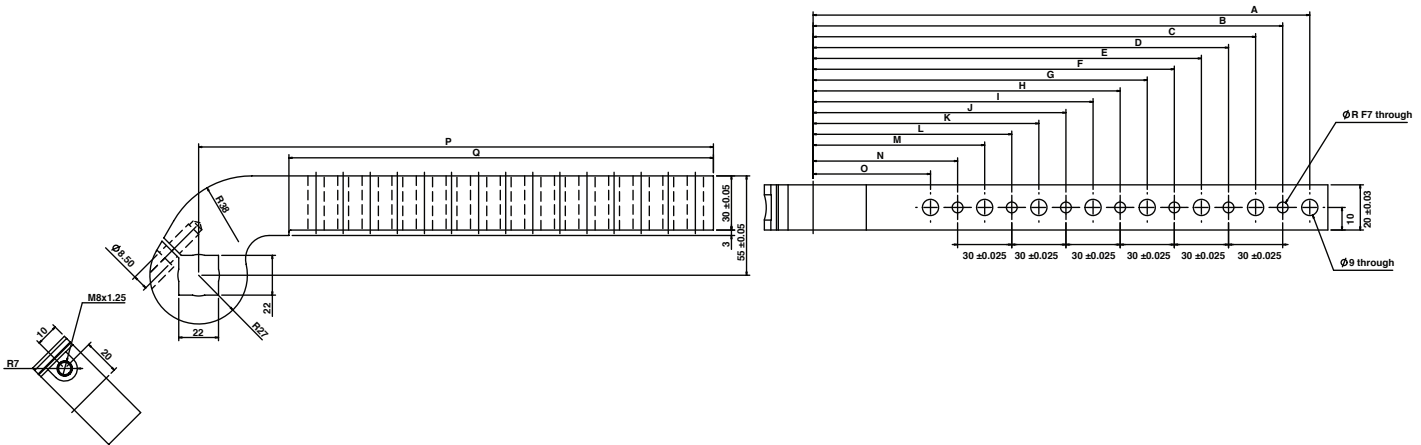

Part Number	NAAMS	A	B	C	D	E	F	G	H	I	J	K	L	M	N	O	P	Q	R (DWL)	Weight kg(lbs)
CKZ-63A519-X6013	ACA519M	125.0	110.0	95.0	80.0	65.0	-	-	-	-	-	-	-	-	-	-	135.0	85.0	6.0	1.0 (2.29)
CKZ-63A520-X6013	ACA520M	155.0	140.0	125.0	110.0	95.0	80.0	65.0	-	-	-	-	-	-	-	-	165.0	115.0	6.0	1.2 (2.65)
CKZ-63A521-X6013	ACA521M	185.0	170.0	155.0	140.0	125.0	110.0	95.0	80.0	65.0	-	-	-	-	-	-	195.0	145.0	6.0	1.3 (2.82)
CKZ-63A522-X6013	ACA522M	215.0	200.0	185.0	170.0	155.0	140.0	125.0	110.0	95.0	80.0	65.0	-	-	-	-	225.0	175.0	6.0	1.3 (3.00)
CKZ-63A523-X6013	ACA523M	245.0	230.0	215.0	200.0	185.0	170.0	155.0	140.0	125.0	110.0	95.0	80.0	65.0	-	-	255.0	205.0	6.0	1.5 (3.35)
CKZ-63A524-X6013	ACA524M	275.0	260.0	245.0	230.0	215.0	200.0	185.0	170.0	155.0	140.0	125.0	110.0	95.0	80.0	65.0	285.0	235.0	6.0	1.7 (3.70)
CKZ-63A525-X6013	ACA525M	125.0	110.0	95.0	80.0	65.0	-	-	-	-	-	-	-	-	-	-	135.0	85.0	8.0	1.0 (2.29)
CKZ-63A526-X6013	ACA526M	155.0	140.0	125.0	110.0	95.0	80.0	65.0	-	-	-	-	-	-	-	-	165.0	115.0	8.0	1.2 (2.65)
CKZ-63A527-X6013	ACA527M	185.0	170.0	155.0	140.0	125.0	110.0	95.0	80.0	65.0	-	-	-	-	-	-	195.0	145.0	8.0	1.3 (2.82)
CKZ-63A528-X6013	ACA528M	215.0	200.0	185.0	170.0	155.0	140.0	125.0	110.0	95.0	80.0	65.0	-	-	-	-	225.0	175.0	8.0	1.3 (3.00)
CKZ-63A529-X6013	ACA529M	245.0	230.0	215.0	200.0	185.0	170.0	155.0	140.0	125.0	110.0	95.0	80.0	65.0	-	-	255.0	205.0	8.0	1.5 (3.35)
CKZ-63A530-X6013	ACA530M	275.0	260.0	245.0	230.0	215.0	200.0	185.0	170.0	155.0	140.0	125.0	110.0	95.0	80.0	65.0	285.0	235.0	8.0	1.7 (3.70)

63mm Bore Dimensions

63mm Bore 70mm Offset-Machined

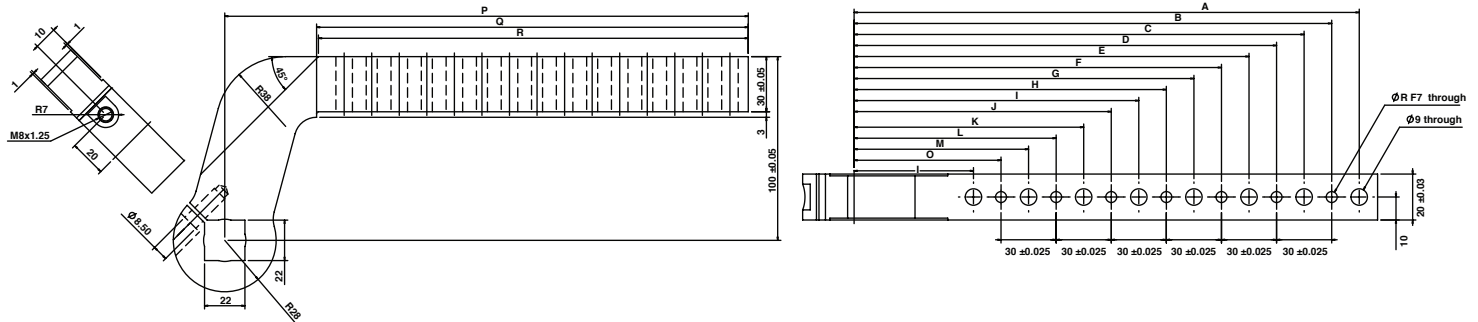

Part Number	NAAMS	A	B	C	D	E	F	G	H	I	J	K	L	M	N	O	P	Q	R (DWL)	Weight kg(lbs)
CKZ-63A531-X6013	ACA531M	125.0	110.0	95.0	80.0	65.0	-	-	-	-	-	-	-	-	-	-	135.0	85.0	6.0	1.1 (2.47)
CKZ-63A532-X6013	ACA532M	155.0	140.0	125.0	110.0	95.0	80.0	65.0	-	-	-	-	-	-	-	-	165.0	115.0	6.0	1.3 (2.82)
CKZ-63A533-X6013	ACA533M	185.0	170.0	155.0	140.0	125.0	110.0	95.0	80.0	65.0	-	-	-	-	-	-	195.0	145.0	6.0	1.4 (3.18)
CKZ-63A534-X6013	ACA534M	215.0	200.0	185.0	170.0	155.0	140.0	125.0	110.0	95.0	80.0	65.0	-	-	-	-	225.0	175.0	6.0	1.5 (3.35)
CKZ-63A535-X6013	ACA535M	245.0	230.0	215.0	200.0	185.0	170.0	155.0	140.0	125.0	110.0	95.0	80.0	65.0	-	-	255.0	205.0	6.0	1.7 (3.70)
CKZ-63A536-X6013	ACA536M	275.0	260.0	245.0	230.0	215.0	200.0	185.0	170.0	155.0	140.0	125.0	110.0	95.0	80.0	65.0	285.0	235.0	6.0	1.8 (4.06)
CKZ-63A537-X6013	ACA537M	125.0	110.0	95.0	80.0	65.0	-	-	-	-	-	-	-	-	-	-	135.0	85.0	8.0	1.1 (2.47)
CKZ-63A538-X6013	ACA538M	155.0	140.0	125.0	110.0	95.0	80.0	65.0	-	-	-	-	-	-	-	-	165.0	115.0	8.0	1.3 (2.82)
CKZ-63A539-X6013	ACA539M	185.0	170.0	155.0	140.0	125.0	110.0	95.0	80.0	65.0	-	-	-	-	-	-	195.0	145.0	8.0	1.4 (3.18)
CKZ-63A540-X6013	ACA540M	215.0	200.0	185.0	170.0	155.0	140.0	125.0	110.0	95.0	80.0	65.0	-	-	-	-	225.0	175.0	8.0	1.5 (3.35)
CKZ-63A541-X6013	ACA541M	245.0	230.0	215.0	200.0	185.0	170.0	155.0	140.0	125.0	110.0	95.0	80.0	65.0	-	-	255.0	205.0	8.0	1.7 (3.70)
CKZ-63A542-X6013	ACA542M	275.0	260.0	245.0	230.0	215.0	200.0	185.0	170.0	155.0	140.0	125.0	110.0	95.0	80.0	65.0	285.0	235.0	8.0	1.8 (4.06)

63mm Bore 120mm Offset-Machined

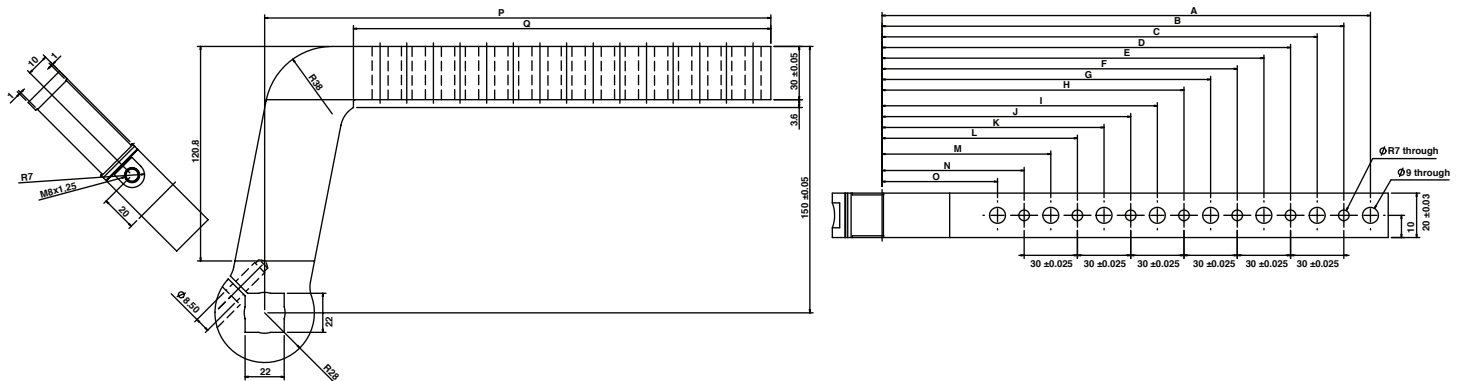

Part Number	NAAMS	A	B	C	D	E	F	G	H	I	J	K	L	M	N	O	P	Q	R (DWL)	Weight kg(lbs)
CKZ-63A543-X6013	ACA543M	125.0	110.0	95.0	80.0	65.0	-	-	-	-	-	-	-	-	-	-	135.0	85.0	6.0	1.4 (3.18)
CKZ-63A544-X6013	ACA544M	155.0	140.0	125.0	110.0	95.0	80.0	65.0	-	-	-	-	-	-	-	-	165.0	115.0	6.0	1.6 (3.53)
CKZ-63A545-X6013	ACA545M	185.0	170.0	155.0	140.0	125.0	110.0	95.0	80.0	65.0	-	-	-	-	-	-	195.0	145.0	6.0	1.7 (3.70)
CKZ-63A546-X6013	ACA546M	215.0	200.0	185.0	170.0	155.0	140.0	125.0	110.0	95.0	80.0	65.0	-	-	-	-	225.0	175.0	6.0	1.8 (4.06)
CKZ-63A547-X6013	ACA547M	245.0	230.0	215.0	200.0	185.0	170.0	155.0	140.0	125.0	110.0	95.0	80.0	65.0	-	-	255.0	205.0	6.0	2.0 (4.41)
CKZ-63A548-X6013	ACA548M	275.0	260.0	245.0	230.0	215.0	200.0	185.0	170.0	155.0	140.0	125.0	110.0	95.0	80.0	65.0	285.0	235.0	6.0	2.1 (4.76)
CKZ-63A549-X6013	ACA549M	125.0	110.0	95.0	80.0	65.0	-	-	-	-	-	-	-	-	-	-	135.0	85.0	8.0	1.4 (3.18)
CKZ-63A550-X6013	ACA550M	155.0	140.0	125.0	110.0	95.0	80.0	65.0	-	-	-	-	-	-	-	-	165.0	115.0	8.0	1.6 (3.53)
CKZ-63A551-X6013	ACA551M	185.0	170.0	155.0	140.0	125.0	110.0	95.0	80.0	65.0	-	-	-	-	-	-	195.0	145.0	8.0	1.7 (3.70)
CKZ-63A552-X6013	ACA552M	215.0	200.0	185.0	170.0	155.0	140.0	125.0	110.0	95.0	80.0	65.0	-	-	-	-	225.0	175.0	8.0	1.8 (4.06)
CKZ-63A553-X6013	ACA553M	245.0	230.0	215.0	200.0	185.0	170.0	155.0	140.0	125.0	110.0	95.0	80.0	65.0	-	-	255.0	205.0	8.0	2.0 (4.41)
CKZ-63A554-X6013	ACA554M	275.0	260.0	245.0	230.0	215.0	200.0	185.0	170.0	155.0	140.0	125.0	110.0	95.0	80.0	65.0	285.0	235.0	8.0	2.1 (4.76)

Series CKZN Reference

How to Order

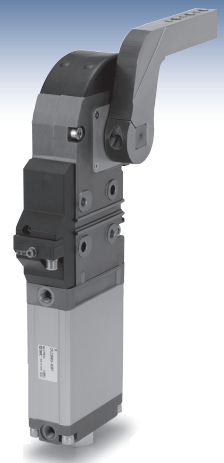

CKZ2N 63 TF 120 R T A A002

Power clamp cylinder conforming to the new NAAMS standard

Bore size

50	Equivalent to 50 mm
63	Equivalent to 63 mm
80	Equivalent to 80 mm

Cylinder port

Nil	NPT
TF	G

Arm opening angle

30	30
45	45
60	60
75	75
90	90
105	105
120	120
135	135

Arm position

R	L	D
Right	Left	Both sides

Arm style

Nil	Without arm
-	Arm code (See attached code.)

Note 1) Please indicate appropriate arm position and arm code in serial as following example in case of D type arm position.
Note 2) Not installed when delivered.

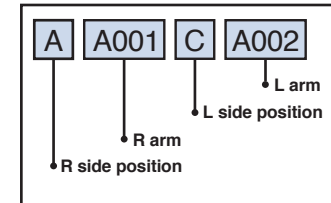

Arm mounting position (A, B, C, D)

Note 1) See below "Arm Mounting Position".

Arm Mounting Position: A, B, C, D

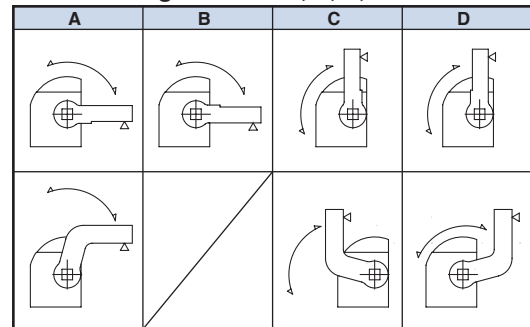

△ denotes tool attachment surface.

Switch type

T	Turck
P	P & F

Series CKZN Reference

Cylinder Specifications

Bore size (mm)	50	60	80
Action	Double acting		
Fluid	Air		
Proof pressure	1.2 MPa (174 psi)		
Max. operating pressure	0.8 MPa (116 psi)		
Min. operating pressure	0.3 MPa (44 psi)		
Ambient and fluid temperature	-10 to 60C (14 to 140F)		
Cushion	Clamping side: None Unclamping side: Rubber bumper		
Min. operating time	1.0 second to clamp, 1.0 second to unclamp		

Weight (Cylinder Without Arm)

Unit : kg (lbs)

Bore size (mm)	Arm position	Arm angle							
		30	45	60	75	90	105	120	135
50	R/L	5.21 (11.46)	5.19 (11.42)	5.17 (11.37)	5.15 (11.33)	5.12 (11.26)	5.09 (11.20)	5.07 (11.15)	5.06 (11.13)
	D	5.27 (11.54)	5.25 (11.50)	5.23 (11.45)	5.21 (11.46)	5.18 (11.34)	5.15 (11.28)	5.13 (11.23)	5.12 (11.21)
63	R/L	7.37 (16.21)	7.34 (16.15)	7.31 (16.08)	7.28 (16.02)	7.24 (15.93)	7.21 (15.86)	7.18 (15.80)	7.16 (15.75)
	D	7.47 (16.36)	7.44 (16.29)	7.41 (16.23)	7.38 (16.16)	7.34 (16.07)	7.31 (16.01)	7.28 (15.94)	7.26 (15.90)
80	R/L	17.20 (37.84)	17.13 (37.69)	17.07 (37.55)	17.00 (37.40)	16.93 (37.25)	16.86 (37.09)	16.80 (36.96)	16.76 (36.87)
	D	17.42 (38.15)	17.35 (38.00)	17.29 (37.87)	17.21 (37.69)	17.15 (37.56)	17.08 (15.51)	17.02 (37.27)	16.98 (37.19)

Switch Specifications

Manufacturer	TURCK	P & F
Operating range	2 mm 10%	2 mm 10%
Supply voltage	10 to 30 VDC	10 to 30 VDC
Output	N.O., PNP	N.O., PNP
Continuous load current	150 mA	100 mA
Response frequency	30 Hz	25 Hz
Housing material	PBT-GP30	PA6, PBT
Output indication	Clamping side: Red Unclamping side: Yellow	Clamping side: Red Unclamping side: Yellow
Voltage indication	Green	Green

Note) Switch specifications are correspondingly to manufacturer's technical information

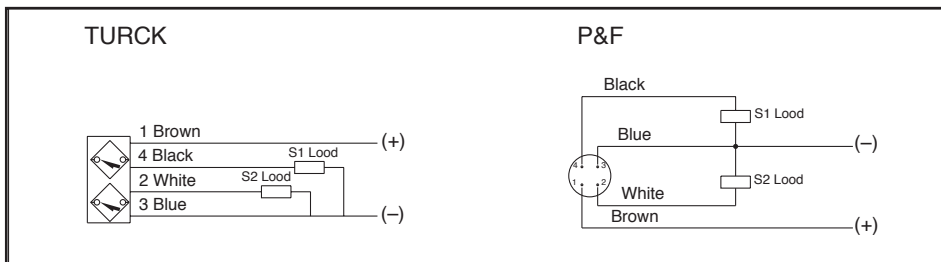

For information regarding CKZN power clamp and additional clamp arm selection and precautions, please refer to CKZN Series Catalog #CAT. EX20-1



Series CKZN

Actuator Precautions 1 *Be sure to read before handling.*

Design

Warning

- 1. There is a danger of sudden action by air cylinders if sliding parts of machinery are twisted, etc., and changes in forces occur.**

In such cases, human injury may occur; e.g., by catching hands or feet in the machinery, or damage to the machinery itself may occur. Therefore, the machine should be designed to avoid such dangers.

- 2. Attach a protective cover to minimize the risk of human injury.**

If a driven object and moving parts of a cylinder pose a danger of human injury, design the structure to avoid contact with the human body.

- 3. Securely tighten all stationary parts and connected parts so that they will not become loose.**

Especially when a cylinder operates with high frequency or is installed where there is a lot of vibration, ensure that all parts remain secure.

- 4. A deceleration circuit or shock absorber, etc., may be required.**

When a driven object is operated at high speed or the load is heavy, a cylinder's cushion will not be sufficient to absorb the impact. Install a deceleration circuit to reduce the speed before cushioning, or install an external shock absorber to relieve the impact. In this case, the rigidity of the machinery should also be examined.

- 5. Consider a possible drop in circuit pressure due to a power outage, etc.**

When a cylinder is used in a clamping mechanism, there is a danger of work pieces dropping if there is a decrease in clamping force due to a drop in circuit pressure caused by a power outage, etc. Therefore, safety equipment should be installed to prevent damage to machinery and/or human injury. Suspension mechanisms and lifting devices also require consideration for drop prevention.

- 6. Consider a possible loss of power source.**

Measures should be taken to protect against human injury and equipment damage in the event that there is a loss of power to equipment controlled by air pressure, electricity or hydraulics, etc.

- 7. Design circuitry to prevent sudden lurching of driven objects.**

When a cylinder is driven by an exhaust center type directional control valve or when starting up after residual pressure is exhausted from the circuit, etc., the piston and its driven object will lurch at high speed if pressure is applied to one side of the cylinder because of the absence of air pressure inside the cylinder. Therefore, equipment should be selected and circuits designed to prevent sudden lurching because, there is a danger of human injury and/or damage to equipment when this occurs.

- 8. Consider emergency stops.**

Design so that human injury and/or damage to machinery and equipment will not be caused when machinery is stopped by a safety device under abnormal conditions, a power outage or a manual emergency stop.

- 9. Consider the action when operation is restarted after an emergency stop or abnormal stop.**

Design the machinery so that human injury or equipment damage will not occur upon restart of operation. When the cylinder has to be reset at the starting position, install safe manual control equipment.

Selection

Warning

- 1. Confirm the specifications.**

The products advertised in this catalog are designed according to use in industrial compressed air systems. If the products are used in conditions where pressure, temperature, etc., are out of specification, damage and/or malfunction may be caused. Do not use in these conditions. (Refer to specifications.)

Consult SMC if you use a fluid other than compressed air.

Caution

- 1. Operate the piston within a range such that collision damage will not occur at the stroke end.**

Operate within a range such that damage will not occur when the piston having inertial force stops by striking the cover at the stroke end. Refer to the cylinder model selection procedure for the range within which damage will not occur.

- 2. Use a speed controller to adjust the cylinder drive speed, gradually increasing from a low speed to the desired speed setting.**

Mounting

Caution

- 1. Do not scratch or gouge the sliding parts of the cylinder tube or piston rod, etc., by striking or grasping them with other objects.**

Cylinder bores are manufactured to precise tolerances, so that even a slight deformation may cause malfunction. Also, scratches or gouges, etc., in the piston rod may lead to damaged seals and cause air leakage.

- 2. Do not use until you can verify that equipment can operate properly.**

Following mounting, maintenance or conversions, verify correct mounting by suitable function and leakage tests after compressed air and power are connected.



Series CKZN

Actuator Precautions 2 *Be sure to read before handling.*

Piping

Caution

1. Preparation before piping

Before piping is connected, it should be thoroughly blown out with air (flushing) or washed to remove chips, cutting oil and other debris from inside the pipe.

2. Wrapping of pipe tape

When screwing together pipes and fittings, etc., be certain that chips from the pipe threads and sealing material do not get inside the piping.

Also, when pipe tape is used, leave 1.5 to 2 thread ridges exposed at the end of the threads.

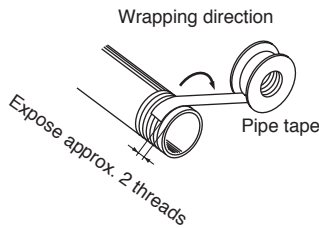

Lubrication

Caution

1. Lubrication on cylinder.

The cylinder has been lubricated for life at the factory and can be used without any further lubrication.

However, in the event that it will be lubricated, use class 1 turbine oil (with no additives) ISO VG32.

Stopping lubrication later may lead to malfunction due to the loss of the original lubricant. Therefore, lubrication must be continued once it has been started.

Air Supply

Warning

1. Use clean air.

Do not use compressed air that includes chemicals, synthetic oils containing organic solvents, salt or corrosive gases, etc., as it can cause damage or malfunction.

Air Supply

Caution

1. Install air filters.

Install air filters at the upstream side of valves. The filtration degree should be $5\mu\text{m}$ or finer.

2. Install an after-cooler, air dryer or water separator, etc.

Air that includes excessive drainage may cause malfunction of valves and other pneumatic equipment. To prevent this, install an after-cooler, air dryer or water separator, etc.

3. Use the product within the specified range of fluid and ambient temperature.

Take measures to prevent freezing, since moisture in circuits can be frozen below 5°C , and this may cause damage to seals and lead to malfunction.

Refer to SMC's "Air Cleaning Equipment" catalog for further details on compressed air quality.

Operating Environment

Warning

1. Do not use in environments where there is a danger of corrosion.

Maintenance

Caution

1. Drain flushing

Remove drainage from air filters regularly.
(Refer to specifications.)



Series CKZN

Specific Product Precautions *Be sure to read before handling.*

1. Manual Toggle Release

The toggle link mechanism can be released easily by hitting the portion of round shaped projection on the cover by using of plastic hammer (hammer made of soft material), etc.

Please be sure to perform manual toggle release after safety has been confirmed because the clamp arm can suddenly move up moving during manual release.

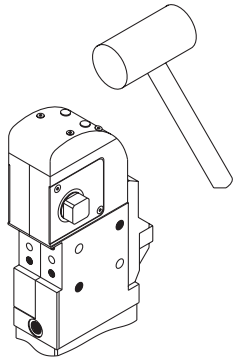

2. Do Not Disassemble The Power Clamp

No special maintenance is necessary because the power clamp has a fully enclosed design to protect the clamp against welding spatter, and also the power clamp has a contamination resistant construction. So, please do not disassemble the power clamp except changing replaceable parts as there is a possibility of deterioration of the clamp performance.

3. Tightening Torque of Spare Parts

Please make sure to tighten spare parts recommended in accordance with the following torque shown in the table.

Description	Bore size (mm)	Tightening torque	
		Nm	lbf-in
Switch Cassette Kit	50	5.0 to 7.0	44 to 62
	63	5.0 to 7.0	44 to 62
	80	5.0 to 7.0	44 to 62
Switch Bracket Kit	50	3.0 to 4.0	27 to 35
	63	3.0 to 4.0	27 to 35
	80	3.0 to 4.0	27 to 35
Stopper Bolt Kit	50	130 to 150	1150 to 1327
	63	160 to 200	1416 to 1770
	80	480 to 520	4248 to 4600
Top Cover Kit	50	2.5 to 3.0	22 to 27
	63	2.5 to 3.0	22 to 27
	80	3.0 to 5.0	27 to 44

- Note:** (1) Please make sure that the switch cassette is tightly secured to the body when it has been replaced with a new one.
 (2) Please make sure that the switch actuator is mounted so that the stamped side is secured as shown below if replacing.

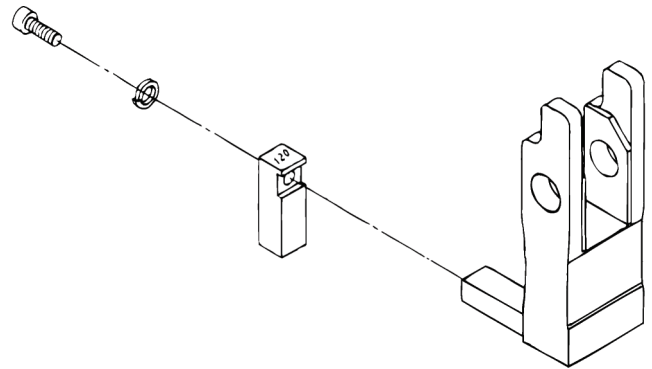

4. Clamp Arm Tightening Torque

Bore size (mm)	Tightening torque	
	Nm	lbf-in
50	12 to 15	106 to 133
63	15 to 20	133 to 177
80	18 to 24	159 to 212

Global Manufacturing, Distribution and Service Network

Worldwide Subsidiaries

EUROPE

AUSTRIA SMC Pneumatik GmbH (Austria)	LATVIA SMC Pneumatics Latvia SIA
BELGIUM SMC Pneumatics N.V./S.A.	LITHUANIA SMC Pneumatics Lietuva, UAB
BULGARIA SMC Industrial Automation Bulgaria EOOD	NETHERLANDS SMC Pneumatics BV
CROATIA SMC Industrijska Automatika d.o.o.	NORWAY SMC Pneumatics Norway A/S
CZECH SMC Industrial Automation CZ s.r.o.	POLAND SMC Industrial Automation Polska Sp.z.o.o.
DENMARK SMC Pneumatik A/S	ROMANIA SMC Romania S.r.l.
ESTONIA SMC Pneumatics Estonia	RUSSIA SMC Pneumatik LLC.
FINLAND SMC Pneumatics Finland OY	SLOVAKIA SMC Priemyselna Automatizacia, s.r.o.
FRANCE SMC Pneumatique S.A.	SLOVENIA SMC Industrijska Avtomatika d.o.o.
GERMANY SMC Pneumatik GmbH	SPAIN / PORTUGAL SMC España, S.A.
GREECE SMC Hellas EPE	SWEDEN SMC Pneumatics Sweden AB
HUNGARY SMC Hungary Ipari Automatizálási Kft.	SWITZERLAND SMC Pneumatik AG
IRELAND SMC Pneumatics (Ireland) Ltd.	UK SMC Pneumatics (U.K.) Ltd.
ITALY SMC Italia S.p.A.	

ASIA

CHINA SMC (China) Co., Ltd.
HONG KONG SMC Pneumatics (Hong kong) Ltd.
INDIA SMC Pneumatics (India) Pvt. Ltd.
JAPAN SMC Corporation
MALAYSIA SMC Pneumatics (S.E.A.) Sdn. Bhd.
PHILIPPINES SMC Pneumatics (Philippines), Inc.
SINGAPORE SMC Pneumatics (S.E.A.) Pte. Ltd.
SOUTH KOREA SMC Pneumatics Korea Co., Ltd.
TAIWAN SMC Pneumatics (Taiwan) Co., Ltd.
THAILAND SMC Thailand Ltd.

NORTH AMERICA

CANADA SMC Pneumatics (Canada) Ltd.
MEXICO SMC Corporation (Mexico) S.A. DE C.V.
USA SMC Corporation of America

SOUTH AMERICA

ARGENTINA SMC Argentina S.A.
BOLIVIA SMC Pneumatics Bolivia S.R.L.
BRAZIL SMC Pneumaticos do Brazil Ltda.
CHILE SMC Pneumatics (Chile) S.A.
VENEZUELA SMC Neumatica Venezuela S.A.

OCEANIA

AUSTRALIA SMC Pneumatics (Australia) Pty. Ltd.
NEW ZEALAND SMC Pneumatics (N.Z.) Ltd.

U.S. & Canadian Sales Offices

WEST

Austin
Dallas
Los Angeles
Phoenix
Portland
San Francisco

CENTRAL

Chicago
Cincinnati
Cleveland
Detroit
Indianapolis
Milwaukee
Minneapolis
St. Louis

EAST

Atlanta
Birmingham
Boston
Charlotte
Nashville
New Jersey
Rochester
Tampa

CANADA

Vancouver
Toronto
Windsor
Montreal

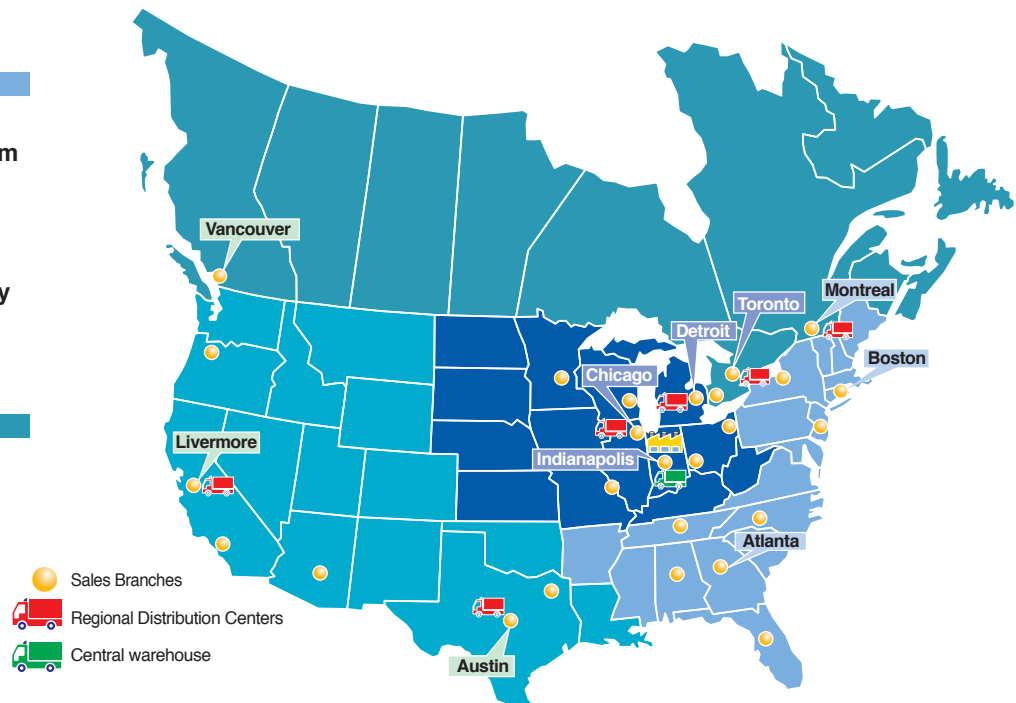

SMC Corporation of America
10100 SMC Blvd., Noblesville, IN 46060
www.smcusa.com

SMC Pneumatics (Canada) Ltd.
www.smcpcneumatics.ca

(800) SMC.SMC1 (762-7621)
e-mail: sales@smcusa.com
International inquiries: www.smcworld.com

