

Rotary Actuator/Vane Type

CRB□2 Series

Size: 10, 15, 20, 30, 40

Standard Type

Free Mount Type

RoHS

Many combinations available!

Standard type/CRB2 Series

- Piping ports are located on the flat surface.
Fittings can be secured firmly, piping is also improved.
- Many variations of shaft-end shape (6 types)
- Applicable to the D-M9□ type compact auto switch.

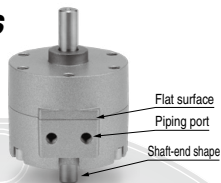

With auto switch unit

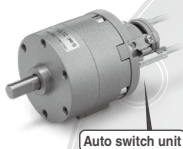

Auto switch unit

With angle adjuster unit

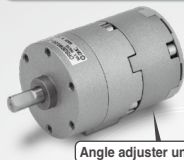

Angle adjuster unit

Possible to adjust the angle as desired

Rotating angle	Rotating angle adjustment range
270°	0 to 240° (Size 30)
180°	0 to 175°
90°	0 to 85°

With angle adjuster unit

+

With auto switch unit



Free mount type/CRBU2 Series

- 12% weight reduction
- Many mounting variations
- Applicable to the D-M9□ type compact auto switch.
- Possible to move the plate mounting position as desired

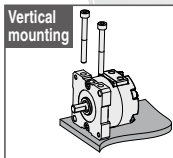

Vertical mounting

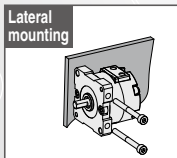

Lateral mounting

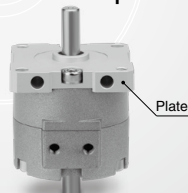

Plate

With auto switch unit

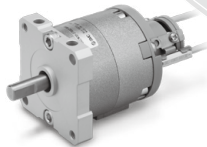

With angle adjuster unit

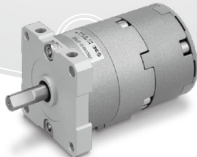

With angle adjuster unit

+

With auto switch unit



Rotating angle: 90°, 180°, 270°
All series can rotate up to 270°.

The use of specially designed seals and stoppers now enables our compact vane type rotary actuators to rotate up to 270°. (Single vane type)

Interchangeable mounting pitch with the current model

Mounting pitches A to C shown on the right and mounting hole diameters are interchangeable with the current model.

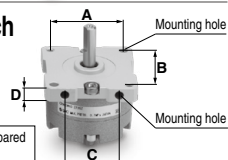

D: Height is reduced compared to the current model.

CRB□2

CRB1

MSU

CRJ

CRA1

CRQ2

MSQ

MSZ

CRQ2X

MSQX

MRQ

D-□

Shaft type variations

Six shaft options available
 (* The figures below show size 30 actuators.)

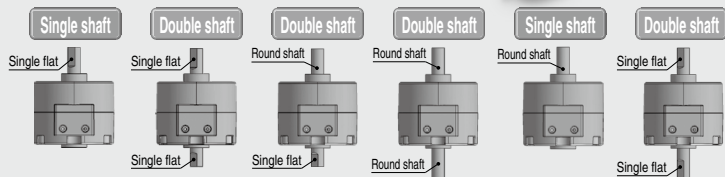

Direct mounting

The rotary actuator body can be mounted directly.

* Not possible for size 10 to 40 with unit(s)

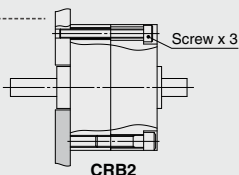

The mounting position of the auto switch can be set freely.

The switch can be fixed in the desired position in the circumferential direction.

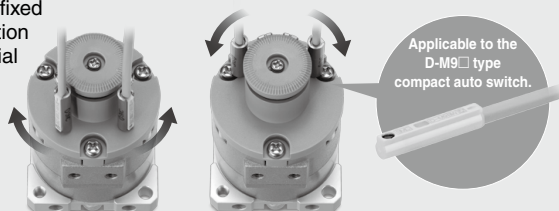

Connecting port location: Side ported or Axial ported

The port location can be selected according to the application.

(Size 10 to 40 with unit(s) are side ported only.)

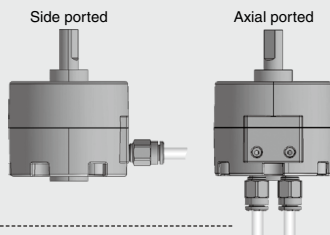

Double vane type is standardized for 90° and 100°.

The outside dimensions of the double vane type are equivalent to those of the single vane type (except size 10). Double vane construction can get twice the torque of the single vane type.

Series	Rotating angle	Single vane	Double vane	page
Standard type CRB2 Series	90°	●	●	P.52
	100°	●	●	
	180°	●	●	
	270°	●	●	
Free mount type CRBU2 Series	90°	●	●	P.68
	100°	●	●	
	180°	●	●	
	270°	●	●	

Free Mount Type/**CRBU2 Series**

Size: 10, 15, 20, 30, 40

- Possible to change the starting position as desired to suit the installation conditions.

Current: 4 directions → 8 directions

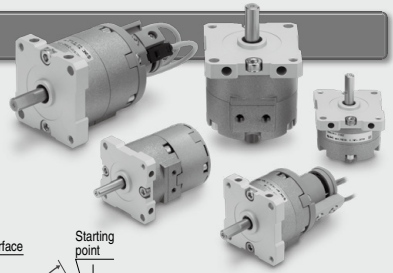
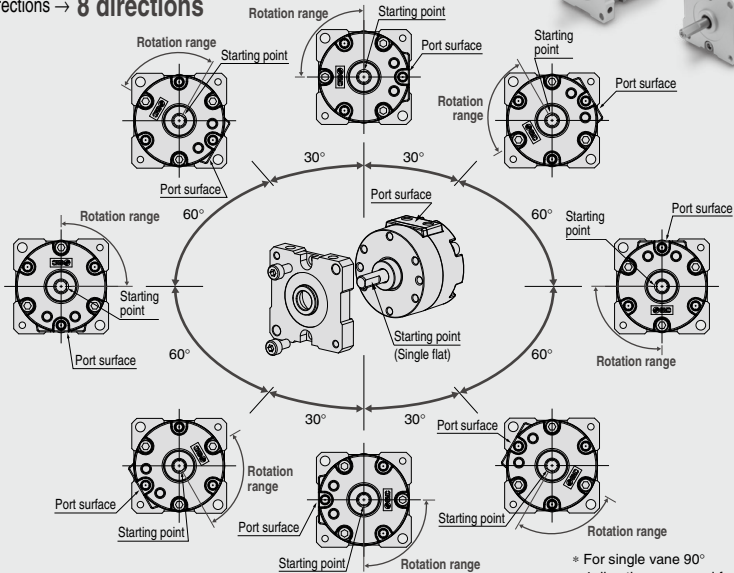

- CRB□2
- CRB1
- MSU
- CRJ
- CRA1
- CRQ2
- MSQ
- MSZ
- CRQ2X
MSQX
- MRQ

- **12% weight reduction**

Lighter installation can be achieved.

Size	CRBU2 [g]	Reduction rate [%]	Current model [g]
10	42	12	47.5
15	64	12	73
20	130	10	143
30	248	5	263
40	465	5	491

* Compared with single vane at 90°

- **Interchangeable mounting with the current model**

- **Six types of direct mounting are possible.**

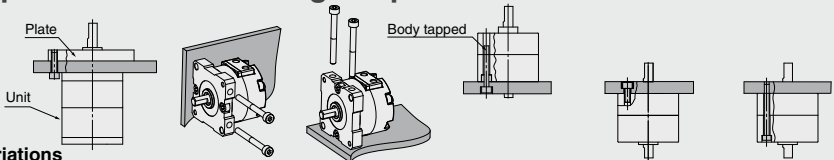

Mounting Variations

Applicable series	Free mount type	Free mount type	Free mount type	Standard type Free mount type	Standard type	Standard type
Mounting	Plate	Plate	Plate	Body tapped	Body tapped	Body through-hole (Fixed with the customer's plate.)
Mounting of each unit	Available	Available	Available	Not available	Available	Not available
Number of starting points	8 points	8 points	8 points	3 points	3 points	3 points
Workpiece removal during maintenance	No	No	No	No	Yes	Yes

Rotary Actuator/Vane Type CRB□2 Series

Standard type

CRB2 Series

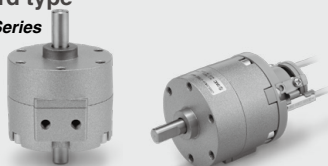

With auto switch

With angle adjuster

CRB2□WU Series

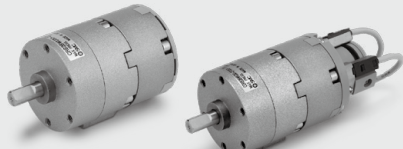

With auto switch

Free mount type

CRBU2 Series

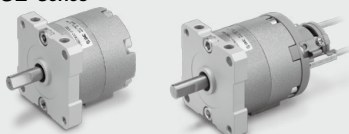

With auto switch

With angle adjuster

CRBU2WU Series

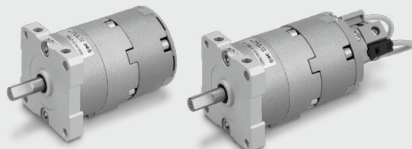

With auto switch

Series Variations

		Fluid		Air											
		Size		10		15		20, 30		40					
Vane type	S: Single vane D: Double vane		S	D	S	D	S	D	S	D	S	D			
	Port location	Side ported (Nil) Axial ported (E)		Side ported	Axial ported	Side ported	Axial ported	Side ported	Axial ported	Side ported	Axial ported	Side ported	Axial ported		
Rotating angle		90°		●	●	●	●	●	●	●	●	●	●	●	
	100°			●	●					●	●		●		
	180°		●			●			●			●			
	270°		●	●											
Shaft type	Single shaft	S	●	●	●	●	●	●	●	●	●	●	●		
	Double shaft	W	●	●	●	●	●	●	●	●	●	●	●		
	Long shaft with round shaft & Short shaft with single flat	J	●	●	●	●	●	●	●	●	●	●	●		
	Same length double long shaft with single flat on both shafts	Y	●	●	●	●	●	●	●	●	●	●	●		
	Double shaft key		●	●	●	●	●	●	●	●	●	●	●		
	Double round shaft	K	●	●	●	●	●	●	●	●	●	●	●		
Single round shaft	T	●	●	●	●	●	●	●	●	●	●	●			
Cushion	Rubber bumper		●	●	●	●	●	●	●	●	●	●	●		
Variations	With auto switch (WJ shaft)		●	●	●	●	●	●	●	●	●	●	●		
	With angle adjuster (WJ shaft)		●	●	●	●	●	●	●	●	●	●	●		
	With auto switch and angle adjuster (WJ shaft)		●	●	●	●	●	●	●	●	●	●	●		
Option	Mounting	With flange*	F	●	●	●	●	●	●	●	●	●			
Made to Order	Pattern	Shaft pattern		●	●	●	●	●	●	●	●	●	●		
		Rotating angle pattern		●	●	●	●	●	●	●	●	●	●	●	

* The CRB series only

CONTENTS

Rotary Actuator/Vane Type **CRB□2 Series**

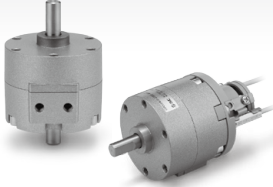

● Rotary Actuator/Vane Type

CRB2 Series

How to Order	Page 52
Specifications	Page 53
Construction	Page 55
Dimensions	Page 57

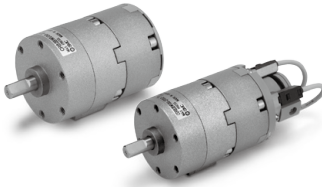

● Rotary Actuator with Angle Adjuster/Vane Type

CRB2□WU Series

How to Order	Page 63
Construction	Page 64
Dimensions	Page 65

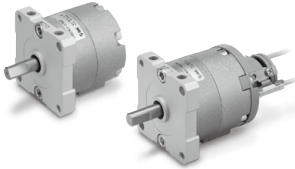

● Free Mount Type Rotary Actuator/Vane Type

CRBU2 Series

How to Order	Page 68
Specifications	Page 69
Construction	Page 71
Dimensions	Page 73

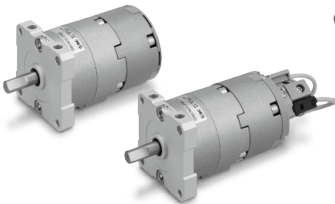

● Free Mount Type Rotary Actuator with Angle Adjuster/Vane Type

CRBU2WU Series

How to Order	Page 78
Construction	Page 79
Dimensions	Page 80

● Simple Specials

Shaft Pattern Sequencing I -XA1 to -XA24	Page 84
Shaft Pattern Sequencing II -XA31 to -XA58	Page 90

● Made to Order	Page 96
-----------------------	---------

● Component Unit	Page 99
------------------------	---------

● Angle Adjustment Setting	Page 100
----------------------------------	----------

● Auto Switch Mounting	Page 102
------------------------------	----------

CRB□2

CRB1

MSU

CRJ

CRA1

CRQ2

MSQ

MSZ

CRQ2X

MSQX

MRQ

D-□

Rotary Actuator Vane Type

RoHS

CRB2 Series

Size: 10, 15, 20, 30, 40

How to Order

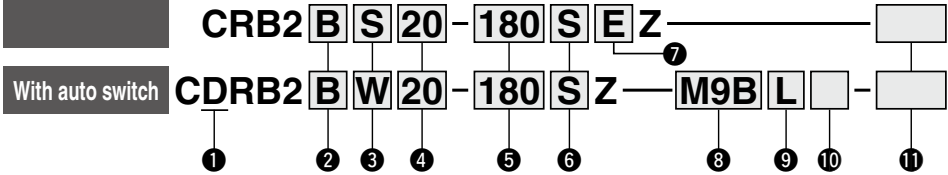

1 With auto switch

(With auto switch unit and built-in magnet)
* Refer to page 99 when the auto switch unit is needed separately.

2 Mounting

Symbol	Mounting
B	Basic type
F*	Flange type

* F: Excess size 40

3 Shaft type

Symbol	Shaft type	Shaft-end shape	
		Long shaft	Short shaft
S	Single shaft	Single flat*	—
W	Double shaft	Single flat*	Single flat
J**	Double shaft	Round shaft	Single flat
K**	Double shaft	Round shaft	Round shaft
T**	Single shaft	Round shaft	—
Y**	Double shaft	Single flat*	Long shaft with single flat*

* A key is used for size 40. ** J, K, T and Y are made to order.

*** When an auto switch is mounted to the rotary actuator, only shaft types W and J are available.

4 Size

10
15
20
30
40

9 Electrical entry/Lead wire length

Nil	Grommet/Lead wire: 0.5 m
M	Grommet/Lead wire: 1 m
L	Grommet/Lead wire: 3 m
CN	Connector/Without lead wire
C	Connector/Lead wire: 0.5 m
CL	Connector/Lead wire: 3 m

* Connectors are available only for the R73, R80, T79.

** Lead wire with connector part nos.
D-LC05: Lead wire 0.5 m
D-LC30: Lead wire 3 m
D-LC50: Lead wire 5 m

5 Rotating angle

Single vane	90	90°
	180	180°
	270	270°
Double vane	90	90°
	100	100°

6 Vane type

S	Single vane
D	Double vane

7 Connecting port location

Nil	Side ported
E	Axial ported

8 Auto switch

Nil	Without auto switch (Built-in magnet)
M	Without M9 type auto switch (Built-in magnet)

* For applicable auto switch model, refer to the table below.

** The operating range and hysteresis of the D-M9□ are different from those of the other auto switches. For details, refer to page 102.

10 Number of auto switches

S	1 pc.*
Nil	2 pcs.**

* S: A right-hand auto switch is shipped.

** Nil: A right-hand switch and a left-hand switch are shipped.

11 Made to Order

For details, refer to the next page.

Applicable Auto Switches/Refer to pages 797 to 850 for further information on auto switches.

Applicable size	Type	Special function	Electrical entry	Indicator light	Wiring (Output)	Load voltage		Auto switch model		Lead wire type	Lead wire length [m]					Pre-wired connector	Applicable load
						DC	AC	Perpendicular	In-line		0.5 (Nil)	1 (M)	3 (L)	5 (Z)	None (N)		
For 10, 15	Solid state auto switch	—	Grommet	Yes	3-wire (NPN)	5 V, 12 V	—	M9NV	M9N	Oilproof heavy-duty cord	●	●	●	○	—	○	IC circuit
					3-wire (PNP)			M9PV	M9P		●	●	●	○	—	○	IC circuit
					2-wire			M9BV	M9B		●	●	●	○	—	○	—
	Reed auto switch	—	Grommet	No	3-wire (NPN)	5 V, 12 V	—	S99V	S99	Vinyl parallel cord	●	●	●	○	—	○	IC circuit
					3-wire (PNP)			S99V	S99		●	●	●	○	—	○	IC circuit
					2-wire			S9PV	S9P		●	●	●	○	—	○	—
For 20, 30, 40	Solid state auto switch	—	Grommet	Yes	3-wire (NPN)	5 V, 12 V	—	M9NV	M9N	Oilproof heavy-duty cord	●	●	●	○	—	○	IC circuit
					3-wire (PNP)			M9PV	M9P		●	●	●	○	—	○	—
					2-wire			M9BV	M9B		●	●	●	○	—	○	—
					3-wire (NPN)			—	S79		●	●	●	○	—	○	IC circuit
					3-wire (PNP)			—	S7P		●	●	●	○	—	○	IC circuit
					2-wire			—	T79		●	●	●	○	—	○	—
	Reed auto switch	—	Grommet	Yes	2-wire	—	—	T99V	T99	Oilproof heavy-duty cord	●	●	●	○	—	○	—
					—			—	—		—	—	—	—	—	—	—
					—			—	—		—	—	—	—	—	—	—
					—			—	—		—	—	—	—	—	—	—
					—			—	—		—	—	—	—	—	—	—
					—			—	—		—	—	—	—	—	—	—
Reed auto switch	—	Connector	No	2-wire	48 V, 100 V	—	R73	R73	Oilproof heavy-duty cord	●	●	●	○	—	○	—	
				—			—	—		—	—	—	—	—	—	—	
				—			—	—		—	—	—	—	—	—	—	
				—			—	—		—	—	—	—	—	—	—	
				—			—	—		—	—	—	—	—	—	—	
				—			—	—		—	—	—	—	—	—	—	
Reed auto switch	—	Grommet	No	2-wire	100 V	—	R73C	R73C	Oilproof heavy-duty cord	●	●	●	○	—	○	—	
				—			—	—		—	—	—	—	—	—	—	
				—			—	—		—	—	—	—	—	—	—	
				—			—	—		—	—	—	—	—	—	—	
				—			—	—		—	—	—	—	—	—	—	
				—			—	—		—	—	—	—	—	—	—	
Reed auto switch	—	Grommet	No	2-wire	24 V or loss	—	R80	R80	Oilproof heavy-duty cord	●	●	●	○	—	○	—	
				—			—	—		—	—	—	—	—	—	—	
				—			—	—		—	—	—	—	—	—	—	
				—			—	—		—	—	—	—	—	—	—	
				—			—	—		—	—	—	—	—	—	—	
				—			—	—		—	—	—	—	—	—	—	

* Lead wire length symbols: 0.5 m..... Nil (Example) R73C

3 m..... L (Example) R73CL

5 m..... Z (Example) R73CZ

None..... N (Example) R73CN

* Auto switches are shipped together, (but not assembled).

** Solid state auto switches marked with "○" are produced upon receipt of order.

Single Vane Specifications

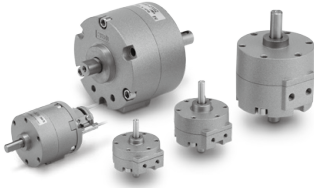

Symbol



Flange Assembly Part No.

(For details about dimensions, refer to page 62.)

Model	Assembly part no.
CRB2F□10	P211070-2
CRB2F□15	P211090-2
CRB2F□20	P211060-2
CRB2F□30	P211080-2



Made to Order

(For details, refer to pages 84 to 98.)

Symbol	Description	Applicable shaft type
XA1 to XA24	Shaft type pattern I	W
XA31 to XA58	Shaft type pattern II	S, J, K, T, Y
XC1	Add connecting ports	W, S, J, K, T, Y
XC2	Change threaded hole to through-hole	W, S, J, K, T, Y
XC3	Change the screw position	W, S, J, K, T, Y
XC4	Change the rotation range	W, S, J, K, T, Y
XC5	Change rotation range between 0 to 200°	W, S, J, K, T, Y
XC6	Change rotation range between 0 to 110°	W, S, J, K, T, Y
XC7	Reversed shaft	W, J
XC30	Fluorine grease	W, S, J, K, T, Y
X5	For M5 port (90°/180°)	W, S, J, K, T, Y

The above may not be selected when the product comes with an auto switch or angle adjustment unit. For details, refer to pages 84, 85, 90, 91, 96.

Refer to pages 102 to 106 for actuators with auto switches.

- Operating range and hysteresis
- How to change the auto switch detecting position
- Auto switch mounting
- Auto switch adjustment

Size	10	15	20	30	40
Rotating angle	90°, 180°, 270°				
Fluid	Air (Non-lube)				
Proof pressure [MPa]	1.05		1.5		
Ambient and fluid temperature	5 to 60°C				
Max. operating pressure [MPa]	0.7		1.0		
Min. operating pressure [MPa]	0.2	0.15			
Rotation time adjustment range s/90° ^{Note 1)}	0.03 to 0.3		0.04 to 0.3	0.07 to 0.5	
Allowable kinetic energy [J] ^{Note 2)}	0.00015	0.001	0.003	0.02	0.04
		0.00025	0.0004	0.015	0.03
Shaft load [N]	Allowable radial load	15	15	25	30
	Allowable thrust load	10	10	20	25
Port location	Side ported or Axial ported				
Port size (Side ported, Axial ported)	M3 x 0.5			M5 x 0.8	
Angle adjustable range ^{Note 3)}	0 to 230°	0 to 240°		0 to 230°	

Note 1) Make sure to use the actuator within the adjustable speed range. Exceeding the low speed range (0.3 s/90°) can cause the unit to stick or not operate.

For size 10, when operation at the maximum speed (0.03 s/90°) is required, the operating pressure should be set to 0.35 MPa or higher.

Note 2) The upper numbers in this section in the table indicate the energy factor when the rubber bumper is used (at the end of the rotation), and the lower numbers indicate the energy factor when the rubber bumper is not used.

Note 3) Adjustment range in the table is for 270°. For 90° and 180°, refer to page 64.

Double Vane Specifications

Size	10	15	20	30	40
Rotating angle	90°, 100°				
Fluid	Air (Non-lube)				
Proof pressure [MPa]	1.05		1.5		
Ambient and fluid temperature	5 to 60°C				
Max. operating pressure [MPa]	0.7		1.0		
Min. operating pressure [MPa]	0.2	0.15			
Rotation time adjustment range s/90° ^{Note 1)}	0.03 to 0.3		0.04 to 0.3	0.07 to 0.5	
Allowable kinetic energy [J]	0.0003	0.0012	0.0033	0.02	0.04
Shaft load [N]	Allowable radial load	15	15	25	30
	Allowable thrust load	10	10	20	25
Port location	Side ported or Axial ported				
Port size (Side ported, Axial ported)	M3 x 0.5			M5 x 0.8	
Angle adjustable range ^{Note 2)}	0 to 90°				

Note 1) Make sure to use the actuator within the adjustable speed range. Exceeding the low speed range (0.3 s/90°) can cause the unit to stick or not operate.

For size 10, when operation at the maximum speed (0.03 s/90°) is required, the operating pressure should be set to 0.35 MPa or higher.

Note 2) Adjustment range in the table is for 100°. For 90°, refer to page 64.

CRB2

CRB1

MSU

CRJ

CRA1

CRQ2

MSQ

MSZ

CRQ2X
MSQX

MRQ

D-□

CRB2 Series

Volume

[cm³]

Vane type Size	Single vane												Double vane												
	10			15			20			30			40			10		15		20		30		40	
Rotating angle	90°	180°	270°	90°	180°	270°	90°	180°	270°	90°	180°	270°	90°	180°	270°	90°	100°	90°	100°	90°	100°	90°	100°	90°	100°
Volume	1 (0.6)	1.2	1.5	1.5 (1.0)	2.9	3.7	4.8 (3.6)	6.1	7.9	11.3 (8.5)	15	20.2	25 (18.7)	31.5	41	1.0	1.1	2.6	2.7	5.6	5.7	14.4	14.5	33	34

* Values inside () are volume of the supply side when A port is pressurized.

Weight

[g]

Vane type Size	Single vane												Double vane												
	10			15			30			40			10		15		30		40						
Rotating angle	90°	180°	270°	90°	180°	270°	90°	180°	270°	90°	180°	270°	90°	180°	270°	90°	100°	90°	100°	90°	100°	90°	100°	90°	100°
Rotary actuator body	27	26	26	48	47	46	104	103	101	199	194	189	385	374	363	42	43	55	58	119	142	219	239	398	444
Flange assembly	9	9	9	10	10	10	19	19	19	25	25	25	—	—	—	9	10	19	25	25	25	—	—	—	—
Auto switch unit	15	15	15	20	20	20	28	28	28	38	38	38	43	43	43	15	20	28	28	38	38	43	43	43	43
Angle adjuster unit	30	30	30	47	47	47	90	90	90	150	150	150	203	203	203	30	47	90	90	150	150	203	203	203	203

Effective Output

Size 10

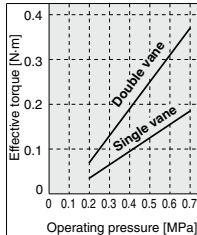

Size 15

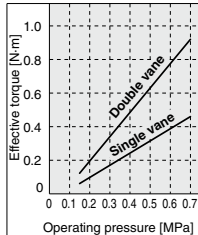

Size 20

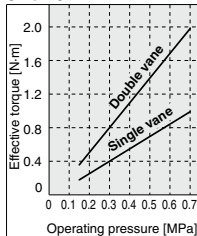

Size 30

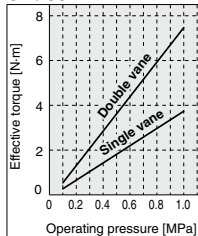

Size 40

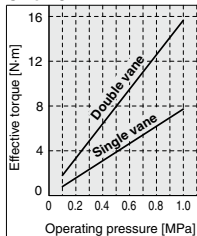

Direct Mounting of Body

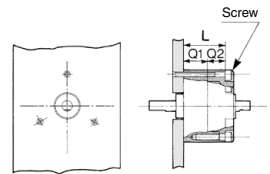

Dimension "L" of the actuators is provided in the table below for JIS standard hexagon socket head cap screws. If these types of screw are used, their heads will fit in the mounting hole.

Reference Screw Size

Size	L	Screw
10	11.5*	M2.5
15	16	M2.5
20	24.5	M3
30	34.5	M4
40	39.5	M4

* Only the size 10 actuators have different L dimensions for single and double vane.

Double vane: L = 20.5

* Refer to page 57 for Q1 and Q2 dimensions.

Chamfered Position and Rotation Range: Top View from Long Shaft Side

Chamfered positions shown below illustrate the conditions of actuators when B port is pressurized.

Single vane

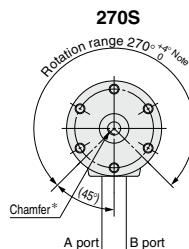
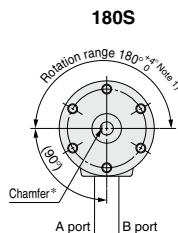
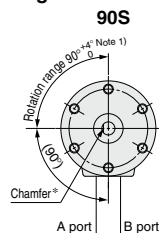

Double vane

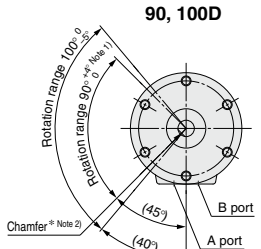

* For size 40 actuators, a parallel key will be used instead of chamfer.

Note 1) For single vane type, the tolerance of rotating angle of 90°, 180°, 270° will be $^{+5}_{0}$ for size 10 only.

For double vane type, the tolerance of rotating angle of 90° will be $^{+5}_{0}$ for size 10 only.

Note 2) The chamfered position of the double vane type shows the 90° specification position.

Construction

Single vane • Figures for 90° and 180° show the condition of the actuators when B port is pressurized, and the figure for 270° shows the position of the ports during rotation.

Size: 10, 15, 20, 30, 40

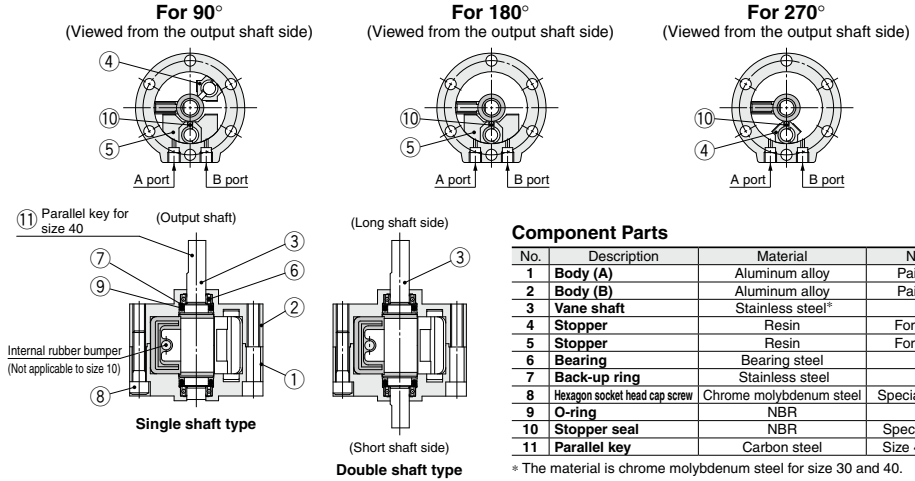

Double vane • Figures below show the intermediate rotation position when A or B port is pressurized.

Size: 10

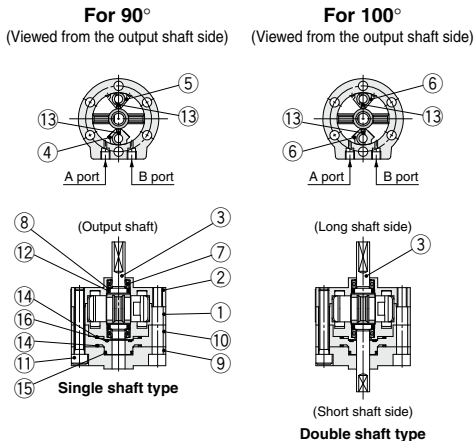

Size: 15, 20, 30, 40

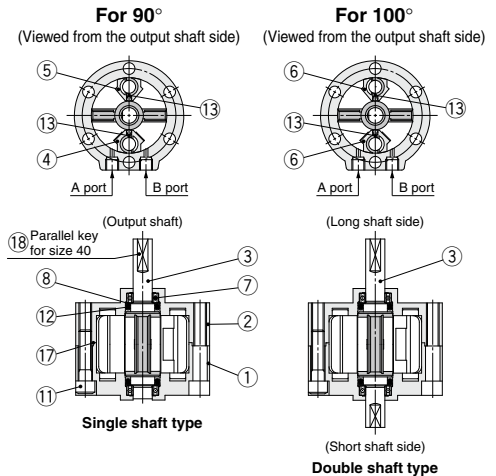

Component Parts

No.	Description	Material	Note
1	Body (A)	Aluminum alloy	Painted
2	Body (B)	Aluminum alloy	Painted
3	Vane shaft	Chrome molybdenum steel	
4	Stopper	Stainless steel*	
5	Stopper	Resin	
6	Stopper	Stainless steel*	
7	Bearing	Bearing steel	
8	Back-up ring	Stainless steel	
9	Cover	Aluminum alloy	

* For size 40, material for ④, ⑥ is aluminum alloy.

No.	Description	Material	Note
10	Plate	Resin	
11	Hexagon socket head cap screw	Chrome molybdenum steel	Special screw
12	O-ring	NBR	
13	Stopper seal	NBR	Special seal
14	Gasket	NBR	Special seal
15	O-ring	NBR	
16	O-ring	NBR	
17	O-ring	NBR	Size 40 only
18	Parallel key	Carbon steel	Size 40 only

CRB2 Series

Construction (With Auto Switch)

Single vane

- Following figures show actuators for 90° and 180° when B port is pressurized.

(The unit is common for single vane type and double vane type.)

Double vane

- Following figures show the intermediate rotation position when A or B port is pressurized.

Size: 40

Size: 10, 15

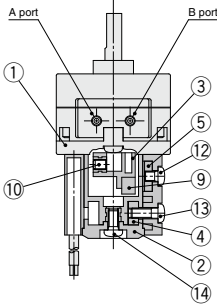

Size: 20, 30

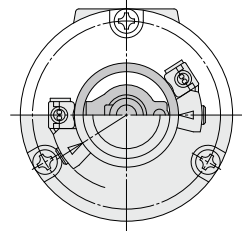
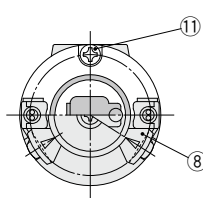
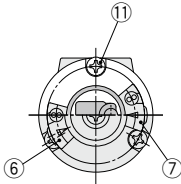
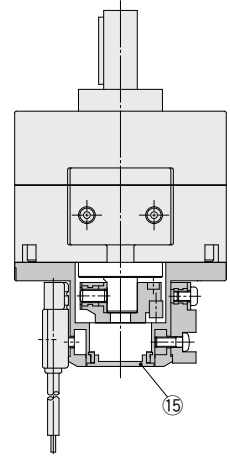
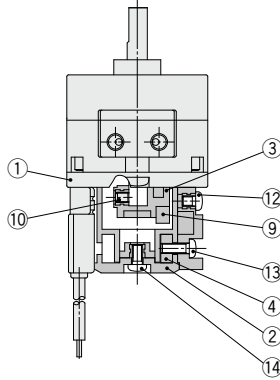

D-M9□

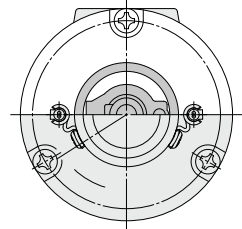
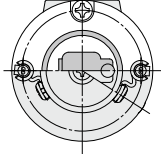
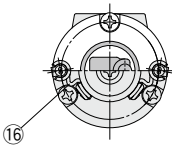

Component Parts

No.	Description	Material
1	Cover (A)	Resin
2	Cover (B)	Resin
3	Magnet lever	Resin
4	Holding block	Stainless steel
5	Holding block (B)	Aluminum alloy
6	Switch block (A)	Resin
7	Switch block (B)	Resin
8	Switch block	Resin
9	Magnet	

No.	Description	Material
10	Hexagon socket head set screw	Stainless steel
11	Cross recessed round head screw	Stainless steel
12	Cross recessed round head screw	Stainless steel
13	Cross recessed round head screw	Stainless steel
14	Cross recessed round head screw	Stainless steel
15	Rubber cap	NBR
16	Switch holder	Stainless steel

* For size 10, 2 cross recessed round head screws ⑪ are required.

Dimensions: Standard Type 10, 15, 20, 30, 40

- For single vane type, the figures below show actuators for 90° and 180° when B port is pressurized.
For double vane type, the figures below show the intermediate rotation position when the A or B port is pressurized.

Single shaft/Port location: Side ported

(The size 10 double vane type is indicated on page 58.)

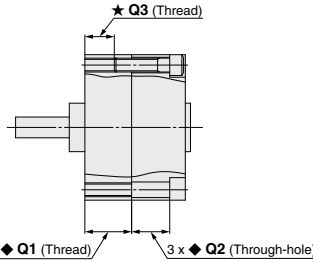
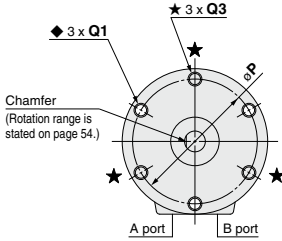

Shaft-end shape of size 40

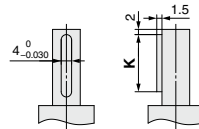

Parallel key dimensions

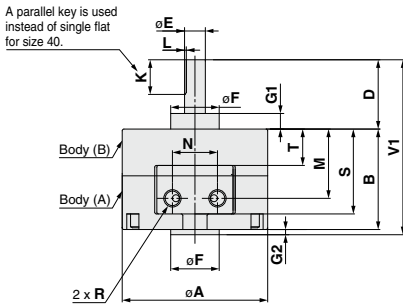
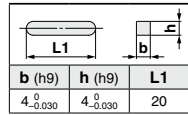

Double shaft/Port location: Side ported

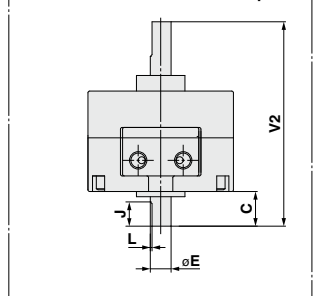

Size: 10
<Port location: Side ported>

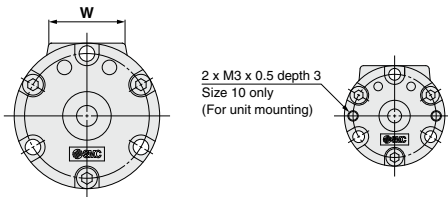

Size: 10, 15, 20, 30, 40
<Port location: Axial ported>

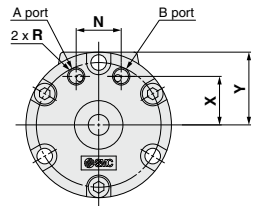

Refer to page 61 for details of shaft types J, K, T and Y.

Size	A	B	C	D	E (g7)	F (h9)	G1	G2	J	K	L	M	N	P	Q			R	S	T	V1	V2	W	X	Y
															◆ Q1	◆ Q2	★ Q3								
10	29	15	8	14	4 ^{-0.004} _{-0.016}	9 ⁰ _{-0.036}	3	1	5	9	0.5	9.5	9.5	24	M3 x 0.5 depth 6	6	—	M3 x 0.5	14	3.6	30	37	19.8	8.5	14.5
15	34	20	9	18	5 ^{-0.004} _{-0.016}	12 ⁰ _{-0.043}	4	1.5	6	10	0.5	14	10	29	M3 x 0.5 depth 10	6	M3 x 0.5 depth 5	M3 x 0.5	19	7.6	39.5	47	21	11	17
20	42	29	10	20	6 ^{-0.004} _{-0.016}	14 ⁰ _{-0.043}	4.5	1.5	7	10	0.5	20	13	36	M4 x 0.7 depth 13.5	11	M4 x 0.7 depth 7.5	M5 x 0.8	24.5	10.5	50.5	59	22	14	21
30	50	40	13	22	8 ^{-0.005} _{-0.020}	16 ⁰ _{-0.043}	5	2	8	12	1.0	26	14	43	M5 x 0.8 depth 18	16.5	M5 x 0.8 depth 10	M5 x 0.8	34.5	14	64	75	24	15.5	25
40	63	45	15	30	10 ^{-0.005} _{-0.020}	25 ⁰ _{-0.052}	6.5	4.5	9	20	1.0	31	20	56	M5 x 0.8 depth 16	17.5	M5 x 0.8 depth 10	M5 x 0.8	39.8	17	79.5	90	30	21	31.6

CRB2 Series

Dimensions: Standard Type 10

Double vane • Following figures show the intermediate rotation position when A or B port is pressurized.

Single shaft/Port location: Side ported

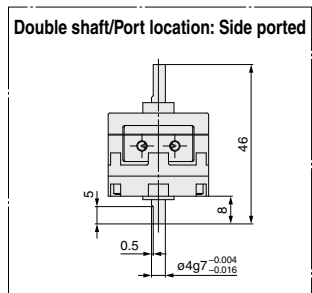
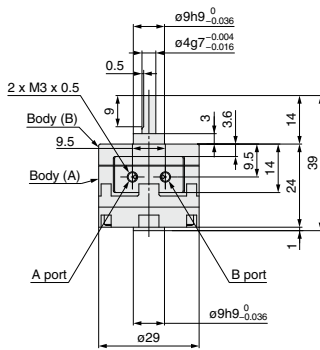
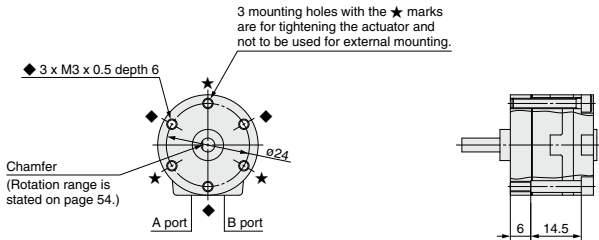

<Port location: Axial ported>

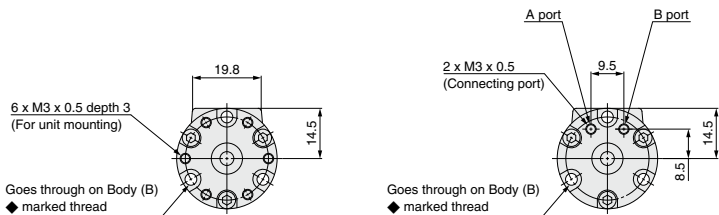

Refer to page 61 for details of shaft types J, K, T and Y.

Dimensions: Standard Type (With Auto Switch) 10, 15, 20, 30, 40

- For single vane type, the figures below show actuators for 90° and 180° when B port is pressurized.
For double vane type, the figures below show the intermediate rotation position when the A or B port is pressurized.

Size: 10, 15

(The size 10 double vane type is indicated on page 60.)

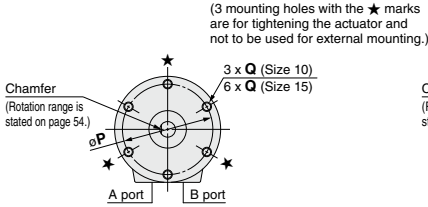

Size: 20, 30, 40

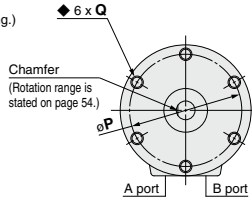

Shaft-end shape of size 40

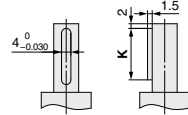

Parallel key dimensions

b (h9)	h (h9)	L1
4 _{-0.030} ⁰	4 _{-0.030} ⁰	20

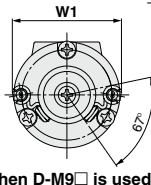
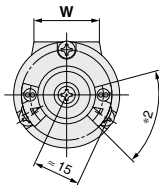
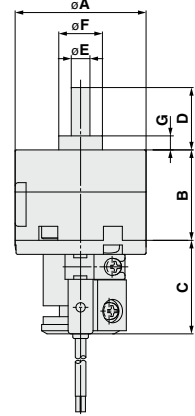
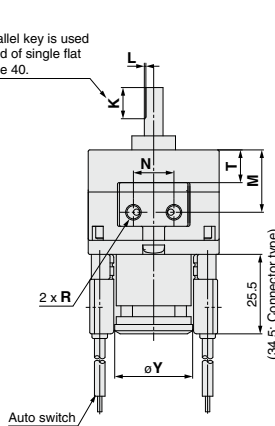
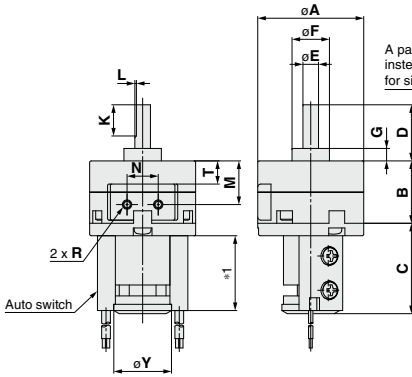

When D-M9□ is used

Size: 20, 30

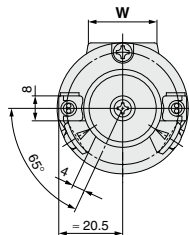

Size: 40

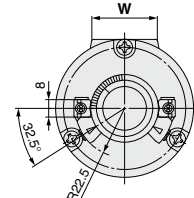

- *1. The length is 24 when any of the following are used:
D-90/90A/S99(V)/T99(V)/S9P(V)
The length is 30 when any of the following are used: D-97/93A
The length is 25.5 when the D-M9 is used.
- *2. The angle is 60° when any of the following are used: D-90/90A/97/93A
The angle is 69° when any of the following are used: D-S99(V)/T99(V)/S9P(V)

Refer to page 61 for details of shaft types J, K, T and Y.

Size	A	B	C	D	E (g7)	F (h9)	G	K	L	M	N	P	Q	R	T	W	W1	Y
10	29	15	29	14	4 _{-0.016} ⁰	9 _{-0.036} ⁰	3	9	0.5	9.5	9.5	24	M3 x 0.5 depth 6	M3 x 0.5	3.6	19.8	35	18.5
15	34	20	29	18	5 _{-0.016} ⁰	12 _{-0.043} ⁰	4	10	0.5	14	10	29	M3 x 0.5 depth 5	M3 x 0.5	7.6	21	35	18.5
20	42	29	30	20	6 _{-0.016} ⁰	14 _{-0.043} ⁰	4.5	10	0.5	20	13	36	M4 x 0.7 depth 7	M5 x 0.8	10.5	22	—	25
30	50	40	31	22	8 _{-0.020} ⁰	16 _{-0.043} ⁰	5	12	1.0	26	14	43	M5 x 0.8 depth 10	M5 x 0.8	14	24	—	25
40	63	45	31	30	10 _{-0.020} ⁰	25 _{-0.052} ⁰	6.5	20	1.0	31	20	56	M5 x 0.8 depth 10	M5 x 0.8	17	30	—	31

[mm]

CDRB2 Series

Dimensions: Standard Type (With Auto Switch) 10

Double vane • Following figures show the intermediate rotation position when A or B port is pressurized.

Size: 10

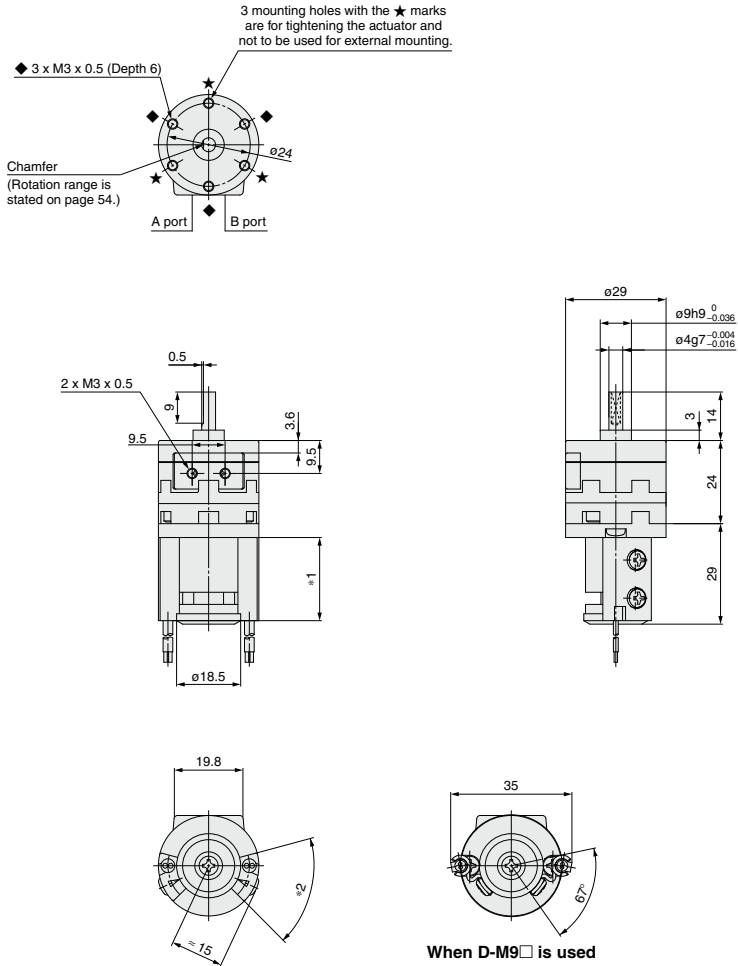

*1. The length is 24 when any of the following are used: D-90/90A/S99(V)/T99(V)/S9P(V)
The length is 30 when any of the following are used: D-97/93A
The length is 25.5 when the D-M9 is used.

*2. The angle is 60° when any of the following are used: D-90/90A/97/93A
The angle is 69° when any of the following are used: D-S99(V)/T99(V)/S9P(V)

Refer to page 61 for details of shaft types J, K, T and Y.

Shaft Type Dimensions (Dimensions other than specified below are the same as the standard type.)

Size: 10, 15, 20, 30, 40

Double shaft/CRB2□J

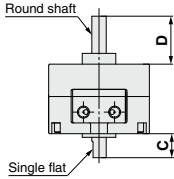

Double shaft/CRB2□K

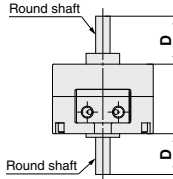

Single shaft/CRB2□T

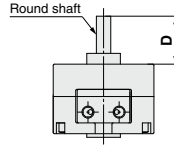

Double shaft/CRB2□Y

A parallel key is used instead of single flat for size 40.

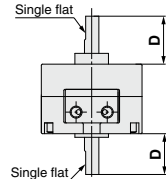

Double shaft/CRB2□J

With auto switch

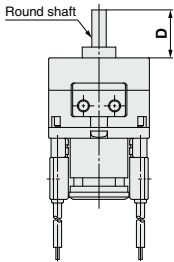

Double shaft/CRB2□JU

With angle adjuster unit

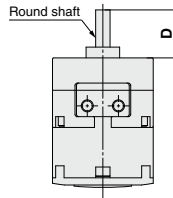

Double shaft/CRB2□JU

With auto switch and angle adjuster unit

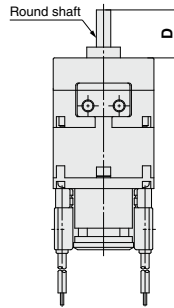

[mm]

Size	10	15	20	30	40
C	8	9	10	13	15
D	14	18	20	22	30

Note 1) Dimensions of the shaft and single flat (a parallel key for size 40) are the same as the standard. Dimension parts different from the standard conform to the general tolerance.

Note 2) For rotary actuators with auto switch and angle adjuster unit, connection ports are side ports.

CRB2
CRB1
MSU
CRJ
CRA1
CRQ2
MSQ
MSZ
CRQ2X
MSQX
MRQ

D-□

CRB2 Series

Optional Specifications: Flange (Size: 10, 15, 20, 30)



Flange assembly for C□RB2F□□10
Part no.: P211070-2

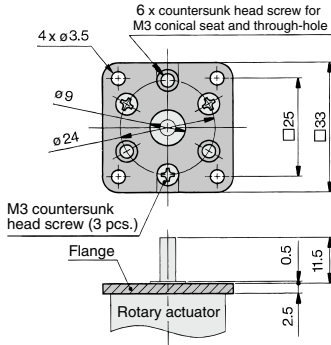

Flange assembly for C□RB2F□□15
Part no.: P211090-2

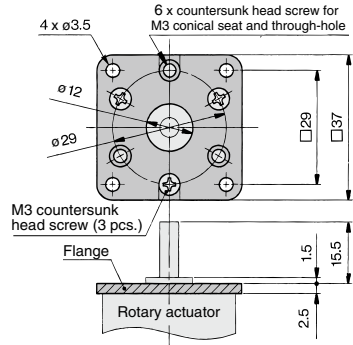

Flange assembly for C□RB2F□□20
Part no.: P211060-2

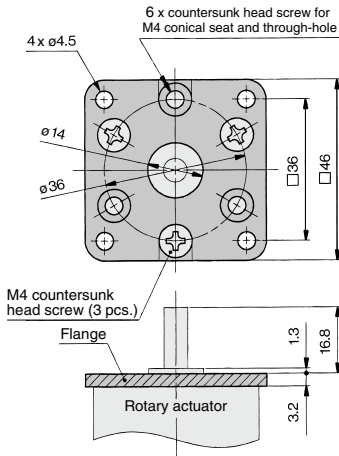

Flange assembly for C□RB2F□□30
Part no.: P211080-2

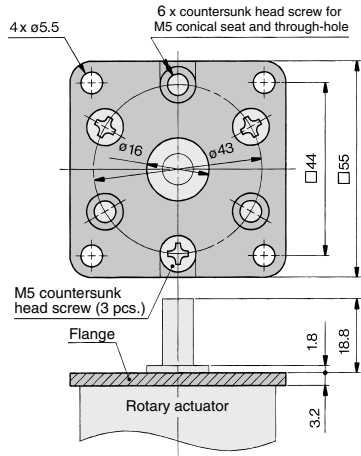

Rotary Actuator With Angle Adjuster/Vane Type

(RoHS)

CRB2□WU Series

Size: 10, 15, 20, 30, 40

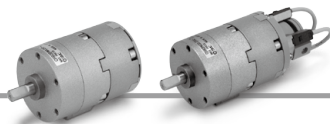

How to Order

CRB2 **B** **W** **U** **20** - **180** **S** **Z** - □

With auto switch

CDRB2 **B** **W** **U** **20** - **180** **S** **Z** - **M9B** **L** □ - □



1 With auto switch

(With auto switch unit and built-in magnet)
* Refer to page 99 when the auto switch unit is needed separately.

2 Mounting

Symbol	Mounting
B	Basic type
F*	Flange type

* F: Except size 40

3 Shaft type

Symbol	Shaft-end shape
W	Single flat*
J**	Round shaft

* A key is used for size 40.

** J is made to order.

4 With angle adjuster unit

* Refer to page 99 when the angle adjuster unit is needed separately.

5 Size

10	
15	
20	
30	
40	

6 Rotating angle

Single vane	90	90°
	180	180°
	270	270°
Double vane	90	90°
	100	100°

7 Vane type

S	Single vane
D	Double vane

8 Auto switch

Nil	Without auto switch (Built-in magnet)
M	Without M9 type auto switch (Built-in magnet)

* For applicable auto switch model, refer to the table below.

** The operating range and hysteresis of the D-M9□ are different from those of the other auto switches. For details, refer to page 102.

9 Electrical entry/Lead wire length

Nil	Grommet/Lead wire: 0.5 m
M	Grommet/Lead wire: 1 m
L	Grommet/Lead wire: 3 m
CN	Connector/Without lead wire
C	Connector/Lead wire: 0.5 m
CL	Connector/Lead wire: 3 m

** Connectors are available only for the R73, R80, T79.

** Lead wire with connector part nos.
D-LC05: Lead wire 0.5 m
D-LC30: Lead wire 3 m
D-LC50: Lead wire 5 m

Refer to pages 102 to 106 for actuators with auto switches.

- Operating range and hysteresis
- How to change the auto switch detecting position
- Auto switch mounting
- Auto switch adjustment

10 Number of auto switches

S	1 pc.*
Nil	2 pcs.**

* S: A right-hand auto switch is shipped.

** Nil: A right-hand switch and a left-hand switch are shipped.

11 Made to Order

For details, refer to the table below.



Made to Order

(For details, refer to pages 84 to 98.)

Applicable Auto Switches/Refer to pages 797 to 850 for further information on auto switches.

Applicable size	Type	Special function	Electrical entry	Indicator/light	Wiring (Output)	Load voltage		Auto switch model		Lead wire type	Lead wire length [m]					Pre-wired connector	Applicable load
						DC	AC	Perpendicular	In-line		0.5 (Nil)	1 (M)	3 (L)	5 (Z)	None (Nil)		
For 10, 15	Solid state auto switch	—	Grommet	Yes	3-wire (NPV)	5 V, 12 V	—	M9NV	M9N	Oilproof heavy-duty cord	●	●	●	○	—	○	IC circuit
					3-wire (PNP)	12 V	—	M9PV	M9P		●	●	●	○	—	○	
	Reed auto switch	—	Grommet	No	2-wire	5 V, 12 V	—	S99V	S99	Oilproof heavy-duty cord	●	●	●	○	—	○	IC circuit
					3-wire (NPV)	12 V	—	S99V	S9P		●	●	●	○	—	○	
For 20, 30, 40	Solid state auto switch	—	Grommet	Yes	3-wire (NPV)	5 V, 12 V	—	M9NV	M9N	Oilproof heavy-duty cord	●	●	●	○	—	○	IC circuit
					3-wire (PNP)	12 V	—	M9PV	M9P		●	●	●	○	—	○	
					2-wire	5 V, 12 V	—	M9BV	M9B		●	●	●	○	—	○	
					3-wire (NPV)	12 V	—	M9BV	M9B		●	●	●	○	—	○	
	Reed auto switch	—	Grommet	No	2-wire	5 V, 12 V	5 V, 12 V, 24 V	—	S79	Oilproof heavy-duty cord	●	●	●	○	—	○	IC circuit
					3-wire (NPV)	5 V, 12 V, 100 V	—	S7P	●		●	●	○	—	○		
					3-wire (PNP)	—	—	T79	●		●	●	○	—	○		
					2-wire	100 V	—	T79C	●		●	●	○	—	○		
	Reed auto switch	—	Connector	No	2-wire	—	100 V	—	R73	Oilproof heavy-duty cord	●	●	●	○	—	○	IC circuit
					2-wire	—	—	R73C	●		●	●	○	—	○		
					2-wire	—	—	R80	●		●	●	○	—	○		
					2-wire	48 V, 100 V	100 V	—	R80C		●	●	●	○	—	○	
						24 V or less	—	R80C						—	IC circuit		

* Lead wire length symbols: 0.5 m Nil (Example) R73C
3 m L (Example) R73CL
5 m Z (Example) R73CZ
None N (Example) R73CN

* Auto switches are shipped together, (but not assembled).
* Solid state auto switches marked with "○" are produced upon receipt of order.

The above may not be selected when the product comes with an auto switch or angle adjuster unit. For details, refer to pages 84, 85, 90, 91, 96.

CRB2□WU Series

Construction: 10, 15, 20, 30, 40

- The unit is common for single vane type and double vane type.

With angle adjuster

Size: 10, 15, 20, 30, 40

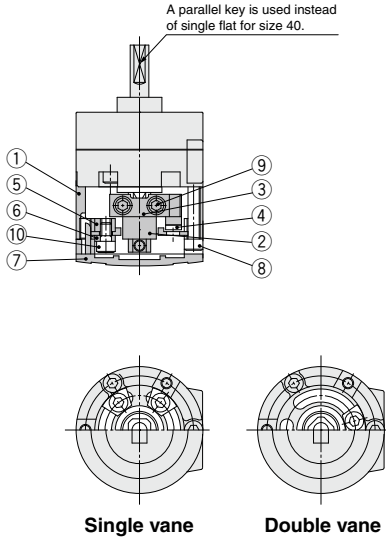

With auto switch and angle adjuster

Size: 10, 15

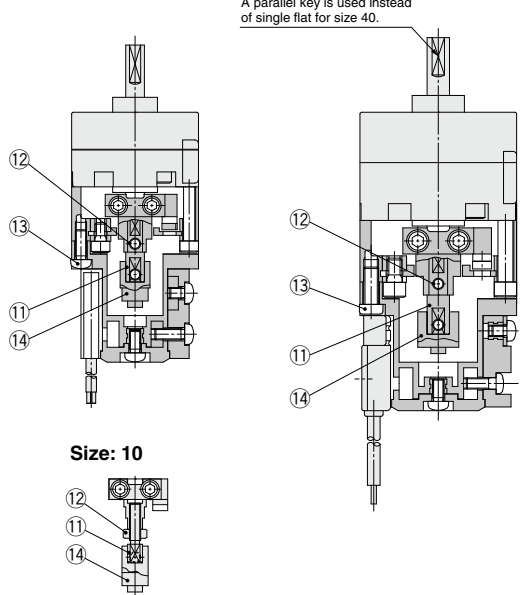

Component Parts

No.	Description	Material	Note
1	Stopper ring	Aluminum alloy	
2	Stopper lever	Chrome molybdenum steel	
3	Lever retainer	Rolled steel	Zinc chromated
4	Rubber bumper	NBR	
5	Stopper block	Chrome molybdenum steel	Zinc chromated
6	Block retainer	Rolled steel	Zinc chromated
7	Cap	Resin	
8	Hexagon socket head cap screw	Stainless steel	Special screw
9	Hexagon socket head cap screw	Stainless steel	Special screw
10	Hexagon socket head cap screw	Stainless steel	Special screw
11	Joint		
12	Hexagon socket head set screw	Stainless steel	Hexagon nut will be used for size 10 only.
13	Hexagon nut	Stainless steel	
14	Cross recessed round head screw	Stainless steel	
14	Magnet lever	—	

⚠ Specific Product Precautions

Be sure to read this before handling the products. Refer to back page 50 for Safety Instructions and pages 4 to 14 for Rotary Actuator and Auto Switch Precautions.

Angle Adjuster Unit

⚠ Caution

1. Since the maximum angle of the rotating angle adjustment range will be limited by the rotation of the rotary actuator, make sure to take this into consideration when ordering.

Rotating angle of rotary actuator	Rotating angle adjustment range
270^{+4}_0	0° to 230° (Size: 10, 40) * 0° to 240° (Size: 15, 20, 30)
180^{+4}_0	0° to 175°
90^{+4}_0	0° to 85°

* The maximum adjustment angle of the angle adjuster unit for size 10 and 40 is 230°

2. Connecting ports are side ported only.
3. The allowable kinetic energy is the same as the specifications of the rotary actuator.
4. Use a 100° rotary actuator when you desire to adjust the angle to 90° using a double vane type.

Dimensions: Standard Type (With Angle Adjuster) 10, 15, 20, 30, 40

- For single vane type, the figures below show actuators for 90° (without unit) when the B port is pressurized.
For double vane type, the figures below show the intermediate rotation position when the A or B port is pressurized.

Size: 10, 15, 20, 30, 40

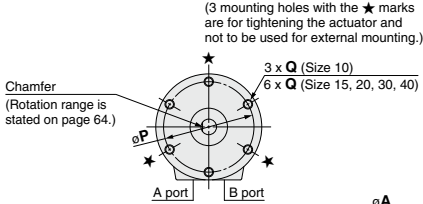

Size: 10 (Double vane)

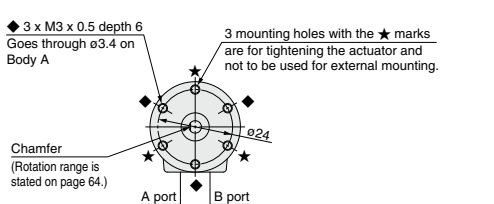

A parallel key is used instead of single flat for size 40.

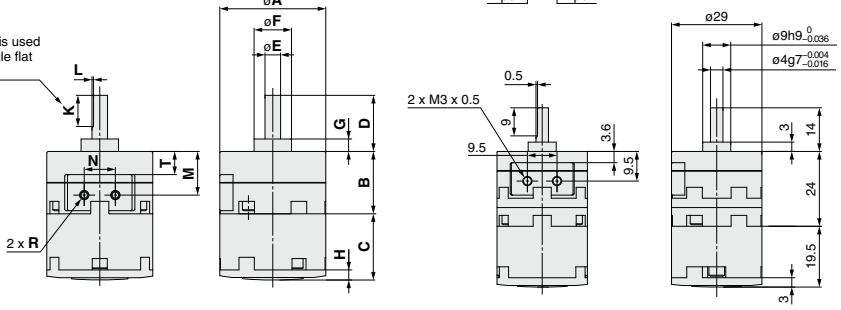

Shaft-end shape of size 40

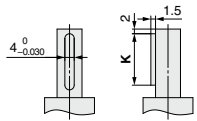

Parallel key dimensions

b (h9)	h (h9)	L1
4 ⁰ _{-0.030}	4 ⁰ _{-0.030}	20

Refer to page 61 for details of shaft type J.

Size	A	B	C	D	E (g7)	F (h9)	G	H	K	L	M	N	P	Q	R	T
10	29	15	19.5	14	4 ^{-0.004} _{-0.016}	9 ⁰ _{-0.036}	3	3	9	0.5	9.5	9.5	24	M3 x 0.5 depth 6	M3 x 0.5	3.6
15	34	20	21.2	18	5 ^{-0.004} _{-0.016}	12 ⁰ _{-0.043}	4	3.2	10	0.5	14	10	29	M3 x 0.5 depth 5	M3 x 0.5	7.6
20	42	29	25	20	6 ^{-0.004} _{-0.016}	14 ⁰ _{-0.043}	4.5	4	10	0.5	20	13	36	M4 x 0.7 depth 7	M5 x 0.8	10.5
30	50	40	29	22	8 ^{-0.005} _{-0.020}	16 ⁰ _{-0.043}	5	4.5	12	1.0	26	14	43	M5 x 0.8 depth 10	M5 x 0.8	14
40	63	45	36.3	30	10 ^{-0.005} _{-0.020}	25 ⁰ _{-0.052}	6.5	5	20	—	31	20	56	M5 x 0.8 depth 10	M5 x 0.8	17

CRB2
CRB1
MSU
CRJ
CRA1
CRQ2
MSQ
MSZ
CRQ2X
MSQX
MRQ

D-□

CDRB2□WU Series

Dimensions: Standard Type (With Auto Switch and Angle Adjuster) 10, 15, 20, 30, 40

- For single vane type, the figures below show actuators for 90° (without unit) when the B port is pressurized. For double vane type, the figures below show the intermediate rotation position when the A or B port is pressurized.

Size: 10, 15

(The size 10 double vane type is indicated on page 67.)

Size: 20, 30, 40

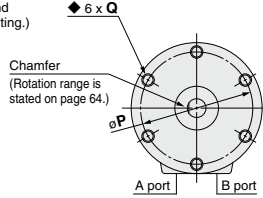
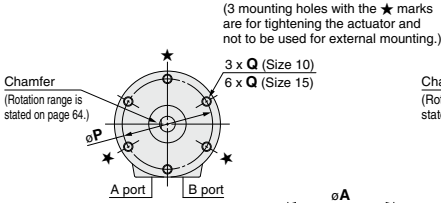

Shaft-end shape of size 40

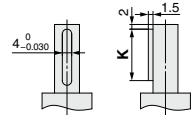

Parallel key dimensions

L1		F	
b (h9)	h (h9)	L1	
4.0 ⁰ _{-0.030}	4.0 ⁰ _{-0.030}	20	

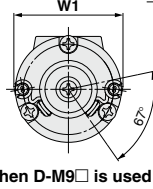
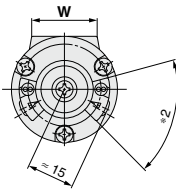
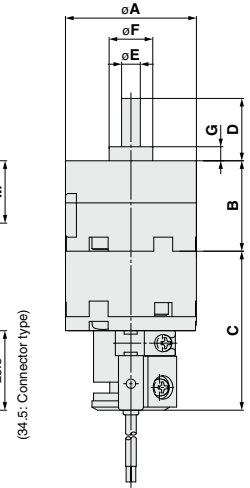
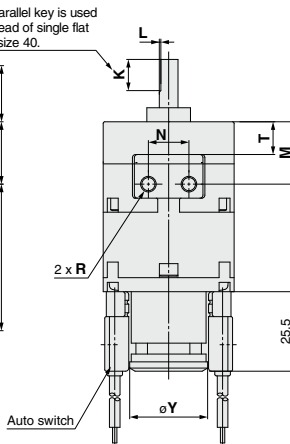
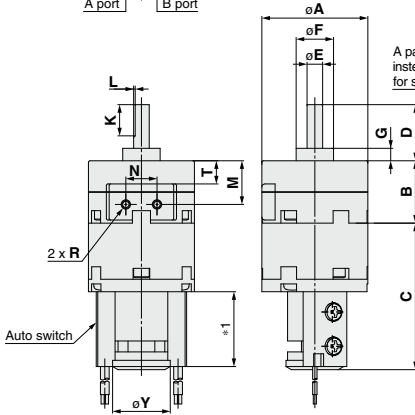

When D-M9□ is used

Size: 20, 30

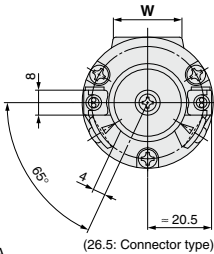

Size: 40

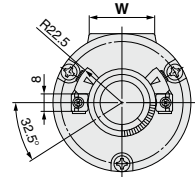

Refer to page 61 for details of shaft type J.

- *1. The length is 24 when any of the following are used: D-90/90A/S99(V)/T99(V)/S9P(V)
The length is 30 when any of the following are used: D-97/93A
The length is 25.5 when the D-M9 is used.
- *2. The angle is 60° when any of the following are used: D-90/90A/97/93A
The angle is 69° when any of the following are used: D-S99(V)/T99(V)/S9P(V)

Size	A	B	C	D	E (g7)	F (h9)	G	K	L	M	N	P	Q	R	T	W	W1	Y
10	29	15	45.5	14	4 ^{-0.004} _{-0.016}	9 ⁰ _{0.036}	3	9	0.5	9.5	9.5	24	M3 x 0.5 depth 6	M3 x 0.5	3.6	19.8	35	18.5
15	34	20	47	18	5 ^{-0.004} _{-0.016}	12 ⁰ _{0.043}	4	10	0.5	14	10	29	M3 x 0.5 depth 5	M3 x 0.5	7.6	21	35	18.5
20	42	29	51	20	6 ^{-0.004} _{-0.016}	14 ⁰ _{0.043}	4.5	10	0.5	20	13	36	M4 x 0.7 depth 7	M5 x 0.8	10.5	22	—	25
30	50	40	55.5	22	8 ^{-0.005} _{-0.020}	16 ⁰ _{0.043}	5	12	1.0	26	14	43	M5 x 0.8 depth 10	M5 x 0.8	14	24	—	25
40	63	45	62.2	30	10 ^{-0.005} _{-0.020}	25 ⁰ _{0.052}	6.5	20	—	31	20	56	M5 x 0.8 depth 10	M5 x 0.8	17	30	—	31

[mm]

Dimensions: Standard Type (With Auto Switch and Angle Adjuster) 10

Double vane • Following figures show the intermediate rotation position when A or B port is pressurized.

Size: 10

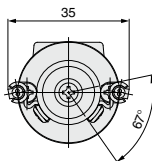
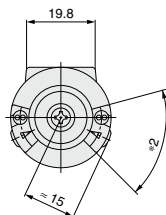
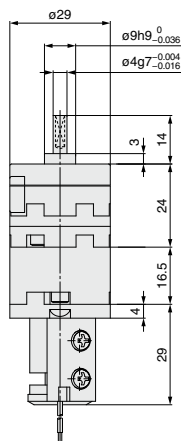
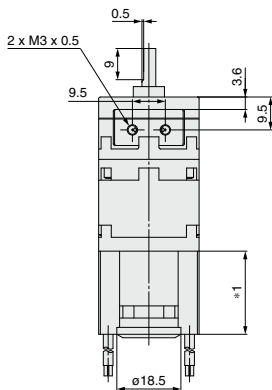
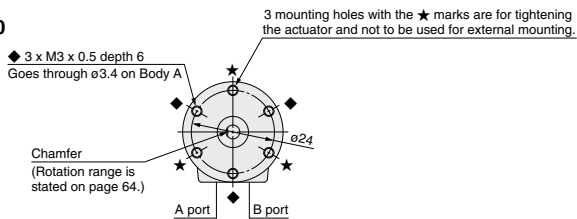

When D-M9 is used

Refer to page 61 for details of shaft type J.

- *1. The length is 24 when any of the following are used: D-90/90A/S99(V)/T99(V)/S9P(V)
The length is 30 when any of the following are used: D-97/93A
The length is 25.5 when the D-M9 is used.
- *2. The angle is 60° when any of the following are used: D-90/90A/97/93A
The angle is 69° when any of the following are used: D-S99(V)/T99(V)/S9P(V)

CRB2

CRB1

MSU

CRJ

CRA1

CRQ2

MSQ

MSZ

CRQ2X
MSQX

MRQ

D-

Free Mount Type Rotary Actuator Vane Type

RoHS

CRBU2 Series

Size: 10, 15, 20, 30, 40

How to Order

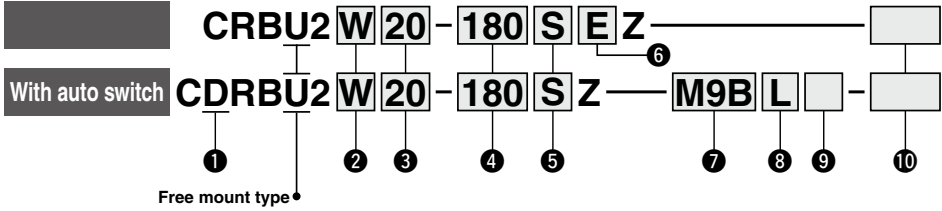

1 With auto switch

(With auto switch unit and built-in magnet)

* Refer to page 99 when the auto switch unit is needed separately.

2 Shaft type

Symbol	Shaft type	Shaft-end shape	
		Long shaft	Short shaft
S	Single shaft	Single flat*	—
W	Double shaft	Single flat*	Single flat
J**	Double shaft	Round shaft	Single flat
K**	Double shaft	Round shaft	Round shaft
T**	Single shaft	Round shaft	—
Y**	Double shaft	Single flat*	Long shaft with single flat*

* A key is used for size 40.

** J, K, T and Y are made to order.

*** When an auto switch is mounted to the rotary actuator, only shaft types W and J are available.

3 Size

10
15
20
30
40

4 Rotating angle

Single vane	90	90°
	180	180°
	270	270°
Double vane	90	90°
	100	100°

5 Vane type

S	Single vane
D	Double vane

7 Auto switch

Nil	Without auto switch (Built-in magnet)
M	Without M9 type auto switch (Built-in magnet)

* For applicable auto switch model, refer to the table below.

8 Electrical entry/Lead wire length

Nil	Grommet/Lead wire: 0.5 m
M	Grommet/Lead wire: 1 m
L	Grommet/Lead wire: 3 m
CN	Connector/Without lead wire
CL	Connector/Lead wire: 0.5 m
C	Connector/Lead wire: 3 m

* Connectors are available only for the R73, R80, T79.

** Lead wire with connector part nos.

D-LC05: Lead wire 0.5 m

D-LC30: Lead wire 3 m

D-LC50: Lead wire 5 m

9 Number of auto switches

S	1 pc.*
Nil	2 pcs.**

* S: A right-hand auto switch is shipped.

** Nil: A right-hand switch and a left-hand switch are shipped.

*** The operating range and hysteresis of the D-M9□ are different from those of the other auto switches. For details, refer to page 102.

10 Made to Order

For details, refer to the next page.

Applicable Auto Switches/Refer to pages 797 to 850 for further information on auto switches.

Applicable size	Type	Special function	Electrical entry	Indicator/light	Wiring (Output)	Load voltage		Auto switch model		Lead wire type	Lead wire length [m]					Pre-wired connector	Applicable load
						DC	AC	Perpendicular	In-line		0.5 (Nil)	1 (M)	3 (L)	5 (Z)	None (N)		
For 10, 15	Solid state auto switch	—	Grommet	Yes	3-wire (NPN)	5 V, 12 V	—	M9NV	M9N	Oilproof heavy-duty cord	●	●	●	○	—	○	IC circuit
					3-wire (PNP)			M9PV	M9P		●	●	●	○	—		
					2-wire			M9BV	M9B		●	●	●	○	—		
	Reed auto switch	—	Grommet	No	3-wire (NPN)	5 V, 12 V	—	S99V	S99	Vinyl parallel cord	●	—	●	—	—	—	IC circuit
					3-wire (PNP)			S99V	S99		●	—	●	—	—		
					2-wire			S99V	S99		●	—	●	—	—		
For 20, 30, 40	Solid state auto switch	—	Grommet	Yes	3-wire (NPN)	5 V, 12 V	—	M9NV	M9N	Oilproof heavy-duty cord	●	●	●	○	—	○	IC circuit
					3-wire (PNP)			M9PV	M9P		●	●	●	○	—		
					2-wire			M9BV	M9B		●	●	●	○	—		
					3-wire (NPN)			—	S79		●	—	●	—	—		
					3-wire (PNP)			—	S7P		●	—	●	—	—		
					2-wire			—	T79		●	—	●	—	—		
	Reed auto switch	—	Grommet	Yes	2-wire	5 V, 12 V	—	T99V	T99	Oilproof heavy-duty cord	●	—	●	—	—	—	IC circuit
					2-wire			—	90A		●	—	●	—	—		
					2-wire			—	97		●	—	●	—	—		
					2-wire			—	93A		●	—	●	—	—		
					2-wire			—	T79C		●	—	●	—	—		
					2-wire			—	R73		●	—	●	—	—		
Reed auto switch	—	Connector	No	2-wire	48 V, 100 V	—	R73C	—	Oilproof heavy-duty cord	●	—	●	—	—	—	IC circuit	
				2-wire			—	R80		●	—	●	—	—			
				2-wire			—	R80C		●	—	●	—	—			
				2-wire			—	—		●	—	●	—	—			
				2-wire			—	—		●	—	●	—	—			
				2-wire			—	—		●	—	●	—	—			

* Lead wire length symbols: 0.5 m.....Nil (Example) R73C
3 m..... L (Example) R73CL
5 m..... Z (Example) R73CZ
None..... N (Example) R73CN

* Auto switches are shipped together, (but not assembled).

* Solid state auto switches marked with "○" are produced upon receipt of order.

Single Vane Specifications

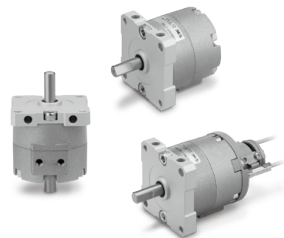

Symbol



Made to Order

(For details, refer to pages 84 to 98.)

Symbol	Description	Applicable shaft type
XA1 to XA24	Shaft type pattern I	W
XA31 to XA58	Shaft type pattern II	S, J, K, T, Y
XC1	Add connecting ports	W, S, J, K, T, Y
XC2	Change threaded hole to through-hole	W, S, J, K, T, Y
XC3	Change the screw position	W, S, J, K, T, Y
XC4	Change the rotation range	W, S, J, K, T, Y
XC5	Change rotation range between 0 to 200°	W, S, J, K, T, Y
XC6	Change rotation range between 0 to 110°	W, S, J, K, T, Y
XC7	Reversed shaft	W, J
XC30	Fluorine grease	W, S, J, K, T, Y
X5	For M5 port (90°/180°)	W, S, J, K, T, Y

The above may not be selected when the product comes with an auto switch or angle adjustment unit. For details, refer to pages 84, 85, 90, 91, 96.

Refer to pages 102 to 106 for actuators with auto switches.

- Operating range and hysteresis
- How to change the auto switch detecting position
- Auto switch mounting
- Auto switch adjustment

Size	10	15	20	30	40
Rotating angle	90°, 180°, 270°				
Fluid	Air (Non-lube)				
Proof pressure [MPa]	1.05			1.5	
Ambient and fluid temperature	5 to 60°C				
Max. operating pressure [MPa]	0.7			1.0	
Min. operating pressure [MPa]	0.2	0.15			
Rotation time adjustment range s/90° ^{Note 1)}	0.03 to 0.3		0.04 to 0.3		0.07 to 0.5
Allowable kinetic energy [J] ^{Note 2)}	0.00015	0.001	0.003	0.02	0.04
		0.00025	0.0004	0.015	0.03
Shaft load	Allowable radial load	15	15	25	30
	Allowable thrust load	10	10	20	25
Port location	Side ported or Axial ported				
Port size (Side ported, Axial ported)	M3 x 0.5			M5 x 0.8	
Angle adjustable range ^{Note 3)}	0 to 230°		0 to 240°		0 to 230°

Note 1) Make sure to use the actuator within the adjustable speed range. Exceeding the low speed range (0.3 s/90°) can cause the unit to stick or not operate.

For size 10, when operation at the maximum speed (0.03 s/90°) is required, the operating pressure should be set to 0.35 MPa or higher.

Note 2) The upper numbers in this section in the table indicate the energy factor when the rubber bumper is used (at the end of the rotation), and the lower numbers indicate the energy factor when the rubber bumper is not used.

Note 3) Adjustment range in the table is for 270°. For 90° and 180°, refer to page 79.

Double Vane Specifications

Size	10	15	20	30	40
Rotating angle	90°, 100°				
Fluid	Air (Non-lube)				
Proof pressure [MPa]	1.05			1.5	
Ambient and fluid temperature	5 to 60°C				
Max. operating pressure [MPa]	0.7			1.0	
Min. operating pressure [MPa]	0.2	0.15			
Rotation time adjustment range s/90° ^{Note 1)}	0.03 to 0.3		0.04 to 0.3		0.07 to 0.5
Allowable kinetic energy [J]	0.0003	0.0012	0.0033	0.02	0.04
Shaft load	Allowable radial load	15	15	25	30
	Allowable thrust load	10	10	20	25
Port location	Side ported or Axial ported				
Port size (Side ported, Axial ported)	M3 x 0.5			M5 x 0.8	
Angle adjustable range ^{Note 2)}	0 to 90°				

Note 1) Make sure to use the actuator within the adjustable speed range. Exceeding the low speed range (0.3 s/90°) can cause the unit to stick or not operate.

For size 10, when operation at the maximum speed (0.03 s/90°) is required, the operating pressure should be set to 0.35 MPa or higher.

Note 2) Adjustment range in the table is for 100°. For 90°, refer to page 79.

CRBU2

CRB1

MSU

CRJ

CRA1

CRQ2

MSQ

MSZ

CRQ2X
MSQX

MRQ

D-□

CRBU2 Series

Volume

[cm³]

Vane type	Single vane												Double vane												
	10			15			20			30			40			10		15		20		30		40	
Rotating angle	90°	180°	270°	90°	180°	270°	90°	180°	270°	90°	180°	270°	90°	180°	270°	90°	100°	90°	100°	90°	100°	90°	100°	90°	100°
Volume	1 (0.6)	1.2	1.5	1.5 (1.0)	2.9	3.7	4.8 (3.6)	6.1	7.9	11.3 (8.5)	15	20.2	25 (18.7)	31.5	41	1.0	1.1	2.6	2.7	5.6	5.7	14.4	14.5	33	34

* Values inside () are volume of the supply side when A port is pressurized.

Weight

[g]

Vane type	Single vane												Double vane												
	10			15			20			30			40			10		15		20		30		40	
Rotating angle	90°	180°	270°	90°	180°	270°	90°	180°	270°	90°	180°	270°	90°	180°	270°	90°	100°	90°	100°	90°	100°	90°	100°	90°	100°
Rotary actuator body	42	42	42	64	63	62	130	129	127	248	243	238	465	454	443	58	59	71	74	145	168	268	288	478	524
Auto switch unit	15			20			28			38			43			15		20		28		38		43	
Angle adjuster unit	30			47			90			150			203			30		47		90		150		203	

* The weight includes a plate and two hexagon socket head cap screws (shipped together). It does not include hexagon socket head cap screws (M3 x 12) for mounting size 10.

Effective Output

Size 10

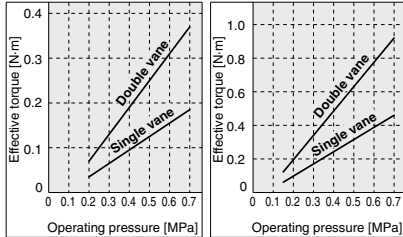

Size 15

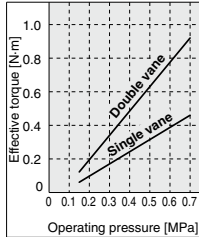

Size 20

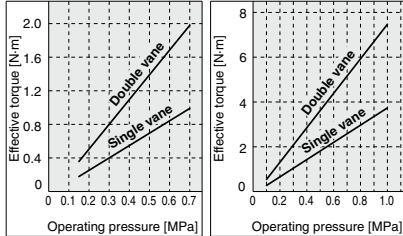

Size 30

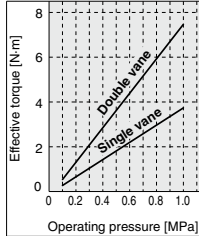

Size 40

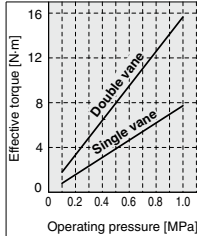

Chamfered Position and Rotation Range: Top View from Long Shaft Side

Chamfered positions shown below illustrate the conditions of actuators when B port is pressurized.

Single vane

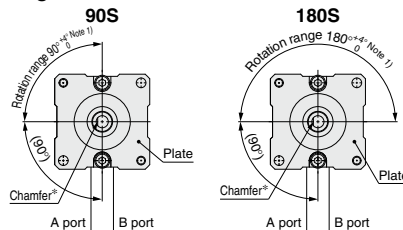

Double vane

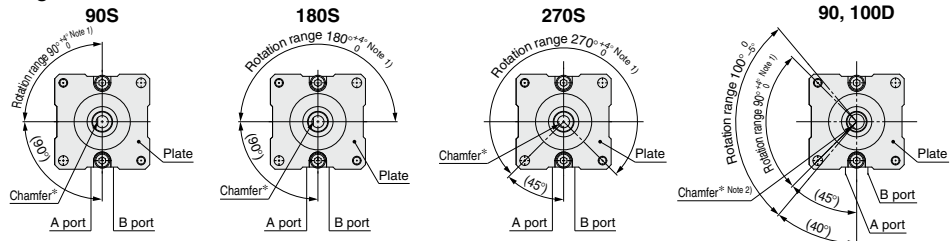

* For size 40 actuators, a parallel key will be used instead of chamfer.

Note 1) For single vane type, the tolerance of rotating angle of 90°, 180°, 270° will be $\pm \frac{4}{100}^\circ$ for size 10 only.

For double vane type, the tolerance of rotating angle of 90° will be $\pm \frac{2}{100}^\circ$ for size 10 only.

Note 2) The chamfered position of the double vane type shows the 90° specification position.

Note 3) Only size 10 has a different plate shape.

Construction

Single vane • Figures for 90° and 180° show the condition of the actuators when B port is pressurized, and the figure for 270° shows the position of the ports during rotation.

Size: 10, 15, 20, 30, 40

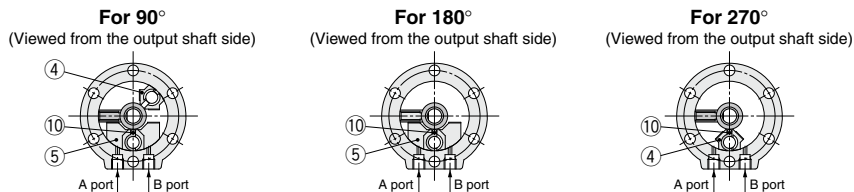

Component Parts

No.	Description	Material	Note
1	Body (A)	Aluminum alloy	Painted
2	Body (B)	Aluminum alloy	Painted
3	Vane shaft	Stainless steel*1	
4	Stopper	Resin	For 270°
5	Stopper	Resin	For 180°
6	Bearing	Bearing steel	
7	Back-up ring	Stainless steel	
8	Hexagon socket head cap screw	Chrome molybdenum steel	Special screw
9	O-ring	NBR	
10	Stopper seal	NBR	Special seal
11	Parallel key	Carbon steel	Size 40 only
12	Plate	Aluminum alloy	Anodized
13	Hexagon socket head cap screw ¹²	Chrome molybdenum steel	Special screw for size 40

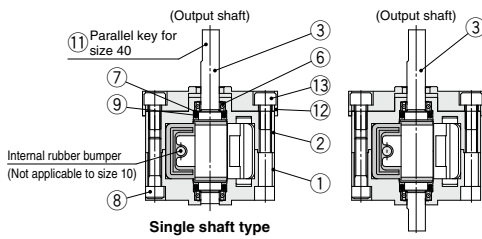

- *1. The material is chrome molybdenum steel for size 30 and 40.
- *2. Hexagon socket flat countersunk head cap screw is used for size 10.
- ¹² and ¹³ are shipped with the product for all sizes, and special mounting screws (M3 x 12) are attached for size 10.

Double vane • Figures below show the intermediate rotation position when A or B port is pressurized.

Size: 10

Size: 15, 20, 30, 40

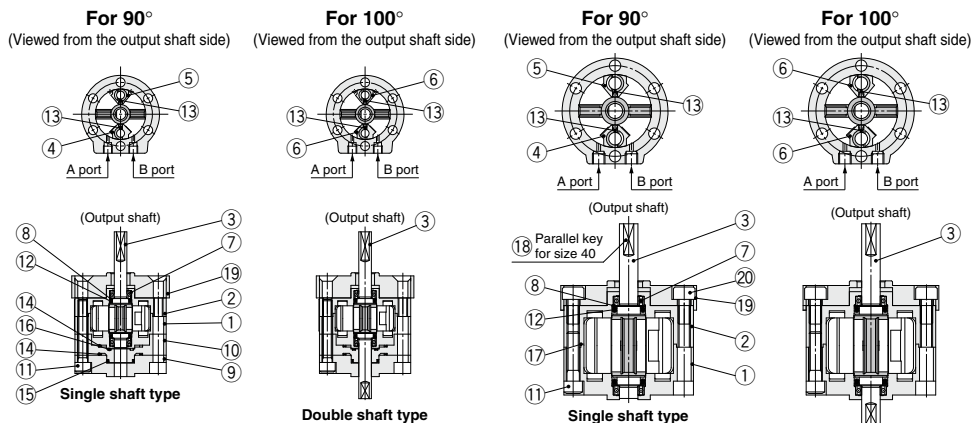

Component Parts

No.	Description	Material	Note
1	Body (A)	Aluminum alloy	Painted
2	Body (B)	Aluminum alloy	Painted
3	Vane shaft	Chrome molybdenum steel	
4	Stopper	Stainless steel*1	
5	Stopper	Resin	
6	Stopper	Stainless steel*1	
7	Bearing	Bearing steel	
8	Back-up ring	Stainless steel	
9	Cover	Aluminum alloy	
10	Plate	Resin	

No.	Description	Material	Note
11	Hexagon socket head cap screw	Chrome molybdenum steel	Special screw
12	O-ring	NBR	
13	Stopper seal	NBR	Special seal
14	Gasket	NBR	Special seal
15	O-ring	NBR	
16	O-ring	NBR	
17	O-ring	NBR	Size 40 only
18	Parallel key	Carbon steel	Size 40 only
19	Plate	Aluminum alloy	Anodized
20	Hexagon socket head cap screw ¹²	Chrome molybdenum steel	Special screw for size 40

- *1. For size 40, material for (4), (6) is aluminum alloy.
- *2. Hexagon socket flat countersunk head cap screw is used for size 10. ¹⁹ and ²⁰ are shipped with the product for all sizes, and special mounting screws (M3 x 12) are attached for size 10.

CRBU2
CRB1
MSU
CRJ
CRA1
CRQ2
MSQ
MSZ
CRQ2X
MSQX
MRQ

D-□

CRBU2 Series

Construction (With Auto Switch)

Single vane

- Following figures show actuators for 90° and 180° when B port is pressurized.

(The unit is common for single vane type and double vane type.)

Double vane

- Following figures show the intermediate rotation position when A or B port is pressurized.

Size: 10, 15

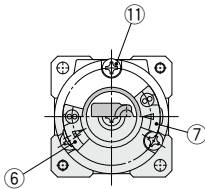
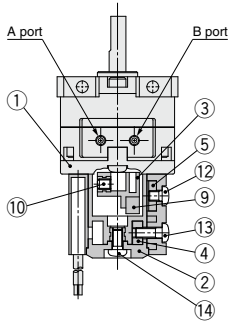

Size: 20, 30

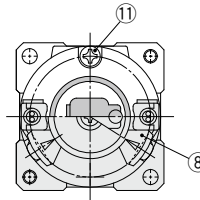
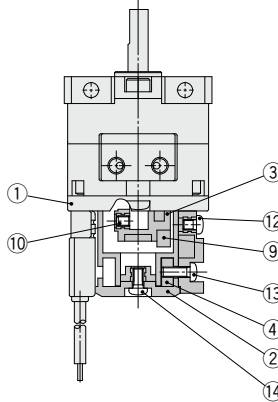

Size: 40

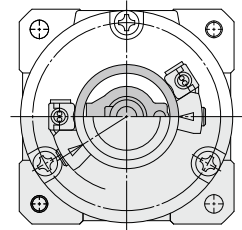
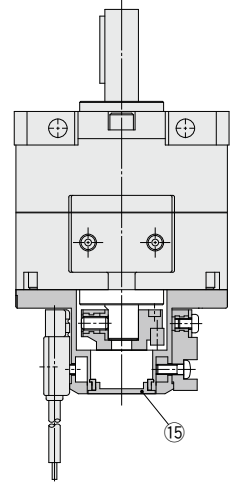

D-M9□

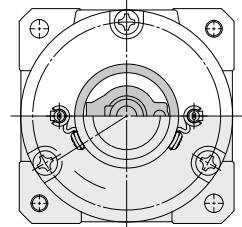
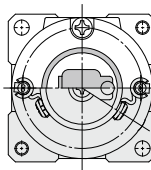
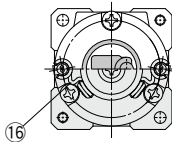

Component Parts

No.	Description	Material
1	Cover (A)	Resin
2	Cover (B)	Resin
3	Magnet lever	Resin
4	Holding block	Stainless steel
5	Holding block (B)	Aluminum alloy
6	Switch block (A)	Resin
7	Switch block (B)	Resin
8	Switch block	Resin

No.	Description	Material
9	Magnet	
10	Hexagon socket head set screw	Stainless steel
11	Cross recessed round head screw	Stainless steel
12	Cross recessed round head screw	Stainless steel
13	Cross recessed round head screw	Stainless steel
14	Cross recessed round head screw	Stainless steel
15	Rubber cap	NBR
16	Switch holder	Stainless steel

* For size 10, 2 cross recessed round head screws ⑪ are required.

Dimensions: Free Mount Type 10, 15, 20, 30, 40

- For single vane type, the figures below show actuators for 90° and 180° when B port is pressurized.
For double vane type, the figures below show the intermediate rotation position when the A or B port is pressurized.
Only size 10 has a different plate shape. (Refer to page 74.)

Single shaft/Port location: Side ported

(The size 10 double vane type is indicated on page 74.)

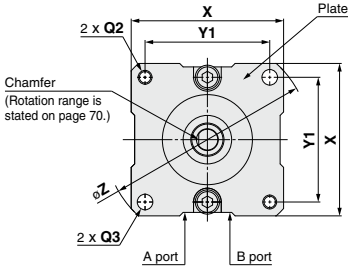

Shaft-end shape of size 40

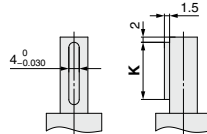

Parallel key dimensions

b (h9)	h (h9)	L1
4 ⁰ _{-0.030}	4 ⁰ _{-0.030}	20

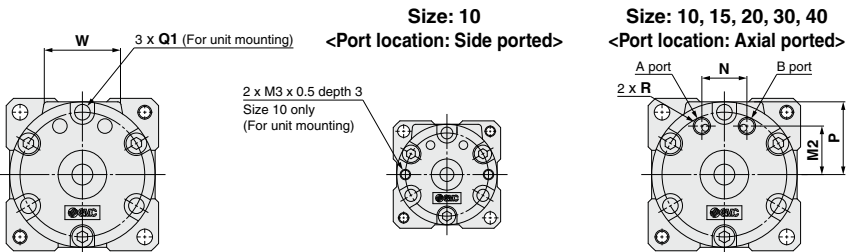
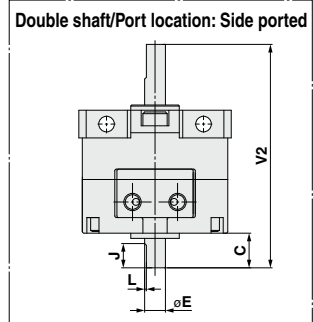
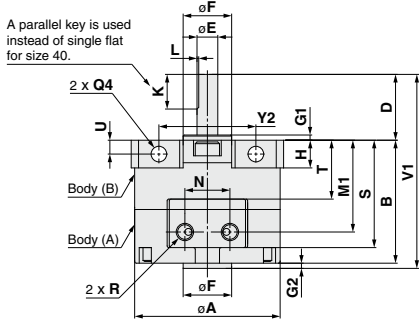

Refer to page 77 for details of shaft types J, K, T and Y.

Size	A	B	C	D	E (g7)	F (h9)	G1	G2	H	J	K	L	M1	M2	N	P	Q				R	S	T	U	V1	V2	W	X	Y1	Y2	Z
																	Q1	Q2	Q3	Q4											
10	29	22	8	14	4 ^{-0.004} _{-0.016}	9 ⁰ _{-0.026}	1	1	7	5	9	0.5	16.5	8.5	9.5	14.5	—	M3 x 0.5	3.5	3.5	M3 x 0.5	21	10.6	3	37	44	19.8	31	25	17	41
15	34	25	9	18	5 ^{-0.004} _{-0.016}	12 ⁰ _{-0.043}	1.5	1.5	6	6	10	0.5	19	11	10	17	M3 x 0.5	M3 x 0.5	3.5	3.5	M3 x 0.5	24	12.6	3	44.5	52	21	36	29	21	48
20	42	34.5	10	20	6 ^{-0.004} _{-0.016}	14 ⁰ _{-0.043}	1.5	1.5	8	7	10	0.5	25.5	14	13	21	M4 x 0.7	M4 x 0.7	4.5	4.5	M5 x 0.8	30	16	4	56	64.5	22	44	36	26	59
30	50	47.5	13	22	8 ^{-0.005} _{-0.020}	16 ⁰ _{-0.043}	2	2	9	8	12	1.0	33.5	15.5	14	25	M5 x 0.8	M5 x 0.8	5.5	5.5	M5 x 0.8	42	21.5	4.5	71.5	82.5	24	52	42	29	69
40	63	53	15	30	10 ^{-0.005} _{-0.020}	25 ⁰ _{-0.052}	3	4.5	10	9	20	1.0	39	21	20	31.6	M5 x 0.8	M5 x 0.8	5.5	5.5	M5 x 0.8	47.8	25	5	87.5	98	30	64	52	38	85

CRBU2 Series

Dimensions: Free Mount Type 10

Double vane • Following figures show the intermediate rotation position when A or B port is pressurized.

Single shaft/Port location: Side ported

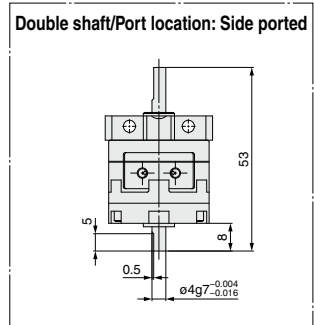
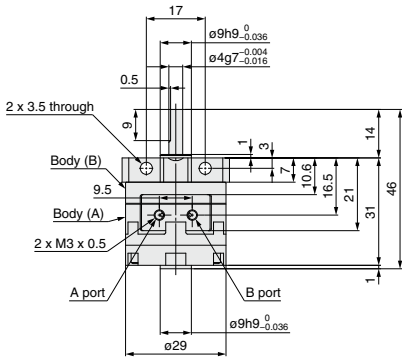
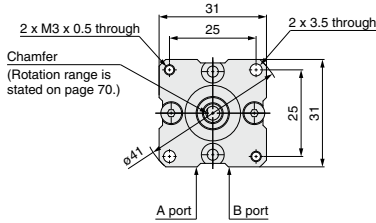

Size: 10 <Port location: Axial ported>

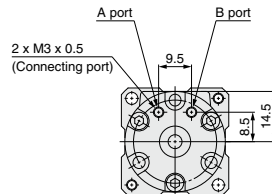
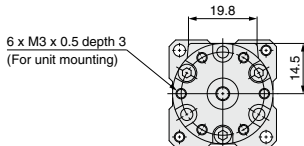

Refer to page 77 for details of shaft types J, K, T and Y.

Dimensions: Free Mount Type (With Auto Switch) 10, 15, 20, 30, 40

- For single vane type, the figures below show actuators for 90° and 180° when B port is pressurized.
- For double vane type, the figures below show the intermediate rotation position when the A or B port is pressurized.
- Only size 10 has a different plate shape. (Refer to page 76.)

Size: 10, 15

(The size 10 double vane type is indicated on page 76.)

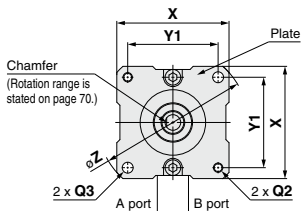

Size: 20, 30, 40

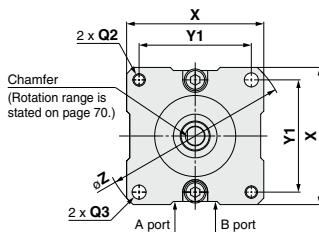

Shaft-end shape of size 40

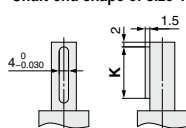

Parallel key dimensions

b (h9)	h (h9)	L1
4 ⁰ _{-0.030}	4 ⁰ _{-0.030}	20

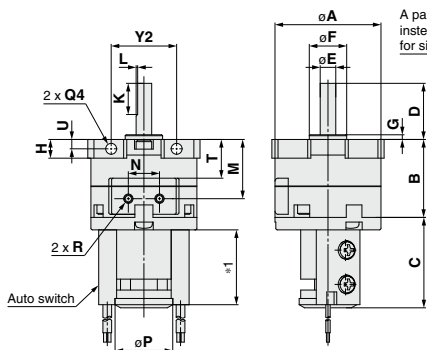

A parallel key is used instead of single flat for size 40.

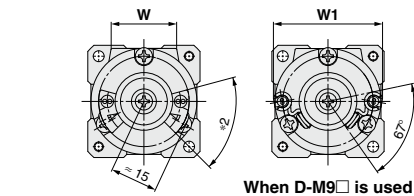
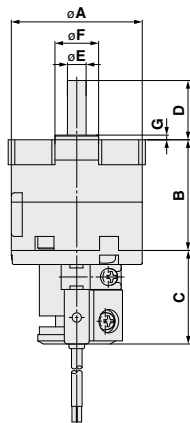
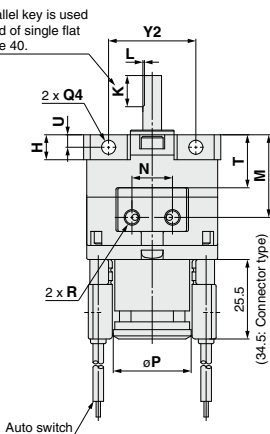

When D-M9□ is used

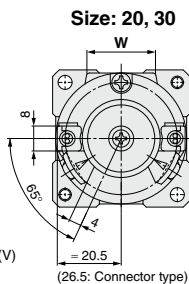

Size: 20, 30

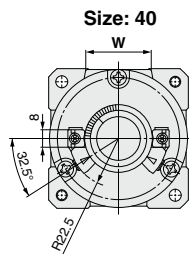

Size: 40

- *1. The length is 24 when any of the following are used:
D-90/90A/S99(V)/T99(V)/S9P(V)
The length is 30 when any of the following are used: D-97/93A
The length is 25.5 when the D-M9 is used.
- *2. The angle is 60° when any of the following are used: D-90/90A/97/93A
The angle is 69° when any of the following are used: D-S99(V)/T99(V)/S9P(V)

Refer to page 77 for details of shaft type J.

Size	A	B	C	D	E (g7)	F (h9)	G	H	K	L	M	N	P	Q			R	T	W	W1	X	Y1	Y2	Z
														Q2	Q3	Q4								
10	29	22	29	14	4 ^{-0.004} _{-0.016}	9 ⁰ _{-0.036}	1	7	9	0.5	16.5	9.5	18.5	M3 x 0.5	3.5	3.5	M3 x 0.5	10.6	19.8	35	31	25	17	41
15	34	25	29	18	5 ^{-0.004} _{-0.016}	12 ⁰ _{-0.043}	1.5	6	10	0.5	19	10	18.5	M3 x 0.5	3.5	3.5	M3 x 0.5	12.6	21	35	36	29	21	48
20	42	34.5	30	20	6 ^{-0.004} _{-0.016}	14 ⁰ _{-0.043}	1.5	8	10	0.5	25.5	13	25	M4 x 0.7	4.5	4.5	M5 x 0.8	16	22	—	44	36	26	59
30	50	47.5	31	22	8 ^{-0.005} _{-0.020}	16 ⁰ _{-0.043}	2	9	12	1.0	33.5	14	25	M5 x 0.8	5.5	5.5	M5 x 0.8	21.5	24	—	52	42	29	69
40	63	53	31	30	10 ^{-0.005} _{-0.020}	25 ⁰ _{-0.082}	3	10	20	—	39	20	31	M5 x 0.8	5.5	5.5	M5 x 0.8	25	30	—	64	52	38	85

Shaft Type Dimensions (Dimensions other than specified below are the same as the standard type.)

Size: 10, 15, 20, 30, 40

Double shaft/CRBU2J

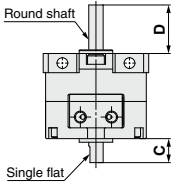

Double shaft/CRBU2K

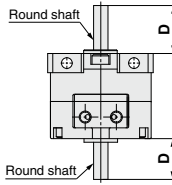

Single shaft/CRBU2T

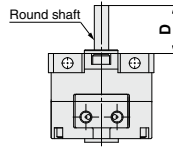

Double shaft/CRBU2Y

A parallel key is used instead of single flat for size 40.

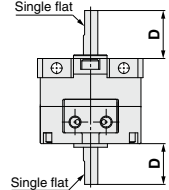

Double shaft/CDRBU2J

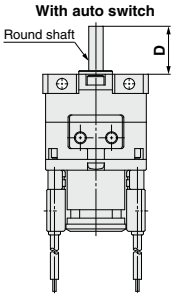

Double shaft/CRBU2JU

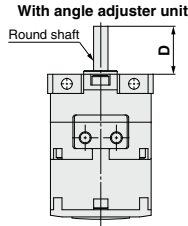

Double shaft/CDRBU2JU

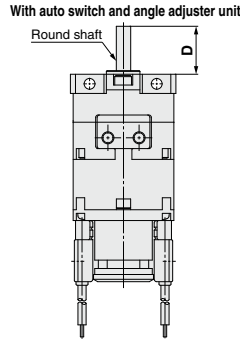

[mm]

Size	10	15	20	30	40
C	8	9	10	13	15
D	14	18	20	22	30

Note 1) Dimensions of the shaft and single flat (a parallel key for size 40) are the same as the standard. Dimension parts different from the standard conform to the general tolerance.

Note 2) For rotary actuators with auto switch and angle adjuster unit, connection ports are side ports.

CRBU2
CRB1
MSU
CRJ
CRA1
CRQ2
MSQ
MSZ
CRQ2X
MSQX
MRQ

D-□

Free Mount Type Rotary Actuator With Angle Adjuster/Vane Type

RoHS

CRBU2WU Series

Size: 10, 15, 20, 30, 40

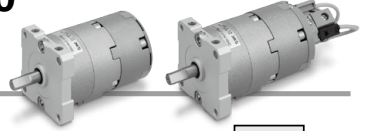

How to Order

CRBU2WU20-180SZ

With auto switch

CDRBU2WU20-180SZ-M9BL

1 2 3 4 5 6 7 8 9 10

Free mount type*

1 With auto switch

(With auto switch unit and built-in magnet)
* Refer to page 99 when the auto switch unit is needed separately.

2 Shaft type

Symbol	Shaft-end shape
W	Single flat*
J**	Round shaft

* A key is used for size 40.
** J is made to order.

3 With angle adjuster unit

* Refer to page 99 when the angle adjuster unit is needed separately.

4 Size

10
15
20
30
40

5 Rotating angle

Single vane	90	90°
	180	180°
Double vane	90	90°
	100	100°

6 Vane type

S	Single vane
D	Double vane

9 Number of auto switches

S	1 pc.*
Nil	2 pcs.**

* S: A right-hand auto switch is shipped.
** Nil: A right-hand switch and a left-hand switch are shipped.

7 Auto switch

Nil	Without auto switch (Built-in magnet)
M	Without M9 type auto switch (Built-in magnet)

* For applicable auto switch model, refer to the table below.
** The operating range and hysteresis of the D-M9□ are different from those of the other auto switches. For details, refer to page 102.

8 Electrical entry/Lead wire length

Nil	Grommet/Lead wire: 0.5 m
M	Grommet/Lead wire: 1 m
L	Grommet/Lead wire: 3 m
CN	Connector/Without lead wire
C	Connector/Lead wire: 0.5 m
CL	Connector/Lead wire: 3 m

* Connectors are available only for the R73, R80, T79.
** Lead wire with connector part nos.
D-LC05: Lead wire 0.5 m
D-LC30: Lead wire 3 m
D-LC50: Lead wire 5 m

Refer to pages 102 to 106 for actuators with auto switches.

- Operating range and hysteresis
- How to change the auto switch detecting position
- Auto switch mounting
- Auto switch adjustment

10 Made to Order

For details, refer to the table below.



Made to Order

(For details, refer to pages 84 to 98.)

Applicable Auto Switches/Refer to pages 797 to 850 for further information on auto switches.

Applicable size	Type	Special function	Electrical entry	Indicator light	Wiring (Output)		Load voltage		Auto switch model		Lead wire type	Lead wire length [m]					Pre-wired connector	Applicable load	
					3-wire (NPN)	3-wire (PNP)	2-wire	DC	AC	Perpendicular		In-line	0.5 (Nil)	1 (M)	3 (L)	5 (Z)			None (Nil)
For 10, 15	Solid state auto switch	—	Grommet	Yes	—	3-wire (NPN)	5 V, 12 V	—	M9NV	M9N	Oilproof heavy-duty cord	●	●	●	○	○	IC circuit		
						3-wire (PNP)	12 V	—	M9PV	M9P		●	●	●	○	○			
						2-wire	5 V, 12 V	—	M9BV	M9B		●	●	●	○	○			
	Reed auto switch	—	—	No	—	—	3-wire (NPN)	5 V, 12 V	—	S9V	S9P	Oilproof heavy-duty cord	●	●	●	○	○	IC circuit	
							3-wire (PNP)	12 V	—	S9PV	S9P		●	●	●	○	○		
							2-wire	5 V, 12 V	5 V, 12 V, 24 V	—	T9V		T9P	●	●	●	○		○
For 20, 30, 40	Solid state auto switch	—	Grommet	Yes	—	3-wire (NPN)	5 V, 12 V	—	M9NV	M9N	Oilproof heavy-duty cord	●	●	●	○	○	IC circuit		
						3-wire (PNP)	12 V	—	M9PV	M9P		●	●	●	○	○			
						2-wire	5 V, 12 V	—	M9BV	M9B		●	●	●	○	○			
						3-wire (NPN)	5 V, 12 V	—	S7P	—		●	●	●	○	○			
						3-wire (PNP)	12 V	—	S9P	—		●	●	●	○	○			
						2-wire	5 V, 12 V	5 V, 12 V, 24 V	—	T79		—	●	●	●	○		○	
	Reed auto switch	—	—	Connector	Yes	—	—	100 V	—	R73	—	Oilproof heavy-duty cord	●	●	●	○	○	IC circuit	
							—	—	—	R73C	—		●	●	●	○	○		
							—	—	—	R80	—		●	●	●	○	○		
							—	—	—	R80C	—		●	●	●	○	○		
							—	—	—	—	—		●	●	●	○	○		
							—	—	—	—	—		●	●	●	○	○		

* Lead wire length symbols: 0.5 m Nil (Example) R73C
3 m L (Example) R73CL
5 m Z (Example) R73CZ
None N (Example) R73CN

* Auto switches are shipped together, (but not assembled).
* Solid state auto switches marked with "○" are produced upon receipt of order.

Symbol	Description	Applicable shaft type
XA1 to XA24	Shaft type pattern I	W
XA31 to XA58	Shaft type pattern II	J
XC1	Add connecting ports	W, J
XC2	Change threaded hole to through-hole	W, J
XC3	Change the screw position	W, J
XC4	Change the rotation range	W, J
XC5	Change rotation range between 0 and 200°	W, J
XC6	Change rotation range between 0 and 110°	W, J
XC7	Reversed shaft	W, J
XC30	Fluorine grease	W, J
X5	For M5 port (90°/180°)	W, J

The above may not be selected when the product comes with an auto switch or angle adjuster unit. For details, refer to pages 84, 85, 90, 91, 96.

Construction: 10, 15, 20, 30, 40

• The unit is common for single vane type and double vane type.

With angle adjuster

Size: 10, 15, 20, 30, 40

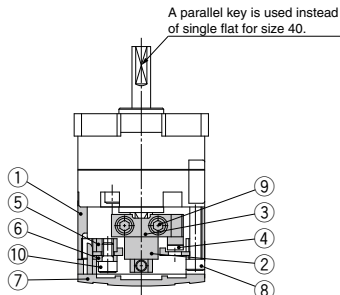

Single vane

Double vane

With auto switch and angle adjuster

Size: 10, 15

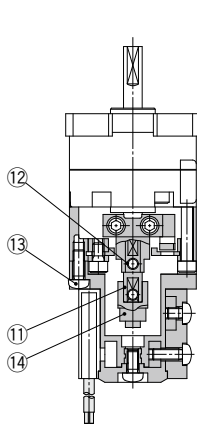

Size: 10

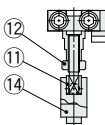

Size: 20, 30, 40

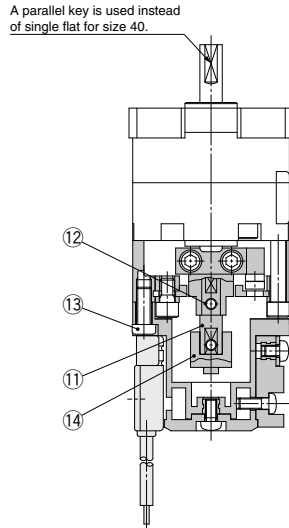

Component Parts

No.	Description	Material	Note
1	Stopper ring	Aluminum alloy	
2	Stopper lever	Chrome molybdenum steel	
3	Lever retainer	Rolled steel	Zinc chromated
4	Rubber bumper	NBR	
5	Stopper block	Chrome molybdenum steel	Zinc chromated
6	Block retainer	Rolled steel	Zinc chromated
7	Cap	Resin	
8	Hexagon socket head cap screw	Stainless steel	Special screw
9	Hexagon socket head cap screw	Stainless steel	Special screw
10	Hexagon socket head cap screw	Stainless steel	Special screw
11	Joint		
12	Hexagon socket head set screw	Stainless steel	Hexagon nut will be used for size 10 only.
13	Hexagon nut	Stainless steel	
14	Cross recessed round head screw	Stainless steel	
14	Magnet lever	—	

Specific Product Precautions

Be sure to read this before handling the products. Refer to back page 50 for Safety Instructions and pages 4 to 14 for Rotary Actuator and Auto Switch Precautions. <http://www.smcworld.com>

Angle Adjuster Unit

Caution

1. Since the maximum angle of the rotating angle adjustment range will be limited by the rotation of the rotary actuator, make sure to take this into consideration when ordering.

Rotating angle of rotary actuator	Rotating angle adjustment range
270° ⁺⁴ / ₀	0° to 230° (Size: 10, 40) *
180° ⁺⁴ / ₀	0° to 240° (Size: 15, 20, 30)
90° ⁺⁴ / ₀	0° to 175°
	0° to 85°

* The maximum adjustment angle of the angle adjuster unit for size 10 and 40 is 230°.

2. Connecting ports are side ported only.
3. The allowable kinetic energy is the same as the specifications of the rotary actuator.
4. Use a 100° rotary actuator when you desire to adjust the angle to 90° using a double vane type.

CRBU2
CRB1
MSU
CRJ
CRA1
CRQ2
MSQ
MSZ
CRQ2X MSQX
MRQ

D-□

CRBU2WU Series

Dimensions: Free Mount Type (With Angle Adjuster) 10, 15, 20, 30, 40

- For single vane type, the figures below show actuators for 90° (without unit) when the B port is pressurized.
For double vane type, the figures below show the intermediate rotation position when the A or B port is pressurized.

Size: 10, 15, 20, 30, 40

(Only size 10 has a different plate shape.)

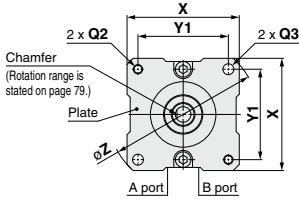

A parallel key is used instead of single flat for size 40.

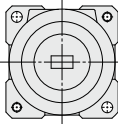
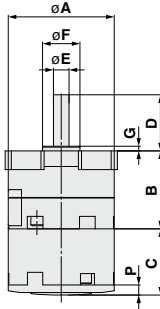
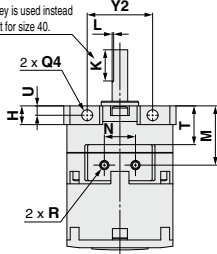

Size: 10 (Double vane)

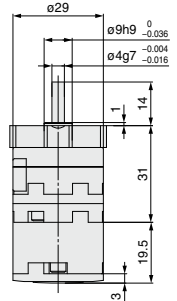
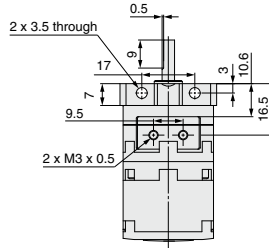
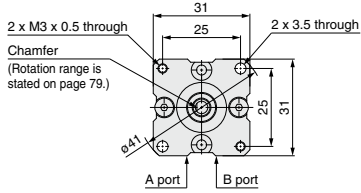

Shaft-end shape of size 40

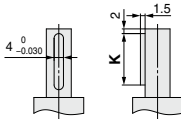

Parallel key dimensions

b (h9)	h (h9)	L1
4 ⁰ _{-0.030}	4 ⁻⁰ _{-0.030}	20

Refer to page 77 for details of shaft type J.

[mm]

Size	A	B	C	D	E (g7)	F (h9)	G	H	K	L	M	N	P	Q			R	T	U	X	Y1	Y2	Z
														Q2	Q3	Q4							
10	29	22	19.5	14	4 ^{-0.004} _{-0.016}	9 ⁰ _{-0.036}	1	7	9	0.5	16.5	9.5	3	M3 x 0.5	3.5	3.5	M3 x 0.5	10.6	3	31	25	17	41
15	34	25	21.2	18	5 ^{-0.004} _{-0.016}	12 ⁰ _{-0.043}	1.5	6	10	0.5	19	10	3.2	M3 x 0.5	3.5	3.5	M3 x 0.5	12.6	3	36	29	21	48
20	42	34.5	25	20	6 ^{-0.004} _{-0.016}	14 ⁰ _{-0.043}	1.5	8	10	0.5	25.5	13	4	M4 x 0.7	4.5	4.5	M5 x 0.8	16	4	44	36	26	59
30	50	47.5	29	22	8 ^{-0.005} _{-0.020}	16 ⁰ _{-0.043}	2	9	12	1.0	33.5	14	4.5	M5 x 0.8	5.5	5.5	M5 x 0.8	21.5	4.5	52	42	29	69
40	63	53	36.3	30	10 ^{-0.005} _{-0.020}	25 ⁰ _{-0.052}	3	10	20	—	39	20	5	M5 x 0.8	5.5	5.5	M5 x 0.8	25	5	64	52	38	85

Free Mount Type Rotary Actuator with Angle Adjuster With Auto Switch **CDRBU2WU Series**

Dimensions: Free Mount Type (With Auto Switch and Angle Adjuster) 10, 15, 20, 30, 40

- For single vane type, the figures below show actuators for 90° (without unit) when the B port is pressurized.
- For double vane type, the figures below show the intermediate rotation position when the A or B port is pressurized.
- Only size 10 has a different plate shape. (Refer to page 82.)

Size: 10, 15

(The size 10 double vane type is indicated on page 82.)

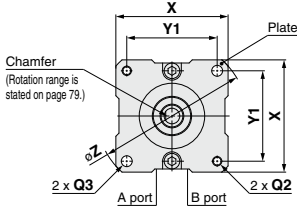

Size: 20, 30, 40

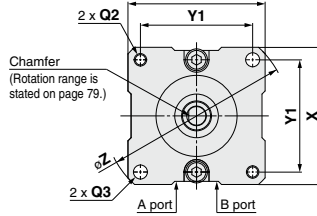

Shaft-end shape of size 40

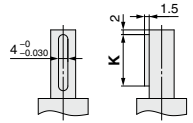

Parallel key dimensions

b (h9)	h (h9)	L1
4 ⁰ _{-0.030}	4 ⁰ _{-0.030}	20

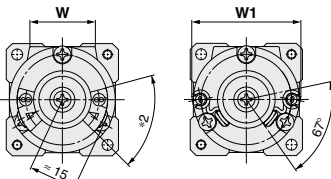
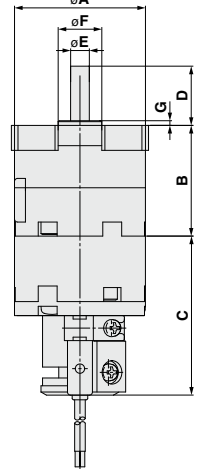
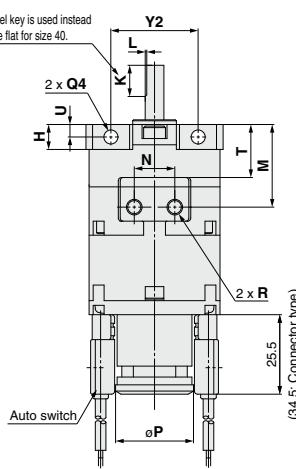
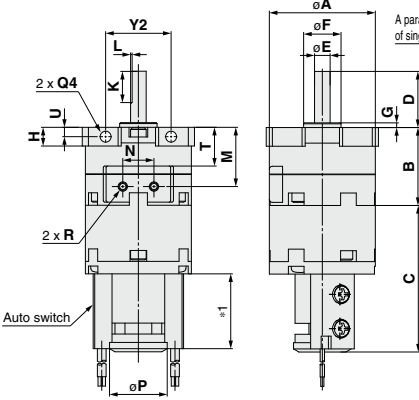

When D-M9□ is used

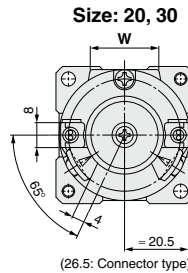

Size: 20, 30

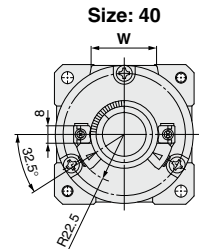

Size: 40

Refer to page 77 for details of shaft type J.

- *1. The length is 24 when any of the following are used:
D-90/90A/S99(V)/T99(V)/S9P(V)
The length is 30 when any of the following are used: D-97/93A
The length is 25.5 when the D-M9 is used.
- *2. The angle is 60° when any of the following are used: D-90/90A/97/93A
The angle is 69° when any of the following are used: D-S99(V)/T99(V)/S9P(V)

Size	A	B	C	D	E (g7)	F (h9)	G	H	K	L	M	N	P	Q			R	T	U	W	W	X	Y1	Y2	Z
														Q2	Q3	Q4									
10	29	22	45.5	14	4 ^{-0.004} _{-0.016}	9 ⁰ _{-0.036}	1	7	9	0.5	16.5	9.5	18.5	M3 x 0.5	3.5	3.5	M3 x 0.5	10.6	3	19.8	35	31	25	17	41
15	34	25	47	18	5 ^{-0.004} _{-0.016}	12 ⁰ _{-0.043}	1.5	6	10	0.5	19	10	18.5	M3 x 0.5	3.5	3.5	M3 x 0.5	12.6	3	21	35	36	29	21	48
20	42	34.5	51	20	6 ^{-0.004} _{-0.016}	14 ⁰ _{-0.043}	1.5	8	10	0.5	25.5	13	25	M4 x 0.7	4.5	4.5	M5 x 0.8	16	4	22	—	44	36	26	59
30	50	47.5	55.5	22	8 ^{-0.005} _{-0.020}	16 ⁰ _{-0.043}	2	9	12	1.0	33.5	14	25	M5 x 0.8	5.5	5.5	M5 x 0.8	21.5	4.5	24	—	52	42	29	69
40	63	53	62.2	30	10 ^{-0.005} _{-0.020}	25 ⁰ _{-0.052}	3	10	20	—	39	20	31	M5 x 0.8	5.5	5.5	M5 x 0.8	25	5	30	—	64	52	38	85

CDRBU2WU Series

Dimensions: Free Mount Type (With Auto Switch and Angle Adjuster) 10

Double vane • Following figures show the intermediate rotation position when A or B port is pressurized.

Size: 10

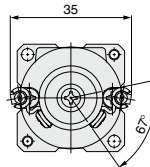
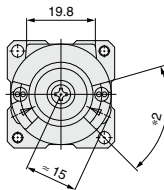
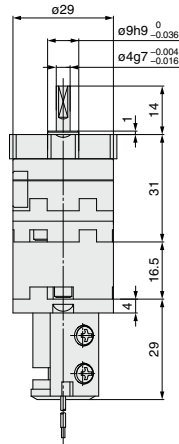
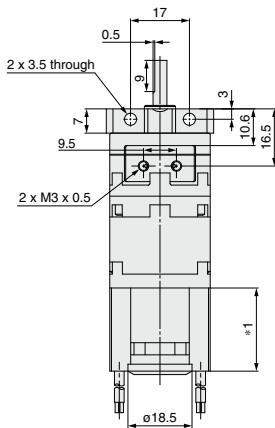
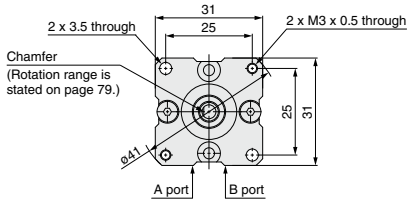

When D-M9□ is used

Refer to page 77 for details of shaft type J.

- *1. The length is 24 when any of the following are used: D-90/90A/S99(V)/T99(V)/S9P(V)
The length is 30 when any of the following are used: D-97/93A
The length is 25.5 when the D-M9 is used.
- *2. The angle is 60° when any of the following are used: D-90/90A/97/93A
The angle is 69° when any of the following are used: D-S99(V)/T99(V)/S9P(V)

CRB2
CRB1
MSU
CRJ
CRA1
CRQ2
MSQ
MSZ
CRQ2X
MSQX
MRQ

D-□

CRB2/CRBU2 Series (Size: 10, 15, 20, 30, 40)

Simple Specials

-XA1 to -XA24: Shaft Pattern Sequencing I

Shaft shape pattern is dealt with simple made-to-order system. (Refer to the front matter.)

Please contact SMC for a specification sheet when placing an order.

Symbol

Shaft Pattern Sequencing I

-XA1 to -XA24

Applicable shaft type: W (Standard)

Standard type/CRB2 Series

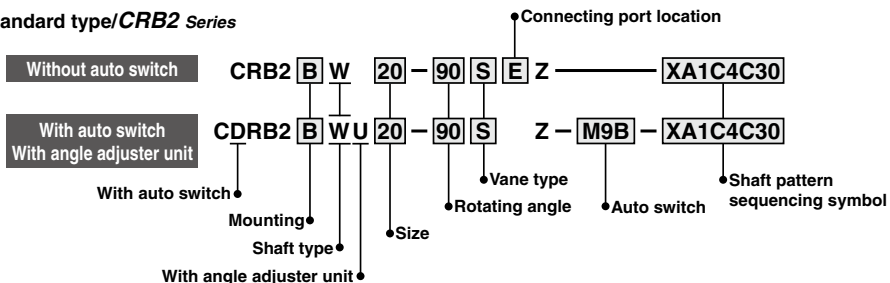

Free mount type/CRBU2 Series

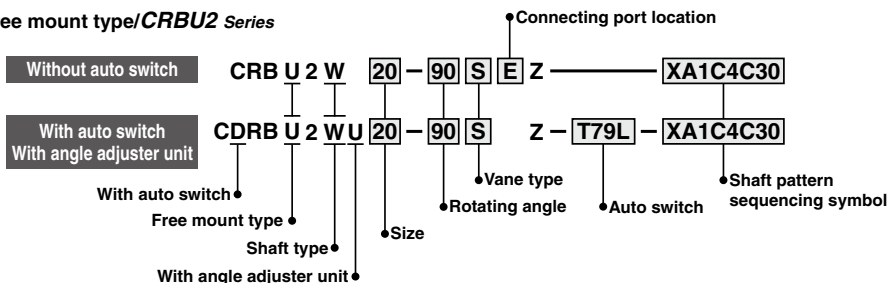

Shaft Pattern Sequencing Symbol

●Axial: Top (Long shaft side)

Symbol	Description	Applicable size				
		10	15	20	30	40
XA1	Shaft-end female thread	●	●	●	●	
XA3	Shaft-end male thread	●	●	●	●	
XA5	Stepped round shaft	●	●	●	●	
XA7	Stepped round shaft with male thread	●	●	●	●	
XA9	Modified length of standard chamfer	●	●	●	●	
XA11	Double-sided chamfer	●	●	●	●	
XA14*	Shaft through-hole + Shaft-end female thread	●	●	●	●	●
XA17	Shortened shaft	●	●	●	●	●
XA21	Stepped round shaft with double-sided chamfer	●	●	●	●	
XA23	Right-angle chamfer					
XA24	Double key					●

* These specifications are not available for rotary actuators with auto switch and/or with angle adjuster unit.

●Axial: Bottom (Short shaft side)

Symbol	Description	Applicable size				
		10	15	20	30	40
XA2*	Shaft-end female thread	●	●	●	●	
XA4*	Shaft-end male thread	●	●	●	●	
XA6*	Stepped round shaft	●	●	●	●	
XA8*	Stepped round shaft with male thread	●	●	●	●	
XA10*	Modified length of standard chamfer	●	●	●	●	
XA12*	Double-sided chamfer	●	●	●	●	
XA15*	Shaft through-hole + Shaft-end female thread	●	●	●	●	●
XA19*	Shortened shaft	●	●	●	●	●
XA22*	Stepped round shaft with double-sided chamfer	●	●	●	●	

●Double Shaft

Symbol	Description	Applicable size				
		10	15	20	30	40
XA13*	Shaft through-hole	●	●	●	●	
XA16*	Shaft through-hole + Double shaft-end female thread	●	●	●	●	
XA19*	Shortened shaft	●	●	●	●	
XA20*	Reversed shaft	●	●	●	●	●

Combination

XA□ Combination

Symbol	Combination																							
XA1	XA1																							
XA2	●	XA2																						
XA3	—	●	XA3																					
XA4	●	—	●	XA4																				
XA5	—	●	—	●	XA5																			
XA6	●	—	●	—	●	XA6																		
XA7	—	●	—	●	—	●	XA7																	
XA8	●	—	●	—	●	—	●	XA8																
XA9	—	●	—	●	—	●	—	●	XA9															
XA10	●	—	●	—	●	—	●	—	●	XA10														
XA11	—	●	—	●	—	●	—	●	—	●	XA11													
XA12	●	—	●	—	●	—	●	—	●	—	●	XA12												
XA13	—	—	—	—	—	—	—	—	—	—	—	●	●	—										
XA14	—	—	—	—	—	—	—	—	—	—	—	●	●	—	—									
XA15	—	—	—	—	—	—	—	—	—	—	—	—	●	●	—	—								
XA16	—	—	—	—	—	—	—	—	—	—	—	—	—	—	—	—								
XA17	—	●	—	●	—	●	—	●	—	●	—	●	—	●	—	●	—							
XA18	●	—	●	—	●	—	●	—	●	—	●	—	●	—	●	—	●	—						
XA19	—	—	—	—	—	—	—	—	—	—	—	—	—	—	—	—	—							
XA20	—	—	—	—	—	—	—	—	—	—	—	—	—	—	—	—	—							
XA21	—	●	—	●	—	●	—	●	—	●	—	●	—	●	—	●	—	●						
XA22	●	—	●	—	●	—	●	—	●	—	●	—	●	—	●	—	●	—	●					
XA23	—	●	—	●	—	●	—	●	—	●	—	●	—	●	—	●	—	●	—	●				
XA24	—	●	—	●	—	●	—	●	—	●	—	●	—	●	—	●	—	●	—	●	—	●	—	—

A total of two XA□ and XA□ combinations is available.

Example: -XA2A24

Note) The tolerance of the additionally machined parts conforms to the general tolerance.

XA□, XC□ Combination

Combination other than -XA□, such as Made to Order (-XC□), is also available.

Refer to pages 96 to 98 for details on the Made-to-Order specifications.

Symbol	Description	Applicable size	Combination
			XA1 to XA24
XC1*	Add connecting ports	10, 15, 20, 30, 40	●
XC2*	Change threaded hole to through-hole	15, 20, 30, 40	●
XC3*	Change the screw position	10, 15, 20, 30, 40	●
XC4	Change the rotation range		●
XC5*	Change rotation range between 0 to 200°		●
XC6*	Change rotation range between 0 to 110°		●
XC7*	Reversed shaft		—
XC30	Fluorine grease		●
X5**	For M5 port		10, 15

* These specifications are not available for rotary actuators with auto switch and/or with angle adjuster unit.

** Only the shaft type W or J can select "with auto switch" and/or "with angle adjuster unit".

A total of four XA□ and XC□ combinations is available.

Example: -XA2A24C1C30

-XA2C1C4C30

CRB□2

CRB1

MSU

CRJ

CRA1

CRQ2

MSQ

MSZ

CRQ2X
MSQX

MRQ

D-□

Axial: Top (Long shaft side)

Symbol: A1

The long shaft can be further shortened by machining female threads into it. (If shortening the shaft is not required, indicate "*" for dimension X.)

- Not available for size 10
- The maximum dimension L1 is, as a rule, twice the thread size. (Example) For M3: L1 = 6 mm
- Applicable shaft type: W

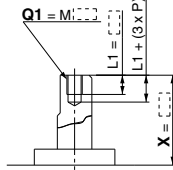

[mm]

Size	CRB2		CRBU2	
	X	Q1	X	Q1
15	4 to 18	M3	1.5 to 18	M3
20	4.5 to 20	M3, M4	1.5 to 20	M3, M4
30	5 to 22	M3, M4, M5	2 to 22	M3, M4, M5

Symbol: A3

The long shaft can be further shortened by machining male threads into it. (If shortening the shaft is not required, indicate "*" for dimension X.)

- Applicable shaft type: W

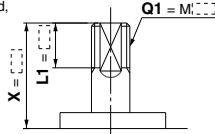

[mm]

Size	CRB2			CRBU2		
	X	L1 max	Q1	X	L1 max	Q1
10	9 to 14	X-5	M4	7 to 14	X-3	M4
15	11 to 18	X-6	M5	8.5 to 18	X-3.5	M5
20	13 to 20	X-7	M6	10 to 20	X-4	M6
30	16 to 22	X-8	M8	13 to 22	X-5	M8

Symbol: A5

The long shaft can be further shortened by machining it into a stepped round shaft. (If shortening the shaft is not required, indicate "*" for dimension X.)

- Applicable shaft type: W
- Equal dimensions are indicated by the same marker. (If not specifying dimension CA, indicate "*" instead.)

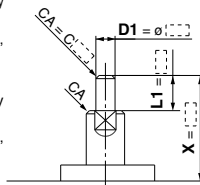

[mm]

Size	CRB2			CRBU2		
	X	L1 max	D1	X	L1 max	D1
10	4 to 14	X-3	ø3	2 to 14	X-1	ø3
15	5 to 18	X-4	ø3 to ø4	3 to 18	X-1.5	ø3 to ø4
20	6 to 20	X-4.5	ø3 to ø5	3 to 20	X-1.5	ø3 to ø5
30	6 to 22	X-5	ø3 to ø6	3 to 22	X-2	ø3 to ø6

Axial: Bottom (Short shaft side)

Symbol: A2

The short shaft can be further shortened by machining female threads into it. (If shortening the shaft is not required, indicate "*" for dimension Y.)

- Not available for size 10
- The maximum dimension L2 is, as a rule, twice the thread size. (Example) For M3: L2 = 6 mm
- Applicable shaft type: W

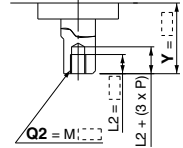

[mm]

Size	CRB2, CRBU2	
	Y	Q2
15	1.5 to 9	M3
20	1.5 to 10	M3, M4
30	2 to 13	M3, M4, M5
40	4.5 to 15	M3, M4, M5

Symbol: A4

The short shaft can be further shortened by machining male threads into it. (If shortening the shaft is not required, indicate "*" for dimension Y.)

- Applicable shaft type: W

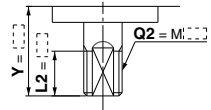

[mm]

Size	CRB2, CRBU2		
	Y	L2 max	Q2
10	7 to 8	Y-3	M4
15	8.5 to 9	Y-3.5	M5
20	10	Y-4	M6
30	13	Y-5	M8
40	15	Y-6	M10

Symbol: A6

The short shaft can be further shortened by machining it into a stepped round shaft. (If shortening the shaft is not required, indicate "*" for dimension Y.)

- Applicable shaft type: W
- Equal dimensions are indicated by the same marker. (If not specifying dimension CB, indicate "*" instead.)

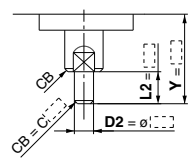

[mm]

Size	CRB2, CRBU2		
	Y	L2 max	D2
10	2 to 8	Y-1	ø3
15	3 to 9	Y-1.5	ø3 to ø4
20	3 to 10	Y-1.5	ø3 to ø5
30	3 to 13	Y-2	ø3 to ø6
40	6 to 15	Y-4.5	ø3 to ø8

Axial: Top (Long shaft side)

Symbol: **A7**

The long shaft can be further shortened by machining it into a stepped round shaft with male threads.
(If shortening the shaft is not required, indicate "*" for dimension X.)

- Applicable shaft type: W
- Equal dimensions are indicated by the same marker.
(If not specifying dimension CA, indicate "*" instead.)

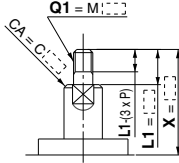

Size	CRB2			CRBU2		
	X	L1 max	Q1	X	L1 max	Q1
10	7.5 to 14	X-3	3	5.5 to 14	X-1	3
15	10 to 18	X-4	3, 4	7.5 to 18	X-1.5	3
20	12 to 20	X-4.5	3, 4, 5	9 to 20	X-1.5	3, 4
30	14 to 22	X-5	3, 4, 5, 6	11 to 22	X-2	3, 4, 5, 6

Symbol: **A9**

The long shaft can be further shortened by changing the length of the standard chamfer on the long shaft side.
(If shortening the shaft is not required, indicate "*" for dimension X.)

- Applicable shaft type: W

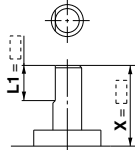

Size	CRB2		CRBU2	
	X	L1	X	L1
10	5 to 14	9-(14-X) to (X-3)	3 to 14	9-(14-X) to (X-1)
15	8 to 18	10-(18-X) to (X-4)	5.5 to 18	10-(18-X) to (X-1.5)
20	10 to 20	10-(20-X) to (X-4.5)	7 to 20	10-(20-X) to (X-1.5)
30	10 to 22	12-(22-X) to (X-5)	7 to 22	10-(22-X) to (X-2)

Symbol: **A11**

The long shaft can be further shortened by machining a double-sided chamfer onto it.
(If altering the standard chamfer and shortening the shaft are not required, indicate "*" for both the L1 and X dimensions.)

- Since L1 is a standard chamfer, dimension E1 is 0.5 mm or more, and 1 mm or more with a shaft bore size of ø30.
- Applicable shaft type: W

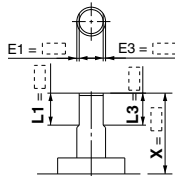

Size	CRB2			CRBU2		
	X	L1	L3 max	X	L1	L3 max
10	5 to 14	9-(14-X) to (X-3)	X-3	3 to 14	9-(14-X) to (X-1)	X-1
15	8 to 18	10-(18-X) to (X-4)	X-4	3 to 18	10-(18-X) to (X-1.5)	X-1.5
20	10 to 20	10-(20-X) to (X-4.5)	X-4.5	3 to 20	10-(20-X) to (X-1.5)	X-1.5
30	10 to 22	12-(22-X) to (X-5)	X-5	5 to 22	12-(22-X) to (X-2)	X-2

Axial: Bottom (Short shaft side)

Symbol: **A8**

The short shaft can be further shortened by machining it into a stepped round shaft with male threads.
(If shortening the shaft is not required, indicate "*" for dimension Y.)

- Applicable shaft type: W
- Equal dimensions are indicated by the same marker.
(If not specifying dimension CB, indicate "*" instead.)

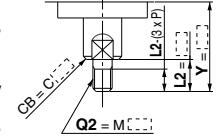

Size	CRB2, CRBU2		
	Y	L2 max	Q2
10	5.5 to 8	Y-1	3
15	7.5 to 9	Y-1.5	3, 4
20	9 to 10	Y-1.5	3, 4, 5
30	11 to 13	Y-2	3, 4, 5, 6
40	14 to 15	Y-4.5	3, 4, 5, 6, 8

Symbol: **A10**

The short shaft can be further shortened by changing the length of the standard chamfer on the short shaft side.
(If shortening the shaft is not required, indicate "*" for dimension Y.)

- Applicable shaft type: W

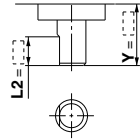

Size	CRB2, CRBU2	
	Y	L2
10	3 to 8	5-(8-Y) to (Y-1)
15	3 to 9	6-(9-Y) to (Y-1.5)
20	3 to 10	7-(10-Y) to (Y-1.5)
30	5 to 13	8-(13-Y) to (Y-2)
40	7 to 15	9-(15-Y) to (Y-2) [9-(15-Y) to (Y-4.5)] (Note)

(Note) Values inside [] are for the CRBU2.

Symbol: **A12**

The short shaft can be further shortened by machining a double-sided chamfer onto it.
(If altering the standard chamfer and shortening the shaft are not required, indicate "*" for both the L2 and Y dimensions.)

- Since L2 is a standard chamfer, dimension E2 is 0.5 mm or more, and 1 mm or more with shaft bore size of ø30 and ø40.
- Applicable shaft type: W

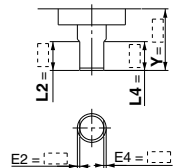

Size	CRB2, CRBU2		
	Y	L2	L4 max
10	3 to 8	5-(8-Y) to (Y-1)	Y-1
15	3 to 9	6-(9-Y) to (Y-1.5)	Y-1.5
20	3 to 10	7-(10-Y) to (Y-1.5)	Y-1.5
30	5 to 13	8-(13-Y) to (Y-2)	Y-2
40	7 to 15	9-(15-Y) to (Y-4.5)	Y-4.5

CRB□2

CRB1

MSU

CRJ

CRA1

CRQ2

MSQ

MSZ

CRQ2X
MSQX

MRQ

D-□

Axial: Top (Long shaft side)

Symbol: A14

Applicable to single vane type only. A special end is machined onto the long shaft, and a through-hole is drilled into it. Female threads are machined into the through-hole, whose diameter is equivalent to the pilot hole diameter.

- Not available for size 10
- The maximum dimension L1 is, as a rule, twice the thread size. (Example) For M3: L1 max. = 6 mm
- A parallel key is used on the long shaft for size 40.
- Applicable shaft type: W

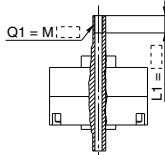

The above figure shows the CRB2 series.

Size/Thread	CRB2, CRBU2			
	15	20	30	40
M3 x 0.5	ø2.5	ø2.5	ø2.5	ø2.5
M4 x 0.7	—	ø3.3	ø3.3	—
M5 x 0.8	—	—	ø4.2	—

Symbol: A17

The long shaft is shortened.

- Applicable shaft type: W

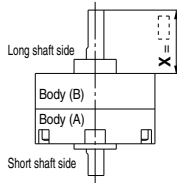

The above figure shows the CRB2 series.

Size	CRB2		CRBU2	
	X		X	
10	3	to 14	1	to 14
15	4	to 18	1.5	to 18
20	4.5	to 20	1.5	to 20
30	5	to 22	2	to 22
40	18	to 30	18	to 30

Symbol: A21

The long shaft can be further shortened by machining it into a stepped round shaft with a double-sided chamfer. (If shortening the shaft is not required, indicate "*" for dimension X.)

- Applicable shaft type: W
- Equal dimensions are indicated by the same marker.
- (If not specifying dimension CA, indicate "*" instead.)

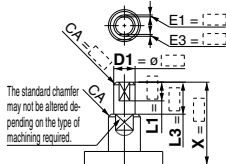

The standard chamfer may not be altered depending on the type of machining required.

Size	CRB2				CRBU2			
	X	L1 max	L3	D1	X	L1 max	L3	D1
10	6 to 14	X-4.5	L1 + 1.5	ø3	4 to 14	X-2.5	L1 + 1.5	ø3
15	7 to 18	X-5.5	L1 + 1.5	ø3 to ø4	4.5 to 18	X-3	L1 + 1.5	ø3 to ø4
20	8 to 20	X-6.5	L1 + 2	ø3 to ø5	5 to 20	X-3.5	L1 + 2	ø3 to ø5
30	10 to 22	X-8	L1 + 3	ø3 to ø6	7 to 22	X-5	L1 + 3	ø3 to ø6

Axial: Bottom (Short shaft side)

Symbol: A15

Applicable to single vane type only. A special end is machined onto the short shaft, and a through-hole is drilled into it. Female threads are machined into the through-hole, whose diameter is equivalent to the pilot hole diameter.

- A parallel key is used on the long shaft for size 40.
- Not available for size 10
- The maximum dimension L2 is, as a rule, twice the thread size. (Example) For M4: L2 max. = 8 mm
- Applicable shaft type: W

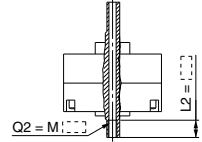

The above figure shows the CRB2 series.

Size/Thread	CRB2, CRBU2			
	15	20	30	40
M3 x 0.5	ø2.5	ø2.5	ø2.5	ø2.5
M4 x 0.7	—	ø3.3	ø3.3	—
M5 x 0.8	—	—	ø4.2	—

Symbol: A18

The short shaft is shortened.

- A parallel key is used on the long shaft for size 40.
- Applicable shaft type: W

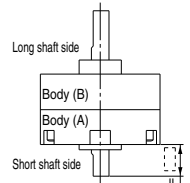

The above figure shows the CRB2 series.

Size	CRB2, CRBU2	
	Y	
10	1	to 8
15	1.5	to 9
20	1.5	to 10
30	2	to 13
40	4.5	to 15

Symbol: A22

The short shaft can be further shortened by machining it into a stepped round shaft with a double-sided chamfer. (If shortening the shaft is not required, indicate "*" for dimension Y.)

- Applicable shaft type: W
- Equal dimensions are indicated by the same marker.
- (If not specifying dimension CB, indicate "*" instead.)

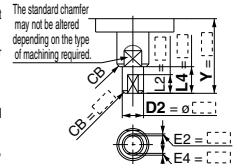

The standard chamfer may not be altered depending on the type of machining required.

Size	CRB2, CRBU2				
	Y	L1 max	L4	D2	
10	4 to 8	Y-2.5	L2 + 1.5	ø3	
15	4.5 to 9	Y-3	L2 + 1.5	ø3 to ø4	
20	5 to 10	Y-3.5	L2 + 2	ø3 to ø5	
30	7 to 13	Y-5	L2 + 3	ø3 to ø6	
40	8 to 15	Y-5.5	L2 + 5 [L2 + 3] (Note)	ø3 to ø6	

Note) Values inside [] are for the CRBU2.

Double Shaft

Symbol: A13

Applicable to single vane type only.
Shaft with through-hole

- Not available for size 10
- Minimum machining diameter for d1 is 0.1 mm.
- A parallel key is used on the long shaft for size 40.
- Applicable shaft type: W

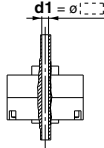

The above figure shows the CRB2 series.

Size	CRB2, CRBU2	
	d1	
15	ø2.5	
20	ø2.5 to ø3.5	
30	ø2.5 to ø4	
40	ø2.5 to ø3	

Symbol: A16

Applicable to single vane type only.
A special end is machined onto both the long and short shafts, and a through-hole is drilled into both shafts. Female threads are machined into the through-holes, whose diameter is equivalent to the diameter of the pilot holes.

- Not available for size 10
- The maximum dimension L1 is, as a rule, twice the thread size.
(Example) For M5: L1 max. = 10 mm
- A parallel key is used on the long shaft for size 40.
- Applicable shaft type: W
- Equal dimensions are indicated by the same marker.

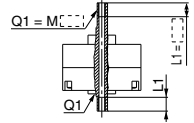

The above figure shows the CRB2 series.

Thread	CRB2, CRBU2			
	15	20	30	40
M3 x 0.5	ø2.5	ø2.5	ø2.5	ø2.5
M4 x 0.7	—	ø3.3	ø3.3	—
M5 x 0.8	—	—	ø4.2	—

Symbol: A19

Both the long shaft and short shaft are shortened.

- A parallel key is used on the long shaft for size 40.
- Applicable shaft type: W

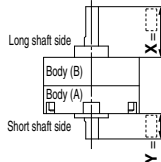

The above figure shows the CRB2 series.

Size	CRB2		CRBU2	
	X	Y	X	Y
10	3 to 14	1 to 8	1 to 14	1 to 8
15	4 to 18	1.5 to 9	1.5 to 18	1.5 to 9
20	4.5 to 20	1.5 to 10	1.5 to 20	1.5 to 10
30	5 to 22	2 to 13	2 to 22	2 to 13
40	18 to 30	4.5 to 15	18 to 30	4.5 to 15

Symbol: A20

The shafts are reversed.
(Both the long shaft and the short shaft are shortened.)

- A parallel key is used on the long shaft for size 40.
- Applicable shaft type: W
- Dimensions inside () are for double vane type of size 10.

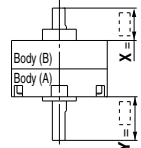

The above figure shows the CRB2 series.

Size	CRB2		CRBU2	
	X	Y	X	Y
10	3 to 10 (19)	1 to 12 (3)	1 to 3 (12)	1 to 19 (10)
15	4 to 11.5	1.5 to 15.5	1.5 to 6.5	1.5 to 20.5
20	4.5 to 13	1.5 to 17	1.5 to 7.5	1.5 to 22.5
30	5 to 16	2 to 19	2 to 8.5	2 to 26.5
40	6.5 to 17	16 to 28	3 to 9	24 to 36

Symbol: A23

The long shaft can be further shortened by machining right-angle double-sided chamfer onto it.
(If altering the standard chamfer and shortening the shaft are not required, indicate "—" for both the L1 and X dimensions.)

- Since L1 is a standard chamfer, dimension E1 is 0.5 mm or more, and 1 mm or more with a shaft bore size of ø30 and ø40.
- Applicable shaft type: W

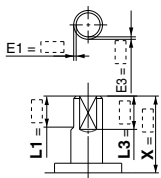

Size	CRB2			CRBU2		
	X	L1	L3 max	X	L1	L3 max
10	5 to 14	9-(14-X) to (X-3)	X-3	3 to 14	9-(14-X) to (X-1)	X-1
15	8 to 18	10-(18-X) to (X-4)	X-4	3 to 18	10-(18-X) to (X-1.5)	X-1.5
20	10 to 20	10-(20-X) to (X-4.5)	X-4.5	3 to 20	10-(20-X) to (X-1.5)	X-1.5
30	10 to 22	12-(22-X) to (X-5)	X-5	5 to 22	12-(22-X) to (X-2)	X-2

Symbol: A24

Double key
Keys and keyways are machined additionally at 180° from the standard position.

- Applicable shaft type: W
- Equal dimensions are indicated by the same marker.

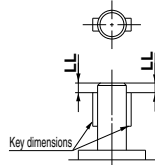

Size	CRB2, CRBU2	
	Key dimensions	LL
40	4 x 4 x 20	2

CRB□2

CRB1

MSU

CRJ

CRA1

CRQ2

MSQ

MSZ

CRQ2X

MSQX

MRQ

D-□

CRB2/CRBU2 Series (Size: 10, 15, 20, 30, 40)

Simple Specials

-XA31 to -XA58: Shaft Pattern Sequencing II

Shaft shape pattern is dealt with simple made-to-order system. (Refer to the front matter.)

Please contact SMC for a specification sheet when placing an order.

Symbol

-XA31 to -XA58

Shaft Pattern Sequencing II

Applicable shaft type: S, J, K, T, Y

Standard type/CRB2 Series

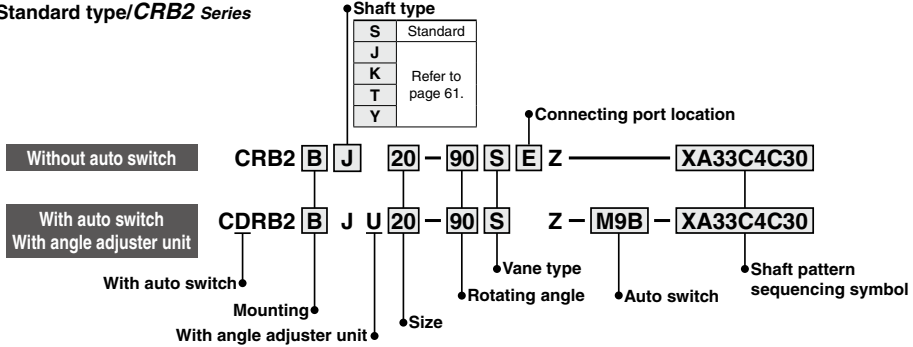

Free mount type/CRBU2 Series

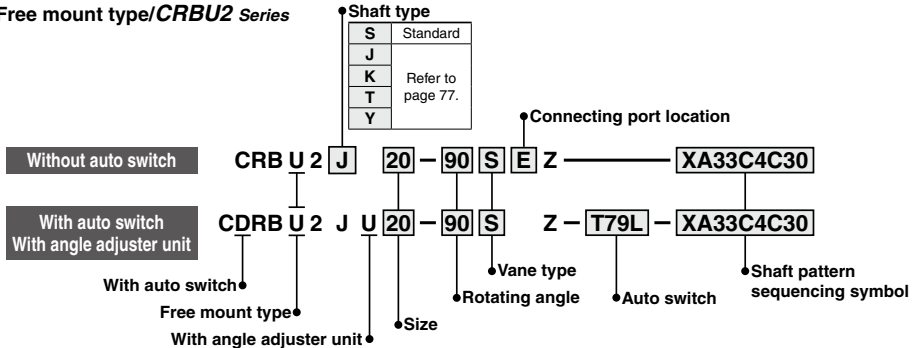

Shaft Pattern Sequencing Symbol

● Axial: Top (Long shaft side)

Symbol	Description	Shaft type	Applicable size				
			10	15	20	30	40
XA31	Shaft-end female thread	S, Y	●	●	●	●	●
XA33	Shaft-end female thread	J, K, T	●	●	●	●	●
XA37	Stepped round shaft	J, K, T	●	●	●	●	●
XA45	Middle-cut chamfer	J, K, T	●	●	●	●	●
XA47	Machined keyway	J, K, T	●	●	●	●	●
XA48	Change of long shaft length	S, Y	●	●	●	●	●
XA51	Change of long shaft length	J, K, T	●	●	●	●	●

● Axial: Bottom (Short shaft side)

Symbol	Description	Shaft type	Applicable size				
			10	15	20	30	40
XA32*	Shaft-end female thread	S, Y	●	●	●	●	●
XA34*	Shaft-end female thread	J, K, T	●	●	●	●	●
XA38*	Stepped round shaft	K	●	●	●	●	●
XA46*	Middle-cut chamfer	K	●	●	●	●	●
XA49*	Change of short shaft length	Y	●	●	●	●	●
XA52*	Change of short shaft length	K	●	●	●	●	●
XA55*	Change of short shaft length	J	●	●	●	●	●

● Double Shaft

Symbol	Description	Shaft type	Applicable size				
			10	15	20	30	40
XA39*	Shaft through-hole	S, Y	●	●	●	●	●
XA40*	Shaft through-hole	K, T	●	●	●	●	●
XA41*	Shaft through-hole	J	●	●	●	●	●
XA42*	Shaft through-hole + Shaft-end female thread	S, Y	●	●	●	●	●
XA43*	Shaft through-hole + Shaft-end female thread	K, T	●	●	●	●	●
XA44*	Shaft through-hole + Shaft-end female thread	J	●	●	●	●	●
XA50*	Change of double shaft length	Y	●	●	●	●	●
XA53*	Change of double shaft length	K	●	●	●	●	●
XA57*	Change of double shaft length	J	●	●	●	●	●
XA58*	Reversed shaft, Change of double shaft length	J	●	●	●	●	●

* These specifications are not available for rotary actuators with auto switch and/or with angle adjuster unit.

Combination

XA Combination

Symbol	Description	Axis direction					Applicable shaft type		Combination												
		Top	Bottom	J	K	S	T	Y													
XA31	Shaft-end female thread	●	●	●	●	●	●	●	XA31	* Shaft type available for combination											
XA32	Shaft-end female thread	●	●	●	●	●	●	●	XA32												
XA33	Shaft-end female thread	●	●	●	●	●	●	●	XA33												
XA34	Shaft-end female thread	●	●	●	●	●	●	●	XA34												
XA37	Stepped round shaft	●	●	●	●	●	●	●	XA37												
XA38	Stepped round shaft	●	●	●	●	●	●	●	K*	K*	XA38										
XA39	Shaft through-hole	●	●	●	●	●	●	●	XA39												
XA40	Shaft through-hole	●	●	●	●	●	●	●	XA40												
XA41	Shaft through-hole	●	●	●	●	●	●	●	XA41												
XA42	Shaft through-hole + Shaft-end female thread	●	●	●	●	●	●	●	XA42												
XA43	Shaft through-hole + Shaft-end female thread	●	●	●	●	●	●	●	XA43												
XA44	Shaft through-hole + Shaft-end female thread	●	●	●	●	●	●	●	XA44												
XA45	Middle-cut chamfer	●	●	●	●	●	●	●	XA45												
XA46	Middle-cut chamfer	●	●	●	●	●	●	●	XA46												
XA47	Machined keyway	●	●	●	●	●	●	●	XA47												
XA48	Change of long shaft length	●	●	●	●	●	●	●	XA48												
XA49	Change of short shaft length	●	●	●	●	●	●	●	Y*	Y*	XA49										
XA50	Change of double shaft length	●	●	●	●	●	●	●	Y*	Y*	XA50										
XA51	Change of long shaft length	●	●	●	●	●	●	●	K*	K*	J*	K,T*	J*	K*	●	K*	●	XA51			
XA52	Change of short shaft length	●	●	●	●	●	●	●	K*	K*	K*	K*	K*	K*	K*	K*	K*	XA52			
XA53	Change of double shaft length	●	●	●	●	●	●	●	K*	K*	K*	K*	K*	K*	K*	K*	K*	XA53			
XA55	Change of short shaft length	●	●	●	●	●	●	●	J*	J*	J*	J*	J*	J*	J*	J*	J*	XA55			
XA57	Change of double shaft length	●	●	●	●	●	●	●	J*	J*	J*	J*	J*	J*	J*	J*	J*	● XA57			
XA58	Reversed shaft, Change of double shaft length	●	●	●	●	●	●	●	J*	J*	J*	J*	J*	J*	J*	J*	J*	J*			

A total of two XA and XA combinations is available.

Example: XA31A32

Note) The tolerance of the additionally machined parts conforms to the general tolerance.

XA , XC Combination

Combination other than XA , such as Made to Order (XC), is also available.

Refer to pages 96 to 98 for details on the Made-to-Order specifications.

Symbol	Description	Applicable size	Combination
			XA31 to XA58
XC1*	Add connecting ports	10, 15, 20, 30, 40	●
XC2*	Change threaded holes to through-holes	15, 20, 30, 40	●
XC3*	Change the screw position	10, 15, 20, 30, 40	●
XC4	Change the rotation range		●
XC5*	Change rotation range between 0 to 200°		●
XC6*	Change rotation range between 0 to 110°		●
XC7*	Reversed shaft		—
XC30	Fluorine grease		●
X5**	For M5 port		10, 15

* These specifications are not available for rotary actuators with auto switch and/or with angle adjuster unit.

** Only the shaft type W or J can select "with auto switch" and/or "with angle adjuster unit".

A total of four XA and XC combinations is available.

Example: XA33A34C5C30

CRB 2

CRB1

MSU

CRJ

CRA1

CRQ2

MSQ

MSZ

CRQ2X
MSQX

MRQ

D-

Axial: Top (Long shaft side)

Symbol: A31

Machine female threads into the long shaft.

- The maximum dimension L1 is, as a rule, twice the thread size. (Example) For M3: L1 = 6 mm
- Applicable shaft types: S, Y

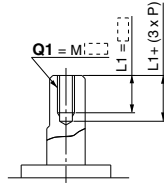

		CRB2, CRBU2	
		Q1	
Size	Symbol	S	Y
10		Not available	
15		M3	
20		M3, M4	
30		M3, M4, M5	

Symbol: A33

Machine female threads into the long shaft.

- The maximum dimension L1 is, as a rule, twice the thread size. (Example) For M3: L1 = 6 mm
- Applicable shaft types: J, K, T

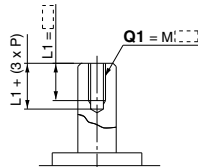

		CRB2, CRBU2		
		Q1		
Size	Symbol	J	K	T
10		Not available		
15		M3		
20		M3, M4		
30		M3, M4, M5		
40		M3, M4, M5		

Symbol: A37

The long shaft can be further shortened by machining it into a stepped round shaft.

(If shortening the shaft is not required, indicate "*" for dimension X.)

- Applicable shaft types: J, K, T
- Equal dimensions are indicated by the same marker. (If not specifying dimension CA, indicate "*" instead.)

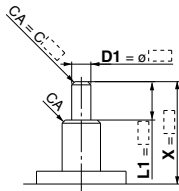

Size	CRB2			CRBU2		
	X	L1 max	D1	X	L1 max	D1
10	4 to 14	X-3	ø3 to ø3.9	2 to 14	X-1	ø3 to ø3.9
15	5 to 18	X-4	ø3 to ø4.9	3 to 18	X-1.5	ø3 to ø4.9
20	6 to 20	X-4.5	ø3 to ø5.9	3 to 20	X-1.5	ø3 to ø5.9
30	6 to 22	X-5	ø3 to ø7.9	3 to 22	X-2	ø3 to ø7.9
40	8 to 30	X-6.5	ø3 to ø9.9	4 to 30	X-3	ø3 to ø9.9

Axial: Bottom (Short shaft side)

Symbol: A32

Machine female threads into the short shaft.

- The maximum dimension L2 is, as a rule, twice the thread size. (Example) For M4: L2 = 8 mm
- However, for M5 with S shaft, the maximum dimension L2 is 1.5 times the thread size.
- Applicable shaft types: S, Y

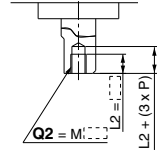

		CRB2, CRBU2	
		Q2	
Size	Symbol	S	Y
10		Not available	
15		M3	
20		M3, M4	
30		M3, M4, M5	

Symbol: A34

Machine female threads into the short shaft.

- The maximum dimension L2 is, as a rule, twice the thread size. (Example) For M3: L2 = 6 mm
- However, for M5 with T shaft, the maximum dimension L2 is 1.5 times the thread size.
- Applicable shaft types: J, K, T

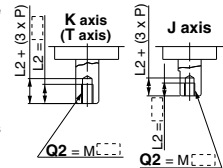

		CRB2, CRBU2		
		Q2		
Size	Symbol	J	K	T
10		Not available		
15		M3		
20		M3, M4		
30		M3, M4, M5		
40		M3, M4, M5		

Symbol: A38

The short shaft can be further shortened by machining it into a stepped round shaft.

(If shortening the shaft is not required, indicate "*" for dimension Y.)

- Applicable shaft type: K
- Equal dimensions are indicated by the same marker. (If not specifying dimension CB, indicate "*" instead.)

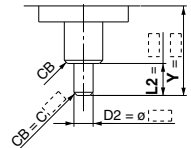

Size	CRB2, CRBU2		
	Y	L2 max	D2
10	2 to 14	Y-1	ø3 to ø3.9
15	3 to 18	Y-1.5	ø3 to ø4.9
20	3 to 20	Y-1.5	ø3 to ø5.9
30	3 to 22	Y-2	ø3 to ø7.9
40	6 to 30	Y-4.5	ø5 to ø9.9

Axial: Top (Long shaft side)

Symbol: A45

The long shaft can be further shortened by machining a middle-cut chamfer into it.
(The position of the chamfer is same as the standard one.)
(If shortening the shaft is not required, indicate "a" for dimension X.)

- Applicable shaft types: J, K, T

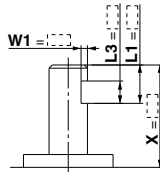

Size	CRB2, CRBU2											
	X			W1			L1 max			L3 max		
	J	K	T	J	K	T	J	K	T	J	K	T
10	6.5 to 14			0.5 to 2			X-3			L1-1		
15	8 to 18			0.5 to 2.5			X-4			L1-1		
20	9 to 20			0.5 to 3			X-4.5			L1-1		
30	11.5 to 22			0.5 to 4			X-5			L1-2		
40	15.5 to 30			0.5 to 5			X-5.5			L1-2		

Symbol: A47

Machina a keyway into the long shaft. (The position of the keyway is the same as the standard model.)
The key must be ordered separately.

- Applicable shaft type: J, K, T

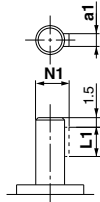

Size	CRB2, CRBU2		
	a1	L1	N1
20	2h9 ⁰ _{-0.025}	10	6.8
30	3h9 ⁰ _{-0.025}	14	9.2

Symbol: A48

The long shaft is shortened.

- Applicable shaft type: S, Y

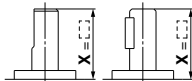

Size: 10 to 30 Size: 40

Size	CRB2	CRBU2
	X	X
10	3 to 14	1 to 14
15	4 to 18	1.5 to 18
20	4.5 to 20	1.5 to 20
30	5 to 22	2 to 22
40	18 to 30	18 to 30

Axial: Bottom (Short shaft side)

Symbol: A46

The short shaft can be further shortened by machining a middle-cut chamfer into it.
(The position of the chamfer is same as the standard one.)
(If shortening the shaft is not required, indicate "a" for dimension Y.)

- Applicable shaft type: K

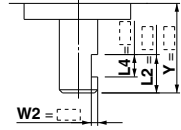

Size	CRB2, CRBU2			
	Y	W2	L2 max	L4 max
10	4.5 to 14	0.5 to 2	Y-1	L2-1
15	5.5 to 18	0.5 to 2.5	Y-1.5	L2-1
20	6 to 20	0.5 to 3	Y-1.5	L2-1
30	8.5 to 22	0.5 to 4	Y-2	L2-2
40	13.5 to 30	0.5 to 5	Y-4.5	L2-2

Symbol: A49

The short shaft is shortened.

- Applicable shaft type: Y

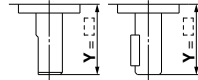

Size: 10 to 30 Size: 40

Size	CRB2, CRBU2
	Y
10	1 to 14
15	1.5 to 18
20	1.5 to 20
30	2 to 22
40	18 to 30

Symbol: A52

The short shaft is shortened.

- Applicable shaft type: K

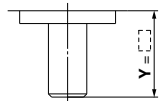

Size	CRB2, CRBU2
	Y
10	1 to 14
15	1.5 to 18
20	1.5 to 20
30	2 to 22
40	4.5 to 30

CRB□2

CRB1

MSU

CRJ

CRA1

CRQ2

MSQ

MSZ

CRQ2X
MSQX

MRQ

D-□

Axial: Top (Long shaft side)

Symbol: A51

The long shaft is shortened.

- Applicable shaft type: J, K, T

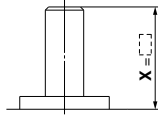

Size	CRB2		CRBU2	
	X		X	
10	3 to 14		1 to 14	
15	4 to 18		1.5 to 18	
20	4.5 to 20		1.5 to 20	
30	5 to 22		2 to 22	
40	6.5 to 30		3 to 30	

Axial: Bottom (Short shaft side)

Symbol: A55

The short shaft is shortened.

- Applicable shaft type: J

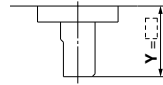

Size	CRB2, CRBU2	
	Y	
10	1 to 8	
15	1.5 to 9	
20	1.5 to 10	
30	2 to 13	
40	4.5 to 15	

Double Shaft

Symbol: A39

Applicable to single vane type only. Shaft with through-hole (Additional machining of S, Y shaft)

- Applicable shaft type: S, Y
- Equal dimensions are indicated by the same marker.
- Not available for size 10
- A parallel key is used on the long shaft for size 40.
- Minimum machining diameter for d1 is 0.1 mm. The above figure shows the CRB2 series.

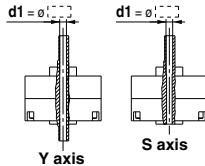

Shaft type	CRB2		CRBU2	
	S	Y	S	Y
Size	d1		d1	
15	ø2.5		ø2.5	
20	ø2.5 to ø3.5		ø2.5 to ø3.5	
30	ø2.5 to ø4		ø2.5 to ø4	
40	ø2.5 to ø3		ø2.5 to ø5	

Symbol: A40

Applicable to single vane type only. Shaft with through-hole (Additional machining of K, T shaft)

- Applicable shaft type: K, T
- Equal dimensions are indicated by the same marker.
- Not available for size 10
- d1 = ø2.5, L1 = 18 (max.) for size 15; minimum machining diameter for d1 is 0.1 mm.
- d1 = d3 for size 20 to 40

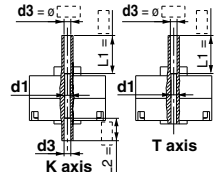

The above figure shows the CRB2 series.

Shaft type	CRB2, CRBU2		CRB2, CRBU2	
	K	T	K	T
Size	d1		d3	
15	ø2.5		ø2.5 to ø3	
20	—		ø2.5 to ø4	
30	—		ø2.5 to ø4.5	
40	—		ø2.5 to ø5	

Symbol: A41

Applicable to single vane type only. Shaft with through-hole

- Not available for size 10
- Applicable shaft type: J
- Equal dimensions are indicated by the same marker.

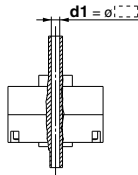

The above figure shows the CRB2 series.

Size	CRB2, CRBU2	
	d1	
15	ø2.5	
20	ø2.5 to ø3.5	
30	ø2.5 to ø4	
40	ø2.5 to ø4.5	

Symbol: A42

Applicable to single vane type only. A special end is machined onto both the long and short shafts, and a through-hole is drilled into both shafts. Female threads are machined into the through-holes, whose diameter is equivalent to the diameter of the pilot holes.

- Not available for size 10
- The maximum dimension L1 is, as a rule, twice the thread size. (Example) For M5: L1 max. = 10 mm. However, for M5 on the short shaft of S shaft: L1 max. = 7.5 mm
- A parallel key is used on the long shaft for size 40.
- Applicable shaft type: S, Y
- Equal dimensions are indicated by the same marker.

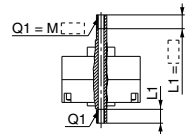

The above figure shows the CRB2 series.

Thread	CRB2, CRBU2				
	15	20	30	40	
S	Y	S	Y	S	Y
M3 x 0.5	ø2.5	ø2.5	ø2.5	ø2.5	—
M4 x 0.7	—	ø3.3	ø3.3	—	—
M5 x 0.8	—	—	ø4.2	—	—

Double Shaft

Symbol: **A43**

Applicable to single vane type only. A special end is machined onto both the long and short shafts, and a through-hole is drilled into both shafts. Female threads are machined into the through-holes, whose diameter is equivalent to the diameter of the pilot holes.

- Not available for size 10
- The maximum dimension L1 is, as a rule, twice the thread size. (Example) For M5: L1 max. = 10 mm
- However, for M5 on the short shaft of T shaft: L1 max. = 7.5 mm
- Applicable shaft type: K, T
- Equal dimensions are indicated by the same marker.

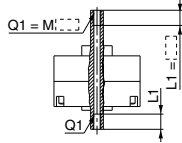

The above figure shows the CRB2 series.

Thread	CRB2, CRBU2 [mm]							
	15	20	30	40	15	20	30	40
M3 x 0.5	ø2.5	ø2.5	ø2.5	ø2.5	—	—	—	—
M4 x 0.7	—	ø3.3	ø3.3	ø3.3	—	—	—	—
M5 x 0.8	—	—	ø4.2	ø4.2	—	—	—	—

Symbol: **A44**

Applicable to single vane type only. A special end is machined onto both the long and short shafts, and a through-hole is drilled into both shafts. Female threads are machined into the through-holes, whose diameter is equivalent to the diameter of the pilot holes.

- Not available for size 10
- The maximum dimension L1 is, as a rule, twice the thread size. (Example) For M5: L1 max. = 10 mm
- Applicable shaft type: J
- Equal dimensions are indicated by the same marker.

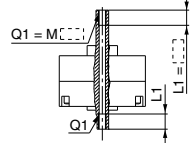

The above figure shows the CRB2 series.

Thread	CRB2, CRBU2 [mm]							
	15	20	30	40	15	20	30	40
M3 x 0.5	ø2.5	ø2.5	ø2.5	ø2.5	—	—	—	—
M4 x 0.7	—	ø3.3	ø3.3	ø3.3	—	—	—	—
M5 x 0.8	—	—	ø4.2	ø4.2	—	—	—	—

Symbol: **A50**

Both the long shaft and the short shaft are shortened.

- Applicable shaft type: Y

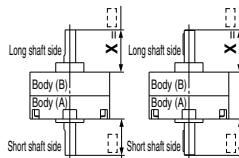

Size: **10 to 30** Size: **40**

The above figure shows the CRB2 series. [mm]

Size	CRB2		CRBU2	
	X	Y	X	Y
10	3 to 14	1 to 14	1 to 14	1 to 14
15	4 to 18	1.5 to 18	1.5 to 18	1.5 to 18
20	4.5 to 20	1.5 to 20	1.5 to 20	1.5 to 20
30	5 to 22	2 to 22	2 to 22	2 to 22
40	18 to 30	18 to 30	18 to 30	18 to 30

Symbol: **A53**

Both the long shaft and the short shaft are shortened.

- Applicable shaft type: K

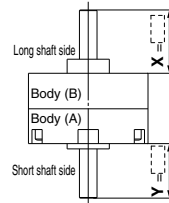

The above figure shows the CRB2 series. [mm]

Size	CRB2		CRBU2	
	X	Y	X	Y
10	3 to 14	1 to 14	1 to 14	1 to 14
15	4 to 18	1.5 to 18	1.5 to 18	1.5 to 18
20	4.5 to 20	1.5 to 20	1.5 to 20	1.5 to 20
30	5 to 22	2 to 22	2 to 22	2 to 22
40	6.5 to 30	4.5 to 30	3 to 30	4.5 to 30

Symbol: **A57**

Both the long shaft and the short shaft are shortened.

- Applicable shaft type: J

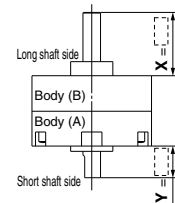

The above figure shows the CRB2 series. [mm]

Size	CRB2		CRBU2	
	X	Y	X	Y
10	3 to 14	1 to 14	1 to 14	1 to 14
15	4 to 18	1.5 to 18	1.5 to 18	1.5 to 18
20	4.5 to 20	1.5 to 20	1.5 to 20	1.5 to 20
30	5 to 22	2 to 22	2 to 22	2 to 22
40	6.5 to 30	4.5 to 30	3 to 30	3 to 30

Symbol: **A58**

The shafts are reversed. Additionally, both the long shaft and the short shaft are shortened. (If shortening the shaft is not required, indicate "—" for dimension X, Y.)

- Applicable shaft type: J
- Dimensions inside () are for double vane type of size 10.

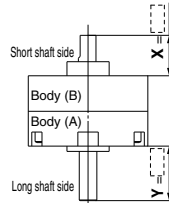

The above figure shows the CRB2 series. [mm]

Size	CRB2		CRBU2	
	X	Y	X	Y
10	3 to 10 (19)	1 to 12 (3)	1 to 3 (12)	1 to 19 (10)
15	4 to 11.5	1.5 to 15.5	1.5 to 6.5	1.5 to 20.5
20	4.5 to 13	1.5 to 17	1.5 to 7.5	1.5 to 22.5
30	5 to 16	2 to 19	2 to 8.5	2 to 26.5
40	6.5 to 17	4.5 to 28	3 to 9	4.5 to 36

- CRB□2
- CRB1
- MSU
- CRJ
- CRA1
- CRQ2
- MSQ
- MSZ
- CRQ2X
- MSQX
- MRQ

D-□

CRB2/CRBU2 Series (Size: 10, 15, 20, 30, 40)

Made to Order

-XC1, 2, 3, 4, 5, 6, 7, 30, X5

Symbol

-XC1 to -XC7, -XC30, X5

Standard type/CRB2 Series

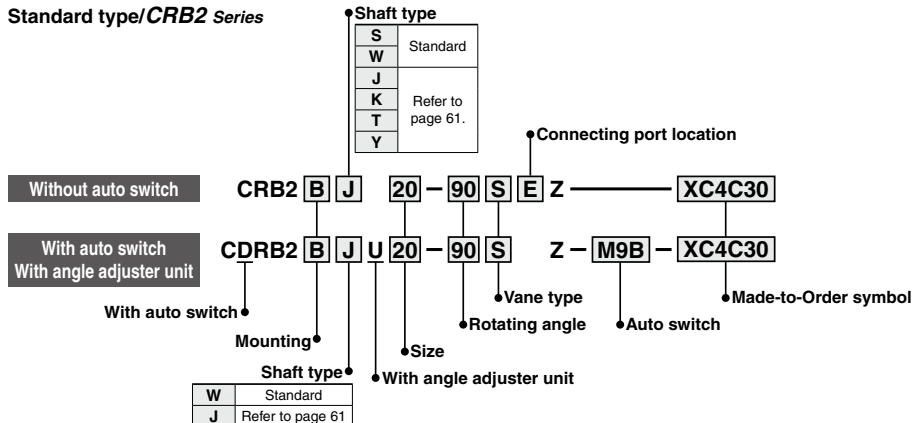

Free mount type/CRBU2 Series

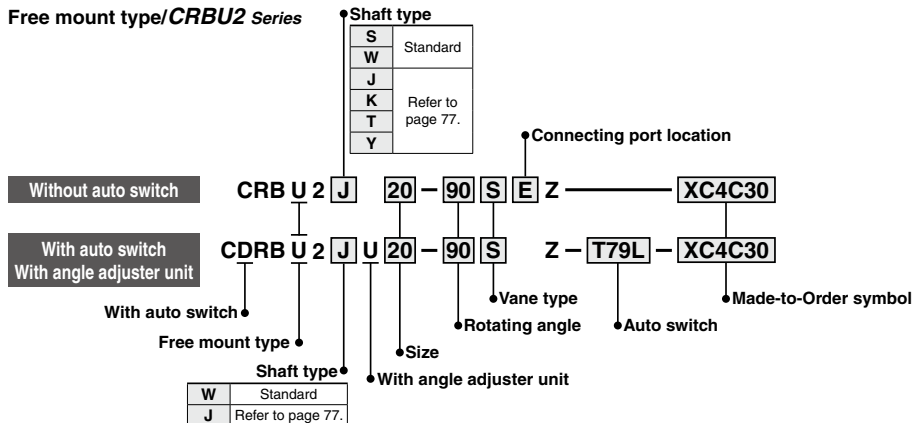

Made to Order Symbol

Symbol	Description	Applicable shaft type W, J, K, S, T, Y	Applicable size
XC1*	Add connecting ports	●	10, 15, 20, 30, 40
XC2*	Change threaded holes to through-holes	●	15, 20, 30, 40
XC3*	Change the screw position	●	10, 15, 20, 30, 40
XC4	Change the rotation range	●	
XC5*	Change rotation range between 0 to 200°	●	
XC6*	Change rotation range between 0 to 110°	●	
XC7*	Reversed shaft	W, J	
XC30	Fluorine grease	●	
X5**	For M5 port (90°/180°)	●	

* These specifications are not available for rotary actuators with auto switch and/or angle adjuster unit.

** Only the shaft type W or J can select "with auto switch" and/or "with angle adjuster unit".

Combination

Symbol	Combination						
XC1	XC1						
XC2	●	XC2					
XC3	●	—	XC3				
XC4	●	●	●	XC4			
XC5	●	●	●	—	XC5		
XC6	●	●	●	—	—	XC6	
XC7	●	●	●	●	●	—	XC7
XC30	●	●	●	●	●	●	●
X5	●	●	●	●	●	●	●

Symbol: C1

The connecting ports are added on the Body (A) end surface. (It will have an aluminum surface since the additional machining will be left unfinished.)

- A parallel key is used instead of chamfer on the long shaft for size 40.
- Not available for the rotary actuator with auto switch

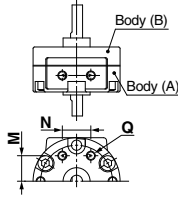

The above figure shows the CRB2 series.

Size	CRB2, CRBU2		
	Q	M	N
10	M3	8.5	9.5
15	M3	11	10
20	M5	14	13
30	M5	15.5	14
40	M5	21	20

Symbol: C3

The position of the screws for tightening the actuator body is changed.

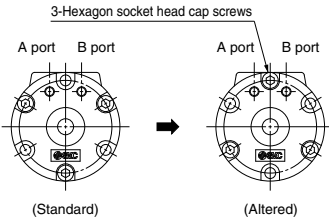

The above figure shows the CRB2 series. (Viewed from the short shaft side)

Symbol: C5

Applicable to single vane type only. Start of rotation is 45° up from the bottom of the vertical line to the left side.

- Rotation tolerance for CRB2BW10 is $\pm 5^\circ$
- Port size for CRB2BW10, 15 is M3.
- A parallel key is used instead of chamfer for size 40.

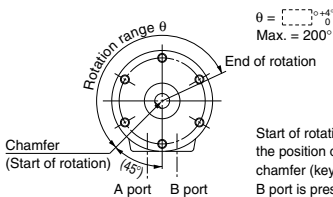

The above figure shows the CRB2 series. (Viewed from the long shaft side)

Symbol: C2

CRB2 Series

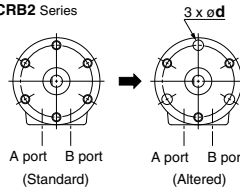

The threaded holes on the Body (B) are changed to through-holes. (It will have an aluminum surface since the additional machining will be left unfinished.)

- Not available for the rotary actuator with auto switch

CRBU2 Series

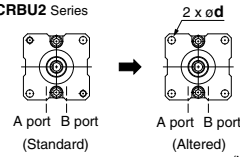

Size	CRB2, CRBU2	
	d [mm]	
15	3.4	
20	4.5	
30	5.5	
40	5.5	

(Viewed from the long shaft side)

Symbol: C4

- Applicable to single vane type only.
- The rotation range is changed. Rotating angle 90°.
- Starts of rotation is the horizontal line (90° down from the top to the right side).
- Rotation tolerance for CRB2BW10 is $\pm 5^\circ$
- A parallel key is used instead of chamfer on the long shaft for size 40.

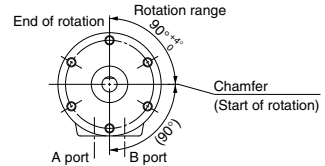

Start of rotation is the position of the chamfer (key) when A port is pressurized. The above figure shows the CRB2 series. (Viewed from the long shaft side)

Symbol: C6

- Applicable to single vane type only.
- Start of rotation is horizontal line (90° down from the top to the left side).
- Rotation tolerance for CRB2BW10 is $\pm 5^\circ$
- A parallel key is used instead of chamfer on the long shaft for size 40.

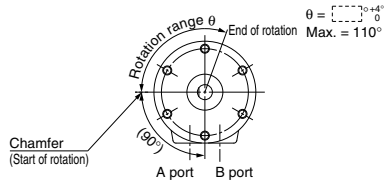

Start of rotation is the position of the chamfer (key) when B port is pressurized. The above figure shows the CRB2 series. (Viewed from the long shaft side)

CRB□2

CRB1

MSU

CRJ

CRA1

CRQ2

MSQ

MSZ

CRQ2X
MSQX

MRQ

D-□

CRB□2 Series

Symbol: C7

The shafts are reversed.

- A parallel key is used instead of chamfer on the long shaft for size 40.
- Dimensions inside () are for double vane type of size 10.

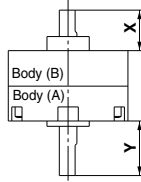

The above figure shows the CRB2 series.

Size	CRB2		CRBU2	
	Y	X	Y	X
10	12 (3)	10 (19)	19 (10)	3 (12)
15	15.5	11.5	20.5	6.5
20	17	13	22.5	7.5
30	19	16	26.5	8.5
40	28	17	36	9

Symbol: X5

Specifications with connection port size of sizes 10 and 15 changed to M5

- The rotating angle is only 90° and 180°.
- The vane type is compatible with single vanes only.
- Only the shaft type W or J can select "with auto switch" and/or "with angle adjuster unit".

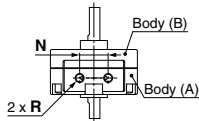

The above figure shows the CRB2 series.

Size	CRB2, CRBU2	
	N	R
10	11.7	M5
15	11.7	M5

Symbol: C30

The standard grease is changed to fluorine grease. (Not the low-speed specification)

CRB□2 Series Component Unit

Auto Switch Unit and Angle Adjuster Unit

CRB2/CRBU2 Series Auto switch unit and/or angle adjuster unit can be mounted on the rotary actuator vane type.

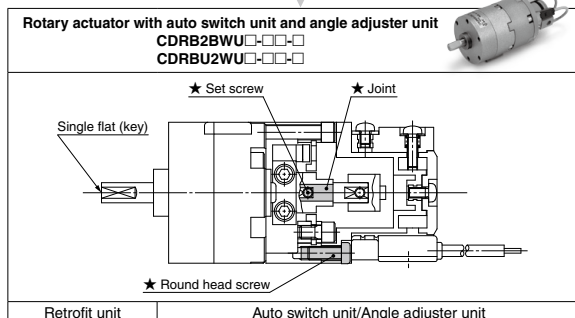
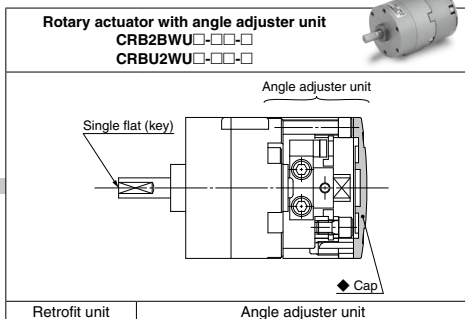
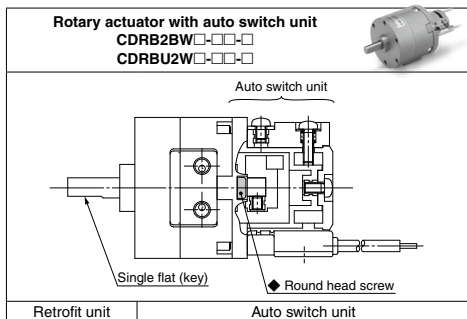

- * The rotary actuator with auto switch and angle adjuster is basically a combination of the auto switch unit and angle adjuster unit. The items marked with ★ are additional parts required for connection (joint unit parts), and the items marked with ◆ are unnecessary.
 - * Use a unit part number when ordering joint unit separately.
- (Note) The figures show the CRB2 series.

Unit Part Number for D-M9□

Size	Auto switch unit part number ¹	Switch block unit part number Common to right-hand and left-hand	Angle adjuster unit part number	Auto switch angle adjuster unit part number	Joint unit part number ³
10	P611070-1M	P811010-8M	P811010-3	P811010-4M	P211070-10
15	P611090-1M		P811020-3	P811020-4M	P211090-10
20	P611060-1M	P811030-8M	P811030-3	P811030-4M	P211060-10
30	P611080-1M		P811040-3	P811040-4M	P211080-10
40	P611010-1M	P811010-8M	P811050-3	P811050-4M	P211010-10

Unit Part Number Common to Series (Except D-M9□)

Size	Auto switch unit part number ¹	Switch block unit part number ²		Angle adjuster unit part number	Auto switch angle adjuster unit part number	Joint unit part number ³
		Right-hand	Left-hand			
10	P611070-1	P611070-8	P611070-9	P811010-3	P811010-4	P211070-10
15	P611090-1			P811020-3	P811020-4	P211090-10
20	P611060-1	P611060-8	P811030-3	P811030-4	P811030-4	P211060-10
30	P611080-1			P811040-3	P811040-4	P211080-10
40	P611010-1	P611010-8	P611010-9	P811050-3	P811050-4	P211010-10

- *1. An auto switch will not be included, please order it separately.
- *2. Auto switch unit comes with one right-hand and one left-hand switch blocks that are used for addition or when the switch block is damaged. Since the solid state switch for size 10 and 15 requires no switch block, the unit part number will be the P211070-13.
- *3. Joint unit is required to retrofit the angle adjuster unit to a rotary actuator with auto switch or to retrofit the auto switch unit to a rotary actuator with angle adjuster.

CRB□2 Series Angle Adjustment Setting

Rotating Angle Adjustment Method

Remove the resin cap in the illustrations below, slide the stopper block on the long groove and lock it into the appropriate position to adjust the rotating angle and rotating position. Protruding four chamfers for wrench on the output shaft that rotates allows manual operation and convenient positioning. (Refer to the rotating angle setting examples shown in the next page for details.)

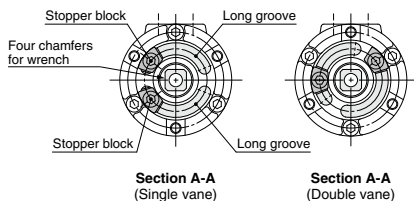

Note) For size 40, each stopper block comes with 2 holding screws.

Other Operating Method

Although one stopper block is mounted on each long groove for standard specifications as shown in the illustrations below, 2 stopper blocks can be mounted on one long groove.

Angle adjustment range when 2 stopper blocks are mounted on one long groove
 Size: 10, 4050°
 Size: 15, 20, 3060°

As shown in <Fig. b>, when mounting 2 stopper blocks on one long groove, by revolving each stopper block (A)(B), the rotation range of the output shaft with single flat (key) is adjustable, as described in <Fig. a>, within either left 50° or 60° against port A and B.

(Rotation range of single flat (key) when mounting 2 stopper blocks on the other side's groove is the opposite side from <Fig. a> and the setting range is within either right 50° or 60° against port A and B.)

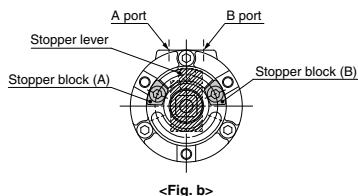
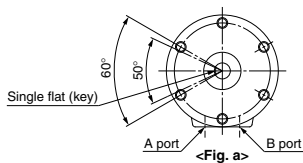

* These figures show the CRB2 series.

Rotating Angle Setting Examples

Example 1 The stopper ring is mounted on the standard position.
(Rotary actuator with a rotating angle of 270° is used.)

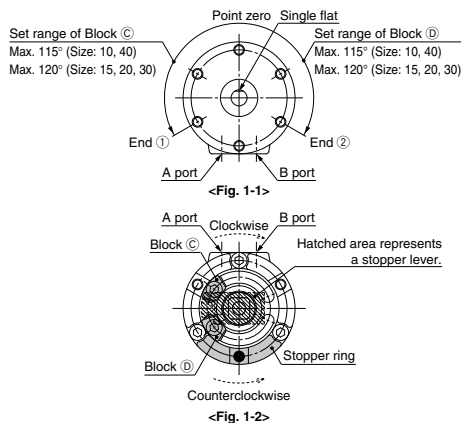

Lock Block D in Fig. 1-2, and move Block C clockwise to allow the rotation of the shaft with single flat in Fig. 1-1 from point zero to End ①. When Block C is locked and Block D is moved counterclockwise, the shaft with single flat in Fig. 1-1 rotates from point zero to End ②. The maximum rotation range of the shaft with single flat is as follows: Sizes 10, 40: up to 230°; Sizes 15, 20, 30: up to 240° (Fig. 1-2 shows when the rotating angle is 0°.)

Example 2 The stopper ring is mounted on 120° counterclockwise from the standard position shown in Fig. 1-2 of Example 1.

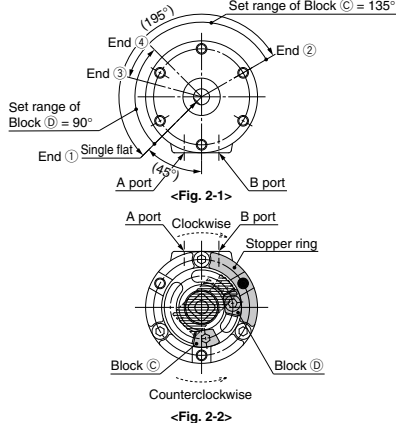

The maximum rotation range of the shaft with single flat in Fig. 2-2 is 195°, from End ① to End ②. The rotation range of the shaft with single flat in Fig. 2-1 decreases to the range between End ② and ③ when moving Block C in Fig. 2-2 clockwise, and similarly when moving Block D counterclockwise, the rotation range decreases to the range between End ① and ④. However, since the internal stopper will come into contact with the vane at End ① position of the shaft with single flat in Fig. 2-1, make sure that the stopper lever stops at Block D when adjusting.

Example 3 The stopper ring is mounted on 120° clockwise from the standard position shown in Fig. 1-2 of Example 1 as in Fig. 4-2 of Example 4.

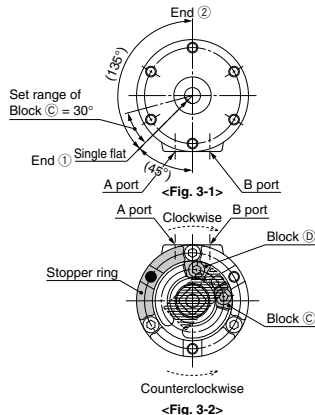

Lock Block C in Fig. 3-2 and move Block D counterclockwise to allow the rotation of the shaft with single flat in Fig. 3-1 from End ① to End ②. However, since the internal stopper will come into contact with the vane at End ① position of the shaft with single flat, make sure that the stopper lever stops at Block C when adjusting. End ① side can be adjusted within 30° by moving Block C counterclockwise.

Example 4 The stopper ring is mounted on 120° clockwise from the standard position shown in Fig. 1-2 of Example 1 as in Fig. 3-2 of Example 3.

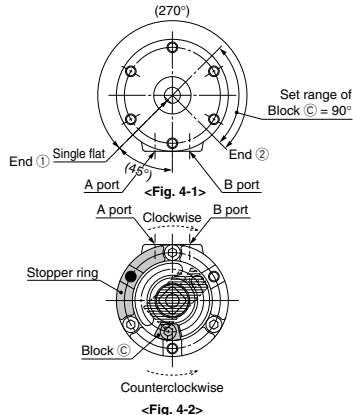

The maximum rotation range of the shaft with single flat is 270°, from End ① to End ②, when using the actuator for 270° and End ① side in Fig. 4-1 is stopped using the internal stopper and End ② side is adjusted using Block C. The rotation range can be adjusted within 90° in End ② side. Note that Block C cannot be moved and set 90° or more counterclockwise from its position in Fig. 4-2 since the internal stopper will come into contact with the vane.

Note 1) Mounting of the stopper ring shown in Examples 2, 3, 4 are not applicable for size 10.

Note 2) ● marks in the illustrations above indicate the mounting position of the stopper ring.

Note 3) Select the appropriate rotation of the rotary actuator after careful consideration of the content of "Angle Adjustment Setting."

Note 4) For size 40, each block comes with 2 holding screws.

Note 5) These figures show the CRB2 series.

CRB□2 Series Auto Switch Mounting

Operating Range and Hysteresis

* **Operating range: θm**

The range between the position where the auto switch turns ON as the magnet inside the auto switch unit moves and the position where the auto switch turns OFF as the magnet travels the same direction.

* **Hysteresis range: θd**

The range between the position where the auto switch turns ON as the magnet inside the auto switch unit moves and the position where the auto switch turns OFF as the magnet travels the opposite direction.

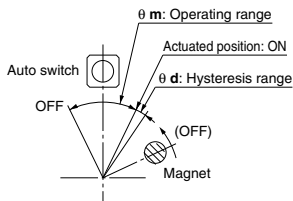

D-M9□

Size	θm : Operating range	θd : Hysteresis range
10, 15	170°	20°
20, 30	100°	15°
40	86°	10°

**D-S/T99(V)□, S9P(V), S/T79, S7P,
D-97/93A, 90/90A, R73/80□**

Size	θm : Operating range	θd : Hysteresis range
10, 15	110°	10°
20, 30	90°	
40	52°	8°

Note) Since the figures in the above table are provided as a guideline only, they cannot be guaranteed. Adjust the auto switch after confirming the operating conditions in the actual setting.

How to Change the Auto Switch Detecting Position

* When setting the detecting position, loosen the cross recessed round head screw a bit and move the auto switch to the preferred position and then tighten again and fix it. At this time, if tightened too much, screw can become damaged and unable to fix position. Proper tightening torque: 0.4 to 0.6 [N·m]. When tightening the cross recessed round head screw, take care that the auto switch does not tilt.

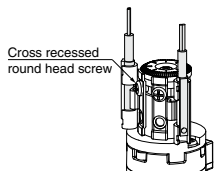

Size: 10 to 40

D-M9□

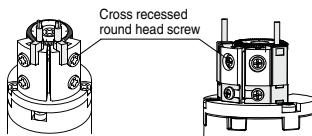

Size: 10, 15

D-S/T99(V)□, S9P(V), S/T79, S7P,
D-97/93A, 90/90A, R73/80□

Size: 20 to 40

Auto Switch Mounting: Size 10 to 40 (D-M9□)

External view and descriptions of auto switch unit

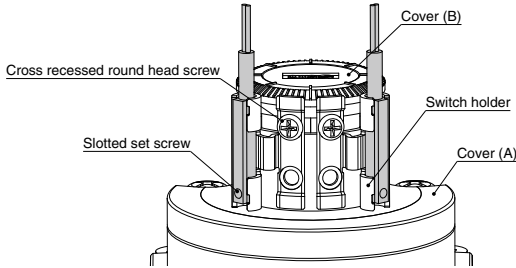

For CRB10, 15

1. Auto switch mounting

Insert the auto switch into the groove of the switch holder.

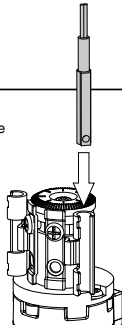

2. Auto switch securing

Align the auto switch with the upper surface of the groove on the side of the switch holder, and secure the slotted set screw. (Refer to the enlarged view.)

* Proper tightening torque: 0.05 to 0.1 [N·m]

Align with the groove upper surface to secure.

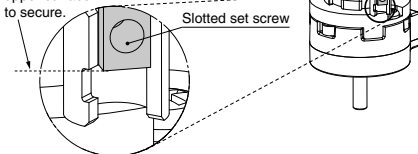

Enlarged view

3. Switch holder securing

After the actuated position has been adjusted with the cross recessed round head screw, use the auto switch.

* When tightening the screw, take care that the auto switch does not tilt.

For CRB20 to 40

1. Auto switch mounting

Insert the auto switch into the groove of the switch holder.

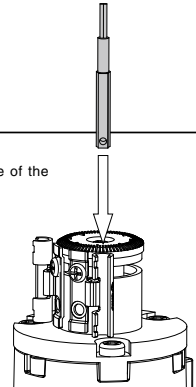

2. Auto switch securing

Align the auto switch with the lower surface of the groove on the side of the switch holder, and secure the slotted set screw. (Refer to the enlarged view.)

* Proper tightening torque: 0.05 to 0.1 [N·m]

Align with the groove lower surface to secure.

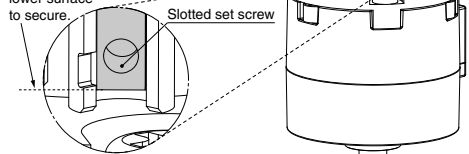

Enlarged view

3. Switch holder securing

After the actuated position has been adjusted with the cross recessed round head screw, use the auto switch.

* When tightening the screw, take care that the auto switch does not tilt.

CRB□2
CRB1
MSU
CRJ
CRA1
CRQ2
MSQ
MSZ
CRQ2X
MSQX
MRQ

D-□

Auto Switch Mounting: Size 10, 15 (D-S/T99(V)□, S9P(V), 97/93A, 90/90A)

External view and descriptions of auto switch unit

This following shows the external view and typical descriptions of the auto switch unit.

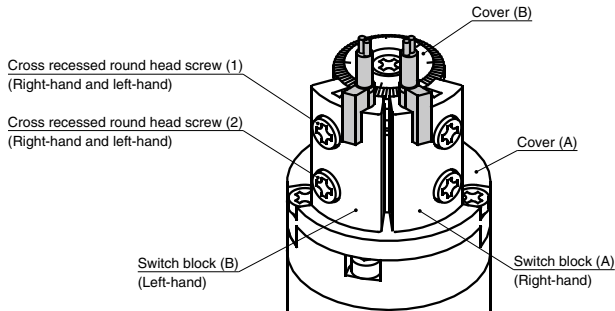

Solid state auto switch

<Applicable auto switch>

3-wire type.....D-S99(V)□, S9P(V)□

2-wire type.....D-T99(V)□

1. Switch block detaching

Remove the cross recessed round head screw (1) to detach the switch block.

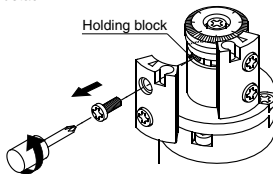

2. Auto switch mounting

Secure the auto switch with the cross recessed round head screw (1) and holding block.

Proper tightening torque: 0.4 to 0.6 [N·m]

* Since the holding block moves inside the groove, move it to the mounting position beforehand.

· After the actuated position has been adjusted with the cross recessed round head screw (1), use the auto switch.

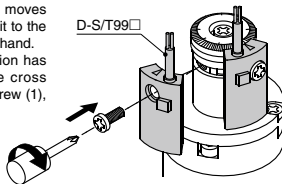

Reed auto switch

<Applicable auto switch>

D-97/93A (With indicator light)

D-90/90A (Without indicator light)

1. Preparations

Loosen the cross recessed round head screw (2) (About 2 to 3 turns).

* This screw has been secured temporarily at shipment.

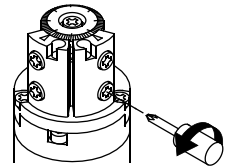

2. Auto switch mounting

Insert the auto switch until it is in contact with the switch block hole.

* For the D-97/93A model, insert the auto switch in the direction shown in the Fig. on the right.

* Since the D-90/90A model is a round type, it has no directionality.

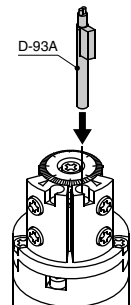

3. Auto switch securing

Tighten the cross recessed round head screw (2) to secure the auto switch.

Proper tightening torque: 0.4 to 0.6 [N·m]

· After the actuated position has been adjusted with the cross recessed round head screw (1), use the auto switch.

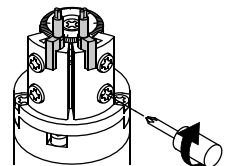

Auto Switch Mounting: Size 20 to 40 (D-S/T79□, S7P, R73/80□)

External view and descriptions of auto switch unit

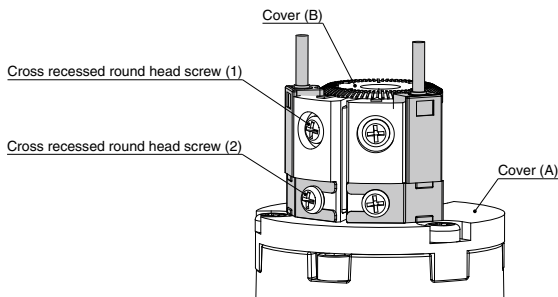

Mounting Procedure

<Applicable auto switch>

Solid state auto switch

**D-S79, S7P
D-T79, T79C**

Reed auto switch

**D-R73, R73C
D-R80, R80C**

1. Auto switch mounting

Loosen the cross recessed round head screw (2), and insert the arm of the auto switch.

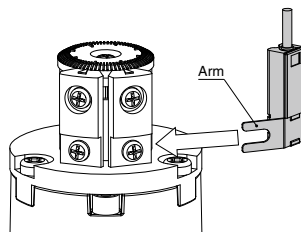

2. Auto switch securing

Set the auto switch so that it is in contact with the switch block, and tighten the cross recessed round head screw (2).

* Proper tightening torque: 0.4 to 0.6 [N·m]

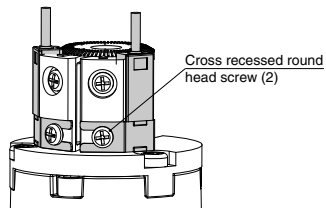

3. Switch holder securing

After the actuated position has been adjusted with the cross recessed round head screw (1), use the auto switch.

* Proper tightening torque: 0.4 to 0.6 [N·m]

CRB□2

CRB1

MSU

CRJ

CRA1

CRQ2

MSQ

MSZ

CRQ2X
MSQX

MRQ

D-□

Auto Switch Adjustment

Rotation range of the output shaft with single flat (key for size 40 only) and auto switch mounting position
 <Applicable models/Size: 10, 15, 20, 30, 40>

<Single vane>

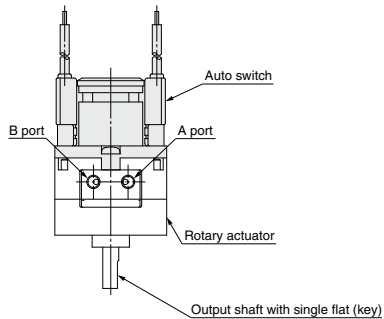
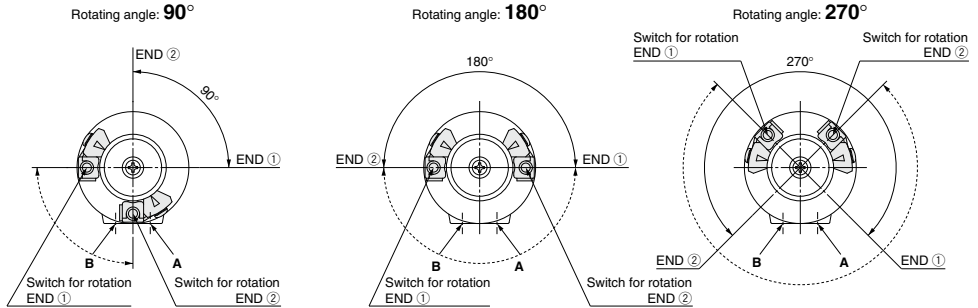

Size: 10 to 40

* The above figure shows the CRB2 series.

- * Solid-lined curves indicate the rotation range of the output shaft with single flat (key). When the single flat (key) is pointing to the END ① direction, the switch for rotation END ① will operate, and when the single flat (key) is pointing to the END ② direction, the switch for rotation END ② will operate.
- * Broken-lined curves indicate the rotation range of the built-in magnet. Operating angle of the switch can be decreased by either moving the switch for rotation END ① clockwise or moving the switch for rotation END ② counterclockwise. Auto switch in the figures above is at the most sensitive position.
- * Each auto switch unit comes with one right-hand and one left-hand switch.