

Rotary Actuator

CRA1 Series

Rack & Pinion Type/Size: 30, 50, 63, 80, 100

Compact auto switches are mountable.
(D-M9□)

Width reduced by
up to 14 mm

Space saving by
changing the auto
switch rail mounting to
groove mounting.

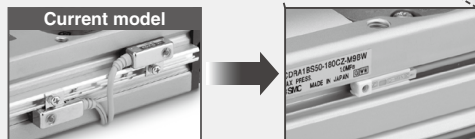

Mountable on
2 surfaces.

Compact
auto switch

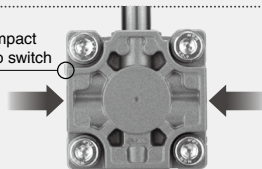

Auto switch can be mounted from the front.

- Auto switch can be mounted from the front at any position on the mounting groove.
- Auto switch can be mounted after installation or when installation condition is changed.

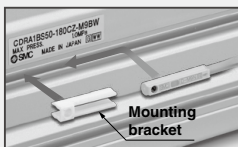

Weight is reduced by up to 14 %.

- Lightweight body by changing the body and the cover shape.

Size	CRA1 [kg]	Current model [kg]	Reduction rate [%]
30	0.27	0.3	10
50	1.3	1.5	13
63	2.2	2.5	12
80	3.9	4.3	10
100	7.3	8.5	14

Mounting interchangeable with the current model

RoHS

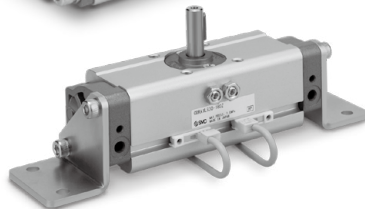
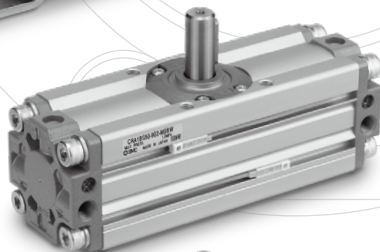
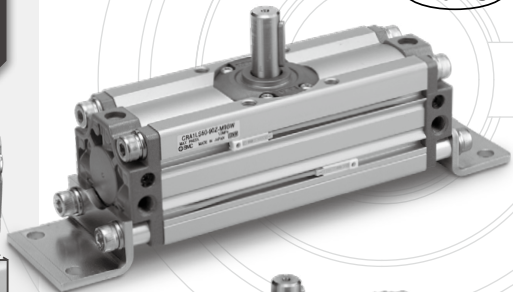

CRB□2

CRB1

MSU

CRJ

CRA1

CRQ2

MSQ

MSZ

CRQ2X
MSQX

MRQ

Standard type

Size: 30, 50, 63, 80, 100

Rotating angle: 30°, 90°, 180°
50 to 100: 90°, 180°, 100°, 190°



Angle adjustable type

Size: 50, 63, 80, 100

Rotating angle: 50 to 100: 90°, 180°, 100°, 190°

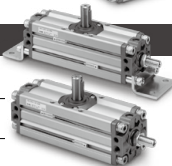

D-□

With solenoid valve

Size: 50, 63, 80, 100

Rotating angle: 50 to 100: 90°, 180°, 100°, 190°

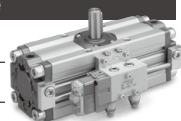

Standard type

Cushion seal is replaceable.

Cushion seal has been made replaceable.
(Not possible for current model. Cushion seal only)

Replacement parts

- Slider
- Piston seal
- Cushion seal (New)
- Tube gasket
- Spring pin

Interchangeable with current model

Exterior dimension, shaft diameter, and mounting dimension are interchangeable with current model.

Rotating angle

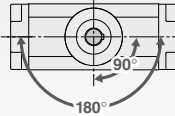

Size 30

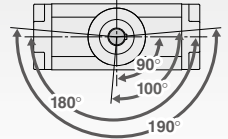

Size 50 to 100

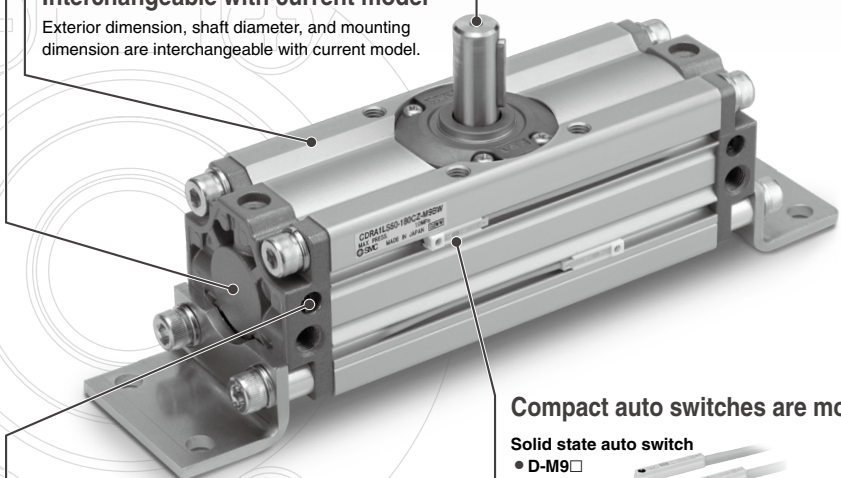

Compact auto switches are mountable.

Solid state auto switch

- D-M9□
- D-M9□W



Reed auto switch

- D-A9□



Easy adjustment of cushion valve

- Cushion valve shape is changed so it can be adjusted using a hexagon wrench only.
- No protrusion from the body.
- Retaining ring is used to prevent drop-out.

Port, cushion valve and auto switch are on the same surface.

Easy to handle.

* Cushion valve cannot be mounted on the air-hydro type.

With cushion valve retaining ring

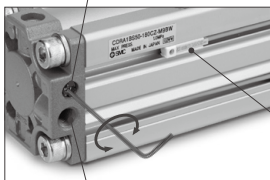

Auto switch

Port

Mountable on 2 surfaces.

Auto switches can be mounted in two rows.

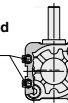

Size 30

Auto switch

Auto switches can be mounted in two rows.

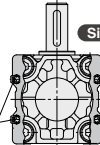

Size 50 to 100

Auto switches can be mounted in two rows.

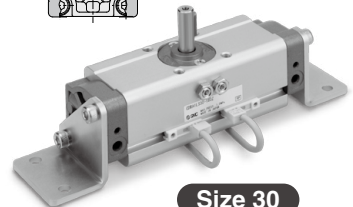

Size 30

Many variations of shaft type

Current model
Standard : 2 types
Semi-standard : 6 types

CRA1 Series
Standard: 8 types

- Shaft type can be selected to suit the specification.
- Part number is assigned for shaft types <single round shaft, double shaft (round shaft, with four chamfers), double round shaft>.

Single shaft with four chamfers:
CRA1BX

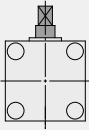

Double shaft with key:
CRA1BY

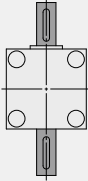

Double shaft with four chamfers:
CRA1BZ

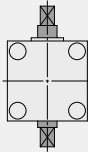

Single round shaft:
CRA1BT

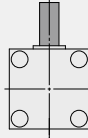

Double shaft (round shaft, with four chamfers):
CRA1BJ

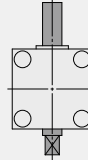

Double round shaft:
CRA1BK

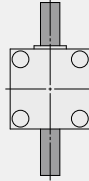

* Single round shaft, double shaft (round shaft, with four chamfers), double round shaft are made to order.

Mounting suitable for operating conditions is possible.

Foot bracket can be mounted at a desired position. (Foot bracket is included in the rotary actuator at shipment.)

Bottom side

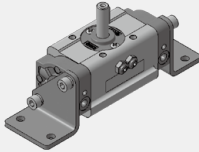

Shaft side

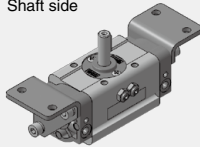

Port side

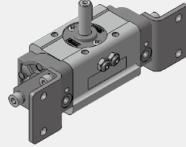

Back side

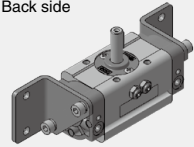

Angle adjustable type

Angle can be adjusted to a desired level in a range of up to 90°.

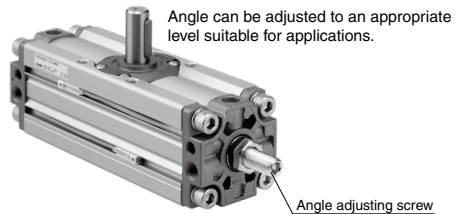
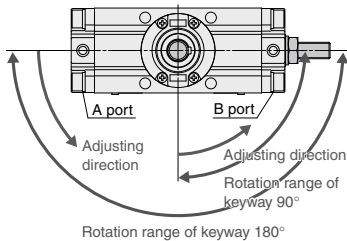

Angle can be adjusted to an appropriate level suitable for applications.

Angle adjusting screw

With solenoid valve

- Solenoid valve and rotation speed adjustment function are integrated.
- Part number is set for the angle adjustable type.

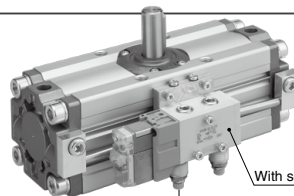

With solenoid valve

Rotation speed adjustment function

Rotary Actuator *CRA1 Series* 30, 50, 63, 80, 100

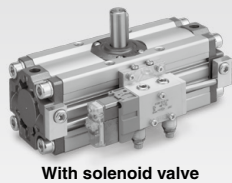
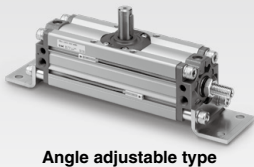
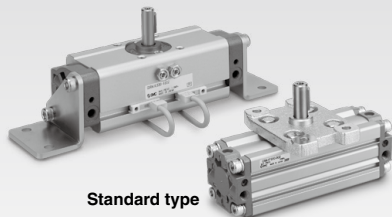

Series Variations

Type		Pneumatic					Air-hydro			
		30	50	63	80	100	50	63	80	100
Rotating angle	90°	●	●	●	●	●	●	●	●	●
	100°	●	●	●	●	●	●	●	●	●
	180°	●	●	●	●	●	●	●	●	●
	190°	●	●	●	●	●	●	●	●	●
Shaft type	Single shaft	S	●	●	●	●	●	●	●	●
	Double shaft	W	●	●	●	●	●	●	●	●
	Single shaft with four chamfers	X	●	●	●	●	●	●	●	●
	Double shaft with key	Y	●	●	●	●	●	●	●	●
	Double shaft with four chamfers	Z	●	●	●	●	●	●	●	●
	Single round shaft	T	●	●	●	●	●	●	●	●
	Double shaft (round shaft, with four chamfers)	J	●	●	●	●	●	●	●	●
	Double round shaft	K	●	●	●	●	●	●	●	●
Cushion	None	●	●	●	●	●	●	●	●	●
	Air cushion	●	●	●	●	●	●	●	●	●
Variations	With auto switch	●	●	●	●	●	●	●	●	●
	Angle adjustable type	●	●	●	●	●	●	●	●	●
	With solenoid valve	●	●	●	●	●	●	●	●	●
	Clean series ^{Note)}	11-	●	●	●	●	●	●	●	●
Mounting bracket	Flange	F	●	●	●	●	●	●	●	●
	Foot	L	●	●	●	●	●	●	●	●
Pattern	Shaft type pattern	●	●	●	●	●	●	●	●	●
	Rotation range	●	●	●	●	●	●	●	●	●
	Port location	●	●	●	●	●	●	●	●	●
	Stainless steel shaft/bolt/parallel key	-X 6	●	●	●	●	●	●	●	●
Operating temperature	Heat resistant 100°C	-X 7	●	●	●	●	●	●	●	
Both sides angle adjustable		-X10	●	●	●	●	●	●	●	●
One side angle adjustable, One side with cushion		-X11	●	●	●	●	●	●	●	●
Fluororubber seal		-X16	●	●	●	●	●	●	●	●

Note) For further specifications, refer to "Pneumatic Clean Series (CAT.E02-23)" catalog.

CONTENTS

Rotary Actuator *CRA1 Series*

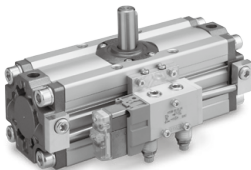
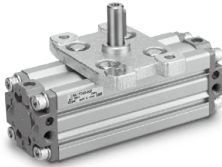
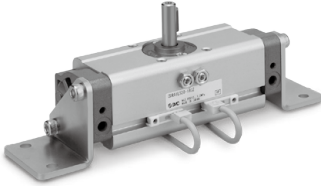

● Rotary Actuator CRA1 Series

How to Order	Page 188
Specifications	Page 189
Dimensions	Page 190
Construction	Page 196

● Rotary Actuator: Angle Adjustable Type CRA1□□U Series

How to Order	Page 198
Specifications	Page 199
Dimensions	Page 200
Construction	Page 201

● Rotary Actuator with Solenoid Valve CVRA1 Series

How to Order	Page 202
Specifications	Page 204
Dimensions	Page 205
Construction	Page 206

● Auto Switch Mounting

Page 208

● Simple Specials/Made to Order

Simple specials

Shaft pattern sequencing I	-XA1 to -XA24	Page 212
Shaft pattern sequencing II	-XA33 to -XA59	Page 216

Made to Order

How to Order	Page 221
① Reversed shaft -XC7	Page 222
② Change of rotation range -XC8 to -XC11	Page 222
③ Changed to fluorine grease -XC30	Page 222
④ Change of rotation range and shaft rotation direction -XC31 to XC36	Page 223
⑤ Change of rotation range and angle adjusting direction -XC37 to XC42	Page 224
⑥ Change of rotation range and angle adjusting direction -XC43 to XC46	Page 225
⑦ Change of rotation range and angle adjusting direction (Angle adjusting screw is equipped on the left.) -XC47 to XC52 ..	Page 226
⑧ Change of rotation range and angle adjusting direction (Angle adjusting screw is equipped on the left.) -XC53 to XC58 ..	Page 227
⑨ Change of port location (Mounting location of the cover is changed.) -XC59 to XC61 ..	Page 228
⑩ One side air-hydro, One side air -XC63, -XC64	Page 228
⑪ Stainless steel shaft/Bolt/Parallel key -X6	Page 229
⑫ Heat resistant -X7	Page 229
⑬ Both sides angle adjustable -X10	Page 229
⑭ One side angle adjustable, One side with cushion -X11	Page 230
⑮ Fluororubber seal -X16	Page 230
Made to Order/-X6 to -X16	Page 231

Specific Product Precautions

Page 232

Rotary Actuator

CRA1 Series

RoHS

Rack & Pinion Type/Size: 30, 50, 63, 80, 100

How to Order

CRA1 B S 50 - 90 Z

With auto switch CDRA1 B S 50 - 90 Z - M9BW

Built-in magnet

Mounting

B	Basic type
L	Foot type*
F (Note)	Flange type

* For foot bracket and part number, refer to page 189.
* Foot bracket is included in the same package, (but not assembled).
Note) Except size 30

Shaft type

S	Single shaft
W	Double shaft
X	Single shaft with four chamfers
Y	Double shaft with key
Z	Double shaft with four chamfers
T	Single round shaft
J	Double shaft (round shaft, with four chamfers)
K	Double round shaft

* Flange type is not available for T, J, K.
* T, J, K are made to order.

Type

Nil	Pneumatic
H *	Air-hydro

* Except size 30. Refer to page 232 for handling precautions.

Size

30
50
63
80
100

Air cushion

Nil	None
C *	With air cushion

* Except air-hydro type

Rotating angle

90	90°
180	180°
100 *	100°
190 *	190°

* Except size 30

Number of auto switches

Nil	2 pcs.
S	1 pc.

* Up to two auto switches are mountable.

Auto switch

Nil	Without auto switch (Built-in magnet)
------------	---------------------------------------

* For applicable auto switch model, refer to the table below.

Port type

Size		30	50	63	80	100
Nil	M thread	M5	—	—	—	—
	Rc	—	—	—	—	—
TF	G	—	—	—	—	—
TN	NPT	—	1/8	1/8	1/4	3/8
TT	NPTF	—	—	—	—	—

Made to Order
Refer to page 189.

Applicable Auto Switches/Refer to pages 797 to 850 for further information on auto switches.

Type	Special function	Electrical entry	Indicator light	Wiring (Output)	Load voltage		Auto switch model		Lead wire length [m]			Pre-wired connector	Applicable load	
					DC	AC	Perpendicular	In-line	0.5 (Nil)	1 (M)	3 (L)			5 (Z)
Solid state auto switch	—	Grommet	Yes	3-wire (NPN)	5 V, 12 V	—	M9NV	M9N	●	●	○	○	IC circuit	Relay, PLC
				3-wire (PNP)			M9PV	M9P	●	●	○	○		
				2-wire	M9BV		M9B	●	●	○	○	—		
				3-wire (NPN)	M9NWW		M9NW	●	●	○	○	—		
				3-wire (PNP)	M9PWW		M9PW	●	●	○	○	—		
				2-wire	M9BWW		M9BW	●	●	○	○	—		
	Diagnosis indication (2-color indicator)	Grommet	Yes	3-wire (NPN)	5 V, 12 V	M9NAV ^{*1}	M9NA ^{*1}	○	○	○	○	○	IC circuit	Relay, PLC
				3-wire (PNP)		M9PAV ^{*1}	M9PA ^{*1}	○	○	○	○			
				2-wire	M9BAV ^{*1}	M9BA ^{*1}	○	○	○	○	—			
				3-wire (PNP)	M9BAV ^{*1}	M9BA ^{*1}	○	○	○	○	—			
Water resistant (2-color indicator)	Grommet	Yes	3-wire (NPN equivalent)	—	5 V	A96V	A96	●	●	—	—	IC circuit	—	
			2-wire			A93V ^{*2}	A93	●	●	●	●			—
Head auto switch	—	Grommet	No	3-wire	24 V	12 V	A90V	A90	●	●	—	—	IC circuit	Relay, PLC
				2-wire			100 V	A93V ^{*2}	A93	●	●	●		
						100 V or less	A90V	A90	●	●	—	—	IC circuit	

*1 Although it is possible to mount water resistant type auto switches, note that the rotary actuator itself is not of water resistant construction.

*2 1 m type lead wire is only applicable to D-A93.

* Lead wire length symbols: 0.5 m Nil (Example) M9NW
1 m M (Example) M9NWM
3 m L (Example) M9NWL
5 m Z (Example) M9NWZ

* Refer to pages 837 and 838 for detailed solid state auto switches with pre-wired connectors.

* Auto switches marked with "○" are produced upon receipt of order.

* Auto switches are shipped together, (but not assembled).

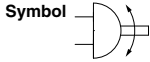
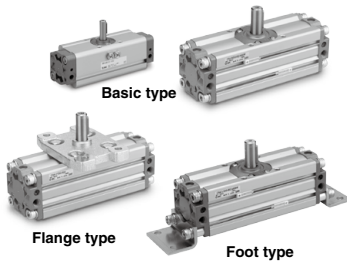

Made to Order
(For details, refer to pages 211 to 231.)

Symbol	Description	Applicable shaft type
-XA1 to -XA24	Shaft pattern sequencing I	S, W, Y
-XA33 to -XA59	Shaft pattern sequencing II	X, Z, T, J, K
-XC7	Reversed shaft	S, W, X, T, J
-XC8 to -XC11	Change of rotation range	S, W, Y
-XC30	Changed to fluorine grease	S, W, X, Y, Z, T, J, K
-XC31 to -XC36	Change of rotation range and shaft rotation direction	S, W, Y
-XC59 to -XC61	Change of port direction	S, W, X, Y, Z, T, J, K
-XC63, -XC64	One side air-hydro, One side air	S, W, X, Y, Z, T, J, K
-X6	Stainless steel shaft/bolt, etc.	S, W, X, Y, Z, T, J, K
-X7*	Heat resistant (100°C)	S, W, X, Y, Z, T, J, K
-X16	Fluororubber seal	S, W, X, Y, Z, T, J, K

* -X7: Not available for the built-in magnet type

Rotation Range of Keyway

The shaft rotates clockwise when the pressure is applied from the A port while it rotates counterclockwise when the pressure is applied from the B port.

Size: 30

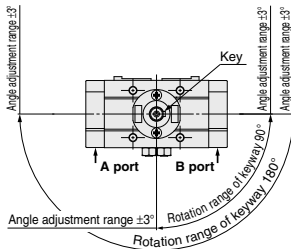

Size: 50 to 100

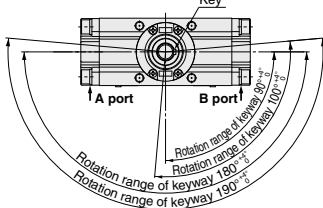

Specifications

Type	Pneumatic					Air-hydro			
	30	50	63	80	100	50	63	80	100
Size	Air (Non-lube)					Turbine oil			
Fluid									
Max. operating pressure						1.0 MPa			
Min. operating pressure						0.1 MPa			
Ambient and fluid temperature	0 to 60°C (No freezing)								
Cushion	Not attached, Air cushion					None			
Backlash	None*					Within 1°			
Tolerance in rotating angle	—					0 to +4°			

* Since the CRA1□30 has a stopper installed, there is no backlash produced under pressure.

Effective Torque

Size	Operating pressure [MPa]									
	0.1	0.2	0.3	0.4	0.5	0.6	0.7	0.8	0.9	1.0
30	0.38	0.76	1.14	1.53	1.91	2.29	2.67	3.05	3.44	3.82
50	1.85	3.71	5.57	7.43	9.27	11.2	13.0	14.9	16.7	18.5
63	3.44	6.88	10.4	13.8	17.2	20.6	24.0	27.5	31.0	34.4
80	6.34	12.7	19.0	25.3	31.7	38.0	44.4	50.7	57.0	63.4
100	14.9	29.7	44.6	59.4	74.3	89.1	104	119	133	149

Allowable Kinetic Energy/Adjustable Range of Rotation Time Safe in Operation

Size	Allowable kinetic energy [J]		Adjustable range of rotation time safe in operation [s/90°]
	Without air cushion	With air cushion*	
30	0.01	0.12	0.2 to 1
50	0.05	0.98	0.2 to 2
63	0.12	1.50	0.2 to 3
80	0.16	2.00	0.2 to 4
100	0.54	2.90	0.2 to 5

* Allowable kinetic energy of the product with air cushion is the maximum absorbed energy when the cushion valve adjustment is optimized.

Weight

Size	Standard weight		Additional weight		
	90°	180°	With auto switch*	Foot bracket	Flange bracket
30	0.27	0.36	0.1	0.1	—
50	1.3	1.5	0.2	0.3	0.5
63	2.2	2.6	0.4	0.5	0.9
80	3.9	4.4	0.6	0.9	1.5
100	7.3	8.3	0.9	1.2	2.0

* With 2 auto switches

Foot Bracket/Part No.

Size	Foot bracket	Contents	Mounting screw size included in foot bracket
30	CRA1L 30-Y-1Z		M 5 x 0.8 x 25
50	CRA1L 50-Y-1Z		M 8 x 1.25 x 35
63	CRA1L 63-Y-1Z	Foot bracket : 2 pcs. Mounting screw: 4 pcs.	M10 x 1.5 x 40
80	CRA1L 80-Y-1Z	Collar* : 4 pcs.	M12 x 1.75 x 50
100	CRA1L100-Y-1Z		M12 x 1.75 x 50

* Size 30 does not include collars.

* Remove the basic type mounting screws and use the mounting screws included in the foot bracket to secure the foot bracket to the cover. Use the collar as a spacer for the cover counterbore part and secure it together with the foot.

* For size 30, be careful not to drop the cover when removing the basic type mounting screws. Additionally, do not mount the foot bracket with the pressure applied to the port.

CRA1 Series

Dimensions/Basic Type: C□RA1BS

Size: 30

Single shaft: C□RA1BS

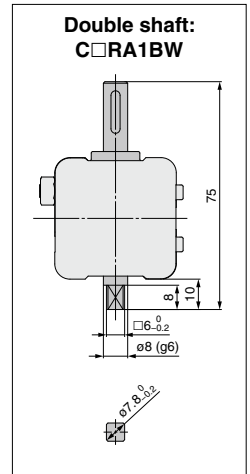
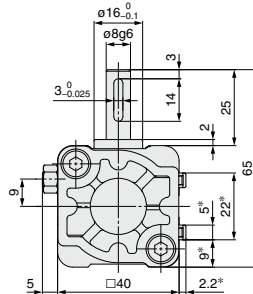
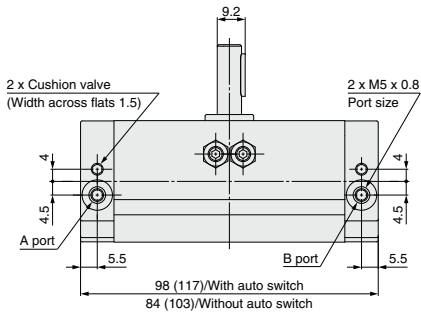
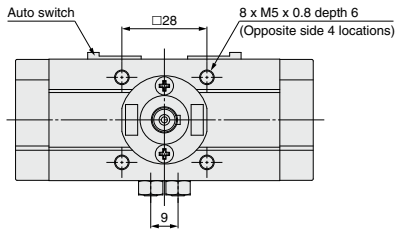
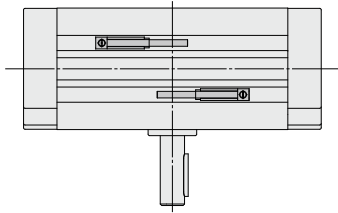

- Drawing shows the appearance for rotation of 90°.
- Dimensions show pressurization to B port.
- Drawing shows that the auto switch is mounted on the side opposite to the port side. (Dimensions with an asterisk mark (*) are not required for actuators without the auto switch.)

* () are the dimensions for rotation of 180°.

Note) A parallel key is included in the same package, (but not assembled).

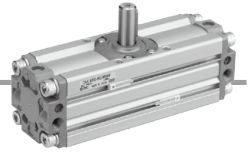

Dimensions/Basic Type: C□RA1BS

Size: 50/63/80/100

Single shaft: C□RA1BS

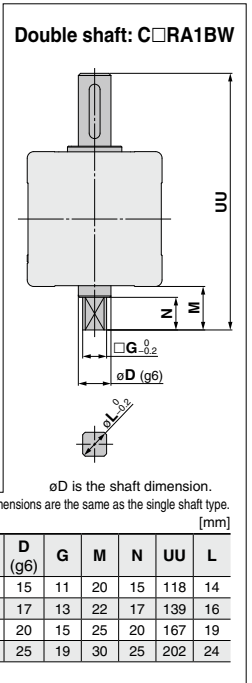
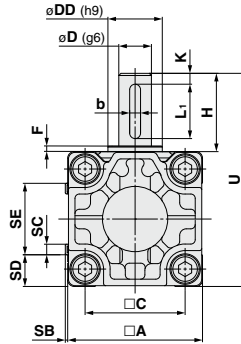
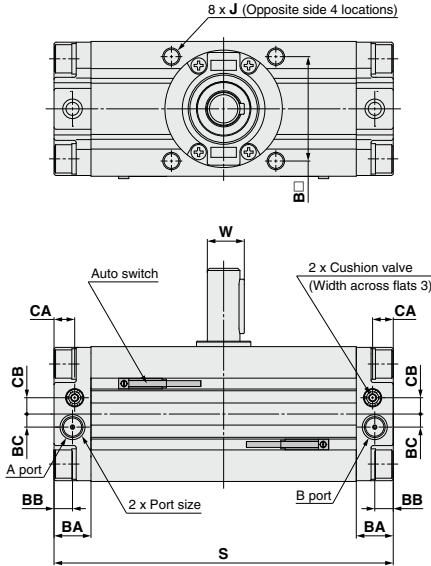

- Drawing shows the appearance for rotation of 90° and 100°.
 - Dimensions show pressurization to B port.
 - Drawing shows the auto switch mounted on the port side.
- * () are the dimensions for rotation of 180° and 190°.

Size	Note 1) Port size	A	B	C	D (g6)	DD (h9)	F	H	J	K	With auto switch					Without auto switch	U	W	BA	BB	BC	★ CA	★ CB	Note 2) Key dimensions	
											S	SB	SC	SD	SE	S								b	L1
50	Rc1/8	62	48	46	15	25	2.5	36	M8 x 1.25 depth 8	5	156 (189)	1.5	5	14.5	33	144 (177)	98	17	17	8.5	6	9.5	7.5	5 ⁰ _{-0.030}	25
63	Rc1/8	76	60	57	17	30	2.5	41	M10 x 1.5 depth 12	5	175 (213.5)	1.5	5	21.5	33	163 (201.5)	117	19.5	20	10	7	11	8	6 ⁰ _{-0.030}	30
80	Rc1/4	92	72	70	20	35	3	50	M12 x 1.75 depth 13	5	199 (243)	1.5	5	29.5	33	186 (230)	142	22.5	23.5	12	8	13	9	6 ⁰ _{-0.030}	40
100	Rc3/8	112	85	85	25	40	4	60	M12 x 1.75 depth 14	5	259 (325)	1.5	5	39.5	33	245 (311)	172	28	25	12.5	8	14	10	8 ⁰ _{-0.036}	45

Note 1) In addition to Rc, G, NPT and NPTF are also available.

Note 2) A parallel key is included in the same package, (but not assembled).

★ For model with air cushion

CRA1 Series

Dimensions/Basic Type: C□RA1B□ (Dimensions other than specified below are the same as the standard type.)

Size: 30/50/63/80/100

Single shaft with four chamfers: C□RA1BX

Double shaft with key: C□RA1BY

Double shaft with four chamfers: C□RA1BZ

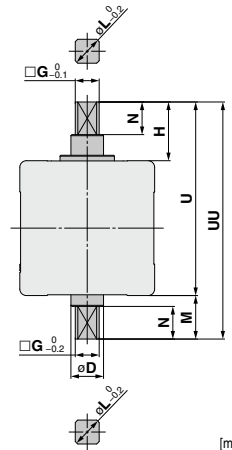
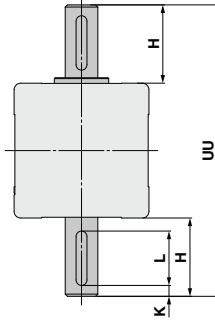
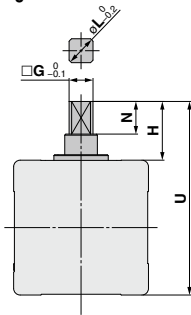

Size	G	H	N	U	L
30	6	13	8	53	7.8
50	11	27	15	89	14
63	13	29	17	105	16
80	15	38	20	130	19
100	19	44	25	156	24

Note) Dimension parts different from the standard conform to the general tolerance.

Size	H	K	UU	L
30	25	3	90	14
50	36	5	134	25
63	41	5	158	30
80	50	5	192	40
100	60	5	232	45

Note) Dimension parts different from the standard conform to the general tolerance.

Size	D (g6)	G	H	M	N	U	UU	L
30	8	6	13	10	8	53	63	7.8
50	15	11	27	20	15	89	109	14
63	17	13	29	22	17	105	127	16
80	20	15	38	25	20	130	155	19
100	25	19	44	30	25	156	186	24

Note) Dimension parts different from the standard conform to the general tolerance.

Single round shaft: C□RA1BT

Double shaft (round shaft, with four chamfers): C□RA1BJ

Double round shaft: C□RA1BK

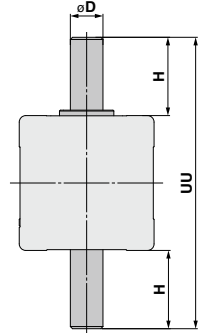
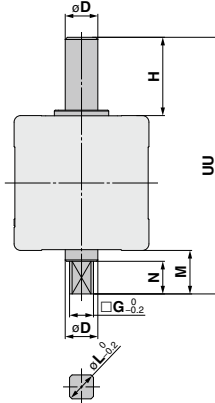
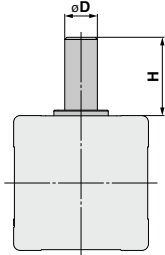

Size	D (g6)	H
30	8	25
50	15	36
63	17	41
80	20	50
100	25	60

Note) Dimension parts different from the standard conform to the general tolerance.

Size	D (g6)	G	H	M	N	UU	L
30	8	6	25	10	8	75	7.8
50	15	11	36	20	15	118	14
63	17	13	41	22	17	139	16
80	20	15	50	25	20	167	19
100	25	19	60	30	25	202	24

Note) Dimension parts different from the standard conform to the general tolerance.

Size	D (g6)	H	UU
30	8	25	90
50	15	36	134
63	17	41	158
80	20	50	192
100	25	60	232

Note) Dimension parts different from the standard conform to the general tolerance.



Dimensions/Foot Type: C□RA1LS

Size: 30

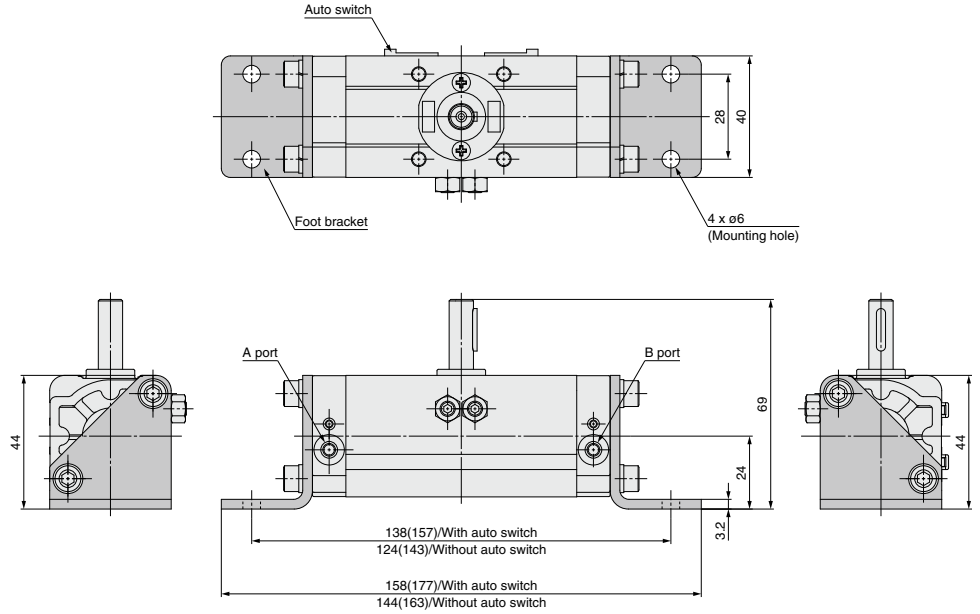

- Drawing shows the appearance for rotation of 90°.
 - Dimensions show pressurization to B port.
 - Drawing shows that the auto switch is mounted on the side opposite to the port side.
- * () are the dimensions for rotation of 180°.

CRB□2
CRB1
MSU
CRJ
CRA1
CRQ2
MSQ
MSZ
CRQ2X
MSQX
MRQ

D-□

CRA1 Series

Dimensions/Foot Type: C□RA1LS

Size: 50/63/80/100

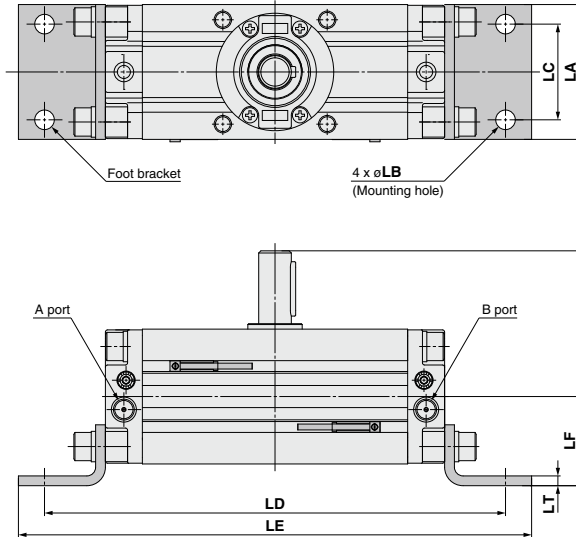

- Drawing shows the appearance for rotation of 90° and 100°.
 - Dimensions show pressurization to B port.
 - Drawing shows that the auto switch mounted on the port side.
- * () are the dimensions for rotation of 180° and 190°.

Note) Other dimensions are the same as the basic type. [mm]

Size	LA	LB	LC	With auto switch		Without auto switch		LF	LH	LT
				LD	LE	LD	LE			
50	62	9	44	212 (245)	236 (269)	200 (233)	224 (257)	41	108	4.5
63	76	11	55	247 (285.5)	275 (313.5)	235 (273.5)	263 (301.5)	48	127	5
80	92	13	67	287 (331)	329 (373)	274 (318)	316 (360)	58	154	6
100	112	13	87	347 (413)	389 (455)	333 (399)	375 (441)	73.5	189.5	6

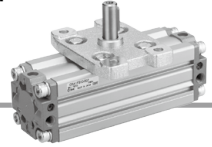

Dimensions/Flange Type: C□RA1F□

Size: 50/63/80/100

Single shaft: C□RA1FS

Double shaft: C□RA1FW

Single shaft with four chamfers: C□RA1FX

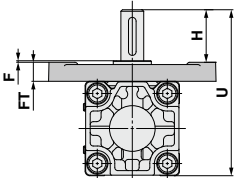
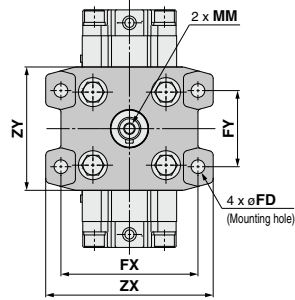

Note) Other dimensions are the same as the basic type. [mm]

Size	F	H	MM	U	FD
50	4	39	M6 x 1.0 depth 12	114	9
63	5	45	M6 x 1.0 depth 12	136	11.5
80	5	55	M8 x 1.25 depth 16	165	13.5
100	5	60	M10 x 1.5 depth 20	190	13.5

Size	FT	FX	FY	ZX	ZY
50	13	90	50	110	81
63	15	105	59	130	101
80	18	130	76	160	119
100	18	150	92	180	133

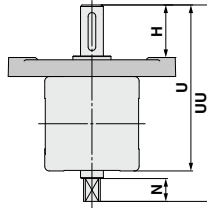

Note) Other dimensions are the same as the single shaft type. [mm]

Size	H	N	U	UU
50	39	15	114	134
63	45	17	136	158
80	55	20	165	190
100	60	25	190	220

Double shaft with key: C□RA1FY

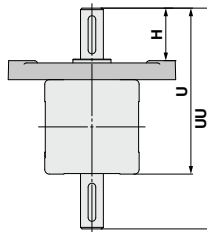

Note) Other dimensions are the same as the single shaft type. [mm]

Size	H	U	UU
50	39	114	150
63	45	136	177
80	55	165	215
100	60	190	250

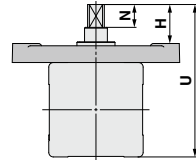

Note) Other dimensions are the same as the single shaft type. [mm]

Size	H	N	U
50	30	15	105
63	33	17	124
80	43	20	153
100	44	25	174

Double shaft with four chamfers: C□RA1FZ

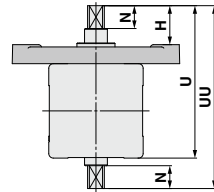

Note) Other dimensions are the same as the single shaft type. [mm]

Size	H	N	U	UU
50	30	15	105	125
63	33	17	124	146
80	43	20	153	178
100	44	25	174	204

- CRA1
- CRB□2
- CRB1
- MSU
- CRJ
- CRQ2
- MSQ
- MSZ
- CRO2X
- MSQX
- MRQ

D-□

The dimensions of shaft key and four chamfers are the same as the basic type. For details, refer to page 192.

CRA1 Series

Construction: Size 30

Without air cushion

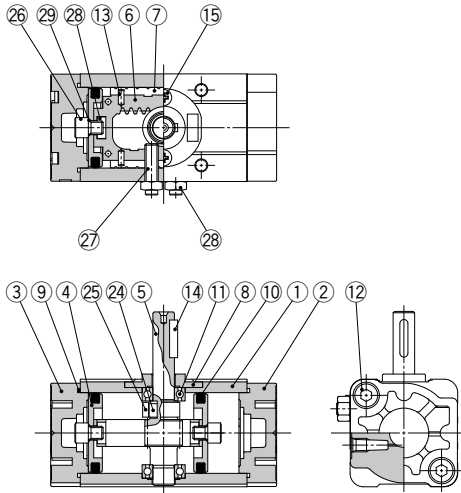

With air cushion

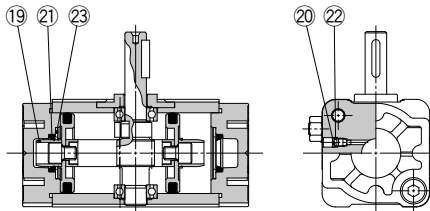

Without air cushion With auto switch

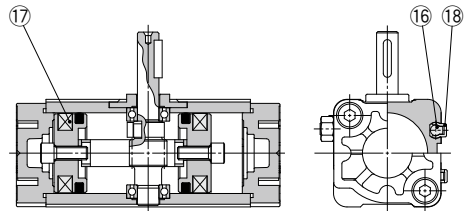

Component Parts

No.	Description	Material	Note
1	Body	Aluminum alloy	Anodized
2	Right cover	Aluminum alloy	Metallic coating
3	Left cover	Aluminum alloy	Metallic coating
4	Piston	Aluminum alloy	
5	Shaft	Alloy steel	
6	Rack	Carbon steel	Nitrided
7	Slider	Resin	
8	Bearing retainer	Zinc alloy	Chromated
9	Tube gasket	NBR	
10	Piston seal	NBR	
11	Bearing	High carbon chrome bearing steel	
12	Hexagon socket head cap screw with washer	Alloy steel	Zinc chromated
13	Spring pin	Steel	Zinc chromated
14	Parallel key	Carbon steel	
15	Cross-recessed pan head tapping screw	Steel	Zinc chromated
16	Auto switch	—	
17	Magnet	—	
18	Switch spacer	Resin	
19	Cushion ring	Aluminum alloy	Anodized
20	Cushion valve	Steel	Nickel plated
21	Cushion seal	Urethane	
22	O-ring	NBR	

No.	Description	Material	Note
23	Seal retainer	Steel	
24	Parallel key	Carbon steel	
25	Stopper	Alloy steel	
26	Piston holding bolt	Alloy steel	Zinc chromated
27	Hexagon socket head set screw	Alloy steel	Zinc chromated
28	Hexagon nut	Steel	Zinc chromated
29	O-ring	NBR	

Replacement Parts

Size	Part no.		
	Without air cushion	With air cushion	Air-hydro
Note 2) 90°	P694010-20	P694010-22	—
30 180°	P694010-21	P694010-23	—
Corresponding parts	⑦, ⑨, ⑩, ⑬ are included as a set.		⑦, ⑨, ⑩, ⑬, ⑳ are included as a set.

Note 1) When ordering replacement parts, write "1" for one set of the parts per actuator.
 Note 2) Replacement parts for different rotation angles are set.
 A grease pack (10 g) is included.
 If an additional grease pack is needed, order with the following part number.
Grease pack part number: GR-S-010 (10 g)

Construction: Size 50 to 100

Without air cushion

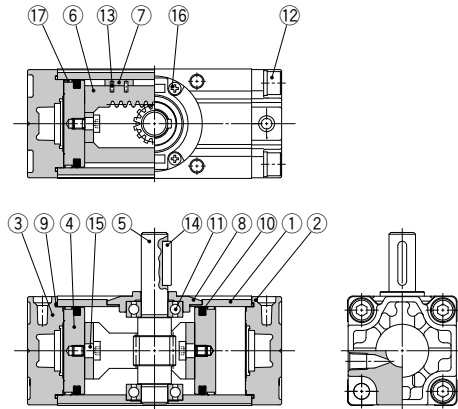

With air cushion

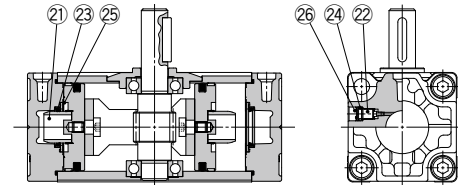

Without air cushion With auto switch

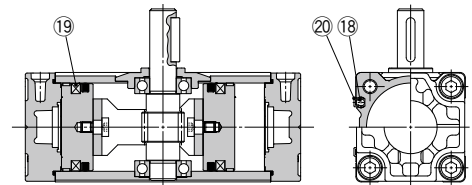

Component Parts

No.	Description	Material	Note
1	Body	Aluminum alloy	Anodized
2	Right cover	Aluminum alloy	Metallic coating
3	Left cover	Aluminum alloy	Metallic coating
4	Piston	Aluminum alloy	
5	Shaft	Alloy steel	
6	Rack	Carbon steel	Nitrided
7	Slider	Resin	
8	Bearing retainer	Aluminum alloy	Chromated
9	Tube gasket	NBR	
10	Piston seal	NBR	
11	Bearing	High carbon chrome bearing steel	
12	Hexagon socket head cap screw with washer	Alloy steel	Zinc chromated
13	Spring pin	Steel	Zinc chromated
14	Parallel key	Carbon steel	
15	Connecting screw	Carbon steel	Zinc chromated
16	Cross-recessed pan head tapping screw	Steel	Zinc chromated
17	Wear ring	Resin	
18	Auto switch	—	
19	Magnet	—	
20	Switch spacer	Resin	
21	Cushion ring	Aluminum alloy	Anodized
22	Cushion valve	Steel	Zinc chromated
23	Cushion seal	Urethane	
24	O-ring	NBR	
25	Seal retainer	Steel	
26	Retaining ring	Steel	

Replacement Parts

Size	Part no.		
	Without air cushion	With air cushion	Air-hydro
50	P694020-20	P694020-21	P694020-23
63	P694030-20	P694030-21	P694030-23
80	P694040-20	P694040-21	P694040-23
100	P694050-20	P694050-21	P694050-23
Corresponding parts	⑦, ⑨, ⑩, ⑬ are included as a set.	⑦, ⑨, ⑩, ⑬, ⑳ are included as a set.	⑦, ⑨, ⑩, ⑬ are included as a set.

Note) When ordering replacement parts, write "1" for one set of the parts per actuator. A grease pack (10 g) is included. If an additional grease pack is needed, order with the following part number. Grease pack part number: GR-S-010 (10 g)

- CRB□2
- CRB1
- MSU
- CRJ
- CRA1**
- CRQ2
- MSQ
- MSZ
- CRQ2X
- MSQX
- MRQ



Rotary Actuator: Angle Adjustable Type

(Angle adjustment mechanism is provided as standard.)

CRA1□□U Series

RoHS

Rack & Pinion Type/Size: 50, 63, 80, 100

How to Order

CRA1 B S U 50 - 90 Z - □

With auto switch CDRA1 B S U 50 - 90 Z - M9BW - □

Mounting

B	Basic type
L	Foot type*
F	Flange type

* For foot bracket and part number, refer to page 199.
* Foot bracket is included in the same package, (but not assembled).

Built-in magnet

Shaft type

S	Single shaft
W	Double shaft
X	Single shaft with four chamfers
Y	Double shaft with key
Z	Double shaft with four chamfers
T	Single round shaft
J	Double shaft (round shaft, with four chamfers)
K	Double round shaft

* Flange type is not available for T, J, K.
* T, J, K are made to order.

Angle adjustable type

90	90°
180	180°
100	100°
190	190°

Rotating angle

Auto switch

Nil	Without auto switch (Built-in magnet)
-----	---------------------------------------

* For applicable auto switch model, refer to the table below.

Number of auto switches

Nil	2 pcs.
S	1 pc.

Note) Up to two auto switches are mountable.

Size

50
63
80
100

Port type

Size		50	63	80	100
Nil	Rc	1/8	1/4	3/8	
TF	G				
TN	NPT				
TT	NPTF				

Made to Order
Refer to page 199.

Applicable Auto Switches/Refer to pages 797 to 850 for further information on auto switches.

Type	Special function	Electrical entry	Indicator light	Wiring (Output)	Load voltage		Auto switch model		Lead wire length [m]			Pre-wired connector	Applicable load	
					DC	AC	Perpendicular	In-line	0.5 (Nil)	1 (M)	3 (L)		5 (Z)	
Solid state auto switch	—	Grommet	Yes	3-wire (NPN)	5 V, 12 V	—	M9NV	M9N	●	●	○	○	IC circuit	Relay, PLC
				3-wire (PNP)			M9PV	M9P	●	●	○	○		
				2-wire	M9BV		M9B	●	●	○	○	—		
				3-wire (NPN)	M9NVW		M9NW	●	●	○	○	IC circuit		
	Diagnosis indication (2-color indicator)			3-wire (PNP)	M9PWV		M9PW	●	●	○	○	—		
				2-wire	M9BWW		M9BW	●	●	○	○	—		
				3-wire (NPN)	M9NAV*1		M9NA*1	○	○	●	●	IC circuit		
				3-wire (PNP)	M9PAV*1		M9PA*1	○	○	●	●	—		
Water resistant (2-color indicator)	2-wire	M9BAV*1	M9BA*1	○	○	●	●	—						
	—	Grommet	No	3-wire (NPN equivalent)	—	5 V	—	A96V	A96	●	—	—	IC circuit	—
2-wire	24 V			12 V	100 V	A93V*2	A93	●	●	●	—	—	Relay, PLC	
						100 V or less		A90V	A90	●	—	—	IC circuit	

*1 Although it is possible to mount water resistant type auto switches, note that the rotary actuator itself is not of water resistant construction.

*2 1 m type lead wire is only applicable to D-A93.

* Lead wire length symbols: 0.5 m Nil (Example) M9NW
1 m M (Example) M9NWM
3 m L (Example) M9NWL
5 m Z (Example) M9NWZ

* Refer to pages 837 and 838 for detailed solid state auto switches with pre-wired connectors.

* Auto switches marked with "○" are produced upon receipt of order.

* Auto switches are shipped together, (but not assembled).

Rotary Actuator: Angle Adjustable Type Rack & Pinion Type **CRA1□□U Series**

Specifications

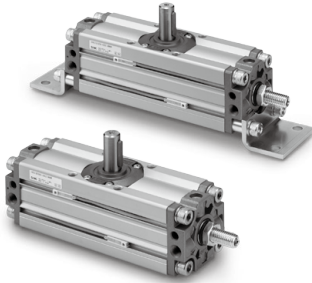

Type	Pneumatic			
	50	63	80	100
Fluid	Air (Non-lube)			
Max. operating pressure	1.0 MPa			
Min. operating pressure	0.1 MPa			
Ambient and fluid temperature	0 to 60°C (No freezing)			
Cushion	None			
Backlash	Within 1°			
Angle adjustment range	Max. 90°			

* For details about the effective torque, allowable kinetic energy, and adjustable range of rotation time safe in operation, refer to page 189.

Weight

Size	Standard weight		Additional weight		
	90°	180°	With auto switch*	Foot bracket	Flange bracket
50	1.4	1.6	0.2	0.3	0.5
63	2.4	2.8	0.4	0.5	0.9
80	4.2	4.7	0.6	0.9	1.5
100	7.8	8.8	0.9	1.2	2.0

* With 2 auto switches

Made to Order

Made to Order

(For details, refer to pages 211 to 231.)

Symbol	Description	Applicable shaft type
-XA1 to -XA24	Shaft pattern sequencing I	S, W, Y
-XA33 to -XA59	Shaft pattern sequencing II	X, Z, T, J, K
-XC7	Reversed shaft	S, W, X, T, J
-XC30	Changed to fluorine grease	S, W, X, Y, Z, T, J, K
-XC37 to -XC46	Change of rotation range and angle adjusting direction	S, W, Y
-XC47 to -XC58	Change of rotation range and angle adjusting direction (Angle adjusting screw is equipped on the left.)	S, W, Y
-XC59 to -XC61	Change of port direction	S, W, X, Y, Z, T, J, K
-X7*	Heat resistant type (100°C)	S, W, X, Y, Z, T, J, K
-X16	Fluororubber seal	S, W, X, Y, Z, T, J, K
-X10	Both sides angle adjustable	S, W, X, Y, Z, T, J, K
-X11	One side angle adjustable, One side with cushion	S, W, X, Y, Z, T, J, K

* -X7: Not available for the built-in magnet type.

Rotation Range of Keyway/Angle Adjustment

The shaft rotates clockwise when the pressure is applied from the A port. The clockwise rotation end position is adjusted using the angle adjusting screw. (Note) Take appropriate measures so that no excessive external impact or vibration is applied to the angle adjusting screw. Failure to do so may cause the angle adjusting screw to become loose or drop.

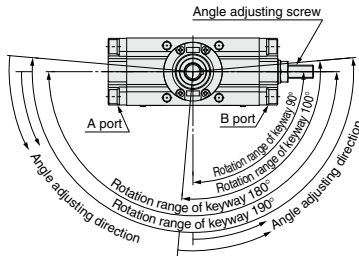

Adjustment angle per rotation of angle adjusting screw

Size	50	63	80	100
Adjusting angle	9.5°	9.4°	8.2°	6.8°

Foot Bracket/Part No.

Size	Foot bracket	Contents	Mounting screw size included in foot bracket
50	CRA1L 50-Y-1Z	Foot bracket : 2 pcs. Mounting screw: 4 pcs. Collar* : 4 pcs.	M 8 x 1.25 x 35
63	CRA1L 63-Y-1Z		M10 x 1.5 x 40
80	CRA1L 80-Y-1Z		M12 x 1.75 x 50
100	CRA1L100-Y-1Z		M12 x 1.75 x 50

* Remove the basic type mounting screws and use the mounting screws included in the foot bracket to secure the foot bracket to the cover. Use the collar as a spacer for the cover counterbore part and secure it together with the foot.

CRA1□□U Series

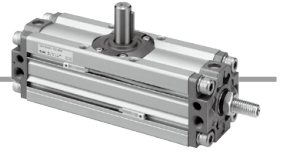

Dimensions/Basic Type: C□RA1BSU

Size: 50/63/80/100

Single shaft: C□RA1BSU

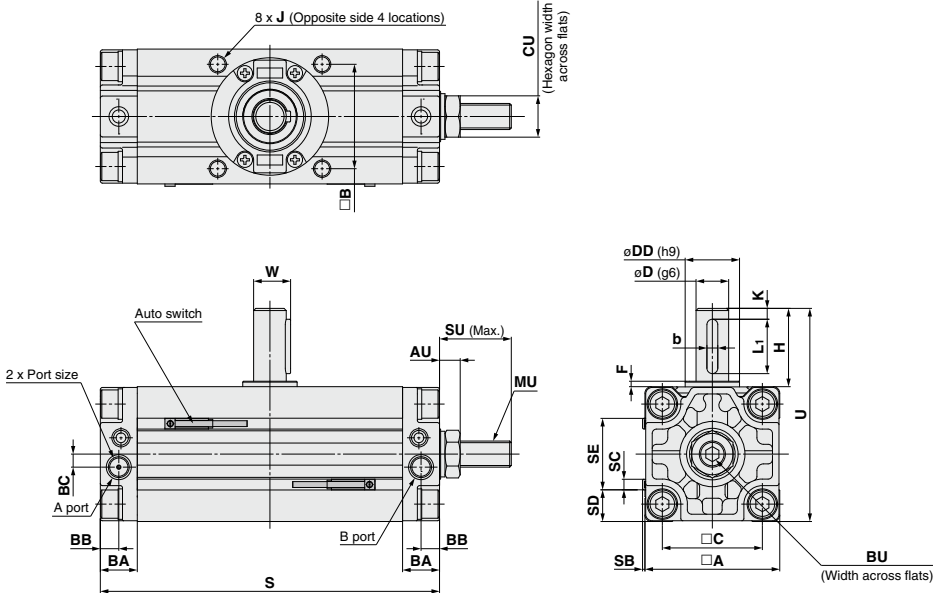

- Drawing shows the appearance for rotation of 90° and 100°.
- Dimensions show pressurization to B port.
- Drawing shows the auto switch mounted on the port size.

* () are the dimensions for rotation of 180° and 190°.

Size	Note 1) Port size	A	B	C	D (g6)	DD (h9)	F	H	J	K	With auto switch					Without auto switch	U	W	BA	BB	BC
											S	SB	SC	SD	SE	S					
50	Rc1/8	62	48	46	15	25	2.5	36	M8 x 1.25 depth 8	5	156 (189)	1.5	5	14.5	33	144 (177)	98	17	17	8.5	6
63	Rc1/8	76	60	57	17	30	2.5	41	M10 x 1.5 depth 12	5	175 (213.5)	1.5	5	21.5	33	163 (201.5)	117	19.5	20	10	7
80	Rc1/4	92	72	70	20	35	3	50	M12 x 1.75 depth 13	5	199 (243)	1.5	5	29.5	33	186 (230)	142	22.5	23.5	12	8
100	Rc3/8	112	85	85	25	40	4	60	M12 x 1.75 depth 14	5	259 (325)	1.5	5	39.5	33	245 (311)	172	28	25	12.5	8

Size	AU	BU	CU	SU	MU	Key Note 2) dimensions	
						b	L1
50	9.5	6	19	33	M12 x 1.75	5 ⁰ _{-0.030}	25
63	10.5	6	22	35.5	M14 x 2	6 ⁰ _{-0.030}	30
80	12.5	8	24	44	M16 x 2	6 ⁰ _{-0.030}	40
100	14.5	10	30	56	M20 x 2.5	8 ⁰ _{-0.036}	45

Note 1) In addition to Rc, G, NPT and NPTF are also available.

Note 2) A parallel key is included in the same package, (but not assembled).

200

The dimensions of the shaft type (W: Double shaft, X: Single shaft with four chamfers, Y: Double shaft with key, Z: Double shaft with four chamfers, T: Single round shaft, J: Double shaft (round shaft, with four chamfers), K: Double round shaft), foot type, and flange type are the same as the standard type. For details, refer to pages 191 to 195.

Construction

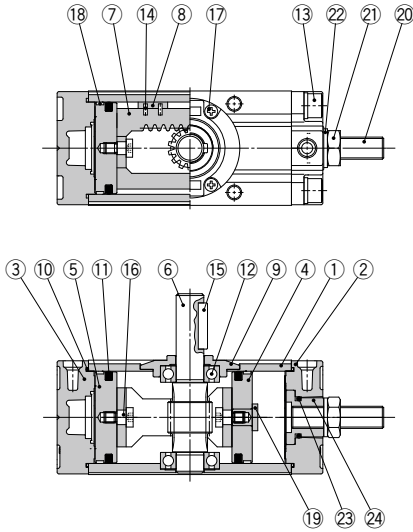

With auto switch

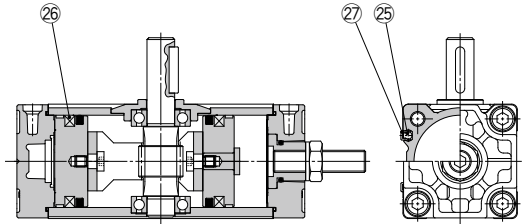

Component Parts

No.	Description	Material	Note
1	Body	Aluminum alloy	Anodized
2	Right cover	Aluminum alloy	Metallic coating
3	Left cover	Aluminum alloy	Metallic coating
4	Right piston	Aluminum alloy	
5	Left piston	Aluminum alloy	
6	Shaft	Alloy steel	
7	Rack	Carbon steel	Nitrided
8	Slider	Resin	
9	Bearing retainer	Aluminum alloy	Chromated
10	Tube gasket	NBR	
11	Piston seal	NBR	
12	Bearing	High carbon chrome bearing steel	
13	Hexagon socket head cap screw with washer	Alloy steel	Zinc chromated
14	Spring pin	Steel	Zinc chromated

No.	Description	Material	Note
15	Parallel key	Carbon steel	
16	Connecting screw	Carbon steel	Zinc chromated
17	Cross-recessed pan head tapping screw	Steel	Zinc chromated
18	Wear ring	Resin	
19	Stopper	Carbon steel	Zinc chromated
20	Hexagon socket head set screw (flat point)	Alloy steel	Zinc chromated
21	Hexagon nut	Steel	Zinc chromated
22	Seal washer	NBR	
23	O-ring	NBR	
24	Angle adjusting collar	Carbon steel	Zinc chromated
25	Auto switch	—	
26	Magnet	—	
27	Switch spacer	Resin	

Replacement Parts

Size	Part no.	Corresponding parts
50	P694020-22	⑧, ⑩, ⑪, ⑭, ⑳ are included as a set.
63	P694030-22	
80	P694040-22	
100	P694050-22	

Note) When ordering replacement parts, write "1" for one set of the parts per actuator.

A grease pack (10 g) is included.

If an additional grease pack is needed, order with the following part number. **Grease pack part number: GR-S-010** (10 g)

CRA1□□

CRA1

MSU

CRJ

CRA1

CRQ2

MSQ

MSZ

CRQ2X
MSQX

MRQ

D-□

Rotary Actuator with Solenoid Valve

CVRA1 Series

RoHS

Rack & Pinion Type/Size: 50, 63, 80, 100

How to Order

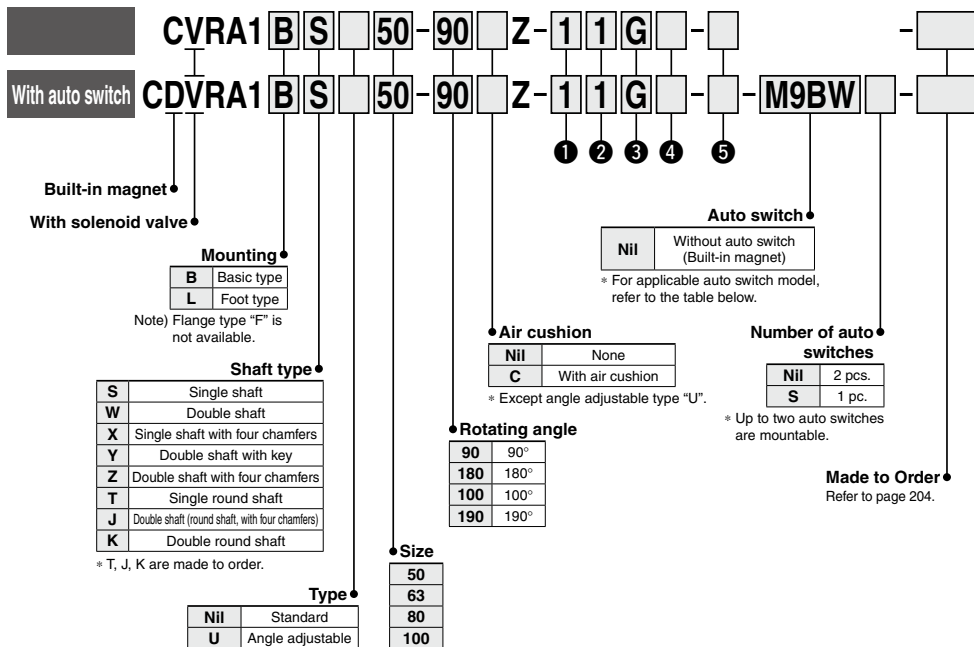

Applicable Auto Switches/Refer to pages 797 to 850 for further information on auto switches.

Type	Special function	Electrical entry	Indicator light	Wiring (Output)	Load voltage		Auto switch model		Lead wire length [m]			Pre-wired connector	Applicable load			
					DC	AC	Perpendicular	In-line	0.5 (Nil)	1 (M)	3 (L)			5 (Z)		
Solid state auto switch	—	Grommet	Yes	3-wire (NPN)	5 V, 12 V	—	M9NV	M9N	●	●	○	○	IC circuit	Relay, PLC		
				3-wire (PNP)			M9PV	M9P	●	●	○	○				
				2-wire	M9BV		M9B	●	●	○	○	—				
	Diagnosis indication (2-color indicator)			Grommet	Yes		3-wire (NPN)	5 V, 12 V	M9NWW	M9NWX	●	●	○		○	IC circuit
							3-wire (PNP)		M9PWW	M9PW	●	●	○		○	—
							2-wire	M9BWW	M9BW	●	●	○	○		—	
	Water resistant (2-color indicator)	Grommet	Yes	3-wire (NPN)	5 V, 12 V	M9NAV*1	M9NA*1	○	○	○	○	IC circuit				
				3-wire (PNP)		M9PAV*1	M9PA*1	○	○	○	○	—				
				2-wire	M9BAV*1	M9BA*1	○	○	○	○	—					
Reed auto switch	—	Grommet	Yes	3-wire (NPN equivalent)	—	5 V	—	A96V	A96	●	—	—	IC circuit	—		
				No	2-wire	24 V	12 V	100 V	A93V*2	A93	●	●	●	—	—	Relay, PLC
								100 V or less	A90V	A90	●	—	—	IC circuit	—	

* 1 Although it is possible to mount water resistant type auto switches, note that the rotary actuator itself is not of water resistant construction.

* 2 1 m type lead wire is only applicable to D-A93.

* Lead wire length symbols: 0.5 m Nil (Example) M9NW
 1 m M (Example) M9NWM
 3 m L (Example) M9NWL
 5 m Z (Example) M9NWX

* Refer to pages 837 and 838 for detailed solid state auto switches with pre-wired connectors.

* Auto switches marked with "○" are produced upon receipt of order.

* Auto switches are shipped together, (but not assembled).









1 Type of actuation

1	2 position single
2	2 position double
3	3 position closed center
4	3 position exhaust center
5	3 position pressure center

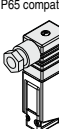
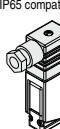
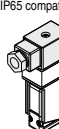
2 Rated voltage

Symbol	AC specification [50/60 Hz]	Symbol	DC specification
1	100 AC	5	24 VDC
2	200 AC	6	12 VDC
3	110 VAC [115 VAC]		
4	220 VAC [230 VAC]		
7	240 VAC		
B	24 VAC		

3 Electrical entry

Grommet	L-type plug connector	M-type plug connector	DIN terminal	DIN (EN175301-803) terminal	Conduit terminal
 G: Lead wire length 300 mm H: Lead wire length 600 mm	 L: With lead wire (length 300 mm)	 M: With lead wire (length 300 mm)	 D: With connector	 Y: With connector	 T: Conduit terminal
 G: Lead wire length 300 mm H: Lead wire length 600 mm DC Without light/surge voltage suppressor	 LN: Without lead wire	 MN: Without lead wire	 DO: Without connector	 YO: Without connector	
CE compliant	DC AC	CE	CE	CE	CE
	—	—	—	—	—

* LN and MN types are with 2 sockets.

* Refer to the Best Pneumatics No. 1-2 when different length of lead wire of plug connector is required.

* Refer to the Best Pneumatics No. 1-2 for details on the DIN (EN175301-803) terminal.

Note 1) When using IP65, select the main/pilot valve common exhaust type or pilot valve base exhaust type. (Except VF1000)

Note 2) With the same specifications as the DC type, all electrical entries for the 24 VAC type are CE marking compliant.

4 Light/Surge voltage suppressor

Symbol	Light/Surge voltage suppressor	DC	AC
Nil	Without light/surge voltage suppressor	○	○
S	With surge voltage suppressor	○	— ^(Note)
Z	With light/surge voltage suppressor	○	○
R	With surge voltage suppressor (Non-polar)	○	—
U	With light/surge voltage suppressor (Non-polar)	○	—

Note) S type is not available with AC mode, since a rectifier prevents surge voltage generation.

* In the DIN terminal type, since a light is installed in the connector, DOZ, DOU, YOZ, YOU are not available.

5 Manual override

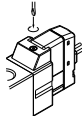
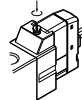
Nil: Non-locking push type	D: Push-turn locking slotted type	E: Push-turn locking lever type
		

CRB□2

CRB1

MSU

CRJ

CRA1

CRQ2

MSQ

MSZ

CRQ2X
MSQX

MRQ

D-□

CVRA1 Series

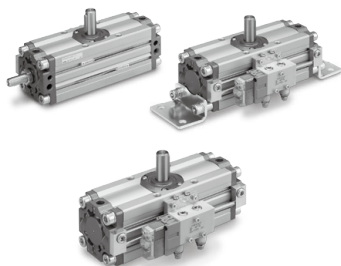

Made to Order

Made to Order

(Refer to pages 211 to 231 for details.)

Symbol	Specifications/Description	Applicable shaft type
—	Shaft type variations	S, X, Y, Z, T, J, K
XA1 to XA24	Shaft pattern sequencing I	S, W, Y
XA33 to XA46	Shaft pattern sequencing II	X, Z, T, J, K
XC7	Reversed shaft	S, W, X, T, J
XC8 to XC11	Change of rotation range	S, W, Y
XC30	Fluorine grease	S, W, X, Y, Z, T, J, K
XC31 to XC36	Change of rotation range and rotation direction of shaft	S, W, Y
XC37 to XC46	Change of rotation range and angle adjusting direction	S, W, Y
XC47 to XC58	Change of rotation range and angle adjusting direction (Angle adjusting screw is equipped on the left.)	S, W, Y
X6	Stainless steel specifications for main parts	S, W, X, Y, Z, T, J, K
X10	Both sides angle adjustable type	S, W, X, Y, Z, T, J, K
X11	One side angle adjustable, One side cushion	S, W, X, Y, Z, T, J, K

Rotation Range of Keyway Solenoid Valve Mounting Positions

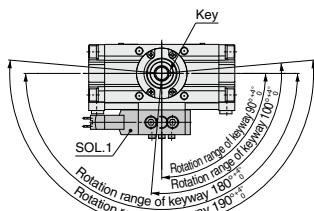

Specifications

Rotary Actuator

Type	Pneumatic			
Size	50	63	80	100
Fluid	Air (Non-lube)			
Max. operating pressure	1.0 MPa			
Min. operating pressure	0.15 MPa			
Ambient and fluid temperature	0 to 50°C (No freezing)			
Cushion	Not attached, Air cushion			
Backlash	Within 1°			
Tolerance in rotating angle	0 to +4°			
Mounting	Basic type, Foot type			

Solenoid Valve

Electrical entry	Grommet (G), (H)		DIN terminal (D)	
	L plug connector (L)		DIN (EN175301-803) terminal (Y)	
Coil rated voltage V	AC (50/60 Hz)		24, 100, 110, 200, 220, 240	
	DC		12, 24	
Allowable voltage change		-10 to +10% of the rated voltage		
Apparent power VA	AC	24 V	1.5 (With light 1.55)	1.5 (With light 1.75)
		100 V	1.55 (With light 1.65)	1.55 (With light 1.7)
		110 V [115 V]		
		200 V		
		220 V [230 V]		
240 V	1.5 (With light 1.55)	1.5 (With light 1.75)		
Power consumption W	DC	Standard	1.5 (With light 1.55)	1.5 (With light 1.75)

* In common between 110 VAC and 115 VAC, and between 220 VAC and 230 VAC.

* For 115 VAC and 230 VAC, the allowable voltage is -15% to +5% of rated voltage.

* Since voltage drops due to the internal circuit in S and Z types, the allowable voltage fluctuation should be within the following range.

24 VDC: -7% to +10% 12 VDC: -4% to +10%

Solenoid Valve Weight

Size	Type of actuation				
	Single solenoid	Double solenoid	Closed center	Exhaust center	Pressure center
50 to 100	0.4	0.5	0.6	0.6	0.6

How to calculate weight

Weight = Basic weight + Solenoid valve weight

* Refer to page 189 for basic weight.

How to Adjust the Rotation Speed

Rotation direction

When current is applied to SOL.1, the shaft rotates clockwise.

How to adjust the rotation speed:

Turn the needle valve of the metering valve clockwise to reduce the exhaust flow volume, thus slowing the rotation speed. Metering valve A regulates the clockwise rotation speed of the shaft and throttle valve B regulates the counterclockwise speed to the shaft.

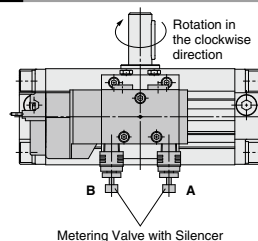

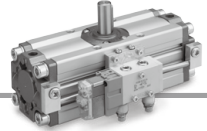

Dimensions/Basic Type: C□VRA1BS

Size: 50/63/80/100

Single shaft/C□VRA1BS

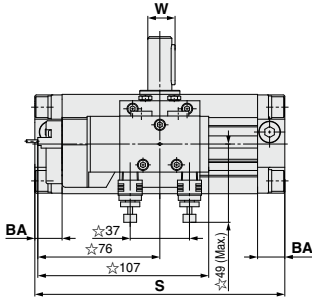
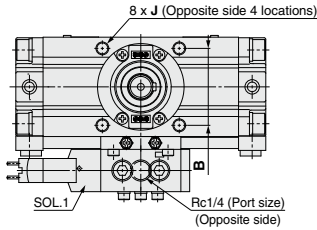
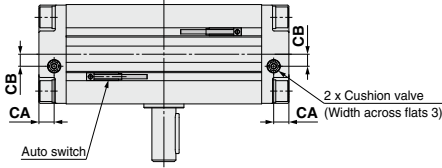

Angle adjustable type/C□VRA1BS

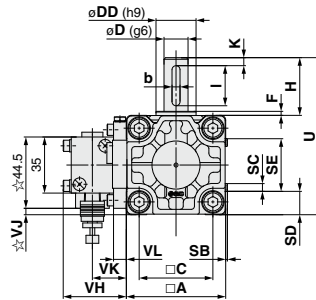
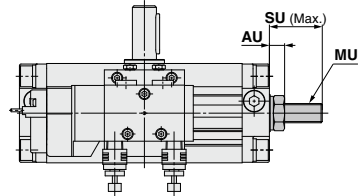
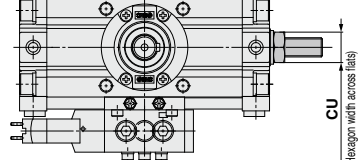

- Drawing shows the appearance for rotation of 90° and 100°.
- Drawing shows that SOL.1 is in the de-energized state.
- Drawing shows the auto switch mounted on the port side.

* () are the dimensions for rotation of 180° and 190°.
☆ mark shows the dimensions of the solenoid valve VF3120K-1G1-02-X14.

Size	A	B	C	D (g6)	DD (h9)	F	H	J	K	With auto switch					Without auto switch	U	W	BA	★ CA	★ CB	Valve dimensions				Key dimensions ⁽¹⁾⁽²⁾	
										S	SB	SC	SD	SE	S						VH	VJ	VK	VL	b	l
50	62	48	46	15	25	2.5	36	M8 x 1.25 depth 8	5	156 (189)	1.5	5	14.5	33	144 (177)	98	17	17	9.5	7.5	39.5	4	21	8	5 ⁰ _{-0.030}	25
63	76	60	57	17	30	2.5	41	M10 x 1.5 depth 12	5	175 (213.5)	1.5	5	21.5	33	163 (201.5)	117	19.5	20	11	8	39.5	11	21	8	6 ⁰ _{-0.030}	30
80	92	72	70	20	35	3	50	M12 x 1.75 depth 13	5	199 (243)	1.5	5	29.5	33	186 (230)	142	22.5	23.5	13	9	43.5	19	25	12	6 ⁰ _{-0.030}	40
100	112	85	85	25	40	4	60	M12 x 1.75 depth 14	5	259 (325)	1.5	5	39.5	33	245 (311)	172	28	25	14	10	43.5	29	25	12	8 ⁰ _{-0.036}	45

(Note) A parallel key is included in the same package, (but not assembled).

★ For model with air cushion

Angle adjustable

Size	AU	CU	SU	MU
50	9.5	19	33	M12 x 1.75
63	10.5	22	35.5	M14 x 2
80	12.5	24	44	M16 x 2
100	14.5	30	56	M20 x 2.5

The dimensions of the shaft (W: Double shaft, X: Single shaft with four chamfers, Y: Double shaft with key, Z: Double shaft with four chamfers, T: Single round shaft, J: Double shaft (round shaft, with four chamfers, K: Double round shaft), foot type, and flange type are the same as the standard type. For details, refer to pages 191 to 195.

- CRB□2
- CRB1
- MSU
- CRJ
- CRA1**
- CRQ2
- MSQ
- MSZ
- CRQ2X
- MSQX
- MRQ

D-□

CVRA1 Series

Construction/With Solenoid Valve

Without air cushion

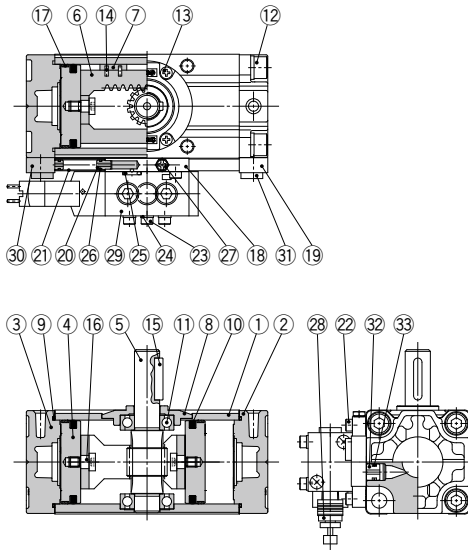

With air cushion

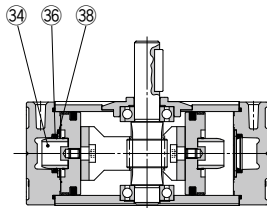

Without air cushion With auto switch

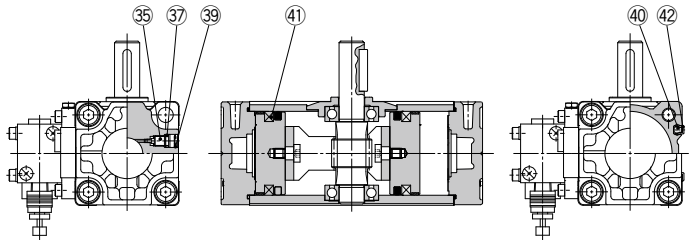

Component Parts

No.	Description	Material	Note
1	Body	Aluminum alloy	Anodized
2	Right cover	Aluminum alloy	Metallic coating
3	Left cover	Aluminum alloy	Metallic coating
4	Piston	Aluminum alloy	
5	Shaft	Alloy steel	
6	Rack	Carbon steel	Nitrided
7	Slider	Resin	
8	Bearing retainer	Aluminum alloy	Chromated
9	Tube gasket	NBR	
10	Piston seal	NBR	
11	Bearing	High carbon chrome bearing steel	
12	Hexagon socket head cap screw with washer	Alloy steel	Zinc chromated
13	Cross-recessed pan head lapping screw	Steel	Zinc chromated
14	Spring pin	Steel	Zinc chromated
15	Parallel key	Carbon steel	
16	Connecting screw	Carbon steel	Zinc chromated

Component Parts

No.	Description	Material	Note
17	Wear ring	Resin	
18	Sub-plate	Aluminum alloy	Chromated
19	Sub-plate (Right cover side)	Aluminum alloy	Chromated
20	Guide tube fitting	Aluminum alloy	Chromated
21	Pipe	Stainless steel	
22	Hexagon socket head cap screw	Alloy steel	Zinc chromated
23	Hexagon socket head cap screw	Alloy steel	Zinc chromated
24	Spring washer	Alloy steel	Zinc chromated
25	O-ring	NBR	
26	O-ring	NBR	
27	M5 plug	—	
28	Metering valve with silencer	—	ASN2-□
29	Solenoid valve	—	
30	Sub-plate (Left cover side)	Aluminum alloy	Chromated
31	Hexagon socket head cap screw	Alloy steel	Zinc chromated
32	Guide tube fitting (Cover side)	Aluminum alloy	Chromated

Construction/Angle Adjustable Type

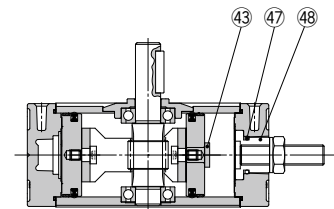
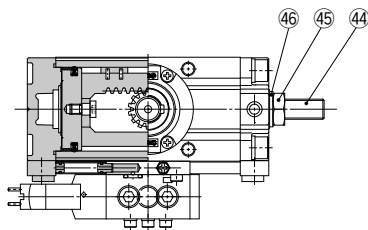

CRB□2

CRB1

MSU

CRJ

CRA1

CRQ2

MSQ

MSZ

CRQ2X
MSQX

MRQ

Component Parts

No.	Description	Material	Note
33	O-ring	NBR	
34	Cushion ring	Aluminum alloy	Anodized
35	Cushion valve	Steel	Zinc chromated
36	Cushion seal	Urethane	
37	O-ring	NBR	
38	Seal retainer	Steel	
39	Retaining ring	Steel	
40	Auto switch	—	
41	Magnet	—	
42	Switch spacer	Resin	
43	Stopper	Carbon steel	Zinc chromated
44	Hexagon socket head set screw (flat point)	Alloy steel	Zinc chromated
45	Hexagon nut	Steel	Zinc chromated
46	Seal washer	NBR	
47	O-ring	NBR	
48	Angle adjusting collar	Carbon steel	Zinc chromated

Replacement Parts

Size	Part no.		
	Without air cushion	With air cushion	Angle adjustable type
50	P694020-49	P694020-50	P694020-51
63	P694030-49	P694030-50	P694030-51
80	P694040-49	P694040-50	P694040-51
100	P694050-49	P694050-50	P694050-51
Corresponding parts	⑦, ⑨, ⑩, ⑭, ⑳, ㉔, ㉓ are included as a set.	⑦, ⑨, ⑩, ⑭, ⑳, ㉔, ㉓, ㉖ are included as a set.	⑦, ⑨, ⑩, ⑭, ⑳, ㉔, ㉓, ㉖ are included as a set.

Note) When ordering replacement parts, write "1" for one set of the parts per actuator.

A grease pack (10 g) is included.

If an additional grease pack is needed, order with the following part number.

Grease pack part number: GR-S-010 (10 g)

D-□

CRA1 Series Auto Switch Mounting

Auto Switch Proper Mounting Position at Rotation End

Size: 30

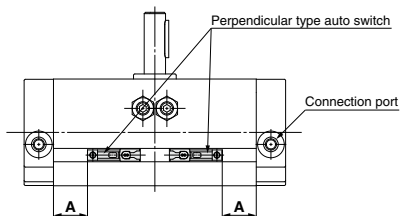
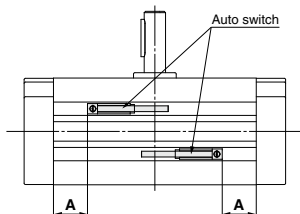

For size 30, only the perpendicular type auto switch can be mounted since two auto switches are mounted in the same switch groove when mounting the switch on the connection port side.

Size: 50 to 100

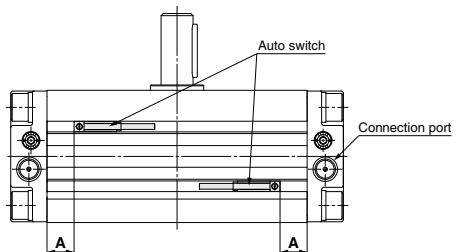

* For models with the solenoid valve, the auto switch can be mounted only on the rear side (opposite to the solenoid valve).

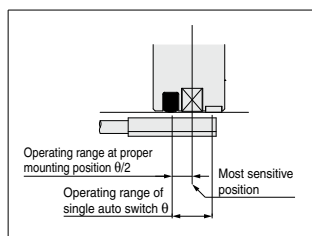

Size	Rotating angle	D-M9□/M9□V D-M9□W/M9□WV D-M9□A/M9□AV		D-A9□/A9□V	
		Proper mounting position A [mm]	Operating range θ [°]	Proper mounting position A [mm]	Operating range θ [°]
30	90	13	42°	9	81°
	180	22		18	
50	90	22.5	30°	18.5	44°
	180	39		35	
63	90	25	28°	21	49°
	180	44.5		40.5	
80	90	27.5	23°	23.5	41°
	180	49.5		45.5	
100	90	42.5	15°	38.5	29°
	180	75.5		71.5	

* Values which include hysteresis are for guideline purposes only, they are not a guarantee (assuming approximately $\pm 30\%$ dispersion) and may change substantially depending on the ambient environment. Adjust the auto switch after confirming the operating conditions in the actual setting.

Switch Spacer/Part No.

Size	30	50	63	80	100
Switch spacer part no.	BMY3-016				

* The above part number includes one switch spacer.

* Two switch spacers are included with the product with built-in magnet.

Auto Switch Mounting

To fix the auto switch, hold the switch spacer, and insert into the groove. Make sure that the switch spacer is in the right position or correct the position if necessary, then slide the auto switch in the groove so that it goes into the spacer. Confirm where the mounting position is, and tighten the auto switch mounting screw using a flat head screwdriver.

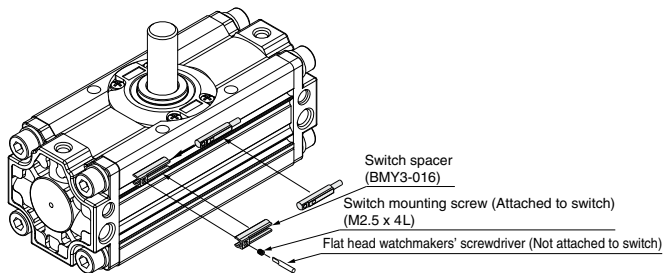

Note) When tightening an auto switch mounting screw, use a watchmakers' screwdriver with a handle of approximately 5 to 6 mm in diameter.

Also, tighten with a torque of about 0.1 to 0.15 N·m.

As a guide, turn about 90° past the point at which tightening can first be felt.

Auto Switch Working Principle

[Pressure is applied from the B port.]

The auto switch B is turned ON by the magnet B in the state that the pressure is applied from the B port and the piston B moves to the left side. At this time, the auto switch A turns OFF.

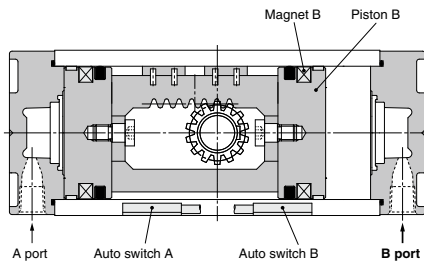

[Pressure is applied from the A port.]

When the pressure is applied from the A port, the piston A moves to the right side and the shaft rotates clockwise. The auto switch B turns OFF and the auto switch A is turned ON by the magnet A at the rotation end.

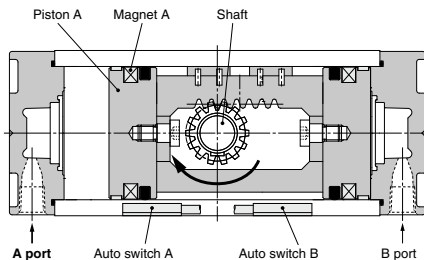

CRB□2

CRB1

MSU

CRJ

CRA1

CRQ2

MSQ

MSZ

CRQ2X

MSQX

MRQ

D-□

CONTENTS

Rotary Actuator *CRA1 Series*

Simple Specials/Made to Order

Simple specials

Shaft pattern sequencing I	-XA1 to -XA24	Page 212
Shaft pattern sequencing II	-XA33 to -XA59	Page 216

Made to Order

How to Order		Page 221
① Reversed shaft	-XC7	Page 222
② Change of rotation range	-XC8 to -XC11	Page 222
③ Changed to fluorine grease	-XC30	Page 222
④ Change of rotation range and shaft rotation direction	-XC31 to XC36	Page 223
⑤ Change of rotation range and angle adjusting direction	-XC37 to XC42	Page 224
⑥ Change of rotation range and angle adjusting direction	-XC43 to XC46	Page 225
⑦ Change of rotation range and angle adjusting direction (Angle adjusting screw is equipped on the left.)	-XC47 to XC52	Page 226
⑧ Change of rotation range and angle adjusting direction (Angle adjusting screw is equipped on the left.)	-XC53 to XC58	Page 227
⑨ Change of port location (Mounting location of the cover is changed.)	-XC59 to XC61	Page 228
⑩ One side air-hydro, One side air	-XC63, -XC64	Page 228
⑪ Stainless steel shaft/Bolt/Parallel key	-X6	Page 229
⑫ Heat resistant	-X7	Page 229
⑬ Both sides angle adjustable	-X10	Page 229
⑭ One side angle adjustable, One side with cushion	-X11	Page 230
⑮ Fluororubber seal	-X16	Page 230
Made to Order/-X6 to -X16		Page 231

CRB□2

CRB1

MSU

CRJ

CRA1

CRQ2

MSQ

MSZ

CRQ2X
MSQX

MRQ

D-□

CRA1 Series Simple Specials

Shaft shape pattern is dealt with simple made-to-order system. A specification sheet is available for ordering. Please access SMC website, or consult your nearest sales branch.



Symbol

Shaft Pattern Sequencing I

-XA1 to -XA24

Applicable shaft type: S, W, Y

How to Order

C D RA1 B S 50 - 90 Z- M9BW -X A1 A2 C8 C59

• Magnet

Nil	None
D	Built-in magnet

• Solenoid valve

Nil	None
V*	With solenoid valve

* Except size 30, air-hydro type

• Mounting

B	Basic type
L	Foot type

• Shaft type

S	Single shaft
W	Double shaft
Y	Double shaft with key

• Variation

Nil	Without angle adjustment
U*	Angle adjustable type
H*	Air-hydro type

* Except size 30

• Size

30
50
63
80
100

• Port type

Port type	Size					
	30	50	63	80	100	
Nil	M thread	M5	—	—	—	—
	Rc	—	—	—	—	—
TF	G	—	—	—	—	—
TN	NPT	—	1/8	1/8	1/4	3/8
TT	NPTF	—	—	—	—	—

• Number of auto switches

Nil	2 pcs.
S	1 pc.

• Auto switch

Nil	Without auto switch (Built-in magnet)
-----	---------------------------------------

* For applicable auto switch model, refer to page 188.

* Auto switches are shipped together, (but not assembled).

• Model with solenoid valve

* Refer to page 202 for model number with solenoid valve.

• Cushion

Nil	Without air cushion
C*	With air cushion

* Except angle adjustable type, air-hydro type

• Rotating angle

90	90°
180	180°
100*	100°
190*	190°

* Except size 30

• Symbol for simple specials, made-to-order products

* Combination of XA is possible for up to 2 types.

• Combination 3 types

A 1	A24	C59
A13	C 8	C59

• Combination of applicable chart

Chart 1, 2
Chart 2, 7

Combination is available only when all the conditions are fulfilled in the combination chart.

• Combination 4 types

A 1	A 2	C 8	C59
A 2	A24	C10	C60

• Combination of applicable chart

Chart 1, 2, 7
Chart 1, 2, 7

Combination is available only when all the conditions are fulfilled in the combination chart.

* Combination of simple special and made-to-order is possible for up to 4 types.

* Above is the typical example of combination.

Symbol

Shaft Pattern Sequencing I

-XA1 to -XA24

Applicable shaft type: S, W, Y

Combination Chart of Simple Specials for Shaft Shape

Chart 1. Combination between -XA□ and -XA□ (S, W, Y shaft)

Symbol	Description	Axial direction		Applicable shaft type			Combination			
		Top	Bottom	S	W	Y	-XA1	-XA2	-XA13	-XA24
-XA1	Shaft-end female thread	●	—	●	●	●	—	—	—	●
-XA2	Shaft-end female thread	—	●	●	●	●	●	—	—	●
-XA13	Shaft through-hole	●	●	●	●	●	—	—	—	●
-XA14	Shaft through-hole + Shaft-end female thread	●	—	●	●	●	—	—	—	●
-XA15	Shaft through-hole + Shaft-end female thread	—	●	●	●	●	—	—	—	●
-XA16	Shaft through-hole + Double shaft-end female thread	●	●	●	●	●	—	—	—	●
-XA17	Shorted shaft (Long shaft with key)	●	—	●	●	●	—	●	●	—
-XA18	Shorted shaft (Short shaft and with four sided chamfer)	—	●	—	●	●	W, Y*	—	W, Y*	—
-XA19	Shorted shaft (Double shaft)	●	●	—	●	●	—	—	W, Y*	—
-XA20	Reverse shaft, Shorted shaft	●	●	—	●	●	—	—	S, W*	—
-XA24	Double key	●	—	●	●	●	—	—	—	—

* Corresponding shafts type available for combination

Combination Chart of Made to Order

Chart 2. Combination between -XA□ and -XC□

Symbol	Description	Applicable shaft type			Applicable size	Combination	
		S	W	Y		-XA1, 2, 13 to 19	-XA20, 24
-XC7	Reversed shaft	●	●	—	50, 63, 80, 100	—	—
-XC8 to -XC11	Change of rotation range	●	●	●	30 to 100	●	—
-XC30	Changed to fluorine grease	●	●	●		●	●
-XC31 to -XC36	Change of rotation range and shaft rotation direction	●	●	●	50, 63, 80, 100	●	—
-XC37 to -XC46	Change of rotation range and angle adjusting direction	●	●	●		●	—
-XC47 to -XC58	Change of rotation range and angle adjusting direction (Angle adjusting screw is equipped on the left.)	●	●	●		●	—
-XC59 to -XC61	Change of port location	●	●	●	30 to 100	●	●
-XC63	One side air-hydro, One side air	●	●	●	50, 63, 80, 100	●	●
-XC64	One side air-hydro, One side air	●	●	●	50, 63, 80, 100	●	●

- * -XC8 to -XC11 and -XC31 to -XC36 do not include the angle adjustable type.
- * -XC37 to -XC46 and -XC47 to -XC58 are only the angle adjustable type.
- * -XC59 to -XC61 do not include the model with solenoid valve.
- * -XC63 and -XC64 are only the air-hydro type.

Chart 3. Combination between -X□ and -XA□

Symbol	Description	Applicable shaft type			Applicable size	Combination	
		S	W	X		-XA1, 2, 13 to 19	-XA20, 24
-X6	Stainless steel shaft/bolt, etc.	●	●	●	30 to 100	●	●
-X7	Heat resistant (100°C)	●	●	●		●	●
-X10	Both sides angle adjustable	●	●	●	50 to 100	●	●
-X11	One side angle adjustable, One side with cushion	●	●	●		●	●
-X16	Fluororubber seal	●	●	●	30 to 100	●	●

- * -X10 and -X11 are only the angle adjustable type.
- * -X7 and -X16 do not include the model with solenoid valve.

CRB□2
CRB1
MSU
CRJ
CRA1
CRQ2
MSQ
MSZ
CRQ2X
MSQX
MRQ

D-□

Shaft Pattern Sequencing I

Applicable shaft type: S, W, Y

Additional Reminders

1. Enter the dimensions within a range that allows for additional machining.
2. Unless indicated otherwise, the dimensional tolerance conforms to the general tolerance. SMC will make appropriate arrangements.
3. The length of the unthreaded portion is 2 to 3 pitches.
4. Unless specified otherwise, the thread pitch is based on coarse metric threads.
P = Thread pitch
M4 x 0.7, M5 x 0.8, M6 x 1,
M8 x 1.25, M10 x 1.5
5. Enter the desired figures in the portion of the diagram.
6. Chamfer face of the parts machining additionally is C0.5.

Symbol: A2 Machine female threads into the short shaft. Note) Except flange type

The maximum dimension L2 is, as a rule, twice the thread size. (Example) For M4: L2 = 8
· Applicable shaft types: S, W, Y

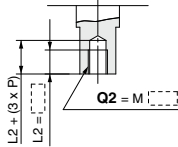

Size	Q2
30	M3, M4
50	M4, M5, M6
63	M4, M5, M6
80	M4, M5, M6, M8
100	M5, M6, M8, M10

Symbol: A15 Note) Except flange type

A special end is machined onto the short shaft, and a through-hole is drilled into it. Female threads are machined into the through-hole, whose diameter is equivalent to the pilot hole diameter. The maximum dimension L2 is, as a rule, twice the thread size. (Example) For M5: L2 = 10
· Applicable shaft types: S, W, Y

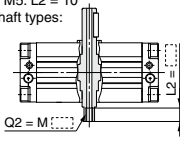

Thread	Size	30	50	63	80	100
M3 x 0.5	ø2.5	—	—	—	—	—
M5 x 0.8	—	ø4	ø4	—	—	—
M6 x 1	—	ø5	ø5	—	—	—
M8 x 1.25	—	—	—	ø6.8	ø 6.8	ø 6.8
M10 x 1.5	—	—	—	ø 8.5	ø 8.5	—
M12 x 1.75	—	—	—	ø10.3	ø10.3	—
Rc1/8	—	—	—	ø 8	ø 8	—
Rc1/4	—	—	—	—	ø11	—

Symbol: A13 Shaft through-hole Note) Except flange type

Minimum machining diameter for d1 is 0.1.
· Applicable shaft types: S, W, Y

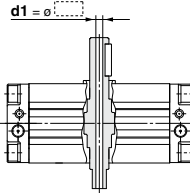

Size	d1
30	ø2.5
50	ø4 to ø 7
63	ø4 to ø 8
80	ø6.8 to ø11
100	ø6.8 to ø11

Symbol: A16 Note) Except flange type

A special end is machined onto both the long and short shafts, and a through-hole is drilled into both shafts. Female threads are machined into the through-holes, whose diameter is equivalent to the diameter of the pilot holes. The maximum dimension L1 is, as a rule, twice the thread size. (Example) For M5: L1 = 10
· Applicable shaft types: S, W, Y
· Equal dimensions are indicated by the same marker.

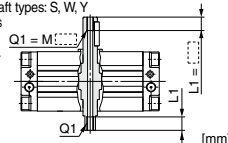

Thread	Size	30	50	63	80	100
M3 x 0.5	ø2.5	—	—	—	—	—
M5 x 0.8	—	ø4	ø4	—	—	—
M6 x 1	—	ø5	ø5	—	—	—
M8 x 1.25	—	—	—	ø6.8	ø 6.8	ø 6.8
M10 x 1.5	—	—	—	ø 8.5	ø 8.5	—
M12 x 1.75	—	—	—	ø10.3	ø10.3	—
Rc1/8	—	—	—	ø 8	ø 8	—
Rc1/4	—	—	—	—	ø11	—

Symbol: A1 Machine female threads into the long shaft. Note) Except flange type

The maximum dimension L1 is, as a rule, twice the thread size. (Example) For M4: L1 = 8
· Applicable shaft types: S, W, Y

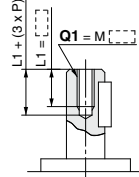

Size	Q1
30	M3
50	M4, M5, M6
63	M4, M5, M6
80	M4, M5, M6, M8
100	M5, M6, M8, M10

Symbol: A14 Note) Except flange type

A special end is machined onto the long shaft, and a through-hole is drilled into it. Female threads are machined into the through-hole, whose diameter is equivalent to the pilot hole diameter. The maximum dimension L1 is, as a rule, twice the thread size. (Example) For M5: L1 = 10
· Applicable shaft types: S, W, Y

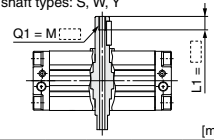

Thread	Size	30	50	63	80	100
M3 x 0.5	ø2.5	—	—	—	—	—
M5 x 0.8	—	ø4	ø4	—	—	—
M6 x 1	—	ø5	ø5	—	—	—
M8 x 1.25	—	—	—	ø6.8	ø 6.8	ø 6.8
M10 x 1.5	—	—	—	ø 8.5	ø 8.5	—
M12 x 1.75	—	—	—	ø10.3	ø10.3	—
Rc1/8	—	—	—	ø 8	ø 8	—
Rc1/4	—	—	—	—	ø11	—

Symbol: A17 Note) Except flange type

Shorten the long shaft.
· Applicable shaft types: S, W, Y

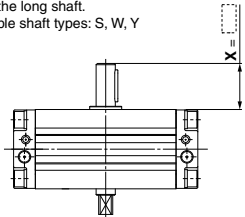

Size	X
30	15 to 25
50	18.5 to 36
63	21 to 41
80	25 to 50
100	32.5 to 60

Symbol

-XA18 to -XA24

Shaft Pattern Sequencing I

Applicable shaft type: S, W, Y

Symbol: A18 (Note) Except flange type

Shorten the short shaft.
 · Applicable shaft types: W, Y

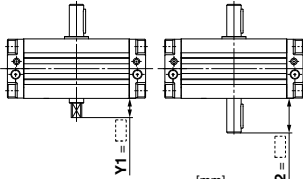

Size	Y1		Y2	
	W	Y	W	Y
30	3 to 8	15 to 25		
50	1 to 20	18.5 to 36		
63	1 to 22	21 to 41		
80	1 to 25	25 to 50		
100	1 to 30	32.5 to 60		

Symbol: A19 (Note) Except flange type

Both the long shaft and short shaft are shortened.
 · Applicable shaft types: W, Y

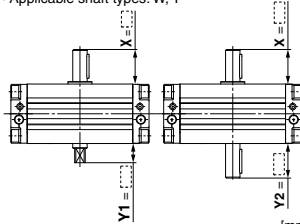

Size	X		Y1		Y2	
	W	Y	W	Y	W	Y
30	15 to 25	3 to 8	15 to 25			
50	18.5 to 36	1 to 20	18.5 to 36			
63	21 to 41	1 to 22	21 to 41			
80	25 to 50	1 to 25	25 to 50			
100	32.5 to 60	1 to 30	32.5 to 60			

Symbol: A20 (Note) Except flange type

Reverse the assembly of the shaft. (Thus shortening the long end and the short end of the shaft.)
 (If shortening the shaft is not required, indicate "∞" for dimension X and Y.)
 · Applicable shaft types: S, W

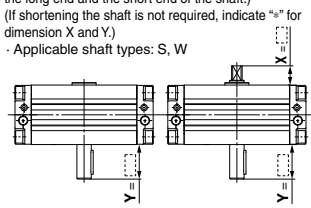

Size	X		Y	
	W	S	W	Y
50	2 to 11	18.5 to 36		
63	2.5 to 16.5	21 to 41		
80	3 to 20	25 to 50		
100	3 to 22	32.5 to 60		

Symbol: A24

Double key
 Keys and keyways are machined additionally at 180° from the standard position.

· Applicable shaft types: S, W, Y

· Equal dimensions are indicated by the same marker.

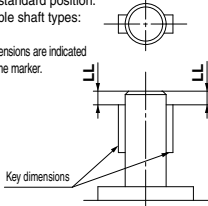

Size	Key dimensions	LL
30	3 x 3 x 14	3
50	5 x 5 x 25	5
63	6 x 6 x 30	5
80	6 x 6 x 40	5
100	8 x 7 x 45	5

- CRB□2
- CRB1
- MSU
- CRJ
- CRA1
- CRQ2
- MSQ
- MSZ
- CRQ2X
- MSQX
- MRQ

D-□

Shaft Pattern Sequencing II

-XA33 to -XA59

Applicable shaft type: X, Z, T, J, K

How to Order

C **D** **RA1** **B** **J** **50** **90** **Z** **M9BW** **X** **A33** **A34** **C8** **C30**

• **Magnet**

Nil	None
D	Built-in magnet

• **Solenoid valve**

Nil	None
V*	With solenoid valve

* Except size 30, air-hydro type

• **Mounting**

B	Basic type
L	Foot type

• **Shaft type**

X	Single shaft with four chamfers
Z	Double shaft with four chamfers
T	Single round shaft
J	Double shaft (round shaft, with four chamfers)
K	Double round shaft

• **Variation**

Nil	Without angle adjustment
U*	Angle adjustable type
H*	Air-hydro type

* Except size 30

• **Size**

30
50
63
80
100

• **Port type**

Size	30	50	63	80	100
Nil	M thread	M5	—	—	—
	Rc	—	—	—	—
TF	G	—	—	—	—
TN	NPT	1/8	1/8	1/4	3/8
TT	NPTF	—	—	—	—

• **Number of auto switches**

Nil	2 pcs.
S	1 pc.

• **Auto switch**

Nil	Without auto switch (Built-in magnet)
-----	---------------------------------------

* For applicable auto switch model, refer to page 188.
* Auto switches are shipped together, (but not assembled).

• **Model with solenoid valve**

* Refer to page 202 for model number with solenoid valve.

• **Cushion**

Nil	Without air cushion
C*	With air cushion

* Except angle adjustable type, air-hydro type

• **Rotating angle**

90	90°
180	180°
100*	100°
190*	190°

* Except size 30

• **Symbol for simple specials, made-to-order products**

* Combination of XA is possible for up to 2 types.

• **Combination 3 types**

A33	A34	C30
A35	C	9 C59

→ Chart 4, 5
→ Chart 5, 7

Combination is available only when all the conditions are fulfilled in the combination chart.

• **Combination 4 types**

A33	A34	C30	C59
A45	A46	C30	C61

→ Chart 4, 5, 7
→ Chart 4, 5, 7

Combination is available only when all the conditions are fulfilled in the combination chart.

* Combination of simple special and made-to-order is possible for up to 4 types.
* Above is the typical example of combination.

Symbol

-XA33 to -XA59

Shaft Pattern Sequencing II

Applicable shaft type: X, Z, T, J, K

Combination Chart of Simple Specials for Shaft Shape

Chart 4. Combination between -XA□ and -XA□

Symbol	Description	Axial direction		Applicable shaft type						Combination						
		Top	Bottom	X	Z	T	J	K	* Corresponding shafts type available for combination							
-XA33	Shaft-end female thread	●	—	—	—	●	●	●	-XA33							
-XA34	Shaft-end female thread	—	●	—	—	●	●	●	T, J, K*	-XA34						
-XA35	Shaft-end female thread	●	—	●	—	—	—	—	—	-XA35						
-XA36	Shaft-end female thread	—	●	●	—	—	—	—	X, Z*	-XA36						
-XA37	Stepped round shaft	●	—	—	—	●	●	●	T, J, K*	—	-XA37					
-XA38	Stepped round shaft	—	●	—	—	—	—	●	K*	—	—	K*				
-XA40	Shaft through-hole	●	●	—	—	●	—	●	—	—	—	—				
-XA41	Shaft through-hole	●	●	●	—	●	—	—	—	—	—	—				
-XA43	Shaft through-hole + Double shaft-end female thread	●	●	—	—	●	—	●	—	—	—	—				
-XA44	Shaft through-hole + Double shaft-end female thread	●	●	●	—	●	—	—	—	—	—	—	-XA38			
-XA45	Middle-cut chamfer	●	—	—	—	●	●	●	T, J, K*	—	K*	-XA40	-XA41	-XA45		
-XA46	Middle-cut chamfer	—	●	—	—	—	—	●	K*	—	K*	—	—	K*	-XA46	
-XA51	Change of long shaft length (Without keyway)	●	—	—	—	●	●	●	T, J, K*	—	—	K*	T, K*	J*	—	K*
-XA52	Change of short shaft length (Without keyway)	—	●	—	—	—	—	●	K*	—	—	—	K*	—	K*	—
-XA53	Change of double shaft length (Both without keyway)	●	—	—	—	—	—	●	—	—	—	—	K*	—	—	—
-XA54	Change of long shaft length (With four chamfers)	●	—	●	—	—	—	—	—	X, Z*	—	—	—	X, Z*	—	—
-XA55	Change of short shaft length (With four chamfers)	—	●	—	—	—	—	—	J*	—	Z*	—	J*	—	J, Z*	J*
-XA56	Change of double shaft length (Both with four chamfers)	●	—	●	—	—	—	—	—	—	—	—	—	Z*	—	—
-XA57	Change of double shaft length (Without keyway, With four chamfers)	●	●	—	—	—	—	—	—	—	—	—	—	J*	—	—
-XA58	Reversed shaft, Change of shaft length (With four chamfers, Without keyway)	●	●	—	—	●	—	—	—	—	—	—	T*	J*	—	—
-XA59	Reversed shaft, Change of shaft length (With four chamfers)	—	●	●	—	—	—	—	—	—	—	—	—	X*	—	—

Combination Chart of Made to Order

Chart 5. Combination between -XA□ and -XC□

Symbol	Description	Applicable shaft type					Applicable size	Combination
		X	Z	T	J	K		-XA33 to 38, 40 to 46, 51 to 59
-XC7	Reversed shaft	●	—	●	●	—	50, 63, 80, 100	—
-XC8 to -XC11	Change of rotation range	—	—	—	—	—	50, 63, 80, 100	—
-XC30	Changed to fluorine grease	●	●	●	●	●	30 to 100	●
-XC31 to -XC36	Change of rotation range and shaft rotation direction	—	—	—	—	—	—	—
-XC37 to -XC46	Change of rotation range and angle adjusting direction	—	—	—	—	—	50, 63, 80, 100	—
-XC47 to -XC58	Change of rotation range and angle adjusting direction (Angle adjusting screw is equipped on the left.)	—	—	—	—	—	—	—
-XC59 to -XC61	Change of port location	●	●	●	●	●	30 to 100	●
-XC63	One side air-hydro, One side air	●	●	●	●	●	50, 63, 80, 100	●
-XC64	One side air-hydro, One side air	●	●	●	●	●	80, 100	●

- * -XC8 to -XC11 and -XC31 to -XC36 do not include the angle adjustable type.
- * -XC37 to -XC46 and -XC47 to -XC58 are only the angle adjustable type.
- * -XC59 to -XC61 do not include the model with solenoid valve.
- * -XC63 and -XC64 are only the air-hydro type.

Chart 6. Combination between -X□ and -XA□

Symbol	Description	Applicable shaft type					Applicable size	Combination
		X	Z	T	J	K		-XA33 to 38, 40 to 46, 51 to 59
-X6	Stainless steel shaft/bolt, etc.	●	●	●	●	●	30 to 100	●
-X7	Heat resistant (100°C)	●	●	●	●	●	—	—
-X10	Both sides angle adjustable	●	●	●	●	●	50 to 100	●
-X11	One side angle adjustable, One side with cushion	●	●	●	●	●	—	—
-X16	Fluororubber seal	●	●	●	●	●	30 to 100	●

- * -X10 and -X11 are only the angle adjustable type.
- * -X7 and -X16 do not include the model with solenoid valve.

CRB□2

CRB1

MSU

CRJ

CRA1

CRQ2

MSQ

MSZ

CRQ2X

MSQX

MRQ

D-□

Shaft Pattern Sequencing II

Applicable shaft type: X, Z, T, J, K

Additional Reminders

1. Enter the dimensions within a range that allows for additional machining.
2. Unless indicated otherwise, the dimensional tolerance conforms to the general tolerance. SMC will make appropriate arrangements.
3. The length of the unthreaded portion is 2 to 3 pitches.
4. Unless specified otherwise, the thread pitch is based on coarse metric threads.
P = Thread pitch
M4 x 0.7, M5 x 0.8
M6 x 1, M8 x 1.25, M10 x 1.5
5. Enter the desired figures in the portion of the diagram.
6. Chamfer face of the parts machining additionally is C0.5.

Symbol: A33 Machine female threads into the long shaft. Note) Except flange type

The maximum dimension L1 is, as a rule, twice the thread size. (Example) For M4: L1 = 8
·Applicable shaft types: J, K, T

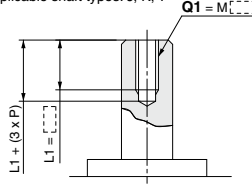

Size	Q1
30	M3
50	M4, M5, M6, M8
63	M4, M5, M6, M8, M10
80	M4, M5, M6, M8, M10, M12
100	M5, M6, M8, M10, M12

Symbol: A34 Machine female threads into the short shaft. Note) Except flange type

The maximum dimension L2 is, as a rule, twice the thread size. (Example) For M4: L2 = 8
·Applicable shaft types: J, K, T

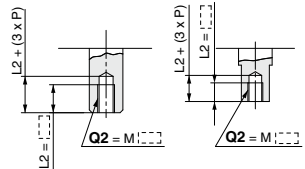

Size	Q2
30	M3
50	M4, M5, M6, M8
63	M4, M5, M6, M8, M10
80	M4, M5, M6, M8, M10, M12
100	M5, M6, M8, M10, M12

Symbol: A35 Machine female threads into the long shaft. Note) Except flange type

The maximum dimension L1 is, as a rule, twice the thread size. (Example) For M4: L1 = 8
·Applicable shaft types: X, Z

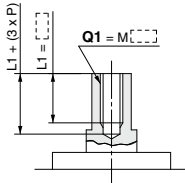

Size	Q1
30	M3
50	M4, M5, M6, M8
63	M4, M5, M6, M8, M10
80	M4, M5, M6, M8, M10, M12
100	M5, M6, M8, M10, M12

Symbol: A36 Machine female threads into the short shaft. Note) Except flange type

The maximum dimension L2 is, as a rule, twice the thread size. (Example) For M4: L2 = 8
·Applicable shaft types: X, Z

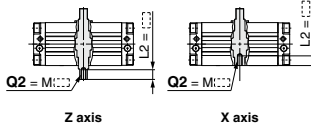

Size	Q2
30	M3
50	M4, M5, M6, M8
63	M4, M5, M6, M8, M10
80	M4, M5, M6, M8, M10, M12
100	M5, M6, M8, M10, M12

Symbol: A37 Note) Except flange type

The long shaft can be further shortened by machining it into a stepped round shaft.
·The minimum unit of the dimensions within a range that allows for machining is 0.1.
(If shortening the shaft is not required, indicate "0" for dimension X.)
(If not specifying dimension C1, indicate "0" instead.)
·Applicable shaft types: J, K, T
·Equal dimensions are indicated by the same marker.

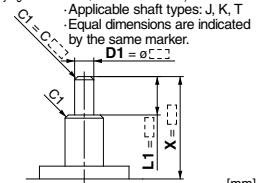

Size	X	L1max	D1
30	3 to 25	X-2	ø5 to ø 7.9
50	3.5 to 36	X-2.5	ø5 to ø14.9
63	3.5 to 41	X-2.5	ø5 to ø16.9
80	4 to 50	X-3	ø8 to ø19.9
100	5 to 60	X-4	ø8 to ø24.9

Symbol: A38 Note) Except flange type

The short shaft can be further shortened by machining it into a stepped round shaft.
·The minimum unit of the dimensions within a range that allows for machining is 0.1.
(If shortening the shaft is not required, indicate "0" for dimension Y.)
(If not specifying dimension C2, indicate "0" instead.)
·Applicable shaft type: K
·Equal dimensions are indicated by the same marker.

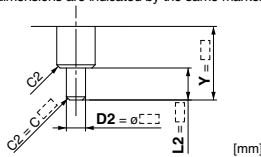

Size	Y	L2max	D2
30	3 to 25	Y-2	ø5 to ø 7.9
50	1 to 36	Y	ø5 to ø14.9
63	1 to 41	Y	ø5 to ø16.9
80	1 to 50	Y	ø8 to ø19.9
100	1 to 60	Y	ø8 to ø24.9

Symbol: A40 Shaft through-hole Note) Except flange type

·Minimum machining diameter for d1 is 0.1.
·Applicable shaft types: K, T

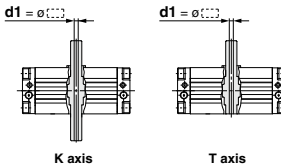

Size	d1
30	ø2.5
50	ø4 to ø 7.5
63	ø4 to ø 8
80	ø6.8 to ø11
100	ø6.8 to ø13

Symbol: A41 Shaft through-hole Note) Except flange type

·Minimum machining diameter for d1 is 0.1.
·Applicable shaft types: J, X, Z

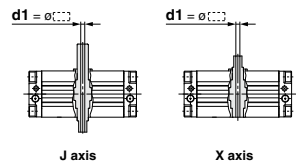

Size	d1
30	ø2.5
50	ø4 to ø 7.5
63	ø4 to ø 8
80	ø6.8 to ø11
100	ø6.8 to ø13

Symbol

-XA43 to -XA55

Shaft Pattern Sequencing II

Applicable shaft type: X, Z, T, J, K

Symbol: A43 (Note) Except flange type
Shaft through-hole and female thread

· Applicable shaft types: K, T
· Equal dimensions are indicated by the same marker.

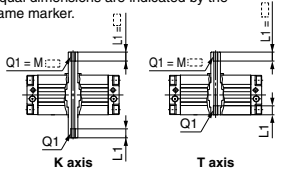

Thread	Size	30	50	63	80	100
M3 x 0.5	ø2.5	—	—	—	—	—
M5 x 0.8	—	ø4	ø4	—	—	—
M6 x 1	—	ø5	ø5	—	—	—
M8 x 1.25	—	—	ø6.8	ø 6.8	ø 6.8	—
M10 x 1.5	—	—	—	ø 8.5	ø 8.5	—
M12 x 1.75	—	—	—	ø10.3	ø10.3	—
Rc1/8	—	—	—	ø 8	ø 8	—
Rc1/4	—	—	—	—	ø11	—

Symbol: A44 (Note) Except flange type

Shaft through-hole and female thread machining
· Applicable shaft types: J, X, Z
· Equal dimensions are indicated by the same marker.

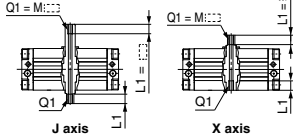

Thread	Size	30	50	63	80	100
M3 x 0.5	ø2.5	—	—	—	—	—
M5 x 0.8	—	ø4	ø4	—	—	—
M6 x 1	—	ø5	ø5	—	—	—
M8 x 1.25	—	—	ø6.8	ø 6.8	ø 6.8	—
M10 x 1.5	—	—	—	ø 8.5	ø 8.5	—
M12 x 1.75	—	—	—	ø10.3	ø10.3	—
Rc1/8	—	—	—	ø 8	ø 8	—
Rc1/4	—	—	—	—	ø11	—

Symbol: A45 (Note) Except flange type

The long shaft can be further shortened by machining a middle-cut chamfer into it.
· The minimum unit of the dimensions within a range that allows for machining is 0.1.
(The position is that of the standard flat at the keyway portion.)
(If shortening the shaft is not required, indicate "∞" for dimension X.)
· Applicable shaft types: J, K, T

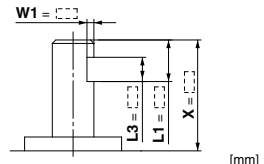

Size	X	W1	L1max	L3max
30	8.5 to 25	1 to 2	X-2	L1-2
50	12.5 to 36	1 to 5.5	X-2.5	L1-2
63	13.5 to 41	1 to 6.5	X-2.5	L1-2
80	16.5 to 50	1 to 8	X-3	L1-3
100	21 to 60	1.5 to 10.5	X-4	L1-4

Symbol: A46 (Note) Except flange type

The short shaft can be further shortened by machining a middle-cut chamfer into it.
· The minimum unit of the dimensions within a range that allows for machining is 0.1.
(The position is that of the standard flat at the keyway portion.)
(If shortening the shaft is not required, indicate "∞" for dimension Y.)
· Applicable shaft type: K

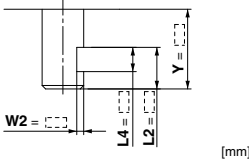

Size	Y	W2	L2max	L4max
30	8.5 to 25	1 to 2	Y-2	L2-2
50	10 to 36	1 to 5.5	Y	L2-2
63	11 to 41	1 to 6.5	Y	L2-2
80	13.5 to 50	1 to 8	Y	L2-3
100	17 to 60	1.5 to 10.5	Y	L2-4

Symbol: A51 (Note) Except flange type

Shorten the long shaft.
· Applicable shaft types: J, K, T

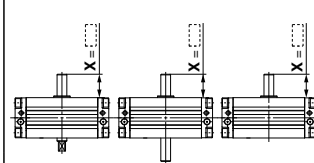

Size	X
30	3 to 25
50	3.5 to 36
63	3.5 to 41
80	4 to 50
100	5 to 60

Symbol: A52 (Note) Except flange type

Shorten the short shaft.
· Applicable shaft type: K

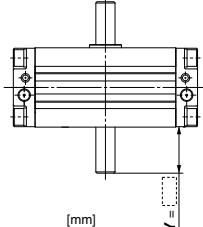

Size	Y
30	3 to 25
50	1 to 36
63	1 to 41
80	1 to 50
100	1 to 60

Symbol: A53 (Note) Except flange type

Both the long shaft and short shaft are shortened.
· Applicable shaft type: K

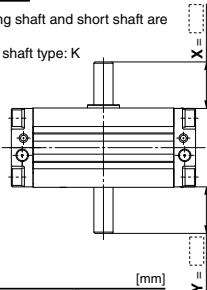

Size	X	Y
30	3 to 25	3 to 25
50	3.5 to 36	1 to 36
63	3.5 to 41	1 to 41
80	4 to 50	1 to 50
100	5 to 60	1 to 60

Symbol: A54 (Note) Except flange type

Shorten the long shaft.
· Applicable shaft types: X, Z

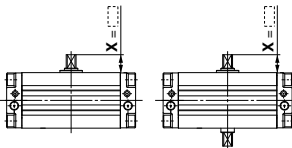

Size	X
30	3 to 13
50	3.5 to 27
63	3.5 to 29
80	4 to 38
100	5 to 44

Symbol: A55 (Note) Except flange type

Shorten the short shaft.
· Applicable shaft types: J, Z

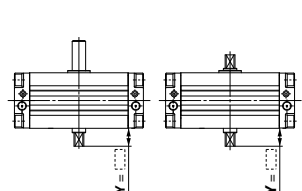

Size	Y
30	3 to 10
50	1 to 20
63	1 to 22
80	1 to 25
100	1 to 30

CRB□2

CRB1

MSU

CRJ

CRA1

CRQ2

MSQ

MSZ

CRQ2X

MSQX

MRQ

D-□

Shaft Pattern Sequencing II

Applicable shaft type: X, Z, T, J, K

Symbol: A56 (Note) Except flange type

Both the long shaft and short shaft are shortened.

· Applicable shaft type: Z

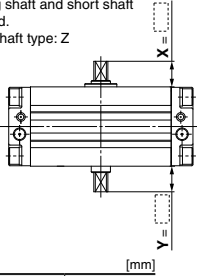

Size	X	Y [mm]
30	3 to 13	3 to 10
50	3.5 to 27	1 to 20
63	3.5 to 29	1 to 22
80	4 to 38	1 to 25
100	5 to 44	1 to 30

Symbol: A57 (Note) Except flange type

Both the long shaft and short shaft are shortened.

· Applicable shaft type: J

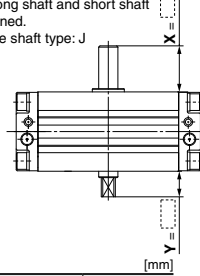

Size	X	Y [mm]
30	3 to 25	3 to 10
50	3.5 to 36	1 to 20
63	3.5 to 41	1 to 22
80	4 to 50	1 to 25
100	5 to 60	1 to 30

Symbol: A58 (Note) Except flange type

The rotation axis is reversed, and then shorten the long and short shafts.

· Applicable shaft types: J, T

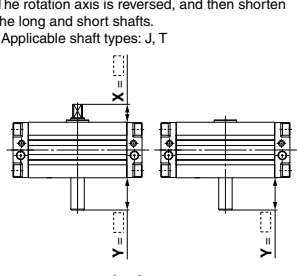

Size	Y [mm]
50	1 to 36
63	1 to 41
80	1 to 50
100	1 to 60

Symbol: A59 (Note) Except flange type

The rotation axis is reversed, and then shorten the long and short shafts.

· Applicable shaft type: X

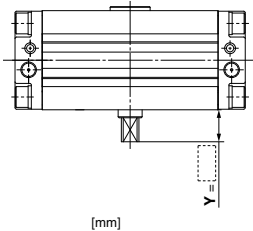

Size	Y [mm]
50	1 to 27
63	1 to 29
80	1 to 38
100	1 to 44

CRA1 Series

1 Reversed Shaft Symbol -XC7

C□RA1
C□RA1□□U Standard model no. -XC7

Reversed shaft
(-XC7)

Specifications

Applicable size	50, 63, 80, 100
Applicable shaft type	S, W, X, T, J

2 Change of Rotation Range Symbol -XC8 to -XC11

C□RA1 Standard model no. -XC8

Change of rotation range
(-XC8 to -XC11)

Specifications

Applicable size	50, 63, 80, 100
Applicable shaft type	S, W, Y

Symbol: C7

Rotation range of keyway $90^{\circ} +4^{\circ} -0^{\circ}$

Note) If it is pressurized from the port indicated with the arrow, the shaft rotates in the clockwise direction.

Symbol: C8

Change of rotation range

Rotation range of keyway $90^{\circ} +4^{\circ} -0^{\circ}$

Note) If it is pressurized from the port indicated with the arrow, the shaft rotates in the clockwise direction.

Symbol: C10

Change of rotation range

Rotation range of keyway $90^{\circ} +0^{\circ} -0^{\circ}$

Note) If it is pressurized from the port indicated with the arrow, the shaft rotates in the clockwise direction.

Symbol: C9

Change of rotation range

Rotation range of keyway $90^{\circ} +4^{\circ} -0^{\circ}$

Note) If it is pressurized from the port indicated with the arrow, the shaft rotates in the clockwise direction.

Symbol: C11

Change of rotation range

Rotation range of keyway $180^{\circ} +4^{\circ} -0^{\circ}$

Note) If it is pressurized from the port indicated with the arrow, the shaft rotates in the clockwise direction.

3 Changed to Fluorine Grease Symbol -XC30

C□RA1
C□RA1□□U Standard model no. -XC30

Fluorine grease
(-XC30)

Lubricant oil in the seal parts and inner wall of the cylinder is changed to fluorine grease. (Not the low-speed specification)

Specifications

Applicable size	30, 50, 63, 80, 100
Applicable shaft type	S, W, X, Y, Z, T, J, K

* Refer to standard type and angle adjustable type for other specifications.

Symbol

4 Change of Rotation Range and Shaft Rotation Direction

-XC31 to -XC36

C□RA1 Standard model no. -XC31

Specifications

Applicable size	50, 63, 80, 100
Applicable shaft type	S, W, Y

● Change of rotation range and shaft rotation direction (-XC31 to -XC36)

Symbol: C31

The rotation range is changed and the rotating direction is reversed.

Rotation range of keyway $90^{\circ} \begin{smallmatrix} +4^{\circ} \\ 0^{\circ} \end{smallmatrix}$

Note) If it is pressurized from the port indicated with the arrow, the shaft rotates in the clockwise direction.

Symbol: C32

The rotation range is changed and the rotating direction is reversed.

Rotation range of keyway $90^{\circ} \begin{smallmatrix} +4^{\circ} \\ 0^{\circ} \end{smallmatrix}$

Note) If it is pressurized from the port indicated with the arrow, the shaft rotates in the clockwise direction.

Symbol: C33

The rotation range is changed and the rotating direction is reversed.

Rotation range of keyway $90^{\circ} \begin{smallmatrix} +4^{\circ} \\ 0^{\circ} \end{smallmatrix}$

Note) If it is pressurized from the port indicated with the arrow, the shaft rotates in the clockwise direction.

Symbol: C34

The rotation range is changed and the rotating direction is reversed.

Rotation range of keyway $150^{\circ} \begin{smallmatrix} +4^{\circ} \\ 0^{\circ} \end{smallmatrix}$

Note) If it is pressurized from the port indicated with the arrow, the shaft rotates in the clockwise direction.

Symbol: C35

The rotation range is changed and the rotating direction is reversed.

Rotation range of keyway $90^{\circ} \begin{smallmatrix} +4^{\circ} \\ 0^{\circ} \end{smallmatrix}$

Note) If it is pressurized from the port indicated with the arrow, the shaft rotates in the clockwise direction.

Symbol: C36

The rotation range is changed and the rotating direction is reversed.

Rotation range of keyway $180^{\circ} \begin{smallmatrix} +4^{\circ} \\ 0^{\circ} \end{smallmatrix}$

Note) If it is pressurized from the port indicated with the arrow, the shaft rotates in the clockwise direction.

- CRB□2
- CRB1
- MSU
- CRJ
- CRA1**
- CRQ2
- MSQ
- MSZ
- CRQ2X
- MSQX
- MRQ

D-□

5 Change of Rotation Range and Angle Adjusting Direction

-XC37 to -XC42

C□RA1□□U Standard model no. -XC37

Specifications

Applicable size	50, 63, 80, 100
Applicable shaft type	S, W, Y

● Change of rotation range and angle adjusting direction (-XC37 to -XC42)

Symbol: C37

The rotation range and the angle adjusting direction of the angle adjustable type are changed.

Angle adjusting screw

Angle adjusting direction

Rotation range of keyway 90°

The rotation range under the adjustment of an angle at 60° is indicated below.

Rotation range

Note) If it is pressurized from the port indicated with the arrow, the shaft rotates in the clockwise direction.

Symbol: C38

The rotation range and the angle adjusting direction of the angle adjustable type are changed.

Angle adjusting screw

Angle adjusting direction

Rotation range of keyway 90°

The rotation range under the adjustment of an angle at 60° is indicated below.

Rotation range

Note) If it is pressurized from the port indicated with the arrow, the shaft rotates in the clockwise direction.

Symbol: C39

The rotation range and the angle adjusting direction of the angle adjustable type are changed.

Angle adjusting screw

Angle adjusting direction

Rotation range of keyway 90°

The rotation range under the adjustment of an angle at 60° is indicated below.

Rotation range

Note) If it is pressurized from the port indicated with the arrow, the shaft rotates in the clockwise direction.

Symbol: C40

The rotation range and the angle adjusting direction of the angle adjustable type are changed.

Angle adjusting screw

Angle adjusting direction

Rotation range of keyway 90°

The rotation range under the adjustment of an angle at 60° is indicated below.

Rotation range

Note) If it is pressurized from the port indicated with the arrow, the shaft rotates in the clockwise direction.

Symbol: C41

The rotation range and the angle adjusting direction of the angle adjustable type are changed.

Angle adjusting screw

Angle adjusting direction

Rotation range of keyway 90°

The rotation range under the adjustment of an angle at 60° is indicated below.

Rotation range

Note) If it is pressurized from the port indicated with the arrow, the shaft rotates in the clockwise direction.

Symbol: C42

The rotation range and the angle adjusting direction of the angle adjustable type are changed.

Angle adjusting screw

Angle adjusting direction

Rotation range of keyway 90°

The rotation range under the adjustment of an angle at 60° is indicated below.

Rotation range

Note) If it is pressurized from the port indicated with the arrow, the shaft rotates in the clockwise direction.

Symbol

6 Change of Rotation Range and Angle Adjusting Direction

-XC43 to -XC46

C□RA1□□U

Standard model no.

-XC43

Specifications

Applicable size	50, 63, 80, 100
Applicable shaft type	S, W, Y

●Change of rotation range and angle adjusting direction (-XC43 to -XC46)

Symbol: C43

The rotation range and the angle adjusting direction of the angle adjustable type are changed.

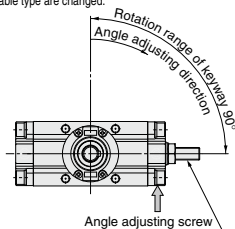

The rotation range under the adjustment of an angle at 60° is indicated below.

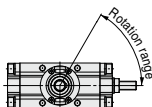

Note) If it is pressurized from the port indicated with the arrow, the shaft rotates in the clockwise direction.

Symbol: C44

The rotation range and the angle adjusting direction of the angle adjustable type are changed.

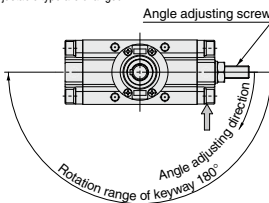

The rotation range under the adjustment of an angle at 120° is indicated below.

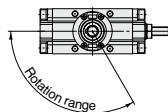

Note) If it is pressurized from the port indicated with the arrow, the shaft rotates in the clockwise direction.

Symbol: C45

The rotation range and the angle adjusting direction of the angle adjustable type are changed.

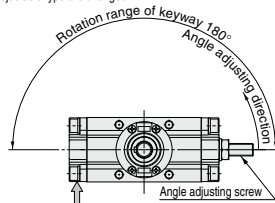

The rotation range under the adjustment of an angle at 120° is indicated below.

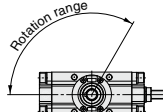

Note) If it is pressurized from the port indicated with the arrow, the shaft rotates in the clockwise direction.

Symbol: C46

The rotation range and the angle adjusting direction of the angle adjustable type are changed.

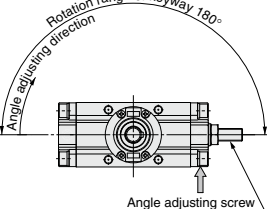

The rotation range under the adjustment of an angle at 120° is indicated below.

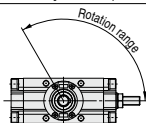

Note) If it is pressurized from the port indicated with the arrow, the shaft rotates in the clockwise direction.

CRB□2

CRB1

MSU

CRJ

CRA1

CRQ2

MSQ

MSZ

CRQ2X

MSQX

MRQ

D-□

7 Change of Rotation Range and Angle Adjusting Direction (Angle adjusting screw is equipped on the left.) -XC47 to -XC52

C□RA1□□U Standard model no. -XC47

Specifications

Applicable size	50, 63, 80, 100
Applicable shaft type	S, W, Y

• Change of rotation range and angle adjusting direction (Angle adjusting screw is equipped on the left.) (-XC47 to -XC52)

Symbol: C47

For the angle adjusting type, angle adjusting screws are mounted to the left cover.

Angle adjusting screw

Angle adjusting direction

Rotation range of keyway 90°

The rotation range under the adjustment of an angle at 60° is indicated below.

Rotation range

Note) If it is pressurized from the port indicated with the arrow, the shaft rotates in the clockwise direction.

Symbol: C48

For the angle adjusting type, angle adjusting screws are mounted to the left cover.

Angle adjusting screw

Angle adjusting direction

Rotation range of keyway 90°

The rotation range under the adjustment of an angle at 60° is indicated below.

Rotation range

Note) If it is pressurized from the port indicated with the arrow, the shaft rotates in the clockwise direction.

Symbol: C49

For the angle adjusting type, angle adjusting screws are mounted to the left cover.

Angle adjusting screw

Angle adjusting direction

Rotation range of keyway 90°

The rotation range under the adjustment of an angle at 60° is indicated below.

Rotation range

Note) If it is pressurized from the port indicated with the arrow, the shaft rotates in the clockwise direction.

Symbol: C50

For the angle adjusting type, angle adjusting screws are mounted to the left cover.

Angle adjusting screw

Angle adjusting direction

Rotation range of keyway 90°

The rotation range under the adjustment of an angle at 60° is indicated below.

Rotation range

Note) If it is pressurized from the port indicated with the arrow, the shaft rotates in the clockwise direction.

Symbol: C51

For the angle adjusting type, angle adjusting screws are mounted to the left cover.

Angle adjusting screw

Angle adjusting direction

Rotation range of keyway 90°

The rotation range under the adjustment of an angle at 60° is indicated below.

Rotation range

Note) If it is pressurized from the port indicated with the arrow, the shaft rotates in the clockwise direction.

Symbol: C52

For the angle adjusting type, angle adjusting screws are mounted to the left cover.

Angle adjusting screw

Angle adjusting direction

Rotation range of keyway 90°

The rotation range under the adjustment of an angle at 60° is indicated below.

Rotation range

Note) If it is pressurized from the port indicated with the arrow, the shaft rotates in the clockwise direction.

Symbol

8 Change of Rotation Range and Angle Adjusting Direction (Angle adjusting screw is equipped on the left.) **-XC53 to -XC58**

C□RA1□□U Standard model no. -XC53

Specifications

Applicable size	50, 63, 80, 100
Applicable shaft type	S, W, Y

●Change of rotation range and angle adjusting direction (Angle adjusting screw is equipped on the left.) (-XC53 to -XC58)

Symbol: C53

For the angle adjusting type, angle adjusting screws are mounted to the left cover.

Rotation range of keyway 90°
Angle adjusting direction

Angle adjusting screw

The rotation range under the adjustment of an angle at 60° is indicated below.

Rotation range

Note) If it is pressurized from the port indicated with the arrow, the shaft rotates in the clockwise direction.

Symbol: C54

For the angle adjusting type, angle adjusting screws are mounted to the left cover.

Rotation range of keyway 90°
Angle adjusting direction

Angle adjusting screw

The rotation range under the adjustment of an angle at 60° is indicated below.

Rotation range

Note) If it is pressurized from the port indicated with the arrow, the shaft rotates in the clockwise direction.

Symbol: C55

For the angle adjusting type, angle adjusting screws are mounted to the left cover.

Rotation range of keyway 180°
Angle adjusting direction

Angle adjusting screw

The rotation range under the adjustment of an angle at 120° is indicated below.

Rotation range

Note) If it is pressurized from the port indicated with the arrow, the shaft rotates in the clockwise direction.

Symbol: C56

For the angle adjusting type, angle adjusting screws are mounted to the left cover.

Rotation range of keyway 180°
Angle adjusting direction

Angle adjusting screw

The rotation range under the adjustment of an angle at 120° is indicated below.

Rotation range

Note) If it is pressurized from the port indicated with the arrow, the shaft rotates in the clockwise direction.

Symbol: C57

For the angle adjusting type, angle adjusting screws are mounted to the left cover.

Angle adjusting screw

Angle adjusting direction

Rotation range of keyway 180°

The rotation range under the adjustment of an angle at 120° is indicated below.

Rotation range

Note) If it is pressurized from the port indicated with the arrow, the shaft rotates in the clockwise direction.

Symbol: C58

For the angle adjusting type, angle adjusting screws are mounted to the left cover.

Angle adjusting screw

Angle adjusting direction

Rotation range of keyway 180°

The rotation range under the adjustment of an angle at 120° is indicated below.

Rotation range

Note) If it is pressurized from the port indicated with the arrow, the shaft rotates in the clockwise direction.

- CRB□2
- CRB1
- MSU
- CRJ
- CRA1
- CRQ2
- MSQ
- MSZ
- CRQ2X
- MSQX
- MRQ

D-□

9 Change of Port Location (Mounting location of the cover is changed.) -XC59 to -XC61

C□RA1 Standard model no. -XC59

Specifications

Applicable size	30, 50, 63, 80, 100
Applicable shaft type	S, W, X, Y Z, T, J, K

● Change of port location (Mounting location of the cover is changed.)
(-XC59 to -XC61)

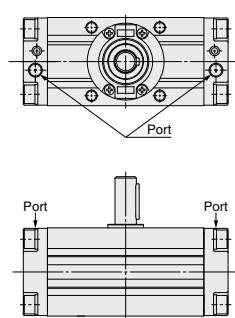
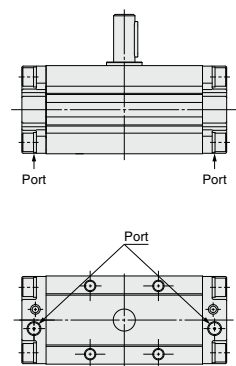
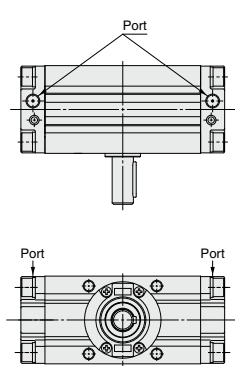
<p>Symbol: C59</p> <p>Direction of the port is changed. (Upward)</p> 	<p>Symbol: C60</p> <p>Direction of the port is changed. (Downward)</p> 	<p>Symbol: C61</p> <p>Direction of the port is changed. (Backward)</p> 
---	---	---

10 One Side Air-hydro, One Side Air -XC63, -XC64

C□RA1 Standard model no. -XC63

Specifications

Applicable size	50, 63, 80, 100
Applicable shaft type	S, W, X, Y Z, T, J, K

* Except angle adjustable type and air cushion equipped type

● One side air-hydro, One side air
-XC63: Left side air
Right side air-hydro
-XC64: Left side air-hydro
Right side air

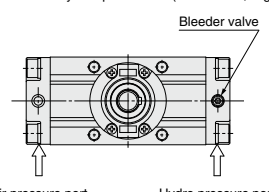
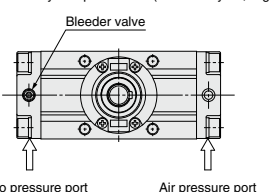
<p>Symbol: C63</p> <p>One side air, one side air-hydro specification (Left side air, Right side hydro)</p>  <p>The figure shows the pressurized situation to the hydro pressure port.</p>	<p>Symbol: C64</p> <p>One side air, one side air-hydro specification (Left side hydro, Right side air)</p>  <p>The figure shows the pressurized situation to the air pressure port.</p>
---	---

11 Stainless Steel Shaft/Bolt/Parallel Key **Symbol -X6**

C□RA1 Standard model no. -X6
 Stainless steel for main part

For applications in areas that pose a risk of rust or corrosion, a portion of the materials used in the standard parts has been changed to stainless steel.

Specifications

Type	Pneumatic, Air-hydro
Size	30, 50, 63, 80, 100
Rotating angle	90°, 180° (Size 30 to 100) 100°, 190° (Size 50 to 100)
Mounting	Flange, Foot
Shaft type	Single shaft (S), Double shaft (W), Single shaft with four chamfers (X), Double shaft with key (Y), Double shaft with four chamfers (Z), Single round shaft (T), Double shaft (round shaft, with four chamfers) (J), Double round shaft (K)
Stainless steel part	Shaft, Bolt, Screw, Parallel key
Cushion	Not attached, Air cushion (Except air-hydro type)
Auto switch	Mountable

* Refer to page 188 for other specifications.
 ** Except angle adjustable type
 *** Only single shaft (S) and double shaft (W) types are applicable to flange type.

13 Both Sides Angle Adjustable **Symbol -X10**

C□RA1□□U Standard model no. -X10
 Both sides angle adjustable



Specifications

Type	Pneumatic
Size	50, 63, 80, 100
Rotating angle	90°, 180°, 100°, 190°
Mounting	Flange, Foot
Shaft type	Single shaft (S), Double shaft (W), Single shaft with four chamfers (X), Double shaft with key (Y), Double shaft with four chamfers (Z), Single round shaft (T), Double shaft (round shaft, with four chamfers) (J), Double round shaft (K)
Cushion	None
Angle adjustment range	Max. 90° (One side)

* Refer to page 198 for other specifications.

12 Heat Resistant **Symbol -X7**

CRA1 Standard model no. -X7
 Heat resistant

In this rotary actuator, the material of the seals has been changed to the heat resistant type (to withstand up to 100°C), for applications in environments that exceed the standard specification temperatures of 0 to 60°C.

Specifications

Type	Pneumatic
Size	30, 50, 63, 80, 100
Rotating angle	90°, 180° (Size 30 to 100) 100°, 190° (Size 50 to 100)
Ambient and fluid temperature	0 to 100°C
Mounting	Flange, Foot
Shaft type	Single shaft (S), Double shaft (W), Single shaft with four chamfers (X), Double shaft with key (Y), Double shaft with four chamfers (Z), Single round shaft (T), Double shaft (round shaft, with four chamfers) (J), Double round shaft (K)
Seal material	FKM
Cushion	Size 30: None Size 50 to 100: Not attached, Air cushion
Auto switch	Not mountable

* Refer to page 188 for other specifications.
 ** Except with solenoid valve type.

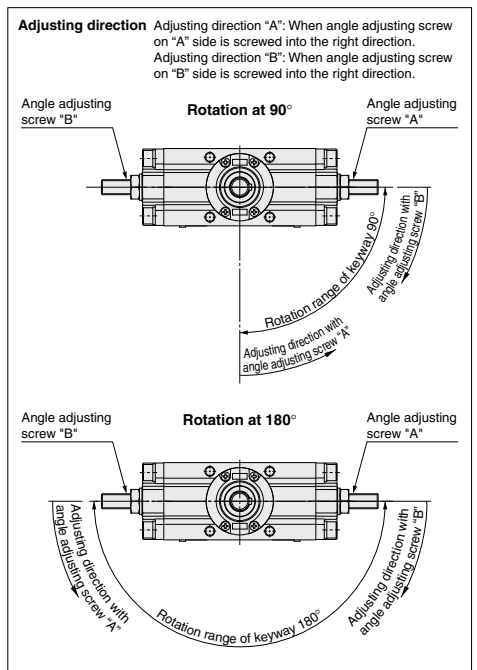

- CRC□2
- CRCB1
- MSU
- CRJ
- CRA1
- CRQ2
- MSQ
- MSZ
- CRCO2X
- MSQX
- MRQ

D-□

CRA1 Series

14 One Side Angle Adjustable, One Side with Cushion **Symbol -X11**

C□RA1□□□U **Standard model no.** **-X11**



One side angle adjustable
One side with cushion

Specifications

Type	Pneumatic
Size	50, 63, 80, 100
Rotating angle	90°, 180°, 100°, 190°
Mounting	Flange, Foot
Shaft type	Single shaft (S), Double shaft (W), Single shaft with four chamfers (X), Double shaft with key (Y), Double shaft with four chamfers (Z), Single round shaft (T), Double shaft (round shaft, with four chamfers) (J), Double round shaft (K)
Cushion	With cushion on one side
Angle adjustment range	Max. 90°

* Refer to page 198 for other specifications.

15 Fluororubber Seal **Symbol -X16**

CDRA1 **Standard model no.** **-X16**

Fluororubber seal

Seal is now changed to fluororubber.

Specifications

Type	Pneumatic
Size	30, 50, 63, 80, 100
Rotating angle	90°, 180° (Size 30 to 100) 100°, 190° (Size 50 to 100)
Ambient and fluid temperature	0 to 60°C (No freezing)
Mounting	Flange, Foot
Shaft type	Single shaft (S), Double shaft (W), Single shaft with four chamfers (X), Double shaft with key (Y), Double shaft with four chamfers (Z), Single round shaft (T), Double shaft (round shaft, with four chamfers) (J), Double round shaft (K)
Seal material	FKM
Cushion	Not attached, Air cushion
Auto switch	Mountable

* Refer to page 188 for other specifications.

** Except with solenoid valve type.

*** For built-in magnet type only.

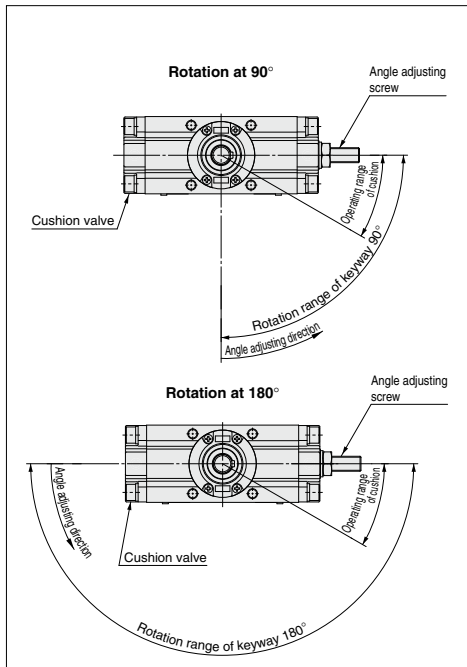

* Refer to page 200 for dimensions.



How to Order

C **D** **RA1** **B** **S** **50** **-90** **Z** **M9BW** **X6** **X16**

• **Magnet**

Nil	None
D	Built-in magnet

• **Solenoid valve**

Nil	None
V*	With solenoid valve

* Except size 30, air-hydro type

• **Mounting**

B	Basic type
L	Foot type
F*	Flange type

* Except size 30, with solenoid valve type.

• **Shaft type**

S	Single shaft
W	Double shaft
X	Single shaft with four chamfers
Y	Double shaft with key
Z	Double shaft with four chamfers
T	Single round shaft
J	Double shaft (round shaft, with four chamfers)
K	Double round shaft

• **Variation**

Nil	Without angle adjustment
U*	Angle adjustable type
H*	Air-hydro type

* Except size 30

• **Size**

30
50
63
80
100

• **Model with solenoid valve**

* Refer to page 202 for model number with solenoid valve.

• **Auto switch**

Nil	2 pcs.
S	1 pc.

• **Auto switch**

Nil	Without auto switch (Built-in magnet)
-----	---------------------------------------

* For applicable auto switch model, refer to page 188.
* Auto switches are shipped together, (but not assembled).

• **Cushion**

Nil	Without air cushion
C*	With air cushion

* Except angle adjustable type, air-hydro type

• **Rotating angle**

90	90°
180	180°
100*	100°
190*	190°

* Except size 30

• **Port type**

Size	30	50	63	80	100
Nil	M thread	M5	—	—	—
	Rc	—	—	—	—
TF	G	—	—	—	—
TN	NPT	1/8	1/8	1/4	3/8
TT	NPTF	—	—	—	—

• **Number of auto switches**

• **Made to Order**

* Combination is available only when all the conditions are fulfilled in the combination chart 9.

- CRB□2
- CRB1
- MSU
- CRJ
- CRA1**
- CRQ2
- MSQ
- MSZ
- CRQ2X
- MSQX
- MRQ

Combination Chart of Made to Order

Chart 9. Combination between -X□ and -X□

(S, W, X, Y, Z, T, J, K shaft)

Symbol	Description	Applicable shaft type							Applicable size	Combination		
		S	W	X	Y	Z	T	J		K	-X6	-X7
-X6	Stainless steel shaft/bolt/parallel key	●	●	●	●	●	●	●	30 to 100	●	●	
-X7 ³⁾	Heat resistant (100°C)	●	●	●	●	●	●	●		●	●	
-X10	Both sides angle adjustable	●	●	●	●	●	●	●	50 to 100	—	●	
-X11	One side angle adjustable, One side with cushion	●	●	●	●	●	●	●		—	●	●
-X16	Fluororubber seal	●	●	●	●	●	●	●	30 to 100	●	—	●

* -X7: Not available for the built-in magnet type.



CRA1 Series Specific Product Precautions

Be sure to read this before handling the products.

Refer to back page 50 for Safety Instructions and pages 4 to 14 for Rotary Actuator and Auto Switch Precautions.

How to Use the Air-hydro Type

Caution on Design

⚠ Warning

1. Do not use a rotary actuator of the air-hydro type near flames, or in equipment or machinery that exceeds an ambient temperatures of 60°C.

There is a danger of causing a fire because the rotary actuator of the air-hydro type uses a flammable hydraulic fluid.

⚠ Caution

1. Do not use in an environment, equipment, or machine that is not compatible with oil mist.

Rotary actuators of the air-hydro types generate an oil mist during operation which may affect the environment.

2. Be sure to install an exhaust cleaner on the directional control valve for the rotary actuator of the air-hydro type.

A very small amount of hydraulic fluid is discharged from the exhaust port of the rotary actuator of the air-hydro type's directional control valve, which may contaminate the surrounding area.

3. Install a rotary actuator of the air-hydro type in locations where it can be serviced easily.

Since the rotary actuator of the air-hydro type requires maintenance, such as refilling of hydraulic fluid and bleeding of air, ensure sufficient space for these activities.

4. Do not use in cases where external leakage of hydraulic oil may adversely affect equipment or machinery.

Although it only occurs in minute amounts, a certain amount of sliding leakage from the piston seal is unavoidable with the rotary actuator of the air-hydro type. Because of the construction of the rotary actuator of the air-hydro type, hydraulic oil may leak into the outside due to sliding leakage.

Selection

⚠ Caution

1. Select the rotary actuator of the air-hydro type based on the combination with the air-hydro unit.

Select a proper air-hydro unit that is necessary for good operation of the rotary actuator of the air-hydro type.

Piping

⚠ Caution

1. Use self-align fittings in conjunction with the piping for the rotary actuator of the air-hydro type.

Do not use a one-touch fitting with the piping for the rotary actuator of the air-hydro type, as this may result in oil leakage.

Piping

⚠ Caution

2. For rotary actuator of the air-hydro type piping, use hard nylon tubing or copper piping.

As in the case of hydraulic circuits, surge pressures greater than the operating pressure may occur in a rotary actuator of the air-hydro type's piping, making it necessary to use safer piping materials.

Lubrication

⚠ Warning

1. Make sure to completely discharge the compressed air in the system before filling the air-hydro unit with hydraulic oil.

When supplying hydraulic fluid to the air-hydro unit, first confirm that safety measures are implemented to prevent dropping of objects and the release of clamped objects, etc. Then, shut off the air supply and the equipment's electric power and exhaust the compressed air in the system.

If the air-hydro unit's supply port is opened with compressed air still remaining in the system, there is a danger of hydraulic fluid being blown out.

Maintenance

⚠ Caution

1. Bleed air from the rotary actuator of the air-hydro type on a regular basis.

Since air may accumulate inside a rotary actuator of the air-hydro type, bleed air from it, for example before starting work. Bleed air from a bleeder valve provided on the rotary actuator of the air-hydro type or the piping.

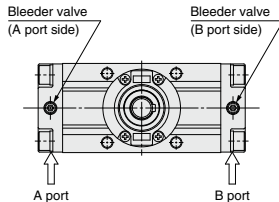

2. Verify the oil level of the air-hydro system on a regular basis.

Since a very small amount of hydraulic fluid is discharged from the rotary actuator of the air-hydro type and air-hydro unit circuit, the fluid will gradually decrease. Therefore, check the fluid regularly and refill as necessary.

The oil level can be checked with a level gauge in the air-hydro converter.