

Pin Cylinders

CJP2/CJP Series

ø4, ø6, ø10, ø15, ø16

2 auto switches can even be mounted on a cylinder with ø4 bore size (5 mm stroke).



Double acting / **CJP2 Series**

One-touch fitting can be connected.

(Panel mount type)

ø2 One-touch fitting, miniature fitting, and speed controller can be connected.



Single acting / **CJP Series**



CJ1
CJP
CJ2
JCM
CM2
CM3
CG1
CG3
JMB
MB
MB1
CA2
CS1
CS2

D-□
-X□
Technical Data

Small and Light

Double acting / **CJP2 Series**

- Full length: **Shortened by 6 to 9.5 mm**
- Weight: **Reduced by 55 to 65%**

New aluminum body is light weight compared with the current CJP series.
(Compared with the basic model CJP cylinder without auto switch)

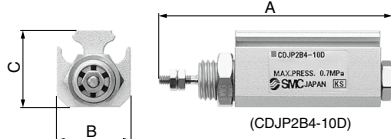

Dimensions				Unit: mm
Bore size	A	B	C	
4	29 + stroke (34 + stroke)	14	14.5	
6	33 + stroke (38 + stroke)	14	16.5	
10	39.5 + stroke (44.5 + stroke)	15	19	
16	43.5 + stroke (48.5 + stroke)	20	24.5	

Weight					Unit: g
Stroke	Bore size (mm)				
	4	6	10	16	
5	11	16	27	42	
10	13	18	29	46	
15	15	21	32	50	
20	17	23	35	54	
25	—	25	37	58	
30	—	—	40	63	
35	—	—	43	67	
40	—	—	45	71	

* () : Dimension for built-in magnet type

Single acting / **CJP Series**

Panel mount type (CJPB4-5)

Scale: 100%

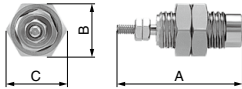

Dimensions						Unit: mm
Bore size	A			B	C	
	5st	10st	15st			
4	23.5	31.5	39.5	10	11.5	
6	27.5	34.5	41.5	12	13.9	
10	32.5	39	46	19	22	
15	37.5	43.5	50	27	31	

Embedded type (CJPS4-5)

Scale: 100%

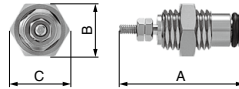

Weight						Unit: g
Stroke (mm)	Bore size (mm)					
	4	6	10	15		
5	10	10.6	28	75		
10	13	13.1	33	82		
15	15	15.6	38	92		

Variation

Series	Action	Bore size (mm)	Standard stroke (mm)	Mounting ^{Note 2)}
CJP2	Double acting, Single rod	4	5, 10, 15 (20) ^{Note 1)}	Basic Flange Foot Clevis Trunnion
		6	5, 10, 15, 20, 25	
		10	5, 10, 15, 20, 25, 30, 35, 40	
		16	5, 10, 15, 20, 25, 30, 35, 40	

Series	Action	Bore size (mm)	Standard stroke (mm)	Mounting
CJP	Single acting, Spring return	4	5, 10, 15	Panel mount type, Embedded type
		6	5, 10, 15	
		10	5, 10, 15	
		15	5, 10, 15	

Note 1) A stroke of 20 is available with a standard product only. Note 2) Bore size of ø4 is available with basic mounting only.

Related Products

Refer to Best Pneumatics No. 7.



Pin Cylinder: Double Acting, Single Rod

CJP2 Series

ø4, ø6, ø10, ø16

How to Order

Standard CJP2 **F** 10 - 15 D - [] - []

Built-in magnet CDJP2 **F** 10 - 15 D - [] - **M9BW** **S** - []

With auto switch
(Built-in magnet)

Mounting

Symbol	Mounting	Standard	Built-in magnet
B	Basic	●	●
F	Flange	●	●
L	Foot	●	●
D	Clevis	●	●
T	Trunnion	●	●

* Bore size of 4 mm is available with basic mounting only.
* Mounting bracket is shipped together (but not assembled).
* Trunnion mounting type is shipped after assembled.

Bore size

4	4 mm
6	6 mm
10	10 mm
16	16 mm

Cylinder standard stroke (mm)

ø4	5, 10, 15, (20) <small>Note</small>
ø6	5, 10, 15, 20, 25
ø10, ø16	5, 10, 15, 20, 25, 30, 35, 40

Note A stroke of 20 is available with a standard product only.

Number of auto switches

Nil	2 pcs.
S	1 pc.

Auto switch

Nil	Without auto switch
-----	---------------------

* For the applicable auto switch model, refer to the below table.

Rod end thread

Nil	With thread
B	Without thread

Double acting

Built-in Magnet Cylinder Model

If a built-in magnet cylinder without an auto switch is required, there is no need to enter the symbol for the auto switch.
(Example) CDJP2B6-20

- CJ1
- CJP**
- CJ2
- JCM
- CM2
- CM3
- CG1
- CG3
- JMB
- MB
- MB1
- CA2
- CS1
- CS2

Applicable Auto Switches / For detailed auto switch specifications, refer to page 1575 through to 1701.

Type	Special function	Electrical entry	Indicator light	Wiring (Output)	Load voltage		Auto switch model		Lead wire length (m)*				Pre-wired connector	Applicable load	
					DC	AC	Electrical entry direction		0.5 (Nil)	1 (M)	3 (L)	5 (Z)		IC circuit	Relay, PLC
							Perpendicular	In-line							
Solid state auto switch	—	Grommet	Yes	3-wire (NPN)	5 V, 12 V	—	M9NV	M9N	●	●	●	○	—	IC circuit	—
				3-wire (PNP)			M9PV	M9P	●	●	●	○			
				2-wire	M9BV	M9B	●	●	●	○	—				
				3-wire (NPN)	M9NVW	M9NW	●	●	●	○					
				3-wire (PNP)	M9PVW	M9PW	●	●	●	○					
				2-wire	M9BWW	M9BW	●	●	●	○					
	Water resistant (2-color indicator)	Grommet	Yes	3-wire (NPN)	5 V, 12 V	—	M9NAV ^{*1}	M9NA ^{*1}	○	○	●	○	—	IC circuit	—
				3-wire (PNP)			M9PAV ^{*1}	M9PA ^{*1}	○	○	●	○			
				2-wire	M9BAV ^{*1}	M9BA ^{*1}	○	○	●	○					
				2-wire	M9BAV ^{*1}	M9BA ^{*1}	○	○	●	○					
Reed auto switch	—	Grommet	Yes	3-wire (NPN equiv.)	—	5 V	A96V ^{**}	A96 ^{**}	●	—	●	—	—	IC circuit	—
				2-wire			A93V ^{**}	A93 ^{**}	●	●	●	—			
				2-wire	24 V	5 V, 12 V	100 V or less	A90V ^{**}	A90 ^{**}	●	—	●			

*1 Water resistant type auto switches can be mounted on the above models, but in such case SMC cannot guarantee water resistance.

* Consult with SMC regarding water resistant types with the above model numbers.

*2 1 m type lead wire is only applicable to D-A93.

* Lead wire length symbols: 0.5 m Nil (Example) M9NVW
1 m M M9NWM
3 m L M9NWL
5 m Z M9NVZ

** The D-A9□(V) switch is not attachable to ø4.

* Auto switches marked with "○" are made to order specification.

* For details about auto switches with pre-wired connector, refer to pages 1648 and 1649.

* Auto switches are shipped together, (but not assembled).

- D-□
- X□
- Technical Data



Symbol

Double acting, Single rod, Rubber bumper



Made to Order: Individual Specifications (For details, refer to page 33.)

Symbol	Specifications
-X1666	Interchangeability of clevis and trunnion types

Made to Order (For details, refer to pages 1703 to 1896.)

Symbol	Specifications
-XA□	Change of rod end type
-XB6	Heat resistant cylinder (150°C)
-XB7	Cold resistant cylinder
-XC22	Fluororubber seals

Theoretical Output

Bore size (mm)	Operating direction	Operating pressure (MPa)		
		0.3	0.5	0.7
4	IN	2.8	4.7	6.6
	OUT	3.8	6.3	8.8
6	IN	6.4	10.6	14.8
	OUT	8.5	14.1	19.8
10	IN	19.8	33.0	46.2
	OUT	23.6	39.3	55.0
16	IN	51.8	86.4	121.0
	OUT	60.3	100.5	140.7

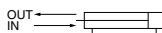

Moisture Control Tube IDK Series

When operating an actuator with a small diameter and a short stroke at a high frequency, the dew condensation (water droplet) may occur inside the piping depending on the conditions.

Simply connecting the moisture control tube to the actuator will prevent dew condensation from occurring. For details, refer to [the IDK series in the Best Pneumatics No. 6](#).



Specifications

Action	Double acting, Single rod	
Maximum operating pressure	0.7 MPa	
Minimum operating pressure	ø4	0.15 MPa
	ø6	0.12 MPa
	ø10, ø16	0.06 MPa
Proof pressure	1 MPa	
Ambient and fluid temperature	Without auto switch: -10 to 70°C With auto switch: -10 to 60°C (No freezing)	
Lubrication	Not required (Non-lube)	
Stroke length tolerance	+1.0 0	
Rod end type	With thread/Without thread	
Piston speed	10 to 500 mm/s*	
Cushion	Rubber bumper	
Mounting <small>(Note)</small>	Basic, Flange, Foot, Clevis, Trunnion	

Note) Bore size of ø4 is available with basic mounting only. The piston speed for a bore size of ø4 is 50 to 500 mm/s.

Standard Equipment Accessory

Accessory	Mounting nut (1 pc.)	Rod end nut (2 pcs.) (with thread)	Trunnion (with pin)
Mounting			
Basic	●	●	—
Flange	●	●	—
Foot	●	●	—
Clevis	—	●	—
Trunnion	—	●	●

Standard Stroke

Bore size (mm)	Stroke (mm)
4	5, 10, 15, 20 <small>(Note)</small>
6	5, 10, 15, 20, 25
10	5, 10, 15, 20, 25, 30, 35, 40
16	5, 10, 15, 20, 25, 30, 35, 40

* 20 stroke of bore size 4 mm is standard type only.

Option

Bore size (mm)	6	10	16
Description			
Auto switch	D-A9□(V), D-M9□(V), D-M9□W(V)		
Single knuckle joint	I-P006A	I-P010A	I-P016A
Double knuckle joint (with pin)	Y-P006A	Y-P010A	Y-P016A

* Refer to page 30 for dimensions.

Mounting Bracket Part No.

Bore size (mm)	6	10	16
Bracket			
Flange	CP-F006A	CP-F010A	CP-F016A
Foot	CP-L006A	CP-L010A	CP-L016A
Trunnion (with pin)	CP-T006A	CP-T010A	CP-T016A

Weight

	Stroke (mm) Mounting	Bore size (mm)			
		4	6	10	16
Basic weight	5	11	16	27	42
	10	13	18	29	46
	15	15	21	32	50
	20	17	23	35	54
	25	—	25	37	58
	30	—	—	40	63
	35	—	—	43	67
	40	—	—	45	71
Bracket weight	Flange	—	5	6	16
	Foot	—	7	9	24
	Clevis	—	2	5	8
	Trunnion (with pin)	—	15	25	70
Additional weight for built-in magnet		2	3	5	7

Allowable Kinetic Energy

⚠ Caution

When driving an inertial load, operate a cylinder with kinetic energy within the allowable value. The range in the chart below that is delineated by bold solid lines indicates the relation between load mass and maximum driving speeds.

Bore size (mm)	4	6	10	16
Piston speed (m/s)	0.05 to 0.5			
Allowable kinetic energy (J)	0.75×10^{-2}	1.2×10^{-2}	2.5×10^{-2}	5.0×10^{-2}

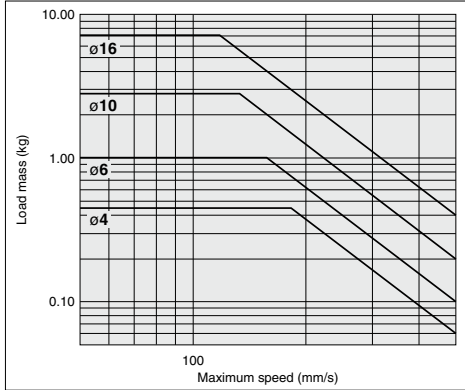

Allowable Lateral Load

Strictly observe the limiting range of lateral load on a piston rod. (Refer to the below graph.) If this product is used beyond the limits, it may shorten the machine life or cause damage.

Allowable lateral load

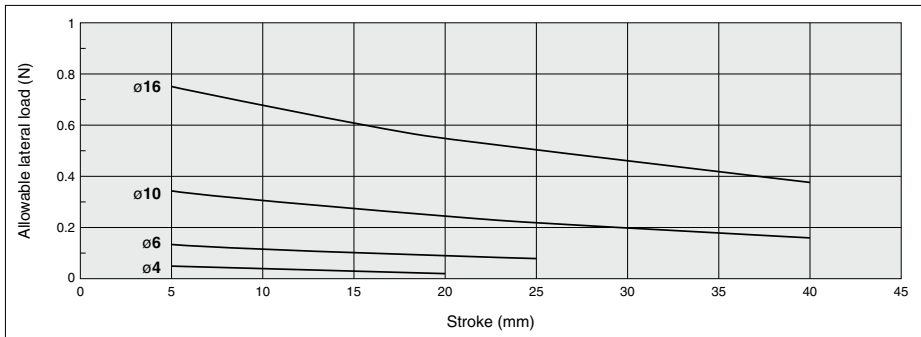
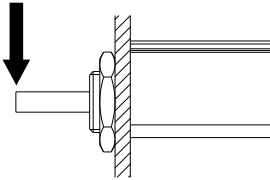

- CJ1
- CJP**
- CJ2
- JCM
- CM2
- CM3
- CG1
- CG3
- JMB
- MB
- MB1
- CA2
- CS1
- CS2

- D-
- X
- Technical Data

CJP2 Series

Construction

C□JP2B4

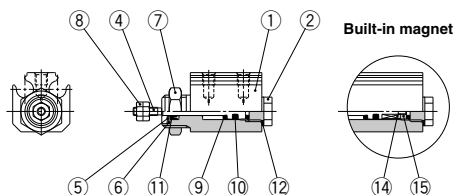

C□JP2B6

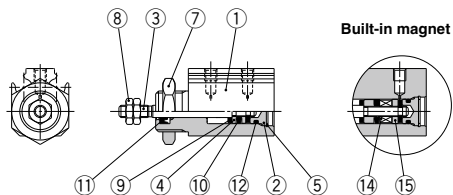

C□JP2B10, 16

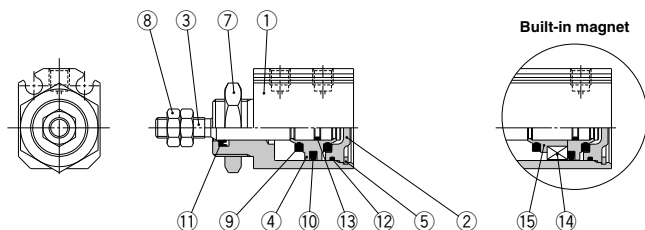

Component Parts

No.	Description	Material	Note
1	Body	Aluminum alloy	Hard anodized
2	Head cover	ø4, ø6, ø10	Brass
		ø16	Aluminum alloy
3	Piston rod	Stainless steel	Chromated
4	Piston	ø4	Stainless steel
		ø6, ø10	Brass
		ø16	Aluminum alloy
5	Retaining ring	Tool steel	Phosphate coating
6	Seal retainer	Special steel	Nickel plated
7	Mounting nut	Brass	Electroless nickel plated
8	Rod end nut	Steel	Zinc chromated
9	Bumper	Urethane rubber	
10	Piston seal	NBR	
11	Rod seal	NBR	
12	Gasket	ø4	Stainless steel + NBR
		ø6, ø10, ø16	NBR
13	Piston gasket	NBR	
14	Magnet	—	
15	Magnet retainer	ø4, ø6, ø10	Brass
		ø16	Aluminum alloy

Replacement Parts: Seal Kit

Standard

Bore size (mm)	Kit no.	Contents
6	CJP2B6D-PS	Set of left nos. ⑩, ⑪, ⑫.
10	CJP2B10D-PS	
16	CJP2B16D-PS	

* Seal kit includes a grease pack (5 g).
Order with the following part number when only the grease pack is needed.
Grease pack part number: GR-L-005 (5 g)

XB6/Heat-resistant cylinder (-10 to 150°C)

Bore size (mm)	Kit no.	Contents
6	CJP2B6D-XB6-PS	Set of left nos. ⑩, ⑪, ⑫.
10	CJP2B10D-XB6-PS	
16	CJP2B16D-XB6-PS	

* Seal kit includes a grease pack (5 g).
Order with the following part number when only the grease pack is needed.
Grease pack part number: GR-F-005 (5 g)

XB7/Cold-resistant cylinder

Bore size (mm)	Kit no.	Contents
6	CJP2B6D-XB7-PS	Set of left nos. ⑩, ⑪, ⑫.
10	CJP2B10D-XB7-PS	
16	CJP2B16D-XB7-PS	

* Seal kit includes a grease pack (5 g).
Order with the following part number when only the grease pack is needed.
Grease pack part number: GR-T-005 (5 g)

XC22/Fluororubber seal

Bore size (mm)	Kit no.	Contents
6	CJP2B6D-XC22-PS	Set of left nos. ⑩, ⑪, ⑫.
10	CJP2B10D-XC22-PS	
16	CJP2B16D-XC22-PS	

* Seal kit includes a grease pack (5 g).
Order with the following part number when only the grease pack is needed.
Grease pack part number: GR-L-005 (5 g)

Dimensions: Basic Mounting ($\varnothing 4$)

Standard: CJP2B4

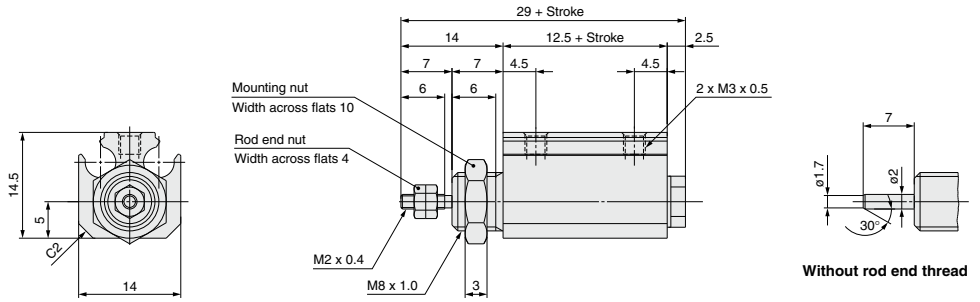

Built-in magnet: CDJP2B4

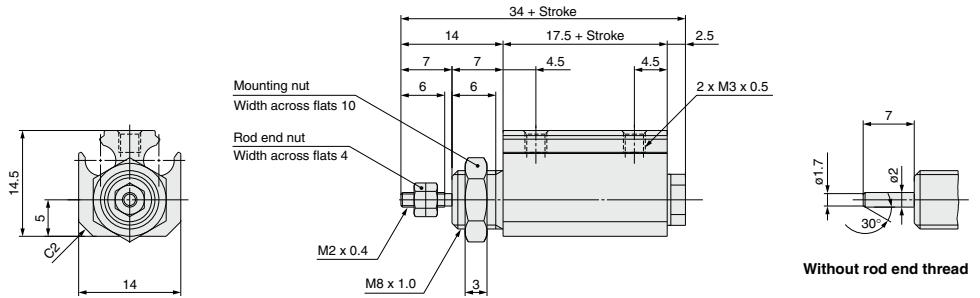

- CJ1**
- CJP**
- CJ2**
- JCM**
- CM2**
- CM3**
- CG1**
- CG3**
- JMB**
- MB**
- MB1**
- CA2**
- CS1**
- CS2**

- D-□**
- X□**
- Technical Data

CJP2 Series

Dimensions: Basic Mounting ($\varnothing 6$ to $\varnothing 16$)

Standard: CJP2B6 to 16

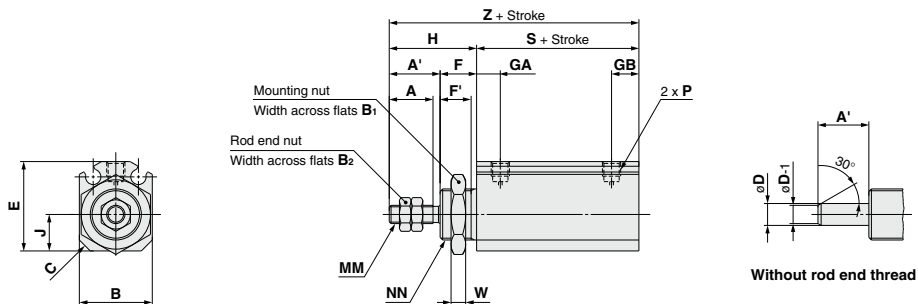

Symbol	A	A'	B	B ₁	B ₂	C	D	E	F	F'	GA	GB	H	J	MM	NN	P	S	W	Z
6	7	9	14	14	5.5	2	3	16.5	8	6.5	5.5	6.5	17	6	M3 x 0.5	M10 x 1.0	M3 x 0.5	16	3	33
10	10	12	15	17	7	2.5	4	19	8	6.5	6	7	20	7	M4 x 0.7	M12 x 1.0	M3 x 0.5	19.5	3	39.5
16	12	14	20	19	8	3	6	24.5	10	8.5	6.5	7.5	24	10	M5 x 0.8	M14 x 1.0	M5 x 0.8	19.5	4	43.5

Built-in magnet: CDJP2B6 to 16

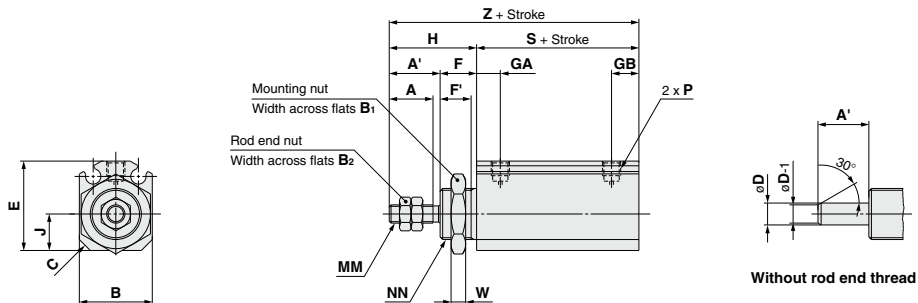

Symbol	A	A'	B	B ₁	B ₂	C	D	E	F	F'	GA	GB	H	J	MM	NN	P	S	W	Z
6	7	9	14	14	5.5	2	3	16.5	8	6.5	5.5	6.5	17	6	M3 x 0.5	M10 x 1.0	M3 x 0.5	21	3	38
10	10	12	15	17	7	2.5	4	19	8	6.5	6	7	20	7	M4 x 0.7	M12 x 1.0	M3 x 0.5	24.5	3	44.5
16	12	14	20	19	8	3	6	24.5	10	8.5	6.5	7.5	24	10	M5 x 0.8	M14 x 1.0	M5 x 0.8	24.5	4	48.5

Mounting Bracket Dimensions

Flange: C(D)JP2F6 to 16

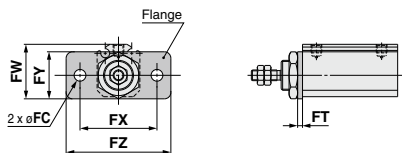

Flange

Symbol	FC	FT	FW	FX	FY	FZ
Bore size						
6	3.4	1.6	18.5	24	16	32
10	4.5	1.6	21	28	18	37
16	5.5	2.3	25.5	36	22	49

* Other dimensions are the same as basic mounting.

Foot: C(D)JP2L6 to 16

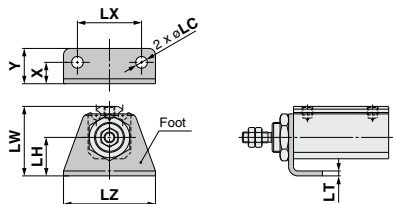

Foot

Symbol	X	Y	LC	LH	LT	LW	LX	LZ
Bore size								
6	6.5	10.5	3.4	11	1.6	21.5	20	28
10	7	12	4.5	13	1.6	25	24	33
16	10	16.5	5.5	18	2.3	32.5	30	43

* Other dimensions are the same as basic mounting.

Clevis: C(D)JP2D6 to 16

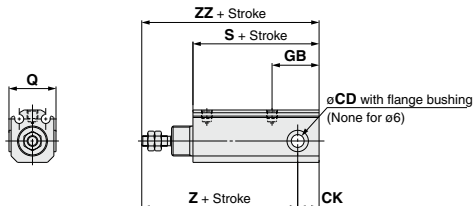

Clevis

Symbol	CD	CK	GB	Q
Bore size				
6	3 ^{+0.040} ₀	4	11.5	—
10	5 ^{+0.065} ₀	6.5	18	17 ⁰ _{-0.5}
16	6 ^{+0.065} ₀	10	22	22 ⁰ _{-0.5}

Symbol	S	Z	ZZ
Bore size	Without magnet	Built-in magnet	Without magnet
6	21	26	34
10	30.5	35.5	44
16	34	39	48

Trunnion: C(D)JP2T6 to 16

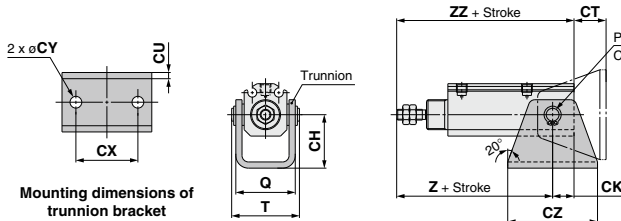

Rotation angle

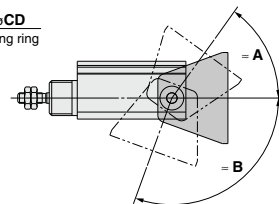

Trunnion

Symbol	CD	CH	CK	CT	CU	CX	CY	CZ	Q	T	Z	ZZ
Bore size											Without magnet	Built-in magnet
6	3	16	4	12	1.6	18	3.4	26	18.5	20.4	34	39
10	5	20	6.5	13.5	1.6	24	4.5	33	20.5	23.9	44	49
16	6	25	10	15	2.9	29	5.5	42	28	31.7	48	53

Applicable bore	ø6	ø10	ø16
= A	54°	62°	55°
= B	110°	110°	102°

* Provided as guidelines.
The values are varied depending on the condition.

CJ1

CJP

CJ2

JCM

CM2

CM3

CG1

CG3

JMB

MB

MB1

CA2

CS1

CS2

D-□

-X□

Technical Data

CJP2 Series

Accessory Bracket Dimensions

Single knuckle joint

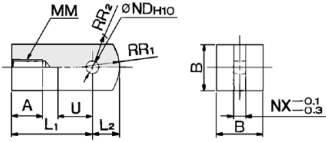

Material: Rolled steel

Part no.	Applicable bore size (mm)	A	B	L ₁	L ₂	MM	ND _{H10}	NX	R ₁	R ₂	U
I-P006A	6	5	6	12	3.5	M3 x 0.5	3 ^{+0.040} ₀	3	5	4	5
I-P010A	10	6.5	10	16	5.5	M4 x 0.7	5 ^{+0.048} ₀	5	8	6.3	7
I-P016A	16	7	12	19	7	M5 x 0.8	6 ^{+0.048} ₀	6	10	7.8	9

Double knuckle joint

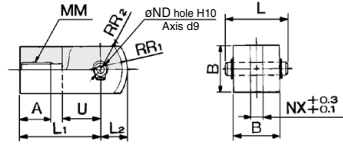

* Knuckle pin and retaining ring are included.

Material: Rolled steel

Part no.	Applicable bore size (mm)	A	B	L ₁	L ₂	MM	ND _{d9}	ND _{H10}	NX	R ₁	R ₂	U
Y-P006A	6	5	6	9	12	M3 x 0.5	3 ^{+0.020} ₀	3 ^{+0.040} ₀	3	5	4	5
Y-P010A	10	6.5	10	13.6	16	M4 x 0.7	5 ^{+0.030} ₀	5 ^{+0.048} ₀	5	8	6.3	7
Y-P016A	16	7	12	15.8	19	M5 x 0.8	6 ^{+0.030} ₀	6 ^{+0.048} ₀	6	10	7.8	9

Knuckle pin

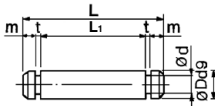

Material: Stainless steel

Part no.	Applicable bore size (mm)	D d9	L	d	L ₁	m	t	Retaining* ring
IY-P006	6	3 ^{+0.020} _{-0.045}	9	2.85	6.2	0.75	0.65	Clip C-type 3
IY-P010	10	5 ^{+0.030} _{-0.060}	13.6	4.8	10.2	1	0.7	C-type 5
IY-P015	16	6 ^{+0.030} _{-0.060}	15.8	5.7	12.2	1	0.8	C-type 6

* Included

Trunnion pin

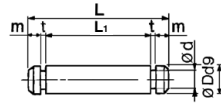

Material: Stainless steel

Part no.	Applicable bore size (mm)	D d9	L	d	L ₁	m	t	Retaining* ring
CT-P006	6	3 ^{+0.020} _{-0.045}	20.4	2.85	17.6	0.75	0.65	Clip C-type 3
CT-P010	10	5 ^{+0.030} _{-0.060}	23.9	4.8	20.5	1	0.7	C-type 5
CT-P015	16	6 ^{+0.030} _{-0.060}	31.7	5.7	28.1	1	0.8	C-type 6

* Included

Mounting nut

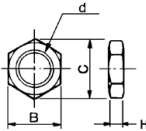

Material: Brass

Part no.	Applicable bore size (mm)	d	H	B	C
SNPS-004	4	M8 x 1.0	3	10	11.5
SNP-006	6	M10 x 1.0	3	14	16.2
SNP-010	10	M12 x 1.0	3	17	19.6
SNP-015	16	M14 x 1.0	4	19	21.9

Rod end nut

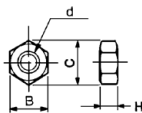

Material: Iron

Part no.	Applicable bore size (mm)	d	H	B	C
NTJ-004	4	M2 x 0.4	1.6	4	4.6
NTP-006	6	M3 x 0.5	1.8	5.5	6.4
NTP-010	10	M4 x 0.7	2.4	7	8.1
NTP-015	16	M5 x 0.8	3.2	8	9.2

Rod end cap

Flat type: CJ-CF□□□

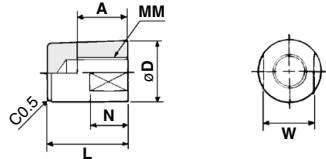

Round type: CJ-CR□□□

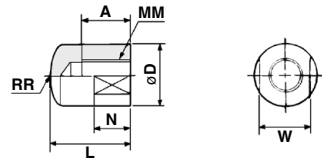

Material: Polyacetal

Part no.		Applicable bore size (mm)	A	D	L	MM	N	RR	W
Flat type	Round type								
CJ-CF004	CJ-CR004	4	5	6	9	M2 x 0.4	3	6	5
CJ-CF006	CJ-CR006	6	6	8	11	M3 x 0.5	5	8	6
CJ-CF010	CJ-CR010	10	8	10	13	M4 x 0.7	6	10	8
CJ-CF016	CJ-CR016	16	10	12	15	M5 x 0.8	7	12	10

CJP2 Series Auto Switch Mounting 1

Auto Switch Proper Mounting Position (Detection at Stroke End) and Its Mounting Height

D-A9□(V), D-M9□(V), D-M9□W(V), D-M9□A(V)

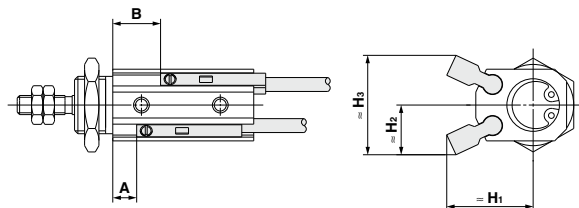

Applicable Auto Switches: D-A9□, D-A9□V

Bore size	A (When detecting at extended stroke end position)	B (When detecting at retracted stroke end position)								H ₁	H ₂	H ₃
		5 st	10 st	15 st	20 st	25 st	30 st	35 st	40 st			
ø4	—	—	—	—	—	—	—	—	—	—	—	—
ø6	1	6	11	16	21	26	—	—	—	13	10	20
ø10	1	6	11	16	21	26	31	36	41	16	9.5	19
ø16	1	6	11	16	21	26	31	36	41	18	12	24

Applicable Auto Switches: D-M9□, D-M9□V, D-M9□W, D-M9□WV, D-M9□A, D-M9□AV

Bore size	A (When detecting at extended stroke end position)	B (When detecting at retracted stroke end position)								H ₁	H ₂	H ₃
		5 st	10 st	15 st	20 st	25 st	30 st	35 st	40 st			
ø4	4	9	14	19	—	—	—	—	—	14.5	11.5	23
ø6	5	10	15	20	25	30	—	—	—	15	11.5	23
ø10	5	10	15	20	25	30	35	40	45	18	10.5	21
ø16	5	10	15	20	25	30	35	40	45	20	13	26

Note) Only adjust the setting position after confirming the auto switch is properly activated.

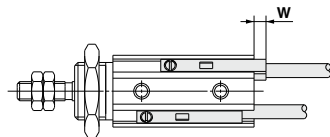

Mounting: Basic, Flange, Foot

Auto switch model	D-M9□ D-M9□W	D-M9□V D-M9□WV	D-M9□A	D-M9□AV	D-A96 D-A9□V	D-A90 D-A93
Bore size	W					
ø4	6	4	8	6	—	—
ø6	6	4	8	6	2	4.5
ø10	2.5	0.5	4.5	2.5	0	1
ø16	2.5	0.5	4.5	2.5	0	1

Mounting: Clevis, Trunnion

Auto switch model	D-M9□ D-M9□W	D-M9□V D-M9□WV D-A9□ D-A9□V	D-M9□A	D-M9□AV
Bore size	W			
ø4	—	—	—	—
ø6	1	0	3	2
ø10	0	0	2	2
ø16	0	0	2	2

* 0 (zero) denotes the auto switch does not protrude from the end surface.

Note) Adjust the auto switch after confirming the operating conditions in the actual setting.

Auto Switch Mounting 2

Operating Range

Auto switch model	Bore size (mm)			
	4	6	10	16
D-A9□(V)	—	5	6	7
D-M9□(V)	2.5	2.5	3	3.5
D-M9□W(V)				
D-M9□A(V)				

* Since the operating range is provided as a guideline including hysteresis, it cannot be guaranteed (assuming approximately ±30% dispersion). It may vary substantially depending on an ambient environment.

Minimum Stroke for Auto Switch Mounting

No. of auto switches mounted	Applicable auto switch model (mm)	
	D-M9□, D-M9□V	D-M9□W, D-M9□WV D-M9□A, D-M9□A(V) D-A9□, D-A9□V
1	5	5
2	5	10

Mounting and Moving Auto Switches

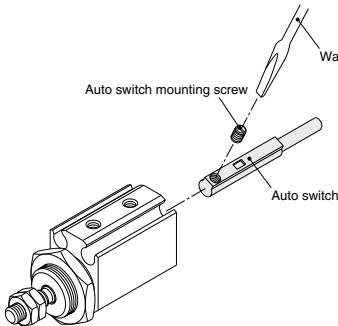

- Fit an auto switch into the auto switch mounting groove to set it roughly to the mounting position for an auto switch.
- After reconfirming the detecting position, tighten the auto switch mounting screw* to secure the auto switch.
- Modification of the detecting position should be made in the condition of ①.

* When tightening an auto switch mounting screw, use a watchmaker's screwdriver with a handle of approximately 5 to 6 mm in diameter.
(Use a tightening torque of approximately 0.10 to 0.20 N·m.)

Tightening torque for auto switch mounting screw (N·m)

Auto switch model	Tightening torque
D-A9□(V)	0.10 to 0.20
D-M9□(V)	0.05 to 0.15
D-M9□W(V)	
D-M9□A(V)	

⚠ Specific Product Precautions

Before handling auto switches, refer to pages 8 to 12 for Auto Switches Precautions.

⚠ Caution

- If auto switch cylinders are used in parallel, keep the distance between cylinders in accordance with the below chart.

Mounting Pitch

Auto switch model	Bore size (mm)			
	4	6	10	16
D-A9□(V)	—	20	25	30
D-M9□(V)	25	25	30	35
D-M9□W(V)				
D-M9□A(V)				

Use caution not to use them, getting closer than the specified pitch. Otherwise, it may cause auto switch to malfunction.

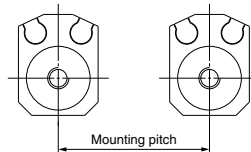



1 Clevis / Trunnion Type Mounting Interchangeable

Symbol

-X1666

CJP2 series standard model no. — **X1666**

↓ Clevis / Trunnion type mounting interchangeable (Former CJP)

Specifications

Applicable series	CJP2
Bore size	ø6, ø10, ø16

Other specifications	Same as standard type.
----------------------	------------------------

* ø6 is available for both standard and built-in magnet types.

* ø10 and ø16 are available for the standard type (The built-in magnet type is interchangeable.)

Dimensions

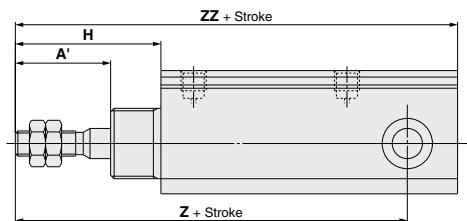

Bore size(mm)	A'	H	Z	ZZ
6	18.5 (13.5)	26.5 (21.5)	43.5	47.5
10	17	25	49	55.5
16	19	29	53	63

* Dimensions other than above are same as basic type.

(): For the built-in magnet type

CJ1

CJP

CJ2

JCM

CM2

CM3

CG1

CG3

JMB

MB

MB1

CA2

CS1

CS2

D-□

-X□

Technical Data



CJP2 Series Specific Product Precautions

Be sure to read this before handling the products. Please consult with SMC for the use other than the specifications.

Mounting

⚠ Caution

Mounting nut maximum tightening torque and panel width

- ① Do not apply more torque than the maximum torque range when mounting the cylinder or bracket. Also, do not attach a panel with a thickness beyond the specified range.

Cylinder bore size	Thread	Maximum tightening torque (N·m)	A dimension maximum value (mm)
ø4	M8 x 1	6.2	3
ø6	M10 x 1	12.5	4
ø10	M12 x 1	21.0	4
ø16	M14 x 1	34.0	5

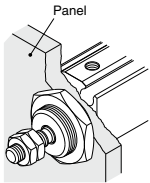

Panel mounting

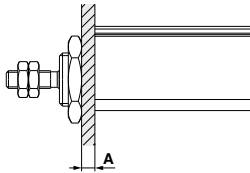

Panel maximum thickness

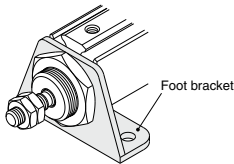

Foot mounting

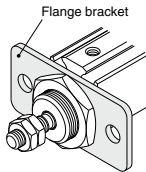

Flange mounting

- ② Do not apply more tightening torque than the below specified range when attaching a load on the rod end, rod end cap, single or double knuckle joint.

Applicable bore size	Thread size	Maximum tightening torque (N·m)
ø4	M2 x 0.4	0.1
ø6	M3 x 0.5	0.3
ø10	M4 x 0.7	0.8
ø16	M5 x 0.8	1.6

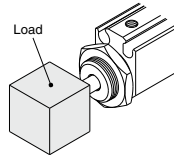

Rod end load mounting

Rod end cap (flat type)

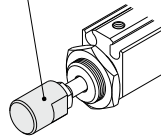

Rod end cap (flat type) mounting

Rod end cap (round type)

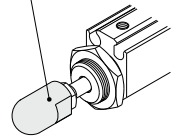

Rod end cap (round type) mounting

Single knuckle joint

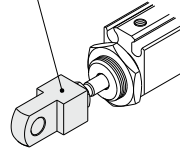

Single knuckle joint mounting

Double knuckle joint

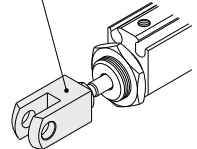

Double knuckle joint mounting

Piping

⚠ Caution

The piping port size of CJ2□6 and CJP2□10 is M3 x 0.5. If using piping tube O.D. ø6, piping is possible on M3 One-touch fittings (applicable tube O.D. ø4) when used with a reducer (KQ2R06-04A).

* For details of One-touch fittings, refer to Best Pneumatics No. 7.

Disassembly and Maintenance

⚠ Caution

Snap ring installation / removal

- To replace seals or grease the cylinder during maintenance, use an appropriate pair of pliers (tool for installing a C-type retaining ring for hole). After re-installing the cylinder, make sure that the retaining ring is placed securely in the groove before supplying air.
- To remove and install the retaining ring for the knuckle pin or the trunnion pin, use an appropriate pair of pliers (tool for installing a C-type retaining ring for hole). In particular, use a pair of ultra-mini pliers, for removing and installing the retaining rings on the ø6 cylinder. Do not disassemble the CJP4 cylinder. Do not loosen or remove the head cover.

Pin Cylinder: Single Acting, Spring Return

CJP Series

ø4, ø6, ø10, ø15

A short stroke miniature cylinder with a shorter overall length.

The installation space can be significantly reduced because this cylinder can be recessed directly into a machine body or installed on a panel. Thus, the machine can be made more compact.

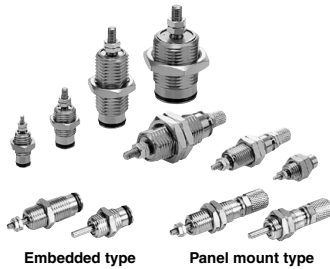

Symbol

Single acting, Spring return

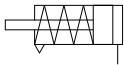

Made to Order (ø6 to ø15)
(For details, refer to pages 1703 to 1896.)

Symbol	Specifications
XC17	Pin cylinder with rod quenched
XC22	Fluororubber seals

Mounting

Panel mount type **Embedded type**

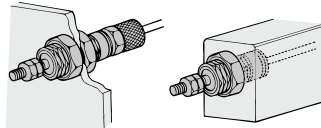

Moisture Control Tube IDK Series

When operating an actuator with a small diameter and a short stroke at a high frequency, the dew condensation (water droplet) may occur inside the piping depending on the conditions.

Simply connecting the moisture control tube to the actuator will prevent dew condensation from occurring. For details, refer to [the IDK series in the Best Pneumatics No. 6](#).

How to Order

CJP B 10 - 15 H4 - [] - []

Pin cylinder •

Mounting •

B	Panel mount type
S	Embedded type

Bore size •

4	4 mm
6	6 mm
10	10 mm
15	15 mm

Cylinder standard stroke (mm) •

ø4, ø6, ø10, ø15	5, 10, 15
-------------------------	-----------

Rod end thread

Nil	With thread
B	Without thread

Hose nipple (Applicable to the mounting type B panel mount type (ø6 to ø15) only.)
(Hose nipple is not attached to embedded type.)

Nil	Without hose nipple *
H4	For ø4/ø2.5 tubing
H6	For ø6/ø4 tubing

* Refer to Δ caution on piping on page 39.

Specifications

Action	Single acting, Spring return	
Maximum operating pressure	0.7 MPa	
Minimum operating pressure	ø4	0.3 MPa
	ø6	0.2 MPa
	ø10, ø15	0.15 MPa
Proof pressure	1 MPa	
Ambient and fluid temperature	-10 to 70°C (No freezing)	
Lubrication	Not required (Non-lube)	
Piston speed	50 to 500 mm/s	
Cushion	None	
Stroke length tolerance	$^{+1.0}$ 0	
Rod end type	With thread/Without thread	
Mounting	Panel mount type	Embedded type
Accessory (Standard equipment)	Standard equipment	Mounting nut (2) Rod end nut (2) *
	Option	Hose nipple (Except ø4)
		Mounting nut (1) Gasket (1) Rod end nut (2) *
		—

* When rod end is threaded.

* For details about the hose nipple (accessory), refer to page 39.

Application Examples

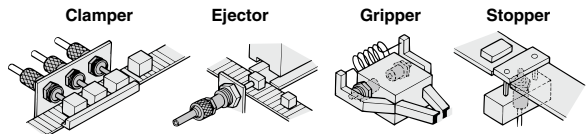

CJ1

CJP

CJ2

JCM

CM2

CM3

CG1

CG3

JMB

MB

MB1

CA2

CS1

CS2

CS2

CS2

CS2

CS2

CS2

CS2

CS2

CS2

CS2

CS2

CS2

CS2

CS2

CS2

CS2

CS2

CS2

CJP2 Series

Standard Stroke

Bore size (mm)	Stroke (mm)
4	5, 10, 15
6	5, 10, 15
10	5, 10, 15
15	5, 10, 15

Weight

Model	Stroke (mm)		
	5	10	15
CJP□4	10	13	15
CJP□6	10.6	13.1	15.6
CJP□10	28	33	38
CJP□15	72	82	92

* Weight of hose nipple (4 g) for panel mounting is excluded.

Theoretical Output

Bore size (mm)	Operating direction	Operating pressure (MPa)		
		0.3	0.5	0.7
4	OUT	0.97	3.48	6.00
	IN	1.0		
6	OUT	4.56	10.2	15.9
	IN	1.42		
10	OUT	17.6	33.3	49.0
	IN	2.45		
15	OUT	42.2	77.5	113
	IN	4.41		

Spring Reaction Force

Bore size (mm)	Stroke (mm)	Retracted side	Extended side
4	5, 10, 15	2.80	1.00
6	5, 10, 15	3.92	1.42
10	5, 10, 15	5.98	2.45
15	5, 10, 15	10.80	4.41

* Same spring force for each stroke.

Hose Nipple Dedicated for Panel Mount Type

(With fixed orifice)

Applicable tubing	Part no.
For ø4/ø2.5 tubing	CJ-5H-4
For ø6/ø4 tubing	CJ-5H-6

Construction (Not able to disassemble.)

Panel mount type

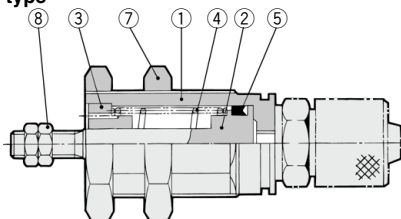

Embedded type

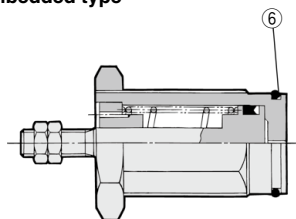

Component Parts

No.	Description	Material	Note
1	Cover	Brass	Electroless nickel plated
2	Piston	Stainless steel	
3	Collar	Oil-impregnated sintered alloy	ø4 Brass + Electroless nickel plated ø6, ø10 Bronze
4	Return spring	Steel wire	Zinc chromated
5	Piston seal	NBR	
6	Gasket	NBR	Special product (O-ring) embedded type only
7	Mounting nut	Brass	Electroless nickel plated
8	Rod end nut	Steel	Zinc chromated

Dedicated Nut / Part No.

Description	Bore size (mm)	4	6	10	15
	Mounting nut		SNPS-004	SNPS-006	SNPS-010
Rod end nut		NTJ-004	NTP-006	NTP-010	NTP-015

Replacement Parts / Gasket

Bore size (mm)	Order no.	Contents
4	CJPS4-G	Above no. ⑥
6	CJPS6-G	
10	CJPS10-G	
15	CJPS15-G	

* For the plug mounting type
 * Since gaskets (10 pcs/set) do not include a grease pack (10 g), order it separately.
Grease pack part number: GR-S-010 (10g)

* Dedicated for the embedded type.

Mounting nut

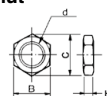

Part no.	Applicable bore size (mm)	d	H	B	C
SNPS-004	4	M8 x 1.0	3	10	11.5
SNPS-006	6	M10 x 1.0	3	12	13.9
SNPS-010	10	M15 x 1.5	4	19	22
SNPS-015	15	M22 x 1.5	5	27	31

Material: Brass

Rod end nut



Part no.	Applicable bore size (mm)	d	H	B	C
NTJ-004	4	M2 x 0.4	1.6	4	4.6
NTP-006	6	M3 x 0.5	1.8	5.5	6.4
NTP-010	10	M4 x 0.7	2.4	7	8.1
NTP-015	15	M5 x 0.8	3.2	8	9.2

Material: Steel

Allowable Kinetic Energy

⚠ Caution

When driving an inertial load, operate a cylinder with kinetic energy within the allowable value. The range in the chart below that is delineated by bold solid lines indicates the relation between load mass and maximum driving speeds.

Bore size (mm)	4	6	10	15
Piston speed (m/s)	0.05 to 0.5			
Allowable kinetic energy (J)	0.5×10^{-3}	3×10^{-3}	8×10^{-3}	19×10^{-3}

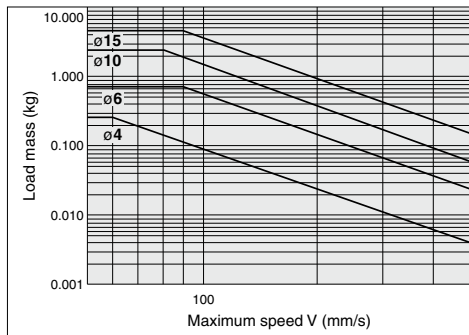

Allowable Lateral Load

Strictly observe the limiting range of lateral load on a piston rod. (Refer to the below graph.) If this product is used beyond the limits, it may shorten the machine life or cause damage.

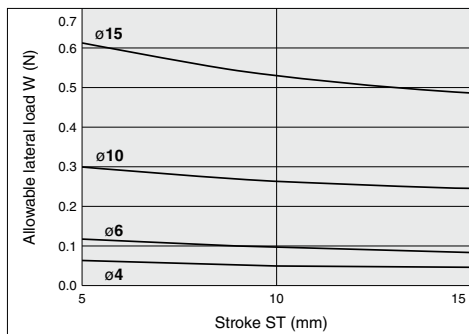

CJ1

CJP

CJ2

JCM

CM2

CM3

CG1

CG3

JMB

MB

MB1

CA2

CS1

CS2

D-

-X

Technical
Data

Recommended Mounting Hole Dimensions for Embedded Type

When embedded

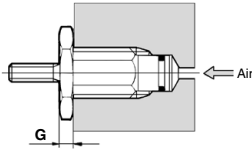

Machining dimensions for mounting

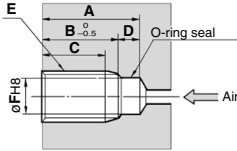

Bore size (mm)	Stroke	(mm)						
		A	B	C	D	E	F	G
4	5	12	8.5	6	3.5	M8 x 1.0	6.5	3
	10	20	16.5	14				
	15	28	24.5	22				
6	5	16	12.5	10	3.5	M10 x 1.0	8.5	3
	10	23	19.5	17				
	15	30	26.5	24				
10	5	17	13.5	10.5	3.5	M15 x 1.5	12	4
	10	23.5	20	17				
	15	30.5	27	24				
15	5	19	14.5	11.5	4.5	M22 x 1.5	19	5
	10	25	20.5	17.5				
	15	31.5	27	24				

Note) E and ϕF should be machined in a concentric manner.

Dimensions: Panel Mount Type

CJPB4

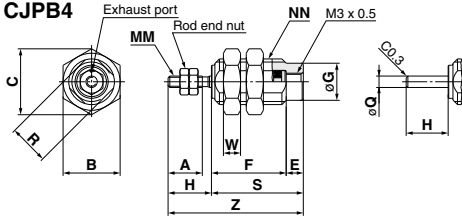

CJPB6, 10, 15

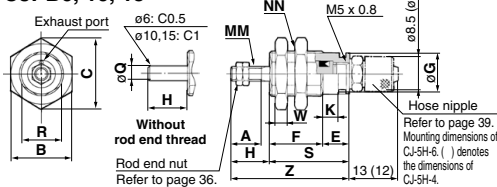

Bore size (mm)	A	B	C	E	F			G	H	K	MM
					5 st	10 st	15 st				
4	6	10	11.5	3	13	21	29	6.5	7.5	—	M2 x 0.4
6	7	12	13.9	6	12.5	19.5	26.5	8.5	9	3.5	M3 x 0.5
10	10	19	22	6	14.5	21	28	12	12	3.5	M4 x 0.7
15	12	27	31	7	16.5	22.5	29	19	14	4.2	M5 x 0.8

Bore size (mm)	NN	R	S			Z				
			5 st	10 st	15 st	W	5 st	10 st	15 st	Q
4	M8 x 1.0	7	16	24	32	3	23.5	31.5	39.5	2
6	M10 x 1.0	9	18.5	25.5	32.5	3	27.5	34.5	41.5	3
10	M15 x 1.5	13	20.5	27	34	4	32.5	39	46	5
15	M22 x 1.5	20	23.5	29.5	36	5	37.5	43.5	50	6

Dimensions: Embedded Type

CJPS4

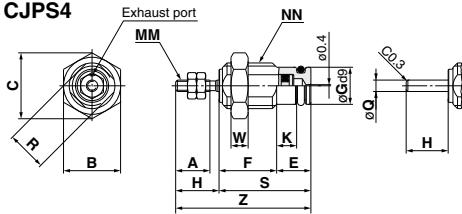

CJPS6, 10, 15

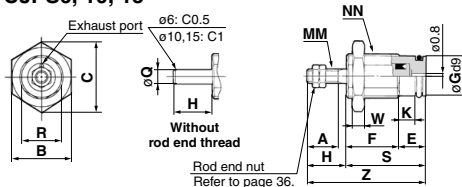

Bore size (mm)	A	B	C	E	F			G	H	K	MM
					5 st	10 st	15 st				
4	6	10	11.5	6	10	18	26	6.5	7.5	3.5	M2 x 0.4
6	7	12	13.9	6	12.5	19.5	26.5	8.5	9	3.5	M3 x 0.5
10	10	19	22	6	14.5	21	28	12	12	3.5	M4 x 0.7
15	12	27	31	7	16.5	22.5	29	19	14	4.2	M5 x 0.8

Bore size (mm)	NN	R	S			Z				
			5 st	10 st	15 st	W	5 st	10 st	15 st	Q
4	M8 x 1.0	7	16	24	32	3	23.5	31.5	39.5	2
6	M10 x 1.0	9	18.5	25.5	32.5	3	27.5	34.5	41.5	3
10	M15 x 1.5	13	20.5	27	34	4	32.5	39	46	5
15	M22 x 1.5	20	23.5	29.5	36	5	37.5	43.5	50	6



CJP Series Specific Product Precautions

Be sure to read this before handling the products. Please consult with SMC for the use other than the specifications.

Piping

⚠ Caution

The following fittings are recommended for this cylinder connection. However, there may be a case where the piston speed exceeds 500 mm/sec. even with the recommended fittings for this cylinder. Use a speed controller in such cases.

Cylinder bore size	Applicable bore size	Fitting type	Connection thread	Model
ø4	ø2	One-touch fitting	M3 x 0.5	KQ2□02-M3G
		Miniature fitting		M-3AU-2
One-touch fitting		M5 x 0.8	KQ2□02-M5N	
Miniature fitting			M-5AU-2	
ø6 ø10 ø15	ø4/2.5 ø6/4	Dedicated hose nipple (with fixed orifice)		CJ-5H-4 CJ-5H-6

* Please be aware that cylinder speed may slow down on the retracting side when using the above one-touch fittings and miniature fittings with a cylinder bore size of ø15.

Hose nipple

CJ-5H-4

(For ø4/ø2.5 tubing)

CJ-5H-6

(For ø6/ø4 tubing)

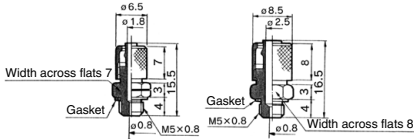

In addition to the above fittings and hose nipples, the below fittings can also be attached to the cylinder. When using the below fittings be sure to provide a speed controller after adjusting it to 500 mm/s or less.

Cylinder bore size	Applicable bore size	Fitting type	Connection thread	Model
ø4	3.2	One-touch fitting	M3 x 0.5	KQ2□23-M3G
	4			KQ2□04-M3G
ø6 ø10 ø15	3.2		M5 x 0.8	KQ2□23-M5□
	4			KQ2□04-M5□
	6		KQ2□06-M5□	

Recommended Speed Controller

Applicable bore size (mm)	Connection thread	Elbow type meter-in	Universal type meter-in	In-line type meter-in
ø2	M3	AS1211F-M3-02	—	AS1002F-02
	M5	AS1211F-M5E-02A	—	
ø3.2	M3	AS1211F-M3-23	AS1311F-M3-23	AS1002F-23
	M5	AS1211F-M5E-23A	AS1311F-M5E-23A	
ø4	M3	AS1211F-M3-04	AS1311F-M3-04	AS1002F-04
	M5	AS1211F-M5E-04A	AS1311F-M5E-04A	
ø6	M5	AS1211F-M5E-06A	AS1311F-M5E-06A	AS1002F-06

* For details about one-touch fittings, miniature fittings and speed controllers (applicable tubing O.D. ø2 only), refer to the Best Pneumatics No. 7. Also, for details about speed controllers (applicable tubing O.D. ø3.2 to ø6), refer to the Best Pneumatics No. 7.

* Refer to the Fittings and Tubing Precautions (Best Pneumatics No. 7) for how to handle one-touch fittings.

Mounting

⚠ Caution

Do not use it in such a way that a load could be applied to the piston rod during the retraction. The spring that is built into the cylinder provides only enough force to retract the piston rod. Thus, if a load is applied, the piston rod may not be able to retract to the end of the stroke.

CJ1

CJP

CJ2

JCM

CM2

CM3

CG1

CG3

JMB

MB

MB1

CA2

CS1

CS2

D-□

-X□

Technical Data