

Air-hydro Unit

CC Series

Converting pneumatic pressure to hydraulic pressure (equivalent pressure) solves cylinder problems occurring due to the compression characteristics of pneumatic pressure.

- Constant-speed operation is possible with load fluctuations.
- Solves the problems of sticking and slipping associated with low-speed operation.
- Intermediate stopping and skip movement possible.
- Suitable for slow operation of a rotary actuator.

Integrate a converter and a valve unit in a compact configuration.

- Possible to select 4 types of valve units for applications.
- Possible to connect a converter and a valve unit independently.

Wide range of series in terms of converter capacity and valve unit flow rate control capability.

- Compatible with cylinder bore sizes up to $\phi 300$.
- Operation at a piston speed of 180 mm/sec with a size $\phi 80$ cylinder bore.
(Operating pressure: 0.5 MPa, Load mass: No load, Piping: I.D. $\phi 19$ mm x length 1 m)

CC

**Air-hydro Unit
CC Series**



**Air-hydro Converter
CCT Series**



**Valve Unit
CCVS/CCVL Series**



Application Example

1. Function of stop valve

Prevents load dropping (In an emergency)

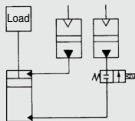

Multipoint intermediate stops

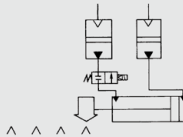

Fixed end point (Not only solid but also liquid is available if there is pump mechanism at the end.)

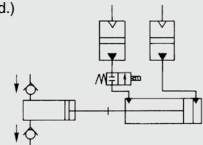

2. Function of skip valve

Fast forward to working process

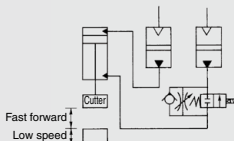

3. Flow control valve (With pressure compensation)

Uniform driving for load fluctuations

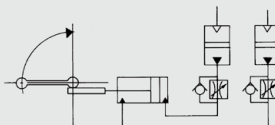

4. Throttle valve/Speed controller

- Working without jumping at low speeds or when starting.
- Control with throttle valve and speed controller when transferring and carrying.

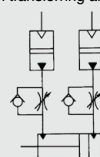

D-
-X
Technical Data

CC Series Selection Procedure

Step (1) Select the bore size of air-hydro cylinder

First of all, select a bore size from data (D) <Theoretical Output Table>. When making a selection, the ratio between the theoretical output and the load should be 0.5 or less.

Step (2) Select converter

Select the nominal diameter and the effective oil level stroke from data (A), <Cylinder Displacement and Converter Capacity Diagram>. When selecting a converter by its nominal diameter, the converter's oil level speed should be 200 mm/s or less. When the cylinder stroke is beyond <Cylinder Displacement and Converter Capacity Diagram>, select a converter capacity that is 1.5 or more times larger than the cylinder capacity as a guide.

Step (3) Select required function for valve unit

Select a model from data (B), <Converter and Valve Unit Combinations and Applications Table> by determining the functions that are needed for the valve unit in accordance with your application.

Step (4) Select the size of valve unit

Using data (C), <Air-Hydro Cylinder's Maximum Operating Speed> as a reference, select the size of a valve unit by determining whether it meets the desired cylinder operating speed.

* The model of an air-hydro unit that is suitable for a particular application is determined by the combination of the converter that was selected in steps (1) and (2), and the valve unit that was selected in steps (3) and (4). For details on how the models are indicated, refer to "How to Order".

⚠ Caution on Selection

1. Make sure to select a cylinder and a rotary actuator for an air-hydro operation. Do not use these for pneumatic operations because they will lead to oil leaks.

Air-hydro cylinder: **CA1**□H□-□
CQ2□H□-□
CS1□H□-□
CM2□H□-□
CG1□H□-□ (up to ø63)
HC03-X1□-□ x □□

Air-hydro rotary actuator:
CRA1H□-□

2. When determining the size of a converter based on the <Cylinder Displacement and Converter Capacity Diagram>, do not select a converter bore that is too small for the cylinder's bore size because this will increase the oil level speed, causing the oil to blow out. Thus, select a converter bore, so that the oil level speed will be 200 mm/s or less.

Refer to the table below for the relationship of the converter size, cylinder bore size and cylinder piston speed, which make the oil level 200 mm/s or more.

When the cylinder piston speed becomes more than those listed in the table below, select a converter one size bigger.

Converter size	Cylinder bore size (mm)	Cylinder piston speed (mm/s)
CCT40	ø32	310 or more
	ø40	200 or more
CCT63	ø50	315 or more
	ø63	200 or more
	ø80	120 or more
	ø100	75 or more

Data (A) Volume of Cylinder/Capacity of Converter

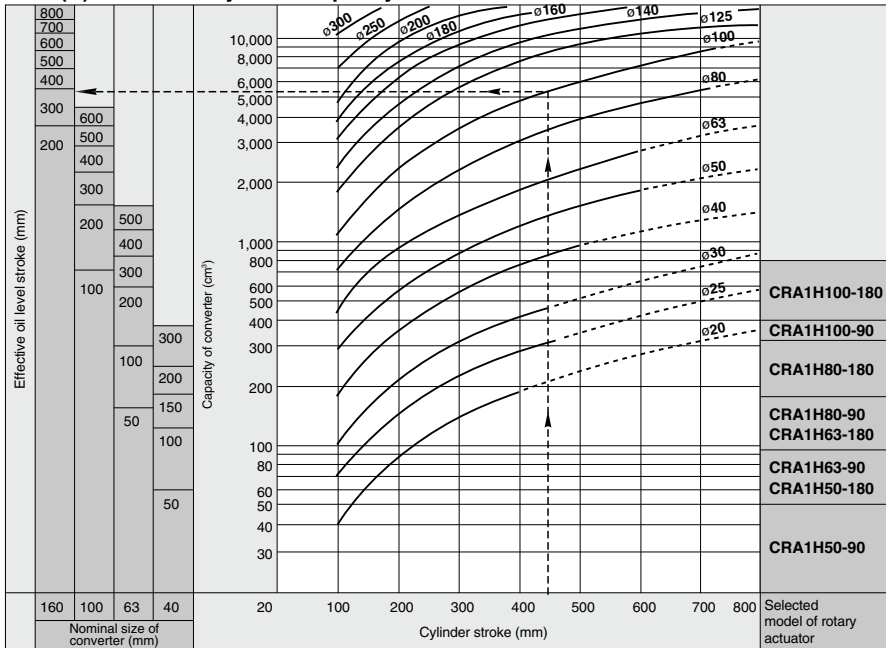

How to read the graph (ex: when using a φ100 to 450 st cylinder): Draw a line perpendicularly from the cylinder stroke of 450 to the point at which it intersects the (curve) cylinder bore size of φ100, and extend it to the left to obtain the displacement of approximately 5,300 cm³. Then, select a converter with a larger capacity. The converter will be φ160 to 300. To obtain the capacity of the converter, multiply the cylinder displacement by approximately 1.5. (Note) Select the nominal diameter of the converter so that the converter's oil level speed does not exceed 200 mm/s.

Data (B) Combination of Converter and Valve Unit/Operating Purpose

Control valve Combined valve	Without control valve	Throttle valve	Flow control valve (With pressure compensation)	Operating purpose
Without stop valve Without skip valve	—			In case only speed control is needed.
Stop valve				Intermediate stops, step feed, emergency stops, and stop for service are possible.
Skip valve	—			Double speed change is possible. (Fast forward, Uniform speed delivery)
With stop valve With skip valve	—			Intermediate stops, step feed, emergency stops, stops for service, double speed change are possible.
Operating purpose	For applications that do not require speed control, as long as objects are moved smoothly. Or for applications in which a pneumatic speed controller suffices. (3 dm³/min or more)	For applications that require a crawl speed control (0.3 dm³/min or more), provided that fluctuations caused by operating pressures and loads are permissible.	For applications that require a crawl speed fluctuation control (0.04 to 0.06 dm³/min or more), and require an almost constant speed even when the operating pressure or the load fluctuates.	

CC

D-□
-X□
Technical Data

Data (C) Maximum Driving Speed of Valve Unit and Cylinder

Cylinder driving speed when operating flow control valve

Condition: Operating press.: 0.3 to 0.7 MPa
 Load ratio: 50% or less
 Operating oil: No additive turbine oil Class 1 (ISO VG32)
 Oil piping length: 1 m

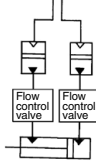

CCVS10/11/12/13

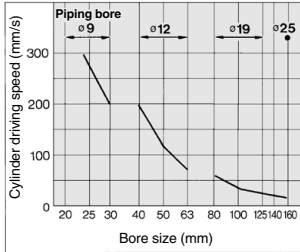

CCVS30/31/32/33

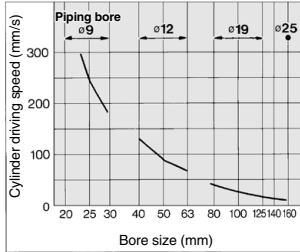

CCVL10/11/12/13

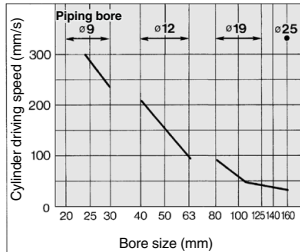

Caution on Circuit Construction

1. The converter's oil level must be properly maintained because a slight oil leak from the sliding of the seal of the air-hydro unit can not be avoided.
2. Make sure to install an exhaust cleaner (AMC series/Best Pneumatics No.7) on the direction switching valve.

Cylinder driving speed when operating throttle valve

Condition: Operating press.: 0.5 MPa
 Operating oil: No additive turbine oil Class 1 (ISO VG32)
 Oil piping length: 1 m

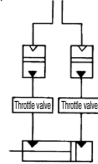

CCVS20/21/22/23

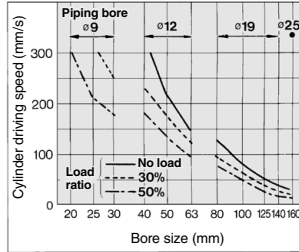

CCVL20/21/22/23

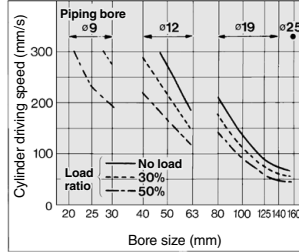

Cylinder driving speed when operating stop valve

Condition: Operating press.: 0.5 MPa
 Operating oil: No additive turbine oil Class 1 (ISO VG32)
 Oil piping length: 1 m

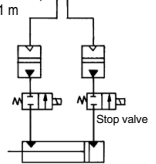

CCVS02

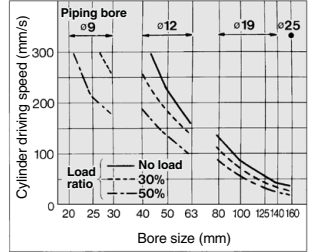

CCVL02

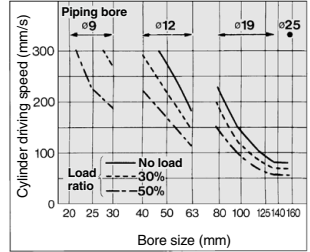

3. Within the reciprocating movement of the actuator, if only the movement in one direction must be controlled, connect an air-hydro unit to the cylinder piping port of the control direction as shown in Fig. (1).

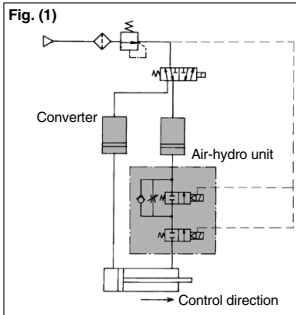

4. To operate (without synchronizing) two or more actuators with a single converter, use a valve unit with individual cylinders as shown in Fig. (2). The actuators will operate starting with the one that is the easiest to operate.

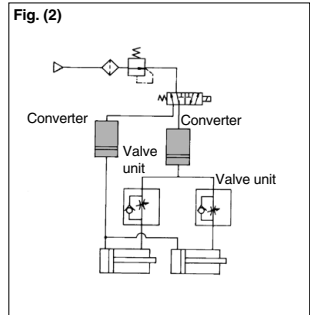

[Synchronized operation]

It is practically impossible to completely synchronize the operation of two or more cylinders. Therefore, a mechanical device must be used for regulating the operation of individual cylinders. The mechanical device must provide a level of rigidity that is appropriate for the cylinder thrust. If it lacks rigidity, it could apply an unbalanced load on the cylinders, leading to a considerable reduction in the durability of the cylinders.



Data (D) Theoretical Output

Bore size (mm)	Rod size (mm)	Operating direction	Piston area (mm ²)	Operating pressure (MPa)								
				0.2	0.3	0.4	0.5	0.6	0.7	0.8	0.9	1.0
20	8	OUT	314	62.8	94.2	126	157	188	220	251	283	314
		IN	264	52.8	79.2	106	132	158	185	211	238	264
25	10	OUT	491	98.2	147	196	246	295	344	393	442	491
		IN	412	82.4	124	165	206	247	288	330	371	412
32	12	OUT	804	161	241	322	402	482	563	643	724	804
		IN	691	138	207	276	346	415	484	553	622	691
40	14	OUT	1260	252	378	504	630	756	882	1010	1130	1260
		IN	1100	220	330	440	550	660	770	880	990	1100
50	20	OUT	1960	392	588	784	980	1180	1370	1570	1760	1960
		IN	1650	330	495	660	825	990	1160	1320	1490	1650
63	20	OUT	3120	624	936	1250	1560	1870	2180	2500	2810	3120
		IN	2800	560	840	1120	1400	1680	1960	2240	2520	2800
80	25	OUT	5030	1010	1510	2010	2520	3020	3520	4020	4530	5030
		IN	4540	908	1360	1820	2270	2720	3180	3630	4090	4540
100	30	OUT	7850	1570	2360	3140	3930	4710	5500	6280	7070	7850
		IN	7150	1430	2150	2860	3580	4290	5010	5720	6440	7150
125	36	OUT	12300	2460	3690	4920	6150	7380	8610	9840	11100	12300
		IN	11300	2260	3390	4520	5650	6780	7910	9040	10200	11300
140	36	OUT	15400	3080	4620	6160	7700	9240	10800	12300	13800	15400
		IN	14400	2880	4320	5760	7200	8640	10100	11500	13000	14400
160	40	OUT	20100	4020	6030	8040	10100	12100	14100	15100	18100	20100
		IN	18800	3760	5640	7520	9400	11300	13200	15000	16900	18800
180	45	OUT	25400	5080	7620	10200	12700	15200	17800	20300	22900	25400
		IN	23900	4780	7170	9560	12000	14300	16700	19100	21500	23900
200	50	OUT	31400	6280	9420	12600	15700	18800	22000	25100	28300	31400
		IN	29500	5900	8850	11800	14800	17700	20700	23600	26600	29500
250	60	OUT	49100	9820	14700	19600	24600	29500	34400	39300	44200	49100
		IN	46300	9260	13900	18500	23200	27800	32400	37000	41700	46300
300	70	OUT	70700	14100	21200	28200	35400	42400	49500	56600	63600	70700
		IN	66800	13400	20000	26700	33400	40100	46800	53400	60100	66800

CC

⚠ Caution on Circuit Construction

Skip valve

- When using a skip valve, the maximum allowable ratio between the high speed and the low speed is approximately 3:1. If this ratio is too large, air bubbles could form due to cavitations, and could lead to the conditions described in the single-side hydro (1), 2), 3), and 4) of the Product Specific Precautions (page 1176).
- If the skip valve of an air-hydro unit with skip valve is operated, because it is not equipped with a speed control valve, the fast-forward speed will be determined by the model, piping conditions, and the actuator used. In this case, the cylinder could operate at extremely high speeds if the cylinder bore size is small. If it is necessary to control the fast forward speed, use a pneumatic speed controller as shown in Fig. (3).

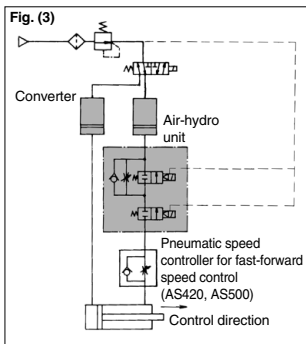

Stop valve

- Operate the stop valve under meter-out control.
- If the movement must be stopped at an intermediate position in both directions through the use of a stop valve, make sure to provide a stop valve for both the head side and the rod side.

- If the cylinder is operated facing up, when the stop valve that is provided on the rod side is closed, the piston rod could descend when the pressure on the head side is turned to zero. To prevent this, a stop valve must also be provided on the head side.
- Because the stop valve uses a metal seal, it has a slight leak. Due to this leakage, the cylinder could move in the amount that is shown in the Fig. (4), after making an intermediate stop.

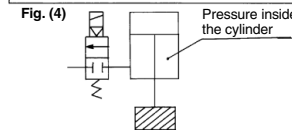
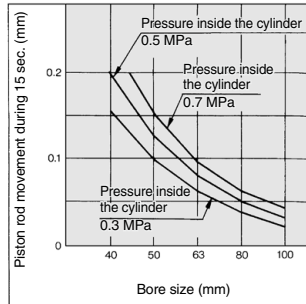

- For response time of stop valve, refer to the list below.

Model	Response time
CCVS	0.07 ± 0.015 sec.
CCVL	0.11 ± 0.02 sec.

Intermediate stop accuracy of CCVS:
50 mm/s × ±0.015 sec. = ±0.75 mm in case of 50 mm/s

Surge pressure

- When the cylinder is operated at high speeds and reaches the stroke end, surge pressure could be created in the rod side or in the head side. At this time, if the stop valve of the rod side or the head side is closed, the surge pressure could become sealed in, preventing the stop valve from operating. This can be solved by closing the stop valve 1 to 2 seconds later.

Temperature rise

- When the cylinder is stopped at the stroke end, a speed control valve located opposite to the stroke end (which is the stop valve on the rod cover during retraction, and the stop valve on the head cover during extension) remains closed, the cylinder's internal pressure could increase with temperature, preventing the stop valve from opening. Therefore, do not close the stop valve in this condition.

Jumping of pressure compensating mechanism

- Be aware that the amount of jumping that is shown in Fig. (5) applies to the pressure compensation mechanism during the operation of the cylinder. "Jumping" is a condition in which the cylinder operates without control at a speed that is higher than the control speed.

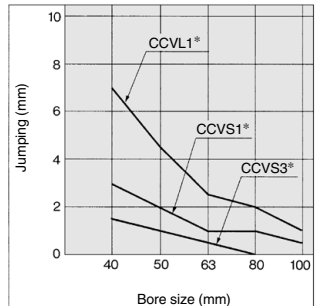

Fig. (5)

D-□

-X□

Technical Data

Air-hydro Unit CC Series

The air-hydro unit consists of a converter and a valve unit that are compactly integrated. It converts air pressure to an equivalent hydraulic pressure, and this hydraulic pressure is used for operating an actuator, thus solving the problem that is associated with the compression characteristics of air. Thus, in spite of using pneumatic equipment, it performs similarly to a hydraulic unit, operating at a constant speed during starting or in the presence of load fluctuations, and at the same time solving the problems of sticking and slipping associated with low speed operations. This unit is ideal for achieving accurate and constant speed of the cylinder, intermediate stopping, skip movement, or for slow operation of a rotary actuator.

A selection of valve unit is available to suit your application.

High cylinder driving speed.

Through the availability of a wide range of series in terms of converter capacity and valve unit flow rate control capability, speed as high as 180 mm/s (throttle valve) can be achieved with a ø80 cylinder.

(Operating pressure: 0.5 MPa, unloaded, Piping: Bore 19 mm x 1 m)

Although the converter and the valve unit are integrated, they can also be operated by providing individual piping.



CC Air-hydro Unit Part No. Combinations

Converter nominal size	Valve unit size	Control valve	Combined valve
63	S	0	2
		1	0, 1, 2, 3
		2	0, 1, 2, 3
		3	0, 1, 2, 3
100	S	0	2
		1	0, 1, 2, 3
		2	0, 1, 2, 3
		3	0, 1, 2, 3
		0	2
160	L	1	0, 1, 2, 3
		2	0, 1, 2, 3
		0	2
		1	0, 1, 2, 3
		2	0, 1, 2, 3

How to Order

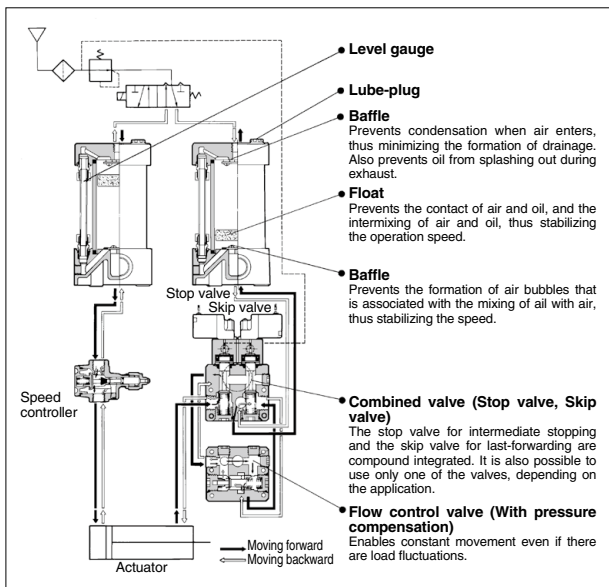
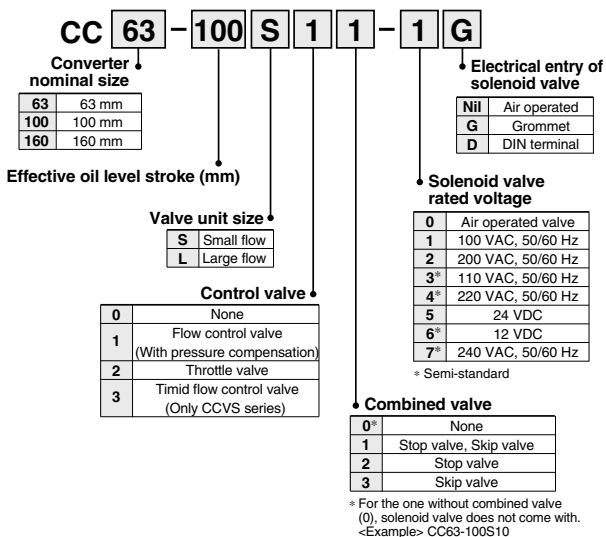

Dimensions

Hydro Unit

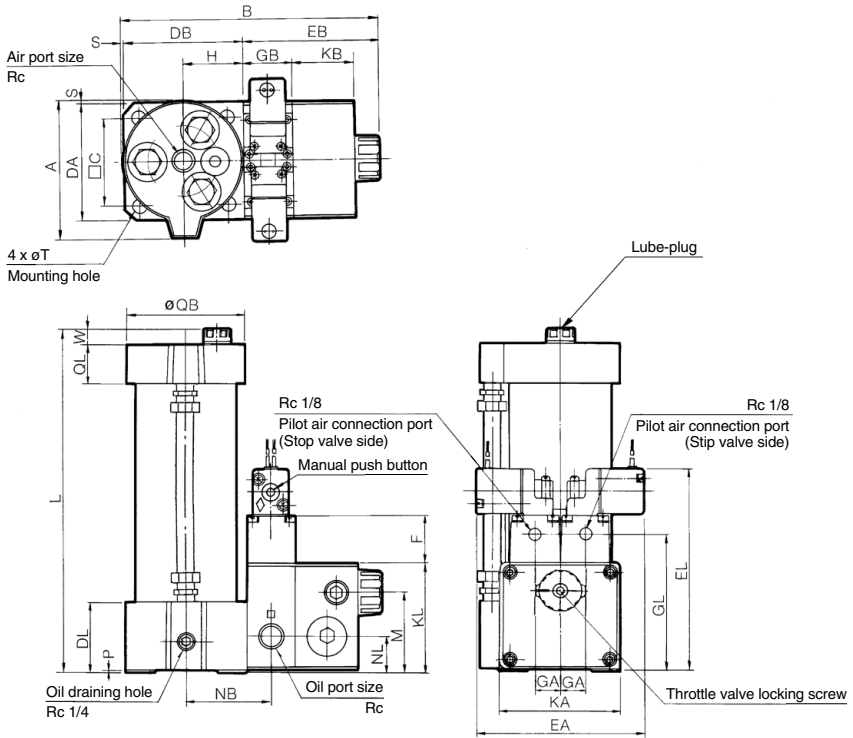

CC

Model	Air port size Rc	Oil port size Rc	A	B	C	DA	DB	DL	EA	EB	EL	F	GA	GB	GL	H	KA	KB	KL	M
CC63-□S□1-□G	3/8	1/2	104	186	64	86	88	53	121.8	98	151.5	35	18	35	104	45	86	45	83	60
CC100-□S□1-□G	1/2	1/2	139	223	92	116	123	61	121.8	98	156.5	35	18	35	109	65	86	45	88	65
CC100-□L□1-□G	1/2	3/4	139	259	92	116	123	61	133.8	134	185.5	40	24	50	140	65	116	66	112	85
CC160-□L□1-□G	3/4	3/4	202.5	319.5	144	180	183	60	133.8	134	181.5	40	24	50	136	93	116	66	108	81

Model	NB	NL	P	QB	QL	S	T ^a	W
CC63-□S□1-□G	62.5	28	3	86	30	0	11	9.5
CC100-□S□1-□G	82.5	33	5	120	32	2	13	7
CC100-□L□1-□G	92	33	5	120	32	2	13	7
CC160-□L□1-□G	120	29	0	185	46	2.5	20	7

L Dimension

Effective oil level stroke	50	100	200	300	400	500	600	700	800
CC63-□S□1-□G	228.5	278.5	378.5	503.5	603.5	728.5	—	—	—
CC100-□□□1-□G	—	286	386	511	611	736	836	—	—
CC160-□L□1-□G	—	—	399	524	624	749	849	949	1049

* Hexagon socket head cap screw is used for mounting hole.

D-□
-X□
Technical Data

Air-hydro Converter

CCT Series



How to Order

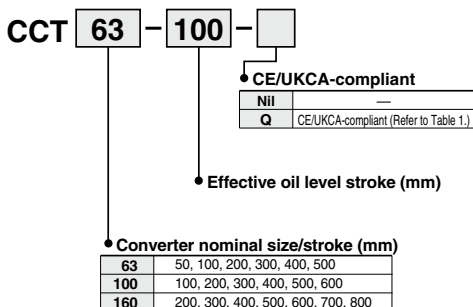

Specifications

Operating pressure	0 to 0.7 MPa
Proof pressure	1.05 MPa
Ambient and fluid temperature	5 to 50°C
Fluid	Turbine oil (40 to 100 mm ² /s)

Converter Standard Effective Oil Level Stroke/Effective Volume (cm³)

Converter nominal size (mm)	Standard effective oil level stroke (mm)								Limited flow* (dm ³ /min)	
	50	100	200	300	400	500	600	700		800
63	150	300	600	890	1190	1480	—	—	—	36
100	—	750	1510	2260	3010	3770	4520	—	—	88
160	—	—	3660	5490	7320	9150	10980	12810	14640	217

* Limited flow shows the limit of converter oil level speed (200 mm/s) which can maintain stability of converter oil level.

Table 1 CE/UKCA-compliant

Applicable model	CE/UKCA marking applicable standard
CCT160-400 to 800	Directive 97/23/EC Category I

CCT40 — Effective oil level stroke

Because the CCT40 is a converter for an actuator with a small capacity, it cannot be made into an air-hydro unit. Instead, use an individual CC valve unit or a speed controller (AS2000, AS3000, AS4000, etc.) through a pipe connection.



Specifications

Operating pressure	0 to 0.7 MPa
Proof pressure	1.05 MPa
Ambient and fluid temperature	5 to 50°C
Fluid	Turbine oil (40 to 100 mm ² /s)
Nominal size	40 mm

Converter Standard Effective Oil Level Stroke/Effective Volume

Standard effective oil level stroke (mm)	50	100	150	200	300
Effective volume (cm ³)	60	120	180	250	370
Limited flow (dm ³ /min)	15				

* Limited flow shows the limit of converter oil level speed (200 mm/s) which can maintain stability of converter oil level.

Dimensions

CCT63/CCT100/CCT160

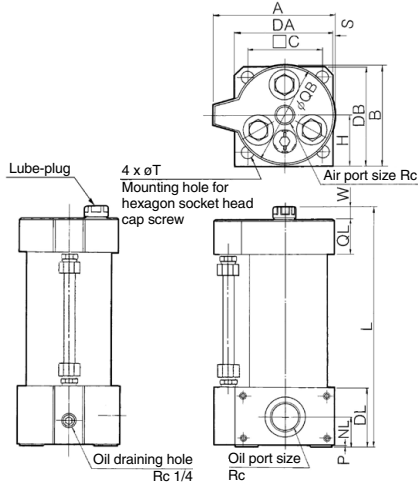

(mm)

Model	Air port size Rc	Oil port size Rc	A	B	□C	DA	DB	DL	H	NL	P	QB	QL	S	T ^ø	W
CCT63-□	3/8	3/4	104	88	64	86	88	53	45	28	3	86	30	0	11	9.5
CCT100-□	1/2	1	139	125	92	116	123	61	65	33	5	120	32	2	13	7
CCT160-□	3/4	1 1/4	202.5	185	144	180	183	60	93	29	0	185	46	2	20	7

L Dimension

(mm)

Effective oil level stroke (mm)	50	100	200	300	400	500	600	700	800
CCT63-□	228.5	278.5	378.5	503.5	603.5	728.5	—	—	—
CCT100-□	—	286	386	511	611	736	836	—	—
CCT160-□	—	—	399	524	624	749	849	949	1049

* Hexagon socket head cap screw is used for mounting.

CCT40

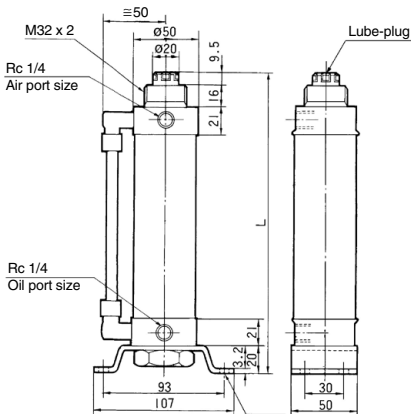

L Dimension (Effective oil level stroke)

(mm)

Effective oil level stroke (mm)	50	100	150	200	300
L	213.5	263.5	313.5	363.5	463.5

CC

D-□
-X□
Technical Data

Valve Unit



CCVS/CCVL Series



CCVS/CCVL Valve Unit Part No. Combinations

Valve unit size	Control valve	Combined valve
S	0	2
	1	0, 1, 2, 3
	2	0, 1, 2, 3
	3	0, 1, 2, 3
L	0	2
	1	0, 1, 2, 3
	2	0, 1, 2, 3

How to Order

CCV S 1 1 - 1 - U1 -

Valve unit size

S	Small flow
L	Large flow

Control valve

0	None
1	Flow control valve (With pressure compensation)
2	Throttle valve
3	Timid flow control valve (CCVS series only)

Combined valve

0*	None
1	Stop valve + Skip valve
2	Stop valve
3	Skip valve

* For the one without combined valve (0), solenoid valve does not come with.
<Example> CCVS10-U1

CE/UKCA-compliant

Nil	—
Q	CE/UKCA-compliant (Refer to Table 1.)

Suffix

S	Single valve
U ₁	Unit for CC63 (Unit mounted to CCT63)
U ₂	Unit for CC100 and CC160 (Unit mounted to CCT100 and 160)

Electrical entry of solenoid valve

Nil	Air operated
G	Grommet
D	DIN terminal

Solenoid valve rated voltage

0	Air operated valve
1	100 VAC, 50/60 Hz
2	200 VAC, 50/60 Hz
3*	110 VAC, 50/60 Hz
4*	220 VAC, 50/60 Hz
5	24 VDC
6*	12 VDC
7*	240 VAC, 50/60 Hz

* Semi-standard

Specifications

Specifications	Combined valve		Control valve			
	Stop valve, Skip valve	Throttle valve	Flow control valve		Flow control valve	
	Small flow Large flow	Small flow Large flow	Timid flow	Small flow	Large flow	
Operating pressure	0 to 0.7 MPa		0 to 0.7 MPa		0.3 to 0.7 MPa	
External pilot pressure	0.3 to 0.7 MPa		—		—	
Proof pressure	1.05 MPa					
Ambient and Fluid temperature	5 to 50°C					
Fluid	Turbine oil (40 to 100 mm ² /s)					
Effective area (mm²)	Stop valve, Skip valve	40	88	—		
	Control valve free open	—		35	77	18, 24, 60
	Control valve free flow	—		30	80	23, 30, 80
Minimum control flow (dm³/min)	—		0.3		0.04	0.06
Pressure compensating ability	—		—		±10%	
Pressure compensating range	—		—		Load ratio: 60% compared to theoretical output.	
Valve type	N.C.					

Table 1 CE/UKCA-compliant

Applicable model	CE/UKCA marking applicable standard
CCV□□□-□D-□	EMC Directive 2004/108/EC Low Voltage Directive 2006/95/EC

Solenoid Valve Specifications of Combined Valve (Stop valve/Skip valve)

Solenoid valve model	VO307-□□1		
External pilot pressure	0.3 to 0.7 MPa		
Coil rated voltage (V)	AC (50/60 Hz)	100, 200, 110*, 220*, 240*	
	DC	24, 12*	
Apparent power (Note 1)	AC	Start-up 12.7 VA (50 Hz), 10.7 VA (60 Hz) Holding 7.6 VA (50 Hz), 5.4 VA (60 Hz)	
	DC	4 W	
Electrical entry	Grommet (Standard), DIN terminal		

* Semi-standard
Note 1) At rated voltage

Applicable Converter

Valve unit	Nominal size (mm)
Small flow	63, 100
Large flow	100, 160

Solenoid Valve Function Plate

Solenoid valve type		N.C.*	N.O.**
Valve type	Stop valve	No mark	N.O.
	Skip valve	N.O.	No mark

* Valve opens when solenoid valve conducts electricity.

** Valve opens when solenoid valve stops conducting electricity.

Dimensions

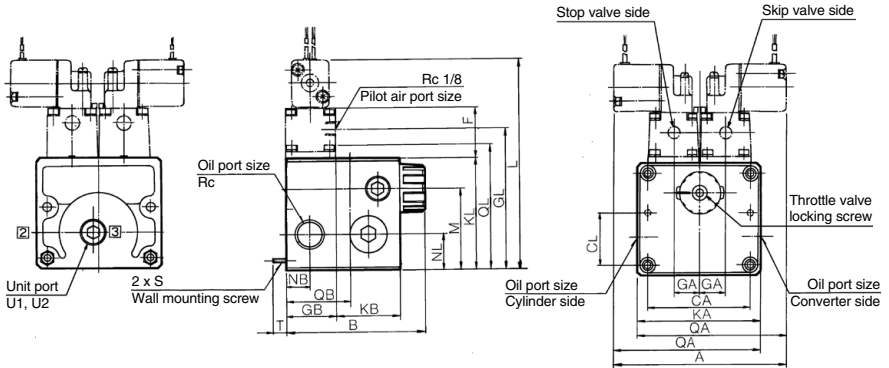

Model	Oil port size Rc	A	B	CA*	CL*	F	GA	GB	GL	KA	KB	KL	L	M	NB	NL	QA	QB	QL	R	S	T
CCVS02-□G-S	1/2	—	—	72	36	35	18	35	101	86	45	80	148.5	—	17.5	25	103.9	45	88.2	1	M5 x 0.8	5.4 to 7.5
CCVS□1-□G-S	1/2	121.8	98	72	36	35	18	35	101	86	45	80	148.5	57	17.5	25	—	—	—	2		
CCVS□2-□G-S	1/2	—	98	72	36	35	18	35	101	86	45	80	148.5	57	17.5	25	103.9	—	88.2	1		
CCVS□3-□G-S	1/2	—	98	72	36	35	18	35	101	86	45	80	148.5	57	17.5	25	103.9	—	88.2	1	M6 x 1	10.5 to 12.5
CCVS□0-S	1/2	—	98	72	36	—	—	35	—	86	45	80	—	57	17.5	25	—	—	88.2	—		
CCVL02-□G-S	3/4	—	—	100	40	40	24	50	135	116	66	107	180.5	—	27	28	124.9	62	115	1		
CCVL□1-□G-S	3/4	132.8	135	100	40	40	24	50	135	116	66	107	180.5	80	27	28	—	—	—	2		
CCVL□2-□G-S	3/4	—	135	100	40	40	24	50	135	116	66	107	180.5	80	27	28	124.9	—	115	1		
CCVL□3-□G-S	3/4	—	135	100	40	40	24	50	135	116	66	107	180.5	80	27	28	124.9	—	115	1		
CCVL□0-S	3/4	—	135	100	40	—	—	50	—	116	66	107	—	80	27	28	—	—	115	—		

* Pitch of mounting on the wall is CA and CL.

CC

D-□

-X□

Technical
Data

Air-hydro Unit Weight

Converter nominal size	Valve unit size	Control valve	Combined valve	Effective oil level stroke											
				50	100	150	200	300	400	500	600	700	800		
63	S	0	2	2.7	2.9	3.1	3.3	3.7	4.1	4.5	—	—	—		
			1	0	3.2	3.4	3.6	3.8	4.2	4.6	5.0	—	—	—	
				1	3.4	3.6	3.8	4.0	4.4	4.8	5.2	—	—	—	
		2		3.3	3.5	3.7	3.9	4.3	4.7	5.1	—	—	—		
		2	0	3.2	3.4	3.6	3.8	4.2	4.6	5.0	—	—	—		
			1	3.4	3.6	3.8	4.0	4.4	4.8	5.2	—	—	—		
			2	3.3	3.5	3.7	3.9	4.3	4.7	5.1	—	—	—		
		3	0	3.2	3.4	3.6	3.8	4.2	4.6	5.0	—	—	—		
			1	3.4	3.6	3.8	4.0	4.4	4.8	5.2	—	—	—		
			2	3.3	3.5	3.7	3.9	4.3	4.7	5.1	—	—	—		
		100	S	0	2	—	4.5	—	5.2	5.9	6.6	7.3	8.0	—	—
					1	0	—	5.0	—	5.7	6.4	7.1	7.8	8.5	—
1	—					5.2	—	5.9	6.6	7.3	8.0	8.7	—	—	
2	—			5.1		—	5.8	6.5	7.2	7.9	8.6	—	—		
2	0			—	5.0	—	5.7	6.4	7.1	7.8	8.5	—	—		
	1			—	5.2	—	5.9	6.6	7.3	8.0	8.7	—	—		
	2			—	5.1	—	5.8	6.5	7.2	7.9	8.6	—	—		
3	0			—	5.0	—	5.7	6.4	7.1	7.8	8.5	—	—		
	1			—	5.2	—	5.9	6.6	7.3	8.0	8.7	—	—		
	2			—	5.1	—	5.8	6.5	7.2	7.9	8.6	—	—		
160	L			0	2	—	5.6	—	6.3	7.0	7.7	8.4	9.1	—	—
					1	0	—	6.8	—	7.5	8.2	8.9	9.6	10.3	—
		1	—			7.2	—	7.9	8.6	9.3	10.0	10.7	—	—	
		2	—	7.0		—	7.7	8.4	9.1	9.8	10.5	—	—		
		2	0	—	6.8	—	7.5	8.2	8.9	9.6	10.3	—	—		
			1	—	7.2	—	7.9	8.6	9.3	10.0	10.7	—	—		
			2	—	7.0	—	7.7	8.4	9.1	9.8	10.5	—	—		
		3	0	—	7.0	—	7.7	8.4	9.1	9.8	10.5	—	—		
			1	—	6.8	—	7.5	8.2	8.9	9.6	10.3	—	—		
			2	—	7.2	—	7.9	8.6	9.3	10.0	10.7	—	—		
		63	L	0	2	—	—	—	12.6	14.4	16.2	18.0	19.8	21.6	23.4
					1	0	—	—	—	13.8	15.6	17.4	19.2	21.0	22.8
1	—					—	—	14.2	16.0	17.8	19.6	21.4	23.2	25.0	
2	—			—		—	14.0	15.8	17.6	19.4	21.2	23.0	24.8		
2	0			—	—	—	14.0	15.8	17.6	19.4	21.2	23.0	24.8		
	1			—	—	—	13.8	15.6	17.4	19.2	21.0	22.8	24.6		
	2	—	—	—	14.2	16.0	17.8	19.6	21.4	23.2	25.0				
3	0	—	—	—	14.0	15.8	17.6	19.4	21.2	23.0	24.8				
	1	—	—	—	14.0	15.8	17.6	19.4	21.2	23.0	24.8				
	2	—	—	—	14.0	15.8	17.6	19.4	21.2	23.0	24.8				

Air-hydro Converter Weight

Converter nominal size	CCT40	CCT63	CCT100	CCT160
50	0.85	1.6	—	—
100	0.90	1.8	3.4	—
150	0.95	—	—	—
200	1.0	2.2	4.1	10.4
300	1.1	2.6	4.8	12.2
400	—	3.0	5.5	14.0
500	—	3.4	6.2	15.8
600	—	—	6.9	17.6
700	—	—	—	19.4
800	—	—	—	21.1

Air-hydro Valve Unit Weight

Small flow	Weight	Small flow	Weight	Large flow	Weight
CCVS02-□□	1.1	CCVS30-□□	1.6	CCVL02-□□	2.2
CCVS10-□□	1.6	CCVS31-□□	1.8	CCVL10-□□	3.4
CCVS11-□□	1.8	CCVS32-□□	1.7	CCVL11-□□	3.8
CCVS12-□□	1.7	CCVS33-□□	1.7	CCVL12-□□	3.6
CCVS13-□□	1.7			CCVL13-□□	3.6
CCVS20-□□	1.6			CCVL20-□□	3.4
CCVS21-□□	1.8			CCVL21-□□	3.8
CCVS22-□□	1.7			CCVL22-□□	3.6
CCVS23-□□	1.7			CCVL23-□□	3.6

If intricate speed control is unnecessary and the changes in speed due to load fluctuations can be tolerated, the pneumatic speed controller can be used as a control valve.

The minimum controllable flow volume of the speed controller is 3 dm³/min.

The speed controller and the converter must have individual pipe connections. They cannot be integrated into a unit.

Refer to Best Pneumatics No. 7 for the details of speed controllers.

Maximum Driving Speed of Cylinders (Speed controller)

Conditions: Operating pressure — 0.5 MPa, Operating oil — Turbine oil Class 1 (ISO VG32), Piping length — 1 m

AS420-02/03/04

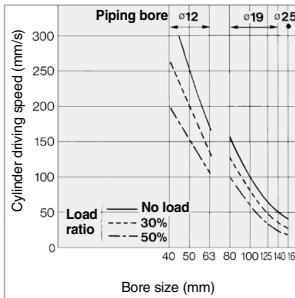

AS500-06

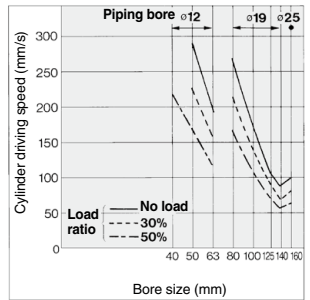

CC

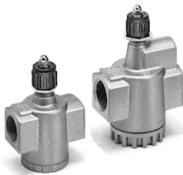

AS600-10

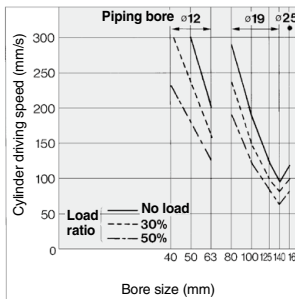

AS2000-01/02

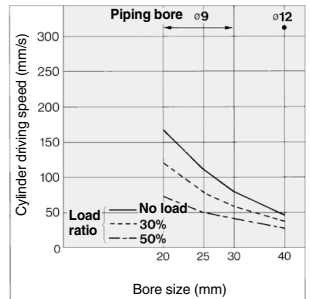

AS3000-02/03

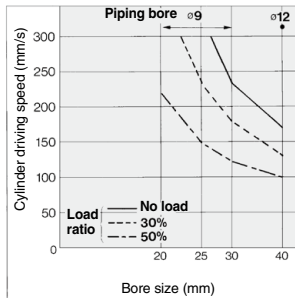

AS4000-02/03/04

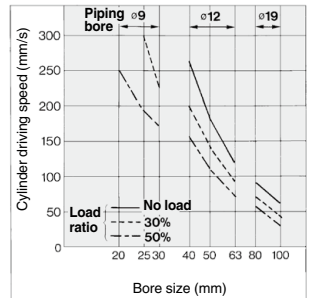

Circuit diagram

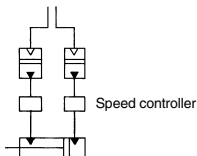

D-□

-X□

Technical Data



CC Series Specific Product Precautions

Be sure to read this before handling the products.

Air Supply

- A mist separator prevents the intermixing of drainage, preventing the air-hydro unit from malfunctioning, and prolonging the life of the oil.

Environment

- Avoid use near fire.
- It cannot be used in the clean room.

Mounting

- Install the converter vertically.
 - Install the converter at a position that is higher than the cylinder. If placed lower than the cylinder, air accumulates in the cylinder. Use the air bleed valve on the cylinder to bleed the air. If the cylinder is not provided with an air bleed valve, loosen the hydraulic pipe to bleed.
 - Leakage associated with the sliding movement inevitably occurs. In particular, with the single side hydro unit, the operating oil that leaks to the pneumatic side will be discharged from the switching valve, thus soiling the switching valve. Thus, install an exhaust cleaner (AMC series). (Fig. (6))
- When the oil case of the exhaust cleaner becomes full, operating oil will blow out of the exhaust cleaner. Therefore, open the drain valve on a regular basis.

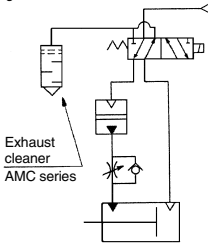

Fig. (6)

Piping

- Before connecting the pipes, remove any foreign matter.
- The (T series W (white)) nylon tube can be used for hydraulic piping. Self-aligning fittings can be used for hydraulic piping, but One-touch fittings cannot be used.
- Make sure that there are no extreme differences in the bore of the pipes used for hydraulic piping. Also check for protrusions or burrs.
- Prevent air from being drawn into the hydraulic piping.
- When operating a stop valve or a skip valve with a solenoid valve, considering it is an external pilot, provide pneumatic piping with 0.3 to 0.7 MPa of air pressure. The pressure for the pilot must be set to the operating pressure of the cylinder or higher.
- When operating a stop valve or a skip valve with a solenoid valve, considering it is an external pilot, provide pneumatic piping with 0.3 to 0.7 MPa of air pressure. The pressure for the pilot must be set to the operating pressure of the cylinder or higher.
- The stop and skip valves must be "normally closed".

Piping

- Be aware that the specified speed might not be attained if there is restriction in the fittings or there are 90° bends.
- Air bubbles could form during operation due to cavitation. To prevent this:
 - 1) Configure the piping from the cylinder to the converter to have an ascending gradient.
 - 2) Shorten the hydraulic piping.
 - 3) Port position should not be vertically downward.

Maintenance

Double-side hydro

- Even as a double side hydro unit, leakage occurs with the sliding movement of the air-hydro cylinder, increasing the converter's operating fluid in one area and decreasing it in the other. Fig. (7) provides a countermeasure circuit. Maintain the converter's oil level at an appropriate level by opening valve A.

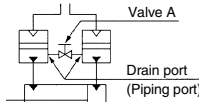

Fig. (7)

Single-side hydro

- The basic composition of the air-hydro system is the double side hydro; however, it can also be used as a single side hydro. The viscosity of the operating oil of the single side hydro is approximately one half of the double side hydro. The speed will be approximately 1.4 times the rate given on page 10-17-3. When the system is used as a single side hydro, air could become intermixed with the operating oil, leading to the symptoms listed below:
 - 1) Cylinder's speed is not constant.
 - 2) Stopping accuracy of the stop valve decreases.
 - 3) Overrun of the skip valve increases.
 - 4) The flow control valve with pressure compensator knocks (even with a small flow rate).

Therefore, it is necessary to check periodically to prevent air from intermixing with the oil. If the symptoms described above occur, air must be bled. In particular, to prevent "4)", use a double side hydro.

Lubrication

If the converter is positioned higher than the cylinder:

1. Make sure to move the cylinder's piston to the stroke end of the side that will be filled with oil.
2. Open the air bleeder valve on top of the cylinder.
3. If equipped with a stop valve, provide a pilot pressure of approximately 0.2 MPa to the stop valve, and maintain the stop valve in an open position through manual operation or by applying current.
4. Open the oil filler plug to fill with oil. When air no longer comes out intermixed with oil, close the cylinder's air bleeder valve. Make sure that the oil level is near the upper limit mark on the level gauge, and replenish with oil if needed.
5. Next, fill the opposite side with oil. Move the piston to the stroke end of the side that will be filled with oil, and perform steps 1 through 4 in the same sequence as described above.

If the converter is positioned lower than the cylinder:

- After filling with oil as described in step 4 above, close the oil filler plug. Then, introduce air pressure of approximately 0.05 MPa into the converter's air port to push the oil into the cylinder. When air no longer comes out intermixed with oil, close the cylinder's air bleeder valve. Perform the remaining steps in the same way as when the converter is located higher than the cylinder, in order to fill it with oil.
- * This operation necessarily causes air to accumulate in the cylinder during the operation of the cylinder. Therefore, air must be bled on a regular basis.

Fluid (Hydraulic fluid)

- Use petroleum based turbine hydraulic operating oil. The use of non-combustible operating oil could lead to problems.
- An appropriate viscosity is about 40 to 100 mm²/s at the operating temperature.
- Using ISO VG32 oil, the temperature range will be between 15 and 35°C.
- To operate in a temperature range that exceeds that of the ISO VG32 oil, use ISO VG46 (25 to 45°C).

Reference: Example of brands of lubricant manufacturers (as of July 2018)

Lubricant manufacturer	Lubricant brands	Note
Idemitsu Kosan Co., Ltd.	Diana Fresia S32	Class 1 turbine oil, ISO VG32
JXTG Nippon Oil & Energy Corporation	Turbine Oil 32	Class 1 turbine oil, ISO VG32
COSMO OIL CO., LTD	Cosmo Turbine 32	Class 1 turbine oil, ISO VG32
Kygnus Sekiyu K.K.	Turbine Oil 32	Class 1 turbine oil, ISO VG32
Exxon Mobil Corporation	Mobil DTE Oil Light VG32	Class 2 turbine oil, ISO VG32 ^{*1}

- *1 This is a class 2 turbine oil (additive) allowed for use. Please contact SMC regarding other class 2 turbine oil.
- *2 Do not add additives. This may affect the operation of the product.

The name of the lubricant manufacturer and the lubricant brand may change. Please contact each of the companies for details.

VNA Series/Process Valve

2 Port Valve For Compressed Air and Air-hydro Circuit Control

Related Equipment

Exclusively for air pressure system and air-hydro circuit control

Universal 2 Port Valve

Cylinder actuation by external pilot air

The balance poppet permits normal and reverse flow.

Operation from 0 MPa is possible.

Wide variations
N.C., N.O., C.O. types are available.
Threaded type from 6A to 50A is standardized.



CC

Air-hydro Air pressure circuit: Application examples

Operation Capacity When Used in Air-hydro Units

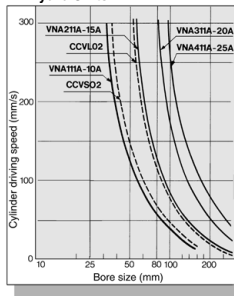

This series can supplement the capacity of current air-hydro valve units. They are suited to operate large bore cylinders as well as to simultaneously operate multiple cylinders and suspend their operation. Thus they can be used in the same way as the current air-hydro units.

Air-hydro circuit: Application example

Basic circuit

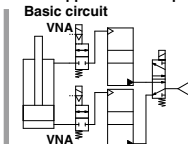

Conditions

Supply pressure	0.49 MPa	
Hydraulic fluid	ISO VG32	
Load	No load	
Piping length	1 m	
Piping diameter	VNA111A, CCVSO2	3/8B (9mm)
	VNA211A, CCVLO2	1/2B (13mm)
	VNA311A	3/4B (19mm)
	VNA411A	1B (25mm)

Refer to Best Pneumatics No. 9 for the details of valves.

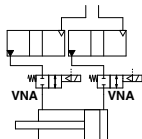

Caution

When speed controller is mounted

Connect a speed controller (AS series etc.) to A port of VNA□11 (in order to protect the speed control valve from surges when cylinder operation is suspended, thus improving stopping accuracy).

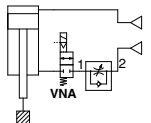

Caution

Skip valve function

Combination of 2 or more valves of the VNA series provides a skip valve function. Connect the skip valve to the A port side of a stop valve.

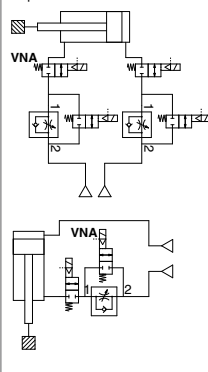

D-□

-X□

Technical Data