

Air Cylinder

CA2 Series

ø40, ø50, ø63, ø80, ø100

RoHS

Reduced weight by changing the shape of the rod cover and head cover.

Weight reduced by up to

(ø50-50 stroke)
15% lighter

1.31 kg

1.54 kg
Current model



Easy air cushion control

Number of cushion valve adjustment rotations increased from 1 rotation to **3 rotations**.

Fine adjustment becomes easy, **ensuring smooth operation at the stroke end**.

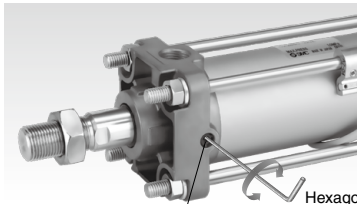

Cushion valve

Hexagon wrench

Various switches such as compact auto switches and magnetic field resistant auto switches can be mounted.

Compact auto switches

- D-M9□
- D-A9□

Magnetic field resistant auto switches

- D-P3DWA
- D-P4DW

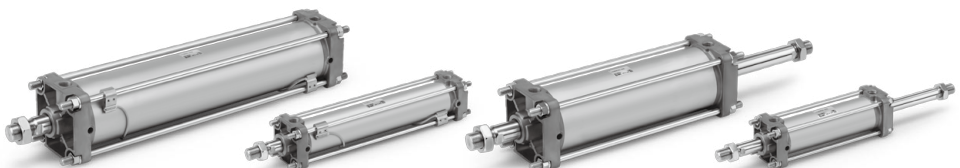
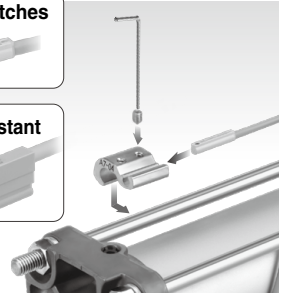

CJ1
CJP
CJ2
JCM
CM2
CM3
CG1
CG3
JMB
MB
MB1
CA2
CS1
CS2

D-□
-X□
Technical Data

Part numbers with rod end bracket and/or pivot bracket available

Not necessary to order a bracket for the applicable cylinder separately

Note) Mounting bracket is shipped together with the product, but not assembled.

Example) CDA2 **D** 40-100Z- **N W** -M9BW

● Mounting

Pivot bracket

Nil	None
N	Pivot bracket is shipped together with the product, but not assembled.

* Applicable to only mounting D (Double clevis) and T (Center trunnion).

N: Kit of pivot bracket and double clevis



Kit of pivot bracket and trunnion



Rod end bracket

Nil	None
V	Single knuckle joint
W	Double knuckle joint

With rod end bracket

V: Single knuckle joint W: Double knuckle joint



Various mounting bracket options

- Suitable mounting brackets can be selected for the installation condition.
- Improved amount of mounting freedom

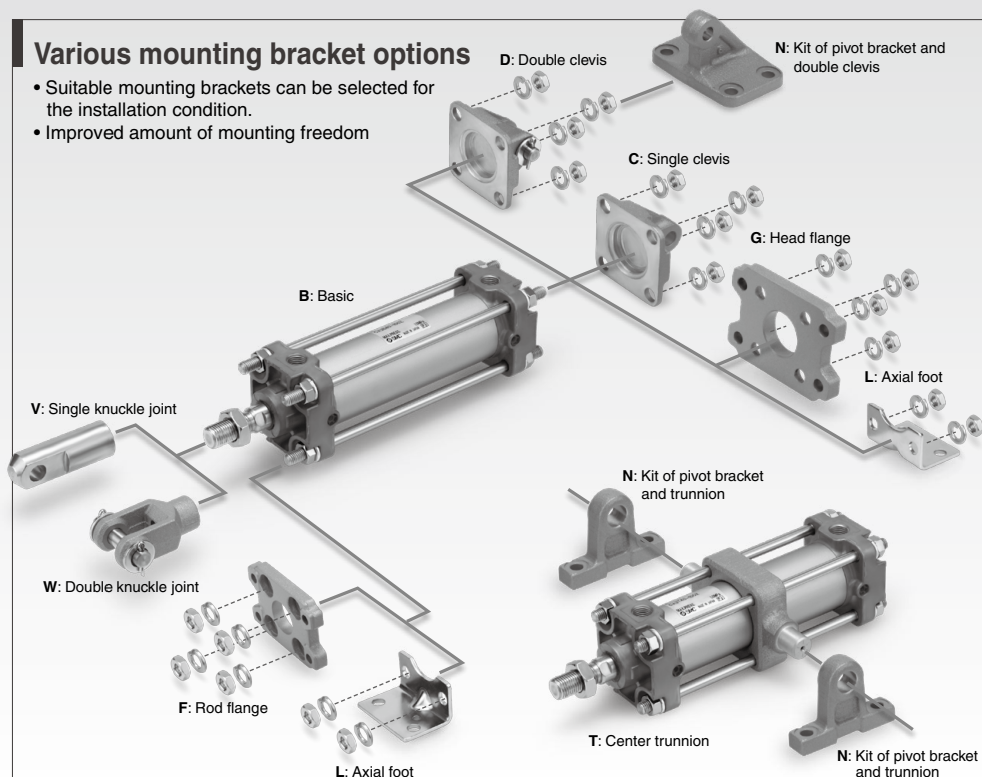

Reduced weight by changing the shape of the rod cover and head cover.

Bore size (mm)	CA2	Reduction rate	Current model (kg)
40	0.93	12%	1.06
50	1.31	15%	1.54
63	1.84	14%	2.15
80	3.17	11%	3.56
100	4.29	10%	4.76

* Compared to 50 stroke for each size

No substances hazardous to the environment are used.

Lead free bushing is used as sliding material. Compliant with EU RoHS directive.

Mounting dimensions are the same as the current product.

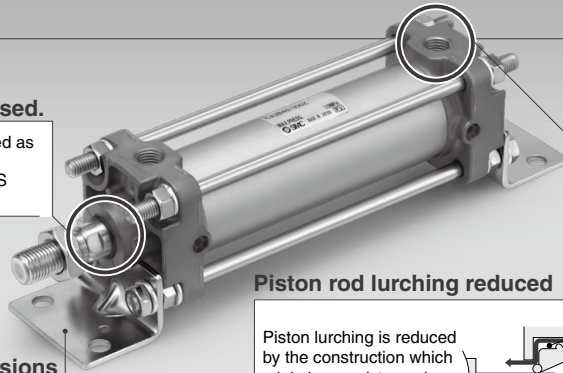

Piston rod lurching reduced

Piston lurching is reduced by the construction which minimizes resistance in the air passage at startup.

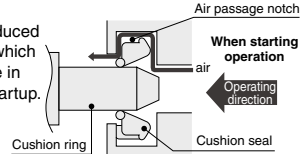

Stroke Variations

Bore size (mm)	Standard stroke																
	25	50	75	100	125	150	175	200	250	300	350	400	450	500	600	700	Up to 1800
40	●	●	●	●	●	●	●	●	●	●	●	●	●	●	●	●	
50	●	●	●	●	●	●	●	●	●	●	●	●	●	●	●	●	
63	●	●	●	●	●	●	●	●	●	●	●	●	●	●	●	●	
80	●	●	●	●	●	●	●	●	●	●	●	●	●	●	●	●	
100	●	●	●	●	●	●	●	●	●	●	●	●	●	●	●	●	

Series Variations

Series	Type	Bore size (mm)					Variations		Page
		40	50	63	80	100	With rod boot	Water resistant	
Standard CA2-Z 	Single rod	●	●	●	●	●	●	●	Page 470
	Double rod	●	●	●	●	●	●	●	Page 486
Non-rotating rod CA2K 	Single rod	●	●	●	●	●	●	●	Page 494
	Double rod	●	●	●	●	●	●	●	Page 498
With end lock CBA2 	Single rod	●	●	●	●	●	●	●	Page 502
Air-hydro CA2□H 	Single rod	●	●	●	●	●	●	●	Page 508
	Double rod	●	●	●	●	●	●	●	Page 512
Smooth Cylinder CA2Y-Z 	Single rod	●	●	●	●	●	●	●	Best Pneumatics No. 2-3
Low friction CA2□Q 	Single rod	●	●	●	●	●	●	●	

Use the new series "Smooth Cylinder CA2Y Series" to realize both-direction low friction and low-speed operation. (Refer to the Best Pneumatics No. 2-3.)

* For details about the clean series, refer to the "Pneumatic Clean Series" (CAT.E02-23).

CJ1

CJP

CJ2

JCM

CM2

CM3

CG1

CG3

JMB

MB

MB1

CA2

CS1

CS2

D-□

-X□

Technical Data

Combinations of Standard Products and Made to Order Specifications

CA2 Series

- : Standard
- : Made to Order
- : Special product (Please contact SMC for details.)
- : Not available

Series	CA2 (Standard type)		CA2K ^{Note 4)} (Non-rotating rod type)		Page
	Double acting				
	Single rod	Double rod	Single rod	Double rod	
Action/ Type	Page 470	Page 486	Page 494	Page 498	
Page	Page 470	Page 486	Page 494	Page 498	
Symbol	Specifications				Applicable bore size
Standard	Standard				ø40 to ø100
CDA2-□Z	Built-in magnet				
Long st	Long stroke				
CA2□-□JZ	With rod boot (Nylon tarpaulin)				
CA2□-□KZ	With rod boot (Heat resistant tarpaulin)				ø40 to ø63
10-, 11-	Clean series ^{Note 4)}				
25A-	Copper (Cu) and Zinc (Zn)-free ^{Note 1)}				ø40 to ø100
20-	Copper ^{Note 2)} and Fluorine-free				
CA2□R	Water resistant (NBR seal)				ø40 to ø100
CA2□V	Water resistant (FKM seal)				
CA2□M	Cylinder with stable lubrication function (Lube-retainer)				
XA□	Change of rod end shape				ø40 to ø100
XB5	Oversized rod cylinder ^{Note 4)}				
XB6	Heat resistant cylinder (-10 to 150°C)				
XC3	Special port location ^{Note 4)}				
XC4	With heavy duty scraper				
XC5	Heat resistant cylinder (-10 to 110°C)				
XC6	Made of stainless steel ^{Note 4)}				
XC7	Tie-rod, cushion valve, tie-rod nut, etc. made of stainless steel				
XC8	Adjustable stroke cylinder/Adjustable extension type				
XC9	Adjustable stroke cylinder/Adjustable retraction type				
XC10	Dual stroke cylinder/Double rod type				
XC11	Dual stroke cylinder/Single rod type				
XC12	Tandem cylinder				
XC14	Change of trunnion bracket mounting position				
XC15	Change of tie-rod length				
XC22	Fluororubber seal				
XC27	Double clevis and double knuckle joint pins made of stainless steel				
XC28	Compact flange made of SS400				
XC29	Double knuckle joint with spring pin				
XC30	Rod trunnion				
XC35	With coil scraper				
XC65	Made of stainless steel (Combination of XC7 and XC68)				
XC68	Made of stainless steel (with hard chrome plated piston rod)				
XC85	Grease for food processing equipment				
XC88	Spatter resistant coil scraper, Lube-retainer, Grease for welding (Piston rod: Stainless steel 304)				
XC89	Spatter resistant coil scraper, Lube-retainer, Grease for welding (Piston rod: S45C)				
XC91	Spatter resistant coil scraper, Grease for welding (Piston rod: S45C)				
X1184	Cylinder with heat resistant reed auto switch (-10 to 120°C)				

Note 1) For details, refer to the **Web Catalog**.
 Note 2) Copper-free for the externally exposed part. For details, refer to the **Web Catalog**.
 Note 3) For details about the smooth cylinder, refer to the Best Pneumatics No. 2-3.
 Note 4) The cover shape is the same as the current product.

Use the new series "Smooth Cylinder CA2Y Series" to realize both-direction low friction and low-speed operation. (Refer to the Best Pneumatics No. 2-3.)

CBA2 <small>Note 4)</small> (With end lock)		CA2□H <small>Note 4)</small> (Air-hydro type)		CA2Y <small>Note 3)</small> (Smooth Cylinder)	CA2□Q <small>Note 4)</small> (Low friction type)	
Double acting						
Single rod	Single rod	Double rod	Single rod	Single rod		Symbol
Page 502	Page 508	Page 512	Best Pneumatics No. 2-3	Page 516		
		—				Standard
●	●	●	●	●	●	CDA2-□Z
●	●	●	○	○	○	Long st
●	●	●	○	○	○	CA2□-□JZ
●	●	●	○	○	○	CA2□-□KZ
● <small>Note 5)</small>	—	—	—	—	—	10-, 11-
—	—	—	⊙	—	—	25A-
●	○	○	—	—	—	20-
● <small>Note 5)</small>	○	○	—	—	—	CA2□R
● <small>Note 5)</small>	○	○	—	—	—	CA2□V
—	—	—	—	—	—	CA2□M
○	○	○	⊙	⊙	—	XA□
○	○	○	—	—	—	XB5
○	—	—	—	—	—	XB6
○	○	○	—	—	⊙ <small>Note 8)</small>	XC3
⊙ <small>Note 5)</small>	⊙ <small>Note 7)</small>	⊙ <small>Note 7)</small>	—	—	—	XC4
○	—	—	—	—	—	XC5
⊙ <small>Note 5)</small>	⊙	⊙	—	—	—	XC6
○	○	○	⊙	⊙	—	XC7
⊙ <small>Note 5)</small>	○	—	○	○	—	XC8
⊙ <small>Note 6)</small>	○	—	○	⊙	—	XC9
⊙	○	—	○	⊙	—	XC10
○	○	○	○	○	—	XC11
○	○	○	—	—	—	XC12
○	⊙	⊙	⊙	⊙	—	XC14
○	⊙	⊙	⊙	⊙	—	XC15
○	○	—	—	—	—	XC22
○	○	—	⊙	⊙	—	XC27
○	○	○	⊙	⊙	—	XC28
○	○	○	⊙	⊙	—	XC29
—	○	○	⊙	⊙	—	XC30
○	○	○	—	—	—	XC35
○	○	○	⊙	⊙	—	XC65
—	—	—	⊙	—	—	XC68
○	—	—	—	—	—	XC85
○	—	—	—	—	—	XC88
○	—	—	—	—	—	XC89
○	—	—	—	—	—	XC91
○	—	—	—	—	—	X1184

Note 5) Available only for locking at head end.

Note 6) Available only for locking at rod end.

Note 7) Standard for the air-hydro type

Note 8) CA2□Q series has no cushion. Only XC3BC, XC3CD and XC3DA are available.

CJ1

CJP

CJ2

JCM

CM2

CM3

CG1

CG3

JMB

MB

MB1

CA2

CS1

CS2

D-□

-X□

Technical Data

Air Cylinder: Standard Type Double Acting, Single Rod

CA2 Series

ø40, ø50, ø63, ø80, ø100

RoHS

How to Order

CA2 B **50** - **100** **Z** - -

With auto switch **CDA2 B** **50** - **100** **Z** - - **M9BW** -

With auto switch (Built-in magnet)

Mounting

B	Basic
L	Axial foot
F	Rod flange
G	Head flange
C	Single clevis
D	Double clevis
T	Center trunnion

* Mounting brackets other than center trunnion are shipped together.

Bore size

40	40 mm
50	50 mm
63	63 mm
80	80 mm
100	100 mm

Port thread type

Nil	Rc
TN	NPT
TF	G

* Not available with auto switch.

Tube material

Nil	Aluminum tube
F*	Steel tube

Cylinder stroke (mm)

For details, refer to the next page.

Bracket 1

Nil	Without bracket
N	Pivot bracket

* Only for D and T mounting types.
* Pivot bracket is shipped together with the product, but not assembled.

Suffix (Cushion)

Nil	Air cushion
N	Rubber bumper

Suffix (Rod boot)

Nil	None
J	Nylon tarpaulin
K	Heat resistant tarpaulin

Auto switch

Nil	Without auto switch
V	Single knuckle joint
W	Double knuckle joint

* For applicable auto switches, refer to the table below.

Bracket 2

Nil	Without bracket
V	Single knuckle joint
W	Double knuckle joint

* A knuckle joint pin is not provided with the single knuckle joint.
* Rod end bracket is shipped together with the product, but not assembled.

Number of auto switches

Nil	2 pcs.
S	1 pc.
3	3 pcs.
n	"n" pcs.

Made to Order

For details, refer to the next page.

Applicable Auto Switches/Refer to pages 1575 to 1701 for further information on auto switches.

Type	Special function	Electrical entry	Indicator (opt)	Wiring (Output)	Load voltage		Auto switch model		Lead wire length (m)			Pre-wired connector	Applicable load		
					DC	AC	Tie-rod mounting	Band mounting	0.5 (Nil)	1 (M)	3 (L)			5 (Z)	
Solid state auto switch	—	Grommet	—	3-wire (NPN)	24 V	5 V, 12 V	—	M9N	●	●	○	○	IC circuit	—	
				3-wire (PNP)				G59	●	●	○	○			
				2-wire				M9P	●	●	○	○			
		Terminal conduit		3-wire (NPN)				G5P	●	●	○	○			
				2-wire				M9B	●	●	○	○			
				3-wire (PNP)				K59	●	●	○	○			
	Diagnostic indication (2-color indicator)	Grommet	Yes	3-wire (NPN)	24 V	5 V, 12 V	—	G39C	●	●	○	○	IC circuit	Relay, PLC	
				3-wire (PNP)				G39	●	●	○	○			
				2-wire				K39C	●	●	○	○			
		Terminal conduit		3-wire (NPN)				M9NW	●	●	○	○			
				2-wire				G59W	●	●	○	○			
				3-wire (PNP)				M9PW	●	●	○	○			
Water resistant (2-color indicator)	Grommet	—	3-wire (NPN)	24 V	5 V, 12 V	—	M9NA*1	—	○	○	○	—	—		
			3-wire (PNP)				M9PA*1	—	○	○	○				
			2-wire				M9BA*1	—	○	○	○				
	Terminal conduit		4-wire (NPN)				G5BA*1	—	○	○	○				
			2-wire				F59F	●	●	○	○				
			2-wire (Non-polar)				P3DWA	●	●	○	○				
Reed auto switch	—	Grommet	Yes	3-wire (NPN equivalent)	24 V	5 V	—	A96	●	●	○	○	IC circuit	—	
				2-wire				A93	●	●	○	○			
				Terminal conduit				100 V or less	A90	●	●	○			○
		100 V, 200 V						A54	B54	●	●	○			○
		200 V or less						A64	B64	●	●	○			○
		Diagnostic indication (2-color indicator)		Grommet				Yes	2-wire	24 V	12 V	—			A33C
	3-wire (NPN)		A34C		A34	—	—		—						
	3-wire (PNP)		A44C		A44	—	—		—						
	DIN terminal		2-wire	A59W	B59W	●	●		○				○		
			3-wire (NPN)	—	—	—	—		—						
			3-wire (PNP)	—	—	—	—		—						

*1 Water resistant type auto switches can be mounted on the above models, but in such case SMC cannot guarantee water resistance.

* A water-resistant type cylinder is recommended for use in an environment which requires water resistance.

* Lead wire length symbols: 0.5 m..... Nil (Example) M9NW * Solid state auto switches marked with "○" are produced upon receipt of order.

1 m..... M (Example) M9NWM
3 m..... L (Example) M9NWL
5 m..... Z (Example) M9NWX

* Since there are other applicable auto switches than listed above, refer to page 523 for details.

* For details about auto switches with pre-wired connector, refer to pages 1649 and 1649.

* The D-A9□/M9□□/P3DWA□ auto switches are shipped together, (but not assembled). (However, auto switch mounting brackets are assembled for the D-A9□/M9□□ before shipment.)



Symbol

Double acting



Air cushion



Made to Order: Individual Specifications
(For details, refer to page 524.)

Symbol	Specifications
-X1184	Cylinder with heat resistant reed auto switch (-10 to 120°C)

Made to Order

[Click here for details](#)

Symbol	Specifications
-XA□	Change of rod end shape
-XB5	Oversized rod cylinder*
-XB6	Heat resistant cylinder (-10 to 150°C)
-XC3	Special port location*
-XC4	With heavy duty scraper
-XC5	Heat resistant cylinder (-10 to 110°C)
-XC7	Tie-rod, cushion valve, tie-rod nut, etc. made of stainless steel
-XC8	Adjustable stroke cylinder/Adjustable extension type
-XC9	Adjustable stroke cylinder/Adjustable retraction type
-XC10	Dual stroke cylinder/Double rod type
-XC11	Dual stroke cylinder/Single rod type
-XC12	Tandem cylinder
-XC14	Change of trunnion bracket mounting position
-XC15	Change of tie-rod length
-XC22	Fluororubber seal
-XC27	Double clevis and double knuckle joint pins made of stainless steel
-XC28	Compact flange made of SS400
-XC29	Double knuckle joint with spring pin
-XC30	Rod trunnion
-XC35	With coil scraper
-XC65	Made of stainless steel (Combination of XC7 and XC68)
-XC68	Made of stainless steel (with hard chrome plated piston rod)
-XC85	Grease for food processing equipment
-XC88	Spatter resistant coil scraper, Lube-retainer, Grease for welding (Piston rod: Stainless steel 304)
-XC89	Spatter resistant coil scraper, Lube-retainer, Grease for welding (Piston rod: S45C)
-XC91	Spatter resistant coil scraper, Grease for welding (Piston rod: S45C)

For special port location (-XC3), the mounting bracket and port location can be determined using the standard product corresponding to the operating conditions.

* The cover shape is the same as the current product.

For made of stainless steel (-XC6), use made of stainless steel (with hard chrome plated piston rod) (-XC68) that the surface treatment is performed on the piston rod with the same specifications.

- Refer to pages 517 to 523 for cylinders with auto switches.
- Auto switch proper mounting position (detection at stroke end) and its mounting height
 - Operating range
 - Minimum stroke for auto switch mounting
 - Auto switch mounting brackets/Part no.

Specifications

Bore size (mm)		40	50	63	80	100
Fluid		Air				
Action		Double acting				
Proof pressure		1.5 MPa				
Maximum operating pressure		1.0 MPa				
Ambient and fluid temperature		Without auto switch: -10 to 70°C*1 With auto switch: -10 to 60°C*1				
Minimum operating pressure		0.05 MPa				
Piston speed		50 to 500 mm/s				
Cushion		Air cushion or Rubber bumper				
Stroke length tolerance		Up to 250 st: ^{+1.0} / ₀ 251 to 1000 st: ^{+1.4} / ₀ 1001 to 1500 st: ^{+1.8} / ₀ 1501 to 1800 st: ^{+2.2} / ₀				
Lubrication		Not required (Non-lube)				
Mounting		Basic, Foot, Rod flange, Head flange Single clevis, Double clevis, Center trunnion				
Allowable kinetic energy (J)⁽²⁾	Air cushion	2.8	4.6	7.8	16	29
	When activated	0.33	0.56	0.91	1.5	2.68
	When not activated	1.8	3.6	6.0	12.0	12.0
	Rubber bumper					

*1 No freezing

*2 Activate the air cushion when operating the cylinder. If this is not done, the piston rod assembly or the tie-rods will be damaged when the allowable kinetic energy exceeds the values shown in the above table.

Standard Strokes

Bore size	Standard stroke ^{Note 1)}		Max. manufacturable stroke
	Stroke range ①	Stroke range ②	
40	25, 50, 75, 100, 125, 150, 175, 200, 250, 300, 350, 400, 450, 500	Up to 1800	Up to 2700
50, 63	25, 50, 75, 100, 125, 150, 175, 200, 250, 300, 350, 400, 450, 500, 600		
80, 100	25, 50, 75, 100, 125, 150, 175, 200, 250, 300, 350, 400, 450, 500, 600, 700		

Note 1) Intermediate strokes not listed above are produced upon receipt of order.

Note 2) Activate strokes should be confirmed according to the usage. For details, refer to "Air Cylinders Model Selection" on front matter pages. In addition, the products that exceed the stroke range ① might not be able to fulfill the specifications due to the deflection etc.

Note 3) Please consult with SMC for manufacturability and the part numbers when exceeding the stroke range ②.

Note 4) The stroke range with rod boot is 20 to 1800 mm. Please consult with SMC when exceeding 1800 mm strokes.

Minimum Stroke for Auto Switch Mounting

⚠ Caution

The minimum stroke for mounting varies with the auto switch type and cylinder mounting type. In particular, the center trunnion type needs careful attention. (For details, refer to pages 521 and 522.)

Rod Boot Material

Symbol	Rod boot material	Max. ambient temperature
J	Nylon tarpaulin	70°C
K	Heat resistant tarpaulin	110°C*

* Maximum ambient temperature for the rod boot

Accessories

Mounting		Basic	Axial foot	Rod flange	Head flange	Single clevis	Double clevis	Center trunnion
Standard	Rod end nut	●	●	●	●	●	●	●
	Clevis pin	—	—	—	—	—	●	—
Option	Single knuckle joint	●	●	●	●	●	●	●
	Double knuckle joint (with pin)	●	●	●	●	●	●	●
	With rod boot	●	●	●	●	●	●	●

* Refer to page 485 for part numbers and dimensions.

CJ1

CJP

CJ2

JCM

CM2

CM3

CG1

CG3

JMB

MB

MB1

CA2

CS1

CS2

D-□

-X□

Technical Data

CA2 Series

Ordering Example of Cylinder Assembly

Cylinder model:
CDA2D50-100Z-NW-M9BW

Mounting D: Double clevis
Pivot bracket N: Yes
Rod end bracket W: Double knuckle joint
Auto switch D-M9BW: 2 pcs.

* Pivot bracket, double knuckle joint and auto switch are shipped together with the product, but not assembled.

Weights/Aluminum Tube (Steel Tube)

Bore size (mm)		(kg)						
		40	50	63	80	100		
Basic weight	Basic	Aluminum tube	0.73	1.06	1.53	2.73	3.71	
		Steel tube	0.78	1.12	1.62	2.91	3.98	
	Axial foot	Aluminum tube	0.91	1.25	1.83	3.40	4.64	
		Steel tube	0.96	1.31	1.92	3.58	4.91	
	Flange	Aluminum tube	1.09	1.48	2.28	4.18	5.57	
		Steel tube	1.14	1.54	2.37	4.36	5.84	
	Single clevis	Aluminum tube	0.95	1.37	2.12	3.84	5.43	
		Steel tube	1.00	1.43	2.21	4.02	5.70	
	Double clevis	Aluminum tube	0.99	1.46	2.28	4.13	5.95	
		Steel tube	1.04	1.52	2.37	4.31	6.22	
	Trunnion	Aluminum tube	1.08	1.51	2.29	4.28	5.93	
		Steel tube	1.13	1.57	2.38	4.46	6.20	
	Additional weight per 50 mm of stroke	All mounting brackets	Aluminum tube	0.20	0.25	0.31	0.46	0.58
			Steel tube	0.28	0.35	0.43	0.7	0.87
Accessories	Single knuckle	0.23	0.26	0.26	0.60	0.83		
	Double knuckle (with pin)	0.37	0.43	0.43	0.87	1.27		

Calculation:
 Example) **CA2L40-100Z**
 (Axial foot, ø40, 100 stroke)

- Basic weight.....0.91 kg
- Additional weight.....0.20/50 stroke
- Cylinder stroke 100 stroke

$$0.91 + 0.20 \times 100/50 = 1.31 \text{ kg}$$

Mounting Brackets/Part No.

Bore size (mm)	40	50	63	80	100
Axial foot*	CA2-L04	CA2-L05	CA2-L06	CA2-L08	CA2-L10
Flange	CA2-F04	CA2-F05	CA2-F06	CA2-F08	CA2-F10
Single clevis	CA2-C04	CA2-C05	CA2-C06	CA2-C08	CA2-C10
Double clevis**	CA2-D04	CA2-D05	CA2-D06	CA2-D08	CA2-D10

* When axial foot brackets are used, order two pieces per cylinder.
 ** A clevis pin, flat washers and split pins are shipped together with double clevis.

Allowable Kinetic Energy

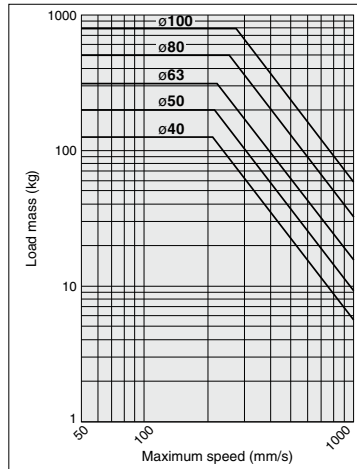

(Example) Find the upper limit of rod end load when an air cylinder of ø63 is operated at 500 mm/s.
 From a point indicating 500 mm/s on the axis of abscissas, extend a line upward and find a point where it intersects with a line for the 63 mm bore size. Extend a line from the intersection to the left and find a load mass 60 kg.

Water Resistant

CDA2 - - -

R	NBR seal (Nitrile rubber)
V	FKM seal (Fluororubber)

Specifications

Action	Double acting, Single rod
Bore size (mm)	40, 50, 63, 80, 100
Cushion	Air cushion
Auto switch mounting	Tie-rod mounting
Made to Order	XC68: Made of stainless steel (with hard chrome plated piston rod)

* Specifications other than the above are the same as the standard basic type.
 Note 1) Excluding the air-hydro type and the type with a rod boot of the CA2 series.
 Note 2) Combination of auto switches and steel tube is not available.
 For details, refer to page 1125.

Dimensions

* The dimensions are the same as the standard double acting, single rod type. Refer to page 475 for details.

Cylinder with Stable Lubrication Function (Lube-retainer)

CDA2 - - -



Specifications

Bore size (mm)	40, 50, 63, 80, 100
Action	Double acting, Single rod
Minimum operating pressure	0.1 MPa
Piston speed	50 to 500 mm/s
Cushion	Air cushion

* Specifications other than the above are the same as the standard type.

Dimensions (Dimensions other than those shown below are the same as the standard type.)

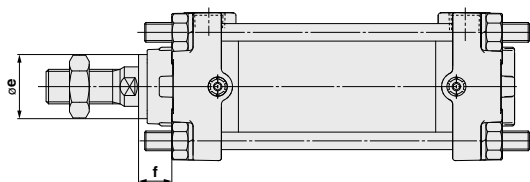

Bore size	oe	f
40	26	13.5
50	30	12.5
63	30	12.5
80	36	16.5
100	42	16

* The mounting dimensions of the mounting bracket are the same as the standard type.

For details, refer to the **Web Catalog**.

CJ1

CJP

CJ2

JCM

CM2

CM3

CG1

CG3

JMB

MB

MB1

CA2

CS1

CS2

D-□

-X□

Technical Data

CA2 Series

Construction

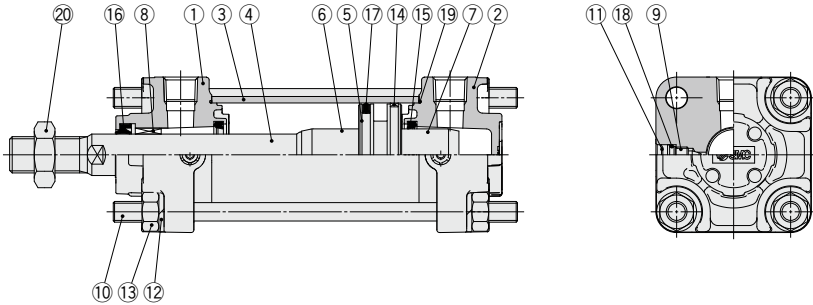

Component Parts

No.	Description	Material	Note
1	Rod cover	Aluminum die-casted	Trivalent chromated
2	Head cover	Aluminum die-casted	Trivalent chromated
3	Cylinder tube	Aluminum alloy	Hard anodized
4	Piston rod	Carbon steel	Hard chrome plating
5	Piston	Aluminum alloy	
6	Cushion ring	Aluminum alloy	Anodized
7	Cushion ring B	Aluminum alloy	Anodized
8	Bushing	Bearing alloy	
9	Cushion valve	Steel wire	Trivalent zinc chromated
10	Tie-rod	Carbon steel	Trivalent zinc chromated
11	Retaining ring	Spring steel	Phosphate coating
12	Spring washer	Steel wire	Trivalent zinc chromated
13	Tie-rod nut	Rolled steel	Trivalent zinc chromated
14	Wear ring	Resin	
15	Cushion seal	Urethane	
16	Rod seal	NBR	
17	Piston seal	NBR	
18	Cushion valve seal	NBR	
19	Cylinder tube gasket	NBR	
20	Rod end nut	Rolled steel	Trivalent zinc chromated

Replacement Parts: Seal Kit

Bore size (mm)	Kit no.	Contents
40	CA2-40Z-PS	Set of the nos. 15, 16, 17, 19
50	CA2-50Z-PS	
63	CA2-63Z-PS	
80	CA2-80Z-PS	
100	CA2-100Z-PS	

- * Seal kit includes 15, 16, 17, 19. Order the seal kit based on each bore size.
- * Do not disassemble the trunnion type. Refer to page 525.
- * Seal kit includes a grease pack (ø40, ø50: 10 g, ø63, ø80: 20 g, ø100: 30 g). Order with the following part number when only the grease pack is needed.
Grease pack part number: GR-S-010 (10 g), GR-S-020 (20 g)

Basic: CA2B

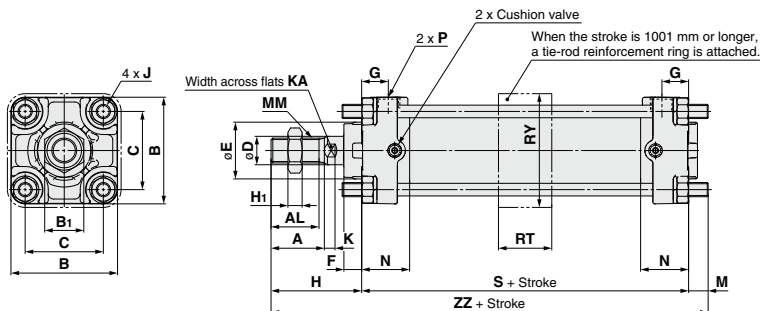

With rod boot

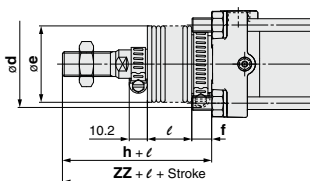

- CA1
- CJP
- CJ2
- JCM
- CM2
- CM3
- CG1
- CG3
- JMB
- MB
- MB1
- CA2**
- CS1
- CS2

Bore size (mm)	A	AL	B	B ₁	C	D	E	F	G	H ₁	J	K	KA	M		MM	
															Without reinforcement ring	With reinforcement ring	
40	30	27	60	22	44	16	32	10	15	8	M8 x 1.25	6	14		11	11	M14 x 1.5
50	35	32	70	27	52	20	40	10	17	11	M8 x 1.25	7	18		11	12	M18 x 1.5
63	35	32	85	27	64	20	40	10	17	11	M10 x 1.25	7	18		14	15	M18 x 1.5
80	40	37	102	32	78	25	52	14	21	13	M12 x 1.75	10	22		17	19	M22 x 1.5
100	40	37	116	41	92	30	52	14	21	16	M12 x 1.75	10	26		17	19	M26 x 1.5

Bore size (mm)	N	P	RT	RY	S	Without rod boot				With rod boot					
						H	ZZ		d	e	f	h	l	ZZ	
							Without reinforcement ring	With reinforcement ring						Without reinforcement ring	With reinforcement ring
40	27	1/4	30	64	84	51	146	146	56	43	11.2	59	1/4 stroke	154	154
50	30	3/8	30	76	90	58	159	160	64	52	11.2	66	1/4 stroke	167	168
63	31	3/8	40	92	98	58	170	171	64	52	11.2	66	1/4 stroke	178	179
80	37	1/2	45	112	116	71	204	206	76	65	12.5	80	1/4 stroke	213	215
100	40	1/2	50	136	126	72	215	217	76	65	14	81	1/4 stroke	224	226

Note 1) When a flange bracket is mounted on the head cover side of the basic type with bore size of ø50 to ø100 and stroke of 1001 mm or more, it is necessary to loosen the tie-rod to adjust the M dimension. When head flange type is ordered, adjustment is not necessary.

Note 2) For models with bore size of ø50 to ø100 and stroke of 1001 mm or more, do not mount a flange bracket on the rod cover side of the basic type since H dimension is different from those shown above. When rod flange type is used, order with the part number with bracket.

- D-□
- X□
- Technical Data

CA2 Series

Axial Foot: CA2L

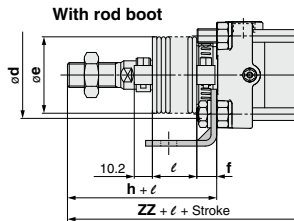
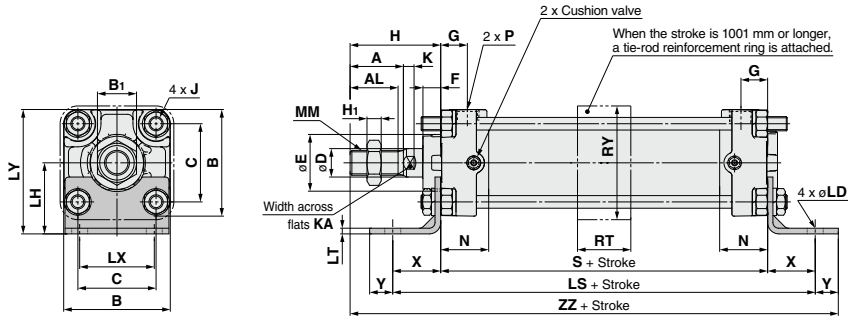

(mm)

Bore size (mm)	A	AL	B	B_1	C	D	E	F	G	H_1	J	K	KA	LD	LH	LS	LT	LX	LY
40	30	27	60	22	44	16	32	10	15	8	M8 x 1.25	6	14	9	40	138	3.2	42	70
50	35	32	70	27	52	20	40	10	17	11	M8 x 1.25	7	18	9	45	144	3.2	50	80
63	35	32	85	27	64	20	40	10	17	11	M10 x 1.25	7	18	11.5	50	166	3.2	59	93
80	40	37	102	32	78	25	52	14	21	13	M12 x 1.75	10	22	13.5	65	204	4.5	76	116
100	40	37	116	41	92	30	52	14	21	16	M12 x 1.75	10	26	13.5	75	212	6	92	133

Bore size (mm)	MM	N	P	S	X	Y	RT	RY	Without rod boot		With rod boot					
									H	ZZ	d	e	f	h	ℓ	ZZ
40	M14 x 1.5	27	1/4	84	27	13	30	64	51	175	56	43	11.2	59	1/4 stroke	183
50	M18 x 1.5	30	3/8	90	27	13	30	76	58	188	64	52	11.2	66	1/4 stroke	196
63	M18 x 1.5	31	3/8	98	34	16	40	92	58	206	64	52	11.2	66	1/4 stroke	214
80	M22 x 1.5	37	1/2	116	44	16	45	112	71	247	76	65	12.5	80	1/4 stroke	256
100	M26 x 1.5	40	1/2	126	43	17	50	136	72	258	76	65	14.0	81	1/4 stroke	267

Rod Flange: CA2F

Stroke of 1000 mm or less

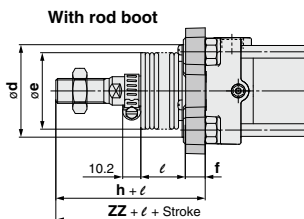
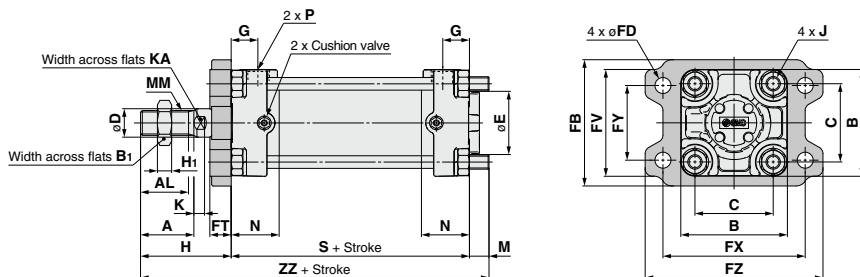

- CJ1
- CJP
- CJ2
- JCM
- CM2
- CM3
- CG1
- CG3
- JMB
- MB
- MB1
- CA2
- CS1
- CS2

Bore size (mm)	(mm)																		
	A	AL	B	B ₁	C	D	E	FB	FD	FT	FV	FX	FY	FZ	G	H ₁	J	K	KA
40	30	27	60	22	44	16	32	71	9	12	60	80	42	100	15	8	M8 x 1.25	6	14
50	35	32	70	27	52	20	40	81	9	12	70	90	50	110	17	11	M8 x 1.25	7	18
63	35	32	85	27	64	20	40	101	11.5	15	86	105	59	130	17	11	M10 x 1.25	7	18
80	40	37	102	32	78	25	52	119	13.5	18	102	130	76	160	21	13	M12 x 1.75	10	22
100	40	37	116	41	92	30	52	133	13.5	18	116	150	92	180	21	16	M12 x 1.75	10	26

Bore size (mm)	M	MM	N	P	S	Without rod boot		With rod boot						
						H	ZZ	*d	e	f	h	ℓ	ZZ	
						40	11	M14 x 1.5	27	1/4	84	51	146	52
50	11	M18 x 1.5	30	3/8	90	58	159	58	52	15	66	1/4 stroke	167	
63	14	M18 x 1.5	31	3/8	98	58	170	58	52	17.5	66	1/4 stroke	178	
80	17	M22 x 1.5	37	1/2	116	71	204	80	65	21.5	80	1/4 stroke	213	
100	17	M26 x 1.5	40	1/2	126	72	215	80	65	21.5	81	1/4 stroke	224	

★For installing an air cylinder, when a hole must be made to accommodate the rod portion, make sure to machine a hole that is larger than the outer diameter of the boot mounting bracket ød.

- D-□
- -X□
- Technical Data

CA2 Series

Rod Flange: CA2F

Stroke of 1001 mm or more

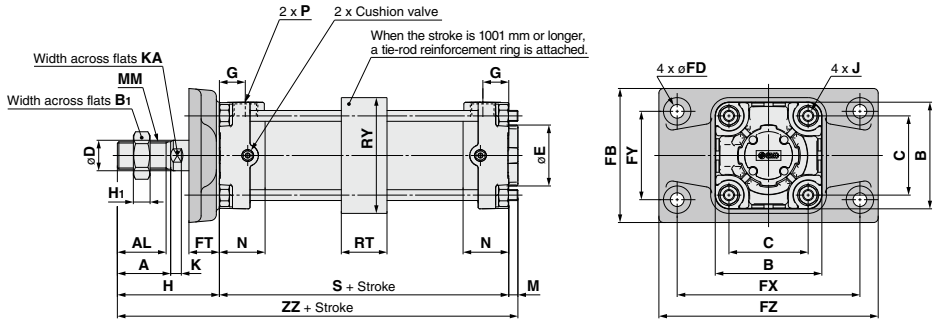

With rod boot

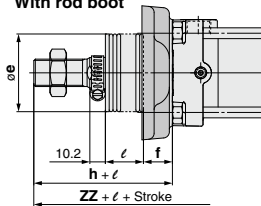

Bore size (mm)																	(mm)			
	A	AL	B	B ₁	C	D	E	FB	FD	FT	FX	FY	FZ	G	H ₁	J	K	KA	M	
40	30	27	60	22	44	16	32	71	9	12	80	42	100	15	8	M8 x 1.25	6	14	11	
50	35	32	70	27	52	20	40	88	9	20	120	58	144	17	11	M8 x 1.25	7	18	6	
63	35	32	85	27	64	20	40	105	11.5	23	140	64	170	17	11	M10 x 1.25	7	18	10	
80	40	37	102	32	78	25	52	124	13.5	28	164	84	198	21	13	M12 x 1.75	10	22	12	
100	40	37	116	41	92	30	52	140	13.5	29	180	100	220	21	16	M12 x 1.75	10	26	12	

Bore size (mm)	MM	N	P	RT	RY	S	Without rod boot				With rod boot			
							H	ZZ	*e	f	h	ℓ	ZZ	ZZ
40	M14 x 1.5	27	1/4	30	64	84	51	146	52	19	66	1/4 stroke	162	
50	M18 x 1.5	30	3/8	30	76	90	67	163	52	19	66	1/4 stroke	162	
63	M18 x 1.5	31	3/8	40	92	98	71	179	52	19	66	1/4 stroke	174	
80	M22 x 1.5	37	1/2	45	112	116	87	215	65	21	80	1/4 stroke	208	
100	M26 x 1.5	40	1/2	50	136	126	89	227	65	21	81	1/4 stroke	219	

★For installing an air cylinder, when a hole must be made to accommodate the rod portion, make sure to machine a hole that is larger than the outer diameter of the boot ϕ .

Note 1) For flange type with bore size of $\phi 40$, the same flange bracket is used for all strokes.

Note 2) For models with bore size of $\phi 50$ to $\phi 100$ and stroke of 1001 mm or more, do not mount a flange bracket on the rod cover side of the basic type since H dimension is different from those shown above. When rod flange type is used, order with the part number with bracket.

Head Flange: CA2G

Stroke of 1000 mm or less

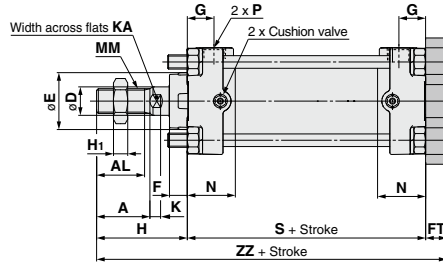
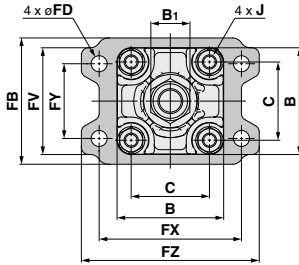

With rod boot

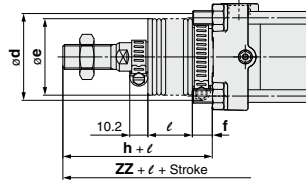

- CA1
- CJP
- CJ2
- JCM
- CM2
- CM3
- CG1
- CG3
- JMB
- MB
- MB1
- CA2**
- CS1
- CS2

Bore size (mm)	A	AL	B	B ₁	C	D	E	F	FB	FD	FT	FV	FX	FY	FZ	G	H ₁	J
40	30	27	60	22	44	16	32	10	71	9	12	60	80	42	100	15	8	M8 x 1.25
50	35	32	70	27	52	20	40	10	81	9	12	70	90	50	110	17	11	M8 x 1.25
63	35	32	85	27	64	20	40	10	101	11.5	15	86	105	59	130	17	11	M10 x 1.25
80	40	37	102	32	78	25	52	14	119	13.5	18	102	130	76	160	21	13	M12 x 1.75
100	40	37	116	41	92	30	52	14	133	13.5	18	116	150	92	180	21	16	M12 x 1.75

(mm)

Bore size (mm)	K	KA	MM	N	P	S	Without rod boot		With rod boot					
							H	ZZ	d	e	f	h	ℓ	ZZ
40	6	14	M14 x 1.5	27	1/4	84	51	147	56	43	11.2	59	1/4 stroke	155
50	7	18	M18 x 1.5	30	3/8	90	58	160	64	52	11.2	66	1/4 stroke	168
63	7	18	M18 x 1.5	31	3/8	98	58	171	64	52	11.2	66	1/4 stroke	179
80	10	22	M22 x 1.5	37	1/2	116	71	205	76	65	12.5	80	1/4 stroke	214
100	10	26	M26 x 1.5	40	1/2	126	72	216	76	65	14.0	81	1/4 stroke	225

- D-□
- X□
- Technical Data

CA2 Series

Head Flange: CA2G

Stroke of 1001 mm or more

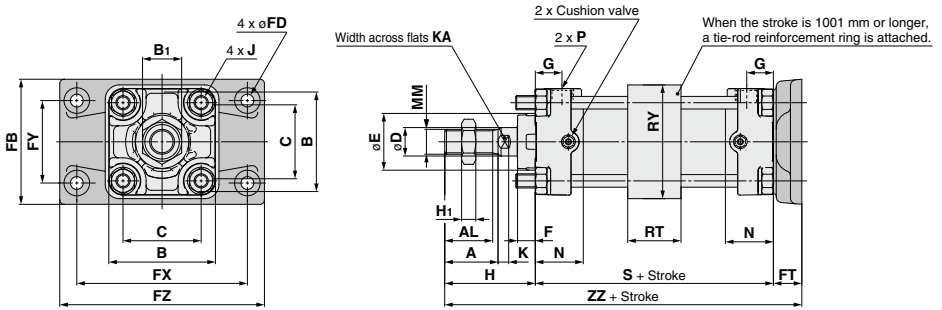

With rod boot

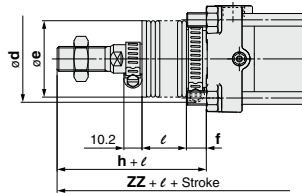

Bore size (mm)	A	AL	B	B ₁	C	D	E	FB	FD	FT	FX	FY	FZ	G	H ₁	J	K	KA
	40	30	27	60	22	44	16	30	71	9	12	80	42	100	15	8	M8 x 1.25	6
50	35	32	70	27	52	20	40	88	9	20	120	58	144	17	11	M8 x 1.25	7	18
63	35	32	85	27	64	20	40	105	11.5	23	140	64	170	17	11	M10 x 1.25	7	18
80	40	37	102	32	78	25	52	124	13.5	28	164	84	198	21	13	M12 x 1.75	10	22
100	40	37	116	41	92	30	52	140	13.5	29	180	100	220	21	16	M12 x 1.75	10	26

Bore size (mm)	MM	N	P	S	RT	RY	Without rod boot		With rod boot					
							H	ZZ	d	e	f	h	ℓ	ZZ
40	M14 x 1.5	27	1/4	84	30	64	51	147	56	43	11.2	59	1/4 stroke	155
50	M18 x 1.5	30	3/8	90	30	76	58	168	64	52	11.2	66	1/4 stroke	176
63	M18 x 1.5	31	3/8	98	40	92	58	179	64	52	11.2	66	1/4 stroke	187
80	M22 x 1.5	37	1/2	116	45	112	71	215	76	65	12.5	80	1/4 stroke	224
100	M26 x 1.5	40	1/2	126	50	136	72	227	76	65	14	81	1/4 stroke	236

Note 1) For flange type with bore size of $\phi 40$, the same flange bracket is used for all strokes.

Note 2) When a flange bracket is mounted on the head cover side of the basic type with bore size of $\phi 50$ to $\phi 100$ and stroke of 1001 mm or more, it is necessary to loosen the tie-rod to adjust the M dimension. When head flange type is ordered, adjustment is not necessary.

Single Clevis: CA2C

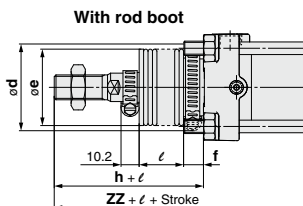
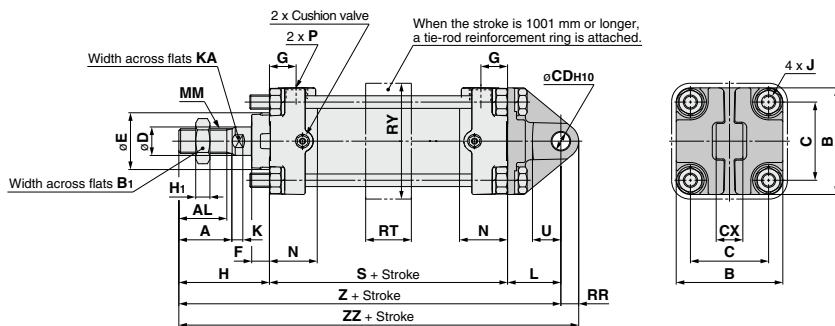

- CJ1
- CJP
- CJ2
- JCM
- GM2
- CM3
- CG1
- CG3
- JMB
- MB
- MB1
- CA2**
- CS1
- CS2

Bore size (mm)	A	AL	B	B ₁	C	CD _{H10}	CX	D	E	F	G	H ₁	J	K	KA	L
40	30	27	60	22	44	10 ^{+0.058} ₀	15 ^{-0.1} _{-0.3}	16	32	10	15	8	M8 x 1.25	6	14	30
50	35	32	70	27	52	12 ^{+0.070} ₀	18 ^{-0.1} _{-0.3}	20	40	10	17	11	M8 x 1.25	7	18	35
63	35	32	85	27	64	16 ^{+0.070} ₀	25 ^{-0.1} _{-0.3}	20	40	10	17	11	M10 x 1.25	7	18	40
80	40	37	102	32	78	20 ^{+0.084} ₀	31.5 ^{-0.1} _{-0.3}	25	52	14	21	13	M12 x 1.75	10	22	48
100	40	37	116	41	92	25 ^{+0.084} ₀	35.5 ^{-0.1} _{-0.3}	30	52	14	21	16	M12 x 1.75	10	26	58

Bore size (mm)	MM	N	P	RR	S	U	Without rod boot			With rod boot						
							H	Z	ZZ	d	e	f	h	ℓ	Z	ZZ
40	M14 x 1.5	27	1/4	10	84	16	51	165	175	56	43	11.2	59	1/4 stroke	173	183
50	M18 x 1.5	30	3/8	12	90	19	58	183	195	64	52	11.2	66	1/4 stroke	191	203
63	M18 x 1.5	31	3/8	16	98	23	58	196	212	64	52	11.2	66	1/4 stroke	204	220
80	M22 x 1.5	37	1/2	20	116	28	71	235	255	76	65	12.5	80	1/4 stroke	244	264
100	M26 x 1.5	40	1/2	25	126	36	72	256	281	76	65	14.0	81	1/4 stroke	265	290

- D-□
- X□
- Technical Data

CA2 Series

Double Clevis: CA2D

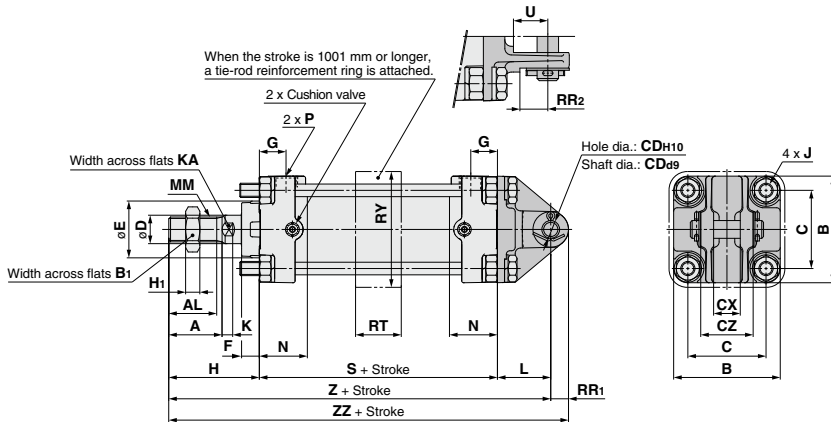

With rod boot

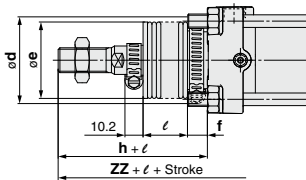

Bore size (mm)															(mm)		
	A	AL	B	B ₁	C	CD _{H10}	CX	CZ	D	E	F	G	H ₁	J	K	KA	L
40	30	27	60	22	44	10 ^{+0.058} ₀	15 ^{+0.3} _{-0.1}	29.5	16	32	10	15	8	M8 x 1.25	6	14	30
50	35	32	70	27	52	12 ^{+0.070} ₀	18 ^{+0.3} _{-0.1}	38	20	40	10	17	11	M8 x 1.25	7	18	35
63	35	32	85	27	64	16 ^{+0.070} ₀	25 ^{+0.3} _{-0.1}	49	20	40	10	17	11	M10 x 1.25	7	18	40
80	40	37	102	32	78	20 ^{+0.084} ₀	31.5 ^{+0.3} _{-0.1}	61	25	52	14	21	13	M12 x 1.75	10	22	48
100	40	37	116	41	92	25 ^{+0.084} ₀	35.5 ^{+0.3} _{-0.1}	64	30	52	14	21	16	M12 x 1.75	10	26	58

Bore size (mm)	MM	N	P	RR ₁	RR ₂	S	U	Without rod boot			With rod boot						
								H	Z	ZZ	d	e	f	h	ℓ	Z	ZZ
40	M14 x 1.5	27	1/4	10	16	84	16	51	165	175	56	43	11.2	59	1/4 stroke	173	183
50	M18 x 1.5	30	3/8	12	19	90	19	58	183	195	64	52	11.2	66	1/4 stroke	191	203
63	M18 x 1.5	31	3/8	16	23	98	23	58	196	212	64	52	11.2	66	1/4 stroke	204	220
80	M22 x 1.5	37	1/2	20	28	116	28	71	235	255	76	65	12.5	80	1/4 stroke	244	264
100	M26 x 1.5	40	1/2	25	23.5	126	36	72	256	281	76	65	14.0	81	1/4 stroke	265	290

* A clevis pin, flat washers and split pins are included.

Center Trunnion: CA2T

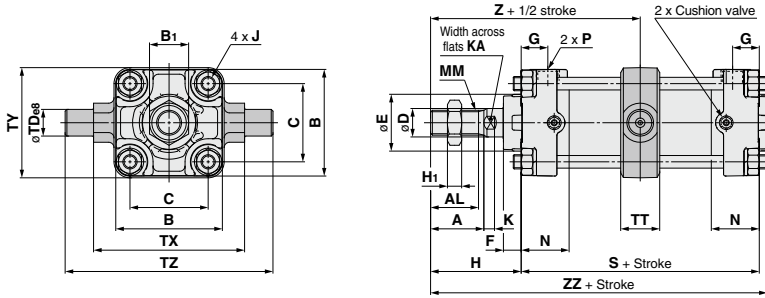

With rod boot

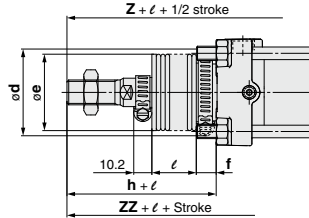

Bore size (mm)	A	AL	B	B ₁	C	D	E	F	G	H ₁	J	K	KA	MM	N	P	S
	40	30	27	60	22	44	16	32	10	15	8	M8 x 1.25	6	14	M14 x 1.5	27	1/4
50	35	32	70	27	52	20	40	10	17	11	M8 x 1.25	7	18	M18 x 1.5	30	3/8	90
63	35	32	85	27	64	20	40	10	17	11	M10 x 1.25	7	18	M18 x 1.5	31	3/8	98
80	40	37	102	32	78	25	52	14	21	13	M12 x 1.75	10	22	M22 x 1.5	37	1/2	116
100	40	37	116	41	92	30	52	14	21	16	M12 x 1.75	10	26	M26 x 1.5	40	1/2	126

Bore size (mm)	TD _{es}	TT	TX	TY	TZ	Without rod boot			With rod boot						
						H	Z	ZZ	d	e	f	h	ℓ	Z	ZZ
40	15 ^{-0.032} _{-0.059}	22	85	62	117	51	93	140	56	43	11.2	59	1/4 stroke	101	148
50	15 ^{-0.032} _{-0.059}	22	95	74	127	58	103	154	64	52	11.2	66	1/4 stroke	111	162
63	16 ^{-0.048} _{-0.059}	28	110	90	148	58	107	162	64	52	11.2	66	1/4 stroke	115	170
80	25 ^{-0.040} _{-0.073}	34	140	110	192	71	129	194	76	65	12.5	80	1/4 stroke	138	203
100	25 ^{-0.040} _{-0.073}	40	162	130	214	72	135	206	76	65	14.0	81	1/4 stroke	144	215

* Do not disassemble the trunnion type. Refer to page 525.

- CJ1
- CJP
- CJ2
- JCM
- CM2
- CM3
- CG1
- CG3
- JMB
- MB
- MB1
- CA2**
- CS1
- CS2

- D-□
- X□
- Technical Data

CA2 Series

Trunnion and Double Clevis Pivot Bracket

- Strength is the same as cylinder brackets.

Applicable Series

Bracket type	Applicable series
Trunnion pivot bracket	CA2
Double clevis pivot bracket	CA2

* Please contact SMC at the time of mounting.

Bore size	CA2□40	CA2□50	CA2□63	CA2□80	CA2□100
Description	CA2-S04		CA2-S06	MB-S10	
Trunnion pivot bracket	CA2-S04		CA2-S06	MB-S10	
Double clevis pivot bracket	CA2-B04	CA2-B05	CA2-B06	CA2-B08	CA2-B10

* Order 2 trunnion pivot brackets per cylinder.

Trunnion pivot bracket

Material: Cast iron

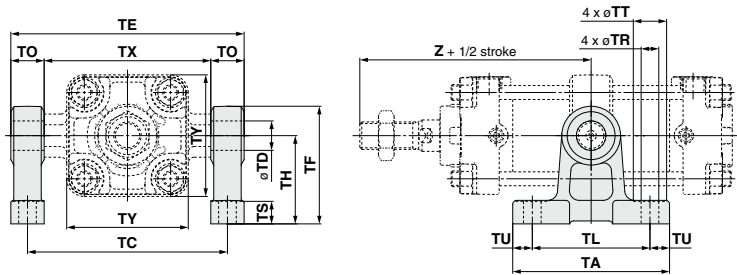

(mm)

Part no.	Bore size (mm)	TA	TL	TU	TC	TX	TE	TO	TR	TT	TS	TH	TF	TY	Z	TD-H10 (Hole)
CA2-S04	40	80	60	10	102	85	119	17	9	17	12	45	60	62	93	15 ^{+0.070} ₀
	50	80	60	10	112	95	129	17	9	17	12	45	60	74	103	15 ^{+0.070} ₀
CA2-S06	63	100	70	15	130	110	150	20	11	22	14	55	73	90	107	18 ^{+0.070} ₀
	80	120	90	15	166	140	192	26	13.5	24	17	75	100	110	129	25 ^{+0.084} ₀
MB-S10	100	120	90	15	188	162	214	26	13.5	24	17	75	100	130	135	25 ^{+0.084} ₀

Double clevis pivot bracket

Material: Cast iron

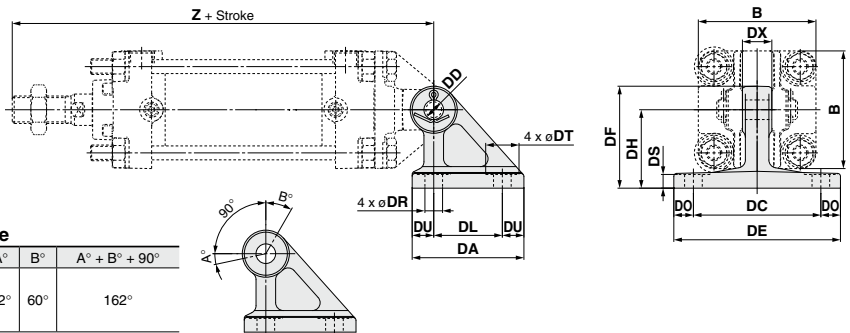

Rotating Angle

Bore size (mm)	A°	B°	A° + B° + 90°
40 to 100	12°	60°	162°

(mm)

Part no.	Bore size (mm)	DA	DL	DU	DC	DX	DE	DO	DR	DT	DS	DH	DF	B	Z	DDH10 (Hole)
CA2-B04	40	57	35	11	65	15	85	10	9	17	8	40	52	60	165	10 ^{+0.058} ₀
CA2-B05	50	57	35	11	65	18	85	10	9	17	8	40	52	70	183	12 ^{+0.070} ₀
CA2-B06	63	67	40	13.5	80	25	105	12.5	11	22	10	50	66	85	196	16 ^{+0.070} ₀
CA2-B08	80	93	60	16.5	100	31.5	130	15	13.5	24	12	65	90	102	235	20 ^{+0.084} ₀
CA2-B10	100	93	60	16.5	100	35.5	130	15	13.5	24	12	65	90	116	256	25 ^{+0.084} ₀

CA2 Series Dimensions of Accessories

Y Type Double Knuckle Joint

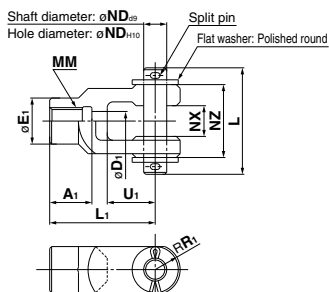

Material: Cast iron (mm)

Part no.	Applicable bore size	A ₁	E ₁	D ₁	L ₁	MM	R ₁	U ₁	ND	NX	NZ	L	Split pin size	Flat washer size
Y-04D	40	22	24	10	55	M14 x 1.5	13	25	12	16 ^{+0.3} / _{+0.1}	38	55.5	ø3 x 18 L	Polished round 12
Y-05D	50, 63	27	28	14	60	M18 x 1.5	15	27	12	16 ^{+0.3} / _{+0.1}	38	55.5	ø3 x 18 L	Polished round 12
Y-08D	80	37	36	18	71	M22 x 1.5	19	28	18	26 ^{+0.3} / _{+0.1}	55	76.5	ø4 x 25 L	Polished round 18
Y-10D	100	37	40	21	83	M26 x 1.5	21	38	20	30 ^{+0.3} / _{+0.1}	61	83	ø4 x 30 L	Polished round 20

* A knuckle pin, split pins and flat washers are included.

Clevis Pin/Knuckle Pin

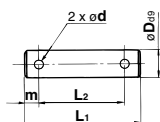

Material: Carbon steel (mm)

Part no.	Applicable bore size		Dd9	L ₁	L ₂	m	d	Included split pin	Included flat washer
	Clevis	Knuckle							
CDP-2A	40	—	10 ^{-0.040} / _{-0.076}	46	38	4	3	ø3 x 18 L	Polished round 10
CDP-3A	50	40, 50, 63	12 ^{-0.050} / _{-0.093}	55.5	47.5	4	3	ø3 x 18 L	Polished round 12
CDP-4A	63	—	16 ^{-0.050} / _{-0.093}	71	61	5	4	ø4 x 25 L	Polished round 16
CDP-5A	—	80	18 ^{-0.050} / _{-0.093}	76.5	66.5	5	4	ø4 x 25 L	Polished round 18
CDP-6A	80	100	20 ^{-0.065} / _{-0.117}	83	73	5	4	ø4 x 30 L	Polished round 20
CDP-7A	100	—	25 ^{-0.065} / _{-0.117}	88	78	5	4	ø4 x 36 L	Polished round 24

* Split pins and flat washers are included.

I Type Single Knuckle Joint

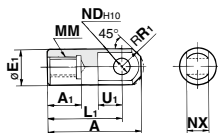

Material: Free cutting sulfur steel (mm)

Part no.	Applicable bore size	A	A ₁	E ₁	L ₁	MM	R ₁	U ₁	ND _{H10}	NX
I-04A	40	69	22	24	55	M14 x 1.5	15.5	20	12 ^{+0.070} / ₀	16 ^{-0.1} / _{-0.3}
I-05A	50, 63	74	27	28	60	M18 x 1.5	15.5	20	12 ^{+0.070} / ₀	16 ^{-0.1} / _{-0.3}
I-08A	80	91	37	36	71	M22 x 1.5	22.5	26	18 ^{+0.070} / ₀	28 ^{-0.1} / _{-0.3}
I-10A	100	105	37	40	83	M26 x 1.5	24.5	28	20 ^{+0.084} / ₀	30 ^{-0.1} / _{-0.3}

Rod End Nut (Standard)

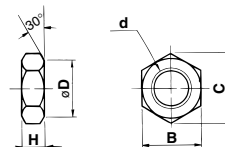

Material: Rolled steel (mm)

Part no.	Applicable bore size	d	H	B	C	D
NT-04	40	M14 x 1.5	8	22	25.4	21
NT-05	50, 63	M18 x 1.5	11	27	31.2	26
NT-08	80	M22 x 1.5	13	32	37.0	31
NT-10	100	M26 x 1.5	16	41	47.3	39

CJ1

CJP

CJ2

JCM

CM2

CM3

CG1

CG3

JMB

MB

MB1

CA2

CS1

CS2

D-□

-X□

Technical Data

Air Cylinder: Standard Type Double Acting, Double Rod

CA2W Series

ø40, ø50, ø63, ø80, ø100

RoHS

How to Order

CA2W L **50** - **100** **Z** -

With auto switch **CDA2W L** **50** - **100** **Z** - **M9BW** -

With auto switch (Built-in magnet)
Built-in Magnet Cylinder Model
If a built-in magnet cylinder without an auto switch is required, there is no need to enter the symbol for the auto switch. (Example) CDA2WL40-100Z

Tube material

Nil	Aluminum tube
F*	Steel tube

* Not available with auto switch.

Double rod

Mounting

B	Basic
L	Axial foot
F	Rod flange
T	Center trunnion

* Mounting brackets other than center trunnion are shipped together.

Bore size

40	40 mm
50	50 mm
63	63 mm
80	80 mm
100	100 mm

Suffix (Cushion)

Nil	Air cushion
N	Rubber bumper

Suffix (Rod boot)

One side	Nil	Without rod boot
	J	Nylon tarpaulin
Both sides	K	Heat resistant tarpaulin
	Nil	Without rod boot
	JJ	Nylon tarpaulin
	KK	Heat resistant tarpaulin

Made to Order
For details, refer to the next page.

Number of auto switches

Nil	2 pcs.
S	1 pc.
3	3 pcs.
n	"n" pcs.

Auto switch

Nil	Without auto switch
-----	---------------------

* For applicable auto switches, refer to the table below.

Port thread type

Nil	Rc
TN	NPT
TF	G

Cylinder stroke (mm)
For details, refer to the next page.

Applicable Auto Switches/Refer to pages 1575 to 1701 for further information on auto switches.

Type	Special function	Electrical entry	Indication light	Wiring (Output)	Load voltage		Auto switch model		Lead wire length (m)					Pre-wired connector	Applicable load				
					DC	AC	Tie-rod mounting	Band mounting	0.5 (Nil)	1 (M)	3 (L)	5 (Z)	IC circuit		Relay, PLC				
Solid state auto switch	—	Grommet	No	3-wire (NPN)	24 V	5 V, 12 V	—	M9N	●	●	○	○	○	—	—	—			
				3-wire (PNP)				G59	●	●	○	○	○						
				2-wire	12 V	M9B	●	●	○	○	○	—	—	—					
		3-wire (NPN)		12 V	G39C	G39	—	—	—	—									
		2-wire			K39C	K39	—	—	—	—									
		3-wire (NPN)		5 V, 12 V	M9NW	●	●	○	○	○	IC circuit	Relay, PLC							
	3-wire (PNP)	G59W	●		●	○	○	○											
	Diagnostic indication (2-color indicator)	Grommet	Yes	2-wire	24 V	12 V	—	M9PW	●	●	○	○	○	—	—	—			
				3-wire (PNP)				G5PW	●	●	○	○	○						
				2-wire	M9BW	●	●	○	○	○									
		Water resistant (2-color indicator)		Grommet	3-wire (NPN)	5 V, 12 V	—	M9NA*1	—	○	○	●	○	○	—	—	—		
					3-wire (PNP)			M9PA*1	—	○	○	●	○	○					
2-wire					12 V	M9BA*1	—	○	○	●	○	○							
With diagnostic output (2-color indicator)	Grommet	Yes	4-wire (NPN)	5 V, 12 V	—	G5BA*1	—	—	—	—	—	—	—	—					
			2-wire (Non-polar)	—	F59F	G59F	●	—	●	○	○				○				
Magnetic field resistant (2-color indicator)	Grommet	Yes	2-wire (Non-polar)	—	—	P3DWA	—	—	—	—	—	—	—	—					
			3-wire (NPN equiv.)	—	5 V	P4DW	—	—	—	—	—				○				
Reed auto switch	—	Grommet	Yes	2-wire	24 V	12 V	—	A96	—	●	●	—	—	—	—	—			
								A93	—	●	●	—	—						
								A90	—	●	●	—	—						
								A54	B54	—	—	—	—						
								A64	B64	—	—	—	—						
		Terminal conduit		Yes	DIN terminal	2-wire	24 V	12 V	—	A33C	A33	—	—	—	—	—	—	—	
										A34C	A34	—	—	—	—				
										A44C	A44	—	—	—	—				
										A59W	B59W	●	—	●	—				—
										—	—	—	—	—	—				

*1 Water resistant type auto switches can be mounted on the above models, but in such case SMC cannot guarantee water resistance.

A water-resistant type cylinder is recommended for use in an environment which requires water resistance.

* Lead wire length symbols: 0.5 m.....Nil (Example) M9NW 3 m.....L (Example) M9NWL 1 m.....M (Example) M9NWM 5 m.....Z (Example) M9NWZ

* Solid state auto switches marked with "○" are produced upon receipt of order.

* Since there are other applicable auto switches than listed above, refer to page 523 for details.

* For details about auto switches with pre-wired connector, refer to pages 1648 and 1649.

* The D-A9□/M9□□□P3DWA□ auto switches are shipped together, (but not assembled). (However, auto switch mounting brackets are assembled for the D-A9□/M9□□ before shipment.)

Specifications

Bore size (mm)	40	50	63	80	100
Fluid	Air				
Action	Double acting				
Proof pressure	1.5 MPa				
Maximum operating pressure	1.0 MPa				
Minimum operating pressure	0.08 MPa				
Piston speed	50 to 500 mm/s				
Ambient and fluid temperature	Without auto switch: -10 to 70°C* With auto switch : -10 to 60°C*				
Cushion	Air cushion or Rubber bumper				
Stroke length tolerance	Up to 250 st: ^{+1.0} / _n 251 to 1000 st: ^{+1.4} / _n				
Lubrication	Not required (Non-lube)				
Mounting	Basic, Axial foot, Rod flange, Center trunnion				

* No freezing

Standard Strokes

Bore size	Standard stroke ^{Note 1)}		Max. manufacturable stroke
	Stroke range ①	Stroke range ②	
40	25, 50, 75, 100, 125, 150, 175, 200, 250, 300, 350, 400, 450, 500	Up to 1000	Up to 1800
50, 63	25, 50, 75, 100, 125, 150, 175, 200, 250, 300, 350, 400, 450, 500, 600	Up to 1200	
80, 100	25, 50, 75, 100, 125, 150, 175, 200, 250, 300, 350, 400, 450, 500, 600, 700	Up to 1500	

Note 1) Intermediate strokes not listed above are produced upon receipt of order.

Note 2) Applicable strokes should be confirmed according to the usage. For details, refer to "Air Cylinders Model Selection" on front matter pages. In addition, the products that exceed the stroke range ① might not be able to fulfill the specifications due to the deflection etc.

Note 3) Please consult with SMC for manufacturability and the part numbers when exceeding the stroke range ②.

Note 4) The stroke range with rod boot is 20 to 1400 mm. Please consult with SMC when exceeding 1400 mm strokes.

Minimum Stroke for Auto Switch Mounting

Caution

The minimum stroke for mounting varies with the auto switch type and cylinder mounting type. In particular, the center trunnion type needs careful attention. (For details, refer to pages 521 and 522.)

Rod Boot Material

Symbol	Rod boot material	Max. ambient temperature
J	Nylon tarpaulin	70°C
K	Heat resistant tarpaulin	110°C*

* Maximum ambient temperature for the rod boot

Accessories

Standard	Mounting				
	Rod end nut	Basic	Foot	Flange	Center trunnion
Option	Single knuckle joint	●	●	●	●
	Double knuckle joint (with pin)	●	●	●	●
	With rod boot	●	●	●	●

* Refer to page 485 for part numbers and dimensions.

Weights/Aluminum Tube (Steel Tube)

Bore size (mm)		(kg)					
		40	50	63	80	100	
Basic weight	Basic	Aluminum tube	0.92	1.38	1.86	3.32	4.55
		Steel tube	0.97	1.44	1.96	3.5	4.83
	Axial foot	Aluminum tube	1.11	1.6	2.19	3.99	5.54
		Steel tube	1.16	1.66	2.29	4.17	5.82
	Flange	Aluminum tube	1.29	1.83	2.65	4.77	6.47
		Steel tube	1.34	1.89	2.75	4.95	6.75
Trunnion	Aluminum tube	1.28	1.86	2.66	4.87	6.83	
	Steel tube	1.33	1.92	2.76	5.05	7.11	
Additional weight per 50 mm of stroke	All mounting brackets	0.28	0.37	0.44	0.66	0.86	
	Steel tube	0.35	0.47	0.55	0.89	1.15	
Accessories	Single knuckle	0.23	0.26	0.26	0.60	0.83	
	Double knuckle (with pin)	0.37	0.43	0.43	0.87	1.27	

Calculation:

(Example) CA2WL40-100

(Axial foot, ø40, 100 stroke)

- Basic weight
..... 1.18 (Axial foot, ø40)
- Additional weight
..... 0.28/50 stroke
- Cylinder stroke
..... 100 stroke
1.18 + 0.28 x 100/50 = 1.74 kg



Symbol

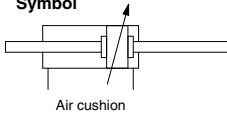

Made to Order
[Click here for details](#)

Symbol	Specifications
-XA□	Change of rod end shape
-XB6	Heat resistant cylinder (-10 to 150°C)
-XC3	Special port location*
-XC4	With heavy duty scraper
-XC5	Heat resistant cylinder (-10 to 110°C)
-XC7	Tie-rod, cushion valve, tie-rod nut, etc. made of stainless steel
-XC14	Change of trunnion bracket mounting position
-XC15	Change of tie-rod length
-XC22	Fluororubber seal
-XC28	Compact flange made of SS400
-XC35	With coil scraper
-XC58	Water resistant/ Built-in hard plastic magnet*
-XC59	Fluororubber seal/ Built-in hard plastic magnet*
-XC65	Made of stainless steel (Combination of XC7 and XC68)
-XC68	Made of stainless steel (with hard chrome plated piston rod)
-XC85	Grease for food processing equipment

For special port location (-XC3), the mounting bracket and port location can be determined using the standard product corresponding to the operating conditions.

* The cover shape is the same as the current product.

For made of stainless steel (-XC6), use made of stainless steel (with hard chrome plated piston rod) (-XC68) that the surface treatment is performed on the piston rod with the same specifications.

Refer to pages 517 to 523 for cylinders with auto switches.

- Auto switch proper mounting position (detection at stroke end) and its mounting height
- Operating range
- Minimum stroke for auto switch mounting
- Auto switch mounting brackets/Part no.

CJ1

CJP

CJ2

JCM

CM2

CM3

CG1

CG3

JMB

MB

MB1

CA2

CS1

CS2

D-□

-X□

Technical Data

CA2W Series

Construction

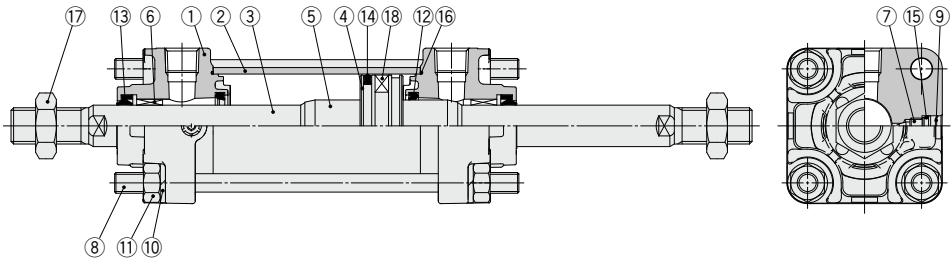

Component Parts

No.	Description	Material	Q'ty	Note
1	Rod cover	Aluminum die-casted	2	Trivalent chromated
2	Cylinder tube	Aluminum alloy	1	Hard anodized
3	Piston rod	Carbon steel	1	Hard chrome plating
4	Piston	Aluminum alloy	1	
5	Cushion ring	Aluminum alloy	2	Anodized
6	Bushing	Bearing alloy	1	
7	Cushion valve	Steel wire	2	Trivalent zinc chromated
8	Tie-rod	Carbon steel	4	Trivalent zinc chromated
9	Retaining ring	Spring steel	2	Phosphate coating
10	Spring washer	Steel wire	8	Trivalent zinc chromated
11	Tie-rod nut	Rolled steel	8	Trivalent zinc chromated
12	Cushion seal	Urethane	2	
13	Rod seal	NBR	2	
14	Piston seal	NBR	1	
15	Cushion valve seal	NBR	2	
16	Cylinder tube gasket	NBR	2	
17	Rod end nut	Rolled steel	2	Trivalent zinc chromated
18	Magnet	—	(1)	

Replacement Parts: Seal Kit

Bore size (mm)	Kit no.	Contents
	Pneumatic type	
40	CA2W40Z-PS	Set of the nos. 12, 13, 14, 16
50	CA2W50Z-PS	
63	CA2W63Z-PS	
80	CA2W80Z-PS	
100	CA2W100Z-PS	

* Do not disassemble the trunnion type. Refer to page 525.

* Seal kit includes a grease pack (ø40, ø50: 10 g, ø63, ø80: 20 g, ø100: 30 g).

* Seal kit includes a grease pack (ø40, ø50: 10 g, ø63, ø80: 20 g, ø100: 30 g).

Order with the following part number when only the grease pack is needed.
Grease pack part number: GR-S-010 (10 g), GR-S-020 (20 g)

Air Cylinder: Standard Type **CA2W Series**

Basic: CA2WB

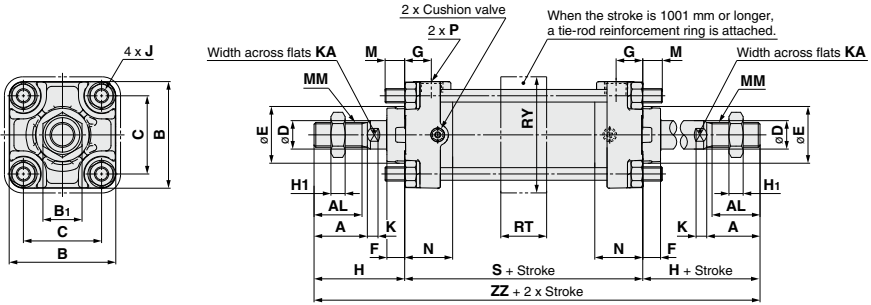

With rod boot (One side)

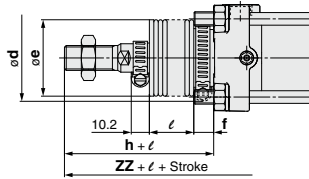

With rod boot (Both sides)

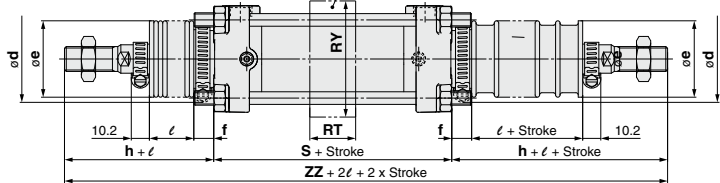

- CJ1
- CJP
- CJ2
- JCM
- CM2
- CM3
- CG1
- CG3
- JMB
- MB
- MB1
- CA2**
- CS1
- CS2

Bore size (mm)	A	AL	B	B ₁	C	D	E	F	G	H ₁	J	K	KA	M	MM
40	30	27	60	22	44	16	32	10	15	8	M8 x 1.25	6	14	11	M14 x 1.5
50	35	32	70	27	52	20	40	10	17	11	M8 x 1.25	7	18	11	M18 x 1.5
63	35	32	85	27	64	20	40	10	17	11	M10 x 1.25	7	18	14	M18 x 1.5
80	40	37	102	32	78	25	52	14	21	13	M12 x 1.75	10	22	17	M22 x 1.5
100	40	37	116	41	92	30	52	14	21	16	M12 x 1.75	10	26	17	M26 x 1.5

Bore size (mm)	N	P	RT	RY	S	Without rod boot		With rod boot (One side)						[Both sides]	
						H	ZZ	d	e	f	h	ℓ	ZZ	ZZ	
40	27	1/4	30	64	84	51	186	56	43	11.2	59	1/4 stroke	194	202	
50	30	3/8	30	76	90	58	206	64	52	11.2	66	1/4 stroke	214	222	
63	31	3/8	40	92	98	58	214	64	52	11.2	66	1/4 stroke	222	230	
80	37	1/2	45	112	116	71	258	76	65	12.5	80	1/4 stroke	267	276	
100	40	1/2	50	136	126	72	270	76	65	14.0	81	1/4 stroke	279	288	

- D-□
- X□
- Technical Data

CA2W Series

Axial Foot: CA2WL

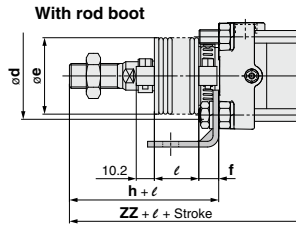
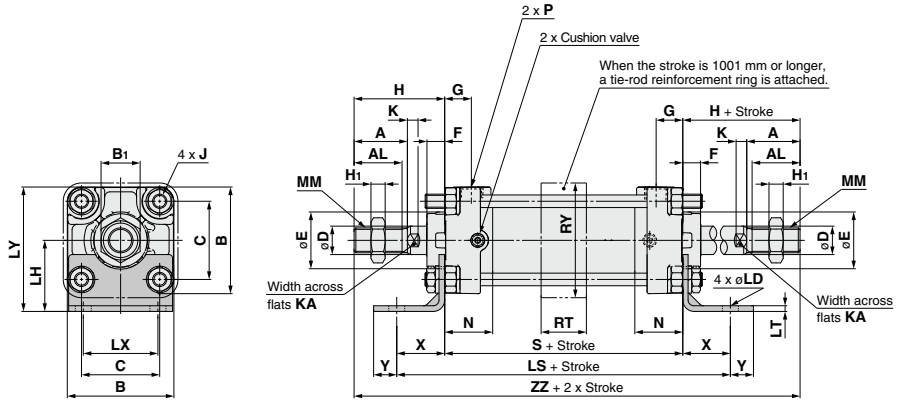

(mm)

Bore size (mm)	A	AL	B	B ₁	C	D	E	F	G	H _i	J	K	KA	LD	LH	LS	LT	LX	LY
40	30	27	60	22	44	16	32	10	15	8	M8 x 1.25	6	14	9	40	138	3.2	42	70
50	35	32	70	27	52	20	40	10	17	11	M8 x 1.25	7	18	9	45	144	3.2	50	80
63	35	32	85	27	64	20	40	10	17	11	M10 x 1.25	7	18	11.5	50	166	3.2	59	93
80	40	37	102	32	78	25	52	14	21	13	M12 x 1.75	10	22	13.5	65	204	4.5	76	116
100	40	37	116	41	92	30	52	14	21	16	M12 x 1.75	10	26	13.5	75	212	6	92	133

Bore size (mm)	MM	N	P	RT	RY	S	X	Y	Without rod boot		With rod boot (One side)						[Both sides]	
									H	ZZ	d	e	f	h	ℓ	ZZ	ZZ	
40	M14 x 1.5	27	1/4	30	64	84	27	13	51	186	56	43	11.2	59	1/4 stroke	194	202	
50	M18 x 1.5	30	3/8	30	76	90	27	13	58	206	64	52	11.2	66	1/4 stroke	214	222	
63	M18 x 1.5	31	3/8	40	92	98	34	16	58	214	64	52	11.2	66	1/4 stroke	222	230	
80	M22 x 1.5	37	1/2	45	112	116	44	16	71	258	76	65	12.5	80	1/4 stroke	267	276	
100	M26 x 1.5	40	1/2	50	136	126	43	17	72	270	76	65	14.0	81	1/4 stroke	279	288	

Rod Flange: CA2WF

Stroke of 1000 mm or less

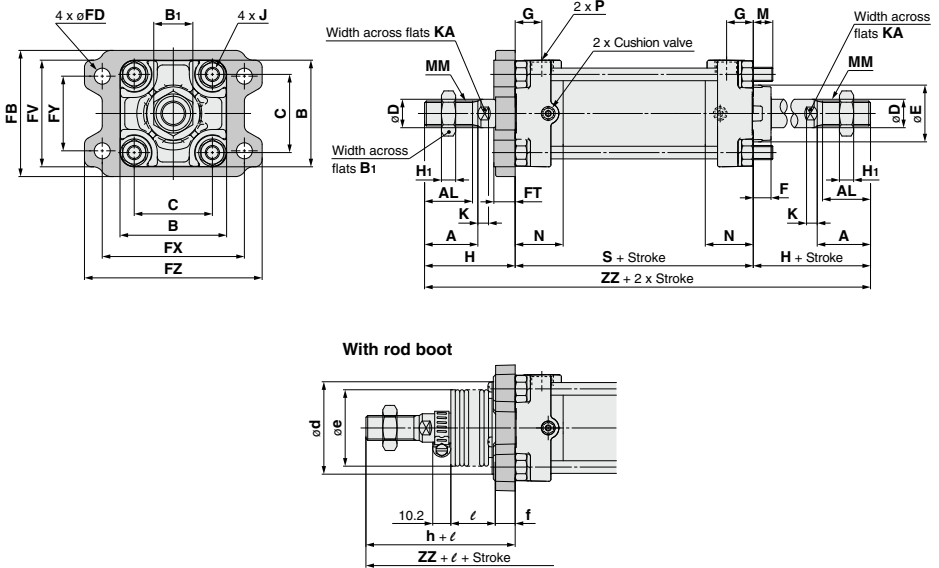

- CJ1
- CJP
- CJ2
- JCM
- CM2
- CM3
- CG1
- CG3
- JMB
- MB
- MB1
- CA2
- CS1
- CS2

Bore size (mm)	A	AL	B	B ₁	C	D	E	FB	FD	FT	FV	FX	FY	FZ	G	H ₁	J	K	KA	M
40	30	27	60	22	44	16	32	71	9	12	60	80	42	100	15	8	M8 x 1.25	6	14	11
50	35	32	70	27	52	20	40	81	9	12	70	90	50	110	17	11	M8 x 1.25	7	18	11
63	35	32	85	27	64	20	40	101	11.5	15	86	105	59	130	17	11	M10 x 1.25	7	18	14
80	40	37	102	32	78	25	52	119	13.5	18	102	130	76	160	21	13	M12 x 1.75	10	22	17
100	40	37	116	41	92	30	52	133	13.5	18	116	150	92	180	21	16	M12 x 1.75	10	26	17

Bore size (mm)	MM	N	P	S	Without rod boot		With rod boot (One side)					Both sides	
					H	ZZ	*d	e	f	h	ℓ	ZZ	ZZ
40	M14 x 1.5	27	1/4	84	51	186	52	43	15	59	1/4 stroke	194	202
50	M18 x 1.5	30	3/8	90	58	206	58	52	15	66	1/4 stroke	214	222
63	M18 x 1.5	31	3/8	98	58	214	58	52	17.5	66	1/4 stroke	222	230
80	M22 x 1.5	37	1/2	116	71	258	80	65	21.5	80	1/4 stroke	267	276
100	M26 x 1.5	40	1/2	126	72	270	80	65	21.5	81	1/4 stroke	279	288

★For installing an air cylinder, when a hole must be made to accommodate the rod portion, make sure to machine a hole that is larger than the outer diameter of the boot mounting bracket ød.

- D-□
- -X□
- Technical Data

CA2W Series

Rod Flange: CA2WF

Stroke of 1001 mm or more

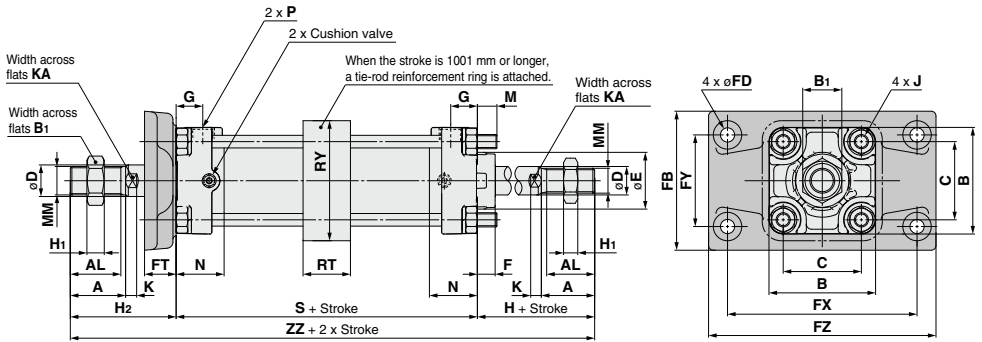

With rod boot

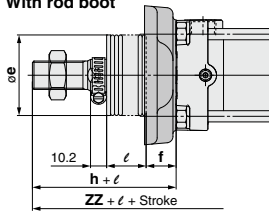

(mm)

Bore size (mm)	A	AL	B	B ₁	C	D	E	FB	FD	FT	FX	FY	FZ	G	H ₁	J	K	KA	M
40	30	27	60	22	44	16	32	71	9	12	80	42	100	15	8	M8 x 1.25	6	14	11
50	35	32	70	27	52	20	40	88	9	20	120	58	144	17	11	M8 x 1.25	7	18	6
63	35	32	85	27	64	20	40	105	11.5	23	140	64	170	17	11	M10 x 1.25	7	18	10
80	40	37	102	32	78	25	52	124	13.5	28	164	84	198	21	13	M12 x 1.75	10	22	12
100	40	37	116	41	92	30	52	140	13.5	29	180	100	220	21	16	M12 x 1.75	10	26	12

Bore size (mm)	MM	N	P	RT	RY	S	Without rod boot			With rod boot (One side)					(Both sides)	
							H	H ₂	ZZ	d	e	f	h	ℓ	ZZ	ZZ
40	M14 x 1.5	27	1/4	30	76	84	51	51	186	52	43	15	59	1/4 stroke	194	202
50	M18 x 1.5	30	3/8	30	76	90	58	67	215	58	52	19	66	1/4 stroke	214	222
63	M18 x 1.5	31	3/8	40	92	98	58	71	227	58	52	19	66	1/4 stroke	222	230
80	M22 x 1.5	37	1/2	45	112	116	71	87	274	80	65	21	80	1/4 stroke	266	276
100	M26 x 1.5	40	1/2	50	136	126	72	89	287	80	65	21	81	1/4 stroke	279	288

Note 1) For flange type with bore size of ø40, the same bracket is used for all strokes.

Note 2) For models with bore size of ø50 to ø100 and stroke of 1001 mm or more, do not mount a flange bracket on basic cylinders since H dimension is different from those shown above. When rod flange type is used, order with the part number with bracket.

Center Trunnion: CA2WT

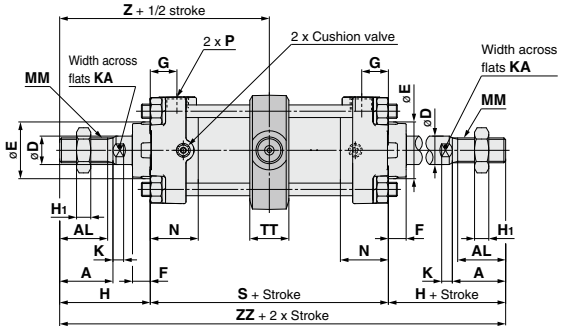
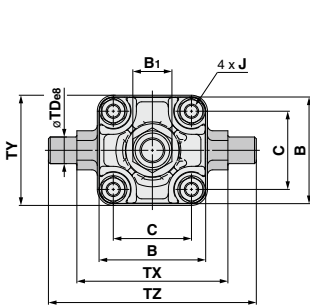

With rod boot

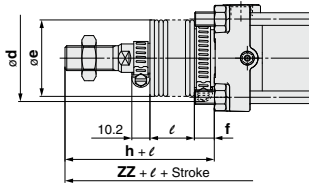

Bore size (mm)	A	AL	B	B ₁	C	D	E	F	G	H ₁	J	K	KA	MM	N	P	S	TD ₈₈
40	30	27	60	22	44	16	32	10	15	8	M8 x 1.25	6	14	M14 x 1.5	27	1/4	84	15 ^{+0.032} _{-0.059}
50	35	32	70	27	52	20	40	10	17	11	M8 x 1.25	7	18	M18 x 1.5	30	3/8	90	15 ^{+0.032} _{-0.059}
63	35	32	85	27	64	20	40	10	17	11	M10 x 1.25	7	18	M18 x 1.5	31	3/8	98	18 ^{+0.032} _{-0.059}
80	40	37	102	32	76	25	52	14	21	13	M12 x 1.75	10	22	M22 x 1.5	37	1/2	116	25 ^{+0.040} _{-0.073}
100	40	37	116	41	92	30	52	14	21	16	M12 x 1.75	10	26	M26 x 1.5	40	1/2	126	25 ^{+0.040} _{-0.073}

Bore size (mm)	TT	TX	TY	TZ	Without rod boot			With rod boot (One side)					(Both sides)			
					H	Z	ZZ	d	e	f	h	ℓ	Z	ZZ	Z	ZZ
40	22	85	62	117	51	93	186	56	43	11.2	59	1/4 stroke	101	194	101	202
50	22	95	74	127	58	103	206	64	52	11.2	66	1/4 stroke	111	214	111	222
63	28	110	90	148	58	107	214	64	52	11.2	66	1/4 stroke	115	222	115	230
80	34	140	110	192	71	129	258	76	65	12.5	80	1/4 stroke	138	267	138	276
100	40	162	130	214	72	135	270	76	65	14.0	81	1/4 stroke	144	279	144	288

* Do not disassemble the trunnion type. Refer to page 525.

- CJ1
- CJP
- CJ2
- JCM
- CM2
- CM3
- CG1
- CG3
- JMB
- MB
- MB1
- CA2**
- CS1
- CS2

- D-□
- X□
- Technical Data

Air Cylinder: Non-rotating Rod Type Double Acting, Single Rod

CA2K Series

ø40, ø50, ø63

How to Order

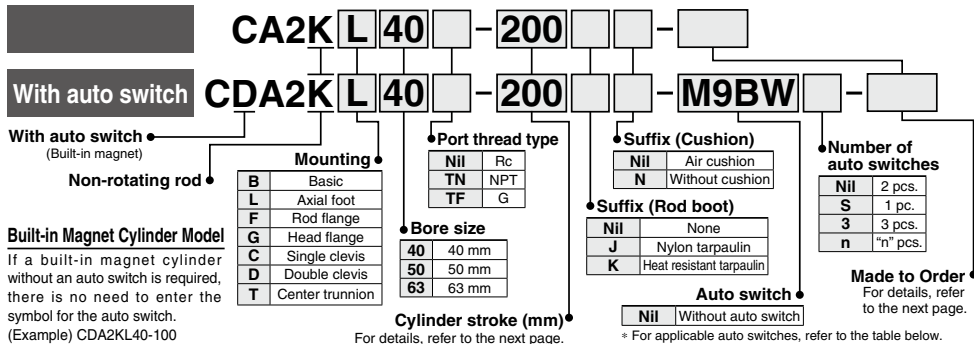

Applicable Auto Switches/Refer to pages 1575 to 1701 for further information on auto switches.

Type	Special function	Electrical entry	Indicator light	Wiring (Output)	Load voltage		Auto switch model		Lead wire length (m)					Pre-wired connector	Applicable load		
					DC	AC	Tie-rod mounting	Band mounting	0.5 (Nil)	1 (M)	3 (L)	5 (Z)	IC circuit		Relay, PLC		
Solid state auto switch	—	Grommet	No	3-wire (NPN)	24 V	5 V, 12 V	—	M9N	●	●	●	○	○	IC circuit	—	—	
				3-wire (PNP)				—	G59	●	—	●	○				○
				2-wire				—	M9P	●	●	●	○				○
				—				—	G5P	●	—	●	○				○
	Diagnostic indication (2-color indicator)	Terminal conduit	Yes	3-wire (NPN)	24 V	12 V	—	G39C	G39	—	—	—	—	IC circuit	Relay, PLC		
				2-wire				K39C	K39	—	—	—	—				
				3-wire (NPN)				M9NW	—	●	●	●	○			○	
				3-wire (PNP)				—	G59W	●	—	●	○			○	
				2-wire				M9PW	—	●	●	●	○			○	
				—				—	G5PW	●	—	●	○			○	
Water resistant (2-color indicator)	Grommet	No	3-wire (NPN)	24 V	12 V	—	M9BW	—	●	●	●	○	—	—			
			3-wire (PNP)				—	K59W	●	—	●	○			○		
			2-wire				M9NA*1	—	○	○	●	○			○		
			—				M9PA*1	—	○	○	●	○			○		
			—				M9BA*1	—	○	○	●	○			○		
			—				—	G5BA*1	—	—	—	—			—		
With diagnostic output (2-color indicator)	Terminal conduit	No	4-wire (NPN)	24 V	5 V, 12 V	—	F59F	G59F	●	—	●	○	IC circuit	—			
			2-wire (Non-polar)				P3DWA	—	—	—	—	—					
Reed auto switch	—	Grommet	Yes	3-wire (NPN equiv.)	24 V	12 V	—	A96	—	●	—	●	—	IC circuit	—		
				No				100 V	A93	—	●	●	●			—	
				Yes				100 V or less	A90	—	●	—	—			—	
				No				100 V, 200 V	A54	B54	●	—	●			—	
				—				200 V or less	A64	B64	●	—	●			—	
				—				—	A33C	A33	—	—	—			—	
Diagnostic indication (2-color indicator)	DIN terminal	Yes	100 V, 200 V	24 V	12 V	—	A34C	A34	—	—	—	—	—	PLC			
			—				A44C	A44	—	—	—	—					
			—				A59W	B59W	●	—	●	—					
			—				—	—	—	—	—	—					

*1 Water resistant type auto switches can be mounted on the above models, but in such case SMC cannot guarantee water resistance. Please contact SMC regarding water resistant types with the above model numbers.

* Lead wire length symbols: 0.5 m..... Nil (Example) M9NW * Solid state auto switches marked with "○" are produced upon receipt of order.

1 m..... M (Example) M9NWM
3 m..... L (Example) M9NWL
5 m..... Z (Example) M9NWZ

* Since there are other applicable auto switches than listed above, refer to page 523 for details.

* For details about auto switches with pre-wired connector, refer to pages 1649 and 1649.

* The D-A9□/M9□□/P3DWA□ auto switches are shipped together, (but not assembled). (However, auto switch mounting brackets are assembled for the D-A9□/M9□□ before shipment.)

Non-rotating accuracy: $\pm 0.8^\circ$
Same mounting dimensions as those of standard cylinder



Symbol
Air cushion

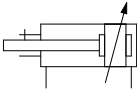

Made to Order

Made to Order
[Click here for details](#)

Symbol	Specifications
-XA□	Change of rod end shape
-XC7	Tie-rod, cushion valve, tie-rod nut, etc. made of stainless steel
-XC8	Adjustable stroke cylinder/Adjustable extension type
-XC9	Adjustable stroke cylinder/Adjustable retraction type
-XC10	Dual stroke cylinder/Double rod type
-XC11	Dual stroke cylinder/Single rod type
-XC14	Change of trunnion bracket mounting position
-XC15	Change of tie-rod length
-XC27	Double clevis and double knuckle joint pins made of stainless steel
-XC28	Compact flange made of SS400

Refer to pages 517 to 523 for cylinders with auto switches.

- Auto switch proper mounting position (detection at stroke end) and its mounting height
- Operating range
- Minimum stroke for auto switch mounting
- Auto switch mounting brackets/Part no.

Specifications

Bore size (mm)	40	50	63
Fluid	Air		
Proof pressure	1.5 MPa		
Maximum operating pressure	1.0 MPa		
Minimum operating pressure	0.05 MPa		
Ambient and fluid temperature	Without auto switch: -10 to 70°C^* With auto switch : -10 to 60°C^*		
Piston speed	50 to 500 mm/s		
Cushion	Air cushion		
Stroke length tolerance	Up to 250 st: $^{+1.0}_0$, 251 to 600 st: $^{+1.4}_0$		
Rod non-rotating accuracy	$\pm 0.8^\circ$		
Allowable rotational torque	0.44 N-m or less		
Lubrication	Not required (Non-Lube)		
Mounting	Basic, Axial foot, Rod flange, Head flange Single clevis, Double clevis, Center trunnion		

* No freezing

Standard Strokes In case of a type with auto switch, also refer to the table of minimum strokes for auto switch mounting on pages 521 and 522.

Bore size	Standard stroke (mm)	
40	25, 50, 75, 100, 125, 150, 175, 200, 250, 300, 350, 400, 450, 500*	
50, 63	25, 50, 75, 100, 125, 150, 175, 200, 250, 300, 350, 400, 450, 500, 600*	

* Intermediate strokes not listed above are also available.

Please consult with SMC for longer strokes than the strokes marked with "a".

Weights

Bore size (mm)	40	50	63	
Basic weight	Basic	0.88	1.32	1.91
	Axial foot	1.07	1.54	2.25
	Flange	1.25	1.77	2.70
	Single clevis	1.11	1.66	2.54
	Double clevis	1.15	1.75	2.70
	Trunnion	1.24	1.80	2.71
Additional weight per 50 mm of stroke		0.20	0.25	0.30
Accessories	Single knuckle	0.23	0.26	0.26
	Double knuckle (with pin)	0.37	0.43	0.43

Calculation: (Example) **CA2KL40-100**

- Basic weight..... 1.07 (Axial foot, $\phi 40$)
 - Additional weight..... 0.20/50 stroke
 - Cylinder stroke 100 stroke
- $1.07 + 0.20 \times 100/50 = 1.47 \text{ kg}$

Rod Boot Material

Symbol	Rod boot material	Max. ambient temperature
J	Nylon tarpaulin	70°C
K	Heat resistant tarpaulin	110°C^*

* Maximum ambient temperature for the rod boot itself.

Minimum Stroke for Auto Switch Mounting

⚠ Caution

1. The minimum stroke for mounting varies with the auto switch type and cylinder mounting type. In particular, the center trunnion type needs careful attention. (For details, refer to pages 521 and 522.)

CJ1

CJP

CJ2

JCM

CM2

CM3

CG1

CG3

JMB

MB

MB1

CA2

CS1

CS2

D-□

-X□

Technical Data

⚠ Precautions

Be sure to read this before handling the products. Refer to back page 50 for Safety Instructions and pages 3 to 12 for Actuator and Auto Switch Precautions.

Handling

⚠ Caution

1. Avoid applications in which rotational torque is applied to the piston rod.

If rotational torque is applied, the non-rotating guide will be deformed, resulting in a loss of non-rotating accuracy. Also, to screw a bracket or a nut onto the threaded portion at the end of the piston rod, make sure that the piston rod is fully retracted, and place a wrench on the parallel section of the rod that protrudes. To tighten, take precautions to prevent the tightening torque from being applied to the non-rotating guide.

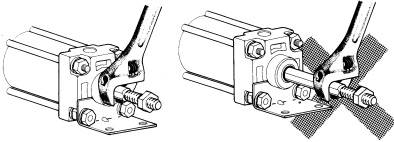

Disassembly/Replacement

⚠ Caution

1. Please consult with SMC when the rod seal is to be replaced.
A rod seal may allow air leakage depending on the position where it is installed. Therefore, please consult with SMC when a rod seal is to be replaced.
2. Do not replace the non-rotating guide.
Since the non-rotating guide is press fitted, the entire cover assembly needs to be replaced instead of a single part.

Construction

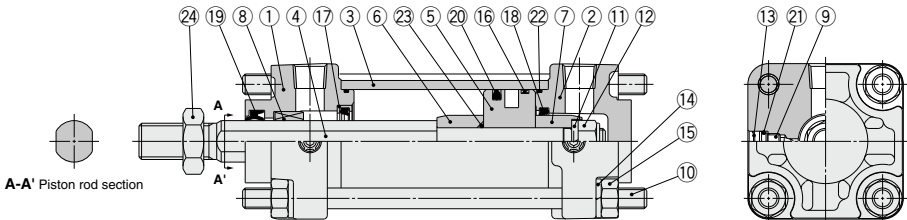

Component Parts

No.	Description	Material	Note
1	Rod cover	Aluminum alloy	Metallic painted
2	Head cover	Aluminum die-casted	Metallic painted
3	Cylinder tube	Aluminum alloy	Hard anodized
4	Piston rod	Carbon steel	Hard chrome plating
5	Piston	Aluminum alloy	Chromated
6	Cushion ring A	Rolled steel	Zinc chromated
7	Cushion ring B	Rolled steel	Zinc chromated
8	Non-rotating guide	Oil-impregnated sintered alloy	
9	Cushion valve	Steel wire	Trivalent zinc chromated
10	Tie-rod	Carbon steel	Trivalent zinc chromated
11	Spring washer	Steel wire	Trivalent zinc chromated
12	Piston nut	Rolled steel	Trivalent zinc chromated
13	Retaining ring	Spring steel	Phosphate coating
14	Spring washer	Steel wire	Trivalent zinc chromated
15	Tie-rod nut	Rolled steel	Trivalent zinc chromated
16	Wear ring	Resin	

No.	Description	Material	Note
17	Cushion seal holder	Aluminum alloy	
18	Cushion seal	Urethane	
19	Rod seal	NBR	
20	Piston seal	NBR	
21	Cushion valve seal	NBR	
22	Cylinder tube gasket	NBR	
23	Piston gasket	NBR	O-ring
24	Rod end nut	Rolled steel	Trivalent zinc chromated

Replacement Parts: Seal Kit

Bore size (mm)	Kit no.	Contents
40	CA2K40-PS	Set of the nos. 18, 19, 20, 21, 22.
50	CA2K50-PS	
63	CA2K63-PS	

* Seal kit includes 18, 19, 20 and 22. Order the seal kit based on each bore size.
* Do not disassemble the trunion type. Refer to page 525.

* Seal kit includes a grease pack (ø40, ø50: 10 g, over ø63: 20 g).

Order with the following part number when only the grease pack is needed.

Grease pack part number: GR-S-010 (10 g), GR-S-020 (20 g)

Air Cylinder: Non-rotating Rod Type Double Acting, Single Rod **CA2K Series**

Basic: CA2KB

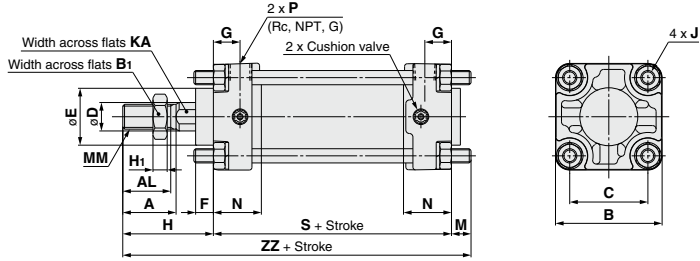

With rod boot

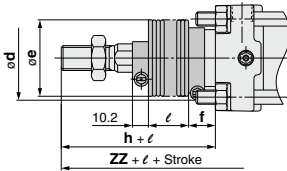

Bore size (mm)	Stroke range (mm)		A	AL	B	B ₁	C	D	E	F	G	H ₁	J	KA	M	MM
	Without rod boot	With rod boot														
40	Up to 500	20 to 500	30	27	60	22	44	16	32	10	15	8	M8 x 1.25	14	11	M14 x 1.5
50	Up to 600	20 to 600	35	32	70	27	52	20	40	10	17	11	M8 x 1.25	18	11	M18 x 1.5
63	Up to 600	20 to 600	35	32	85	27	64	20	40	10	17	11	M10 x 1.25	18	14	M18 x 1.5

Bore size (mm)	N	P	S	Without rod boot		With rod boot					
				H	ZZ	d	e	f	h	ℓ	ZZ
40	27	1/4	84	51	146	56	43	11.2	59	1/4 stroke	154
50	30	3/8	90	58	159	64	52	11.2	66	1/4 stroke	167
63	31	3/8	98	58	170	64	52	11.2	66	1/4 stroke	178

The dimensions for each mounting type and the dimensions of accessories (options) are the same as the standard double acting single rod model. Refer to pages 476 to 485.

- CJ1
- CJP
- CJ2
- JCM
- CM2
- CM3
- CG1
- CG3
- JMB
- MB
- MB1
- CA2**
- CS1
- CS2

- D-□
- X□
- Technical Data

Air Cylinder: Non-rotating Rod Type Double Acting, Double Rod

CA2KW Series

ø40, ø50, ø63

How to Order

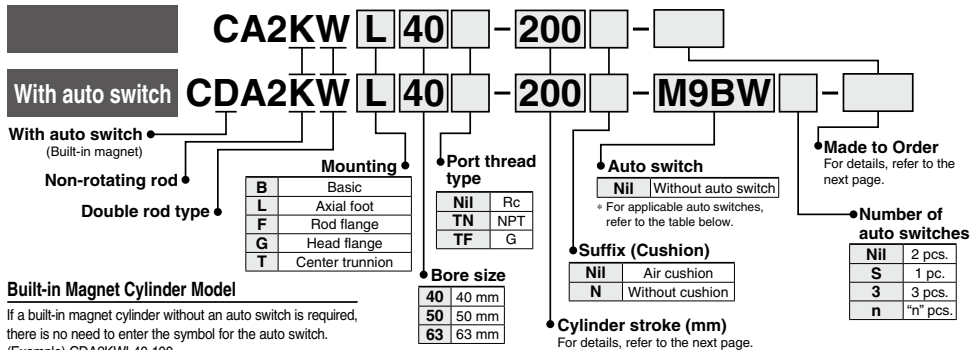

Applicable Auto Switches/Refer to pages 1575 to 1701 for further information on auto switches.

Type	Special function	Electrical entry	Indicator light	Wiring (Output)	Load voltage		Auto switch type		Lead wire length (m)					Pre-wired connector	Applicable load						
					DC	AC	Tie-rod mounting	Band mounting	0.5 (Nil)	1 (M)	3 (L)	5 (Z)									
Solid state auto switch	—	Grommet	—	3-wire (NPN)	24 V	5 V, 12 V	—	M9N	●	●	●	○	○	—	IC circuit						
				3-wire (PNP)				G59	●	●	●	○	○								
		2-wire		12 V	M9B	●	●	●	○	○	—	—									
		3-wire (NPN)			K59	●	●	●	○	○											
	Diagnostic indication (2-color indicator)	Terminal conduit	Yes	3-wire (NPN)	24 V	5 V, 12 V	—	G39C	—	—	—	—	—	—	IC circuit						
				2-wire				G39	—	—	—	—	—								
	Water resistant (2-color indicator)	Grommet	—	3-wire (NPN)	24 V	5 V, 12 V	—	M9NW	●	●	●	○	○	—	IC circuit						
				3-wire (PNP)				G59W	●	●	●	○	○								
	With diagnostic output (2-color indicator)	Grommet	—	2-wire	24 V	12 V	—	M9PW	●	●	●	○	○	—	Relay, PLC						
				3-wire (NPN)				G59W	●	●	●	○	○								
Magnetic field resistant (2-color indicator)	Grommet	—	2-wire	24 V	12 V	—	M9BW	●	●	●	○	○	—	—							
			3-wire (NPN)				K59W	●	●	●	○	○									
—	Grommet	—	3-wire (NPN)	24 V	5 V, 12 V	—	M9NA*1	—	○	○	●	○	—	—							
			3-wire (PNP)				M9PA*1	—	○	○	●	○									
—	Grommet	—	2-wire	24 V	12 V	—	M9BA*1	—	○	○	●	○	—	—							
			4-wire (NPN)				G5BA*1	—	○	○	●	○									
—	Grommet	—	2-wire (Non-polar)	24 V	5 V, 12 V	—	F59F	—	—	—	—	—	—	IC circuit							
			3-wire (NPN equiv.)				P3DWA	—	●	●	●	○									
Reed auto switch	Diagnostic indication (2-color indicator)	Grommet	Yes	3-wire (NPN equiv.)	—	5 V	—	A96	—	●	—	●	—	—	IC circuit						
								No	24 V	12 V	—	A93	—			●	●	●	●	—	—
												A90	—			●	—	●	—		
								Yes	24 V	12 V	—	A54	B54			●	—	●	●	—	—
		A64	B64	●	—	●	—					—	—								
		No	Terminal conduit	Yes	2-wire	24 V	12 V	—	A33C	A33	—			—	—	—	—	PLC			
									A34C	A34	—	—	—	—	—	—					
		DIN terminal	Grommet	—	—	—	—	—	A44C	A44	—	—	—	—			—	Relay, PLC			
A59W	B59W								—	—	—	—	—	—							

*1 Water resistant type auto switches can be mounted on the above models, but in such case SMC cannot guarantee water resistance. Please contact SMC regarding water resistant types with the above model numbers.

* Lead wire length symbols: 0.5 m..... Nil (Example) M9NW * Solid state auto switches marked with "○" are produced upon receipt of order.

1 m..... M (Example) M9NWM
 3 m..... L (Example) M9NWL
 5 m..... Z (Example) M9NWX

* Since there are other applicable auto switches than listed above, refer to page 523 for details.

* For details about auto switches with pre-wired connector, refer to pages 1648 and 1649.

* The D-A9□/M9□□□□P3DWA□ auto switches are shipped together, (but not assembled). (However, auto switch mounting brackets are assembled for the D-A9□/M9□□□ before shipment.)

Non-rotating accuracy: $\pm 0.8^\circ$
Same mounting dimensions as those of standard cylinder



Symbol

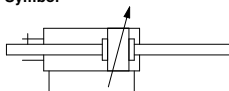

Made to Order
[Click here for details](#)

Symbol	Specifications
-XC7	Tie-rod, cushion valve, tie-rod nut, etc. made of stainless steel
-XC14	Change of trunnion bracket mounting position
-XC15	Change of tie-rod length
-XC28	Compact flange made of SS400

Refer to pages 517 to 523 for cylinders with auto switches.

- Auto switch proper mounting position (detection at stroke end) and its mounting height
- Operating range
- Minimum stroke for auto switch mounting
- Auto switch mounting brackets/Part no.

Specifications

Bore size (mm)	40	50	63
Fluid	Air		
Proof pressure	1.5 MPa		
Maximum operating pressure	1.0 MPa		
Minimum operating pressure	0.08 MPa		
Ambient and fluid temperature	Without auto switch: -10 to 70°C^* With auto switch : -10 to 60°C^*		
Piston speed	50 to 500 mm/s		
Cushion	Air cushion		
Stroke length tolerance	Up to 250 st: $^{+1.0}$ / $_0$, 251 to 600 st: $^{+1.4}$ / $_0$		
Rod non-rotating accuracy	$\pm 0.8^\circ$		
Allowable rotational torque	0.44 N·m or less		
Lubrication	Not required (Non-Lube)		
Mounting	Basic, Axial foot, Rod flange, Head flange, Center trunnion		

* No freezing

Standard Strokes In case of a type with auto switch, also refer to the table of minimum strokes for auto switch mounting on pages 521 and 522.

Bore size	Standard stroke (mm)		
40	25, 50, 75, 100, 125, 150, 175, 200, 250, 300, 350, 400, 450, 500*		
50, 63	25, 50, 75, 100, 125, 150, 175, 200, 250, 300, 350, 400, 450, 500, 600*		

* Intermediate strokes not listed above are also available.
Please consult with SMC for longer strokes than the strokes marked with "*".

Weights/Aluminum Tube

Bore size (mm)		40	50	63
Basic weight	Basic	1.01	1.54	2.17
	Axial foot	1.20	1.76	2.50
	Flange	1.38	1.99	2.96
	Trunnion	1.37	2.02	2.97
Additional weight per 50 mm of stroke		0.27	0.36	0.42
Accessories	Single knuckle	0.23	0.26	0.26
	Double knuckle (with pin)	0.37	0.43	0.43

Calculation: (Example) **CA2KWL40-100**
 • Basic weight..... 1.20 (Axial foot, $\varnothing 40$)
 • Additional weight.... 0.27/50 stroke
 • Cylinder stroke 100 stroke
 $1.20 + 0.27 \times 100/50 = 1.74 \text{ kg}$

Production of Types with Rod Boot

CA2KW series is also available with rod boot. Please consult with SMC for more information.

Minimum Stroke for Auto Switch Mounting

⚠ Caution

1. The minimum stroke for mounting varies with the auto switch type and cylinder mounting type. In particular, the center trunnion type needs careful attention. (For details, refer to pages 521 and 522.)

CJ1

CJP

CJ2

JCM

CM2

CM3

CG1

CG3

JMB

MB

MB1

CA2

CS1

CS2

D-□

-X□

Technical Data

CA2KW Series

Construction

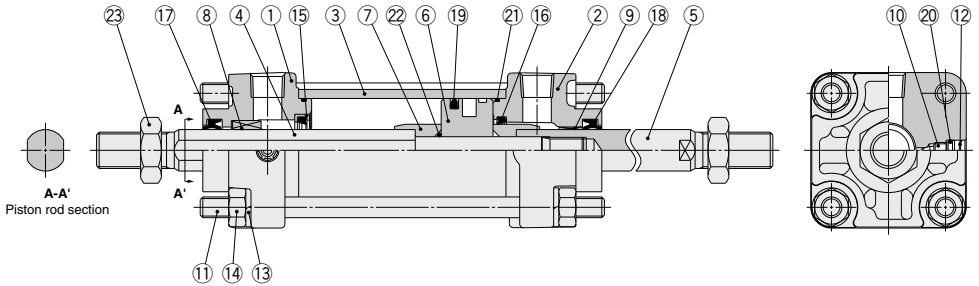

Component Parts

No.	Description	Material	Note
1	Rod cover A	Aluminum alloy	Metallic painted
2	Rod cover B	Aluminum die-casted	Metallic painted
3	Cylinder tube	Aluminum alloy	Hard anodized
4	Piston rod A	Carbon steel	Hard chrome plating
5	Piston rod B	Carbon steel	Hard chrome plating
6	Piston	Aluminum alloy	Chromated
7	Cushion ring	Rolled steel	Zinc chromated
8	Non-rotating guide	Oil-impregnated sintered alloy	
9	Bushing	Bearing alloy	
10	Cushion valve	Steel wire	Trivalent zinc chromated
11	Tie-rod	Carbon steel	Trivalent zinc chromated
12	Retaining ring	Spring steel	Phosphate coating
13	Spring washer	Steel wire	Trivalent zinc chromated
14	Tie-rod nut	Rolled steel	Trivalent zinc chromated
15	Cushion seal holder	Aluminum alloy	
16	Cushion seal	Urethane	
17	Rod seal A	NBR	
18	Rod seal B	NBR	
19	Piston seal	NBR	
20	Cushion valve seal	NBR	
21	Cylinder tube gasket	NBR	
22	Piston gasket	NBR	O-ring
23	Rod end nut	Rolled steel	Trivalent zinc chromated

Replacement Parts: Seal Kit

Bore size (mm)	Kit no.	Contents
40	CA2KW40-PS	Set of the nos. 16, 17, 18, 19, 21.
50	CA2KW50-PS	
63	CA2KW63-PS	

* Seal kit includes 16, 17, 18, 19, and 21. Order the seal kit based on each bore size.

* Do not disassemble the trunnion type. Refer to page 525.

* Seal kit includes a grease pack (ø40, ø50: 10 g, ø63, ø80: 20 g, ø100: 30 g).

Order with the following part number when only the grease pack is needed.
Grease pack part number: GR-S-010 (10 g), GR-S-020 (20 g)

Air Cylinder: Non-rotating Rod Type Double Acting, Double Rod **CA2KW Series**

Basic: CA2KWB

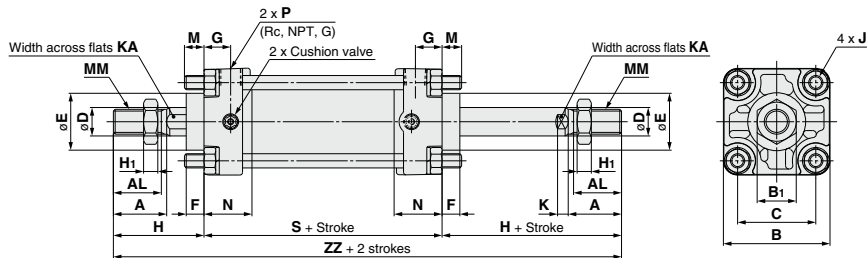

Bore size (mm)	Stroke range (mm)	A	AL	B	B ₁	C	D	E	F	G	H ₁	J	K	KA	M	MM	N	P	S	H	ZZ
40	Up to 500	30	27	60	22	44	16	32	10	15	8	M8 x 1.25	6	14	11	M14 x 1.5	27	1/4	84	51	186
50	Up to 600	35	32	70	27	52	20	40	10	17	11	M8 x 1.25	7	18	11	M18 x 1.5	30	3/8	90	58	206
63	Up to 600	35	32	85	27	64	20	40	10	17	11	M10 x 1.25	7	18	14	M18 x 1.5	31	3/8	98	58	214

The dimensions for each mounting type are the same as the standard double acting double rod model. Refer to pages 490 to 493. For details about accessories (options), refer to page 485.

CJ1

CJP

CJ2

JCM

CM2

CM3

CG1

CG3

JMB

MB

MB1

CA2

CS1

CS2

D-□

-X□

Technical
Data

Air Cylinder: With End Lock

CBA2 Series

ø40, ø50, ø63, ø80, ø100

How to Order

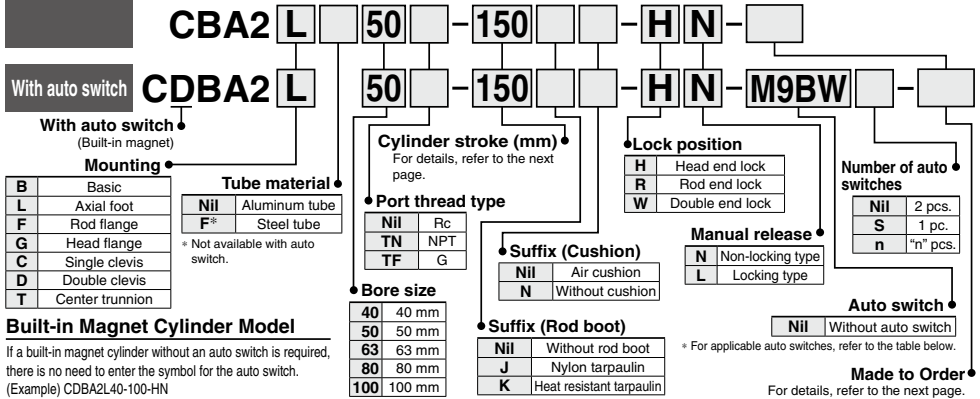

Applicable Auto Switches/Refer to pages 1575 to 1701 for further information on auto switches.

Type	Special function	Electrical entry	Indicator light	Wiring (Output)	Load voltage		Auto switch model		Lead wire length (m)				Pre-wired connector	Applicable load	
					DC	AC	Tie-rod mounting	Band mounting	0.5 (Nil)	1 (M)	3 (L)	5 (Z)			
Solid state auto switch	—	Grommet	—	3-wire (NPN)	24 V	5 V, 12 V	—	M9N	●	●	●	○	○	IC circuit	
				3-wire (PNP)				G59	●	●	●	○	○		
				2-wire	G5P	●	●	●	○	○	—				
		Terminal conduit		3-wire (NPN)	12 V	—	M9B	●	●	●		○	○		
				2-wire			K59	●	●	●		○	○		
				3-wire (NPN)	5 V, 12 V	—	G39C	●	●	●	○	○			
	3-wire (PNP)	G39	●	●			●	○	○						
	Diagnostic indication (2-color indicator)	Grommet	Yes	—	2-wire	24 V	12 V	—	M9NW	●	●	●	○	○	IC circuit
					3-wire (NPN)				G59W	●	●	●	○	○	
					3-wire (PNP)	M9PW	●	●	●	○	○				
		Terminal conduit			2-wire	12 V	—	M9B	●	●	●	○	○		
					2-wire			K59W	●	●	●	○	○		
4-wire (NPN)					5 V, 12 V	—	M9NA ^{*1}	—	○	○	○	○			
3-wire (PNP)	M9PA ^{*1}	—	○	○			○	○							
With diagnostic output (2-color indicator)	Grommet	—	—	2-wire	24 V	12 V	—	M9BA ^{*1}	—	○	○	○	○	—	
				2-wire (Non-polar)				G5BA ^{*1}	—	○	○	○	○		
				Terminal conduit	4-wire (NPN)	5 V, 12 V	—	F59F	●	●	●	○	○		
	2-wire (Non-polar)				G59F			●	●	●	○	○			
	2-wire (Non-polar)				—	—	P3DWA	—	—	—	—	—			
	P4DW			—			—	—	—	—					
Reed auto switch	—	Grommet	Yes	3-wire (NPN equiv.)	24 V	12 V	—	A96	●	●	●	—	—	IC circuit	
				—				A93	—	●	●	●	—		—
				—	100 V or less	—	A90	—	●	●	●	—	IC circuit		
				—			A54	B54	●	●	●	—		—	
				—	100 V, 200 V	—	A64	B64	●	●	●	—	—		
		—		A33C			A33	—	—	—	—	—			
		Terminal conduit		—	100 V, 200 V	—	A44C	A44	—	—	—	—	—		
				—			A34C	A34	—	—	—	—		—	
				—	—	—	A44C	A44	—	—	—	—	PLC		
				—			A59W	B59W	●	—	●	—		—	
—	Grommet		—	—	—	—	—	—	—	Relay, PLC					
—		—			—	—	—	—	—						

*1 Water resistant type auto switches can be mounted on the above models, but in such case SMC cannot guarantee water resistance. Please contact SMC regarding water resistant types with the above model numbers.

* Lead wire length symbols: 0.5 m..... Nil (Example) M9NW
 1 m..... M (Example) M9NWM
 3 m..... L (Example) M9NWL
 5 m..... Z (Example) M9NWZ

* Solid state auto switches marked with "○" are produced upon receipt of order.

* Since there are other applicable auto switches than listed above, refer to page 523 for details.

* For details about auto switches with pre-wired connector, refer to pages 1648 and 1649.

* The D-A9□/M9□□/P3DWA□ auto switches are shipped together, (but not assembled). (However, auto switch mounting brackets are assembled for the D-A9□/M9□□ before shipment.)

Maintains the cylinder's original position even if the air supply is interrupted.

When air is discharged at the stroke end position, the lock engages to maintain the rod in that position.

**Same dimensions as those of the standard cylinder (CA2 series)
Non-locking and locking types are standard for manual release.**

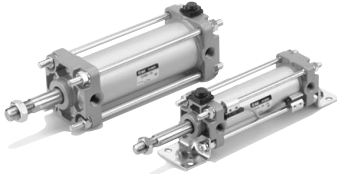

Symbol
Air cushion

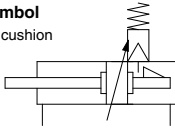

Made to Order
[Click here for details](#)

Symbol	Specifications
-XA□	Change of rod end shape
-XB6	Heat resistant cylinder (-10 to 150°C)
-XC3	Special port location
-XC4 *1	With heavy duty scraper
-XC6 *1	Made of stainless steel
-XC7	Tie-rod, cushion valve, tie-rod nut, etc. made of stainless steel
-XC8 *1	Adjustable stroke cylinder/Adjustable extension type
-XC9 *2	Adjustable stroke cylinder/Adjustable retraction type
-XC10	Dual stroke cylinder/Double rod type
-XC14	Change of trunnion bracket mounting position
-XC15	Change of tie-rod length
-XC22	Fluororubber seal
-XC27	Double clevis and double knuckle joint pins made of stainless steel
-XC28	Compact flange made of SS400
-XC29	Double knuckle joint with spring pin
-XC35 *1	With coil scraper

*1 For head end lock only
*2 For rod end lock only

Refer to pages 517 to 523 for cylinders with auto switches.

- Auto switch proper mounting position (detection at stroke end) and its mounting height
- Operating range
- Minimum stroke for auto switch mounting
- Auto switch mounting brackets/Part no.

Specifications

Bore size (mm)	40	50	63	80	100
Fluid	Air				
Proof pressure	1.5 MPa				
Maximum operating pressure	1.0 MPa				
Minimum operating pressure	0.15 MPa*1				
Ambient and fluid temperature	Without auto switch: -10 to 70°C*2 With auto switch : -10 to 60°C*2				
Piston speed	50 to 500 mm/s				
Cushion	Air cushion				
Stroke length tolerance	Up to 250 st: ^{+1.8} 0 251 to 1000 st: ^{+1.4} 0 1001 to 1500 st: ^{+1.8} 0				
Lubrication	Not required (Non-lube)				
Mounting	Basic, Axial foot, Rod flange, Head flange, Single clevis, Double clevis, Center trunnion				

*1 0.05 MPa except locking parts.
*2 No freezing

Lock Specifications

Lock position	Head end, Rod end, Double end				
Holding force (Max.) (N)	ø40	ø50	ø63	ø80	ø100
	860	1340	2140	3450	5390
Backlash	2 mm or less				
Manual release	Non-locking type, Locking type				

Accessories / Refer to page 485 for part numbers and dimensions.

Accessories	Standard			Option		
	Rod end nut	Clevis pin	Lock release bolt (N type only)	Single knuckle joint	Double knuckle joint (with pin)	Rod boot
Mounting						
Basic	●	—	●	●	●	●
Axial foot	●	—	●	●	●	●
Rod flange	●	—	●	●	●	●
Head flange	●	—	●	●	●	●
Single clevis	●	—	●	●	●	●
Double clevis*	●	●	●	●	●	●
Center trunnion	●	—	●	●	●	●

* Double clevis and double knuckle joint types are packed with pin, split pin and flat washer.

Standard Strokes

Bore size	Standard stroke (mm)
40	25, 50, 75, 100, 125, 150, 175, 200, 250, 300, 350, 400, 450, 500
50, 63	25, 50, 75, 100, 125, 150, 175, 200, 250, 300, 350, 400, 450, 500, 600
80, 100	25, 50, 75, 100, 125, 150, 175, 200, 250, 300, 350, 400, 450, 500, 600, 700

* Types with auto switch have different minimum strokes. Refer to pages 521 and 522.

Rod Boot Material

Symbol	Rod boot material	Max. ambient temperature
J	Nylon tarpaulin	70°C
K	Heat resistant tarpaulin	110°C*

* Maximum ambient temperature for the rod boot itself.

Minimum Stroke for Auto Switch Mounting

⚠ Caution

1. The minimum stroke for mounting varies with the auto switch type and cylinder mounting type. In particular, the center trunnion type needs careful attention. (For details, refer to pages 521 and 522.)

CJ1

CJP

CJ2

JCM

CM2

CM3

CG1

CG3

JMB

MB

MB1

CA2

CS1

CS2

D-□

-X□

Technical Data

CBA2 Series

Weights/Aluminum Tube (Steel Tube)

Bore size (mm)		(kg)				
		40	50	63	80	100
Basic weight	Basic	0.89 (0.94)	1.36 (1.40)	2.00 (2.04)	3.48 (3.63)	4.87 (5.07)
	Axial foot	1.08 (1.13)	1.58 (1.62)	2.34 (2.38)	4.15 (4.30)	5.86 (6.06)
	Flange	1.26 (1.30)	1.81 (1.86)	2.79 (2.84)	4.93 (5.08)	6.79 (6.99)
	Single clevis	1.12 (1.17)	1.70 (1.74)	2.63 (2.67)	4.59 (4.74)	6.65 (6.86)
	Double clevis	1.16 (1.21)	1.79 (1.84)	2.79 (2.83)	4.88 (5.03)	7.17 (7.38)
	Trunnion	1.25 (1.35)	1.84 (1.94)	2.80 (3.00)	5.03 (5.32)	7.15 (7.54)
Additional weight per 50 mm of stroke	All mounting brackets (Except steel tube trunnion)	0.22 (0.28)	0.28 (0.35)	0.37 (0.43)	0.52 (0.70)	0.65 (0.87)
	Steel tube trunnion	(0.36)	(0.46)	(0.65)	(0.86)	(1.07)
Accessories	Single knuckle	0.23	0.26	0.26	0.60	0.83
	Double knuckle (with pin)	0.37	0.43	0.43	0.87	1.27

* Values inside the parentheses are those for the steel tube type.

Lock Unit Additional Weights

Bore size (mm)		(kg)				
		40	50	63	80	100
Non-locking type manual release (N)	Head end lock (H)	0.02	0.03	0.03	0.10	0.12
	Rod end lock (R)	0.02	0.02	0.02	0.07	0.06
	Double end lock (W)	0.04	0.05	0.05	0.17	0.18
Locking type manual release (L)	Head end lock (H)	0.04	0.05	0.05	0.13	0.15
	Rod end lock (R)	0.04	0.04	0.04	0.10	0.09
	Double end lock (W)	0.08	0.09	0.09	0.23	0.24

Calculation: (Example) **CBA2L40-100-HN**

- Basic weight..... 1.08 kg (ø40, Axial foot)
 - Additional weight.... 0.22/50 stroke
 - Cylinder stroke 100 stroke
 - Lock unit weight 0.02 kg
- (Head end lock, Non-locking type manual release)
- $$1.08 + 0.22 \times 100/50 + 0.02 = 1.54 \text{ kg}$$

Construction

Head end lock

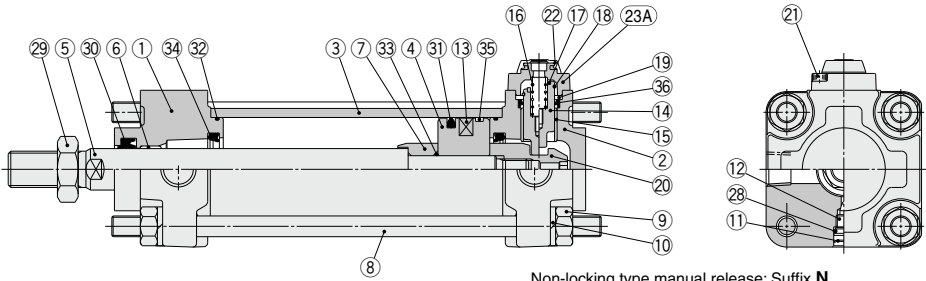

Non-locking type manual release: Suffix N

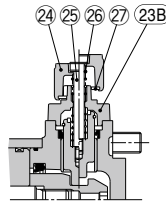

Locking type manual release: Suffix L

Component Parts

No.	Description	Material	Note
1	Rod cover	Aluminum die-casted	Metallic painted
2	Head cover	Aluminum die-casted	Metallic painted
3	Cylinder tube	Aluminum alloy	Hard anodized
4	Piston	Aluminum alloy	Chromated
5	Piston rod	Carbon steel	Hard chrome plating
6	Bushing	Bearing alloy	
7	Cushion ring A	Rolled steel	Electroless nickel plating
8	Tie-rod	Carbon steel	Zinc chromated
9	Tie-rod nut	Rolled steel	Trivalent zinc chromated
10	Spring washer	Steel wire	Trivalent zinc chromated
11	Retaining ring	Spring steel	Phosphate coating
12	Cushion valve	Steel wire	Trivalent zinc chromated
13	Magnet*	—	* With auto switch
14	Lock piston	Carbon steel	Quench hard chrome plating
15	Lock bushing	Lead-bronze casted	
16	Lock spring	Stainless steel	
17	Bumper	Urethane	
18	C-ring	Steel wire	Zinc chromated
19	Seal retainer	Rolled steel	Zinc chromated
20	Cushion ring nut	Chromium molybdenum steel	Quench, Electroless nickel plating
21	Hexagon socket head cap screw	Chromium molybdenum steel	Black zinc chromated
22	Rubber cap	Chloroprene rubber	
23A	Cap A	Aluminum casted	Black coated
23B	Cap B	Carbon steel	Oxide film treated

No.	Description	Material	Note
24	M/O knob	Zinc die-casted	Black coated
25	M/O bolt	Chromium molybdenum steel	Black zinc chromated, Red painted
26	M/O spring	Steel wire	Zinc chromated
27	Stopper ring	Carbon steel	Zinc chromated
28	Cushion valve seal	NBR	
29	Rod end nut	Rolled steel	Trivalent zinc chromated
30	Rod seal	NBR	
31	Piston seal	NBR	
32	Cylinder tube gasket	NBR	
33	Piston gasket	NBR	
34	Cushion seal	NBR	
35	Wear ring	Resin	
36	Lock piston seal	NBR	

Replacement Parts: Seal Kit

Bore size (mm)	Kit no.		Contents
	One end lock	Double end lock	
40	MBB40-PS	MBB40-PS-W	Set of the nos. 30, 31, 32, 34, 36.
50	MBB50-PS	MBB50-PS-W	
63	MBB63-PS	MBB63-PS-W	
80	MBB80-PS	MBB80-PS-W	
100	MBB100-PS	MBB100-PS-W	

* Seal kit includes 30, 31, 32, 34 and 36. Order the seal kit based on each bore size.

* Do not disassemble the trunnion type. Refer to page 525.

* Seal kit includes a grease pack (ø40, ø50: 10 g, ø63, ø80: 20 g, ø100: 30 g).

Order with the following part number when only the grease pack is needed.

Grease pack part number: GR-S-010 (10 g), GR-S-020 (20 g)

CJ1
CJP
CJ2
JCM
CM2
CM3
CG1
CG3
JMB
MB
MB1
CA2
CS1
CS2

D-□

-X□

Technical Data

CBA2 Series

Basic (Dimensions are common to head end lock, rod end lock and double end lock types.)

Head end lock: CBA2B Bore size – Stroke -HN

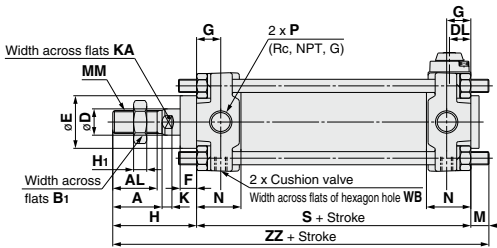

Non-locking type manual release:
Suffix N

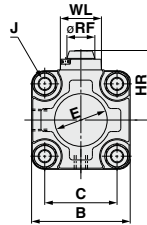

Locking type manual release:
Suffix L

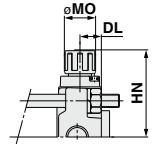

Rod end lock: CBA2B Bore size – Stroke -RN

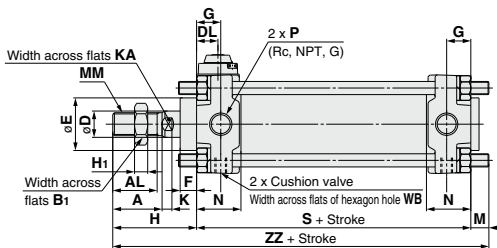

Non-locking type manual release:
Suffix N

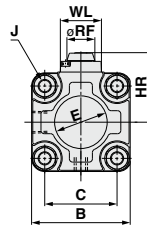

Locking type manual release:
Suffix L

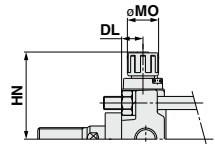

Double end lock: CBA2B Bore size – Stroke -WN

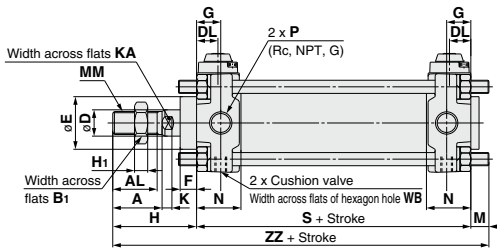

Non-locking type manual release:
Suffix N

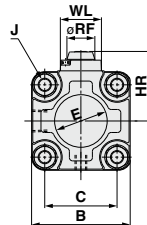

Locking type manual release:
Suffix L

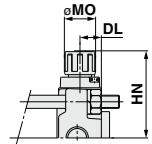

With rod boot

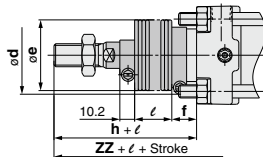

With Rod Boot

Bore size (mm)	Stroke range (mm)	d	e	f	h	ℓ	ZZ
40	20 to 500	56	43	11.2	59	1/4 stroke	154
50	20 to 600	64	52	11.2	66	1/4 stroke	167
63	20 to 600	64	52	11.2	66	1/4 stroke	178
80	20 to 750	76	65	12.5	80	1/4 stroke	213
100	20 to 750	76	65	14	81	1/4 stroke	224

Bore size (mm)	Stroke range	A	AL	B	B ₁	C	D	DL	E	F	G	H	H ₁	HR	HN (Max.)	J	K	KA	M	MM	MO	N	P	RF	S	WB	WL	ZZ
40	Up to 500	30	27	60	22	44	16	13	32	10	15	51	8	42.3	56	M8 x 1.25	6	14	11	M14 x 1.5	19	27	1/4	17	84	2.5	25	146
50	Up to 600	35	32	70	27	52	20	13	40	12	17	58	11	47.3	61	M8 x 1.25	7	18	11	M18 x 1.5	19	30	3/8	17	90	2.5	25	159
63	Up to 600	35	32	85	27	64	20	15.5	40	10	17	58	11	54.8	68.5	M10 x 1.25	7	18	14	M18 x 1.5	19	31	3/8	17	98	4	25	170
80	Up to 750	40	37	102	32	78	25	18.5	52	14	21	71	13	65.8	80.5	M12 x 1.75	11	22	17	M22 x 1.5	23	37	1/2	21	116	4	40	204
100	Up to 750	40	37	116	41	92	30	20	52	14	21	72	16	72.8	87.5	M12 x 1.75	11	26	17	M26 x 1.5	23	40	1/2	21	126	4	40	215

The dimensions for each mounting type and the dimensions of accessories (options) are the same as the standard double acting single rod model. Refer to pages 476 to 485.



CBA2 Series

Specific Product Precautions

Be sure to read this before handling the products. Refer to back page 50 for Safety Instructions and pages 3 to 12 for Actuator and Auto Switch Precautions.

Use the Recommended Pneumatic Circuit

⚠ Caution

This is necessary for proper operation and release of the lock.

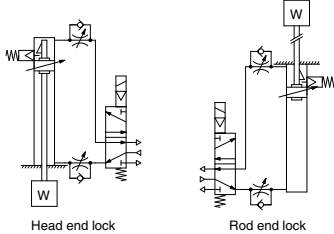

Handling

⚠ Caution

1. Do not use a 3 position solenoid valve.

Avoid using this cylinder in combination with a 3 position solenoid valve (particularly the closed center metal seal type). If air pressure becomes sealed inside the port on the lock mechanism side, the cylinder cannot be locked. Even if the lock is released at first, the air that leaks from the solenoid valve could enter the cylinder and cause the lock to release as time elapses.

2. Back pressure is required to release end lock.

Be sure air is supplied to the side of the cylinder without a lock mechanism (side of the piston rod without lock for double end lock), before starting up, as in the above figures. Otherwise, the lock may not be released. (Refer to "Releasing the Lock".)

3. Release the lock when mounting or adjusting the cylinder.

If mounting or other work is performed when the cylinder is locked, the lock unit may be damaged.

4. Operate with a load ratio of 50% or less.

If the load ratio exceeds 50%, this may cause problems such as failure of the lock to release, or damage to the lock unit.

5. Do not operate multiple synchronized cylinders.

Avoid applications in which two or more cylinders with end lock are synchronized to move one workpiece, as one of the cylinder locks may not be able to release when required.

6. Use a speed controller with meter-out control.

If operated under meter-in control, the lock may not be released.

7. Be sure to operate completely to the cylinder stroke end on the side with the lock.

The lock may not be engaged or released if the piston in the cylinder has not reached the stroke end.

Operating Pressure

⚠ Caution

1. Supply air pressure of 0.15 MPa or higher to the port on the lock mechanism side, as it is necessary for releasing the lock.

Exhaust Speed

⚠ Caution

1. When the pressure on the lock mechanism side drops to 0.05 MPa or below, the lock engages automatically. If the piping on the lock mechanism side is thin and long, or if the speed controller is away from the cylinder port, the lock engagement may take some time to decline of the exhaust speed. The same result will be caused by clogging of the silencer installed at the EXH port of the solenoid valve.

Relation to Cushion

⚠ Caution

1. When the cushion valve on the lock mechanism side is fully closed or almost closed, the piston rod may not be able to reach the stroke end, resulting in lock engagement failure. Furthermore, if the lock becomes engaged while the cushion valve is almost fully closed, it may become impossible to be released. Therefore, the cushion valve must be adjusted properly.

Releasing the Lock

⚠ Caution

1. To release the lock, make sure to supply air pressure to the port on the side without a lock mechanism, thus preventing the load from being applied to the lock mechanism. (Refer to the recommended pneumatic circuits.) If the lock is released, while the port on the side without a lock mechanism is in the exhausted state and the load is being applied to the lock mechanism, undue force may be applied to the lock mechanism, causing the lock mechanism to be damaged. Also, it could be extremely dangerous, because the piston rod could move suddenly.

Manual Release

⚠ Caution

1. Non-locking type manual release

Insert the bolt, which is provided as an accessory, through the rubber cap (it is not necessary to remove the rubber cap). Screw the bolt into the lock piston and pull the bolt to release the lock. Releasing the bolt will re-engage the lock.

The bolt size, pulling force, and the stroke are listed below.

Bore size (mm)	Thread size	Pulling force	Stroke (mm)
40, 50, 63	M3 x 0.5 x 30 L or more	10 N	3
80, 100	M5 x 0.8 x 40 L or more	24.5 N	3

* Remove the bolt for normal operation.

* It can cause lock malfunction or faulty release.

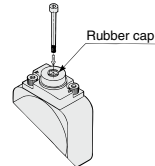

2. Locking type manual release

Push the M/O knob and turn it 90° counterclockwise. The lock is released when the ▲ mark on the cap is aligned with the ▼ OFF mark on the M/O knob (and the lock will remain released).

To engage the lock, push the M/O knob all the way in and turn it 90° clockwise to align the ▲ mark on the cap with the ▼ ON mark on the M/O knob. At this time, make sure that the knob stops by clicking into place.

Failure to click it into place properly can cause the lock to release.

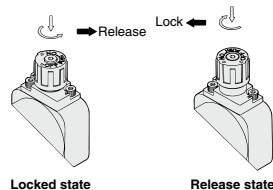

CJ1

CJP

CJ2

JCM

CM2

CM3

CG1

CG3

JMB

MB

MB1

CA2

CS1

CS2

D-□

-X□

Technical Data

Air Cylinder: Air-hydro Type Double Acting, Single Rod

CA2□H Series

ø40, ø50, ø63, ø80, ø100

How to Order

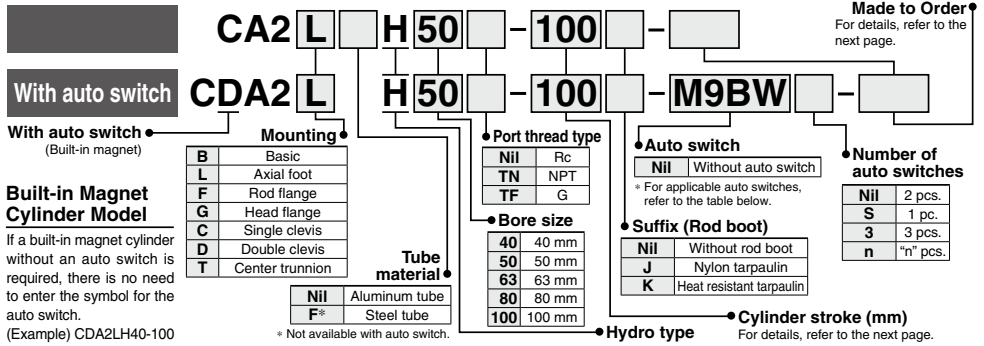

Applicable Auto Switches/Refer to pages 1575 to 1701 for further information on auto switches.

Type	Special function	Electrical entry	Indicator/light	Wiring (Output)	Load voltage		Auto switch model		Lead wire length (m)					Pre-wired connector	Applicable load			
					DC	AC	Tie-rod mounting	Band mounting	0.5 (Nil)	1 (M)	3 (L)	5 (Z)						
Solid state auto switch	—	Grommet	—	3-wire (NPN)	24 V	5 V, 12 V	—	M9N	●	●	●	○	○	IC circuit	—			
				3-wire (PNP)				G59	●	—	●	○	○					
				2-wire	G5P	●	—	●	○	○								
		Terminal conduit		3-wire (NPN)	12 V	—	G39C	G39	—	—	—	—	IC circuit					
				2-wire			K39C	K39	—	—	—	—						
				3-wire (NPN)	24 V	5 V, 12 V	—	M9NW	—	●	●	●		○		○	IC circuit	
	3-wire (PNP)	G59W	●	—				●	○	○								
	Diagnostic indication (2-color indicator)	Grommet	Yes	—	2-wire	24 V	12 V	—	M9PW	—	●	●	●	○	○	Relay, PLC		
					2-wire				G5PW	—	●	●	●	○	○			
					3-wire (NPN)	12 V	—	M9BW	—	●	●	●	○	○				
		3-wire (PNP)			K59W			—	●	—	●	○	○					
		Water resistant (2-color indicator)			Grommet	—	—	2-wire	24 V	5 V, 12 V	—	M9NA*1	—	○	○	●	○	○
3-wire (NPN)								M9PA*1				—	○	○	○	○		
3-wire (PNP)	M9BA*1		—	○				○	●	○	○							
With diagnostic output (2-color indicator)	Terminal conduit		—	—	2-wire			12 V	—	—	M9BA*1	—	○	—	●	○	○	IC circuit
					4-wire (NPN)						G5BA*1	—	—	—	●	○	○	
					2-wire (Non-polar)			5 V, 12 V	—	F59F	G59F	●	—	●	○	○		
Magnetic field resistant (2-color indicator)	Grommet	—	—	2-wire	—	—	—	P3DW	—	●	—	●	○	○	—			
				P4DW				—	—	—	—	○	○					
				3-wire (NPN equiv.)	5 V	—	A96**	—	●	—	●	—	○	○		IC circuit		
	Terminal conduit			Yes	—	—	24 V	12 V	—	A93**	—	●	●	●	—		—	IC circuit
										A90**	—	●	—	●	—		—	
										A54	B54	●	—	●	●	—		
Diagnostic indication (2-color indicator)	DIN terminal	Yes	—	2-wire	24 V	100 V, 200 V or less	—	A64	B64	●	—	●	—	—	Relay, PLC			
								A33C	A33	—	—	—	—	—				
								A34C	A34	—	—	—	—	—				
—	Grommet	—	—	—	—	100 V, 200 V	—	A44C	A44	—	—	—	—	—	PLC			
								A59W	B59W	●	—	●	—	—		Relay, PLC		

*1 Water resistant type auto switches can be mounted on the above models, but in such case SMC cannot guarantee water resistance. Please contact SMC regarding water resistant types with the above model numbers.

* Lead wire length symbols: 0.5 m..... Nil (Example) M9NW
1 m..... M (Example) M9NW
3 m..... L (Example) M9WL
5 m..... Z (Example) M9WZ

* Solid state auto switches marked with "○" are produced upon receipt of order.
**D-A9□ and D-A9□V types cannot be mounted on ø50. Use D-Z7□ and D-Z80 instead.

* Since there are other applicable auto switches than listed above, refer to page 523 for details.
* For details about auto switches with pre-wired connector, refer to pages 1648 and 1649.
* The D-A9□/M9□□/P3DW□ auto switches are shipped together, (but not assembled). (However, auto switch mounting brackets are assembled for the D-A9□/M9□□ before shipment.)

Air Cylinder: Air-hydro Type Double Acting, Single Rod **CA2□H Series**



Symbol

Double acting, without cushion



Made to Order

[Click here for details](#)

Symbol	Specifications
-XA□	Change of rod end shape
-XC6	Made of stainless steel
-XC14	Change of trunnion bracket mounting position
-XC15	Change of tie-rod length

Note) Since a heavy duty scraper (-XC4) is installed as standard, there is no need to specify it.

⚠ Precautions

Setting

⚠ Caution

- Do not use the cylinder near fire or on equipment or machinery whose ambient temperature exceeds 60°C. Since the air-hydro cylinder uses flammable hydraulic fluid, there is danger of potential fire.

Selection

⚠ Caution

- Keep the air-hydro cylinder load at 50% or less than the theoretical output. For the air-hydro cylinder to achieve performance that is close to that of the hydraulic cylinder in constant-speed operation and stopping accuracy, the load must be kept at 50% or less than theoretical output.

Minimum Stroke for Auto Switch Mounting

⚠ Caution

- The minimum stroke for mounting varies with the auto switch type and cylinder mounting type. In particular, the center trunnion type needs careful attention. (For details, refer to pages 521 and 522.)

Refer to pages 517 to 523 for cylinders with auto switches.

- Auto switch proper mounting position (detection at stroke end) and its mounting height
- Operating range
- Minimum stroke for auto switch mounting
- Auto switch mounting brackets/Part no.

Specifications

Bore size (mm)	40	50	63	80	100
Type	Air-hydro				
Fluid	Turbine oil				
Action	Double acting				
Proof pressure	1.5 MPa				
Maximum operating pressure	1.0 MPa				
Ambient and fluid temperature	5 to 60°C				
Minimum operating pressure	0.1 MPa				
Piston speed	0.5 to 300 mm/s				
Cushion	None				
Stroke length tolerance	Up to 250 st: $^{+1.0}_{-0}$ 251 to 1000 st: $^{+1.4}_{-0}$ 1001 to 1500 st: $^{+1.8}_{-0}$				
Mounting	Basic, Foot, Rod flange, Head flange, Single clevis, Double clevis, Center trunnion				

Standard Strokes

In case of a type with auto switch, also refer to the table of minimum strokes for auto switch mounting on pages 521 and 522.

Bore size	Standard stroke ^{Note)}	Long stroke (L and F only)
40	25, 50, 75, 100, 125, 150, 175, 200, 250, 300, 350, 400, 450, 500	800
50, 63	25, 50, 75, 100, 125, 150, 175, 200, 250, 300, 350, 400, 450, 500, 600	1200
80, 100	25, 50, 75, 100, 125, 150, 175, 200, 250, 300, 350, 400, 450, 500, 600, 700	ø80: 1400 ø100: 1500

Note) Intermediate strokes not listed above are produced upon receipt of order.

Accessories

Mounting	Basic	Axial foot	Rod flange	Head flange	Single clevis	Double clevis	Center trunnion
Standard	Rod end nut	●	●	●	●	●	●
	Clevis pin	—	—	—	—	—	—
Option	Single knuckle joint	●	●	●	●	●	●
	Double knuckle joint (with pin)	●	●	●	●	●	●
	With rod boot	●	●	●	●	●	●

* Refer to page 485 for part numbers and dimensions.

Rod Boot Material

Symbol	Rod boot material	Max. ambient temperature
J	Nylon tarpaulin	70°C
K	Heat resistant tarpaulin	110°C*

* Maximum ambient temperature for the rod boot itself.

Weights/Aluminum Tube (Steel Tube)

Bore size (mm)		40	50	63	80	100
Basic weight	Basic	0.89 (0.94)	1.36 (1.40)	2.00 (2.04)	3.48 (3.63)	4.87 (5.07)
	Axial foot	1.08 (1.13)	1.58 (1.62)	2.34 (2.38)	4.15 (4.30)	5.86 (6.06)
	Flange	1.26 (1.30)	1.81 (1.86)	2.79 (2.84)	4.93 (5.08)	6.79 (6.99)
	Single clevis	1.12 (1.17)	1.70 (1.74)	2.63 (2.67)	4.59 (4.74)	6.65 (6.86)
	Double clevis	1.16 (1.21)	1.79 (1.83)	2.79 (2.83)	4.88 (5.03)	7.17 (7.38)
	Trunnion	1.25 (1.35)	1.84 (1.94)	2.80 (3.00)	5.03 (5.32)	7.15 (7.54)
	Additional weight per 50 mm of stroke	All mounting brackets (Except steel tube trunnion)	0.22 (0.28)	0.28 (0.35)	0.37 (0.43)	0.52 (0.70)
Accessories	Steel tube trunnion	0.36 (0.36)	0.46 (0.46)	0.65 (0.65)	0.86 (0.86)	1.07 (1.07)
	Single knuckle	0.23	0.26	0.26	0.60	0.83
	Double knuckle (with pin)	0.37	0.43	0.43	0.87	1.27

Calculation:

(Example)

CA2LH40-100

(Axial foot, ø40, 100 stroke)

● Basic weight

.....1.08 kg

● Additional weight

.....0.22/50 stroke

● Cylinder stroke

.....100 stroke

1.08 + 0.22 x

100/50 = **1.52 kg**

* Values inside the parentheses are those for the steel tube type.

CJ1

CJP

CJ2

JCM

CM2

CM3

CG1

CG3

JMB

MB

MB1

CA2

CS1

CS2

D-□

-X□

Technical Data

Construction

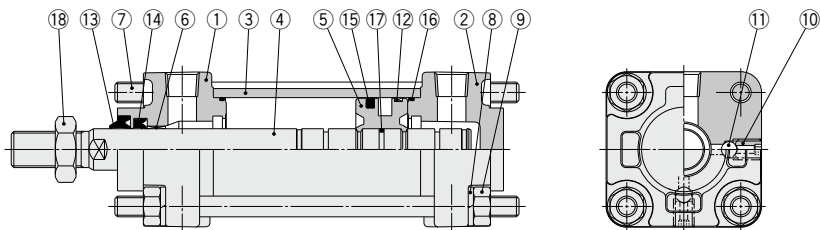

Component Parts

No.	Description	Material	Note
1	Rod cover	Aluminum alloy	Metallic painted
2	Head cover	Aluminum alloy	Metallic painted
3	Cylinder tube	Aluminum alloy	Hard anodized
4	Piston rod	Carbon steel	Hard chrome plating
5	Piston	Aluminum alloy	Chromated
6	Bushing	Bearing alloy	
7	Tie-rod	Carbon steel	Trivalent zinc chromated
8	Spring washer	Rolled steel	Trivalent zinc chromated
9	Tie-rod nut	Rolled steel	Trivalent zinc chromated
10	Air release valve	Chromium molybdenum steel	Black zinc chromated
11	Check ball	Bearing steel	
12	Wear ring	Resin	
13	Scraper	NBR	
14	Rod seal	NBR	
15	Piston seal	NBR	
16	Cylinder tube gasket	NBR	
17	Piston gasket	NBR	
18	Rod end nut	Rolled steel	Trivalent zinc chromated

Replacement Parts: Seal Kit

Bore size (mm)	Kit no.		Contents
	Air-hydro type		
40	CA2H40A-PS		Set of the nos. ⑭, ⑮, ⑯.
50	CA2H50A-PS		
63	CA2H63A-PS		
80	CA2H80A-PS		
100	CA2H100A-PS		

* Do not disassemble the trunnion type. Refer to page 525.

* Seal kit includes ⑭, ⑮ and ⑯. Order the seal kit based on each bore size.

* Seal kit includes a grease pack (ø40, ø50: 10 g, ø63 or more: 20 g).

Order with the following part number when only the grease pack is needed.

Grease pack part number: GR-S-010 (10 g), GR-S-020 (20 g)

Air Cylinder: Air-hydro Type Double Acting, Single Rod **CA2□H Series**

Basic: CA2BH

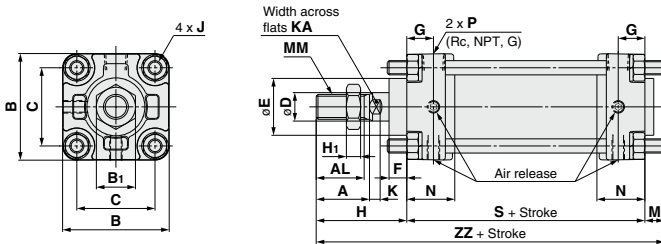

With rod boot

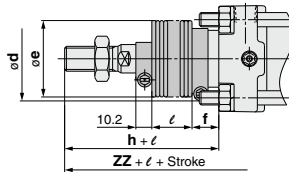

Bore size (mm)	Stroke range (mm)		A	AL	B	B ₁	C	D	E	F	G	H ₁	J	K	KA	M	MM	N	P
	Without rod boot	With rod boot																	
40	Up to 500	20 to 500	30	27	60	22	44	16	32	10	15	8	M8 x 1.25	6	14	11	M14 x 1.5	27	1/4
50	Up to 600	20 to 600	35	32	70	27	52	20	40	10	17	11	M8 x 1.25	7	18	11	M18 x 1.5	30	3/8
63	Up to 600	20 to 600	35	32	85	27	64	20	40	10	17	11	M10 x 1.25	7	18	14	M18 x 1.5	31	3/8
80	Up to 750	20 to 750	40	37	102	32	78	25	52	14	21	13	M12 x 1.75	10	22	17	M22 x 1.5	37	1/2
100	Up to 750	20 to 750	40	37	116	41	92	30	52	14	21	16	M12 x 1.75	10	26	17	M26 x 1.5	40	1/2

Bore size (mm)	S	Without rod boot		With rod boot					
		H	ZZ	d	e	f	h	ℓ	ZZ
40	84	51	146	56	43	11.2	59	1/4 stroke	154
50	90	58	159	64	52	11.2	66	1/4 stroke	167
63	98	58	170	64	52	11.2	66	1/4 stroke	178
80	116	71	204	76	65	12.5	80	1/4 stroke	213
100	126	72	215	76	65	14	81	1/4 stroke	224

The dimensions for each mounting type and the dimensions of accessories (options) are the same as the standard double acting single rod model. Refer to pages 476 to 485.

- CJ1
- CJP
- CJ2
- JCM
- CM2
- CM3
- CG1
- CG3
- JMB
- MB
- MB1
- CA2**
- CS1
- CS2

- D-□
- X□
- Technical Data

Air Cylinder: Air-hydro Type Double Acting, Double Rod

CA2W□H Series

ø40, ø50, ø63, ø80, ø100

How to Order

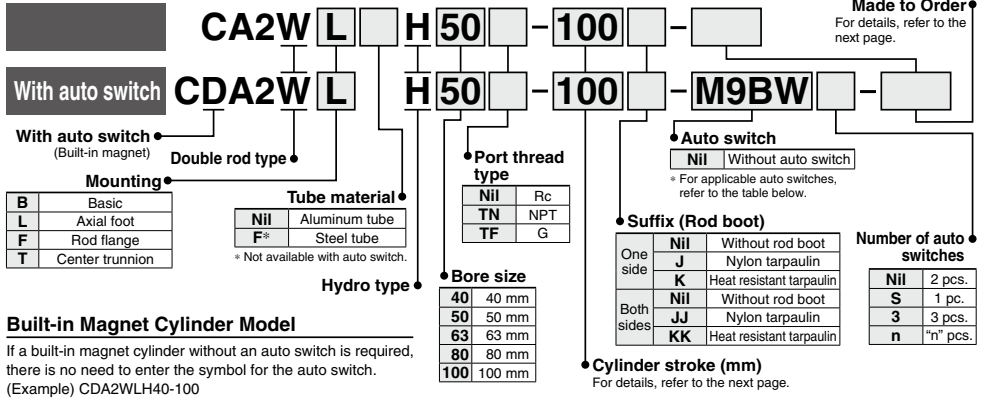

Built-in Magnet Cylinder Model

If a built-in magnet cylinder without an auto switch is required, there is no need to enter the symbol for the auto switch.
(Example) CDA2WLH40-100

Applicable Auto Switches/Refer to pages 1575 to 1701 for further information on auto switches.

Type	Special function	Electrical entry	Indicator light	Wiring (Output)	Load voltage		Auto switch model		Lead wire length (m)					Pre-wired connector	Applicable load
					DC	AC	Tie-rod mounting	Band mounting	0.5 (Nil)	1 (M)	3 (L)	5 (Z)			
Solid state auto switch	—	Grommet	—	3-wire (NPN)	24 V	5 V, 12 V	—	M9N	●	●	●	○	○	IC circuit	—
				3-wire (PNP)				G59	●	●	●	○	○		
				2-wire				M9P	●	●	●	○	○		
				—				G5P	●	●	●	○	○		
				—				M9B	●	●	●	○	○		
				—				K59	●	●	●	○	○		
	Diagnostic indication (2-color indicator)	Terminal conduit	Yes	3-wire (NPN)	12 V	5 V, 12 V	—	G39C	●	●	●	○	○	IC circuit	Relay, PLC
				2-wire				G39	●	●	●	○	○		
				3-wire (NPN)				K39C	●	●	●	○	○		
				3-wire (PNP)				M9NW	●	●	●	○	○		
				2-wire				G59W	●	●	●	○	○		
				—				M9PW	●	●	●	○	○		
Water resistant (2-color indicator)	Grommet	—	2-wire	24 V	12 V	—	M9BW	●	●	●	○	○	—	—	
			3-wire (NPN)				K59W	●	●	●	○	○			
			3-wire (PNP)				M9A ^{*1}	—	○	○	○	○			
			2-wire				M9PA ^{*1}	—	○	○	○	○			
			—				M9BA ^{*1}	—	○	○	○	○			
			—				G5BA ^{*1}	—	○	○	○	○			
With diagnostic output (2-color indicator) Magnetic field resistant (2-color indicator)	Grommet	—	4-wire (NPN)	24 V	5 V, 12 V	—	F59F	●	●	●	○	○	IC circuit	—	
			2-wire (Non-polar)				P3DW	●	●	●	○	○			
			—				P4DW	●	●	●	○	○			
			—				A96 ^{*2}	●	●	●	○	○			
			—				A93 ^{*2}	●	●	●	○	○			
			—				A90 ^{*2}	●	●	●	○	○			
—	Grommet	Yes	3-wire (NPN equiv.)	24 V	12 V	—	A54	●	●	●	○	○	IC circuit	Relay, PLC	
							—	B54	●	●	●	○			○
							—	A64	●	●	●	○			○
							—	A33C	●	●	●	○			○
							—	A34C	●	●	●	○			○
							—	A44C	●	●	●	○			○
Diagnostic indication (2-color indicator)	Grommet	Yes	3-wire (NPN equiv.)	24 V	12 V	—	A44C	●	●	●	○	○	—	PLC	
							—	A59W	●	●	●	○			○

*1 Water resistant type auto switches can be mounted on the above models, but in such case SMC cannot guarantee water resistance.
Please contact SMC regarding water resistant types with the above model numbers.

* Lead wire length symbols: 0.5 m..... Nil (Example) M9NW * Solid state auto switches marked with "○" are produced upon receipt of order.
1 m..... M (Example) M9NWM **D-A9□ and D-A9□V types cannot be mounted on ø50. Use D-Z7□ and D-Z80 instead.
3 m..... L (Example) M9NL *
5 m..... Z (Example) M9NWZ

* Since there are other applicable auto switches than listed above, refer to page 523 for details.

* For details about auto switches with pre-wired connector, refer to pages 1649 and 1649.

* The D-A9□/M9□□/P3DW□ auto switches are shipped together, (but not assembled). (However, auto switch mounting brackets are assembled for the D-A9□/M9□□ before shipment.)

Air Cylinder: Air-hydro Type Double Acting, Double Rod **CA2W□H Series**

Specifications

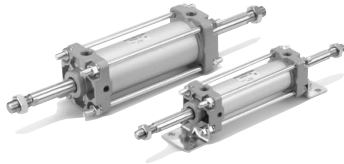

Symbol

Without cushion

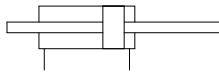

Made to Order
Click here for details

Symbol	Specifications
-XC6	Made of stainless steel
-XC14	Change of trunnion bracket mounting position
-XC15	Change of tie-rod length

Note) Since a heavy duty scraper (-XC4) is installed as standard, there is no need to specify it.

Minimum Stroke for Auto Switch Mounting

⚠ Caution

1. The minimum stroke for mounting varies with the auto switch type and cylinder mounting type.

In particular, the center trunnion type needs careful attention. (For details, refer to pages 521 and 522.)

Refer to pages 517 to 523 for cylinders with auto switches.

- Auto switch proper mounting position (detection at stroke end) and its mounting height
- Operating range
- Minimum stroke for auto switch mounting
- Auto switch mounting brackets/Part no.

Bore size (mm)	40	50	63	80	100
Type	Air-hydro				
Fluid	Turbine oil				
Action	Double acting				
Proof pressure	1.5 MPa				
Maximum operating pressure	1.0 MPa				
Minimum operating pressure	0.16 MPa				
Piston speed	0.5 to 300 mm/s				
Ambient and fluid temperature	5 to 60°C				
Cushion	None				
Stroke length tolerance	Up to 250 st: ^{+1.0} ₀ , 251 to 750 st: ^{+1.4} ₀				
Mounting	Basic, Axial foot, Rod flange, Center trunnion				

In case of a type with auto switch, also refer to the table of minimum strokes for auto switch mounting on pages 521 and 522.

Bore size	Standard stroke (mm)				
40	25, 50, 75, 100, 125, 150, 175, 200, 250, 300, 350, 400, 450, 500				
50, 63	25, 50, 75, 100, 125, 150, 175, 200, 250, 300, 350, 400, 450, 500, 600				
80, 100	25, 50, 75, 100, 125, 150, 175, 200, 250, 300, 350, 400, 450, 500, 600, 700				

* Intermediate strokes not listed above are produced upon receipt of order.

Rod Boot Material

Symbol	Rod boot material	Max. ambient temperature
J	Nylon tarpaulin	70°C
K	Heat resistant tarpaulin	110°C*

* Maximum ambient temperature for the rod boot itself.

Accessories

Mounting		Basic	Foot	Flange	Center trunnion
Standard	Rod end nut	●	●	●	●
	Single knuckle joint	●	●	●	●
Option	Double knuckle joint (with pin)	●	●	●	●
	With rod boot	●	●	●	●

* Refer to page 485 for part numbers and dimensions.

Weights/Aluminum Tube (Steel Tube)

Bore size (mm)		40	50	63	80	100
Basic weight	Basic	1.03 (1.08)	1.59 (1.64)	2.26 (2.30)	3.94 (4.09)	5.57 (5.78)
	Axial foot	1.22 (1.27)	1.81 (1.86)	2.59 (2.63)	4.61 (4.76)	6.65 (6.77)
	Flange	1.40 (1.45)	2.05 (2.09)	3.05 (3.09)	5.39 (5.55)	7.49 (7.70)
	Trunnion	1.39 (1.49)	2.07 (2.18)	3.06 (3.25)	5.49 (5.78)	7.85 (8.24)
	Additional weight per 50 mm of stroke	All mounting brackets (Except steel tube trunnion)	0.30 (0.35)	0.40 (0.47)	0.50 (0.55)	0.71 (0.89)
Accessories	Steel tube trunnion	0.44 (0.44)	0.58 (0.58)	0.77 (0.77)	1.06 (1.06)	1.35 (1.35)
	Single knuckle	0.23	0.26	0.26	0.60	0.83
	Double knuckle (with pin)	0.37	0.43	0.43	0.87	1.27

Calculation: (Example) **CA2WLH40-100** (Axial foot, ø40, 100 stroke)

- Basic weight..... 1.22 (Axial foot, ø40)
 - Additional weight..... 0.30/50 stroke
 - Cylinder stroke 100 stroke
- 1.22 + 0.30 x 100/50 = **1.82 kg**

* Values inside the parentheses are those for the steel tube type.

CJ1

CJP

CJ2

JCM

CM2

CM3

CG1

CG3

JMB

MB

MB1

CA2

CS1

CS2

D-□

-X□

Technical Data

CA2W□H Series

Construction

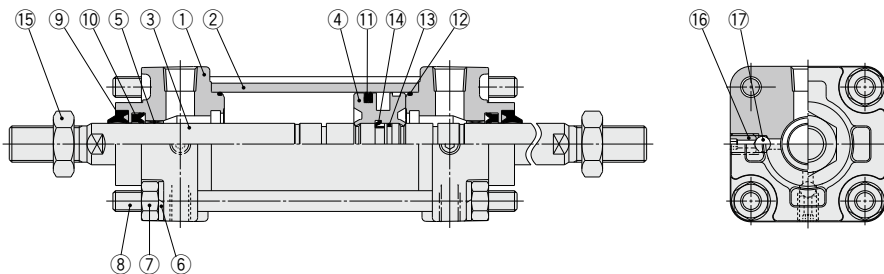

Component Parts

No.	Description	Material	Note
1	Rod cover	Aluminum alloy	Metallic painted
2	Cylinder tube	Aluminum alloy	Hard anodized
3	Piston rod	Carbon steel	Hard chrome plating
4	Piston	Aluminum alloy	Chromated
5	Bushing	Bearing alloy	
6	Spring washer	Rolled steel	Chromated
7	Tie-rod nut	Rolled steel	Nickel plating
8	Tie-rod	Carbon steel	Zinc chromated
9	Scraper	NBR	
10	Rod seal	NBR	
11	Piston seal	NBR	
12	Cylinder tube gasket	NBR	
13	Piston gasket	NBR	
14	Piston holder	Urethane	
15	Rod end nut	Rolled steel	Nickel plating
16	Air release valve	Chromium molybdenum steel	Black zinc chromated
17	Check ball	Bearing steel	

Replacement Parts: Seal Kit

Bore size (mm)	Kit no.	Contents
	Air-hydro type	
40	CA2WH40A-PS	Set of the nos. ⑩, ⑪, ⑫.
50	CA2WH50A-PS	
63	CA2WH63A-PS	
80	CA2WH80A-PS	
100	CA2WH100A-PS	

* Do not disassemble the trunnion type. Refer to page 525.

* Seal kit includes ⑩, ⑪ and ⑫. Order the seal kit based on each bore size.

* Seal kit includes a grease pack (ø40, ø50: 10 g, ø63 or more: 20 g).

Order with the following part number when only the grease pack is needed.

Grease pack part number: GR-S-010 (10 g), GR-S-020 (20 g)

Air Cylinder: Air-hydro Type Double Acting, Double Rod **CA2W□H Series**

Basic: CA2WBH

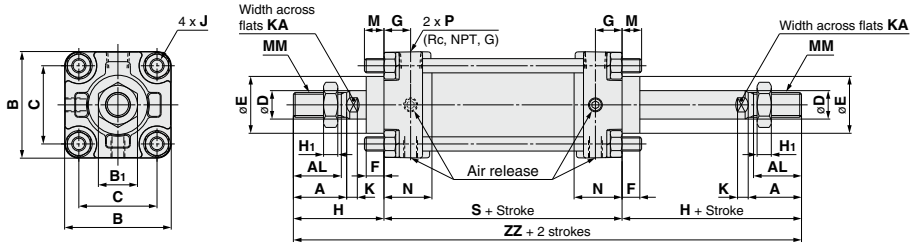

With rod boot (One side)

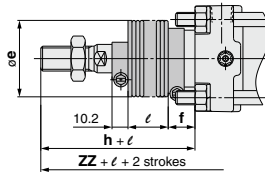

With rod boot (Both sides)

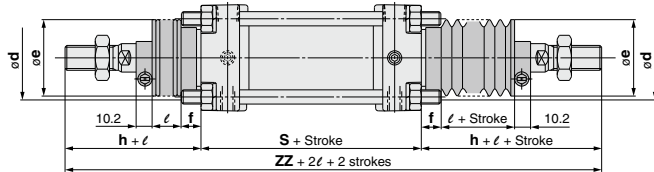

Bore size (mm)	Stroke range (mm)		A	AL	B	B ₁	C	D	E	F	G	H ₁	J	K	KA	M	MM	N
	Without rod boot	With rod boot																
40	Up to 500	20 to 500	30	27	60	22	44	16	32	10	15	8	M8 x 1.25	6	14	11	M14 x 1.5	27
50	Up to 600	20 to 600	35	32	70	27	52	20	40	10	17	11	M8 x 1.25	7	18	11	M18 x 1.5	30
63	Up to 600	20 to 600	35	32	85	27	64	20	40	10	17	11	M10 x 1.25	7	18	14	M18 x 1.5	31
80	Up to 750	20 to 750	40	37	102	32	78	25	52	14	21	13	M12 x 1.75	11	22	17	M22 x 1.5	37
100	Up to 750	20 to 750	40	37	116	41	92	30	52	14	21	16	M12 x 1.75	11	26	17	M26 x 1.5	40

Bore size (mm)	P	S	Without rod boot		With rod boot (One side)					(Both sides)	
			H	ZZ	d	e	f	h	ℓ	ZZ	ZZ
40	1/4	84	51	186	56	43	11.2	59	1/4 stroke	194	202
50	3/8	90	58	206	64	52	11.2	66	1/4 stroke	214	222
63	3/8	98	58	214	64	52	11.2	66	1/4 stroke	222	230
80	1/2	116	71	258	76	65	12.5	80	1/4 stroke	267	276
100	1/2	126	72	270	76	65	14.0	81	1/4 stroke	279	288

The dimensions for each mounting type are the same as the standard double acting double rod model. Refer to pages 490 to 493. For details about accessories (options), refer to page 485.

- CJ1**
- CJP**
- CJ2**
- JCM**
- CM2**
- CM3**
- CG1**
- CG3**
- JMB**
- MB**
- MB1**
- CA2**
- CS1**
- CS2**

- D-□**
- X□**
- Technical Data

Air Cylinder: Low Friction Type Double Acting, Single Rod

CA2□Q Series

ø40, ø50, ø63, ø80, ø100

Use the new "Smooth Cylinder CA2Y Series" to realize dual-side low friction and low-speed operation. (Refer to the Best Pneumatics No. 2-3.)

How to Order

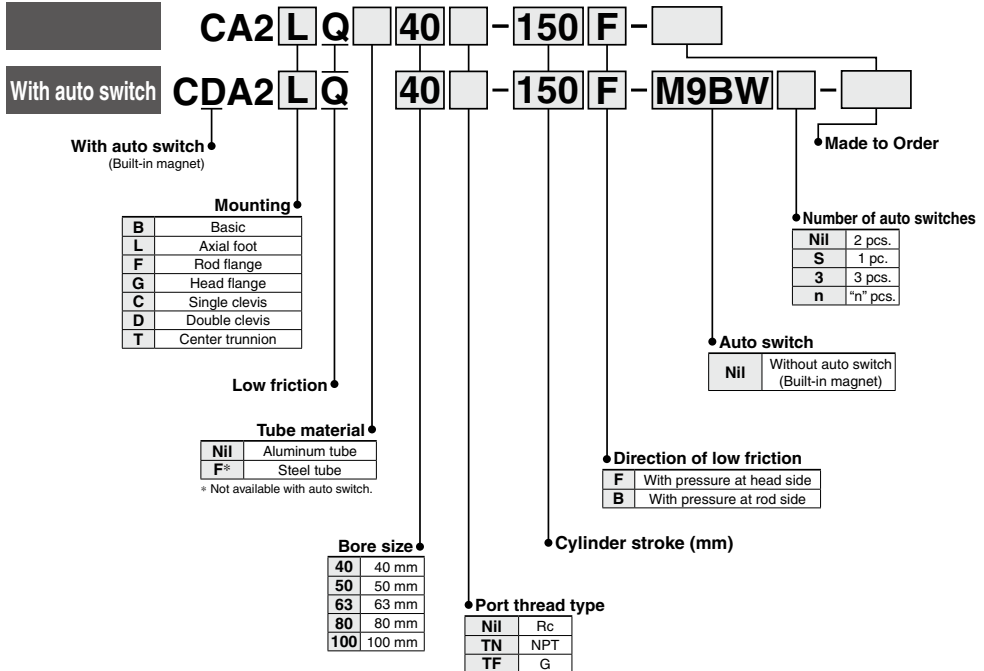

Built-in Magnet Cylinder Model

If a built-in magnet cylinder without an auto switch is required, there is no need to enter the symbol for the auto switch.

(Example) CDA2BQ40-100

CA2 Series Auto Switch Mounting

Auto Switch Proper Mounting Position (Detection at stroke end) and Its Mounting Height

<Band mounting>

D-B5□/B64/B59W

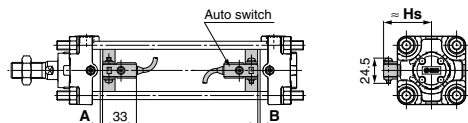

D-A3□
D-G39/K39

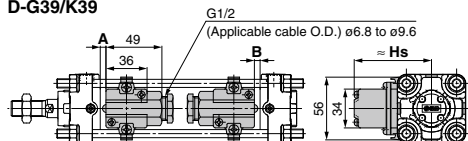

D-G5□/K59 D-G5BA
D-G5□W/K59W D-G59F/G5NT

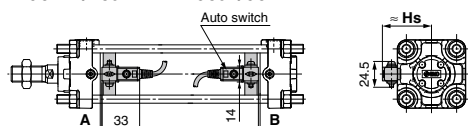

D-A44

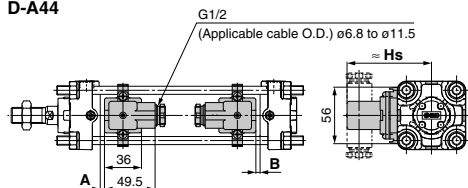

<Tie-rod mounting>

D-M9□/M9□V D-Y59□/Y69□/Y7P/Y7PV
D-M9□W/M9□WV D-Y7□W/Y7□WV
D-M9□A/M9□AV D-Y7BA
D-A9□/A9□V D-Z7□/Z80

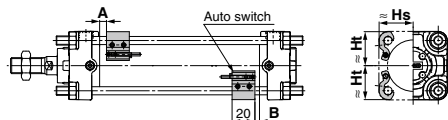

D-A5□/A6□
D-A59W

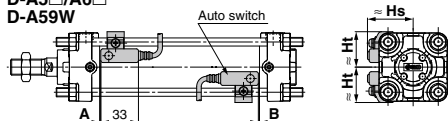

D-G39C/K39C
D-A3□C

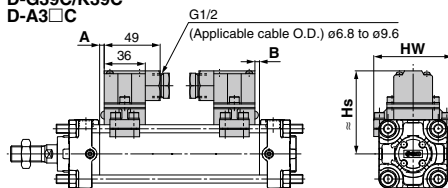

D-F5□/J59 D-F5□W/J59W
D-F5NT D-F5BA/F59F

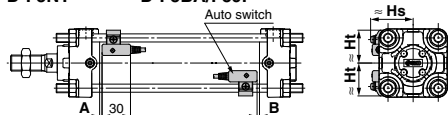

D-A44C

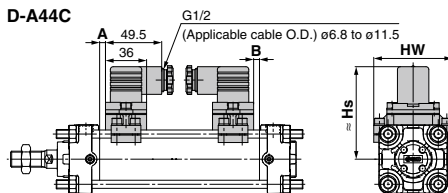

D-P3DWA
D-P3DW

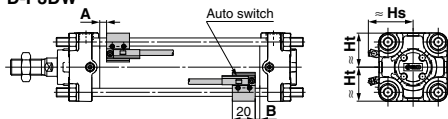

D-P4DW

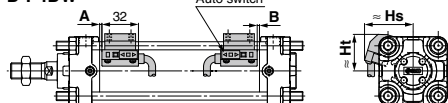

CJ1

CJP

CJ2

JCM

CM2

CM3

CG1

CG3

JMB

MB

MB1

CA2

CS1

CS2

D-□

-X□

Technical
Data

Auto Switch Proper Mounting Position (Detection at stroke end) and Its Mounting Height

Auto Switch Proper Mounting Position (Standard type)

(mm)

Auto switch model	D-M9□ D-M9□V D-M9□W D-M9□A D-M9□AV		D-A9□ D-A9□V		D-Y59□ D-Y69□ D-Y7P D-Y7P D-Y7□W D-Y7□WV D-Z7□ D-Z80 D-B59W		D-P3DWA		D-P4DW		D-F5□ D-J59 D-F59F D-F5□W D-J59W D-F5BA		D-F5NT		D-A59W		D-G39 D-G39C D-K39 D-K39C D-A5□ D-A6□ D-A3□ D-A3□C D-A44 D-A44C		D-G5□ D-K59 D-G5NT D-G5□W D-K59W D-G5BA D-G59F		D-B5□ D-B64		
	A	B	A	B	A	B	A	B	A	B	A	B	A	B	A	B	A	B	A	B	A	B	A
40	9	9	5	5	2.5	2.5	4.5	4.5	2	2	5.5	5.5	10.5	10.5	3	3	0	0	1	1	0	0	
50	9.5	8.5	5.5	4.5	3	2	5	4	2.5	1.5	6	5	11	10	3.5	2.5	0	0	1.5	0.5	0	0	
63	12.5	11.5	8.5	7.5	6	5	8	7	5.5	4.5	9	8	14	13	6.5	5.5	2.5	1.5	4.5	3.5	3	2	
80	16.5	13.5	12.5	9.5	10	7	12	9	9.5	6.5	13	10	18	15	10.5	7.5	6.5	3.5	8.5	5.5	7	4	
100	18	16	14	12	11.5	9.5	13.5	11.5	11	9	14.5	12.5	19.5	17.5	12	10	8	6	10	8	8.5	6.5	

Note) Adjust the auto switch after confirming the operating conditions in the actual setting.

Auto Switch Proper Mounting Height (Standard type)

(mm)

Auto switch model	D-M9□ D-M9□W D-M9□A D-A9□		D-M9□V D-M9□WV D-M9□AV		D-A9□V		D-Y59□ D-Y7P D-Y7BA D-Y7□W D-Z7□ D-Z80		D-Y69□ D-Y7PV D-Y7□WV		D-P3DWA		D-P4DW		D-G5□ D-K59 D-G5NT D-G5□W D-K59W D-G5BA D-G59F D-B5□ D-B64 D-B59W		D-G39 D-K39 D-A3□		D-A44		D-F5□ D-J59 D-F5□W D-J59W D-F5BA D-F59F D-F5NT		D-A5□ D-A6□ D-A59W		D-G39C D-K39C D-A3□C		D-A44C		
	Hs	Ht	Hs	Ht	Hs	Ht	Hs	Ht	Hs	Ht	Hs	Ht	Hs	Ht	Hs	Ht	Hs	Ht	Hs	Ht	Hs	Ht	Hs	Ht	Hs	Ht	Hs	Ht	Hs
40	30	30	34	30	31	30	30	30	30	30	37.5	35	42.5	33	37	71.5	81.5	38	31.5	38.5	31.5	73	69	81	69				
50	34	34	38	34	35	34	34	34	34	34	41.5	39	46.5	37.5	42	76.5	86.5	42	35.5	42	35.5	78.5	77	86.5	77				
63	41	41	44	41	41.5	41	41	41	41	41	50	41	52	43	49	83.5	93.5	47	43	46.5	43	85.5	91	93.5	91				
80	49.5	49	52.5	49	50	49	49.5	49	49.5	49	58	49	58.5	51.5	57.5	92	102	53.5	51	53.5	51	94	107	102	107				
100	56.5	56	61	56	58.5	56	56.5	55.5	57.5	55.5	66	56	66	58.5	68	102.5	112.5	61	57.5	61.5	57.5	104	121	112	121				

Auto Switch Proper Mounting Position (Detection at stroke end) and Its Mounting Height

Auto Switch Proper Mounting Position (Non-rotating rod type, With end lock)

(mm)

Auto switch model	D-M9□ D-M9□V D-M9□W D-M9□A D-M9□AV		D-A9□ D-A9□V		D-Y59□ D-Y69□ D-Y7P D-Y7PV D-Y7□W D-Y7□WV D-Y7BA D-B59W D-Z7□ D-Z80		D-P3DWA		D-P4DW		D-G39 D-G39C D-K39 D-K39C D-A5□ D-A6□ D-A3□ D-A3□C D-A44 D-A44C		D-G5□ D-K59 D-G5NT D-G5□W D-K59W D-G5BA D-G59F		D-B5□ D-B64		D-F5□ D-J59 D-F59F D-F5□W D-J59W D-F5BA		D-F5NT		D-A59W	
	A	B	A	B	A	B	A	B	A	B	A	B	A	B	A	B	A	B	A	B	A	B
40	10	8	6	4	4	1	5.5	3.5	3.5	0.5	0.5	0	2.5	0	1	0	7	4	12	9	4.5	1.5
50	10	8	6	4	3.5	1.5	5.3	3.5	3	1	0	0	2	0	0.5	0	6.5	4.5	11.5	9.5	4	2
63	12.5	11.5	8.5	7.5	6	5	8	7	5.5	4.5	2.5	1.5	4.5	3.5	3	2	9	8	14	13	6.5	5.5
80	16	14	12	10	9.5	7.5	11.5	9.5	9	7	6	4	8	6	6.5	4.5	12.5	10.5	17.5	15.5	10	8
100	17.5	16.5	13.5	12.5	11	10	13	12	10.5	9.5	7.5	6.5	9.5	8.5	8	7	14	13	19	18	11.5	10.5

Note) Adjust the auto switch after confirming the operating conditions in the actual setting.

Auto Switch Proper Mounting Height (Non-rotating rod type, With end lock)

(mm)

Auto switch model	D-M9□ D-M9□V D-M9□W D-M9□A D-A9□		D-M9□V D-M9□W D-M9□AV		D-A9□V		D-Y59□ D-Y7P D-Y7□W D-Y7BA D-Z7□ D-Z80		D-Y69□ D-Y7PV D-Y7□WV		D-P3DWA		D-P4DW		D-G5□ D-K59 D-G5□W D-K59W D-G59F D-G5BA D-G5NT D-B5□ D-B64 D-B59W		D-G39 D-K39 D-A3□		D-A44		D-F5□ D-J59 D-F5□W D-J59W D-F59F D-F5BA D-F5NT		D-A5□ D-A6□ D-A59W		D-G39C D-K39C D-A3□C		D-A44C		
	Hs	Ht	Hs	Ht	Hs	Ht	Hs	Ht	Hs	Ht	Hs	Ht	Hs	Ht	Hs	Ht	Hs	Ht	Hs	Ht	Hs	Ht	Hs	Ht	Hs	Ht	Hs	Ht	Hs
40	30	30	34	30	31	30	30	30	30	30	37.5	35	42.5	33	37	71.5	81.5	38	31.5	38.5	31.5	73	69	81	69				
50	34	34	38	34	35	34	34	34	34	34	41.5	39	46.5	37.5	42	76.5	86.5	42	35.5	42	35.5	78.5	77	86.5	77				
63	41	41	44	41	41.5	41	41	41	41	50	41	52	43	49	83.5	93	47	43	46.5	43	85.5	91	93.5	91					
80	49.5	49	52.5	49	50	49	49.5	49	49.5	58	49	58.5	51.5	57.5	92	102	53.5	51	53.5	51	94	107	102	107					
100	56.5	56	61	56	58.5	56	58.5	55.5	57.5	66	56	66	58.5	68	102.5	112.5	61	57.5	61.5	57.5	104	121	112	121					

CJ1

CJP

CJ2

JCM

CM2

CM3

CG1

CG3

JMB

MB

MB1

CA2

CS1

CS2

D-□

-X□

Technical Data

CA2 Series

Auto Switch Proper Mounting Position (Detection at stroke end) and Its Mounting Height

Auto Switch Proper Mounting Position (Air-hydro type)

(mm)

Auto switch model	D-M9□ D-M9□V D-M9□W D-M9□WV D-M9□A D-M9□AV		D-A9□ D-A9□V		D-Y59□ D-Y69□ D-Y7P D-Y7P□ D-Y7□W D-Y7□WV		D-Y7BA D-B59W D-Z7□ D-Z80		D-P3DW		D-P4DW		D-G39 D-G39C D-K39 D-K39C D-A5□ D-A6□ D-A3□ D-A3□C D-A44 D-A44C		D-G5□ D-K59 D-G5NT D-G5□W D-K59W D-G5BA D-G59F		D-B5□ D-B64		D-F5□ D-J59 D-F59F D-F5□W D-J59W D-F5BA		D-F5NT		D-A59W		
	A	B	A	B	A	B	A	B	A	B	A	B	A	B	A	B	A	B	A	B	A	B	A	B	A
40	9.5	8.5	5.5	4.5	3.5	1.5	5.5	3.5	3	1	0	0	2	0	0.5	0	6.5	4.5	11.5	9.5	4	2			
50	10	8	—	—	3.5	1.5	5.5	3.5	3	1	0	0	2	0	0.5	0	6.5	4.5	11.5	9.5	4	2			
63	12.5	11.5	8.5	7.5	6	5	3	1.5	5.5	4	2.5	1.5	4.5	3.5	3	2	9	8	14	13	6.5	5.5			
80	16	14	12	10	9.5	7.5	6	4.5	9	7	6	4	8	6	6.5	4.5	4.5	12.5	17.5	15.5	10	8			
100	17.5	16.5	13.5	12.5	11	10	8	6.5	10.5	9	7.5	6.5	9.5	8.5	8	7	14	13	19	18	11.5	10.5			

* D-A9□ and D-A9□V types cannot be mounted on ø50.

Note) Adjust the auto switch after confirming the operating conditions in the actual setting.

Auto Switch Proper Mounting Height (Air-hydro type)

(mm)

Auto switch model	D-M9□ D-M9□V D-M9□A D-A9□		D-M9□V D-M9□W D-M9□AV		D-A9□V		D-Y59□ D-Y7P D-Y7BA D-Y7□W D-Z7□ D-Z80		D-Y69□ D-Y7P□ D-Y7□WV		D-P3DW		D-P4DW		D-G5□ D-K59 D-G5NT D-G5□W D-K59W D-G5BA D-G59F D-B5□ D-B64 D-B59W		D-G39 D-K39 D-A3□		D-A44		D-F5□ D-J59 D-F5□W D-J59W D-F5BA D-F59F D-F5NT		D-A5□ D-A6□ D-A59W		D-G39C D-K39C D-A3□C		D-A44C		
	Hs	Ht	Hs	Ht	Hs	Ht	Hs	Ht	Hs	Ht	Hs	Ht	Hs	Ht	Hs	Ht	Hs	Ht	Hs	Ht	Hs	Ht	Hs	Ht	Hs	Ht	Hs	Ht	Hs
40	30	30	35	30	32	30	30	30.5	30	38	30	43	33.5	38	72.5	82.5	38.5	31	40	31	73	69	81	69					
50	34	34	39	34	—	—	34	34	35	34	42	34	47	38	43.5	78	88	42.5	35	43.5	35	78.5	77	86.5	77				
63	41	41	46	41	43.5	41	41	41	42.5	41	49	41	53	44	50.5	85	95	48	42	49	42	85.5	91	93.5	91				
80	49.5	49	54	49	51.5	49	49.5	48.5	51	48.5	56	49	60	52	59	93.5	103.5	54	50	55.5	50	94	107	102	107				
100	57	56	62.5	56	59.5	56	58.5	56	59	56	65	56	67	59	69.5	104	114	62	57.5	63	57.5	104	121	112	121				

* D-A9□ and D-A9□V types cannot be mounted on ø50.

Operating Range

(mm)

Auto switch model	Bore size				
	40	50	63	80	100
D-M9□/M9□V D-M9□W/M9□WV D-M9□A/M9□AV	4.5	5	5.5	5	6
D-A9□/A9□V	7.5 (7)	8.5 (—)	9.5 (9)	9.5 (9)	10.5 (9)
D-Z7□/Z80	8.5	7.5	9.5	9.5	10.5
D-A3□/A44 D-A3□C/A44C	9	10	11	11	11
D-A5□/A6□					
D-B5□/B64					
D-A59W	13	13	14	14	15
D-B59W	14	14	17	16	18

Auto switch model	Bore size				
	40	50	63	80	100
D-Y59□/Y69□ D-Y7P/Y7□V D-Y7□W/Y7□WV D-Y7BA	8	7	5.5	6.5	6.5
D-F5□/J59/F5□W D-J59W/F5BA D-F5NT/F59F	4	4	4.5	4.5	4.5
D-G5□/K59/G5□W D-K59W/G5BA D-G5NT/G59F	5	6	6.5	6.5	7
D-G5NBL	35	35	40	40	40
D-G39/K39 D-G39C/K39C	9	9	10	10	11
D-P3DWA	4.5	4.5	5.5	5.5	5.5
D-P3DW (Note 3)	4.5	5	6	5.5	6
D-P4DW	4	4	4.5	4	4.5

* Values which include hysteresis are for guideline purposes only, they are not a guarantee (assuming approximately ±30% dispersion) and may change substantially depending on the ambient environment.

Note 1) (): For CDA2□H and CDA2W□H Series.

Note 2) D-A9□ and D-A9□V types cannot be mounted on ø50 of the CDA2□H and CDA2W□H series.

Note 3) Applicable to the CDA2□H and CDA2W□H series.

Minimum Stroke for Auto Switch Mounting

Auto switch model	Number of auto switches	Brackets other than center trunnion	Center trunnion					
			ø40	ø50	ø63	ø80	ø100	
			n: Number of auto switches (mm)					
D-M9□ D-M9□W	2 (Different surfaces and same surface) 1	15	80		85	90	95	
	n	$15 + 40 \frac{(n-2)}{2}$ (n = 2, 4, 6, 8... Note 1)	$80 + 40 \frac{(n-4)}{2}$ (n = 4, 8, 12, 16... Note 2)		$85 + 40 \frac{(n-4)}{2}$ (n = 4, 8, 12, 16... Note 2)	$90 + 40 \frac{(n-4)}{2}$ (n = 4, 8, 12, 16... Note 2)	$95 + 40 \frac{(n-4)}{2}$ (n = 4, 8, 12, 16... Note 2)	
D-M9□V D-M9□WV	2 (Different surfaces and same surface) 1	10	55		60	65	70	
	n	$10 + 30 \frac{(n-2)}{2}$ (n = 2, 4, 6, 8... Note 1)	$55 + 30 \frac{(n-4)}{2}$ (n = 4, 8, 12, 16... Note 2)		$60 + 30 \frac{(n-4)}{2}$ (n = 4, 8, 12, 16... Note 2)	$65 + 30 \frac{(n-4)}{2}$ (n = 4, 8, 12, 16... Note 2)	$70 + 30 \frac{(n-4)}{2}$ (n = 4, 8, 12, 16... Note 2)	
D-M9□A	2 (Different surfaces and same surface) 1	15	80		85	95	100	
	n	$15 + 40 \frac{(n-2)}{2}$ (n = 2, 4, 6, 8... Note 1)	$80 + 40 \frac{(n-4)}{2}$ (n = 4, 8, 12, 16... Note 2)		$85 + 40 \frac{(n-4)}{2}$ (n = 4, 8, 12, 16... Note 2)	$95 + 40 \frac{(n-4)}{2}$ (n = 4, 8, 12, 16... Note 2)	$100 + 40 \frac{(n-4)}{2}$ (n = 4, 8, 12, 16... Note 2)	
D-M9□AV	2 (Different surfaces and same surface) 1	10	60		65	70	75	
	n	$10 + 30 \frac{(n-2)}{2}$ (n = 2, 4, 6, 8... Note 1)	$60 + 30 \frac{(n-4)}{2}$ (n = 4, 8, 12, 16... Note 2)		$65 + 30 \frac{(n-4)}{2}$ (n = 4, 8, 12, 16... Note 2)	$70 + 30 \frac{(n-4)}{2}$ (n = 4, 8, 12, 16... Note 2)	$75 + 30 \frac{(n-4)}{2}$ (n = 4, 8, 12, 16... Note 2)	
D-A9□	2 (Different surfaces and same surface) 1	15	75		80	85	90	
	n	$15 + 40 \frac{(n-2)}{2}$ (n = 2, 4, 6, 8... Note 1)	$75 + 40 \frac{(n-4)}{2}$ (n = 4, 8, 12, 16... Note 2)		$80 + 40 \frac{(n-4)}{2}$ (n = 4, 8, 12, 16... Note 2)	$85 + 40 \frac{(n-4)}{2}$ (n = 4, 8, 12, 16... Note 2)	$90 + 40 \frac{(n-4)}{2}$ (n = 4, 8, 12, 16... Note 2)	
D-A9□V	2 (Different surfaces and same surface) 1	10	50		55	60	65	
	n	$10 + 30 \frac{(n-2)}{2}$ (n = 2, 4, 6, 8... Note 1)	$50 + 30 \frac{(n-4)}{2}$ (n = 4, 8, 12, 16... Note 2)		$55 + 30 \frac{(n-4)}{2}$ (n = 4, 8, 12, 16... Note 2)	$60 + 30 \frac{(n-4)}{2}$ (n = 4, 8, 12, 16... Note 2)	$65 + 30 \frac{(n-4)}{2}$ (n = 4, 8, 12, 16... Note 2)	
D-F5□/J59 D-F5□W/J59W D-F5BA/F59F D-A5□/A6	2 (Different surfaces and same surface) 1	15	90		100	110	120	
	n (Same surface)	$15 + 55 \frac{(n-2)}{2}$ (n = 2, 4, 6, 8... Note 1)	$90 + 55 \frac{(n-4)}{2}$ (n = 4, 8, 12, 16... Note 2)		$100 + 55 \frac{(n-4)}{2}$ (n = 4, 8, 12, 16... Note 2)	$110 + 55 \frac{(n-4)}{2}$ (n = 4, 8, 12, 16... Note 2)	$120 + 55 \frac{(n-4)}{2}$ (n = 4, 8, 12, 16... Note 2)	
D-F5NT	2 (Different surfaces and same surface) 1	25	110		120	130	140	
	n (Same surface)	$25 + 55 \frac{(n-2)}{2}$ (n = 2, 4, 6, 8... Note 1)	$110 + 55 \frac{(n-4)}{2}$ (n = 4, 8, 12, 16... Note 2)		$120 + 55 \frac{(n-4)}{2}$ (n = 4, 8, 12, 16... Note 2)	$130 + 55 \frac{(n-4)}{2}$ (n = 4, 8, 12, 16... Note 2)	$140 + 55 \frac{(n-4)}{2}$ (n = 4, 8, 12, 16... Note 2)	
D-A59W	2 (Different surfaces and same surface) 1	20	90		100	110	120	
	n (Same surface)	$20 + 55 \frac{(n-2)}{2}$ (n = 2, 4, 6, 8... Note 1)	$90 + 55 \frac{(n-4)}{2}$ (n = 4, 8, 12, 16... Note 2)		$100 + 55 \frac{(n-4)}{2}$ (n = 4, 8, 12, 16... Note 2)	$110 + 55 \frac{(n-4)}{2}$ (n = 4, 8, 12, 16... Note 2)	$120 + 55 \frac{(n-4)}{2}$ (n = 4, 8, 12, 16... Note 2)	
	1	15	90		100	110	120	
D-G5□/K59 D-G5□W D-K59W D-G5BA D-G59F D-G5NT D-B5□/B64	2	Different surfaces	15		90	100	110	
		Same surface	75		90	100	110	
	n	Different surfaces	$15 + 50 \frac{(n-2)}{2}$ (n = 2, 4, 6, 8... Note 1)	$90 + 50 \frac{(n-4)}{2}$ (n = 4, 8, 12, 16... Note 2)		$100 + 50 \frac{(n-4)}{2}$ (n = 4, 8, 12, 16... Note 2)	$110 + 50 \frac{(n-4)}{2}$ (n = 4, 8, 12, 16... Note 2)	
		Same surface	$75 + 50 (n-2)$ (n = 2, 3, 4...)	$90 + 50 (n-2)$ (n = 2, 4, 6, 8... Note 1)		$100 + 50 (n-2)$ (n = 2, 4, 6, 8... Note 1)	$110 + 50 (n-2)$ (n = 2, 4, 6, 8... Note 1)	
	1	10	90		100	110		
D-B59W	2	Different surfaces	20		100	110		
		Same surface	75		90	100	110	
	n	Different surfaces	$20 + 50 \frac{(n-2)}{2}$ (n = 2, 4, 6, 8... Note 1)	$90 + 50 \frac{(n-4)}{2}$ (n = 4, 8, 12, 16... Note 2)		$100 + 50 \frac{(n-4)}{2}$ (n = 4, 8, 12, 16... Note 2)	$110 + 50 \frac{(n-4)}{2}$ (n = 4, 8, 12, 16... Note 2)	
		Same surface	$75 + 50 (n-2)$ (n = 2, 3, 4...)	$90 + 50 (n-2)$ (n = 2, 4, 6, 8... Note 1)		$100 + 50 (n-2)$ (n = 2, 4, 6, 8... Note 1)	$110 + 50 (n-2)$ (n = 2, 4, 6, 8... Note 1)	
1	15	90		100	110			

Note 1) When "n" is an odd number, an even number that is one larger than this odd number is used for the calculation.
 Note 2) When "n" is an odd number, a multiple of 4 that is larger than this odd number is used for the calculation.

CJ1
CJP
CJ2
JCM
CM2
CM3
CG1
CG3
JMB
MB
MB1
CA2
CS1
CS2

D-□
-X□
Technical Data

Minimum Stroke for Auto Switch Mounting

			n: Number of auto switches (mm)				
Auto switch model	Number of auto switches	Brackets other than center trunnion	Center trunnion				
			ø40	ø50	ø63	ø80	ø100
D-G39 D-K39 D-A3□	2	Different surfaces	35	75	80	90	
		Same surface	100	100	100	100	
	n	Different surfaces	$35 + 30(n-2)$ (n = 2, 3, 4...)	$75 + 30(n-2)$ (n = 2, 4, 6, 8...) ^{Note 1)}	$80 + 30(n-2)$ (n = 2, 4, 6, 8...) ^{Note 1)}	$90 + 30(n-2)$ (n = 2, 4, 6, 8...) ^{Note 1)}	
		Same surface	$100 + 100(n-2)$ (n = 2, 3, 4...)		$100 + 100(n-2)$ (n = 2, 4, 6, 8...) ^{Note 1)}		
	1	10	75	80	90		
D-A44	2	Different surfaces	35	75	80	90	
		Same surface	55				
	n	Different surfaces	$35 + 30(n-2)$ (n = 2, 3, 4...)	$75 + 30(n-2)$ (n = 2, 4, 6, 8...) ^{Note 1)}	$80 + 30(n-2)$ (n = 2, 4, 6, 8...) ^{Note 1)}	$90 + 30(n-2)$ (n = 2, 4, 6, 8...) ^{Note 1)}	
		Same surface	$55 + 50(n-2)$ (n = 2, 3, 4...)	$75 + 50(n-2)$ (n = 2, 4, 6, 8...) ^{Note 1)}	$80 + 50(n-2)$ (n = 2, 4, 6, 8...) ^{Note 1)}	$90 + 50(n-2)$ (n = 2, 4, 6, 8...) ^{Note 1)}	
	1	10	75	80	90		
D-G39C D-K39C D-A3□C	2	Different surfaces	20	75	80	90	
		Same surface	100	100	100	100	
	n	Different surfaces	$20 + 35(n-2)$ (n = 2, 3, 4...)	$75 + 35(n-2)$ (n = 2, 4, 6, 8...) ^{Note 1)}	$80 + 35(n-2)$ (n = 2, 4, 6, 8...) ^{Note 1)}	$90 + 35(n-2)$ (n = 2, 4, 6, 8...) ^{Note 1)}	
		Same surface	$100 + 100(n-2)$ (n = 2, 3, 4, 5...)		$100 + 100(n-2)$ (n = 2, 4, 6, 8...) ^{Note 1)}		
	1	10	75	80	90		
D-A44C	2	Different surfaces	20	75	80	90	
		Same surface	55	75	80	90	
	n	Different surfaces	$20 + 35(n-2)$ (n = 2, 3, 4...)	$75 + 35(n-2)$ (n = 2, 4, 6, 8...) ^{Note 1)}	$80 + 35(n-2)$ (n = 2, 4, 6, 8...) ^{Note 1)}	$90 + 35(n-2)$ (n = 2, 4, 6, 8...) ^{Note 1)}	
		Same surface	$55 + 50(n-2)$ (n = 2, 3, 4...)	$75 + 50(n-2)$ (n = 2, 4, 6, 8...) ^{Note 1)}	$80 + 50(n-2)$ (n = 2, 4, 6, 8...) ^{Note 1)}	$90 + 50(n-2)$ (n = 2, 4, 6, 8...) ^{Note 1)}	
	1	10	75	80	90		
D-Y59□/Y7P D-Y7□W D-Z7□/Z80	2 (Different surfaces and same surface) 1	15	80	85	90	95	105
	n	$15 + 40 \frac{(n-2)}{2}$ (n = 2, 4, 6, 8...) ^{Note 1)}	$80 + 40 \frac{(n-4)}{2}$ (n = 4, 8, 12, 16...) ^{Note 2)}	$85 + 40 \frac{(n-4)}{2}$ (n = 4, 8, 12, 16...) ^{Note 2)}	$90 + 40 \frac{(n-4)}{2}$ (n = 4, 8, 12, 16...) ^{Note 2)}	$95 + 40 \frac{(n-4)}{2}$ (n = 4, 8, 12, 16...) ^{Note 2)}	$105 + 40 \frac{(n-4)}{2}$ (n = 4, 8, 12, 16...) ^{Note 2)}
D-Y69□/Y7PV D-Y7□WV	2 (Different surfaces and same surface) 1	10	65	75	80	90	
	n	$10 + 30 \frac{(n-2)}{2}$ (n = 2, 4, 6, 8...) ^{Note 1)}	$65 + 30 \frac{(n-4)}{2}$ (n = 4, 8, 12, 16...) ^{Note 2)}	$75 + 30 \frac{(n-4)}{2}$ (n = 4, 8, 12, 16...) ^{Note 2)}	$80 + 30 \frac{(n-4)}{2}$ (n = 4, 8, 12, 16...) ^{Note 2)}	$90 + 30 \frac{(n-4)}{2}$ (n = 4, 8, 12, 16...) ^{Note 2)}	
D-Y7BA	2 (Different surfaces and same surface) 1	20	95	100	105	110	
	n	$20 + 45 \frac{(n-2)}{2}$ (n = 2, 4, 6, 8...) ^{Note 1)}	$95 + 45 \frac{(n-4)}{2}$ (n = 4, 8, 12, 16...) ^{Note 2)}	$100 + 45 \frac{(n-4)}{2}$ (n = 4, 8, 12, 16...) ^{Note 2)}	$105 + 45 \frac{(n-4)}{2}$ (n = 4, 8, 12, 16...) ^{Note 2)}	$110 + 45 \frac{(n-4)}{2}$ (n = 4, 8, 12, 16...) ^{Note 2)}	
D-P3DWA	2 (Different surfaces and same surface) 1	15		85			
	n	$15 + 50 \frac{(n-2)}{2}$ (n = 2, 4, 6, 8...) ^{Note 1)}		$85 + 50 \frac{(n-4)}{2}$ (n = 4, 8, 12, 16...) ^{Note 2)}			
D-P3DW ^{Note 3)}	2 (Different surfaces and same surface) 1	15		85			
	n	$15 + 50 \frac{(n-2)}{2}$ (n = 2, 4, 6, 8...) ^{Note 1)}		$85 + 50 \frac{(n-4)}{2}$ (n = 4, 8, 12, 16...) ^{Note 2)}			
D-P4DW	2 (Different surfaces and same surface) 1	15	120	130	140		
	n	$15 + 65 \frac{(n-2)}{2}$ (n = 2, 4, 6, 8...) ^{Note 1)}	$120 + 65 \frac{(n-4)}{2}$ (n = 4, 8, 12, 16...) ^{Note 2)}	$130 + 65 \frac{(n-4)}{2}$ (n = 4, 8, 12, 16...) ^{Note 2)}	$140 + 65 \frac{(n-4)}{2}$ (n = 4, 8, 12, 16...) ^{Note 2)}		

Note 1) When "n" is an odd number, an even number that is one larger than this odd number is used for the calculation.

Note 2) When "n" is an odd number, a multiple of 4 that is larger than this odd number is used for the calculation.

Note 3) Only applicable to the CDA2□H and CDA2□WH series.

Auto Switch Mounting Brackets/Part No.

<Tie-rod mounting>

Auto switch model	Bore size (mm)				
	40	50	63	80	100
D-M9□/M9□V D-M9□W/M9□WV D-M9□A/M9□AV D-A9□/A9□V	BA7-040	BA7-040	BA7-063	BA7-080	BA7-080
D-F5□/J59 D-F5□W/J59W D-F59F/F5NT D-A5□/A6□ D-A59W	BT-04	BT-04	BT-06	BT-08	BT-08
D-G39C/K39C D-A3□C/A44C	BA3-040	BA3-050	BA3-063	BA3-080	BA3-100
D-Y59□/Y69□ D-Y7P/Y7PV D-Y7□W/Y7□WV D-Y7BA D-Z7□/Z80	BA4-040	BA4-040	BA4-063	BA4-080	BA4-080
D-P3DW	BK7-040S	BK7-040S	BA10-063S	BA10-080S	BA10-080S
D-P3DW (Note 2)	BMB9-050S	BMB9-050S	BA9T-063S	BA9T-080S	BA9T-080S
D-P4DW	BAP2-040	BAP2-040	BAP2-063	BAP2-080	BAP2-080

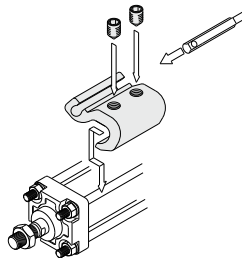

* The figure shows the mounting example for the D-M9□(V)/M9□W(V)/M9□A(V)/A9□(V) types.

<Band mounting>

Except air-hydro type

Auto switch model	Bore size (mm)				
	40	50	63	80	100
D-G39/K39 D-A3□/A44	BDS-04M	BDS-05M	BMB1-063	BMB1-080	BMB1-100
D-G5□/K59 D-G5□W/K59W D-G59F D-G5NT D-G5NB D-B5□/B64 D-B59W	BH2-040	BA5-050	BAF-06	BAF-08	BAF-10

Note 1) Auto switch brackets are included in the D-A3□C/A44C/G39C/K39C types. Specify the part number as follows depending on the cylinder size when ordering.
(Example) ø40: D-A3□C-4, ø50: D-A3□C-5, ø63: D-A3□C-6, ø80: D-A3□C-8, ø100: D-A3□C-10

[Stainless Steel Mounting Screw]

The following stainless steel mounting screw kit (including set screws) is also available. Use it in accordance with the operating environment.

(Since the auto switch mounting bracket and band are not included, order them separately.)

BBA1: For D-A5/A6/F5/J5 types

BBA3: For D-B5/B6/G5/K5 types

Note 2) Only applicable to the CDA2□H and CDA2W□H series.

Note 3) Refer to pages 1681 and 1689 for details on the BBA1 and BBA3.

The above stainless steel screws are used when a cylinder is shipped with D-F5BA or G5BA auto switches. When only an auto switch is shipped independently, the BBA1 or BBA3 is attached.

Note 4) When using the D-M9□A(V) or Y7BA, do not use the steel set screws which are included with the above auto switch mounting brackets (BA7-□□□, BA4-□□□). Order a stainless steel screw kit (BBA1) separately, and use the M4 x 6 L stainless steel set screws included in the BBA1.

Note 5) There is a difference in the cylinder tube thickness depending on the cylinder model. Use caution when a band mounting type is used as an applicable auto switch and a cylinder model is changed.

Air-hydro type

Auto switch model	Bore size (mm)				
	40	50	63	80	100
D-G39/K39 D-A3□/A44	BD1-04M	BD1-05M	BD1-06M	BD1-08M	BD1-10M
D-G5□/K59 D-G5□W/K59W D-G59F D-G5NT D-G5NB D-B5□/B64 D-B59W	BA-04	BA-05	BA-06	BA-08	BA-10

Other than the applicable auto switches listed in "How to Order", the following auto switches are mountable.

Refer to pages 1575 to 1701 for the detailed specifications.

Type	Model	Electrical entry	Features
Solid state	D-M9NV/M9PV/M9BV	Grommet (Perpendicular)	—
	D-Y69A/Y69B/Y7PV		—
	D-M9NWV/M9PWV/M9BWV		Diagnostic indication (2-color indicator)
	D-Y7NWV/Y7PWV/Y7BWW		Water resistant (2-color indicator)
	D-M9NAV/M9PAV/M9BAV		—
	D-Y59A/Y59B/Y7P	Grommet (In-line)	—
	D-F59/F5P/J59		—
	D-Y7NWV/Y7PWV/Y7BW		Diagnostic indication (2-color indicator)
	D-F59W/F5PW/J59W		Water resistant (2-color indicator)
	D-F5BA/Y7BA		With timer
D-F5NT/G5NT	Magnetic field resistant (2-color indicator)		
D-P5DW	—		
Reed	D-A93V/A96V	Grommet (Perpendicular)	—
	D-A90V	—	Without indicator light
	D-A53/A56/B53/Z73/Z76	Grommet (In-line)	—
	D-A67/Z80	—	Without indicator light

* With pre-wired connector is also available for solid state auto switches. For details, refer to pages 1648 and 1649.

* Normally closed (NC = b contact) solid state auto switches (D-F9G/F9H/Y7G/Y7H) are also available. For details, refer to pages 1593 and 1595.

CJ1

CJP

CJ2

JCM

CM2

CM3

CG1

CG3

JMB

MB

MB1

CA2

CS1

CS2

D-□

-X□

Technical Data

1 Cylinder with Heat Resistant Reed Auto Switch (-10 to 120°C)

Symbol
-X1184

Applicable Series

Description	Model	Action	Note
Standard type	CA2	Double acting, Single rod	

How to Order

CDA2 Standard model no. Z - Pivot bracket Rod end bracket - Heat resistant reed auto switch - X1184

Switch model		Number of switches	
Symbol	Description	Symbol	Description
Nil	Without switch	S	1 pc.
B30	D-B30	Nil	2 pcs.
B30J	D-B30J	n	n pcs.
B31	D-B31		
B31J	D-B31J		
B35	D-B35		
B35J	D-B35J		

Cylinder with heat resistant reed auto switch

* For details about auto switches, refer to page 1671.

Specifications

Ambient temperature range	-10°C to 120°C
Seal material	Fluororubber
Grease	Heat resistant grease

Warning Precautions

Be aware that smoking cigarettes etc. after your hands have come into contact with the grease used in this cylinder can create a gas that is hazardous to humans.

Dimensions (Dimensions other than below are the same as standard type.)

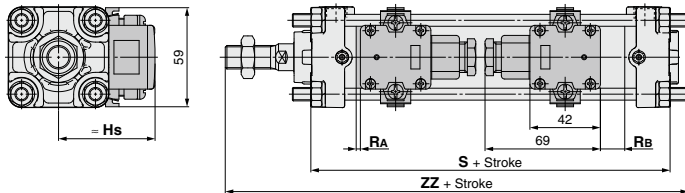

(mm)

Bore size	Hs	RA	RB	S	ZZ	Minimum mounting stroke		Auto switch mounting bracket part number
						Other than center trunnion	Center trunnion	
40	57.5	4	13	99	161	180 st or more	BD1-04M	
50	62.5	4	13	105	174	180 st or more	BD1-05M	
63	69	7	16	113	185	190 st or more	BD1-06M	
80	78	5.5	23.5	131	219	200 st or more	BD1-08M	
100	88.5	7.5	25.5	141	230	210 st or more	BD1-10M	



CA2 Series

Specific Product Precautions

Be sure to read this before handling the products. Refer to back page 50 for Safety Instructions and pages 3 to 12 for Actuator and Auto Switch Precautions.

Handling

⚠ Caution

1. **Do not open the cushion valve beyond the stopper.**
A retaining ring is installed as a cushion valve retention mechanism. Do not open the cushion valve beyond it. If not operated in accordance with the above precautions, the cushion valve may be ejected from the cover when air pressure is supplied.

Bore size (mm)	Width across flats	Socket wrench
40, 50	2.5	JIS 4648 Hexagonal wrench key 2.5
63, 80, 100	4	JIS 4648 Hexagonal wrench key 4

2. **Use the air cushion at the end of cylinder stroke.**
Otherwise, the tie-rod or piston rod assembly will be damaged.

⚠ Caution

1. **Do not use a pneumatic type as an air-hydro cylinder.** It can cause oil leak.
2. **Do not rotate the piston rod when the rod boot is fixed.**
Before rotating the piston rod, loosen the band to avoid twisting the rod boot.
3. **Install the rod boot with the breathing hole facing downwards or in a direction suitable to prevent dust, moisture etc. from entering easily into the rod boot.**

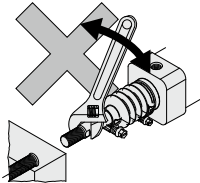

Disassembly/Replacement

⚠ Caution

1. **Use a socket wrench when the bracket is replaced.**
If other tools are used, the nut or other parts may be deformed or the work efficiency may decrease.
For applicable sockets, refer to the table below.

Bore size (mm)	Nut	Width across flats	Socket	Tightening torque (N·m)
40, 50	DA00040	13	JIS B4636	7.4
	(M8 x 1.25, Hexagon nut 3 types)		+ Two-angle socket 13	
63	DA00010	17	JIS B4636	20
	(M10 x 1.25, Hexagon nut 3 types)		+ Two-angle socket 17	
80, 100	DA00131	19	JIS B4636	29
	(M12 x 1.75, Hexagon nut 3 types)		+ Two-angle socket 19	

2. **Do not replace the bushing.**
As the bushing is press-fit, replace the cover assembly when the bushing must be replaced.
3. **When a seal is replaced, apply grease to the new seal before it is assembled.**
Operation of the cylinder without greasing will result in extreme abrasion of the seal, causing premature air leakage.
4. **The trunnion type cylinder requires accuracy in assembly.**
The trunnion type cylinder may lose dimensional accuracy and malfunction when it is disassembled and reassembled because the axial center of the trunnion and that of the cylinder will not be aligned easily.

Water Resistant Air Cylinder

Water resistant air cylinders are also available in CA2 series, which are suitable for use on machine tools, where exposure to coolant is possible and applicable for food machinery and automobile washing equipment in an environment where water splashes. Please contact SMC for more information.

CJ1

CJP

CJ2

JCM

CM2

CM3

CG1

CG3

JMB

MB

MB1

CA2

CS1

CS2

D-□

-X□

Technical Data