

Modular Type Filter Regulator **AW Series**

Filter Regulator AW Series



P.468 to 479

Model	Port size	Options
AW10-A	M5 x 0.8	Bracket Float type auto drain Round type pressure gauge Set nut (for panel mount)*
AW20-A	1/8, 1/4	
AW30-A	1/4, 3/8	
AW40-A	1/4, 3/8, 1/2	
AW40-06-A	3/4	

Made to Order

①	0.4 MPa Setting (-X406) The maximum set pressure is 0.4 MPa. When a pressure gauge is included, the display will show a range from 0 to 0.7 MPa.	P.476 to 479
②	Long Bowl (-X64) Drain capacity is greater than that of standard models.	
③	0.85 MPa Setting (-X2068) The maximum set pressure is 0.85 MPa. When a pressure gauge is included, the display will show a range from 0 to 1.0 MPa.	

AC-A
AF-A
AF□-A
AR-A
AL-A
AW-A
AC-B
AF-A
AF□-A
AR-**B**
AL-A
AW-**B**
AW□
AF-G
E□
AV
AF

Filter Regulator

AW10-A to AW40-A

Symbol

Filter Regulator

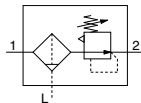

- Integrated filter and regulator units save space and require less piping.

How to Order

AW **30** - **03** **BG** - **A** -

① ② ③ ④ ⑤

- Option/Semi-standard: Select one each for a to i.
- Option/Semi-standard symbol: When more than one specification is required, indicate in alphanumeric order.
Example) AW30-03BG-1N-A

• Made to Order

(Refer to pages 476 to 479 for details.)

		Symbol	Description	①				
				Body size				
				10	20	30	40	
②	Pipe thread type	Nil	Metric thread (M5)	●	—	—	—	
		N <small>Note 1)</small>	Rc	—	●	●	●	
		F <small>Note 2)</small>	NPT	—	●	●	●	
			G	—	●	●	●	
+								
③	Port size	M5	M5	●	—	—	—	
		01	1/8	—	●	—	—	
		02	1/4	—	●	—	●	
		03	3/8	—	—	●	●	
		04	1/2	—	—	—	●	
		06	3/4	—	—	—	●	
+								
④	a	Mounting	Nil	Without mounting option	●	●	●	●
			B <small>Note 4)</small>	With bracket	●	●	●	●
			H	With set nut (for panel mount)	●	●	●	●
	+							
	b	Float type auto drain	Nil	Without auto drain	●	●	●	●
			C <small>Note 5)</small>	N.C. (Normally closed) Drain port is closed when pressure is not applied.	●	●	●	●
			D <small>Note 6)</small>	N.O. (Normally open) Drain port is open when pressure is not applied.	—	—	●	●
	+							
	c	Pressure gauge <small>Note 7)</small>	Nil	Without pressure gauge	●	●	●	●
			G	Round type pressure gauge (without limit indicator)	●	—	—	—
			M	Round type pressure gauge (with limit indicator)	—	●	●	●
	+							
⑤	d	Set pressure <small>Note 8)</small>	Nil	0.05 to 0.7 MPa setting	●	●	●	●
			1	0.02 to 0.2 MPa setting	●	●	●	●
	+							
	e	Bowl <small>Note 9)</small>	Nil	Polycarbonate bowl	●	●	●	●
			2	Metal bowl	●	●	●	●
			6	Nylon bowl	●	●	●	●
			8	Metal bowl with level gauge	—	—	●	●
			C	With bowl guard	—	—	— <small>Note 10)</small>	— <small>Note 10)</small>
			6C	With bowl guard (Nylon bowl)	—	●	— <small>Note 11)</small>	— <small>Note 11)</small>

Filter Regulator **AW10-A to AW40-A Series**

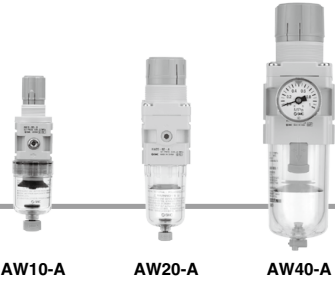

AW10-A

AW20-A

AW40-A

		Symbol	Description	①				
				Body size				
				10	20	30	40	
5	f	Drain port ^{Note 12)}	Nil	With drain cock	●	●	●	●
			J ^{Note 13)}	Drain guide 1/8	—	●	—	—
				Drain guide 1/4	—	—	●	●
		W ^{Note 14)}	Drain cock with barb fitting (for ø6 x ø4 nylon tube)	—	—	●	●	
		+						
	g	Exhaust mechanism	Nil	Relieving type	●	●	●	●
			N	Non-relieving type	●	●	●	●
		+						
	h	Flow direction	Nil	Flow direction: Left to right	●	●	●	●
			R	Flow direction: Right to left	●	●	●	●
	+							
i	Pressure unit	Nil	Name plate, caution plate for bowl, and pressure gauge in imperial units: MPa	●	●	●	●	
		Z ^{Note 15)}	Name plate, caution plate for bowl, and pressure gauge in imperial units: psi, °F	○ ^{Note 16)}	○ ^{Note 16)}	○ ^{Note 16)}	○ ^{Note 16)}	

Note 1) Drain guide is NPT1/8 (applicable to the AW20-A) and NPT1/4 (applicable to the AW30-A to AW40-A). The auto drain port comes with ø3/8" One-touch fitting (applicable to the AW30-A to AW40-A).

Note 2) Drain guide is G1/8 (applicable to the AW20-A) and G1/4 (applicable to the AW30-A to AW40-A).

Note 3) Option B, G, H, M are not assembled and supplied loose at the time of shipment.

Note 4) Assembly of a bracket and set nuts

Note 5) When pressure is not applied, condensate which does not start the auto drain mechanism will be left in the bowl. Releasing the residual condensate before ending operations for the day is recommended.

Note 6) If the compressor is small (0.75 kW, discharge flow is less than 100 L/min[ANR]), air leakage from the drain cock may occur during start of operations. N.C. type is recommended.

Note 7) When the pressure gauge is attached, a 1.0 MPa pressure gauge will be fitted for standard (0.7 MPa) type. 0.4 MPa pressure gauge for 0.2 MPa type (1.0 MPa pressure gauge only for the AW10-A).

Note 8) Pressure can be set higher than the specification pressure in some cases, but use pressure within the specification range.

Note 9) Refer to Chemical data on page 471 for chemical resistance of the bowl.

Note 10) A bowl guard is provided as standard equipment (polycarbonate).

Note 11) A bowl guard is provided as standard equipment (nylon).

Note 12) The combination of float type auto drain: C and D is not available.

Note 13) Without a valve function

Note 14) The combination of metal bowl: 2 and 8 is not available.

Note 15) For pipe thread type: NPT. This product is for overseas use only according to the new Measurement Law. (The SI unit type is provided for use in Japan.) Cannot be used with M: Round pressure gauge (with color zone). Available by request for special.

Note 16) ○: For pipe thread type: M5, NPT only

Standard Specifications

Model	AW10-A	AW20-A	AW30-A	AW40-A	AW40-06-A
Port size	M5 x 0.8	1/8, 1/4	1/4, 3/8	1/4, 3/8, 1/2	3/4
Pressure gauge port size	1/16 ^{Note)}				1/8
Fluid	Air				
Ambient and fluid temperature	-5 to 60°C (with no freezing)				
Proof pressure	1.5 MPa				
Maximum operating pressure	1.0 MPa				
Set pressure range	0.05 to 0.7 MPa				
Nominal filtration rating	5 µm				
Drain capacity (cm ³)	2.5	8	25		45
Bowl material	Polycarbonate				
Bowl guard	—	Semi-standard (Steel)	Standard (Polycarbonate)		
Construction	Relieving type				
Weight (kg)	0.09	0.21	0.41	0.75	0.81

Note) Use a bushing (part no: 131368) when connecting the R1/8 pressure gauge to the Rc1/16.

AW10-A to AW40-A Series

Options/Part No.

Optional specifications			Model				
			AW10-A	AW20-A	AW30-A	AW40-A	AW40-06-A
Bracket assembly ^{Note 1)}			AR12P-270AS	AR22P-270AS	AR32P-270AS	AR42P-270AS	
Set nut			AR12P-260S	AR22P-260S	AR32P-260S	AR42P-260S	
Pressure ^{Note 2)} gauge	Round type	Standard	G27-10-R1	G36-10-□01		G46-10-□01	
		0.02 to 0.2 MPa setting	G27-10-R1 ^{Note 3)}	G36-4-□01		G46-4-□01	
	Round type (with color zone)	Standard	—	G36-10-□01-L		G46-10-□01-L	
		0.02 to 0.2 MPa setting	—	G36-4-□01-L		G46-4-□01-L	

Note 1) Assembly of a bracket and set nuts

Note 2) □ in round pressure gauge part numbers indicates a pipe thread type. No indication is necessary for R; however, indicate N for NPT.

Please contact SMC regarding the pipe thread type NPT and the supply of pressure gauge with psi unit display specifications.

Note 3) Standard pressure gauge

Bowl Assembly/Part No.

Bowl material	Drain discharge mechanism	Drain port	Other	Model					
				AW10-A	AW20-A	AW30-A	AW40-A	AW40-06-A	
Polycarbonate bowl	Manual discharge	With drain cock	—	C1SF-A	C2SF-A	—	—		
		Drain cock with barb fitting	With bowl guard	—	C2SF-C-A	C3SF-A	C4SF-A		
		With drain guide (without valve function)	With bowl guard	—	C2SF□-J-A	C3SF-W-A	C4SF-W-A		
		With drain guide (without valve function)	With bowl guard	—	C2SF□-CJ-A	C3SF□-J-A	C4SF□-J-A		
	Automatic discharge ^{Note 2)} (Auto drain)	Normally closed (N.C.)	With bowl guard	—	AD17-A	AD27-A	—	—	
		Normally open (N.O.)	With bowl guard	—	—	AD37□-A	AD38□-A	AD47□-A	
Nylon bowl	Manual discharge	With drain cock	—	C1SF-6-A	C2SF-6-A	—	—		
		Drain cock with barb fitting	With bowl guard	—	C2SF-6C-A	C3SF-6-A	C4SF-6-A		
		With drain guide (without valve function)	With bowl guard	—	—	C3SF-6W-A	C4SF-6W-A		
		With drain guide (without valve function)	With bowl guard	—	C2SF□-6J-A	—	—		
	Automatic discharge ^{Note 2)} (Auto drain)	Normally closed (N.C.)	With bowl guard	—	AD17-6-A	AD27-6-A	—	—	
		Normally open (N.O.)	With bowl guard	—	—	AD37□-6-A	AD38□-6-A	AD47□-6-A	
Metal bowl	Manual discharge	With drain cock	With level gauge	—	C1SF-2-A	C2SF-2-A	C3SF-2-A	C4SF-2-A	
		With drain guide (without valve function)	With level gauge	—	—	C3LF-8-A	C4LF-8-A		
		With drain guide (without valve function)	With level gauge	—	C2SF□-2J-A	C3SF□-2J-A	C4SF□-2J-A		
		With drain guide (without valve function)	With level gauge	—	—	C3LF□-8J-A	C4LF□-8J-A		
	Automatic discharge ^{Note 2)} (Auto drain)	Normally closed (N.C.)	With level gauge	—	AD17-2-A	AD27-2-A	AD37□-2-A	AD47□-2-A	
		Normally open (N.O.)	With level gauge	—	—	AD37□-8-A	AD38□-2-A	AD47□-8-A	
Normally open (N.O.)	With level gauge	—	—	AD38□-8-A	AD48□-2-A	AD48□-8-A			

Note) Minimum operating pressure: N.O. type-0.1 MPa (AD38-A, AD48-A); N.C. type-0.1 MPa (AD17-A, AD27-A) and 0.15 MPa (AD37-A, AD47-A).

Bowl assembly for the AW10-A to AW40-06-A models comes with a bowl seal.

□ in bowl assembly part numbers indicates a pipe thread type (applicable tubing for auto drain).

No indication is necessary for Rc thread; however, indicate N for NPT thread, and F for G thread. (For auto drain, Nil: ø10, N: ø3/8")

Please consult with SMC separately for psi and °F unit display specifications.

⚠ Specific Product Precautions

Be sure to read this before handling the products. Refer to back page 50 for Safety Instructions and pages 387 to 391 for F.R.L. Precautions.

Design/Selection

⚠ Warning

- Although exhaust of the residual pressure to the inlet side is possible when eliminating the inlet pressure, exhaust is not possible when the set pressure is 0.15 MPa or less. Use the regulator with backflow function.
- The standard bowl for the air filter, filter regulator, and lubricator, as well as the sight dome for the lubricator are made of polycarbonate. Do not use in an environment where they are exposed to or come in contact with organic solvents, chemicals, cutting oil, synthetic oil, alkali, and thread lock solutions.

Effects of atmosphere of organic solvents and chemicals, and where these elements are likely to adhere to the equipment.
Chemical data for substances causing degradation (Reference)

Type	Chemical name	Application examples	Material	
			Polycarbonate	Nylon
Acid	Hydrochloric acid Sulfuric acid, Phosphoric acid Chromic acid	Acid washing liquid for metals	△	×
Alkaline	Sodium hydroxide (Caustic soda) Potash Calcium hydroxide (Slack lime) Ammonia water Carbonate of soda	Degreasing of metals Industrial salts Water-soluble cutting oil	×	○
Inorganic salts	Sodium sulfide Sulfate of potash Sulfate of soda	—	×	△
Chlorine solvents	Carbon tetrachloride Chloroform Ethylene chloride Methylene chloride	Cleansing liquid for metals Printing ink Dilution	×	△
Aromatic series	Benzene Toluene Paint thinner	Coatings Dry cleaning	×	△
Ketone	Acetone Methyl ethyl ketone Cyclohexane	Photographic film Dry cleaning Textile industries	×	×
Alcohol	Ethyl alcohol IPA Methyl alcohol	Antifreeze Adhesives	△	×
Oil	Gasoline Kerosene	—	×	○
Ester	Phthalic acid dimethyl Phthalic acid diethyl Acetic acid	Synthetic oil Anti-rust additives	×	○
Ether	Methyl ether Ethyl ether	Brake oil additives	×	○
Amino	Methyl amino	Cutting oil Brake oil additives Rubber accelerator	×	×
Others	Thread-lock fluid Seawater Leak tester	—	×	△

○: Essentially safe △: Some effects may occur. ×: Effects will occur.

When the above factors are present, or there is some doubt, use a metal bowl for safety.

Maintenance

⚠ Warning

- Replace the element every 2 years or when the pressure drop becomes 0.1 MPa, whichever comes first, to prevent damage to the element.

Mounting/Adjustment

⚠ Warning

- Set the regulator while verifying the displayed values of the inlet and outlet pressure gauges. Turning the regulator knob excessively can cause damage to the internal parts.
- Do not use tools on the pressure regulator knob as this may cause damage. It must be operated manually.

⚠ Caution

- Be sure to unlock the knob before adjusting the pressure and lock it after setting the pressure. Failure to follow this procedure can cause damage to the knob and the outlet pressure may fluctuate.
 - Pull the pressure regulator knob to unlock. (You can visually verify this with the "orange mark" that appears in the gap.)
 - Push the pressure regulator knob to lock. When the knob is not easily locked, turn it left and right a little and then push it (when the knob is locked, the "orange mark", i.e., the gap will disappear).
- Pulsation will be generated when the difference between the inlet and the outlet pressure is large. In this case, reduce the pressure difference between the inlet and the outlet. Please consult with SMC if the pulsation problem is not resolved.
- When the bowl is installed on the AW30-A/AW40-A, install them so that the lock button lines up to the groove of the front (or the back) of the body to avoid drop or damage of the bowl.

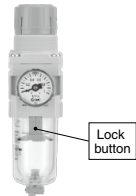

AC-A

AF-A

AF-A

AR-A

AL-A

AW-A

AC-B

AF-A

AF-A

AF-A

AR-A

AL-A

AW-A

AW

AG

E

AV

AF

AW10-A to AW40-A Series

Flow Rate Characteristics (Representative values)

Condition: Inlet pressure 0.7 MPa

AW10-A

M5

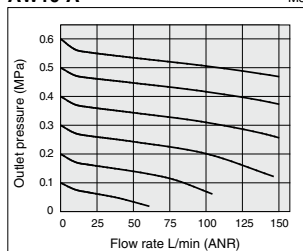

AW20-A

Rc1/4

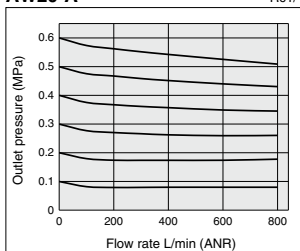

AW30-A

Rc3/8

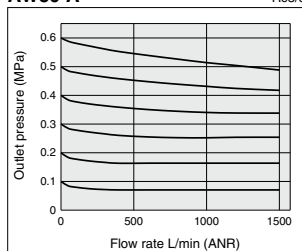

AW40-A

Rc1/2

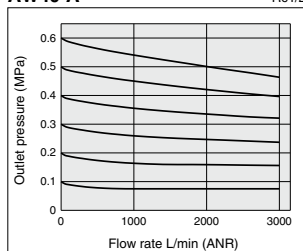

AW40-06-A

Rc3/4

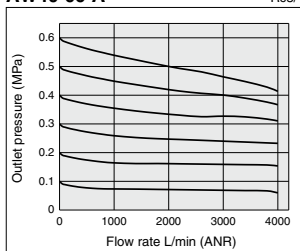

Pressure Characteristics (Representative values)

Conditions: Inlet pressure 0.7 MPa, Outlet pressure 0.2 MPa, Flow rate 20 L/min (ANR)

AW10-A

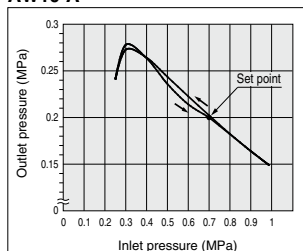

AW20-A

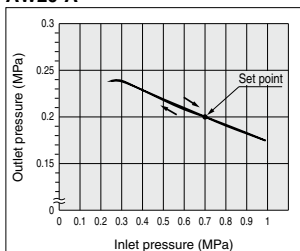

AW30-A

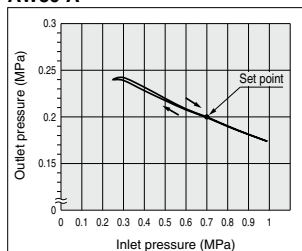

AW40-A/AW40-06-A

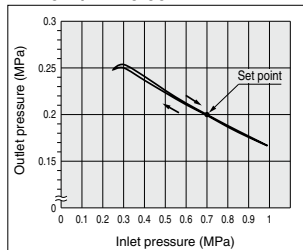

Filter Regulator **AW10-A to AW40-A Series**

Construction

AW10-A

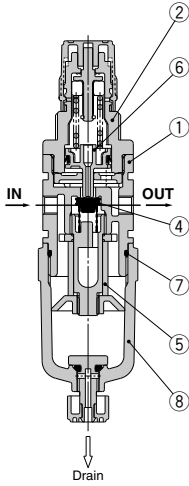

AW20-A

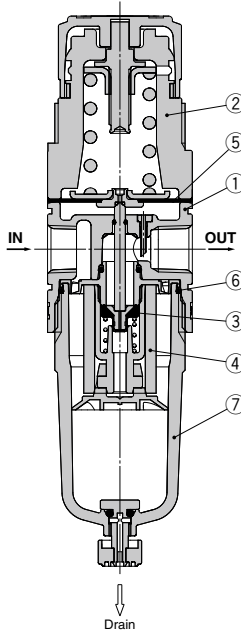

AW30-A to AW40-06-A

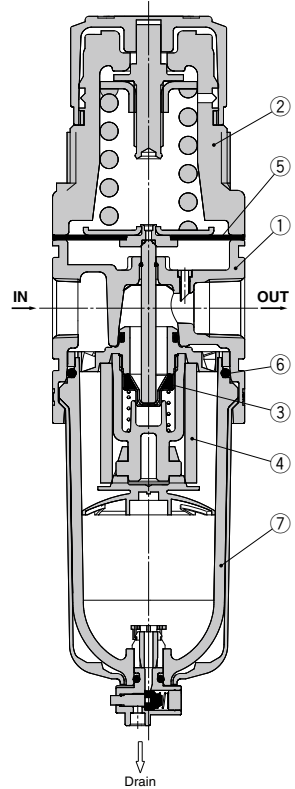

AC-A
AF-A
AF□-A
AR-A
AL-A
AW-A
AC-B
AF-A
AF□-A
AR-B
AL-A
AW-B
AW□
AW□G
E□
AV
AF

Component Parts

No.	Description	Material	Model	Color
1	Body	Zinc die-cast	AW10-A	White
		Aluminum die-cast	AW20-A to AW40-06-A	
2	Bonnet	Polycetal	AW10-A to AW40-06-A	White

Replacement Parts

No.	Description	Material	Part no.				
			AW10-A	AW20-A	AW30-A	AW40-A	AW40-06-A
3	Valve assembly	Stainless steel, HNBR	AR10P-090S	AW22P-060AS	AW32P-060AS	AW42P-060AS	
4	Filter element	Non-woven fabric	AF10P-060S	AF20P-060S	AF30P-060S	AF40P-060S	
5	Diaphragm assembly	Weatherable NBR	AR10P-150AS ^{Note 1)}	AR22P-150AS	AR32P-150AS	AR42P-150AS	
6	Bowl seal	NBR	C1SFP-260S	C2SFP-260S	C32FP-260S	C42FP-260S	
7	Bowl assembly ^{Note 2)}	Polycarbonate	C1SF-A	C2SF-A	C3SF-A	C4SF-A	

Note 1) The AW10-A is a piston type. Assembly of a piston and a seal (KSYP-13).

Note 2) Bowl seal is included for the AW20-A to AW40-06-A. Please contact SMC regarding the supply of bowl assembly with psi and °F unit display specifications.

AW10-A to AW40-A Series

Dimensions

AW10-A

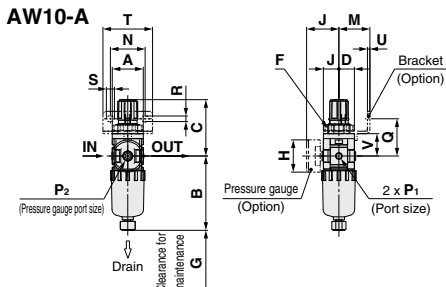

AW20-A

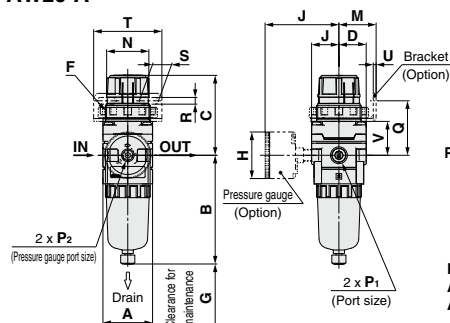

AW30-A to AW40-06-A

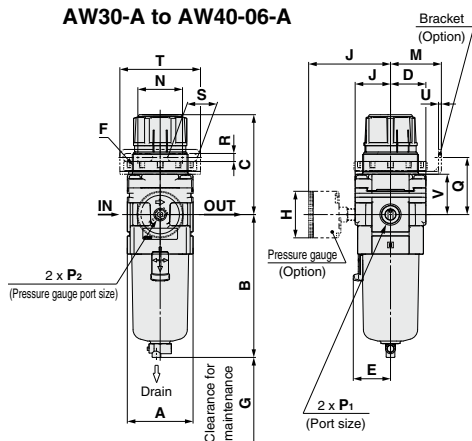

Panel fitting dimensions

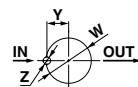

Plate thickness
AW10-A: Max. 3.5
AW20-A: Max. 4

Panel fitting dimensions

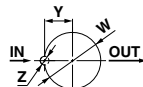

Plate thickness
AW30-A to AW40-06-A: Max. 8

Applicable model	AW10-A/AW20-A		AW20-A		AW30-A to AW40-06-A
Optional/Semi-standard specifications	With auto drain (N.C.)	Metal bowl	With drain guide	Metal bowl with drain guide	With auto drain (N.O./N.C.)
Dimensions					

Applicable model	AW30-A to AW40-06-A					
Optional/Semi-standard specifications	Metal bowl	Metal bowl with drain guide	Metal bowl with level gauge	Metal bowl with level gauge, with drain guide	With drain guide	Drain cock with barb fitting
Dimensions						

Model	Standard specifications											Optional specifications			
	P ₁	P ₂	A	B	C (Note)	D	E	F	G	J	H	J	H	J	
AW10-A	M5 x 0.8	1/16	25	59.9	47.4	12.5	—	M18 x 1	25	12.5	ø26	26	—	—	
AW20-A	1/8, 1/4	1/8	40	87.6	67.4	22	—	M36 x 1.5	25	22	ø37.5	58.5	ø37.5	59.5	
AW30-A	1/4, 3/8	1/8	53	115.1	83.5	28.5	30	M45 x 1.5	35	28.5	ø37.5	65	ø37.5	66	
AW40-A	1/4, 3/8, 1/2	1/8	70	147.1	100	34.5	38.4	M52 x 1.5	40	34.5	ø42.5	72	ø42.5	72	
AW40-06-A	3/4	1/8	75	149.1	101.5	34.5	38.4	M52 x 1.5	40	34.5	ø42.5	72	ø42.5	72	

Model	Optional specifications										Semi-standard specifications							
	Bracket mount					Panel mount					With auto drain	With barb fitting	With drain guide	Metal bowl	Metal bowl with drain guide	Metal bowl with level gauge	Metal bowl with level gauge, with drain guide	
	M	N	Q	R	S	T	U	V	W	Y	Z	B	B	B	B	B	B	
AW10-A	25	28	30	4.5	6.5	40	2	18	18.5	—	—	77.9	—	—	59.3	—	—	
AW20-A	30	34	43.9	5.4	15.4	55	2.3	27.3	36.5	17.5	6	104.9	—	91.4	87.4	93.9	—	
AW30-A	41	36	46	6.5	24	65	2.3	32.5	45.5	22.5	7	156.8	123.6	121.9	117.6	122.1	137.6	142.1
AW40-A	50	38	54	8.5	26.5	70	2.3	38.4	52.5	26	7	186.9	155.6	153.9	149.6	154.1	169.6	174.1
AW40-06-A	50	38	55.5	8.5	26.5	70	2.3	39.9	52.5	26	7	188.9	157.6	155.9	151.6	156.1	171.6	176.1

Note) The dimension of C is the length when the filter regulator knob is unlocked.

- AC-A
- AF-A
- AF□-A
- AR-A
- AL-A
- AW-A**
- AC-B
- AF-A
- AF□-A
- AR-B
- AL-A
- AW-B
- AW□
- AF-G
- E□
- AV
- AF

		Symbol	Description	0.4 MPa Setting			Long Bowl			
				①			①			
				Body size			Body size			
				20	30	40	20	30	40	
5 Semi-standard	d	Set pressure <small>Note 9)</small>	Nil	0.05 to 0.7 MPa setting	—	—	—	●	●	●
			1	0.02 to 0.2 MPa setting	—	—	—	●	●	●
			+							
	e	Bowl <small>Note 10)</small>	Nil	Polycarbonate bowl	●	●	●	●	●	●
			2	Metal bowl	●	●	●	●	●	●
			6	Nylon bowl	●	●	●	●	●	●
			8	Metal bowl with level gauge	—	●	●	—	—	—
			C	With bowl guard	●	—	—	●	—	—
			6C	With bowl guard (Nylon bowl)	●	—	—	●	—	—
			+							
	f	Drain port <small>Note 11)</small>	Nil	With drain cock	●	●	●	●	●	●
			J <small>Note 14)</small>	Drain guide 1/8	●	—	—	●	—	—
			W <small>Note 15)</small>	Drain cock with barb fitting (for ø6 x ø4 nylon tube)	—	●	●	—	●	●
			+							
	g	Exhaust mechanism	Nil	Relieving type	●	●	●	●	●	●
N			Non-relieving type	●	●	●	●	●	●	
		+								
h	Flow direction	Nil	Flow direction: Left to right	●	●	●	●	●	●	
		R	Flow direction: Right to left	●	●	●	●	●	●	
		+								
i	Pressure unit	Nil	Name plate and caution plate for bowl in imperial units: MPa	●	●	●	●	●	●	
		Z <small>Note 16)</small>	Name plate and caution plate for bowl in imperial units: psi, °F	○ <small>Note 17)</small>	○ <small>Note 17)</small>	○ <small>Note 17)</small>	○ <small>Note 17)</small>	○ <small>Note 17)</small>	○ <small>Note 17)</small>	

Note 9) Pressure can be set higher than the specification pressure in some cases, but use pressure within the specification range.
 Note 10) Refer to Chemical data on page 471 for chemical resistance of the bowl.
 Note 11) The combination of float type auto drain: C and D is not available.
 Note 12) A bowl guard is provided as standard equipment (polycarbonate).
 Note 13) A bowl guard is provided as standard equipment (nylon).
 Note 14) Without a valve function
 Note 15) The combination of metal bowl: 2 and 8 is not available.
 Note 16) For pipe thread type: NPT. This product is for overseas use only according to the new Measurement Law. (The SI unit type is provided for use in Japan.)
 Cannot be used with M: Round pressure gauge (with color zone). Available by request for special.
 Note 17) ○: For pipe thread type: NPT only

Filter Regulator/AW20-A to AW40-06-A

Made to Order

Please contact SMC for detailed dimensions, specifications and lead times.



③ 0.85 MPa Setting

The maximum set pressure is 0.85 MPa. When a pressure gauge is included, the display will show a range from 0 to 1.0 MPa.

Specifications

Proof pressure	1.5 MPa
Maximum operating pressure	1.0 MPa
Set pressure range	0.05 to 0.85 MPa

Applicable Model

Model	AW20-A	AW30-A	AW40-A	AW40-06-A
Port size	1/8, 1/4	1/4, 3/8	1/4, 3/8, 1/2	3/4

How to Order

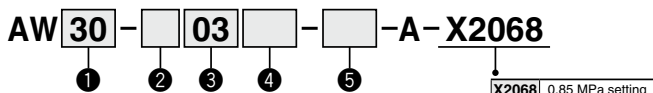

- Option/Semi-standard: Select one each for a to h.
- Option/Semi-standard symbol: When more than one specification is required, indicate in alphanumeric order.
Example) AW30-03BG-2N-A-X2068

0.85 MPa Setting

		Symbol	Description	① Body size			
				20	30	40	
②	Pipe thread type	Nil	Rc	●	●	●	
		N ^{Note 1)}	NPT	●	●	●	
		F ^{Note 2)}	G	●	●	●	
+							
③	Port size	01	1/8	●	—	—	
		02	1/4	●	●	●	
		03	3/8	—	●	●	
		04	1/2	—	—	●	
		06	3/4	—	—	●	
+							
④ Option (Note 3)	a	Mounting	Nil	Without mounting option	●	●	●
			B ^{Note 4)}	With bracket	●	●	●
			H	With set nut (for panel mount)	●	●	●
	+						
	b	Float type auto drain	Nil	Without auto drain	●	●	●
			C ^{Note 5)}	Float type auto drain (N.C.)	●	●	●
			D ^{Note 6)}	Float type auto drain (N.O.)	—	●	●
	+						
	c	Pressure gauge	Nil	Without pressure gauge	●	●	●
			G	Round type pressure gauge (with limit indicator)	●	●	●
M			Round type pressure gauge (with color zone)	●	●	●	

Note 1) Drain guide is NPT1/8 (applicable to the AW20-A) and NPT1/4 (applicable to the AW30-A to AW40-A).

The auto drain port comes with ø3/8" One-touch fitting (applicable to the AW30-A to AW40-A).

Note 2) Drain guide is G1/8 (applicable to the AW20-A) and G1/4 (applicable to the AW30-A to AW40-A).

Note 3) Option B, G, H, M are not assembled and supplied loose at the time of shipment.

Note 4) Assembly of a bracket and set nuts

Note 5) When pressure is not applied, condensate which does not start the auto drain mechanism will be left in the bowl.

Releasing the residual condensate before ending operations for the day is recommended.

Note 6) If the compressor is small (0.75 kW, discharge flow is less than 100 L/min[ANR]), air leakage from the drain cock may occur during start of operations. N.C. type is recommended.

- AC-A
- AF-A
- AF□-A
- AR-A
- AL-A
- AW-A**
- AC-B
- AF-A
- AF□-A
- AR- $\frac{B}{8}$
- AL-A
- AW- $\frac{B}{8}$
- AW□
- A□G
- E□
- AV
- AF

0.85 MPa Setting		
1		
Body size		
20	30	40

	Symbol	Description	1			
			Body size			
			20	30	40	
5 Semi-standard	d Bowl <small>Note 7)</small>	Nil Polycarbonate bowl	●	●	●	
		2 Metal bowl	●	●	●	
		6 Nylon bowl	●	●	●	
		8 Metal bowl with level gauge	—	●	●	
		C With bowl guard	●	—	—	
		6C With bowl guard (Nylon bowl)	●	—	—	
	+					
	e Drain port <small>Note 8)</small>	Nil With drain cock	●	●	●	
		J <small>Note 9)</small> Drain guide 1/8	●	—	—	
		Drain guide 1/4	—	●	●	
W <small>Note 10)</small> Drain cock with barb fitting (for $\phi 6 \times \phi 4$ nylon tube)		—	●	●		
+						
f Exhaust mechanism	Nil Relieving type	●	●	●		
	N Non-relieving type	●	●	●		
+						
g Flow direction	Nil Flow direction: Left to right	●	●	●		
	R Flow direction: Right to left	●	●	●		
+						
h Pressure unit	Nil Name plate and caution plate for bowl in imperial units: MPa	●	●	●		
	Z <small>Note 11)</small> Name plate and caution plate for bowl in imperial units: ps _i , °F	○ <small>Note 12)</small>	○ <small>Note 12)</small>	○ <small>Note 12)</small>		

Note 7) Refer to Chemical data on page 471 for chemical resistance of the bowl.
 Note 8) The combination of float type auto drain: C and D is not available.
 Note 9) Without a valve function
 Note 10) The combination of metal bowl: 2 and 8 is not available.
 Note 11) For pipe thread type: NPT. This product is for overseas use only according to the new Measurement Law. (The SI unit type is provided for use in Japan.)
 Cannot be used with M: Round pressure gauge (with color zone). Available by request for special.
 Note 12) ○: For pipe thread type: NPT only