

How to Order

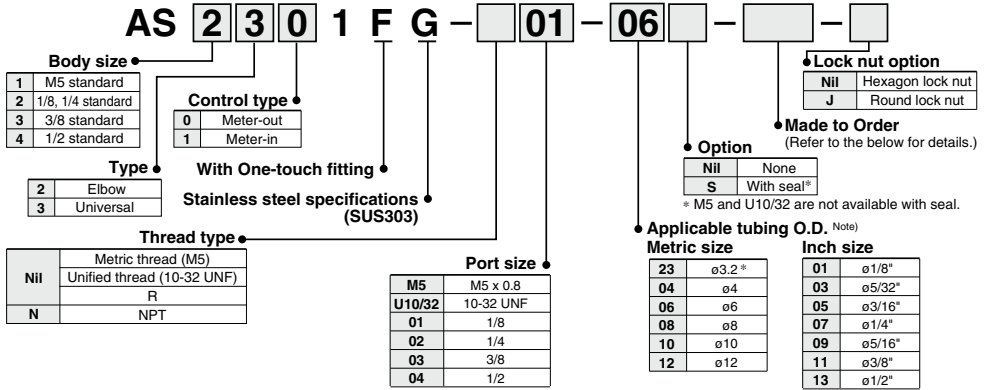

Made to Order



1 Lubricant: Vaseline X12

Ex.) AS1201FG-M5-23-X12

3 Throttle Valve (Without Check Valve) X214

Ex.) AS1201FG-M5-23-X214

Note) This product is a restrictor without a check valve (no control direction). Be aware that all part numbers are for a meter-out type; there is no part number for a meter-in type.

2 Grease-free (Seal: Fluorine Coated) + Throttle Valve (Without Check Valve) X21

Ex.) AS1201FG-M5-23-X21

Note 1) Not particle-free

Note 2) This product is a restrictor without a check valve (no control direction). Be aware that all part numbers are for a meter-out type; there is no part number for a meter-in type.

Needle Valve/Flow Rate Characteristics

Note) The flow rate characteristics are representative values.

AS12□1FG
AS13□1FG

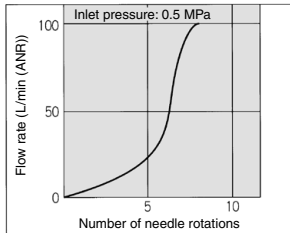

AS22□1FG-□01
AS23□1FG-□01

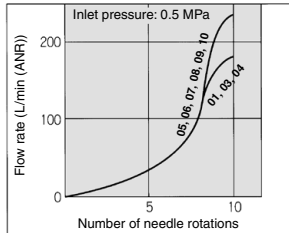

AS22□1FG-□02
AS23□1FG-□02

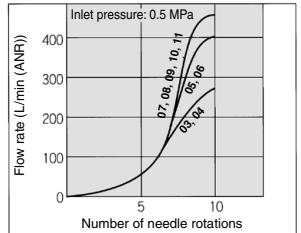

AS32□1FG
AS33□1FG

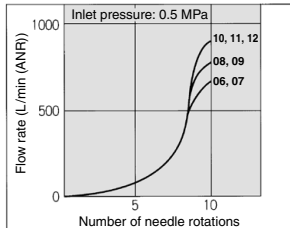

AS42□1FG
AS43□1FG

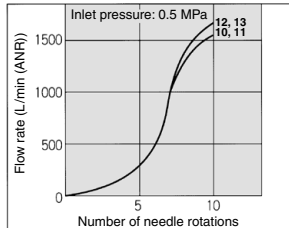

Construction: Elbow Type

Meter-out type

M5 type
 U10/32 type

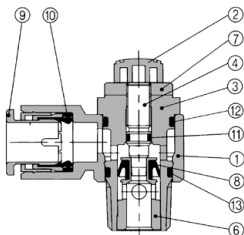
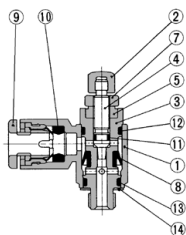

AS3201FG-02

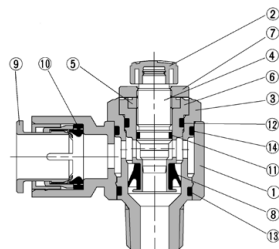

Meter-in type

M5 type
 U10/32 type

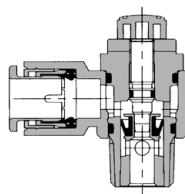
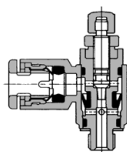

AS3211FG-02

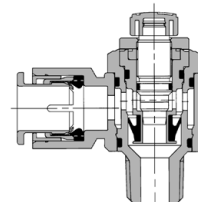

No.	Description	Material	Note
1	Body A	PBT	
2	Handle	PBT	
3	Body B	Stainless steel 303	
4	Needle	Stainless steel 303	
5	Needle guide	Stainless steel 303	
6	Seat ring	Stainless steel 303	
7	Lock nut	Stainless steel 303	
8	U seal	HNBR	
9	Cassette	—	
10	Seal	NBR	
11	O-ring	NBR	
12	O-ring	NBR	
13	O-ring	NBR	
14	O-ring	NBR	
15	Gasket	NBR, Stainless steel	M5 type only

⚠ Caution

Be sure to read this before handling the products.
 Refer to page 11 for safety instructions and pages 19 to 22 for flow control equipment precautions.

AS-FG Series

Construction: Universal Type

Meter-out type

M5 type
U10/32 type

AS3301FG-02

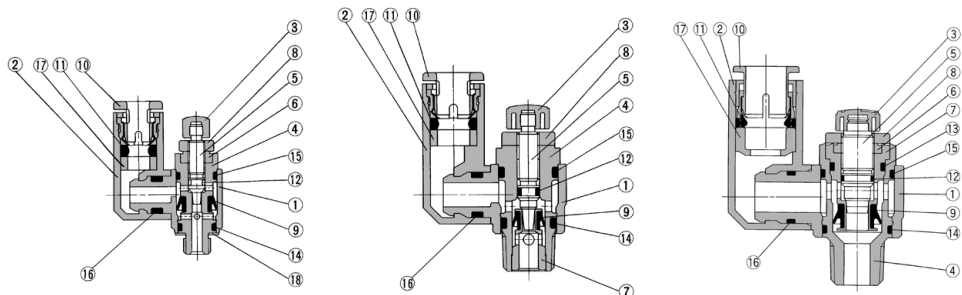

Meter-in type

M5 type
U10/32 type

AS3311FG-02

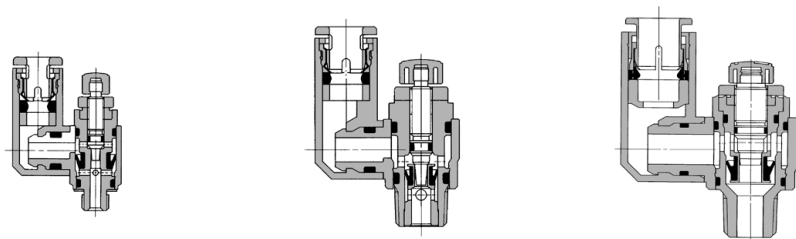

Component Parts

No.	Description	Material	Note
1	Body A	PBT	
2	Elbow body	PBT	
3	Handle	PBT	
4	Body B	Stainless steel 303	
5	Needle	Stainless steel 303	
6	Needle guide	Stainless steel 303	
7	Seat ring	Stainless steel 303	
8	Lock nut	Stainless steel 303	
9	U seal	HNBR	
10	Cassette	—	
11	Seal	NBR	
12	O-ring	NBR	
13	O-ring	NBR	
14	O-ring	NBR	
15	O-ring	NBR	
16	O-ring	NBR	
17	Spacer	—	
18	Gasket	NBR, Stainless steel	M5 type only

Dimensions: Elbow Type

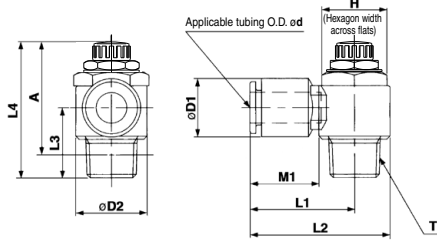

M5 type
 U10/32 type

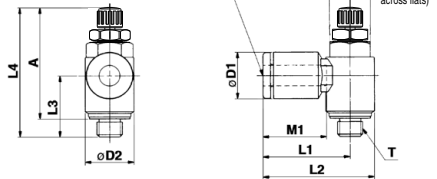

Metric Size

Model	d	T	H	D1	D2	L1	L2	L3	L4 (1)		A (2)		M1	Weight (g)
									Max.	Min.	Max.	Min.		
AS12□1FG-M5-23	3.2	M5x0.8	8	8.4	9.6	17.3	22.1	12.3	28.6	25.8	25	22.2	12.7	7
AS12□1FG-M5-04	4	M5x0.8	8	9.3	9.6	17.3	22.1	12.3	28.6	25.8	25	22.2	12.7	7
AS12□1FG-M5-06	6	M5x0.8	8	11.6	11.6	18.1	22.9	11.7	28.6	25.8	25	22.2	13.5	7
AS22□1FG-01-23	3.2	R 1/8	12	9.3	14.2	20.4	27.5	14.3	38.1	31.1	32.1	27.1	12.7	16
AS22□1FG-01-04	4			9.3		20.4	27.5						12.7	17
AS22□1FG-01-06	6			11.6	14.2	20.4	27.5	13.4	35.2	30.2	32.1	27.1	13.5	19
AS22□1FG-01-08	8	R 1/8	12	15.2	15.2	25.3	32.4		18.5	18.5			16.5	19
AS22□1FG-01-10	10			18.5		32.1	39.2	14.1					21	21
AS22□1FG-02-04	4			10.4		25.2	34.4						16	32
AS22□1FG-02-06	6			12.8	18.5	25.2	34.4	17.7	39.9	34.9	34.4	29.4	17	
AS22□1FG-02-08	8	R 1/4	17	15.2		27.2	36.4		18.5	34			16.5	34
AS22□1FG-02-10	10			18.5		35.3	44.5	18.3					21	36
AS32□1FG-02-06	6			12.8		27.8	39.3						17	60
AS32□1FG-02-08	8			15.2		29.5	41		48.3	42.8	37.8		18.5	63
AS32□1FG-02-10	10	R 1/4	19	18.5	23	31.8	43.3	21.3	48.3	43.3	37.8		21	67
AS32□1FG-02-12	12			20.9		32.8	44.3						22	69
AS32□1FG-03-06	6			12.8		27.8	39.3		45.4	40.4	40.2	35.2	17	55
AS32□1FG-03-08	8			15.2	23	29.5	41		45.4	40.4	40.2	35.2	18.5	57
AS32□1FG-03-10	10	R 3/8	19	18.5	23	31.8	43.3	19.8	45.4	40.4	40.2	35.2	21	59
AS32□1FG-03-12	12			20.9		32.8	44.3						22	61
AS42□1FG-04-10	10			18.5	24	33.8	47.9		56.7	49.2	49.6	42.1	21	100
AS42□1FG-04-12	12	R 1/2	24	20.9	28.6	35.2	49.5	24.5	56.7	49.2	49.6	42.1	22	101

Note 1) Reference dimensions
 Note 2) Reference dimensions of M5 x 0.8, R threads after installation.

Inch Size

Model	d	T	H	D1	D2	L1	L2	L3	L4 (1)		A (2)		M1	Weight (g)
									Max.	Min.	Max.	Min.		
AS12□1FG-U10/32-01	1/8"			8.4		17.3	22.1	12.3					12.7	
AS12□1FG-U10/32-03	5/32"			9.3	9.6	17.3	22.1	12.3					12.7	
AS12□1FG-U10/32-05	3/16"			11.4		21.3	26.1	11.7	28.6	25.8	25	22.2	16.5	7
AS12□1FG-U10/32-07	1/4"			12		18.3	23.1						13.5	
AS22□1FG-U10/32-01	1/8"			9.3		20.4	27.5						12.7	16
AS22□1FG-U10/32-03	5/32"			11.4	14.2	23.1	30.2	13.4	35.2	30.2	32.1	27.1	16.5	17
AS22□1FG-U10/32-05	3/16"			12.7		18.3	23.1						13.5	19
AS22□1FG-U10/32-07	1/4"			15.2		25.3	32.4	14.1					18.5	21
AS22□1FG-U10/32-09	5/16"			18.5		32.1	39.2	14.1					21	21
AS22□1FG-U10/32-11	3/8"			21.3		35.3	44.5	18.6					24	24
AS22□1FG-U10/32-13	1/2"			24		38.5	47.7	18.6					27	27
AS32□1FG-U10/32-01	1/8"			10.4		25.2	34.4						16	32
AS32□1FG-U10/32-03	5/32"			12.8	18.5	25.2	34.4	17.7	39.9	34.9	34.4	29.4	17	
AS32□1FG-U10/32-05	3/16"			15.2		27.2	36.4		18.5	34			16.5	34
AS32□1FG-U10/32-07	1/4"			18.5		32.1	39.2	14.1					21	36
AS32□1FG-U10/32-09	5/16"			21.3		35.3	44.5	18.6					24	36
AS32□1FG-U10/32-11	3/8"			24		38.5	47.7	18.6					27	36
AS32□1FG-U10/32-13	1/2"			27.1		41.7	50.9	18.6					30	36
AS32□1FG-U10/32-01	1/8"			10.4		25.2	34.4						16	32
AS32□1FG-U10/32-03	5/32"			12.8	18.5	25.2	34.4	17.7	39.9	34.9	34.4	29.4	17	
AS32□1FG-U10/32-05	3/16"			15.2		27.2	36.4		18.5	34			16.5	34
AS32□1FG-U10/32-07	1/4"			18.5		32.1	39.2	14.1					21	36
AS32□1FG-U10/32-09	5/16"			21.3		35.3	44.5	18.6					24	36
AS32□1FG-U10/32-11	3/8"			24		38.5	47.7	18.6					27	36
AS32□1FG-U10/32-13	1/2"			27.1		41.7	50.9	18.6					30	36
AS32□1FG-U10/32-01	1/8"			10.4		25.2	34.4						16	32
AS32□1FG-U10/32-03	5/32"			12.8	18.5	25.2	34.4	17.7	39.9	34.9	34.4	29.4	17	
AS32□1FG-U10/32-05	3/16"			15.2		27.2	36.4		18.5	34			16.5	34
AS32□1FG-U10/32-07	1/4"			18.5		32.1	39.2	14.1					21	36
AS32□1FG-U10/32-09	5/16"			21.3		35.3	44.5	18.6					24	36
AS32□1FG-U10/32-11	3/8"			24		38.5	47.7	18.6					27	36
AS32□1FG-U10/32-13	1/2"			27.1		41.7	50.9	18.6					30	36
AS32□1FG-U10/32-01	1/8"			10.4		25.2	34.4						16	32
AS32□1FG-U10/32-03	5/32"			12.8	18.5	25.2	34.4	17.7	39.9	34.9	34.4	29.4	17	
AS32□1FG-U10/32-05	3/16"			15.2		27.2	36.4		18.5	34			16.5	34
AS32□1FG-U10/32-07	1/4"			18.5		32.1	39.2	14.1					21	36
AS32□1FG-U10/32-09	5/16"			21.3		35.3	44.5	18.6					24	36
AS32□1FG-U10/32-11	3/8"			24		38.5	47.7	18.6					27	36
AS32□1FG-U10/32-13	1/2"			27.1		41.7	50.9	18.6					30	36
AS32□1FG-U10/32-01	1/8"			10.4		25.2	34.4						16	32
AS32□1FG-U10/32-03	5/32"			12.8	18.5	25.2	34.4	17.7	39.9	34.9	34.4	29.4	17	
AS32□1FG-U10/32-05	3/16"			15.2		27.2	36.4		18.5	34			16.5	34
AS32□1FG-U10/32-07	1/4"			18.5		32.1	39.2	14.1					21	36
AS32□1FG-U10/32-09	5/16"			21.3		35.3	44.5	18.6					24	36
AS32□1FG-U10/32-11	3/8"			24		38.5	47.7	18.6					27	36
AS32□1FG-U10/32-13	1/2"			27.1		41.7	50.9	18.6					30	36
AS32□1FG-U10/32-01	1/8"			10.4		25.2	34.4						16	32
AS32□1FG-U10/32-03	5/32"			12.8	18.5	25.2	34.4	17.7	39.9	34.9	34.4	29.4	17	
AS32□1FG-U10/32-05	3/16"			15.2		27.2	36.4		18.5	34			16.5	34
AS32□1FG-U10/32-07	1/4"			18.5		32.1	39.2	14.1					21	36
AS32□1FG-U10/32-09	5/16"			21.3		35.3	44.5	18.6					24	36
AS32□1FG-U10/32-11	3/8"			24		38.5	47.7	18.6					27	36
AS32□1FG-U10/32-13	1/2"			27.1		41.7	50.9	18.6					30	36
AS32□1FG-U10/32-01	1/8"			10.4		25.2	34.4						16	32
AS32□1FG-U10/32-03	5/32"			12.8	18.5	25.2	34.4	17.7	39.9	34.9	34.4	29.4	17	
AS32□1FG-U10/32-05	3/16"			15.2		27.2	36.4		18.5	34			16.5	34
AS32□1FG-U10/32-07	1/4"			18.5		32.1	39.2	14.1					21	36
AS32□1FG-U10/32-09	5/16"			21.3		35.3	44.5	18.6					24	36
AS32□1FG-U10/32-11	3/8"			24		38.5	47.7	18.6					27	36
AS32□1FG-U10/32-13	1/2"			27.1		41.7	50.9	18.6					30	36

Note 1) Reference dimensions
 Note 2) Reference dimensions of 10-32 UNF and NPT threads after installation.

AS-FG Series

Dimensions: Universal Type

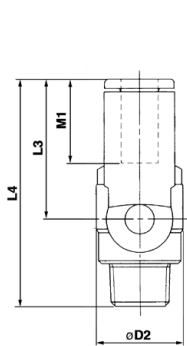

M5 type
U10/32 type

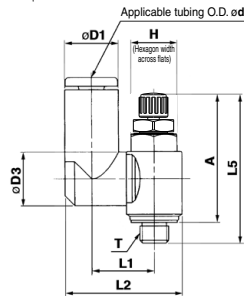
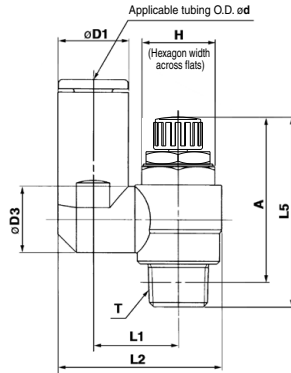
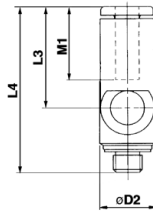

Metric Size

Model	d	T	H	D1	D2	D3	L1	L2	L3	L4	L5 (1)		A (2)		M1	Weight (g)	
											Max.	Min.	Max.	Min.			
AS13□1FG-M5-23	3.2		8.4					19.8	17.5	28.7	28.6	25	22.2	12.7	7		
AS13□1FG-M5-04	4	M5 x 0.8	9.3	9.6	9.3	10.8	20.3	21.4	20.6	31.8				13.5	7		
AS13□1FG-M5-06	6		11.6					21.4	20.6	31.8				13.5	7		
AS23□1FG-01-23	3.2		8.4					9.3	13.1	24.4	17.5	30.9		12.7	17		
AS23□1FG-01-04	4		9.3					14.2	14.2	24.4	35.2	30.2	32.1	12.7	17		
AS23□1FG-01-06	6	R 1/8	11.6					10.9	14	26.9	22.9	36.3		13.5	18		
AS23□1FG-01-08	8		15.2					12.9	16.2	30.9	28.2	40.8		18.5	21		
AS23□1FG-02-04	4		10.4					10.9	16.2	30.6	21.9	39.6		16	32		
AS23□1FG-02-06	6		12.8					16.4	34	25.2	42.1			17	33		
AS23□1FG-02-08	8	R 1/4	15.2					12.9	16.3	35.2	28.2	45.1	39.9	34.9	29.4	18.5	36
AS23□1FG-02-10	10		18.5					20.2	30.7	31	47.9			21	40		
AS33□1FG-02-06	6		12.8					12.9	20.9	38.5	25.2	46.5		17	60		
AS33□1FG-02-08	8		15.2					23	23	39.7	28.2	48.3	43.3	42.8	37.8	18.5	63
AS33□1FG-02-10	10	R 1/4	18.5					23	23	43.7	32.6	53.9	56.7	49.2	37.8	21	67
AS33□1FG-02-12	12		20.9					16.2	23	44.9	34.4	55.7		22	69		
AS33□1FG-03-06	6		12.8					12.9	20.9	38.5	25.2	45		17	56		
AS33□1FG-03-08	8		15.2					23	23	39.7	28.2	48	45.4	40.4	35	18.5	59
AS33□1FG-03-10	10	R 3/8	18.5					23	23	43.7	32.6	52.4		21	63		
AS33□1FG-03-12	12		20.9					16.2	23	44.9	34.4	54.2		22	65		
AS43□1FG-04-10	10		18.5					28.6	16.2	26.9	48.4	32.6	57.1	56.7	49.2	21	104
AS43□1FG-04-12	12	R 1/2	21.7					19.8	28.6	32	36.3	60.8		22	105		

Note 1) Reference dimensions

Note 2) Reference dimensions of M5 x 0.8, R threads after installation.

Inch Size

Model	d	T	H	D1	D2	D3	L1	L2	L3	L4	L5 (1)		A (2)		M1	Weight (g)	
											Max.	Min.	Max.	Min.			
AS13□1FG-U10/32-01	1/8"		8.4					19.8	17.5	28.7				12.7	7		
AS13□1FG-U10/32-03	5/32"	10-32 UNF	9.3					20.3	20.3	31.8				13.5	7		
AS13□1FG-U10/32-05	3/16"	UNF	11.4	9.6	9.3	10.8	21.3	23.3	34.5	28.6	25.6	25	22.2	16.5	8		
AS13□1FG-U10/32-07	1/4"		12				21.6	20.7	31.9				13.7	8			
AS23□1FG-N01-01	1/8"		8.4					9.3	13.1	24.4	17.5	30.9		12.7	17		
AS23□1FG-N01-03	5/32"		9.3					10.9	14	26.8	23.9	39.6		13.7	17		
AS23□1FG-N01-05	3/16"	NPT 1/8	12.7	11.4	14	11.4	14	10.9	14	26.8	23.9	39.6	35.2	30.2	32.1	16.5	18
AS23□1FG-N01-07	1/4"		13.2					12.9	16.2	29.6	26.6	36.3		18.5	19		
AS23□1FG-N01-09	5/16"		15.2					15.2	16.2	30.9	28.2	40.8		21	21		
AS23□1FG-N02-03	5/32"		10.4					10.9	16.2	30.6	21.9	39.6		16	32		
AS23□1FG-N02-05	3/16"		11.4					11.4	16.2	31.1	23.9	42.1		17	33		
AS23□1FG-N02-07	1/4"	NPT 1/4	15.2	13.2	14	11.4	11.4	16.3	16.3	34.2	25.6	45.1	39.9	34.9	34.4	18.5	36
AS23□1FG-N02-09	5/16"		15.2					20.2	28.2	28.2	47.9			21	39		
AS23□1FG-N02-11	3/8"		17.9					17.9	20.2	38.7	31	46.5		21	40		
AS33□1FG-N02-07	1/4"	NPT 1/4	13.2					12.9	20.6	38.7	25.6	46.9	48.3	43.3	37.8	17	60
AS33□1FG-N02-09	5/16"		15.2					16.2	23	39.7	28.2	49.5	48.3	42.8	37.8	18.5	63
AS33□1FG-N03-08	3/8"		17.9					16.2	23	43.7	32.6	53.9		21	69		
AS33□1FG-N03-07	1/4"		13.2					12.9	20.6	38.7	25.6	45		17	56		
AS33□1FG-N03-09	5/16"	NPT 3/8	15.2					15.2	23	39.7	28.2	48	45.4	40.4	35.2	18.5	59
AS33□1FG-N03-11	3/8"		17.9					16.2	23	43.7	32.6	52.4		21	65		
AS43□1FG-N04-11	3/8"	NPT 1/2	17.9					28.6	16.2	26.9	48.4	32.6	54.4	56.7	49.2	21	104
AS43□1FG-N04-13	1/2"		21.7					19.8	28.6	32	36.3	63.1		22	106		

Note 1) Reference dimensions

Note 2) Reference dimensions of 10-32 UNF and NPT threads after installation.

Speed Controller with One-touch Fitting Stainless Steel Series In-line Type

AS-FG Series



Model

Model	Applicable tubing O.D.												
	Metric size						Inch size						
	3.2	4	6	8	10	12	1/8"	5/32"	3/16"	1/4"	5/16"	3/8"	1/2"
AS1001FG	●	●	●				●	●	●	●			
AS2001FG		●	●					●	●	●			
AS2051FG				●	●				●	●	●		
AS3001FG			●	●	●	●				●	●	●	
AS4001FG					●	●						●	●

Specifications

Fluid	Air
Proof pressure	1.5 MPa
Max. operating pressure	1 MPa
Min. operating pressure	0.1 MPa
Ambient and fluid temperature	-5 to 60°C (No freezing)
Applicable tubing material	Nylon, Soft nylon, Polyurethane

Note) Use caution regarding the max. operating pressure when soft nylon or polyurethane tubing is used.
(Refer to pages 678 and 682 for details.)

Flow Rate and Sonic Conductance

Model		AS1001FG	AS2001FG		AS2051FG		AS3001FG			AS4001FG	
Tubing O.D.	Metric size	ø3.2 ø4 ø6	ø4	ø6	ø6	ø8	ø6	ø8	ø10 ø12	ø10	ø12
	Inch size	ø1/8" ø5/32" ø3/16"	ø5/32" ø1/4"	ø3/16" ø1/4"	ø3/16"	ø1/4" ø5/16"	ø1/4"	ø5/16"	ø3/8"	ø3/8"	ø1/2"
Controlled flow	Flow rate (L/min (ANR))	100	130	230	290	460	420	660	920	1050	1390
Free flow	Sonic conductance dm ³ /(s·bar)	0.28	0.36	0.64	0.8	1.3	1.2	1.8	2.6	2.9	3.9
Critical pressure ratio	Controlled flow	0.2	0.2		0.2			0.2		0.2	
	Free flow	0.25	0.25		0.25			0.25		0.25	

Note) Flow rate values are measured at 0.5 MPa and 20°C.

Flow Direction Symbols on Body

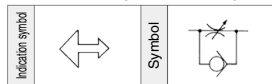

Made to Order
(Refer to page 1002 for details.)

How to Order

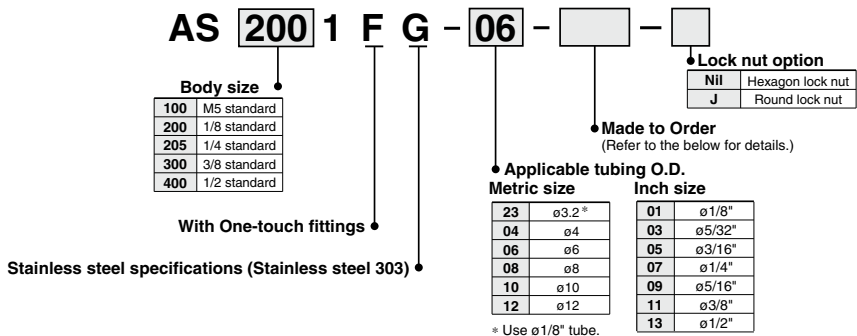

Made to Order



Lubricant: Vaseline

X12

Ex.) AS1001FG-04-X12

Grease-free (Seal: Fluorine Coated) + Throttle Valve (Without Check Valve)

X21

Ex.) AS1001FG-04-X21

Note) Not particle-free

Throttle Valve (Without Check Valve)

X214

Ex.) AS1001FG-04-X214

Needle Valve/Flow Rate Characteristics

Note) The flow rate characteristics are representative values.

AS1001FG

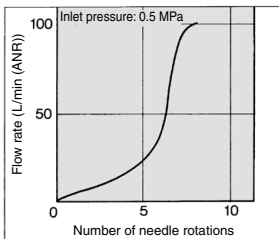

AS2001FG

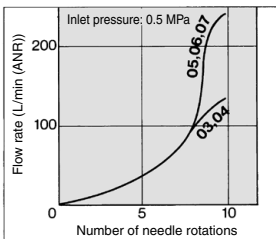

AS2051FG

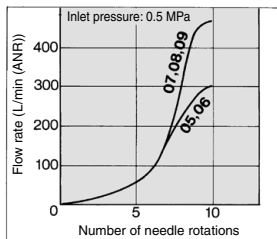

AS3001FG

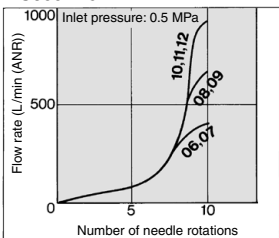

AS4001FG

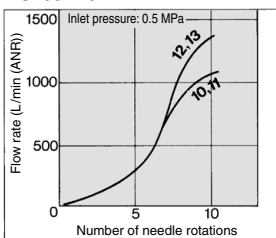

Construction

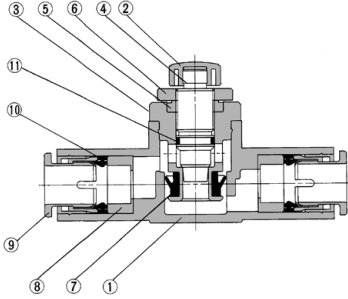

Component Parts

No.	Description	Material	Note
1	Body A	PBT	
2	Handle	PBT	
3	Body B	Stainless steel 303	
4	Needle	Stainless steel 303	
5	Needle guide	Stainless steel 303	
6	Lock nut	Stainless steel 303	
7	U seal	HNBR	
8	Spacer	—	
9	Cassette	—	
10	Seal	NBR	
11	O-ring	NBR	

Dimensions

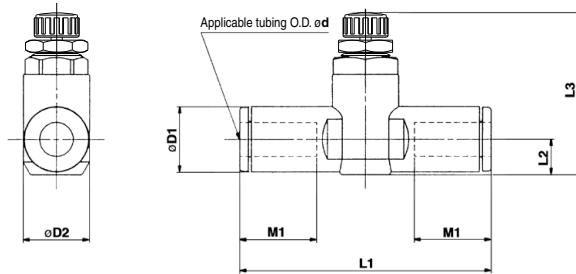

Metric Size

Model	d	D1	D2	L1	L2	L3 ⁽¹⁾		M1	Weight (g)
						Max.	Min.		
AS1001FG-23	3.2	8.4	10.5	38	4.5	23.5	20.7	12.7	6
AS1001FG-04	4	9.3		39.2	5.2	24.2	21.4		7
AS1001FG-06	6	11.6	12.3	40.7	6.2	25.2	22.4	13.5	8
AS2001FG-04	4	9.3		40.7	5.2	32.6	27.6	12.7	12
AS2001FG-06	6	11.6	15.5	44.8	6.3	33.7	28.7	13.5	13
AS2051FG-06	6	12.8		53.2	6.7	35.2	30.2	17	22
AS2051FG-08	8	15.2	20.6	59.8	8.1	32.6	27.6	18	25
AS3001FG-06	6	12.8		59	7.4	38.3	33.3	17	36
AS3001FG-08	8	15.2	27.6	64.4	8.2	39.1	34.1	18	40
AS3001FG-10	10	18.5		71.6	9.8	40.6	35.6	21	44
AS3001FG-12	12	20.9	27.6	76	11	41.8	36.8	22	48
AS4001FG-10	10	18.5		77.7	11.3	51.1	43.6	21	85
AS4001FG-12	12	20.9		82.1		52.1	44.6	22	89

Note 1) Reference dimensions

Inch Size

Model	d	D1	D2	L1	L2	L3 ⁽¹⁾		M1	Weight (g)
						Max.	Min.		
AS1001FG-01	1/8"	8.4	10.5	38	4.5	23.5	20.7	12.7	6
AS1001FG-03	3/32"	9.3		39.2	5.2	24.2	21.4		7
AS1001FG-05	3/16"	11.4	12.3	48.7	6.2	25.2	22.4	13.5	12
AS1001FG-07	1/4"	12		40.7					
AS2001FG-03	5/32"	9.3	15.5	40.7	5.2	32.6	27.6	12.7	12
AS2001FG-05	3/16"	11.4		50	6.2	33.6	28.6	16.5	18
AS2001FG-07	1/4"	13.2	20.6	52.2	7.1	34.5	29.5	17	16
AS2051FG-05	3/16"	11.4		52.2	6.2	34.6	29.6	16.5	24
AS2051FG-07	1/4"	13.2	27.6	54.4	7.1	35.5	30.5	17	22
AS2051FG-09	5/16"	15.2		59.8	8.1	32.6	27.6	18	25
AS3001FG-07	1/4"	13.2	27.6	59	7.4	38.3	33.3	17	36
AS3001FG-09	5/16"	15.2		64.4	8.2	39.1	34.1	18	40
AS3001FG-11	3/8"	17.9	27.6	70.8	9.5	40.3	35.3	21	52
AS4001FG-11	3/8"	17.9		76.9	10.3	51	43.5	21	93
AS4001FG-13	1/2"	21.7		83.1	11.6	52.4	44.9	22	106

Note 1) Reference dimensions

Dual Speed Controller with One-touch Fittings Stainless Steel Series

ASD-FG Series

RoHS

Two flow control valves and check valves have been integrated.

Prevention of stick-slip phenomenon, and speed control of a single acting cylinder.

Stable speed control is achievable even with load fluctuations.



Symbol

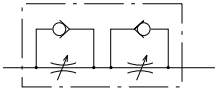

Flow Direction Symbols on Body

	Meter-out type	Meter-in type
Indication symbol		
Symbol		

Made to Order



Lubricant: Vaseline

X12

Model

Model	Port size	Applicable tubing O.D.																
		Metric size					Inch size											
		4	6	8	10	12	1/8"	5/32"	3/16"	1/4"	5/16"	3/8"						
ASD230FG-M5	M5 x 0.8	●	●															
ASD330FG-01	R 1/8		●	●														
ASD430FG-02	R 1/4		●	●	●													
ASD530FG-02	R 1/4		●	●	●	●												
ASD530FG-03	R 3/8		●	●	●	●												
ASD630FG-04	R 1/2				●	●												
ASD230FG-U10/32	10-32 UNF							●	●		●	●						
ASD330FG-N01	NPT 1/8										●	●	●	●				
ASD430FG-N02	NPT 1/4											●	●	●	●			
ASD530FG-N02	NPT 1/4											●	●	●	●			
ASD530FG-N03	NPT 3/8											●	●	●	●			
ASD630FG-N04	NPT 1/2														●	●		

Specifications

Fluid	Air
Proof pressure	1.5 MPa
Max. operating pressure	1 MPa
Min. operating pressure	0.1 MPa
Ambient and fluid temperature	-5 to 60°C (No freezing)
Applicable tubing material	Nylon, Soft nylon, Polyurethane

Note) Use caution regarding the max. operating pressure when soft nylon or polyurethane tubing is used.

(Refer to pages 678 and 682 for details.)

Flow Rate and Sonic Conductance

Model	ASD230FG		ASD330FG		ASD430FG		ASD530FG			ASD630FG	
	Metric size	ø4, ø6	ø6, ø8	ø6	ø8, ø10	ø6	ø8	ø10, ø12	ø10	ø12	
Tubing O.D.	Metric size	ø3/16"	ø1/4"	ø1/4"	ø1/4"	ø1/4"	ø5/16"	ø3/8"	—	ø3/8"	
	Inch size	ø1/4"	ø1/8"	ø5/32"	—	—	—	—	—	—	
Controlled flow	Flow rate (L/min (ANR))	75	175	295	350	500	600	700	1200	1300	
	Free flow	Sonic conductance dm ³ /(s·bar)	0.21	0.49	0.82	0.97	1.4	1.7	1.9	3.3	3.6
Critical pressure ratio	Controlled flow	0.25	0.2	—	0.2	—	0.2	—	—	0.2	
	Free flow	0.3	0.15	—	0.15	—	0.15	—	—	0.15	

Note) Flow rate values are measured at 0.5 MPa and 20°C.

How to Order

ASD **3** **30** **FG** - **01** - **06** **S** - -

Body size

2	M5 standard
3	1/8 standard
4	1/4 standard
5	3/8 standard
6	1/2 standard

Universal

With One-touch fitting

Stainless steel specifications (SUS303)

Thread type

NII	Metric thread (M5)
	Unified thread (10-32 UNF)
	R
N	NPT

Lock nut option

NII	Hexagon lock nut
J	Round lock nut

Made to Order

X12 Lubricant: Vaseline

With seal

* M5 and U10/32 are not available with seals.

Applicable tubing O.D. (Note)

Metric size

04	ø4
06	ø6
08	ø8
10	ø10
12	ø12

Inch size

01	ø1/8"
03	ø5/32"
05	ø3/16"
07	ø1/4"
09	ø5/16"
11	ø3/8"

(Note) For applicable tubing O.D. selection, refer to the Model on page 1004.

Port size

M5	M5 x 0.8
U10/32	10-32 UNF
01	1/8
02	1/4
03	3/8
04	1/2

Needle Valve/Flow Rate Characteristics

(Note) The flow rate characteristics are representative values.

ASD230FG

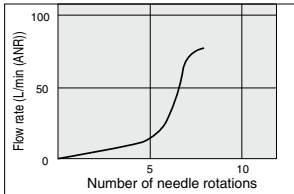

ASD330FG

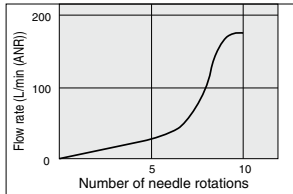

ASD430FG

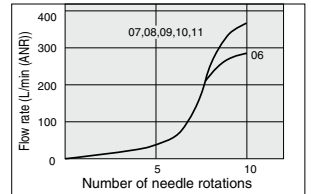

ASD530FG

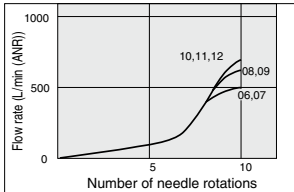

ASD630FG

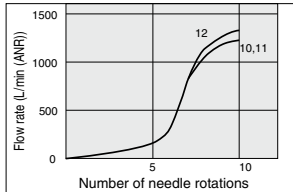

ASD-FG Series

Construction

ASD230FG

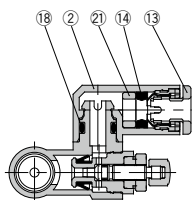

ASD330FG/430FG
ASD530FG/630FG

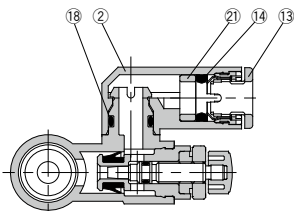

ASD530FG-02

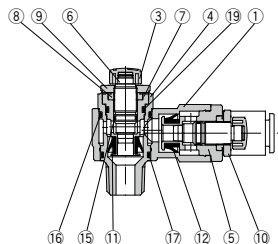
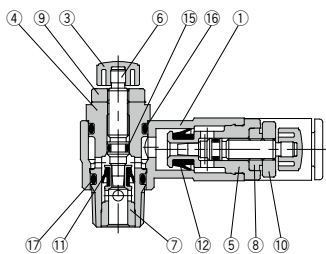
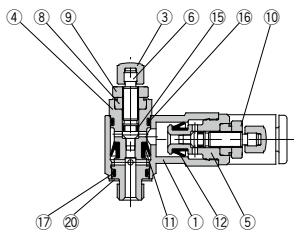
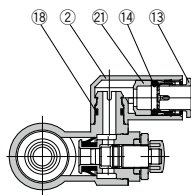

Component Parts

No.	Description	Material	Note
1	Body A	PBT	
2	Elbow body	PBT	
3	Handle	PBT	
4	Body B	Stainless steel 303	
5	Body B	Stainless steel 303	
6	Needle	Stainless steel 303	
7	Seat ring	Stainless steel 303	
8	Needle guide	Stainless steel 303	
9	Lock nut	Stainless steel 303	
10	Lock nut	Stainless steel 303	
11	U seal	HNBR	

No.	Description	Material	Note
12	U seal	HNBR	
13	Cassette	—	
14	Seal	NBR	
15	O-ring	NBR	
16	O-ring	NBR	
17	O-ring	NBR	
18	O-ring	NBR	
19	O-ring	NBR	
20	Gasket	NBR, Steel	M5 type only
21	Spacer	—	

Dual Speed Controller with One-touch Fittings Stainless Steel Series **ASD-FG Series**

Dimensions: Metric Size

ASD230FG

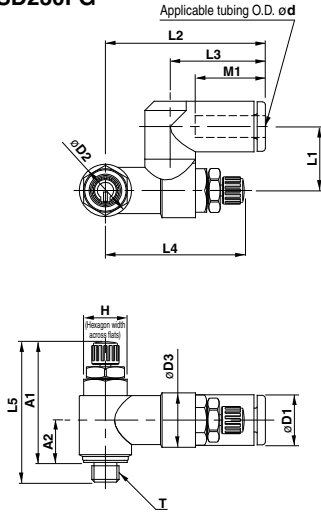

**ASD330FG/430FG
ASD530FG/630FG**

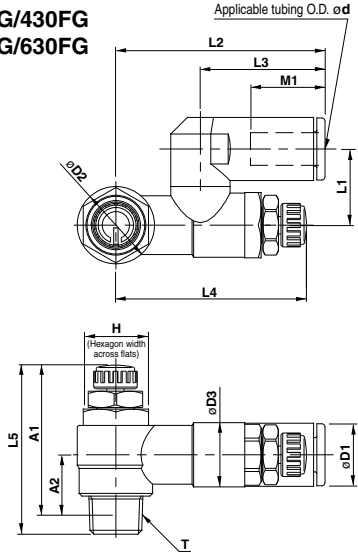

Metric Size

Model	d	T	H	D1	D2	D3	L1	L2	L3	L4 ⁽¹⁾		L5 ⁽¹⁾		A1 ⁽²⁾		A2 ⁽²⁾	M1	Weight (g)
										Max.	Min.	Max.	Min.	Max.	Min.			
ASD230FG-M5-04	4	M5 x 0.8	8	9.3	9.6	10	11.7	29.4	17.5	28.3	25.5	28.6	25.8	25	22.2	7.8	12.9	12
ASD230FG-M5-06	6			11.6				20.6	13.7								13	
ASD330FG-01-06S	6	R 1/8	12	11.6	14.2	11.8	14	38.5	22.9	39.6	34.6	35.2	30.2	32.1	27.1	10.6	13.7	29
ASD330FG-01-08S	8			15.2				28.2	18.5								31	
ASD430FG-02-06S	6	R 1/4	17	12.8	18.5	15	18	43.5	25.2	41.7	36.7	39.9	34.9	34.4	29.4	11	17	53
ASD430FG-02-08S	8			15.2				28.2	18.5								31	
ASD430FG-02-10S	10			18.5			19.7	49.3	31								21	58
ASD530FG-02-06S	6	R 1/4	19	12.8	23	19.8	20.3	48.3	25.2	46.9	41.9	48.3	43.3	42.8	37.8	15.4	17	74
ASD530FG-02-08S	8			15.2				28.2	18.5								31	
ASD530FG-02-10S	10			18.5			23.1	54.1	32.6								21	80
ASD530FG-02-12S	12			20.9				55.9	34.4								22	83
ASD530FG-03-06S	6	R 3/8	19	12.8	23	19.8	20.3	48.3	25.2	46.9	41.9	45.4	40.4	40	35	14	17	74
ASD530FG-03-08S	8			15.2				28.2	18.5								31	
ASD530FG-03-10S	10			18.5			23.1	54.1	32.6								21	98
ASD530FG-03-12S	12			20.9				55.9	34.4								22	101
ASD630FG-04-10S	10	R 1/2	24	18.5	28.6	26.5	25.9	64.3	32.6	64.8	57.3	56.7	49.2	49.6	42.1	18.6	21	177
ASD630FG-04-12S	12			20.9				34.4	22								179	

Note 1) Reference dimensions

Note 2) Reference dimensions of M5 x 0.8, R threads after installation.

ASD-FG Series

Dimensions: Inch Size

ASD230FG

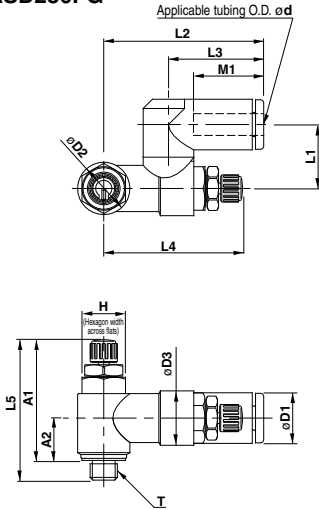

ASD330FG/430FG ASD530FG/630FG

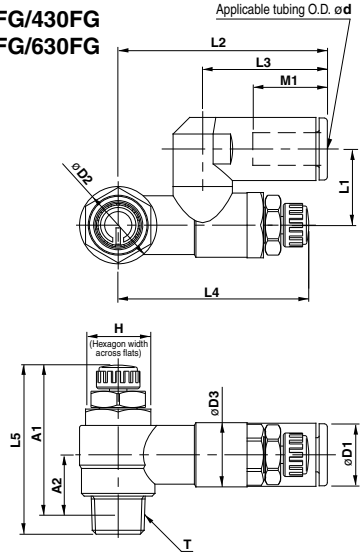

Inch Size

Model	d	T	H	D1	D2	D3	L1	L2	L3	L4 ⁽¹⁾		L5 ⁽¹⁾		A1 ⁽²⁾		A2 ⁽²⁾	M1	Weight (g)
										Max.	Min.	Max.	Min.	Max.	Min.			
ASD230FG-U10/32-01	1/8"	10-32 UNF	8	8.4	9.6	10	11.7	29.4	17.5	28.3	25.5	28.6	25.8	25	22.2	7.8	12.9	12
ASD230FG-U10/32-03	5/32"			9.3				35.2	23.3								13	
ASD230FG-U10/32-05	3/16"			11.4				32.6	20.7								15	
ASD230FG-U10/32-07	1/4"			12				32.6	20.7								13	
ASD330FG-N01-05S	3/16"	NPT 1/8	12.7	11.6	14.2	11.8	14	38.5	23.9	39.6	34.6	35.2	30.2	32	27	10.6	16.5	30
ASD330FG-N01-07S	1/4"			13.2				42.2	25.6								17	
ASD330FG-N01-09S	5/16"			15.2				44.8	28.2								31	
ASD430FG-N02-07S	1/4"			13.2				43.9	25.6								17	
ASD430FG-N02-09S	5/16"	NPT 1/4	17.5	15.2	18.5	15	18	46.5	28.2	41.7	36.7	39.9	34.9	34.6	29.6	11	18.5	55
ASD430FG-N02-11S	3/8"			18.5				49.3	31								62	
ASD530FG-N02-07S	1/4"			13.2				48.7	25.6								17	
ASD530FG-N02-09S	5/16"			15.2				51.3	28.2								76	
ASD530FG-N02-11S	3/8"	NPT 1/4	19	18.5	23	19.8	20.3	54.1	32.6	46.9	41.9	48.3	43.3	43	38	15.4	21	84
ASD530FG-N03-07S	1/4"			13.2				48.7	25.6								17	
ASD530FG-N03-09S	5/16"			15.2				51.3	28.2								93	
ASD530FG-N03-11S	3/8"			18.5				54.1	32.6								102	
ASD630FG-N04-11S	3/8"	NPT 1/2	23.8	18.5	28.6	26.5	25.9	64.3	32.6	64.8	57.3	56.7	49.2	46.9	42.1	18.6	21	180

Note 1) Reference dimensions

Note 2) Reference dimensions of 10-32UNF and NPT threads after installation.



ASD-FG Series Specific Product Precautions

Be sure to read this before handling the products.

Refer to page 11 for safety instructions and pages 19 to 22 for flow control equipment precautions.

Design/Selection

⚠ Caution

1. Single acting cylinder

When controlling a single acting cylinder, the cylinder's return speed will differ depending on the operating conditions. Operate after confirming the maximum return speeds shown in the table below.

Speed Controller	Cylinder	Solenoid valve	Tubing	Silencer	Maximum return speed (mm/s)		
					100	200	300
ASD230FG	CJ2	SYJ500	TU0604 1 m	AN110-01			
					Cylinder size		
ASD330FG	CM2	SYJ700	TU0604 1 m	AN110-01			
					Cylinder size		

* Values at 0.5 MPa and 20°C.

<Operating conditions>

- Cylinder extension speed: 100 mm/s
- Meter-out needle fully open

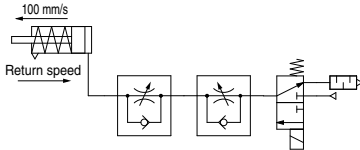

(Reference) Recommended circuit for high return speed

When low extension speed and high return speed are desired, the following circuit using 3-port is recommended.

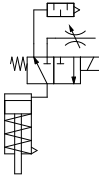

Note) Use AS-FG series with -X214 for the throttle valve.