

Speed Controller with One-touch Fittings

AS Series

In-line Type

RoHS

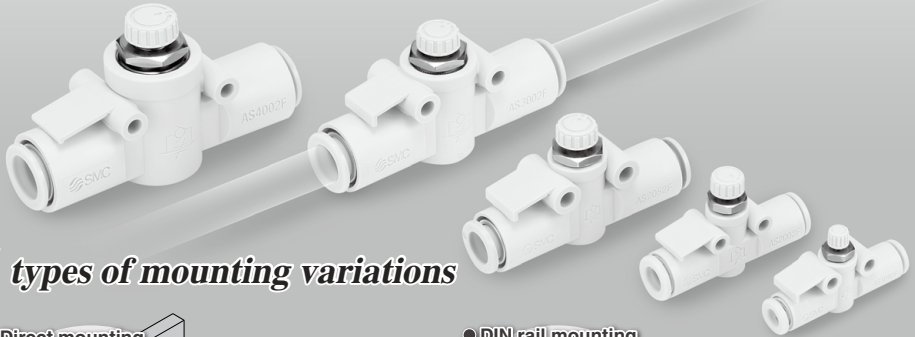

4 types of mounting variations

● Direct mounting

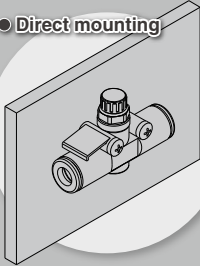

● DIN rail mounting

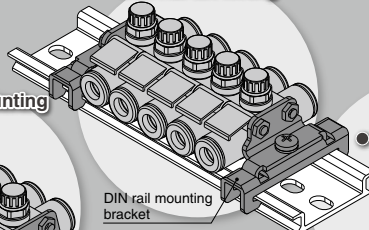

● L-bracket mounting

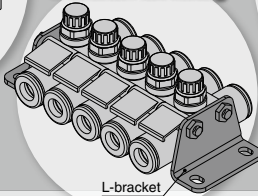

● Holder mounting

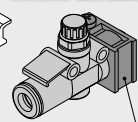

L-bracket

DIN rail mounting bracket

Holder for speed controller

Index plate

It is possible to identify the product when multiple controllers are mounted and identify the flow direction by attaching an identification label.

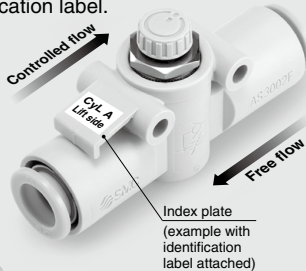

Index plate
(example with identification label attached)

Compact

NEW

Four AS3002F-10 controllers connected

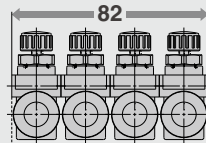

27% DOWN
112

Current

Four AS3001F-10 controllers connected with holders (TMH-10)

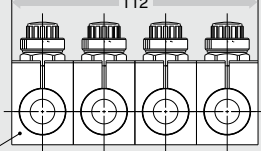

Holder

Lightweight

Reduced by **30%** compared with the current product (AS2002F-04)

Flow rate characteristics are equivalent to the current product.

AS-F
TMH
ASD
AS
AS-FE
KE
AS-FG
AS-FP
AS-FM
AS-D
AS-T
ASP
ASN
AQ
ASV
AK
VCHC
ASR
ASQ

AS Series

Series

Series	Applicable tubing O.D.												
	Metric size						Inch size						
	2	3.2	4	6	8	10	12	1/8"	5/32"	1/4"	5/16"	3/8"	1/2"
AS1002F	○	○	○	○				○	○	○			
AS2002F			○	○				○	○	○			
AS2052F				○	○					○	○		
AS3002F					○	○				○	○	○	
AS4002F						○	○					○	○

Specifications

Fluid	Air
Proof pressure	1.5 MPa (1.05 MPa ^{Note 1)})
Max. operating pressure	1 MPa (0.7 MPa ^{Note 1)})
Min. operating pressure	0.1 MPa
Ambient and fluid temperature	-5 to 60°C (No freezing)
Applicable tubing material ^{Note 2)}	Nylon, Soft nylon, Polyurethane

Note 1) In case of AS1002F-02

Note 2) Use caution at the max. operating pressure when using soft nylon or polyurethane tubing. (Refer to pages 464 and 465 for details.)

Note 3) Brass parts are all electroless nickel plated.

Flow Rate and Sonic conductance

Series		AS1002F		AS2002F		AS2052F		AS3002F			AS4002F	
Tube O.D.	Metric size	ø2	ø3.2, ø4, ø6	ø4	ø6	ø6	ø8	ø6	ø8	ø10, ø12	ø10	ø12
	Inch size	—	ø1/8", ø5/32" ø1/4"	ø5/32"	ø1/4"	—	ø1/4" ø5/16"	ø1/4"	ø5/16"	ø3/8"	ø3/8"	ø1/2"
Controlled flow	Flow rate (L/min (ANR))	20	100	130	230	290	460	390	660	920	920	1390
Free flow	Sonic conductance cm ³ /(s·bar)	0.06	0.28	0.36	0.64	0.81	1.3	1.1	1.8	2.6	2.6	3.9
Critical pressure ratio	Controlled flow	0.2										
	Free flow	0.25										

Note) Flow rate values are measured at 0.5 MPa and 20°C.

Flow Direction Symbol on Body

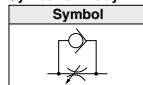

How to Order

AS 400 2F - 12 - [] - []

Body size

100	M3, M5 standard
200	1/8 standard
205	1/4 standard
300	3/8 standard
400	1/2 standard

Made to Order

Applicable tubing O.D.

Metric size	Inch size
02	ø2
23	ø3.2 [±]
04	ø4
06	ø6
08	ø8
10	ø10
12	ø12

* Use ø1/8" tube.

RoHS



Lock nut option

Nil	Hexagon lock nut
J	Round lock nut

Made to Order

Lubricant: Vaseline

X12

Ex.) AS2002F-04-X12

Grease-free (Sealant: Fluoro coated) + Restrictor (Without Check Valve)

X21

Ex.) AS2002F-04-X21

Note) Not particle-free

Restrictor (Without Check Valve) X214

Ex.) AS2002F-04-X214

Options

L-bracket

Part no.	Applicable series
AS-12L	AS1002F-02
AS-10L	AS1002F
AS-20L	AS2002F
AS-25L	AS2052F
AS-30L	AS3002F
AS-40L	AS4002F

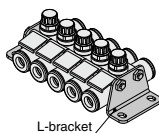

L-bracket

DIN rail mounting bracket

Part no.	Applicable series
AS-10D	AS1002F
AS-20D	AS2002F
AS-25D	AS2052F
AS-30D	AS3002F
AS-40D	AS4002F

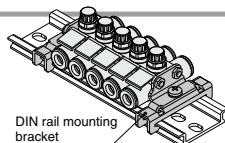

DIN rail mounting bracket

* Bracket for AS1002F-02 is not available.

* Prepare DIN rail by user.

Part no. list of threaded stud kit for manifold

Model		4 stations	6 stations	8 stations	10 stations
Metric size	Inch size				
AS1002F-02	—	AS-31B	AS-32B	AS-33B	AS-34B
AS1002F-23	AS1002F-01	AS-31B	AS-33B	AS-34B	AS-36B
AS1002F-04	AS1002F-03	AS-32B	AS-33B	AS-35B	AS-36B
AS1002F-06	—		AS-34B	AS-36B	AS-37B
—	AS1002F-07	AS-32B	AS-34B	AS-35B	AS-38B
AS2002F-04	AS2002F-03	AS-32B	AS-34B	AS-36B	AS-37B
AS2002F-06	—		AS-36B	AS-38B	AS-37B
—	AS2002F-07	AS-32B	AS-34B	AS-36B	AS-38B
AS2052F-06	—	AS-41B	AS-42B	AS-44B	AS-45B
—	AS2052F-07		AS-44B	AS-45B	AS-46B
AS2052F-08	AS2052F-09	AS-42B	AS-44B	AS-45B	AS-47B
AS3002F-06	—		AS-46B	AS-47B	AS-48B
—	AS3002F-07	AS-42B	AS-44B	AS-45B	AS-47B
AS3002F-08	AS3002F-09		AS-46B	AS-47B	AS-48B
AS3002F-10	—	AS-42B	AS-44B	AS-45B	AS-47B
—	AS3002F-11		AS-46B	AS-47B	AS-48B
AS3002F-12	—	AS-43B	AS-45B	AS-47B	AS-48B
AS4002F-10	—		AS-45B	AS-47B	AS-48B
—	AS4002F-11	AS-43B	AS-45B	AS-47B	AS-48B
AS4002F-12	—		AS-45B	AS-47B	AS-48B
—	AS4002F-13	AS-43B	AS-45B	AS-47B	AS-48B

Details of threaded stud kit for manifold

Part no.	Threaded stud		Accessories			
	Length	pcs.	Hexagon nut	pcs.	Flat washer	pcs.
AS-31B	38	2	M3	4	M3	4
AS-32B	62	2				
AS-33B	72	2				
AS-34B	90	2				
AS-35B	104	2				
AS-36B	114	2				
AS-37B	135	2				
AS-38B	140	2				
AS-41B	78	2	M4	4	M4	4
AS-42B	111	2				
AS-43B	119	2				
AS-44B	147	2				
AS-45B	179	2				
AS-46B	191	2				
AS-47B	236	2				
AS-48B	277	2				

* Precautions when options are ordered

Threaded studs for manifold are not included when L-bracket and DIN rail mounting bracket are ordered. Please order them according to the number of stations.

Ex.) AS2002F-04 When connecting 4 pcs. and mounting L-brackets on both sides

• Speed controller	AS2002F-04	4 pcs.
• L-bracket	AS-20L	2 pcs.
• Threaded stud kit for manifold	AS-32B	1 pc.

Needle Valve/Flow Rate Characteristics

Note) The flow rate characteristics are representative values.

AS1002F-02

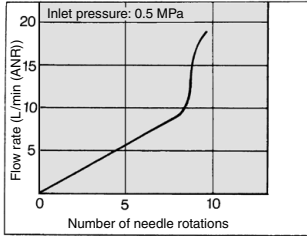

AS1002F

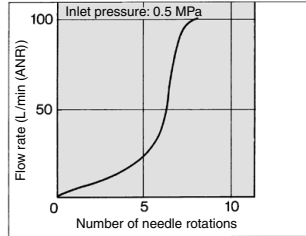

AS2002F

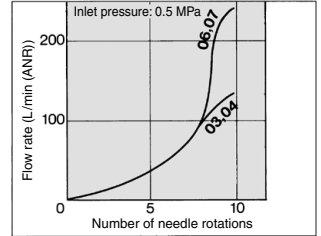

AS2052F

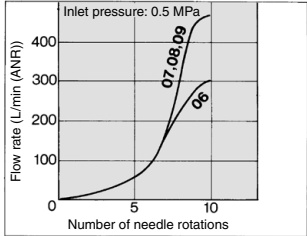

AS3002F

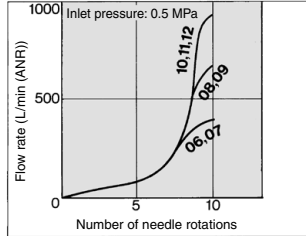

AS4002F

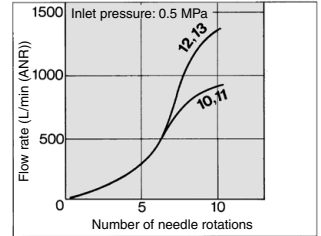

Construction

AS1002F, AS2002F, AS2052F

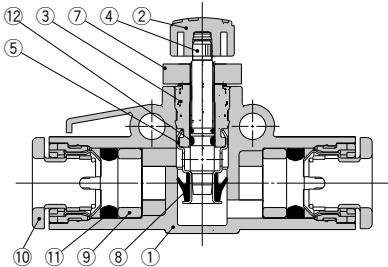

AS1002F-02, AS3002F, AS4002F

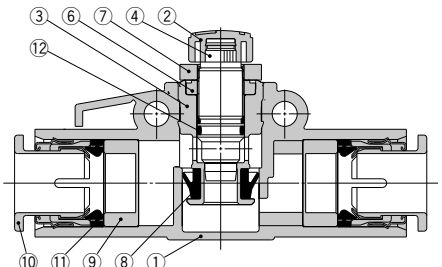

Component Parts

No.	Description	Material	Note
1	Body A	PBT	
2	Handle	PBT	
3	Body B	Brass	Electroless nickel plated
4	Needle	Brass	Electroless nickel plated
5	Seat ring	Brass	Electroless nickel plated
6	Needle guide	Brass	Electroless nickel plated

No.	Description	Material	Note
7	Lock nut	Steel wire ^{Note 2)}	Zinc chromated ^{Note 2)}
8	U-seal	HNBR	
9	Spacer	POM ^{Note 1)}	
10	Cassette	—	
11	Seal	NBR	
12	O-ring	NBR	

Note 1) AS2052F, AS3002F, AS4002F are made of PBT. AS3002F-11, AS4002F-11, AS4002F-13 are made of electroless nickel plated brass.

Note 2) For the material and surface treatment of the lock nut option-J (round type), only the AS1002F-02, AS3002F, and AS4002F types use brass and electroless nickel plated.

L-bracket

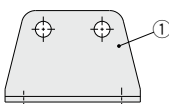

Component Part

No.	Description	Material
1	Bracket	Steel strip

DIN rail mounting bracket

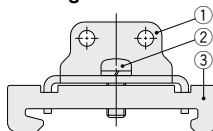

Component Parts

No.	Description	Material
1	Bracket	Steel strip
2	Cross recessed round head screw	Steel wire
3	Clasp	Steel strip

⚠ Caution

Be sure to read this before handling the products.
Refer to back page 50 for Safety Instructions and pages 543 to 546 for Flow Control Equipment Precautions.

AS Series

Dimensions

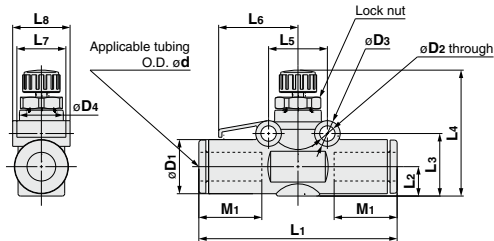

Metric Size

Model	Applicable tubing O.D. ød	D1	D2	D3	D4	L1	L2	L3	L4 (Note)		L5	L6	L7	L8	M1	Weight (g)
									MAX.	MIN.						
AS1002F-02	2	6	3.2	5	6	25.4	3.4	7.9	20.9	18.4	11	9.8	5	6.7	8.8	3
AS1002F-23	3.2	8.4				36	4.4	11.1	23.8	21				9.8	12.7	5
AS1002F-04	4	9.3	3.3	5.5	9.1	37	5.1	11.8	24.5	21.7	11	15.4	8.8	10.1	12.7	5.5
AS1002F-06	6	11.6				39.5	6.1	12.8	25.5	22.7				12.3	13.5	6.5
AS2002F-04	4	9.3				40.7	5.2	12.3	28.9	25.4				11.5	12.7	8.5
AS2002F-06	6	11.6	3.3	5.5	10	42.5	6.3	13.4	30	26.5	12.6	17	10.5	12.3	13.5	9.5
AS2052F-06	6	12.8				53.2	6.7	16.3	33.2	28.2				15.7	17	19
AS2052F-08	8	15.2	4.3	7.8	14	57.2	8	17.6	34.5	29.5	17	22.8	12	16.1	18	22
AS3002F-06	6	13.2				59	7.4	19.3	38.6	33.6				17	36	
AS3002F-08	8	15.2				65	8.2	20.1	39.4	34.4				20.5	18	38
AS3002F-10	10	18.5	4.3	8	19.3	70.8	9.8	21.7	41	36	22	25	12	21	42	
AS3002F-12	12	20.9				76	10.9	22.8	42.1	37.1				22.1	22	44
AS4002F-10	10	18.5				76.9	10.3	22.7	51.6	44.1				21	76	
AS4002F-12	12	21.7	4.3	8	25	81.3	11.3	23.7	52.6	45.1	28	33	14	26.2	22	82

(Note) Reference dimensions

Inch Size

Model	Applicable tubing O.D. ød	D1	D2	D3	D4	L1	L2	L3	L4 (Note)		L5	L6	L7	L8	M1	Weight (g)
									MAX.	MIN.						
AS1002F-01	1/8"	8.4				36	4.5	11.2	23.8	21				9.8	12.7	5
AS1002F-03	5/32"	9.3	3.3	5.5	9.1	37	5.2	11.9	24.5	21.7	11	15.4	8.8	10.1	12.7	5.5
AS1002F-07	1/4"	12				39.5	6.1	12.8	25.5	22.7				12.3	13.7	6.5
AS2002F-03	5/32"	9.3				40.7	5.2	12.3	28.9	25.4				11.5	12.7	8.5
AS2002F-07	1/4"	12	3.3	5.5	10	42.6	6.5	13.6	30.2	26.7	12.6	17	10.5	12.8	13.7	9.5
AS2052F-07	1/4"	13.2				53.4	6.9	16.5	33.4	28.4				15.7	17	19
AS2052F-09	5/16"	15.2	4.3	7.8	14	57.2	8	17.6	34.5	29.5	17	22.8	12	16.1	18	22
AS3002F-07	1/4"	13.2				59	7.4	19.3	38.6	33.6				17	35	
AS3002F-09	5/16"	15.2				65	8.2	20.1	39.4	34.4				20.5	18	38
AS3002F-11	3/8"	18.5	4.3	8	19.3	69.8	9.8	21.7	41	36	22	25	12	21	52	
AS4002F-11	3/8"	18.5				76.9	10.3	22.7	51.6	44.1				21	86	
AS4002F-13	1/2"	21.7	4.3	8	25	81.3	11.3	23.7	52.6	45.1	28	33	14	26.2	22	95

(Note) Reference dimensions

The hexagon lock nut can be fastened by hand. When stronger tightening is required, please retighten using a tool. The proper tightening torques for tools are shown in the table below. For standard installation, turn 15 to 30° using tool, after fastening by hand.

Pay attention not to over torque the product.

Series	Proper tightening torque (N·m)
AS1002F-02	0.07
AS1002F	0.2
AS2002F	0.3
AS2052F	1
AS3002F	2
AS4002F	4

Dimensions

L-bracket

Bracket on a single side

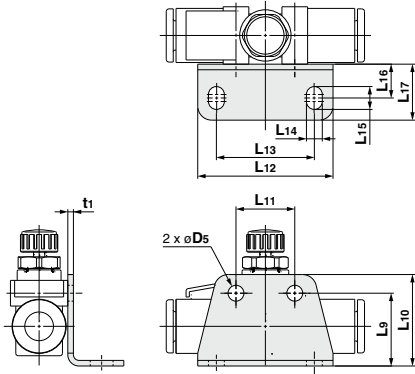

Part no.	Applicable series	D5	L9	L10	L11	L12	L13	L14	L15	L16	L17	t1
AS-12L	AS1002F-02		9.9	13.4	11	27.5	19.5					1
AS-10L	AS1002F	3.4	14.8	18.3				3.4	4.9	7.3	12	
AS-20L	AS2002F		15.6	19.6	12.6	29	21					1.2
AS-25L	AS2052F		19.6	24.6	17	38	28					
AS-30L	AS3002F	4.5	24.8	29.8	22	43	33	4.5	6.5	9.5	15.5	
AS-40L	AS4002F		25.7	30.7	28	49	39					1.4

Brackets on both sides

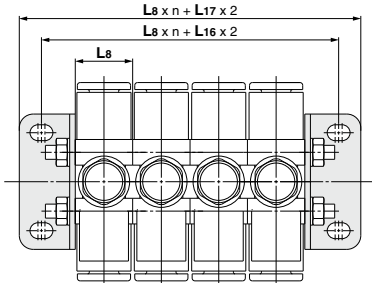

*1 Refer to page 618 for L8.

*2 The above figure shows the manifold with controllers connected using two L-brackets and a threaded stud kit for manifold. Refer to page 616 for threaded stud kits for manifold.

DIN rail mounting bracket

Bracket on a single side

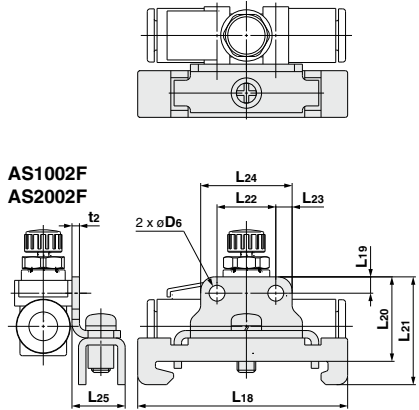

AS1002F
AS2002F

AS2052F
AS3002F
AS4002F

Part no.	Applicable series	D6	L18	L19	L20	L21	L22	L23	L24	L25	t2
AS-10D	AS1002F				18.2	23.2	11			18	
AS-20D	AS2002F	3.4		3.5	18.6	23.6	12.6	3.5		19.6	
AS-25D	AS2052F				22	27	17			25.8	11.2
AS-30D	AS3002F	4.5	4.4		27.2	32.2	22	4.4		30.8	
AS-40D	AS4002F				28.1	33.1	28			36.8	

Brackets on both sides

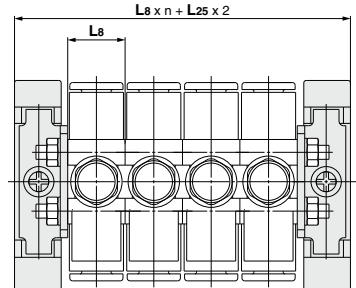

*1 Refer to page 618 for L8.

*2 The above figure shows the manifold with controllers connected using two DIN rail mounting brackets and a threaded stud kit for manifold. Refer to page 616 for threaded stud kits for manifold.

AS-F

TMH

ASD

AS

AS-FE

KE

AS-FG

AS-FP

AS-FM

AS-D

AS-T

ASP

ASN

AQ

ASV

AK

VCHC

ASR

ASQ