

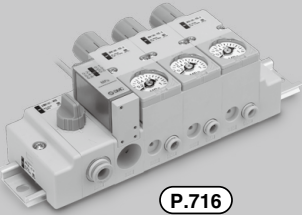

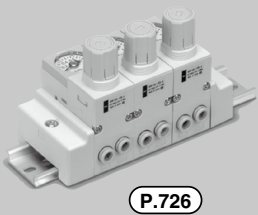

Compact Manifold Regulator

ARM10/11 Series



Manifold Type		Single Unit Type	
Common supply	Individual supply	Standard	Front knob
			
P.716	P.726	P.739	P.740
			Example of panel mounting 

Front knob type is newly added to the single unit specifications.

Allows high degree of freedom in selection according to the installation conditions.

- Knob position: Top, Front, Bottom
- Piping direction: Top ported, Bottom ported
- One-touch fitting types: Straight, Elbow

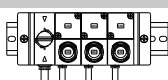
Installation example

Upper space is limited. 	Lower space is limited. 
Front knob/Bottom ported	Front knob/Top ported

Types and sizes of the One-touch fittings can be changed.

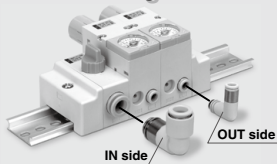

	Fitting type	Applicable tubing O.D. (mm)			
		4	6	8	10
IN side	Straight, Elbow	●	●	●	●
OUT side	Straight, Elbow	●	●	●	●





Also available in inch sizes.

Reverse flow function is equipped as a standard.

Can control thrust of the actuator.

Four types of supply blocks (for common supply)

The mounting position of the supply block can be selected from the right, left and both sides of the manifold.

Supply block	With 3-way pressure relief valve	With pressure switch	With 3-way pressure relief valve + Pressure switch
			

Mixed manifold

Common exhaust type and individual exhaust type can be mounted on the same manifold base.
(Available as Simple Specials)

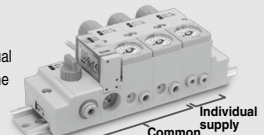

Pressure gauge with limit indicator.

Opening and closing lens cover makes adjustment easy.

Compatible with units with a digital pressure switch

Individual lines can be controlled with electric signals.

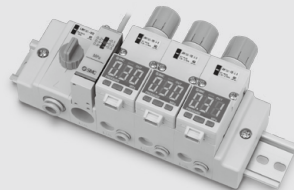

ARJ

AR425
to 935

ARX

AMR

ARM

ARP

IR□-A

IR

IRV

VEV

SRH

SRP

SRF

ITV

IC

ITVH

ITVX

PVQ

VY1

VBA

VBAT

AP100

Compact Manifold Regulator

Common Supply Type

ARM11A Series



Made to Order
(Refer to page 746 for details.)

How to Order

ARM11A **A** **1** - **3** **07** - **M** **Z** - **N**

① ② ③ ④ ⑤ ⑥ ⑦ ⑧

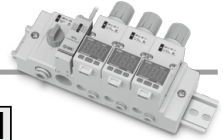

1. Knob Position

Symbol	Position
A	Top
B	Front
C	Bottom

Top **Front** **Bottom**



2. IN/OUT Piping Position

Position Symbol	IN side		OUT side	
	Bottom	Top	Bottom	Top
1	●			
2		●		
3	●		●	
4			●	●

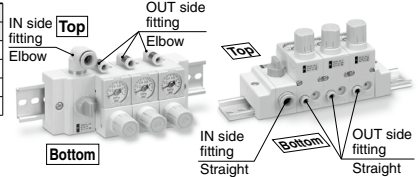

3. Regulator Block Stations

Symbol	Stations
1	1 station
2	2 stations
3	3 stations
4	4 stations
5	5 stations
6	6 stations
7	7 stations
8	8 stations
9	9 stations
M	10 stations

4. IN/OUT Fitting Type (Refer to the figure below.)

Metric size

Mounting position Fitting type Symbol	IN side					OUT side				
	Straight		Elbow			Straight		Elbow ^{Note)}		
	ø6	ø8	ø10	ø6	ø8	ø10	ø4	ø6	ø4	ø6
07	●									
08	●							●		●
09		●								
10		●							●	
11			●							
12			●						●	
19				●						●
20					●					●
21						●				●
22							●			●
23								●		●
24									●	●
26	●									●
27	●									●
28		●								●
29		●								●
30			●							●
31				●						●
33					●					●
34						●				●
35							●			●
36								●		●
37									●	●
38										●

Inch size

Mounting position Fitting type Symbol	IN side					OUT side				
	Straight		Elbow			Straight		Elbow ^{Note)}		
	ø1/4	ø5/16	ø3/8	ø1/4	ø5/16	ø3/8	ø5/32	ø1/4	ø5/32	ø1/4
57										
58	●								●	●
59		●								
60		●								●
61			●							
62			●						●	
69				●						●
70					●					●
71						●				●
72							●			●
73								●		●
74									●	●
76	●									●
77	●									●
78		●								●
79		●								●
80			●							●
81				●						●
83					●					●
84						●				●
85							●			●
86								●		●
87									●	●
88										●

Note) When the knob and the OUT piping are located on the same side, the elbow fitting is directed to the rear side (DIN rail side). Use caution to ensure the connector is not disturbed, depending on piping direction, when choosing to attach a digital pressure switch.

Knob position: Top
OUT piping position: Top

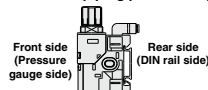

Knob position: Bottom
OUT piping position: Bottom

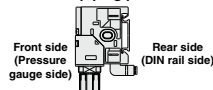

Compact Manifold Regulator Common Supply Type **ARM11A Series**

5. Accessories

Symbol	Pressure display ^{Note 1, 2)}		Supply block type ^{Note 3)}				Supply block mounting position		
	Without pressure display	With pressure display	Common supply block	Common supply block with pressure switch	3-way valve common supply block	3-way valve common supply block + Pressure switch block	L side (Left)	R side (Right)	B side (Both)
Nii	●		●				●		
A	●			●			●		
B	●				●				
C	●					●	●		
D	●		●					●	
E	●			●				●	
F	●				●			●	
G	●					●		●	
H	●		●						●
J		●	●				●		
K		●		●			●		
L		●			●		●		
M		●				●	●		
N		●	●					●	
O		●		●				●	
P		●			●			●	
Q		●				●		●	
R		●	●						●

Note 1) Pressure display means a pressure gauge or digital pressure switch is attached.

When choosing to attach a digital pressure switch is chosen for attachment, be sure to enter the symbol, referring to table 8, "Digital Pressure Switch Output Specifications". Otherwise, a pressure gauge will come with the regulator.

Note 2) Pressure gauges are not compatible with copper-free and fluorine-free specifications.

Note 3) Pressure switches are not available with the oil-free specification.

6. Semi-standard

Symbol	None	0.35 MPa setting ^{Note 1)}	Non-relieving	^{Note 2)} Oil-free
Nil	●			
1		●		
2			●	
3				●
4		●	●	
5		●		●
6			●	●
7		●	●	●

Note 1) A pressure gauge with a full span of 0.4 MPa is attached.

Note 2) The oil-free specification is grease-free in the fluid contact area.

7. Unit Representation

Symbol	Description
Nil	Display unit for product name plate and pressure gauge: MPa
Z ^{Note 1, 2)}	Display unit for product name plate and pressure gauge: psi
ZA ^{Note 1, 3)}	Digital pressure switch: with unit switching (MPa is initially set.)

Note 1) This option is available for use outside Japan only. (The SI unit has to be used in Japan.) Additionally, the pressure switch offers dual unit presentation in MPa and psi.

Note 2) The digital pressure switch is equipped with unit switching and initially set to psi.

Note 3) This option is available with the digital pressure switch. A lead wire with connector (2 m) is included.

Symbol

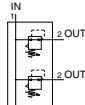

Note) A standard model is equipped with a backflow function. Main valve opens when the inlet pressure is released, and then the outlet pressure backflows into the inlet side.

8. Digital Pressure Switch Output Specifications ^{Note)}

Symbol	Details
Nil	None
N	NPN open collector
P	PNP open collector

Note) When a digital pressure switch is attached, the "pressure display" in table 5 "Accessories" will be equipped. The electrical entry is positioned on the side opposite the knob.

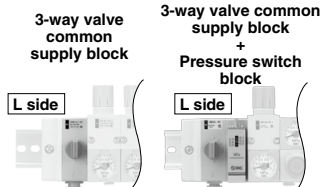
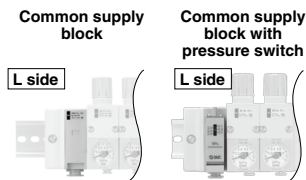
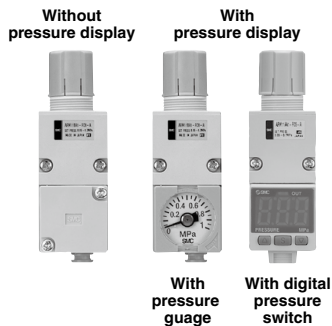

Specifications

Manifold (Regulator block, Common supply block, 3-way valve common supply block)

Regulator construction	Direct acting	
Working principal	Diaphragm regulator	
Relief mechanism	Standard	Relief type
	Optional	Non-relieving type
Backflow function ^{Note 1)}	Within (Unbalance type)	
IN side tubing O.D.	ø6, ø8, ø10, ø1/4, ø5/16, ø3/8	
OUT side tubing O.D.	ø4, ø6, ø5/32, ø1/4	
Proof pressure	1.5 MPa	
Maximum operating pressure	1.0 MPa	
Set pressure range	Standard	0.05 to 0.7 MPa
	Optional	0.05 to 0.35 MPa (Low pressure type)
Fluid	Air	
Ambient and operating fluid temperature ^{Note 2)}	5 to 60°C	

Note 1) 0.1 MPa or greater set pressure is required when used in the reverse flow.

Note 2) 5 to 50°C when the digital pressure switch will be used.

Refer to pages 734 and 736 for the digital pressure switch and pressure switch specifications.

ARM11A Series

Flow Rate Characteristics (Representative Values)

ARM11AA1-307 (One-touch fittings: IN ϕ 6, OUT ϕ 4) Condition: Inlet pressure 0.7 MPa

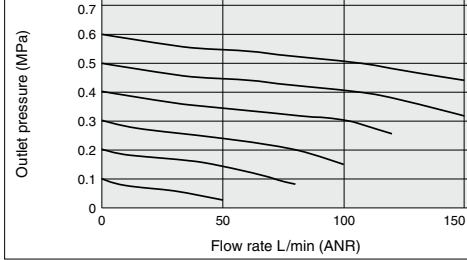

ARM11AA1-307-1 (One-touch fittings: IN ϕ 6, OUT ϕ 4) Condition: Inlet pressure 0.5 MPa

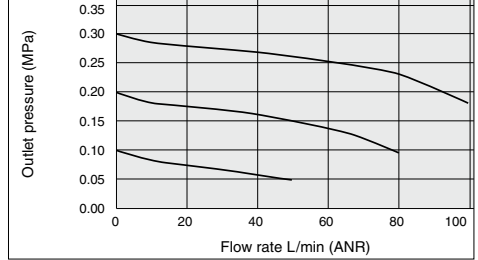

ARM11AA1-310 (One-touch fittings: IN ϕ 8, OUT ϕ 6) Condition: Inlet pressure 0.7 MPa

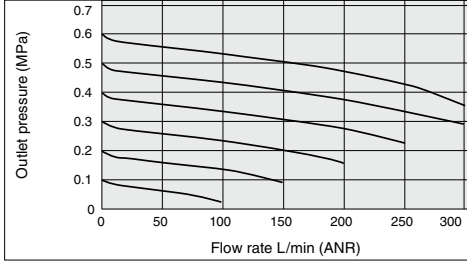

ARM11AA1-310-1 (One-touch fittings: IN ϕ 8, OUT ϕ 6) Condition: Inlet pressure 0.5 MPa

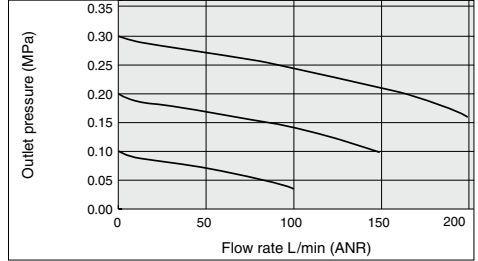

ARM11AA1-312 (One-touch fittings: IN ϕ 10, OUT ϕ 6) Condition: Inlet pressure 0.7 MPa

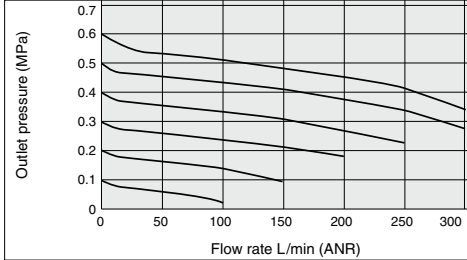

ARM11AA1-312-1 (One-touch fittings: IN ϕ 10, OUT ϕ 6) Condition: Inlet pressure 0.5 MPa

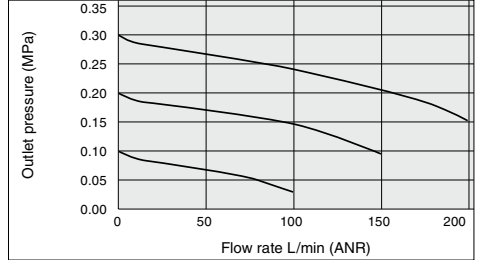

Pressure Characteristics (Representative Values)

ARM11AA1-307 Conditions: Inlet pressure 0.7 MPa, Outlet pressure 0.2 MPa, Flow rate 20 L/min (ANR)

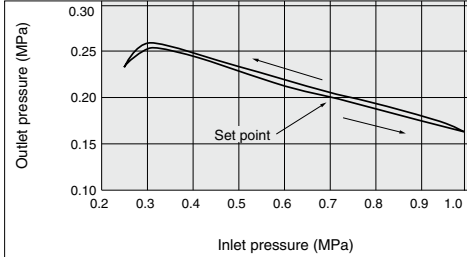

ARM11AA1-307-1 Conditions: Inlet pressure 0.5 MPa, Outlet pressure 0.2 MPa, Flow rate 20 L/min (ANR)

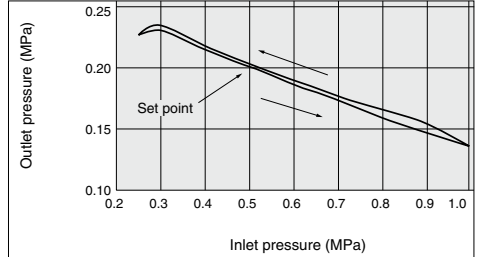

Construction

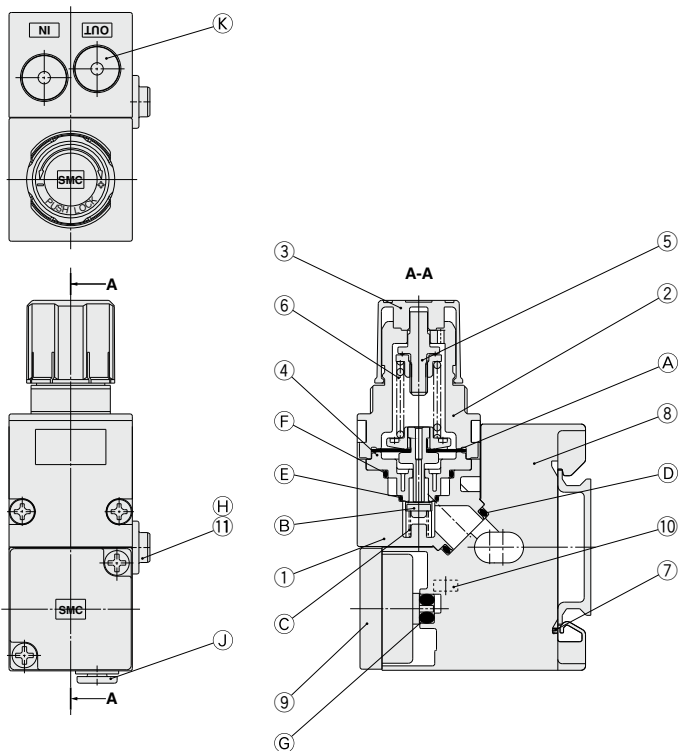

Component Parts

No.	Description	Material
1	Body for regulator block	PBT
2	Bonnet	PBT
3	Knob	POM
4	Valve seat	POM
5	Adjusting screw assembly	Reinforced steel
6	Adjustment spring	Steel wire
7	Regulator clip	Stainless steel
8	Manifold block	PBT
9	Blanking plate assembly	—
10	Square nut	Steel
11	Common exhaust bushing	POM

Replacement Parts

No.	Description	Material	Part no.	Note
A	Diaphragm assembly	Weatherproof	136126A	Relieving type
		NBR, POM	136126-1A	Non-relieving type
B	Valve	HNBR, Aluminum alloy	136127-30#1	
C	Valve spring	Stainless steel	136131	
D	Gasket	HNBR	136137-30	
		NBR	136146	Standard model
E	O-ring	HNBR	136146-30	Oil-free specification
		NBR	136147	Standard model
F	O-ring	HNBR	136147-30	Oil-free specification
		NBR	136148	Standard model
		HNBR	136148-30	Oil-free specification
G	O-ring	NBR	KA01731	Standard model for digital pressure switch
		HNBR	KA01613	Oil-free spec. for digital pressure switch
		NBR	136149	Standard model
H	O-ring	HNBR	136149-30	Oil-free specification
		—	—	Refer to page 737.
K	Port plug	PBT/HNBR	—	Refer to page 738.

ARJ

AR425
to 935

ARX

AMR

ARM

ARP

IR□-A

IR

IRV

VEX

SRH

SRP

SRF

ITV

IC

ITVH

ITVX

PVQ

VY1

VBA

VBAT

AP100

ARM11A Series

Dimensions

ARM11AA1-□12

Knob position: Top / Common supply block

For One-touch fittings part and manifold option dimensions, refer to pages 731 to 738.

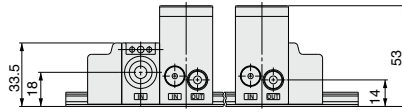
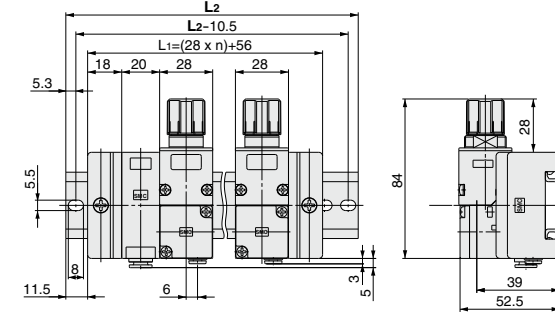

Stations	DIN rail part no. (for L and R sides)	L2 dimension
1	AXT100-DR-9	123
2	AXT100-DR-11	148
3	AXT100-DR-13	173
4	AXT100-DR-16	210.5
5	AXT100-DR-18	235.5
6	AXT100-DR-20	260.5
7	AXT100-DR-22	285.5
8	AXT100-DR-25	323
9	AXT100-DR-27	348
M	AXT100-DR-29	373

ARM11AA1-□12-A

Knob position: Top / Common supply block with pressure switch

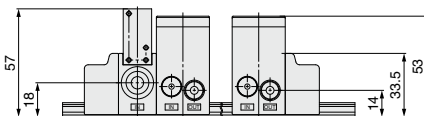
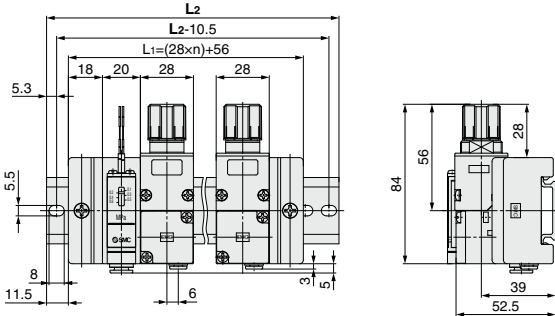

Stations	DIN rail part no. (for L and R sides)	L2 dimension
1	AXT100-DR-9	123
2	AXT100-DR-11	148
3	AXT100-DR-13	173
4	AXT100-DR-16	210.5
5	AXT100-DR-18	235.5
6	AXT100-DR-20	260.5
7	AXT100-DR-22	285.5
8	AXT100-DR-25	323
9	AXT100-DR-27	348
M	AXT100-DR-29	373

Dimensions

ARM11AA1-□12-B

Knob position: Top / 3-way valve common supply block

For One-touch fittings part and manifold option dimensions, refer to pages 731 to 738.

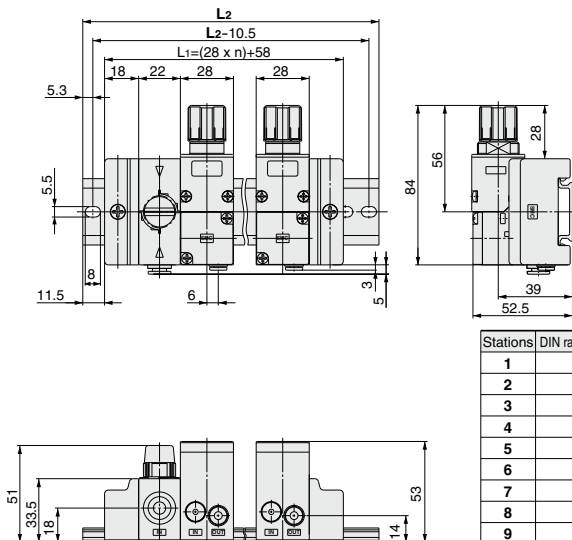

Stations	DIN rail part no. (for L and R sides)	L2 dimension
1	AXT100-DR-9	123
2	AXT100-DR-11	148
3	AXT100-DR-13	173
4	AXT100-DR-16	210.5
5	AXT100-DR-18	235.5
6	AXT100-DR-20	260.5
7	AXT100-DR-22	285.5
8	AXT100-DR-25	323
9	AXT100-DR-27	348
M	AXT100-DR-29	373

ARM11AA1-□12-C

Knob position: Top / 3-way valve common supply block + Pressure switch block

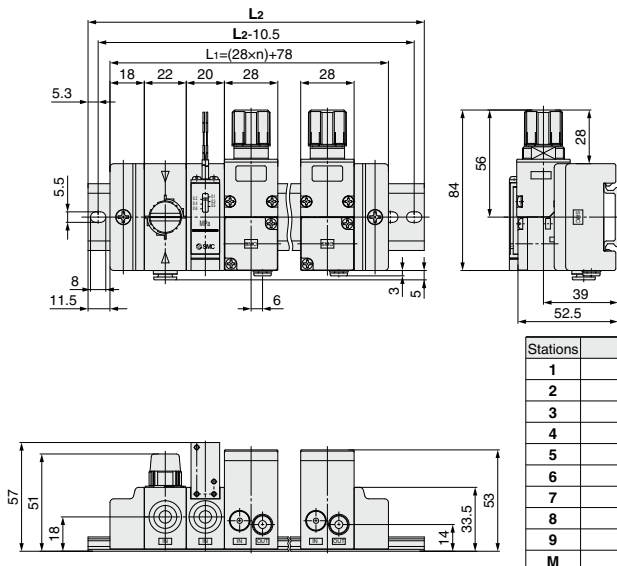

Stations	DIN rail part no.	L2 dimension
1	AXT100-DR-11	148
2	AXT100-DR-13	173
3	AXT100-DR-15	198
4	AXT100-DR-17	223
5	AXT100-DR-19	248
6	AXT100-DR-22	285.5
7	AXT100-DR-24	310.5
8	AXT100-DR-26	335.5
9	AXT100-DR-28	360.5
M	AXT100-DR-31	398

ARJ
AR425 to 935
ARX
AMR
ARM
ARP
IR□-A
IR
IRV
VEX
SRH
SRP
SRF
ITV
IC
ITVH
ITVX
PVQ
VY1
VBA
VBAT
AP100

ARM11A Series

Dimensions

ARM11AB1-□12

Knob position: Front / Common supply block

For One-touch fittings part and manifold option dimensions, refer to pages 731 to 738.

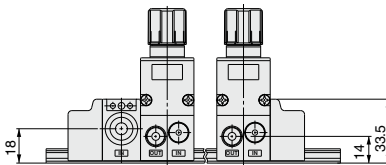
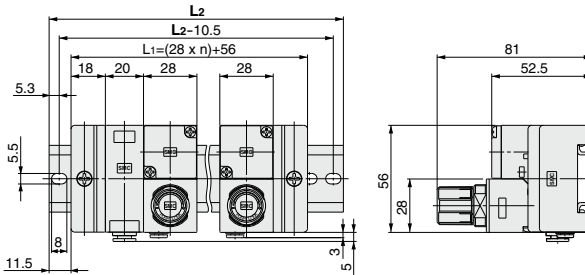

Stations	DIN rail part no.	L2 dimension
1	AXT100-DR-9	123
2	AXT100-DR-11	148
3	AXT100-DR-13	173
4	AXT100-DR-16	210.5
5	AXT100-DR-18	235.5
6	AXT100-DR-20	260.5
7	AXT100-DR-22	285.5
8	AXT100-DR-25	323
9	AXT100-DR-27	348
M	AXT100-DR-29	373

ARM11AB1-□12-A

Knob position: Front / Common supply block with pressure switch

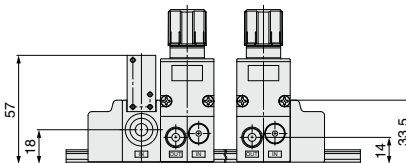
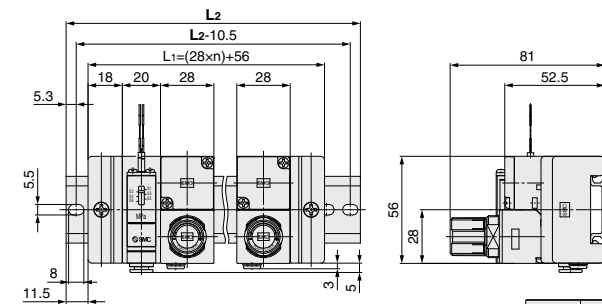

Stations	DIN rail part no.	L2 dimension
1	AXT100-DR-9	123
2	AXT100-DR-11	148
3	AXT100-DR-13	173
4	AXT100-DR-16	210.5
5	AXT100-DR-18	235.5
6	AXT100-DR-20	260.5
7	AXT100-DR-22	285.5
8	AXT100-DR-25	323
9	AXT100-DR-27	348
M	AXT100-DR-29	373

Dimensions

ARM11AB1-□12-B

Knob position: Front / 3-way valve common supply block

For One-touch fittings part and manifold option dimensions, refer to pages 731 to 738.

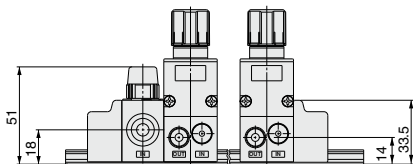
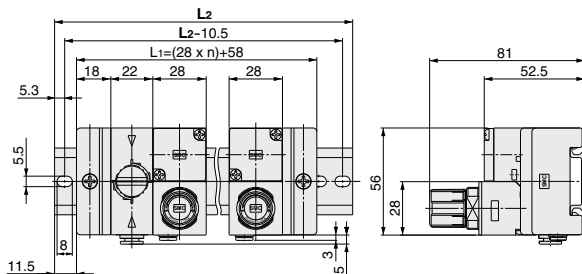

Stations	DIN rail part no.	L2 dimension
1	AXT100-DR-9	123
2	AXT100-DR-11	148
3	AXT100-DR-13	173
4	AXT100-DR-16	210.5
5	AXT100-DR-18	235.5
6	AXT100-DR-20	260.5
7	AXT100-DR-22	285.5
8	AXT100-DR-25	323
9	AXT100-DR-27	348
M	AXT100-DR-29	373

ARM11AB1-□12-C

Knob position: Front / 3-way valve common supply block + Pressure: switch block

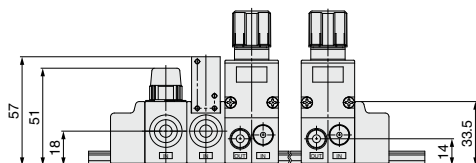
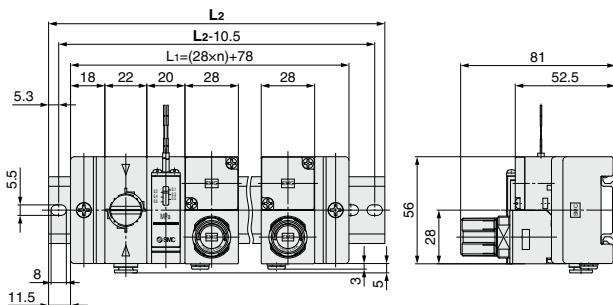

Stations	DIN rail part no.	L2 dimension
1	AXT100-DR-11	148
2	AXT100-DR-13	173
3	AXT100-DR-15	198
4	AXT100-DR-17	223
5	AXT100-DR-19	248
6	AXT100-DR-22	285.5
7	AXT100-DR-24	310.5
8	AXT100-DR-26	335.5
9	AXT100-DR-28	360.5
M	AXT100-DR-31	398

ARM11A Series

Dimensions

ARM11AC2-□12

Knob position: Bottom / Common supply block

For One-touch fittings part and manifold option dimensions, refer to pages 731 to 738.

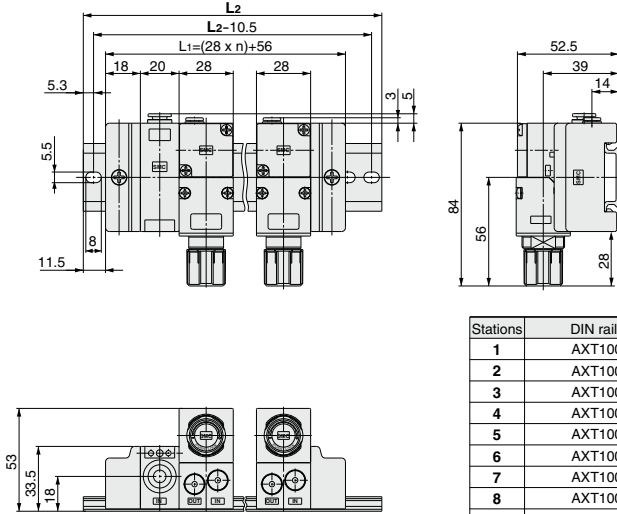

Stations	DIN rail part no.	L2 dimension
1	AXT100-DR-9	123
2	AXT100-DR-11	148
3	AXT100-DR-13	173
4	AXT100-DR-16	210.5
5	AXT100-DR-18	235.5
6	AXT100-DR-20	260.5
7	AXT100-DR-22	285.5
8	AXT100-DR-25	323
9	AXT100-DR-27	348
M	AXT100-DR-29	373

ARM11AC2-□12-A

Knob position: Bottom / Common supply block with pressure switch

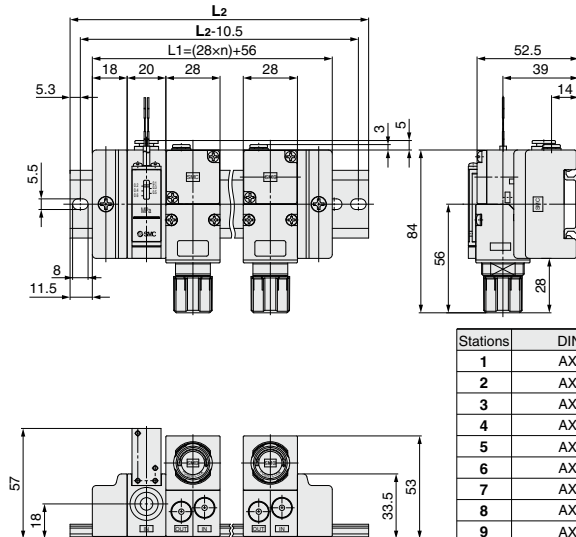

Stations	DIN rail part no.	L2 dimension
1	AXT100-DR-9	123
2	AXT100-DR-11	148
3	AXT100-DR-13	173
4	AXT100-DR-16	210.5
5	AXT100-DR-18	235.5
6	AXT100-DR-20	260.5
7	AXT100-DR-22	285.5
8	AXT100-DR-25	323
9	AXT100-DR-27	348
M	AXT100-DR-29	373

Dimensions

ARM11AC2-□12-B

Knob position: Bottom / 3-way valve common supply block

For One-touch fittings part and manifold option dimensions, refer to pages 731 to 738.

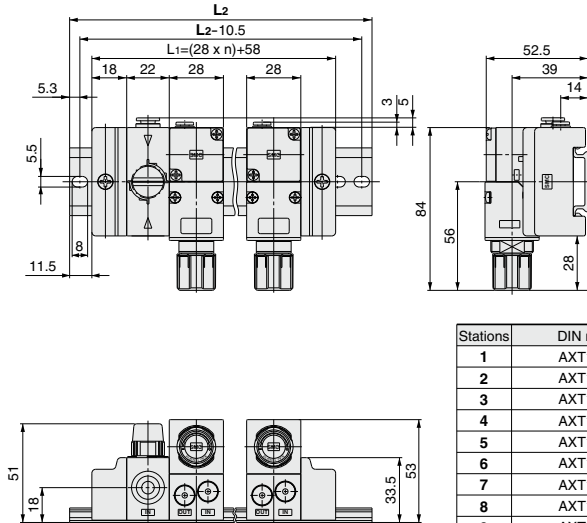

Stations	DIN rail part no.	L2 dimension
1	AXT100-DR-9	123
2	AXT100-DR-11	148
3	AXT100-DR-13	173
4	AXT100-DR-16	210.5
5	AXT100-DR-18	235.5
6	AXT100-DR-20	260.5
7	AXT100-DR-22	285.5
8	AXT100-DR-25	323
9	AXT100-DR-27	348
M	AXT100-DR-29	373

ARM11AC2-□12-C

Knob position: Bottom / 3-way valve common supply block + Pressure switch block

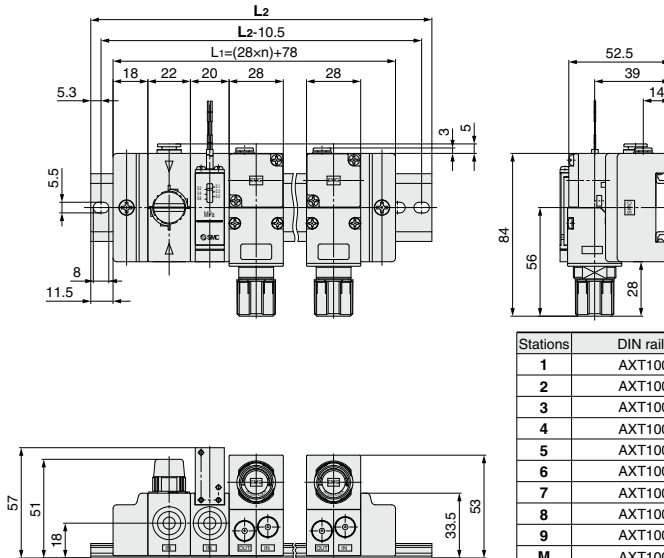

Stations	DIN rail part no.	L2 dimension
1	AXT100-DR-11	148
2	AXT100-DR-13	173
3	AXT100-DR-15	198
4	AXT100-DR-17	223
5	AXT100-DR-19	248
6	AXT100-DR-22	285.5
7	AXT100-DR-24	310.5
8	AXT100-DR-26	335.5
9	AXT100-DR-28	360.5
M	AXT100-DR-31	398

Compact Manifold Regulator

Individual Supply Type

ARM11B Series

How to Order

ARM11B **B** **1** - **3** **06** - **A** **Z** - **N**

① ② ③ ④ ⑤ ⑥ ⑦ ⑧



1. Knob Position

Symbol	Position
A	Top
B	Front
C	Bottom



2. IN/OUT Piping Position

Position Symbol	IN side		OUT side	
	Bottom	Top	Bottom	Top
1	●		●	
2		●		●
3	●			
4		●	●	

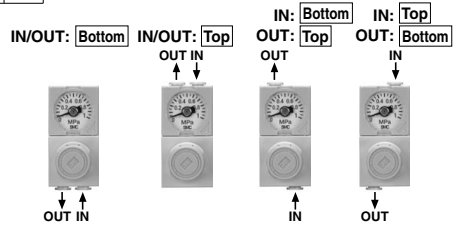

3. Regulator Block Stations

Symbol	Stations
1	1 station
2	2 stations
3	3 stations
4	4 stations
5	5 stations
6	6 stations
7	7 stations
8	8 stations
9	9 stations
M	10 stations

4. IN/OUT Fitting Type (Refer to the figure below.)

Metric size

Mounting position	Fitting type	IN side			OUT side		
		Straight	Elbow <small>(Note)</small>	Elbow <small>(Note)</small>	Straight	Elbow <small>(Note)</small>	Elbow <small>(Note)</small>
Symbol		ø4	ø6	ø4	ø6	ø4	ø6
06	●						
07		●				●	
08		●					●
18			●				●
19				●			●
20					●		●
25	●						
26		●					
27		●					●
32			●		●		
33				●	●		
34					●		●

Inch size

Mounting position	Fitting type	IN side			OUT side		
		Straight	Elbow <small>(Note)</small>	Elbow <small>(Note)</small>	Straight	Elbow <small>(Note)</small>	Elbow <small>(Note)</small>
Symbol		ø5/32	ø1/4	ø5/32	ø1/4	ø5/32	ø1/4
56	●						
57		●				●	
58		●					●
68			●				●
69				●			●
70					●		●
75	●						
76		●					
77		●					●
82			●		●		
83				●	●		
84					●		●

(Note) When the knob and the OUT piping are located on the same side, the elbow fitting is directed to the rear side (DIN rail side). Use caution to ensure the connector is not disturbed, depending on piping direction, when choosing to attach a digital pressure switch.

Knob position: Top
OUT piping position: Top

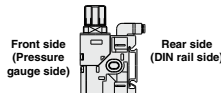

Knob position: Bottom
OUT piping position: Bottom

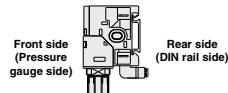

Compact Manifold Regulator Individual Supply Type **ARM11B Series**

5. Accessory (Pressure Display)

Symbol	Accessory
Nil	Without pressure display
A <small>Note 1, 2)</small>	With pressure display

Note 1) Pressure display means a pressure gauge or digital pressure switch is attached.

When choosing to attach a digital pressure switch is chosen for attachment, be sure to enter the symbol, referring to table 8, "Digital Pressure Switch Output Specifications". Otherwise, a pressure gauge will come with the regulator.

Note 2) Pressure gauges are not compatible with copper-free and fluorine-free specifications.

Without pressure display With pressure display



With pressure gauge

With digital pressure switch

7. Unit Representation

Symbol	Description
Nil	Display unit for product name plate and pressure gauge: MPa
Z <small>Note 1, 2)</small>	Display unit for product name plate and pressure gauge: psi
ZA <small>Note 1, 3)</small>	Digital pressure switch: with unit switching (MPa is initially set.)

Note 1) This option is available for use outside Japan only. (The SI unit has to be used in Japan.)

Note 2) The digital pressure switch is equipped with unit switching and initially set to psi.

Note 3) This option is available with the digital pressure switch. A lead wire with connector (2 m) is included.

8. Digital Pressure Switch Output Specifications Note)

Symbol	Details
Nil	None
N	NPN open collector
P	PNP open collector

Note) When a digital pressure switch is attached, the "pressure display" in table 5 "Accessory" will be equipped. The electrical entry is positioned on the side opposite the knob.

6. Semi-standard

Symbol	None	0.35 MPa setting <small>Note 1)</small>	Non-relieving	<small>Note 2)</small> Oil-free
Nil	●			
1		●		
2			●	
3				●
4		●	●	
5		●		●
6			●	●
7		●	●	●

Note 1) A pressure gauge with a full span of 0.4 MPa is attached.

Note 2) The oil-free specification is grease-free in the fluid contact area.

Specifications

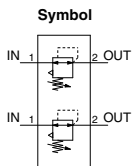

Note) A standard model is equipped with a backflow function. Main valve opens when the inlet pressure is released, and then the outlet pressure backflows into the inlet side.

Regulator construction		Direct acting
Working principal		Diaphragm regulator
Relief mechanism	Standard	Relief type
	Optional	Non-relieving type
Backflow function <small>Note 1)</small>		Within (Unbalance type)
IN side tubing O.D.		ø4, ø6, ø5/32, ø1/4
OUT side tubing O.D.		ø4, ø6, ø5/32, ø1/4
Proof pressure		1.5 MPa
Maximum operating pressure		1.0 MPa
Set pressure range	Standard	0.05 to 0.7 MPa
	Optional	0.05 to 0.35 MPa (Low pressure type)
Fluid		Air
Ambient and operating fluid temperature <small>Note 2)</small>		5 to 60°C

Note 1) 0.1 MPa or greater set pressure is required when used in the reverse flow.

Note 2) 5 to 50°C when the digital pressure switch will be used.

Refer to page 734 for the digital pressure switch specifications.

⚠ Specific Product Precautions

Be sure to read this before handling the products.
Refer to back page 50 for Safety Instructions and pages 387 to 391 for Precautions on every series.

Maintenance

⚠ Warning

1. Make sure to perform a periodic inspection of the pressure gauge when the compact manifold regulator is installed between a solenoid valve and an actuator. Sudden pressure changes could happen and the durability of the product could be reduced. Using an electronic type pressure gauge is recommended, depending on the situation.

ARM11B Series

Construction

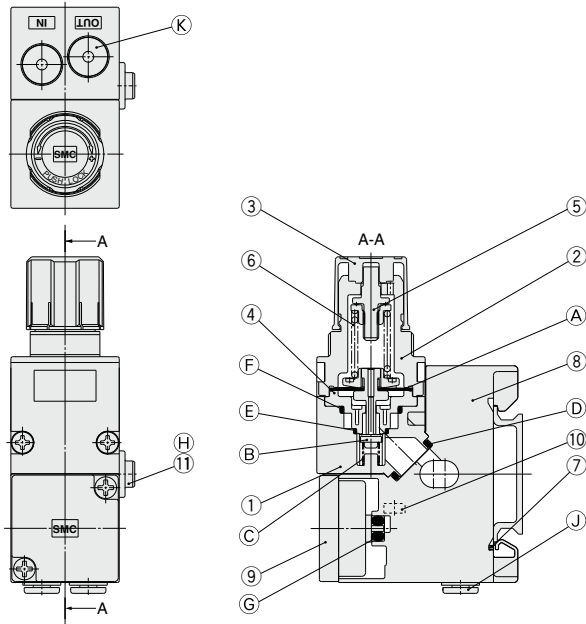

Component Parts

No.	Description	Material
1	Body for regulator block	PBT
2	Bonnet	PBT
3	Knob	POM
4	Valve seat	POM
5	Adjusting screw assembly	Reinforced steel
6	Adjustment spring	Steel wire
7	Regulator clip	Stainless steel
8	Manifold block	PBT
9	Blanking plate assembly	—
10	Square nut	Steel
11	Individual supply bushing	POM

Replacement Parts

No.	Description	Material	Part no.	Note
A	Diaphragm assembly	Weatherproof NBR, POM	136126A	Relieving type
			136126-1A	Non-relieving type
B	Valve	HNBR, Aluminum alloy	136127-30#1	
C	Valve spring	Stainless steel	136131	
D	Gasket	HNBR	136137-30	
E	O-ring	NBR	136146	Standard model
		HNBR	136146-30	Oil-free specification
F	O-ring	NBR	136147	Standard model
		HNBR	136147-30	Oil-free specification
G	O-ring	NBR	136148	Standard model
		HNBR	136148-30	Oil-free specification
		NBR	KA01731	Standard model for digital pressure switch
H	O-ring	HNBR	KA01613	Oil-free spec. for digital pressure switch
		NBR	136149	Standard model
J	Fitting assembly	—	Refer to page 737.	
		HNBR	136149-30	Oil-free specification
K	Port plug	PBT/HNBR	Refer to page 738.	

Flow Rate Characteristics (Representative Values)

ARM11BA1-306 (One-touch fittings: IN/OUT $\phi 4$) Condition: Inlet pressure 0.7 MPa

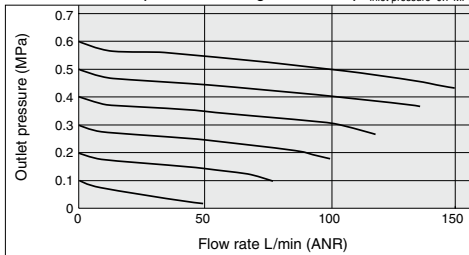

ARM11BA1-306-1 (One-touch fittings: IN/OUT $\phi 4$) Condition: Inlet pressure 0.5 MPa

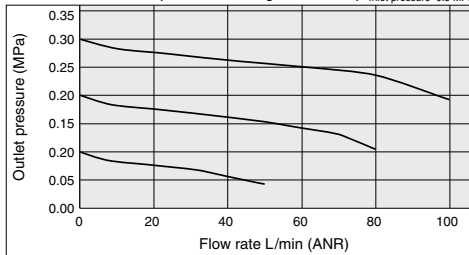

ARM11BA1-307 (One-touch fittings: IN $\phi 6$, OUT $\phi 4$) Condition: Inlet pressure 0.7 MPa

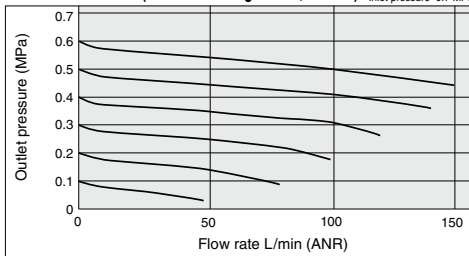

ARM11BA1-307-1 (One-touch fittings: IN $\phi 6$, OUT $\phi 4$) Condition: Inlet pressure 0.5 MPa

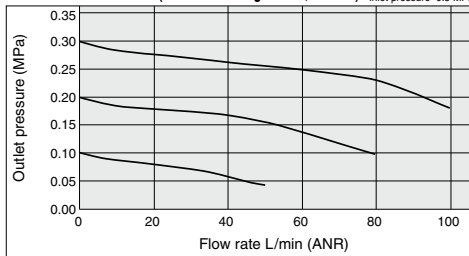

ARM11BA1-308 (One-touch fittings: IN/OUT $\phi 6$) Condition: Inlet pressure 0.7 MPa

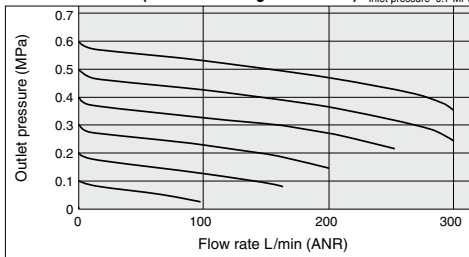

ARM11BA1-308-1 (One-touch fittings: IN/OUT $\phi 6$) Condition: Inlet pressure 0.5 MPa

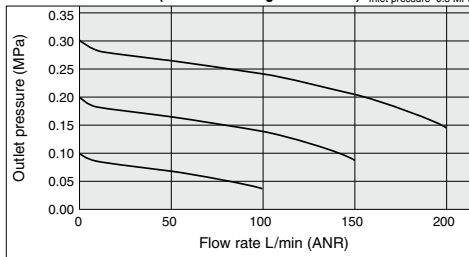

Pressure Characteristics (Representative Values)

ARM11BA1-306

Conditions: Inlet pressure 0.7 MPa
Outlet pressure 0.2 MPa
Flow rate 20 L/min (ANR)

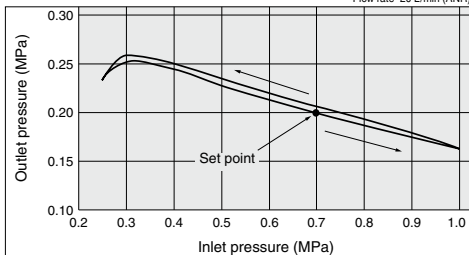

ARM11BA1-306-1

Conditions: Inlet pressure 0.5 MPa
Outlet pressure 0.2 MPa
Flow rate 20 L/min (ANR)

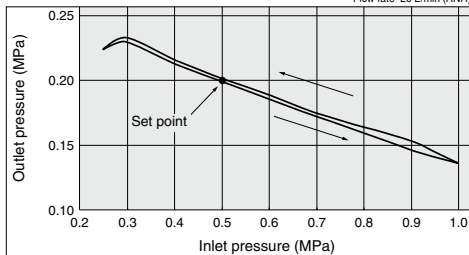

ARJ

AR425
to 935

ARX

AMR

ARM

ARP

IR□-A

IR

IRV

VEV

SRH

SRP

SRF

ITV

IC

ITVH

ITVX

PVQ

VY1

VBA

VBAT

AP100

ARM11B Series

Dimensions

ARM11BA1-□08

Knob position: Top

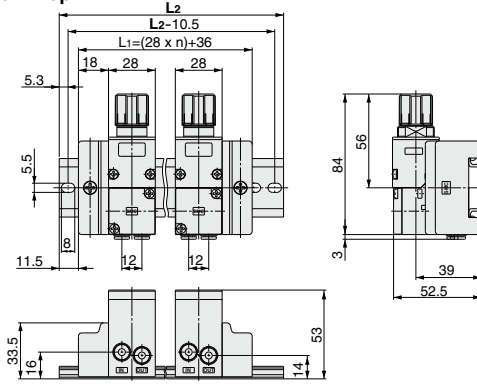

Stations	DIN rail part no.	L2 dimension
1	AXT100-DR-8	110.5
2	AXT100-DR-10	135.5
3	AXT100-DR-12	160.5
4	AXT100-DR-14	185.5
5	AXT100-DR-16	210.5
6	AXT100-DR-19	248
7	AXT100-DR-21	273
8	AXT100-DR-23	298
9	AXT100-DR-25	323
M	AXT100-DR-28	360.5

ARM11BB1-□08

Knob position: Front

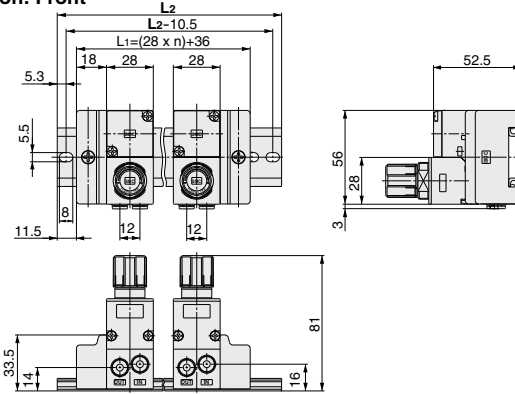

Stations	DIN rail part no.	L2 dimension
1	AXT100-DR-8	110.5
2	AXT100-DR-10	135.5
3	AXT100-DR-12	160.5
4	AXT100-DR-14	185.5
5	AXT100-DR-16	210.5
6	AXT100-DR-19	248
7	AXT100-DR-21	273
8	AXT100-DR-23	298
9	AXT100-DR-25	323
M	AXT100-DR-28	360.5

ARM11BC2-□08

Knob position: Bottom

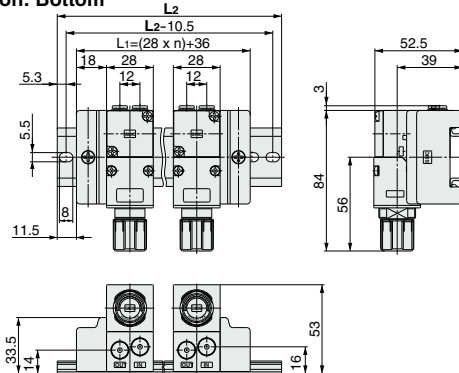

Stations	DIN rail part no.	L2 dimension
1	AXT100-DR-8	110.5
2	AXT100-DR-10	135.5
3	AXT100-DR-12	160.5
4	AXT100-DR-14	185.5
5	AXT100-DR-16	210.5
6	AXT100-DR-19	248
7	AXT100-DR-21	273
8	AXT100-DR-23	298
9	AXT100-DR-25	323
M	AXT100-DR-28	360.5

Compact Manifold Regulator Options

Common Supply Type

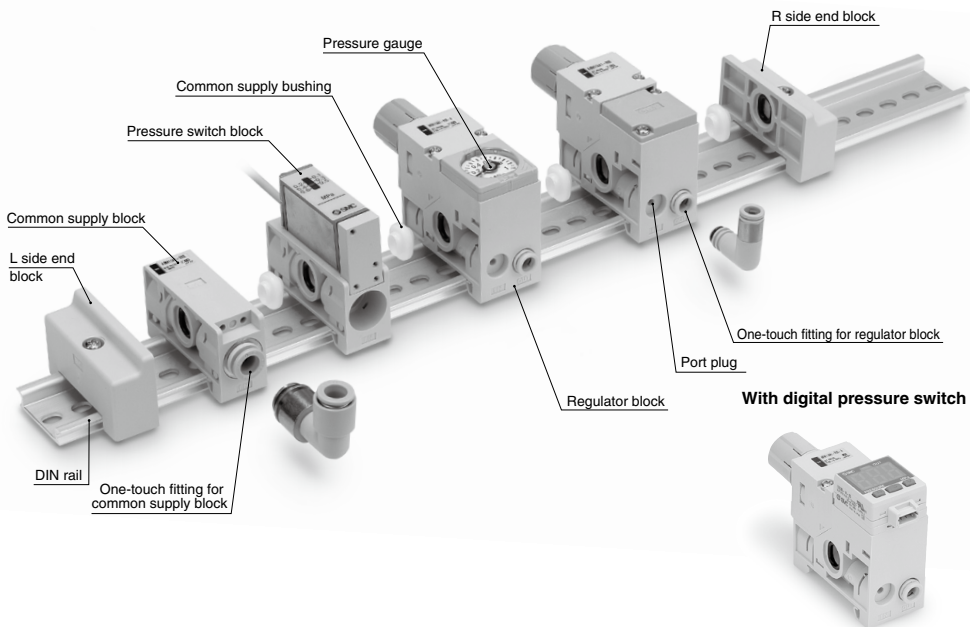

Individual Supply Type

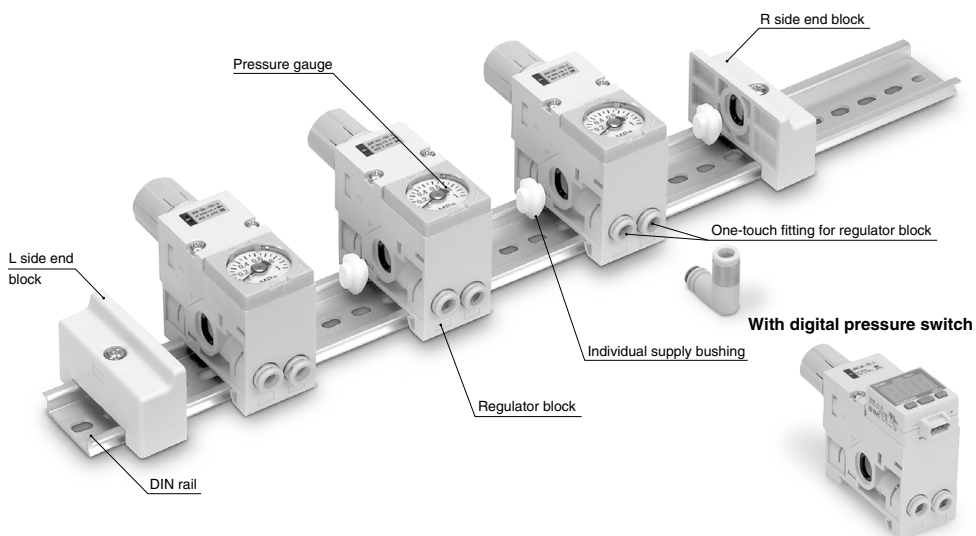

ARJ

AR425
to 935

ARX

AMR

ARM

ARP

IR□-A

IR

IRV

VEX

SRH

SRP

SRF

ITV

IC

ITVH

ITVX

PVQ

VY1

VBA

VBAT

AP100

ARM11A/B Series

Regulator Block

Common Supply Type

ARM11A **A** **1** - R **04** - **A** **Z** - **N**

① ② ③ ④ ⑤ ⑥ ⑦

1. Knob Position

Symbol	Position
A	Top
B	Front
C	Bottom

Knob position **Top**

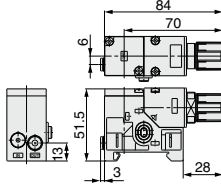

Knob position **Front**

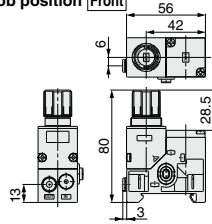

Knob position **Bottom**

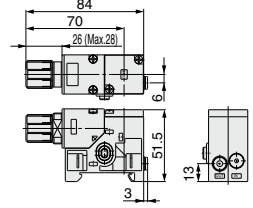

2. OUT Piping Position

Symbol	Position
1	Bottom
2	Top

3. OUT Fitting Type

Metric size

Fitting type Symbol	Straight		Elbow	
	ø4	ø6	ø4	ø6
04	●			
05		●		
16			●	
17				●

Inch size

Fitting type Symbol	Straight		Elbow	
	ø5/32	ø1/4	ø5/32	ø1/4
54	●			
55		●		
66			●	
67				●

4. Accessory (Pressure Display)

Symbol	Accessory
Nil	Without pressure display
A <small>Note 1, 2)</small>	With pressure display

Note 1) Pressure display means a pressure gauge or digital pressure switch is attached.

When choosing to attach a digital pressure switch is chosen for attachment, be sure to enter the symbol, referring to table 7, "Digital Pressure Switch Output Specifications".

Otherwise, a pressure gauge will come with the regulator.

Note 2) Pressure gauges are not compatible with copper-free and fluorine-free specifications.

5. Semi-standard

Symbol	None	Note 2)		
		0.35 MPa setting <small>Note 1)</small>	Non-relieving	Oil-free
Nil	●			
1		●		
2			●	
3				●
4		●	●	
5		●		●
6			●	●
7		●	●	●

Note 1) A pressure gauge with a full span of 0.4 MPa is attached.

Note 2) The oil-free specification is grease-free in the fluid contact area.

6. Unit Representation

Symbol	Description
Nil	Display unit for product name plate and pressure gauge: MPa
Z <small>Note 1, 2)</small>	Display unit for product name plate and pressure gauge: psi
ZA <small>Note 1, 3)</small>	Digital pressure switch: with unit switching (MPa is initially set.)

Note 1) This option is available for use outside Japan only. (The SI unit has to be used in Japan.) Additionally, the pressure switch offers dual unit presentation in MPa and psi.

Note 2) The digital pressure switch is equipped with unit switching and initially set to psi.

Note 3) This option is available with the digital pressure switch.

7. Digital Pressure Switch Output Specifications Note)

Symbol	Details
Nil	None
N	NPN open collector
P	PNP open collector

Note) When a digital pressure switch is attached, the "pressure display" in table 4 "Accessory" will be equipped. The electrical entry is positioned on the side opposite the knob.

Regulator Block

Individual Supply Type **ARM11B** **A** **1** - **R** **06** - **A** **Z** - **N**

① ② ③ ④ ⑤ ⑥ ⑦

1. Knob Position

Symbol	Position
A	Top
B	Front
C	Bottom

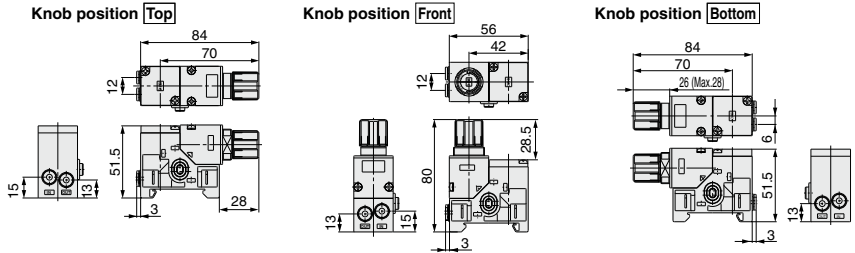

2. IN/OUT Piping Position

Position Symbol	IN side		OUT side	
	Bottom	Top	Bottom	Top
1	●		●	
2		●		●
3	●			●
4		●	●	

3. IN/OUT Fitting Type

Metric size

Mounting position	IN side				OUT side			
	Straight		Elbow		Straight		Elbow	
	Symbol	ø4	ø6	ø4	ø6	ø4	ø6	
06	●				●			
07		●					●	
08		●				●		
18			●				●	
19				●			●	
20				●			●	
25	●						●	
26		●					●	
27		●					●	
32			●		●			
33			●		●			
34				●		●		

Inch size

Mounting position	IN side				OUT side			
	Straight		Elbow		Straight		Elbow	
	Symbol	ø5/32	ø1/4	ø5/32	ø1/4	ø5/32	ø1/4	
56	●				●			
57		●					●	
58		●				●		
68			●				●	
69				●			●	
70				●			●	
75	●						●	
76		●					●	
77		●					●	
82			●		●			
83			●		●			
84				●		●		

4. Accessory (Pressure Display)

Symbol	Accessory
Nil	Without pressure display
A <small>Note 1, 2)</small>	With pressure display

Note 1) Pressure display means a pressure gauge or digital pressure switch is attached.

When choosing to attach a digital pressure switch is chosen for attachment, be sure to enter the symbol, referring to table 7, "Digital Pressure Switch Output Specifications".

Otherwise, a pressure gauge will come with the regulator.

Note 2) Pressure gauges are not compatible with copper-free and fluorine-free specifications.

5. Semi-standard

Symbol	None	0.35 MPa setting <small>Note 1)</small>	Non-relieving	<small>Note 2)</small> Oil-free
Nil	●			
1		●		
2			●	
3				●
4		●	●	
5		●		●
6			●	●
7		●		●

Note 1) A pressure gauge with a full span of 0.4 MPa is attached.

Note 2) The oil-free specification is grease-free in the fluid contact area.

6. Unit Representation

Symbol	Description
Nil	Display unit for product name plate and pressure gauge: MPa
Z <small>Note 1, 2)</small>	Display unit for product name plate and pressure gauge: psi
ZA <small>Note 1, 3)</small>	Digital pressure switch: with unit switching (MPa is initially set.)

Note 1) This option is available for use outside Japan only. (The SI unit has to be used in Japan.) Additionally, the pressure switch offers dual unit presentation in MPa and psi.

Note 2) The digital pressure switch is equipped with unit switching and initially set to psi.

Note 3) This option is available with the digital pressure switch.

7. Digital Pressure Switch Output Specifications Note)

Symbol	Details
Nil	None
N	NPN open collector
P	PNP open collector

Note) When a digital pressure switch is attached, the "pressure display" in table 4 "Accessory" will be equipped. The electrical entry is positioned on the side opposite the knob.

ARJ

AR425 to 935

ARX

AMR

ARM

ARP

IR□-A

IR

IRV

IRV

IRV

IRV

IRV

IRV

IRV

IRV

IRV

IRV

IRV

IRV

IRV

IRV

IRV

IRV

IRV

IRV

IRV

IRV

IRV

Digital Pressure Switch

Specifications

Rated pressure range	0 to 1 MPa
Display/Set pressure range	-0.1 to 1 MPa
Withstand pressure	1.5 MPa
Display/Minimum setting unit	0.01 MPa
Applicable fluid	Air, Non-corrosive gas, Non-flammable gas
Power supply voltage	12 to 24 VDC $\pm 10\%$, Ripple (p-p) 10% or less (With power supply polarity protection)
Current consumption	55 mA or less (at no load)
Switch output	NPN or PNP open collector output: 1 output
Max. load current	80 mA
Max. applied voltage	30 V (With NPN output)
Residual voltage	1 V or less (With load current of 80 mA)
Response time	1 s (0.25, 0.5, 2, 3 selections)
Short circuit protection	Yes
Repeatability	$\pm 1\%$ F.S.
Hysteresis	Adjustable (can be set from 0)
Hysteresis mode	
Window comparator mode	
Display	3-digit, 7-segment indicator, 2-color display (Red/Green) A switch can be operated simultaneously.
Display accuracy	$\pm 2\%$ F.S. ± 1 digit (at 25°C $\pm 3^\circ\text{C}$ ambient temperature)
Indicator light	Illuminates when output is ON. (Green)
Environmental resistance	IP40
Enclosure	
Operating temperature range	- 5 to 50°C (No freezing or condensation)
Lead wire with connector ^{Note)} (Option: L)	$\phi 3.4$ 3-wire 25 AWG 2 m With connector cover
Weight	Approx. 14g (body only)/Approx. 38g (including lead wire with connector)
Standards	CE, UL, CSA, RoHS

Note) Refer to the Operation Manual in SMC's website (<http://www.smcworld.com>) for wiring.

Model

ISE35 - N - 25 - M - X501

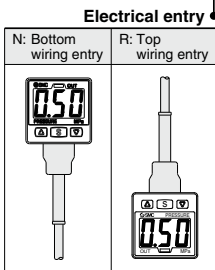

Output specification

Symbol	Details
25	NPN output
65	PNP output

Unit specification

Symbol	Description
M	Fixed SI unit
Ni ^{Note)}	With unit switching (Initial value: MPa)
P ^{Note)}	With unit switching (Initial value: psi)

Note) This option is available for use outside Japan only. (The SI unit has to be used in Japan.) A unit plate is attached.

Option/Part No

When optional parts are required separately, use the following part numbers to place an order.

Part no.	Options
ZS-32-A	Lead wire with connector (2m)
ZS-32-D	Accessories (adapter, O-ring (1 pc.), mounting screw (2 pcs.), lock pin)

Refer to Best Pneumatics No. 8 for Pressure Switch Precautions, and the Operation Manual on SMC's website for Specific Product Precautions.

Dimensions

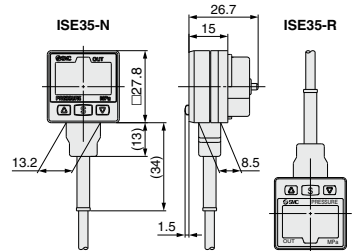

Lead wire with connector

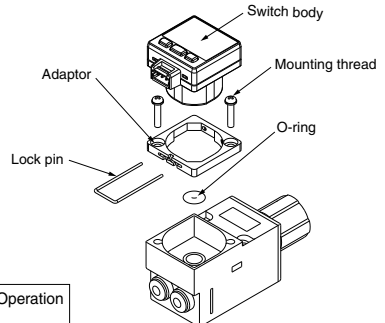
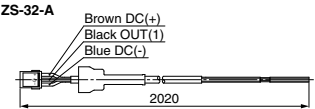

Common Supply Block

ARM11A 1 - S 01 - 3 A Z

① ② ③ ④ ⑤ ⑥

1. IN Piping Position

Symbol	Position
1	Bottom
2	Top

3. IN Fitting Type

Fitting type Symbol	Metric size			Inch size		
	Straight	Elbow		Straight	Elbow	
01	●	●		●	●	
02		●			●	
03			●			●
13			●		●	
14						●
15						●

4. Option

Symbol	Description
NII	None
3	Oil-free

(Note) The oil-free type has non-greased fluid contact areas.

5. Accessory

Symbol	Description
NII	Pressure switch lead wire length: 0.5 m
A	Pressure switch lead wire length: 3.0 m

(Note) Leave the field blank for types without pressure switch.

6. Unit Representation

Symbol	Description
NII	Display unit for product name plate: MPa
Z (Note)	Display unit for product name plate: psi

(Note) This option is available for use outside Japan only. (The SI unit has to be used in Japan.) Additionally, the pressure switch offers dual unit presentation in MPa and psi.

2. Common Supply Block Type

Symbol	Description
S	Common supply block
P	Common supply block with pressure switch
V	3-way valve common supply block
W	3-way valve common supply block + Pressure switch block

(Note) The oil-free specification is not available for P and W types of common supply blocks (types with pressure switch).

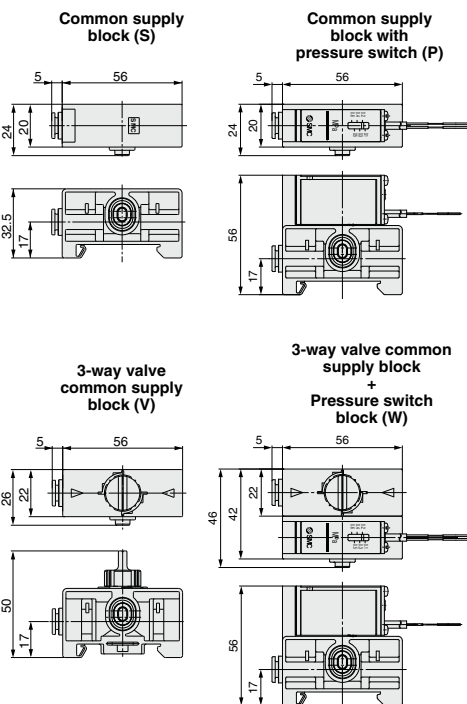

ARM

ARM11A/B Series

ARM

ARM

ARM

ARM

ARM

ARM

ARM

ARM

ARM

ARM

ARM

ARM

ARM

ARM

ARM

ARM

ARM

ARM

ARM

ARM

ARM

ARM11A/B Series

Pressure Switch Block

ARM11AW-**A****Z**

① ②

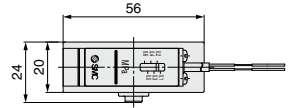

1. Accessory

Symbol	Description
NII	Pressure switch lead wire length: 0.5 m
A	Pressure switch lead wire length: 3.0 m

2. Unit Representation

Symbol	Description
NII	Display unit for product name plate: MPa
Z ^(Note)	Display unit for product name plate: psi

Note) This option is available for use outside Japan only. (The SI unit has to be used in Japan.) Additionally, the pressure switch offers dual unit presentation in MPa and psi.

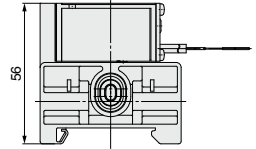

Specifications

Pressure switch (Common supply block with pressure switch, 3-way valve common supply block plus pressure switch block)

Contact type	Reed type		
Contact construction	Reed switch type		
Contact component	1a		
Reed switch action	Piston type (built-in magnet)		
Wiring specification	Grommet type		
Wiring length	0.5 m (standard model)		
Proof pressure	1.0 MPa		
Maximum operating pressure	0.7 MPa		
Set pressure range	0.1 to 0.6 MPa		
Hysteresis	0.08 MPa or less		
Repeatability	±0.05 MPa		
Maximum contact capacity	AC 2 VA, DC 2 W		
Operating voltage AC, DC	24 V or less	48 V	100 V
Max. operating current and range	50 mA	40 mA	20 mA
Impact resistance	30 G		
Environmental resistance Enclosure	IP40		

Set Pressure Range

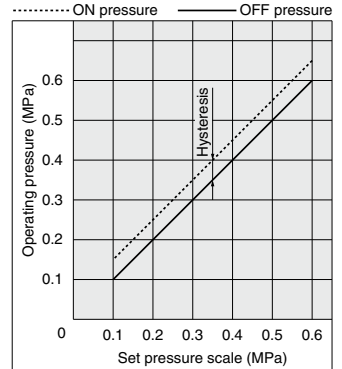

Electric Circuit

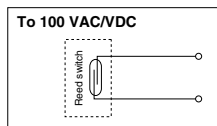

DIN Rail

When only DIN rail is required:

DIN rail part no.

AXT100-DR-7

L dimension

Select L dimension from the table below and enter an applicable symbol.

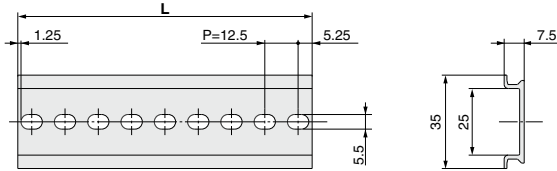

L Dimension

$L=12.5 \times n + 10.5$

Symbol	1	2	3	4	5	6	7	8	9	10
L	23	35.5	48	60.5	73	85.5	98	110.5	123	135.5

Symbol	11	12	13	14	15	16	17	18	19	20
L	148	160.5	173	185.5	198	210.5	223	235.5	248	260.5

Symbol	21	22	23	24	25	26	27	28	29	30
L	273	285.5	298	310.5	323	335.5	348	360.5	373	385.5

Symbol	31	32	33	34	35	36	37	38	39	40
L	398	410.5	423	435.5	448	460.5	473	485.5	498	510.5

One-touch Fittings for Regulator Block

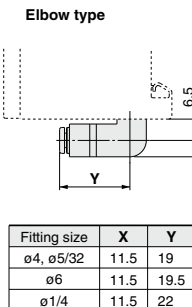
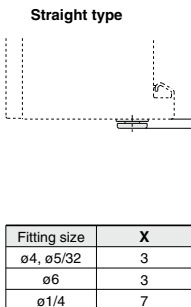
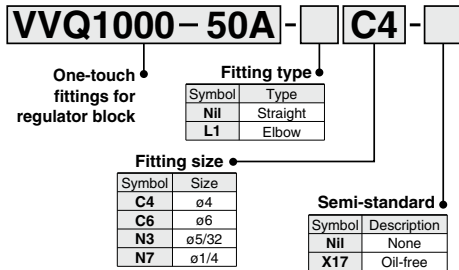

One-touch Fittings for Common Supply Block

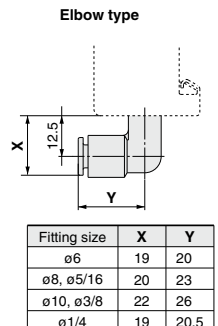
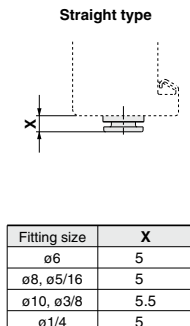
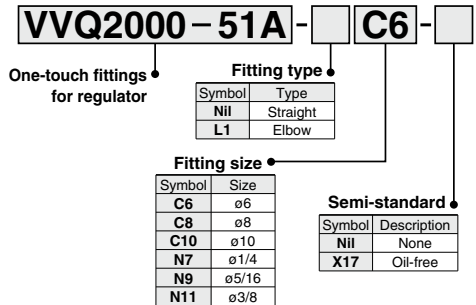

ARM11A/B Series

End Block

ARM11E L -

End block

End block type

Symbol	Mounting position
L	Left side
R	Right side

Semi-standard

Symbol	Description
Nil	None
3	Oil-free

Note) Since the L side end block is oil-free, leave the field blank for it.

L side end block

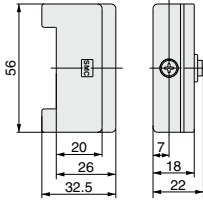

R side end block

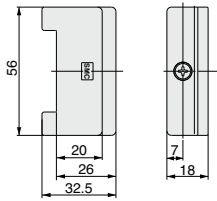

Pressure Gauge

Part no.	Pressure gauge indication range	Indication unit
GC3-4A-X2101	0 to 0.4 MPa	MPa
GC3-10A-X2101	0 to 1.0 MPa	
GC3-P4A-X2101	0 to 60 psi	psi
GC3-P10A-X2101	0 to 150 psi	

Specifications

Display accuracy	±3%F.S. (Full Span)
Calibration angle	230°
Limit indicator	With limit indicator

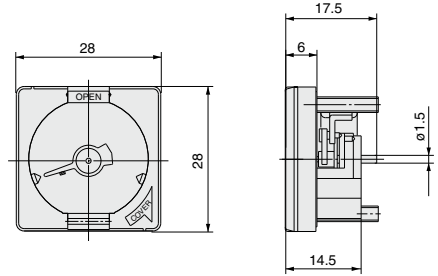

Port Plug

VVQ0000 -58A -

Single unit regulator /
Port plug for regulator block

Semi-standard

Symbol	Description
Nil	None
X17	Oil-free

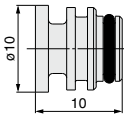

Bushing

Part no.	Description
136144-S	Common supply bushing
136144-K	Individual supply bushing

136144-S

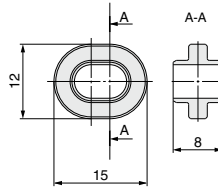

136144-K

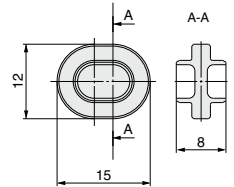

Regulator

Single Unit Type

ARM10 Series

How to Order

Standard Type **ARM10** - **06** **B** - **1** **Z** - **N**

① ② ③ ④ ⑤

1. IN/OUT Fitting Type

Metric size

Mounting position Fitting type Symbol	IN side				OUT side			
	Straight	Elbow	Note 1)		Straight	Elbow	Note 2)	
06	●							
07		●			●			
08		●				●		
18			●				●	
19				●				●
20				●				●
25	●							●
26		●						●
27		●						●
32			●		●			
33				●		●		
34				●			●	

Inch size

Mounting position Fitting type Symbol	IN side				OUT side			
	Straight	Elbow	Note 1)		Straight	Elbow	Note 2)	
56	●							
57		●			●			
58		●				●		
68			●				●	
69				●				●
70				●				●
75	●							●
76		●						●
77		●						●
82			●		●			
83				●		●		
84				●			●	

Straight

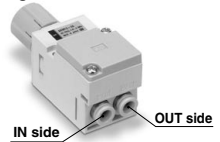

Elbow

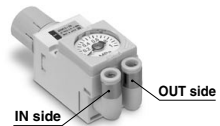

Note 2) Use caution to ensure the connector is not disturbed, depending on piping direction, when choosing to attach a digital pressure switch.

2. Accessories

Symbol	None	Note 1)		Note 2)	
		Bracket	Pressure gauge	Panel nut	Panel nut
NII	●				●
B		●			
G			●		
P					●
BG		●	●		●
GP			●		●

Note 1) In case of a type with bracket, the panel nut is included.

Note 2) Pressure display means a pressure gauge or digital pressure switch is attached.

When choosing to attach a digital pressure switch is chosen for attachment, be sure to enter the symbol, referring to table 5, "Digital Pressure Switch Output Specifications". Otherwise, a pressure gauge will come with the regulator. Additionally, pressure gauges are not compatible with copper-free and fluorine-free specifications.

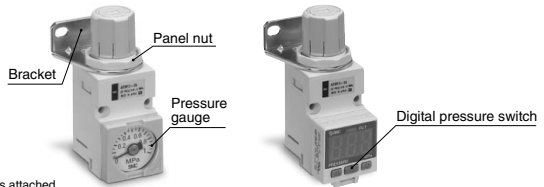

3. Semi-standard

Symbol	None	0.35 MPa setting		Non-relieving	Note 2)
		setting	Oil-free		
NII	●				
1		●			
2				●	
3					●
4		●		●	
5		●			●
6				●	●
7		●		●	●

Note 1) A pressure gauge with a full span of 0.4 MPa is attached.

Note 2) The oil-free specification is grease-free in the fluid contact area.

5. Digital Pressure Switch Output Specifications ^{Note 2)}

Symbol	Details
NII	None
N	NPN open collector
P	PNP open collector

Note) When a digital pressure switch is attached, the "pressure display" in table 2 "Accessories" will be equipped. The electrical entry is positioned on the side opposite the knob.

4. Unit Representation

Symbol	Description
NII	Display unit for product name plate and pressure gauge: MPa
Z ^{Note 1, 2)}	Display unit for product name plate and pressure gauge: psi
ZA ^{Note 1, 3)}	Digital pressure switch: with unit switching (MPa is initially set.)

Note 1) This option is available for use outside Japan only. (The SI unit has to be used in Japan.) Additionally, the pressure switch offers dual unit presentation in MPa and psi.

Note 2) The digital pressure switch is equipped with unit switching and initially set to psi.

Note 3) This option is available with the digital pressure switch. A lead wire with connector (2 m) is included.

- ARJ
- AR425 to 935
- ARX
- AMR
- ARM
- ARP
- IR□-A
- IR
- IRV
- VEV
- SRH
- SRP
- SRF
- ITV
- IC
- ITVH
- ITVX
- PVQ
- VY1
- VBA
- VBAT
- AP100



Front Knob Type **ARM10F** 1 - 06 B - [] Z - N

① ② ③ ④ ⑤ ⑥

1. IN/OUT Piping Position

Position Symbol	IN side		OUT side	
	Bottom	Top	Bottom	Top
1	●		●	
2		●		●
3	●			●
4		●	●	

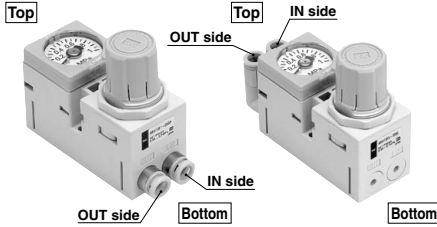

Example of panel mounting



2. IN/OUT Fitting Type

Metric size

Mounting position Fitting type Symbol	IN side				OUT side			
	Straight		Elbow ^{Note 1)}		Straight		Elbow ^{Note 1)}	
	ø4	ø6	ø4	ø6	ø4	ø6	ø4	ø6
06	●				●			
07		●			●			
08			●			●		
18				●			●	
19							●	
20					●			●
25	●						●	
26		●					●	
27			●					●
32				●		●		
33					●	●		
34				●			●	

Inch size

Mounting position Fitting type Symbol	IN side				OUT side			
	Straight		Elbow ^{Note 1)}		Straight		Elbow ^{Note 1)}	
	ø5/32	ø1/4	ø5/32	ø1/4	ø5/32	ø1/4	ø5/32	ø1/4
56	●				●			
57		●			●			
58			●			●		
68				●			●	
69							●	
70					●			●
75	●						●	
76		●					●	
77			●					●
82				●		●		
83					●	●		
84				●			●	

Note) Use caution to ensure the connector is not disturbed, depending on piping direction, when choosing to attach a digital pressure switch.

3. Accessories

Symbol	None	Note 1)	Note 2)	Panel nut	Note 3)
		Bracket	Pressure display		Decorative cover
Nil	●				
B		●		●	
G			●		
BG		●	●	●	
GP			●	●	●
GPC ^{Note 4)}			●	●	●

Note 1) In case of a type with bracket, the panel nut is included.

Note 2) Pressure display means a pressure gauge or digital pressure switch is attached.

When choosing to attach a digital pressure switch is chosen for attachment, be sure to enter the symbol, referring to table 6, "Digital Pressure Switch Output Specifications". Otherwise, a pressure gauge will come with the regulator.

Additionally, pressure gauges are not compatible with copper-free and fluorine-free specifications.

Note 3) Not attachable to a model with digital pressure switch.

Note 4) Please note that the dimensions will be bigger when GPC is selected.

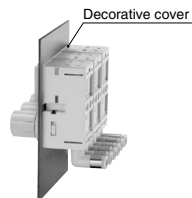
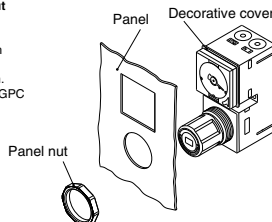
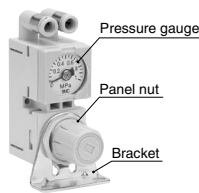

4. Semi-standard

Symbol	None	0.35 MPa setting ^{Note 1)}	Non-relieving	^{Note 2)} Oil-free
NII	●			
1		●		
2			●	
3				●
4		●	●	
5		●		●
6			●	●
7		●	●	●

Note 1) A pressure gauge with a full span of 0.4 MPa is attached.

Note 2) The oil-free specification is grease-free in the fluid contact area.

6. Digital Pressure Switch Output Specifications ^{Note)}

Symbol	Details
NII	None
N	NPN open collector
P	PNP open collector

Note) When a digital pressure switch is attached, the "pressure display" in table 3 "Accessories" will be equipped.

The electrical entry is positioned on the side opposite the knob.

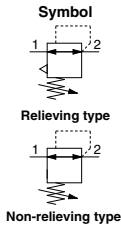

Note) A standard model is equipped with a backflow function. Main valve opens when the inlet pressure is released, and then the outlet pressure backflows into the inlet side.

5. Unit Representation

Symbol	Description
NII	Display unit for product name plate and pressure gauge: MPa
Z ^{Note 1, 2)}	Display unit for product name plate and pressure gauge: psi
ZA ^{Note 1, 3)}	Digital pressure switch: with unit switching (MPa is initially set).

Note 1) This option is available for use outside Japan only. (The SI unit has to be used in Japan.)

Note 2) The digital pressure switch is equipped with unit switching and initially set to psi.

Note 3) This option is available with the digital pressure switch. A lead wire with connector (2 m) is included.

Specifications

Model		ARM10	ARM10F
Regulator construction		Direct acting	
Working principal		Diaphragm regulator	
Relief mechanism	Standard	Relief type	
	Optional	Non-relieving type	
Backflow function ^{Note 1)}		Within (unbalance type)	
IN side tubing O.D.		ø4, ø6, ø5/32, ø1/4	
OUT side tubing O.D.		ø4, ø6, ø5/32, ø1/4	
Proof pressure		1.5 MPa	
Maximum operating pressure		1.0 MPa	
Set pressure range	Standard	0.05 to 0.7 MPa	
	Optional	0.05 to 0.35 MPa (Low pressure type)	
Fluid		Air	
Ambient and operating fluid temperature ^{Note 2)}		5 to 60°C	
Weight		60 g	72 g

Note 1) 0.1 MPa or greater set pressure is required when used in the reverse flow.

Note 2) 5 to 50°C when the digital pressure switch will be used.

Refer to page 734 for the digital pressure switch specifications.

⚠ Specific Product Precautions

Be sure to read this before handling the products.
 Refer to back page 50 for Safety Instructions and pages 387 to 391 for Precautions on every series.

Maintenance

⚠ Warning

1. Make sure to perform a periodic inspection of the pressure gauge when the compact manifold regulator is installed between a solenoid valve and an actuator. Sudden pressure changes could happen and the durability of the product could be reduced. Using an electronic type pressure gauge is recommended, depending on the situation.

ARJ
AR425 to 935
ARX
AMR
ARM
ARP
IR□-A
IR
IRV
VEV
SRH
SRP
SRF
ITV
IC
ITVH
ITVX
PVQ
VY1
VBA
VBAT
AP100

ARM10 Series

Flow Rate Characteristics (Representative Values)

ARM10F□-06

ARM10-06 (One-touch fittings: IN/OUT $\phi 4$) Condition: Inlet pressure 0.7 MPa

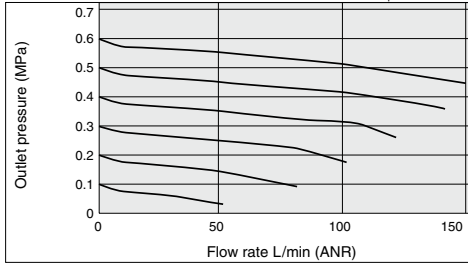

ARM10F□-06-1

ARM10-06-1 (One-touch fittings: IN/OUT $\phi 4$) Condition: Inlet pressure 0.5 MPa

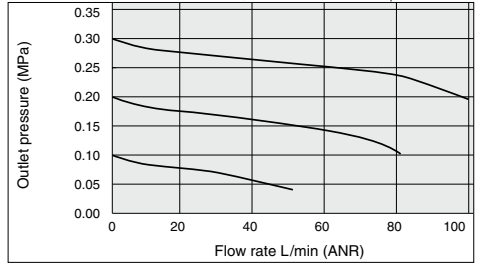

ARM10F□-07

ARM10-07 (One-touch fittings: IN $\phi 6$, OUT $\phi 4$) Condition: Inlet pressure 0.7 MPa

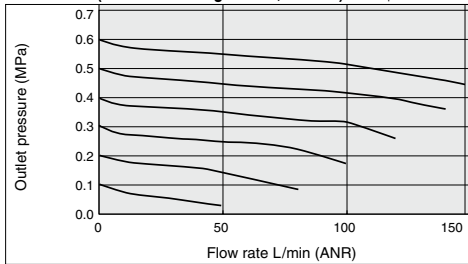

ARM10F□-07-1

ARM10-07-1 (One-touch fittings: IN $\phi 6$, OUT $\phi 4$) Condition: Inlet pressure 0.5 MPa

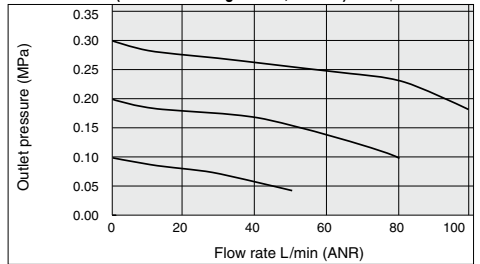

ARM10F□-08

ARM10-08 (One-touch fittings: IN/OUT $\phi 6$) Condition: Inlet pressure 0.7 MPa

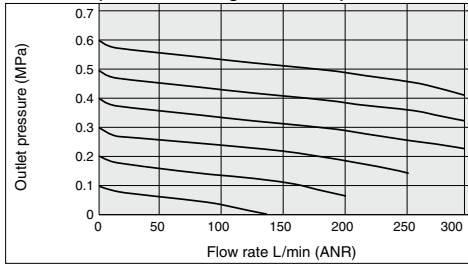

ARM10F□-08-1

ARM10-08-1 (One-touch fittings: IN/OUT $\phi 6$) Condition: Inlet pressure 0.5 MPa

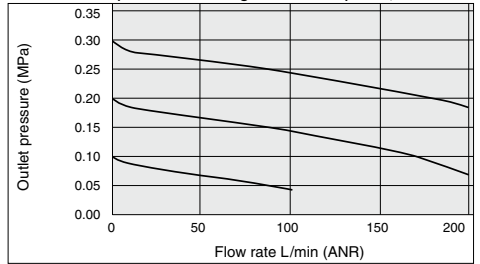

Pressure Characteristics (Representative Values)

ARM10F□-06

ARM10-06 Conditions: Inlet pressure 0.7 MPa, Outlet pressure 0.2 MPa, Flow rate 20 L/min (ANR)

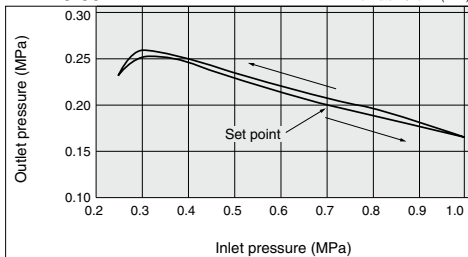

ARM10F□-06-1

ARM10-06-1 Conditions: Inlet pressure 0.5 MPa, Outlet pressure 0.2 MPa, Flow rate 20 L/min (ANR)

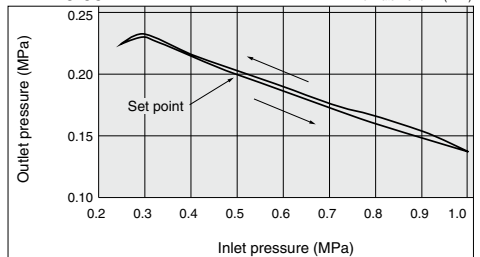

Construction

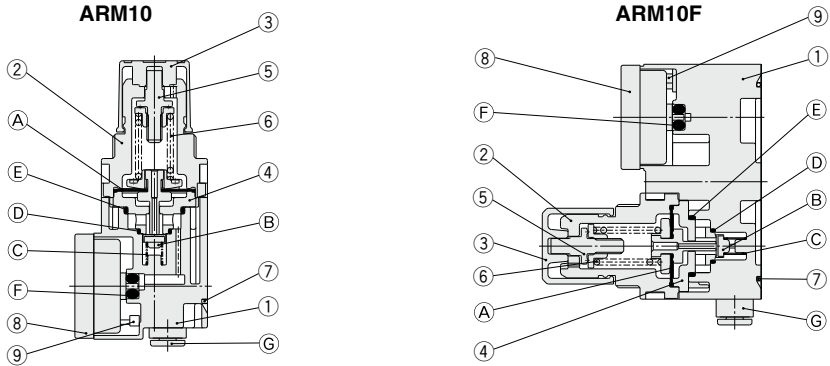

Component Parts

No.	Description	Material
1	Body	PBT
2	Bonnet	PBT
3	Knob	POM
4	Valve seat	POM
5	Adjusting screw assembly	Reinforced steel
6	Adjustment spring	Steel wire
7	Regulator clip	Stainless steel
8	Blanking plate assembly	—
9	Square nut	Steel

Replacement Parts

No.	Description	Material	Part no.	Note
A	Diaphragm assembly	Weatherproof NBR, POM	136126A	Relieving type
			136126-1A	Non-relieving type
B	Valve	HNBR, Aluminum alloy	136127-30#1	
C	Valve spring	Stainless steel	136131	
D	O-ring	NBR	136146	Standard model
		HNBR	136146-30	Oil-free specification
E	O-ring	NBR	136147	Standard model
		HNBR	136147-30	Oil-free specification
F	O-ring	NBR	136148	Standard model
		HNBR	136148-30	Oil-free specification
		NBR	KA01731	Standard model for digital pressure switch
		HNBR	KA01613	Oil-free spec. for digital pressure switch
G	Fitting assembly	—	Refer to page 745.	

Dimensions

ARM10-06
ARM10-08

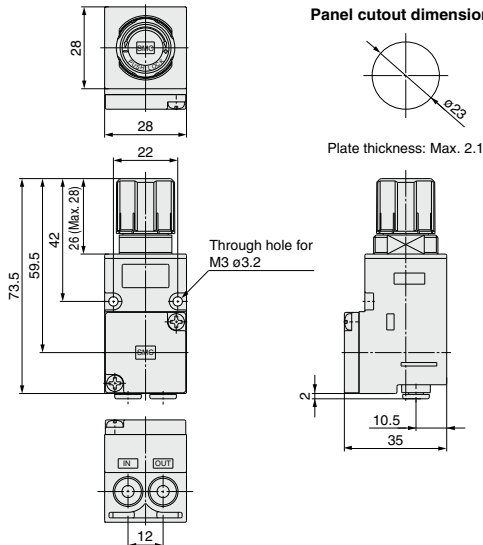

Panel cutout dimensions

For dimensions and accessories of One-touch fittings, please refer to page 745.

Plate thickness: Max. 2.1

ARM10 Series

Dimensions

ARM10F1-⁰⁶₀₈

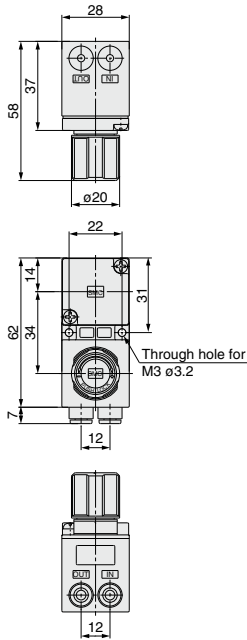

Panel cutout dimensions

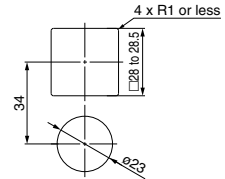
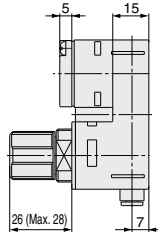
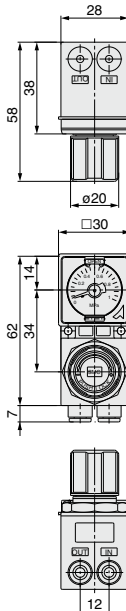

Plate thickness: Max. 2.1



ARM10F1-^{06GPC}_{08GPC}



Panel cutout dimensions

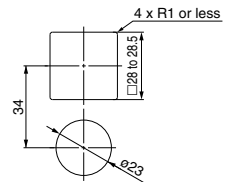
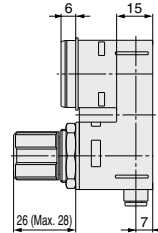

Plate thickness: Max. 2.1



Regulator/Single Unit Type Options

Pressure Gauge

Part no.	Pressure gauge indication range	Indication unit
GC3-4A-X2101	0 to 0.4 MPa	MPa
GC3-10A-X2101	0 to 1.0 MPa	
GC3-P4A-X2101	0 to 60 psi	psi
GC3-P10A-X2101	0 to 150 psi	

Specifications

Display accuracy	±3% F.S. (Full Span)
Calibration angle	230°
Limit indicator	With limit indicator
Weight	17 g

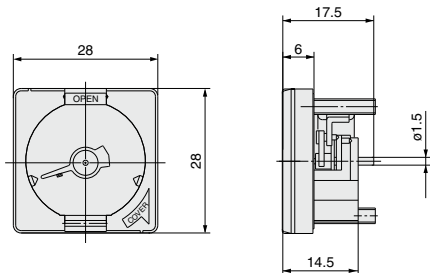

Digital Pressure Switch

Refer to page 734.

Panel Nut

Part no.	136133
Material	POM
Weight	1 g

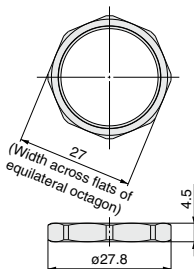

Decorative Cover

Part no.	136155
Material	PBT
Weight	0.5 g

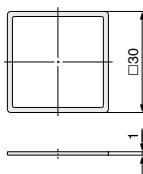

One-touch Fittings for Regulator

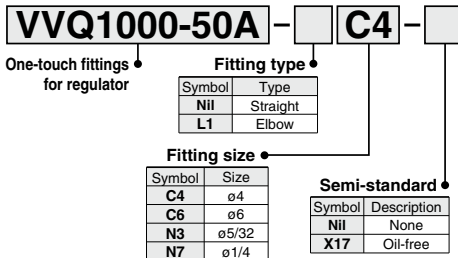

ARM10

Straight type

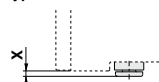

Fitting size	X
ø4, ø5/32	2
ø6	2
ø1/4	6

Elbow type

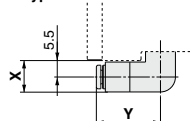

Fitting size	X	Y
ø4, ø5/32	10.5	21.5
ø6	10.5	22
ø1/4	10.5	24.5

ARM10F

Straight type

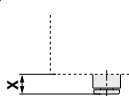

Fitting size	X
ø4, ø5/32	7
ø6	7
ø1/4	11

Elbow type

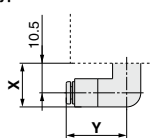

Fitting size	X	Y
ø4, ø5/32	15.5	21.5
ø6	15.5	22
ø1/4	15.5	24.5

Bracket

Part no.	136134#1
Material	Steel band (Zinc chromated)
Weight	17 g

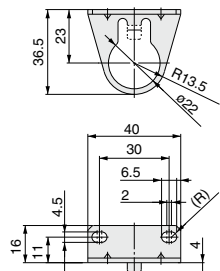



Regulator Single Unit Front Knob Type/ For Manifold

Specifications

Regulator construction		Direct acting
Working principal		Diaphragm regulator
Relief mechanism	Standard	Relief type
	Optional	Non-relieving type
Backflow function		Within (Unbalance type)
IN/OUT air passage diameter		ø4
IN/OUT gasket sealing O.D.		ø7
Proof pressure		1.5 MPa
Maximum operating pressure		1.0 MPa
Set pressure range	Standard	0.05 to 0.7 MPa
	Optional	0.05 to 0.35 MPa (Low pressure type)
Fluid		Air
Ambient and fluid temperature		5 to 60°C
Weight		73 g



Note 1) Two mounting bolts and two O-rings are attached.

Note 2) 0.1 MPa or greater set pressure is required when used in the reverse flow.

Note 3) 5 to 50°C when the digital pressure switch will be used. Refer to page 734 for the digital pressure switch specifications.

How to Order

ARM10F - **A** **Z** - **N** - X201
 ① ② ③ ④
 • For manifold

1. Accessory (Pressure Display)

Enter symbol for when the model requires a digital pressure switch.

Symbol	Accessory
NII	Without pressure display
A	With pressure display

Note 1) Pressure display means a pressure gauge or digital pressure switch is attached.

When choosing to attach a digital pressure switch is chosen for attachment, be sure to enter the symbol, referring to table 4, "Digital Pressure Switch Output Specifications". Otherwise, a pressure gauge will come with the regulator.

Note 2) Pressure gauges are not compatible with copper-free and fluorine-free specifications.

2. Semi-standard

Symbol	None	0.35 MPa setting ^{Note 1)}	Non-relieving	Oil-free ^{Note 2)}
NII	●			
1		●		
2			●	
3				●
4		●	●	
5		●		●
6			●	●
7		●	●	●

Note 1) A pressure gauge with a full span of 0.4 MPa is attached.

Note 2) The oil-free type has non-greased fluid contact areas.

3. Unit Representation

Symbol	Description
NII	Display unit for product name plate and pressure gauge: MPa
Z ^{Note 1, 2)}	Display unit for product name plate and pressure gauge: psi
ZA ^{Note 1, 3)}	Digital pressure switch: with unit switching (MPa is initially set.)

Note 1) This option is available for use outside Japan only. (The SI unit has to be used in Japan.)

Note 2) The digital pressure switch is equipped with unit switching and initially set to psi.

Note 3) This option is available with the digital pressure switch.

4. Digital Pressure Switch Output Specifications

Symbol	Details
NII	None
N	NPN open collector
P	PNP open collector

Note) When a digital pressure switch is attached, the "pressure display" in table 1 "Accessory" will be equipped. The electrical entry is positioned on the side opposite the knob.

Example

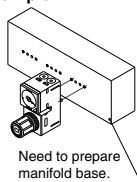

Need to prepare manifold base.

Dimensions

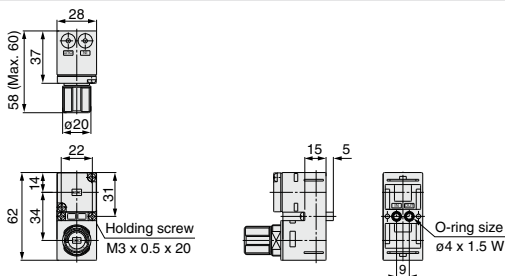



ARM10/11 Series Blocks/Specific Product Precautions 1

Be sure to read this before handling the products.
Refer to back page 50 for Safety Instructions and pages 387 to 391 for Precautions on every series.

Handling

Warning

Observe the proper screw tightening torque in installation.

Tightening beyond the proper tightening torque may damage the mounting screws, blocks or switches.

If the force is below the tightening torque range, the threaded joint can come loose.

1. Tightening torque for fixing screws and panel nuts of a single unit regulator

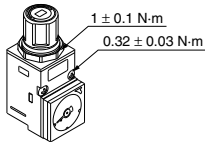

2. Tightening torque for regulator assembly fixing screws on regulator block

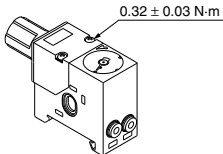

3. Tightening torque for blanking plates and pressure gauge fixing screws on regulator block

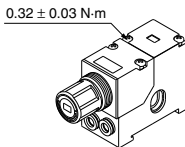

4. Tightening torque for pressure switch fixing screws on common supply block with pressure switch and pressure switch block

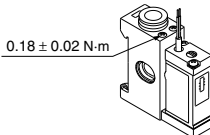

5. Tightening torque for DIN rail clamp screws on end block

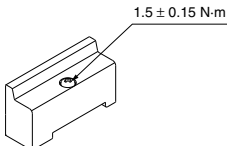

Warning

● Digital Pressure Switch
Mount it with the proper screw-tightening torque.

Overtightening may damage the regulator body or adaptor, etc. Meanwhile, insufficient tightening may loosen the connecting threads.

1. Attach an O-ring to the regulator O-ring slit.

2. Attach the adaptor with the 2 set screws by positioning the adapter slot on the opposite side of the knob and keeping the 2 square nuts (right/left) attached.
Tightening torque: 0.32 ± 0.03 N·m

3. Attach the switch body.

4. Fully insert the locking pin into the adapter slot.

The switch body can be replaced by attaching/removing the locking pin.

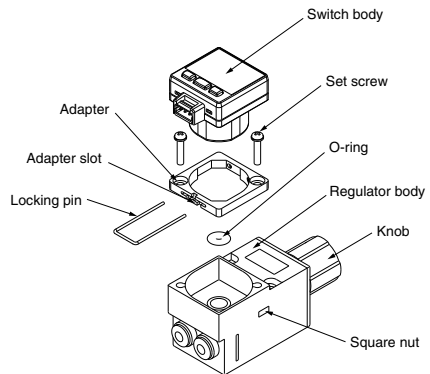

ARM

AR425
to 935

ARX

AMR

ARM

ARP

IR□-A

IR

IRV

VEV

SRH

SRP

SRF

ITV

IC

ITVH

ITVX

PVQ

VY1

VBA

VBAT

AP100



ARM10/11 Series Blocks/Specific Product Precautions 2

Be sure to read this before handling the products.

Refer to back page 50 for Safety Instructions and pages 387 to 391 for Precautions on every series.

Handling

Warning

Mounting and Removal of Manifold with DIN Rail

Be sure to shut off the power and air supplies before disassembly. Furthermore, since air may remain inside the actuator, piping and manifold, confirm that the air is completely exhausted before performing any work.

When disassembly and assembly are performed, air leakage may result if connections between blocks and tightening of the end block's holding screw are inadequate.

Before supplying air, confirm that there are no gaps between blocks, and that manifold blocks are securely fastened to the DIN rail. Then supply air and confirm that there is no air leakage before operating.

Removing blocks from DIN rail

1. Loosen the end plate clamping screws on the side until they turn freely. (The screws do not come out.)
2. Remove it by sliding it to the side (in the direction of the arrow).

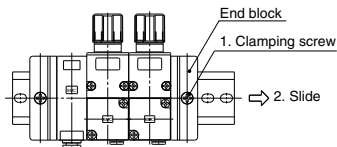

Mounting blocks on DIN rail

1. Confirm that the clamping screws of the end block on one side are securely tightened.
2. Install blocks sliding them from the side. Push the end block on the opposite side so that there will be no gap between blocks.
3. Tighten the end plate clamping screws on the opposite side.

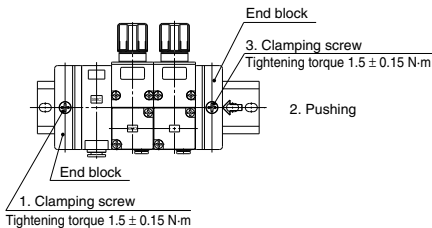

Confirming DIN rail clasp

Confirm that the DIN rail clasps are securely hooked into the DIN rail.

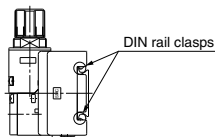

Caution

One-touch fitting replacement

For the ease of replacement, One-touch fittings are installed as the cassette type. One-touch fittings are retained with clips inserted from the directions illustrated below. Remove the clips with a flat head screw driver to replace the One-touch fittings. When installing, insert each One-touch fitting deeply to the end and reinsert the clip to the specified position.

1. Single unit regulator

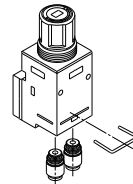

2. Regulator block

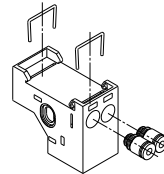

3. Various common supply blocks

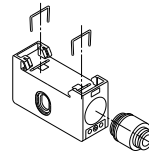

Pressure supply of 3-way valve common supply block

Make sure that the knob is set at the OPEN or SHUT position in operation. The block cannot be used for the purpose of containing pressure because it allows a small amount of leakage.

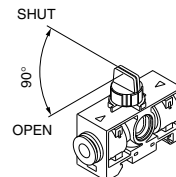



ARM10/11 Series Blocks/Specific Product Precautions 3

Be sure to read this before handling the products.

Refer to back page 50 for Safety Instructions and pages 387 to 391 for Precautions on every series.

Handling

⚠ Caution

● Digital Pressure Switch How to attach a connector

Insert the connector vertically onto the pins, pinching the lever and connector with your fingers. Insert the lever into the switch body slot until it is locked. Cover the connector with a cover.

How to remove a connector

Displace the cover and pull the lever straight forward by pushing its claw to remove it from the slot.

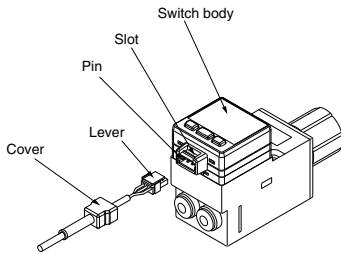

Adjustment

⚠ Caution

How to adjust indicator of the pressure gauge.

Make sure to follow the instruction when opening the lens cover to adjust the pressure gauge.

1. Open the lens cover to the arrow's direction with finger nail.

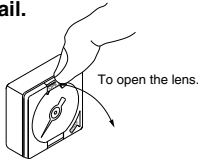

2. Adjust the gauge needle with for example, a flat head screw driver.

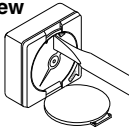

3. Close the lens cover to the arrow's direction until it snaps on.

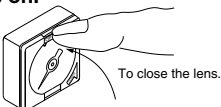

ARJ

AR425
to 935

ARX

AMR

ARM

ARP

IR□-A

IR

IRV

VEV

SRH

SRP

SRF

ITV

IC

ITVH

ITVX

PVQ

VY1

VBA
VBAT

AP100



ARM10/11 Series Pressure Switch Blocks Specific Product Precautions

Be sure to read this before handling the products.

Refer to back page 50 for Safety Instructions and pages 387 to 391 for Precautions on every series.

Design & Selection

Warning

- Operate the switch only within the specified voltage.**
Use of the switch outside the range of the specified voltage can cause malfunction and damage to the switch, it may also increase the risks of electrical shocks or fire.
- Never apply a load above the maximum load capacity.**
It can damage the switch or shorten the service life.
- Be sure to observe the set pressure range and maximum operating pressure.**
Use of the switch outside the set pressure range can cause failure and use beyond the maximum operating pressure can damage the switch.

Caution

- When operating at an inlet pressure lower than the inlet pressure used in the flow rate characteristics graph, the pressure drop on the outlet side may be greater. Therefore, be sure to conduct testing using the actual equipment.**
For pressure control equipment selection, refer to page 123 in the "Product Selection Guide."

Mounting

Warning

- Do not use the switch unless the equipment operates normally.**
After installation, repair or reform, connect air and electricity and conduct appropriate function and leakage tests to confirm proper installation.
- Do not apply a tensile force to a cord.**
Be sure to hold the body to handle the product. Applying a tensile force to a cord may cause damage to the product.
- Do not drop or bump the product.**
Dropping or bumping while handling may cause damage to the product.

Pressure Supply

Warning

- Do not use the switch with corrosive gas or liquid.**
Do not use the switch with corrosive gas or liquid. Such gas or fluid may cause damage to the switch.
- Do not use the switch at a vacuum pressure.**
If used in a vacuum pressure range, the switch will suction the outer air and become unable to operate.

Pressure Setting

Caution

- The switching setting indication scale shows the set value for pressure decrease.**
- When the ON pressure signal is to be detected, the ON signal comes on at the pressure found by adding the hysteresis to the pressure set on the scale plate.**
- The pressure indication on the scale plate is provided as a guideline. Use a pressure gauge to measure the precise settings.**

Wiring

Warning

- Connect the load**
Be sure to connect the load to the pressure switch before connecting the power supply.
- Use a contact protection box.**
If the load driven by the pressure switch is an induction load or connected with a lead wire of 5 m or longer, use a contact protection box in the following table.

Contact protection box	Operating voltage	Lead wire length
CD-P11	100 VAC	Switch connection side: 0.5 m
CD-P12	24 VDC	Load connection side: 0.5 m

3. Contact protection box internal circuit

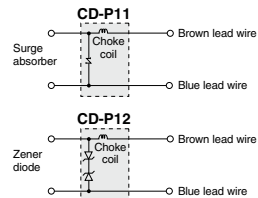

4. Contact protection box/Connection method

To connect the switch body and the contact protection box, connect the lead wire of the contact protection box on the side marked with "SWITCH" and the lead wire from the switch body. Connect the switch body and the contact protection box with a lead wire of 1 m or shorter and arrange them as close as possible.

5. Lead wire dimensions

Covering: $\phi 3.4$
Insulator: $\phi 1.1$
Conductor: $\phi 0.64$

Operating Environment

Warning

- Never use in the presence of explosive gases.**
These switches are not rated as explosion proof. Never use in the presence of an explosive gas as this may cause a serious explosion.
- Do not use in an environment where a strong magnetic field is present.**
The influence of the external magnetic field may cause the switch to malfunction.
- Do not use in an environment where the switch is exposed to water or oil splashes.**
Because the switch has an open type construction, ingress of water or oil can corrode the electric circuit, resulting in malfunction and damage.
- Do not apply vibration to the switch.**
If vibration is applied, malfunction or setting errors may result.