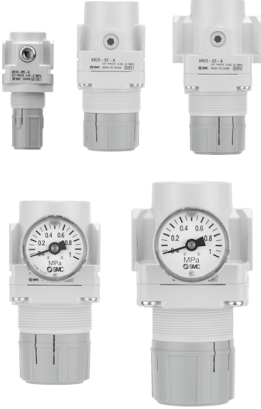

# Modular Type Regulator **AR Series**

Regulator AR Series	Model	Port size	Options
 <p data-bbox="115 898 236 919">P.450 to 457</p>	AR10-A	M5 x 0.8	<p data-bbox="837 539 897 560">Bracket</p> <p data-bbox="760 644 972 665">Round type pressure gauge</p> <p data-bbox="768 740 964 761">Set nut (for panel mount)*</p> <p data-bbox="745 879 986 927">* For AR20-A to AR40-06-A, panel fitting dimensions are different from those of the current AR series.</p>
	AR20-A	1/8, 1/4	
	AR25-A	1/4, 3/8	
	AR30-A		
	AR40-A	1/4, 3/8, 1/2	
	AR40-06-A	3/4	

## Made to Order

①	<p data-bbox="141 1010 350 1031"><b>0.4 MPa Setting (-X406)</b></p> <p data-bbox="141 1031 572 1090">The maximum set pressure is 0.4 MPa. When a pressure gauge is included, the display will show a range from 0 to 0.7 MPa.</p>	<p data-bbox="624 1086 729 1107"><b>P.456, 457</b></p>
②	<p data-bbox="141 1106 370 1126"><b>0.85 MPa Setting (-X2068)</b></p> <p data-bbox="141 1126 580 1185">The maximum set pressure is 0.85 MPa. When a pressure gauge is included, the display will show a range from 0 to 1.0 MPa.</p>	

AC-A  
AF-A  
AF-A  
AR-A  
AL-A  
AW-A  
AC-B  
AF-A  
AF-A  
AR-A  
AL-A  
AW-A  
AW-□  
AC-G  
E-□  
AV  
AF

# Regulator

# AR10-A to AR40-A

Symbol  
Regulator

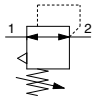

## How to order

AR 30 -   03 BG -   - A -  

1   
 2   
 3   
 4   
 5

- Option/Semi-standard: Select one each for a to g.
- Option/Semi-standard symbol: When more than one specification is required, indicate in alphanumeric order.  
Example) AR30-03BG-1N-A

### • Made to Order

(Refer to pages 456 and 457 for details.)

		Symbol	Description	①					
				Body size					
				10	20	25	30	40	
②	Pipe thread type	Nil	Metric thread (M5)	●	—	—	—	—	
			Rc	—	●	●	●	●	
			NPT	—	●	●	●	●	
			G	—	●	●	●	●	
+									
③	Port size	M5	M5	●	—	—	—	—	
		01	1/8	—	●	—	—	—	
		02	1/4	—	●	●	—	—	
		03	3/8	—	—	●	●	●	
		04	1/2	—	—	—	—	●	
+									
④	a	Mounting	Nil	Without mounting option	●	●	●	●	●
			B <sup>(Note 2)</sup>	With bracket	●	●	●	●	●
			H	With set nut (for panel mount) <sup>(Note 3)</sup>	●	●	●	●	●
+									
④	b	Pressure gauge <sup>(Note 4)</sup>	Nil	Without pressure gauge	●	●	●	●	●
			G	Round type pressure gauge (without limit indicator)	●	—	—	—	—
			M	Round type pressure gauge (with color zone)	—	●	●	●	●
+									
⑤	c	Set pressure <sup>(Note 5)</sup>	Nil	0.05 to 0.7 MPa setting	●	●	●	●	●
			1	0.02 to 0.2 MPa setting	●	●	●	●	●
+									
⑤	d	Exhaust mechanism	Nil	Relieving type	●	●	●	●	●
			N	Non-relieving type	●	●	●	●	●
+									
⑤	e	Flow direction	Nil	Flow direction: Left to right	●	●	●	●	●
			R	Flow direction: Right to left	●	●	●	●	●
+									
⑤	f	Knob	Nil	Downward	●	●	●	●	●
			Y	Upward	●	●	●	●	●
+									
⑤	g	Pressure unit	Nil	Name plate and pressure gauge in imperial units: MPa	●	●	●	●	●
			Z <sup>(Note 6)</sup>	Name plate and pressure gauge in imperial units: psi	○ <sup>(Note 7)</sup>	○ <sup>(Note 7)</sup>	○ <sup>(Note 7)</sup>	○ <sup>(Note 7)</sup>	○ <sup>(Note 7)</sup>

Note 1) Option B, G, H, M are not assembled and supplied loose at the time of shipment.

Note 2) Assembly of a bracket and set nuts

Note 3) Mounting pitch is different from that of the current AR20 to AR40 and AR20-B to AR40-B.

Note 4) When the pressure gauge is attached, a 1.0 MPa pressure gauge will be fitted for standard (0.7 MPa) type, 0.4 MPa pressure gauge for 0.2 MPa type (1.0 MPa pressure gauge only for the AR10-A).

Note 5) Pressure can be set higher than the specification pressure in some cases, but use pressure within the specification range.

Note 6) For pipe thread type: NPT

This product is for overseas use only according to the new Measurement Law. (The SI unit type is provided for use in Japan.)

Cannot be used with M: Round pressure gauge (with color zone). Available by request for special.

Note 7) ○: For pipe thread type: M5, NPT only

## Standard Specifications

Model	AR10-A	AR20-A	AR25-A	AR30-A	AR40-A	AR40-06-A
Port size	M5 x 0.8	1/8, 1/4	1/4, 3/8	1/4, 3/8	1/4, 3/8, 1/2	3/4
Pressure gauge port size	1/16 <sup>Note)</sup>		1/8			
Fluid	Air					
Ambient and fluid temperature	- 5 to 60°C (with no freezing)					
Proof pressure	1.5 MPa					
Maximum operating pressure	1.0 MPa					
Set pressure range	0.05 to 0.7 MPa					
Construction	Relieving type					
Weight (kg)	0.06	0.17	0.19	0.34	0.58	0.60

Note) Use a bushing (part no: 131368) when connecting the R1/8 pressure gauge to the Rc1/16.

## Options/Part No.

Optional specifications		Model					
		AR10-A	AR20-A	AR25-A	AR30-A	AR40-A	AR40-06-A
Bracket assembly <sup>Note 1)</sup>		AR12P-270AS	AR22P-270AS	AR27P-270AS	AR32P-270AS	AR42P-270AS	AR42P-270AS
Set nut		AR12P-260S	AR22P-260S	AR22P-260S	AR32P-260S	AR42P-260S	AR42P-260S
Pressure gauge	Round type <sup>Note 2)</sup>	Standard	G27-10-R1	G36-10-□01		G46-10-□01	
		0.02 to 0.2 MPa setting	G27-10-R1 <sup>Note 3)</sup>	G36-4-□01		G46-4-□01	
	Round type <sup>Note 2)</sup> (with color zone)	Standard	—	G36-10-□01-L		G46-10-□01-L	
		0.02 to 0.2 MPa setting	—	G36-4-□01-L		G46-4-□01-L	

Note 1) Assembly of a bracket and set nuts

Note 2) □ in round pressure gauge part numbers indicates a pipe thread type. No indication is necessary for R; however, indicate N for NPT.

Please contact SMC regarding the pipe thread type NPT and the supply of pressure gauge with psi unit display specifications.

Note 3) Standard pressure gauge

## ⚠ Specific Product Precautions

Be sure to read this before handling the products. Refer to back page 50 for Safety Instructions and pages 387 to 391 for F.R.L. Precautions.

### Selection

#### ⚠ Warning

- Although exhaust of the residual pressure to the inlet side is possible when eliminating the inlet pressure, exhaust is not possible when the set pressure is 0.15 MPa or less. Use the regulator with backflow function.

### Maintenance

#### ⚠ Warning

- When using the regulator between a solenoid valve and an actuator, check the pressure gauge periodically. Sudden pressure fluctuations may shorten the durability of the pressure gauge. A digital pressure gauge is recommended for such situation or as deemed necessary.

### Mounting/Adjustment

#### ⚠ Warning

- Set the regulator while verifying the displayed values of the inlet and outlet pressure gauges. Turning the regulator knob excessively can cause damage to the internal parts.
- Do not use tools on the pressure regulator knob as this may cause damage. It must be operated manually.

#### ⚠ Caution

- Be sure to unlock the knob before adjusting the pressure and lock it after setting the pressure. Failure to follow this procedure can cause damage to the knob and the outlet pressure may fluctuate.
  - Pull the pressure regulator knob to unlock. (You can visually verify this with the "orange mark" that appears in the gap.)
  - Push the pressure regulator knob to lock. When the knob is not easily locked, turn it left and right a little and then push it (when the knob is locked, the "orange mark", i.e., the gap will disappear).
- Pulsation will be generated when the difference between the inlet and the outlet pressure is large. In this case, reduce the pressure difference between the inlet and the outlet. Please consult with SMC if the pulsation problem is not resolved.

AC-A  
 AF-A  
 AF-A  
 AR-A  
 AL-A  
 AW-A  
 AC-B  
 AF-A  
 AF-A  
 AR-A  
 AL-A  
 AW-A  
 AW-□  
 AF-G  
 E-□  
 AV  
 AF

# AR10-A to AR40-A Series

## Flow Rate Characteristics (Representative values)

Condition: Inlet pressure 0.7 MPa

### AR10-A

M5

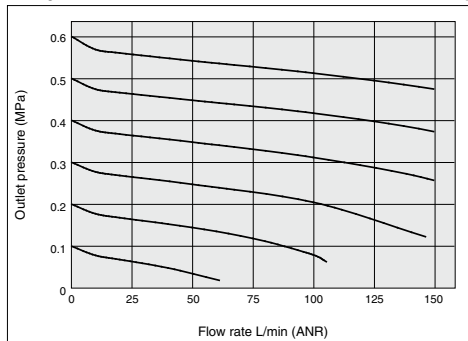

### AR20-A

Rc1/4

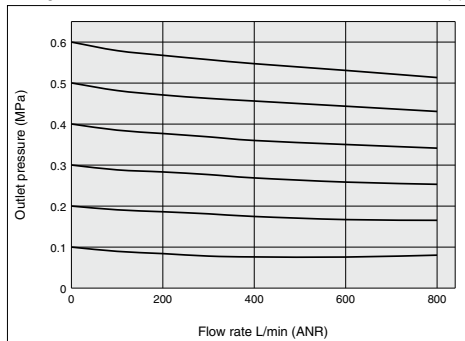

### AR25-A

Rc3/8

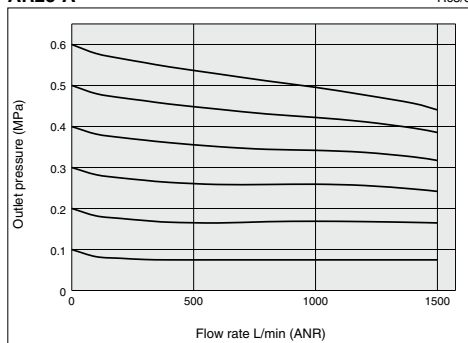

### AR30-A

Rc3/8

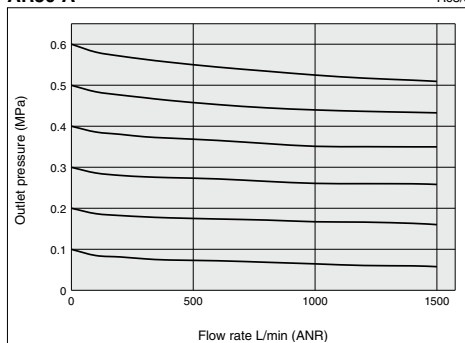

### AR40-A

Rc1/2

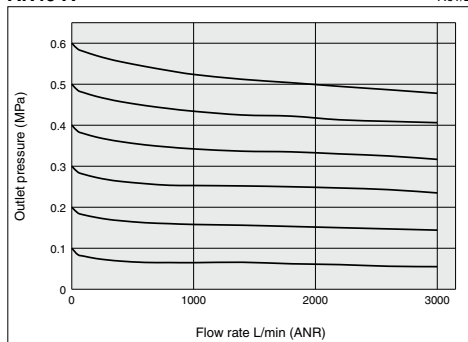

### AR40-06-A

Rc3/4

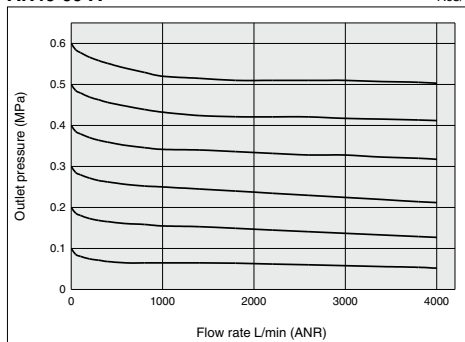

# Regulator **AR10-A to AR40-A Series**

## Pressure Characteristics (Representative values)

Conditions: Inlet pressure 0.7 MPa, Outlet pressure 0.2 MPa, Flow rate 20 L/min (ANR)

**AR10-A**

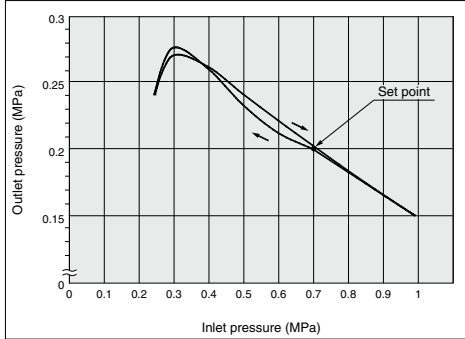

**AR20-A**

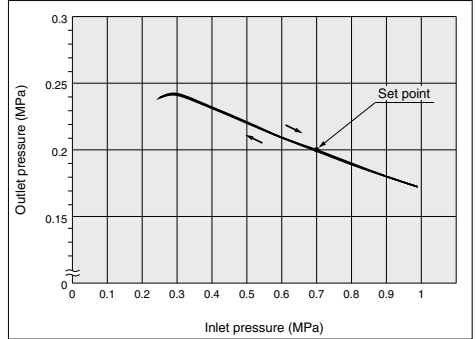

**AR25-A**

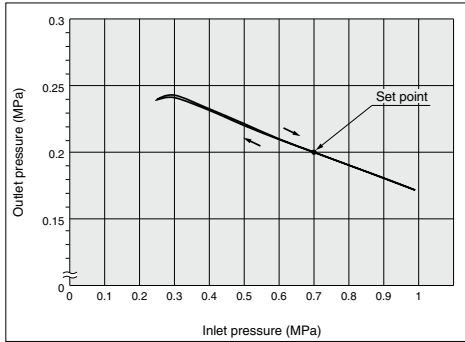

**AR30-A**

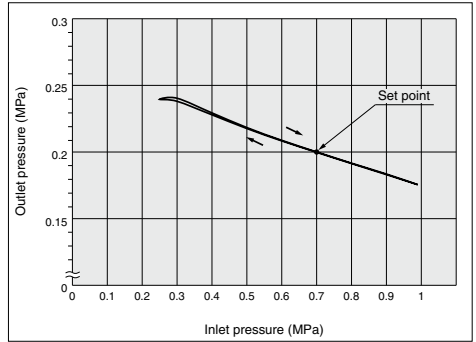

**AR40-A/AR40-06-A**

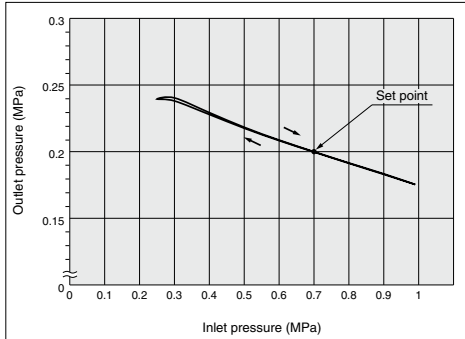

AC-A

AF-A

AF-A

AR-A

AL-A

AW-A

AC-B

AF-A

AF-A

AR-B

AL-A

AW-B

AW

AG

E

AV

AF

# AR10-A to AR40-A Series

## Construction

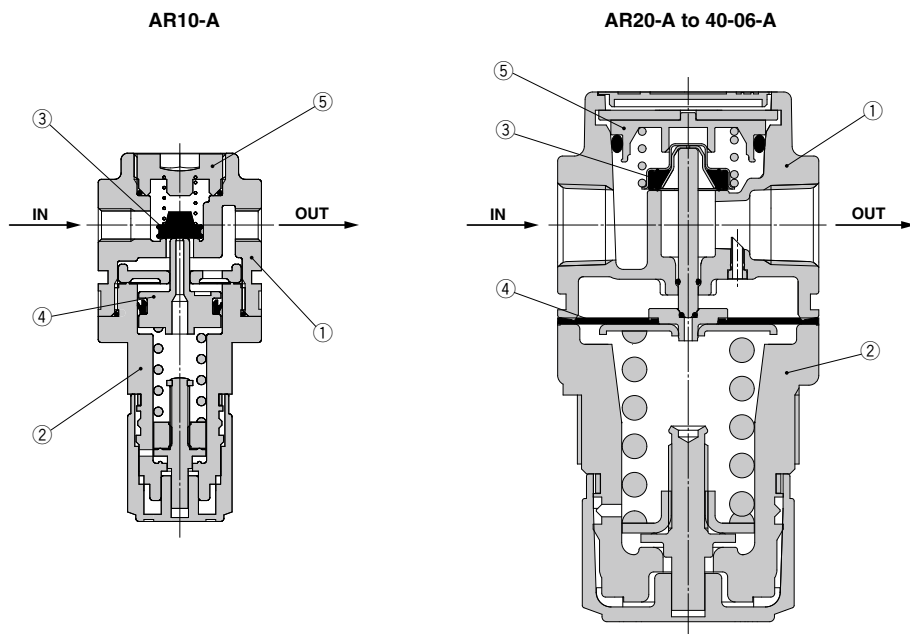

### Component Parts

No.	Description	Material	Model	Color
1	Body	Zinc die-cast	AR10-A	White
		Aluminum die-cast	AR20-A to AR40-A	
2	Bonnet	Polyacetal	AR10-A to AR40-A	White

### Replacement Parts

No.	Description	Material	Part no.				
			AR10-A	AR20-A	AR25-A	AR30-A	AR40-A
3	Valve assembly	Stainless steel, HNBR	AR10P-090S	AR22P-060AS	AR25P-060AS	AR32P-060AS	AR42P-060AS
4	Diaphragm assembly	Weatherable NBR	AR10P-150AS <sup>(Note)</sup>	AR22P-150AS	AR25P-150AS	AR32P-150AS	AR42P-150AS
5	Valve guide assembly	Polyacetal	131329	AR22P-050AS	AR25P-050AS	AR32P-050AS	AR42P-050AS

Note) The AR10-A is a piston type. Assembly of a piston and a seal (KSYP-13).

# Regulator **AR10-A to AR40-A Series**

## Dimensions

### AR10-A to AR40-06-A

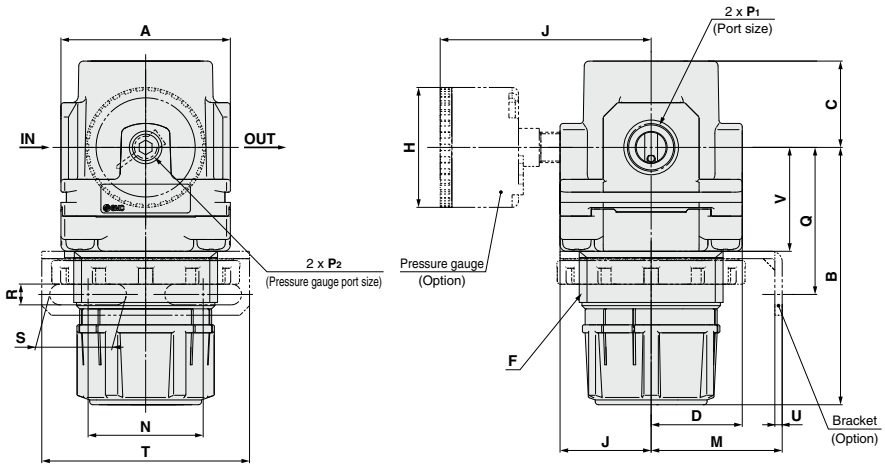

### Panel fitting dimensions

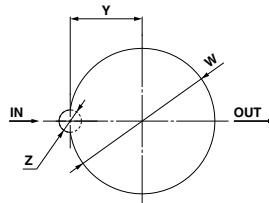

Plate thickness  
**AR10-A** : Max. 3.5  
**AR20-A to AR25-A** : Max. 4  
**AR30-A to AR40-06-A** : Max. 8

- AC-A
- AF-A
- AF□-A
- AR-A**
- AL-A
- AW-A
- AC-B
- AF-A
- AF□-A
- AR-B**
- AL-A
- AW-B
- AW□
- A□G
- E□
- AV
- AF

Model	Standard specifications																Optional specifications									
	P <sub>1</sub>	P <sub>2</sub>	A	B <sup>(Note)</sup>	C	D	F	J	Round type pressure gauge		Round type pressure gauge (with color zone)		Bracket mount						Panel mount							
									H	J	H	J	M	N	Q	R	S	T	U	V	W	Y	Z			
<b>AR10-A</b>	M5 x 0.8	1/16	25	47.4	11	12.5	M18 x 1	12.5	ø26	26	—	—	25	28	30	4.5	6.5	40	2	18	18.5	—	—			
<b>AR20-A</b>	1/8, 1/4	1/8	40	67.4	23.5	22	M36 x 1.5	22	ø37.5	58.5	ø37.5	59.5	30	34	43.9	5.4	15.4	55	2.3	27.3	36.5	17.5	6			
<b>AR25-A</b>	1/4, 3/8	1/8	53	70.4	23.5	22	M36 x 1.5	22	ø37.5	58.5	ø37.5	59.5	30	34	44.3	5.4	15.4	55	2.3	30.3	36.5	17.5	6			
<b>AR30-A</b>	1/4, 3/8	1/8	53	83.5	27	28.5	M45 x 1.5	28.5	ø37.5	65	ø37.5	66	41	36	46	6.5	24	65	2.3	32.5	45.5	22.5	7			
<b>AR40-A</b>	1/4, 3/8, 1/2	1/8	70	100	33.5	34.5	M52 x 1.5	34.5	ø42.5	72	ø42.5	72	50	38	54	8.5	26.5	70	2.3	38.4	52.5	26	7			
<b>AR40-06-A</b>	3/4	1/8	75	101.5	33.5	34.5	M52 x 1.5	34.5	ø42.5	72	ø42.5	72	50	38	55.5	8.5	26.5	70	2.3	39.9	52.5	26	7			

Note) The dimension of B is the length when the filter regulator knob is unlocked.

# Regulator/AR20-A to AR40-06-A

# Made to Order

Please contact SMC for detailed dimensions, specifications and lead times.



## ① 0.4 MPa Setting

The setting specification is 0.4 MPa. When a pressure gauge is included, the display will show a range from 0 to 0.7 MPa.

### Specifications

Proof pressure	1.5 MPa
Maximum operating pressure	1.0 MPa
Set pressure range <small>Note 1)</small>	0.05 to 0.4 MPa

Note 1) Pressure can be set higher than the specification pressure in some cases, but use pressure within the specification range.

### Applicable Model

Model	AR20-A	AR25-A	AR30-A	AR40-A	AR40-06-A
Port size	1/8, 1/4	1/4, 3/8	1/4, 3/8	1/4, 3/8, 1/2	3/4

AR 30 -   03   -   - A - X406

①
②
③
④
⑤
0.4 MPa setting

• Option/Semi-standard: Select one each for a to f.  
 • Option/Semi-standard symbol: When more than one specification is required, indicate in alphanumeric order.  
 Example) AR30-03BG-NR-A-X406

		Symbol	Description	① Body size				
				20	25	30	40	
②	Pipe thread type	Nil	Rc	●	●	●	●	
		N	NPT	●	●	●	●	
		F	G	●	●	●	●	
		+						
③	Port size	01	1/8	●	—	—	—	
		02	1/4	●	●	●	●	
		03	3/8	—	●	●	●	
		04	1/2	—	—	—	●	
		06	3/4	—	—	—	●	
		+						
④	Option <small>Note 2)</small> a Mounting	Nil	Without mounting option	●	●	●	●	
		B <small>Note 3)</small>	With bracket	●	●	●	●	
		H	With set nut (for panel mount) <small>Note 4)</small>	●	●	●	●	
		+						
④	b Pressure gauge	Nil	Without pressure gauge	●	●	●	●	
		G	Round type pressure gauge (with limit indicator)	●	●	●	●	
		M	Round type pressure gauge (with color zone)	●	●	●	●	
		+						
⑤	Semi-standard c Exhaust mechanism	Nil	Relieving type	●	●	●	●	
		N	Non-relieving type	●	●	●	●	
			+					
	d Flow direction	Nil	Flow direction: Left to right	●	●	●	●	
		R	Flow direction: Right to left	●	●	●	●	
		+						
e Knob	Nil	Downward	●	●	●	●		
	Y	Upward	●	●	●	●		
		+						
f Pressure unit	Nil	Name plate and caution plate for bowl in imperial units: MPa	●	●	●	●		
	Z <small>Note 5)</small>	Name plate and caution plate for bowl in imperial units: psi	○ <small>Note 6)</small>	○ <small>Note 6)</small>	○ <small>Note 6)</small>	○ <small>Note 6)</small>		

Note 2) Option B, G, H, M are not assembled and supplied loose at the time of shipment.

Note 3) Assembly of a bracket and set nuts

Note 4) Only for the AR20-A to 40-A

Note 5) For pipe thread type: NPT

This product is for overseas use only according to the new Measurement Law. (The SI unit type is provided for use in Japan.)

Cannot be used with M: Round pressure gauge (with color zone). Available by request for special.

Note 6) ○: For pipe thread type: NPT only



# Regulator/AR20-A to AR40-06-A

## Made to Order

Please contact SMC for detailed dimensions, specifications and lead times.



### ② 0.85 MPa Setting

The maximum set pressure is 0.85 MPa. When a pressure gauge is included, the display will show a range from 0 to 1.0 MPa.

#### Specifications

Proof pressure	1.5 MPa
Maximum operating pressure	1.0 MPa
Set pressure range	0.05 to 0.85 MPa

#### Applicable Model

Model	AR20-A	AR25-A	AR30-A	AR40-A	AR40-06-A
Port size	1/8, 1/4	1/4, 3/8	1/4, 3/8	1/4, 3/8, 1/2	3/4

AR **30** - **03** - **A** - **X2068**

① ② ③ ④ ⑤ ⑥ 0.85 MPa setting

- Option/Semi-standard: Select one each for a to f.
- Option/Semi-standard symbol: When more than one specification is required, indicate in alphanumeric order.  
Example) AR30-03BG-NR-A-X2068

		Symbol	Description	① Body size			
				20	25	30	40
②	Pipe thread type	Nil	Rc	●	●	●	●
		N	NPT	●	●	●	●
		F	G	●	●	●	●
+							
③	Port size	01	1/8	●	—	—	—
		02	1/4	●	●	●	●
		03	3/8	—	●	●	●
		04	1/2	—	—	—	●
		06	3/4	—	—	—	●
+							
④ Option (Note 1)	a Mounting	Nil	Without mounting option	●	●	●	●
		B (Note 2)	With bracket	●	●	●	●
		H	With set nut (for panel mount) (Note 3)	●	●	●	●
+							
b	Pressure gauge	Nil	Without pressure gauge	●	●	●	●
		G	Round type pressure gauge (with limit indicator)	●	●	●	●
		M	Round type pressure gauge (with color zone)	●	●	●	●
+							
c	Exhaust mechanism	Nil	Relieving type	●	●	●	●
		N	Non-relieving type	●	●	●	●
+							
⑤ Semi-standard	d Flow direction	Nil	Flow direction: Left to right	●	●	●	●
		R	Flow direction: Right to left	●	●	●	●
+							
e	Knob	Nil	Downward	●	●	●	●
		Y	Upward	●	●	●	●
+							
f	Pressure unit	Nil	Name plate and caution plate for bowl in imperial units: MPa	●	●	●	●
		Z (Note 4)	Name plate and caution plate for bowl in imperial units: psi	○ (Note 5)	○ (Note 5)	○ (Note 5)	○ (Note 5)

Note 1) Option B, G, H, M are not assembled and supplied loose at the time of shipment.

Note 2) Assembly of a bracket and set nuts

Note 3) Only for the AR20-A to 40-A

Note 4) For pipe thread type: NPT

This product is for overseas use only according to the new Measurement Law. (The SI unit type is provided for use in Japan.)

Cannot be used with M: Round pressure gauge (with color zone). Available by request for special.

Note 5) ○: For pipe thread type: NPT only

AC-A

AF-A

AF□-A

AR-A

AL-A

AW-A

AC-B

AF-A

AF□-A

AR-B

AL-A

AW-B

AW□

AF□G

E□

AV

AF

# Regulator/AR20-A to AR40-06-A

## Made to Order

Please contact SMC for detailed dimensions, specifications and lead times.



### ② 0.85 MPa Setting

The maximum set pressure is 0.85 MPa. When a pressure gauge is included, the display will show a range from 0 to 1.0 MPa.

#### Specifications

Proof pressure	1.5 MPa
Maximum operating pressure	1.0 MPa
Set pressure range	0.05 to 0.85 MPa

#### Applicable Model

Model	AR20-A	AR25-A	AR30-A	AR40-A	AR40-06-A
Port size	1/8, 1/4	1/4, 3/8	1/4, 3/8	1/4, 3/8, 1/2	3/4

AR **30** - **03** - **03** - **A** - **X2068**

① ② ③ ④ ⑤ ⑥ 0.85 MPa setting

- Option/Semi-standard: Select one each for a to f.
- Option/Semi-standard symbol: When more than one specification is required, indicate in alphanumeric order.  
Example) AR30-03BG-NR-A-X2068

		Symbol	Description	① Body size			
				20	25	30	40
②	Pipe thread type	Nil	Rc	●	●	●	●
		N	NPT	●	●	●	●
		F	G	●	●	●	●
+							
③	Port size	01	1/8	●	—	—	—
		02	1/4	●	●	●	●
		03	3/8	—	●	●	●
		04	1/2	—	—	—	●
		06	3/4	—	—	—	●
+							
④ Option (Note 1)	a Mounting	Nil	Without mounting option	●	●	●	●
		B (Note 2)	With bracket	●	●	●	●
		H	With set nut (for panel mount) (Note 3)	●	●	●	●
+							
b	Pressure gauge	Nil	Without pressure gauge	●	●	●	●
		G	Round type pressure gauge (with limit indicator)	●	●	●	●
		M	Round type pressure gauge (with color zone)	●	●	●	●
+							
c	Exhaust mechanism	Nil	Relieving type	●	●	●	●
		N	Non-relieving type	●	●	●	●
+							
⑤ Semi-standard	d Flow direction	Nil	Flow direction: Left to right	●	●	●	●
		R	Flow direction: Right to left	●	●	●	●
+							
e	Knob	Nil	Downward	●	●	●	●
		Y	Upward	●	●	●	●
+							
f	Pressure unit	Nil	Name plate and caution plate for bowl in imperial units: MPa	●	●	●	●
		Z (Note 4)	Name plate and caution plate for bowl in imperial units: psi	○ (Note 5)	○ (Note 5)	○ (Note 5)	○ (Note 5)

Note 1) Option B, G, H, M are not assembled and supplied loose at the time of shipment.

Note 2) Assembly of a bracket and set nuts

Note 3) Only for the AR20-A to 40-A

Note 4) For pipe thread type: NPT

This product is for overseas use only according to the new Measurement Law. (The SI unit type is provided for use in Japan.)

Cannot be used with M: Round pressure gauge (with color zone). Available by request for special.

Note 5) ○: For pipe thread type: NPT only

AC-A

AF-A

AF□-A

AR-A

AL-A

AW-A

AC-B

AF-A

AF□-A

AR-B

AL-A

AW-B

AW□

AF□G

E□

AV

AF