

Modular Type Lubricators Series AL

Lubricator Series AL	Model	Port size	Option
 <p data-bbox="115 639 344 662">Pages 508 through to 513</p>	AL10	M5 x 0.8	Bracket
	AL20	1/8, 1/4	
	AL30	1/4, 3/8	
	AL40	1/4, 3/8, 1/2	
	AL40-06	3/4	
	AL50	3/4, 1	
	AL60	1	

AC-A

AF-A

AF□-A

AR-A

AL-A

AW-A

AC

AF

AF□

AR

AL

AW□

A□G

E□

AV

AF

Lubricator

AL10 to AL60

Symbol
Lubricator

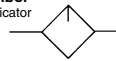

AL20



AL40

How to Order

AL 30 - 03 B -

1
 2
 3
 4
 5

• Option/Semi-standard: Select one each for a to d.
 • Option/Semi-standard symbol: When more than one specification is required, indicate in alphanumeric order.
 Example AL30-03B-2R

		Symbol	Description	①							
				Body size							
				10	20	30	40	50	60		
②	Thread type	Nil	Metric thread (M5)	●	—	—	—	—	—		
		N	Rc	—	●	●	●	●	●		
		F	NPT	—	●	●	●	●	●		
		+	G	—	●	●	●	●	●		
③	Port size	M5	M5	●	—	—	—	—	—		
		01	1/8	—	●	—	—	—	—		
		02	1/4	—	●	●	—	—	—		
		03	3/8	—	—	●	●	—	—		
		04	1/2	—	—	—	●	●	—		
		06	3/4	—	—	—	—	●	●		
		10	1	—	—	—	—	—	●	●	
④	Option (Mounting)	Nil	Without mounting option	●	Nil	●	●	●	●		
		B <small>Note 1)</small>	With bracket	—	●	●	●	●	●		
⑤	Semi-standard	a	Bowl <small>Note 2)</small>	Nil	Polycarbonate bowl	●	●	●	●	●	●
				1	1000 cm ³ tank	—	—	△ <small>Note 3)</small>	△ <small>Note 3)</small>	△ <small>Note 3)</small>	△ <small>Note 3)</small>
				10	1000 cm ³ tank (with switch) Lowest limit ON	—	—	△ <small>Note 3)</small>	△ <small>Note 3)</small>	△ <small>Note 3)</small>	△ <small>Note 3)</small>
				11	1000 cm ³ tank (with switch) Lowest limit OFF	—	—	△ <small>Note 3)</small>	△ <small>Note 3)</small>	△ <small>Note 3)</small>	△ <small>Note 3)</small>
				2	Metal bowl	●	●	●	●	●	●
				6	Nylon bowl	●	●	●	●	●	●
				8	Metal bowl with level gauge	—	—	●	●	●	●
				C	With bowl guard	—	●	—	—	—	—
				6C	Nylon bowl with bowl guard	—	●	—	—	—	—
				b	Lubricant exhaust port	Nil	Without drain cock	●	●	●	●
		3	With drain cock			●	●	●	●	●	●
		3W	Drain cock with barb fitting: For ø6 x ø4 nylon tube			—	—	●	●	●	●
		c	Flow direction	Nil	Flow direction: Left to right	●	●	●	●	●	●
				R	Flow direction: Right to left	●	●	●	●	●	●
d	Pressure unit	Nil	Name plate and caution plate for bowl in imperial units: MPa	●	●	●	●	●	●		
		Z <small>Note 4)</small>	Name plate and caution plate for bowl in imperial units: psi, °F	○ <small>Note 5)</small>	○ <small>Note 5)</small>	○ <small>Note 5)</small>	○ <small>Note 5)</small>	○ <small>Note 5)</small>	○ <small>Note 5)</small>		

Note 1) Option B is not assembled and supplied loose at the time of shipment.

Note 2) Refer to Chemical Data on page 365 when selecting a case material.

Note 3) △: Dedicated lubricant discharge function is equipped, and semi-standard b-3, or 3W are not available.

Note 4) For thread type: M5 and NPT. This product is for overseas use only according to the new Measurement Law. (The SI unit type is provided for use in Japan.)

Note 5) ○: For thread type: M5 and NPT only

Standard Specifications

Model	AL10	AL20	AL30	AL40	AL40-06	AL50	AL60
Port size	M5 x 0.8	1/8, 1/4	1/4, 3/8	1/4, 3/8, 1/2	3/4	3/4, 1	1
Fluid	Air						
Proof pressure	1.5 MPa						
Maximum operating pressure	1.0 MPa						
Ambient and fluid temperature	-5 to 60°C (with no freezing)						
Minimum dripping flow rate ^{Note)} [L/min (ANR)]	4	15	1/4: 30 3/8: 40	1/4: 30 3/8: 40 1/2: 50	50	190	220
Oil capacity (cm ³)	7	25	55	135			
Recommended lubricant	Class 1 turbine oil (ISO VG32)						
Bowl material	Polycarbonate						
Bowl guard	—	Semi-standard	Standard				
Weight (kg)	0.07	0.11	0.24	0.47	0.52	1.06	1.13

Note) • The flow rate is 5 drips or greater/min under the following conditions: Inlet pressure of 0.5 MPa; Class 1 turbine oil (ISO VG32); Temperature at 20°C; Oil adjustment valve fully opened.

- Use air consumption flow rate for minimum dripping flow rate.

Option/Part No.

Optional specifications	Model						
	AL10	AL20	AL30	AL40	AL40-06	AL50	AL60
Bracket assembly ^{Note)}	—	AF20P-050AS	AF30P-050AS	AF40P-050AS	AF40P-070AS	AF50P-050AS	AF50P-050AS

Note) Assembly of a bracket and 2 mounting screws. The part number for bracket assembly for 1000 cm³ is AF50P-050AS (applicable to the AL30 to AL60).

Semi-standard/Bowl Assembly Part No.

Bowl material	Semi-standard specifications				Model							
	With drain guide	With barb fitting	With bowl guard	With switch		AL10	AL20	AL30	AL40	AL40-06	AL50	AL60
				Lowest limit ON	Lowest limit OFF							
Polycarbonate	●	—	—	—	—	C1SL-3	C2SL-3	C3SL-3	C4SL-3			
	—	—	●	—	—	—	C2SL-C	—	—	—	—	—
	●	—	●	—	—	—	C2SL-3C	—	—	—	—	—
	●	●	—	—	—	—	—	C3SL-3W	C4SL-3W			
Nylon	—	—	—	—	—	C1SL-6	C2SL-6	C3SL-6	C4SL-6			
	●	—	—	—	—	C1SL-36	C2SL-36	C3SL-36	C4SL-36			
	—	—	●	—	—	—	C2SL-6C	—	—	—	—	—
	●	●	●	—	—	—	C2SL-36C	—	—	—	—	—
Metal	—	—	—	—	—	C1SL-2	C2SL-2	C3SL-2	C4SL-2			
	●	—	—	—	—	C1SL-23	C2SL-23	C3SL-23	C4SL-23			
Metal bowl with level gauge	—	—	—	—	—	—	—	C3LL-8	C4LL-8			
	●	—	—	—	—	—	—	C3LL-38	C4LL-38			
1000 cm ³ tank (Metal bowl with level gauge)	—	—	—	—	—	—	—	121538-1A				
	—	—	—	●	●	—	—	121538-1A-S1 [IS400-1 (Float switch only)]				
	—	—	—	—	—	—	—	121538-1A-S2 [IS400-2 (Float switch only)]				

Note) • Bowl O-ring (or seal) is included for the AL20 to AL60.

- Bowl assembly for the AL30 to AL60 models comes with a bowl guard (steel band material). (except when the bowl material is metal)
- Please consult SMC for psi and °F unit display specifications.
- When switching bowl materials from a polycarbonate or nylon product to a metal bowl with a level gauge, the oil feed tube assembly must be replaced. (Also, when switching bowl materials from a metal bowl with a level gauge to a polycarbonate or nylon product, the oil feed tube assembly must be replaced.) Please consult SMC separately.
- It is not possible to switch from a polycarbonate, nylon or metal bowl, or from a metal bowl with a level gauge to a 1000 cm³ tank. Please order the product separately.

Series AL10 to AL60

Flow Characteristics (Representative values)

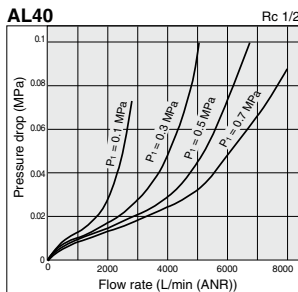
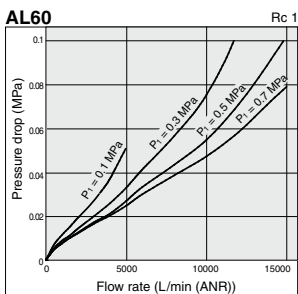
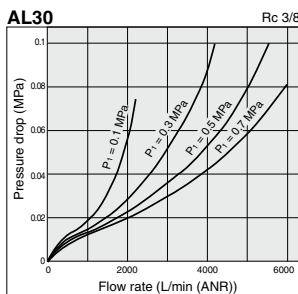
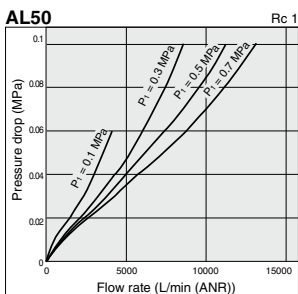
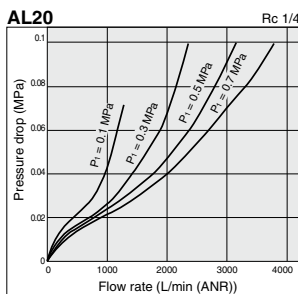
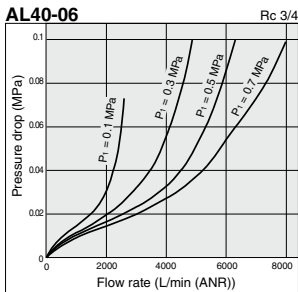
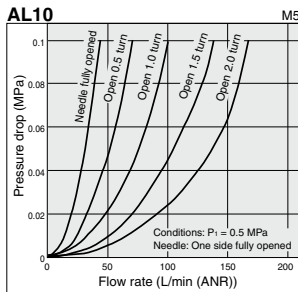

Working Principle: AL10 Type

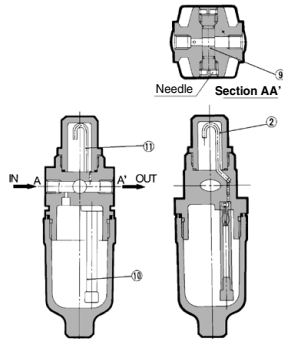

A portion of the air introduced from the IN side pressurizes the lubricant inside the bowl. The remainder of the air passes through the needles (9), and flows to the OUT side. The pressure differential between the inside of the bowl and the inside of the sight dome (2), causes the lubricant inside the bowl into the oil passage (10). The lubricant drips from the dripping tube (1), and lubricates the OUT side. The amount of lubricant is adjusted by the needle (9), on the front face. Turning the needle clockwise increases the amount of the lubricant, and turning it counterclockwise until fully opened shuts off the lubricant. The needle on the side that is not used should be left fully opened.

⚠ Specific Product Precautions

Be sure to read before handling.
Refer to front matter 43 for Safety Instructions and pages 365 to 369 for F.R.L. Precautions.

Selection

⚠ Warning

- Do not introduce air from the outlet side as this can damage the damper.

⚠ Caution

- Use a check valve (AKM series) to prevent back flow of the lubricant when redirecting the air flow before the lubricator.

Maintenance

⚠ Warning

- For the AL10/20 type, replenish the lubricant after releasing the inlet pressure. Lubrication cannot take place under a pressurized condition.
- Adjustment of the oil regulating valve (sight dome assembly) for models from the AL20 to AL60 should be carried out manually. Turning it counterclockwise increases the dripping amount, and turning it clockwise reduces the dripping amount. The use of tools, etc. can result in damage to the unit. From the fully closed position, three rotations will bring it to the fully open position. Please do not rotate it any further than this. Note that the numbered scale markings are guidelines for adjusting the position, and not indicators of the dripping amount.

⚠ Caution

- Check the dripping amount once a day. Drip failure can cause damage to the components that need lubrication.

Construction

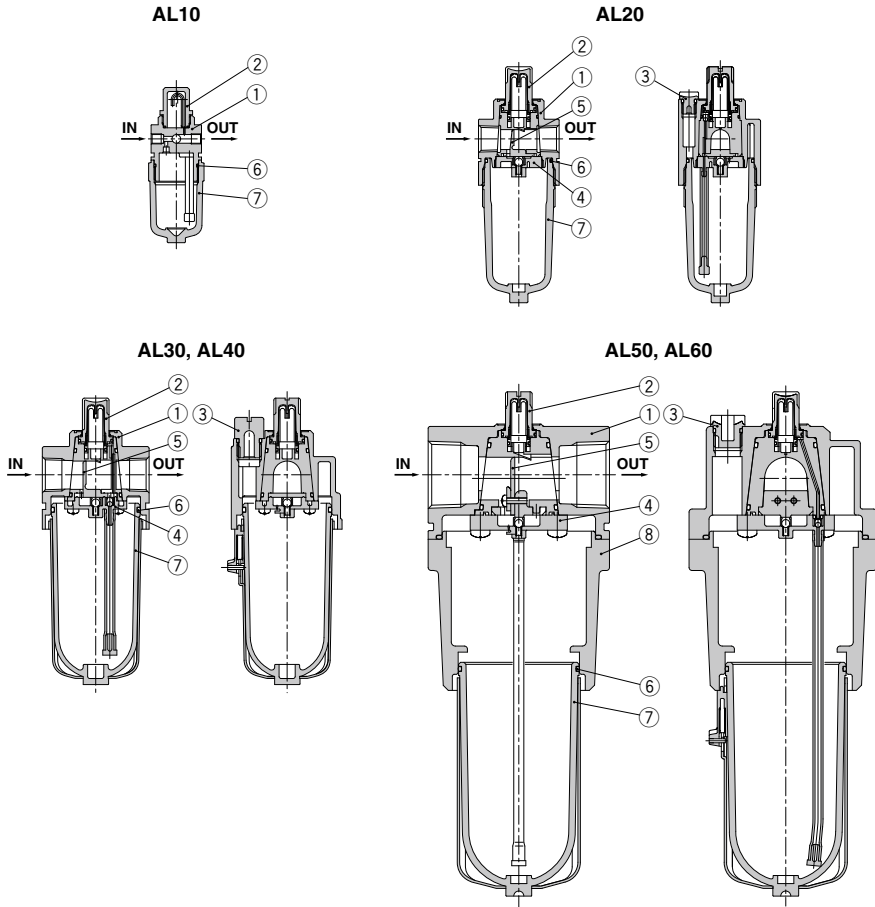

AC-A
AF-A
AF□-A
AR-A
AL-A
AW-A
AC
AF
AF□
AR
AL
AW□
A□G
E□
AV
AF

Component Parts

No.	Description	Material	Model	Color
1	Body	Zinc die-cast	AL10	Platinum silver
		Aluminum die-cast	AL20 to AL60	
8	Housing	Aluminum die-cast	AL50, AL60	Platinum silver

Replacement Parts

No.	Description	Material	Part no.							
			AL10	AL20	AL30	AL40	AL40-06	AL50	AL60	
2	Sight dome assembly	Polycarbonate	AL10P-080AS	AL20P-080AS						
3	Lubrication plug assembly	—	—	AL20P-060AS	AL30P-060AS	AL40P-060AS				
4	Damper retainer assembly ^{Note 1)}	—	—	AL20P-030AS	AL30P-030AS	AL40P-030AS	AL50P-030AS	AL60P-030AS		
5	Damper (assembly)	Synthetic resin	—	AL20P-040S	AL30P-040S	AL40P-040S	AL50P-040AS	AL60P-040AS		
6	Bowl O-ring	NBR	C1SFP-260S	C2SFP-260S	C3SFP-260S	C4SFP-260S				
7	Bowl assembly ^{Note 2)}	Polycarbonate	C1SL	C2SL	C3SL ^{Note 3)}	C4SL ^{Note 3)}				

Note 1) Add "-1" at the end of the part number when ordering a damper retainer assembly for 1000 cm³. Example) AL30P-030AS-1

Note 2) Bowl O-ring is included for the AL20 to AL60. Please contact SMC regarding the bowl assembly supply for psi and °F unit specifications.

Note 3) Bowl assembly for the AL30 to AL60 models comes with a bowl guard (steel band material).

Series AL10 to AL60

Dimensions

AL10

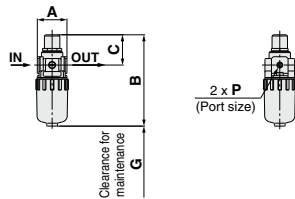

AL20

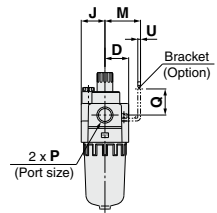
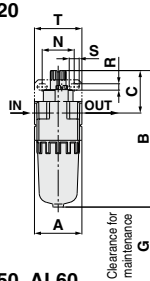

AL30, AL40

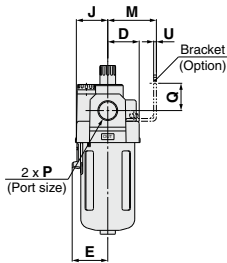
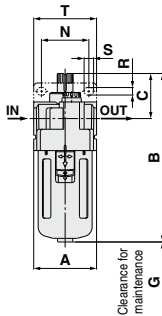

AL50, AL60

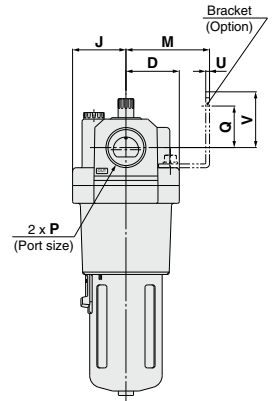
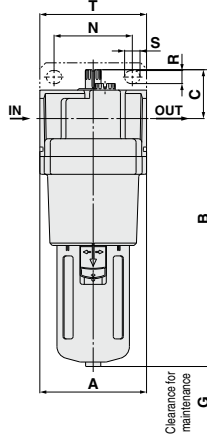

Applicable model Optional/Semi-standard specifications	AL10/20				AL30 to AL60			
	With drain cock	Metal bowl with drain cock	Metal bowl	With drain cock	Metal bowl with level gauge	Metal bowl with drain cock	Metal bowl with drain cock & level gauge	Drain cock with barb fitting
Dimensions								

Model	Standard specifications									Optional specifications						
	P	A	B	C	D	E	G	J	M	N	Q	R	S	T	U	
AL10	M5 x 0.8	25	77	26	12.5	—	35	12.5	—	—	—	—	—	—	—	
AL20	1/8, 1/4	40	115	36	20	—	60	20	30	27	22	5.4	8.4	40	2.3	
AL30	1/4, 3/8	53	142	38	26.5	30	80	26.5	41	40	23	6.5	8	53	2.3	
AL40	1/4, 3/8, 1/2	70	176	40	35	38	110	35	50	54	26	8.5	10.5	70	2.3	
AL40-06	3/4	75	176	38	35	38	110	35	50	54	25	8.5	10.5	70	2.3	
AL50	3/4, 1	90	250	41	45	45	110	45	70	66	35	11	13	90	3.2	
AL60	1	95	268	45	47.5	—	110	47.5	70	66	35	11	13	90	3.2	

Model	Semi-standard specifications					
	With drain cock	With barb fitting	Metal bowl	Metal bowl with drain cock	Metal bowl with level gauge	Metal bowl with drain cock & level gauge
	B	B	B	B	B	B
AL10	85	—	82	85	—	—
AL20	123	—	121	124	—	—
AL30	153	161	142	166	162	186
AL40	187	195	176	200	196	220
AL40-06	187	195	176	200	196	220
AL50	261	269	250	274	270	294
AL60	279	287	268	292	288	312

Dimensions

Semi-standard specifications: 1000 cm³ tank

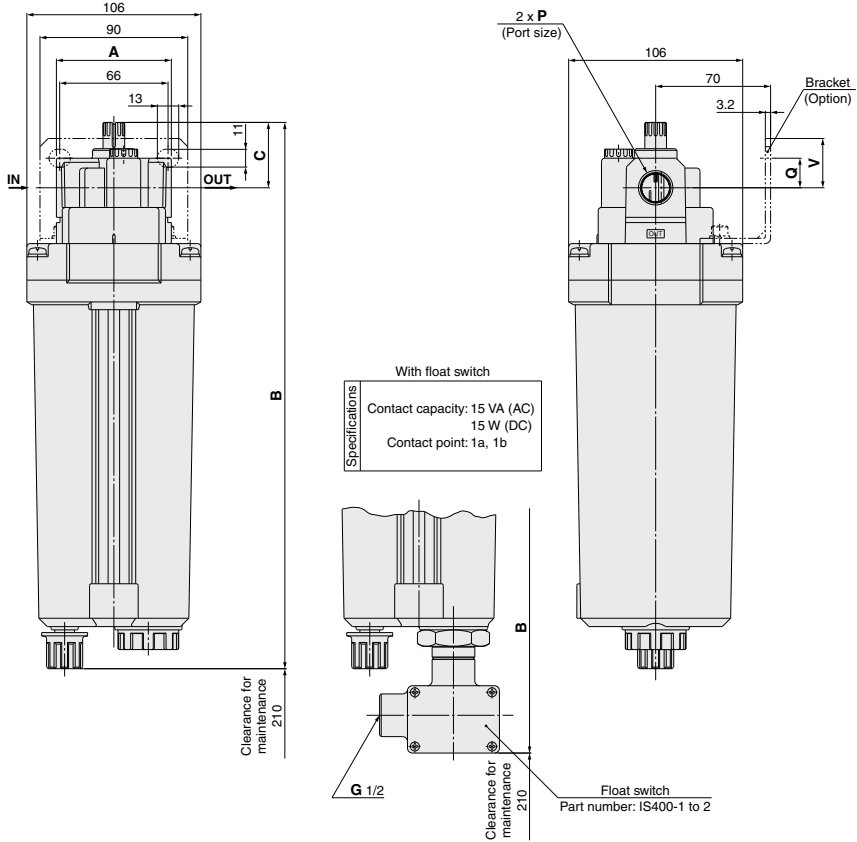

- AC-A
- AF-A
- AF□-A
- AR-A
- AL-A
- AW-A
- AC
- AF
- AF□
- AR
- AL**
- AW□
- A□G
- E□
- AV
- AF

Model	P	A	B	C	Bracket mount		With float switch
					Q	V	B
AL30	1/4, 3/8	53	324	38	25	—	374
AL40	1/4, 3/8, 1/2	70	333	40	18	—	383
AL40-06	3/4	75	333	38	16	—	383
AL50	3/4, 1	90	332	41	35	47	382
AL60	1	95	335	45	35	47	385