

# PM150CVA060

FLAT-BASE TYPE  
INSULATED PACKAGE

## PM150CVA060



### FEATURE

- 3φ 150A, 600V Current-sense IGBT for 20kHz switching
- Monolithic gate drive & protection logic
- Detection, protection & status indication circuits for over-current, short-circuit, over-temperature & under-voltage (P-Fo available from upper leg devices)
- Acoustic noise-less 15kW class inverter application
- UL Recognized

Yellow Card No. E80276(N)

File No. E80271

## APPLICATION

General purpose inverter, servo drives and other motor controls

## PACKAGE OUTLINES

Dimensions in mm

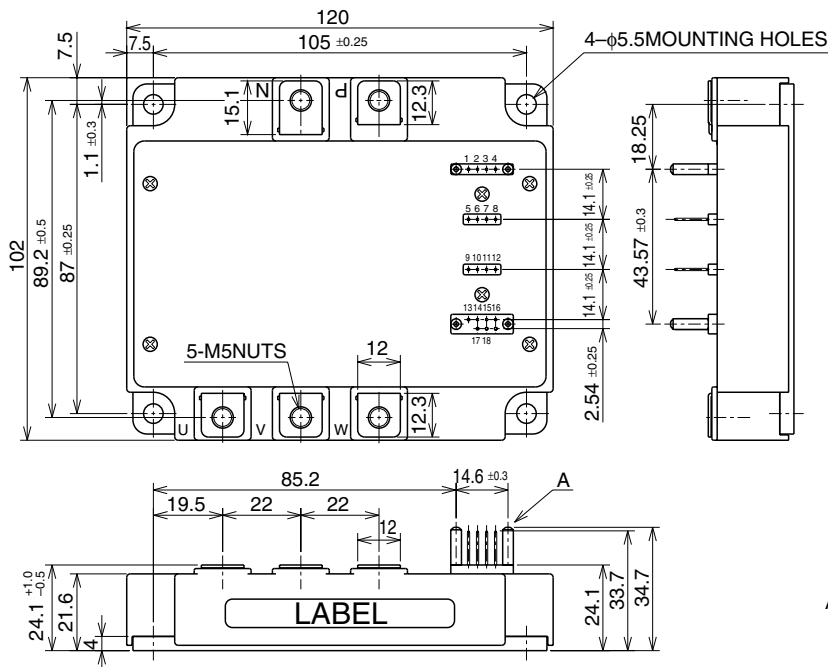

### TERMINAL CODE

|         |          |         |
|---------|----------|---------|
| 1. WFO  | 8. VVP1  | 15. VNC |
| 2. VWPC | 9. UFO   | 16. VN1 |
| 3. WP   | 10. VUPC | 17. UN  |
| 4. VWP1 | 11. UP   | 18. VN  |
| 5. VFO  | 12. VUP1 | 19. WN  |
| 6. VVPC | 13. NC   |         |
| 7. VP   | 14. FO   |         |

A : DETAIL

# PM150CVA060

FLAT-BASE TYPE  
INSULATED PACKAGE

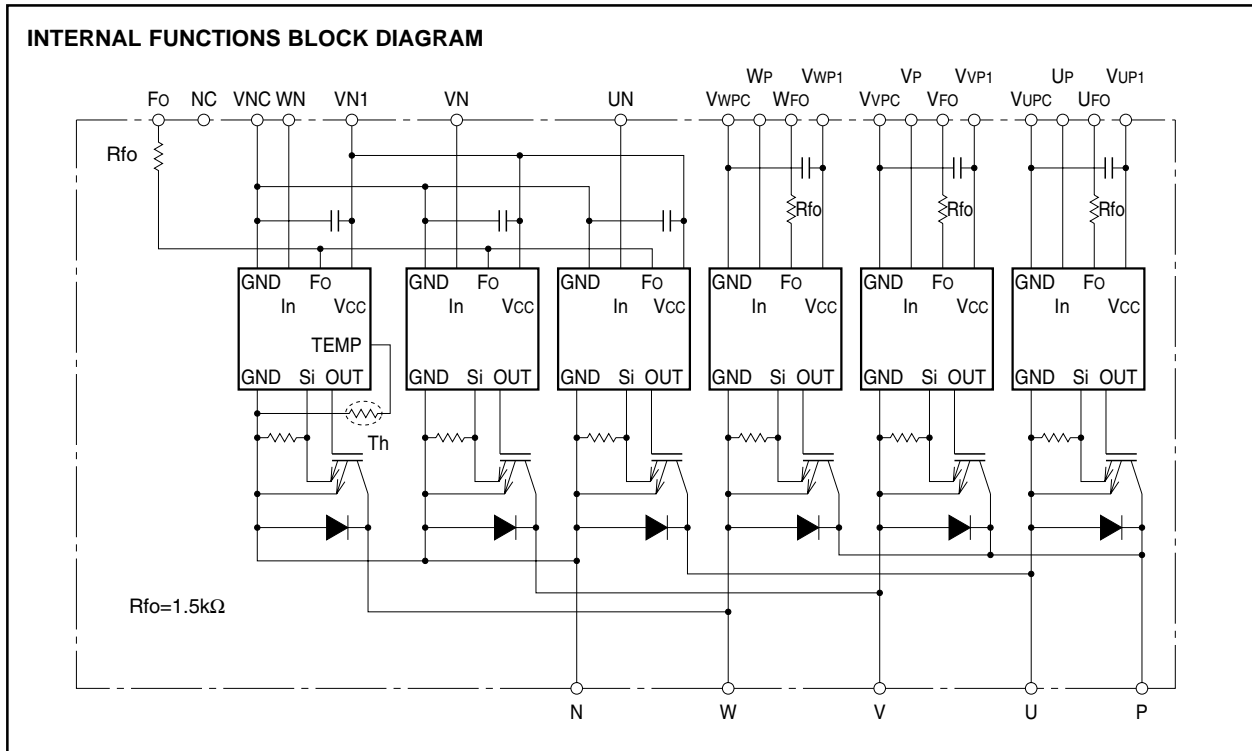

**MAXIMUM RATINGS** ( $T_j = 25^\circ\text{C}$ , unless otherwise noted)

**INVERTER PART**

| Symbol       | Parameter                 | Condition                                   | Ratings         | Unit             |
|--------------|---------------------------|---|-----------------|------------------|
| $V_{CES}$    | Collector-Emitter Voltage | $V_D = 15\text{V}$ , $V_{CIN} = 15\text{V}$ | 600             | V                |
| $\pm I_C$    | Collector Current         | $T_C = 25^\circ\text{C}$                    | 150             | A                |
| $\pm I_{CP}$ | Collector Current (Peak)  | $T_C = 25^\circ\text{C}$                    | 300             | A                |
| $P_C$        | Collector Dissipation     | $T_C = 25^\circ\text{C}$                    | 406             | W                |
| $T_j$        | Junction Temperature      |   | $-20 \sim +150$ | $^\circ\text{C}$ |

**CONTROL PART**

| Symbol    | Parameter                   | Condition   | Ratings | Unit |
|-----------|-----------------------------|---|---------|------|
| $V_D$     | Supply Voltage              | Applied between : $V_{UP1}-V_{UPC}$<br>$V_{VP1}-V_{VPC}$ , $V_{WP1}-V_{WPC}$ , $V_{N1}-V_{NC}$      | 20      | V    |
| $V_{CIN}$ | Input Voltage               | Applied between : $U_P-V_{UPC}$ , $V_P-V_{VPC}$ , $W_P-V_{WPC}$<br>$U_N \cdot V_N \cdot W_N-V_{NC}$ | 20      | V    |
| $V_{FO}$  | Fault Output Supply Voltage | Applied between : $U_{FO}-V_{UPC}$ , $V_{FO}-V_{VPC}$ , $W_{FO}-V_{WPC}$<br>$F_O-V_{NC}$            | 20      | V    |
| $I_{FO}$  | Fault Output Current        | Sink current at $U_{FO}$ , $V_{FO}$ , $W_{FO}$ and $F_O$ terminal                                   | 20      | mA   |

# PM150CVA060

FLAT-BASE TYPE  
INSULATED PACKAGE

## TOTAL SYSTEM

| Symbol                 | Parameter                         | Condition   | Ratings    | Unit             |
|------------------------|-----------------------------------|---|------------|------------------|
| V <sub>CC(Prot)</sub>  | Supply Voltage Protected by SC    | V <sub>D</sub> = 13.5 ~ 16.5V, Inverter Part,<br>T <sub>j</sub> = 125°C Start | 400        | V                |
| V <sub>CC(surge)</sub> | Supply Voltage (Surge)            | Applied between : P-N, Surge value or without switching                       | 500        | V                |
| T <sub>c</sub>         | Module Case Operating Temperature | (Note-1)  | -20 ~ +100 | °C               |
| T <sub>stg</sub>       | Storage Temperature               |   | -40 ~ +125 | °C               |
| V <sub>iso</sub>       | Isolation Voltage                 | 60Hz, Sinusoidal, Charged part to Base, AC 1 min.                             | 2500       | V <sub>rms</sub> |

(Note-1) T<sub>c</sub> measurement point is below. (3mm depth at the center of the side of base plate)

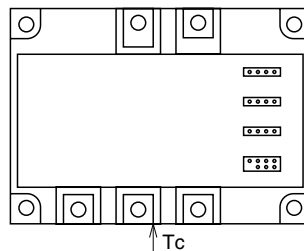

## ELECTRICAL CHARACTERISTICS (T<sub>j</sub> = 25°C, unless otherwise noted)

### INVERTER PART

| Symbol               | Parameter                            | Test Condition   | Limits                 |      |      | Unit |    |
|----------------------|--------------------------------------|--|------------------------|------|------|------|----|
|                      |                                      |  | Min.                   | Typ. | Max. |      |    |
| V <sub>CE(sat)</sub> | Collector-Emitter Saturation Voltage | V <sub>D</sub> = 15V, I <sub>c</sub> = 150A<br>V <sub>CIN</sub> = 0V   | T <sub>j</sub> = 25°C  | —    | 2.35 | 2.80 | V  |
|                      |                                      |  | T <sub>j</sub> = 125°C | —    | 2.55 | 3.05 |    |
| V <sub>EC</sub>      | FWDi Forward Voltage                 | -I <sub>c</sub> = 150A, V <sub>D</sub> = 15V, V <sub>CIN</sub> = 15V   | —                      | 2.20 | 3.30 | V    |    |
| t <sub>on</sub>      | Switching Time                       | V <sub>D</sub> = 15V, V <sub>CIN</sub> = 0V↔15V<br>V <sub>CC</sub> = 300V, I <sub>c</sub> = 150A<br>T <sub>j</sub> = 125°C<br>Inductive Load (upper and lower arm) | —                      | 0.4  | 0.8  | 2.1  | μs |
| t <sub>tr</sub>      |                                      |  | —                      | 0.2  | 0.3  |      |    |
| t <sub>c(on)</sub>   |                                      |  | —                      | 0.3  | 1.1  |      |    |
| t <sub>off</sub>     |                                      |  | —                      | 1.8  | 2.9  |      |    |
| t <sub>c(off)</sub>  |                                      |  | —                      | 0.6  | 1.2  |      |    |
| I <sub>CES</sub>     | Collector-Emitter Cutoff Current     | V <sub>CE</sub> = V <sub>CEs</sub> , V <sub>CIN</sub> = 15V  | T <sub>j</sub> = 25°C  | —    | —    | 1    | mA |
|                      |                                      |  | T <sub>j</sub> = 125°C | —    | —    | 10   |    |

### CONTROL PART

| Symbol               | Parameter                               | Test Condition  | Limits                           |      |      | Unit |    |
|----------------------|---|---|----------------------------------|------|------|------|----|
|                      |   |   | Min.                             | Typ. | Max. |      |    |
| I <sub>D</sub>       | Circuit Current                         | V <sub>D</sub> = 15V, V <sub>CIN</sub> = 15V  | V <sub>N1</sub> -V <sub>Nc</sub> | —    | 40   | 55   | mA |
|                      |   |   | V*P1-V*PC                        | —    | 13   | 18   |    |
| V <sub>th(ON)</sub>  | Input ON Threshold Voltage              | Applied between : UP-VU <sub>PC</sub> , VP-VV <sub>PC</sub> , WP-VW <sub>PC</sub><br>UN • VN • WN-V <sub>Nc</sub> | 1.2                              | 1.5  | 1.8  | V    |    |
| V <sub>th(OFF)</sub> | Input OFF Threshold Voltage             |   | 1.7                              | 2.0  | 2.3  |      |    |
| SC                   | Short Circuit Trip Level                | -20 ≤ T <sub>j</sub> ≤ 125°C, V <sub>D</sub> = 15V  | 210                              | —    | —    | A    |    |
| t <sub>off(SC)</sub> | Short Circuit Current Delay Time        | V <sub>D</sub> = 15V  | —                                | 10   | —    | μs   |    |
| OT                   | Over Temperature Protection             | Base-plate Temperature detection, V <sub>D</sub> = 15V  | Trip level                       | 111  | 118  | 125  | °C |
|                      |   |   | Reset level                      | —    | 100  | —    |    |
| UV                   | Supply Circuit Under-Voltage Protection | -20 ≤ T <sub>j</sub> ≤ 125°C  | Trip level                       | 11.5 | 12.0 | 12.5 | V  |
|                      |   |   | Reset level                      | —    | 12.5 | —    |    |
| I <sub>FO(H)</sub>   | Fault Output Current                    | V <sub>D</sub> = 15V, V <sub>FO</sub> = 15V   | (Note-2)                         | —    | —    | 0.01 | mA |
| I <sub>FO(L)</sub>   |   |   | (Note-2)                         | —    | 10   | 15   |    |
| t <sub>FO</sub>      | Minimum Fault Output Pulse Width        | V <sub>D</sub> = 15V  | (Note-2)                         | 1.0  | 1.8  | —    | ms |

(Note-2) Fault output is given only when the internal SC, OT & UV protection.  
 Fault output of OT protection operate by lower arm  
 Fault output of OT, UV protection given pulse while over level.

**PM150CVA060**FLAT-BASE TYPE  
INSULATED PACKAGE**THERMAL RESISTANCES**

| Symbol                | Parameter                            | Test Condition                                     | Limits |      |       | Unit |
|-----------------------|--------------------------------------|--|--------|------|-------|------|
|                       |                                      |  | Min.   | Typ. | Max.  |      |
| R <sub>th(j-c)Q</sub> | Junction to case Thermal Resistances | Inverter IGBT part (per 1/6 module)                | —      | —    | 0.308 | °C/W |
| R <sub>th(j-c)F</sub> |                                      | Inverter FWDi part (per 1/6 module)                | —      | —    | 0.47  |      |
| R <sub>th(c-f)</sub>  | Contact Thermal Resistance           | Case to fin, Thermal grease applied (per 1 module) | —      | —    | 0.022 |      |

**MECHANICAL RATINGS AND CHARACTERISTICS**

| Symbol | Parameter       | Test Condition           | Limits |      |      | Unit  |
|--------|-----------------|--------------------------|--------|------|------|-------|
|        |                 |                          | Min.   | Typ. | Max. |       |
| —      | Mounting torque | Mounting part screw : M5 | 2.5    | 3.0  | 3.5  | N • m |
| —      | Mounting torque | Main terminal screw : M5 | 2.5    | 3.0  | 3.5  | N • m |
| —      | Weight          |                          | —      | 730  | —    | g     |

**RECOMMENDED CONDITIONS FOR USE**

| Symbol                | Parameter                       | Test Condition   | Recommended value | Unit |
|-----------------------|---------------------------------|--|-------------------|------|
| V <sub>CC</sub>       | Supply Voltage                  | Applied across P-N terminals   | ≤ 400             | V    |
| V <sub>D</sub>        | Control Supply Voltage          | Applied between : V <sub>UP1</sub> -V <sub>UPC</sub> , V <sub>VP1</sub> -V <sub>VPC</sub><br>V <sub>WP1</sub> -V <sub>WPC</sub> , V <sub>N1</sub> -V <sub>NVC</sub> (Note-3)                   | 15 ± 1.5          | V    |
| V <sub>CIN(ON)</sub>  | Input ON Voltage                | Applied between : U <sub>P</sub> -V <sub>UPC</sub> , V <sub>P</sub> -V <sub>VPC</sub> , W <sub>P</sub> -V <sub>WPC</sub><br>U <sub>N</sub> • V <sub>N</sub> • W <sub>N</sub> -V <sub>NVC</sub> | ≤ 0.8             | V    |
| V <sub>CIN(OFF)</sub> | Input OFF Voltage               |  | ≥ 4.0             |      |
| t <sub>dead</sub>     | Arm Shoot-through Blocking Time | For IPM's each input signals   | ≥ 2.5             | μs   |
| f <sub>PWM</sub>      | PWM Input Frequency             | Using Application Circuit input signal of IPM, 3φ Sinusoidal PWM VVVF inverter   | ≤ 20              | kHz  |

(Note-3) With ripple satisfying the following conditions dv/dt swing ≤ ±5V/μs, Variation ≤ 2V peak to peak

# PM150CVA060

FLAT-BASE TYPE  
INSULATED PACKAGE

## PERFORMANCE CURVES

**OUTPUT CHARACTERISTICS (TYPICAL)**

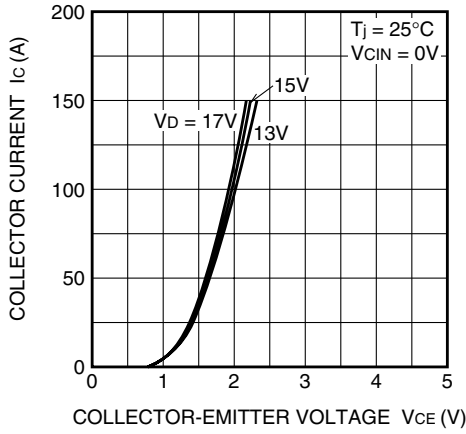

**COLLECTOR-EMITTER SATURATION VOLTAGE CHARACTERISTICS (TYPICAL)**

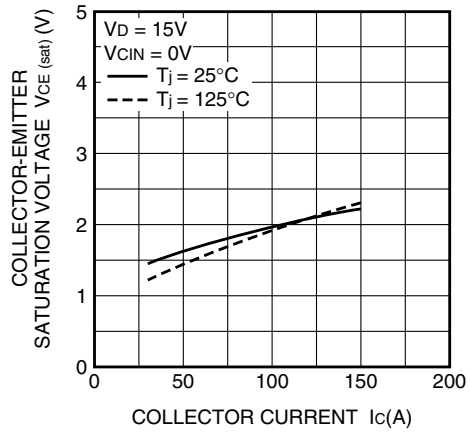

**COLLECTOR-EMITTER SATURATION VOLTAGE CHARACTERISTICS (TYPICAL)**

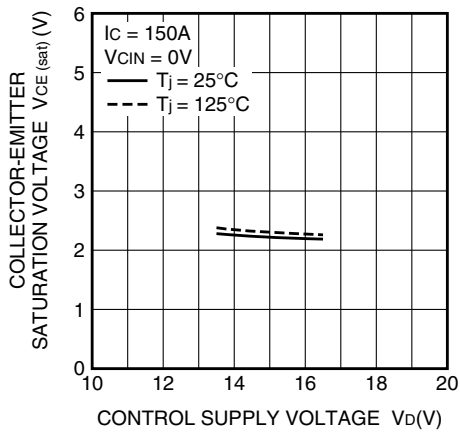

**SWITCHING CHARACTERISTICS (TYPICAL)**

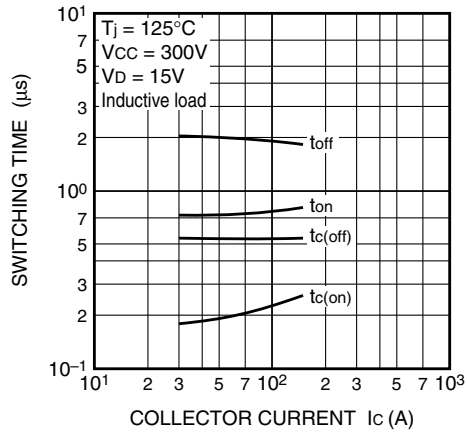

**DIODE FORWARD CHARACTERISTICS (TYPICAL)**

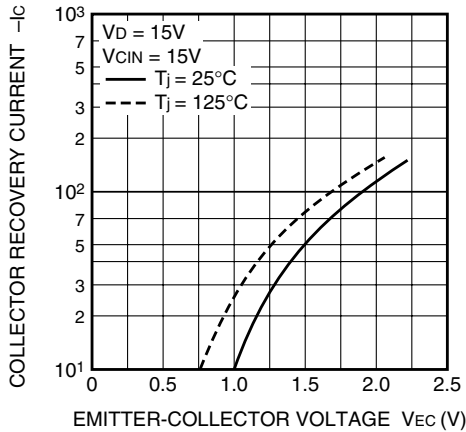

**DIODE REVERSE RECOVERY CHARACTERISTICS (TYPICAL)**

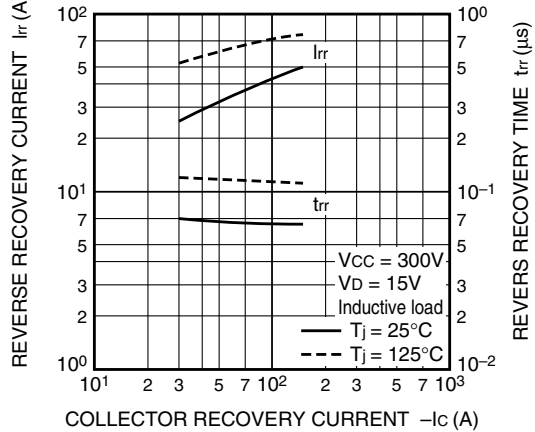

# PM150CVA060

FLAT-BASE TYPE  
INSULATED PACKAGE

**TRANSIENT THERMAL  
IMPEDANCE CHARACTERISTICS  
(IGBT per 1 element)**

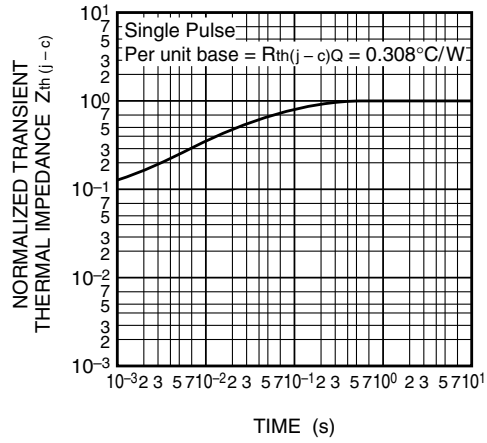

**TRANSIENT THERMAL  
IMPEDANCE CHARACTERISTICS  
(FWDi per 1 element)**

