



**SEMIPONT® 1**

## Controllable Bridge Rectifiers

**SKBT 28**

### Features

- Sturdy isolated metal baseplate
- Fast-on terminals with solder tips
- Suitable for wave soldering
- High surge current rating
- UL recognized, file no. E 63 532

### Typical Applications\*

- Controllable single phase rectifier
- DC power supplies
- DC motor controllers
- DC motor field controllers

1) Painted metal shield of minimum 250 x 250 x 1 mm:  $R_{th(c-a)} = 1,85 \text{ K/W}$

2) Freely suspended or mounted on insulator

$V_{RSM}$ V	$V_{RRM}, V_{DRM}$ V	$I_D = 28 \text{ A (full conduction)}$ ( $T_c = 89 \text{ °C}$ )
600	600	SKBT 28/06
800	800	SKBT 28/08
1200	1200	SKBT 28/12
1400	1400	SKBT 28/14

Symbol	Conditions	Values	Units
$I_D$	$T_c = 85 \text{ °C}$	30	A
	$T_a = 45 \text{ °C; chassis } ^1)$	13	A
	$T_a = 45 \text{ °C; P5A/100}$	15	A
	$T_a = 45 \text{ °C; P13A/125}$	16	A
	$T_a = 45 \text{ °C; P1A/120}$	23	A
$I_{TSM}, I_{FSM}$	$T_{vj} = 25 \text{ °C; } 10 \text{ ms}$	320	A
	$T_{vj} = 125 \text{ °C; } 10 \text{ ms}$	280	A
$i^2t$	$T_{vj} = 25 \text{ °C; } 8,3 \dots 10 \text{ ms}$	510	A <sup>2</sup> s
	$T_{vj} = 125 \text{ °C; } 8,3 \dots 10 \text{ ms}$	390	A <sup>2</sup> s
$V_T$	$T_{vj} = 25 \text{ °C; } I_T = 75 \text{ A}$	max. 2,25	V
$V_{T(TO)}$	$T_{vj} = 125 \text{ °C;}$	max. 1	V
$r_T$	$T_{vj} = 125 \text{ °C}$	max. 16	mΩ
$I_{DD}, I_{RD}$	$T_{vj} = 125 \text{ °C; } V_{DD} = V_{DRM}; V_{RD} = V_{RRM}$	max. 8	mA
$t_{gd}$	$T_{vj} = 25 \text{ °C; } I_G = 1 \text{ A; } di_G/dt = 1 \text{ A/}\mu\text{s}$	1	μs
$t_{gr}$	$V_D = 0,67 \cdot V_{DRM}$	1	μs
$(dv/dt)_{cr}$	$T_{vj} = 125 \text{ °C}$	max. 500	V/μs
$(di/dt)_{cr}$	$T_{vj} = 125 \text{ °C; } f = 50 \text{ Hz}$	max. 50	A/μs
$t_q$	$T_{vj} = 125 \text{ °C; typ.}$	80	μs
$I_H$	$T_{vj} = 25 \text{ °C; typ. / max.}$	50 / 150	mA
$I_L$	$T_{vj} = 25 \text{ °C; } R_G = 33 \text{ }\Omega$	100 / 300	mA
$V_{GT}$	$T_{vj} = 25 \text{ °C; d.c.}$	min. 2	V
$I_{GT}$	$T_{vj} = 25 \text{ °C; d.c.}$	min. 100	mA
$V_{GD}$	$T_{vj} = 125 \text{ °C; d.c.}$	max. 0,25	V
$I_{GD}$	$T_{vj} = 125 \text{ °C; d.c.}$	max. 3	mA
$R_{th(j-c)}$	per thyristor / diode	1,8	K/W
	total	0,45	K/W
	$R_{th(c-s)}$ total	0,1	K/W
	$R_{th(j-a)}$ total <sup>2)</sup>	15	K/W
$T_{vj}$		- 40 ... + 125	°C
$T_{stg}$		- 40 ... + 125	°C
$V_{isol}$	a. c. 50 Hz; r.m.s.; 1 s / 1 min.	3600 ( 3000 )	V
$M_s$	case to heatsink	2	Nm
$M_t$		n.a.	Nm
m		66	g
Case	SKBT	G 22	

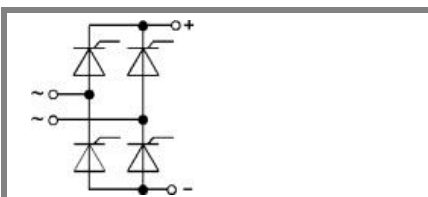

**SKBT**

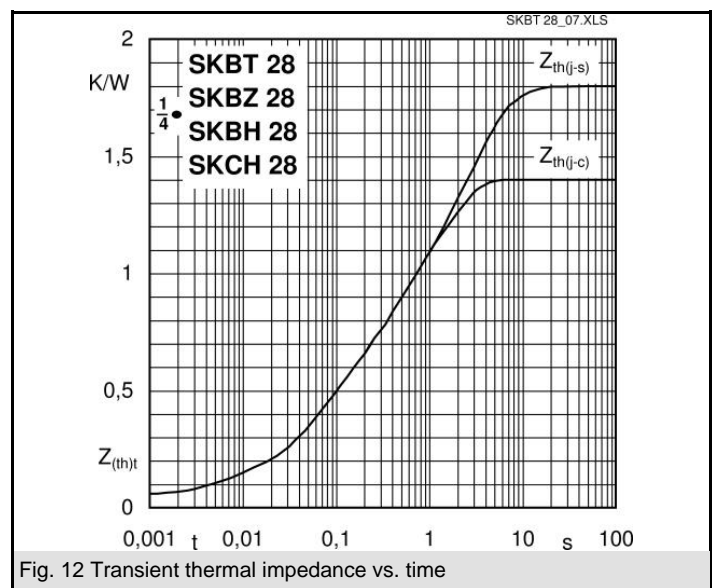
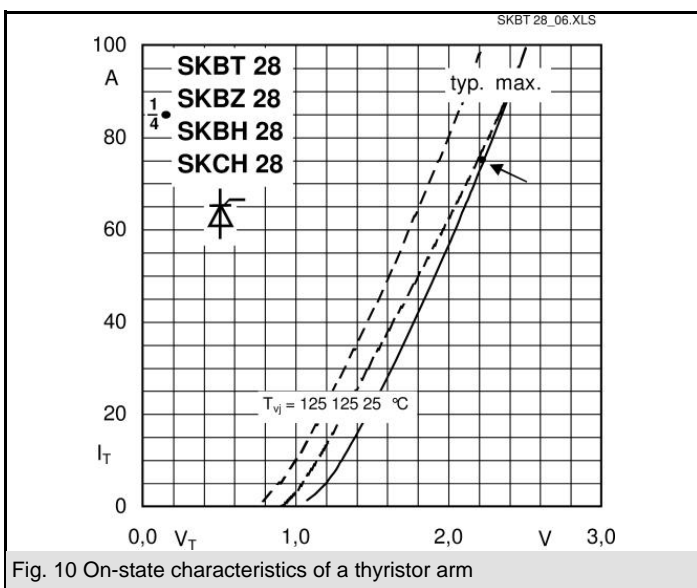
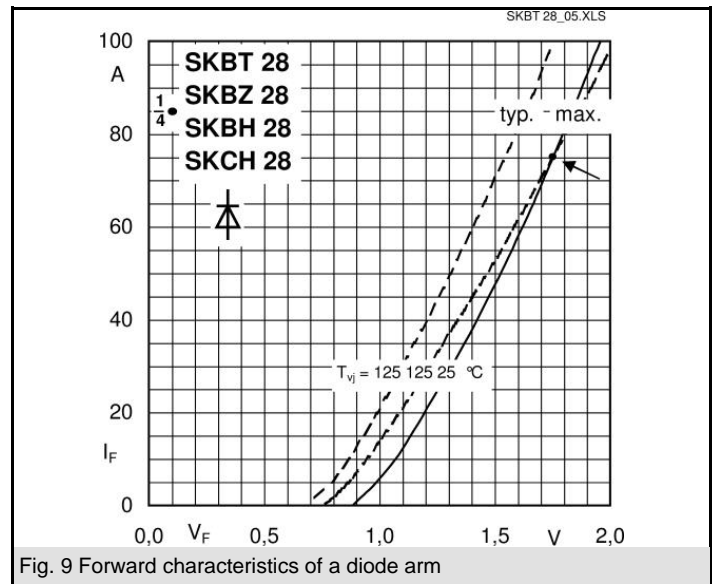
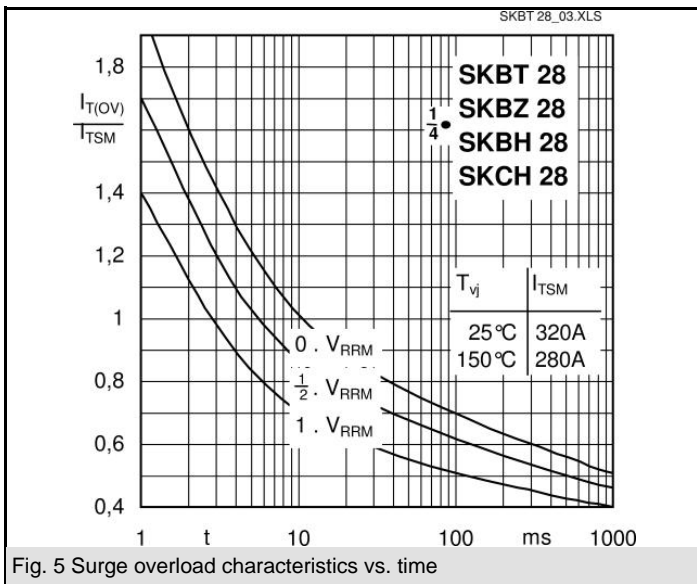
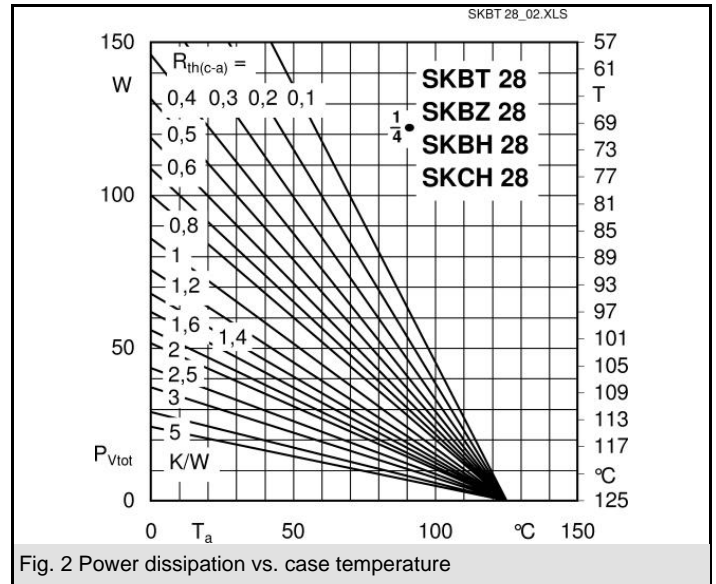
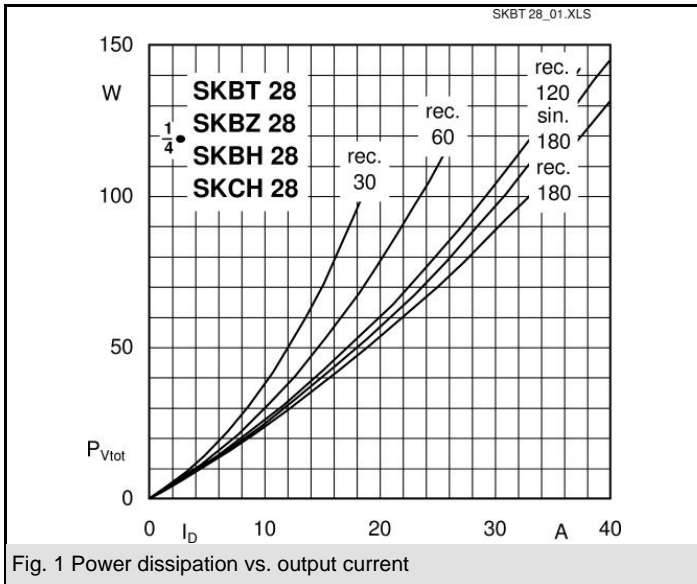

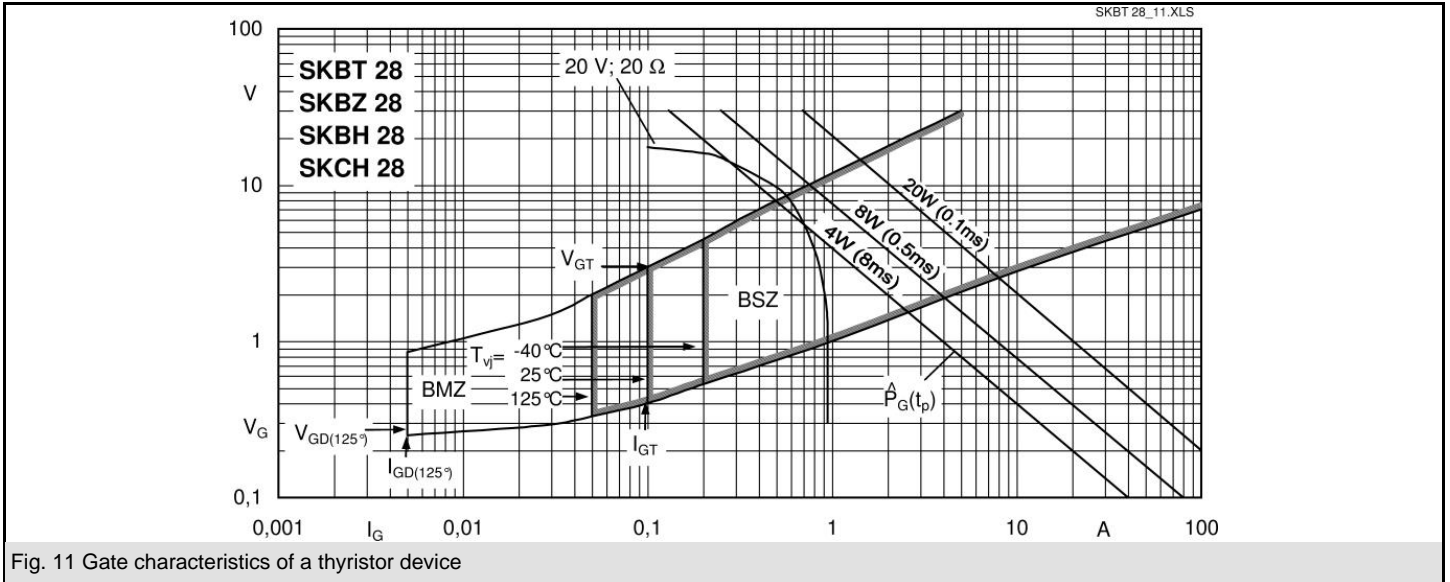
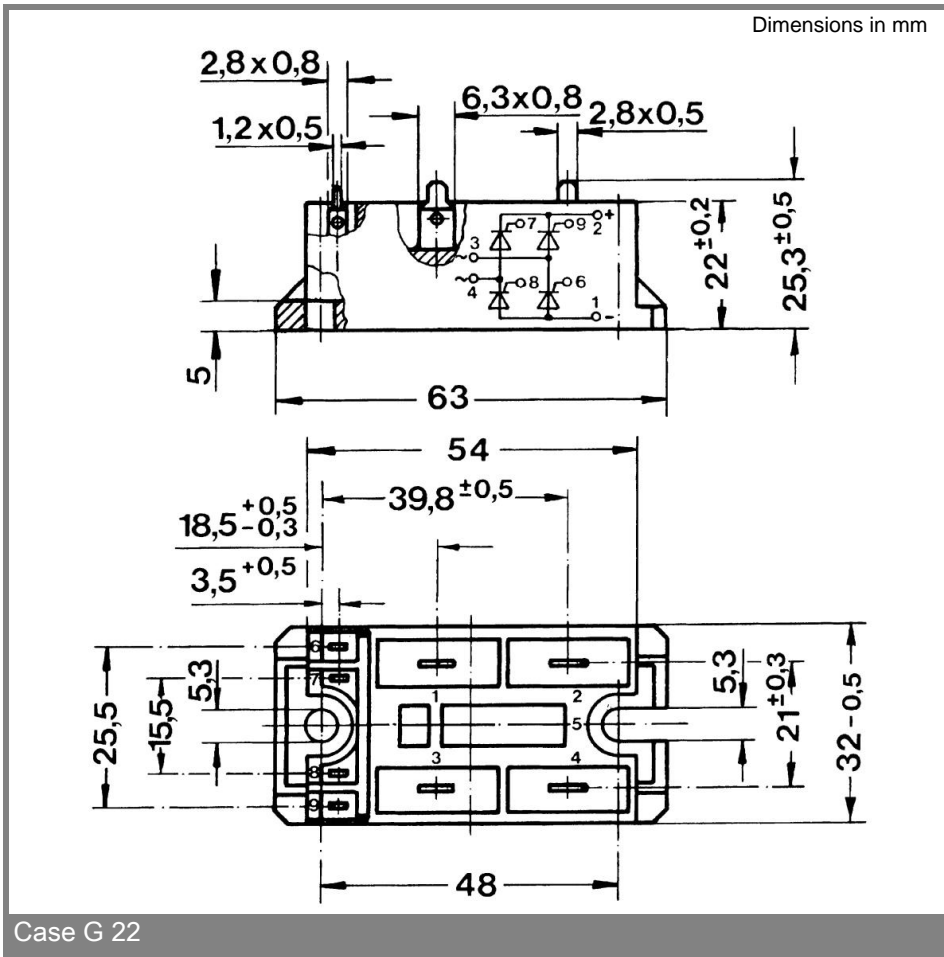

Fig. 11 Gate characteristics of a thyristor device



\* The specifications of our components may not be considered as an assurance of component characteristics. Components have to be tested for the respective application. Adjustments may be necessary. The use of SEMIKRON products in life support appliances and systems is subject to prior specification and written approval by SEMIKRON. We therefore strongly recommend prior consultation of our personal.