

DDR4 SDRAM Memory

Product Guide

SAMSUNG ELECTRONICS RESERVES THE RIGHT TO CHANGE PRODUCTS, INFORMATION AND SPECIFICATIONS WITHOUT NOTICE.

Products and specifications discussed herein are for reference purposes only. All information discussed herein is provided on an "AS IS" basis, without warranties of any kind.

This document and all information discussed herein remain the sole and exclusive property of Samsung Electronics. No license of any patent, copyright, mask work, trademark or any other intellectual property right is granted by one party to the other party under this document, by implication, estoppel or otherwise.

Samsung products are not intended for use in life support, critical care, medical, safety equipment, or similar applications where product failure could result in loss of life or personal or physical harm, or any military or defense application, or any governmental procurement to which special terms or provisions may apply.

For updates or additional information about Samsung products, contact your nearest Samsung office.

All brand names, trademarks and registered trademarks belong to their respective owners.

© 2018 Samsung Electronics Co., Ltd. All rights reserved.

1. DDR4 SDRAM MEMORY ORDERING INFORMATION

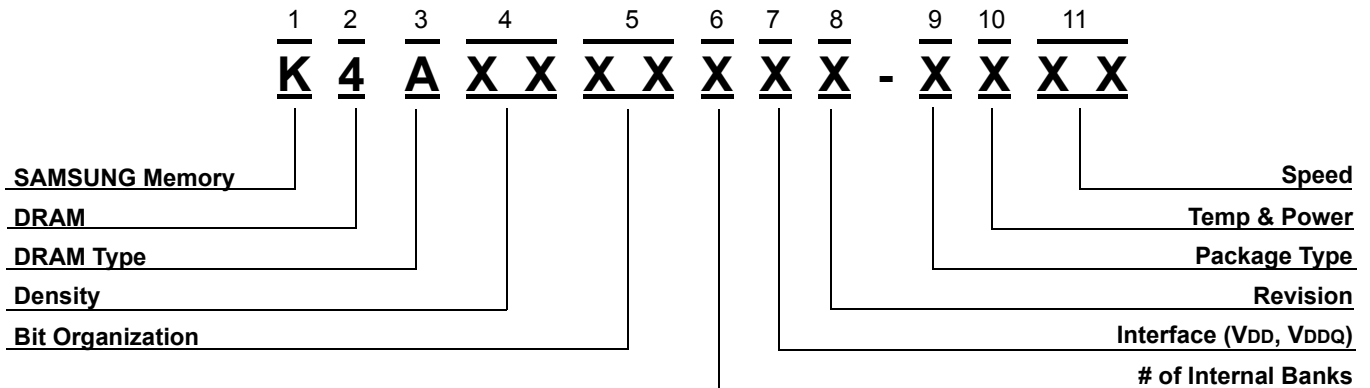

1. SAMSUNG Memory : K

2. DRAM : 4

3. DRAM Type

A: DDR4 SDRAM (1.2V VDD)

4. Density

4G: 4Gb
8G: 8Gb
AG: 16Gb
BG: 32Gb

5. Bit Organization

04: x 4
08: x 8
16: x16

6. # of Internal Banks

5: 16 Banks

7. Interface (VDD, VDDQ)

W: POD (1.2V, 1.2V)

8. Revision

M: 1st Gen.
A: 2nd Gen.
B: 3rd Gen.
C: 4th Gen.
D: 5th Gen.
E: 6th Gen.
F: 7th Gen.
G: 8th Gen.

9. Package Type

B: FBGA (Halogen-free & Lead-free, Flip Chip)
M: FBGA (Halogen-free & Lead-free, DDP)
2: FBGA (Halogen-free & Lead-free, 2H TSV)
3: FBGA (Halogen-free & Lead-free, 2H 3DS)
4: FBGA (Halogen-free & Lead-free, 4H TSV)
5: FBGA (Halogen-free & Lead-free, 4H 3DS)

10. Temp & Power

C: Commercial Temp.(0°C ~ 85°C) & Normal Power
I: Industrial Temp.(-40°C ~ 95°C) & Normal Power

11. Speed

PB: DDR4-2133 (1066MHz @ CL=15, tRCD=15, tRP=15)
RC: DDR4-2400 (1200MHz @ CL=17, tRCD=17, tRP=17)
TD: DDR4-2666 (1333MHz @ CL=19, tRCD=19, tRP=19)
RB: DDR4-2133 (1066MHz @ CL=17, tRCD=15, tRP=15)
TC: DDR4-2400 (1200MHz @ CL=19, tRCD=17, tRP=17)
WD: DDR4-2666 (1333MHz @ CL=22, tRCD=19, tRP=19)
VF: DDR4-2933 (1466MHz @ CL=21, tRCD=21, tRP=21)
WE: DDR4-3200 (1600MHz @ CL=22, tRCD=22, tRP=22)
YF: DDR4-2933 (1466MHz @ CL=24, tRCD=21, tRP=21)
AE: DDR4-3200 (1600MHz @ CL=26, tRCD=22, tRP=22)

2. DDR4 SDRAM Component Product Guide

[Table 1] DDR4 SDRAM Component Product Guide for PC/SVR

Density	Banks	Part Number	Package & Power, Temp. & Speed	Org.	VDD Voltage	PKG	Avail.	Note
8Gb B-die	16Banks (4Bank Groups)	K4A8G045WB ¹⁾	BCPB/RC/TD	2G x4	1.2V	78 ball FBGA	'19 2Q EOL	
		K4A8G085WB	BCPB/RC/TD	1G x8				
	8Banks (2Bank Groups)	K4A8G165WB	BCPB/RC/TD	512M x16	1.2V	96 ball FBGA		
8Gb C-die	16Banks (4Bank Groups)	K4A8G045WC ¹⁾	BCTD/VF/WE	2G x4	1.2V	78 ball FBGA	MP	
		K4A8G085WC	BCTD/*VF/*WE	1G x8				
	8Banks (2Bank Groups)	K4A8G165WC	BCTD/*VF/*WE	512M x16	1.2V	96 ball FBGA		
8Gb D-die	16Banks (4Bank Groups)	K4A8G045WD ¹⁾	BC/TD/VF/WE	2G x4	1.2V	78 ball FBGA	'18 4Q CS	
		K4A8G085WD	BC/TD/*VF/*WE	1G x8				
16Gb A-die	16Banks (4Bank Groups)	K4AAG085WA	BCTD/*VF/*WE	2G x8	1.2V	78 ball FBGA	'19 1Q CS	
	8Banks (2Bank Groups)	K4AAG165WA	BCTD/*VF/*WE	1G x16	1.2V	96 ball FBGA		
32Gb A-die	16Banks (4Bank Groups)	K4AAG085WA	BCTD/*VF/*WE	2G x8	1.2V	78 ball FBGA	'19 1Q CS	
	8Banks (2Bank Groups)	K4AAG165WA	BCTD/*VF/*WE	1G x16	1.2V	96 ball FBGA		

NOTE :

1) Please contact Samsung for sample availability.

[Table 2] DDR4 SDRAM Component Product Guide for Consumer

Density	Banks	Part Number	Package & Power, Temp. & Speed	Org.	VDD Voltage	PKG	Avail.	Note
4Gb D-die	16Banks (4Bank Groups)	K4A4G085WD	BCPB/RC BIPB/RC	512M x8	1.2V	78 ball FBGA	'18 4Q EOL	
	8Banks (2Bank Groups)	K4A4G165WD	BCPB/RC BIPB/RC	256M x16	1.2V	96 ball FBGA		
4Gb E-die	16Banks (4Bank Groups)	K4A4G085WE	BCRC/TD/WE BIRC/TD/WE	512M x8	1.2V	78 ball FBGA	MP	
	8Banks (2Bank Groups)	K4A4G165WE	BCRC/TD/WE BIRC/TD/WE	256M x16	1.2V	96 ball FBGA		
4Gb F-die	16Banks (4Bank Groups)	K4A4G085WF	BCTD/*WE	512M x8	1.2V	78 ball FBGA	'18 4Q CS	
	8Banks (2Bank Groups)	K4A4G165WF	BCTD/*WE	256M x16	1.2V	96 ball FBGA		
8Gb B-die	16Banks (4Bank Groups)	K4A8G085WB	BCRC/TD/WE BIRC/TD/WE	1G x8	1.2V	78 ball FBGA	MP	
	8Banks (2Bank Groups)	K4A8G165WB	BCRC/TD/WE BIRC/TD/WE	512M x16	1.2V	96 ball FBGA		
8Gb C-die	16Banks (4Bank Groups)	K4A8G085WC	BCRC/TD/*WE	1G x8	1.2V	78 ball FBGA	MP	
	8Banks (2Bank Groups)	K4A8G165WC	BCRC/TD/*WE	512M x16	1.2V	96 ball FBGA		
16Gb B-die	16Banks (4Bank Groups)	K4AAG085WB	MCRC/TD	1G x8	1.2V	78 ball FBGA	MP	
	8Banks (2Bank Groups)	K4AAG165WB	MCRC/TD	512M x16	1.2V	96 ball FBGA		
16Gb A-die	16Banks (4Bank Groups)	K4AAG085WA	BCTD/*WE	2G x8	1.2V	78 ball FBGA	'19 1Q CS	
	8Banks (2Bank Groups)	K4AAG165WA	BCTD/*WE	1G x16	1.2V	96 ball FBGA		

3. DDR4 SDRAM Module Ordering Information

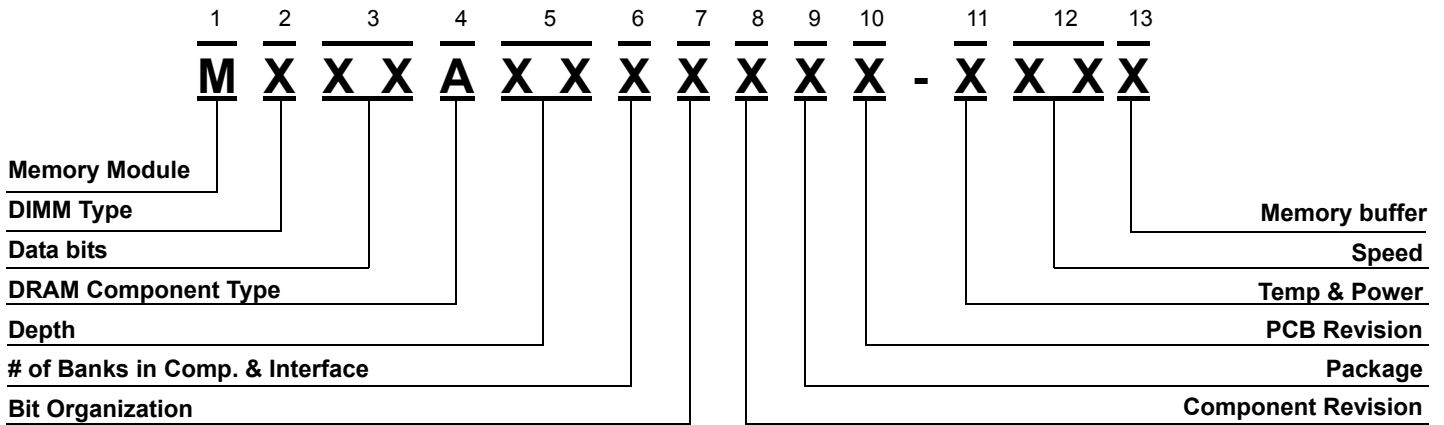

1. Memory Module : M

2. DIMM Type

- 3: DIMM
- 4: SODIMM

3. Data Bits

- 71: x64 260pin Unbuffered SODIMM
- 74: x72 260pin ECC Unbuffered SODIMM
- 78: x64 288pin Unbuffered DIMM
- 86: x72 288pin Load Reduced DIMM
- 91: x72 288pin ECC Unbuffered DIMM
- 92: x72 288pin VLP Registered DIMM
- 93: x72 288pin Registered DIMM

4. DRAM Component Type

- A: DDR4 SDRAM (1.2V VDD)

5. Depth

- 56 : 256M
- 51 : 512M
- 1G : 1G
- 2G : 2G
- 4G : 4G
- 8G : 8G
- AG : 16G
- 1K : 1G (for 8Gb)
- 2K : 2G (for 8Gb)
- 4K : 4G (for 8Gb)
- 8K : 8G (for 8Gb)
- AK : 16G

6. # of Banks in comp. & Interface

- 4 : 16Banks & POD-1.2V

7. Bit Organization

- 0 : x 4
- 3 : x 8
- 4 : x 16

8. Component Revision

- M: 1st Gen.
- B: 3rd Gen.
- D: 5th Gen.
- F: 7th Gen.
- A: 2nd Gen.
- C: 4th Gen.
- E: 6th Gen.
- G: 8th Gen.

9. Package

- B: FBGA (Halogen-free & Lead-free, Flip Chip)
- M: FBGA (Halogen-free & Lead-free, DDP)
- 2: FBGA (Halogen-free & Lead-free, 2H TSV)
- 3: FBGA (Halogen-free & Lead-free, 2H 3DS)
- 4: FBGA (Halogen-free & Lead-free, 4H TSV)
- 5: FBGA (Halogen-free & Lead-free, 4H 3DS)

10. PCB Revision

- 0: None
- 2: 2nd Rev.
- 4: 4th Rev.
- 1: 1st Rev.
- 3: 3rd Rev.

11. Temp & Power

- C: Commercial Temp.(0°C ~ 85°C) & Normal Power

12. Speed

- PB: DDR4-2133 (1066MHz @ CL=15, tRCD=15, tRP=15)
- RC: DDR4-2400 (1200MHz @ CL=17, tRCD=17, tRP=17)
- TD: DDR4-2666 (1333MHz @ CL=19, tRCD=19, tRP=19)
- RB: DDR4-2133 (1066MHz @ CL=15, tRCD=15, tRP=15)
- TC: DDR4-2400 (1200MHz @ CL=17, tRCD=17, tRP=17)
- WD: DDR4-2666 (1333MHz @ CL=19, tRCD=19, tRP=19)
- VF: DDR4-2933 (1466MHz @ CL=21, tRCD=21, tRP=21)
- WE: DDR4-3200 (1600MHz @ CL=22, tRCD=22, tRP=22)
- YF: DDR4-2933 (1466MHz @ CL=24, tRCD=21, tRP=21)
- AE: DDR4-3200 (1600MHz @ CL=26, tRCD=22, tRP=22)

4. DDR4 SDRAM MODULE PRODUCT GUIDE

4.1 288Pin DDR4 Registered DIMM

[Table 3] 288Pin DDR4 Registered DIMM

Org.	Density	Part Number	Temp & Power & Speed	Raw Card	Composition	Comp. Version		Internal Banks	Rank	PKG	Height	Avail.
1G x72	8GB	M393A1G40EB1	CPB	C (1Rx4)	1G x4 * 18pcs	4Gb	E-die	16	1	78ball FBGA	31.25mm	EOL 2Q'18
1G x72	8GB	M393A1G40EB1	CRC	C (1Rx4)	1G x4 * 18pcs	4Gb	E-die	16	1	78ball FBGA	31.25mm	EOL 2Q'18
1G x72	8GB	M393A1G40EB2	CTD	C (1Rx4)	1G x4 * 18pcs	4Gb	E-die	16	1	78ball FBGA	31.25mm	EOL 2Q'18
1G x72	8GB	M393A1G43EB1	CPB	E (2Rx8)	512G x8 * 18pcs	4Gb	E-die	16	2	78ball FBGA	31.25mm	EOL 2Q'18
1G x72	8GB	M393A1G43EB1	CRC	E (2Rx8)	512G x8 * 18pcs	4Gb	E-die	16	2	78ball FBGA	31.25mm	EOL 2Q'18
1G x72	8GB	M393A1G43EB1	CTD	E (2Rx8)	512G x8 * 18pcs	4Gb	E-die	16	2	78ball FBGA	31.25mm	EOL 2Q'18
1G x72	8GB	M393A1K43BB0	CPB	D (1Rx8)	1G x8 * 9pcs	8Gb	B-die	16	1	78ball FBGA	31.25mm	MP
1G x72	8GB	M393A1K43BB0	CRC	D (1Rx8)	1G x8 * 9pcs	8Gb	B-die	16	1	78ball FBGA	31.25mm	MP
1G x72	8GB	M393A1K43BB1	CTD	D (1Rx8)	1G x8 * 9pcs	8Gb	B-die	16	1	78ball FBGA	31.25mm	MP
2G x72	16GB	M393A2G40EB1	CPB	A (2Rx4)	1G x4 * 36pcs	4Gb	E-die	16	2	78ball FBGA	31.25mm	EOL 2Q'18
2G x72	16GB	M393A2G40EB1	CRC	A (2Rx4)	1G x4 * 36pcs	4Gb	E-die	16	2	78ball FBGA	31.25mm	EOL 2Q'18
2G x72	16GB	M393A2G40EB2	CTD	A (2Rx4)	1G x4 * 36pcs	4Gb	E-die	16	2	78ball FBGA	31.25mm	EOL 2Q'18
2G x72	16GB	M393A2K43BB1	CPB	E (2Rx8)	1G x8 * 18pcs	8Gb	B-die	16	2	78ball FBGA	31.25mm	MP
2G x72	16GB	M393A2G40EB1	CRC	A (2Rx4)	1G x4 * 36pcs	4Gb	E-die	16	2	78ball FBGA	31.25mm	EOL 2Q'18
2G x72	16GB	M393A2G40EB2	CTD	A (2Rx4)	1G x4 * 36pcs	4Gb	E-die	16	2	78ball FBGA	31.25mm	EOL 2Q'18
2G x72	16GB	M393A2K40BB0	CPB	C (1Rx4)	2G x4 * 18pcs	8Gb	B-die	16	1	78ball FBGA	31.25mm	MP
2G x72	16GB	M393A2K40BB1	CRC	C (1Rx4)	2G x4 * 18pcs	8Gb	B-die	16	1	78ball FBGA	31.25mm	MP
2G x72	16GB	M393A2K40BB2	CTD	C (1Rx4)	2G x4 * 18pcs	8Gb	B-die	16	1	78ball FBGA	31.25mm	MP
2G x72	16GB	M393A2K43BB1	CPB	E (2Rx8)	1G x8 * 18pcs	8Gb	B-die	16	2	78ball FBGA	31.25mm	MP
2G x72	16GB	M393A2K43BB1	CRC	E (2Rx8)	1G x8 * 18pcs	8Gb	B-die	16	2	78ball FBGA	31.25mm	MP
2G x72	16GB	M393A2K43BB1	CTD	E (2Rx8)	1G x8 * 18pcs	8Gb	B-die	16	2	78ball FBGA	31.25mm	MP
4G x72	32GB	M393A4K40BB0	CPB	A (2Rx4)	2G x4 * 36pcs	8Gb	B-die	16	2	78ball FBGA	31.25mm	MP
4G x72	32GB	M393A4K40BB1	CRC	A (2Rx4)	2G x4 * 36pcs	8Gb	B-die	16	2	78ball FBGA	31.25mm	MP

[Table 3] 288Pin DDR4 Registered DIMM

Org.	Density	Part Number	Temp & Power & Speed	Raw Card	Composition	Comp. Version		Internal Banks	Rank	PKG	Height	Avail.
4G x72	32GB	M393A4K40BB2	CTD	B (2Rx4)	2G x4 * 36pcs	8Gb	B-die	16	2	78ball FBGA	31.25mm	MP
8G x72	64GB	M393A8K40B21	CRB	A (4Rx4)	3DS 2H 8G x4 * 36pcs	8Gb	B-die	16	4	78ball FBGA	31.25mm	MP
8G x72	64GB	M393A8K40B21	CTC	A (4Rx4)	3DS 2H 8G x4 * 36pcs	8Gb	B-die	16	4	78ball FBGA	31.25mm	MP
8G x72	64GB	M393A8K40B2B	CTC	A (4Rx4)	3DS 2H 8G x4 * 36pcs	8Gb	B-die	16	4	78ball FBGA	31.25mm	MP
8G x72	64GB	M393A8K40B22	CWD	B (4Rx4)	3DS 2H 8G x4 * 36pcs	8Gb	B-die	16	4	78ball FBGA	31.25mm	MP
16G x72	128GB	M393AAK40B41	CTC	A (8Rx4)	3DS 4H 8G x4 * 36pcs	8Gb	B-die	16	8	78ball FBGA	31.25mm	MP
16G x72	128GB	M393AAK40B42	CWD	B (8Rx4)	3DS 4H 8G x4 * 36pcs	8Gb	B-die	16	8	78ball FBGA	31.25mm	MP
2G x72	16GB	M393A2K43CB1	CRC	E (2Rx8)	1G x8 * 18pcs	8Gb	C-die	16	2	78ball FBGA	31.25mm	MP
2G x72	16GB	M393A2K43CB2	CTD	E (2Rx8)	1G x8 * 18pcs	8Gb	C-die	16	2	78ball FBGA	31.25mm	MP
2G x72	16GB	M393A2K43CB2	CVF	E (2Rx8)	1G x8 * 18pcs	8Gb	C-die	16	2	78ball FBGA	31.25mm	CS 3Q'18
2G x72	16GB	M393A2K40CB1	CRC	C (1Rx4)	2G x4 * 18pcs	8Gb	C-die	16	1	78ball FBGA	31.25mm	MP
2G x72	16GB	M393A2K40CB2	CTD	C (1Rx4)	2G x4 * 18pcs	8Gb	C-die	16	1	78ball FBGA	31.25mm	MP
2G x72	16GB	M393A2K40CB2	CVF	C (1Rx4)	2G x4 * 18pcs	8Gb	C-die	16	1	78ball FBGA	31.25mm	CS 3Q'18
4G x72	32GB	M393A4K40CB1	CRC	A (2Rx4)	2G x4 * 36pcs	8Gb	C-die	16	2	78ball FBGA	31.25mm	MP
4G x72	32GB	M393A4K40CB2	CTD	B (2Rx4)	2G x4 * 36pcs	8Gb	C-die	16	2	78ball FBGA	31.25mm	MP
4G x72	32GB	M393A4K40CB2	CVF	B (2Rx4)	2G x4 * 36pcs	8Gb	C-die	16	2	78ball FBGA	31.25mm	CS 3Q'18

4.2 288Pin DDR4 Load Reduced DIMM

[Table 4] 288Pin DDR4 Load Reduced DIMM

Org.	Density	Part Number	Temp & Power & Speed	Raw Card	Composition	Comp. Version		Internal Banks	Rank	PKG	Height	Avail.
4G x72	32GB	M386A4G40EM2	CPB	D (4Rx4)	DDP 2G x4 * 36pcs	4Gb	E-die	16	4	78ball FBGA	31.25mm	EOL 2Q'18
4G x72	32GB	M386A4G40EM2	CRC	D (4Rx4)	DDP 2G x4 * 36pcs	4Gb	E-die	16	4	78ball FBGA	31.25mm	EOL 2Q'18
4G x72	32GB	M386A4K40BB0	CRC	A (2Rx4)	2G x4 * 36pcs	8Gb	B-die	16	2	78ball FBGA	31.25mm	MP
8G x72	64GB	M386A8K40BM1	CPB	D (4Rx4)	DDP 4G x4 * 36pcs	8Gb	B-die	16	4	78ball FBGA	31.25mm	MP
8G x72	64GB	M386A8K40BM1	CRC	D (4Rx4)	DDP 4G x4 * 36pcs	8Gb	B-die	16	4	78ball FBGA	31.25mm	MP
8G x72	64GB	M386A8K40BM2	CTD	D (4Rx4)	DDP 4G x4 * 36pcs	8Gb	B-die	16	4	78ball FBGA	31.25mm	MP
8G x72	64GB	M386A8K40BMB	CPB	D (4Rx4)	DDP 4G x4 * 36pcs	8Gb	B-die	16	4	78ball FBGA	31.25mm	MP
8G x72	64GB	M386A8K40BMB	CRC	D (4Rx4)	DDP 4G x4 * 36pcs	8Gb	B-die	16	4	78ball FBGA	31.25mm	MP
16G x72	128GB	M386AAK40B40	CUC	A (8Rx4)	3DS 4H 8G x4 * 36pcs	8Gb	B-die	16	8	78ball FBGA	31.25mm	MP
16G x72	128GB	M386AAK40B40	CWD	A (8Rx4)	3DS 4H 8G x4 * 36pcs	8Gb	B-die	16	8	78ball FBGA	31.25mm	MP
8G x72	64GB	M386A8K40CM2	CRC	D (4Rx4)	DDP 4G x4 * 36pcs	8Gb	C-die	16	4	78ball FBGA	31.25mm	MP
8G x72	64GB	M386A8K40CM2	CTD	D (4Rx4)	DDP 4G x4 * 36pcs	8Gb	C-die	16	4	78ball FBGA	31.25mm	MP
8G x72	64GB	M386A8K40CM2	CVF	D (4Rx4)	DDP 4G x4 * 36pcs	8Gb	C-die	16	4	78ball FBGA	31.25mm	CS 3Q'18

4.3 288Pin DDR4 VLP Registered DIMM

[Table 5] 288Pin DDR4 VLP Registered DIMM

Org.	Density	Part Number	Temp & Power & Speed	Raw Card	Composition	Comp. Version		Internal Banks	Rank	PKG	Height	Avail.
2G x72	16GB	M392A2K43BB0	CPB	H (2Rx8)	1G x8 * 18pcs	8Gb	B-die	16	2	78ball FBGA	18.75mm	MP
2G x72	16GB	M392A2K43BB0	CRC	H (2Rx8)	1G x8 * 18pcs	8Gb	B-die	16	2	78ball FBGA	18.75mm	MP
4G x72	32GB	M392A4K40BM0	CPB	J (2Rx4)	4G x4 * 18pcs	8Gb	B-die	16	2	78ball FBGA	18.75mm	MP
4G x72	32GB	M392A4K40BM0	CRC	J (2Rx4)	4G x4 * 18pcs	8Gb	B-die	16	2	78ball FBGA	18.75mm	MP

4.4 260Pin DDR4 ECC SODIMM

[Table 6] 260Pin DDR4 ECC SODIMM

Org.	Density	Part Number	Temp & Power & Speed	Raw Card	Composition	Comp. Version		Internal Banks	Rank	PKG	Height	Avail.
1G x72	8GB	M474A1G43EB1	CPB	G (2Rx8)	512M x8 * 18pcs	4Gb	E-die	16	2	78ball FBGA	30mm	EOL 2Q'18
1G x72	8GB	M474A1G43EB1	CRC	G (2Rx8)	512M x8 * 18pcs	4Gb	E-die	16	2	78ball FBGA	30mm	EOL 2Q'18
1G x72	8GB	M474A1K43BB1	CTD	D (1Rx8)	1G x8 * 9pcs	8Gb	B-die	16	1	78ball FBGA	30mm	MP
2G x72	16GB	M474A2K43BB1	CPB	G (2Rx8)	1G x8 * 18pcs	8Gb	B-die	16	2	78ball FBGA	30mm	MP
2G x72	16GB	M474A2K43BB1	CRC	G (2Rx8)	1G x8 * 18pcs	8Gb	B-die	16	2	78ball FBGA	30mm	MP
2G x72	16GB	M474A2K43BB1	CTD	G (2Rx8)	1G x8 * 18pcs	8Gb	B-die	16	2	78ball FBGA	30mm	MP

4.5 260Pin DDR4 ECC UDIMM

[Table 7] 260Pin DDR4 ECC UDIMM

Org.	Density	Part Number	Temp & Power & Speed	Raw Card	Composition	Comp. Version		Internal Banks	Rank	PKG	Height	Avail.
512M x72	4GB	M391A5143EB1	CPB	D (1Rx8)	512M x8 * 9pcs	4Gb	E-die	16	1	78ball FBGA	31.25mm	EOL 2Q'18
512M x72	4GB	M391A5143EB1	CRC	D (1Rx8)	512M x8 * 9pcs	4Gb	E-die	16	1	78ball FBGA	31.25mm	EOL 2Q'18
1G x72	8GB	M391A1G43EB1	CPB	E (2Rx8)	512M x8 * 18pcs	4Gb	E-die	16	2	78ball FBGA	31.25mm	EOL 2Q'18
1G x72	8GB	M391A1G43EB1	CRC	E (2Rx8)	512M x8 * 18pcs	4Gb	E-die	16	2	78ball FBGA	31.25mm	EOL 2Q'18
1G x72	8GB	M391A1K43BB1	CPB	D (1Rx8)	1G x8 * 9pcs	8Gb	B-die	16	1	78ball FBGA	31.25mm	MP
1G x72	8GB	M391A1K43BB1	CRC	D (1Rx8)	1G x8 * 9pcs	8Gb	B-die	16	1	78ball FBGA	31.25mm	MP
1G x72	8GB	M391A1K43BB2	CTD	D (1Rx8)	1G x8 * 9pcs	8Gb	B-die	16	1	78ball FBGA	31.25mm	MP
2G x72	16GB	M391A2K43BB1	CPB	E (2Rx8)	1G x8 * 18pcs	8Gb	B-die	16	2	78ball FBGA	31.25mm	MP
2G x72	16GB	M391A2K43BB1	CRC	E (2Rx8)	1G x8 * 18pcs	8Gb	B-die	16	2	78ball FBGA	31.25mm	MP
2G x72	16GB	M391A2K43BB1	CTD	E (2Rx8)	1G x8 * 18pcs	8Gb	B-die	16	2	78ball FBGA	31.25mm	MP

4.6 260Pin DDR4 Non ECC SODIMM

[Table 8] 260Pin DDR4 Non ECC SODIMM

Org.	Density	Part Number	Temp & Power & Speed	Raw Card	Composition	Comp. Version		Internal Banks	Rank	PKG	Height	Avail.
256M x64	2GB	M471A5644EB0	CRC	C (1Rx16)	256M x16 * 4pcs	4Gb	E-die	8	1	96ball FBGA	30mm	EOL '18 1Q
512M x64	4GB	M471A5244CB0	CTD	C (1Rx16)	256M x16 * 4pcs	8Gb	C-die	8	1	96ball FBGA	30mm	MP
512M x64	4GB	M471A5244BB0	CRC	C (1Rx16)	256M x16 * 4pcs	8Gb	B-die	8	1	96ball FBGA	30mm	EOL '19 1Q
512M x64	4GB	M471A5244BB0	CTD	C (1Rx16)	256M x16 * 4pcs	8Gb	B-die	8	1	96ball FBGA	30mm	EOL '19 1Q
512M x64	4GB	M471A5143EB1	CRC	A (1Rx8)	512M x8 * 8pcs	4Gb	E-die	16	1	78ball FBGA	30mm	EOL '18 2Q
1G x64	8GB	M471A1K43DB1	CTD	A (1Rx8)	1G x8 * 8pcs	8Gb	D-die	16	1	78ball FBGA	30mm	MP
1G x64	8GB	M471A1K43CB1	CRC	A (1Rx8)	1G x8 * 8pcs	8Gb	C-die	16	1	78ball FBGA	30mm	MP
1G x64	8GB	M471A1K43CB1	CTD	A (1Rx8)	1G x8 * 8pcs	8Gb	C-die	16	1	78ball FBGA	30mm	MP
1G x64	8GB	M471A1K43BB1	CRC	A (1Rx8)	1G x8 * 8pcs	8Gb	B-die	16	1	78ball FBGA	30mm	EOL '19 1Q
1G x64	8GB	M471A1K43BB1	CTD	A (1Rx8)	1G x8 * 8pcs	8Gb	B-die	16	1	78ball FBGA	30mm	EOL '19 1Q
1G x64	8GB	M471A1G43EB1	CRC	E (2Rx8)	512M x8 * 16pcs	4Gb	E-die	16	2	78ball FBGA	30mm	EOL '18 2Q
2G x64	16GB	M471A2K43DB1	CTD	E (2Rx8)	1G x8 * 16pcs	8Gb	D-die	16	2	78ball FBGA	30mm	MP
2G x64	16GB	M471A2K43CB1	CRC	E (2Rx8)	1G x8 * 16pcs	8Gb	C-die	16	2	78ball FBGA	30mm	MP
2G x64	16GB	M471A2K43CB1	CTD	E (2Rx8)	1G x8 * 16pcs	8Gb	C-die	16	2	78ball FBGA	30mm	MP
2G x64	16GB	M471A2K43BB1	CRC	E (2Rx8)	1G x8 * 16pcs	8Gb	B-die	16	2	78ball FBGA	30mm	EOL '19 1Q
2G x64	16GB	M471A2K43BB1	CTD	E (2Rx8)	1G x8 * 16pcs	8Gb	B-die	16	2	78ball FBGA	30mm	EOL '19 1Q
4G x64	32GB	M471A4G43MB1	CTD	E (2Rx8)	2G x8 * 16pcs	16Gb	M-die	16	2	78ball FBGA	30mm	MP
4G x64	32GB	M471A4G43AB1	CVF	E (2Rx8)	2G x8 * 16pcs	16Gb	A-die	16	2	78ball FBGA	30mm	CS '18 4Q

4.7 260Pin DDR4 Non ECC UDIMM

[Table 9] 260Pin DDR4 Non ECC UDIMM

Org.	Density	Part Number	Temp & Power & Speed	Raw Card	Composition	Comp. Version		Internal Banks	Rank	PKG	Height	Avail.
256M x64	2GB	M378A5644EB0	CRC	C (1Rx16)	256M x16 * 4pcs	4Gb	E-die	8	1	96ball FBGA	30mm	EOL '18 1Q
512M x64	4GB	M378A5244CB0	CTD	C (1Rx16)	256M x16 * 4pcs	8Gb	C-die	8	1	96ball FBGA	30mm	MP
512M x64	4GB	M378A5244BB0	CRC	C (1Rx16)	256M x16 * 4pcs	8Gb	B-die	8	1	96ball FBGA	30mm	EOL '19 1Q
512M x64	4GB	M378A5244BB0	CTD	C (1Rx16)	256M x16 * 4pcs	8Gb	B-die	8	1	96ball FBGA	30mm	EOL '19 1Q
512M x64	4GB	M378A5143EB2	CRC	A (1Rx8)	512M x8 * 8pcs	4Gb	E-die	16	1	78ball FBGA	30mm	EOL '18 2Q
1G x64	8GB	M378A1K43DB2	CTD	A (1Rx8)	1G x8 * 8pcs	8Gb	D-die	16	1	78ball FBGA	30mm	CS '18 2Q
1G x64	8GB	M378A1K43CB2	CRC	A (1Rx8)	1G x8 * 8pcs	8Gb	C-die	16	1	78ball FBGA	30mm	MP
1G x64	8GB	M378A1K43CB2	CTD	A (1Rx8)	1G x8 * 8pcs	8Gb	C-die	16	1	78ball FBGA	30mm	MP
1G x64	8GB	M378A1K43BB2	CRC	A (1Rx8)	1G x8 * 8pcs	8Gb	B-die	16	1	78ball FBGA	30mm	EOL '19 1Q
1G x64	8GB	M378A1K43BB2	CTD	A (1Rx8)	1G x8 * 8pcs	8Gb	B-die	16	1	78ball FBGA	30mm	EOL '19 1Q
1G x64	8GB	M378A1G43EB1	CRC	E (2Rx8)	512M x8 * 16pcs	4Gb	E-die	16	2	78ball FBGA	30mm	EOL '18 2Q
2G x64	16GB	M378A2K43DB1	CTD	E (2Rx8)	1G x8 * 16pcs	8Gb	D-die	16	2	78ball FBGA	30mm	CS '18 2Q
2G x64	16GB	M378A2K43CB1	CRC	E (2Rx8)	1G x8 * 16pcs	8Gb	C-die	16	2	78ball FBGA	30mm	MP
2G x64	16GB	M378A2K43CB1	CTD	E (2Rx8)	1G x8 * 16pcs	8Gb	C-die	16	2	78ball FBGA	30mm	MP
2G x64	16GB	M378A2K43BB1	CRC	E (2Rx8)	1G x8 * 16pcs	8Gb	B-die	16	2	78ball FBGA	30mm	EOL '19 1Q
2G x64	16GB	M378A2K43BB1	CTD	E (2Rx8)	1G x8 * 16pcs	8Gb	B-die	16	2	78ball FBGA	30mm	EOL '19 1Q
4G x64	32GB	M378A4G43MB1	CTD	E (2Rx8)	2G x8 * 16pcs	16Gb	M-die	16	2	78ball FBGA	30mm	CS '18 2Q
4G x64	32GB	M378A4G43AB1	CVF	E (2Rx8)	2G x8 * 16pcs	16Gb	A-die	16	2	78ball FBGA	30mm	CS '19 1Q

5. RDIMM, LRDIMM Memory Buffer Information

5.1 Label Example



5.2 JEDEC Description Information

1. Module total capacity, in gigabytes, for primary bus (ECC not counted)
2. Number of package ranks of memory installed and number of logical ranks per package rank
3. Device organization (data bit width) of SDRAMs used on this assembly
4. SDRAM and support component supply voltage (VDD)
 - blank = 1.2 V operable
5. Module speed in Mb/s/data pin
6. SDRAM speed grade
7. Module Type
 - A = Unbuffered 16-bit Small Outline DIMM ("16b-SO-DIMM"), x16 data bus (placeholder)
 - B = Unbuffered 32-bit Small Outline DIMM ("32b-SO-DIMM"), x32 data bus (placeholder)
 - C = Registered 72-bit Small Outline DIMM ("72b-SO-RDIMM"), x64 primary + 8 bit ECC module data bus(placeholder)
 - E = Unbuffered DIMM ("UDIMM"), x64 primary + 8 bit ECC module data bus
 - L = Load Reduced DIMM ("LRDIMM"), x64 primary + 8 bit ECC module data bus
 - N = Mini registered DIMM ("Mini-RDIMM"), x64 primary + 8 bit ECC module data bus
 - R = Registered DIMM ("RDIMM"), x64 primary + 8 bit ECC module data bus
 - S = Small Outline DIMM ("SO-DIMM"), no ECC (x64 bit module data bus)
 - T = Unbuffered 72-bit Small Outline DIMM ("72b-SO-DIMM"), x64 primary + 8 bit ECC module data bus
 - U = Unbuffered DIMM ("UDIMM"), no ECC (x64 bit module data bus)
 - W = Mini unbuffered DIMM ("Mini-UDIMM"), x64 primary + 8 bit ECC module data bus
8. Reference design file used for this design (if applicable)
 - A = Reference design for raw card 'A' is used for this assembly
 - B = Reference design for raw card 'B' is used for this assembly
 - AC = Reference design for raw card 'AC' is used for this assembly (example only)
 - ZZ = None of the JEDEC standard reference designs were used for this assembly
9. Revision number of the reference design used
 - 0 = Initial release
 - 1 = First revision
 - 2 = Second revision
 - P = Pre-release or Engineering sample
 - Z = To be used when reference raw card = ZZ
10. JEDEC SPD Revision Encoding and Additions level used on this DIMM

5.3 RCD (& Data Buffer) Information

(These codes are only used SAMSUNG, Not JEDEC)

11&12. RCD, Data Buffer Revision & Vendor used on this DIMM

Jedec Description on label	Buffer Vendor	RCD ver	DB ver (Only LRDIMM)
DC0	IDT	C0	B1
MB1	Montage	B1	A1
MC0	Montage	C0	B0
DC3	IDT	C0	A3
MA0	Montage	A0	A1
DB1	IDT	B1	B0
PA0	Rambus (Inphi)	A0	A0
DC1	IDT	C1	C1

6. PACKAGE DIMENSION

78ball FBGA for

4Gb D-die (x4/x8) / DDP 8Gb D-die (x4) / 4H 16Gb D-die (x4)

4Gb E-die (x4/x8)

8Gb B-die (x4/x8) / DDP 16Gb B-die (x4) / 2H 16Gb B-die (x4) / 4H 32Gb B-die (x4)

8Gb C-die (x4/x8)

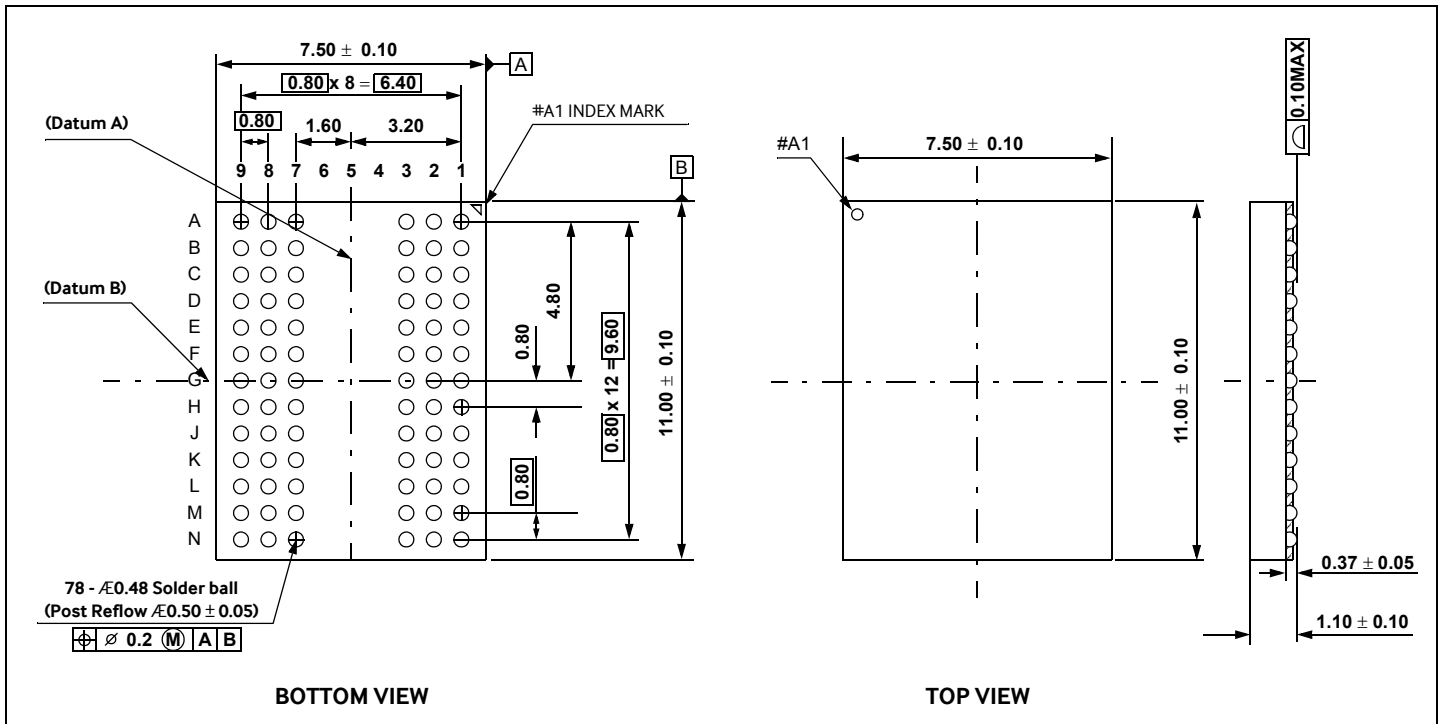

78ball FBGA for 16Gb M-die (x4/x8)

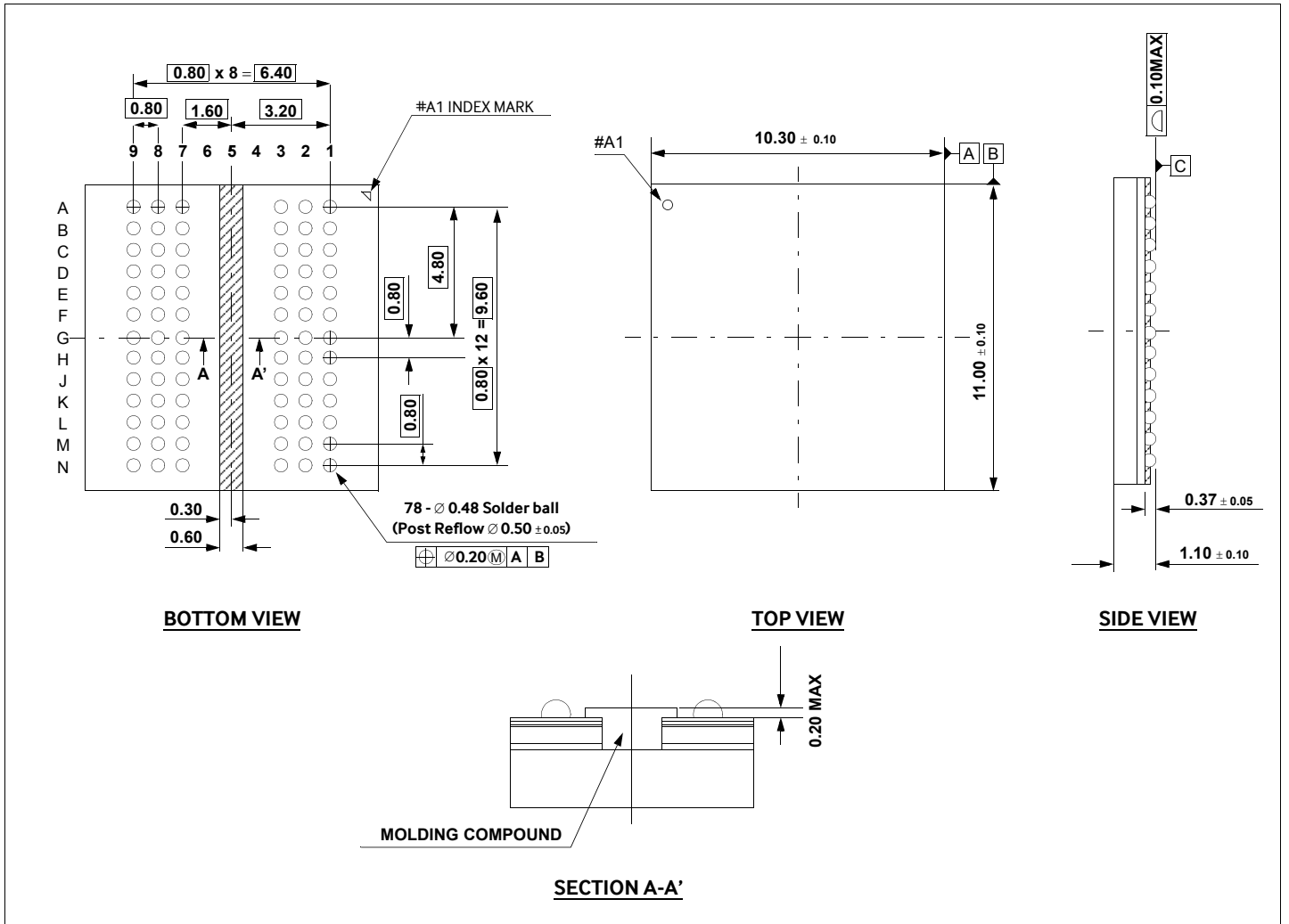

96ball FBGA for
4Gb D-die (x16) / 4Gb E-die (x16)
8Gb B-die (x16) / 8Gb C-die (x16)

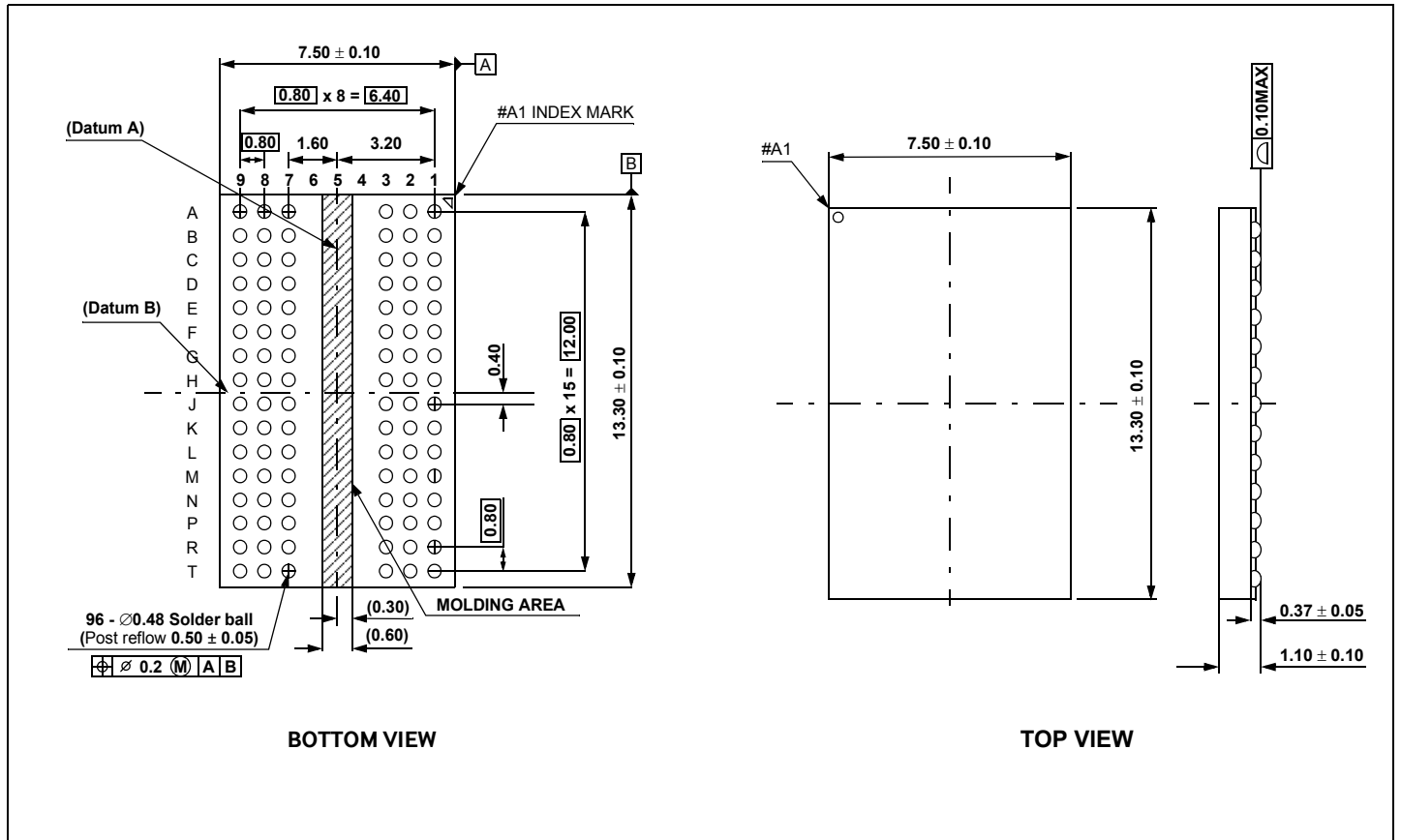

96ball FBGA for 16Gb M-die (x16)

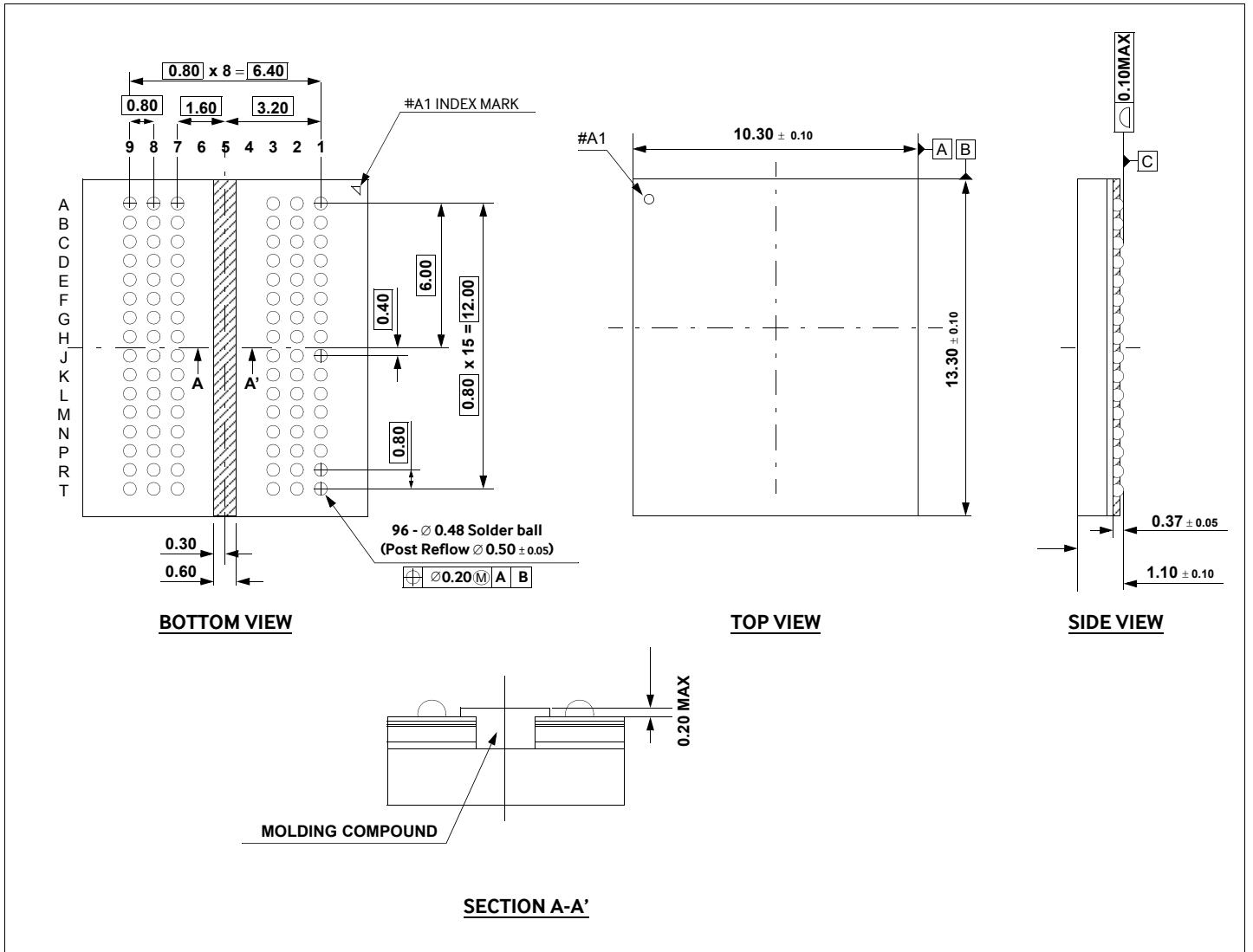

7. MODULE DIMENSION

- x72 288pin DDR4 SDRAM RDIMM
- x72 288pin DDR4 SDRAM LRDIMM
- x72 288pin DDR4 SDRAM ECC UDIMM
- x64 288pin DDR4 SDRAM Non ECC UDIMM

Units : Millimeters

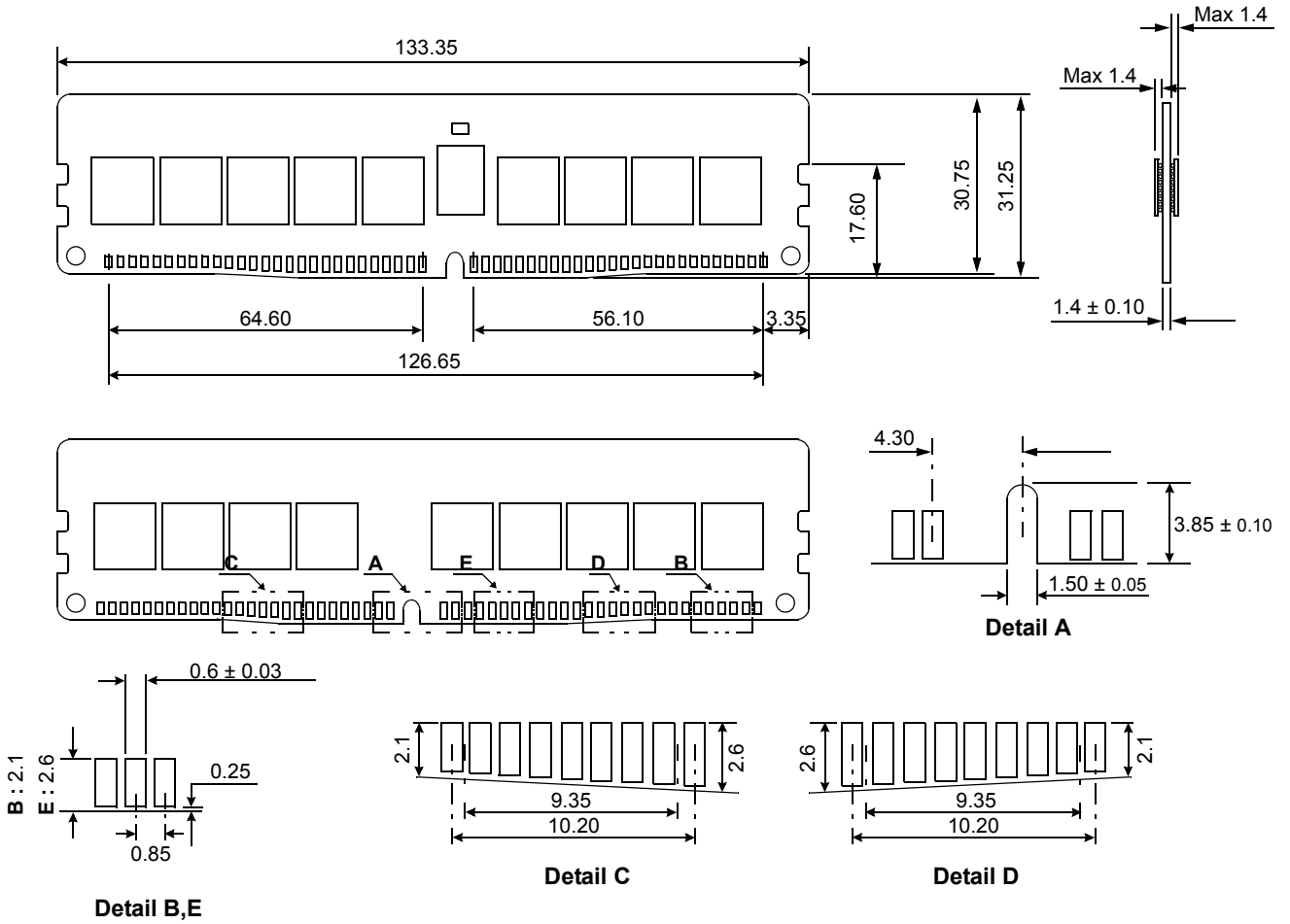

Product Guide

DDR4 SDRAM Memory

x72 260pin DDR4 SDRAM ECC SODIMM
x64 260pin DDR4 SDRAM Non ECC SODIMM

Units : Millimeters

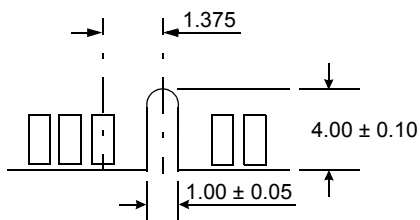
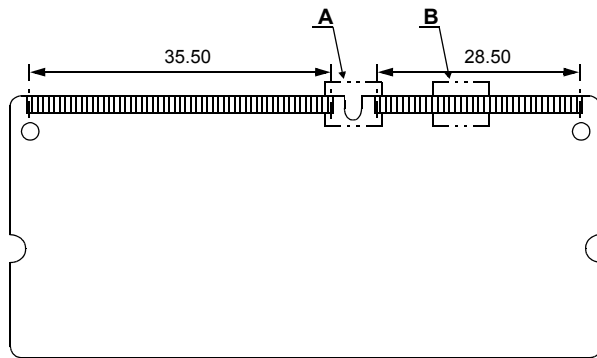
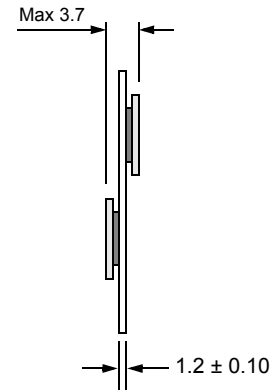
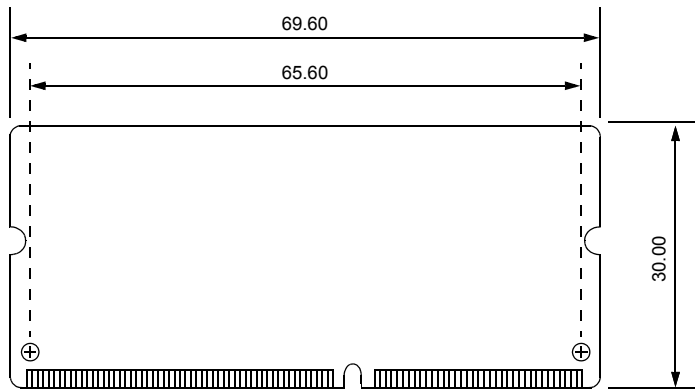

Detail A

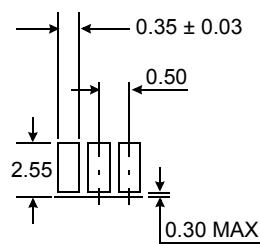

Detail B

x72 288pin DDR4 SDRAM VLP RDIMM

Units : Millimeters

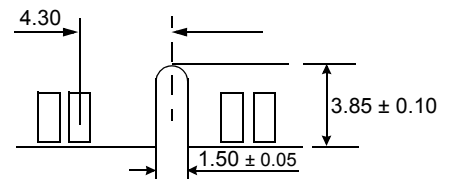
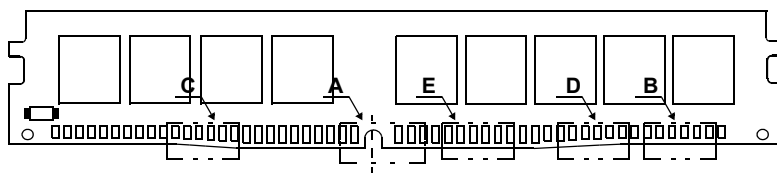
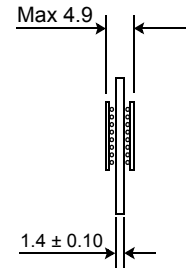
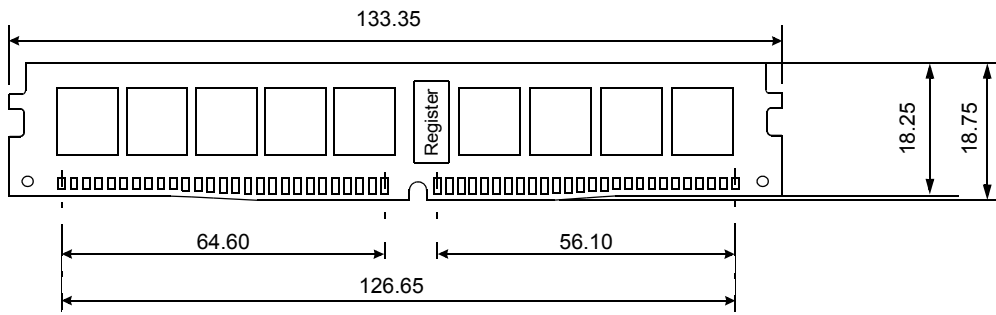

Detail A

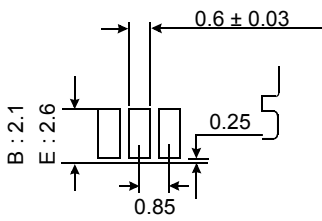

Detail B,E

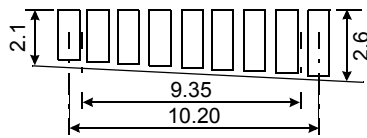

Detail C

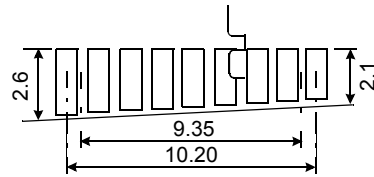

Detail D

x72 288pin DDR4 SDRAM VLP RDIMM Heat Spreader Design Guide (DDP)

1. FRONT

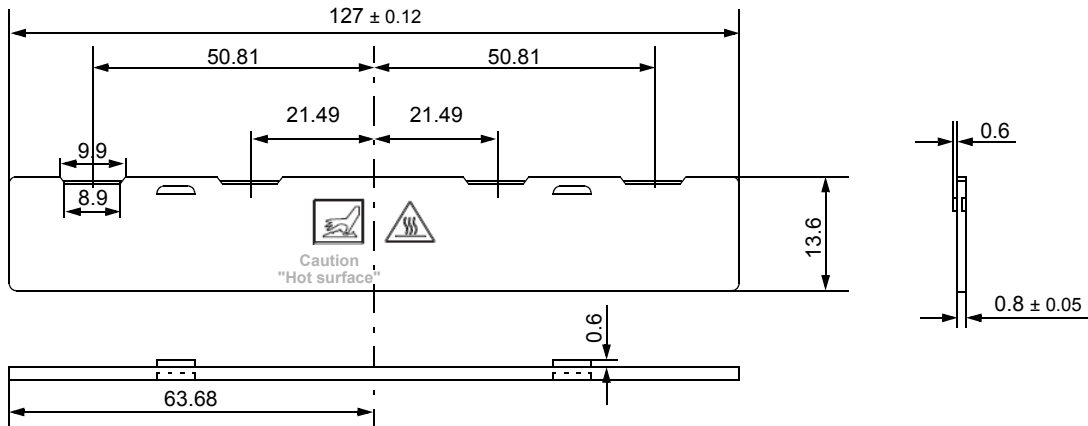

2. BACK

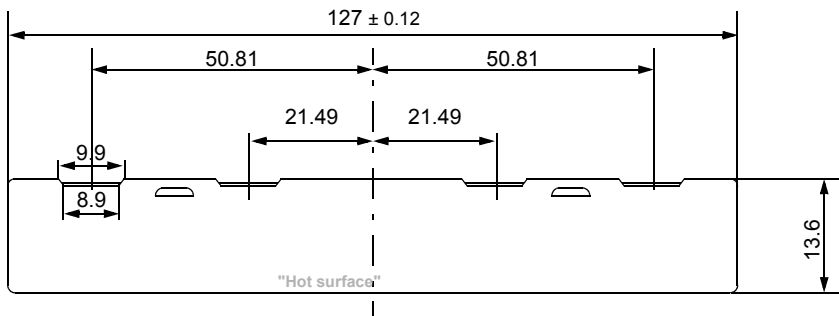

3. CLIP

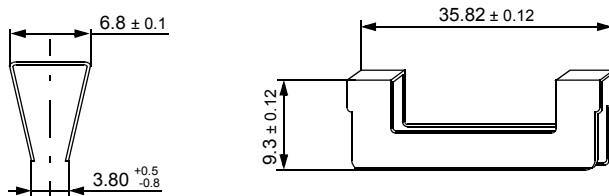

4. ASS'Y VIEW

Reference thickness total (Maximum) : 7.30 (With clip thickness)



x72 288pin DDR4 SDRAM RDIMM Heat Spreader Design Guide (TSV)

1. FRONT PART

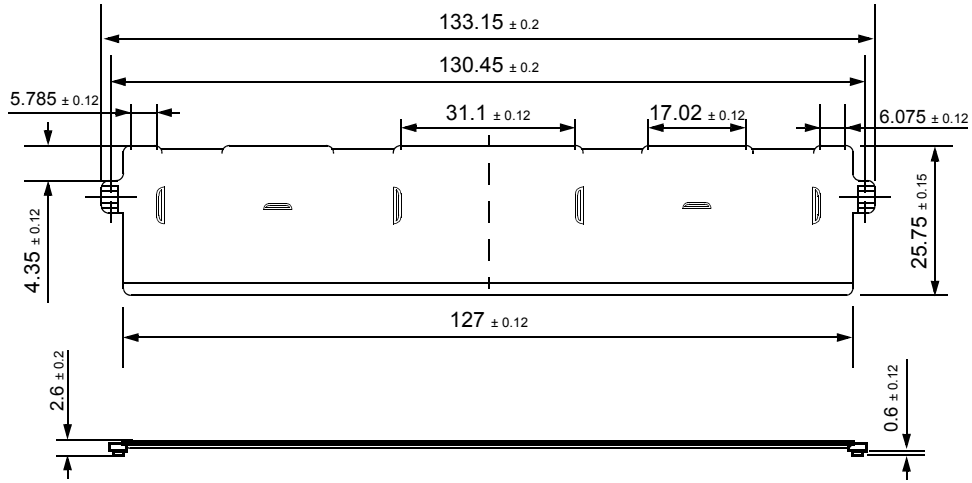

2. BACK PART

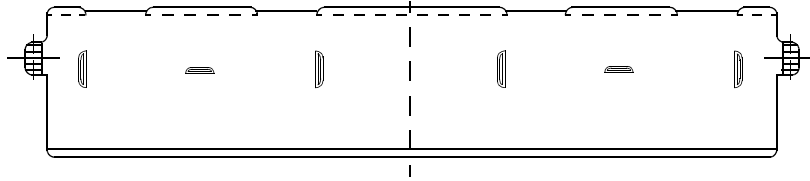

3. CLIP PART

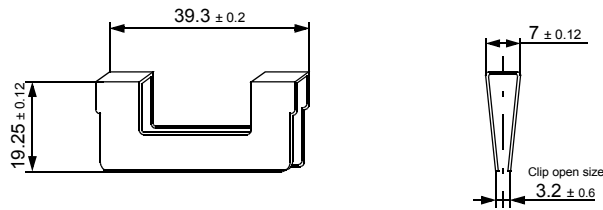

x72 288pin DDR4 SDRAM LRDIMM Heat Spreader Design Guide (DDP)

1. FRONT PART

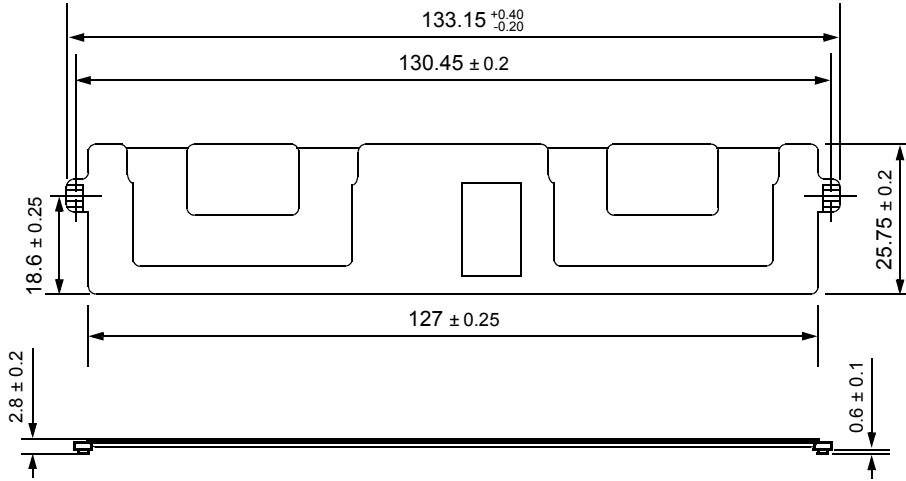

2. BACK PART



3. CLIP PART

