

T02EN13 / T02FN13 / T02GN13 / T02HN13 / T02JN13



HRB33724

Contactors
Contactores

Contacteurs
接触器

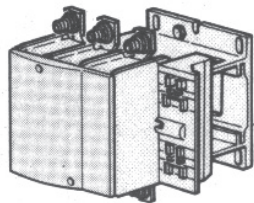

T02EN13
T02FN13
T02GN13

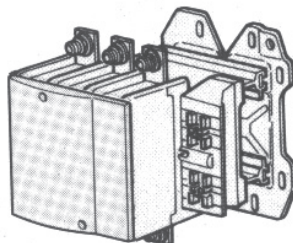

T02HN13

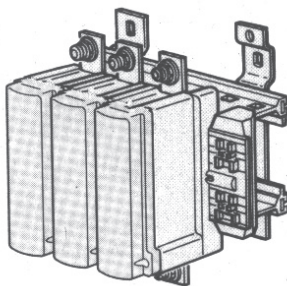

T02JN13

⚠ DANGER / PELIGRO / DANGER / 危险

HAZARD OF ELECTRIC SHOCK, EXPLOSION, OR ARC FLASH

Disconnect all power before servicing equipment.
Failure to follow these instructions will result in death or serious injury.

RISQUE D'ÉLECTROCUTION, D'EXPLOSION OU D'ARC ÉLECTRIQUE

Coupez toutes les alimentations avant de travailler sur cet équipement.
Le non-respect de ces instructions entraînera la mort ou des blessures graves.

PELIGRO DE DESCARGA ELÉCTRICA, EXPLOSIÓN O DESTELLO POR ARQUEO

Desenergice el equipo antes de prestarle servicios de mantenimiento.
El incumplimiento de estas instrucciones podrá causar la muerte o lesiones serias.

可能有触电、爆炸或者电弧灼伤的危险，
维修本电力设备时，请先切断所有电源。
若违背这些说明，则会导致严重的人身伤害甚至死亡。

Dimensions
Dimensiones

Encombremes
尺寸

T02EN13
T02FN13
T02GN13

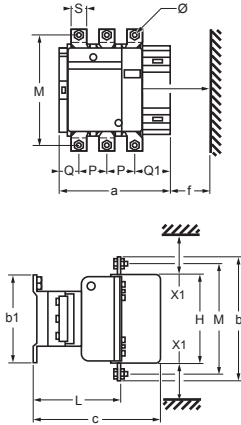

T02HN13

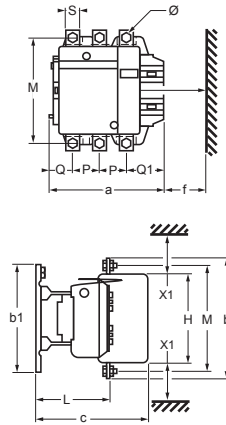

T02JN13

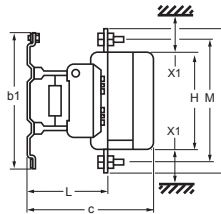
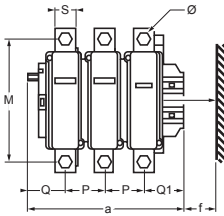

mm (in.)	T02EN13	T02FN13	T02GN13	T02HN13	T02JN13
a	163.5 (6.4)	163.5 (6.4)	213 (8.4)	233 (9.2)	309 (12.2)
P	37 (1.5)	40 (1.6)	48 (1.9)	55 (2.2)	80 (3.2)
Q	29.5 (1.2)	26 (1)	43 (1.7)	46 (1.8)	60 (2.4)
Q1	60 (2.4)	57.5 (2.3)	74 (2.9)	77 (3)	89 (3.5)
S	20 (0.8)	20 (0.8)	25 (1)	30 (1.2)	40 (1.6)
Ø	M6	M8	M10	M10	M12
f	131 (5.2)	131 (5.2)	147 (5.8)	150 (5.9)	181 (7.1)
b	162 (6.4)	170 (6.7)	206 (8.1)	238 (9.4)	304 (12)
b1	137 (5.4)	137 (5.4)	145 (5.7)	209 (8.2)	280 (11)
M	147 (5.8)	150 (5.9)	181 (7.1)	208 (8.2)	264 (10.4)
H	124 (4.9)	124 (4.9)	158 (6.2)	172 (6.8)	202 (8)
c	171 (6.7)	171 (6.7)	219 (8.6)	232 (9.1)	255 (10)
L	107 (4.2)	107 (4.2)	145 (5.7)	146 (5.7)	155 (6.1)
X1 220-500 V	10 (0.4)	10 (0.4)	10 (0.4)	15 (0.6)	20 (0.8)

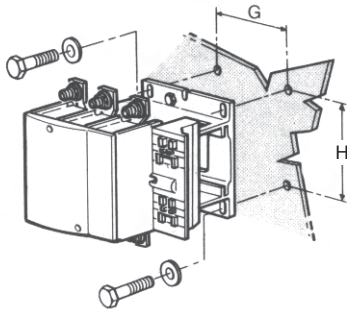

mm (in.)	T02EN13	T02FN13	T02GN13	T02HN13	T02JN13
G	80 (3.2)	80 (3.2)	96 (3.8)	80 (3.2)	189 (7.1)
H	110–120 (4.3–4.7)	110–120 (4.3–4.7)	110–120 (4.3–4.7)	170–180 (6.7–7.1)	180–190 (7.1–7.5)

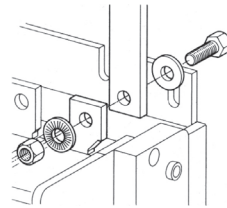
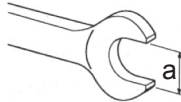

	a (mm)	C (N•m)	C (lb-in)
T02EN13	10	10	89
T02FN13	13	18	159
T02GN13 / T02HN13	16	35	310
T02JN13	18	58	513

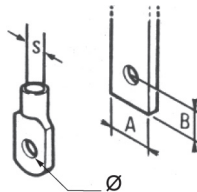
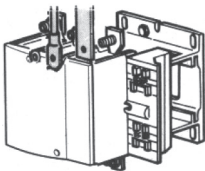

	T02EN13	T02FN13	T02GN13	T02HN13	T02JN13
A (mm / in.)	≤ 20 / 0.8	≤ 25 / 1	≤ 30 / 1.2	≤ 40 / 1.6	≤ 60 / 2.4
B (mm / in.)	10 / 0.4	12.5 / 0.5	15 / 0.6	20 / 0.8	25 / 1
Ø (mm / in.)	6.6 / 0.3	9 / 0.4	11 / 0.4	11 / 0.4	13 / 0.5
S (mm ² / AWG-Kcmil)	95 / 3/0 AWG	120 / 4/0 AWG	240 / 400 Kcmil	2 x 240 / 2 x 400 Kcmil	—
C (N•m / lb-in)	10 / 89	18 / 160	35 / 310	35 / 310	58 / 514
⚡ C (N•m / lb-in)	10 / 89	10 / 89	10 / 89	35 / 310	58 / 514

Contactor Installation
Instalación del contactor

Installation du contacteur
接触器安装

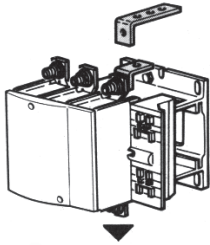

LA9 F●979



LA9 F●981

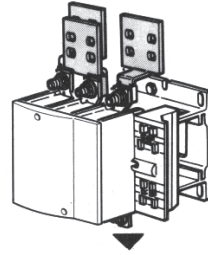



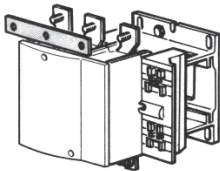

LA9 F●980



LA9 F●601



	3 x 	3 x 	3 x 	1 x 
T02EN13	LA9 FF981	LA9 FG979	LA9 FF980	LA9 FF601
T02FN13	LA9 FG981	LA9 FG979	LA9 FG980	LA9 FG601
T02GN13	LA9 FJ981	LA9 FJ979	LA9 FJ980	LA9 FH601
T02HN13	LA9 FK981	LA9 FK979	LA9 FK980	LA9 FK601
T02JN13	LA9 FL981	LA9 FL979	LA9 FL980	LA9 FL601

T02EN13
T02FN13

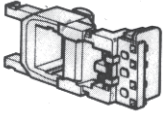

T02GN13
T02HN13
T02JN13

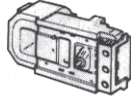

LX1 F... ~

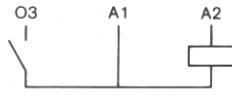

LX4 F... ≡

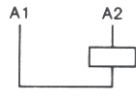

T02EN13
T02FN13
T02GN13

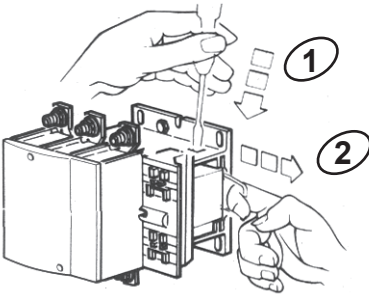

T02HN13
T02JN13

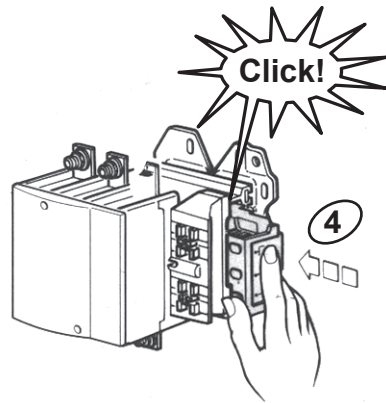
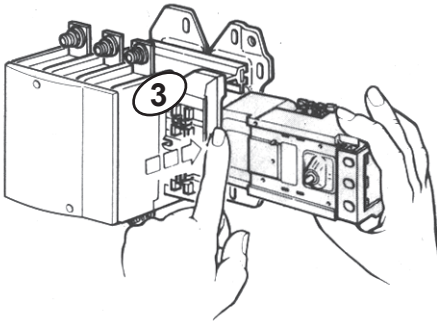
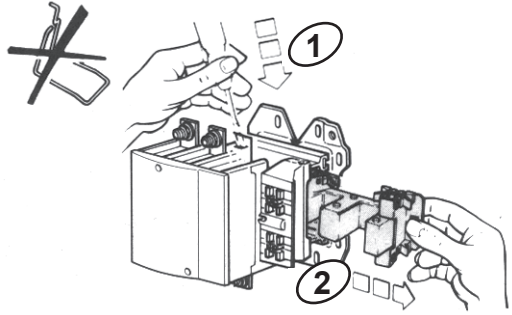

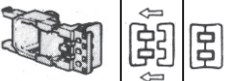
			
~ 60 Hz	VA (1)	VA (1)	U_n

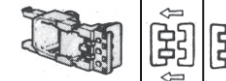
			
~ 40 – 400 Hz	VA (1)	VA (1)	U_n

T02EN13 / T02FN13			
LX1 FF020	550	45	24 V
LX1 FF095	660	55	115/120 V
LX1 FF162	660	55	200/208 V
LX1 FF187	660	55	230/240 V
LX1 FF380	660	55	460/480 V

T02GN13			
LX1 FH1272	600	8	120 V
LX1 FH2002	↕	↕	208 V
LX1 FH2402	↕	↕	240 V
LX1 FH5002	700	10	480 V

			
~ 40 – 400 Hz	VA (1)	VA (1)	U_n

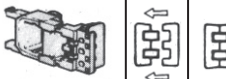
			
DC ---	W	W	U_n

T02HN13			
LX1 FK110	1050	16	110/120 V
LX1 FK200	↕	↕	208 V
LX1 FK240	↕	↕	240 V
LX1 FK415	1150	20	480 V

T02EN13 / T02FN13			
LX4 FF024	543	3.94	24 V
	↕	↕	
	665	4.83	

T02JN13			
LX1 FL110	1500	20	110/120 V
LX1 FL200	↕	↕	208 V
LX1 FL240	↕	↕	240 V
LX1 FL415	1730	25	480 V

(1) 50/60 Hz, $\theta = 20\text{ }^\circ\text{C}$ (68 $^\circ\text{F}$)

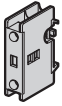

LA DN 10
01

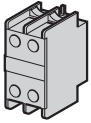

LA DN 11
20
02

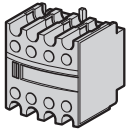

LA DN
LA DC
LA1 DX (1)
DZ (1)
DY (1)

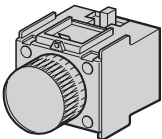

LA DS
LA DT
LA DR

1 "F" (N.O. / N.A.)	LA DN10
1 "O" (N.C.)	LA DN01
1 "F" + 1 "O" (N.O. / N.A.) (N.C.)	LA DN11
2 "F" (N.O. / N.A.)	LA DN20
2 "O" (N.C.)	LA DN02
2 "F" + 2 "O" (N.O. / N.A.) (N.C.)	LA DN22
1 "F" + 3 "O" (N.O. / N.A.) (N.C.)	LA DN13
4 "F" (N.O. / N.A.)	LA DN40
4 "O" (N.C.)	LA DN04
3 "F" + 1 "O" (N.O. / N.A.) (N.C.)	LA DN31
2 "F" + 2 "O" (N.O. / N.A.) (N.C.)	LA DC22
2 "F" (N.O. / N.A.)	LA1 DX20 (1)
2 "F" + 2 "F" (N.O. / N.A.) (N.O. / N.A.)	LA1 DZ40 (1)
1 "F" + 1 "O" + 2 "F" (N.O. / N.A.) (N.C.) (N.O. / N.A.)	LA1 DZ31 (1)
2 "F" (N.O. / N.A.)	LA1 DY20 (1)

(1) LA1 DX/DY/DZ

Dust-tight
Hermético al polvo
Étanche à la poussière
防尘

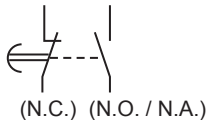

0.1 – 3 s
0.1 – 30 s
1 – 30 s
10 – 180 s
LADT0
LADT2
LADS2
LADT4

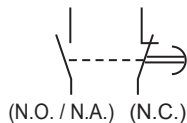

0.1 – 3 s
0.1 – 30 s
10 – 180 s
LADR0
LADR2
LADR4

T02EN13, T02FN13, T02GN13, T02HN13, T02JN13

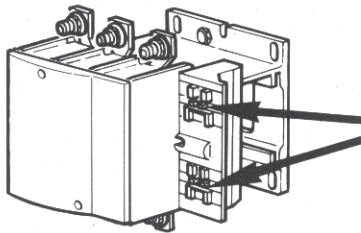
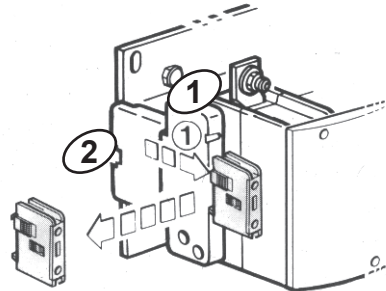
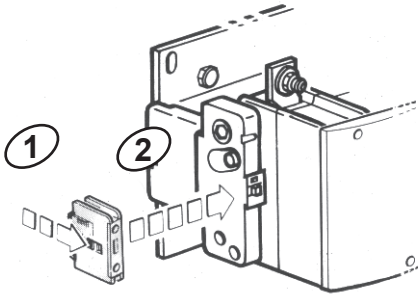

+

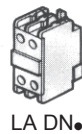

LA DN.

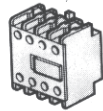

LA DN.
LA DC.
LA1 D.

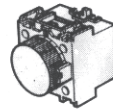

LA DS.
LA DT.
LA DR.

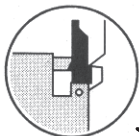
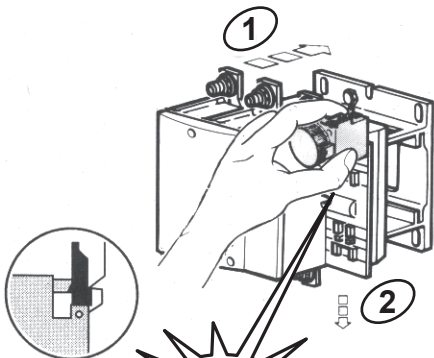

Click!

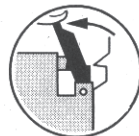
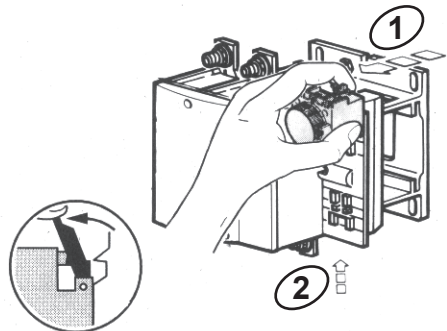

T02EN13, T02FN13, T02GN13, T02JN13

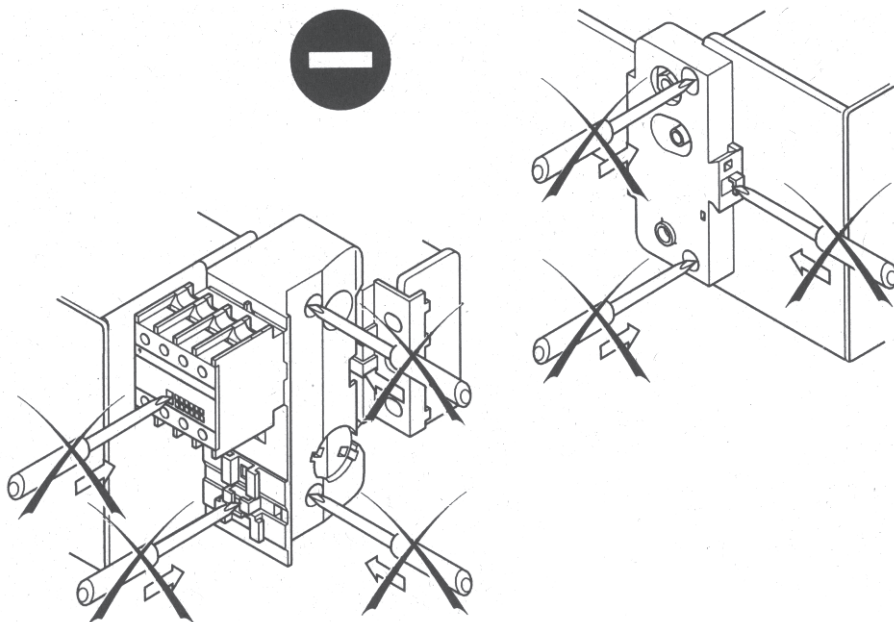
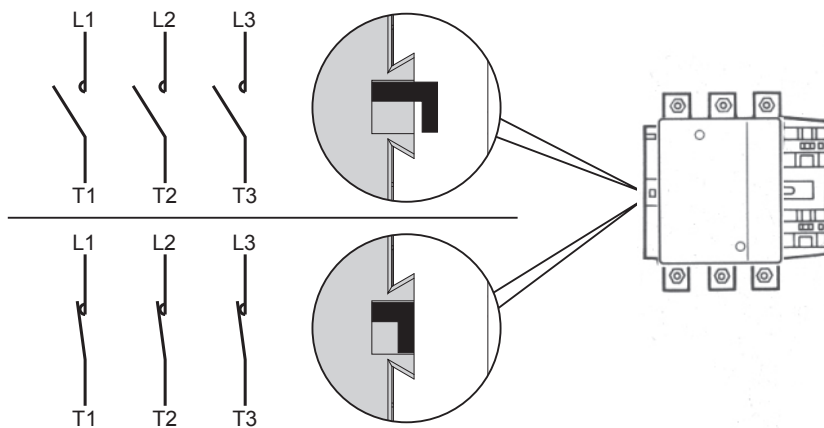

Contact wear indicator
 Indicador de desgaste de los contactos
 Indicateur d'usure des contacts
 触点磨损指示器

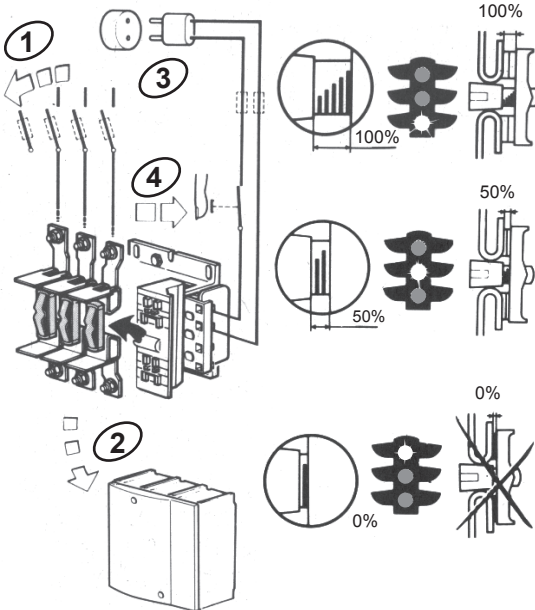

- The blackening of the contacts and the arc-boxes is a natural consequence which occurs during normal operation, and does not affect the functioning of the product.
- El ennegrecimiento de los contactos y las cajas de arco es una consecuencia natural que se produce durante el funcionamiento normal, y no afecta el funcionamiento del producto.
- La noircissement des contacts et des boîtes d'arc est une conséquence naturelle qui se produit durant un fonctionnement normal et n'affecte pas le fonctionnement du produit.
- 触点和电弧室变黑属正常操作中的正常现象，对产品运行无任何影响。

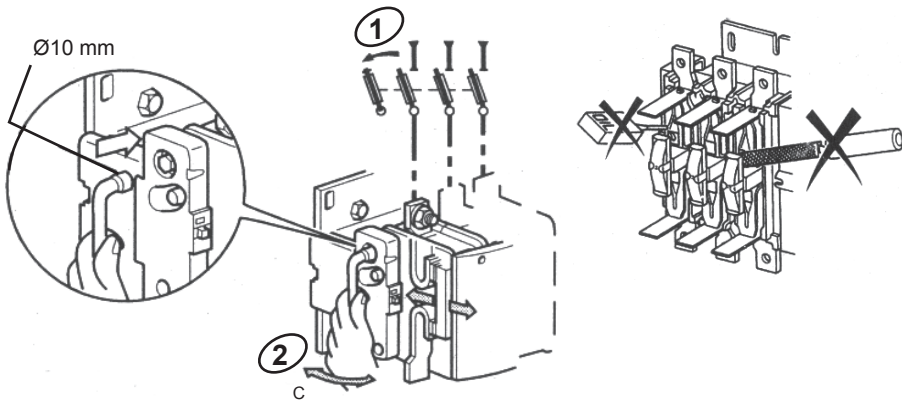

C (max. / maxi. / 最大) = 10 N•m / 89 lb-in T02EN13 / T02FN13

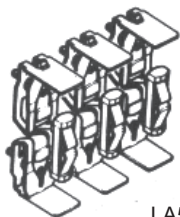

LA5 FF431
(T02EN13 / T02FN13)

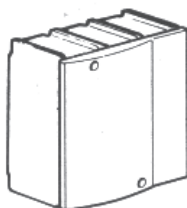

LA5 F11550 (T02EN13)
LA5 F15050 (T02FN13)

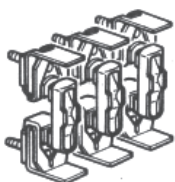

LA5 F400803 (T02GN13)
LA5 F500803 (T02HN13)

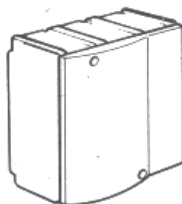

LA5 F33050 (T02GN13)
LA5 F50050 (T02HN13)

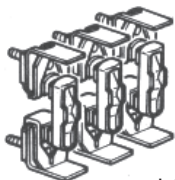

LA5 F630803 (T02JN13)

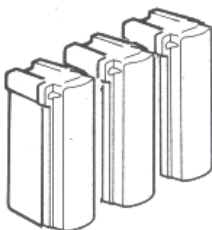

LA5 F63050 (T02JN13)

Maximum Control Distance
Distancia máxima de control

Distance de contrôle maximale
最大控制距离

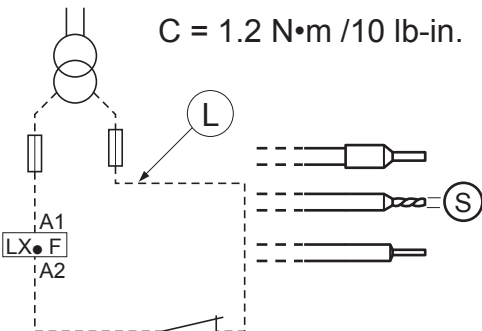
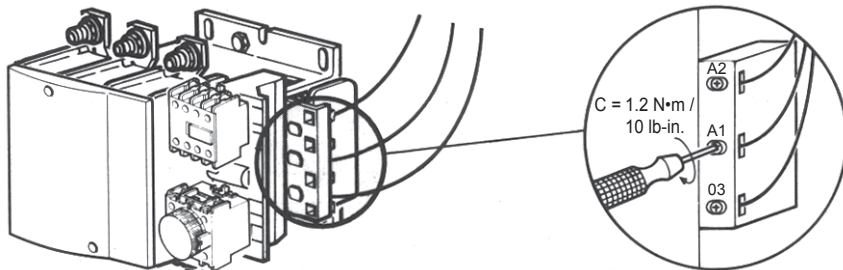

T02EN13 / T02FN13 / T02GN13			
LX•F ~ / ∩	L ≤ (m)	L ≤ (yd)	S ≥ (AWG)
24 V	4 7	4.4 7.7	13 11
48 V	10 20 30	10.9 21.9 32.8	15 13 11
110 V	40 60 100 150	43.7 65.6 109.4 164.0	17 15 13 11
220 V	150 250 400 600	164.0 273.4 437.5 656.2	17 15 13 11
380 V 440 V	500 750 1200	546.8 820.2 1312.3	17 15 13

LX1 F ~ LX1 F / LX9 F ~
LX8 F ~ / ∩

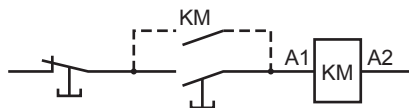

LX4-F
∩



48 V {
110 V {
125 V {

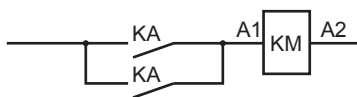

220 V {
250 V {
440 V {



T02HN13 / T02JN13			
LX•F ~ / ∩	L ≤ (m)	L ≤ (yd)	S ≥ (AWG)
48 V	4 6 10	4.4 6.6 10.9	15 13 11
110 V	15 20 40 60	16.4 21.9 43.7 65.6	17 15 13 11
220 V	60 90 150 250	65.6 98.4 164.0 273.4	17 15 13 11
380 V 440 V	180 270 500	196.9 295.3 546.8	17 15 13