

User Manual - Back-UPS™ Pro Gaming UPS 2200 VA, 230 VAC

Important Safety Instructions

SAVE THESE INSTRUCTIONS - This manual contains important instructions that should be followed during installation and maintenance of the UPS and batteries.



This is the “Read user manual” symbol. Read the user documentation to become familiar with the equipment.

Read these instructions carefully and look at the equipment to become familiar with the device before trying to install or operate it.

The following special messages may appear throughout this document or on the equipment to warn of potential hazards or to call attention to information that clarifies or simplifies a procedure.



The addition of this symbol either to a “Danger” or “Warning” safety label indicates that an electrical hazard exists that will result in personal injury if the instructions are not followed.



This is the safety alert symbol. It is used to alert you to potential personal injury hazards. Obey all safety messages that follow this symbol to avoid possible injury or death.

DANGER

DANGER indicates a hazardous situation which, if not avoided, **will result in** death or serious injury.

WARNING

WARNING indicates a hazardous situation which, if not avoided, **could result in** death or serious injury.







CAUTION

CAUTION indicates a hazardous situation which, if not avoided, **could result in** minor or moderate injury.

NOTICE

NOTICE is used to address practices not related to physical injury.

Product Handling Guidelines

					
<18 kg <40 lb	18-32 kg 40-70 lb	32-55 kg 70-120 lb	>55 kg >120 lb		

Safety and General Information

Inspect the package contents upon receipt. Notify the carrier and dealer if there is any damage.

- This UPS is intended for indoor use only.
- Do not operate this unit in direct sunlight, in contact with fluids, or where there is excessive dust or humidity.
- Do not operate the UPS near open windows or doors.
- Be sure the air vents on the UPS are not blocked. Allow adequate space for proper ventilation.
NOTE: Allow a minimum of 20 cm clearance on both front and rear sides of the UPS.
- Connect the Back-UPS power cable directly to a wall outlet. Do not use surge protectors or extension cords.
- The equipment is heavy. Always practice safe lifting techniques adequate for the weight of the equipment.
- **Changes and modifications to this unit not expressly approved by APC by Schneider Electric could void the warranty.**
- Connect the UPS input power cord to an earthed mains socket.

Electrical safety

- Use tools with insulated handles.
- Do not handle any metallic connector before power has been disconnected.
- **230 V models only:** In order to maintain compliance with the EMC directive for products sold in Europe, output cords and network attached to the UPS must not exceed 10 meters in length.
- The protective earth conductor for the UPS carries the leakage current from the load devices (computer equipment). An insulated ground conductor is to be installed as part of the branch circuit that supplies the UPS. The conductor must have the same size and insulation material as the grounded and ungrounded branch circuit supply conductors. The conductor will typically be green, with or without a yellow stripe.
- Leakage current for a pluggable, Type A UPS may exceed 3.5 mA when a separate ground terminal is used.

- The UPS input ground conductor must be properly bonded to protective earth at the service panel.
- If the UPS input power is supplied by a separately derived system, the ground conductor must be properly bonded at the supply transformer or motor generator set.

Battery safety

CAUTION

RISK OF HYDROGEN SULPHIDE GAS AND EXCESSIVE SMOKE



- Replace the battery at least every 5 years or at the end of its service life, whichever is earlier.
- Replace the battery immediately when the UPS indicates battery replacement is necessary.
- Replace batteries with the same number and type of batteries as originally installed in the equipment.
- Replace the battery immediately when the UPS indicates a battery over-temperature condition, or when there is evidence of electrolyte leakage. Power OFF the UPS, unplug it from the AC input, and disconnect the batteries. Do not operate the UPS until the batteries have been replaced.

Failure to follow these instructions can result in minor or moderate injury and equipment damage.

- Servicing of batteries should be performed or supervised by personnel knowledgeable about batteries and required precautions. Keep unauthorized personnel away from batteries.
- APC by Schneider Electric uses Sealed Maintenance-Free Lead Acid batteries. Under normal use and handling, there is no contact with the internal components of the batteries. Over charging, over heating or other misuse of batteries can result in leakage of battery electrolyte. Released electrolyte is toxic and may be harmful to the skin and eyes.
- The battery typically lasts for 3 to 5 years. Environmental factors impact battery life. Elevated ambient temperatures, poor quality utility power, and frequent short duration discharges will shorten battery life. Batteries should be replaced before end of life.
- CAUTION: Do not dispose of batteries in a fire. The batteries may explode.
- CAUTION: Do not open or mutilate batteries. Released material is harmful to the skin and eyes. It may be toxic.
- CAUTION: Before installing or replacing the batteries, remove conductive jewelry such as chains, wrist watches, and rings. High energy through conductive materials could cause severe burns.
- CAUTION: Failed batteries can reach temperatures that exceed the burn thresholds for touchable surfaces.

- **CAUTION:** A battery can present a risk of electrical shock and high short-circuit current. The following precautions should be taken when working on batteries:
 - Disconnect the charging source prior to connecting or disconnecting battery terminals.
 - Do not wear any metal objects including watches and rings.
 - Do not lay tools or metal parts on top of batteries.
 - Use tools with insulated handles.
 - Wear rubber gloves and boots.
 - Determine if battery is either intentionally or inadvertently grounded. Contact with any part of a grounded battery can result in electric shock and burns by high short-circuit current. The risk of such hazards can be reduced if grounds are removed during installation and maintenance by a skilled person.

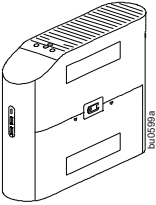
Package Contents

Common to all models	
UPS 	USB cable 
	Safety Guide 

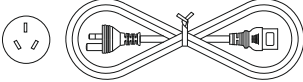
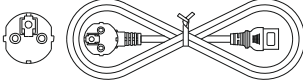
BGM2200-AZ/BGM2200B-AZ	BGM2200-GR/BGM2200B-GR
Australian Power Cable 	German Power Cable 

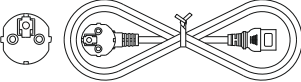
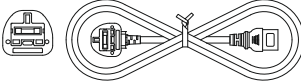
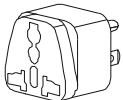
BGM2200-MSX/BGM2200B-MSX	
German Power Cable 	UK Power Cable 
Plug Adapter - Universal to NEMA 	

Connect Battery

CAUTION

RISK OF FALLING OBJECTS

The equipment is heavy. Always practice safe lifting techniques adequate for the weight of the equipment.

Failure to follow this instruction could result in equipment damage and minor or moderate injury.

NOTE: The UPS is shipped with the battery disconnected.

- 1** Lay the UPS with the battery door facing up. The arrows point to the locking tabs of the battery compartment.

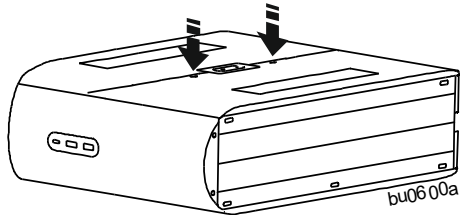

- 2** Press the tabs downwards and pull the battery door away from the unit to access the battery modules.

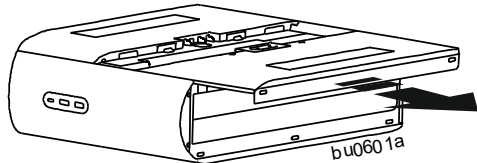

- 3**
1. Remove the protective label on the battery connector (red wire).
 2. Using the handles on both sides of the battery, tilt the battery 30 degrees upward to expose the battery connector. Connect the red wire as shown above.

NOTE: The black wire is already connected in the factory prior to shipment.

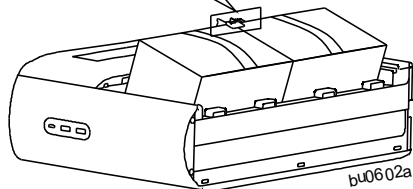
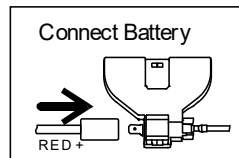

4 Push the battery back into the unit.

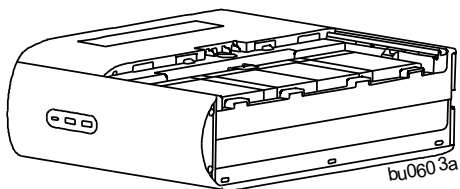

5 Align the side rails on the cover with the rails on the UPS and slide the cover till it locks in position.

NOTE: Be sure that the rails are aligned before sliding the cover.

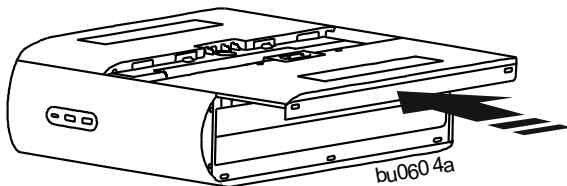

6 Remove all the protective films on the UPS.

Install PowerChute™ Serial Shutdown Software

Use PowerChute Serial Shutdown (PCSS) software to configure the UPS settings. During a power outage, PCSS will save any open files on your computer and shut it down. When power is restored, it will restart the computer.

NOTE: PCSS is only compatible with a Windows operating system. If you are using Mac OSX, use the native shutdown feature to protect your system. See the documentation provided with your computer.

Installation

1. Use the USB Data Port Cable supplied with the Back-UPS to connect the data port on the Back-UPS to the USB port on your computer.
2. Download PowerChute Serial Shutdown Software from <https://www.apc.com/pcss>.
3. Select the appropriate operating system and follow directions to download and install the software.

Connect the Equipment

Battery Backup and Surge Protected outlets

When the Back-UPS is receiving utility power, the Battery Backup with Surge Protection outlets will supply power to connected equipment. During a power outage or brownouts, sags and surges, the Battery Backup outlets supply battery power to the connected equipment for a limited time. Connect Gaming PC, Console, router and Monitor to these outlets so you could stay on line during power outage.

Connect equipment such as External Hard Drive, Television or other peripherals that do not need battery backup power to the Surge Protection Only outlets. These outlets help to provide full-time protection from surges even if the Back-UPS is turned OFF.

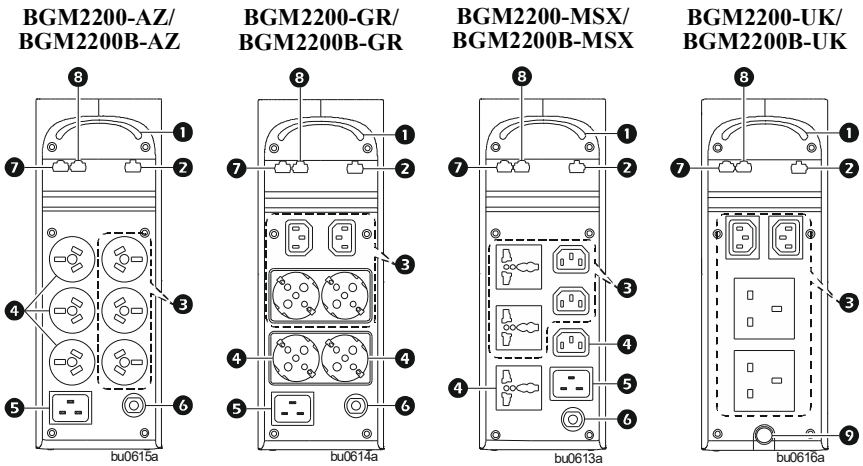

1	Rear LEDs	The Rear LEDs provide 12-color ambient lights to help you add/remove loads from outlets.
2	USB and Serial Data Port	To use PowerChute Serial Shutdown, use the supplied USB communication cable to connect to a computer.
3	Battery Backup Outlets with Surge Protection	During a power outage or other AC problems, the Battery Backup receive power for a limited time from the Back-UPS. Connect essential equipment such as Gaming PC, Console, Router or other gaming gear into these outlets.
4	Surge Protected Outlets	These outlets provide full-time protection from surges, even if the Back-UPS is OFF. Connect equipment such as printers and scanners that do not require battery backup protection.
5	Mains Input (IEC C20 receptacle)	Connect utility power to the UPS input using the input power cord (supplied).
6	Circuit breaker Reset Button	Use to reset the system after an overload condition has tripped the circuit breaker interrupt current flow.





7	Ethernet - In Port (Surge Protected)	Use an Ethernet cable to connect a cable modem to this port.
8	Ethernet - Out Port (Surge Protected)	Use an Ethernet cable to connect a computer to this port.
9	Input Power Cord	Connect the utility power to the UPS.

Operation

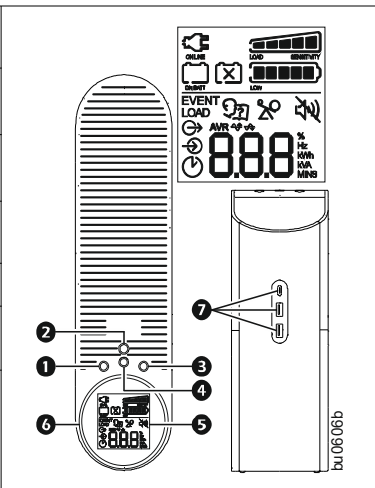

Top Bezel Buttons and Display Interface













Use the four buttons on the front panel of the Back-UPS and the display interface to configure the Back-UPS.

Front Panel

1	 INFORMATION button	
2	 POWER ON/OFF button	
3	 MUTE button	
4	 LED button	
5	LCD Display	
6	Reactor Circle. Provides 12-color ambient lights.	
7	USB charging ports. The 3 USB ports provide a total of 15W of DC power, and will provide power even when the UPS is on battery.	

Display Icons

 ONLINE	On-line: The Back-UPS is supplying conditioned utility power to connected equipment
	Load Capacity: The approximate load capacity percentage is indicated by the number of load bar sections illuminated. Each bar represents approx 20% of load capacity.
	Battery Capacity: The battery charge level is indicated by the number of bar sections illuminated. When all five bar sections are illuminated, it indicates that the battery is fully charged. When only one bar section is illuminated, it indicates the battery charge is nearing depletion.

 LOW	<p>Low Battery: When the battery charge is completely depleted and the UPS is nearing shutdown, the indicator will flash accompanied by a continuous beep.</p>
	<p>Replace Battery: The battery is nearing the end of its useful life and should be replaced immediately.</p>
 ON BATT	<p>On Battery: The UPS is supplying battery power to the connected equipment. The UPS will emit an audible beep 4 times every 30 seconds.</p>
	<p>System Error Detected: A system error has been detected. The system error number will be displayed on the display interface. Refer “Detected system errors” on page 11, for details.</p>
	<p>Overload: The connected equipment is drawing more power than the rated capacity of the UPS.</p>
	<p>Mute: An illuminated line through the icon indicates that the audible alarm is disabled.</p>
	<p>Out: Output voltage, frequency</p>
	<p>In: Input voltage, frequency</p>
<p>AVR  </p>	<p>Automatic Voltage Regulation:</p> <p> When illuminated, the Back-UPS is compensating for low input voltage.</p> <p> When illuminated, the Back-UPS is compensating for high input voltage.</p>
	<p>Estimated Runtime: Indicates the remaining runtime (in minutes) in on-battery mode.</p>
<p>LOAD</p>	<p>Load: The total load in watts (W), VA, or percentage (%) of the devices connected to the UPS.</p>
<p>EVENT</p>	<p>Event: The number of events that shows up on the display interface screen are the number of power disturbances that your UPS has detected. These disturbances can be any of the following: blackout, under/over voltage, total harmonic distortion, surge, spike, etc.</p>



Unit sensitivity

The Back-UPS detects and reacts to line voltage distortions by transferring to battery backup power to help protect connected equipment. In situations where either the Back-UPS or the connected equipment is too sensitive for the input voltage level it is necessary to adjust the transfer voltage.

The higher the sensitivity setting, the more often the Back-UPS switches to battery power.

To adjust the sensitivity of the Back-UPS to control when the UPS will switch over to battery power:

1. Press and hold the INFORMATION button for six seconds. The Load capacity icon will flash on and off, indicating that the Back-UPS is in programming mode.
2. Press INFORMATION button to navigate through the menu options. Stop at selected sensitivity.

Generator Sensitivity	Default	Sensitive Loads
		
Low sensitivity	Medium sensitivity (Default)	High sensitivity
169-307 Vac	176-298 Vac	179-293 Vac
Gaming UPS will change to battery mode only when input voltage is extremely low or high. Not recommended for computer or gaming console loads.	This is default sensitivity setting and is recommended for Gaming PC and Gaming consoles.	Use this sensitivity when the connected equipment is sensitive to voltage fluctuations.

Alarms and Detected System Errors

Audible indicators

Overload	Beep every 0.5 second
Low battery	Beep every 0.5 second
Overcharge	Beep every 1.5 seconds
Battery replacement	Beep every 2 seconds
Battery mode	4 beeps every 30 seconds
Internal error detected	Continuous beep



Detected system errors







If the UPS system does not operate correctly, use the table below to resolve the problem.





F01	Overload fault	Turn OFF the Gaming UPS. Disconnect non-essential equipment from the Battery Backup outlets and then turn ON the Gaming UPS.
F02	Output short	Turn OFF the Gaming UPS. Disconnect all equipment from the Battery Backup outlets and then turn ON the Gaming UPS. Reconnect equipment one item at a time. If the system error is detected again, disconnect the last connected equipment as it is in an inoperable condition.

F05	Over Charge Voltage	Contact APC by Schneider Electric support.
F06	Relay Welding	Contact APC by Schneider Electric support.
F07	Over Temperature or NTC disconnected	Contact APC by Schneider Electric support.
F08	Fan lock error detected	Contact APC by Schneider Electric support.
F12	Battery mode output high	Contact APC by Schneider Electric support.
F13	Battery mode output low	Contact APC by Schneider Electric support.
F28	Low battery voltage	Replace the battery. If the detected error still occurs after battery is replaced, contact APC by Schneider Electric Support.

Button Function Quick Reference

Function	Button	Timing	Description
Power ON		2 seconds	Press and hold the POWER ON/OFF button to turn ON the UPS.
Power OFF		2 seconds	Press and hold the POWER ON/OFF button to turn OFF the UPS.
Self-Test mode		6 seconds	<ol style="list-style-type: none"> Press and hold the POWER ON/OFF button. Release the POWER ON/OFF button when the second beep is heard indicating that the UPS is in Self-Test mode. <p>NOTE: UPS will go into this mode only when it is in Line mode or AVR mode.</p>
UPS Information		0.2 seconds	Press the INFORMATION button to display UPS information. The information will cycle from Event counter → Runtime → Load watt → Load VA → Load percentage → Output voltage → Output frequency → Input voltage → LCD Display illumination OFF.
Sensitivity		6 seconds	When the UPS is in Stand-by, On-line or On-battery mode, press and hold the INFORMATION button, the Load Capacity icon will blink, indicating that the UPS is in programming mode. Use the INFORMATION button to scroll through Low, Medium, and High. Stop at selected sensitivity for 5 seconds. The UPS will beep confirming the selection.
Mute		2 seconds	Press and hold the MUTE button to enable or disable the audible alarms.

Function	Button	Timing	Description
LED Color		0.2 seconds	Click to LED button to select LED Color (There are twelve colors to choose from). The Reactor Circle and Rear LED will be synced in color.
Previous LED Color		2 seconds	Press and hold the LED button (till a beep is heard after 2 seconds) to select previous LED Color
Turn ON/OFF the LED lights		6 seconds	Press and hold the LED button for 6 seconds (till a second beep is heard) to change the LED lights setting as per the sequence below: <ul style="list-style-type: none"> • Reactor Circle and Rear LED ON • Reactor Circle ON, Rear LED OFF • Reactor Circle OFF, Rear LED ON • Reactor Circle and Rear LED OFF
Event Reset	 	0.2 seconds	When the Event screen is visible, press and hold INFORMATION button, then press POWER ON/OFF button to clear the detected event counter.
Turn ON/OFF APC logo	 	0.2 seconds	Press LED button and POWER ON/OFF button simultaneously to turn ON/OFF the APC logo.
Reactor Circle Illumination Brightness NOTE: This feature is available only when the Reactor Circle display mode is set to Static color.	 	2 seconds	Press the MUTE and LED buttons simultaneously to adjust the illumination brightness of the Reactor Circle. Each press of the buttons changes the brightness as per the sequence below: <ul style="list-style-type: none"> • 100% brightness • 75% brightness • 50% brightness • 25% brightness • 0% brightness

Function	Button	Timing	Description
Reactor Circle display mode	 	2 seconds	<p>Press and hold INFORMATION and LED buttons simultaneously for 2 seconds to select the Reactor Circle display mode. Press and hold the buttons for 2 seconds each time to navigate between the options below:</p> <ul style="list-style-type: none"> • Static color mode • Breathing effect mode • Combination of Animation and Breathing effect mode • Animation mode <p>NOTE: Press the LED button to change the color of Reactor Circle; this feature is available only when the Reactor Circle display mode is set to Static color or Breathing effect modes.</p>
LCD Display illumination mode	 	2 seconds	<p>Press and hold the INFORMATION and the MUTE buttons to enable/disable the continuous illumination of the LCD display, when the UPS is working in on-line mode.</p> <p>Enable: Select this mode for the LCD display to be illuminated always.</p> <p>Disable: Select this mode for the LCD display to be illuminated only when a button is pressed. The LCD display illumination will turn off after 80 seconds if no button is pressed (power saving mode).</p> <p>NOTE: The UPS will emit a beep when the state is changed.</p>

Status Indicators

Unit Status	Description
Standby Mode	The unit is plugged into AC Mains and UPS output is off. In standby mode, the connected equipment will not receive any power from the UPS, but the battery will continue to be charged. Both the LCD display and Reactor Circle will not illuminate.
On-line Mode	The Reactor Circle illuminates in Animation mode. After 10 seconds the Reactor Circle mode changes to the set Reactor Circle display mode.
Equipment is plugged in Equipment is unplugged	When a new equipment is connected to the UPS or a connected equipment is disconnected from the UPS, the segments of the Reactor Circle illuminate for 10 seconds, indicating the changed load% and then revert to set Reactor Circle display mode. Each segment of the Reactor Circle represents approx. 8% of the UPS capacity.
On-battery Mode	The segments of the Reactor Circle illuminate indicating the remaining battery capacity. Each segment of the Reactor Circle represents approx. 8% of the full battery capacity. The runtime available in minutes is also displayed on the LCD display and the on-battery icon will also be illuminated.
Low Battery	When the unit is on-battery and the remaining battery capacity is low the Reactor Circle will illuminate red color in breathing effect mode. If the Rear LED illumination is enabled, the Rear LED will also illuminate red color in breathing effect mode.
Overload	All the segments of the Reactor Circle illuminate in red color irrespective of the Reactor Circle display mode setting. It will remain in this state until the excess load connected to the UPS is disconnected. Also, the Overload icon on the LCD display will be illuminated.
Bad Battery	All the segments of the Reactor Circle illuminate in red color irrespective of the Reactor Circle display mode setting. Also, the Replace Battery icon on the LCD display will be illuminated.
AVR Mode	The Reactor Circle display will change from the currently set mode to Breathing effect mode. The color of the Reactor Circle will continue to be the same as the one set for the current mode. The AVR icon on the LCD display will be illuminated.

Unit Status	Description
Reactor Circle indications based on LCD display setting	<ul style="list-style-type: none"> • When the UPS is on-battery and the LCD display is set to display Runtime, the Reactor circle color illuminates <ul style="list-style-type: none"> - green color in breathing effect mode if remaining battery capacity is above 50%, - orange color in breathing effect mode when the remaining battery capacity is between 20% and 50%, - red color in breathing effect mode when the remaining battery capacity is under 20% • When the UPS is on-battery and the LCD display is set to display Load % / Load watt / Load VA, the Reactor Circle color will be green in static color mode. Each Reactor Circle segment represents approximately 8% load. • When the UPS is in on-battery mode and the LCD display is set to display Event counter / Output voltage / Output frequency / Input voltage / Display Off, the Reactor Circle will continue to be in the set Reactor Circle display mode.

Troubleshooting

Problem	Possible Cause	Corrective Action
Back-UPS will not switch ON	The Back-UPS is not connected to utility power.	Be sure that the Back-UPS is securely connected to a utility outlet.
	The circuit breaker has tripped.	Disconnect non-essential equipment from the Back-UPS. Reset the circuit breaker. Reconnect equipment one item at a time. If the circuit breaker trips again, disconnect the device that caused the circuit breaker to trip.
	The internal battery is not connected.	Connect the battery.
	The input voltage is out of range.	Adjust the transfer voltage and sensitivity range.
The Back-UPS does not provide power during a utility power outage	Be sure that essential equipment is not plugged into a surge only outlet.	Disconnect equipment from the surge only outlet and re-connect to a Battery Backup outlet.
The Back-UPS is operating on battery power, while connected to utility power	Plug is not inserted fully into the wall outlet, the wall outlet is no longer receiving utility power, the circuit breaker has tripped.	Be sure that the plug is fully inserted into the wall outlet. Be sure that the wall outlet is receiving utility power by checking it with another device. Reset the circuit breaker
	The Back-UPS is performing an automatic self-test.	No action is necessary.
	The input voltage is out of range, the frequency is out of range, or the waveform is distorted.	Adjust the transfer voltage and sensitivity range.
The Back-UPS does not provide the expected amount of backup time	Battery Backup outlets may be fully or improperly loaded.	Disconnect non-essential equipment from the Battery Backup outlets and connect the equipment to surge outlets.
	The battery was recently discharged due to a power outage and has not fully recharged.	Charge the battery for 16 hours.
	The battery has reached the end of its useful life.	Replace the battery.
The Replace Battery indicator is illuminated	The battery has reached the end of its useful life.	Replace the battery immediately

Problem	Possible Cause	Corrective Action
The Overload indicator is illuminated	The equipment connected to the Back-UPS is drawing more power than the Back-UPS can provide.	Disconnect non-essential equipment from the Battery Backup outlets and connect the equipment to surge outlets.
The System Error Detected indicator is illuminated, all the front panel indicators are flashing	An internal error has been detected.	Determine the detected system error by matching the detected error number displayed on the display interface with the corresponding detected system error number in “Detected system errors” on page 11. Contact APC by Schneider Electric support.
Mobile phone is not getting charged through the USB port.	The UPS is in Stand-by mode.	Be sure that the UPS is in On-battery mode or On-line mode.
	Charging cable connector is not fully inserted into the USB port.	Be sure that the charging cable connector is securely inserted into the USB port.
	Charging cable is damaged.	Replace the charging cable. If problem persists even after the charging cable is replaced, contact APC by Schneider Electric support.
	Mobile phone charging standard not compatible.	Try charging another mobile phone which is compliant with USB charging standard BC1.2. If the problem persists with this mobile phone also, contact APC by Schneider Electric support.
	An Internal error has been detected.	Contact APC by Schneider Electric support.

Specifications

Rating	2200 VA
Maximum Load	1320 W
Nominal Input Voltage	230 V
Online Input Voltage Range	169 - 307 V
Automatic Voltage Regulation	Boost by +15.7% when input voltage drops below limit Trim by -15.7% when input voltage exceeds limit
Input Frequency Range	50/60 Hz \pm 3 Hz
USB charging port	Type C - 1 No., Type A - 2 Nos. (15 W in total)
Typical Recharge Time	16 hours
Transfer Time	8ms (Typical), 10ms (Max)
Operating Temperature	32 to 104 °F (0 to 40 °C)
Storage Temperature	5 to 113 °F (-15 to 45 °C)
Humidity	0 to 95% relative humidity, non-condensing
Unit Dimensions	16.0 \times 4.1 \times 11.4 in (408 \times 105 \times 291 mm)
Unit Weight	BGM2200-AZ/BGM2200B-AZ: 12.32 kg (27.16 lb) BGM2200-GR/BGM2200B-GR: 12.24 kg (26.98 lb) BGM2200-MSX/BGM2200B-MSX: 12.24 kg (26.98 lb) BGM2200-UK/BGM2200B-UK: 12.56 kg (27.69 lb)
Color	BGM2200-AZ/BGM2200-GR/BGM2200-MSX/ BGM2200-UK: White BGM2200B-AZ/BGM2200B-GR/BGM2200B-MSX/ BGM2200B-UK: Black
Interface	USB
On-Battery Runtime	Go to: http://www.apc.com/
International Protection Code	IP20
Altitude	3000 m
Pollution Degree	2
Overvoltage Category	II
Applicable power grid power distribution system	TN Power System
Applicable Standard	IEC62040-1

Replacement Battery

Contact APC support for battery replacement parts. Battery replacement parts for BGM2200-AZ, BGM2200B-AZ, BGM2200-GR, BGM2200B-GR, BGM2200-MSX, BGM2200B-MSX, BGM2200-UK, and BGM2200B-UK is APCRBC216.

Delaying the replacement of batteries may corrode the batteries in the cartridge. Recycle spent battery cartridges.

Battery Recycling

Visit <https://www.apc.com/recycle> for details.

Warranty

The standard warranty is three (3) years from the date of purchase. Schneider Electric IT (SEIT) standard procedure is to replace the original unit with a factory reconditioned unit. Customers who must have the original unit back due to the assignment of asset tags and set depreciation schedules must declare such a need at first contact with an SEIT Technical Support representative. SEIT will ship the replacement unit once the defective unit has been received by the repair department, or cross ship upon the receipt of a valid credit card number. The customer pays for shipping the unit to SEIT. SEIT pays ground freight transportation costs to ship the replacement unit to the customer.

APC by Schneider Electric Customer Support

For country specific customer support, go to APC by Schneider Electric Web Site, www.apc.com.