

# SRP981 PNEUMATIC POSITIONER

These instructions are to be used as a guide for quick start-up. For more detailed information please refer to the standard documents “Master Instructions” and “Product Specification Sheet”. These can be found on our Website.

## 1 MOUNTING TO LINEAR ACTUATORS

### Single-acting diaphragm actuators

Check whether the actuator is in the safety position required by the process. (Does the actuator open or close with spring force?) The mounting side is selected from the table below in accordance with the direction of action and the required direction of movement of the spindle for an increasing input signal.

Actuator closes with spring force	Changeover plate setting	Actuator opens with spring force	Changeover plate setting

The arrow indicates the direction of movement of the spindle at increasing input signal.  
 The direction of action of the input signal can be set on the changeover plate **13** :  
 N = Normal direction of action (increasing input signal produces increasing control pressure to the actuator)  
 U = Reverse direction of action (increasing input signal produces decreasing control pressure to the actuator)

### Double-acting diaphragm actuators

For double-acting positioners the changeover plate **13** always stays in the “N” setting. The assignment of the input signal to the direction of movement of the actuator spindle is determined by the selection of the mounting side of the positioner and the piping of the positioner outputs to the actuator:

	Changeover plate setting		Changeover plate setting

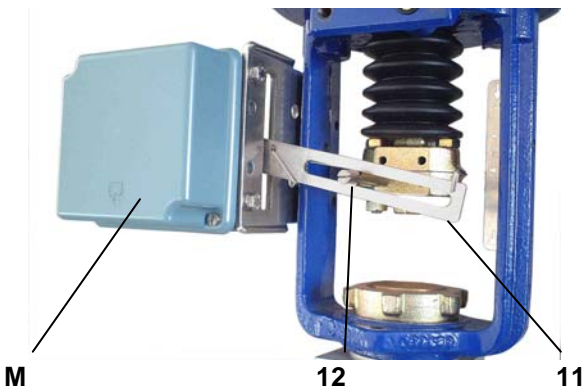

Ensure that the feedback lever **11** is horizontal at 50 % stroke.

Fasten housing cover in such a way that air vent of attached device faces downwards (see Mark ‘M’).

**2 MOUNTING TO ROTARY ACTUATORS**

- a) Remove the transparent cover plate from the housing of the attachment kit.
- b) Mount the housing of the attachment kit on rotary actuator or armature; use mounting hardware supplied by the actuator manufacturer if necessary.
- c) Move actuator into the desired starting position (rotation angle = 0°).



- d) Mount cam **24** in accordance with the direction of rotation of the actuator.

The linear cam is fastened to the actuator drive shaft in such a manner that the distance *x* between the inside of the housing and the came amounts 2 mm, whereas in case of equal percentage cam the dimension *x* is approx. 17.5 mm.

In case of inverse equal percentage cam the dimension *x* is approx. 18 mm.

When employing equal percentage and the inverse equal percentage cams, the range spring (yellow) EW420493013 must be installed in the positioner.

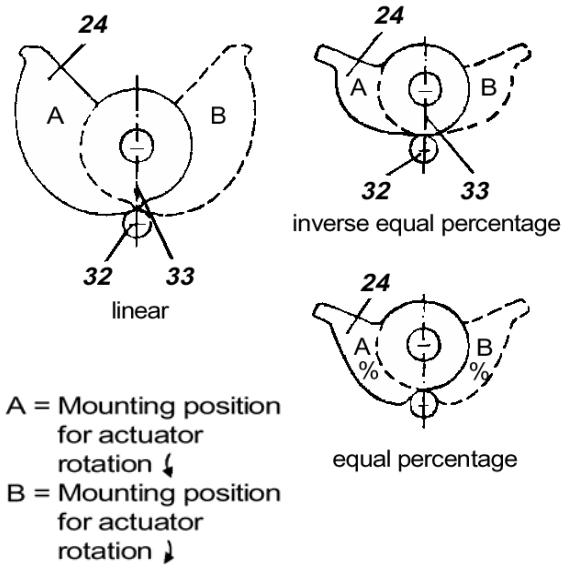

- e) Fasten feedback lever **30** for the rotary actuator onto shaft **15** of positioner.

- f) Mount positioner on housing of attachment kit. Attach spring **31** to feedback lever **30** and cam follower **32** against cam.

Screw positioner to housing of attachment kit. With the linear cam and the inverse equal percentage cam check whether mark **33** points to the center of the cam follower **32**; adjust if necessary.

With the equal percentage cam check whether the cam follower lies directly ahead of the start of the cam lobe; adjust if necessary.

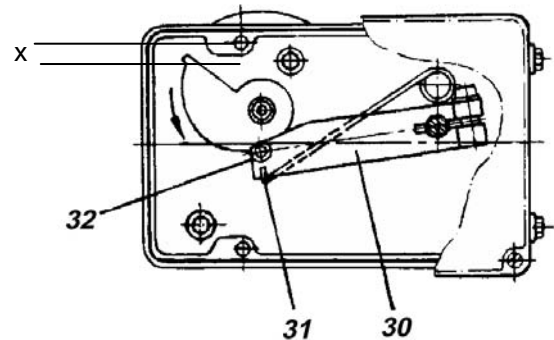

- g) Final mounting of feedback lever on shaft of positioner is performed at a stroke of 0 %, i.e. a rotation angle of 0°. First loosen 5 mm A/F Allen screw of feedback lever **30** through hole **34**, then press stroke factor lever **17** against stop screw **18** (see page 5) and tighten Allen screw firmly.

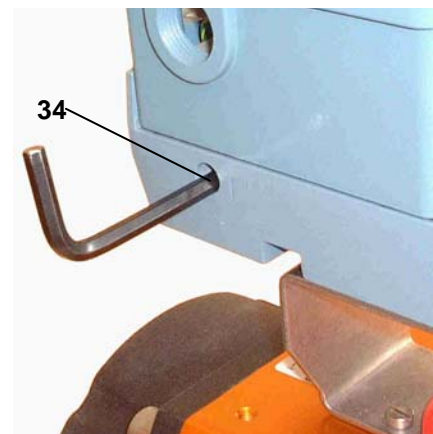

**Note !**

If actuator moves to an end position, the mounting position of cam does not coincide with the direction of rotation of the actuator. In this case install the cam **24** in the reverse position.

### 3 PNEUMATIC CONNECTIONS

**Air supply (s): 1,4 to 6 bar (but not more than the max. pressure of actuator), free of oil, dust and water !**

- 4 Pneumatic input signal (w)
- 6 Internal thread G 1/8 for output II (y2)  
(only on double-acting positioners)
- 7 Internal thread G 1/8 for supply air
- 8 Internal thread G 1/8 for output I (y1)

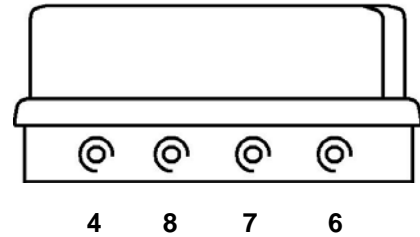

Air supply according to ISO 8573-1  
 - Solid particle size and density class 2  
 - Oil rate class 3  
 Pressure dew point 10 K below ambient temperature

### 4 ELECTRICAL CONNECTIONS OF OPTION

The safety requirements of the document EX EVE0001 as well as the requirements of the PSS EVE0101 and MI EVE0101 for the SRP981 must be observed

#### 4.1 Option “Limit switch”

The limit switches is an accessory either installed in the factory or retrofit. This unit can consist of either inductive slot type sensors or micro switches.

2-wire technique    3-wire technique    micro switch

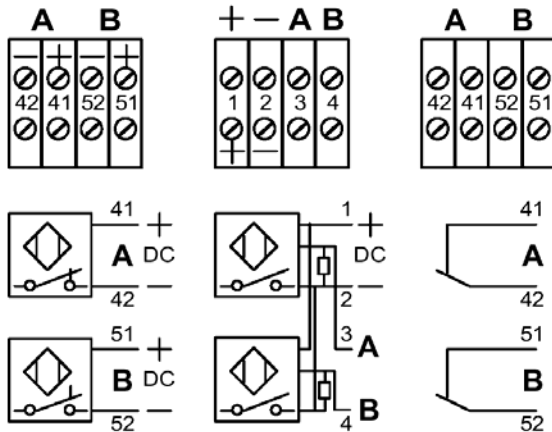

**Warning :** For the connection of micro-switches please refer you to the MI (Master Instruction) and respect the safety requirements of the document EX EVE0001.

#### 4.2 Option “Position Transmitter 4-20 mA”

The electrical position transmitter is an accessory either installed in the factory or retrofit. It converts the stroke or rotary movement of an actuator into an electrical standard signal 4-20 mA.

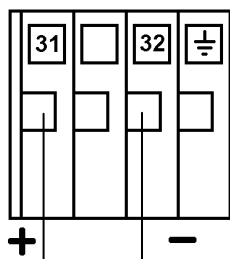

Analog output 4 to 20 mA  
 2 wire system  
 Supply voltage DC 11 to 48 V

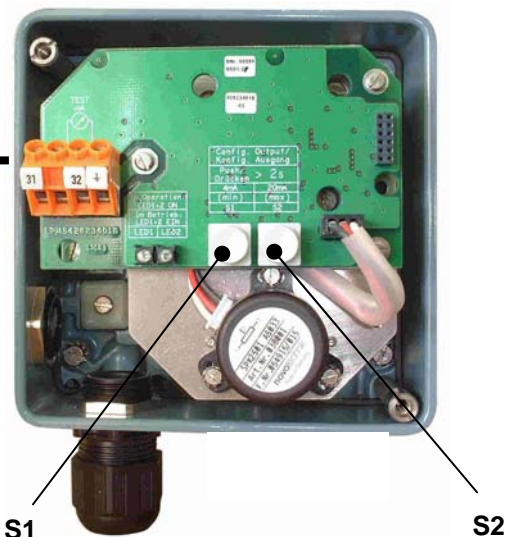

## 5 SETTINGS AND START UP

### 5.1 Setting of zero point and stroke on the positioner

(see page 5 for the reference of the number)

Before starting with the set-up push the flapper lever **40** several times alternately to the left and right in order to align the flappers correctly.

- Set the minimum value of the input signal  $w$  (start of stroke).
- Turn zero screw **41** until actuator just begins to move from its end position.
- Set maximum value of the input signal  $w$  (end of stroke).
- Turn the stroke factor screw **42** until actuator precisely reaches its end position:

Right turn: decrease of travel

Left turn: increase of travel

**Repeat the operations (a to d) 2 or 3 times in order to insure an accurate positioning.**

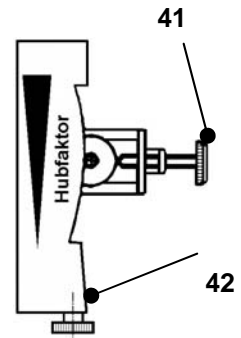

#### Note:

Changes of the gain will influence the settings of zero and span.

If the stroke cannot be adjusted with the installed spring, a suitable spring can be determined with the table on page 5.

### 5.2 Setting the damping

The air output capacity of the positioner can be reduced by means of the damping throttle **44**. Double-acting positioners are equipped with a damping throttle **44** for correcting the variable  $y_1$  and a damping throttle **45** for correcting the variable  $y_2$ . In its normal setting the damping throttle is approximately flush with the amplifier housing.

The air output capacity is reduced by a factor of approximately 2.5 when the damping throttle is turned completely.

### 5.3 Setting and Start Up of position transmitter 4-20 mA

Attachment and start-up of the unit to the actuator must be performed according MI EVE0101 A. At 50% stroke, the control lever must be horizontal.

The electronic connection of the position transmitter must be assured. Both LEDs are then light up.

#### Adjusting the start of the measuring range (4 mA)

- Move the actuator to the starting position.
- Press push button S1 „Config Output 4 mA“ longer than 2 seconds. During this time LED 1 lights up. After 2 seconds both LEDs are light up again, the value for 4mA is stored.

#### Adjusting the end of the measuring range (20 mA)

- Move the actuator to the end position.
- Press push button S2 „Config Output 20 mA“ longer than 2 seconds. During this time LED 2 lights up. After 2 seconds both LEDs are light up again, the value for 20 mA is stored.

### Random adjustment of the current values at the end points

- a) Move the actuator to the end position, where you want to adjust the current.
- b) Press both buttons simultaneously for about 2 seconds. Then both LEDs are alternating flashing in a slow frequency.
- c) With push button S1 „Config Output 4 mA“ the output current value can be decreased and with push button S2 „Config Output 20 mA“ the output current value can be increased. Pressing the buttons for a short moment results in a small change and pressing the button for a longer time results in a fast mode for a bigger change. The value of the current can be freely decreased between about 3.3 and increased up to 22.5 mA.
- d) Without any additional manipulations of the push buttons the new value is automatically saved. After a few seconds, the device returns into the normal operating mode, indicated by both LEDs that are then light up again.

### Trouble shooting of the position transmitter

The components of the position transmitter are under constant surveillance by the installed micro controller. Errors are detected and indicated when both LEDs are off or both LEDs are parallel flashing at a fast frequency.

In the event of a fatal error, e.g. potentiometer not connected, an output current of more then 24 mA will be shown in addition to the error indication given by the LEDs (fast flashing).

In this case check the following:

- a) if the potentiometer is correctly connected to the electronic board.
- b) if the potentiometer is within its working span.

When both LEDs are off, the supply voltage should be checked (minimum tension, polarity).

## 5.4 Spring range

Five different springs for the travel ranges are available for matching to the stroke and input signal range. In the following table the stroke range is given for a normal application (4-20 mA and with our standard feedback lever).

Spring range		Stroke range in mm	Remarks
Ident N°	Colour		
EW420493013	Yellow	8 - 34	
EW420494019	green	17 - 68	Built-in
EW502558017	- without -	28 - 105	
EW420496011	gray	40 - 158	
EW420495014	blue	55 - 200	

### 5.5 Functional designation

Single acting positioner SRP981

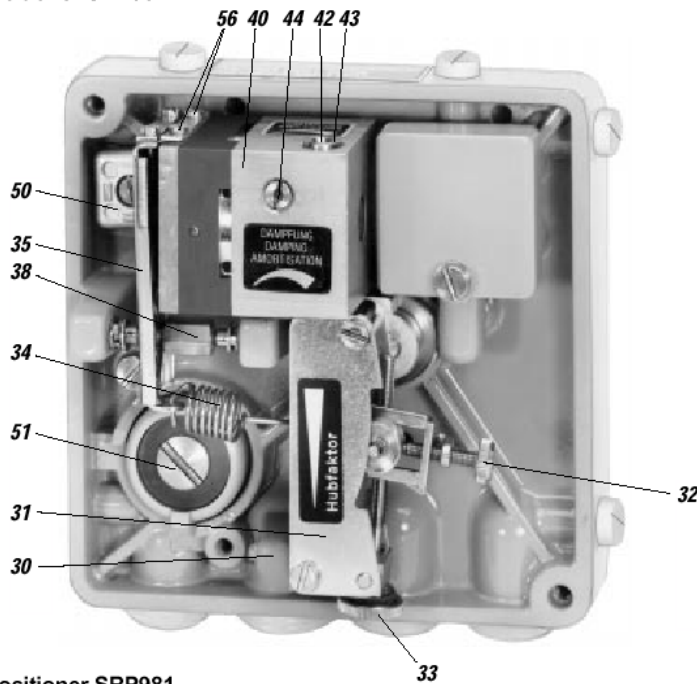

Double acting positioner SRP981

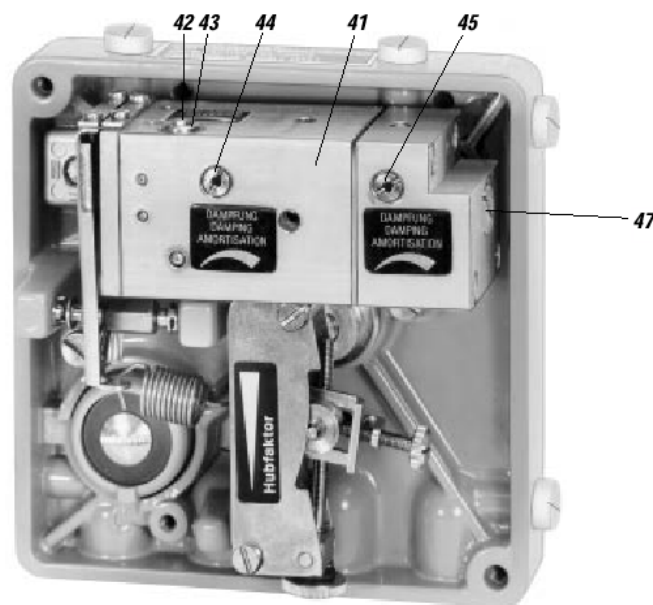

Invensys Systems, Inc.  
38 Neponset Street  
Foxboro, MA 02035  
United States of America

[schneider-electric.com](http://schneider-electric.com)

Global Customer Support  
Toll free: 1-866-746-6477  
Global: 1-508-549-2424  
Website:  
<http://support.ips.invensys.com>

Copyright 2010-2016 Invensys Systems, Inc.  
All rights reserved.  
Invensys, Foxboro, and I/A Series are trademarks of Invensys Limited, its subsidiaries, and affiliates. All other trademarks are the property of their respective owners.

DOKT 556 806 014  
FD-QG-PO-007-EN