

Partial View A (far side)

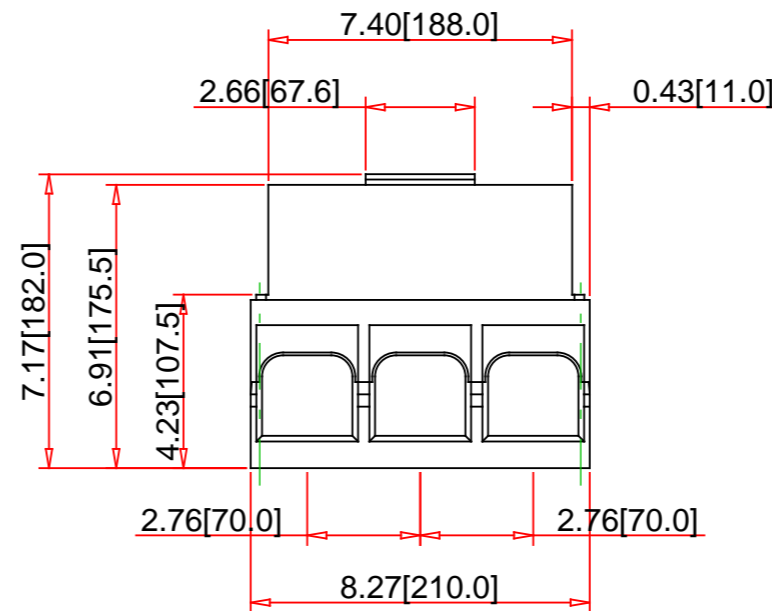
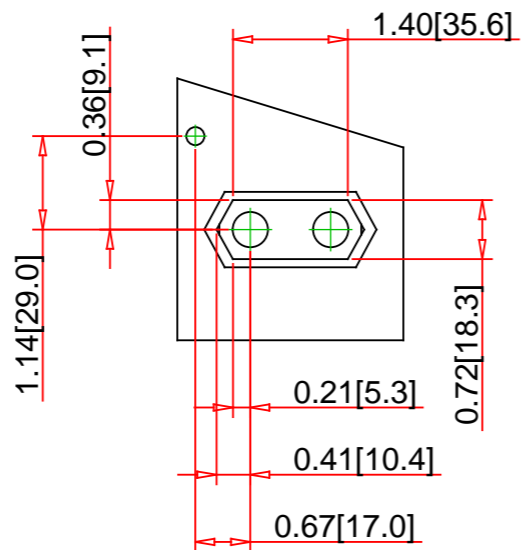

Note:

- Drawings Not To Scale
- Drawings Subject to Change Without Notice
- Dimensions are inches next to [Millimeters]

Part No.:

PGF36080U31AMO



by **Schneider Electric**

Schneider Electric United States
 North American Division
 Boston One Campus
 800 Federal Street
 Andover, MA 01810, USA
 Phone: +1 8773425173
 Email: CCC@us.schneider-electric.com

Technical Information:

General Application: Provides overload and short circuit protection
For Use With: Industrial Enclosures and Switchboards
Approvals: UL Listed - CSA Certified - IEC Rated
Mounting Type: Unit Mount
Terminal Type: Bus Connection - Line: terminal - Load: terminal
Wire Size: (3) #3/0-500 AWG/kcmil(Al/Cu)
Weight:
Depth: 7.17 Inches
Height: 12.86 Inches
Width: 8.27 Inches

Specification:

Description: PowerPact P-frame Molded Case Circuit Breaker
Number of Poles: 3-Pole
Ampere Rating: 800A
Voltage Rating: 600VAC
Interrupting Rating: 65kA at 240VAC - 35kA at 480VAC - 18kA at 600VAC
Circuit Breaker Rating: 80% Rated