

APC[™]

Rack Solutions for any environment

Enclosures, rack systems and accessories



Applications
& Selections



Rack
Enclosures



Accessories



Compatibility

Life Is On

Schneider
Electric

How to use this guide

Schneider Electric delivers globally available and scalable APC rack solutions for almost any application, from large-scale data centers to edge spaces and even harsh industrial environments.

With a large selection of cable management and other accessories, APC racks provide a reliable foundation for your organization's entire IT infrastructure.

Need to find a part number?

Use the quick-scan tables in the Product Index or Compatibility Index tab.

Product Index

Premium Server Racks
NetShelter SX Enclosures (Configured - Doors and Side Panels)

Part	Height	Depth	Width	Weight	Color	Material	Accessories	Value Points
AKS10000	20	1000	600	975	014	000	000	000
AKS10001	20	1000	600	975	014	000	000	000
AKS10002	20	1000	600	975	014	000	000	000
AKS10003	20	1000	600	975	014	000	000	000
AKS10004	20	1000	600	975	014	000	000	000
AKS10005	20	1000	600	975	014	000	000	000
AKS10006	20	1000	600	975	014	000	000	000
AKS10007	20	1000	600	975	014	000	000	000
AKS10008	20	1000	600	975	014	000	000	000
AKS10009	20	1000	600	975	014	000	000	000
AKS10010	20	1000	600	975	014	000	000	000
AKS10011	20	1000	600	975	014	000	000	000
AKS10012	20	1000	600	975	014	000	000	000
AKS10013	20	1000	600	975	014	000	000	000
AKS10014	20	1000	600	975	014	000	000	000
AKS10015	20	1000	600	975	014	000	000	000
AKS10016	20	1000	600	975	014	000	000	000
AKS10017	20	1000	600	975	014	000	000	000
AKS10018	20	1000	600	975	014	000	000	000
AKS10019	20	1000	600	975	014	000	000	000
AKS10020	20	1000	600	975	014	000	000	000

NetShelter SX Networking Racks (Standard)

Part	Height	Depth	Width	Weight	Color	Material	Accessories	Value Points
AKN1000	20	1000	600	975	014	000	000	000
AKN1001	20	1000	600	975	014	000	000	000
AKN1002	20	1000	600	975	014	000	000	000
AKN1003	20	1000	600	975	014	000	000	000
AKN1004	20	1000	600	975	014	000	000	000
AKN1005	20	1000	600	975	014	000	000	000
AKN1006	20	1000	600	975	014	000	000	000
AKN1007	20	1000	600	975	014	000	000	000
AKN1008	20	1000	600	975	014	000	000	000
AKN1009	20	1000	600	975	014	000	000	000
AKN1010	20	1000	600	975	014	000	000	000

Compatibility Index

Accessories
NetShelter SX Enclosures (10)

Category	Product	Description	AKS1000	AKS1001	AKS1002	AKS1003	AKS1004	AKS1005	AKS1006	AKS1007	AKS1008	AKS1009	AKS1010
Power	Open Drive P	AKS1000											
Power	Open Drive P	AKS1001											
Power	Open Drive P	AKS1002											
Power	Open Drive P	AKS1003											
Power	Open Drive P	AKS1004											
Power	Open Drive P	AKS1005											
Power	Open Drive P	AKS1006											
Power	Open Drive P	AKS1007											
Power	Open Drive P	AKS1008											
Power	Open Drive P	AKS1009											
Power	Open Drive P	AKS1010											

Need help choosing?

- 1 View the Rack Series Comparison chart.

[Rack Series Comparison](#)

- 2 Click the tabs for detailed product specifications and value points.

- 3 Build your solution with a Schneider Electric representative.

Contact us or your preferred partner company.



Rack Series Comparison

Rack Series

Premium

SX

Essential

SV

Soundproof

SP

Wall-mount

WX

2-Post & 4-Post

OF

Seismic, Colo & AV

CM

Custom & Configured

CC

Rugged

RX

Shock Packaging & Pallet

SH

Accessories & Upgrades

Airflow & Cabling

AC

Security & Access

SA

Rack PDUs

PD

Index

Product Index

PX









Compatibility Index

CX



Rack series comparison

Product feature by rack series

	 SX	 SV	 Easy	 Seismic	 Soundproof	 Wall-mount	 Open Frame	 GO Rack	 Rugged
Application	Data Center				Commercial	Network Closet			Harsh
Specifications									
RU sizes	12 – 52U	42 & 48U	24 – 48U	42U	12 – 38U	6 – 13U	44 & 45U	18 – 42U	16 – 42U
Colors	Blk/Wht	Black	Black	Black	Oak/Wood	Black	Black	Black	Grey/Wht
Depth									
Large >1200 mm	•	•	•						•
Standard 1000-1200 mm	•	•	•	•	•			•	•
Short <1000 mm			•			•	•	•	•
Width									
Standard 600 mm	•	•	•	•		•	•	•	•
Wide 750 mm	•				•				
X Wide 800 mm	•	•	•					•	•
Static Load									
H > 1350 kg									
M 900-1350 kg	H	M	M	L	H	L	L	L	L/M
L < 900 kg									
Rolling Load (on Casters)									
H > 900 kg									
M 450-900 kg	H	M	M	L	M	L	L	L	L/M
L < 450 kg									
Max Equipment Mounting Depth									
H > 900 mm	H	M	M/H	M	M	L/M	L	L/M	L/M
M 700-900 mm									
L < 700 mm									
Features									
Toolless features	•								
EIA 19" rails	•	•	•	•	•	•	•	•	•
Casters included	•	•	•	•	•			•	•
Zero U accessory channel	•	•	•		•		•	•	Limited
Cable management accessories	•	•	•				•	•	
Top cable entry	•	•	•	•		•	•	•	
Bottom cable entry	•	•	•	•	•	•	•	•	•
PDU included					•				Optional
Special Features									
NEMA/IP rated									•
Seismic rating				•					
Noise reduction					•				
Built-in fan ventilation					•	6U Low Profile		Optional	Optional
Containment compatibility	•		•						
Ratings and Certifications									
UL	•	•		•	•	•			•
IBC/NEBS				•					
NEMA/IP									•
Ordering and Delivery									
Regional availability	Global	US Only	Global (Not US & CA)	Global	Global	Global	Global	MEA Only	Global
Shock packaging option	•								
Flatpack option								•	
Warranty	5 years	5 years	5 years	5 years	2 years	5 years	5 years	5 years	1 year

Rack Series Comparison

Rack Series

Premium 

Essential 

Soundproof 

Wall-mount 

2-Post & 4-Post 

Seismic, Colo & AV 

Custom & Configured 

Rugged 

Shock Packaging & Pallet 

Accessories & Upgrades

Airflow & Cabling 

Security & Access 

Rack PDUs 

Index

Product Index 

Compatibility Index 



NetShelter™ SX Enclosures

The IT rack you can feel certain about

Bring your business the power of global scale, sustainable leadership and unparalleled quality with APC NetShelter SX Enclosures.



More computing in less space

- Quality built IT racks made for AI applications and everyday excellence
- Outstanding load capacity, airflow and security



Sustainable longevity

- Built to last, adapt and reuse
- Remarkable 3.3% reduction in embedded carbon for latest models
- Take-back eligible and 97% recyclability potential



Peace of mind

- Built with all-steel construction
- Secured with 3-point locking system
- Backed by 5-year warranty



Simplified daily workflows

- Makes daily operations more efficient, predictable and enjoyable
- Packed with features that make installation faster, easier and precise
- Ample space for equipment, organization and maintenance



Complete the solution

NetBotz™ provides enhanced environmental and physical security.

NetShelter Intelligent Rack PDUs securely measure and manage power.

Smart-UPS™ Modular Ultra delivers high-density on-line power protection with scalable runtime supported by lithium-ion batteries.

EcoStruxure™ IT provides cloud-based monitoring and control.



Find compatible accessories →

Rack Series Comparison

Rack Series

Premium

SX

Essential

SV

Soundproof

SP

Wall-mount

WX

2-Post & 4-Post

OF

Seismic, Colo & AV

CM

Custom & Configured

CC

Rugged

RX

Shock Packaging & Pallet

SH

Accessories & Upgrades

Airflow & Cabling

AC

Security & Access

SA

Rack PDUs

PD

Index

Product Index

PX

Compatibility Index

CX



NetShelter SX Enclosures selection



	NetShelter SX (latest generation)	NetShelter SX (original)
Static Load	4000 lb. / 1814 kg* NEW	3750 lb. / 1700 kg*
Rolling Load	2250 lb. / 1020 kg*	2250 lb. / 1020 kg*
Equipment Mounting Rails	19" EIA, adjust in .25 in. (6 mm) increments	19" EIA, adjust in .25 in. (6 mm) increments
Door Perforation	80% NEW	69%
Front Door Swing	270° (180° bayed), reversible, curved front NEW	130°, reversible, curved front
Rear Door Swing	270°, flat front NEW	130°, flat front
Side Panels	Split, lockable	Split, lockable
Baying Kit	Included	Included
Roof	8 large cable entry points	8 large cable entry points
Bottom Plate	Optional	Optional
Locking	3-point locking at front NEW	Single-point locking at front
Casters and Leveling Feet	Included	Included
Rear Accessory	Full-height 0U accessory channels*	Full-height 0U accessory channels*
Door Handles**	Key locking**	Key locking**
Toolless Features	Front door, roof, mounting rails, accessory channel, roof cable trough (optional)	Front door, roof, mounting rails, accessory channel, roof cable trough (optional)
Warranty	5 years	5 years

*See SKUs for exact model specification. **Options for combination lock, keycard access and unique key cylinders available.

	Model (Black)	Model (White)	Rack Units	Height (mm)	Width (mm)	Depth (mm)	Max Equipment Depth (mm)	Static (lb.)	Dynamic (lb.)	Doors & Sides	0U Accessory Channels		
NetShelter SX (latest generation)	AR3100B2	-	42	1991	600	1070	915	4000	2250	✓	2	Europe	North America
	AR3150B2	-	42	1991	750	1070	915	4000	2250	✓	2		
	AR3300B2	AR3300W2	42	1991	600	1200	1048	4000	2250	✓	4		
	AR3350B2	AR3350W2	42	1991	750	1200	1048	4000	2250	✓	4		
	AR3105B2	-	45	2124	600	1070	915	4000	2250	✓	2		
	AR3155B2	-	45	2124	750	1070	915	4000	2250	✓	2		
	AR3305B2	-	45	2124	600	1200	1048	4000	2250	✓	4		
	AR3355B2	-	45	2124	750	1200	1048	4000	2250	✓	4		
	AR3107B2	-	48	2258	600	1070	915	4000	2250	✓	2		
	AR3157B2	-	48	2258	750	1070	915	4000	2250	✓	2		
	AR3307B2	AR3307W2	48	2258	600	1200	1048	4000	2250	✓	4		
	AR3357B2	AR3357W2	48	2258	750	1200	1048	4000	2250	✓	4		
	AR3180B2	-	42	1991	800	1070	915	4000	2250	✓	2		
	AR3380B2	AR3380W2	42	1991	800	1200	1048	4000	2250	✓	4		
	AR3187B2	-	48	2258	800	1070	915	4000	2250	✓	2		
AR3387B2	AR3387W2	48	2258	800	1200	1048	4000	2250	✓	4			
NetShelter SX (original)	AR3003	-	12	658	600	889	756	600	600	✓	2	Global	
	AR3103	-	12	658	600	1070	921	600	600	✓	2		
	AR3006	-	18	925	600	889	756	900	900	✓	2		
	AR3106	-	18	925	600	1070	921	900	900	✓	2		
	AR3104	-	24	1198	600	1070	915	3000	2250	✓	2		
	-	AR3100W	42	1991	600	1070	915	3750	2250	✓	2		
	AR3100TAA	-	42	1991	600	1070	915	3750	2250	✓	2		
	-	AR3150W	42	1991	750	1070	915	3750	2250	✓	2		
	-	AR3105W	45	2124	600	1070	915	3750	2250	✓	2		
	AR3105TAA	-	45	2124	600	1070	915	3750	2250	✓	2		
	-	AR3155W	45	2124	750	1070	915	3750	2250	✓	2		
	-	AR3305W	45	2124	600	1200	1048	3750	2250	✓	4		
	-	AR3355W	45	2124	750	1200	1048	3750	2250	✓	4		
	-	AR3107W	48	2258	600	1070	915	3750	2250	✓	2		
	AR3107TAA	-	48	2258	600	1070	915	3750	2250	✓	2		
	-	AR3157W	48	2258	750	1070	915	3750	2250	✓	2		
	AR3307X674	AR3308W	52	2436	600	1200	1048	3750	2250	✓	4		
	AR3158	-	52	2436	750	1070	915	3750	2250	✓	2		
AR3357X674	AR3358W	52	2436	750	1200	1048	3750	2250	✓	4			

Find compatible accessories →

- Rack Series Comparison
- Rack Series
- Premium **SX**
- Essential **SV**
- Soundproof **SP**
- Wall-mount **WX**
- 2-Post & 4-Post **OF**
- Seismic, Colo & AV **CM**
- Custom & Configured **CC**
- Rugged **RX**
- Shock Packaging & Pallet **SH**
- Accessories & Upgrades
- Airflow & Cabling **AC**
- Security & Access **SA**
- Rack PDUs **PD**
- Index
- Product Index **PX**
- Compatibility Index **CX**



NetShelter SX Enclosures selection

NetShelter SX Enclosures (Configured – Doors and Side Panels)

SKU	Rack Units	Height (mm)	Width (mm)	Depth (mm)	Max Equipment Depth (mm)	Static Load (kg / lb.)	Dynamic Load (kg / lb.)	Doors	Sides
AR3104X609	24	1198	600	1070	915	1361 / 3000	1021 / 2250	✓	✗
AR3100X609	42	1991	600	1070	915	1701 / 3750	1021 / 2250	✓	✗
AR3100X610	42	1991	600	1070	915	1701 / 3750	1021 / 2250	✗	✓
AR3100X617	42	1991	600	1070	915	1701 / 3750	1021 / 2250	✗	✗
AR3130X610	42	1991	700	1070	915	1701 / 3750	1021 / 2250	✗	✓
AR3150X609	42	1991	750	1070	915	1701 / 3750	1021 / 2250	✓	✗
AR3150X610	42	1991	750	1070	915	1701 / 3750	1021 / 2250	✗	✓
AR3150X617	42	1991	750	1070	915	1701 / 3750	1021 / 2250	✗	✗
AR3300X609	42	1991	600	1200	1048	1701 / 3750	1021 / 2250	✓	✗
AR3300X610	42	1991	600	1200	1048	1701 / 3750	1021 / 2250	✗	✓
AR3300X617	42	1991	600	1200	1048	1701 / 3750	1021 / 2250	✗	✗
AR3350X609	42	1991	750	1200	1048	1701 / 3750	1021 / 2250	✓	✗
AR3350X610	42	1991	750	1200	1048	1701 / 3750	1021 / 2250	✗	✓
AR3350X617	42	1991	750	1200	1048	1701 / 3750	1021 / 2250	✗	✗
AR3107X609	42	2258	600	1070	915	1701 / 3750	1021 / 2250	✓	✗
AR3107X610	42	2258	600	1070	915	1701 / 3750	1021 / 2250	✗	✓
AR3107X617	42	2258	600	1070	915	1701 / 3750	1021 / 2250	✗	✗
AR3157X609	42	2258	750	1070	915	1701 / 3750	1021 / 2250	✓	✗
AR3157X610	42	2258	750	1070	915	1701 / 3750	1021 / 2250	✗	✓
AR3157X617	42	2258	750	1070	915	1701 / 3750	1021 / 2250	✗	✗
AR3307X609	42	2258	600	1200	1048	1701 / 3750	1021 / 2250	✓	✗
AR3307X610	42	2258	600	1200	1048	1701 / 3750	1021 / 2250	✗	✓
AR3307X617	42	2258	600	1200	1048	1701 / 3750	1021 / 2250	✗	✗
AR3357X609	42	2258	750	1200	1048	1701 / 3750	1021 / 2250	✓	✗
AR3357X610	42	2258	750	1200	1048	1701 / 3750	1021 / 2250	✗	✓
AR3357X617	42	2258	750	1200	1048	1701 / 3750	1021 / 2250	✗	✗

SX networking enclosures

Certain SX models are specifically designed for enhanced networking applications with enhanced features such as:

- More room for cables
- Cable access roof that's easy to remove with cables in place
- Networking-style mounting rails with position preset to accommodate Cisco switches and cable management
- Preinstalled vertical cable managers that provide the proper bend radius for cables
- Optimized side-to-side airflow due to vertical mounting rails



NetShelter SX Networking Enclosures

SKU (Black)	SKU (White)	Rack Units	Height (mm)	Width (mm)	Depth (mm)	Max Equipment Depth (mm)	Static Load (kg / lb.)	Dynamic Load (kg / lb.)	Doors	Sides
AR3140	AR3140W	42	1991	750	1070	819	1701 / 3750	1021 / 2250	✓	✓
AR3340	AR3340W	42	1991	750	1200	959	1701 / 3750	1021 / 2250	✓	✓
AR3347	AR3347W	48	2258	750	1200	959	1701 / 3750	1021 / 2250	✓	✓
-	AR3348WX832	52	2436	750	1200	1048	1701 / 3750	1021 / 2250	✓	✓

Find compatible accessories →

Rack Series Comparison

Rack Series

Premium

SX

Essential

SV

Soundproof

SP

Wall-mount

WX

2-Post & 4-Post

OF

Seismic, Colo & AV

CM

Custom & Configured

CC

Rugged

RX

Shock Packaging & Pallet

SH

Accessories & Upgrades

Airflow & Cabling

AC

Security & Access

SA

Rack PDUs

PD

Index

Product Index

PX

Compatibility Index

CX



NetShelter SV Enclosures

Universal IT racks for low and medium density servers, the SV line facilitates faster installation and deployment with essential standard features.



- 1 Cable access through roof and rack bottom
- 2 Adjustable vertical mounting rails with vertical 1U patching (31.5 in. [800 mm] only)
- 3 Lockable doors and side panels

Rear accessory mounting brackets for easy integration of rack PDU and cable managers

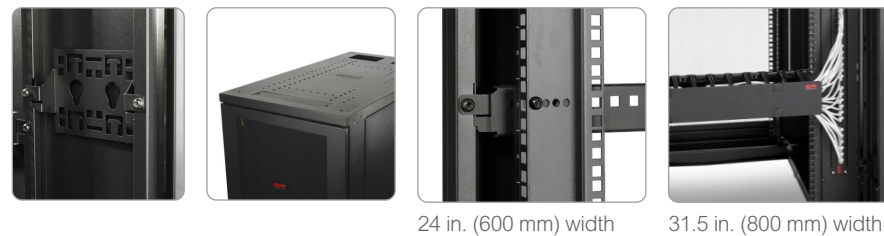

24 in. (600 mm) width 31.5 in. (800 mm) width

NetShelter SX vs. NetShelter SV Enclosures

	NetShelter SX	NetShelter SV
Rack units	12 – 52U	42 – 48U
Load rating	4000 lb.	2205 lb.
Side panels	Split half-height	Single full height
Roof	Toolless removal, brushes	Not removable, multiple cable entry points, brushes on 800 mm models only
Toolless features	✓	✗
Cable management	Full height accessory channels	4 accessory brackets
Rail adjustability	Fully adjustable	Fixed adjustment points
Eyebolt support	✓	✗
Casters	Low profile	4 Normal profile
Design tools available	LEC, Row-designer, InfraStruXure designer	LEC

[Find compatible accessories →](#)

NetShelter SV Enclosures

SKU (assembled)	SKU (unassembled)	Rack Units	Height (mm)	Width (mm)	Depth (mm)	Max Equipment Depth (mm)	Static Load (kg / lb.)	Dynamic Load (kg / lb.)	Doors	Sides
AR2400	AR2400FP1	42	2057	600	1070	777	1000 / 2205	460 / 1014	✓	✓
AR2401	–	42	2057	600	1070	777	1000 / 2205	460 / 1014	✓	✗
AR2480	–	42	2057	800	1070	777	1000 / 2205	460 / 1014	✓	✓
AR2500	–	42	2057	600	1200	917	1000 / 2205	460 / 1014	✓	✓
AR2580	–	42	2057	800	1200	917	1000 / 2205	460 / 1014	✓	✓
AR2407	–	48	2324	600	1070	777	1000 / 2205	460 / 1014	✓	✓
AR2487	–	48	2324	800	1070	777	1000 / 2205	460 / 1014	✓	✓
AR2507	–	48	2324	600	1200	917	1000 / 2205	460 / 1014	✓	✓
AR2587	–	48	2324	800	1200	917	1000 / 2205	460 / 1014	✓	✓

Rack Series Comparison

Rack Series

Premium

SX

Essential

SV

Soundproof

SP

Wall-mount

WX

2-Post & 4-Post

OF

Seismic, Colo & AV

CM

Custom & Configured

CC

Rugged

RX

Shock Packaging & Pallet

SH

Accessories & Upgrades

Airflow & Cabling

AC

Security & Access

SA

Rack PDUs

PD

Index

Product Index

PX

Compatibility Index

CX



APC Easy Racks

Easy Racks are an easy-to-use series of racks and accessories that reduce complexity in your IT infrastructure, so that you can be proactive and stay focused on what matters most. Deploy Easy Racks in data centers, IT closets and edge environments for reliable and scalable solutions on a trusted platform.

Half-height side panels

- Easy to use and handle
- Lockable top side panels
- Toolless installation



Multi-functional roof

- Roof openings with brush strips for managing cabling and proper airflow management
- Compatible with APC overhead cable management system of troughs and partitions

Rear accessory brackets

- 4 accessory brackets pre-installed to support toolless installation of full-cabinet-height vertical rack PDUs
- Add additional brackets to support toolless installation of half-height PDUs and cable managers or replace completely with accessory channels

Ventilated front/rear doors

- Single open-vented front door and split rear doors
- Up to 81% perforation
- Hexagonal pattern

Integrated electrical grounding

- Grounding connections on doors
- Roof, side panels and doors are grounded to the frame of the enclosure
- Additional external grounding locations in the front and rear



800 mm Racks Feature:

- Up to 16 x 1U vertical knockout panels located within the front and rear equipment mounting rails (12 in. 42U)
- Vertically mount patch panels or 1U devices and save horizontal mounting space for other IT devices
- Adds another 16U to an enclosure solution!

Take the 3D tour:

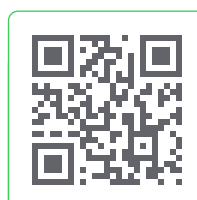

APC Easy Rack
42U Model

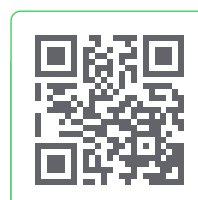

APC Easy Rack
24U Model

Rack Series Comparison

Rack Series

Premium

SX

Essential

SV

Soundproof

SP

Wall-mount

WX

2-Post & 4-Post

OF

Seismic, Colo & AV

CM

Custom & Configured

CC

Rugged

RX

Shock Packaging & Pallet

SH

Accessories & Upgrades

Airflow & Cabling

AC

Security & Access

SA

Rack PDUs

PD

Index

Product Index

PX

Compatibility Index

CX

Find compatible accessories →



APC Easy Rack selection

Rack Components

1. Roof
2. Rear doors
3. Removable top side panel (locking)
4. Removeable bottom side panel
5. Zero U accessory mounting brackets
6. Cabinet frame
7. Casters
8. Levelling feet
9. Removable and reversible front door
10. Hardware bag

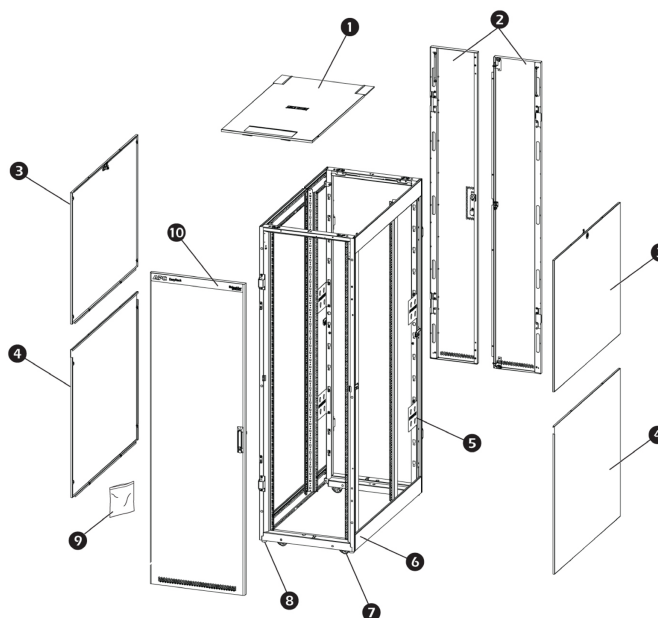

Find compatible accessories →

APC Easy Racks

SKU	Rack Units	Height (mm)	Width (mm)	Depth (mm)	Max Equipment Depth (mm)	Static Load (kg / lb.)	Dynamic Load (kg / lb.)	Doors	Sides
ER6482	24	1198	600	800	641	1197 / 2640	599 / 1320	✓	✓
ER6402	24	1198	600	1000	838	1197 / 2640	599 / 1320	✓	✓
ER6422	24	1198	600	1200	1041	1197 / 2640	599 / 1320	✓	✓
ER6282	42	1991	600	800	641	1197 / 2640	599 / 1320	✓	✓
ER8282	42	1991	800	800	641	1197 / 2640	599 / 1320	✓	✓
ER6202	42	1991	600	1000	838	1197 / 2640	599 / 1320	✓	✓
ER6202FP1*	42	1991	600	1000	838	1197 / 2640	599 / 1320	✓	✓
ER6200	42	1991	600	1000	838	1197 / 2640	599 / 1320	✓	✗
ER8202	42	1991	800	1000	838	1197 / 2640	599 / 1320	✓	✓
ER8200	42	1991	800	1000	838	1197 / 2640	599 / 1320	✓	✗
ER6212	42	1991	600	1100	940	1197 / 2640	599 / 1320	✓	✓
ER8212	42	1991	800	1100	940	1197 / 2640	599 / 1320	✓	✓
ER6222	42	1991	600	1200	1041	1197 / 2640	599 / 1320	✓	✓
ER6220	42	1991	600	1200	1041	1197 / 2640	599 / 1320	✓	✗
ER8222	42	1991	800	1200	1041	1197 / 2640	599 / 1320	✓	✓
ER8220	42	1991	800	1200	1041	1197 / 2640	599 / 1320	✓	✗
ER6802	48	2258	600	1000	838	1197 / 2640	599 / 1320	✓	✓
ER6800	48	2258	600	1000	838	1197 / 2640	599 / 1320	✓	✗
ER8802	48	2258	800	1000	838	1197 / 2640	599 / 1320	✓	✓
ER8800	48	2258	800	1000	838	1197 / 2640	599 / 1320	✓	✗
ER6812	48	2258	600	1100	940	1197 / 2640	599 / 1320	✓	✓
ER8812	48	2258	800	1100	940	1197 / 2640	599 / 1320	✓	✓
ER6822	48	2258	600	1200	1041	1197 / 2640	599 / 1320	✓	✓
ER6820	48	2258	600	1200	1041	1197 / 2640	599 / 1320	✓	✗
ER8822	48	2258	800	1200	1041	1197 / 2640	599 / 1320	✓	✓
ER8820	48	2258	800	1200	1041	1197 / 2640	599 / 1320	✓	✗

*Unassembled and flatpacked rack option and must be assembled onsite.

Rack Series Comparison

Rack Series

Premium

SX

Essential

SV

Soundproof

SP

Wall-mount

WX

2-Post & 4-Post

OF

Seismic, Colo & AV

CM

Custom & Configured

CC

Rugged

RX

Shock Packaging & Pallet

SH

Accessories & Upgrades

Airflow & Cabling

AC

Security & Access

SA

Rack PDUs

PD

Index

Product Index

PX

Compatibility Index

CX



GO Rack

GO Racks are built with essential features and versatile ranges to meet the diverse demands of networking, AV and LAN/WAN applications.

Benefits:

- A variety of sizes to meet various needs
- Two pairs of easily adjustable mounting rails
- Conformity to IP20 rating
- Compatibility with a range of Schneider Electric and APC PDUs and accessories
- Static load capacity of 600 kg and dynamic load capacity of 360 kg (including the weight of the rack)

[Find compatible accessories →](#)



GO Rack with perforated door

This option helps enhance air circulation to prevent equipment from overheating.

SKU	Rack Units	Width (mm)	Depth (mm)
NR8282-P	42	800	800
NR6282-P	42	600	800
NR8202-P	42	800	1000
NR6202-P	42	600	1000
NR8682-P	36	800	800
NR6682-P	36	600	800
NR8602-P	36	800	1000
NR6602-P	36	600	1000
NR8482-P	24	800	800
NR6482-P	24	600	800
NR8402-P	24	800	1000
NR6402-P	24	600	1000
NR8882-P	18	800	800
NR6882-P	18	600	800
NR8802-P	18	800	1000
NR6802-P	18	600	1000



GO Rack with glass door

This option provides a clear view of the equipment inside, allowing for easy access and maintenance (best for businesses with passive networking solutions that don't require frequent adjustment).

SKU	Rack Units	Width (mm)	Depth (mm)
NR8282-G	42	800	800
NR6282-G	42	600	800
NR8202-G	42	800	1000
NR6202-G	42	600	1000
NR8682-G	36	800	800
NR6682-G	36	600	800
NR8602-G	36	800	1000
NR6602-G	36	600	1000
NR8482-G	24	800	800
NR6482-G	24	600	800
NR8402-G	24	800	1000
NR6402-G	24	600	1000
NR8882-G	18	800	800
NR6882-G	18	600	800
NR8802-G	18	800	1000
NR6802-G	18	600	1000



Rack Series Comparison

Rack Series

Premium

SX

Essential

SV

Soundproof

SP

Wall-mount

WX

2-Post & 4-Post

OF

Seismic, Colo & AV

CM

Custom & Configured

CC

Rugged

RX

Shock Packaging & Pallet

SH

Accessories & Upgrades

Airflow & Cabling

AC

Security & Access

SA

Rack PDUs

PD

Index

Product Index

PX

Compatibility Index

CX



NetShelter Soundproof Racks

Discretely deploy IT gear, even in customer-facing areas

When there's no space, budget or time to build a traditional server closet, NetShelter Soundproof Racks offer a cost-effective alternative. Conveniently deploy servers and networking equipment in this quiet, all-in-one, elegant IT rack.

Soundproof Racks are ideal for bank branches, retail spaces, offices, healthcare facilities and classrooms.



Office and storefront friendly

- Elegant exterior blends in seamlessly
- Soundproofing reduces business disruption



Resilient and efficient

- Handles heavy edge servers with 2x heavier dynamic loads than previous model
- Locking front, rear and side prevent unwanted access
- Thermostat-controlled fans enable efficient and more effective cooling
- UL certified for safety



Simple to deploy

- All-in-one design: equipped with fans, integrated cable managers, basic PDU and access control...just add IT



- We used to have servers housed separately in a room with separate air conditioning. This occupies costly retail space [and] energy consumption due to air conditioning. That is the reason [we engaged with Schneider Electric](#) and our service partner.
- [The] integrated rack [EcoStruxure Micro Data Center with soundproof base enclosure] is [aesthetically beautiful](#).
- I expect at least [10-15% energy savings](#) in the next two years.

— Palani Kumar, VP of Integrated Retail Service Group, Titan Company Ltd.



Rack Series Comparison

Rack Series

Premium

SX

Essential

SV

Soundproof

SP

Wall-mount

WX

2-Post & 4-Post

OF

Seismic, Colo & AV

CM

Custom & Configured

CC

Rugged

RX

Shock Packaging & Pallet

SH

Accessories & Upgrades

Airflow & Cabling

AC

Security & Access

SA

Rack PDUs

PD

Index

Product Index

PX

Compatibility Index

CX



NetShelter Soundproof Racks

Complete the solution

With the help of your preferred partner or Schneider Electric representative, you can design your own EcoStruxure Micro Data Center using a NetShelter Soundproof Rack. Partners can register and explore options in the Design Portal on se.com/MySchneider.

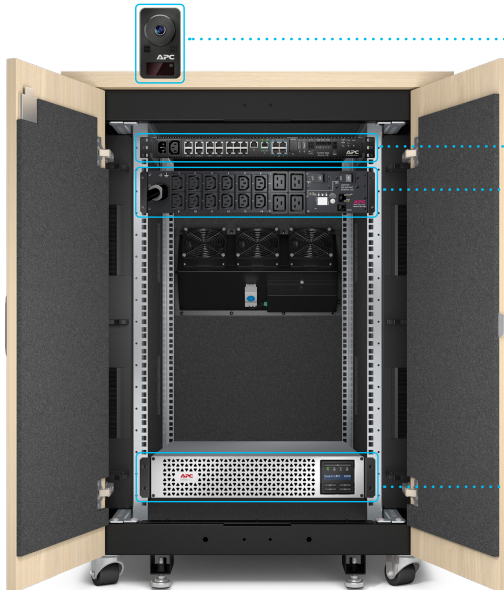

NetBotz™ components (such as cameras and sensors) provide enhanced environmental and physical security.

NetShelter Intelligent Rack PDUs securely measure and manage power.

EcoStruxure IT provides cloud-based monitoring and control.

Smart-UPS™ delivers high-density power protection with lithium-ion batteries.

[Find compatible accessories →](#)

NetShelter Soundproof Racks

SKU (110 – 120 V)	SKU (220 – 240 V)	Rack Units	Height (mm)	Width (mm)	Depth (mm)	Max Equipment Depth (mm)	Static Load (kg / lb.)	Dynamic Load (kg / lb.)	Cooling Capacity (kW)	Sound Reduction (dBA @ 1m)
AR4012A*		12	783	750	1130	834	838 / 1848	748 / 1650	1.2	18.85
AR4017A	AR4017IA	17	1000	750	1130	834	838 / 1848	748 / 1650	1.2	18.85
AR4032A	AR4032IA	32	1666	750	1130	834	1497 / 3300	748 / 1650	2.4	18.85
AR4038LA	AR4038LIA	38	1863	750	1130	834	1497 / 3300	748 / 1650	3.6	18.85

All models are configured with locking front, rear and side panel, built-in PDU, cable manager with brush strips, casters and leveling feet and are UL certified with a 2 year warranty.

*Dual-rated 110-240 V

Rack Series Comparison

Rack Series

Premium

SX

Essential

SV

Soundproof

SP

Wall-mount

WX

2-Post & 4-Post

OF

Seismic, Colo & AV

CM

Custom & Configured

CC

Rugged

RX

Shock Packaging & Pallet

SH

Accessories & Upgrades

Airflow & Cabling

AC

Security & Access

SA

Rack PDUs

PD

Index

Product Index

PX

Compatibility Index

CX



NetShelter Wall-mount Enclosures

NetShelter wall-mount server and network rack solutions provide the functionality, reliability and ease-of-deployment required in edge computing applications.

Benefits:

- Variety of height, weight and configuration options for any edge computing environment
- Compatible with a wide range of APC power, security and monitoring devices and services
- Static weight capacity of up to 350 lb.
- Ideal for rollouts in retail, healthcare, education or finance settings
- Ships fully assembled for quick deployment

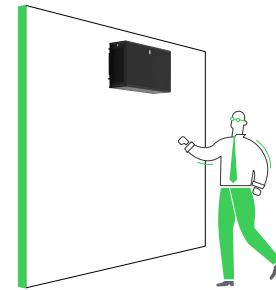

Switch depth

Compact wall-mount enclosures designed for networking gear or other small devices with a minimal footprint. Choose from unassembled options in select sizes or assembled options compatible with NetBotz Rack Access for enhanced security and access control.

Max mounting depth: 329 mm



UPS depth

Seamlessly compatible with most APC single-phase UPS solutions, these enclosures are purpose-built for UPS solutions. Deploy a robust edge computing solution with confidence using this heavy-duty, side-mounted enclosure to conserve valuable space.

Max mounting depth: 835 mm



Server depth

Wall-mount enclosures tailored for servers and smaller single-phase UPS technologies. Options are available for units with a dual-hinge design, allowing the front door to open from either the left or right for increased access and flexibility.

Max mounting depth: 394 or 529 mm, model dependent



Vertical/low-profile

This 6U rack offers a unique low-profile solution for securely housing rack-mount equipment in confined spaces. Its design allows for mounting large-depth devices to a wall in a less obtrusive form factor compared to traditional wall-mount cabinets, making it ideal for space-constrained environments.

Max mounting depth: 762 mm

[Find compatible accessories →](#)

Take the 3D tour:

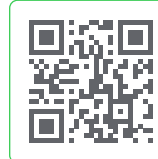

NetShelter Wall-mount Enclosures

SKU (assembled)	SKU (unassembled)	Rack Units	Height (mm)	Width (mm)	Depth (mm)	Max Equipment Depth (mm)	Static Load (kg / lb.)	Ventilation	Door Type*	Rating
SWITCH DEPTH										
AR106SH4	AR106	6	355	600	400	329 / 341	91 / 200	Passive	Perforated	IP20
AR109SH4	AR109	9	485	600	400	329 / 341	91 / 200	Passive	Perforated	IP20
AR112SH4		12	620	600	400	329 / 341	91 / 200	Passive	Perforated	IP20
SERVER DEPTH										
AR106SH6		6	355	600	600	529	91 / 200	Passive	Perforated	IP20
AR109SH6		9	485	600	600	529	91 / 200	Passive	Perforated	IP20
AR112SH6	AR112	12	620	600	600	529 / 541	91 / 200	Passive	Perforated	IP20
AR100		13	663	600	631	394	91 / 200	Passive	Glass	IP20
AR100HD		13	663	600	631	394	91 / 200	Passive	Perforated	IP20
UPS DEPTH										
AR112SM		12	662	600	1019	835	158 / 350	Passive	Perforated	IP2X
AR118SM		18	889	600	1019	835	158 / 350	Passive	Perforated	IP2X
AR124SM		24	1156	600	1019	835	158 / 350	Passive	Perforated	IP2X
VERTICAL/LOW PROFILE										
AR106V		6	648	965	631	762	113 / 250	Fan (120V)	Perforated	IP20
AR106VI		6	648	965	631	762	113 / 250	Fan (230V)	Perforated	IP20

Rack Series Comparison

Rack Series

Premium

SX

Essential

SV

Soundproof

SP

Wall-mount

WX

2-Post & 4-Post

OF

Seismic, Colo & AV

CM

Custom & Configured

CC

Rugged

RX

Shock Packaging & Pallet

SH

Accessories & Upgrades

Airflow & Cabling

AC

Security & Access

SA

Rack PDUs

PD

Index

Product Index

PX

Compatibility Index

CX



NetShelter Open Frame Racks

Open Frame Racks offer a quality and cost-effective solution for installing rack-mountable equipment where security at the individual rack level is not required. Add high-density vertical cable managers for maximum cable volume.



Two-post rack

- 6061-T6 structural grade aluminum
- Self-squaring design



Four-post rack

- Steel construction
- Multiple toolless mounting points for hook-and-loop fasteners (AR8621) or toolless cable management rings (AR7540)
- Multi-position rack PDU mounting bracket (AR8652)
- Reversible stabilization plates
- Grounding inserts

Take the 3D tour:

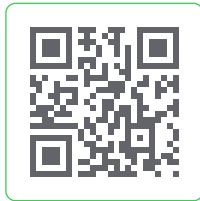

Accessories available

Add vertical cable managers, overhead patch frames and more.

[Find compatible accessories →](#)



(AR8625 and AR8765 shown)



4U overhead patch frame (VDIM33174)

NetShelter Open Frame Racks

SKU	Rack Units	Height (mm)	Width (mm)	Depth (mm)	Max Equipment Depth (mm)	Static Load (kg / lb.)	Hole Type
4 POST RACK							
AR203A	44	2130	600	747	740	907 / 2000	Square
AR204A	44	2130	600	747	740	907 / 2000	#12-24 Threaded
2 POST RACK							
AR201	45	2136	513	376	1048	340 / 750	#12-24 Threaded

Rack Series Comparison

Rack Series

Premium

SX

Essential

SV

Soundproof

SP

Wall-mount

WX

2-Post & 4-Post

OF

Seismic, Colo & AV

CM

Custom & Configured

CC

Rugged

RX

Shock Packaging & Pallet

SH

Accessories & Upgrades

Airflow & Cabling

AC

Security & Access

SA

Rack PDUs

PD

Index

Product Index

PX

Compatibility Index

CX



Seismic, Colo and AV Racks

With IT enclosures designed for specific environments and applications, APC provides flexible platforms to meet unique rack space needs inside and outside the data center.



Seismic Enclosure

The NetShelter VX Seismic enclosure is designed for essential facilities and carrier applications in seismic environments. It meets the NEBS test standard GR-63-CORE Zone 4 at 1,000 lb. (453kg) equipment load.

[Find compatible accessories →](#)



Colo Rack

Designed for colocation facilities with customers requiring a minimal amount of rack space, the NetShelter SX colo rack has two compartments, each with a 3-digit combination style handle. This multi-tenant, security-enhanced enclosure has a compact width to optimize data center space.

[Find compatible accessories →](#)



AV Racks

NetShelter AV enclosures are feature-rich racks specifically designed for the professional audiovisual market and optimized for cable management, power distribution and airflow management.

[Find compatible accessories →](#)

Seismic, Colo and AV Racks

SKU	Rack Units	Height (mm)	Width (mm)	Depth (mm)	Max Equipment Depth (mm)	Static Load (kg / lb.)	Dynamic Load (kg/ lb.)	Features	Doors	Sides
AV AUDIO / VIDEO										
AR3814	24	1199	600	825	702	1361 / 3000	1021 / 2250	#12-24 Holes	✓	✗
AR3810	42	1991	600	825	679	1361 / 3000	1021 / 2250	#12-24 Holes	✗	✗
AR3812	42	1991	600	806	679	1361 / 3000	1021 / 2250	#12-24 Holes	✓	✓
SX MULTI-COMPARTMENT / COLOCATION										
AR3200	42	1991	600	1070	945	1701 / 3750	1021 / 2250	2x20U compartments	✓	✓
VX SEISMIC										
AR2144BLK	42	2070	600	1070	934	454 kg / 1000 lb. seismic load		Seismic Zone 4	✓	✓
AR2145BLK	42	2070	600	1070	934	454 kg / 1000 lb. seismic load		Seismic Zone 4	✓	✗

Rack Series Comparison

Rack Series

Premium

SX

Essential

SV

Soundproof

SP

Wall-mount

WX

2-Post & 4-Post

OF

Seismic, Colo & AV

CM

Custom & Configured

CC

Rugged

RX

Shock Packaging & Pallet

SH

Accessories & Upgrades

Airflow & Cabling

AC

Security & Access

SA

Rack PDUs

PD

Index

Product Index

PX

Compatibility Index

CX



Configure-to-Order and Custom Racks

Configure-to-Order (CTO)

NetShelter Configurable Enclosures are a NetShelter enclosure range offering maximum flexibility. Configure-to-order all rack components, including sides, doors, roof and mounting rails. Have racks configured at our factory to save you effort for easier IT deployments.



Alternate roof designs:

- Server or networking
- Fan tray
- Open roof bridge
- No roof

Alternate side panels:

- Pass-through brushes
- Sides only where needed
- No sides

Cabinet colors:

- Black
- White

Packaging:

- Standard
- For equipment shipment up to 2,000 lb. (907 kg)

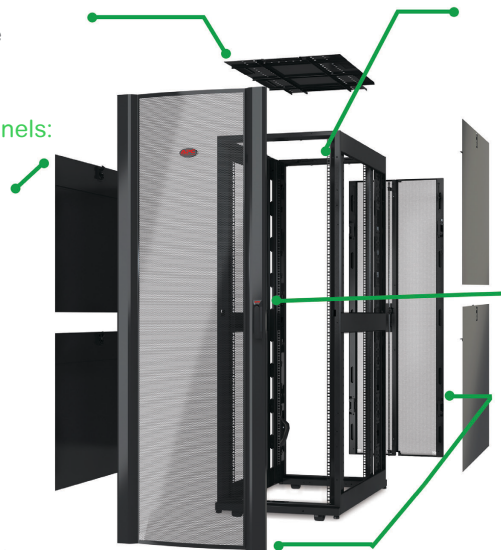

Alternate mounting rail configurations:

- Preset to specific depth
- Alternate mounting holes
- M6, 10-32, 12-24, 23 in. EIA

Alternate door handles:

- Standard handle
- Combination style

Alternate door configurations:

- Single or split doors front/back
- No doors

Common CTO configurations

Find [part numbers](#) for common requests, such as cabinets without sides or without sides and doors.

Engineer-to-Order (ETO)

Can't find what you're looking for with our standard and CTO options? We can work with you to create custom racks to meet your unique needs.

ETO capabilities include (but are not limited to):

- Unique colors
- Seismic
- Designs for colocation
- Unique dimensions
- Custom branding



[Request Easy Custom Racks](#) →

[Request NetShelter Custom Racks](#) →

Rack Series Comparison

Rack Series

Premium

SX

Essential

SV

Soundproof

SP

Wall-mount

WX

2-Post & 4-Post

OF

Seismic, Colo & AV

CM

Custom & Configured

CC

Rugged

RX

Shock Packaging & Pallet

SH

Accessories & Upgrades

Airflow & Cabling

AC

Security & Access

SA

Rack PDUs

PD

Index

Product Index

PX

Compatibility Index

CX



NetShelter Rugged Enclosures

NetShelter RX enclosures are designed for rugged environments such as warehouses, factory floors, plants and other harsh locations. They're ideal for uncontrolled environments where dust, moisture, temperature and exposure vary widely.



Benefits:



NEMA/IP rating for industrial environments



Can be shipped with pre-integrated UPS, PDU and monitoring components



Quickly deploy micro data centers for the industrial edge

[Find compatible accessories →](#)

Take the 3D tour:



NetShelter RX Enclosures

SKU	Rack Units	Height (mm)	Width (mm)	Depth (mm)	Max Equipment Depth (mm)	Static Load (kg / lb.)	Rating	Ventilation	Door Type	Availability
NSYSFRSEDC12680	24	1300	600	800	652	399 / 880	NEMA12/IP54*	Sold separately	Solid	NAM
NSYSFRSEDC206100	42	2100	600	1000	852	399 / 880	NEMA12/IP54*	Sold separately	Solid	NAM
NSYSFRSEDC20680	42	2100	600	800	652	399 / 880	NEMA12/IP54*	Sold separately	Solid	NAM
NSYSFRSEDC208100	42	2100	800	1000	852	399 / 880	NEMA12/IP54*	Sold separately	Solid	NAM
NSYSFRSEDC208120	42	2100	800	1200	1052	399 / 880	NEMA12/IP54*	Sold separately	Solid	NAM
AR5340	42	2000	800	1200	914	1361 / 3000	NEMA12/IP54	✗	Solid	EUR
AR5340F	42	2000	800	1200	914	1361 / 3000	NEMA12/IP54	✓	Solid	EUR

*with ventilation added.

NetShelter RX Wall-mount Enclosure

SKU	Rack Units	Height (mm)	Width (mm)	Depth (mm)	Max Equipment Depth (mm)	Static Load (kg / lb.)	Rating	Ventilation	Door Type	Availability
NSYVDMRS16UEDC	16	800	600	250	248	48 / 105	NEMA12	✗	Glass	NAM

Rack Series Comparison

Rack Series

Premium

SX

Essential

SV

Soundproof

SP

Wall-mount

WX

2-Post & 4-Post

OF

Seismic, Colo & AV

CM

Custom & Configured

CC

Rugged

RX

Shock Packaging & Pallet

SH

Accessories & Upgrades

Airflow & Cabling

AC

Security & Access

SA

Rack PDUs

PD

Index

Product Index

PX

Compatibility Index

CX



NetShelter racks with shock packaging and shock pallet

“Rack and stack” made easy for equipment manufacturers

Secure shipping, fast deployment and enhanced integrated solutions with APC enclosures with shock packaging and shock pallet. These solutions offer:

- Lower physical layer engineering and production costs
- Faster integration time of overall IT solution
- Reduction in physical layer floor space requirements during rack and stack
- Reduction in packaging and recycling of physical layer materials
- Certifications and reference designs with top IT manufacturers



Includes:

- Shock pallet
- Cardboard outer wrap and foam
- Plastic covering to keep dust debris out
- Ramp
- Cabinets include heavy duty casters, fixed and swivel for maneuverability

How does it work?

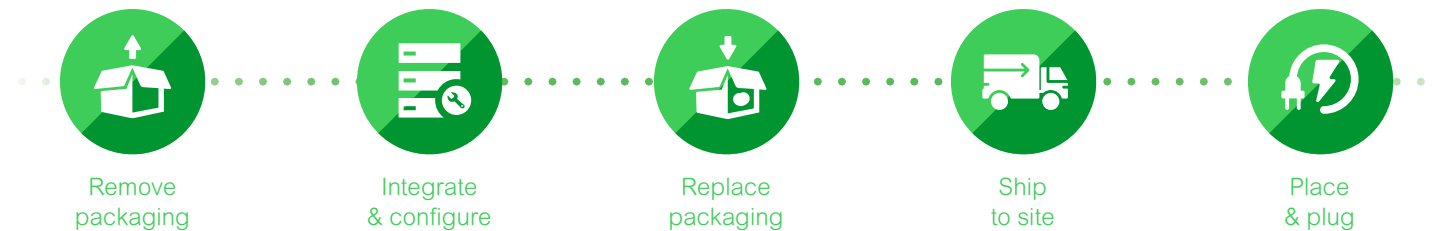

Secure shipping and fast deployment with Cisco + Schneider Electric

Today's converged and hyperconverged infrastructures and off-premises data centers require fully populated IT cabinets to be more securely shipped to customer or colocation sites for fast, low-risk deployment. The loss of or damage to even a single rack can run up to a million dollars or more.

Schneider Electric delivers a Cisco-validated shipping solution that simplifies Cisco UCS “rack and stack” and protects IT equipment to lower costs, reduce risk and provide speed and flexibility for deployment.



Rack Series Comparison

..... Rack Series

Premium

SX

Essential

SV

Soundproof

SP

Wall-mount

WX

2-Post & 4-Post

OF

Seismic, Colo & AV

CM

Custom & Configured

CC

Rugged

RX

Shock Packaging & Pallet

SH

..... Accessories & Upgrades

Airflow & Cabling

AC

Security & Access

SA

Rack PDUs

PD

..... Index

Product Index

PX

Compatibility Index

CX



NetShelter racks with shock packaging and shock pallet

SKU (Black)	SKU (White)	U-space	Height (mm / in.)	Width (mm / in.)	Depth (mm / in.)	Max mounting depth (mm / in.)	Shipping load capacity (kg / lb.)	Packaged
NetShelter SX								
AR3003SP	-	12U	658 / 25.9	600 / 24	900 / 35.4	756 / 29.8	272 / 600	Shock pallet, packaging, one-time use ramp
AR3006SP	-	18U	925 / 36.4	600 / 24	900 / 35.4	756 / 29.8	408 / 900	Shock pallet, packaging, one-time use ramp
AR3103SP	-	12U	658 / 25.9	600 / 24	1070 / 42	921 / 36.3	272 / 600	Shock pallet, packaging, one-time use ramp
AR3106SP	-	18U	925 / 36.4	600 / 24	1070 / 42	921 / 36.3	408 / 900	Shock pallet, packaging, one-time use ramp
AR3104SP1	-	24U	1200 / 47	600 / 24	1070 / 42	915 / 36	907 / 2000	Shock pallet, packaging, one-time use ramp
AR3100SP	-	42U	1991 / 78.4	600 / 24	1070 / 42	915 / 36	907 / 2000	Shock pallet, packaging, one-time use ramp
AR3105SP	-	45U	2124 / 83	600 / 24	1070 / 42	915 / 36	907 / 2000	Shock pallet, packaging, one-time use ramp
AR3107SP	-	48U	2258 / 88.9	600 / 24	1070 / 42	915 / 36	907 / 2000	Shock pallet, packaging, one-time use ramp
AR3150SP	-	42U	1991 / 78.4	750 / 30	1070 / 42	915 / 36	907 / 2000	Shock pallet, packaging, one-time use ramp
AR3155SP	-	45U	2124 / 83	750 / 30	1070 / 42	915 / 36	907 / 2000	Shock pallet, packaging, one-time use ramp
AR3157SP	AR3157WSP	48U	2258 / 88.9	750 / 30	1070 / 42	915 / 36	907 / 2000	Shock pallet, packaging, one-time use ramp
AR3300SP	AR3300WSP	42U	1991 / 78.4	600 / 24	1200 / 48	1048 / 41.3	907 / 2000	Shock pallet, packaging, one-time use ramp
AR3305SP	-	45U	2124 / 83	600 / 24	1200 / 48	1048 / 41.3	907 / 2000	Shock pallet, packaging, one-time use ramp
AR3307SP	AR3307WSP	48U	2258 / 88.9	600 / 24	1200 / 48	1048 / 41.3	907 / 2000	Shock pallet, packaging, one-time use ramp
AR3350SP	AR3350WSP X832	42U	1991 / 78.4	750 / 30	1200 / 48	1048 / 41.3	907 / 2000	Shock pallet, packaging, one-time use ramp
AR3355SP	-	45U	2124 / 83	750 / 30	1200 / 48	1048 / 41.3	907 / 2000	Shock pallet, packaging, one-time use ramp
AR3357SP	AR3357WSP	48U	2258 / 88.9	750 / 30	1200 / 48	1048 / 41.3	907 / 2000	Shock pallet, packaging, one-time use ramp
NetShelter Wall-mount								
AR106V	-	6U	648 / 25.5	965 / 38	331 / 13	762 / 30	113 / 250	Shock packaging
AR106VI	-	6U	648 / 25.5	965 / 38	331 / 13	762 / 30	113 / 250	Shock packaging

Rack Series Comparison

Rack Series

Premium

SX

Essential

SV

Soundproof

SP

Wall-mount

WX

2-Post & 4-Post

OF

Seismic, Colo & AV

CM

Custom & Configured

CC

Rugged

RX

Shock Packaging & Pallet

SH

Accessories & Upgrades

Airflow & Cabling

AC

Security & Access

SA

Rack PDUs

PD

Index

Product Index

PX

Compatibility Index

CX



NetShelter Aisle Containment

Next-generation data center containment

The dynamic nature of whitespace makes it tough to optimize cooling and manage airflow in a constantly changing environment. You need a solution that adapts fast. NetShelter Aisle Containment combines airflow intelligence with flexible containment that delivers superior cooling while helping you reduce your carbon footprint.



Superior cooling performance

- Get up to 20% more cooling performance from your existing infrastructure*

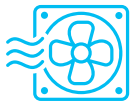

Intelligent airflow control

- Save up to 40% fan energy and reduce air leakage with Active Flow Controller**



Faster install and future flexible

- Adapts to any configuration
- Lightweight for maneuverability
- 5-year warranty***



Reduce carbon footprint

- Reduce energy expense by 5–10%†

[Learn more](#) →

*Source: [Link](#)

**Compared to constant fan speed. [Source: Link](#)

***Excludes lighting control box.

† General savings expected from containment. Does not include additional savings expected from Active Flow Controller. [Source: Link](#)



[Rack Series Comparison](#)

..... Rack Series

Premium

SX

Essential

SV

Soundproof

SP

Wall-mount

WX

2-Post & 4-Post

OF

Seismic, Colo & AV

CM

Custom & Configured

CC

Rugged

RX

Shock Packaging & Pallet

SH

..... Accessories & Upgrades

Airflow & Cabling

AC

Security & Access

SA

Rack PDUs

PD

..... Index

Product Index

PX

Compatibility Index

CX



NetShelter Aisle Containment

Adaptable configurations

Simple design and endless configurations — that's the principle behind this next generation of aisle containment. Intelligent airflow features take containment a step further, proactively optimizing energy use. Plus, it's easy to modify or expand your containment solution as your needs change.

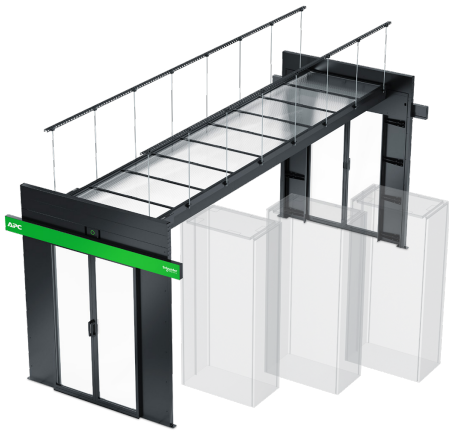

Rack-ready system

- Ideal for new builds and colocations
- Ceiling support for rack-ready layouts

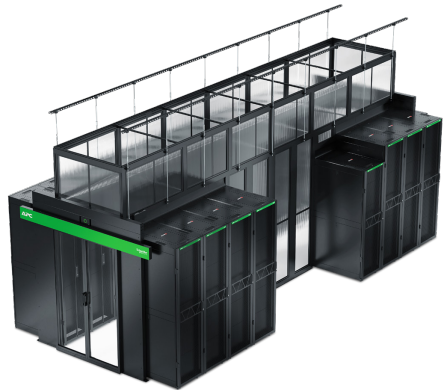

Flexible rack accommodation

- Supports uneven spacing and rack sizes (42U–52U)
- Ceiling-supported configurations work with any rack vendor



Intelligence and access options

- Active Flow Controller provides up to 40% fan energy reduction
- Breakout, dual sliding, single sliding and curtain door options



Aisle variations

- Accommodates aisle widths of 3 ft. (972 mm), 4 ft. (1268 mm) and 6 ft. (1860 mm)
- Dual and single aisle (for odd rows and small applications)

[Learn more](#) →

Rack Series Comparison

..... Rack Series

Premium

SX

Essential

SV

Soundproof

SP

Wall-mount

WX

2-Post & 4-Post

OF

Seismic, Colo & AV

CM

Custom & Configured

CC

Rugged

RX

Shock Packaging & Pallet

SH

..... Accessories & Upgrades

Airflow & Cabling

AC

Security & Access

SA

Rack PDUs

PD

..... Index

Product Index

PX

Compatibility Index

CX



NetShelter Aisle Containment

Design highlights

The NetShelter Aisle Containment design showcases energy efficiency and innovation with its intelligent airflow management — improving cooling efficiency, reducing energy consumption and helping to ensure optimal performance. Here are some additional highlights.

Active Flow Controller automatically adjusts fan speeds based on air pressure, saving up to 40% fan energy

Unique extrusion profile made of lightweight ABS supports easy customization and “snap-in” assembly

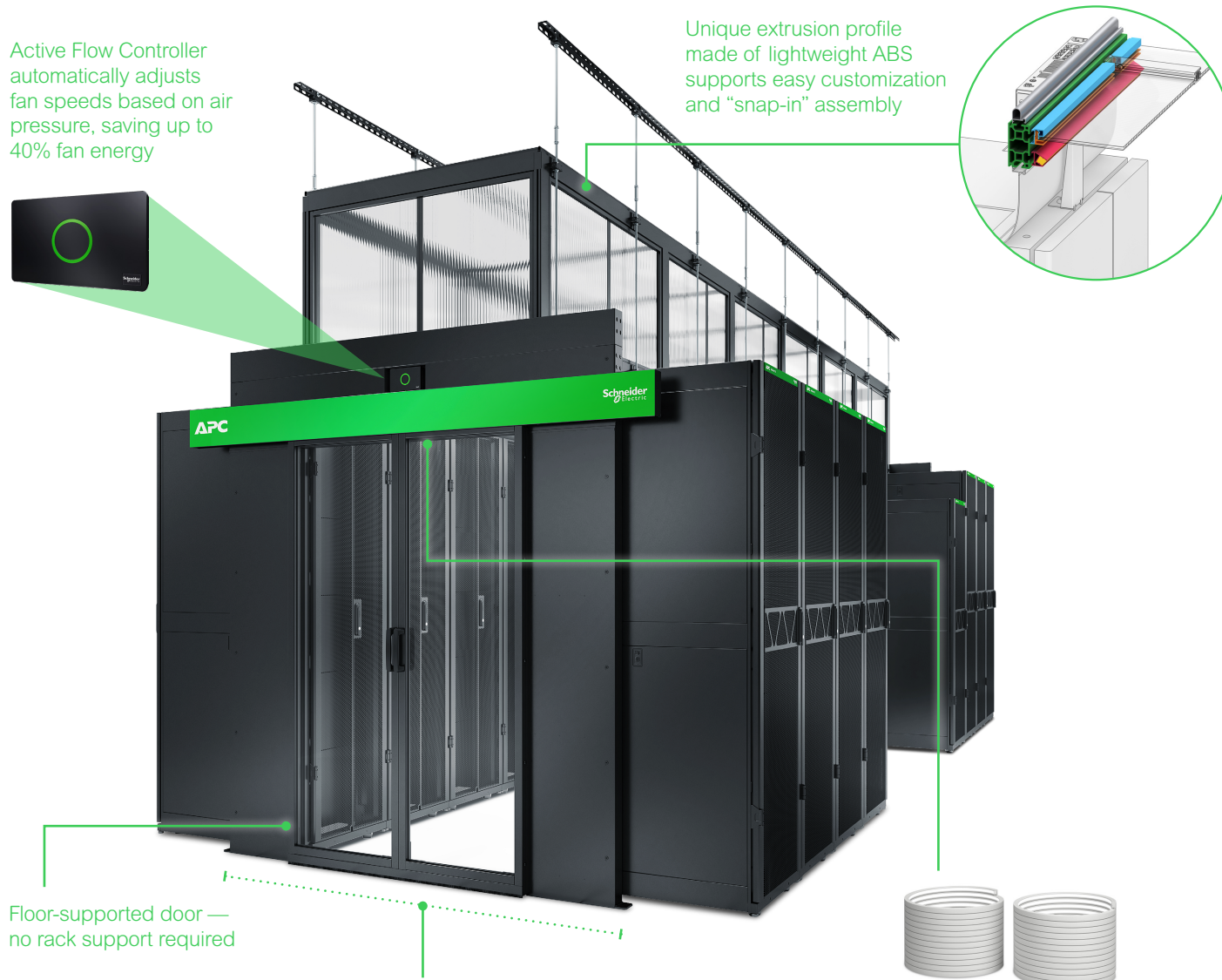

Floor-supported door — no rack support required

Accommodates aisle widths of 3 ft. (972 mm), 4 ft. (1268 mm) and 6 ft. (1860 mm)

Auto-off LED strip lighting system can be cut to length — brighter, energy efficient and flexible

Assembly services available



Rack Series Comparison

Rack Series

Premium

SX

Essential

SV

Soundproof

SP

Wall-mount

WX

2-Post & 4-Post

OF

Seismic, Colo & AV

CM

Custom & Configured

CC

Rugged

RX

Shock Packaging & Pallet

SH

Accessories & Upgrades

Airflow & Cabling

AC

Security & Access

SA

Rack PDUs

PD

Index

Product Index

PX

Compatibility Index

CX



NetShelter Aisle Containment

Configuring and ordering

To build your solution, work with your sales representative or preferred partner to develop an end-to-end design that suits your needs. Approved configurations come complete with 3D renders, technical details and bill of materials through Row Designer on designportal.apc.com.

Category	SKU	Description
Roof system (horizontal and vertical)	NSAC2001	APC NetShelter Aisle Containment, frame extrusion & end cover, set of 4, black
	NSAC2002	APC NetShelter Aisle Containment, panel mounting rail A&B, set of 10, black
	NSAC2151	APC NetShelter Aisle Containment, panel connector 3 ft., set of 3, black
	NSAC2152	APC NetShelter Aisle Containment, panel connector 4 ft., set of 3, black
	NSAC2153	APC NetShelter Aisle Containment, panel connector plastic 1200 mm, set of 6, black
	NSAC2601	APC NetShelter Aisle Containment, L connector, black
	NSAC2603	APC NetShelter Aisle Containment, interior connector, black
	NSAC2604	APC NetShelter Aisle Containment, cabinet install bracket, black
	NSAC2606	APC NetShelter Aisle Containment, right angle connector bracket, black
	NSAC2607	APC NetShelter Aisle Containment, mounting rail connector, black
	NSAC2608	APC NetShelter Aisle Containment, straight connector, black
	NSAC2610	APC NetShelter Aisle Containment, roof bracket for POD containment, black
	NSAC2006	APC NetShelter Aisle Containment, seal coextrusion 1000 mm, set of 6, black
	NSAC2003	APC NetShelter Aisle Containment, cabinet seal coextrusion, 1000 mm, set of 6, black
	Ceiling support kit	NSAC2051
NSAC2052		APC NetShelter Aisle Containment, ceiling mounting rail 1500 mm, set of 2, black
NSAC2653		APC NetShelter Aisle Containment, supporting rods, 1500 mm, set of 8, zinc
Lighting kit	NSAC2121	APC NetShelter Aisle Containment, LED module
	NSAC2122	APC NetShelter Aisle Containment, lighting control box, black
	NSAC2004	APC NetShelter Aisle Containment, lighting mounting rail 1000 mm, set of 6, black
Roof panels	NSAC2101	APC NetShelter Aisle Containment, multi wall panel 644 x 1232 mm, set of 5
	NSAC2102	APC NetShelter Aisle Containment, mutli wall panel 644 x 1825 mm, set of 5
Doors	NSAC2401	APC NetShelter Aisle Containment, dual sliding door, black
	NSAC2402	APC NetShelter Aisle Containment, single sliding door, black
	ACDC2400	APC NetShelter Aisle Containment, Gen 1, breakout door, sliding
	ACDC2401	APC NetShelter Aisle Containment, Gen 1, breakout door header, for 42U SX
	ACDC2402	APC NetShelter Aisle Containment, Gen 1, breakout door header, for 45U SX
	ACDC2403	APC NetShelter Aisle Containment, Gen 1, breakout door header, for 48U SX
	ACDC2404	APC NetShelter Aisle Containment, Gen 1, breakout door post, 900 – 1200 mm (36 – 48 in.) aisle width
	ACDC2405	APC NetShelter Aisle Containment, Gen 1, breakout door post, 1200 – 1500 mm (48 – 60 in.) aisle width
	ACDC2406	APC NetShelter Aisle Containment, Gen 1, breakout door post, 1500 - 1800mm (60 – 71 in.) aisle width
	ACDC2407	APC NetShelter Aisle Containment, Gen 1, breakout door proxy card access, set of 1
Curtains	ACDC2408	APC NetShelter Aisle Containment, Gen 1, breakout door lock
	ACDC2410	APC NetShelter Aisle Containment, Gen 1, curtain door mounting rail, 900 – 1200 mm (36 – 48 in.) aisle width
	ACDC2411	APC NetShelter Aisle Containment, Gen 1, curtain door mounting rail, 1500 – 1800 mm (60 – 71 in.) aisle width
Air sealing kit	FS-AC-1001-U	Air sealing kit for APC NetShelter Aisle or POD Containment
Assembly services	WASEMNSACS-AX-20	Assembly service for NetShelter Aisle Containment, short (up to 7 m), 5 x 8
	WASEMNSACL-AX-20	Assembly service for NetShelter Aisle Containment, long (above 7 m), 5 x 8

Rack Series Comparison

Rack Series

Premium

SX

Essential

SV

Soundproof

SP

Wall-mount

WX

2-Post & 4-Post

OF

Seismic, Colo & AV

CM

Custom & Configured

CC

Rugged

RX

Shock Packaging & Pallet

SH

Accessories & Upgrades

Airflow & Cabling

AC

Security & Access

SA

Rack PDUs

PD

Index

Product Index

PX

Compatibility Index

CX



Other rack cooling and airflow management solutions

NetShelter data center containment

NetShelter data center containment systems maximize cooling predictability, capacity and efficiency at the rack, row or room level. Modular and flexible, these solutions help organizations deploy IT quickly and efficiently, adding capacity as needed.

Rack containment

- Containment for a single rack
- Modular design easily adapts to both the front and rear of the racks and close-coupling cooling units, simplifying installation
- A scalable open plenum enables capacity sharing to improve cooling system redundancy and utilization



Pod containment

- Pods take containment a step further by supporting up to 4,000 lb. of infrastructure and replacing the need to hang equipment from the ceiling
- Rack-ready system designed to deploy IT at scale in increments of 8 to 12 racks
- A freestanding structure supports necessary IT infrastructure while providing air containment for all rack types
- Easily integrates with a variety of cooling and power configurations



Available as a complete Data Center Solution with integrated power, rack and cooling.

[Learn more →](#)

EcoTruxure™
Innovation At Every Level

Rack Series Comparison

..... Rack Series

Premium

SX

Essential

SV

Soundproof

SP

Wall-mount

WX

2-Post & 4-Post

OF

Seismic, Colo & AV

CM

Custom & Configured

CC

Rugged

RX

Shock Packaging & Pallet

SH

..... Accessories & Upgrades

Airflow & Cabling

AC

Security & Access

SA

Rack PDUs

PD

..... Index

Product Index

PX

Compatibility Index

CX



Passive cooling accessories

Air sealing

Covers open rack space to improve cooling efficiency.



AR8136BLK installed



AR7731

SKU	Description
AR8136BLK	1U toolless snap-in blanking panel, 10 pack (AR8136WHT white version)
AR8136BLK200	1U toolless snap-in blanking panel, 200 pack (AR8136WHT200 white version)
AR8108BLK	1U standard metal blanking panel, 2 pack
AR8101BLK	1U, 2U, 4U, 8U blanking panel kit
AR7708	NetShelter SX Air Recirculation Prevention Kit for closing gaps and pass-through holes between side panels and equipment mounting rails
AR7731	NetShelter SX external air sealing kit for sealing external openings at roof and floor, 10 pack

KoldLok® raised floor grommets

Seal a variety of cutouts in a raised floor environment to improve cooling under the raised floor.

SKU	Description
AR7720	Integral raised floor grommet (enclosed) for new installation, 10 pack
AR7730	Surface-mount raised floor grommet (split) for existing cables, 10 pack
AR7740	Extended raised floor grommet to cover length of floor tile, 10 pack

Side airflow cooling

Support cooling for small and large networking switches mounted within networking enclosures.



AR7720



AR7740

SKU	Description
AR7742 (42U) AR7747 (48U)	Side airflow solution for Cisco Nexus 7018 attaches to sides of 47.5 in. deep enclosures

Ducting only

Vertical exhaust duct (VED) for NetShelter SX is an easy-to-install, low-cost cooling option that can increase the efficiency of the attached cooling system.



AR7751 and AR7755 installed on AR3300 with cable management



SKU	Description
AR7751	VED for 24 in. enclosures, short range
AR7752	VED for 24 in. enclosures, tall range
AR7753	VED for 30 in. enclosures, short range
AR7754	VED for 30 in. enclosures, tall range
AR7755	Overhead cable extension for VED 24 in.
AR7756	Overhead cable extension for VED 30 in.

VEDs also available in white.

Roof fan trays available for 42 in. deep enclosures.

[See rack components →](#)

Active cooling accessories

Rack-mounted cooling

Rack-mounted cooling solution for micro data center and edge computing.



SKU	Description
ACRMD4KT-1	3.5kW split system indoor unit, gravity drain
ACRMD4KT-2	3.5kW split system outdoor unit, pre-charged refrigerant
ACRMD4KI-3	3.5kW split system outdoor unit, none pre-charged

Rack fan panel

2U rack-mounted fan panel and accessories.



ACF600

SKU	Description
ACF600	2U rack fan panel (120V)
ACF601	Rack fan panel temperature controller
ACAC40000	2U vent panel with temperature display
ACAC40001	2U vent panel

Rack Series Comparison

Rack Series

Premium

SX

Essential

SV

Soundproof

SP

Wall-mount

WX

2-Post & 4-Post

OF

Seismic, Colo & AV

CM

Custom & Configured

CC

Rugged

RX

Shock Packaging & Pallet

SH

Accessories & Upgrades

Airflow & Cabling

AC

Security & Access

SA

Rack PDUs

PD

Index

Product Index

PX

Compatibility Index

CX



NetShelter cable management

Vertical cable management

Every NetShelter SX enclosure contains zero-U accessory channels in the rear of the rack. Use these to toollessly mount vertical rack PDUs and vertical cable organizers.

Additional vertical zero-U accessory channels

SKU	Description
AR7502	Vertical 0U accessory channel, 42U, 2 pack
AR7552	Vertical 0U accessory channel, 45U, 2 pack
AR7572	Vertical 0U accessory channel, 48U, 2 pack
AR7511	Narrow vertical 0U accessory channel, 42U
AR7505	Vertical cable organizer, center rear mount

Accessories for vertical cable management

SKU	Description	Features
AR8442	Vertical cable organizer, eight cable rings, 0U	<ul style="list-style-type: none"> Supports 35 to 55 CAT 6/CAT 6A data cables Mounts toollessly on the vertical 0U accessory channel
AR8443A	Vertical fiber organizer	<ul style="list-style-type: none"> Installs toollessly Takes up one bay of channel Fiber spool only kit available (AR8444)
AR8457	Data distribution 0U SX panel	<ul style="list-style-type: none"> Installs toollessly Takes up one bay of channel Toollessly mounts up to four DDC cable heads, 24 ports for rack-to-rack connections
AR7710	Cable containment brackets with rack PDU mounting	<ul style="list-style-type: none"> Low-profile vertical cable management Supports 60 to 90 CAT 6/CAT 6A data cables Mounts toollessly on the vertical 0U accessory channel
AR7711	Zero-U accessory bracket	<ul style="list-style-type: none"> Mounts rack PDUs in rear-facing orientation Supports third-party accessories in numerous mounting configurations Mounts 1U or 2U patch panels or other networking accessories
AR8621	Hook-and-loop cable managers, 10 pack	<ul style="list-style-type: none"> Secures and bundles cables with hook-and-loop ties Mounts toollessly on the vertical 0U accessory channel
AR7721, 22, 23	Low-profile vertical cable managers, zero U	<ul style="list-style-type: none"> Supports up to 38 CAT 6A or 251 fiber cables Mounts toollessly on the vertical 0U accessory channel

High-capacity cable management

SKU	Description
AR7580A	High-capacity vertical cable manager for NetShelter SX 30 in. wide enclosures (AR3x5x) supports 190 to 250 CAT 6A/CAT 6 data cables per section and 190 CAT 6A per channel section. Each kit covers one corner of the enclosure.
AR7581A	Hinged covers for AR7580A vertical cable managers.

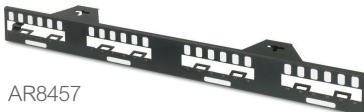
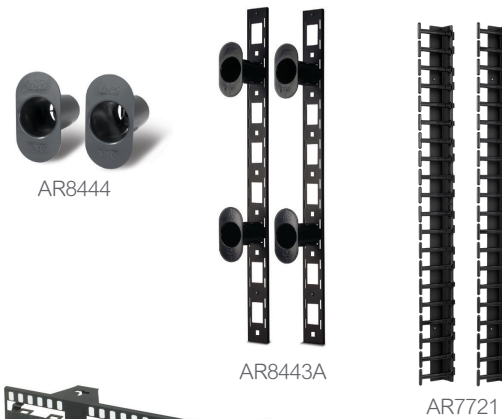

AR7710



AR8442

Rack Series Comparison

Rack Series

Premium

SX

Essential

SV

Soundproof

SP

Wall-mount

WX

2-Post & 4-Post

OF

Seismic, Colo & AV

CM

Custom & Configured

CC

Rugged

RX

Shock Packaging & Pallet

SH

Accessories & Upgrades

Airflow & Cabling

AC

Security & Access

SA

Rack PDUs

PD

Index

Product Index

PX

Compatibility Index

CX



NetShelter cable management

Horizontal cable management

Finger-type horizontal cable managers

Cable managers for patching and crossover applications featuring smooth radius plastic fingers that protect the cable from kinking and binding. Hinged, snap-on covers provide a clean look and retain large cable bundles. These cable managers include hardware for double-sided configurations with two units.

SKU	Description
AR8602A	1U horizontal cable manager with 4 in. (101 mm) fingers and snap-on cover
AR8600A	2U horizontal cable manager with 4 in. (101 mm) fingers and snap-on cover
AR8612	1U horizontal cable manager with 6 in. (152 mm) fingers and snap-on cover
AR8606	2U horizontal cable manager with 6 in. (152 mm) fingers and snap-on cover
AR8603A	2U horizontal cable manager with 6 in. (152 mm) fingers, snap-on cover, rear cable pass-through holes and slots for AR8008BLK/AR8016ABLK horizontal cable channel
AR8605	3U horizontal cable manager with 6 in. (152 mm) fingers, snap-on cover, rear cable pass-through holes and cable channel slots

Ring-type horizontal cable managers

Economical cable managers for patching applications featuring various configurations to meet specific needs.

SKU	Description
AR8425A	1U horizontal cable manager with four rings
AR8426A	2U horizontal cable manager with four rings
AR8428	2U horizontal cable manager with four rings and pass-through holes
AR8427A	2U horizontal cable manager with multiple rings and small cable retainers
AR8113A	Cable management rings, 10 pack (5 large, 5 small)
AR7707	Cable management rings, 8 in. (203 mm) deep for 30 in. (750 mm) wide enclosures (AR3x5x), 8 pack

Horizontal cable management accessories

SKU	Description
AR8429	1U cable pass-through manager with brush strip
AR8129	Cable management arm for use with sliding shelves
AR8008BLK	Horizontal cable side channel, 18 in. (457 mm) to 30 in. (750 mm) adjustment, for routing cable front-to-back between the standard wide rack mounting rails or AR8603 and AR8428 horizontal cable managers
AR8016ABLK	Horizontal cable side channel, 10 in. (254 mm) to 18 in. (457 mm) adjustment, for routing cable front-to-back between the standard wide rack mounting rails or AR8603 and AR8428 horizontal cable managers
AR7706	Mounting rail brush strips for 30 in. (750 mm) wide enclosures (AR3x5x), 6 pack



Accessories are now available for pre-integration in NetShelter Racks and Enclosures.

Contact your Schneider Electric representative to learn how.

Rack Series Comparison

Rack Series

Premium

SX

Essential

SV

Soundproof

SP

Wall-mount

WX

2-Post & 4-Post

OF

Seismic, Colo & AV

CM

Custom & Configured

CC

Rugged

RX

Shock Packaging & Pallet

SH

Accessories & Upgrades

Airflow & Cabling

AC

Security & Access

SA

Rack PDUs

PD

Index

Product Index

PX

Compatibility Index

CX



NetShelter SX cable management

Overhead cable troughs and partitions

NetShelter enclosures allow you to use a system of troughs and partitions for routing power and data cables across the top.

These troughs and partitions:

- Reduce the need for expensive suspended cable tray systems
- Install toollessly with snap-in tabs and have standard attachment points for cable ladder systems

Enclosure troughs are shown here. For information on power and cooling troughs and partitions, see the [APC website](#).



1 Power cable trough

- Supports power distribution cables
- Provides separation from data cables
- Data cables pass through underneath to front partitioned area

SKU	Description
AR8561	Cable trough, 24 in. (600 mm) enclosures
AR8571	Cable trough, 30 in. (750 mm) enclosures

2 Solid data cable partition

- Partitions the top of the enclosure into cable routing areas
- Solid face provides clean appearance at the front of the enclosure

SKU	Description
AR8163ABLK	Pass-through data partition, 24 in. (600 mm) enclosures
AR8173BLK	Pass-through data partition, 30 in. (750 mm) enclosures

3 Pass-through data cable partition

- Partitions the top of the enclosure into cable routing areas
- Pass-through hole provides cable access into multiple cable areas

SKU	Description
AR8162ABLK	Solid data partition, 24 in. (600 mm) enclosures
AR8172BLK	Solid data partition, 30 in. (750 mm) enclosures

4 Cable ladders and accessories

- Cable ladders and attachment kits for routing power and data cabling overhead from rack to rack



SKU	Cable Ladders and Attachment Kits	SKU	Ladder Accessories
AR8164ABLK	Cable ladder, 6 in. (152 mm) (AR8164AKIT 6 in. ladder with attach kit)	AR8461	Ladder corner clamp
AR8165ABLK	Cable ladder, 12 in. (304 mm) (AR8165AKIT 12 in. ladder with attach kit)	AR8462	Ladder angle clamp
AR8576	Alternate mounting — ladder to power troughs	AR8463	Ladder stacking
AR8177BLK	Alternate mounting — ladder to data partitions	AR8465	Ladder wall termination
AR8168BLK	Ladder to NetShelter SX roof	AR8169	Ladder clamp kit
AR8186	Ladder elevation bracket		
AR8460	Ladder to two-post rack		



AR8561



AR8162ABLK



AR8163ABLK



AR8186

Rack Series Comparison

Rack Series

Premium

SX

Essential

SV

Soundproof

SP

Wall-mount

WX

2-Post & 4-Post

OF

Seismic, Colo & AV

CM

Custom & Configured

CC

Rugged

RX

Shock Packaging & Pallet

SH

Accessories & Upgrades

Airflow & Cabling

AC

Security & Access

SA

Rack PDUs

PD

Index

Product Index

PX

Compatibility Index

CX



Shelves and mounting hardware

Mounting accessories to aid in the installation of IT equipment and secure racks into position

Shelving

Fixed and sliding shelves to enable the mounting of tower units, monitors and other equipment.

SKU	Description
AR8105BLK	Fixed shelf, 50 lb. (22 kg)
AR8122BLK	Fixed shelf, 250 lb. (113 kg)
AR8123BLK	Sliding shelf, 100 lb. (45 kg)
AR8128BLK	Sliding shelf, 200 lb. (90 kg)
AR8422	Double-side fixed shelf for two-post rack
AR8126ABLK	17 in. (431 mm) sliding keyboard shelf
AR8127BLK	19 in. (482 mm) sliding, rotating keyboard shelf
AR8006A	Miscellaneous equipment support rails for 24 in. (600 mm) wide enclosure



AR8105BLK



AR8122BLK



AR8128BLK



AR8422

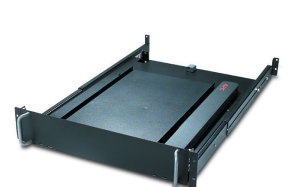

AR8126ABLK/AR8127BLK

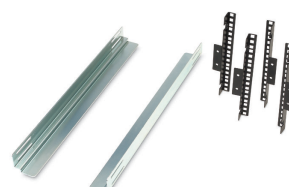

AR8006A

Bolt-down and stabilization

Stabilization plates and hardware to prevent tip over in stand-alone rack applications and meet specific anchoring requirements.

SKU	Description
AR7700	NetShelter SX stabilization plate to prevent tipping when sliding out equipment
AR7701	NetShelter SX bolt-down kit, meets IBC seismic requirements for moderate seismic zones
AR7701-S	NetShelter SX bolt-down kit, meets IBC seismic requirements for high seismic zones



AR7701 and AR7701-S



AR7700

Miscellaneous mounting brackets

Variety of mounting brackets for mounting IT equipment.

SKU	Description
AR7711	0U multipurpose accessory mounting bracket for side mounting of 1U/2U products and rack PDUs
AR8150BLK	23 in. (584 mm) to 19 in. (482 mm) mounting adapter brackets for use with AR7510 23 in. (584 mm) EIA mounting rails



AR7711

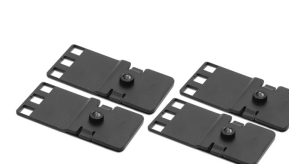

AR8150BLK

Hardware kits

Available for additional hardware needs or to accommodate equipment mounted in varying mounting options.

SKU	Description
AR8100	M6 cage nuts and screws, 32 pack
AR8400	#12-24 screws, 100 pack
AR8005	#10-32 cage nuts, 36 pack

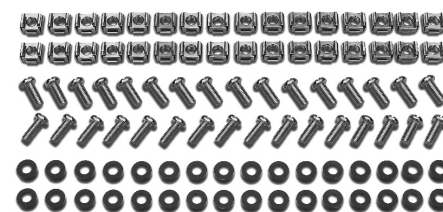

AR8100

Rack Series Comparison

Rack Series

Premium

SX

Essential

SV

Soundproof

SP

Wall-mount

WX

2-Post & 4-Post

OF

Seismic, Colo & AV

CM

Custom & Configured

CC

Rugged

RX

Shock Packaging & Pallet

SH

Accessories & Upgrades

Airflow & Cabling

AC

Security & Access

SA

Rack PDUs

PD

Index

Product Index

PX

Compatibility Index

CX



NetShelter SX rack components

Replacement doors, side panels, roofs

Standard doors, side panels and roofs are available for all enclosure sizes.



Specialty roofs, side panels and accessories

SKU	Description
AR7252*	Networking roof for high density cabling, 30 in. (750 mm) wide x 42 in. (1070 mm) deep
AR7716*	Networking roof for high density cabling, 30 in. (750 mm) wide x 42 in. (1070 mm) deep
AR7215	NetShelter AV enclosure top mount conduit access adapter
AR7209	Open roof support bridge for overhead troughs and partitions
AR7305A	NetShelter SX pass-through side panel, 42U x 42 in. (1070 mm) deep
AR7313	NetShelter SX pass-through side panel, 42U x 47.5 in. (1200 mm) deep
AR7315	NetShelter SX pass-through side panel, 45U x 42 in. (1070 mm) deep
AR7316	NetShelter SX pass-through side panel, 45U x 47.5 in. (1200 mm) deep
AR7375	NetShelter SX pass-through side panel, 48U x 42 in. (1070 mm) deep
AR7314	NetShelter SX pass-through side panel, 48U x 47.5 in. (1200 mm) deep
AR7714	Replacement snap-in brush strips for SX roofs
ACF501	Roof fan for 24 in. (600 mm) wide x 42 in. (1070 mm) deep enclosures, 120 Vac
ACF502	Roof fan for 24 in. (600 mm) wide x 42 in. (1070 mm) deep enclosures, 208–230 Vac
ACF503	Roof fan for 30 in. (750 mm) wide x 42 in. (1070 mm) deep enclosures, 120 Vac
ACF504	Roof fan for 30 in. (750 mm) wide x 42 in. (1070 mm) deep enclosures, 208–230 Vac
ACF505	Roof fan for NetShelter AV 24 in. (600 mm) wide x 32.5 in. (825 mm) deep, 115 Vac
AR8132A	Combination lock handle for NetShelter SX enclosures, 2 pack

*For white version add W to part number

Rails

Mounting rails

Vertical EIA rail mounting kits for different widths and depths.

SKU	Description
AR7510	23 in. (584 mm) EIA mounting rails for 42U x 30 in. (750 mm) wide enclosures

Recessed rail kits

Intermediate mounting rails for supporting shallow-depth equipment.

SKU	Description
AR7503	42U x 24 in. (600 mm) wide
AR7504	48U x 24 in. (600 mm) wide
AR7508	42U x 30 in. (750 mm) wide
AR7578	48U x 30 in. (750 mm) wide

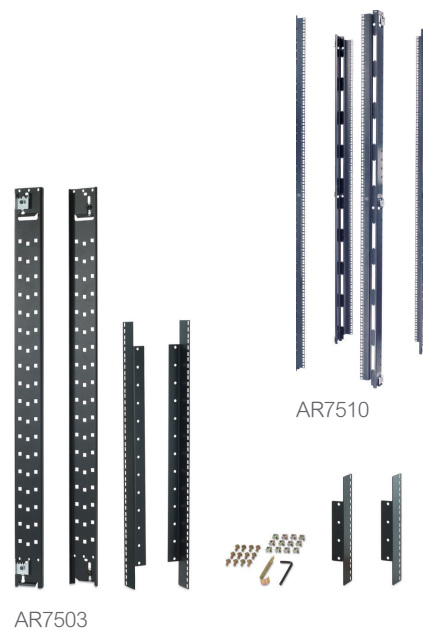
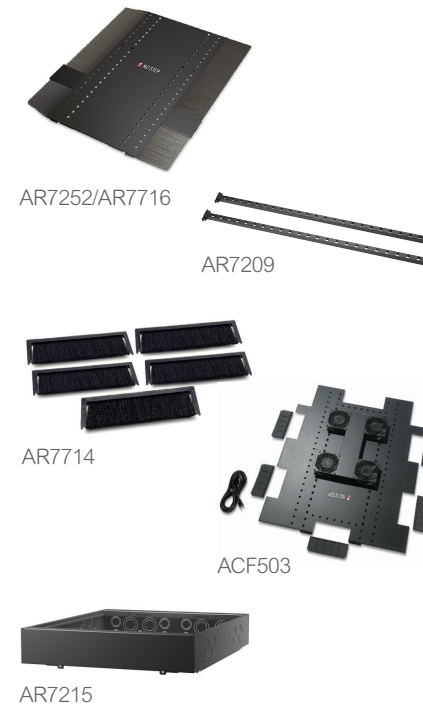

Rack Series Comparison

Rack Series

Premium

SX

Essential

SV

Soundproof

SP

Wall-mount

WX

2-Post & 4-Post

OF

Seismic, Colo & AV

CM

Custom & Configured

CC

Rugged

RX

Shock Packaging & Pallet

SH

Accessories & Upgrades

Airflow & Cabling

AC

Security & Access

SA

Rack PDUs

PD

Index

Product Index

PX

Compatibility Index

CX



NetBotz security and monitoring

NetBotz devices for enhanced security and environmental monitoring



Physical security

- Keycard access control
- Remote access control with intrusion detection and notification
- Remote camera monitoring through NetBotz IP camera



Environmental monitoring

- Wide range of wired and wireless sensor support to monitor the health of your IT assets
- Temperature, humidity, leak, door, smoke, vibration, dew point, airflow, dry contact, 4-20mA and 0-5V



Management capabilities

- Alarming allows alerts, multiple notification methods, scheduling, graph and video attachments, escalation
- Integrate with EcoStruxure IT Expert to manage multiple NetBotz devices through a single interface and view historical alarms and sensor data



NBRK0250A



NBWL0755



NBRK0750





NBPD0165

Flexible access control

Configure proximity cards for access or control access via web browser for remote management and notification.

EcoStruxure™
Innovation At Every Level

APC Rack Access Control	SKU	For use with	Description	Features
 125 kHz Access Control	NBACS125 NBHN125S* (single handle)	NetBotz 250 or 750	Stand-alone appliance for two handles to plug into (i.e., one appliance per rack)	<ul style="list-style-type: none"> • Central authentication via RADIUS • Remote Syslog capability
 13.56 MHz Access Control	NBACS1356 NBHN1356S* (single handle)	NetBotz 250 or 750		
 Rack Access Pods	NBPD0175	NetBotz 750 or 755	Rack access pod that is daisy chained off a Netbotz 750 or 755 appliance	<ul style="list-style-type: none"> • Basement or 19 in. mounting • Supports NetShelter SX, SV and CX • Supports up to 200 unique users

*Single handle for NetShelter Wall-mount Enclosures AR1xxSHx. See [Compatibility Index](#) for more information.

Rack Series Comparison

..... Rack Series

Premium

SX

Essential

SV

Soundproof

SP

Wall-mount

WX

2-Post & 4-Post

OF

Seismic, Colo & AV

CM

Custom & Configured

CC

Rugged

RX

Shock Packaging & Pallet

SH

..... Accessories & Upgrades

Airflow & Cabling

AC

Security & Access

SA

Rack PDUs

PD

..... Index

Product Index

PX

Compatibility Index

CX



LCD monitors and KVM switches

Rack LCD Console

Optimize rack space and maximize system visibility with a NetShelter Rack LCD Console. A streamlined solution built for server management, the console can be used in a variety of IT environments, from computer rooms to large data centers.

What's included:

- Keyboard with touchpad
- LCD monitor (17 or 19 in.)
- USB port for external media
- Integrated 8 or 16 port analog KVM switch (optional, 17 in. model only)

Benefits:

- Space-saving 1U design
- Ultra-thin LCD screen
- Easy to install
- Easy to add a KVM switch to back of monitor

Rack KVM switches

Access your servers across the room or across the world. APC Rack KVM switches empower IT administrators through both local and remote POST- and BIOS-level access and control of connected servers.



KVM1116R



KVM-DVIVMCAC



AP5253



AP5808

LCD consoles	SKU
17 in. rack LCD console	AP5717
19 in. rack LCD console	AP5719

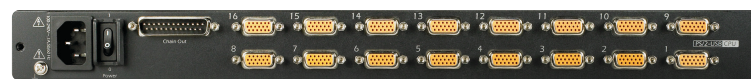

AP5816

LCD consoles with integrated KVM switch	SKU
17 in. rack LCD console with integrated 8-port KVM switch	AP5808
17 in. rack LCD console with integrated 16-port KVM switch	AP5816

KVM switches	SKU
16-port digital IP KVM with virtual media, one remote user	KVM1116R
16-port analog enterprise KVM with virtual media, two local users	KVM0216A
16-port analog KVM, one local user	KVM0116A
8-port analog KVM, one local user	KVM0108A

KVM accessories	SKU
KVM DVI server module with virtual media and KVM-DVIVMCAC CAC support	KVM-DVIVMCAC
KVM HDMI server module with virtual media and KVM-HDMIVMCAC CAC support	KVM-HDMIVMCAC
KVM USB server module	KVM-USB
KVM PS/2 server module	KVM-PS2
KVM USB server module with virtual media	KVM-USBVM
KVM PS/2 server module with virtual media	KVM-PS2VM
KVM USB server module with virtual media and CAC support	KVM-USBVMCAC
KVM serial server module	KVM-SERIAL
KVM to rack PDU power management cable	AP5641
KVM 1U bracket for rear mount behind rack LCD console	KVM-LCDMOUNT
KVM access software license upgrade to enterprise (1,024 nodes)	SEKVM1024N

Cables	2 ft. / 610 mm	3 ft. / 914 mm	6 ft. / 1829 mm	12 ft. / 3658 mm	25 ft. / 7620 mm
KVM USB cable			AP5821 AP5253	AP5822 AP5257	AP5823 AP5261
KVM PS/2 cable		AP5264	AP5250	AP5254	AP5258
KVM daisy-chain cable	AP5262		AP5263		

Rack Series Comparison

Rack Series

Premium

SX

Essential

SV

Soundproof

SP

Wall-mount

WX

2-Post & 4-Post

OF

Seismic, Colo & AV

CM

Custom & Configured

CC

Rugged

RX

Shock Packaging & Pallet

SH

Accessories & Upgrades

Airflow & Cabling

AC

Security & Access

SA

Rack PDUs

PD

Index

Product Index

PX

Compatibility Index

CX



Rack power distribution



NetShelter Rack PDU Advanced

A rack power distribution unit (PDU) with an industry-first 4-in-1 outlet design that works for the most common types of plugs, with models able to deliver even more power.

Designed for the high-density power needs of service providers, large enterprises and medium-to-large data centers.



NetShelter Rack PDUs

NetShelter standard PDUs with industry-leading reliability, manageability and security.

Ideal for small and medium sized businesses, small-to-medium data centers and edge computing.

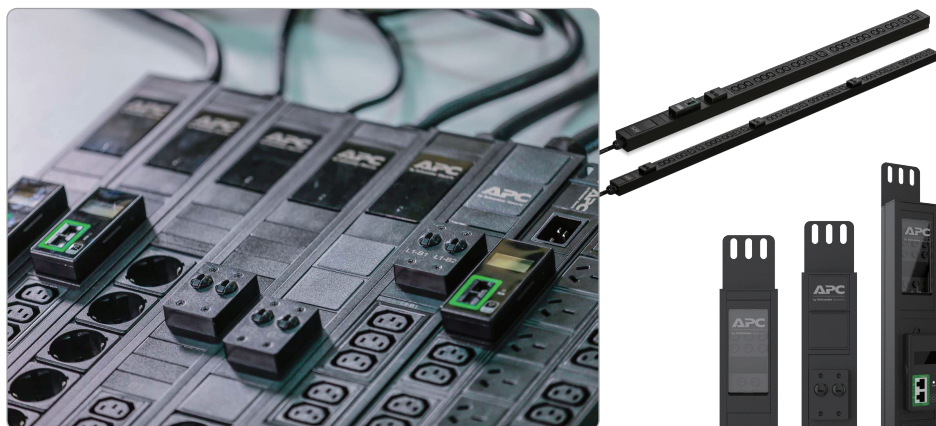

Easy Rack PDUs

Available globally excluding US & Canada

An easy-to-install, easy-to-use, easy-to-customize rackmount PDU that provides reliable power distribution to the equipment in the rack and with the functionality of monitoring and control.

Perfect for small and medium data centers and computer rooms, as well as colocation and large enterprise data centers.

Rack Series Comparison

Rack Series

Premium

SX

Essential

SV

Soundproof

SP

Wall-mount

WX

2-Post & 4-Post

OF

Seismic, Colo & AV

CM

Custom & Configured

CC

Rugged

RX

Shock Packaging & Pallet

SH

Accessories & Upgrades

Airflow & Cabling

AC

Security & Access

SA

Rack PDUs

SA

Index

Product Index

PX

Compatibility Index

CX



Rack power distribution

Product features by Rack PDU family

We offer a wide array of standardized rack PDUs designed to increase manageability and efficiency in your data center. Find the right PDU for you by comparing features across our NetShelter, NetShelter Advanced and Easy Rack PDU families. Quickly find the part number you need via the [PDU Pocket Guide](#) along with other power distribution accessories and automatic transfer switches.

SKUs	APDU10XXX	APDU9XXX	AP8XXX	AP7XXX	EPDUXXX
Rack PDU Family	NetShelter Advanced		NetShelter		Easy Rack
Availability	Global		Global		Global (excluding US & Canada)
Nominal power	7.5 – 43.5kW	3.6 – 11kW	2.3 – 22kW		3.6 – 22kW
Maximum operating temperature	60°C	60°C	60°C	60°C	45°C
Max sockets per unit	48	24	42		24
U-space (implied positioning)	0U	0U – 1U	0U	1U – 2U	0U – 1U
Basic, Metered, Switched, by Outlet or Combo	All	Switched	All	All	All
High retention outlets	•	•	•	•	
Ultra-low profile circuit breakers	•	•	•		
Locking IEC outlets	•	•	•		
4-in-1 outlet	•				
High-density outlets	•				
Alternating phase and color-coded outlets	•				
Wi-Fi connectivity		•	•	•	
Remote outlet control, power sequencing and grouping	•	•	•	•	•
User access control	•	•	•	•	Limited
Ethernet connectivity	Gigabit	Gigabit	10/100	10/100	10/100
Network port sharing	32	32	4		4
Easy local firmware updates	•	•	•		•
NMC power sharing	•				
Dual network ports for multi-user access	•				
Metering accuracy	±1%	±1%	±3%	±5%	±1% or ±3%
Environmental monitoring port	Up to 8	•	•		•
EcoStruxure IT compatibility	Limited	•	•	•	•
Field-replaceable network management module	Live swap	•	•		
Warranty	3 year	3 year	2 year	2 year	2 year



[View the PDU Pocket Guide](#) →

Rack Series Comparison

Rack Series

Premium

SX

Essential

SV

Soundproof

SP

Wall-mount

WX

2-Post & 4-Post

OF

Seismic, Colo & AV

CM

Custom & Configured

CC

Rugged

RX

Shock Packaging & Pallet

SH

Accessories & Upgrades

Airflow & Cabling

AC

Security & Access

SA

Rack PDUs

SA

Index

Product Index

PX

Compatibility Index

CX



Product Index

Premium Server Racks

NetShelter SX Enclosures



	Model (Black)	Model (White)	Rack Units	Height (mm)	Width (mm)	Depth (mm)	Max Equipment Depth (mm)	Static (lb.)	Dynamic (lb.)	Doors & Sides	0U Accessory Channels	
NetShelter SX (latest generation)	AR3100B2	-	42	1991	600	1070	915	4000	2250	✓	2	Europe North America
	AR3150B2	-	42	1991	750	1070	915	4000	2250	✓	2	
	AR3300B2	AR3300W2	42	1991	600	1200	1048	4000	2250	✓	4	
	AR3350B2	AR3350W2	42	1991	750	1200	1048	4000	2250	✓	4	
	AR3105B2	-	45	2124	600	1070	915	4000	2250	✓	2	
	AR3155B2	-	45	2124	750	1070	915	4000	2250	✓	2	
	AR3305B2	-	45	2124	600	1200	1048	4000	2250	✓	4	
	AR3355B2	-	45	2124	750	1200	1048	4000	2250	✓	4	
	AR3107B2	-	48	2258	600	1070	915	4000	2250	✓	2	
	AR3157B2	-	48	2258	750	1070	915	4000	2250	✓	2	
	AR3307B2	AR3307W2	48	2258	600	1200	1048	4000	2250	✓	4	
	AR3357B2	AR3357W2	48	2258	750	1200	1048	4000	2250	✓	4	
	AR3180B2	-	42	1991	800	1070	915	4000	2250	✓	2	
	AR3380B2	AR3380W2	42	1991	800	1200	1048	4000	2250	✓	4	
	AR3187B2	-	48	2258	800	1070	915	4000	2250	✓	2	
AR3387B2	AR3387W2	48	2258	800	1200	1048	4000	2250	✓	4		
NetShelter SX (original)	AR3003	-	12	658	600	889	756	600	600	✓	2	Global
	AR3103	-	12	658	600	1070	921	600	600	✓	2	
	AR3006	-	18	925	600	889	756	900	900	✓	2	
	AR3106	-	18	925	600	1070	921	900	900	✓	2	
	AR3104	-	24	1198	600	1070	915	3000	2250	✓	2	
	-	AR3100W	42	1991	600	1070	915	3750	2250	✓	2	
	AR3100TAA	-	42	1991	600	1070	915	3750	2250	✓	2	
	-	AR3150W	42	1991	750	1070	915	3750	2250	✓	2	
	-	AR3105W	45	2124	600	1070	915	3750	2250	✓	2	
	AR3105TAA	-	45	2124	600	1070	915	3750	2250	✓	2	
	-	AR3155W	45	2124	750	1070	915	3750	2250	✓	2	
	-	AR3305W	45	2124	600	1200	1048	3750	2250	✓	4	
	-	AR3355W	45	2124	750	1200	1048	3750	2250	✓	4	
	-	AR3107W	48	2258	600	1070	915	3750	2250	✓	2	
	AR3107TAA	-	48	2258	600	1070	915	3750	2250	✓	2	
	-	AR3157W	48	2258	750	1070	915	3750	2250	✓	2	
	AR3307X674	AR3308W	52	2436	600	1200	1048	3750	2250	✓	4	
	AR3158	-	52	2436	750	1070	915	3750	2250	✓	2	
AR3357X674	AR3358W	52	2436	750	1200	1048	3750	2250	✓	4		

Rack Series Comparison

Rack Series

Premium

SX

Essential

SV

Soundproof

SP

Wall-mount

WX

2-Post & 4-Post

OF

Seismic, Colo & AV

CM

Custom & Configured

CC

Rugged

RX

Shock Packaging & Pallet

SH

Accessories & Upgrades

Airflow & Cabling

AC

Security & Access

SA

Rack PDUs

PD

Index

Product Index

PX

Compatibility Index

CX



Product Index



Premium Server Racks

NetShelter SX Enclosures (Configured – Doors and Side Panels)

SKU	Rack Units	Height (mm)	Width (mm)	Depth (mm)	Max Equipment Depth (mm)	Static Load (kg / lb.)	Dynamic Load (kg / lb.)	Doors	Sides
AR3104X609	24	1198	600	1070	915	1361 / 3000	1021 / 2250	✓	✗
AR3100X609	42	1991	600	1070	915	1701 / 3750	1021 / 2250	✓	✗
AR3100X610	42	1991	600	1070	915	1701 / 3750	1021 / 2250	✗	✓
AR3100X617	42	1991	600	1070	915	1701 / 3750	1021 / 2250	✗	✗
AR3130X610	42	1991	700	1070	915	1701 / 3750	1021 / 2250	✗	✓
AR3150X609	42	1991	750	1070	915	1701 / 3750	1021 / 2250	✓	✗
AR3150X610	42	1991	750	1070	915	1701 / 3750	1021 / 2250	✗	✓
AR3150X617	42	1991	750	1070	915	1701 / 3750	1021 / 2250	✗	✗
AR3300X609	42	1991	600	1200	1048	1701 / 3750	1021 / 2250	✓	✗
AR3300X610	42	1991	600	1200	1048	1701 / 3750	1021 / 2250	✗	✓
AR3300X617	42	1991	600	1200	1048	1701 / 3750	1021 / 2250	✗	✗
AR3350X609	42	1991	750	1200	1048	1701 / 3750	1021 / 2250	✓	✗
AR3350X610	42	1991	750	1200	1048	1701 / 3750	1021 / 2250	✗	✓
AR3350X617	42	1991	750	1200	1048	1701 / 3750	1021 / 2250	✗	✗
AR3107X609	42	2258	600	1070	915	1701 / 3750	1021 / 2250	✓	✗
AR3107X610	42	2258	600	1070	915	1701 / 3750	1021 / 2250	✗	✓
AR3107X617	42	2258	600	1070	915	1701 / 3750	1021 / 2250	✗	✗
AR3157X609	42	2258	750	1070	915	1701 / 3750	1021 / 2250	✓	✗
AR3157X610	42	2258	750	1070	915	1701 / 3750	1021 / 2250	✗	✓
AR3157X617	42	2258	750	1070	915	1701 / 3750	1021 / 2250	✗	✗
AR3307X609	42	2258	600	1200	1048	1701 / 3750	1021 / 2250	✓	✗
AR3307X610	42	2258	600	1200	1048	1701 / 3750	1021 / 2250	✗	✓
AR3307X617	42	2258	600	1200	1048	1701 / 3750	1021 / 2250	✗	✗
AR3357X609	42	2258	750	1200	1048	1701 / 3750	1021 / 2250	✓	✗
AR3357X610	42	2258	750	1200	1048	1701 / 3750	1021 / 2250	✗	✓
AR3357X617	42	2258	750	1200	1048	1701 / 3750	1021 / 2250	✗	✗



NetShelter SX Networking Racks (Standard)

SKU (Black)	SKU (White)	Rack Units	Height (mm)	Width (mm)	Depth (mm)	Max Equipment Depth (mm)	Static Load (kg / lb.)	Dynamic Load (kg / lb.)	Doors	Sides
AR3140	AR3140W	42	1991	750	1070	819	1701 / 3750	1021 / 2250	✓	✓
AR3340	AR3340W	42	1991	750	1200	959	1701 / 3750	1021 / 2250	✓	✓
AR3347	AR3347W	48	2258	750	1200	959	1701 / 3750	1021 / 2250	✓	✓
-	AR3348WX832	52	2436	750	1200	1048	1701 / 3750	1021 / 2250	✓	✓

Rack Series Comparison

Rack Series

Premium

SX

Essential

SV

Soundproof

SP

Wall-mount

WX

2-Post & 4-Post

OF

Seismic, Colo & AV

CM

Custom & Configured

CC

Rugged

RX

Shock Packaging & Pallet

SH

Accessories & Upgrades

Airflow & Cabling

AC

Security & Access

SA

Rack PDUs

PD

Index

Product Index

PX

Compatibility Index

CX



Product Index



Premium Server Racks

NetShelter SX Server Enclosures (Shock Packaging)

SKU (Black)	SKU (White)	Rack Units	Height (mm)	Width (mm)	Depth (mm)	Max Equipment Depth (mm)	Static Load (kg / lb.)	Dynamic Load (kg / lb.)	Shippable (kg / lb.)	Doors	Sides
AR3003SP	-	12	658	600	889	756	272 / 600	272 / 600	272 / 600	✓	✓
AR3103SP	-	12	658	600	1070	921	272 / 600	272 / 600	272 / 600	✓	✓
AR3006SP	-	18	925	600	889	756	408 / 900	408 / 900	408 / 900	✓	✓
AR3106SP	-	18	925	600	1070	921	408 / 900	408 / 900	408 / 900	✓	✓
AR3104SP1	-	24	1198	600	1070	915	1361 / 3000	1021 / 2250	907 / 2000	✓	✓
AR3100SP	-	42	1991	600	1070	915	1701 / 3750	1021 / 2250	907 / 2000	✓	✓
AR3150SP	-	42	1991	750	1070	915	1701 / 3750	1021 / 2250	907 / 2000	✓	✓
AR3300SP	AR3300WSP	42	1991	600	1200	1048	1701 / 3750	1021 / 2250	907 / 2000	✓	✓
AR3350SP	AR3350WSPX832	42	1991	750	1200	1048	1701 / 3750	1021 / 2250	907 / 2000	✓	✓
AR3105SP	-	45	2124	600	1070	915	1701 / 3750	1021 / 2250	907 / 2000	✓	✓
AR3155SP	-	45	2124	750	1070	915	1701 / 3750	1021 / 2250	907 / 2000	✓	✓
AR3305SP	-	45	2124	600	1200	1048	1701 / 3750	1021 / 2250	907 / 2000	✓	✓
AR3355SP	-	45	2124	750	1200	1048	1701 / 3750	1021 / 2250	907 / 2000	✓	✓
AR3107SP	-	48	2258	600	1070	915	1701 / 3750	1021 / 2250	907 / 2000	✓	✓
AR3157SP	AR3157WSP	48	2258	750	1070	915	1701 / 3750	1021 / 2250	907 / 2000	✓	✓
AR3307SP	AR3307WSP	48	2258	600	1200	1048	1701 / 3750	1021 / 2250	907 / 2000	✓	✓
AR3357SP	-	48	2258	750	1200	1048	1701 / 3750	1021 / 2250	907 / 2000	✓	✓

Essential Server Racks

NetShelter SV Enclosures



SKU (assembled)	SKU (unassembled)	Rack Units	Height (mm)	Width (mm)	Depth (mm)	Max Equipment Depth (mm)	Static Load (kg / lb.)	Dynamic Load (kg / lb.)	Doors	Sides
AR2400	AR2400FP1	42	2057	600	1070	777	1000 / 2205	460 / 1014	✓	✓
AR2401	-	42	2057	600	1070	777	1000 / 2205	460 / 1014	✓	✗
AR2480	-	42	2057	800	1070	777	1000 / 2205	460 / 1014	✓	✓
AR2500	-	42	2057	600	1200	917	1000 / 2205	460 / 1014	✓	✓
AR2580	-	42	2057	800	1200	917	1000 / 2205	460 / 1014	✓	✓
AR2407	-	48	2324	600	1070	777	1000 / 2205	460 / 1014	✓	✓
AR2487	-	48	2324	800	1070	777	1000 / 2205	460 / 1014	✓	✓
AR2507	-	48	2324	600	1200	917	1000 / 2205	460 / 1014	✓	✓
AR2587	-	48	2324	800	1200	917	1000 / 2205	460 / 1014	✓	✓

Rack Series Comparison

Rack Series

Premium

SX

Essential

SV

Soundproof

SP

Wall-mount

WX

2-Post & 4-Post

OF

Seismic, Colo & AV

CM

Custom & Configured

CC

Rugged

RX

Shock Packaging & Pallet

SH

Accessories & Upgrades

Airflow & Cabling

AC

Security & Access

SA

Rack PDUs

PD

Index

Product Index

PX

Compatibility Index

CX



Product Index



Essential Server Racks APC Easy Racks

SKU	Rack Units	Height (mm)	Width (mm)	Depth (mm)	Max Equipment Depth (mm)	Static Load (kg / lb.)	Dynamic Load (kg / lb.)	Doors	Sides
ER6482	24	1198	600	800	641	1197 / 2640	599 / 1320	✓	✓
ER6402	24	1198	600	1000	838	1197 / 2640	599 / 1320	✓	✓
ER6422	24	1198	600	1200	1041	1197 / 2640	599 / 1320	✓	✓
ER6282	42	1991	600	800	641	1197 / 2640	599 / 1320	✓	✓
ER8282	42	1991	800	800	641	1197 / 2640	599 / 1320	✓	✓
ER6202	42	1991	600	1000	838	1197 / 2640	599 / 1320	✓	✓
ER6202FP1*	42	1991	600	1000	838	1197 / 2640	599 / 1320	✓	✓
ER6200	42	1991	600	1000	838	1197 / 2640	599 / 1320	✓	✗
ER8202	42	1991	800	1000	838	1197 / 2640	599 / 1320	✓	✓
ER8200	42	1991	800	1000	838	1197 / 2640	599 / 1320	✓	✗
ER6212	42	1991	600	1100	940	1197 / 2640	599 / 1320	✓	✓
ER8212	42	1991	800	1100	940	1197 / 2640	599 / 1320	✓	✓
ER6222	42	1991	600	1200	1041	1197 / 2640	599 / 1320	✓	✓
ER6220	42	1991	600	1200	1041	1197 / 2640	599 / 1320	✓	✗
ER8222	42	1991	800	1200	1041	1197 / 2640	599 / 1320	✓	✓
ER8220	42	1991	800	1200	1041	1197 / 2640	599 / 1320	✓	✗
ER6802	48	2258	600	1000	838	1197 / 2640	599 / 1320	✓	✓
ER6800	48	2258	600	1000	838	1197 / 2640	599 / 1320	✓	✗
ER8802	48	2258	800	1000	838	1197 / 2640	599 / 1320	✓	✓
ER8800	48	2258	800	1000	838	1197 / 2640	599 / 1320	✓	✗
ER6812	48	2258	600	1100	940	1197 / 2640	599 / 1320	✓	✓
ER8812	48	2258	800	1100	940	1197 / 2640	599 / 1320	✓	✓
ER6822	48	2258	600	1200	1041	1197 / 2640	599 / 1320	✓	✓
ER6820	48	2258	600	1200	1041	1197 / 2640	599 / 1320	✓	✗
ER8822	48	2258	800	1200	1041	1197 / 2640	599 / 1320	✓	✓
ER8820	48	2258	800	1200	1041	1197 / 2640	599 / 1320	✓	✗

*Unassembled and flatpacked rack option and must be assembled onsite.

Rack Series Comparison

Rack Series

Premium

SX

Essential

SV

Soundproof

SP

Wall-mount

WX

2-Post & 4-Post

OF

Seismic, Colo & AV

CM

Custom & Configured

CC

Rugged

RX

Shock Packaging & Pallet

SH

Accessories & Upgrades

Airflow & Cabling

AC

Security & Access

SA

Rack PDUs

PD

Index

Product Index

PX

Compatibility Index

CX



Product Index



GO Rack

GO Rack with perforated door

SKU	Rack Units	Width (mm)	Depth (mm)	Max Equipment Depth (mm)	Static Load (kg / lb.)	Dynamic Load (kg / lb.)	Fan Ventilation	Perforated Doors	Glass Doors
NR8282-P	42	800	800	585	272 / 600	163 / 360	Sold separately	✓	✗
NR6282-P	42	600	800	585	272 / 600	163 / 360	Sold separately	✓	✗
NR8202-P	42	800	1000	785	272 / 600	163 / 360	Sold separately	✓	✗
NR6202-P	42	600	1000	785	272 / 600	163 / 360	Sold separately	✓	✗
NR8682-P	36	800	800	585	272 / 600	163 / 360	Sold separately	✓	✗
NR6682-P	36	600	800	585	272 / 600	163 / 360	Sold separately	✓	✗
NR8602-P	36	800	1000	785	272 / 600	163 / 360	Sold separately	✓	✗
NR6602-P	36	600	1000	785	272 / 600	163 / 360	Sold separately	✓	✗
NR8482-P	24	800	800	585	272 / 600	163 / 360	Sold separately	✓	✗
NR6482-P	24	600	800	585	272 / 600	163 / 360	Sold separately	✓	✗
NR8402-P	24	800	1000	785	272 / 600	163 / 360	Sold separately	✓	✗
NR6402-P	24	600	1000	785	272 / 600	163 / 360	Sold separately	✓	✗
NR8882-P	18	800	800	585	272 / 600	163 / 360	Sold separately	✓	✗
NR6882-P	18	600	800	585	272 / 600	163 / 360	Sold separately	✓	✗
NR8802-P	18	800	1000	785	272 / 600	163 / 360	Sold separately	✓	✗
NR6802-P	18	600	1000	785	272 / 600	163 / 360	Sold separately	✓	✗



GO Rack

GO Rack with glass door

SKU	Rack Units	Width (mm)	Depth (mm)	Max Equipment Depth (mm)	Static Load (kg / lb.)	Dynamic Load (kg / lb.)	Fan Ventilation	Perforated Doors	Glass Doors
NR8282-G	42	800	800	585	272 / 600	163 / 360	Sold separately	✗	✓
NR6282-G	42	272 / 600	800	585	272 / 600	163 / 360	Sold separately	✗	✓
NR8202-G	42	800	1000	785	272 / 600	163 / 360	Sold separately	✗	✓
NR6202-G	42	272 / 600	1000	785	272 / 600	163 / 360	Sold separately	✗	✓
NR8682-G	36	800	800	585	272 / 600	163 / 360	Sold separately	✗	✓
NR6682-G	36	272 / 600	800	585	272 / 600	163 / 360	Sold separately	✗	✓
NR8602-G	36	800	1000	785	272 / 600	163 / 360	Sold separately	✗	✓
NR6602-G	36	272 / 600	1000	785	272 / 600	163 / 360	Sold separately	✗	✓
NR8482-G	24	800	800	585	272 / 600	163 / 360	Sold separately	✗	✓
NR6482-G	24	272 / 600	800	585	272 / 600	163 / 360	Sold separately	✗	✓
NR8402-G	24	800	1000	785	272 / 600	163 / 360	Sold separately	✗	✓
NR6402-G	24	272 / 600	1000	785	272 / 600	163 / 360	Sold separately	✗	✓
NR8882-G	18	800	800	585	272 / 600	163 / 360	Sold separately	✗	✓
NR6882-G	18	272 / 600	800	585	272 / 600	163 / 360	Sold separately	✗	✓
NR8802-G	18	800	1000	785	272 / 600	163 / 360	Sold separately	✗	✓
NR6802-G	18	272 / 600	1000	785	272 / 600	163 / 360	Sold separately	✗	✓

Rack Series Comparison

Rack Series

Premium

SX

Essential

SV

Soundproof

SP

Wall-mount

WX

2-Post & 4-Post

OF

Seismic, Colo & AV

CM

Custom & Configured

CC

Rugged

RX

Shock Packaging & Pallet

SH

Accessories & Upgrades

Airflow & Cabling

AC

Security & Access

SA

Rack PDUs

PD

Index

Product Index

PX

Compatibility Index

CX



Product Index

Specialty Racks

NetShelter Soundproof Racks



SKU (110 –120 V)	SKU (220 – 240 V)	Rack Units	Height (mm)	Width (mm)	Depth (mm)	Max Equipment Depth (mm)	Static Load (kg / lb.)	Dynamic Load (kg / lb.)	Cooling Capacity (kW)	Sound Reduction (dBA @ 1m)
AR4012A*		12	783	750	1130	834	838 / 1848	748 / 1650	1.2	18.85
AR4017A	AR4017IA	17	1000	750	1130	834	838 / 1848	748 / 1650	1.2	18.85
AR4032A	AR4032IA	32	1666	750	1130	834	1497 / 3300	748 / 1650	2.4	18.85
AR4038LA	AR4038LIA	38	1863	750	1130	834	1497 / 3300	748 / 1650	3.6	18.85

All models are configured with locking front, rear and side panel, built-in PDU, cable manager with brush strips, casters and leveling feet and are UL certified with a 2 year warranty.

*Dual-rated 110-240 V



Wall-mount Racks

NetShelter Wall-mount Enclosures

SKU (assembled)	SKU (unassembled)	Rack Units	Height (mm)	Width (mm)	Depth (mm)	Max Equipment Depth (mm)	Static Load (kg / lb.)	Ventilation	Door Type*	Rating
SWITCH DEPTH										
AR106SH4	AR106	6	355	600	400	329 / 341	91 / 200	Passive	Perforated	IP20
AR109SH4	AR109	9	485	600	400	329 / 341	91 / 200	Passive	Perforated	IP20
AR112SH4		12	620	600	400	329 / 341	91 / 200	Passive	Perforated	IP20
SERVER DEPTH										
AR106SH6		6	355	600	600	529	91 / 200	Passive	Perforated	IP20
AR109SH6		9	485	600	600	529	91 / 200	Passive	Perforated	IP20
AR112SH6	AR112	12	620	600	600	529 / 541	91 / 200	Passive	Perforated	IP20
AR100		13	663	600	631	394	91 / 200	Passive	Glass	IP20
AR100HD		13	663	600	631	394	91 / 200	Passive	Perforated	IP20
UPS DEPTH										
AR112SM		12	662	600	1019	835	158 / 350	Passive	Perforated	IP2X
AR118SM		18	889	600	1019	835	158 / 350	Passive	Perforated	IP2X
AR124SM		24	1156	600	1019	835	158 / 350	Passive	Perforated	IP2X
VERTICAL/LOW PROFILE										
AR106V		6	648	965	631	762	113 / 250	Fan (120V)	Perforated	IP20
AR106VI		6	648	965	631	762	113 / 250	Fan (230V)	Perforated	IP20



Specialty Racks

2-Post and 4-Post Open Frame Racks

SKU	Rack Units	Height (mm)	Width (mm)	Depth (mm)	Max Equipment Depth (mm)	Static Load (kg / lb.)	Hole Type
4 POST RACK							
AR203A	44	2130	600	747	740	907 / 2000	Square
AR204A	44	2130	600	747	740	907 / 2000	#12-24 Threaded
2 POST RACK							
AR201	45	2136	513	376	1048	340 / 750	#12-24 Threaded

Rack Series Comparison

Rack Series

Premium

SX

Essential

SV

Soundproof

SP

Wall-mount

WX

2-Post & 4-Post

OF

Seismic, Colo & AV

CM

Custom & Configured

CC

Rugged

RX

Shock Packaging & Pallet

SH

Accessories & Upgrades

Airflow & Cabling

AC

Security & Access

SA

Rack PDUs

PD

Index

Product Index

PX

Compatibility Index

CX



Product Index



Specialty Racks

Seismic, Colo and AV Racks

SKU	Rack Units	Height (mm)	Width (mm)	Depth (mm)	Max Equipment Depth (mm)	Static Load (kg / lb.)	Dynamic Load (kg/ lb.)	Features	Doors	Sides
AV AUDIO / VIDEO										
AR3814	24	1199	600	825	702	1361 / 3000	1021 / 2250	#12-24 Holes	✓	✗
AR3810	42	1991	600	825	679	1361 / 3000	1021 / 2250	#12-24 Holes	✗	✗
AR3812	42	1991	600	806	679	1361 / 3000	1021 / 2250	#12-24 Holes	✓	✓
SX MULTI-COMPARTMENT / COLOCATION										
AR3200	42	1991	600	1070	945	1701 / 3750	1021 / 2250	2x20U compartments	✓	✓
VX SEISMIC										
AR2144BLK	42	2070	600	1070	934	454 kg / 1000 lb. seismic load		Seismic Zone 4	✓	✓
AR2145BLK	42	2070	600	1070	934	454 kg / 1000 lb. seismic load		Seismic Zone 4	✓	✗



Rugged Racks

NetShelter RX Enclosures

SKU	Rack Units	Height (mm)	Width (mm)	Depth (mm)	Max Equipment Depth (mm)	Static Load (kg / lb.)	Rating	Ventilation	Door Type	Availability
NSYSFRSEDC12680	24	1300	600	800	652	399 / 880	NEMA12/IP54*	Sold separately	Solid	NAM
NSYSFRSEDC206100	42	2100	600	1000	852	399 / 880	NEMA12/IP54*	Sold separately	Solid	NAM
NSYSFRSEDC20680	42	2100	600	800	652	399 / 880	NEMA12/IP54*	Sold separately	Solid	NAM
NSYSFRSEDC208100	42	2100	800	1000	852	399 / 880	NEMA12/IP54*	Sold separately	Solid	NAM
NSYSFRSEDC208120	42	2100	800	1200	1052	399 / 880	NEMA12/IP54*	Sold separately	Solid	NAM
AR5340	42	2000	800	1200	914	1361 / 3000	NEMA12/IP54	✗	Solid	EUR
AR5340F	42	2000	800	1200	914	1361 / 3000	NEMA12/IP54	✓	Solid	EUR

*with ventilation added.

NetShelter RX Wall-mount Enclosure

SKU	Rack Units	Height (mm)	Width (mm)	Depth (mm)	Max Equipment Depth (mm)	Static Load (kg / lb.)	Rating	Ventilation	Door Type	Availability
NSYVDMRS16UEDC	16	800	600	250	248	48 / 105	NEMA12	✗	Glass	NAM

Rack Series Comparison

Rack Series

Premium

SX

Essential

SV

Soundproof

SP

Wall-mount

WX

2-Post & 4-Post

OF

Seismic, Colo & AV

CM

Custom & Configured

CC

Rugged

RX

Shock Packaging & Pallet

SH

Accessories & Upgrades

Airflow & Cabling

AC

Security & Access

SA

Rack PDUs

PD

Index

Product Index

PX

Compatibility Index

CX



Compatibility Index

Table of Contents

NetShelter SX Racks

NetShelter SV Racks

APC Easy Racks

GO Rack

NetShelter Soundproof Racks

NetShelter Wall-mount Enclosures

NetShelter Open Frame and Specialty Racks

NetShelter RX Racks

Rack Series Comparison

Rack Series

Premium

SX

Essential

SV

Soundproof

SP

Wall-mount

WX

2-Post & 4-Post

OF

Seismic, Colo & AV

CM

Custom & Configured

CC

Rugged

RX

Shock Packaging & Pallet

SH

Accessories & Upgrades

Airflow & Cabling

AC

Security & Access

SA

Rack PDUs

PD

Index

Product Index

PX

Compatibility Index

CX



Compatibility Index



Accessories

NetShelter SX Enclosures (1/5)

Category	Product	Description	SKU	Premium Server Racks						Networking Racks			
				NetShelter SX								NetShelter SX	
				600 mm W			750/800 mm W			750 mm W			
			12/18U	24U	42U	45U	48U	42U	45U	48U	42U	48U	
Vertical Cable Management	Finger	Single (Front) 6"	AR7717A									✓	
			AR7737										✓
	Finger	Dual (Front/Rear) 6"	AR7580A						✓			✓	
			AR7585							✓			
			AR7588								✓		✓
	Finger	Hinged Cover for Dual Finger	AR7581A						✓				
			AR7586							✓			
			AR7589								✓		
	Finger	Cable Retainers for Dual Finger	AR7582A									✓	✓
			AR7721			✓						✓	
			AR7722				✓						
	Finger	Single (Rear) 4"	AR7723					✓					✓
			AR7707									✓	✓
			AR8442		✓	✓	✓	✓	✓	✓	✓	✓	✓
	Ring	8 Ring, Half-Height	AR8442		✓	✓	✓	✓	✓	✓	✓	✓	✓
AR7540					✓	✓	✓				✓	✓	
Bracket	Cable Containment w/ PDU Mount	AR7710	✓	✓	✓	✓	✓				✓	✓	
		AR7585			✓		✓	✓		✓	✓	✓	
Cable Tree	Center Mount	AR7585			✓		✓	✓		✓	✓	✓	
		AR8443A		✓	✓	✓	✓				✓	✓	
Fiber Organizer	Bracket + Spool	AR8443A		✓	✓	✓	✓				✓	✓	
		AR8444	✓	✓	✓	✓	✓				✓	✓	
Vertical Channel	0 U Accessory Channel w/ PDU Mount	AR7502			✓			✓			✓		
		AR7552				✓			✓				
		AR7572					✓			✓		✓	

Rack Series Comparison

Rack Series

Premium

SX

Essential

SV

Soundproof

SP

Wall-mount

WX

2-Post & 4-Post

OF

Seismic, Colo & AV

CM

Custom & Configured

CC

Rugged

RX

Shock Packaging & Pallet

SH

Accessories & Upgrades

Airflow & Cabling

AC

Security & Access

SA

Rack PDUs

PD

Index

Product Index

PX

Compatibility Index

CX



Continued on the next page

Compatibility Index



Accessories

NetShelter SX Enclosures (2/5)

Category	Product	Description	SKU	Premium Server Racks									Networking Racks	
				NetShelter SX									NetShelter SX	
				600 mm W					750/800 mm W				750 mm W	
				12/18U	24U	42U	45U	48U	42U	45U	48U	42U	48U	
Horizontal Cable Management	1U Cable Managers	Finger 1.5"	ER7HCM	✓	✓	✓	✓	✓	✓	✓	✓	✓	✓	
		Finger 4"	AR8602A	✓	✓	✓	✓	✓	✓	✓	✓	✓	✓	
		Finger 6"	AR8612	✓	✓	✓	✓	✓	✓	✓	✓	✓	✓	
		Ring	AR8425A	✓	✓	✓	✓	✓	✓	✓	✓	✓	✓	
		Brush Passthrough	AR8429	✓	✓	✓	✓	✓	✓	✓	✓	✓	✓	
		Management Arm	AR8129	✓	✓	✓	✓	✓	✓	✓	✓	✓	✓	
	2U Cable Managers	Finger 4"	AR8600A	✓	✓	✓	✓	✓	✓	✓	✓	✓	✓	
		Finger 6"	AR8606	✓	✓	✓	✓	✓	✓	✓	✓	✓	✓	
		Finger 6" + Brush Strip & Lacing Bar	AR8603A	✓	✓	✓	✓	✓	✓	✓	✓	✓	✓	
		Ring (Standard)	AR8426A	✓	✓	✓	✓	✓	✓	✓	✓	✓	✓	
		Ring + Passthrough	AR8428	✓	✓	✓	✓	✓	✓	✓	✓	✓	✓	
		Ring + Fingers	AR8427A	✓	✓	✓	✓	✓	✓	✓	✓	✓	✓	
	3U	Finger 6"	AR8605	✓	✓	✓	✓	✓	✓	✓	✓	✓	✓	
	Misc	Ring (5 lg + 5 sm)	AR8113A	✓	✓	✓	✓	✓	✓	✓	✓	✓	✓	
		Front to Rear 10" – 18" Adjust	AR8016ABLK						✓	✓	✓			
		Front to Rear 18" – 30" Adjust	AR8008BLK						✓	✓	✓			
		Cable Ties (Hook + Loop)	AR8621	✓	✓	✓	✓	✓	✓	✓	✓	✓	✓	
	Airflow Management	Blanking Panel	Toolless/Snap-in 1U (qty 10)	AR8136BLK	✓	✓	✓	✓	✓	✓	✓	✓	✓	✓
Toolless/Snap-in 1U (qty 200)			AR8136BLK200	✓	✓	✓	✓	✓	✓	✓	✓	✓	✓	
Fixed 1U (qty 2)			AR8108BLK	✓	✓	✓	✓	✓	✓	✓	✓	✓	✓	
Fixed 1U, 2U, 4U, 8U Panel Kit			AR8101BLK	✓	✓	✓	✓	✓	✓	✓	✓	✓	✓	
Airflow Recirculation		Air Dam Int.Rack Recirculation Kit	AR7708	✓	✓	✓	✓	✓	✓	✓	✓	✓	✓	
		Air Dam Ext.Rack/Floor Sealing Kit	AR7731	✓	✓	✓	✓	✓	✓	✓	✓	✓	✓	
		Air Dam Baying Trim Kit	AR7600	✓	✓	✓	✓	✓	✓	✓	✓	✓	✓	
		Air Dam Mounting Rail Brush Strips	AR7706						✓	✓	✓	✓	✓	

Rack Series Comparison

Rack Series

Premium

SX

Essential

SV

Soundproof

SP

Wall-mount

WX

2-Post & 4-Post

OF

Seismic, Colo & AV

CM

Custom & Configured

CC

Rugged

RX

Shock Packaging & Pallet

SH

Accessories & Upgrades

Airflow & Cabling

AC

Security & Access

SA

Rack PDUs

PD

Index

Product Index

PX

Compatibility Index

CX



Continued on the next page

Compatibility Index



Accessories

NetShelter SX Enclosures (3/5)

Category	Product	Description	SKU	Premium Server Racks									Networking Racks	
				NetShelter SX									NetShelter SX	
				600 mm W					750/800 mm W				750 mm W	
				12/18U	24U	42U	45U	48U	42U	45U	48U	42U	48U	
Shelves and Drawers	Fixed-Depth 250 lb. Capacity	AR8122BLK	1070 D only	✓	✓	✓	✓	✓	✓	✓	✓	✓	✓	
	Fixed-Depth 50 lb. Capacity	AR8105BLK	1070 D only	✓	✓	✓	✓	✓	✓	✓	✓	✓	✓	
	Sliding/Adjustable XX" Depth 100 lb. Capacity	AR8123BLK	1070 D only	✓	✓	✓	✓	✓	✓	✓	1200 D only	1200 D only		
	Sliding/Adjustable 18 – 25" Depth 250 lb. Capacity	AR8125	1070 D only	✓	✓	✓	✓	✓	✓	✓	✓	✓		
	Sliding/Adjustable XX" Depth 200 lb. Capacity	AR8128BLK	1070 D only	✓	✓	✓	✓	✓	✓	✓	✓	✓		
	17" Keyboard Drawers	AR8126ABLK	1070 D only	✓	✓	✓	✓	✓	✓	✓	✓	✓		
	19" Rotating Keyboard Drawers	AR8127BLK	1070 D only	✓	✓	✓	✓	✓	✓	✓	✓	✓		
Bolt Down Kits	Stabilization Plate	AR7700	✓	✓	✓	✓	✓	✓	✓	✓	✓	✓		
	Standard Kit	AR7701	✓	✓	✓	✓	✓	✓	✓	✓	✓	✓		
	Seismic IBC/ OSHPD	AR7701A-S		✓	✓	✓	✓	✓	✓	✓	✓	✓		
Depth Adapter	Depth Extender 130 mm	ACDC2551			✓	✓	✓	✓	✓	✓	✓	✓		
Mounting Options	PDU Orientation Mounting	AR7711	✓	✓	✓	✓	✓	✓	✓	✓	✓	✓		
	23" – 19" Rail Adapter Kit	AR8150BLK						✓	✓	✓	✓	✓		
	Channel (Japan)	AR7709		✓	✓	✓	✓	✓	✓	✓	✓	✓		
	Level Pads	AR7605		✓	✓	✓	✓	✓	✓	✓	✓	✓		
Hardware / Cage Nuts	#10-32 Cage Nuts (qty 36)	AR8005	✓	✓	✓	✓	✓	✓	✓	✓	✓	✓		
	M6 Cage Nuts (qty 32)	AR8100	✓	✓	✓	✓	✓	✓	✓	✓	✓	✓		
	#12-24 Screws (qty 100)	AR8400	✓	✓	✓	✓	✓	✓	✓	✓	✓	✓		

Rack Series Comparison

Rack Series

Premium

SX

Essential

SV

Soundproof

SP

Wall-mount

WX

2-Post & 4-Post

OF

Seismic, Colo & AV

CM

Custom & Configured

CC

Rugged

RX

Shock Packaging & Pallet

SH

Accessories & Upgrades

Airflow & Cabling

AC

Security & Access

SA

Rack PDUs

PD

Index

Product Index

PX

Compatibility Index

CX



Continued on the next page

Compatibility Index



Accessories

NetShelter SX Enclosures (4/5)

Category	Product	Description	SKU	Premium Server Racks									Networking Racks	
				NetShelter SX									NetShelter SX	
				600 mm W					750/800 mm W				750 mm W	
				12/18U	24U	42U	45U	48U	42U	45U	48U	42U	48U	
Shelves & Mounting Accessories	Rail Kits	Recessed Rail Kits	AR7503			✓								
			AR7504					✓						
			AR7508						✓		✓			
			AR7578							✓		✓		
		23" EIA Rails	AR7510						✓		✓			
	Casters	Swivel (qty 4)	AR7719	✓	✓	✓	✓	✓	✓	✓	✓	✓	✓	
Specialty	Copper Busbar	AR8395		✓	✓	✓	✓	✓	✓	✓	✓	✓		
Roof Mounted Cable Troughs & Partitions	Troughs	Solid 600 mm	AR8561			✓	✓	✓						
		Solid 700 mm	AR8181BLK						700 W	700 W	700 W			
		Solid 750 mm	AR8571						✓	✓	✓	✓	✓	
		Solid 800 mm	AR8571X417						✓	✓	✓			
		Open Btm 600 mm	AR8560			✓	✓	✓						
		Open Btm 750 mm	AR8570						✓	✓	✓	✓	✓	
		Grommet (13' Roll)	AR8579			✓	✓	✓	✓	✓	✓	✓	✓	
	Partitions	Solid 600 mm	AR8162ABLK			✓	✓	✓						
		Solid 700 mm	AR8187BLK						700 W	700 W	700 W			
		Solid 750 mm	AR8172BLK						✓	✓	✓	✓	✓	
		Solid 800 mm	AR8172BLKX417						✓	✓	✓			
		Passthrough 600 mm	AR8163ABLK			✓	✓	✓						
		Passthrough 700 mm	AR8188BLK						700 W	700 W	700 W			
		Passthrough 750 mm	AR8173BLK						✓	✓	✓	✓	✓	
	Passthrough 800 mm	AR8173BLKX417						✓	✓	✓				

Rack Series Comparison

Rack Series

Premium

SX

Essential

SV

Soundproof

SP

Wall-mount

WX

2-Post & 4-Post

OF

Seismic, Colo & AV

CM

Custom & Configured

CC

Rugged

RX

Shock Packaging & Pallet

SH

Accessories & Upgrades

Airflow & Cabling

AC

Security & Access

SA

Rack PDUs

PD

Index

Product Index

PX

Compatibility Index

CX



Continued on the next page

Compatibility Index



Accessories

NetShelter SX Racks (5/5)

				Premium Server Racks									Networking Racks	
				NetShelter SX									NetShelter SX	
				600 mm W					750/800 mm W				750 mm W	
Product Category	Product	Description	SKU	12/18U	24U	42U	45U	48U	42U	45U	48U	42U	48U	
Cable Ladders & Accessories	Ladders	Data Cable Ladder + Attachment Kit	AR8164ABLK			✓	✓	✓	✓	✓	✓	✓	✓	
		Data Cable Ladder	AR8164AKIT			✓	✓	✓	✓	✓	✓	✓	✓	
		Power Cable Ladder + Attachment Kit	AR8165ABLK			✓	✓	✓	✓	✓	✓	✓	✓	
		Power Cable Ladder	AR8165AKIT			✓	✓	✓	✓	✓	✓	✓	✓	
	Attachment Kits	w/ Cable Troughs	AR8166ABLK			✓	✓	✓	✓	✓	✓	✓	✓	✓
		For Partitions	AR8177BLK			✓	✓	✓	✓	✓	✓	✓	✓	✓
		For Enclosures/ Troughs	AR8186			✓	✓	✓	✓	✓	✓	✓	✓	✓
		Clamp Kit	AR8169			✓	✓	✓	✓	✓	✓	✓	✓	✓
		Corner Clamp Kit	AR8461			✓	✓	✓	✓	✓	✓	✓	✓	✓
		Stacking Kit	AR8462			✓	✓	✓	✓	✓	✓	✓	✓	✓
		Angle Clamp Kit	AR8463			✓	✓	✓	✓	✓	✓	✓	✓	✓
		Wall Termination Kit	AR8465			✓	✓	✓	✓	✓	✓	✓	✓	✓
		Ladder Hanger Kit	AR8576			✓	✓	✓	✓	✓	✓	✓	✓	✓
		Falls	Cable Fall	AR8654			✓	✓	✓	✓	✓	✓	✓	✓
Security Options	Door Locks	Combo Door Handle	AR8132A	✓	✓	✓	✓	✓	✓	✓	✓	✓	✓	
		NetBotz Keypad Handle 125 Hz	NBHN125	✓	✓	✓	✓	✓	✓	✓	✓	✓	✓	
		NetBotz Keypad Handle 13.56 Hz	NBHN1356	✓	✓	✓	✓	✓	✓	✓	✓	✓	✓	

Rack Series Comparison

Rack Series

Premium

SX

Essential

SV

Soundproof

SP

Wall-mount

WX

2-Post & 4-Post

OF

Seismic, Colo & AV

CM

Custom & Configured

CC

Rugged

RX

Shock Packaging & Pallet

SH

Accessories & Upgrades

Airflow & Cabling

AC

Security & Access

SA

Rack PDUs

PD

Index

Product Index

PX

Compatibility Index

CX



Compatibility Index



Accessories

NetShelter SV Racks (1/3)

Essential Server Racks			
NetShelter SV			
600 mm W		800 mm W	
42U	48U	42U	48U

Product Category	Product	Description	SKU	42U	48U	42U	48U
Vertical Cable Management	Finger	Single (Rear) 4"	AR7721	✓	✓	✓	✓
	Ring	8 Ring, Half-Height	AR8442	✓	✓	✓	✓
	Bracket	Cable Containment w/ PDU Mount	AR7710	✓	✓	✓	✓
	Fiber Organizer	Bracket + Spool	AR8443A	✓	✓	✓	✓
		Spools Only	AR8444	✓	✓	✓	✓
	Horizontal Cable Management	1U Cable Managers	Finger 1.5"	ER7HCM	✓	✓	✓
Finger 4"			AR8602A	✓	✓	✓	✓
Finger 6"			AR8612	✓	✓	✓	✓
Ring			AR8425A	✓	✓	✓	✓
Brush Passthrough			AR8429	✓	✓	✓	✓
Management Arm			AR8129	✓	✓	✓	✓
2U Cable Managers		Finger 4"	AR8600A	✓	✓	✓	✓
		Finger 6"	AR8606	✓	✓	✓	✓
		Finger 6" + Brush Strip & Lacing Bar	AR8603A	✓	✓	✓	✓
		Ring (Standard)	AR8426A	✓	✓	✓	✓
		Ring + Passthrough	AR8428	✓	✓	✓	✓
		Ring + Fingers	AR8427A	✓	✓	✓	✓
3U		Finger 6"	AR8605	✓	✓	✓	✓
Misc	Ring (5 lg + 5 sm)	AR8113A	✓	✓	✓	✓	
	Cable Ties (Hook + Loop)	AR8621	✓	✓	✓	✓	

Rack Series Comparison

Rack Series

Premium

SX

Essential

SV

Soundproof

SP

Wall-mount

WX

2-Post & 4-Post

OF

Seismic, Colo & AV

CM

Custom & Configured

CC

Rugged

RX

Shock Packaging & Pallet

SH

Accessories & Upgrades

Airflow & Cabling

AC

Security & Access

SA

Rack PDUs

PD

Index

Product Index

PX

Compatibility Index

CX



Continued on the next page

Compatibility Index



Accessories

NetShelter SV Racks (2/3)

				Essential Server Racks			
				NetShelter SV			
				600 mm W		800 mm W	
Product Category	Product	Description	SKU	42U	48U	42U	48U
Airflow Management	Blanking Panel	Toolless/Snap-in 1U (qty 10)	AR8136BLK	✓	✓	✓	✓
		Toolless/Snap-in 1U (qty 200)	AR8136BLK200	✓	✓	✓	✓
		Fixed 1U (qty 2)	AR8108BLK	✓	✓	✓	✓
		Fixed 1U, 2U, 4U, 8U Panel Kit	AR8101BLK	✓	✓	✓	✓
Shelves & Mounting Accessories	Shelves & Drawers	Fixed-Depth 250 lb. Capacity	AR8122BLK	✓	✓	✓	✓
		Fixed-Depth 50 lb. Capacity	AR8105BLK	✓	✓	✓	✓
		Sliding/Adjustable XX" Depth 100 lb. Capacity	AR8123BLK	✓	✓	✓	✓
		Sliding/Adjustable 18 – 25" Depth 250 lb. Capacity	AR8125	✓	✓	✓	✓
		17" Keyboard Drawers	AR8126ABLK	✓	✓	✓	✓
	19" Rotating Keyboard Drawers	AR8127BLK	✓	✓	✓	✓	
	Mounting Options	PDU Mounting - SV	AR824002	✓	✓	✓	✓
		Level Pads	AR7605	✓	✓	✓	✓
	Hardware / Cage Nuts	#10-32 Cage Nuts (qty 36)	AR8005	✓	✓	✓	✓
		M6 Cage Nuts (qty 32)	AR8100	✓	✓	✓	✓
#12-24 Screws (qty 100)		AR8400	✓	✓	✓	✓	
Specialty	Copper Busbar	AR8395	✓	✓	✓	✓	

Rack Series Comparison

Rack Series

Premium

SX

Essential

SV

Soundproof

SP

Wall-mount

WX

2-Post & 4-Post

OF

Seismic, Colo & AV

CM

Custom & Configured

CC

Rugged

RX

Shock Packaging & Pallet

SH

Accessories & Upgrades

Airflow & Cabling

AC

Security & Access

SA

Rack PDUs

PD

Index

Product Index

PX

Compatibility Index

CX



Continued on the next page

Compatibility Index



Accessories

NetShelter SV Racks (3/3)

				Essential Server Racks			
				NetShelter SV			
				600 mm W		800 mm W	
Product Category	Product	Description	SKU	42U	48U	42U	48U
Roof Mounted Cable Troughs & Partitions	Troughs	Solid 600 mm	AR8561	✓	✓		
		Solid 800 mm	AR8571X417			✓	✓
		Open Btm 600 mm	AR8560	✓	✓		
		Grommet (13' Roll)	AR8579	✓	✓	✓	✓
	Partitions	Solid 600 mm	AR8162ABLK	✓	✓		
		Solid 800 mm	AR8172BLKX417			✓	✓
		Passthrough 600 mm	AR8163ABLK	✓	✓		
		Passthrough 800 mm	AR8173BLKX417			✓	✓
Cable Ladders & Accessories	Ladders	Data Cable Ladder + Attachment Kit	AR8164ABLK	✓	✓	✓	✓
		Data Cable Ladder	AR8164AKIT	✓	✓	✓	✓
		Power Cable Ladder + Attachment Kit	AR8165ABLK	✓	✓	✓	✓
		Power Cable Ladder	AR8165AKIT	✓	✓	✓	✓
	Attachment Kits	For Enclosures/Troughs	AR8186	✓	✓	✓	✓
		Corner Clamp Kit	AR8461	✓	✓	✓	✓
		Stacking Kit	AR8462	✓	✓	✓	✓
		Angle Clamp Kit	AR8463	✓	✓	✓	✓
		Wall Termination Kit	AR8465	✓	✓	✓	✓
		Ladder Hanger Kit	AR8576	✓	✓	✓	✓
Falls	Cable Fall	AR8654	✓	✓	✓	✓	
Security Options	Door Locks	Combo Door Handle	AR8132A	✓	✓	✓	✓
		NetBotz Keycard Handle 125 Hz	NBHN125	✓	✓	✓	✓
		NetBotz Keycard Handle 13.56 Hz	NBHN1356	✓	✓	✓	✓

Rack Series Comparison

Rack Series

Premium

SX

Essential

SV

Soundproof

SP

Wall-mount

WX

2-Post & 4-Post

OF

Seismic, Colo & AV

CM

Custom & Configured

CC

Rugged

RX

Shock Packaging & Pallet

SH

Accessories & Upgrades

Airflow & Cabling

AC

Security & Access

SA

Rack PDUs

PD

Index

Product Index

PX

Compatibility Index

CX



Compatibility Index



Accessories APC Easy Racks (1/3)

				Essential Server Racks					
				APC Easy Racks					
				600 mm W			800 mm W		
Product Category	Product	Description	SKU	24U	42U	48U	42U	48U	
Vertical Cable Management	Finger	Dual (Front/Rear) 4"	ER7VCM42				✓		
		Dual (Front/Rear) 4"	ER7VCM48					✓	
	Vertical Channel	0 U Channel w/ PDU Mount	ER7RCC24	✓					
			ER7RCC42		✓		✓		
			ER7RCC48			✓		✓	
	Horizontal Cable Management	1U Cable Managers	Finger 1.5"	ER7HCM	✓	✓	✓	✓	✓
Finger 4"			AR8602A	✓	✓	✓	✓	✓	
Finger 6"			AR8612	✓	✓	✓	✓	✓	
Ring			AR8425A	✓	✓	✓	✓	✓	
Brush Passthrough			AR8429	✓	✓	✓	✓	✓	
Management Arm			AR8129	✓	✓	✓	✓	✓	
2U Cable Managers		Finger 4"	AR8600A	✓	✓	✓	✓	✓	
		Finger 6"	AR8606	✓	✓	✓	✓	✓	
		Finger 6" + Brush Strip & Lacing Bar	AR8603A	✓	✓	✓	✓	✓	
		Ring (Standard)	AR8426A	✓	✓	✓	✓	✓	
		Ring + Passthrough	AR8428	✓	✓	✓	✓	✓	
		Ring + Fingers	AR8427A	✓	✓	✓	✓	✓	
3U		Finger 6"	AR8605	✓	✓	✓	✓	✓	
Misc		Ring (5 lg + 5 sm)	AR8113A	✓	✓	✓	✓	✓	
		Cable Ties (Hook + Loop)	AR8621	✓	✓	✓	✓	✓	
Airflow Management		Blanking Panel	Toolless/Snap-in 1U (qty 10)	AR8136BLK	✓	✓	✓	✓	✓
			Toolless/Snap-in 1U (qty 200)	AR8136BLK200	✓	✓	✓	✓	✓
			Fixed 1U (qty 2)	AR8108BLK	✓	✓	✓	✓	✓
	Fixed 1U, 2U, 4U, 8U Panel Kit		AR8101BLK	✓	✓	✓	✓	✓	

Rack Series Comparison

Rack Series

Premium

SX

Essential

SV

Soundproof

SP

Wall-mount

WX

2-Post & 4-Post

OF

Seismic, Colo & AV

CM

Custom & Configured

CC

Rugged

RX

Shock Packaging & Pallet

SH

Accessories & Upgrades

Airflow & Cabling

AC

Security & Access

SA

Rack PDUs

PD

Index

Product Index

PX

Compatibility Index

CX



Continued on the next page

Compatibility Index



Accessories

APC Easy Racks (2/3)

				Essential Server Racks				
				APC Easy Racks				
				600 mm W			800 mm W	
Product Category	Product	Description	SKU	24U	42U	48U	42U	48U
Shelves & Mounting Accessories	Shelves & Drawers	Fixed-Depth 250 lb. Capacity	AR8122BLK	not 800 D	not 800 D	not 800 D	not 800 D	not 800 D
		Fixed-Depth 50 lb. Capacity	AR8105BLK	not 800 D	not 800 D	not 800 D	not 800 D	not 800 D
		Sliding/Adjustable XX" Depth 100 lb. Capacity	AR8123BLK	not 800 D	not 800 D	not 800 D	not 800 D	not 800 D
		Sliding/Adjustable 18 – 25" Depth 250 lb. Capacity	AR8125	not 800 D	not 800 D	not 800 D	not 800 D	not 800 D
		Sliding/Adjustable XX" Depth 200 lb. Capacity	AR8128BLK	not 800 D	not 800 D	not 800 D	not 800 D	not 800 D
		Sliding/Adjustable Deep 110 lb. Capacity	ER7SHELF	1100–1200 D	1100–1200 D	1100–1200 D	1100–1200 D	1100–1200 D
		Sliding/Adjustable Short 110 lb. Capacity	ER7SHELFS	1000 D	1000 D	1000 D	1000 D	1000 D
		17" Keyboard Drawers	AR8126ABLK	not 800 D	not 800 D	not 800 D	not 800 D	not 800 D
		19" Rotating Keyboard Drawers	AR8127BLK	not 800 D	not 800 D	not 800 D	not 800 D	not 800 D
	PDU Mount Options	Double Width	ER7PDUBRKT	1100–1200 D	1100–1200 D	1100–1200 D	1100–1200 D	1100–1200 D
Single Width		ER7PDUBRKT5	1000 D	1000 D	1000 D	1000 D	1000 D	
Hardware / Cage Nuts	#10-32 Cage Nuts (qty 36)	AR8005	✓	✓	✓	✓	✓	
	M6 Cage Nuts (qty 32)	AR8100	✓	✓	✓	✓	✓	
	#12-24 Screws (qty 100)	AR8400	✓	✓	✓	✓	✓	
Roof Mounted Cable Troughs & Partitions	Troughs	Solid 600 mm	AR8561	✓	✓	✓		
		Solid 800 mm	AR8571X417				✓	✓
		Grommet (13' Roll)	AR8579	✓	✓	✓	✓	
	Partitions	Solid 600 mm	AR8162ABLK	✓	✓	✓		
		Solid 800 mm	AR8172BLKX417				✓	✓
		Passthrough 600 mm	AR8163ABLK	✓	✓	✓		
		Passthrough 800 mm	AR8173BLKX417				✓	✓

Rack Series Comparison

Rack Series

Premium

SX

Essential

SV

Soundproof

SP

Wall-mount

WX

2-Post & 4-Post

OF

Seismic, Colo & AV

CM

Custom & Configured

CC

Rugged

RX

Shock Packaging & Pallet

SH

Accessories & Upgrades

Airflow & Cabling

AC

Security & Access

SA

Rack PDUs

PD

Index

Product Index

PX

Compatibility Index

CX



Continued on the next page

Compatibility Index



Accessories APC Easy Racks (3/3)

				Essential Server Racks				
				APC Easy Racks				
				600 mm W			800 mm W	
Product Category	Product	Description	SKU	24U	42U	48U	42U	48U
Cable Ladders & Accessories	Ladders	Data Cable Ladder + Attachment Kit	AR8164ABLK	✓	✓	✓	✓	✓
		Data Cable Ladder	AR8164AKIT	✓	✓	✓	✓	✓
		Power Cable Ladder + Attachment Kit	AR8165ABLK	✓	✓	✓	✓	✓
		Power Cable Ladder	AR8165AKIT	✓	✓	✓	✓	✓
	Attachment Kits	for Enclosures and Troughs	AR8186	✓	✓	✓	✓	✓
		Clamp Kit	AR8169	✓	✓	✓	✓	✓
		Corner Clamp Kit	AR8461	✓	✓	✓	✓	✓
		Stacking Kit	AR8462	✓	✓	✓	✓	✓
		Angle Clamp Kit	AR8463	✓	✓	✓	✓	✓
		Wall Termination Kit	AR8465	✓	✓	✓	✓	✓
		Ladder Hanger Kit	AR8576	✓	✓	✓	✓	✓
	Falls	Cable Fall	AR8654	✓	✓	✓	✓	✓
	Security Options	Door Locks	Combo Door Handle	AR8132A	✓	✓	✓	✓
NetBotz Keycard Handle 125 Hz			NBHN125	✓	✓	✓	✓	✓
NetBotz Keycard Handle 13.56 Hz			NBHN1356	✓	✓	✓	✓	✓

Rack Series Comparison

Rack Series

Premium

SX

Essential

SV

Soundproof

SP

Wall-mount

WX

2-Post & 4-Post

OF

Seismic, Colo & AV

CM

Custom & Configured

CC

Rugged

RX

Shock Packaging & Pallet

SH

Accessories & Upgrades

Airflow & Cabling

AC

Security & Access

SA

Rack PDUs

PD

Index

Product Index

PX

Compatibility Index

CX



Compatibility Index



Accessories NetShelter GO Rack

Product Category	Product	Description	SKU	GO Rack			
				18U	24U	36U	48U
Base Management	Plinths	100x600x800mm (HxWxD) Modular	NRBMP-6080	✓	✓	✓	✓
		100x600x1000mm (HxWxD) Modular	NRBMP-6010	✓	✓	✓	✓
		100x800x800mm (HxWxD) Modular	NRBMP-8080	✓	✓	✓	✓
		100x800x1000mm (HxWxD) Modular	NRBMP-8010	✓	✓	✓	✓
Hardware	Cage Nuts	M6 Cage Nut Set, 1 Set 20 pcs, Screw, Nut, Washer	NRCN-M620	✓	✓	✓	✓
Cable Management	Panel	1U 19" Cable Management Panel 5 Rings RAL 9005 Black	NRCMP-1U-BL	✓	✓	✓	✓
		2U 19" Cable Management Panel 5 Metal Rings L:63 mm	NRCMP-2U-BL	✓	✓	✓	✓
	Cable Tray	42U Cable Tray Zinc Plated W=100mm	NRCMT-42U-ZN	✓	✓	✓	✓
		36U Cable Tray Zinc Plated W=100 mm	NRCMT-36U-ZN	✓	✓	✓	✓
		24U Cable Tray Zinc Plated W=100 mm	NRCMT-24U-ZN	✓	✓	✓	✓
	Airflow Management	4 Fan Module	On/Off Switched Freestanding Type	NRAFM-4FAN-ONF-FS	✓	✓	✓
Thermostatic-Controlled Freestanding Type			NRAFM-4FAN-THM-FS	✓	✓	✓	✓
Misc	Other Accessories	Fixed Shelf, 19" 1U Metal Bracket, 4 Point Fixing, Depth: 570 mm for D=800 mm Cabinets, Load Capacity 50 kg Universal Model	NRMB-1U-D800	✓	✓	✓	✓
		Fixed Shelf, 19" 1U Metal Bracket, 4 Point Fixing, Depth: 740 mm for D=1000 mm Cabinets, Load Capacity 50 kg Universal Model	NRMB-1U-D1000	✓	✓	✓	✓
		Sliding Shelf, 4 Point Fixing, Depth: 570 mm for D = 800 mm Cabinets, Load Capacity 30 kg	NRSS-4P-D800	✓	✓	✓	✓
		1U 19" Blank Panel Screw Type	NRBP-1U	✓	✓	✓	✓
		3U 19" Blank Panel Screw Type	NRBP-3U	✓	✓	✓	✓

Rack Series Comparison

Rack Series

Premium

SX

Essential

SV

Soundproof

SP

Wall-mount

WX

2-Post & 4-Post

OF

Seismic, Colo & AV

CM

Custom & Configured

CC

Rugged

RX

Shock Packaging & Pallet

SH

Accessories & Upgrades

Airflow & Cabling

AC

Security & Access

SA

Rack PDUs

PD

Index

Product Index

PX

Compatibility Index

CX



Compatibility Index



Accessories

NetShelter Soundproof Racks (1/2)

Specialty Racks			
NetShelter Soundproof Racks			
700 mm W			
12U	17U	32U	38U

Product Category	Product	Description	SKU	12U	17U	32U	38U	
Horizontal Cable Management	1U Cable Managers	Finger 1.5"	ER7HCM	✓	✓	✓	✓	
		Finger 4"	AR8602A	✓	✓	✓	✓	
		Finger 6"	AR8612	✓	✓	✓	✓	
		Ring	AR8425A	✓	✓	✓	✓	
		Brush Passthrough	AR8429	✓	✓	✓	✓	
		Management Arm	AR8129	✓	✓	✓	✓	
	2U Cable Managers	Finger 4"	AR8600A	✓	✓	✓	✓	
		Finger 6"	AR8606	✓	✓	✓	✓	
		Finger 6" + Brush Strip & Lacing Bar	AR8603A	✓	✓	✓	✓	
		Ring (Standard)	AR8426A	✓	✓	✓	✓	
		Ring + Passthrough	AR8428	✓	✓	✓	✓	
		Ring + Fingers	AR8427A	✓	✓	✓	✓	
	3U	Finger 6"	AR8605	✓	✓	✓	✓	
	Misc	Ring (5 lg + 5 sm)	AR8113A	✓	✓	✓	✓	
		Cable Ties (Hook + Loop)	AR8621	✓	✓	✓	✓	
	Airflow Management	Blanking Panel	Toolless/Snap-in 1U (qty 10)	AR8136BLK	✓	✓	✓	✓
			Toolless/Snap-in 1U (qty 200)	AR8136BLK200	✓	✓	✓	✓
			Fixed 1U (qty 2)	AR8108BLK	✓	✓	✓	✓
			Fixed 1U, 2U, 4U, 8U Panel Kit	AR8101BLK	✓	✓	✓	✓

Rack Series Comparison

Rack Series

Premium

SX

Essential

SV

Soundproof

SP

Wall-mount

WX

2-Post & 4-Post

OF

Seismic, Colo & AV

CM

Custom & Configured

CC

Rugged

RX

Shock Packaging & Pallet

SH

Accessories & Upgrades

Airflow & Cabling

AC

Security & Access

SA

Rack PDUs

PD

Index

Product Index

PX

Compatibility Index

CX



Continued on the next page

Compatibility Index



Accessories

NetShelter Soundproof Racks (2/2)

				Specialty Racks			
				NetShelter Soundproof Racks			
				700 mm W			
Product Category	Product	Description	SKU	12U	17U	32U	38U
Shelves & Mounting Accessories	Shelves & Drawers	Fixed-Depth 250 lb. Capacity	AR8122BLK	✓	✓	✓	✓
		Fixed-Depth 50 lb. Capacity	AR8105BLK	✓	✓	✓	✓
		Fixed Double Sided 250 lb. Capacity	AR8422	✓	✓	✓	✓
		Sliding/Adjustable XX" Depth 100 lb. Capacity	AR8123BLK	✓	✓	✓	✓
		Sliding/Adjustable 18 – 25" Depth 250 lb. Capacity	AR8125	✓	✓	✓	✓
		Sliding/Adjustable XX" Depth 200 lb. Capacity	AR8128BLK	✓	✓	✓	✓
		Sliding/Adjustable Deep / 110 lb. Capacity	ER7SHELF	✓	✓	✓	✓
		Sliding/Adjustable Short / 110 lb. Capacity	ER7SHELFS	✓	✓	✓	✓
		17" Keyboard Drawers	AR8126ABLK	✓	✓	✓	✓
		19" Rotating Keyboard Drawers	AR8127BLK	✓	✓	✓	✓
Mounting Options	PDU Orientation Mounting	AR7711	✓	✓	✓	✓	
	Double Width PDU Mount	ER7PDUBRKT	✓	✓	✓	✓	
	Single Width PDU Mount	ER7PDUBRKTS	✓	✓	✓	✓	
Hardware / Cage Nuts	M6 Cage Nuts (qty 32)	AR8100	✓	✓	✓	✓	

Rack Series Comparison

Rack Series

Premium

SX

Essential

SV

Soundproof

SP

Wall-mount

WX

2-Post & 4-Post

OF

Seismic, Colo & AV

CM

Custom & Configured

CC

Rugged

RX

Shock Packaging & Pallet

SH

Accessories & Upgrades

Airflow & Cabling

AC

Security & Access

SA

Rack PDUs

PD

Index

Product Index

PX

Compatibility Index

CX



Continued on the next page

Compatibility Index



Accessories

NetShelter Wall-mount Enclosures (1/2)

Product Category	Product	Description	SKU	Wall-mount Enclosures						
				Switch Depth		Server Depth			UPS Depth	Vertical/ Low Profile
				Assembled	Unassembled	Assembled	Unassembled	Assembled	Assembled	
				6/9/12U	6/9U	6/9/12U	13U	12U	12/18/24U	6U
Vertical Mgmt	Fiber Organizer	Spools Only	AR8444	✓		✓			✓	
	1U Cable Managers	Finger 1.5"	ER7HCM	✓	✓	✓	✓	✓	✓	✓
Finger 4"		AR8602A	✓	✓	✓	✓	✓	✓	✓	
Finger 6"		AR8612				✓		✓		
Ring		AR8425A	✓	✓	✓	✓	✓	✓		
Brush Passthrough		AR8429	✓	✓	✓	✓	✓	✓	✓	
Management Arm		AR8129	✓	✓	✓		✓	✓		
Horizontal Cable Management		2U Cable Managers	Finger 4"	AR8600A	✓	✓	✓	✓	✓	✓
	Finger 6"		AR8606				✓		✓	
	Finger 6" + Brush Strip & Lacing Bar		AR8603A				✓		✓	
	Ring (Standard)		AR8426A	✓	✓	✓	✓	✓	✓	
	Ring + Passthrough		AR8428	✓	✓	✓	✓	✓	✓	
	Ring + Fingers		AR8427A	✓	✓	✓	✓	✓	✓	
	3U		Finger 6"	AR8605				✓		✓
	Misc	Ring (5 lg + 5 sm)	AR8113A	✓	✓	✓	✓	✓	✓	
		Cable Ties (Hook + Loop)	AR8621	✓	✓	✓	✓	✓	✓	
	Airflow Management	Blanking Panel	Toolless/Snap-in 1U (qty 10)	AR8136BLK	✓		✓			✓
Toolless/Snap-in 1U (qty 200)			AR8136BLK200	✓		✓			✓	✓
Fixed 1U (qty 2)			AR8108BLK	✓		✓	✓		✓	
Fixed 1U, 2U, 4U, 8U Panel Kit			AR8101BLK	✓		✓	✓		✓	
Misc		Vent	AR8355				✓			
		Replacement Filter	AR8472							✓

Rack Series Comparison

Rack Series

Premium

SX

Essential

SV

Soundproof

SP

Wall-mount

WX

2-Post & 4-Post

OF

Seismic, Colo & AV

CM

Custom & Configured

CC

Rugged

RX

Shock Packaging & Pallet

SH

Accessories & Upgrades

Airflow & Cabling

AC

Security & Access

SA

Rack PDUs

PD

Index

Product Index

PX

Compatibility Index

CX



Continued on the next page

Compatibility Index



Accessories

NetShelter Wall-mount Enclosures (2/2)

Product Category	Product	Description	SKU	Wall-mount Enclosures						
				Switch Depth		Server Depth		UPS Depth	Vertical/ Low Profile	
				Assembled	Unassembled	Assembled	Unassembled	Assembled	Assembled	
				6/9/12U	6/9U	6/9/12U	13U	13U	12/18/24U	6U
Shelves & Mounting Accessories	Shelves & Drawers	Fixed-Depth 50 lb. Capacity	AR8105BLK			✓	✓		✓	
	Mounting Options	PDU Orientation Mounting	AR7711	✓		✓			✓	
	Hardware / Cage Nuts	#10-32 Cage Nuts (qty 36)	AR8005	✓	✓	✓	✓	✓	✓	✓
		M6 Cage Nuts (qty 32)	AR8100	✓	✓	✓	✓	✓	✓	✓
		#12-24 Screws (qty 100)	AR8400	✓	✓	✓	✓	✓	✓	✓
	Casters	Swivel (qty 4)	AR8471							✓
		Fixed – Wall-Mount	AR8359				✓			
	Specialty	Server Support Bracket	AR8470							✓
Security Options	Door Locks	NetBotz Keycard Handle 125 Hz	NBHN125S*	✓		✓			✓	
		NetBotz Keycard Handle 13.56 Hz	NBHN1356S*	✓		✓			✓	
		Single door contact sensor	NBES0303S	✓		✓			✓	

*Requires a NetBotz rack-mount appliance to operate the handles.

Rack Series Comparison

Rack Series

Premium

SX

Essential

SV

Soundproof

SP

Wall-mount

WX

2-Post & 4-Post

OF

Seismic, Colo & AV

CM

Custom & Configured

CC

Rugged

RX

Shock Packaging & Pallet

SH

Accessories & Upgrades

Airflow & Cabling

AC

Security & Access

SA

Rack PDUs

PD

Index

Product Index

PX

Compatibility Index

CX



Compatibility Index



Accessories

NetShelter Open Frame and Specialty Racks (1/4)

Product Category	Product	Description	SKU	Specialty Racks					
				Open Frame		Colo	Seismic	AV	
				2 Post	4 Post	600 mm W			
				44U	45U	42U	42U	24U	42U
Vertical Cable Management	Finger	Single (Rear) 4"	AR7721				✓		✓
	2/4 Post - Finger Single Sided	6" Wide	AR8615	✓	✓				
		6" Wide w/ Cover	AR8715	✓	✓				
		10" Wide	AR8635	✓	✓				
		12" Wide	AR8665	✓	✓				
		12" Wide w/ Cover	AR8765	✓	✓				
		12" Wide w/ Cover	AR8768	✓					
		Cover	AR8678		✓				
	2/4 Post - Finger Double Sided	6" Wide	AR8625	✓	✓				
		6" Wide w/ Cover	AR8725	✓	✓				
		10" Wide	AR8645	✓	✓				
		12" Wide	AR8675	✓	✓				
		12" Wide w/ Cover	AR8775	✓	✓				
		Cover	AR8679		✓				
		Connector Bracket	AR8682	✓	✓				
	Ring	8 Ring, Half-Height	AR8442			✓	✓	✓	✓
		Single Ring, Toolless	AR7540			✓	✓	✓	✓
	Bracket	Cable Containment w/ PDU Mount	AR7710			✓	✓	✓	✓
	Cable Tree	Center Mount	AR7585						✓
	Fiber Organizer	Bracket + Spool	AR8443A			✓	✓	✓	✓
		Spools Only	AR8444			✓		✓	✓
	Vertical Channel	0 U Channel w/ PDU Mount	AR7502						✓
		Narrow Version	AR7511						✓

Rack Series Comparison

Rack Series

Premium

SX

Essential

SV

Soundproof

SP

Wall-mount

WX

2-Post & 4-Post

OF

Seismic, Colo & AV

CM

Custom & Configured

CC

Rugged

RX

Shock Packaging & Pallet

SH

Accessories & Upgrades

Airflow & Cabling

AC

Security & Access

SA

Rack PDUs

PD

Index

Product Index

PX

Compatibility Index

CX



Continued on the next page

Compatibility Index



Accessories

NetShelter Open Frame and Specialty Racks (2/4)

Product Category	Product	Description	SKU	Specialty Racks						
				Open Frame		Colo	Seismic	AV		
				2 Post	4 Post	600 mm W				
				44U	45U	42U	42U	24U	42U	
Horizontal Cable Management	1U Cable Managers	Finger 1.5"	ER7HCM	✓	✓	✓	✓	✓	✓	✓
		Finger 4"	AR8602A	✓	✓	✓	✓	✓	✓	✓
		Finger 6"	AR8612	✓	✓	✓	✓	✓	✓	✓
		Ring	AR8425A	✓	✓	✓	✓	✓	✓	✓
		Brush Passthrough	AR8429	✓	✓	✓	✓	✓	✓	✓
		Management Arm	AR8129		✓	✓	✓	✓	✓	✓
	2U Cable Managers	Finger 4"	AR8600A	✓	✓	✓	✓	✓	✓	✓
		Finger 6"	AR8606	✓	✓	✓	✓	✓	✓	✓
		Finger 6" + Brush Strip & Lacing Bar	AR8603A	✓	✓	✓	✓	✓	✓	✓
		Ring (Standard)	AR8426A	✓	✓	✓	✓	✓	✓	✓
		Ring + Passthrough	AR8428	✓	✓	✓	✓	✓	✓	✓
		Ring + Fingers	AR8427A	✓	✓	✓	✓	✓	✓	✓
	3U	Finger 6"	AR8605	✓	✓	✓	✓	✓	✓	✓
	Misc	Ring (5 lg + 5 sm)	AR8113A	✓	✓	✓	✓	✓	✓	✓
		Cable Ties (Hook + Loop)	AR8621	✓	✓	✓	✓	✓	✓	✓
	Airflow Management	Blanking Panel	Toolless/Snap-in 1U (qty 10)	AR8136BLK		AR203A	✓	✓		
			Toolless/Snap-in 1U (qty 200)	AR8136BLK200		AR203A	✓	✓		
			Fixed 1U (qty 2)	AR8108BLK	✓	✓	✓	✓		
Fixed 1U, 2U, 4U, 8U Panel Kit		AR8101BLK	✓	✓	✓	✓				
Airflow Recirculation		Air Dam Int.Rack Recirculation Kit	AR7708			✓				✓
		Air Dam Ext.Rack/Floor Sealing Kit	AR7731			✓				
	Air Dam Baying Trim Kit	AR7600			✓					

Rack Series Comparison

Rack Series

Premium

SX

Essential

SV

Soundproof

SP

Wall-mount

WX

2-Post & 4-Post

OF

Seismic, Colo & AV

CM

Custom & Configured

CC

Rugged

RX

Shock Packaging & Pallet

SH

Accessories & Upgrades

Airflow & Cabling

AC

Security & Access

SA

Rack PDUs

PD

Index

Product Index

PX

Compatibility Index

CX



Continued on the next page

Compatibility Index



Accessories

NetShelter Open Frame and Specialty Racks (3/4)

Product Category	Product	Description	SKU	Specialty Racks						
				Open Frame		Colo	Seismic	AV		
				2 Post	4 Post	600 mm W				
				44U	45U	42U	42U	24U	42U	
Shelves & Mounting Accessories	Shelves & Drawers	Fixed-Depth 250 lb. Capacity	AR8122BLK		AR203A	✓	✓			
		Fixed-Depth 50 lb. Capacity	AR8105BLK	✓	✓	✓	✓			
		Fixed Double Sided 250 lb. Capacity	AR8422	✓						
		Sliding/Adjustable XX" Depth 100 lb. Capacity	AR8123BLK		✓	✓	✓			
		Sliding/Adjustable 18 – 25" Depth 250 lb. Capacity	AR8125			✓	✓		✓	✓
		Sliding/Adjustable XX" Depth 200 lb. Capacity	AR8128BLK		✓	✓	✓			
		17" Keyboard Drawers	AR8126ABLK		✓	✓	✓			
		19" Rotating Keyboard Drawers	AR8127BLK		✓	✓	✓			
	Bolt Down Kits	Stabilization Plate	AR7700			✓			✓	✓
		Standard Kit	AR7701			✓			✓	✓
		Seismic IBC/OSHPD	AR7701A-S			✓			✓	✓
	Mounting Options	PDU Orientation Mounting	AR7711		✓	✓	✓		✓	✓
		6" Spacers	AR8652		✓					
		Channel (Japan)	AR7709			✓			✓	✓
		Level Pads	AR7605			✓	✓		✓	✓
Hardware / Cage Nuts	#10-32 Cage Nuts (qty 36)	AR8005		AR203A	✓					
	M6 Cage Nuts (qty 32)	AR8100		AR203A	✓	✓				
	#12-24 Screws (qty 100)	AR8400	✓	AR203A	✓					
Specialty	Copper Busbar	AR8395			✓			✓	✓	

Rack Series Comparison

Rack Series

Premium

SX

Essential

SV

Soundproof

SP

Wall-mount

WX

2-Post & 4-Post

OF

Seismic, Colo & AV

CM

Custom & Configured

CC

Rugged

RX

Shock Packaging & Pallet

SH

Accessories & Upgrades

Airflow & Cabling

AC

Security & Access

SA

Rack PDUs

PD

Index

Product Index

PX

Compatibility Index

CX



Continued on the next page

Compatibility Index



Accessories

NetShelter Open Frame and Specialty Racks (4/4)

Product Category	Product	Description	SKU	Specialty Racks						
				Open Frame		Colo	Seismic	AV		
				2 Post	4 Post	600 mm W				
				44U	45U	42U	42U	24U	42U	
Roof Mounted Cable Troughs & Partitions	Troughs	Solid 600 mm	AR8561			✓	✓			
		Grommet (13' Roll)	AR8579			✓	✓			
		4 Post Rack Adapter	AR8450A		✓					
	Partitions	Solid 600 mm	AR8162ABLK		✓	✓	✓	✓		
		Passthrough 600 mm	AR8163ABLK		✓	✓	✓	✓		
Cable Ladders & Accessories	Ladders	Data Cable Ladder + Attachment Kit	AR8164ABLK		✓	✓	✓			
		Data Cable Ladder	AR8164AKIT		✓	✓	✓			
		Power Cable Ladder + Attachment Kit	AR8165ABLK		✓	✓	✓			
		Power Cable Ladder	AR8165AKIT		✓	✓	✓			
	Attachment Kits	w/ Cable Troughs	AR8166ABLK		✓	✓				
		For Enclosures/Troughs	AR8186				✓	✓		
		Clamp Kit	AR8169		✓	✓				
		Ladder Attach Kit for 2 Post	AR8460	✓						
		Corner Clamp Kit	AR8461	✓	✓	✓			✓	✓
		Stacking Kit	AR8462	✓	✓	✓			✓	✓
Angle Clamp Kit		AR8463	✓	✓	✓			✓	✓	
Falls	Cable Fall	AR8654	✓	✓	✓	✓				
Security Options	Door Locks	Combo Door Handle	AR8132A			✓	✓	✓	✓	
		NetBotz Keycard Handle 125 Hz	NBHN125			✓	✓	✓	✓	
		NetBotz Keycard Handle 13.56 Hz	NBHN1356			✓	✓	✓	✓	

Rack Series Comparison

Rack Series

Premium

SX

Essential

SV

Soundproof

SP

Wall-mount

WX

2-Post & 4-Post

OF

Seismic, Colo & AV

CM

Custom & Configured

CC

Rugged

RX

Shock Packaging & Pallet

SH

Accessories & Upgrades

Airflow & Cabling

AC

Security & Access

SA

Rack PDUs

PD

Index

Product Index

PX

Compatibility Index

CX



Compatibility Index



Accessories NetShelter RX Racks

				Rugged Enclosures			
				NetShelter RX			
				600 mm W		800 mm W	
Product Category	Product	Description	SKU	24U	42U	42U	
Horizontal Cable Management	1U Cable Managers	Finger 1.5"	ER7HCM	✓	✓	✓	
		Finger 4"	AR8602A	✓	✓	✓	
		Finger 6"	AR8612	✓	✓	✓	
		Ring	AR8425A	✓	✓	✓	
		Brush Passthrough	AR8429	✓	✓	✓	
		Management Arm	AR8129	✓	✓	✓	
	2U Cable Managers	Finger 4"	AR8600A	✓	✓	✓	
		Finger 6"	AR8606	✓	✓	✓	
		Finger 6" + Brush Strip & Lacing Bar	AR8603A	✓	✓	✓	
		Ring (Standard)	AR8426A	✓	✓	✓	
		Ring + Passthrough	AR8428	✓	✓	✓	
		Ring + Fingers	AR8427A	✓	✓	✓	
	3U	Finger 6"	AR8605	✓	✓	✓	
	Misc	Ring (5 lg + 5 sm)	AR8113A	✓	✓	✓	
	Airflow Management	Blanking Panel	Toolless/Snap-in 1U (qty 10)	AR8136BLK	✓	✓	✓
			Toolless/Snap-in 1U (qty 200)	AR8136BLK200	✓	✓	✓
			Fixed 1U (qty 2)	AR8108BLK	✓	✓	✓
Fixed 1U, 2U, 4U, 8U Panel Kit			AR8101BLK	✓	✓	✓	
Shelves & Mounting Accessories	Shelves & Drawers	Fixed-Depth 250 lb. Capacity	AR8122BLK	✓	✓	✓	
		Fixed-Depth 50 lb. Capacity	AR8105BLK	✓	✓	✓	
		Sliding/Adjustable XX" Depth 100 lb. Capacity	AR8123BLK	✓	✓	✓	
		Sliding/Adjustable XX" Depth 200 lb. Capacity	AR8128BLK	✓	✓	✓	
		Sliding/Adjustable Deep 110 lb. Capacity	ER7SHELF	✓	✓	✓	
	Hardware / Cage Nuts	#10-32 Cage Nuts (qty 36)	AR8005	✓	✓	✓	
		M6 Cage Nuts (qty 32)	AR8100	✓	✓	✓	

Rack Series Comparison

Rack Series

Premium

SX

Essential

SV

Soundproof

SP

Wall-mount

WX

2-Post & 4-Post

OF

Seismic, Colo & AV

CM

Custom & Configured

CC

Rugged

RX

Shock Packaging & Pallet

SH

Accessories & Upgrades

Airflow & Cabling

AC

Security & Access

SA

Rack PDUs

PD

Index

Product Index

PX

Compatibility Index

CX



Life Is n

Schneider
 Electric

Learn more today!

se.com

Schneider Electric
70 Mechanic Street
Foxborough, MA 02035
www.apc.com

© 2024 Schneider Electric. All Rights Reserved.
Life Is On Schneider Electric is a trademark and the property of Schneider Electric SE, its subsidiaries and affiliated companies.