

Panel Thickness E dim. inches (mm)	Number of Gasket
1/16 (1.6)	4
1/8 (3.2)	3
3/16 (4.8)	2
1/4 (6.4)	1

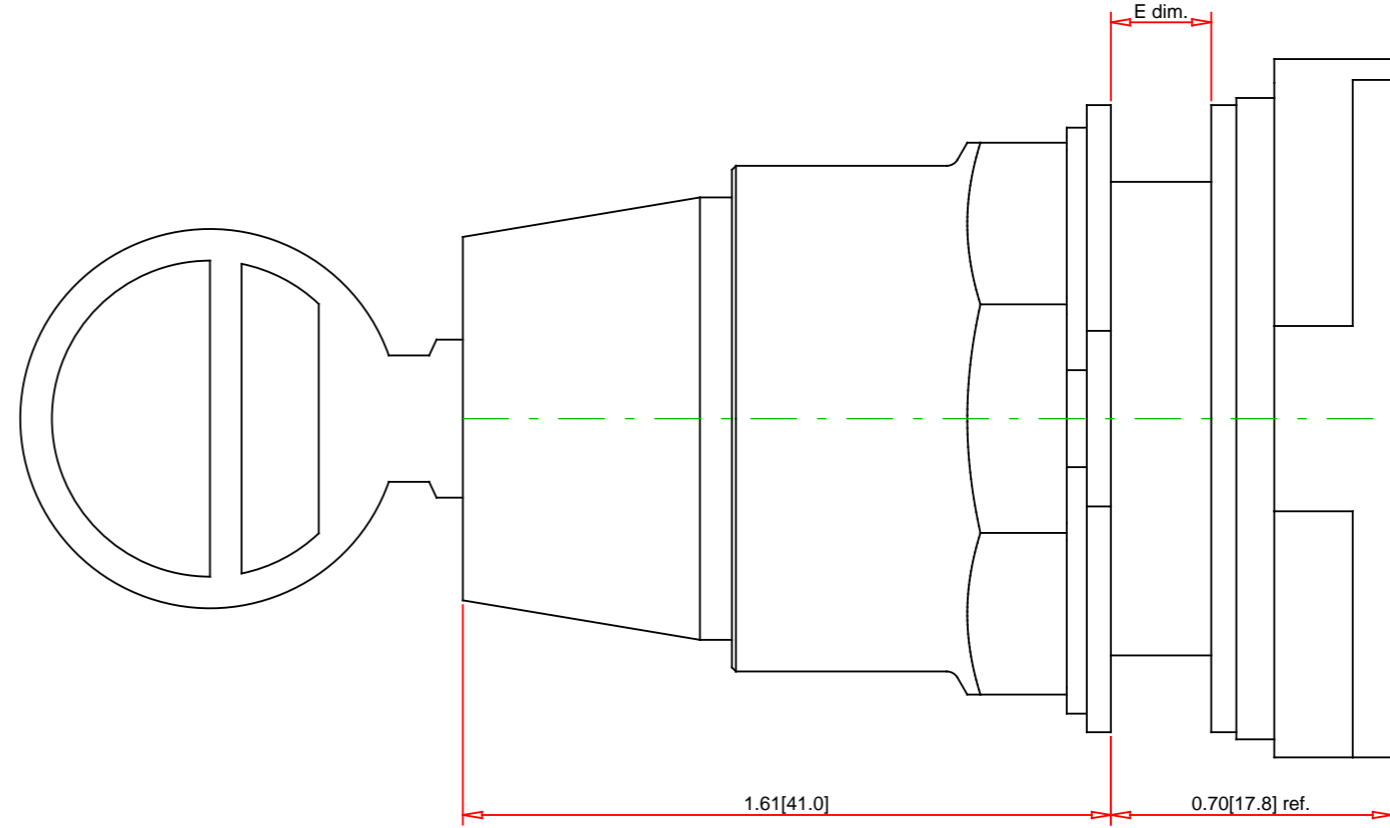
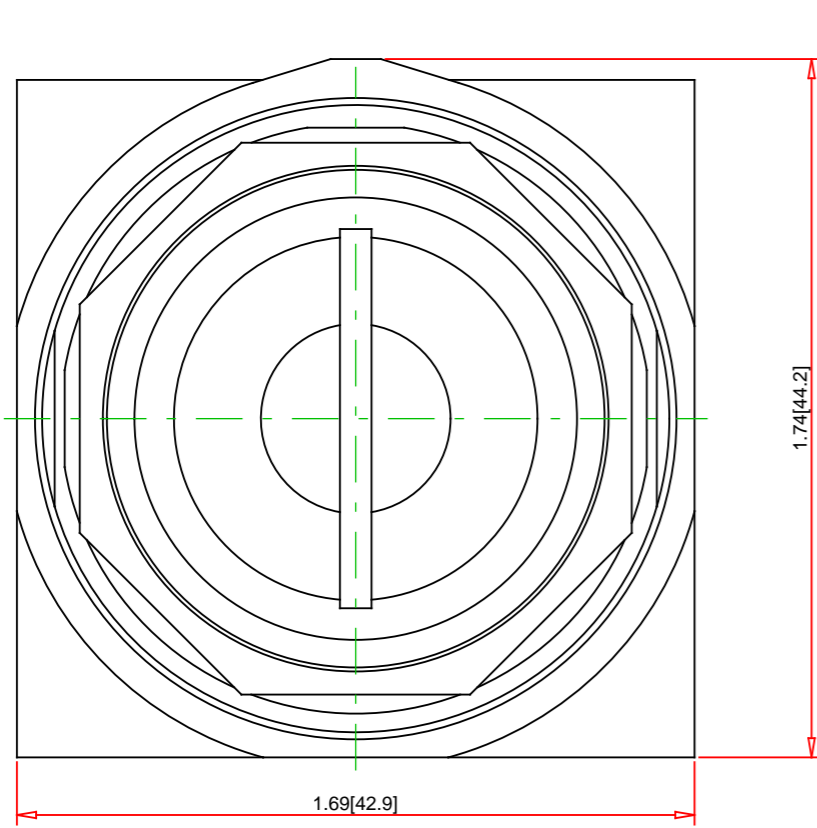

Note:  
- Drawings Not To Scale  
- Drawings Subject to Change Without Notice  
- Dimensions are inches next to [Millimeters]

Part No.:

**9001KS52K5E57**

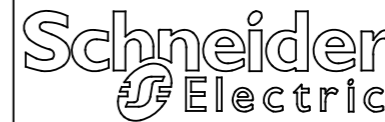

Schneider Electric United States  
North American Division  
Boston One Campus  
800 Federal Street  
Andover, MA 01810, USA  
Phone: +1 8773425173  
Email: CCC@us.schneider-electric.com

Technical Information:

UL File: E78403 CCN NKCR  
CSA File: LR24590 Class 3211-03  
CE Marked: Yes  
RoHS: Yes  
NEMA / IP Rating: NEMA 1/2/3/3R/4/6/12/13 Water tight, Dust tight and Oil tight (Indoor/Outdoor), IP66  
Key Number: E57  
Key Removal: Center Only  
Light Module Supply Voltage: not applicable  
Light Module Type: not applicable  
Number of Operators: 1

Specification:

Description: 30mm Selector Switch  
Ring Nut Material: Chromium Plated Zinc  
Operator Type: Non-Illuminated  
Operator Action: Spring Return (From Both Sides to Center)  
Button Type: n/a  
Guard Type: n/a  
Button/Cap Color: n/a  
Lens Type: not applicable  
Lens Color: not applicable  
Knob Type: Key Operated Knob  
Knob Color: Key  
Number of Positions: 3