

Panel Thickness E dim. inches (mm)	Number of Gasket
1/16 (1.6)	4
1/8 (3.2)	3
3/16 (4.8)	2
1/4 (6.4)	1

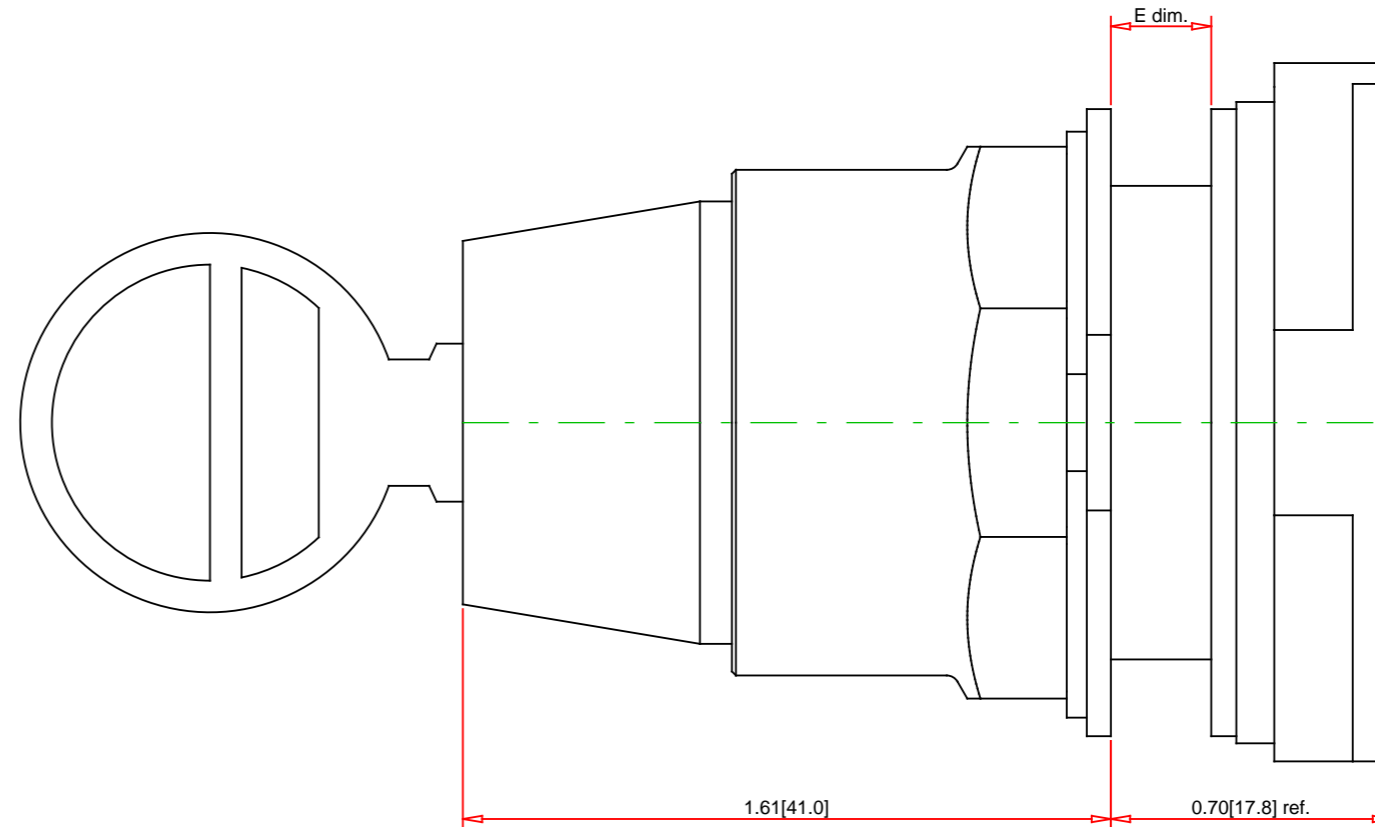
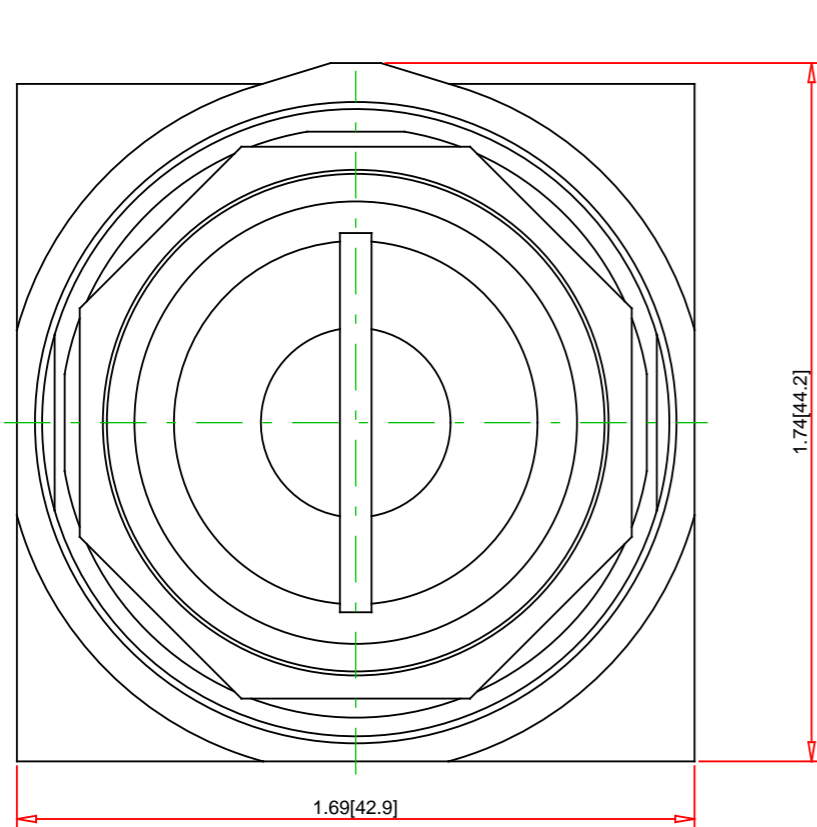

Note:
 - Drawings Not To Scale
 - Drawings Subject to Change Without Notice
 - Dimensions are inches next to [Millimeters]

Part No.:

9001KS34K1E37

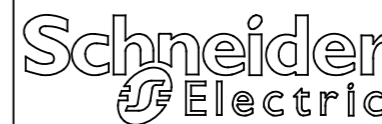

Schneider Electric United States
 North American Division
 Boston One Campus
 800 Federal Street
 Andover, MA 01810, USA
 Phone: +1 8773425173
 Email: CCC@us.schneider-electric.com

Technical Information:

UL File: E78403 CCN NKCR
 CSA File: LR24590 Class 3211-03
 CE Marked: Yes
 RoHS: Yes
 NEMA / IP Rating: NEMA 1/2/3/3R/4/6/12/13 Water tight, Dust tight and Oil tight (Indoor/Outdoor), IP66
 Key Number: E37
 Key Removal: Left Only
 Light Module Supply Voltage: not applicable
 Light Module Type: not applicable
 Number of Operators: 1

Specification:

Description: 30mm Selector Switch
 Ring Nut Material: Chromium Plated Zinc
 Operator Type: Non-Illuminated
 Operator Action: Spring Return (From Right)
 Button Type: n/a
 Guard Type: n/a
 Button/Cap Color: n/a
 Lens Type: not applicable
 Lens Color: not applicable
 Knob Type: Key Operated Knob
 Knob Color: Key
 Number of Positions: 2