

Panel Thickness E dim. inches (mm)	Number of Gasket
1/16 (1.6)	4
1/8 (3.2)	3
3/16 (4.8)	2
1/4 (6.4)	1

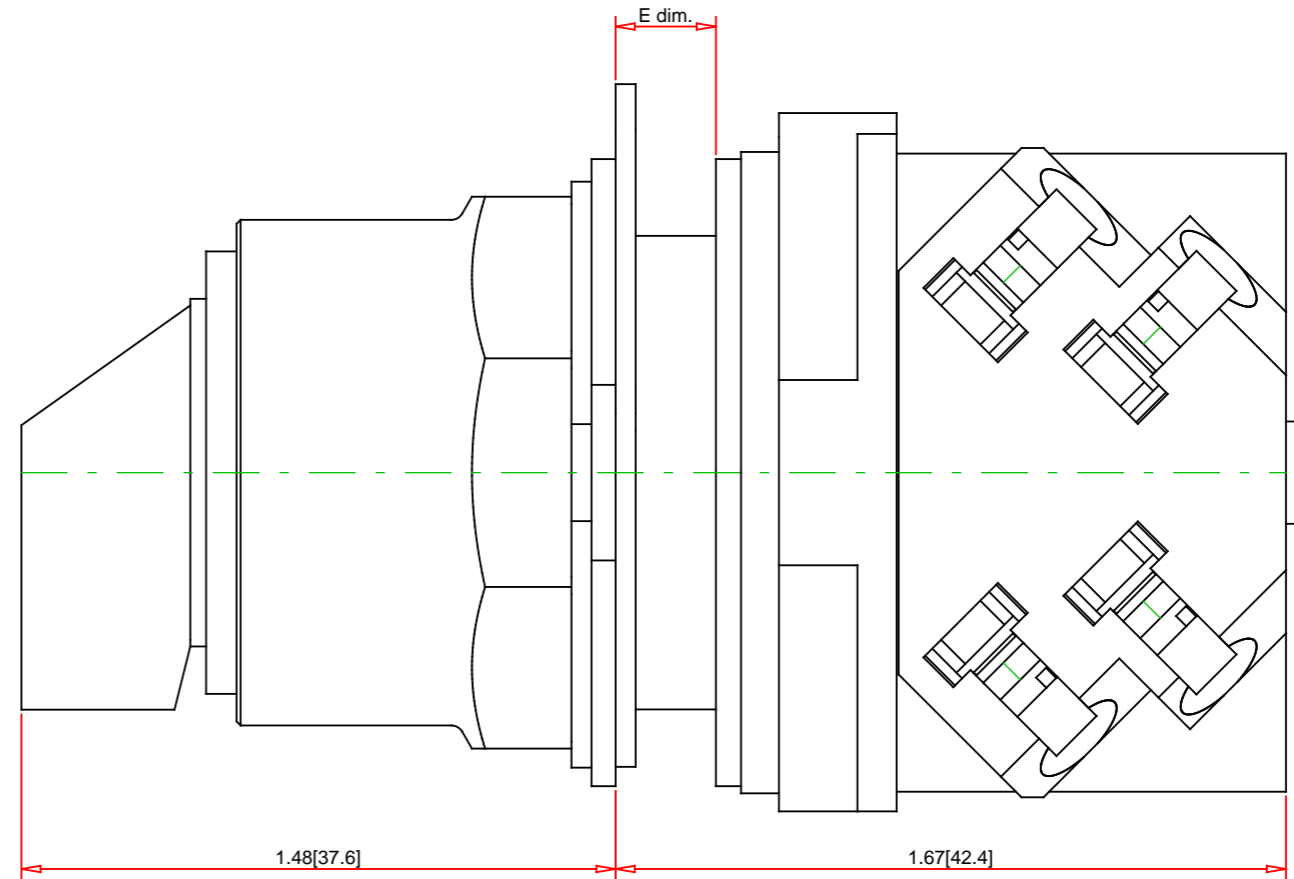
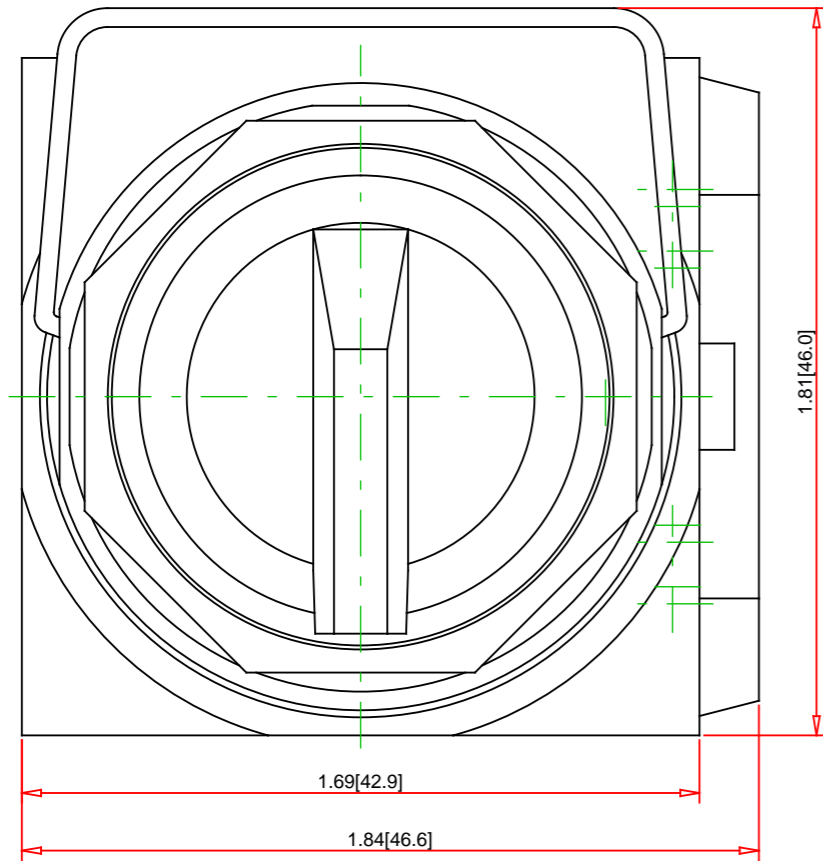

Note:  
- Drawings Not To Scale  
- Drawings Subject to Change Without Notice  
- Dimensions are inches next to [Millimeters]

Part No.:

**9001KS11BH13**



Schneider Electric United States  
North American Division  
Boston One Campus  
800 Federal Street  
Andover, MA 01810, USA  
Phone: +1 8773425173  
Email: CCC@us.schneider-electric.com

Technical Information:

Circuit Configuration: SPDT  
Electrical Life: 100000  
Mechanical Life: 500000  
Operating Temp. Range: -30 to 60 °C (-22 to 140 °F)  
Power Rating: Not HP Rated  
Number of Poles: 1 N.O. + 1 N.C.  
AC Voltage: 600  
Current Rating: 10  
Contact Rating: AC-15: 600V, 1.2A; 240V, 3A; 120V, 6A DC-13: 600V, 0.1A; 250V, 0.27A; 125V, 0.55A

Specification:

Description: Push Buttons 30 mm - Assemblies  
Type: Selector Switch  
Actuator Type: Selector Knob  
Illumination: None  
Terminal Plating: Terminal - Brass - no plating, Screw - Zinc Chromate  
Actuator Color: Black  
Actuator Part No.: 9001KS11B  
Contact Block Part No.: 9001KA1  
Legend Plate Part No.: 9001KN244