

Motor Control Solutions for the North American Market

Data Bulletin

Schneider Electric offers a wide range of solutions to meet your motor control and protection needs. This data bulletin contains information regarding the application of those solutions in the United States and Canada.

8536DB0901 R02/24



Legal Information

The information provided in this document contains general descriptions, technical characteristics and/or recommendations related to products/solutions.

This document is not intended as a substitute for a detailed study or operational and site-specific development or schematic plan. It is not to be used for determining suitability or reliability of the products/solutions for specific user applications. It is the duty of any such user to perform or have any professional expert of its choice (integrator, specifier or the like) perform the appropriate and comprehensive risk analysis, evaluation and testing of the products/solutions with respect to the relevant specific application or use thereof.

The Schneider Electric brand and any trademarks of Schneider Electric SE and its subsidiaries referred to in this document are the property of Schneider Electric SE or its subsidiaries. All other brands may be trademarks of their respective owner.

This document and its content are protected under applicable copyright laws and provided for informative use only. No part of this document may be reproduced or transmitted in any form or by any means (electronic, mechanical, photocopying, recording, or otherwise), for any purpose, without the prior written permission of Schneider Electric.

Schneider Electric does not grant any right or license for commercial use of the document or its content, except for a non-exclusive and personal license to consult it on an "as is" basis.

Schneider Electric reserves the right to make changes or updates with respect to or in the content of this document or the format thereof, at any time without notice.

To the extent permitted by applicable law, no responsibility or liability is assumed by Schneider Electric and its subsidiaries for any errors or omissions in the informational content of this document, as well as any non-intended use or misuse of the content thereof.

Schneider Electric, EverLink, Modbus, Motor Logic, Multi 9, PowerPacT, and TeSys are trademarks and the property of Schneider Electric SE, its subsidiaries, and affiliated companies. All other trademarks are the property of their respective owners.

Table of Contents

Overview of U.S. Standards and Regulations.....	5
U.S. National Standards	5
UL 508 to UL 60947-4-1	5
Product Standards: UL 489 Circuit Breakers vs. UL 1077 Supplementary Protectors.....	6
Certification Process	6
Acceptance of Electrical Equipment in US.....	6
Structure of a Motor Starter in Accordance with UL 508A.....	8
Feeder Circuit and Branch Circuits	8
Disconnecting Means	9
Disconnect Types	9
Application of Disconnect Switches.....	9
Group Motor Installations	9
Required Functions in Branch Circuits for a Motor Load	11
Combination Starter Construction Types.....	12
Combination Motor Controllers.....	12
Type A and C Construction.....	13
Type D Construction	14
Type E Construction	14
Type F Construction.....	14
Self-Protected Designation and Implications.....	15
Construction Type Selection.....	15
Motor Starter Line Diagrams.....	16
Code Requirements for Short-Circuit Current Ratings	17
Calculating the Available Short-Circuit Current	17
Determining the Short-Circuit Current Rating of the Control Panel.....	18
Determining the SCCR for Components.....	19
Combination Starter Components	20
UL 98 Manual Disconnect Switches.....	20
TeSys™ GS Disconnect Switches.....	20
TeSys™VLS Disconnect Switches.....	21
TeSys™ LK Disconnect Switches	22
Class 9422 Disconnect Switches	23
UL 248 Switches	24
TeSys™ DF Fuse Holders.....	24
TeSys™ FB Fuse Holders	24
UL 489 Molded-Case Circuit Breakers	25
PowerPacT™ Circuit Breakers and Motor Circuit Protectors	25
UL 489 Miniature Circuit Breakers and UL 1077 Supplementary Protectors.....	27
Multi 9™ Circuit Breakers and Supplementary Protectors	27
UL 60947 Contactors.....	28
TeSys™ K Contactors.....	28
TeSys™ Deca Contactors	29

TeSys™ Giga Contactors	32
TeSys™ N Contactors	34
Type S Contactors	35
Definite Purpose Contactors	36
Type S Lighting Contactors	39
Type L/LX Lighting Contactors	41
TeSys™ NEMA® Lighting Contactors	42
UL 60947 Overload Relays	43
TeSys™ K Bimetallic Overload Relays	43
TeSys™ Deca Bimetallic Overload Relays	44
TeSys™ Giga Overload Relays	45
TeSys™ LR9D Electronic Overload Relays	46
TeSys™ T Motor Management System	47
Motor Logic™ Solid-State Overload Relays	47
UL 60947 Starters	48
TeSys™ N Starters	48
Type S Starters	49
Definite Purpose Starters	53
UL 60947 Self-Protected Combination Motor Controller (Type E)	54
TeSys™ Ultra	54
TeSys™ Deca	55
TeSys GV2P and GV3P + TeSys D Contactors	57
Two-Component TeSys™ GV + TeSys D Solution	57
TeSys™ GV2 and GV3 + TeSys Deca Solution (Type F)	57
TeSys™ GV3P + TeSys Deca Contactors	59
TeSys™ GV4PB + TeSys Deca	60
Group Motor Installations	61
UL 60947 Group Motor Installations	61
TeSys™ GV2ME + TeSys Deca Contactors	61
TeSys™ GV2P + TeSys Deca Contactors	62
TeSys™ GV3P + TeSys Deca Contactors	63
Wiring Devices	64
Power Distribution Blocks	64
Specific Requirements for the Canadian Market	84
Installation and Product Standards	84
Full-Load Current, Three-Phase Alternating-Current Motors	85

Overview of U.S. Standards and Regulations

U.S. National Standards

The national standards governing electrical installations in the U.S.:

NOTE: UL 508A is both an application and a product standard.

Figure 1 - Standards

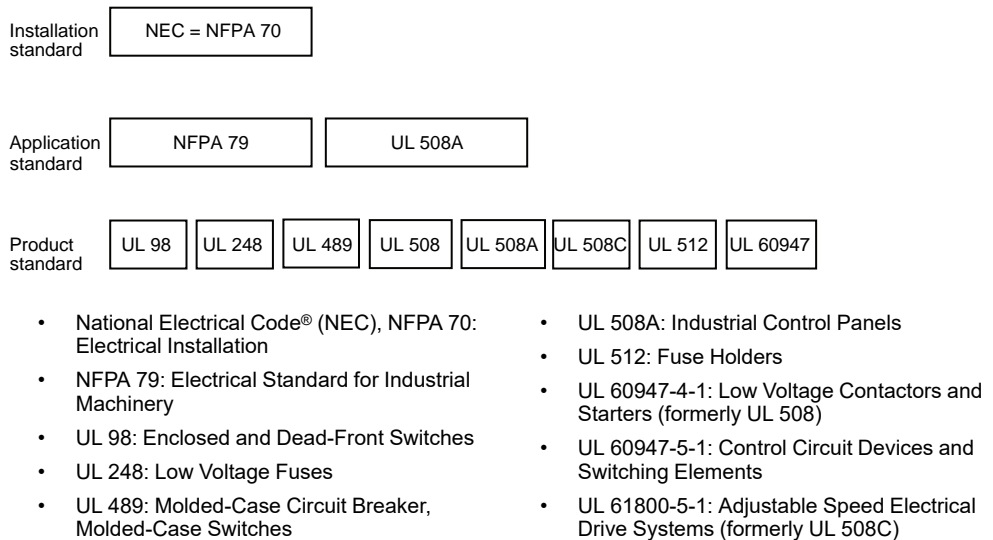

UL 508 to UL 60947-4-1

The standard for Industrial Control Equipment, UL 508, has been harmonized with the relevant product standards of the IEC standard for low-voltage control and automation, IEC 60947-4-1.

This harmonization work was undertaken with the intent of creating standards that, while being based upon and adopting IEC requirements, would incorporate sufficient national differences to ease the transition from UL 508 to UL 60947-4-1. This goal has largely been accomplished in most cases. While the UL 508 and UL 60947-4-1 standards do not look the same, when taking into account the national differences included in the harmonized standards, they are essentially technically identical.

Products originally listed to UL 508 will maintain their listing with no expiration. UL 508 and UL 60947-4-1 products can be used interchangeably.

The following industrial control categories are affected by this harmonization effort.

Table 1 - Industrial Control Categories

Standard	Product Description	Category Control Number
UL 60947-4-1	Magnetic Motor Controllers	NLDX
	Manual Motor Controllers	NLRV
	Combination Motor Controllers	NKJH
	Auxiliary Devices (Overload Relays only, Thermal & Electronic)	NKCR
	Industrial Control Switches	NRNT
UL 60947-5-1	Auxiliary Devices (Relays, Pilot Devices, Limit Switches)	NKCR

For more information on this transition, please refer to UL's website for *Industrial Control Equipment Transition to IEC Standards*.

Product Standards: UL 489 Circuit Breakers vs. UL 1077 Supplementary Protectors

UL 489 circuit breakers are used to protect feeder and branch circuits. UL 1077 supplementary protectors are intended for use as overcurrent protection within a piece of equipment where branch circuit overcurrent protection is already provided. UL 489 circuit breakers are required for compliance with NFPA 70 and NFPA 79.

UL 1077 supplementary protectors are redundant, or additional, protection on branch circuits for equipment. They complement other branch circuit protection, provided by either UL 489 circuit breakers or UL 248 fuses. UL 489 circuit breakers can be used in place of UL 1077 supplementary protectors, but UL 1077 supplementary protectors can never be used in place of UL 489 circuit breakers.

UL 1077 supplementary protectors are often called circuit breakers, but this is incorrect. Circuit breakers are listed to the UL 489 standard, while supplementary protectors are listed to the UL 1077 standard.

Certification Process

A nationally recognized testing laboratory (NRTL) can list or certify the equipment according to applications or product standards including the following: UL, CSA, ETL, and TUV. Other approved agencies are listed at the following website: <http://www.osha.gov/dts/otpca/nrtl/index.html#nrtls>.

Acceptance of Electrical Equipment in US

The process for acceptance is as follows:

1. The equipment is listed or the manufacturer is certified:
 - a. For mass production equipment, the industrial control panel itself is listed by an NRTL.
 - b. For custom or low-volume equipment, the manufacturer or supplier of the industrial control panel is certified.

2. A local inspector under the authority having jurisdiction (AHJ) inspects and approves the electrical equipment and the installation prior to commissioning. The product listing or labeling may be used to assist in the inspection.

Structure of a Motor Starter in Accordance with UL 508A

Feeder Circuit and Branch Circuits

The branch circuit consists of the last short-circuit protective device before a load and all power conductors and components between the last short-circuit protective device (SCPD) and the load.

The feeder circuit consists of all power conductors and components on the supply side of a branch circuit.

Figure 2 - Feeder Circuit and Branch Circuit

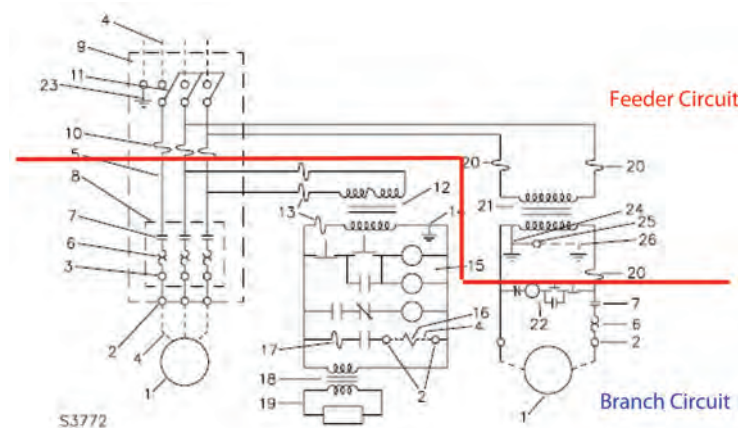

Table 2, page 8 contains a description of the numbered circuit components called out in the figure Feeder Circuit and Branch Circuit, page 8.

Table 2 - Circuit Components

1	Load—provided in the field	14	Control transformer ground (for 1000 VA max. control transformer)
2	Field wiring terminals	15	Control circuit devices and wiring—Class 1 circuit—isolated secondary circuit
3	Alternate field terminals	16	Solenoid or other control device—provided in the field
4	Field wiring	17	Supplementary protection
5	Internal wiring of the power circuit	18	Class 2 transformer
6	Overload relay and heater elements	19	Class 2 circuit
7	Contactor or controller	20	Power transformer fuse—branch circuit protection
8	Starter	21	Power transformer—for motor load and control protector
9	Combination motor controller	22	Control circuit—Class 1 circuit—common control circuit
10	Branch circuit protection	23	Equipment ground and equipment ground terminal
11	Fused disconnect switch or circuit breaker	24	Bonding conductor—bonding jumper
12	Control transformer	25	Grounding electrode conductor terminal
13	Control transformer fuse or supplementary protection	26	Grounding electrode conductor—provided in the field

Disconnecting Means

A disconnect means is required for each incoming supply, and must open each ungrounded conductor of the supply circuit. A disconnect is also required for each controller and motor, and must be within line of sight of the controller and motor. However, it is permissible to use a single disconnect for a group of controllers. A single disconnect can also serve as the disconnect for both the motor and controller.

Disconnect Types

The following components are considered an acceptable means of disconnect for the feeder circuit:

- UL 489 inverse-time circuit breaker or molded case switch
- UL 98 switch unit, either open type or enclosed.

The following components are an acceptable means of disconnect in the branch circuit:

- UL 489 inverse-time circuit breaker, instantaneous trip circuit breaker (motor circuit protector (MCP)), or molded case switch
- UL 98 switch unit, either open type or enclosed
- UL 60947-4-1 disconnect or manual motor controller marked "Suitable as Motor Disconnect"
- Type E self-protected combination motor controller

Application of Disconnect Switches

There are two UL standards that govern disconnect switches: UL 98 and UL 60947-4-1 (formerly UL 508).

- UL 98 listed disconnects are suitable for both branch and feeder circuit applications.
- Disconnects listed to UL 60947-4-1 are intended for motor switching, and should only be used below the branch short-circuit protective device (SCPD).

See NEC 430 and UL 508A for additional requirements and exceptions.

Group Motor Installations

In a group motor installation, a single circuit breaker or fuse may be used for a group of motors. The specific rules are described in NEC Sections 430-112 and 430-53.

Group motor installations are used in the following applications:

- Fractional HP motors—NEC Section 430.53 (A):
- For several motors, each rated 1 HP maximum on a branch circuit of 1000 V maximum, a single short-circuit protective device (SCPD) not exceeding 15 A is permitted under the following circumstances:
 - No single motor is rated greater than 6 A Full Load Amperes (FLA).
 - The branch-circuit short-circuit device rating marked on any controller is not exceeded.
 - Appropriate motor overload protection is used. Refer to NEC Section 430.32.

- Smallest rated motor protected—NEC Section 430.53 (B):
The SCPD is sized for the motor in the group with the lowest rating.
 - If the SCPD is a circuit breaker, it is sized to a maximum of 250% of the smallest motor FLA.
 - If the SCPD is a time-delay fuse, it is sized to a maximum of 175% of the smallest motor FLA.
 - If the SCPD is a non-time delay fuse, it is sized to a maximum of 300% of the smallest motor FLA.
- Other group installations—NEC Section 430.53 (C):
Two or more motors of any rating, or one or more motors and other loads, where all the following conditions are met:
 - Each motor controller and overload protection device carries a Motor Group Installation listing.
 - Each circuit breaker (if used) is listed and is of the inverse time type.
 - The SCPD is sized as follows:
 - If the SCPD is a circuit breaker, it is sized to a maximum of 250% of the largest motor FLA plus the sum of the full load current rating of all other motors and loads.
 - If the SCPD is a time-delay fuse, it is sized to a maximum of 175% of the largest motor FLA plus the sum of the full load current rating of all other motors and loads.
 - If the SCPD is a non-time delay fuse, it is sized to a maximum of 300% of the largest motor FLA plus the sum of the full load current rating of all other motors and loads.
 - Appropriate overcurrent protection is provided for non-motor loads.

Tap Conductor Sizing Rules

The tap conductor sizing rules for group motor installations are governed by NEC Section 430.53 (D). Conductors from the load side of the SCPD for the motor group must comply with one of the following:

- The ampacity is not less than that of the branch circuit conductors.
- The ampacity is not less than 1/3 of the branch circuit conductors, and the length from the point of the tap to the motor overload protection device is not more than 7.5 m (25 ft.).
- The ampacity is not less than 1/10 of the SCPD for the motor group, the length from the point of the tap to the controller(s) is not more than 3 m (10 ft.), and the manual motor controller is marked “Suitable for Tap Conductor Protection in Group Installations.”

NOTE: Products certified for motor grouping must carry the markings on the product label or instruction sheet required by NEC and UL (such as “Suitable for Tap Conductor Protection in Group Installations”).

For more information, see data bulletin 8502DB0701 entitled “Group Motor Installations: Understanding NEC 430.53 Requirements.”

Required Functions in Branch Circuits for a Motor Load

NEC 430 requires four essential functions in the branch circuit for a motor load. Each function plays an important role in the control and protection of the motor load. See the figure Required Functions of Combination Starters for the four functions that compose a complete motor branch circuit.

Figure 3 - Required Functions of Combination Starters

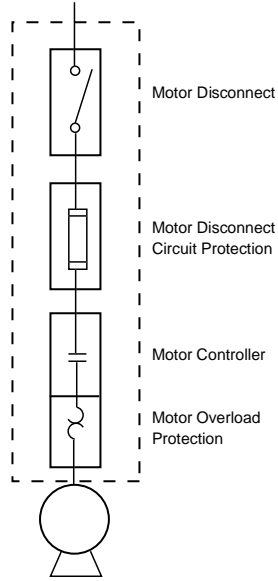

Combination Starter Construction Types

Combination Motor Controllers

A combination motor controller is a combination of devices that collectively possess the four required functions in a branch circuit for a motor load as defined by the NEC. A combination motor controller can be built using different component constructions, but must possess the essential four functions.

Combination motor controllers can consist of an open assembly or an enclosed assembly. Some combination motor controllers may be assembled in the field using components, while others may be required to be pre-assembled at the factory, depending on the combination construction type or the product.







Some combination construction types, but not all, are required by the NEC to be a listed combination. The UL 60947 standard governs the definition and approval requirements for combination motor controllers. See Table 3, page 13 to see which construction types the NEC requires to be listed.

When applying a listed combination motor controller, the components must be applied as stated in the listing, including specific part numbers and all conditions of acceptability.

Combination motor controllers listed to UL 60947-4-1 (formerly UL 508) can be located on the UL website at <https://industries.ul.com/industrial-systems-and-components/industrial-control-products-and-systems/short-circuit-current-ratings-for-combination-motor-controller-components>.

Combination motor controllers can be constructed using different short-circuit protection methods. Table 3, page 13 defines the various construction types, and identifies the construction types that are required by the NEC to be a listed combination.

Table 3 - UL Combination Starter Type Designations

	UL Combination Starter Type	Device Used for Component Function				
		Disconnect	Branch Circuit Protection	Motor Controller	Motor Overload Relay	
Traditional Combination Starters from the 1980s and Earlier	A	UL 98 Manual Disconnect	UL 248 Fuses	UL 60947 Magnetic or Solid-State Controller	UL 60947 Motor Overload Relay	 UL 98 Disconnect Switch  UL 248 Fuses  UL 60947 Controller  UL 60947 Overload Relay
	C	UL 489 Inverse Time Circuit Breaker				
	D ¹	UL 489 Instantaneous Trip Circuit Breaker (Motor Circuit Protector)				
Introduced 1990	E ¹	UL 60947 Self-Protected Combination Controller			 UL 60947 Type E Self-Protected Combination Starter: TeSys U  UL 60947 Type E Manual Self-Protected Combination Starter: TeSys GV2P & GV3P	
Introduced 2002	F ¹	UL 60947 Manual Self-Protected Combination Controller	UL 60947 Magnetic or Solid-State Controller	UL 60947 Manual Self-Protected Combination Controller	 UL 60947 Type F Combination Starter: TeSys GV2P/GV3P + TeSys D Contactor	

Type A and C Construction

Types A and C combination motor controllers are traditional style starters that use either a listed disconnect switch and fuses or a listed circuit breaker as the disconnect means and short-circuit protection. Each type uses a separate UL 60947-4-1 (UL 508) listed motor controller and overload relay. These starters are evaluated by UL under the same set of short-circuit performance tests. Each type of combination starter clears detected faults without causing a fire or posing a risk of an electrical shock hazard to personnel. Each type is allowed to sustain damage that is contained within enclosures and may require the repair or replacement of devices after performing their protective function.

Branch circuits using fuses or circuit breakers are not required to be a part of a listed combination by the NEC. Thus design engineers may elect to apply circuit breakers, fuses, contactors, and overload relays based on their component UL ratings to build a branch circuit. However, a combination motor controller listing may be advantageous for customers to achieve a higher short-circuit current rating.

1. The NEC requires this construction type be part of a listed combination (NEC 430.52)

Circuit breakers offer an advantage over fuses in that they are resettable, and open all three phases during an overcurrent event.

Type D Construction

Type D combination motor controllers use a UL recognized instantaneous trip circuit breaker (also known as a motor circuit protector) as the means of disconnect and short-circuit protection. Motor circuit protectors differ from circuit breakers in that they are often magnetic only, and often include a dial to adjust the motor inrush sensitivity. Because motor circuit protectors do not possess the thermal overload protection, they must be properly paired with a motor starter. Thus the NEC requires that a branch circuit using a motor circuit protector must be applied per the same requirements as a listed combination motor controller.

Type D combination motor controllers are often used in applications where the motor may be a standard type or a high efficiency type, because the motor circuit protector provides adjustment ability for the inrush sensitivity.

The NEC requires that the motor circuit protector inrush setting be no more than 800% for standard motors or 1100% for high efficiency motors. If a motor trip occurs during start up, then the NEC allows the inrush setting to be set as high as 1300% for standard motors or 1700% for high efficiency motors. This requirement does not apply when the motor FLA is 8 amperes or less and when the continuous current rating of the motor circuit protector is 15 amperes or less.

When selecting a Type D combination motor controller, do not assume the prescribed motor circuit protector has the required motor inrush setting range required for code compliancy. Always verify that the inrush dial setting range is compliant for the application.

Type E Construction

The concept of a self-protected combination starter was introduced from Europe during the 1980s. This concept unveiled an integrated device that performed all the required functions of a combination motor controller in a single component.

The first self-protected combination starters were manual, but by the mid-1980s, electromechanical self-protected combination starters were also on the market. These starters cleared detected faults within their rating without sustaining damage and could be put back into operation.

UL introduced this concept in 1990 and added the Type E self-protected category for both manual and electromechanical combination starters. UL added a separate set of short-circuit and endurance performance tests just for the Type E self-protected category.

Type E combination motor controllers possess an advantage over the other construction types in that the combination motor controller must be able to be put back into operation after a short-circuit. Other construction types do not necessarily guarantee that the contactor or overload relay will not sustain any damage during a short circuit, and maintenance may be required to resume operation.

Type F Construction

Many Type E combination motor controllers are manually operated and require the addition of a contactor to permit signals from remote devices or a PLC to start or stop a motor. However, UL component ratings of contactors do not specify protection requirements using a Type E combination motor controller; rather, they only specify protection requirements using a circuit breaker or fuse. Thus UL addressed this by

recognizing a Type F category in 2002. This combination consists of a self-protected combination motor controller and a contactor.

Type F combination motor controllers are advantageous in that they require less space compared to traditional constructions, while having a high short-circuit current rating.

Self-Protected Designation and Implications

A combination starter must pass certain performance tests specified by UL 60947-4-1 (formerly UL 508) before it can be designated as self-protected. The required test sequence for the Type E self-protected combination starters is listed in UL 60947-4-1, Table DVC.4.2.1.1.5. The test sequence includes both high fault and interrupting ability short-circuit (low fault) detection tests, followed by an endurance test.

The tests required for Types A through D and Type F combination starters are listed in UL 60947-4-1, Table DVC.4.2.1.1.4. This test sequence does not include the detection of low fault short-circuit tests followed by the endurance test. This is the difference between the testing and performance of a Type E self-protected combination starter and the other starter types.

Construction Type Selection

Panel designers may choose any of the six construction types for their motor control panel with each construction type offering different advantages.

Construction Types A through D all use the same motor controllers and overload relays. However, they feature different methods of performing disconnect and branch circuit protection functions:

- Type A is the only construction type that features fuses.
- Type B, which uses a UL 60947-4-1 (formerly UL 508) motor short-circuit protector, is no longer commercially available.
- Type C uses UL 489 inverse time circuit breakers.
- Type D uses UL 489 instantaneous trip circuit breakers.

The key distinction between Type A and Types C or D is whether a circuit breaker or fuse is used for branch circuit protection. A fuse is an overcurrent protection device with a circuit-opening fusible part that is heated and severed by the passage of overcurrent through it. A circuit breaker is a device designed to open and close a circuit by non-automatic means and to open the circuit automatically on a predetermined overcurrent without damage to itself when properly applied within its rating. The key difference between a fuse and a circuit breaker is that a fuse must be replaced once it experiences an overcurrent condition while a circuit breaker is resettable. Additionally, fuses operate independently on each phase while circuit breakers have three-phase common trip.

Construction Type E self-protected combination controllers and Type F combination controllers both offer the following advantages for panel designers:

- Higher coordinated short-circuit withstand ratings on UL 508A panels
- Easier component selection to meet the requirements of group motor applications
- Reduced panel space by reducing the number of components
- Required product markings to help designers quickly and accurately select components
- Increased productivity by reducing the number of wiring connections

UL 60947-4-1 Type E self-protected combination starters also offer the advantage of reliability. UL 60947-4-1's special endurance and short-circuit tests help ensure a coordinated combination starter that will clear a detected fault and protect itself from

damage. It is the only category of combination starter that a designer can easily identify as self-protected due to the required "Self-Protected Combination Motor Controller" product marking.

Motor Starter Line Diagrams

Figure 4 - Power Supply Circuit

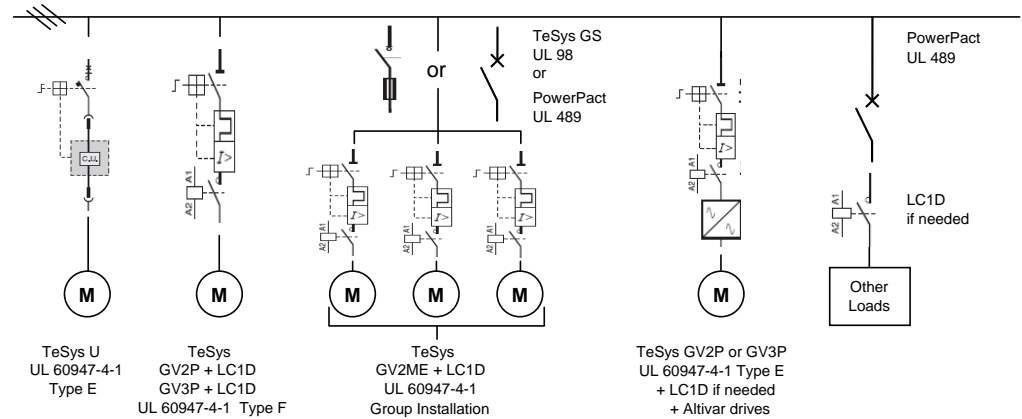

Code Requirements for Short-Circuit Current Ratings

The National Electrical Code, NFPA 79, and OSHA require proper short-circuit protection for control panels and industrial equipment. The following are some of the specific requirements regarding Short-Circuit Current Ratings (SCCRs):

- All control panels must be marked with its SCCR, using an approved evaluation method (such as UL 508A) (NEC 409.110).
- The available short-circuit current at the installation location of the control panel must be documented and available for inspection (NEC 409.22).
- Control panels must not be installed where the available short-circuit current exceeds its short-circuit current rating (NEC 409.22).
- Components intended to interrupt a short circuit must have a sufficient interrupting rating for the short-circuit current available at the line terminals (NEC 110.9, OSHA 1910.303(b)(4)).
- Components not intended to interrupt a short circuit must be properly paired with a short-circuit protection device so as not to create extensive damage during a short-circuit event (NEC 110.10, OSHA 1910.303(b)(5)).

Calculating the Available Short-Circuit Current

Determining the available short-circuit current requires information about the installation site. Information about the nearest upstream transformer and information about the conductors between the transformer and control panel are needed to make this calculation. Some of this information may be more difficult to attain, but conservative estimates can be applied to help define a conservative calculation of the available short-circuit current at the point of connection for the control panel.

To assist with this calculation, Schneider Electric has developed a fault current calculator available on the mySchneider app (located in "My Account"). After entering the installation site details, the fault current is calculated, and a system diagram and label can be sent via email.

Figure 5 - Calculating the fault current using the Fault Current Calculator on the mySchneider app

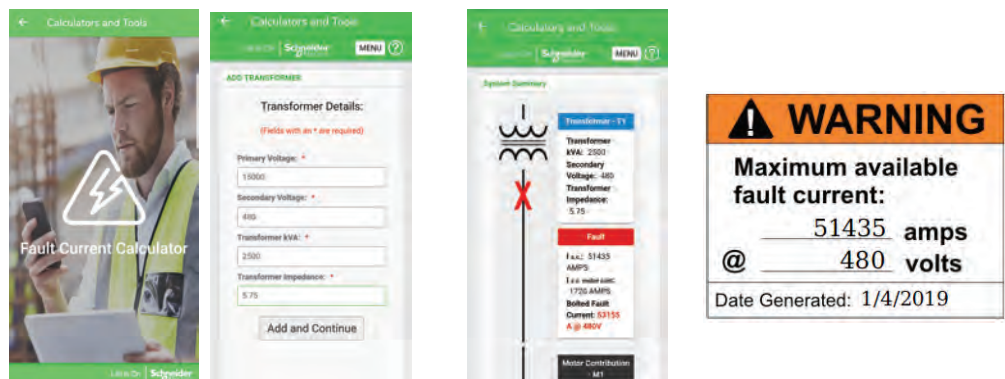

Determining the Short-Circuit Current Rating of the Control Panel

The short-circuit current rating (SCCR) of a control panel can be determined through testing the entire control panel assembly, or it can be determined using the method described in UL 508A Supplement SB.

NOTE: Using the interrupting rating of the main overcurrent protection device (OCPD) for the panel is not an acceptable practice.

⚠ WARNING

INADEQUATE SHORT CIRCUIT INTERRUPTING RATING

Do not use the interrupting rating of the main OCPD as the SCCR rating for the controller.

Failure to follow these instructions can result in death, serious injury, or equipment damage.

UL 508A Supplement SB applies a weak link approach to determine the overall short-circuit current rating for the panel. With a few exceptions, the components in the power circuit are considered in the evaluation.

There are four basic steps to determine the control panel SCCR:

1. Determine the SCCR of each component.
2. Determine if the SCCR of a branch component can be raised using a current limiting device.
3. Determine the interrupting rating of all circuit breakers and fuses.
4. Choose the lowest interrupting rating or established component SCCR.

View a free webinar that explains how SCCR is determined for control panels in more detail using the links below:

- [Determining SCCR per UL 508A \(Part 1\)](#)
- [Determining SCCR per UL 508A \(Part 2\)](#)

See UL 508A for all requirements and exceptions regarding SCCR determination.

Determining the SCCR for Components

The short-circuit current rating (SCCR) of a component is determined by conducting a short-circuit test of the component using an overcurrent protection device. Devices that are not designed to interrupt a short-circuit (such as a contactor, overload relay, or power distribution block) must be properly paired with an overcurrent protection device (such as a circuit breaker or fuse), and tested to determine its SCCR value. Thus it is critical that these devices be applied with the proper overcurrent protection device to achieve a proper short-circuit current rating.

A device can achieve an SCCR in one of two methods:

- Testing a component per its UL standard to achieve a component SCCR (often referred to as High Fault)
- Testing a set of components together as a combination motor controller to achieve an SCCR for the combination

An SCCR can be applied to a device using either method. However, there are some differences between the two types:

Table 4 - Differences in the Two Methods for Testing Components

Component (High Fault) SCCR	Combination Motor Controller SCCR
<ul style="list-style-type: none"> • SCCR information is located on the product marking or in the instruction manual. • Often is more flexible regarding the required short-circuit protection, typically only limits to a maximum size • Applicable to feeder and branch circuits • Applicable to motors and other loads 	<ul style="list-style-type: none"> • SCCR information is located on the UL web site at www.ul.com/sccr. • Specified part numbers must be used as prescribed. • Limited to branch circuits, motor loads only • Often has additional conditions of acceptability that must be observed, such as minimum enclosure volume or wire size • May achieve a higher SCCR than what can be obtained by the component ratings

A summary of short-circuit current ratings of common power circuit devices is provided in the following section of this document for the convenience of the reader.

In the event that an SCCR cannot be determined for a component, a default SCCR value is applied per UL 508A Supplement SB Table SB4.1. These SCCR values are often very low. Below are the default SCCR values for **common** component types:

- Motor Controllers (0–50 hp): 5 kA
- Motor Controllers (15–200 hp): 10 kA
- Non-GFC1 Receptacle: 10 kA
- Switch Unit: 5 kA
- Power Distribution Block: 10 kA
- Terminal Block: 10 kA
- Busbar: 10 kA

Combination Starter Components

UL 98 Manual Disconnect Switches

TeSys™ GS Disconnect Switches

Figure 6 - TeSys GS Disconnect Switch — GS2GU3N



Table 5 - TeSys™ GS Fusible Disconnect Switches

Catalog Number	Rating (A)	Poles	Maximum Rating (HP)				Short-Circuit Current Rating, 600 Vac Max.	
			240 V	480 V	600 V	250 Vdc	Fuse Type	SCCR (kA)
GS1DDU3	30	3	7.5	15	20	5	CC	100
GS1DU3	30	3	7.5	15	20	5	J	100
GS2EEU3	30	3	7.5	15	20	5	CC	100
GS2EU3N	30	3	7.5	15	20	5	J	100
GS2GU3N	60	3	15	30	50	10	J	100
GS2JU3N	100	3	30	60	75	20	J	200
GS2MU3N	200	3	60	125	150	40	J	200
GS2QU3N	400	3	125	250	350	50	J	200
GS2SU3	600	3	200	400	500	—	J	200
GS2TU3	800	3	200	500	500	—	L	200

TeSys™ VLS Disconnect Switches

Figure 7 - TeSys VLS Non-Fusible Disconnect Switches — VLS3P063R2



Table 6 - TeSys VLS Non-Fusible Disconnect Switches

Catalog Number	Mount Type	General Use @ 600 V (Amperes)	Max. Component SCCR (kA)								
			Circuit Breaker @ 480 V			Fuses @ 480 V			Fuses @ 600 V		
			Type	Max. Size (A)	Max. SCCR (kA)	Type	Max. Size (A)	Max. SCCR (kA)	Type	Max. Size (A)	Max. SCCR (kA)
VLS3P030R2	Rear	30	H-Frame	100	100	CC, J, or T	100	100	CC, J, or T	60	50
VLS3P063R2	Rear	60	H- or J-Frame	150	100	CC, J, or T	200	100	CC, J, or T	60	50
VLS3P080R2	Rear	100	J-Frame ²	200	100	CC, J, or T	200	100	CC, J, or T	100	50
VLS3P100R2	Rear	100	J-Frame ²	250	100	CC, J, or T	200	100	CC, J, or T	100	50
VLS3P125R2	Rear	100	J-Frame ²	250	100	CC, J, or T	200	100	CC, J, or T	100	50
VLS3P030D2	Door	30	H-Frame	100	100	CC, J, or T	100	100	CC, J, or T	60	50
VLS3P063D2	Door	60	H- or J-Frame	150	100	CC, J, or T	200	100	CC, J, or T	60	50
VLS3P080D2	Door	100	J-Frame ²	200	100	CC, J, or T	200	100	CC, J, or T	100	50
VLS3P100D2	Door	100	J-Frame ²	250	100	CC, J, or T	200	100	CC, J, or T	100	50
VLS3P125D2	Door	100	J-Frame ²	250	100	CC, J, or T	200	100	CC, J, or T	100	50

2. If using a circuit breaker only, then Type is H-Frame.

TeSys™ LK Disconnect Switches

Figure 8 - TeSys LK Disconnect Switch — LK4SU3N



Table 7 - TeSys LK Non-Fusible Disconnect Switches

Catalog Number	Rating (A)	Poles	Maximum Rating (HP)				Short-Circuit Current Rating, 600 Vac Max.	
			240 V	480 V	600 V	250 Vdc	Fuse Type	SCCR (kA)
LK4DU3CN	30	3	10	20	30	—	J	100
LK4GU3CN	60	3	20	40	50	—	J	100
LK4JU3CN	100	3	20	50	50	—	J	100
LK4JU3N	100	3	30	75	100	15	J	200
LK4MU3N	200	3	75	150	200	15	J	200
LK4QU3N	400	3	125	250	350	50	J	200
LK4SU3N	600	3	200	400	350	50	J	200
LK4TU3N	800	3	200	500	500	—	L	100
LK4UU3N	1000	3	200	500	500	—	L	100
LK4WU3N	1200	3	200	500	500	—	L	100

Class 9422 Disconnect Switches

Figure 9 - Flange Mounted, Variable Depth Disconnect Switch — 9422TF1



Table 8 - Class 9422 Flange Mounted, Variable Depth Fusible and Non-Fusible Disconnect Switches

Disconnect Switch Size (A)	Variable Depth Min.–Max. (in.)	Max. Horsepower Ratings						Fuse Type	Fuse Clip Rating Non-Interchangeable Type for Class H, J, K or R Fuses (A)		Catalog Number ³
		AC System Volts (Motor Volts)				Vdc			250 V	600 V	
		208 (200)	240 (230)	480 (460)	600 (575)	250	600				
30	6.625–18	7.5	7.5	15	20	5	15	None	—	—	9422TCN30
								H, J, K, R	30 60	— 30	9422TCF30 9422TCF33
60	6.625–18	—	15	30	50	10	30	None	—	—	9422TDN60
								H, J, K, R	60 —	— 30 60	9422TDF60 9422TDF63
100	6.625–18	25	30	60	75	20	50	None	—	—	9422TEN10
								H, J, K, R	100	100	9422TEF10
200	9.12–19.25 ⁴	40	60	125	150	40	50	None	—	—	9422TF1
								H, J, K, R	200 —	— 200 400	9422TF2 9422TF3 ⁵
400 Fixed Depth ⁶	11.38 (A5 or A6 Handle)	75	125	250	350	50	50	None	—	—	9422TG17. ⁸
400 Variable Depth ⁶	15.87–19 (A7 or A8 Handle) ⁹							H, J, K, R	400	400	9422TG27. ⁸

3. Switch and operating mechanism only. Does not include handle mechanism

4. 9422 R2 extends maximum mounting depth 7 inches.

5. Accommodates Class J fuses only.

6. Switches are fixed-depth or adjustable, depending on handle selection.

7. Commercially available enclosures may not accept 9422TG1 and two operating mechanisms. Contact the enclosure manufacturer for the availability of enclosures for use with these switches.

8. Right hand flange mounting only and requires a special enclosure.

9. Variable in increments of 0.63 inches.

UL 248 Switches

TeSys™ DF Fuse Holders

Figure 10 - TeSys DF Fuse Holders — DFCC3



Table 9 - TeSys DF Fuse Holders

Fuse Holder	Standards	Maximum Voltage	Current	Short-Circuit Current Rating
DFCC	IEC, UL (UL Listed)	600 Vac	30 A	200 kA
DF10	IEC, UL (UL Recognized)	690 Vac	33 A	200 kA
DF14	IEC, UL (UL Recognized)	690 Vac	50 A	200 kA
DF22	IEC, UL (UL Recognized)	690 Vac	125 A	200 kA

TeSys™ FB Fuse Holders

Figure 11 - Type FB Fuse Holder — 9080FB3611J



Table 10 - Type FB 600 V Fuse Holders

Rating (A)	No. of Poles	Catalog Number		Short-Circuit Current Rating
		Class J	Class R ¹⁰	
30	2	9080FB2611J	9080FB2611R	200 kA
	3	9080FB3611J	9080FB3611R	
60	1	—	9080FB1621R	
	2	9080FB2621J	—	
	3	9080FB3621J	9080FB3621R	
100	3	—	9080FB3631R	

10. Accepts current limiting fuses only.

UL 489 Molded-Case Circuit Breakers

PowerPacT™ Circuit Breakers and Motor Circuit Protectors

Figure 12 - PowerPacT B Circuit Breaker — B JL36125



Table 11 - PowerPacT™ Catalog Numbering System

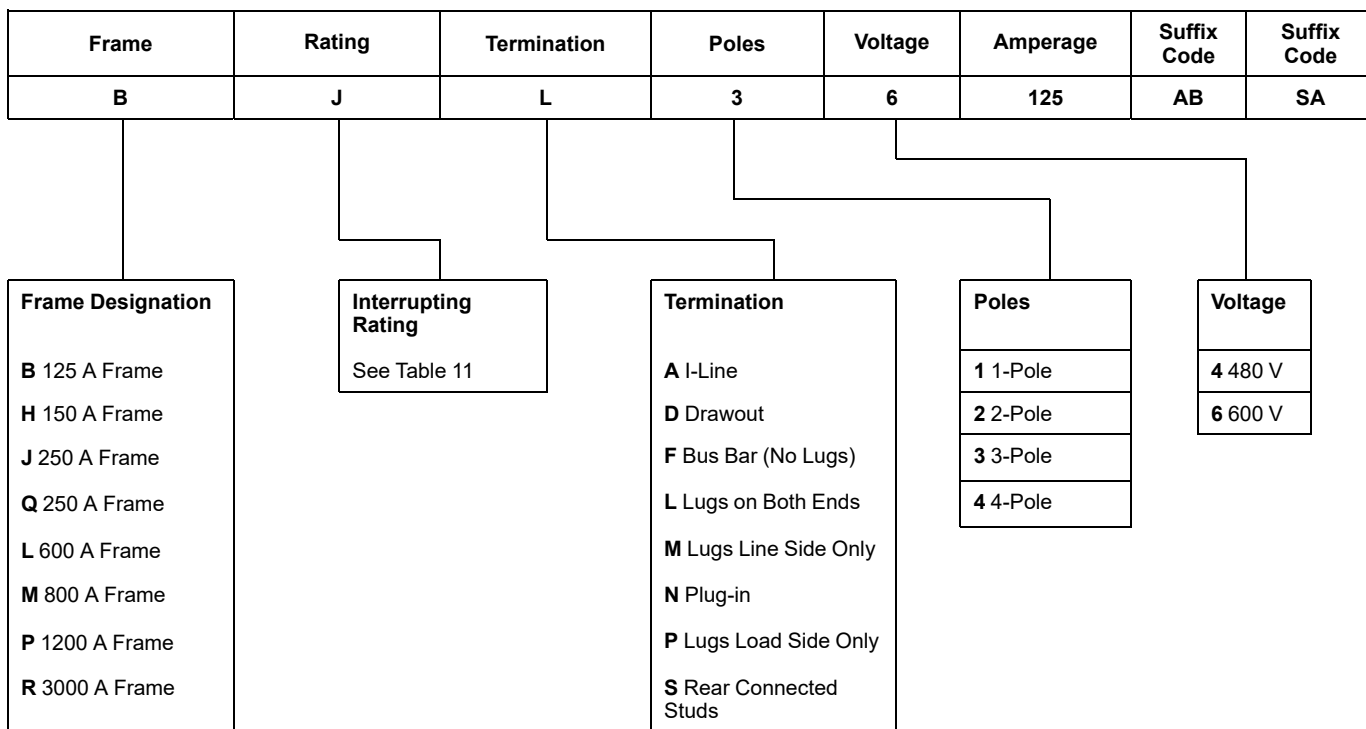

Table 12 - PowerPacT Interrupting Ratings System

Voltage	Interrupting Rating						
	B	D	G	J	K	L	R
240 Vac	10 kA	25 kA	65 kA	100 kA	65 kA	125 kA	200 kA
480 Vac		18 kA	35 kA	65 kA	65 kA	100 kA	200 kA
600 Vac		14 kA	18 kA	25 kA	65 kA	50 kA	100 kA
Frame (X = available)							
B-Frame (15–125 A) ¹¹		X	X	X	X ¹²		
H-Frame (15–150 A)		X	X	X		X	X

11. B-Frame is rated up to 600 Y / 347 V and 480 V only. 600 V is not available.

12. B-Frame K-interrupting rating is 100 kA at 240 Vac

Table 12 - PowerPact Interrupting Ratings System (Continued)

Voltage	Interrupting Rating						
	B	D	G	J	K	L	R
J-Frame (150–250 A)		X	X	X		X	X
Q-Frame (70–250 A)	X	X	X	X			
L-Frame (200–600 A)		X	X	X		X	X
M-Frame (300–800 A)			X	X			
P-Frame (250–1200 A)			X	X	X ¹³	X ¹⁴	
R-Frame (600–3000 A)			X	X	X	X	

Table 13 - BV4 Motor Circuit Protector (MCP) Selection¹⁵

Frame	Motor Circuit Protector Ampacity (In)	Adjustable Instantaneous Trip (li)	Catalog Numbers	
			Standard Protection	High Protection
TeSys BV4	2	12–28	BV4T002D	BV4T002J
	3.5	21–49	BV4T003D	BV4T003J
	7	42–98	BV4T007D	BV4T007J
	13	53–195	BV4T013D	BV4T013J
	25	110–360	BV4T025D	BV4T025J
	50	176–650	BV4T050D	BV4T050J
	80	320–1150	BV4T080D	BV4T080J
	115	600–1150	BV4T115D	BV4T115J

Table 14 - PowerPact H- and J-Frame Electronic Motor Circuit Protectors

Frame	Sensor Rating	Full Load Ampere Range	Adjustable Instantaneous Trip Range	Suffix	Catalog Numbers		
					J-Interrupting Cat. No.	L-Interrupting Cat. No.	R-Interrupting Cat. No.
H-Frame	30 A	1.5–25 A	9–325 A	M71	HJL36030M71	HLL36030M71	HRL36030M71
	50 A	14–42 A	84–546 A	M72	HJL36050M72	HLL36050M72	HRL36050M72
	100 A	30–80 A	180–1040 A	M73	HJL36100M73	HLL36100M73	HRL36100M73
	150 A	58–130 A	348–1690 A	M74	HJL36150M74	HLL36150M74	HRL36150M74
J-Frame	250 A	114–217 A	684–2500 A	M75	JJL36250M75	JLL36250M75	JRL36250M75

13. P-Frame K-interrupting level is 50 kA at 480 Vac and 600 Vac

14. P-Frame L-interrupting level is 25 kA at 600 Vac

15. See UL Listed combination ratings in accordance with UL 60947-4-1 Type D Construction, published on www.UL.com/sccr.

UL 489 Miniature Circuit Breakers and UL 1077 Supplementary Protectors

Multi 9™ Circuit Breakers and Supplementary Protectors

Figure 13 - Multi 9 UL 489 Circuit Breaker — M9F42110



Figure 14 - Multi 9 UL 1077 Supplementary Protector — M9F22110



Table 15 - Multi 9 Catalog Numbering System

Range	Function	Number	Poles	Amperage
M9	F	42	1	10

Range	Function	Number	Poles	Amperage
M9 Multi 9	F MCB P DPN R RCCB D RCBO V Vigi C60 Add-on Y Vigi N40 Add-on C CTRL	Internal code number depending on the standard and electrical characteristics.	1 1-Pole 2 2-Pole 3 3-Pole 4 4-Pole	From 0.5– 63 A

Table 16 - Multi 9 UL 489 Breaking Capacity

Number of Poles	Current Rating (A)	Voltage, AC			
		120 V	240 V	277 V	480/277 V
1 Pole	1–35	14	14	10	—
	40–63	10	10	—	—

Table 16 - Multi 9 UL 489 Breaking Capacity (Continued)

Number of Poles	Current Rating (A)	Voltage, AC			
		120 V	240 V	277 V	480/277 V
2 Pole	1–35	14	14	10	10
	40–63	10	10	—	—
3 Pole	1–35	14	14	10	10
	40–63	10	10	—	—

Table 17 - Multi 9 UL 1077 Breaking Capacity

Number of Poles	Current Rating (A)	Voltage, AC			
		120 V	240 V	277 V	480/277 V
1 Pole	0.5–35	14	14	10	—
	40–63	10	10	5	—
2 Pole	1–35	14	14	10	10
	40–63	10	10	5	5
3 and 4 Pole	1–35	14	14	10	10
	40–63	10	10	5	5

UL 60947 Contactors

TeSys™ K Contactors

Figure 15 - TeSys K Contactor — LC1K09



Table 18 - TeSys K Contactors (Except for Spring Terminal Clamps)

Catalog Number	Standard Motor Ratings @ 50/60 Hz (HP)						Cont. Current Ratings	Max. Component SCCR (kA) ¹⁶					
	Single-Phase		Three-Phase					Circuit Breakers @ 480 V		Circuit Breakers @ 600 V		Fuses @ 600 V	
	120 V	240 V	208 V	240 V	480 V	600 V		Max. Size (A)	Max. SCCR (kA)	Max. Size (A)	Max. SCCR (kA)	Max. Size (A)	Max. SCCR (kA)
LC1K06	1/2	1	1.5	1.5	3	3	10	20	65	20	25	25	100
LC1K09	1/2	1.5	2	3	5	5	20	20	65	20	25	30	100

16. Ratings apply to circuits with voltages no greater than those listed.

Table 18 - TeSys K Contactors (Except for Spring Terminal Clamps) (Continued)

Catalog Number	Standard Motor Ratings @ 50/60 Hz (HP)						Cont. Current Ratings	Max. Component SCCR (kA) ¹⁷					
	Single-Phase		Three-Phase					Circuit Breakers @ 480 V		Circuit Breakers @ 600 V		Fuses @ 600 V	
	120 V	240 V	208 V	240 V	480 V	600 V		Max. Size (A)	Max. SCCR (kA)	Max. Size (A)	Max. SCCR (kA)	Max. Size (A)	Max. SCCR (kA)
LC1K12	1	2	3	3	7.5	10	20	20	65	20	25	30	100

NOTE: This table lists the maximum SCCR of the component when protected by any circuit breaker or fuse. If the maximum component SCCR is 65 kA and a 25 kA rated circuit breaker is used, then the system will be 25 kA, the SCCR rating of the circuit breaker.

TeSys™ Deca Contactors

Figure 16 - TeSys Deca Contactor — LC1D12



Table 19 - TeSys Deca 3-Pole Contactors

Catalog Number	Standard Motor Ratings @ 50/60 Hz (HP)						Cont. Current Rating (A)	Max. Component SCCR (kA) ¹⁸					
	Single-Phase		Three-Phase					Circuit Breakers @ 480 V		Circuit Breakers @ 600 V		Fuses @ 600 V	
	120 V	240 V	208 V	240 V	480 V	600 V		Max. Size (A)	Max. SCCR (kA)	Max. Size (A)	Max. SCCR (kA)	Max. Size (A)	Max. SCCR (kA)
LC1D09	1/3	1	2	2	5	7.5	25	35	85	35	50	25	100
LC1D12	1/2	2	3	3	7.5	10	25	35	85	35	50	30	100
LC1D18	1	3	5	5	10	15	32	60	85	35	50	40	100
LC1D25	2	3	7.5	7.5	15	20	40	60	85	60	50	60	100
LC1D32	2	5	10	10	20	25	50	60	85	60	50	80	100
LC1D38	2	5	10	10	20	25	50	60	85	60	50	80	100
LC1D40A	3	5	10	10	30	30	60	110	100	110	50	90	100
LC1D50A	3	7.5	15	15	40	40	70	110	100	110	50	110	100
LC1D65A	5	10	20	20	40	50	80	110	100	110	50	125	100
LC1D80	7.5	15	25	30	60	60	110	150	100	150	50	175	100
LC1D95	7.5	15	25	30	60	60	110	—	—	—	—	—	—
LC1D115	—	—	30	40	75	100	160	250	100	250	50	250	100

17. Ratings apply to circuits with voltages no greater than those listed.

18. Ratings apply to circuits with voltages no greater than those listed.

Table 19 - TeSys Deca 3-Pole Contactors (Continued)

Catalog Number	Standard Motor Ratings @ 50/60 Hz (HP)						Cont. Current Rating (A)	Max. Component SCCR (kA) ¹⁹					
	Single-Phase		Three-Phase					Circuit Breakers @ 480 V		Circuit Breakers @ 600 V		Fuses @ 600 V	
	120 V	240 V	208 V	240 V	480 V	600 V		Max. Size (A)	Max. SCCR (kA)	Max. Size (A)	Max. SCCR (kA)	Max. Size (A)	Max. SCCR (kA)
LC1D150	—	—	40	50	100	125	160	250	100	250	50	300	100

NOTE: This table lists the maximum SCCR of the component when protected by any circuit breaker or fuse. If the maximum component SCCR is 100 kA and a 25 kA rated circuit breaker is used, then the system will be 25 kA, the SCCR rating of the circuit breaker.

Table 20 - TeSys Deca 4-Pole Contactors

Catalog Number	Continuous Current Rating (A)	No. of Poles		Max. Component SCCR (kA) ²⁰					
				Circuit Breakers @ 480 V		Circuit Breakers @ 600 V		Fuses @ 600 V	
		N.O.	N.C.	Max. Size (A)	Max. SCCR (kA)	Max. Size (A)	Max. SCCR (kA)	Max. Size (A)	Max. SCCR (kA)
LC1DT20	25	4	0	35	85	35	50	25	100
LC1D098	25	2	2	35	85	35	50	25	100
LC1DT25	25	4	0	35	85	35	50	30	100
LC1D128	25	2	2	35	85	35	50	30	100
LC1DT32	32	4	0	60	85	35	50	40	100
LC1D188	32	2	2	60	85	35	50	40	100
LC1DT40	40	4	0	60	85	60	50	60	100
LC1D258	40	2	2	60	85	60	50	60	100
LC1DT60A	60	4	0	110	100	110	50	TBD	100
LC1DT80A	80	4	0	110	100	110	50	TBD	100
LC1D80004	110	4	0	150	100	175	50	175	100
LC1D80008	110	2	2	150	100	175	50	175	100
LC1D115004	160	4	0	250	100	250	50	250	100

NOTE: This table lists the maximum SCCR of the component when protected by any circuit breaker or fuse. If the maximum component SCCR is 100 kA and a 25 kA rated circuit breaker is used, then the system will be 25 kA, the SCCR rating of the circuit breaker.

Table 21 - TeSys Deca LC2D Contactors

Catalog Number	Max. Component SCCR (kA)					
	Circuit Breaker @ 480 V		Circuit Breaker @ 600 V		Fuses @ 600 V	
	Max. Size (A)	Max. SCCR (kA)	Max. Size (A)	Max. SCCR (kA)	Max. Size (A)	Max. SCCR (kA)
LC2D40A	110	100	110	50	90	100
LC2D50A	110	100	110	50	110	100
LC2D65A	110	100	110	50	125	100
LC2D115	250	100	250	50	250	100
LC2D150	250	100	250	50	300	100
LC2D115004	250	100	250	50	250	100

19. Ratings apply to circuits with voltages no greater than those listed.

20. Ratings apply to circuits with voltages no greater than those listed.

Additional TeSys™ Deca Contactor Ratings

Table 22 - UL/CSA Lighting Ratings (HP)

Catalog Number	Ballast	Tungsten		
	600 V	480 Y / 277 V	480 V	600 V
LC1D09 ²¹ , LC1DT20 ²¹	20	20	—	—
LC1D12 ²¹ , LC1DT25 ²¹	25	—	—	—
LC1D18 ²¹ , LC1DT32 ²¹	32	25	—	—
LC1D25 ²¹ , LC1DT40 ²¹	40	40	—	—
LC1D32 ²¹	50	50	—	—
LC1D40A	60	—	—	60
LC1D50A	70	—	—	70
LC1D65A	80	—	—	70
LC1D80, LC1D80004	100	—	100	—
LC1D115, LC1D1150004	115	—	115	—
LC1D150, LC1D1500004	150	—	150	—

Table 23 - Elevator Duty Ratings (HP)

Catalog Number	Single-Phase	Three-Phase			
	240 V	208 V	240 V	480 V	600 V
LC1D12	1.5	2	3	7.5	7.5
LC1D18 ²¹	3	5	5	—	—
LC1D25	3	5	7.5	15	20
LC1D32	5	10	7.5	—	—
LC1D40A ²¹	5	10	10	—	—
LC1D50A ²¹	7.5	15	15	—	—
LC1D50 ²¹	7.5	10	15	25	30
LC1D65 ²¹	10	15	20	40	50
LC1D80	15	20	25	50	50
LC1D150	15	25	30	60	75

Table 24 - Definite Purpose Ratings, 3-Phase, Breaking All Lines (Hermetic Refrigeration Compressor, AC-8a)

Catalog Number	FLA	Locked Rotor Amperes (LRA)			FLA Cycles
		240 V	480 V	600 V	
LC1D09	9	54	45	36	100,000
LC1D12	12	72	60	48	100,000
LC1D18	18	108	90	72	100,000
LC1D25	25	150	125	100	100,000
LC1D32	32	192	160	128	100,000
LC1D40A	40	240	200	160	100,000
LC1D50A	50	300	250	200	100,000

21. AC coil only.

Table 24 - Definite Purpose Ratings, 3-Phase, Breaking All Lines (Hermetic Refrigeration Compressor, AC-8a) (Continued)

Catalog Number	FLA	Locked Rotor Amperes (LRA)			FLA Cycles
		240 V	480 V	600 V	
LC1D65A	65	390	325	260	100,000
LC1D80 (AC)	80	480	400	320	100,000
LC1D80 (DC)	75	450	375	300	100,000
LC1D115	115	690	575	460	100,000
LC1D150	150	900	750	600	100,000

TeSys™ Giga Contactors

Figure 17 - TeSys Giga Contactor — LC1G265

Table 25 - TeSys Giga Contactors

Catalog No.	Standard Motor Ratings @ 50/60 Hz (HP)				Cont. Current Rating (A)	Standard Fault SCCR (kA)						High Fault SCCR (kA)					
	Three-Phase					Circuit Breakers @ 480 V		Circuit Breakers @ 600 V		Fuses @ 600 V		Circuit Breakers @ 480 V		Circuit Breakers @ 600 V		Fuses @ 600 V	
	208 V	240 V	480 V	600 V		Max. Size (A)	Max. SCCR (kA)	Max. Size (A)	Max. SCCR (kA)	Max. Size (A)	Max. SCCR (kA)	Max. Size (A)	Max. SCCR (kA)	Max. Size (A)	Max. SCCR (kA)	Max. Size (A)	Max. SCCR (kA)
LC1G115	30	40	75	100	210	—	—	300	10	225	10	300	100	300	50	300	100
LC1G150	40	50	100	125	230	—	—	300	10	250	10	300	100	300	50	300	100
LC1G185	50	60	125	150	250	—	—	300	10	350	10	300	100	300	50	300	100
LC1G225	60	75	150	150	290	—	—	400	10	350	10	400	100	400	50	400	100
LC1G265	75	100	200	200	340	—	—	500	10	500	10	500	100	500	50	450	100
LC1G330	100	125	250	300	390	—	—	600	18	700	18	600	100	600	50	700	100
LC1G400	125	150	300	400	490	700	18	600	18	800	18	700	65	600	50	700	100
LC1G500	150	200	400	450	600	800	30	600	30	1000	30	600	65	600	50	700	100
LC1G630	250	300	600	700	850	1000	42	—	—	1400	42	1000	100	—	—	1000	100
LC1G800	300	350	700 (*)	800 (**)	900	1200	42	—	—	1600	42	1200	100	—	—	1200	100
LC1G1154	—	—	—	—	210	—	—	300	10	225	10	300	100	300	50	300	100
LC1G1504	—	—	—	—	230	—	—	300	10	250	10	300	100	300	50	300	100
LC1G1854	—	—	—	—	250	—	—	300	10	350	10	300	100	300	50	300	100
LC1G2254	—	—	—	—	290	—	—	400	10	350	10	400	100	400	50	400	100

Table 25 - TeSys Giga Contactors (Continued)

Catalog No.	Standard Motor Ratings @ 50/60 Hz (HP)				Cont. Current Rating (A)	Standard Fault SCCR (kA)						High Fault SCCR (kA)					
	Three-Phase					Circuit Breakers @ 480 V		Circuit Breakers @ 600 V		Fuses @ 600 V		Circuit Breakers @ 480 V		Circuit Breakers @ 600 V		Fuses @ 600 V	
	208 V	240 V	480 V	600 V		Max. Size (A)	Max. SCCR (kA)	Max. Size (A)	Max. SCCR (kA)	Max. Size (A)	Max. SCCR (kA)	Max. Size (A)	Max. SCCR (kA)	Max. Size (A)	Max. SCCR (kA)	Max. Size (A)	Max. SCCR (kA)
LC1G2654	—	—	—	—	340	—	—	500	10	500	10	500	100	500	50	450	100
LC1G3304	—	—	—	—	390	—	—	600	18	700	18	600	100	600	50	700	100
LC1G4004	—	—	—	—	490	700	18	600	18	800	18	700	65	600	50	700	100
LC1G5004	—	—	—	—	600	800	30	600	30	1000	30	600	65	600	50	700	100
LC1G6304	—	—	—	—	850	1000	42	—	—	1400	42	1000	100	—	—	1000	100
LC1G8004	—	—	—	—	900	1200	42	—	—	1600	42	1200	100	—	—	1200	100

(*) 828 FLA.
(**) 754 FLA.

Note: This table lists the maximum SCCR of the component when protected by any circuit breaker or fuse. If the maximum component SCCR is 100 kA and a 25 kA rated circuit breaker is used, then the system will be 25 kA, the SCCR rating of the circuit breaker. Ratings apply to circuits with voltages no greater than those listed.

Additional TeSys™ Giga Contactor Ratings

Table 26 - AC-8a Ratings, 3-Phase, Breaking All Lines (Hermetic Refrigeration Compressor)

Catalog Number	AC-8a Rating up to 600 V	AC-8a Make and Break Test Levels	Endurance Test Cycles
LC1G115	210 A	1740	100 K
LC1G150	230 A	1740	100 K
LC1G185	250 A	1740	100 K
LC1G225	290 A	1740	100 K
LC1G265	340 A	2340	100 K
LC1G330	390 A	2340	100 K
LC1G400	490 A	3780	100 K
LC1G500	630 A	3780	100 K

TeSys™ N Contactors

Figure 18 - TeSys N Contactor — T02CN13



Table 27 - TeSys N Contactors

Catalog Number ²²	Standard Motor Ratings @ 50/60 Hz (HP)				Cont. Current Rating (A)	NEMA Size	Max. Component SCCR (kA) ²³					
	Three-Phase						Circuit Breakers @ 480 V		Circuit Breakers @ 600 V		Fuses @ 600 V	
	200 V	230 V	460 V	575 V			Max. Size (A)	Max. SCCR (kA)	Max. Size (A)	Max. SCCR (kA)	Max. Size (A)	Max. SCCR (kA)
T02AN13	1.5	1.5	2	2	9	00	60	85	60	50	60	100
T02BN13	3	3	5	5	18	0	60	85	60	50	60	100
T02CN13	7.5	7.5	10	10	27	1	60	85	60	50	80	100
T02DN13	10	15	25	25	45	2	110	100	110	50	125	100
T02EN13	25	30	50	50	90	3	200	65	—	—	200 ²⁴	100
T02FN13	40	50	100	100	135	4	250	65	—	—	200 ²⁴	100
T02GN13	75	100	200	200	270	5	—	—	—	—	600 ²⁴	100
T02HN13	150	200	400	400	540	6	—	—	—	—	—	—
T02JN13	—	300	600	600	810	7	—	—	—	—	—	—

NOTE: This table lists the maximum SCCR of the component when protected by any circuit breaker or fuse. If the maximum component SCCR is 100 kA and a 25 kA rated circuit breaker is used, then the system will be 25 kA, the SCCR rating for the circuit breaker.

22. T02-N23 have the same SCCRs as their counterparts T02-N13 above.

23. Ratings apply to circuits with voltages no greater than those listed.

24. Class J fuse

Type S Contactors

Figure 19 - Type S Contactor — 8502SAO11



Table 28 - Type S Contactors²⁵

Catalog Number	Standard Motor Ratings @ 50/60 Hz (HP)				Max. Resistive AC1 Current (A)	NEMA Size	Max. Component SCCR (kA) ²⁶	
	Three-Phase						Circuit Breakers @ 480 V ²⁷	Fuses @ 600 V
	200 V	230 V	460 V	575 V				
8502SAO12	1.5	1.5	2	2	9	00	100	100 ²⁸
8502SBO2	3	3	5	5	18	0	100	100 ²⁸
8502SCO2	7.5	7.5	10	10	27	1	100	100 ²⁸
8502SDO2	10	15	25	25	45	2	100	100 ²⁸
8502SEO2	25	30	50	50	90	3	100	100 ²⁸
8502SFO2	40	50	100	100	135	4	100	100 ²⁹
8502SGO2	75	100	200	200	270	5	100	100 ²⁹
8502SHO2	150	200	400	400	540	6	65	100 ²⁹
8502SJO2	—	300	600	600	810	7	30	30

Table 29 - Type S Contactor Maximum Component SCCR²⁵

Catalog Number	Circuit Breakers @ 480 V ³⁰		Fuses @ 600 V	
	Max. Size (A)	Max. SCCR (kA) ²⁶	Max. Size (A)	Max. SCCR (kA) ²⁶
8502SAO12	70	100	60 ³¹	100
8502SBO2	70	100	60 ³¹	100
8502SCO2	70	100	60 ³¹	100
8502SDO2	100	100	100 ³¹	100
8502SEO2	150	100	200 ³¹	100
8502SFO2	225	100	200 ³²	100
8502SGO2	400	100	400 ³²	100
8502SHO2	800	65	600 ³²	100
8502SJO2	2000	30	1500	30

25. This table lists the maximum SCCR of the component when protected by any circuit breaker or fuse. If the maximum component SCCR is 100 kA and a 25 kA rated circuit breaker is used, then the system will be 25 kA, the SCCR rating of the circuit breaker.
 26. Ratings apply to circuits with voltages no greater than those listed.
 27. When protected by any circuit breaker, including thermal-magnetic and magnetic-only, meeting the size limits in Table 30, page 35.
 28. When protected by any Class RK5, RK1, T or J fuse, meeting the size limits in Table 30, page 35.
 29. When protected by any Class T or J fuse, meeting the size limits in Table 30, page 35.
 30. When protected by any circuit breaker, including thermal-magnetic and magnetic-only.
 31. When protected by any Class RK5, RK1, T, or J fuse.
 32. When protected by any Class T or J fuse.

Definite Purpose Contactors

DP Compact Contactors

Figure 20 - Definite Purpose Type DP Compact Contactor — 8910DP22V09



Table 30 - Definite Purpose Type DP Compact Contactors

Catalog Number	Max. Inductive AC3 Current (A)	Locked Rotor Amperes			Max. Resistive AC1 Current (A)	Max. Component SCCR (kA) ³³	
		277 V	460 V	575 V		Circuit Breakers @ 480 V ³⁴	Fuses @ 600 V ³⁵
1-Pole Contactors							
8910DP11	20	120	100	80	30	100	100
8910DP21	25	150	125	100	35	100	100
8910DP31	30	150	125	100	40	100	100
8910DP41	40	240	200	160	50 ³⁶	100	100
2-Pole Contactors ³⁷							
8910DP12	20	120	100	80	30	100	100
8910DP22	25	150	125	100	35	100	100
8910DP32	30	150	125	100	40	100	100
8910DP42	40	240	200	160	50	100	100
<p>NOTE: This table lists the maximum SCCR of the component when protected by any circuit breaker or fuse. If the maximum component SCCR is 100 kA and a 25 kA rated circuit breaker is used, then the system will be 25 kA, the SCCR rating of the circuit breaker.</p>							

Table 31 - Definite Purpose Type DP Compact Contactor Maximum Component SCCR

Catalog Number ³⁸	Circuit Breaker @ 480 V ³⁹		Fuse @ 600 V ⁴⁰	
	Max. Size (A)	Max. SCCR (kA)	Max. Size (A)	Max. SCCR (kA ³³)
8910DP1*	80	100	60	100
8910DP2*	80	100	60	100
8910DP3*	80	100	60	100
8910DP4*	100	100	100	100
<p>NOTE: This table lists the maximum SCCR of the component when protected by any circuit breaker or fuse. If the maximum component SCCR is 100 kA and a 25 kA rated circuit breaker is used, then the system will be 25 kA, the SCCR rating of the circuit breaker.</p>				

33. Ratings apply to circuits with voltages no greater than those listed.

34. When protected by any circuit breaker, including thermal-magnetic and magnetic only, meeting the size limits in Definite Purpose Type DP Compact Contactor Maximum Component SCCR, page 36.

35. When protected by any Class J time-delay fuse, meeting the size limits in Definite Purpose Type DP Compact Contactor Maximum Component SCCR, page 36.

36. 50 A Resistive, maximum 277 V. All others rated 40 A Resistive (above 277 V).

37. Above 240 V, all lines must be switched.

38. The "*" represents the number of poles. Replace the "*" with a 2 for a 2-pole contactor or a 3 for a 3-pole contactor.

39. When protected by any circuit breaker, including thermal-magnetic and magnetic-only.

40. When protected by any Class J time-delay fuse.

DPA Contactors

Figure 21 - Definite Purpose Type DPA Contactor — 8910DPA32



Table 32 - Definite Purpose Type DPA Contactors⁴¹

Catalog Number	Max. Inductive AC3 Current (A)	Locked Rotor Amperes			Max. Resistive AC1 Current (A)	Horsepower Ratings					Number of Poles	Max. Component SCCR (kA) ⁴²	
		230 V	460 V	575 V		Single-Phase		Three-Phase				Circuit Breakers @ 480 V ⁴³	Fuses @ 600 V ⁴⁴
						115 V	230 V	230 V	460 V	575 V			
8910DPA12	20	120	100	80	30	1.5	3	7.5	7.5	7.5	2	100	100
8910DPA13											3		
8910DPA14											4		
8910DPA22	25	150	125	100	35	2	5	10	15	20	2	100	100
8910DPA23											3		
8910DPA24											4		
8910DPA32	30	180	150	120	40	2	5	10	15	20	2	100	100
8910DPA33											3		
8910DPA34											4		
8910DPA42	40	240	200	160	50	3	7.5	10	20	25	2	100	100
8910DPA43											3		
8910DPA44											4		
8910DPA52	50	300	250	200	65	3	10	15	30	30	2	100	100
8910DPA53											3		
8910DPA62	60	360	300	240	75	5	10	25	30	30	2	100	100
8910DPA63											3		
8910DPA72	75	450	375	300	94	5	15	25	40	40	2	100	100
8910DPA73											3		
8910DPA92	90	540	450	360	120	7.5	20	30	50	50	2	100	100
8910DPA93											3		

NOTE: This table lists the maximum SCCR of the component when protected by any circuit breaker or fuse. If the maximum component SCCR is 100 kA and a 25 kA rated circuit breaker is used, then the system will be 25 kA, the SCCR rating of the circuit breaker.

41. Above 240 V, all lines must be switched.

42. Ratings apply to circuits with voltages no greater than those listed.

43. When protected by any circuit breaker meeting the size limits in Table 34, page 38.

44. When protected by any Class J time-delay fuse, meeting the size limits in Table 34, page 38.

Table 33 - Definite Purpose Type DPA Contactor Maximum Component SCCR⁴⁵

Catalog Number ⁴⁶	Circuit Breaker @ 480 V		Fuse @ 600 V ⁴⁷	
	Max. Size (A)	Max. SCCR (kA)	Max. Size (A)	Max. SCCR (kA)
8910DPA1*	80	100	60	100
8910DPA2*	80	100	60	100
8910DPA3*	80	100	60	100
8910DPA4*	100	100	100	100
8910DPA5*	150	100	200	100
8910DPA6*	150	100	200	100
8910DPA7*	225	100	200	100
8910DPA9*	225	100	200	100

NOTE: This table lists the maximum SCCR of the component when protected by any circuit breaker or fuse. If the maximum component SCCR is 100 kA and a 25 kA rated circuit breaker is used, then the system will be 25 kA, the SCCR rating of the circuit breaker.

45. Ratings apply to circuits with voltages no greater than those listed.

46. The "*" represents the number of poles. Replace the "*" with a 2 for a 2-pole contactor, a 3 for a 3-pole contactor, or a 4 for a 4-pole contactor.

47. When protected by any Class RK5 or Class J time-delay fuse.

Type S Lighting Contactors

Figure 22 - Type S Lighting Contactor — 8903SPO3V02



Table 34 - Type S Lighting Contactors

Contact Ampere Ratings	No. of Poles	Catalog Number, Open Type		Max. Component SCCR (kA) ⁴⁸	
		Electrically Held	Mechanically Held	Circuit Breakers @ 480 V ⁴⁹	Fuses @ 600 V
30	2	8903SMO1	8903SMO10	100	100 ⁵⁰
	3	8903SMO2	8903SMO11		
	4	8903SMO3	8903SMO12		
	5	8903SMO4	8903SMO13		
60	2	8903SPO1	8903SPO10	100	100 ⁵⁰
	3	8903SPO2	8903SPO11		
	4	8903SPO3	8903SPO12		
	5	8903SPO4	8903SPO13		
100	2	8903SQO1	8903SQO10	100	100 ⁵¹
	3	8903SQO2	8903SQO11		
	4	8903SQO3	8903SQO12		
	5	8903SQO4	8903SQO13		
200	2	8903SVO1	8903SVO10	100	100 ⁵²
	3	8903SVO2	8903SVO11		
	4	8903SVO3	8903SVO12		
	5	8903SVO4	—		
300	2	8903SXO1	8903SXO13	100	100 ⁵²
	3	8903SXO2	8903SXO14		
400	2	8903SYO1	8903SYO16	65	100 ⁵²
	3	8903SYO2	8903SYO17		
600	2	8903SZO1	8903SZO18	65	100 ⁵²
	3	8903SZO2	8903SZO19		
800	2	8903SJO1	—	30	30
	3	8903SJO2	—		

48. Ratings apply to circuits with voltages no greater than those listed.
 49. When protected by any circuit breaker meeting the size limits in Table 36, page 40.
 50. When protected by any Class RK5, RK1, T, or J fuse, meeting the size limits in Table 36, page 40.
 51. When protected by any Class RK5, RK1, T, or J fuse, meeting the size limits in .Table 36, page 40.
 52. When protected by any Class T or J fuse, meeting the size limits in Table 36, page 40.

Table 34 - Type S Lighting Contactors (Continued)

Contact Ampere Ratings	No. of Poles	Catalog Number, Open Type		Max. Component SCCR (kA) ⁵³	
		Electrically Held	Mechanically Held	Circuit Breakers @ 480 V ⁵⁴	Fuses @ 600 V
<p>NOTE: This table lists the maximum SCCR of the component when protected by any circuit breaker or fuse. If the maximum component SCCR is 100 kA and a 25 kA rated circuit breaker is used, then the system will be 25 kA, the SCCR rating of the circuit breaker.</p>					

Table 35 - Type S Lighting Contactor Maximum Component SCCR⁵³

Catalog Number	Circuit Breaker @ 480 V		Fuse @ 600 V	
	Max. Size (A)	Max. SCCR (kA)	Max. Size (A)	Max. SCCR (kA)
8903SMO	70	100	60 ⁵⁵	100
8903SPO	100	100	100 ⁵⁵	100
8903SQO	150	100	200 ⁵⁵	100
8903SVO	225	100	200 ⁵⁶	100
8903SXO	400	100	400 ⁵⁶	100
8903SYO	800	65	600 ⁵⁶	100
8903SZO	800	65	600 ⁵⁶	100
8903SJO	2000	30	1500	30
<p>NOTE: This table lists the maximum SCCR of the component when protected by any circuit breaker or fuse. If the maximum component SCCR is 100 kA and a 25 kA rated circuit breaker is used, then the system will be 25 kA, the SCCR rating of the circuit breaker.</p>				

53. Ratings apply to circuits with voltages no greater than those listed.

54. When protected by any circuit breaker meeting the size limits in Table 36, page 40.

55. When protected by any Class RK5, RK1, T, or J fuse.

56. When protected by any Class T or J fuse.

Type L/LX Lighting Contactors

Figure 23 - Type L Lighting Contactor — 8903LO1200

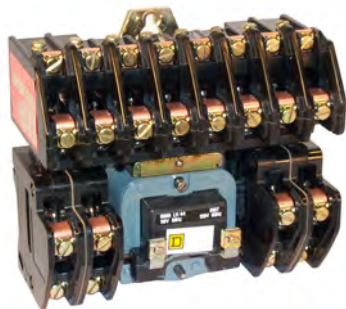

Figure 24 - Type LX Lighting Contactor — 8903LXO1200



Table 36 - Type L/LX Lighting Contactors

Contact Ampere Ratings	No. of Poles	Catalog Number, Open Type		Max. Component SCCR (kA) ⁵⁷	
		Electrically Held	Mechanically Held	Circuit Breakers @ 480 V ⁵⁸	Fuses @ 600 V ⁵⁹
30	2	8903LO20	8903LXO20	100	100 ⁶⁰
	3	8903LO30	8903LXO30		
	4	8903LO40	8903LXO40		
	6	8903LO60	8903LXO60		
	8	8903LO80	8903LXO80		
	10	8903LO1000	8903LXO1000		
	12	8903LO1200	8903LXO1200		

57. Ratings apply to circuits with voltages no greater than those listed.

58. When protected by any circuit breaker, including thermal-magnetic and magnetic-only, meeting the size limits in Table 38, page 42.

59. When protected by any Class RK5, RK1, T, or J fuse, meeting the size limits in Table 38, page 42.

60. When protected by any Class T or J fuse, meeting the size limits in Table 38, page 42.

Table 37 - Type L/LX Lighting Contactor Maximum Component SCCR⁶¹

Catalog Number	Circuit Breakers @ 480 V ⁶²		Fuses @ 600 V ⁶³	
	Max. Size (A)	Max. SCCR (kA)	Max. Size (A)	Max. SCCR (kA)
8903LO	Per NEC Table 430.52	100	Per NEC Table 430.52	100 ⁶⁴
8903LXO				

NOTE: This table lists the maximum SCCR of the component when protected by any circuit breaker or fuse. If the maximum component SCCR is 100 kA and a 25 kA rated circuit breaker is used, then the system will be 25 kA, the SCCR rating of the circuit breaker.

TeSys™ NEMA® Lighting Contactors

Figure 25 - TeSys National Electrical Manufacturers Association (NEMA) Lighting Contactor — LC1D25MEQ4096



Table 38 - TeSys NEMA Lighting Contactors

Contact Ampere Ratings	No. of Poles	Catalog Number	Max. Component SCCR (kA) ⁶¹			
			Electrically Held	Circuit Breakers @ 480 V ⁶⁵	Circuit Breakers @ 600 V ⁶⁶	Fuses @ 600 V ⁶⁷
30	3	LC1D25MEQ4096		85	50	100
60	3	LC1D40AMEQ4096		100	50	100
100	3	LC1D80MEQ4096		100	50	100
150	3	LC1D150MEQ4096		100	50	100

NOTE: This table lists the maximum SCCR of the component when protected by any circuit breaker or fuse. If the maximum component SCCR is 100 kA and a 25 kA rated circuit breaker is used, then the system will be 25 kA, the SCCR rating of the circuit breaker.

Table 39 - TeSys NEMA Lighting Contactor Maximum Component SCCR⁶¹

Catalog Number	Circuit Breakers @ 480 V ⁶²		Circuit Breakers @ 600 V ⁶²		Fuses @ 600 V ⁶⁸	
	Max. Size	Max. SCCR	Max. Size	Max. SCCR	Max. Size	Max. SCCR
	(A)	(kA)	(A)	(kA)	(A)	(kA)
LC1D25MEQ4096	60	85	60	50	60	100
LC1D40AMEQ4096	110	100	110	50	90	100
LC1D80MEQ4096	150	100	150	50	175	100

61. Ratings apply to circuits with voltages no greater than those listed.

62. When protected by any circuit breaker, including thermal-magnetic and magnetic-only.

63. When protected by any Class RK5, RK1, T, or J fuse.

64. When protected by any Class T or J fuse.

65. When protected by any circuit breaker meeting the size limits in Table 40, page 42.

66. When protected by any circuit breaker, including thermal-magnetic and magnetic-only, meeting the size limits in Table 40, page 42.

67. When protected by any Class J or CC time-delay fuse meeting the size limits in Table 40, page 42.

68. When protected by any Class J or CC time-delay fuse.

Table 39 - TeSys NEMA Lighting Contactor Maximum Component SCCR³⁹ - (Continued)

Catalog Number	Circuit Breakers @ 480 V ⁶⁹		Circuit Breakers @ 600 V ⁶⁹		Fuses @ 600 V ⁷⁰	
	Max. Size (A)	Max. SCCR (kA)	Max. Size (A)	Max. SCCR (kA)	Max. Size (A)	Max. SCCR (kA)
LC1D150MEQ4096	250	100	250	50	300	100

NOTE: This table lists the maximum SCCR of the component when protected by any circuit breaker or fuse. If the maximum component SCCR is 100 kA and a 25 kA rated circuit breaker is used, then the system will be 25 kA, the SCCR rating of the circuit breaker.

UL 60947 Overload Relays

TeSys™ K Bimetallic Overload Relays

Figure 26 - TeSys K Overload Relay — LR2K0304



Table 40 - TeSys LR2K Bimetallic Overload Relays

Current Setting Range (A)	Class 10 with Single Phase Sensitivity	Max. Component SCCR (kA) ⁷¹					
		Circuit Breakers @ 480 V ⁶⁹		Circuit Breakers @ 600 V		Fuses @ 600 V ⁷⁰	
		Max. Size (A)	Max. SCCR (kA)	Max. Size (A)	Max. SCCR (kA)	Max. Size (A)	Max. SCCR (kA)
0.1–0.16	LR2K0301	15	65	15	25	10	100
0.16–0.23	LR2K0302	15	65	15	25	10	100
0.23–0.36	LR2K0303	15	65	15	25	10	100
0.35–0.54	LR2K0304	15	65	15	25	10	100
0.54–0.8	LR2K0305	15	65	15	25	10	100
0.8–1.2	LR2K0306	15	65	15	25	10	100
1.2–1.8	LR2K0307	15	65	15	25	10	100
1.8–2.6	LR2K0308	15	65	15	25	10	100
2.6–3.7	LR2K0310	15	65	15	25	10	100
3.8–5.5	LR2K0312	15	65	15	25	20	100
5.5–8	LR2K0314	25	65	25	25	30	100
8–11.5	LR2K0316	25	65	25	25	30	100

NOTE: This table lists the maximum SCCR of the component when protected by any circuit breaker or fuse. If the maximum component SCCR is 65 kA and a 25 kA rated circuit breaker is used, then the system will be 25 kA, the SCCR rating of the circuit breaker.

69. When protected by any circuit breaker, including thermal-magnetic and magnetic-only.

70. When protected by any Class J or CC time-delay fuse.

71. Ratings apply to circuits with voltages no greater than those listed.

TeSys™ Deca Bimetallic Overload Relays

Figure 27 - TeSys Deca Overload Relay



Table 41 - TeSys LRD Bimetallic Overload Relays

Current Setting Range (A)	For Direct Mounting to LC1	Class 10 with Single Phase Sensitivity	Class 10 without Single Phase Sensitivity	Class 20 with Single Phase Sensitivity	Class 20 without Single Phase Sensitivity	Max. Component SCCR (kA) ⁷²					
						Circuit Breakers @ 480 V		Circuit Breakers @ 600 V		Fuses @ 600 V ⁷³	
						Max. Size (A)	Max. SCCR (kA)	Max. Size (A)	Max. SCCR (kA)	Max. Size (A)	Max. SCCR (kA)
0.10–0.16	D09–D38	LRD01	LR3D01	—	—	15	65	15	50	10	100
0.16–0.25		LRD02	LR3D02	—	—	15	65	15	50	10	100
0.25–0.40		LRD03	LR3D03	—	—	15	65	15	50	10	100
0.40–0.63		LRD04	LR3D04	LRD04L	LR3D04L	15	65	15	50	10	100
0.63–1		LRD05	LR3D05	LRD05L	LR3D05L	15	65	15	50	10	100
1–1.6		LRD06	LR3D06	LRD06L	LR3D06L	15	65	15	50	10	100
1.6–2.5		LRD07	LR3D07	LRD07L	LR3D07L	15	65	15	50	10	100
2.5–4		LRD08	LR3D08	LRD08L	LR3D08L	15	65	15	50	15	100
4–6		LRD10	LR3D10	LRD10L	LR3D10L	15	65	15	50	20	100
5.5–8		LRD12	LR3D12	LRD12L	LR3D12L	15	65	15	50	30	100
7–10	LRD14	LR3D14	LRD14L	LR3D14L	20	65	20	50	40	100	
9–13	D12–D38	LRD16	LR3D16	LRD16L	LR3D16L	25	65	25	50	50	100
12–18	D18–D38	LRD21	LR3D21	LRD21L	LR3D21L	35	65	35	50	60	100
16–24	D25–D38	LRD22	LR3D22	—	—	45	65	45	50	60	100
17–24		—	—	LRD22L	LR3D22L	45	65	45	50	60	100
23–32		LRD32	LR3D32	LRD32L	LR3D32L	60	65	60	50	80	100
30–38	D32–D38	LRD35	LR3D35	—	—	70	65	70	50	100	100
9–13	D40A–D65A ⁷⁴	LRD313	LR3D313	LRD313L	—	25	100	25	50	30	100
12–18		LRD318	LR3D318	LRD318L	—	35	100	35	50	45	100
16–25		LRD325	LR3D325	LRD325L	—	45	100	45	50	60	100
23–32		LRD332	LR3D332	LRD332L	—	60	100	60	50	80	100
30–40		LRD340	LR3D340	LRD340L	—	70	100	70	50	100	100
37–50	LRD350	LR3D350	LRD350L	—	90	100	90	50	125	100	
48–65	D50A–D65A ⁷⁵	LRD365	LR3D365	LRD365L	—	125	100	125	50	200	100

72. Ratings apply to circuits with voltages no greater than those listed.

73. When protected by any Class J or CC time-delay fuse.

74. Overload relays with Everlink™ termination. Direct mount to D40A to D65A only.

75. Overload relays with Everlink termination. Direct mount to D40A to D65A only.

Table 41 - TeSys LRD Bimetallic Overload Relays (Continued)

Current Setting Range (A)	For Direct Mounting to LC1	Class 10 with Single Phase Sensitivity	Class 10 without Single Phase Sensitivity	Class 20 with Single Phase Sensitivity	Class 20 without Single Phase Sensitivity	Max. Component SCCR (kA) ⁷⁶					
						Circuit Breakers @ 480 V		Circuit Breakers @ 600 V		Fuses @ 600 V ⁷⁷	
						Max. Size (A)	Max. SCCR (kA)	Max. Size (A)	Max. SCCR (kA)	Max. Size (A)	Max. SCCR (kA)
17–25	D40–D95 ⁷⁸	LRD3322	LR3D3322	LR2D3522	LR3D3522	45	100	45	50	60	100
23–32		LRD3353	LR3D3353	LR2D3553	LR3D3553	60	100	60	50	80	100
30–40		LRD3355	LR3D3355	LR2D3555	LR3D3555	70	100	70	50	90	100
37–50	D50–D95 ⁷⁸	LRD3357	LR3D3357	LR2D3557	LR3D3557	90	100	90	50	125	100
48–65		LRD3359	LR3D3359	LR2D3559	LR3D3559	125	100	125	50	150	100
55–70	D65–D95 ⁷⁸	LRD3361	LR3D3361	LR2D3561	LR3D3561	125	100	125	50	175	100
63–80		LRD3363	LR3D3363	LR2D3563	LR3D3563	150	100	150	50	200	100
80–104	D80–D95	LRD3365	—	—	—	200	100	200	50	250	100
80–104	D115–D150	LRD4365	—	—	—	200	100	200	50	250	100
95–120		LRD4367	—	—	—	250	100	250	50	400	100

NOTE: This table lists the maximum SCCR of the component when protected by any circuit breaker or fuse. If the maximum component SCCR is 100 kA and a 25 kA rated circuit breaker is used, then the system will be 25 kA, the SCCR rating of the circuit breaker.

TeSys™ Giga Overload Relays

Figure 28 - TeSys Giga Overload Relays — LR9G225



Table 42 - TeSys Giga Overload Relays

Current Setting Range	For Direct Mounting to LC1G	Overload Relay	Standard Fault SCCR (kA)						High Fault SCCR (kA)					
			Circuit Breakers @ 480 V		Circuit Breakers @ 600 V		Fuses @ 600 V		Circuit Breakers @ 480 V		Circuit Breakers @ 600 V		Fuses @ 600 V	
			Max. Size (A)	Max. SCCR (kA)	Max. Size (A)	Max. SCCR (kA)	Max. Size (A)	Max. SCCR (kA)	Max. Size (A)	Max. SCCR (kA)	Max. Size (A)	Max. SCCR (kA)	Max. Size (A)	Max. SCCR (kA)
28-115	115-225	LR9G115	—	—	225	10	450	10	—	—	225	100	225	100
57-225	115-225	LR9G225	—	—	400	18	900	18	—	—	400	100	400	100
125-500	265-500	LR9G500	—	—	600	30	2000	30	—	—	600	100	600	100
160-630	630-800	LR9G630	1000	42	—	—	2500	42	1000	100	—	—	1400	100

NOTE: This table lists the maximum SCCR of the component when protected by any circuit breaker or fuse. If the maximum component SCCR is 100 kA and a 25 kA rated circuit breaker is used, then the system will be 25 kA, the SCCR rating of the circuit breaker. Ratings apply to circuits with voltages no greater than those listed.

76. Ratings apply to circuits with voltages no greater than those listed.

77. When protected by any Class J or CC time-delay fuse.

78. Direct mount to D40–D65 (no Everlink terminations) and to D80–D95 only.

TeSys™ LR9D Electronic Overload Relays

Figure 29 - TeSys LR9D Overload Relay — LR9D32



Figure 30 - TeSys Deca Overload Relay — LR9D5369



Table 43 - TeSys LR9D Electronic Overload Relays

Current Setting Range (A)	For Direct Mounting to LC1	Class 10	Class 20	Class 10 or 20 Selectable	Class 5/10/20/30 Selectable	Max. Component SCCR (kA) ⁷⁹					
						Circuit Breakers @ 480 V		Circuit Breakers @ 600 V		Fuses @ 600 V ⁸⁰	
						Max. Size (A)	Max. SCCR (kA)	Max. Size (A)	Max. SCCR (kA)	Max. Size (A)	Max. SCCR (kA)
0.1-0.5	D09-D38	—	—	—	LR9D01	—	—	—	—	1	100
0.4-2	D09-D38	—	—	—	LR9D02	—	—	—	—	6	100
1.6-8	D09-D38	—	—	—	LR9D08	—	—	—	—	30	100
6.4-32	D09-D38	—	—	—	LR9D32	70	65	—	—	125	100
22-110	N/A (Separate Mount Only)	—	—	—	LR9D110S	250	65	—	—	225	100
60-100	D115-D150	LR9D5367	LR9D5567	LR9D67	—	175	100	175	50	225	100

NOTE: This table lists the maximum SCCR of the component when protected by any circuit breaker or fuse. If the maximum component SCCR is 65 kA and a 25 kA rated circuit breaker is used, then the system will be 25 kA, the SCCR rating of the circuit breaker.

79. Ratings apply to circuits with voltages no greater than those listed.

80. When protected by any Class J or CC time-delay fuse.

TeSys™ T Motor Management System

Figure 31 - TeSys T Motor Management System — LTMR08MFM



Table 44 - TeSys T Motor Management System

Current Range (A)	Catalog Number ⁸¹		Max. Component SCCR (kA) ⁸²	
	24 Vdc Control Voltage	100–240 Vac Control Voltage	Circuit Breakers (kA) ⁸³	Fuses (kA)
0.4–8	LTMR08•BD	LTMR08•FM	100	100
1.35–27	LTMR27•BD	LTMR27•FM	100	100
5–100	LTMR100•BD	LTMR100•FM	100	100

NOTE: This table lists the maximum SCCR of the component when protected by any circuit breaker or fuse. If the maximum component SCCR is 100 kA and a 25 kA rated circuit breaker is used, then the system will be 25 kA, the SCCR rating of the circuit breaker.

Motor Logic™ Solid-State Overload Relays

Figure 32 - Motor Logic Solid-State Overload Relay — 9065SFB20

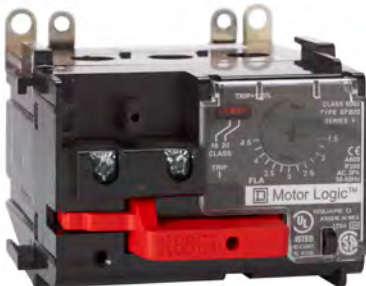

81. The "•" represents the type of fieldbus. Replace the "•" with a M for Modbus™, a P for Profibus DP, an E for Ethernet TCP/IP, a C for CANopen, and a D for DeviceNet.
 82. Ratings apply to circuits no greater than 600 V.
 83. When protected by any circuit breaker, including thermal-magnetic and magnetic-only.

Table 45 - Motor Logic Solid-State Overload Relays

NEMA Size	Current Setting Range (A)	Class 10/20 Selectable Catalog Number	Max. Component SCCR (kA) ⁸⁴	
			Circuit Breakers @ 480 V	Fuses @ 600 V
00	1.5–4.5	9065SFB20	100	100
00	3–9	9065SFC20	100	100
0	6–18	9065SF020	100	100
1	9–27	9065SF120	100	100
2	15–45	9065SF220	100	100
3	30–90	9065SF320	100	100
4	45–135	9065SF420	100	100

NOTE: This table lists the maximum SCCR of the component when protected by any circuit breaker or fuse. If the maximum component SCCR is 100 kA and a 25 kA rated circuit breaker is used, then the system will be 25 kA, the SCCR rating of the circuit breaker.

UL 60947 Starters

TeSys™ N Starters

Figure 33 - TeSys N Starter with Motor Logic™ — T36EN13BD**Table 46 - TeSys N Starters with Motor Logic Overload Relays**

Catalog Number	Standard Motor Ratings @ 50/60 Hz (HP)				Continuous Current Rating (A)	NEMA Size	Max. Component SCCR (kA) ⁸⁵			
	Three-Phase						Circuit Breakers @ 480 V		Fuses @ 600 V	
	208 V	240 V	480 V	600 V			Max. Size (A)	Max. SCCR (kA)	Max. Size (A)	Max. SCCR (kA)
T36AN13	1.5	1.5	2	2	9	00	60	85	60 ⁸⁶	100
T36BN13	3	3	5	5	18	0	60	85	60 ⁸⁶	100
T36CN13	7.5	7.5	10	10	27	1	60	85	80 ⁸⁶	100
T36DN13	10	15	25	25	45	2	110	100	125 ⁸⁶	100
T36EN13	25	30	50	50	90	3	200	65	60 ⁸⁶	100
T36FN13	40	50	100	100	135	4	250	65	125 ⁸⁶	100

84. Ratings apply to circuits no greater than 600 V.

85. Ratings apply to circuits with voltages no greater than those listed.

86. When protected by any Class J or CC time-delay fuse.

Table 46 - TeSys N Starters with Motor Logic Overload Relays (Continued)

Catalog Number	Standard Motor Ratings @ 50/60 Hz (HP)				Continuous Current Rating (A)	NEMA Size	Max. Component SCCR (kA) ⁸⁷			
	Three-Phase						Circuit Breakers @ 480 V		Fuses @ 600 V	
	208 V	240 V	480 V	600 V			Max. Size (A)	Max. SCCR (kA)	Max. Size (A)	Max. SCCR (kA)
T36GN13	75	100	200	200	270	5	–	18	600 ⁸⁸	100
T36HN13	150	200	400	400	540	6	–	30	1000	30
T36JN13	—	300	600	600	810	7	–	42	1200	42

NOTE: This table lists the maximum SCCR of the component when protected by any circuit breaker or fuse. If the maximum component SCCR is 100 kA and a 25 kA rated circuit breaker is used, then the system will be 25 kA, the SCCR rating of the circuit breaker.

Type S Starters

Figure 34 - Type S Starter with Motor Logic™ Overload Relay — 8536SBO2



Table 47 - Type S Starters with Motor Logic Overload Relay or TeSys™ T Overload Relays

Catalog Number	Standard Motor Ratings @ 50/60 Hz (HP)				Continuous Current Rating (A)	NEMA Size	Max. Component SCCR (kA) ⁸⁹	
	Three-Phase						Circuit Breakers @ 480 V ⁹⁰	Fuses @ 600 V
	208 V	240 V	480 V	600 V				
8536SAO12	1.5	1.5	2	2	9	00	100	100 ⁹¹
8536SBO2	3	3	5	5	18	0	100	100 ⁹¹
8536SCO2	7.5	7.5	10	10	27	1	100	100 ⁹¹
8536SDO1	10	15	25	25	45	2	100	100 ⁹¹
8536SEO1	25	30	50	50	90	3	100	100 ⁹¹
8536SFO1	40	50	100	100	135	4	100	100 ⁹²
8536SGO1	75	100	200	200	270	5	100	100 ⁹²
8536SHO2	150	200	400	400	540	6	65	100 ⁹²
8536SJO2	—	300	600	600	810	7	30	30

NOTE: This table lists the maximum SCCR of the component when protected by any circuit breaker or fuse. If the maximum component SCCR is 100 kA and a 25 kA rated circuit breaker is used, then the system will be 25 kA, the SCCR rating of the circuit breaker.

87. Ratings apply to circuits with voltages no greater than those listed.
 88. When protected by any Class J or CC time-delay fuse.
 89. Ratings apply to circuits with voltages no greater than those listed.
 90. When protected by any circuit breaker meeting the size limits in the table TeSys™ BV4 Type D Combination with NEMA Type S Non-Reversing Starters, page 50.
 91. When protected by any Class RK5, RK1, T, or J fuse, meeting the size limits in the table TeSys™ BV4 Type D Combination with NEMA Type S Non-Reversing Starters, page 50.
 92. When protected by any Class T or J fuse, meeting the size limits in the table TeSys™ BV4 Type D Combination with NEMA Type S Non-Reversing Starters, page 50.

Figure 35 - TeSys™ BV4 Motor Circuit Protector



Figure 36 - Type S NEMA Starter



For a complete list of Type D combinations, see www.UL.com/SCCR.

Table 48 - TeSys™ BV4 Type D Combination with NEMA Type S Non-Reversing Starters

ID ⁹³	Component Description ⁹⁴		Combination Motor Controller Ratings ⁹⁵			Enclosure Volume, Cubic Inches ⁹⁶	Wire Code ⁹⁷
	Component Type	Catalog Number ⁹⁸	480 V 3-Phase HP Rating	FLA	480 V 3-Phase SCCR, kA		
SE191167	ICB ⁹⁹	BV4T002J	0.5	1.1	100	2747	7a
	STR ¹⁰⁰	8736SCO***H308					
SE191168	ICB	BV4T002J	0.75	1.6	100	2747	7a
	STR	8736SCO***H308					
SE191169	ICB	BV4T003J	1	2.1	100	2747	7a
	STR	8736SCO***H308					
SE191170	ICB	BV4T007J	1.5	3	100	2747	7a
	STR	8736SCO***H308					
SE191171	ICB	BV4T007J	2	3.4	100	2747	7a
	STR	8736SCO***H308					
SE191172	ICB	BV4T007J	3	4.8	100	2747	7a
	STR	8736SCO***H309					

93. The ID number is issued by Underwriters Laboratories and is shown on its website for UL 508A Listed combinations. For ID number definitions, see "Short Circuit Current Ratings for Combination Motor Controller Components" on the UL web site.

94. Use wire ties evenly spaced apart to secure conductors in place.

95. You must consider the need for cautionary labeling regarding high-fault short-circuit ratings in the end product application for Type D and E combination motor controllers.

96. All specified individual components of the combination motor controller have been installed in an enclosure having a specified internal volume in cubic inches. Additional testing in the combination motor controller is not required when installed in an enclosure.

97. See Table 52, page 52 for minimum internal wiring between the load side of the short-circuit protective device and the line side of starter.

98. Refer to the Digest to complete the contactor catalog number for coil voltage and form modifications.

99. ICB is Instantaneous Trip Circuit Breaker.

100. STR is an Electromechanical Motor Starter or Solid-State Motor Starter.

Table 48 - TeSys™ BV4 Type D Combination with NEMA Type S Non-Reversing Starters (Continued)

ID ¹⁰¹	Component Description ¹⁰²		Combination Motor Controller Ratings ¹⁰³			Enclosure Volume, Cubic Inches ¹⁰⁴	Wire Code ¹⁰⁵
	Component Type	Catalog Number ¹⁰⁶	480 V 3-Phase HP Rating	FLA	480 V 3-Phase SCCR, kA		
SE191173	ICB	BV4T013J	5	7.6	100	2747	7a
	STR	8736SCO***H300					
SE191174	ICB	BV4T013J	7.5	11	100	2747	7a
	STR	8736SCO***H30					
SE191175	ICB	BV4T025J	10	14	100	2747	7a
	STR	8736SCO***H30					
SE191176	ICB	BV4T025J	15	21	100	2747	7b
	STR	8736SDO***H30					
SE191177	ICB	BV4T050J	20	27	100	2747	7b
	STR	8736SDO***H30					
SE191178	ICB	BV4T050J	25	34	100	2747	7b
	STR	8736SDO***H30					
SE191179	ICB	BV4T050J	30	40	100	4120	7c
	STR	8736SEO***H30					
SE191180	ICB	BV4T080J	40	52	100	4120	7c
	STR	8736SEO***H30					
SE191181	ICB	BV4T080J	50	65	100	4120	7c
	STR	8736SEO***H30					
SE191182	ICB	BV4T115J	60	77	100	5036	7d
	STR	8736SFO***H30					

NOTE: This table lists the maximum SCCR of the component when protected by any circuit breaker or fuse. If the maximum component SCCR is 100 kA and a 25 kA rated circuit breaker is used, then the system will be 25 kA, the SCCR rating of the circuit breaker.

Table 49 - Type S Starters with Motor Logic or TeSys T Overload Relays Max. Component SCCR¹⁰⁷

Catalog Number	Circuit Breakers @ 480 V ¹⁰⁸		Fuses @ 600 V	
	Max. Size (A)	Max. SCCR (kA)	Max. Size (A)	Max. SCCR (kA)
8536SAO12	70	100	60 ¹⁰⁹	100
8536SBO2	70	100	60 ¹⁰⁹	100
8536SCO2	70	100	60 ¹⁰⁹	100
8536SDO1	100	100	100 ¹⁰⁹	100
8536SEO1	150	100	200 ¹⁰⁹	100
8536SFO1	225	100	200 ¹¹⁰	100

101. The ID number is issued by Underwriters Laboratories and is shown on its website for UL 508A Listed combinations. For ID number definitions, see " Short Circuit Current Ratings for Combination Motor Controller Components" on the UL web site.
 102. Use wire ties evenly spaced apart to secure conductors in place.
 103. You must consider the need for cautionary labeling regarding high-fault short-circuit ratings in the end product application for Type D and E combination motor controllers.
 104. All specified individual components of the combination motor controller have been installed in an enclosure having a specified internal volume in cubic inches. Additional testing in the combination motor controller is not required when installed in an enclosure.
 105. See Table 52, page 52 for minimum internal wiring between the load side of the short-circuit protective device and the line side of starter.
 106. Refer to the Digest to complete the contactor catalog number for coil voltage and form modifications.
 107. Ratings apply to circuits with voltages no greater than those listed.
 108. When protected by any circuit breaker, including thermal-magnetic and magnetic-only.
 109. When protected by any Class RK5, RK1, T, or J fuse.
 110. When protected by any Class T or J fuse.

Table 49 - Type S Starters with Motor Logic or TeSys T Overload Relays Max. Component SCCR⁴⁹ - (Continued)

Catalog Number	Circuit Breakers @ 480 V ¹¹¹		Fuses @ 600 V	
	Max. Size (A)	Max. SCCR (kA)	Max. Size (A)	Max. SCCR (kA)
8536SGO1	400	100	400 ¹¹²	100
8536SHO2	800	65	600 ¹¹²	100
8536SJO2	2000	30	1500	30

NOTE: This table lists the maximum SCCR of the component when protected by any circuit breaker or fuse. If the maximum component SCCR is 100 kA and a 25 kA rated circuit breaker is used, then the system will be 25 kA, the SCCR rating of the circuit breaker.

Figure 37 - Type S Adapted Bimetallic Starter — 8536SAO12E4050

Table 50 - Type S Starters with Adapted Bimetallic Overload Relays

Catalog Number	Standard Motor Ratings @ 50/60 Hz (HP)				Continuous Current Rating (A)	NEMA Size	Max. Component SCCR (kA) ¹¹³	
	Three-Phase						Circuit Breakers @ 480 V ¹¹⁴	Fuses @ 600 V ¹¹⁵
	208 V	240 V	480 V	600 V				
8536SAO12	1.5	1.5	2	2	9	00	65	65
8536SBO2	3	3	5	5	18	0	65	65
8536SCO2	7.5	7.5	10	10	27	1	65	65

NOTE: This table lists the maximum SCCR of the component when protected by any circuit breaker or fuse. If the maximum component SCCR is 100 kA and a 25 kA rated circuit breaker is used, then the system will be 25 kA, the SCCR rating of the circuit breaker.

Table 51 - Minimum Internal Power Wiring

Wiring from the load side of the short-circuit protective device to the line side of the starter (all copper stranded with 105 °C insulation).	
Wire Code	Wire Size
7a	12 AWG
7b	8 AWG
7c	2 AWG
7d	1 AWG

111. When protected by any circuit breaker, including thermal-magnetic and magnetic-only.

112. When protected by any Class T or J fuse.

113. Ratings apply to circuits with voltages no greater than those listed.

114. When protected by any circuit breaker. Please refer to TeSys D overload relays (see Table 42, page 44) for ampacity restrictions.

115. When protected by any Class J or CC time-delay fuse. Please refer to TeSys D overload relays (see Table 42, page 44) for ampacity restrictions.

Definite Purpose Starters

Figure 38 - Definite Purpose Starter — 8911DPSO33

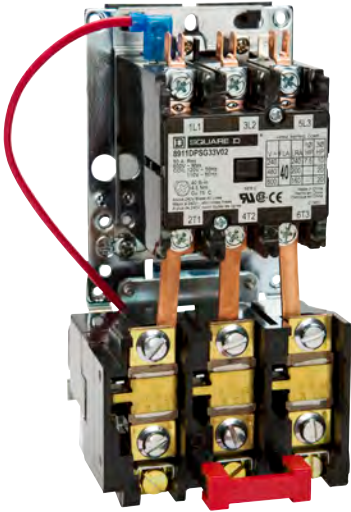

Table 52 - Definite Purpose Starters

Catalog Number	Max. Inductive AC3 Current (A)	Horsepower Ratings					No. of Thermal Units
		Single-Phase		Three-Phase			
		115 V	230 V	230 V	460 V	575 V	
2-Poles							
8911DPSO12	20	1.5	3	—	—	—	1
8911DPSO22	25	2	5	—	—	—	
8911DPSO32	30	2	5	—	—	—	
8911DPSO42	40	3	7.5	—	—	—	
8911DPSO52	50	3	10	—	—	—	
3-Poles							
8911DPSO13	20	1.5	3	7.5	7.5	7.5	3
8911DPSO23	25	2	5	10	15	20	
8911DPSO33	30	2	5	10	15	20	
8911DPSO43	40	3	7.5	10	20	25	
8911DPSO53	50	3	10	15	30	30	

UL 60947 Self-Protected Combination Motor Controller (Type E)

TeSys™ Ultra

Figure 39 - TeSys Ultra — LU9SP0



Table 53 - TeSys Ultra Self-Protected Combination Motor Starter (UL File E164871)¹¹⁶

Standard Motor Ratings @ 50/60 Hz (HP)						Control Connection	Max. Current (A)	Power Base Part Number	Over-load Trip Range (A)	SCCR (kA)		
Single-Phase		Three-Phase								480 Y / 277 V	480 V with LUALB1 Limiter	600 V with LUALB1 Limiter
120 V	240 V	200 V	240 V	480 V	600 V							
1.5	2	3	3	7.5	10	With non-removable screw terminations	12	LUB12	0.15–12	65	130	65
2	5	10	10	20	25		32	LUB32	0.15–32	65	130	65

NOTE: Type E ratings are only valid at 480 Y / 277 V and lower without using limiter block LUALB1. When limiter block LUALB1 is used, the SCCR applies for the stand-alone starter or, with line spacer GV1G09 and GV2G busbar, for multiple starters.

Table 54 - Select Control Unit

Setting Range (A)	Standard 3-Phase Class 10 Trip	Advanced 3-Phase Class 10 Trip	Advanced Single-Phase Class 10 Trip	Advanced 3-Phase Class 20 Trip
0.15-0.6	LUCAX6●●	LUCBX6●●	LUCCX6●●	LUCDX6●●
0.3-1.4	LUCA1X●●	LUCB1X●●	LUCC1X●●	LUCD1X●●
1.25-5.0	LUCA05●●	LUCB05●●	LUCC05●●	LUCD05●●
3.0-12.0	LUCA12●●	LUCB12●●	LUCC12●●	LUCD12●●
4.5-18.0	LUCA18●●	LUCB18●●	LUCC18●●	LUCD18●●
8.0-32.0	LUCA32●●	LUCB32●●	LUCC32●●	LUCD32●●

116. In combination with line spacer LU9SP0 for stand-alone starters or line spacer GV1G09 with GV2G busbars for multiple starters.

TeSys™ Deca

Figure 40 - GV Deca Manual Motor Protector



Line spacer GV1G09 or GV2GH7 is required for Type E approval.

Table 55 - TeSys Deca Frame 2 Manual Self-Protected Combination Motor Starter (UL File E164871)

Manual Self-Protected Starter	Overload Trip Range (A)	Maximum Horsepower Ratings						SCCR (kA)	
		Single-Phase		Three-Phase				480Y/277 V	600Y/347 V
		120 V	240 V	208 V	240 V	480 V	600 V		
GV2P01	0.10–0.16	—	—	—	—	—	—	100	50
GV2P02	0.16–0.25	—	—	—	—	—	—	100	50
GV2P03	0.25–0.40	—	—	—	—	—	—	100	50
GV2P04	0.40–0.63	—	—	—	—	—	—	100	50
GV2P05	0.63–1	—	—	—	—	—	0.5	100	50
GV2P06	1–1.6	—	1/10	—	—	0.75	0.75	100	50
GV2P07	1.6–2.5	—	1/6	0.5	0.5	1	1.5	100	50
GV2P08	2.5–4	1/8	1/3	0.75	0.75	2	3	100	50
GV2P10	4–6.3	0.25	0.5	1	1.5	3	5	100	50
GV2P14	6–10	0.5	1.5	2	3	5	7.5	100	22
GV2P16	9–14	0.75	2	3	3	10	10	10	—
GV2P20	13–18	1	3	5	5	10	15	10	—
GV2P21	17–23	1.5	3	5	7.5	15	20	10	—
GV2P22	20–25	2	—	7.5	7.5	15	20	10	—

NOTE: Type E ratings are only valid at 600Y/347 V and 480Y/277 V voltages and lower.

Line spacer GV3G66 and short-circuit signaling contact GVAM11 is required for Type E approval.

Table 56 - TeSys Deca Frame 3 Manual Self-Protected Combination Motor Starter (UL File E164871)

Manual Self-Protected Starter	Overload Trip Range (A)	Maximum Horsepower Ratings						SCCR (kA)	
		Single-Phase		Three-Phase				480Y/277 V	600Y/347 V
		120 V	240 V	208 V	240 V	480 V	600 V		
GV3P13	9–13	0.5	1.5	3	3	7.5	10	100	25
GV3P18	12–18	0.75	2	3	5	7.5	10	100	25
GV3P25	17–25	1.5	3	5	7.5	15	20	100	25
GV3P32	23–32	2	3	7.5	7.5	20	25	100	25
GV3P40	30–40	3	5	10	10	25	30	65	25
GV3P50	37–50	3	7.5	10	10	30	40	65	25
GV3P65	48–65	3	10	15	15	40	50	65	25

NOTE: Type E ratings are only valid at 600Y/347 V and 480Y/277 V voltages and lower.

TeSys GV2P and GV3P + TeSys D Contactors

Two-Component TeSys™ GV + TeSys D Solution

TeSys™ GV2 and GV3 + TeSys Deca Solution (Type F)

Manual Self-Protected Combination Starter Meeting UL 60947-4-1 Type F UL File E134347.

Figure 41 - TeSys GV2P with TeSys Deca — GV2GH7 + GV2P10 + GV2AF3+ LC1D09



Table 57 - TeSys GV2P Type F Combination Motor Starter (UL File E134347)

Manual Self-Protected Starter ¹¹⁷	Over-load Trip Range (A)	Maximum Horsepower Ratings						Type of Contactor Required	SCCR (kA)			
		Single-Phase		Three-Phase					480 Y / 277 V	600 Y / 347 V	With GV2G Busbar	
		120 V	240 V	208 V	240 V	480 V	600 V				480 Y / 277 V	600 Y / 347 V
GV2P01	0.10–0.16	—	—	—	—	—	—	LC1D09–LC1D12	100	50	100	25
		—	—	—	—	—	—	LC1D12–LC1D18	100	50	42	25
GV2P02	0.16–0.25	—	—	—	—	—	—	LC1D09–LC1D12	100	50	100	25
		—	—	—	—	—	—	LC1D12–LC1D18	100	50	42	25
GV2P03	0.25–0.40	—	—	—	—	—	—	LC1D09–LC1D12	100	50	100	25
		—	—	—	—	—	—	LC1D12–LC1D18	100	50	42	25
GV2P04	0.40–0.63	—	—	—	—	—	—	LC1D09–LC1D12	100	50	100	25
		—	—	—	—	—	—	LC1D12–LC1D18	100	50	42	25
GV2P05	0.63– 1	—	—	—	—	—	0.5	LC1D09–LC1D12	100	50	100	25
		—	—	—	—	—	0.5	LC1D12–LC1D18	100	50	42	25
GV2P06	1–1.6	—	1/10	—	—	0.75	0.75	LC1D09–LC1D12	100	50	100	25
		—	1/10	—	—	0.75	0.75	LC1D12–LC1D18	100	50	42	25

117. In combination with line spacer GV2GH7 or GV1G09 for stand-alone starters or line spacer GV1G09 with GV2G busbars for multiple starters.

Table 57 - TeSys GV2P Type F Combination Motor Starter (UL File E134347) (Continued)

Manual Self-Protected Starter ¹¹⁸	Over-load Trip Range (A)	Maximum Horsepower Ratings						Type of Contactor Required	SCCR (kA)			
		Single-Phase		Three-Phase					480 Y / 277 V	600 Y / 347 V	With GV2G Busbar	
		120 V	240 V	208 V	240 V	480 V	600 V				480 Y / 277 V	600 Y / 347 V
GV2P07	1.6–2.5	—	1/6	0.5	0.5	1	1.5	LC1D09–LC1D12	100	50	100	25
								LC1D12–LC1D18	100	50	42	25
GV2P08	2.5–4	1/8	1/3	0.75	0.75	2	3	LC1D09–LC1D12	100	50	100	25
								LC1D12–LC1D18	100	50	42	25
GV2P10	4–6.3	0.25	0.5	1	1.5	3	5	LC1D09–LC1D12	100	50	100	25
								LC1D12–LC1D18	100	50	42	25
GV2P14	6–10	0.5	1.5	2	3	5	7.5	LC1D09–LC1D12	100	50	100	25
								LC1D12–LC1D18	100	50	42	25
GV2P16	9–14	0.75	2	3	3	10	10	LC1D18–LC1D32	50	—	42	—
GV2P20	13–18	1	3	5	5	10	15	LC1D18–LC1D32	50	—	42	—
GV2P21	17–23	1.5	3	5	7.5	15	20	LC1D18–LC1D32	50	—	42	—
GV2P22	20–25	2	—	7.5	7.5	15	20	LC1D18–LC1D32	50	—	42	—

NOTE: Type F ratings only valid at 600 Y / 347 V and 480 Y / 277 V voltages and lower.

118. In combination with line spacer GV2GH7 or GV1G09 for stand-alone starters or line spacer GV1G09 with GV2G busbars for multiple starters.

TeSys™ GV3P + TeSys Deca Contactors

Figure 42 - TeSys GV3P with TeSys Deca — GV3G66 + GV3P40 + GVAM11 + LC1D40A



Table 58 - TeSys GV3P Type F Combination Motor Starter (UL File E134347)¹¹⁹

Manual Self-Protected Starter	Overload Trip Range (A)	Maximum Horsepower Ratings						Type of Contactor Required	SCCR (kA)	
		Single-Phase		Three-Phase					480 Y / 277 V	600 Y / 347 V
		120 V	240 V	208 V	240 V	480 V	600 V			
GV3P13	9–13	0.5	1.5	3	3	7.5	10	LC1D18, D25, D32, D40A, D50A, or D65A	65	25
GV3P18	12–18	0.75	2	5	5	10	15	LC1D18, D25, D32, D40A, D50A, or D65A	65	25
GV3P25	17–25	1.5	3	5	7.5	15	20	LC1D25, D32, D40A, D50A, or D65A	65	25
GV3P32	23–32	2	5	7.5	10	20	25	LC1D32, D40A, D50A, or D65A	65	25
GV3P40	30–40	3	—	10	—	25	30	LC1D40A, 50A, or 65A	65	25
GV3P50	37–50	—	7.5	10	15	30	40	LC1D50A or 65A	65	25
GV3P65	48–65	5	10	15	20	40	50	LC1D65A or 80	65	25

NOTE: Type F ratings only valid at 600 Y / 347 V and 480 Y / 277 V voltages and lower.

119. In combination with line spacer GV3G66 and short-circuit signaling contact GVAM11 for stand-alone starters

TeSys™ GV4PB + TeSys Deca

Figure 43 - Two-Component Motor Circuit Solution (up to 115 A)



The TeSys GV4PB Motor Protection Circuit Breaker combines the functionality of a circuit breaker and an overload relay in a single device. Approved to UL 489, the TeSys GV4PB is suitable for use as a branch short-circuit protection device, and can be paired with any contactor to build a complete branch circuit for a motor load.

The TeSys GV4PB includes an advanced trip unit with additional protections that can be adjusted to provide the appropriate protection for the application. A pre-trip alarm is also available with the use of the SDx module, providing notification that can be used to initiate proactive measures to avoid downtime or to alert operators of an issue.

Table 59 - Two-Component Motor Circuit Solution with IEC Motor Control

Short-Circuit Protection, Disconnect, and Overload Protection			+	Motor Controller	
GV4PB Reference	Motor FLA Dial Range	UL 489 Interrupting Rating @ 480 Y		TeSys Deca Suggested Reference	SCCR @ 480 Y with shown GV4PB ¹²⁰
GV4PB02S	0.8–2	65 kA	+	LC1D09 to D38	65 kA
GV4PB03S	1.4–3.5	65 kA	+	LC1D09 to D38	65 kA
GV4PB07S	2.9–7	65 kA	+	LC1D09 to D38	65 kA
GV4PB12S	5–12.5	65 kA	+	LC1D09 to D38	65 kA
GV4PB25S	10–25	65 kA	+	LC1D09 to D38	65 kA
GV4PB50S	20–50	65 kA	+	LC1 D40A to D50A	65 kA
GV4PB80S	40–80	65 kA	+	LC1D80	65 kA
GV4PB115S	65–115	65 kA	+	LC1D115	65 kA

Table 60 - TeSys GV4PB (UL 489) + Compact NEMA® TeSys N Solution

Short-Circuit Protection, Disconnect, and Overload Protection			+	Motor Controller	
GV4PB Reference	Motor FLA Dial Range	UL 489 Interrupting Rating @ 480 Y		TeSys N Suggested Reference	SCCR @ 480 Y with shown GV4PB ¹²⁰
GV4PB02S	0.8– 2	65 kA	+	T02AN13 to CN13	65 kA
GV4PB03S	1.4–3.5	65 kA	+	T02AN13 to CN13	65 kA
GV4PB07S	2.9–7	65 kA	+	T02AN13 to CN13	65 kA
GV4PB12S	5–12.5	65 kA	+	T02AN13 to CN13	65 kA
GV4PB25S	10– 25	65 kA	+	T02DN13	65 kA
GV4PB50S	20– 50	65 kA	+	T02EN13	65 kA
GV4PB80S	40–80	65 kA	+	T02FN13	65 kA
GV4PB115S	65–115	65 kA	+	T02FN13	65 kA

120. This table lists the maximum SCCR of the component when protected by a circuit breaker. If the maximum component SCCR is 65 kA and a 35 kA rated circuit breaker is used, then the effective system SCCR will be limited to 35 kA, the SCCR rating of the circuit breaker.

Group Motor Installations

UL 60947 Group Motor Installations

TeSys™ GV2ME + TeSys Deca Contactors

Figure 44 - GV2ME07 with LC1D09



Table 61 - TeSys GV2ME and TeSys Deca Contactors for Group Motor Installations (UL File E164864)¹²¹

Manual Motor Starter	Overload Trip Range (A)	Maximum Horsepower Ratings						SCCR (kA) ¹			
		Single-Phase		Three-Phase				Type of Contactor Required	480 V	600 Y / 347 V	480 V with GV1L3 Limiter
		120 V	240 V	208 V	240 V	480 V	600 V				
GV2ME01	0.10–0.16	—	—	—	—	—	—	LC1D09 or D12	22	22	65
GV2ME02	0.16–0.25	—	—	—	—	—	—	LC1D09 or D12	22	22	65
GV2ME03	0.25–0.40	—	—	—	—	—	—	LC1D09 or D12	22	22	65
GV2ME04	0.40–0.63	—	—	—	—	—	—	LC1D09 or D12	22	22	65
GV2ME05	0.63–1	—	—	—	—	—	0.5	LC1D09 or D12	22	22	65
GV2ME06	1–1.6	—	1/10	—	—	0.75	0.75	LC1D09 or D12	22	22	65
GV2ME07	1.6–2.5	—	1/6	0.5	0.5	1	1.5	LC1D09 or D12	22	22	65
GV2ME08	2.5–4	1/8	1/3	0.75	0.75	2	3	LC1D09 or D12	22	22	65
GV2ME10	4–6.3	0.25	0.5	1	1.5	3	5	LC1D09 or D12	22	22	65
GV2ME14	6–10	0.5	1.5	2	3	5	7.5	LC1D09 or D12	22	22	65
GV2ME16	9–14	0.75	2	3	3	10	10	LC1D12 or D18	22	10	22
GV2ME20	13–18	1	3	5	5	10	15	LC1D12 or D18	22	10	22
GV2ME21	17–23	1.5	3	5	7.5	15	20	LC1D25 or D32	10	10	10
GV2ME22	20–25	2	—	7.5	7.5	15	20	LC1D25 or D32	10	10	10
GV2ME32	24–32	2	5	7.5	10	20	25	LC1D25 or D32	5	5	5

NOTE: Ratings apply to circuit with voltages no greater than those listed.

121. In association with LC1D contactors, suitable for Group Installation when protected by fuses or a circuit breaker (including multi starter with GV1G09 or GV2G05 blocks plus GV2G busbars)

TeSys™ GV2P + TeSys Deca Contactors

Figure 45 - GV2P10 with LC1D09



Table 62 - TeSys GV2P and TeSys Deca Contactors for Group Motor Installations (UL File E164864)¹²²

Manual Motor Starter	Overload Trip Range (A)	Maximum Horsepower Ratings						SCCR (kA)		
		Single-Phase		Three-Phase				Type of Contactor Required	480 V	600 Y / 347 V
		120 V	240 V	208 V	240 V	480 V	600 V			
GV2P01	0.10–0.16	—	—	—	—	—	—	LC1D09 or D12	22	22
GV2P02	0.16–0.25	—	—	—	—	—	—	LC1D09 or D12	22	22
GV2P03	0.25–0.40	—	—	—	—	—	—	LC1D09 or D12	22	22
GV2P04	0.40–0.63	—	—	—	—	—	—	LC1D09 or D12	22	22
GV2P05	0.63–1	—	—	—	—	—	0.5	LC1D09 or D12	22	22
GV2P06	1–1.6	—	1/10	—	—	0.75	0.75	LC1D09 or D12	22	22
GV2P07	1.6–2.5	—	1/6	0.5	0.5	1	1.5	LC1D09 or D12	22	22
GV2P08	2.5–4	1/8	1/3	0.75	0.75	2	3	LC1D09 or D12	22	22
GV2P10	4–6.3	0.25	0.5	1	1.5	3	5	LC1D09 or D12	22	22
GV2P14	6–10	0.5	1.5	2	3	5	7.5	LC1D09 or D12	22	22
GV2P16	9–14	0.75	2	3	3	10	10	LC1D12 or D18	22	18
GV2P20	13–18	1	3	5	5	10	15	LC1D12 or D18	22	18
GV2P21	17–23	1.5	3	5	7.5	15	20	LC1D25 or D32	22	18
GV2P22	20–25	2	—	7.5	7.5	15	20	LC1D25 or D32	22	18

NOTE: Ratings apply to circuit with voltages no greater than those listed.

¹²² In association with LC1D contactors, suitable for Group Installation when LC1D protected by fuses or a circuit breaker (including multi starter with GV1G09 or GV2G05 blocks plus GV2G busbars)

TeSys™ GV3P + TeSys Deca Contactors

Figure 46 - GV3P40 with LC1D40A



Table 63 - TeSys GV3P and TeSys Deca Contactors for Group Motor Installations¹²³

Manual Motor Starter	Overload Trip Range (A)	Maximum Horsepower Ratings						Type of Contactor Required	SCCR (kA)	
		Single-Phase		Three-Phase					480 Y / 277 V	600 Y / 347 V
		120 V	240 V	208 V	240 V	480 V	600 V			
GV3P13	9–13	0.5	1.5	3	3	7.5	10	LC1D18, D25, D32, D40A, D50A, or D65A	65	25
GV3P18	12–18	0.75	2	5	5	10	15	LC1D18, D25, D32, D40A, D50A, or D65A	65	25
GV3P25	17–25	1.5	3	5	7.5	15	20	LC1D25, D32, D40A, D50A, or D65A	65	25
GV3P32	23–32	2	5	7.5	10	20	25	LC1D32, D40A, D50A, or D65A	65	25
GV3P40	30–40	3	—	10	—	25	30	LC1D40A, 50A or 65A	65	25
GV3P50	37–50	—	7.5	10	15	30	40	LC1D50A or 65A	65	25
GV3P65	48–65	5	10	15	20	40	50	LC1D65A or 80	65	25

NOTE: These values are derived from the UL 60947 Type F certification (E164871).

123. In association with LC1D contactors, suitable for Group Installation when protected by fuses or a circuit breaker (including multi starter with GV3G busbars)

Wiring Devices

Power Distribution Blocks

Table 64 - Short-Circuit Current Ratings with Combination of Enclosed Power Distribution Blocks and Circuit Breakers

Wire Type (Class)	Catalog Number	Suitable Copper Conductors Range kcmil/AWG (mm ²)		Overcurrent Protection Circuit Breaker Required			SCCR RMS Sym. A	Volts Max.
		Line	Load	Manufacturer	Type	Maximum A		
B, C	NSYEBAD11611	4-2 (16-25)	10-2 (6-25)	Schneider Electric	JDL36250	250	18 kA	480
					JGL36250	250	35 kA	
					JJL36250	250	65 kA	
					JLL36250	250	65 kA	
		12-2 (4-25)	12-2 (4-25)	Schneider Electric	HDL36150	150	18 kA	
					HGL36150	150	35 kA	
					HJL36150	150	65 kA	
					HLL36150	150	65 kA	
		12-2 (4-25)	12-2 (4-25)	Schneider Electric	BDL36125	125	18kA	
					BGL36125	125	35kA	
					BJL36125	125	65kA	
B, C	NSYEBAD11614	4-2 (16-25)	10 (6)	Schneider Electric	JDL36250	250	18 kA	480
					JGL36250	250	35 kA	
					JJL36250	250	65 kA	
					JLL36250	250	65 kA	
		10-2 (6-25)	10 (6)	Schneider Electric	HDL36150	150	18 kA	
					HGL36150	150	35 kA	
					HJL36150	150	65 kA	
					HLL36150	150	65 kA	
		12-2 (4-25)	12-10 (4-6)	Schneider Electric	BDL36125	125	18kA	
					BGL36125	125	35kA	
					BJL36125	125	65kA	
B, C	NSYEBAD12611 NSYEBAP12611 NSYEBAD12611 NSYEBAD12611	4-3/0 (16-70)	8-3/0 (10-70)	Schneider Electric	JDL36250	250	18 kA	480
					JGL36250	250	35 kA	
					JJL36250	250	65 kA	
					JLL36250	250	65 kA	
B, C	NSYEBAD12614 NSYEBAP12614 NSYEBAD12614 NSYEBAD12614	4-3/0 (16-70)	10-2 (6-25)	Schneider Electric	JDL36250	250	18 kA	480
					JGL36250	250	35 kA	
					JJL36250	250	65 kA	
					JLL36250	250	65 kA	

Table 65 - Enclosed Power Distribution Blocks Short-Circuit Current Ratings with Fuses

Wire Type (Class)	Catalog Number	Suitable Copper Conductors Range AWG (mm ²)		Fuse Type / Amperage						SCCR
		Line	Load	J	T	RK1	RK5	G	CC	
B, C	NSYEBAD11611	14-2 (2.5-25)	14-2 (2.5-25)	175	225	100	—	—	—	100 kA
G, H, I, K		14-4 (2.5-16)	14-4 (2.5-16)	175	225	100	—	—	—	100 kA
124		14-2 (2.5-25)	14-2 (2.5-25)	NONE						10 kA
B, C	NSYEBAD11614	10-2 (6-25)	14-10 (2.5-4)	125	200	100	—	—	—	65 kA
G, H, I, K		10-4 (6-16)	14-10 (2.5-4)	125	200	100	—	—	—	65 kA
124		14-2 (2.5-25)	14-10 (2.5-4)	NONE						10 kA
B, C	NSYEBAD12611 NSYEBAP12611 NSYEBBCD12611 NSYEBBCP12611	8-3/0 (10-70)	8-3/0 (10-70)	225	225	200	60	60	30	100 kA
G, H, I		8-2/0 (10-50)	8-2/0 (10-50)	300	300	200	100	60	30	100 kA
124		14-3/0 (2.5-70)	14-3/0 (2.5-70)	NONE						10 kA
B, C	NSYEBAD12614 NSYEBAP12614 NSYEBBCD12614 NSYEBBCP12614	8-3/0 (10-70)	8-2 (10-25)	225	225	200	60	60	30	100 kA
B, C		8-3/0 (10-70)	12-8 (4-10)	100	110	100	30	60	30	100 kA
G, H, I		8-2/0 (10-50)	8-4 (10-16)	225	225	200	60	60	30	100 kA
G, H, I		8-2/0 (10-50)	12-8 (4-10)	100	110	100	30	60	30	100 kA
124		14-3/0 (2.5-70)	14-2 (2.5-25)	NONE						10 kA
124	NSYEBAD13618 NSYEBBCD13618	6-400 (16-185) and 14-3/0 (2.5-70)	14-2 (2.5-25)	NONE						10 kA

124. Any UL approved wire types that are not approved for higher SCCR will default to 10 kA.

Table 65 - Enclosed Power Distribution Blocks Short-Circuit Current Ratings with Fuses (Continued)

Wire Type (Class)	Catalog Number	Suitable Copper Conductors Range AWG (mm ²)		Fuse Type / Amperage						SCCR
		Line	Load	J	T	RK1	RK5	G	CC	
B, C	NSYEBAP13618 NSYEBCP13618	3/0-400 (70-185)	8-2 (10-25)	400	400	400	200	60	30	100 kA
B, C		6-400 (16-185)	10-2 (6-25)	200	200	200	100	60	30	100 kA
G, H, I		6-400 (16-185)	10-2 (6-25)	300	300	200	100	60	30	100 kA
125		6-400 (16-185) and 14-3/0 (2.5-70)	14-2 (2.5-25)	NONE						10 kA
125	NSYEBAD25622 NSYEBCD25622	6-250 (16-120)	6-250 (16-120)	NONE						10 kA
B, C	NSYEBAP25622 NSYEBCP25622	1/0-250 (50-120)	1/0-250 (50-120)	600	600	—	—	—	—	50 kA
B, C		1/0-250 (50-120)	1/0-250 (50-120)	400	400	400	200	60	30	100 kA
B, C		6-250 (16-120)	6-250 (16-120)	400	400	400	100	60	30	100 kA
G, H, I		1/0-250 (50-120)	1/0-250 (50-120)	300	300	200	100	60	30	100 kA
125		6-250 (16-120)	6-250 (16-120)	NONE						10 kA
B, C	NSYEBAP27622	4-500 (25-240)	4-500 (25-240)	600	600	600	200	60	30	100 kA
G, H, I		2-350 (35-150)	2-350 (35-150)	600	600	600	200	60	30	100 kA
125		4-500 (25-240)	4-500 (25-240)	NONE						10 kA
B, C	NSYEBAP27628	250-500 (120-240)	4-2/0 (25-50)	600	600	400	200	60	30	100 kA
B, C	NSYEBCP27628	250-500 (120-240)	4-2/0 (25-50)	600	600	600	200	60	30	100 kA
B, C	NSYEBAP27628 NSYEBCP27628	4-500 (25-240)	10-2/0 (6-50)	350	350	200	100	60	30	100 kA
G, H, I		250-350 (120-150)	4-1 (25-35)	600	600	600	200	60	30	100 kA
G, H, I		4-350 (25-150)	8-1 (10-35)	350	350	200	100	60	30	100 kA
125		4-500 (25-240)	10-2/0 (6-50)	NONE						10 kA

125. Any UL approved wire types that are not approved for higher SCCR will default to 10 kA.

Table 66 - 9080LBA and 9080LBC Power Distribution Blocks Short-Circuit Current Ratings with Circuit Breakers

Catalog Number	Suitable Conductors MCM/AWG (mm ²) Cu		Overcurrent Protection Circuit Breaker Required			SCCR, RMS Sym. A	Volts Max
	Line	Load	Manufacturer	Type	Maximum A		
9080LBA161101 9080LBA361101	6-2 (16-25)	6-2 (16-25)	Schneider Electric	JDL36250	250	18 kA	480
				JGL36250	250	35 kA	
				JJL36250	250	65 kA	
				JLL36250	250	65 kA	
	10-8 (6)	10-8 (6)	Schneider Electric	HDL36100	100	18 kA	
				HGL36100	100	35 kA	
				HJL36100	100	65 kA	
				HLL36100	100	65 kA	
9080LBA161104 9080LBA261104 9080LBA361104	6-2 (16-25)	4 x 10 (6)	Schneider Electric	JDL36250	250	18 kA	480
				JGL36250	250	35 kA	
				JJL36250	250	65 kA	
				JLL36250	250	65 kA	
	10-8 (6)	4 x 14 (2.5)	Schneider Electric	HDL36100	100	18 kA	
				HGL36100	100	35 kA	
				HJL36100	100	65 kA	
				HLL36100	100	65 kA	
9080LBA162104 9080LBA262104 9080LBA362104	10-2/0 (6-50)	4 x 10-4 (6-16)	Schneider Electric	JDL36250	250	18 kA	480
				JGL36250	250	35 kA	
				JJL36250	250	65 kA	
				JLL36250	250	65 kA	
9080LBA362106	6-2/0 (16-50)	6 x 10-4 (6-16)	Schneider Electric	JDL36250	250	18 kA	480
				JGL36250	250	35 kA	
				JJL36250	250	65 kA	
				JLL36250	250	65 kA	
9080LBA163104 9080LBA263104 9080LBA363104	4-2/0 (25-50)	4 x 8-2 (10-25)	Schneider Electric	JDL36250	250	18 kA	480
				JGL36250	250	35 kA	
				JJL36250	250	65 kA	
				JLL36250	250	65 kA	

Table 66 - 9080LBA and 9080LBC Power Distribution Blocks Short-Circuit Current Ratings with Circuit Breakers (Continued)

Catalog Number	Suitable Conductors MCM/AWG (mm ²) Cu		Overcurrent Protection Circuit Breaker Required			SCCR, RMS Sym. A	Volts Max
	Line	Load	Manufacturer	Type	Maximum A		
9080LBA163106 9080LBA263106 9080LBA363106	6-2/0 (16-50)	6 x 10-2 (6-25)	Schneider Electric	JDL36250	250	18 kA	480
				JGL36250	250	35 kA	
				JJL36250	250	65 kA	
				JLL36250	250	65 kA	
	6-350 (16-150)	10-2 (6-25)	Schneider Electric	JJL36250	600	25 kA	600
	6-400 (16-185)	8-4 (10-16)	Schneider Electric	LJL36600	600	65 kA	480
6-400 (16-185)	8-2 (10-25)	Schneider Electric	LJL36600	600	25 kA	600	
9080LBA163206 9080LBA263206 9080LBA363206	2 x 8-1/0 (10- 50)	6 x 10-4 (6-16)	Schneider Electric	JDL36250	250	18 kA	480
				JGL36250	250	35 kA	
				JJL36250	250	65 kA	
				JLL36250	250	65 kA	
9080LBA164108 9080LBA264108 9080LBA364108	6-2/0 (16-50)	6 x 10-2 (6-25)	Schneider Electric	JDL36250	250	18 kA	480
				JGL36250	250	35 kA	
				JJL36250	250	65 kA	
				JLL36250	250	65 kA	
	6-400 (16-185)	8-2 (10-25)	Schneider Electric	LJL36600	600	65 kA	600
9080LBA165106 9080LBA265106 9080LBA365106	4-2/0 (25-50)	6 x 8 (10)	Schneider Electric	JDL36250	250	18 kA	480
				JGL36250	250	35 kA	
				JJL36250	250	65 kA	
				JLL36250	250	65 kA	
9080LBA165208 9080LBA265208 9080LBA365208	4-500 (25-240)	6-2/0 (16-50)	Schneider Electric	LJL36600	600	65 kA	480
						25 kA	600
9080LBA165112 9080LBA265112 9080LBA365112	4-2/0 (25-50)	12 x 8-2 (10-25)	Schneider Electric	JDL36250	250	18 kA	480
				JGL36250	250	35 kA	
				JJL36250	250	65 kA	
				JLL36250	250	65 kA	
9080LBC162101 9080LBC362101	8-1/0 (10-50)	8-1/0 (10-50)	Schneider Electric	JDL36250	250	18 kA	480
				JGL36250	250	35 kA	
				JJL36250	250	65 kA	
				JLL36250	250	65 kA	

Table 66 - 9080LBA and 9080LBC Power Distribution Blocks Short-Circuit Current Ratings with Circuit Breakers (Continued)

Catalog Number	Suitable Conductors MCM/AWG (mm ²) Cu		Overcurrent Protection Circuit Breaker Required			SCCR, RMS Sym. A	Volts Max
	Line	Load	Manufacturer	Type	Maximum A		
9080LBC162104 9080LBC262104 9080LBC362104	8-2/0 (10-50)	4 x 8-4 (10-16)	Schneider Electric	JDL36250	250	18 kA	480
				JGL36250	250	35 kA	
				JJL36250	250	65 kA	
				JLL36250	250	65 kA	
9080LBC163106 9080LBC263106 9080LBC363106	1 x 4-2/0 (25-50)	6 x 8-2 (10-25)	Schneider Electric	JDL36250	250	18 kA	480
				JGL36250	250	35 kA	480
				JJL36250	250	65 kA	480
				JLL36250	250	65 kA	480
9080LBC163206 9080LBC263206 9080LBC363206	2 x 2-2/0 (35-50)	6 x 8-4 (10-16)	Schneider Electric	JDL36175	175	18 kA	480
				JGL36250	250	35 kA	
				JJL36250	250	65 kA	
				JLL36250	250	65 kA	
	2 x 6-4 (16)	6 x 12-10 (4)	Schneider Electric	JDL36250	250	18 kA	
				JGL36175	175	35 kA	
				JJL36175	175	65 kA	
				JLL36175	175	65 kA	
9080LBA164108 9080LBA264108 9080LBA364108	6-2/0 (16-50)	6 x 10-2 (6-25)	Schneider Electric	JDL36250	250	18 kA	480
				JGL36250	250	35 kA	
				JJL36250	250	65 kA	
				JLL36250	250	65 kA	
	6-400 (16-185)	8-2 (10-25)	Schneider Electric	LJL36600	600	65 kA	600
9080LBA165106 9080LBA265106 9080LBA365106	4-2/0 (25-50)	6 x 8 (10)	Schneider Electric	JDL36250	250	18 kA	480
				JGL36250	250	35 kA	
				JJL36250	250	65 kA	
				JLL36250	250	65 kA	
9080LBA165208 9080LBA265208 9080LBA365208	4-500 (25-240)	6-2/0 (16-50)	Schneider Electric	LJL36600	600	65 kA	480
						25 kA	600
9080LBA165112 9080LBA265112 9080LBA365112	4-2/0 (25-50)	12 x 8-2 (10-25)	Schneider Electric	JDL36250	250	18 kA	480
				JGL36250	250	35 kA	
				JJL36250	250	65 kA	
				JLL36250	250	65 kA	

Table 66 - 9080LBA and 9080LBC Power Distribution Blocks Short-Circuit Current Ratings with Circuit Breakers (Continued)

9080LBC162101 9080LBC362101	8-1/0 (10-50)	8-1/0 (10-50)	Schneider Electric	JDL36250	250	18 kA	480
				JGL36250	250	35 kA	
				JJL36250	250	65 kA	
				JLL36250	250	65 kA	
9080LBC162104 9080LBC262104 9080LBC362104	8-2/0 (10-50)	4 x 8-4 (10-16)	Schneider Electric	JDL36250	250	18 kA	480
				JGL36250	250	35 kA	
				JJL36250	250	65 kA	
				JLL36250	250	65 kA	
9080LBC163106 9080LBC263106 9080LBC363106	1 x 4-2/0 (25-50)	6 x 8-2 (10-25)	Schneider Electric	JDL36250	250	18 kA	480
				JGL36250	250	35 kA	480
				JJL36250	250	65 kA	480
				JLL36250	250	65 kA	480
9080LBC163206 9080LBC263206 9080LBC363206	2 x 2-2/0 (35-50)	6 x 8-4 (10-16)	Schneider Electric	JDL36175	175	18 kA	480
				JGL36250	250	35 kA	
				JJL36250	250	65 kA	
				JLL36250	250	65 kA	
	2 x 6-4 (16)	6 x 12-10 (4)	Schneider Electric	JDL36250	250	18 kA	
				JGL36175	175	35 kA	
				JJL36175	175	65 kA	
				JLL36175	175	65 kA	

Table 67 - 9080LBA and 9080LBC Power Distribution Blocks Short-Circuit Current Ratings with Fuses

Catalog Numbers			Suitable Conductors kcmil/AWG (mm2)		Fuse Type / Amperage						SCCR
1-Pole	2-Poles	3-Poles	Line	Load	J	T	RK1	RK5	G	CC	
9080LB- A161101	—	9080LB- A361101	6-2 (10-25)	6-2 (10-25)	200	200	200	100	60	30	100 kA
			10-2 (6-25)	10-2 (6-25)	100	100	100	30	60	30	100 kA
			10-2 (6-25)	10-2 (6-25)	125	125	60	30	60	30	65 kA
			10-4 (6-16) (class G, H,I,K)	10-4 (6-16) (class G, H,I,K)	150	150	100	30	60	30	100 kA
			14-2 (2.5-25)	14-2 (2.5-25)	NONE						10 kA
9080LB- A161104	9080LB- A261104	9080LB- A361104	6-2 (16-25)	10 (6)	200	200	200	60	60	30	100 kA
			10-2 (6-25)	14-10 (2.5-4)	150	150	100	30	60	30	100 kA
			12-2 (4-25)	14-10 (2.5-4)	60	60	30	—	50	30	100 kA
			10-4 (6-16) (class G, H,I,K)	14-10 (2.5-4) (class G, H,I,K)	150	150	100	30	60	30	100 kA
			14-2 (2.5-25)	14-10 (2.5-4)	NONE						10 kA
9080LB- A162101	9080LB- A262101	9080LB- A362101	6-2/0 (16-50)	6-2/0 (16-50)	300	300	200	100	60	30	65 kA
			6-1 (16-35) (class G, H,I,K)	6-1 (16-35) (class G, H,I,K)	300	300	200	100	60	30	65 kA
			14-2/0 (2.5-50)	14-2/0 (2.5-50)	NONE						10 kA
9080LB- A162104	9080LB- A262104	9080LB- A362104	6-2/0 (16-50)	10-4 (6-16)	200	200	200	100	60	30	100 kA
			6-2/0 (16-50)	14-4 (2.5-16)	150	150	100	30	60	30	100 kA
			6-1 (16- 35) (class G, H,I,K)	12-6 (4-10) (class G, H,I,K)	150	150	100	30	60	30	100 kA
			14-2/0 (2.5-50)	14-4 (2.5-16)	NONE						10 kA

**Table 67 - 9080LBA and 9080LBC Power Distribution Blocks Short-Circuit Current Ratings with Fuses
(Continued)**

Catalog Numbers			Suitable Conductors kcmil/AWG (mm2)		Fuse Type / Amperage						SCCR
1-Pole	2-Poles	3-Poles	Line	Load	J	T	RK1	RK5	G	CC	
—	—	9080LB- A362106	6-2/0 (16-50)	10-4 (6-16)	200	200	200	100	60	30	100 kA
			10-2/0 (6-50)	14-4 (2.5-16)	60	60	60	30	—	30	100 kA
			6-1 (16-35) (class G, H,I,K)	10-6 (6-10) (class G, H,I,K)	150	150	100	30	60	30	100 kA
			10-1 (6-35) (class G, H,I)	14-6 (2.5-10) (class G, H,I)	60	60	60	30	—	30	100 kA
			14-2/0 (2.5-50)	14-4 (2.5-16)	NONE						10 kA
9080LB- A163101	9080LB- A263101	9080LB- A363101	1/0-350 (70-150)	1/0-350 (70-150)	400	400	400	100	60	30	100 kA
			6-350 (16-150)	6-350 (16-150)	300	300	200	100	60	30	100 kA
			1/0-250 (70-120) (class G, H,I,K)	1/0-250 (70-120) (class G, H,I,K)	300	300	200	100	60	30	100 kA
			6-350 (16-150)	6-350 (16-150)	NONE						10 kA
9080LB- A163104	9080LB- A263104	9080LB- A363104	3/0-400 (95-185)	6-2 (16-25)	400	400	400	100	60	30	100 kA
			6-400 (16-185)	10-2 (6-25)	300	300	200	100	60	30	100 kA
			1/0-250 (70-120) (class G, H,I,K)	10-4 (6-16) (class G, H,I,K)	150	150	100	30	60	30	100 kA
			6-400 (16-185)	14-2 (2.5-25)	NONE						10 kA
9080LB- A163106	9080LB- A263106	9080LB- A363106	3/0-400 (95-185)	8-2 (10-25)	500	500	400	200	60	30	100 kA
			6-400 (16-185)	10-2 (6-25)	350	350	200	100	60	30	100 kA
			1/0-250 (70-120) (class G, H,I,K)	10-4 (6-16) (class G, H,I,K)	150	150	100	30	60	30	100 kA
			6-400 (16-185)	14-2 (2.5-25)	NONE						10 kA

Table 67 - 9080LBA and 9080LBC Power Distribution Blocks Short-Circuit Current Ratings with Fuses (Continued)

Catalog Numbers			Suitable Conductors kcmil/AWG (mm2)		Fuse Type / Amperage						SCCR
1-Pole	2-Poles	3-Poles	Line	Load	J	T	RK1	RK5	G	CC	
9080LB- A163206	9080LB- A263206	9080LB- A363206	2-2/0 (35-50)	8-4 (10-16)	400	400	400	100	60	30	100 kA
			6-2/0 (16-50)	8-4 (10-16)	350	350	200	100	60	30	100 kA
			6-2/0 (16-50)	10-4 (6-16)	250	250	200	60	60	30	100 kA
			(1) 6 (16)	(2) 12 (4)	225	225	100	60	60	30	100 kA
			6-1 (16-35) (class G, H,I,K)	8-6 (10) (class G, H,I,K)	150	150	100	30	60	30	100 kA
			14-2/0 (2.5-50)	14-4 (2.5-16)	NONE						10 kA
9080LB- A164101	—	9080LB- A364101	2-600 (35-300)	2-600 (35-300)	600	600	—	—	—	—	50 kA
			2-600 (35-300)	2-600 (35-300)	400	400	400	200	60	30	100 kA
			2-350 (35-150) (class G, H,I,K)	2-350 (35-150) (class G, H,I,K)	400	400	400	200	60	30	100 kA
			2-60 0 (35-300)	2-600 (35-300)	NONE						10 kA
9080LB- A164108	9080LB- A264108	9080LB- A364108	3/0-400 (95-185)	8-2 (10-25)	400	400	400	200	60	30	100 kA
			6-400 (16-185)	10-2 (6-25)	200	200	200	100	60	30	100 kA
			1/0-250 (70-120) (class G, H,I,K)	14-4 (2.5-16) (class G, H,I,K)	150	150	100	30	60	30	100 kA
			6-40 0 (16-185)	14-2 (2.5-25)	NONE						10 kA
9080LB- A165202	9080LB- A265202	9080LB- A365202	4-350 (25-150)	4-350 (25-150)	450	450	400	200	60	30	100 kA
			4-350 (25-150)	4-350 (25-150)	600	600	—	—	—	—	50 kA
			2-250 (35-120) (class G, H,I,K)	2-250 (35-120) (class G, H,I,K)	600	600	—	—	—	—	50 kA
			2-250 (35-120) (class G, H,I,K)	2-250 (35-120) (class G, H,I,K)	450	450	400	200	60	30	100 kA
			4-350 (25-150)	4-350 (25-150)	NONE						10 kA

**Table 67 - 9080LBA and 9080LBC Power Distribution Blocks Short-Circuit Current Ratings with Fuses
(Continued)**

Catalog Numbers			Suitable Conductors kcmil/AWG (mm2)		Fuse Type / Amperage						SCCR
1-Pole	2-Poles	3-Poles	Line	Load	J	T	RK1	RK5	G	CC	
9080LB- A1652021	9080LB- A2652021	9080LB- A3652021	4-500 (25-240)	4-500 (25-240)	500	500	400	200	60	30	100 kA
			2-350 (35-150) (class G, H,I,K)	2-350 (35-150) (class G, H,I,K)	500	500	400	200	60	30	100 kA
			4-500 (25-240)	4-500 (25-240)	NONE						10 kA
9080LB- A165106	9080LB- A265106	9080LB- A365106	3/0-500 (95-240)	6-2/0 (16-50)	400	400	400	100	60	30	100 kA
			4-500 (25-240)	10-2/0 (6-50)	200	200	200	100	60	30	100 kA
			2-350 (35-150) (class G, H,I,K)	6-1 (16-35) (class G, H,I,K)	400	400	400	100	60	30	100 kA
			2-350 (35-150) (class G, H,I,K)	10-1 (6-35) (class G, H,I,K)	250	250	200	100	60	30	100 kA
			4-500 (25-240)	14-2/0 (2.5-50)	NONE						10 kA
9080LB- A165112	9080LB- A265112	9080LB- A365112	3/0-500 (95-240)	6-2 (16-25)	400	400	400	200	60	30	100 kA
			4-500 (25-240)	10-2 (6-25)	250	250	200	100	60	30	100 kA
			2-350 (35-150) (class G, H,I,K)	6-4 (16) (class G, H,I,K)	400	400	400	200	60	30	100 kA
			2-350 (35-150) (class G, H,I,K)	10-4 (6-16) (class G, H,I,K)	250	250	200	200	60	20	100 kA
			4-500 (25-240)	14-2 (2.5-25)	NONE						10 kA

Table 67 - 9080LBA and 9080LBC Power Distribution Blocks Short-Circuit Current Ratings with Fuses (Continued)

Catalog Numbers			Suitable Conductors kcmil/AWG (mm2)		Fuse Type / Amperage						SCCR
1-Pole	2-Poles	3-Poles	Line	Load	J	T	RK1	RK5	G	CC	
9080LB- A165208	9080LB- A265208	9080LB- A365208	250–500 (150– 240)	4–2/0 (25–50)	600	600	400	200	60	30	100 kA
			4–500 (25–240)	10–2/0 (6–50)	350	350	200	100	60	30	100 kA
			250–350 (150) (class G, H,I,K)	4–1 (25–35) (class G, H,I,K)	600	600	400	200	60	30	100 kA
			4–350 (25–150) (class G, H,I,K)	10–6 (6–10) (class G, H,I,K)	350	350	200	100	60	30	100 kA
			4–500 (25–240)	14–2/0 (2.5–50)	NONE						10 kA
9080LB- A165212	9080LB- A265212	9080LB- A365212	250–500 (150– 240)	8–4 (10–16)	400	400	200	100	60	30	100 kA
			4–500 (25–240)	10–4 (6–16)	350	350	200	100	60	30	100 kA
			250–350 (150) (class G, H,I,K)	8–6(10) (class G, H,I,K)	400	400	200	100	60	30	100 kA
			4–350 (25–150) (class G, H,I,K)	10–6 (6–10) (class G, H,I,K)	350	350	200	100	60	30	100 kA
			4–500 (25–240)	14–4 (2.5–16)	NONE						10 kA
9080LB- C162101	—	9080LB- C362101	6–1/0 (16–50)	6–1/0 (16–50)	175	175	100	60	60	30	100 kA
			6–1 (16–35) (class G, H,I,K)	6–1 (16–35) (class G, H,I,K)	175	175	100	60	60	30	100 kA
			14–1/0 (2.5–50)	14–1/0 (2.5–50)	NONE						10 kA
9080LB- C162104	9080LB- C262104	9080LB- C362104	6–2/0 (10–50)	10–4 (6–16)	200	200	200	100	60	30	100 kA
			10–2/0 (6–50)	14–4 (2.5–16)	150	150	100	30	60	30	100 kA
			6–1 (16–35) (class G, H,I,K)	12–6 (4–10) (class G, H,I,K)	150	150	100	30	60	30	100 kA
			14–2/0 (2.5–50)	14–4 (2.5–16)	NONE						10 kA

**Table 67 - 9080LBA and 9080LBC Power Distribution Blocks Short-Circuit Current Ratings with Fuses
(Continued)**

Catalog Numbers			Suitable Conductors kcmil/AWG (mm2)		Fuse Type / Amperage						SCCR
1-Pole	2-Poles	3-Poles	Line	Load	J	T	RK1	RK5	G	CC	
9080LB- C163101	—	9080LB- C363101	6-250 (16-120)	6-250 (16-120)	300	300	200	100	60	30	100 kA
			1/0-250 (70-120) (class G, H,I,K)	1/0-250 (70-120) (class G, H,I,K)	300	300	200	100	60	30	100 kA
			6-250 (16-120)	6-250 (16-120)	NONE						10kA
9080LB- C163106	9080LB- C263106	9080LB- C363106	3/0-500 (95-240)	8-2 (10-25)	400	400	400	200	60	30	100 kA
			4-500 (25-240)	10-2 (6-25)	300	300	200	100	60	30	100 kA
			1/0-250 (70-120) (class G, H,I,K)	10-4 (6-16) (class G, H,I,K)	150	150	100	30	60	30	100 kA
			Suitable Conductors kcmil/AWG (mm2)		Fuse Type / Amperage						SCCR
			Line	Load	J	T	RK1	RK5	G	CC	
			6-2 (10-25)	6-2 (10-25)	200	200	200	100	60	30	100 kA
			10-2 (6-25)	10-2 (6-25)	100	100	100	30	60	30	100 kA
			10-2 (6-25)	10-2 (6-25)	125	125	60	30	60	30	65 kA
			10-4 (6-16) (class G, H,I,K)	10-4 (6-16) (class G, H,I,K)	150	150	100	30	60	30	100 kA
14-2 (2.5-25)	14-2 (2.5-25)	NONE						10 kA			
9080LB- C163106	9080LB- C263106	9080LB- C363106	6-2 (16-25)	10 (6)	200	200	200	60	60	30	100 kA
			10-2 (6-25)	14-10 (2.5-4)	150	150	100	30	60	30	100 kA
			12-2 (4-25)	14-10 (2.5-4)	60	60	30	—	50	30	100 kA
			10-4 (6-16) (class G, H,I,K)	14-10 (2.5-4) (class G, H,I,K)	150	150	100	30	60	30	100 kA
			14-2 (2.5-25)	14-10 (2.5-4)	NONE						10 kA

Table 67 - 9080LBA and 9080LBC Power Distribution Blocks Short-Circuit Current Ratings with Fuses (Continued)

Catalog Numbers			Suitable Conductors kcmil/AWG (mm2)		Fuse Type / Amperage						SCCR
1-Pole	2-Poles	3-Poles	Line	Load	J	T	RK1	RK5	G	CC	
9080LB- C163106	9080LB- C263106	9080LB- C363106	6-2/0 (16-50)	6-2/0 (16-50)	300	300	200	100	60	30	65 kA
			6-1 (16-35) (class G, H,I,K)	6-1 (16-35) (class G, H,I,K)	300	300	200	100	60	30	65 kA
			14-2/0 (2.5-50)	14-2/0 (2.5-50)	NONE						10 kA
9080LB- C163106	9080LB- C263106	9080LB- C363106	6-2/0 (16-50)	10-4 (6-16)	200	200	200	100	60	30	100 kA
			6-2/0 (16-50)	14-4 (2.5-16)	150	150	100	30	60	30	100 kA
			6-1 (16- 35) (class G, H,I,K)	12-6 (4-10) (class G, H,I,K)	150	150	100	30	60	30	100 kA
			14-2/0 (2.5-50)	14-4 (2.5-16)	NONE						10 kA
9080LB- C163106	9080LB- C263106	9080LB- C363106	6-2/0 (16-50)	10-4 (6-16)	200	200	200	100	60	30	100 kA
			10-2/0 (6-50)	14-4 (2.5-16)	60	60	60	30	—	30	100 kA
			6-1 (16-35) (class G, H,I,K)	10-6 (6-10) (class G, H,I,K)	150	150	100	30	60	30	100 kA
			10-1 (6-35) (class G, H,I)	14-6 (2.5-10) (class G, H,I)	60	60	60	30	—	30	100 kA
			14-2/0 (2.5-50)	14-4 (2.5-16)	NONE						10 kA
9080LB- C163106	9080LB- C263106	9080LB- C363106	1/0-350 (70-150)	1/0-350 (70-150)	400	400	400	100	60	30	100 kA
			6-350 (16-150)	6-350 (16-150)	300	300	200	100	60	30	100 kA
			1/0-250 (70-120) (class G, H,I,K)	1/0-250 (70-120) (class G, H,I,K)	300	300	200	100	60	30	100 kA
			6-350 (16-150)	6-350 (16-150)	NONE						10 kA

**Table 67 - 9080LBA and 9080LBC Power Distribution Blocks Short-Circuit Current Ratings with Fuses
(Continued)**

Catalog Numbers			Suitable Conductors kcmil/AWG (mm2)		Fuse Type / Amperage						SCCR
1-Pole	2-Poles	3-Poles	Line	Load	J	T	RK1	RK5	G	CC	
9080LB- C163106	9080LB- C263106	9080LB- C363106	3/0-400 (95-185)	6-2 (16-25)	400	400	400	100	60	30	100 kA
			6-400 (16-185)	10-2 (6-25)	300	300	200	100	60	30	100 kA
			1/0-250 (70-120) (class G, H,I,K)	10-4 (6-16) (class G, H,I,K)	150	150	100	30	60	30	100 kA
			6-400 (16-185)	14-2 (2.5-25)	NONE						10 kA
			3/0-400 (95-185)	8-2 (10-25)	500	500	400	200	60	30	100 kA
			6-400 (16-185)	10-2 (6-25)	350	350	200	100	60	30	100 kA
			1/0-250 (70-120) (class G, H,I,K)	10-4 (6-16) (class G, H,I,K)	150	150	100	30	60	30	100 kA
			6-400 (16-185)	14-2 (2.5-25)	NONE						10 kA
9080LB- C163106	9080LB- C263106	9080LB- C363106	2-2/0 (35-50)	8-4 (10-16)	400	400	400	100	60	30	100 kA
			6-2/0 (16-50)	8-4 (10-16)	350	350	200	100	60	30	100 kA
			6-2/0 (16-50)	10-4 (6-16)	250	250	200	60	60	30	100 kA
			(1) 6 (16)	(2) 12 (4)	225	225	100	60	60	30	100 kA
			6-1 (16-35) (class G, H,I,K)	8-6 (10) (class G, H,I,K)	150	150	100	30	60	30	100 kA
			14-2/0 (2.5-50)	14-4 (2.5-16)	NONE						10 kA
9080LB- C163106	9080LB- C263106	9080LB- C363106	2-600 (35-300)	2-600 (35-300)	600	600	—	—	—	—	50 kA
			2-600 (35-300)	2-600 (35-300)	400	400	400	200	60	30	100 kA
			2-350 (35-150) (class G, H,I,K)	2-350 (35-150) (class G, H,I,K)	400	400	400	200	60	30	100 kA
			2-600 (35-300)	2-600 (35-300)	NONE						10 kA

Table 67 - 9080LBA and 9080LBC Power Distribution Blocks Short-Circuit Current Ratings with Fuses (Continued)

Catalog Numbers			Suitable Conductors kcmil/AWG (mm2)		Fuse Type / Amperage						SCCR
1-Pole	2-Poles	3-Poles	Line	Load	J	T	RK1	RK5	G	CC	
9080LB- C163106	9080LB- C263106	9080LB- C363106	3/0-400 (95-185)	8-2 (10-25)	400	400	400	200	60	30	100 kA
			6-400 (16-185)	10-2 (6-25)	200	200	200	100	60	30	100 kA
			1/0-250 (70-120) (class G, H,I,K)	14-4 (2.5-16) (class G, H,I,K)	150	150	100	30	60	30	100 kA
			6-40 0 (16-185)	14-2 (2.5-25)	NONE						10 kA
9080LB- C163106	9080LB- C263106	9080LB- C363106	4-350 (25-150)	4-350 (25-150)	450	450	400	200	60	30	100 kA
			4-350 (25-150)	4-350 (25-150)	600	600	—	—	—	—	50 kA
			2-250 (35-120) (class G, H,I,K)	2-250 (35-120) (class G, H,I,K)	600	600	—	—	—	—	50 kA
			2-250 (35-120) (class G, H,I,K)	2-250 (35-120) (class G, H,I,K)	450	450	400	200	60	30	100 kA
			4-350 (25-150)	4-350 (25-150)	NONE						10 kA
			4-500 (25-240)	4-500 (25-240)	500	500	400	200	60	30	100 kA
			2-350 (35-150) (class G, H,I,K)	2-350 (35-150) (class G, H,I,K)	500	500	400	200	60	30	100 kA
			4-500 (25-240)	4-500 (25-240)	NONE						10 kA
9080LB- C163106	9080LB- C263106	9080LB- C363106	3/0-500 (95-240)	6-2/0 (16-50)	400	400	400	100	60	30	100 kA
			4-500 (25-240)	10-2/0 (6-50)	200	200	200	100	60	30	100 kA
			2-350 (35-150) (class G, H,I,K)	6-1 (16-35) (class G, H,I,K)	400	400	400	100	60	30	100 kA
			2-350 (35-150) (class G, H,I,K)	10-1 (6-35) (class G, H,I,K)	250	250	200	100	60	30	100 kA
			4-500 (25-240)	14-2/0 (2.5-50)	NONE						10 kA

**Table 67 - 9080LBA and 9080LBC Power Distribution Blocks Short-Circuit Current Ratings with Fuses
(Continued)**

Catalog Numbers			Suitable Conductors kcmil/AWG (mm ²)		Fuse Type / Amperage						SCCR
1-Pole	2-Poles	3-Poles	Line	Load	J	T	RK1	RK5	G	CC	
9080LB- C163106	9080LB- C263106	9080LB- C363106	3/0-500 (95-240)	6-2 (16-25)	400	400	400	200	60	30	100 kA
			4-500 (25-240)	10-2 (6-25)	250	250	200	100	60	30	100 kA
			2-350 (35-150) (class G, H,I,K)	6-4 (16) (class G, H,I,K)	400	400	400	200	60	30	100 kA
			2-350 (35-150) (class G, H,I,K)	10-4 (6-16) (class G, H,I,K)	250	250	200	200	60	20	100 kA
			4-500 (25-240)	14-2 (2.5-25)	NONE						10 kA
9080LB- C163106	9080LB- C263106	9080LB- C363106	250-500 (150- 240)	4-2/0 (25-50)	600	600	400	200	60	30	100 kA
			4-500 (25-240)	10-2/0 (6-50)	350	350	200	100	60	30	100 kA
			250-350 (150) (class G, H,I,K)	4-1 (25-35) (class G, H,I,K)	600	600	400	200	60	30	100 kA
			4-350 (25-150) (class G, H,I,K)	10-6 (6-10) (class G, H,I,K)	350	350	200	100	60	30	100 kA
			4-500 (25-240)	14-2/0 (2.5-50)	NONE						10 kA

Table 67 - 9080LBA and 9080LBC Power Distribution Blocks Short-Circuit Current Ratings with Fuses (Continued)

Catalog Numbers			Suitable Conductors kcmil/AWG (mm2)		Fuse Type / Amperage						SCCR
1-Pole	2-Poles	3-Poles	Line	Load	J	T	RK1	RK5	G	CC	
9080LB- C163106	9080LB- C263106	9080LB- C363106	250-500 (150-240)	8-4 (10-16)	400	400	200	100	60	30	100 kA
			4-500 (25-240)	10-4 (6-16)	350	350	200	100	60	30	100 kA
			250-350 (150) (class G, H,I,K)	8-6(10) (class G, H,I,K)	400	400	200	100	60	30	100 kA
			4-350 (25-150) (class G, H,I,K)	10-6 (6-10) (class G, H,I,K)	350	350	200	100	60	30	100 kA
			4-500 (25-240)	14-4 (2.5-16)	NONE						10 kA
			6-1/0 (16-50)	6-1/0 (16-50)	175	175	100	60	60	30	100 kA
			6-1 (16-35) (class G, H,I,K)	6-1 (16-35) (class G, H,I,K)	175	175	100	60	60	30	100 kA
			14-1/0 (2.5-50)	14-1/0 (2.5-50)	NONE						10 kA
9080LB- C163106	9080LB- C263106	9080LB- C363106	6-2/0 (10-50)	10-4 (6-16)	200	200	200	100	60	30	100 kA
			10-2/0 (6-50)	14-4 (2.5-16)	150	150	100	30	60	30	100 kA
			6-1 (16-35) (class G, H,I,K)	12-6 (4-10) (class G, H,I,K)	150	150	100	30	60	30	100 kA
			14-2/0 (2.5-50)	14-4 (2.5-16)	NONE						10 kA
9080LB- C163106	9080LB- C263106	9080LB- C363106	6-250 (16-120)	6-250 (16-120)	300	300	200	100	60	30	100 kA
			1/0-250 (70-120) (class G, H,I,K)	1/0-250 (70-120) (class G, H,I,K)	300	300	200	100	60	30	100 kA
			6-250 (16-120)	6-250 (16-120)	NONE						10kA

**Table 67 - 9080LBA and 9080LBC Power Distribution Blocks Short-Circuit Current Ratings with Fuses
(Continued)**

Catalog Numbers			Suitable Conductors kcmil/AWG (mm2)		Fuse Type / Amperage						SCCR
1-Pole	2-Poles	3-Poles	Line	Load	J	T	RK1	RK5	G	CC	
9080LB- C163106	9080LB- C263106	9080LB- C363106	3/0-500 (95-240)	8-2 (10-25)	400	400	400	200	60	30	100 kA
			4-500 (25-240)	10-2 (6-25)	300	300	200	100	60	30	100 kA
			1/0-250 (70-120) (class G, H,I,K)	10-4 (6-16) (class G, H,I,K)	150	150	100	30	60	30	100 kA
			4-500 (25-240)	14-4 (2.5-16)	NONE						10 kA
			4-500 (25-240)	14-4 (2.5-16)	NONE						10 kA
9080LB- C163206	9080LB- C263206	9080LB- C363206	2-2/0 (35-50)	8-4 (10-16)	400	400	400	100	60	30	100 kA
			6-2/0 (16-50)	8-4 (10-16)	350	350	200	100	60	30	100 kA
			10-4 (6-16) (class G, H,I,K)	14-10 (2.5-4) (class G, H,I,K)	150	150	100	30	60	30	100 kA
			14-2/0 (2.5-50)	14-4 (2.5-16)	NONE						10 kA
9080LB- C165208	—	9080LB- C365208	250-500 (150- 240)	4-2/0 (25-50)	500	500	400	200	60	30	100 kA
			4-500 (25-240)	6-2/0 (16-50)	450	450	400	200	60	30	100 kA
			250-350 (150) (class G, H,I,K)	4-1 (25-35) (class G, H,I,K)	500	500	400	200	60	30	100 kA
			2-350 (35-150) (class G, H,I,K)	6-1 (16-35) (class G, H,I,K)	450	450	400	200	60	30	100 kA
			4-500 (25-240)	14-2/0 (2.5-50)	NONE						10 kA

Table 67 - 9080LBA and 9080LBC Power Distribution Blocks Short-Circuit Current Ratings with Fuses (Continued)

Catalog Numbers			Suitable Conductors kcmil/AWG (mm2)		Fuse Type / Amperage						SCCR
1-Pole	2-Poles	3-Poles	Line	Load	J	T	RK1	RK5	G	CC	
9080LB- C165212	—	9080LB- C365212	4-500 (25-240)	10-2 (6-25)	400	400	400	200	60	30	100 kA
			250-500 (150- 240)	8-2 (10-25)	600	600	—	—	—	—	50 kA
			2-350 (35-150) (class G, H,I,K)	10-4 (6-16) (class G, H,I,K)	400	400	400	200	60	30	100 kA
			250-350 (150) (class G, H,I,K)	8-4 (10-16) (class G, H,I,K)	600	600	—	—	—	—	50 kA
			4-500 (25-240)	14-2 (2.5-25)	NONE						10 kA

Specific Requirements for the Canadian Market

Installation and Product Standards

The installation standard in Canada is the *Canadian Electrical Code* (CEC). The CEC and the NEC are similar, but not 100% equivalent.

The same is true for the CSA standards and corresponding UL standards (see Table 67, page 84). Some of the major differences are detailed below.

Certification Process

As in the U.S., nationally recognized testing laboratories (such as: CSA, ETL, TUV, and UL) are able to certify equipment according to these CSA standards. Refer to *Acceptance of Electrical Equipment in US*, page 6.

Technical Differences between Canadian and U.S. Standards

Some examples of differences between the Canadian and U.S. standards that currently apply to motor starters are listed in Table 67, page 84. The TeSys™ product line is designed for compliance and compatibility with both the UL and the CSA requirements.

- Type E and Type F applications do not require the use of large spacing adapters when used in Canada.
- Group installation is recognized but the rules to define the common branch-circuit protection setting is quite different.
- Industrial control panels must meet CSA C22.2 No. 14.
- Elevator equipment appliances must comply with the specific CSA Nr. B44.1 standard.
- Product marking requirements differ slightly.

Table 68 - Comparison of CSA and UL Standards

Standard Name	CSA Standard	UL Standard
Enclosed and Dead-Front Switches	CSA C22.2 No. 4	UL 98
Low-Voltage Fuses: Part 1: General Requirements	CSA C22.2 No. 248	UL 248
Molded-Case Circuit Breakers, Molded-Case Switches, and Circuit-Breaker Enclosures	CSA C22.2 No. 5	UL 489
Industrial Control Equipment	CSA C22.2 No. 14	UL 60947
Elevator Equipment	CSA No. B44.1	Partially UL 60947

Full-Load Current, Three-Phase Alternating-Current Motors

The full-load currents in Table 68, page 85 are based on the 2017 National Electrical Code, Table 430.250. These value are indicative; they vary according to the type of motor, the number of poles, and the manufacturer.

Table 69 - Induction-Type Squirrel Cage and Wound Rotor (A)

Horsepower (HP)	115 V	200 V	208 V	230 V	460 V	575 V
0.5	4.4	2.5	2.4	2.2	1.1	0.9
0.75	6.4	3.7	3.5	3.2	1.6	1.3
1	8.4	4.9	4.6	4.2	2.1	1.7
1.5	12.0	6.9	6.6	6.0	3.0	2.4
2	13.6	7.8	7.5	6.8	3.4	2.7
3	—	11.0	10.6	9.6	4.8	3.9
5	—	17.5	16.7	15.2	7.6	6.1
7.5	—	25.3	24.2	22	11	9
10	—	32.2	30.8	28	14	11
15	—	48.3	46.2	42	21	17
20	—	62.1	59.4	54	27	22
25	—	78.2	74.8	68	34	27
30	—	92	88	80	40	32
40	—	120	114	104	52	41
50	—	150	143	130	65	52
60	—	177	169	154	77	62
75	—	221	211	192	96	77
100	—	285	273	248	124	99
125	—	359	343	312	156	125
150	—	414	396	360	180	144
200	—	552	528	480	240	192
250	—	—	—	—	302	242
300	—	—	—	—	361	289
350	—	—	—	—	414	336
400	—	—	—	—	477	382
450	—	—	—	—	515	412
500	—	—	—	—	590	472

Schneider Electric
800 Federal Street
Andover, MA 01810
USA

888-778-2733

www.se.com

As standards, specifications, and design change from time to time,
please ask for confirmation of the information given in this publication.

© 2019 – 2024 Schneider Electric. All rights reserved.

8536DB0901 R02/24