

# Solenoid valves VUVG-EX/valve terminals VTUG-EX

**FESTO**

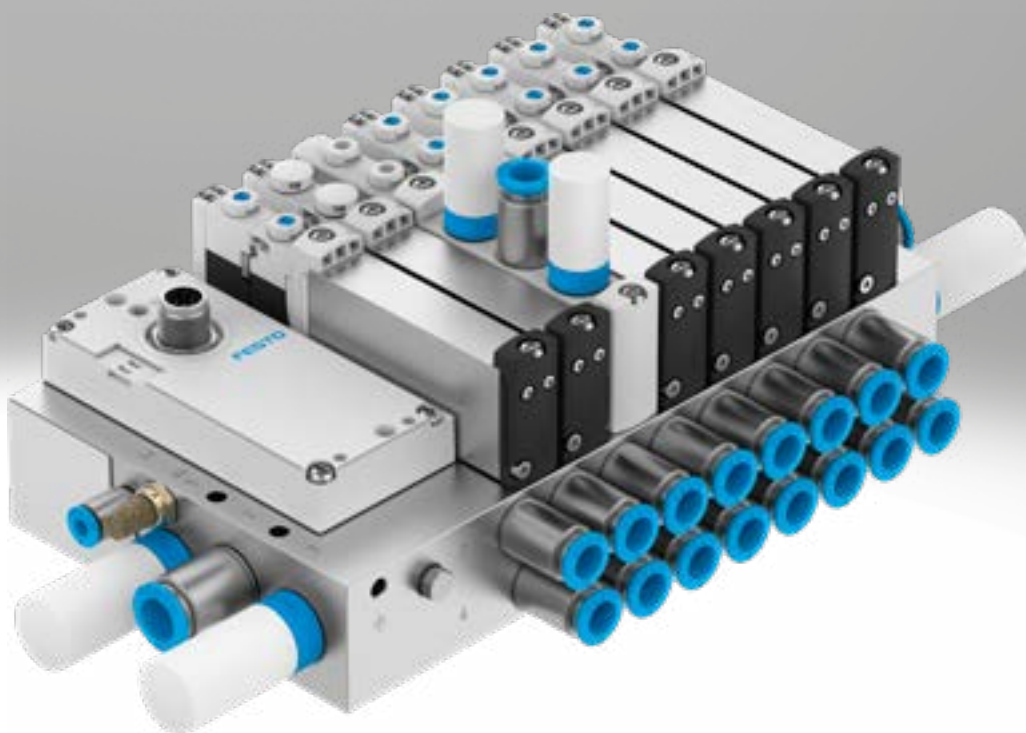

Festo Core Range  
Solves the majority of your automation tasks

Worldwide:  
Simply good:  
Fast:

Quickest delivery – wherever, whenever  
Expected high Festo quality  
Easy and fast to select

With the Festo Core Range, we have selected the most important products and functions from our broad product catalogue, and added the quickest delivery.

The Core Range offers you the best value for your automation tasks.

Just look  
for the  
star!

## Key features

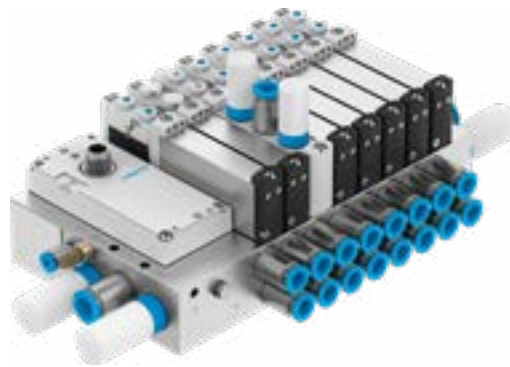
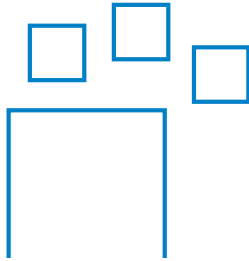

### Innovative

- Festo-specific I-Port interface for bus nodes (CTEU)
- IO-Link® mode for direct connection to a higher-level IO-Link master
- Flexible multi-pin plug connection using Sub-D or ribbon cable
- Reversible piston spool valves, up to 24 valve positions
- Reduced power consumption
- Excellent price/performance ratio

### Versatile

- Choice of quick push-in connectors
- Multiple pressure zones possible
- Sub-D variant and fieldbus interface with protection to IP67
- Internal or external pilot air with the same manifold rail possible by using blanking plugs
- Sub-base valves with working ports underneath for installation in control cabinets

### Reliable

- Sturdy and durable metal components
  - Valves
  - Manifold rails
- Fast troubleshooting thanks to LED indicator
- Manual override: choose from non-detenting, detenting or covered

### Easy to install

- Easy mounting thanks to captive screws and seal
- Easy-to-change connection technology
- Inscription label holder for labelling

### Ordering data – Product options

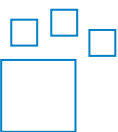

Configurable product  
This product and all its product options can be ordered using the configurator.

The configurator can be found at  
→ [www.festo.com/catalogue/...](http://www.festo.com/catalogue/...)  
Enter the part number or the type.

Part no.	Type
8060699	VTUG-EX

## Key features – Pneumatic components

### Overview – Valve terminal with multi-pin plug connection and fieldbus interface

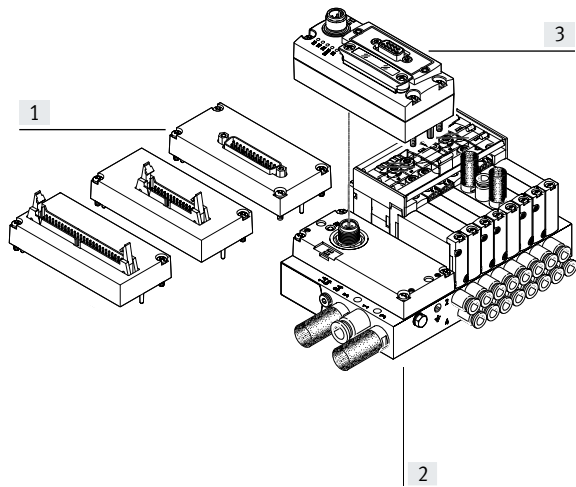

Different electrical connections:

- [1] Ribbon cable or Sub-D
- [2] I-Port interface
- [3] Bus node CTEU

## Key features – Pneumatic components

### Equipment options

#### Valve functions

- 2x 3/2-way, 3/2-way, 5/2-way, 5/3-way valves
- Reversible piston spool valves, up to 24 valve positions

#### Electrical connection options

- IO-Link® mode for direct connection to a higher-level IO-Link master
- Flexible multi-pin plug connection using Sub-D or ribbon cable
- Festo-specific I-Port interface for bus nodes (CTEU)

### Basic valves VUVG-EX

#### Size

- 10
- 14

#### Design

- Sub-base valve

### Valve functions

#### 3/2-way valve

- Single solenoid
- Normally open
- Normally closed

#### 2x 3/2-way valve

- Single solenoid
- Normally open
- Normally closed
- 1x normally closed, 1x normally open
- Mechanical spring
- Pneumatic spring

#### 5/2-way valve

- Single solenoid
- Pneumatic/mechanical spring
- Mechanical spring
- Pneumatic spring
- Double solenoid valve

#### 5/3-way valve

- Mid-position pressurised
- Mid-position exhausted
- Mid-position closed

### Cover caps for manual override

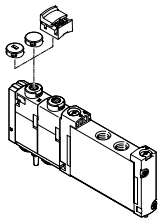

- Closed cover cap, concealed manual override
- Slotted cover cap, non-detenting manual override
- Cover cap for detenting actuation without tools

### Inscription label holders

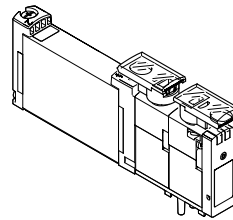

Inscription label holders ASLR-D-L1 for identifying the valves and as a covering for the manual override.

### Inscription label holder

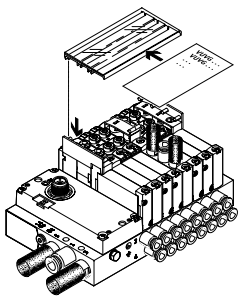

Inscription label holders ASCF-H-L1-... for identifying the valves on the valve terminal VTUG



## Key features – Pneumatic components

### Manifold rail

For sub-base valves

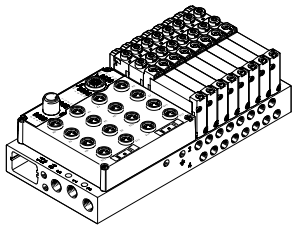

The sub-base valves are supplied with external pilot air. The pilot air is set via the manifold rail. The scope of delivery of the manifold rail includes a short and a long blanking plug for setting the pilot air.

- For sub-base valves M5/M7 (size 10), G1/8 (size 14)
- For 2x 3/2-way, 3/2-way, 5/2-way and 5/3-way valves
- 4 to 24 valve positions with electrical links

For control cabinet installation, outlet direction underneath (U)

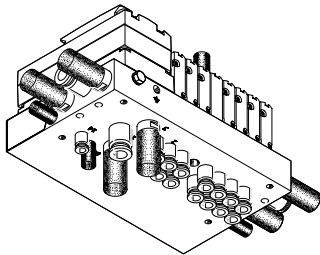

For sub-base valves M7 (size 10), G1/8 (size 14)

For control cabinet installation, outlet direction to the front (FD)

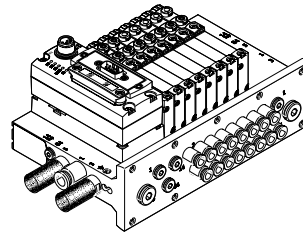

For sub-base valves M7 (size 10) and G1/8 (size 14).

For control cabinet installation, with shut-off function (hot swap)

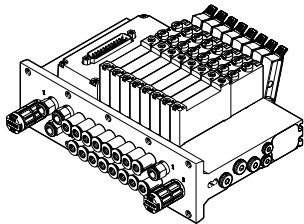

Shut-off function for duct 1, for sub-base valves M7 (size 10) and G1/8 (size 14):

- Internal pilot air supply only
- Vacuum operation not possible

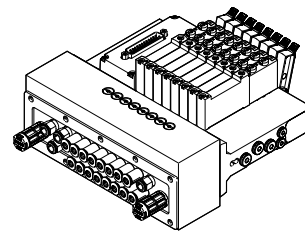

Shut-off function for ducts 1, 2 and 4, for sub-base valves M7 (size 10) and G1/8 (size 14):

- Internal/external pilot air supply
- Vacuum operation not possible

### Note

Pressurisation and exhaust at both ends is recommended for an optimised flow rate in cases where multiple valves switch simultaneously.

## Key features

### Electrical connection

#### Multi-pin plug connection

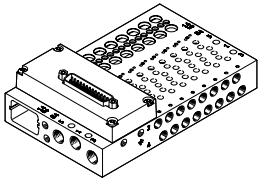

The signals are transmitted from the controller to the valve terminal via a pre-assembled or self-assembled multi-wire cable to the multi-pin plug connection.

This substantially reduces installation time compared to individually connected valves. The valve terminal can be equipped with max. 48 solenoid coils.

Versions:

- Sub-D connection
- Ribbon cable

### I-Port interface

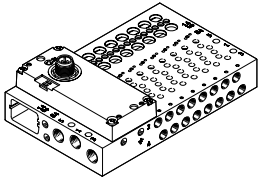

Festo-specific interface as a basis for bus nodes (CTEU) or in IO-Link® mode for direct connection to a higher-order IO-Link master.

Communication and power supply take place via a common M12 interface.

Connection options:

- As I-Port interface for bus nodes (CTEU)
- In IO-Link® mode for direct connection to an IO-Link master

### Supply plate

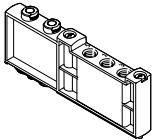

For additional air supply and exhaust via a valve position (ports for duct 1, 3 and 5).

 **Note**

The supply plate VABF-L1-14-P3A4-G18-T1 can only be used with G fittings. R fittings are not permissible.

### Cover plate for vacant position

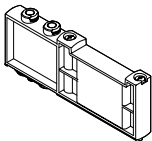

Vacant position cover

### Separator for pressure zones

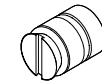

For creating multiple pressure zones in a valve terminal

## Key features – Pneumatic components

### Creating pressure zones and separating exhaust air

Compressed air is supplied and exhausted via the manifold rail and via supply plates.

The position of the supply plates and duct separations can be freely selected with the VTUG.







A pressure zone is created by separating the internal supply ducts using a separator.

Pressure zone separation can be used for the following ducts:

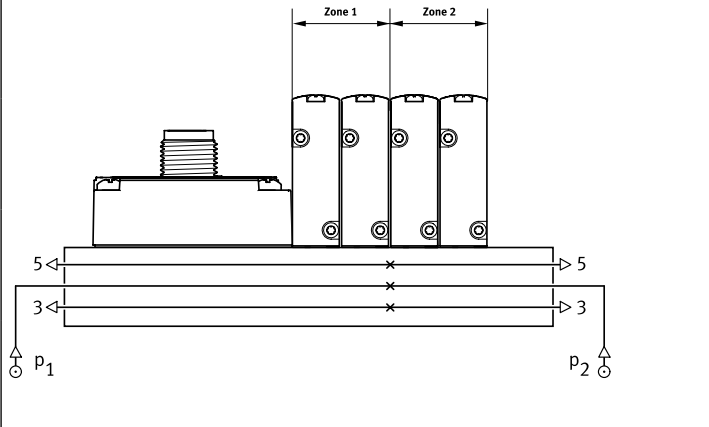
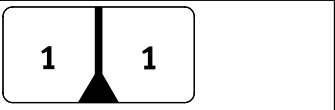
- Duct 1
- Duct 3
- Duct 5

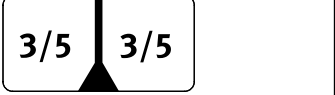
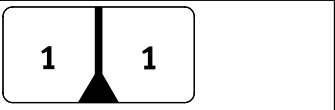
**Note**

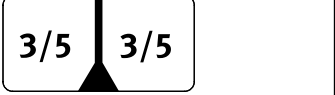
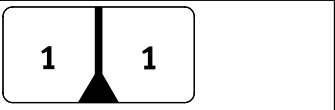
- Use a separating element for high exhaust air pressures
- Use at least one supply plate/air supply for each pressure zone
- Pressure zone separation is not possible in duct 12/14 (pilot air supply)

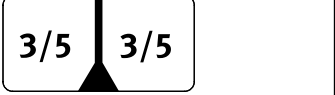
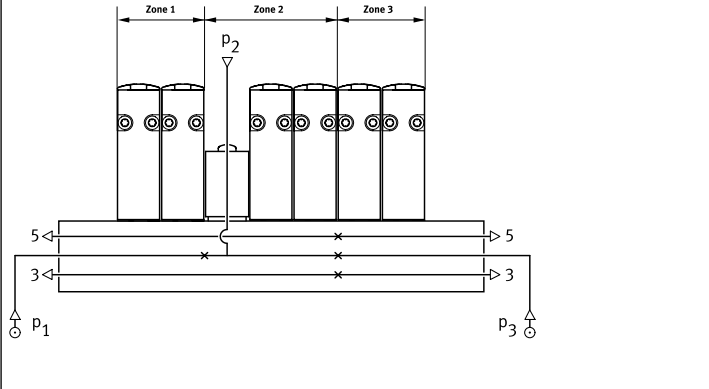
Duct separation	Description						
	<p>The pressure zones can be freely configured with the VTUG. The following duct separations are possible:</p> <table border="1" data-bbox="833 806 1513 1137"> <tr> <td data-bbox="833 806 1173 918">Duct 1 closed</td> <td data-bbox="1179 815 1370 909">  </td> </tr> <tr> <td data-bbox="833 927 1173 1030">Duct 1, 3, 5 closed</td> <td data-bbox="1179 927 1370 1021">  </td> </tr> <tr> <td data-bbox="833 1039 1173 1137">Duct 3, 5 closed</td> <td data-bbox="1179 1039 1370 1133">  </td> </tr> </table>	Duct 1 closed		Duct 1, 3, 5 closed		Duct 3, 5 closed	
Duct 1 closed							
Duct 1, 3, 5 closed							
Duct 3, 5 closed							
	<p>The number of pressure zones with the VTUG is limited by the number of valve positions on the manifold rail. Note that each supply plate occupies one valve position.</p>						

### Separator VABD

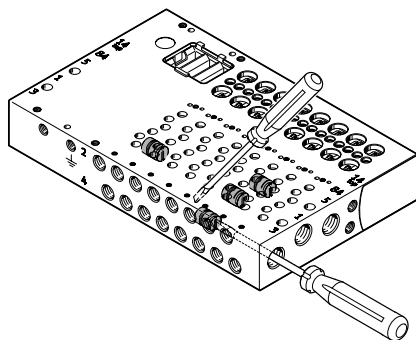

[1] Separator VABD

**Note**

Several pressure zones can be created on the VTUG by inserting separators (VABD). The separators are inserted in the manifold rail using a slotted screwdriver.

## Key features – Pneumatic components

### Shut-off function (hot swap)

For duct 1

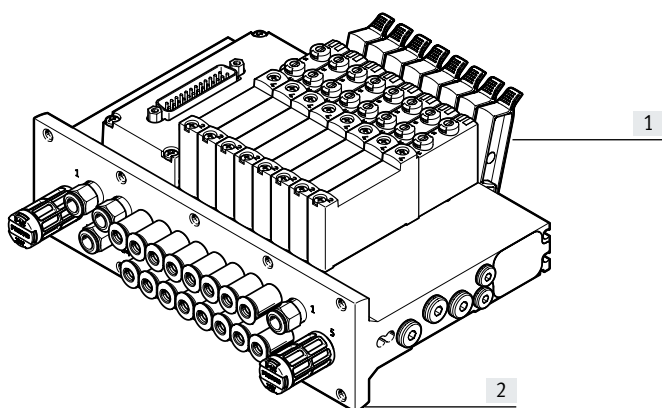

- [1] Actuating lever
- [2] Manifold rail with shut-off plate

The shut-off plate is located below the manifold block. Actuating the lever:

- Disconnects the valve position from the compressed air supply (duct 1)
- Exhausts the pilot air supply on the valve side (duct 12 and 14)

Note the user instructions for use in combination with a supply plate

The actuating levers can be individually locked in place, securing them against unwanted actuation.

For duct 1, 2 and 4

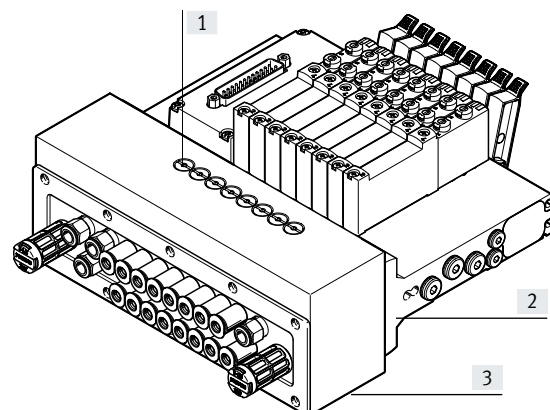

- [1] Plunger
- [2] Manifold rail
- [3] Manifold block

To actuate, press in the plunger with a pointed object or screwdriver and then turn clockwise by 90° until the stop is reached:

- Connection from the valve position to ports 2 and 4 is blocked
- The components connected to ports 2 and 4 are not exhausted

### Pilot air supply

Internal pilot air supply

Internal pilot air supply can be selected with an operating pressure between 1.5 ... 8 bar, 2.5 ... 8 bar, or 3 ... 8 bar (depending on the valve used).

The pilot air supply is branched from duct 1 (compressed air supply) using an internal connection.

External pilot air supply

External pilot air supply is required for vacuum operation or operating pressures above 8 bar. The port for external pilot air supply (port 12/14) is located on the manifold rail.

Pilot exhaust air

The pilot air is exhausted via duct 82/84 of the manifold rail.

Pilot air supply

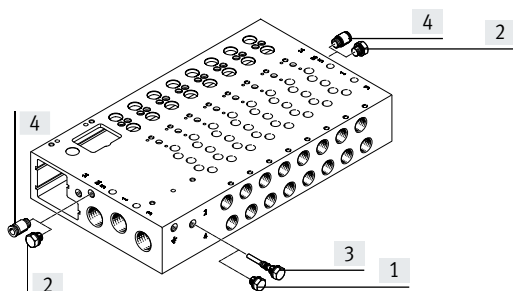

- [1] Blanking plug, short, for internal pilot air
- [2] Blanking plug for duct 12/14 with internal pilot air
- [3] Blanking plug, long, for external pilot air
- [4] Push-in fitting for duct 12/14 with external pilot air

The manifold rails have an internal connection between duct 12/14 and duct 1.

By inserting a blanking plug into this connection, it is possible to switch between internal and external pilot air.

## Key features – Pneumatic components

### Exhaust functions

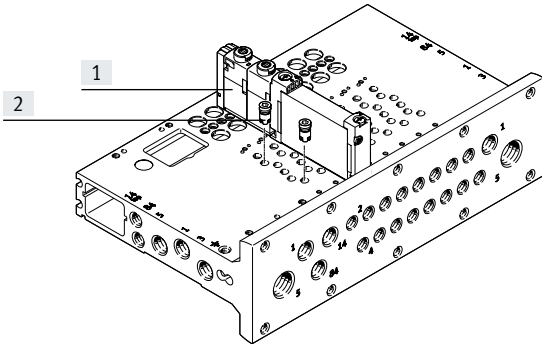

- [1] Valves VUVG
- [2] Fixed flow restrictor, self-tapping/check valve

#### Fixed flow restrictor, self-tapping

The fixed flow restrictor can be used to permanently set the exhaust flow rate in ducts 3 and 5.

The fixed flow restrictors are screwed into ducts 3 and 5 in the manifold rail.

Please see the relevant assembly instructions:

[www.festo.com/catalogue/...](http://www.festo.com/catalogue/...)

→ Support/Downloads

#### Check valve

Check valves block the flow towards the valves if back pressure develops in ducts 3 and 5 in the case of a high exhaust capacity, thereby preventing actuators from switching unexpectedly. The check valves are screwed into ducts 3 and 5 in the manifold rail.

#### Note

- It is not possible to use a check valve and a fixed flow restrictor at the same time (in the same duct).
- When screwing in again, use the threads already present.

Please see the relevant assembly instructions:

[www.festo.com/catalogue/...](http://www.festo.com/catalogue/...)

→ Support/Downloads

## Key features – Pneumatic components

### Operation with different pressures

#### Vacuum operation

#### Points to note with 3/2-way valves with pneumatic spring return:

The 3/2-way valves are available in a design with two valves in one valve body and with pneumatic spring return. With these valves, the force for the return movement is obtained from port 1.

Vacuum operation is only possible at port 3 and 5, not at port 1. With external pilot air supply, vacuum can be connected at port 1, 3, 5 of the 5/2-way and 5/3-way valves.

Vacuum operation is not possible when using the shut-off function (hot swap).

#### Reverse operation

The 3/2-way valves with pneumatic spring are not suitable for reverse operation, since at least the minimum pilot pressure must be present in duct 1.

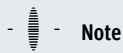

#### Note

Pressure must be present at port 1.

#### Pressure divider (internal pilot air)

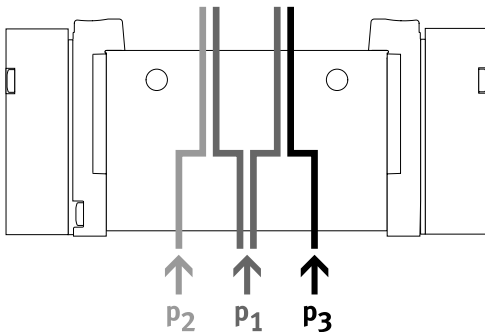

- Two different pressures are required
- Different pressures can be connected at duct 1, 3 and 5

#### Benefits

Any pressure or vacuum can be connected at duct 3 and 5 both with external and internal pilot air

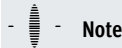

#### Note

- With internal pilot air, adhere to the minimum pilot pressure in duct 1
- With 2x 3/2-way valves without spring return, adhere to the to minimum pilot pressure in duct 1

#### Vacuum, ejector pulse and normal position

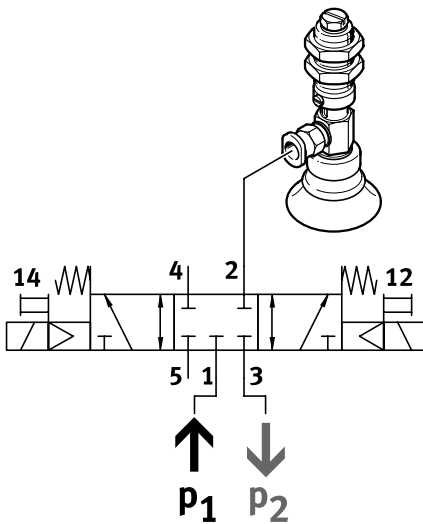

Vacuum, ejector pulse and normal position with internal pilot air can be achieved by connecting vacuum at duct 3 and pressure for the ejector pulse at duct 1.

## Key features – Pneumatic components

### Standard nominal flow rate $q_{nN}$ as a function of the number of switched valves $n$

Size 10 mm, 5/2-way valves

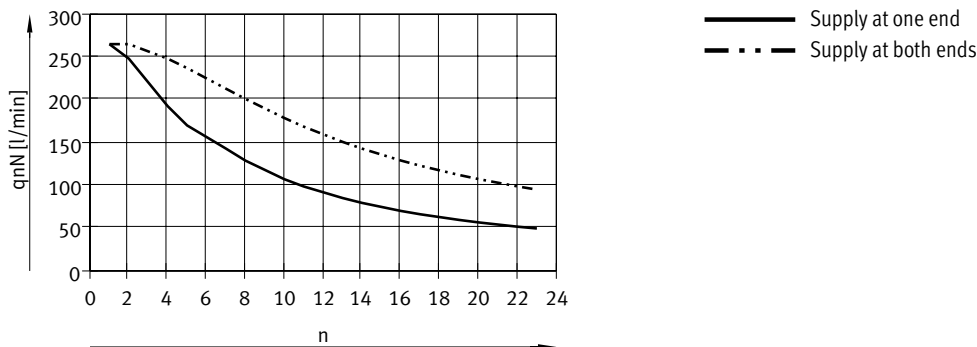

Size 14 mm

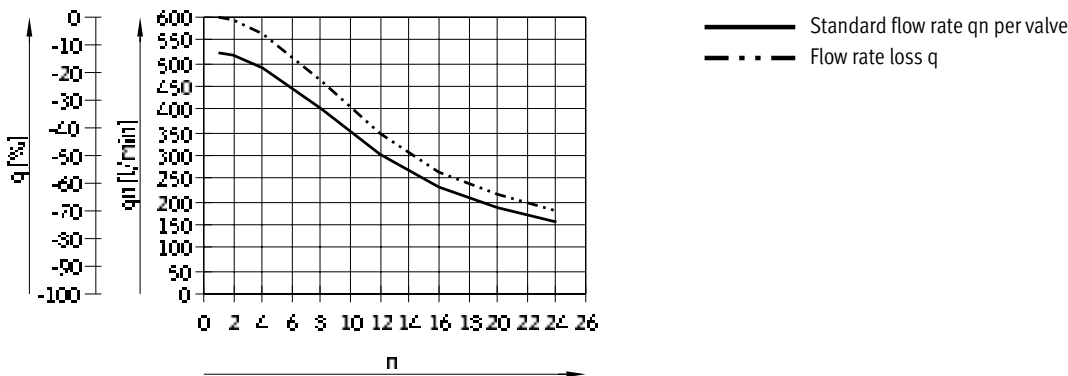

### Pilot pressure $p_2$ as a function of operating pressure $p_1$

2x 3/2-way valve, mechanical spring return

2x 3/2-way valve, pneumatic spring return

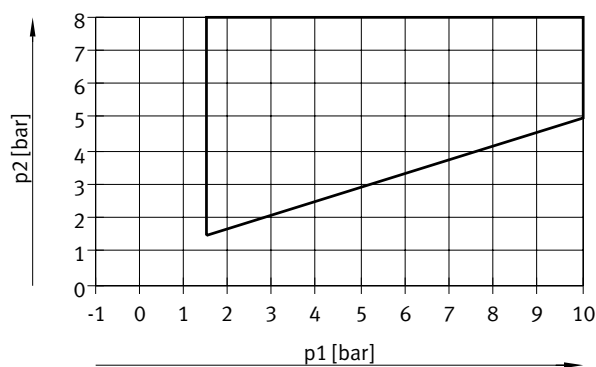
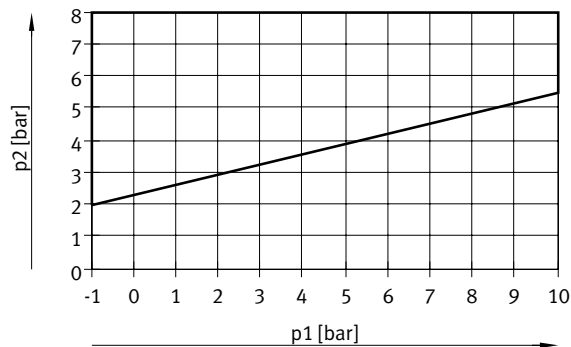

3/2-way single solenoid valve and 5/2-way single solenoid valve

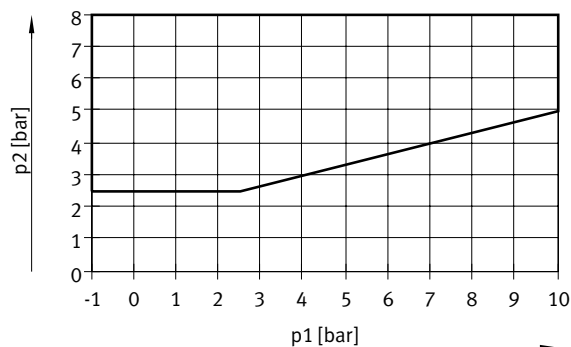

## Key features – Mounting

### Valve terminal mounting

Sturdy terminal mounting via:

- Four through-holes for wall mounting
- H-rail mounting
- Mounting bracket

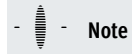

Use the M5 thread provided on the manifold block for earthing the valve terminal.

### Wall mounting

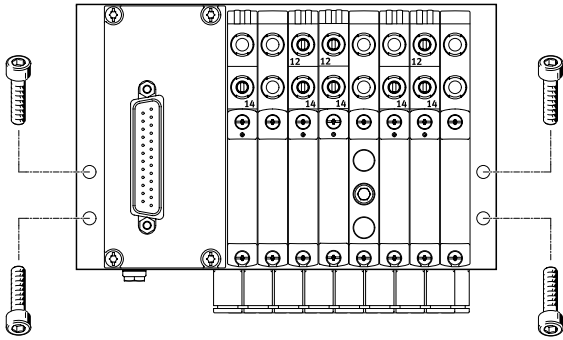

Screw the valve terminal VTUG onto the mounting surface using four M4 screws.

The mounting holes are on the left and right side of the manifold rail.

### H-rail mounting

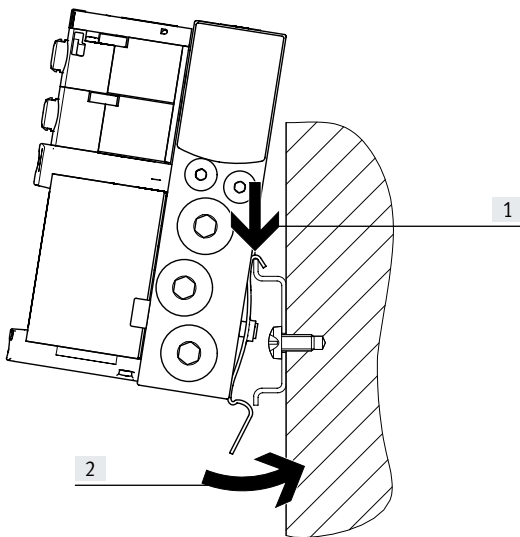

Clip the valve terminal VTUG onto the H-rail (see arrow [1]).

Swivel the valve terminal onto the H-rail and secure in place with the clamping element (see arrow [2]).

Attach the manifold rails to an H-rail to EN 60715-TH35 using the mounting VAME-T-M4.

Use the following screws for mounting (to DIN 912):

- Size 10: M4x30
- Size 14: M4x40

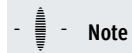

Permissible use of the H-rail:

- Manifold rail with outlet on the side or on top.
  - H-rail exclusively for horizontal mounting.
  - Vibration/shock loads are not permissible for this type of mounting.
- Size 14:
- Use H-rail type TH35-7.5 for valve terminals with a maximum of 8 valve positions.
  - Use H-rail type TH35-15 for mounting in accordance with the standard and for more than 8 valve positions.



## Key features – Mounting

### Hood for VTUG-VI-EX2

Description

→ page 28

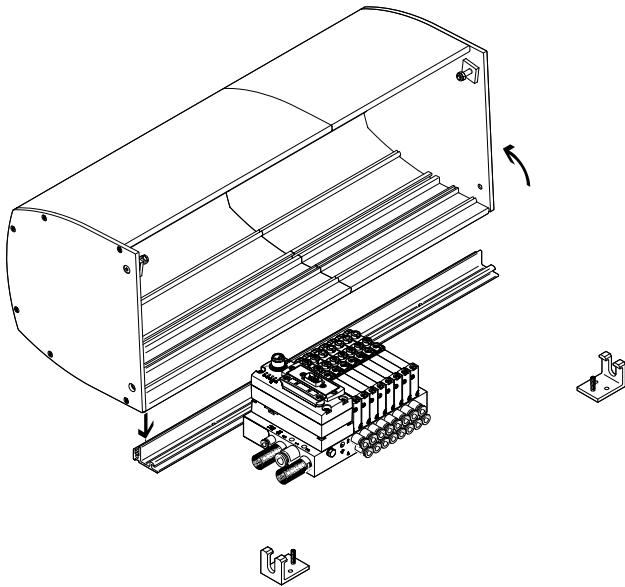

The VTUG-VI-EX2 hood CAFC is a space- and cost-saving alternative to a control cabinet.

It is designed as an extruded aluminum profile and is installed on a mounting plate.

The valve terminal has a well-protected design and is quick to install without the need for complex cabinet through-feed for connecting cables and tubing.

The rail and the two mounting brackets are mounted on a base plate. The hood is attached to the retaining rail and secured with two screws. There is also a stand-by position (detent of the hood in the open position).

The hood is locked using two side screws (which meet the requirements for a special fastener in compliance with ATEX).

The VTUG-VI-EX2 hood can be ordered online using the valve terminal configurator.

#### Advantages of the VTUG-VI-EX2 hood

- Impact protection (min. 7 J) for the modules underneath in combination with a suitable mounting plate provided by the user
- Protection against electrostatic discharge by using electrically conductive materials and the option of connecting an earth wire
- Protection against disconnection of live plug connectors (by securing the hood with at least one special fastener to EN 60079-0, 9.2 and 20)
- UV protection for the VTUG modules underneath

#### Points to note when using the VTUG-VI-EX2 hood

- VTUG-VI-EX2 power supply via angled plugs, no T plugs, no push-pull
- Electrical supply plate/additional supply only possible with angled plug
- Use of larger fittings (for tubing O.D. 12 mm and larger) only possible with the angled design
- Ducted exhaust air only with elbow connector
- The permissible ambient temperature range of the valve terminal is reduced by 5°C.

#### Note

The VTUG-VI-EX2 hood has no influence on the ATEX classification of the valve terminal or of the VTUG-VI-EX2 terminal.

The VTUG-VI-EX2 hood has no influence on the IP degree of protection of the valve terminal or of the VTUG-VI-EX2 terminal.

The VTUG-VI-EX2 hood does not protect against the effects of the weather in installations that are not in enclosed spaces.

## Key features – Mounting

### Hood for VTUG-VI-EX2

Assembly

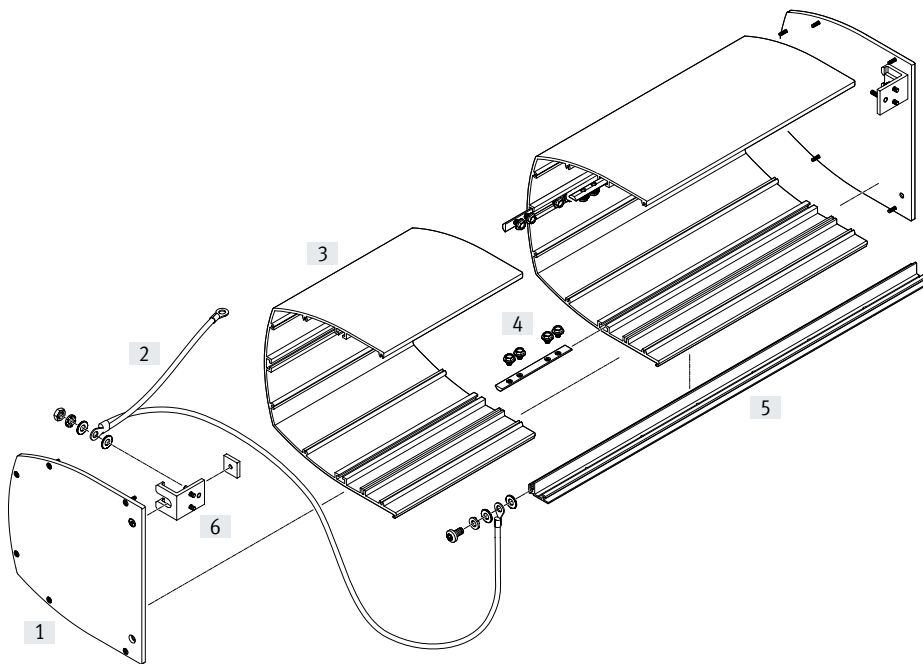

#### Procedure:

- Assemble the rail and mounting bracket included in the mounting kit
- Attach the earthing cable
- Assemble the hood (if applicable, screw together several hood sections and attach the side covers)
- Attach and secure the hood

- [1] Side cover
- [2] Earthing cable
- [3] Hood section
- [4] Slot nut with screws, for joining the hood sections
- [5] Rail
- [6] Mounting bracket

#### Technical data

##### Weight:

- Hood: approx. 500 g per 100 mm of length
- Mounting rail: approx. 550 g per 1000 mm of length
- Side pieces: approx. 500 g per side

- Ambient temperature  $-5 \dots +50^{\circ}\text{C}$

- RoHS-compliant

## Key features – Mounting

### Manual override (MO)

#### MO with automatic return (non-detenting),

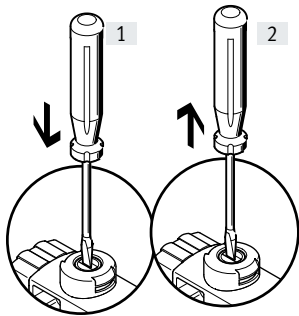

- [1] Press in the plunger of the MO with a pointed object or screwdriver.  
The pilot valve switches and actuates the main valve.
- [2] Remove the pointed object or screwdriver.  
The spring force pushes the plunger of the manual override back.  
The pilot valve returns to its normal position as does the main single solenoid valve (not the case with double solenoid valve code ).

#### MO with locking (detenting)

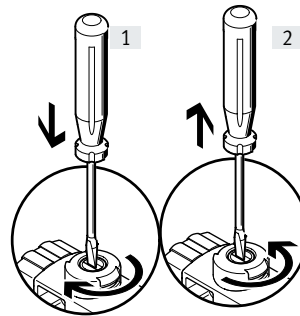

- [1] Press in the plunger of the MO with a pointed object or screwdriver until the valve switches and then turn the plunger clockwise by 90° until the stop is reached. The valve remains actuated
- [2] Turn the plunger 90° anti-clockwise until the stop is reached and then remove the pointed object or screwdriver. The spring force pushes the plunger of the manual override back.  
The valve returns to its normal position (not with double solenoid valve code ).

#### MO non-detenting – with coded cover cap

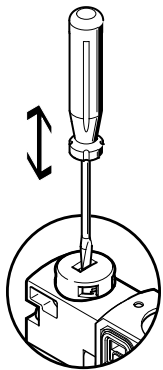

MO is actuated by pushing it with a pointed object or screwdriver and reset by spring force (detenting position prevented by coded cover cap).

#### MO detenting without tools – mounting

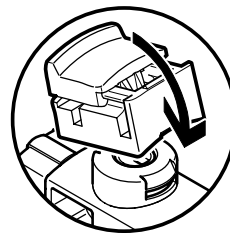

Turn MO to clip it onto the pilot valve. The MO cap can then be operated (detenting) without tools.

#### MO detenting without tools – actuation

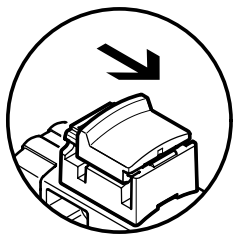

Sliding the cap for the MO with latch in the direction of the arrow results in:

- Cap locks into the end position
- The pilot valve switches and actuates the main valve.

#### MO detenting without tools – actuation

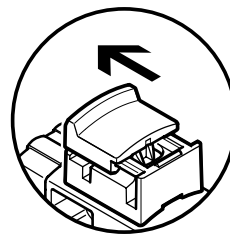

Sliding the cap for the MO with latch in the direction of the arrow results in:

- Cap locks into the end position
- The spring force pushes the plunger of the manual override back.
- The pilot valve returns to its normal position as does the main single solenoid valve (not the case with double solenoid valve code ).

## Key features – Mounting

### Inscription system

#### Inscription label holder

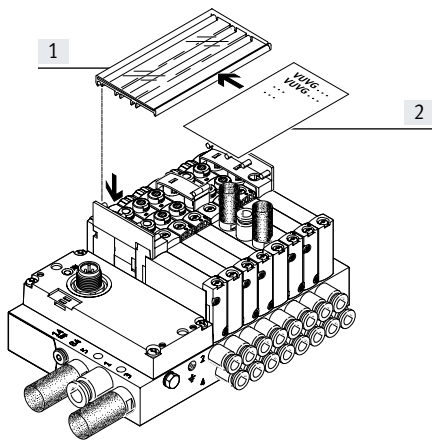

[1] Inscription label holders AS-CF-H-L1 (code TT)

[2] Inscription field

Mount inscription label holders to label the valves. Open the inscription label holder to insert the inscription label and actuate the manual override. The inscription label holders are available in different sizes depending on the number of valve positions.

#### Note

Do not engage the manual override before mounting the inscription label holder.

When mounted, the retainer for the inscription label holder covers the manual override of the valves beneath it.

The manual override for the two valves under the retainers of the inscription label holder can then only be operated as non-detenting.

#### Inscription label holders

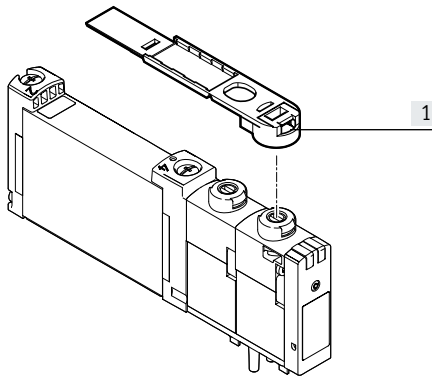

[1] Inscription label holders ASLR-D-L1 (code TV)

Use inscription label holders ASLR-D-L1 (code TV) to label individual valves.

The inscription label holder is placed directly on the manual override.

#### Note

Do not engage the manual override before mounting the inscription label holder.

After the retaining brackets are fitted, the manual override can only be operated as non-detenting.

## Overview of valve functions

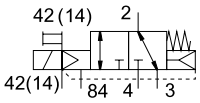
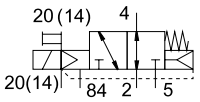
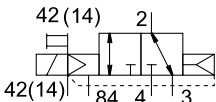
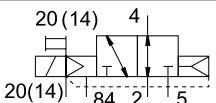
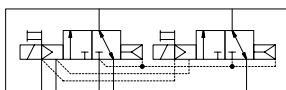
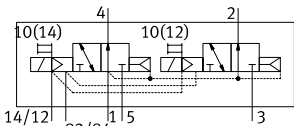
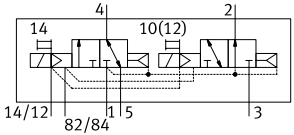
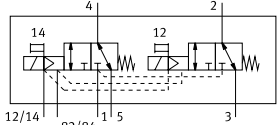
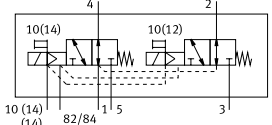
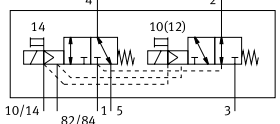
Valve	Valve code	Description	Size	
			M5/M7	G1/8
<b>3/2-way valve, pneumatic/mechanical spring</b>				
	M32C-R	Normally closed	■	–
	M32U-R	Normally open	■	–
<b>3/2-way valve, pneumatic spring</b>				
	M32C-A	Normally closed	–	■
	M32U-A	Normally open	–	■
<b>2x 3/2-way valve, pneumatic spring</b>				
	T32C-A	Normally closed	■	■
	T32U-A	Normally open	■	■
	T32H-A	1x normally open, 1x normally closed	■	■
<b>2x 3/2-way valve, mechanical spring</b>				
	T32C-M	Normally closed	■	■
	T32U-M	Normally open	■	■
	T32H-M	1x normally open, 1x normally closed	■	■

Overview of valve functions

Valve	Valve code	Description	Size	
			M5/M7	G1/8
<b>5/2-way valve, double solenoid</b>				
	B52	External pilot air supply	■	■
<b>5/2-way valve, single solenoid</b>				
	M52-A	Pneumatic spring	-	■
	M52-M	Mechanical spring	■	■
	M52-R	Pneumatic/mechanical spring	■	-
<b>5/3-way valve</b>				
	P53C	Mid-position closed	■	■
	P53U	Mid-position pressurised	■	■
	P53E	Mid-position exhausted	■	■

## Type codes -EX

001	Series	
<b>VTUG</b>	Valve terminal	

002	Size	
<b>10</b>	Size 10	
<b>14</b>	Size 14	

003	Valve control	
<b>M</b>	Multi-pin	
<b>V</b>	Interface for fieldbus module	

004	Multi-pin plug connection type	
	None	
<b>SD</b>	Sub-D plug	

005	Circuitry	
	None	
<b>R</b>	Holding current reduction with integrated protective circuit	

006	Bus protocol/activation	
	None	
<b>LK</b>	IO-Link®	
<b>PT</b>	I-Port interface	

007	Degree of protection, electrical system	
	Standard	
<b>S8</b>	IP67	

008	Valve type	
<b>B</b>	Sub-base valve	

009	Nominal operating voltage	
<b>1</b>	24 V DC	

010	Manual override	
<b>H</b>	Non-detenting	
<b>S</b>	Covered	
<b>Y</b>	Detenting	
<b>T</b>	Non-detenting, detenting with accessories	

011	Pilot air	
	Internal	
<b>Z</b>	External	

012	Number of pins	
	None	
<b>25</b>	25-pin	
<b>26</b>	26-pin	
<b>44</b>	44-pin	
<b>50</b>	50-pin	

013	Pin allocation	
	Standard	
<b>V20</b>	For 12 double solenoid/bistable or 24 single solenoid/monostable valves	
<b>V21</b>	For 18 double solenoid/bistable and 6 single solenoid/monostable valves	
<b>V22</b>	For 10 double solenoid/bistable valves	
<b>V23</b>	For 8 double solenoid/bistable and 4 single solenoid/monostable valves	
<b>V24</b>	For 4 double solenoid/bistable and 12 single solenoid/monostable valves	
<b>V25</b>	For 20 single solenoid/monostable valves	
<b>V26</b>	For 24 double solenoid/bistable valves	

014	Material of fittings	
	Standard	
<b>B2</b>	Brass, nickel-plated	
<b>V1</b>	Stainless steel	

015	Compressed air supply connection	
<b>Q6</b>	Push-in connector 6 mm	
<b>Q8</b>	Push-in connector 8 mm	
<b>Q10</b>	Push-in connector 10 mm	
<b>G18</b>	G1/8	
<b>G14</b>	G1/4	

016	Compressed air supply connection position	
	Both sides	
<b>B</b>	Underneath	
<b>L</b>	Left	
<b>R</b>	Right	
<b>FD</b>	Front, both sides, for control cabinet	
<b>FDL</b>	Front, left, for control cabinet	
<b>FDR</b>	Front, right, for control cabinet	

017	Compressed air supply connection type	
	Straight	
<b>A</b>	Elbow fitting	

018	Exhaust connection	
<b>DQ</b>	Push-in fitting	
<b>DT</b>	Thread	
<b>U</b>	Silencer	

019	Exhaust connection position	
	Both sides	
<b>B</b>	Underneath	
<b>L</b>	Left	
<b>R</b>	Right	
<b>FD</b>	Front, both sides, for control cabinet	
<b>FDL</b>	Front, left, for control cabinet	
<b>FDR</b>	Front, right, for control cabinet	

Type codes -EX

020	Valve connection
G18	G1/8
G14	G1/4
M5	M5
M7	M7
Q3	Push-in connector 3 mm
Q4	Push-in connector 4 mm
QH4	Push-in connector 4 mm, with connecting thread M7
Q6	Push-in connector 6 mm
QH6	Push-in connector 6 mm, with connecting thread M7
Q8	Push-in connector 8 mm
TH14	Push-in connector 1/4", M7
TH316	Push-in connector 3/16", M7

021	Push-in connection type
S	Screwed

022	Valve connection position
	Front, straight outlet
FD	Front, straight outlet, for control cabinet
U	Underneath, straight outlet

023	Flow control function, connections 3 and 5
	None
FE	Fixed flow restrictor nominal size 0.5 mm
FF	Fixed flow restrictor nominal size 0.6 mm
FG	Fixed flow restrictor nominal size 0.7 mm
FH	Fixed flow restrictor nominal size 0.85 mm
FJ	Fixed flow restrictor nominal size 1 mm
FK	Fixed flow restrictor nominal size 1.05 mm
FL	Fixed flow restrictor, nominal size 1.15 mm
FM	Fixed flow restrictor nominal size 1.2 mm
FN	Fixed flow restrictor nominal size 1.4 mm
FP	Fixed flow restrictor nominal size 1.55 mm
FQ	Fixed flow restrictor, nominal size 1.6 mm
FR	Fixed flow restrictor nominal size 1.8 mm
ZS	Exhaust air

024	Shut-off function
	None
SH	With hot swap for supply air ports
WH	With hot swap for supply air ports and working ports

025	Position function
P	5/2-way valve, single solenoid/monostable, pneumatic/mechanical spring
M	4/2 or 5/2-way valve, single solenoid/monostable, pneumatic spring
A	5/2 or 4/2-way valve, single solenoid/monostable, mechanical spring
J	4/2 or 5/2-way double pilot valve
N	1x3/2 or 2x3/2-way valve, normally open, pneumatic spring
VN	2x3/2-way valve, normally open, mechanical spring
K	1x3/2 or 2x3/2-way valve, normally closed, pneumatic spring
VK	2x3/2-way valve, normally closed, mechanical spring
H	2x3/2-way valve, 1x normally closed, 1x normally open, pneumatic spring
VH	2x3/2-way valve, 1x normally closed, 1x normally open, mechanical spring
B	5/3- or 4/3-way valve, mid-position pressurised
G	5/3 or 4/3-way valve, mid-position closed
E	5/3 or 4/3-way valve, mid-position exhausted
L	Vacant position
S	Additional power supply
SD	Additional supply, exhaust, blanking plug
SW	Additional supply, exhaust, push-in fitting
VW	1x3/2-way valve, normally open, external compressed air supply
VX	1x3/2-way valve, normally closed, external compressed air supply
VZ	Without valve

026	Working port, duct 2
	As selected
CC	Blanking plug
QG18	G1/8
QM5	M5
QM7	M7
Q4	Push-in connector, 4 mm
QH4	Push-in connector 4 mm, with connecting thread M7
Q6	Push-in connector 6 mm
QH6	Push-in connector 6 mm, with connecting thread M7
Q8	Push-in connector 8 mm
Q3	Push-in connector, 3 mm
TH14	Push-in connector 1/4", M7
TH316	Push-in connector 3/16", M7

027	Working port, duct 4
	As selected
XCC	Blanking plug
XQG18	G1/8
XQM5	M5
XQM7	M7
XQ3	Push-in connector 3 mm
XQ4	Push-in connector 4 mm
XQH4	Push-in connector 4 mm, with connecting thread M7
XQ6	Push-in connector 6 mm
XQH6	Push-in connector 6 mm, with connecting thread M7
XQ8	Push-in connector 8 mm
XTH14	Push-in connector 1/4", M7
XTH316	Push-in connector 3/16", M7



## Datasheet Valve terminal VTUG-...-EX2, VTUG...-EX2E

Variants  
 VTUG-...-EX2  
 VTUG-...-EX2E (for installation in  
 the housing)

Modular system  
 part no. 8060699

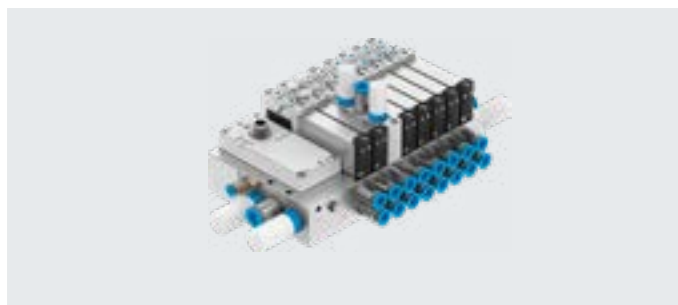

General technical data	
Design	Piston spool
Valve terminal design	Fixed grid
Maximum number of valve positions	24
Maximum number of pressure zones	13
Valve functions	2x3/2-way, single solenoid, open 2x3/2-way, single solenoid, open/closed 3/2-way, closed, single solenoid, closed 5/2-way, double solenoid 5/2-way, single solenoid 5/3-way, pressurised 5/3-way, exhausted 5/3-way, closed
Pilot air port 12/14	G1/8
Signal status indication	LED
Sealing principle	Soft
Type of control	Piloted
Valve size [mm]	10 14
Actuation type	Electrical
Pilot air supply	External Internal
Suitable for vacuum	Yes
Exhaust air function	Can be throttled
Maximum standard nominal flow rate [l/min]	330 at 10 mm 630 at 14 mm
Standard nominal flow rate [l/min]	130 ... 1150
Certification	c UL us - Recognized (OL) RCM

Operating and environmental conditions	
Operating medium	Compressed air to ISO 8573-1:2010 [7:4:4]
Pilot medium	Compressed air to ISO 8573-1:2010 [7:4:4]
Note on the operating/pilot medium	Lubricated operation possible (in which case lubricated operation will always be required)
Operating pressure [MPa]	-0.09 ... +1
[bar]	-0.9 ... +10
Pilot pressure [MPa]	0.15 ... +0.8
[bar]	1.5 ... 8
Ambient temperature [°C]	-5 ... +60
Temperature of medium [°C]	-5 ... +60
Storage temperature [°C]	-10 ... +60
Corrosion resistance class CRC <sup>1)</sup>	2

1) More information: [www.festo.com/x/topic/crc](http://www.festo.com/x/topic/crc)

Datasheet VTUG-...-EX2, VTUG...-EX2E

Electrical data		
Electrical actuation		Fieldbus
		I-Port
		IO-Link®
		Multi-pin plug
Operating voltage	[V DC]	24
Permissible voltage fluctuations	[%]	± 10
		± 25
Nominal pick-up current per solenoid coil	[mA]	47 up to 20 ms
Nominal current with current reduction	[mA]	15.5 after 20 ms
Degree of protection to EN 60529 <sup>1)</sup>		IP20
		IP65



Safety characteristics	
Shock resistance	Shock test with severity level 2 to FN 942017-5 and EN 60068-2-27
Vibration resistant	Transport application test with severity level 2 to FN 942017-4 and EN 60068-2-6

Explosion protection	VTUG-VI-EX2	VTUG-VI-EX2E
ATEX category for gas	II 3G	
ATEX category for dust	II 3D	
Type of (ignition) protection for gas	–	C, I, Z, 2, AEx ec IIC Gc (US)
	–	Ex ec IIC Gc (CA)
		Ex ec IIC T4 Gc
Type of (ignition) protection for dust	–	C,II, Z,2,2, AExtc IIIC T135 Dc (US)
	–	Ex tc IIIC T135 Dc (CA)
		Ex tc IIIC T135°C Dc
Explosion protection certification outside the EU	–	Class I, Div. 2 (CA)
	–	Class I, Div. 2 (US)
	–	Class II, Div. 2 (CA)
	–	Class II, Div. 2 (US)
	–	Class III (CA)
	–	Class III (US)
	–	EPL Dc (CA)
	–	EPL Dc (CN)
		EPL Dc (IECEX)
	–	EPL Dc (US)
	–	EPL Gc (CA)
	–	EPL Gc (CN)
		EPL Gc (IECEX)
–	EPL Gc (US)	
Explosion-proof ambient temperature	[°C]	–5°C ≤ Ta ≤ +50 (I-Port/IO-Link®)
		–5°C ≤ Ta ≤ +60 (multi-pin plug)
CE marking (see declaration of conformity) <sup>1)</sup>		To EU EMC Directive
		To EU Explosion Protection Directive (ATEX)
		To EU RoHS Directive
UKCA marking (see declaration of conformity) <sup>1)</sup>		To UK EMC regulations
		To UK explosion regulations
		To UK RoHS regulations
Certificate-issuing authority	–	GYJ19.1188X
	–	IBExU16ATEXB021 X
	–	IECEX IBE 17.0003 X
	IECEX IBE 19.0018 X	–
	–	UL E198674
		UL MH19482

1) More information: [www.festo.com/catalogue/...](http://www.festo.com/catalogue/...) → Support/Downloads.

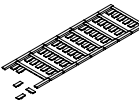

Information on materials	
Seals	HNBR
	NBR
Note on materials	RoHS-compliant
LABS (PWIS) conformity	VDMA24364-B2-L

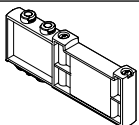
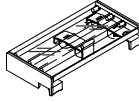
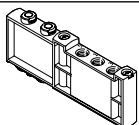
## EX2 accessories – Valve terminal

Ordering data		Description	Part no.	Type	PU <sup>1)</sup>
<b>Cover cap</b>					
	-		540897	VMPA-HBT-B	1
			540898	VMPA-HBV-B	1
			8002234	VAMC-L-1CD	1
<b>Inscription label</b>					
	-		565306	ASLR-C-E4	40
<b>Separator</b>					
	-		569994	VABD-6-B	1
			569996	VABD-10-B	1
<b>Inscription label holders</b>					
	-		570818	ASLR-D-L1	1
<b>Cover plate</b>					
	-		573422	VABB-L1-10-T	1
			573488	VABB-L1-14-T	1
<b>Inscription label holder</b>					
	-		573453	ASCF-H-L1-10-4V	1
			573457	ASCF-H-L1-10-8V	1
			573460	ASCF-H-L1-10-12V	1
			573461	ASCF-H-L1-10-16V	1
			573463	ASCF-H-L1-10-24V	1
			573511	ASCF-H-L1-14-4V	1
			573515	ASCF-H-L1-14-8V	1
			573519	ASCF-H-L1-14-12V	1
			573520	ASCF-H-L1-14-16V	1
	573522	ASCF-H-L1-14-24V	1		
<b>Supply plate</b>					
	-		573924	VABF-L1-10-P3A4-M7-T1	1
			573925	VABF-L1-14-P3A4-G18-T1	1

1) Packaging unit.

EX2 accessories – Valve terminal

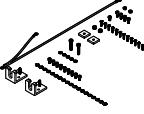
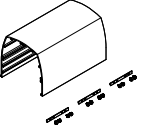

Ordering data		Description	Part no.	Type	PU <sup>1)</sup>	
<b>Fixed flow restrictor</b>						
	-		8047346	VFFG-T-F4-5	1	
	-		8047347	VFFG-T-F4-6	1	
	-		8047348	VFFG-T-F4-7	1	
	-		8047349	VFFG-T-F4-8	1	
	-		8047350	VFFG-T-F4-10	1	
	-		8047351	VFFG-T-F4-12	1	
	-		8047352	VFFG-T-F4-15	1	
	-		8047353	VFFG-T-F6-7	1	
	-		8047354	VFFG-T-F6-11	1	
	-		8047355	VFFG-T-F6-18	1	
	-		8047356	VFFG-T-F6-16	1	
	-		8047357	VFFG-T-F6-10	1	
	-		8047358	VFFG-T-F6-8	1	
-		8047359	VFFG-T-F6-14	1		
<b>Check valve</b>						
	-		8047364	VABF-L1-10H-H2	1	
	-		8047365	VABF-L1-14-H2	1	
<b>Hood</b> <span style="float: right;">Datasheets → Internet: <a href="#">caf</a>/<a href="#">cafcr</a></span>						
	Mounting rail for attaching the hood	196 mm	3307385	CAFM-X1-R-200	1	
		296 mm	3307386	CAFM-X1-R-300	1	
		396 mm	3307387	CAFM-X1-R-400	1	
		496 mm	3307388	CAFM-X1-R-500	1	
		596 mm	3307389	CAFM-X1-R-600	1	
	Mounting kit for VTUG hood		572257	CAFC-X1-BE	1	
	Hood section for VTUG terminal including mounting attachments for connecting several hood sections in series	VTUG-10-4	200 mm	8127858	CAFC-X1-GAL-200-Z	1
		VTUG-10-8/12-14-4	300 mm	8127859	CAFC-X1-GAL-300-Z	1
		VTUG-10-16/24-14-8/12	400 mm	8127860	CAFC-X1-GAL-400-Z	1
		VTUG-14-16	600 mm	8127861	CAFC-X1-GAL-600-Z	1
		VTUG-14-24		8127862	CAFC-X1-GAL-600-Z	1
	Kit for any hood section for terminal VTUG		-	CAFC-... → Internet: <a href="#">cafc</a>	1	

1) Packaging unit.

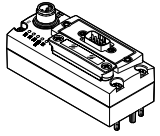
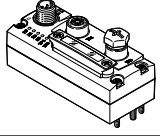
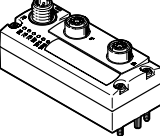
EX2E accessories – Valve terminal

Ordering data – Bus node CTEU			Part no.	Type
Bus node		Description		
	Profibus DP bus node	Exclusively for use with VTUG-EX2E (in the Ex control cabinet)	8107588	CTEU-PB-EX1C
	EtherNet/IP bus node		8107591	CTEU-EP-EX1C
	PROFINET RT bus node		8107589	CTEU-PN-EX1C

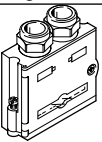
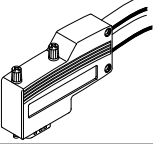
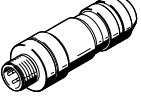
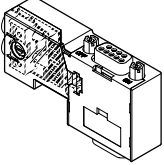
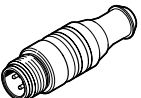
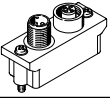
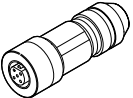

EX2E accessories – Valve terminal

Ordering data – Accessories for CTEU-PB-EX1C			
	Description	Part no.	Type
<b>Plug socket</b>			
	Socket for micro style connection, A-coded	18324	FBSD-GD-9-5POL
<b>Plug</b>			
	Sub-D plug, straight	532216	FBS-SUB-9-GS-DP-B
	Sub-D plug, angled	533780	FBS-SUB-9-WS-PB-K
	Straight plug, M12x1, 5-pin, for assembling a connecting cable compatible with FBA-2-M12-5POL-RK	1066354	NECU-M-S-B12G5-C2-PB
	Sub-D plug, straight, with terminating resistor and programming interface	574589	NECU-S1W9-C2-APB
<b>Terminating resistor</b>			
	Terminating resistor, M12, B-coded for PROFIBUS	1072128	CACR-S-B12G5-220-PB
<b>Bus connection</b>			
	Bus connection M12 adapter, B-coded	533118	FBA-2-M12-5POL-RK
<b>Fitting</b>			
	Straight socket, M12x1, 5-pin, for assembling a connecting cable compatible with FBA-2-M12-5POL-RK	1067905	NECU-M-B12G5-C2-PB
	Threaded sleeve for Sub-D	533000	UNC4-40/M3X8

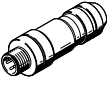
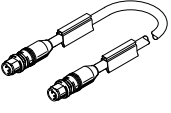
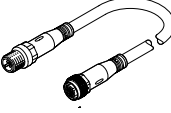
EX2E accessories – Valve terminal

Ordering data – Accessories for CTEU-PN-EX1C and CTEU-EP-EX1C						
Description		Part no.	Type			
<b>Plug socket</b>						
	Socket for micro style connection, A-coded		18324	FBSD-GD-9-5POL		
<b>Plug</b>						
	Plug M12x1, 4-pin, D-coded		543109	NECU-M-S-D12G4-C2-ET		
<b>Connecting cable</b>						
	Straight plug, M12x1, 4-pin, D-coded	Straight plug, M12x1, 4-pin, D-coded	0.5 m	8040446	NEBC-D12G4-ES-0.5-S-D12G4-ET	
			1 m	8040447	NEBC-D12G4-ES-1-S-D12G4-ET	
			3 m	8040448	NEBC-D12G4-ES-3-S-D12G4-ET	
			5 m	8040449	NEBC-D12G4-ES-5-S-D12G4-ET	
			10 m	8040450	NEBC-D12G4-ES-10-S-D12G4-ET	
			Straight plug, RJ45, 8-pin	1 m	8040451	NEBC-D12G4-ES-1-S-R3G4-ET
				3 m	8040452	NEBC-D12G4-ES-3-S-R3G4-ET
				5 m	8040453	NEBC-D12G4-ES-5-S-R3G4-ET
				10 m	8040454	NEBC-D12G4-ES-10-S-R3G4-ET
				5 m	8040456	NEBC-LE4-ES-5-D12G4-ET
	Straight – angled	Suitable for energy chains	5 m	574321	NEBU-M12G5-E-5-Q8N-M12G5	
			7.5 m	574322	NEBU-M12G5-E-7.5-Q8N-M12G5	
			10 m	574323	NEBU-M12G5-E-10-Q8N-M12G5	
	Angled – angled	Standard	0.5 m	570733	NEBU-M12W5-K-0.5-M12W5	
				8003617	NEBU-M12G5-K-0.5-M12W5	
				2 m	570734	NEBU-M12W5-K-2-M12W5
					8003618	NEBU-M12G5-K-2-M12W5

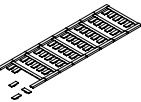

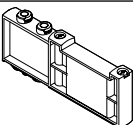
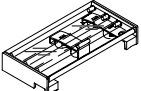
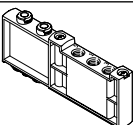
EX2E accessories – Valve terminal

Ordering data	Description	Part no.	Type	PU <sup>1)</sup>
<b>Cover cap</b>				
	-	540897	VMPA-HBT-B	1
		540898	VMPA-HBV-B	1
		8002234	VAMC-L-1CD	1
<b>Inscription label</b>				
	-	565306	ASLR-C-E4	40
<b>Separator</b>				
	-	569994	VABD-6-B	1
		569996	VABD-10-B	1
<b>Inscription label holders</b>				
	-	570818	ASLR-D-L1	1
<b>Cover plate</b>				
	-	573422	VABB-L1-10-T	1
		573488	VABB-L1-14-T	1
<b>Inscription label holder</b>				
	-	573453	ASCF-H-L1-10-4V	1
		573457	ASCF-H-L1-10-8V	1
		573460	ASCF-H-L1-10-12V	1
		573461	ASCF-H-L1-10-16V	1
		573463	ASCF-H-L1-10-24V	1
		573511	ASCF-H-L1-14-4V	1
		573515	ASCF-H-L1-14-8V	1
		573519	ASCF-H-L1-14-12V	1
		573520	ASCF-H-L1-14-16V	1
573522	ASCF-H-L1-14-24V	1		
<b>Supply plate</b>				
	-	573924	VABF-L1-10-P3A4-M7-T1	1
		573925	VABF-L1-14-P3A4-G18-T1	1

1) Packaging unit.





EX2E accessories – Valve terminal

Ordering data		Description	Part no.	Type	PU <sup>1)</sup>
<b>Fixed flow restrictor</b>					
	-		8047346	VFFG-T-F4-5	1
			8047347	VFFG-T-F4-6	1
			8047348	VFFG-T-F4-7	1
			8047349	VFFG-T-F4-8	1
			8047350	VFFG-T-F4-10	1
			8047351	VFFG-T-F4-12	1
			8047352	VFFG-T-F4-15	1
			8047353	VFFG-T-F6-7	1
			8047354	VFFG-T-F6-11	1
			8047355	VFFG-T-F6-18	1
			8047356	VFFG-T-F6-16	1
			8047357	VFFG-T-F6-10	1
			8047358	VFFG-T-F6-8	1
			8047359	VFFG-T-F6-14	1
<b>Check valve</b>					
	-		8047364	VABF-L1-10H-H2	1
			8047365	VABF-L1-14-H2	1
<b>Screw set</b>					
	-		8092501	VAME-S-M5-16-R1-P10	1

Datasheets → Internet: vamer

1) Packaging unit.

## Datasheet – Sub-base valve M5/M7

Function	-  -	Size 10 mm
3/2C, 3/2U		
2x 3/2C, 2x 3/2U, 2x 3/2H	-  -	Flow rate
5/2-way, single solenoid		130 ... 300 l/min
5/2-way, double solenoid		
5/3C, 5/3U, 5/3E	-  -	Voltage
		24 V DC



Circuit diagrams → page 17

General technical data		T32-A			T32-M			M32-R		M52-R	B52	M52-M	P53			
Valve function		C <sup>1)</sup>	U <sup>2)</sup>	H <sup>4)</sup>	C <sup>1)</sup>	U <sup>2)</sup>	H <sup>4)</sup>	C <sup>1)</sup>	U <sup>2)</sup>	–	–	–	C <sup>1)</sup>	U <sup>2)</sup>	E <sup>3)</sup>	
Normal position		Single solenoid									Double solenoid	Single solenoid				
Stable position																
Pneumatic spring return		Yes			No			No		Yes <sup>5)</sup>		–	No		–	
Mechanical spring return		No			Yes			Yes		Yes <sup>5)</sup>		–	Yes		Yes	
Vacuum operation at port 1		No			With external pilot air											
Design		Piston spool														
Sealing principle		Soft														
Actuation type		Electrical														
Type of control		Pilot														
Pilot air supply		External														
Exhaust air function		Can be throttled														
Manual override		Choice of non-detenting, covered, non-detenting/detenting or detenting														
Type of mounting		On manifold rail														
Mounting position		Any														
Overlap		Positive overlap												Indeterminate overlap		
Signal status indication		LED														
Standard nominal flow rate M5/M7	[l/min]	160			140			140		300		260		260		
Flow rate on manifold rail M5, front	[l/min]	150			130			130		220		220		200		
Flow rate on manifold rail M7, front	[l/min]	160			140			140		270		240		250		
Flow rate on manifold rail M7, underneath	[l/min]	160			140			140		300		260		260		
Size	[mm]	10														
Port	1, 3, 5, 12/14, 82/84	On manifold rail														
	2, 4	On manifold rail														
Product weight	[g]	59						53		60		53		58		
Certification		c UL us - Recognized (OL)														
		RCM														
CE marking (see declaration of conformity) <sup>6)</sup>		To EU EMC Directive														
Corrosion resistance class CRC <sup>7)</sup>		2														

- 1) C=Normally closed/mid-position closed
- 2) U=Normally open/mid-position pressurised
- 3) E=Mid-position exhausted
- 4) H=2x 3/2-way valve in one housing with 1x normally closed and 1x normally open
- 5) Combined reset method
- 6) For information about the area of use, see the EC declaration of conformity at: [www.festo.com/catalogue/...](http://www.festo.com/catalogue/...) → Support/Downloads.  
If the devices are subject to usage restrictions in residential, commercial or light-industrial environments, further measures for the reduction of the emitted interference may be necessary.
- 7) More information: [www.festo.com/x/topic/crc](http://www.festo.com/x/topic/crc)

## Datasheet – Sub-base valve M5/M7

Operating and environmental conditions			T32-A <sup>1)</sup>	T32-M <sup>2)</sup>	M32-R <sup>3)</sup>	M52-R <sup>3)</sup>	B52	M52-M <sup>2)</sup>	P53
Valve function			Compressed air to ISO 8573-1:2010 [7:4:4]						
Operating pressure	Internal pilot air supply	[MPa]	0.15 ... 0.8	0.2 ... 0.8	0.15 ... 0.8		0.3 ... 0.8		
		[bar]	1.5 ... 8	2 ... 8	1.5 ... 8		3 ... 8		
	External pilot air supply	[MPa]	0.15 ... 1	-0.09 ... 1		-0.09 ... 0.8		-0.09 ... 1	
		[bar]	1.5 ... 10	-0.9 ... 10		-0.9 ... 8		-0.9 ... 10	
Pilot pressure <sup>4)</sup>		[MPa]	0.15 ... 0.8	0.2 ... 0.8	0.15 ... 0.8		0.3 ... 0.8		
		[bar]	1.5 ... 8	2 ... 8	1.5 ... 8		3 ... 8		
Ambient temperature		[°C]	-5 ... +60						
Temperature of medium		[°C]	-5 ... +60						
LABS (PWIS) conformity		Valve terminals VTUG-...	VDMA24364-B1/B2-L						

- 1) Pneumatic spring  
2) Mechanical spring  
3) Mixed, pneumatic/mechanical spring  
4) See graphs on page 11

Electrical data		
Electrical connection		Via E-box
Operating voltage	[V DC]	24 ±10%
Power consumption per valve solenoid		[W] 1/0.4 (after 25 ms)
Duty cycle		[%] 100
Max. switching frequency		[Hz] 3
Degree of protection to EN 60529 <sup>1)</sup>	Valve terminal VTUG (for control cabinet installation)	IP69K
	Valve terminal VTUG-VI-EX2	IP20, IP65

- 1) Depending on the configuration selected

Safety characteristics		
Max. positive test pulse with logic 0	[µs]	1600
Max. negative test pulse with logic 1	[µs]	3000
Shock resistance		Shock test with severity level 2 to FN 942017-5 and EN 60068-2-27
Vibration resistant		Transport application test with severity level 2 to FN 942017-4 and EN 60068-2-6

Information on materials	
Housing	Wrought aluminium alloy
Seals	HNBR, NBR
Note on materials	RoHS-compliant

Valve switching times			T32-A <sup>1)</sup>	T32-M <sup>2)</sup>	M32-R <sup>3)</sup>	M52-R <sup>3)</sup>	B52	M52-M <sup>2)</sup>	P53
Switching time on	[ms]	8	10	9	9	–	12	12	
Switching time off	[ms]	20	20	17	21	–	30	38	
Switching time changeover	[ms]	–	–	–	–	9	–	16	

- 1) Pneumatic spring  
2) Mechanical spring  
3) Mixed, pneumatic/mechanical spring

Datasheet – Sub-base valve M5/M7

Dimensions

Download CAD data → [www.festo.com](http://www.festo.com)

Sub-base valve M5/M7

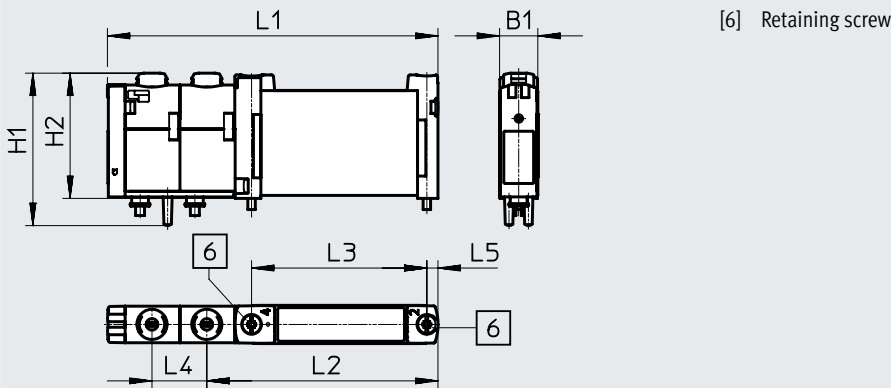

Type	B1	H1	H2	L1	L2	L3	L4	L5
VUVG-B10...-F-1T1L-EX2C	10.3	40.7	33	88.6	62	47	14.7	3

Ordering data

Description	Part no.	Type
<b>Sub-base valve M5/M7</b>		
<b>3/2-way valve</b>		
External pilot air supply	Normally closed, pneumatic/mechanical spring return	8041900 VUVG-B10Z-M32C-RZT-F-1T1L-EX2C
	Normally open, pneumatic/mechanical spring return	8041901 VUVG-B10Z-M32U-RZT-F-1T1L-EX2C
<b>2x 3/2-way valve</b>		
External pilot air supply	Normally closed, pneumatic spring return	8041895 VUVG-B10-T32C-AZT-F-1T1L-EX2C
	Normally open, pneumatic spring return	8041896 VUVG-B10-T32U-AZT-F-1T1L-EX2C
	1x normally open, 1x normally closed, pneumatic spring return	8041897 VUVG-B10-T32H-AZT-F-1T1L-EX2C
	Normally closed, mechanical spring return	8041891 VUVG-B10-T32C-MZT-F-1T1L-EX2C
	Normally open, mechanical spring return	8041898 VUVG-B10-T32U-MZT-F-1T1L-EX2C
	1x normally open, 1x normally closed, mechanical spring return	8041899 VUVG-B10-T32H-MZT-F-1T1L-EX2C
<b>5/2-way valve, single solenoid</b>		
External pilot air supply	Mechanical spring return	8041892 VUVG-B10-M52-MZT-F-1T1L-EX2C
	Pneumatic/mechanical spring return	8041889 VUVG-B10-M52-RZT-F-1T1L-EX2C
<b>5/2-way valve, double solenoid</b>		
External pilot air supply		8041888 VUVG-B10-B52-ZT-F-1T1L-EX2C
<b>5/3-way valve</b>		
External pilot air supply	Mid-position closed, mechanical spring return	8041890 VUVG-B10-P53C-ZT-F-1T1L-EX2C
	Mid-position pressurised, mechanical spring return	8041893 VUVG-B10-P53U-ZT-F-1T1L-EX2C
	Mid-position exhausted, mechanical spring return	8041894 VUVG-B10-P53E-ZT-F-1T1L-EX2C

## Datasheet – Sub-base valve G1/8

## Function

3/2C, 3/2U

2x 3/2C, 2x 3/2U, 2x 3/2H

5/2-way, single solenoid

5/2-way, double solenoid

5/3C, 5/3U, 5/3E

 - Size 14 mm

 - Flow rate  
350 ... 560 l/min

 - Voltage  
24 V DC

Circuit diagrams → page 17

General technical data														
Valve function	T32-A			T32-M			M32-A		M52-A	B52	M52-M	P53		
Normal position	C <sup>1)</sup>	U <sup>2)</sup>	H <sup>4)</sup>	C <sup>1)</sup>	U <sup>2)</sup>	H <sup>4)</sup>	C <sup>1)</sup>	U <sup>2)</sup>	–	–	–	C <sup>1)</sup>	U <sup>2)</sup>	E <sup>3)</sup>
Stable position	Single solenoid									Double solenoid	Single solenoid			
Pneumatic spring return	Yes			No			Yes		Yes	–	No	–		
Mechanical spring return	No			Yes			No		No	–	Yes	Yes		
Vacuum operation at port 1	No			With external pilot air										
Design	Piston spool													
Sealing principle	Soft													
Actuation type	Electrical													
Type of control	Piloted													
Pilot air supply	External													
Exhaust air function	Can be throttled													
Manual override	Choice of non-detenting, covered, non-detenting/detenting or detenting													
Type of mounting	On manifold rail													
Overlap	Positive overlap													
Mounting position	Any													
Signal status indication	LED													
Standard nominal flow rate G1/8	[l/min]			530			470		350	550	560	550	510	
Flow rate on manifold rail G1/8, front	[l/min]			490			440		320	500	510	500	470	
Flow rate on manifold rail G1/8, underneath	[l/min]			530			470		350	550	560	550	510	
Size	[mm]			14										
Port	1, 3, 5, 12/14, 82/84			On manifold rail										
	2, 4			On manifold rail										
Product weight	[g]			102			100		91	98	89	95		
Certification	c UL us - Recognized (OL)													
	RCM													
CE marking (see declaration of conformity) <sup>5)</sup>	To EU EMC Directive													
Corrosion resistance class CRC <sup>6)</sup>	2													

1) C=Normally closed/mid-position closed

2) U=Normally open/mid-position pressurised

3) E=Mid-position exhausted

4) H=2x 3/2-way valve in one housing with 1x normally closed and 1x normally open

 5) For information about the area of use, see the EC declaration of conformity at: [www.festo.com/catalogue/...](http://www.festo.com/catalogue/...) → Support/Downloads.

If the devices are subject to usage restrictions in residential, commercial or light-industrial environments, further measures for the reduction of the emitted interference may be necessary.

 6) More information: [www.festo.com/x/topic/crc](http://www.festo.com/x/topic/crc)

Datasheet – Sub-base valve G1/8

Operating and environmental conditions			T32-A <sup>1)</sup>	T32-M <sup>2)</sup>	M32-A <sup>1)</sup>	M52-A <sup>1)</sup>	B52	M52-M <sup>2)</sup>	P53
Valve function			Compressed air to ISO 8573-1:2010 [7:4:4]						
Operating pressure	Internal pilot air supply	[MPa]	0.15 ... 0.8	0.2 ... 0.8	0.15 ... 0.8		0.3 ... 0.8		
		[bar]	1.5 ... 8	2 ... 8	1.5 ... 8		3 ... 8		
	External pilot air supply	[MPa]	0.15 ... 1	-0.09 ... 1		-0.09 ... 0.8		-0.09 ... 1	
		[bar]	1.5 ... 10	-0.9 ... 10		-0.9 ... 8		-0.9 ... 10	
Pilot pressure <sup>3)</sup>		[MPa]	0.15 ... 0.8	0.2 ... 0.8	0.15 ... 0.8		0.3 ... 0.8		
		[bar]	1.5 ... 8	2 ... 8	1.5 ... 8		3 ... 8		
Ambient temperature		[°C]	-5 ... +60						
Temperature of medium		[°C]	-5 ... +60						
LABS (PWIS) conformity		Valve terminals VTUG-...	VDMA24364-B1/B2-L						

- 1) Pneumatic spring
- 2) Mechanical spring
- 3) See graphs on page 11

Electrical data		
Electrical connection		Via E-box
Operating voltage	[V DC]	24 ±10%
Power	[W]	1/0.4 (after 25 ms)
Duty cycle	[%]	100
Max. switching frequency	[Hz]	3
Degree of protection to EN 60529 <sup>1)</sup>	Valve terminal VTUG (for control cabinet installation)	IP69K
	Valve terminal VTUG-VI-EX2	IP20, IP65

- 1) Depending on the configuration selected

Safety characteristics		
Max. positive test pulse with logic 0	[µs]	1600
Max. negative test pulse with logic 1	[µs]	3000
Shock resistance		Shock test with severity level 2 to FN 942017-5 and EN 60068-2-27
Vibration resistant		Transport application test with severity level 2 to FN 942017-4 and EN 60068-2-6

Information on materials	
Housing	Wrought aluminium alloy
Seals	HNBR, NBR
Note on materials	RoHS-compliant

Valve switching times			T32-A <sup>1)</sup>	T32-M <sup>2)</sup>	M32-A <sup>1)</sup>	M52-A <sup>1)</sup>	B52	M52-M <sup>2)</sup>	P53
Switching time on	[ms]	10	13	13	13	–	10	15	
Switching time off	[ms]	29	21	20	26	–	38	42	
Switching time changeover	[ms]	–	–	–	–	9	–	25	

- 1) Pneumatic spring
- 2) Mechanical spring

## Datasheet – Sub-base valve G1/8

## Dimensions

 Download CAD data → [www.festo.com](http://www.festo.com)

Sub-base valve G1/8

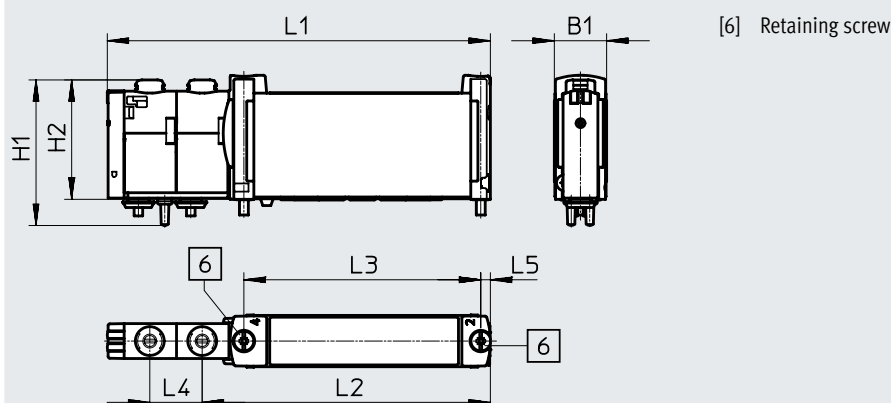

Type	B1	H1	H2	L1	L2	L3	L4	L5
VUVG-B14-...-F-1T1L-EX2C	14.7	40.9	33.5	107.6	81	66.5	15.1	2.8

## Ordering data

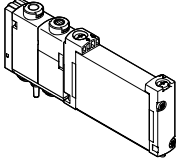
Description	Part no.	Type	
<b>Sub-base valve G1/8</b>			
	<b>3/2-way valve</b>		
	External pilot air supply	Normally closed, pneumatic spring return	8041970 VUVG-B14Z-M32C-AZT-F-1T1L-EX2C
		Normally open, pneumatic spring return	8041971 VUVG-B14Z-M32U-AZT-F-1T1L-EX2C
	<b>2x 3/2-way valve</b>		
	External pilot air supply	Normally closed, pneumatic spring return	8041958 VUVG-B14-T32C-AZT-F-1T1L-EX2C
		Normally open, pneumatic spring return	8041959 VUVG-B14-T32U-AZT-F-1T1L-EX2C
		1x normally open, 1x normally closed, pneumatic spring return	8041960 VUVG-B14-T32H-AZT-F-1T1L-EX2C
		Normally closed, mechanical spring return	8041961 VUVG-B14-T32C-MZT-F-1T1L-EX2C
		Normally open, mechanical spring return	8041962 VUVG-B14-T32U-MZT-F-1T1L-EX2C
		1x normally open, 1x normally closed, mechanical spring return	8041963 VUVG-B14-T32H-MZT-F-1T1L-EX2C
<b>5/2-way valve, single solenoid</b>			
External pilot air supply	Pneumatic spring return	8041964 VUVG-B14-M52-AZT-F-1T1L-EX2C	
	Mechanical spring return	8041965 VUVG-B14-M52-MZT-F-1T1L-EX2C	
<b>5/2-way valve, double solenoid</b>			
External pilot air supply		8041966 VUVG-B14-B52-ZT-F-1T1L-EX2C	
<b>5/3-way valve</b>			
External pilot air supply	Mid-position closed, mechanical spring return	8041967 VUVG-B14-P53C-ZT-F-1T1L-EX2C	
	Mid-position pressurised, mechanical spring return	8041969 VUVG-B14-P53U-ZT-F-1T1L-EX2C	
	Mid-position exhausted, mechanical spring return	8041968 VUVG-B14-P53E-ZT-F-1T1L-EX2C	

## Datasheet – Manifold rail VABM

General technical data			
Manifold rail		Size 10	Size 14
Short type code		VABM	
Grid dimension	[mm]	10.5	16
Mounting position		Any	
Connection type		Semi in-line/sub-base	
Max. no. of valve positions		24	
Port	12/14	M5	M5
	82/84	M5	M5
	2, 4	M5 (VABM-L1-10W-...-GR)	G1/8
		M7 (VABM-L1-10HW-...-GR)	
1, 3, 5	G1/8	–	
Storage temperature	[°C]	–20 ... 60	
Certification		c UL us - Recognized (OL)	
CE marking (see declaration of conformity) <sup>1)</sup>		To EU EMC Directive	
Corrosion resistance class CRC <sup>2)</sup>		2	
LABS (PWIS) conformity		VDMA24364-B1/B2-L	

- 1) For information about the area of use, see the EC declaration of conformity at: [www.festo.com/catalogue/...](http://www.festo.com/catalogue/...) → Support/Downloads.  
If the devices are subject to usage restrictions in residential, commercial or light-industrial environments, further measures for the reduction of the emitted interference may be necessary.
- 2) More information: [www.festo.com/x/topic/crc](http://www.festo.com/x/topic/crc)

Weight [g]											
Valve positions	4	5	6	7	8	9	10	12	16	20	24
VABM-L1-10G-G18-...	329	363	397	431	465	499	533	601	737	873	1009
VABM-L1-10HW-G18-...	388	426	464	502	540	578	616	692	844	996	1148

Materials	
Manifold rail	Wrought aluminium alloy
Note on materials	RoHS-compliant



Datasheet – Manifold rail VABM

Dimensions – Example of valve terminal with I-Port interface

Download CAD data → [www.festo.com](http://www.festo.com)

Outlet direction of electrical components on top

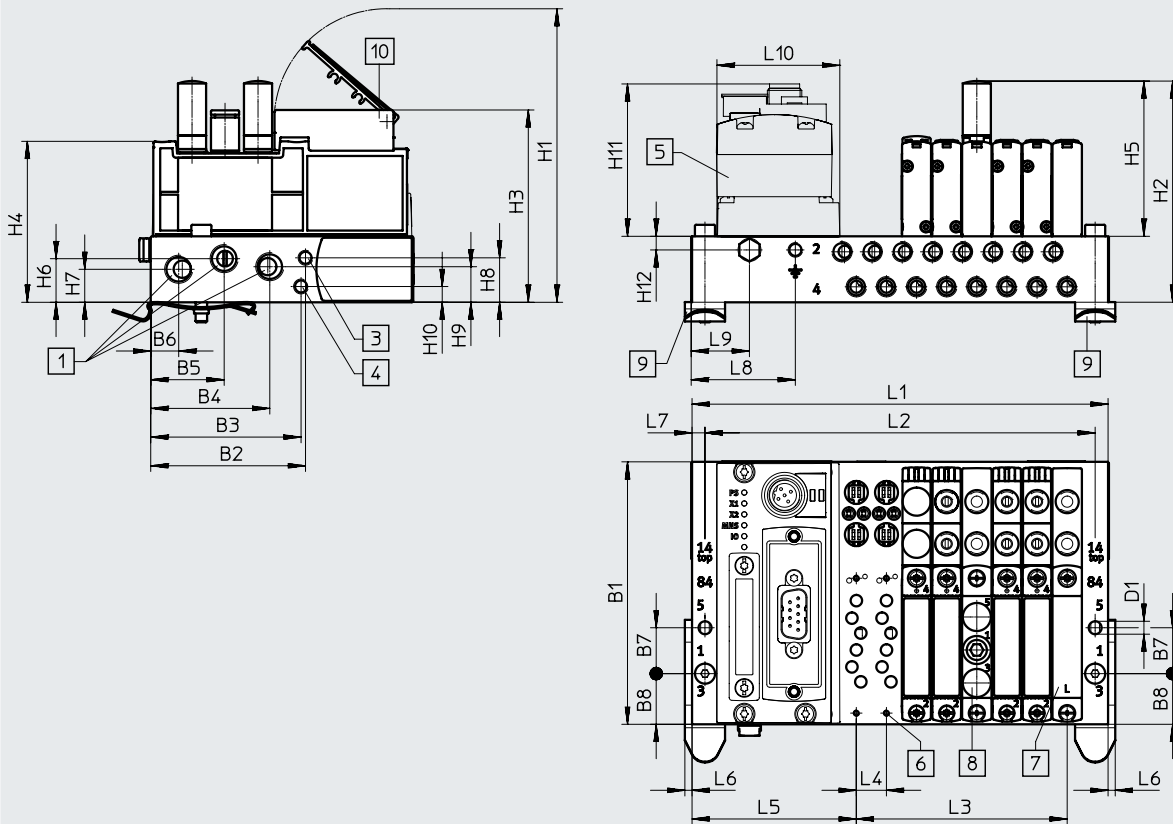

- [1] Port 1, 3 and 5: size 10: G1/8 (at both ends)
- [2] Port 2: size 10: G1/8 (at both ends)
- [3] Port 12/14: size 10 and 14: M5 (at both ends)
- [4] Port 82/84: size 10 and 14: M5 (at both ends)
- [5] CTEU-CANopen
- [6] Valves/cover plates/supply plates – mounting on manifold block: size 10: M2, size 14: M5
- [7] Cover plate
- [8] Supply plate, port 1, 3 and 5: size 10: M7, size 14: G1/8
- [9] H-rail mounting
- [10] Inscription label holder

Type	Number of valve positions	Size 10																
		B1	B2	B3	B4	B5	B6	B7	B8	D1 ø	H1	H2	H3	H4	H5	H6	H7	H8
VABM	4-24	91.5	54	52.4	41.5	25.6	9.8	16	17.7	4.5	102.3	77.1	67	56.1	54.1	15.2	11.5	15.5

Type	Number of valve positions	Size 10										
		H9	H10	H11	H12	L4	L5	L6	L7	L8	L9	L10
VABM	4-24	12.4	5.5	54.8	4.8	10.5	57.3	2.5	4.5	36	20	42.5

Type	Number of valve positions	Size 14																
		B1	B2	B3	B4	B5	B6	B7	B8	D1 ø	H1	H2	H3	H4	H5	H6	H7	H8
VABM	4-24	110	70	59.3	56.5	36.5	16	20	26.5	4.5	113.1	95.1	77.7	68.6	61.3	18.7	15.7	28.7

Datasheet – Manifold rail VABM

Type	Number of valve positions	Size 14										
		H9	H10	H11	H12	L4	L5	L6	L7	L8	L9	L10
VABM	4-24	13.2	23.7	54.8	5.1	16	60.6	2	5	10	25.5	42.5

Type	Number of valve positions	Size 10			Size 14		
		L1	L2	L3	L1	L2	L3
VABM	4	103	94	31.5	128	118	48
	5	113.5	104.5	42	144	134	64
	6	124	115	52.5	160	150	80
	7	134.5	125.5	63	176	166	96
	8	145	136	73.5	192	182	112
	9	155.5	146.5	84	208	198	128
	10	166	157	94.5	224	214	144
	12	187	178	115.5	256	246	176
	16	229	220	157.5	320	310	240
	20	271	262	199.5	384	374	304
24	313	304	241.5	448	438	368	

Datasheet – Manifold rail VABM

Dimensions – Example of valve terminal with I-Port interface

Download CAD data → [www.festo.com](http://www.festo.com)

Outlet direction of electrical components to the left

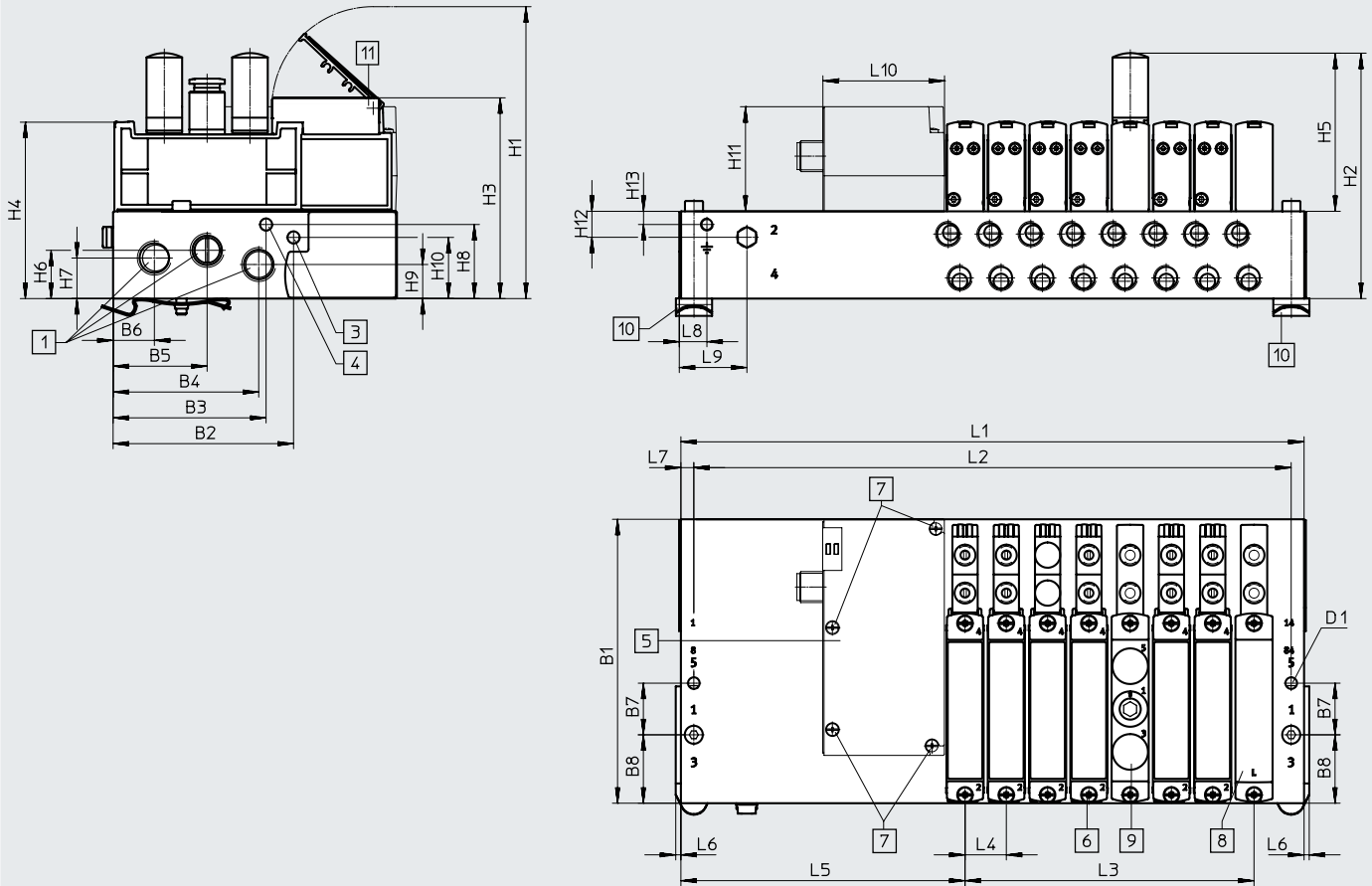

- [1] Port 1, 3 and 5: size 10: G1/8 (at both ends)
- [2] Port 12/14: size 10 and 14: M5
- [3] Port 12/14: size 10 and 14: M5 (at both ends)
- [4] Port 82/84: size 10 and 14: M5 (at both ends)
- [5] Electrical connection I-Port interface/IO-Link®
- [6] Valves/cover plates/supply plates – mounting on manifold block: size 10: M2, size 14: M2.5
- [7] Electrical interface
- [8] Cover plate
- [9] Supply plate, port 1, 3 and 5: size 10: M7, size 14: G1/8
- [10] H-rail mounting
- [11] Inscription label holder

Type	Number of valve positions	Size 10																
		B1	B2	B3	B4	B5	B6	B7	B8	D1ø	H1	H2	H3	H4	H5	H6	H7	H8
VABM	4-24	91.5	54	52.4	41.5	25.6	9.8	16	17.7	4.5	102.3	77.1	67	56.1	54.1	15.2	11.5	15.5

Type	Number of valve positions	Size 10											
		H9	H10	H11	H12	H13	L4	L5	L6	L7	L8	L9	L10
VABM	4-24	12.4	5.5	40.8	10.1	5.1	10.5	106.8	2.5	4.5	36	75	47.1

Type	Number of valve positions	Size 14																
		B1	B2	B3	B4	B5	B6	B7	B8	D1 ø	H1	H2	H3	H4	H5	H6	H7	H8
VABM	4-24	110	70	59.3	56.5	36.5	16	20	26.5	4.5	113.1	95.1	77.7	68.6	61.3	18.7	15.7	28.7

Type	Number of valve positions	Size 14											
		H9	H10	H11	H12	H13	L4	L5	L6	L7	L8	L9	L10
VABM	4-24	13.2	23.7	40.8	10.1	5.1	16	110.1	2	5	10	75	47.1

Datasheet – Manifold rail VABM

Type	Number of valve positions	Size 10			Size 14		
		L1	L2	L3	L1	L2	L3
VABM	4	152.5	143.5	31.5	177.5	167.5	48
	5	163	154	42	193.5	183.5	64
	6	173.5	164.5	52.5	209.5	199.5	80
	7	184	175	63	225.5	215.5	96
	8	194.5	185.5	73.5	241.5	231.5	112
	9	205	196	84	257.5	247.5	128
	10	215.5	206.5	94.5	273.5	263.5	144
	12	236.5	227.5	115.5	305.5	295.5	176
	16	278.5	269.5	157.5	369.5	359.5	240
	20	321	311.5	199.5	433.5	423.5	304
	24	362.5	353.5	241.5	497.5	487.5	368

Datasheet – Manifold rail VABM

Dimensions – Example of control cabinet installation for valve terminal

Download CAD data → [www.festo.com](http://www.festo.com)

Outlet direction of electrical components on top

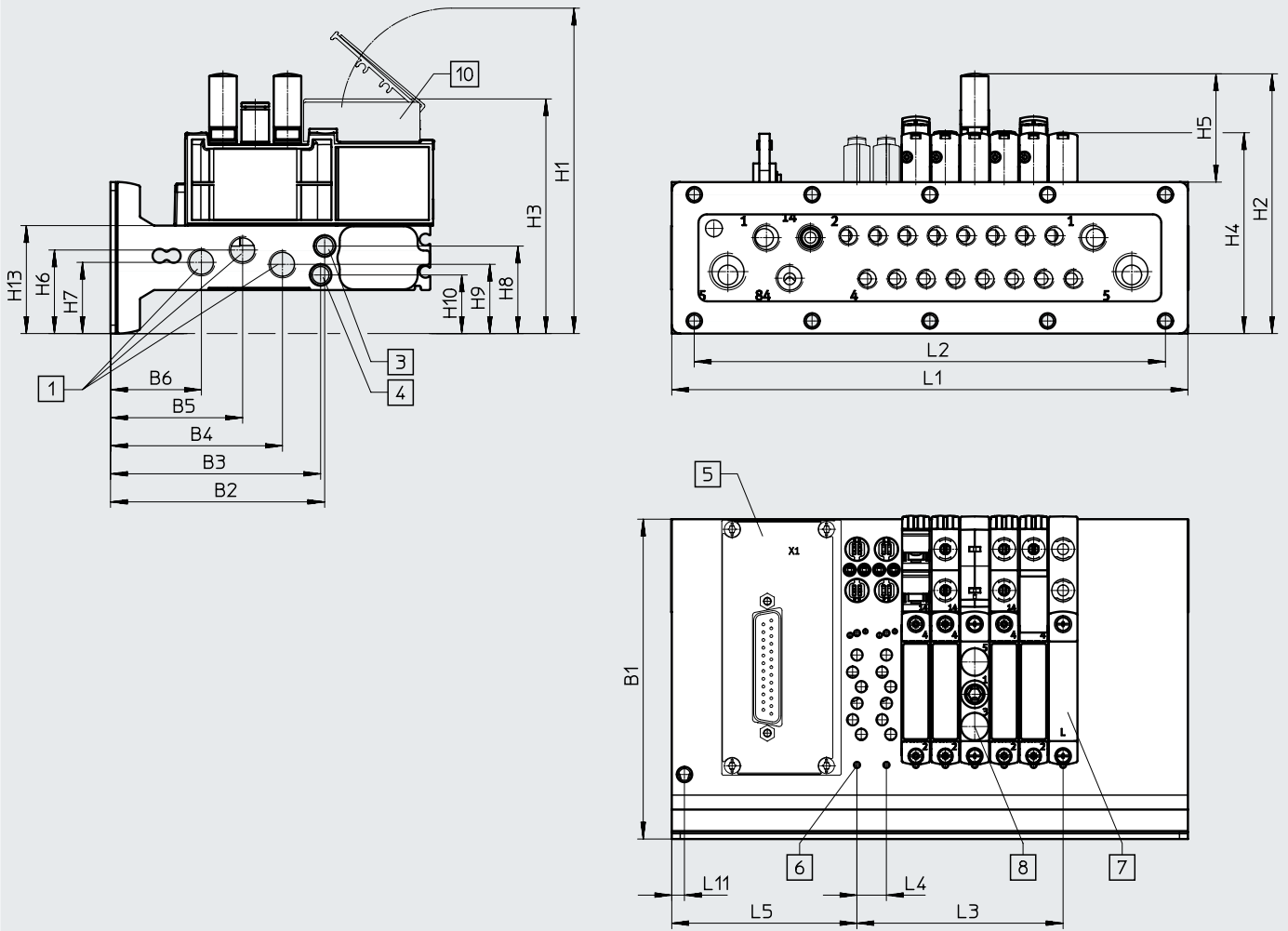

- [1] Port 1, 3 and 5: size 10: G1/8
- [2] Port 2: size 10: G1/8
- [3] Port 12/14: size 10: M5 (at both ends), size 14: M7 (at both ends)
- [4] Port 82/84: size 10: M5 (at both ends), size 14: M7 (at both ends)
- [5] Electrical connection
- [6] Valves/cover plates/supply plates – mounting on manifold block: M2
- [7] Cover plate
- [8] Supply plate, port 1, 3 and 5: M7
- [10] Inscription label holder

Type	Number of valve positions	Size 10									
		B1	B2	B3	B4	B5	B6	H1	H2	H3	H4
VABM	4-24	114	76.4	74.9	61.3	47.1	32.4	116	92.6	84	71.6

Type	Number of valve positions	Size 10									
		H5	H6	H7	H8	H9	H10	H13	L4	L5	L11
VABM	4-24	38.6	29.8	25.4	31.2	24.7	20.9	38.5	10.5	66	4.5

Type	Number of valve positions	Size 14									
		B1	B2	B3	B4	B5	B6	H1	H2	H3	H4
VABM	4-24	132	93	80.8	76.5	55.5	36.1	111.3	101.7	77.6	85.1

Type	Number of valve positions	Size 14									
		H5	H6	H7	H8	H9	H10	H13	L4	L5	L11
VABM	4-24	34.9	35.2	30.3	39.3	30.3	45	50.3	16	72.6	4.5

Datasheet – Manifold rail VABM

Number of valve positions	L1	L2	L3
VABM-L1-10HWS1-G18-4-GR	116.2	84	31.5
VABM-L1-10HWS1-G18-8-GR	158.2	126	73.5
VABM-L1-10HWS2-G18-8-GR	184	168	73.5
VABM-L1-10HWS2-G18-12-GR	226	210	115.5
VABM-L1-10HWS2-G18-16-GR	268	252	157.5
VABM-L1-10HWS2-G18-24-GR	352	336	241.5
VABM-L1-10HWS2-H-G18-8-GR	184	168	73.5
VABM-L1-10HWS2-H-G18-12-GR	226	210	115.5
VABM-L1-10HWS2-H-G18-16-GR	268	252	157.5
VABM-L1-10HWS2-H-G18-24-GR	352	336	241.5
VABM-L1-14HWS1-G14-4-GR	135	64	48
VABM-L1-14HWS1-G14-8-GR	199	128	112
VABM-L1-14HWS2-G14-8-GR	234	192	112
VABM-L1-14HWS2-G14-12-GR	298	256	176
VABM-L1-14HWS2-G14-16-GR	362	320	240
VABM-L1-14HWS2-G14-24-GR	490	448	368
VABM-L1-14HWS2-H-G14-8-GR	234	192	112
VABM-L1-14HWS2-H-G14-12-GR	298	256	176
VABM-L1-14HWS2-H-G14-16-GR	362	320	240
VABM-L1-14HWS2-H-G14-24-GR	490	448	368

Datasheet – Manifold rail VABM

Dimensions – Example of control cabinet installation for valve terminal

Download CAD data → [www.festo.com](http://www.festo.com)

Outlet direction of electrical components on top, with shut-off function (hot swap)

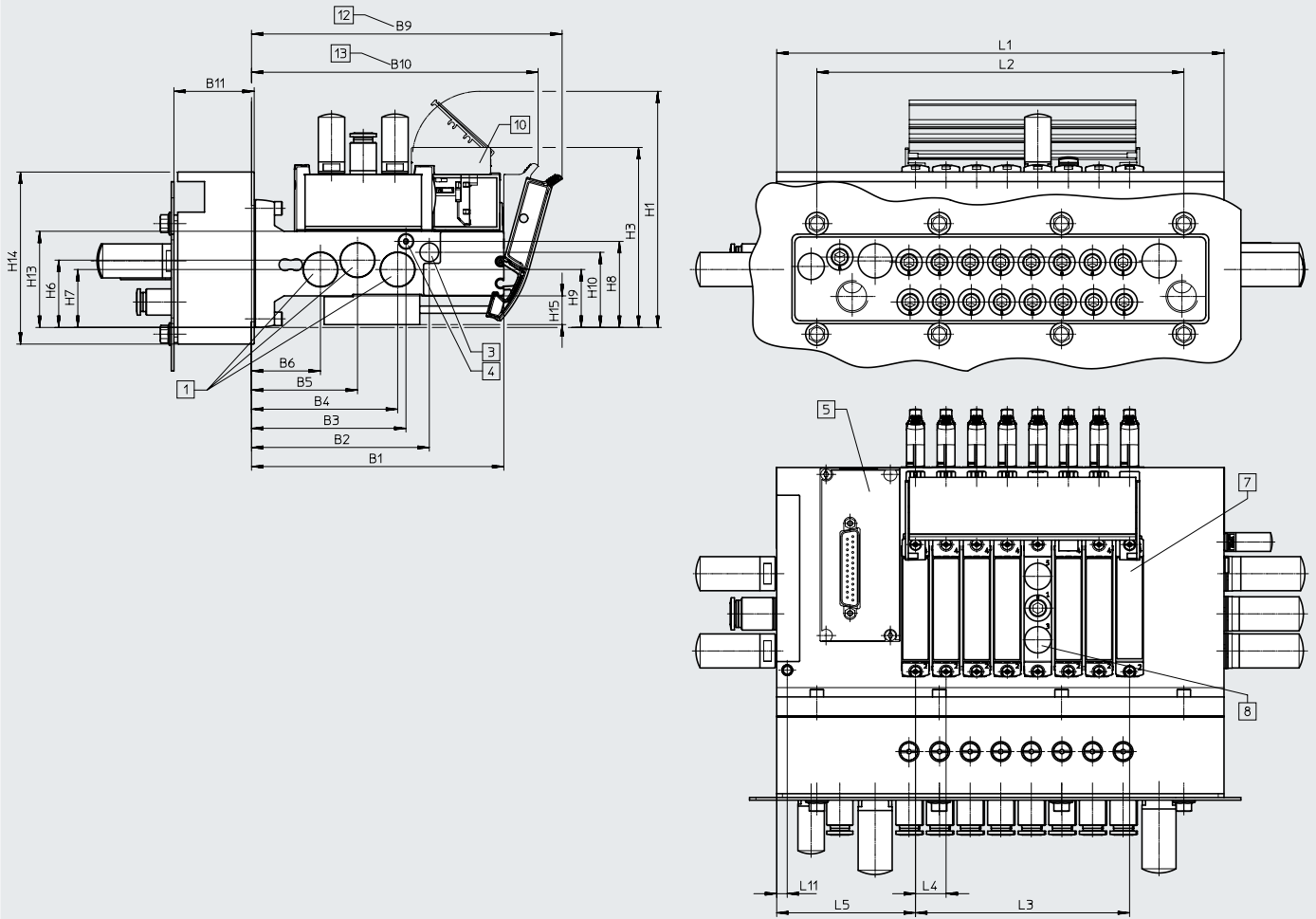

- [1] Port 1, 3 and 5: size 10: G1/8
- [2] Port 12/14: size 10: M5 (at both ends), size 14: M7 (at both ends)
- [3] Port 12/14: size 10: M5 (at both ends), size 14: M7 (at both ends)
- [4] Port 82/84: size 10: M5 (at both ends), size 14: M7 (at both ends)
- [5] Electrical connection
- [6] Cover plate
- [7] Supply plate, port 1, 3 and 5: M7
- [8] Inscription label holder
- [9] VTUG 10: with seal and stainless steel plate
- [10] VTUG 14: with seal and stainless steel plate, hot swap 1 and 2/4
- [11] With seal and stainless steel plate

Type	Number of valve positions	Size 10										
		B1	B2	B3	B4	B5	B6	B9	B10	B11	H1	H3
VABM	4-24	114	76.4	74.9	61.3	47.1	32.4	142	132	-	114	82

Type	Number of valve positions	Size 10										
		H6	H7	H8	H9	H10	H13	H14	H15	L4	L5	L11
VABM	4-24	29.8	25.4	20.9	24.7	31.2	38.5	-	15	10.5	66	5.5

Type	Number of valve positions	Size 14										
		B1	B2	B3	B4	B5	B6	B9	B10	B11	H1	H3
VABM	4-24	132	93	80.8	76.5	55.5	36.1	163	150.4	42	123.5	93.9

Type	Number of valve positions	Size 14										
		H6	H7	H8	H9	H10	H13	H14	H15	L4	L5	L11
VABM	4-24	35.2	30.3	45	30.3	39.3	50.3	90	15	16	72.6	5.5

Datasheet – Manifold rail VABM

Number of valve positions	L1	L2	L3
VABM-L1-10HWS1-G18-4-GR	116.2	84	31.5
VABM-L1-10HWS1-G18-8-GR	158.2	126	73.5
VABM-L1-10HWS2-G18-8-GR	184	168	73.5
VABM-L1-10HWS2-G18-12-GR	226	210	115.5
VABM-L1-10HWS2-G18-16-GR	268	252	157.5
VABM-L1-10HWS2-G18-24-GR	352	336	241.5
VABM-L1-10HWS2-H-G18-8-GR	184	168	73.5
VABM-L1-10HWS2-H-G18-12-GR	226	210	115.5
VABM-L1-10HWS2-H-G18-16-GR	268	252	157.5
VABM-L1-10HWS2-H-G18-24-GR	352	336	241.5
VABM-L1-14HWS1-G14-4-GR	135	64	48
VABM-L1-14HWS1-G14-8-GR	199	128	112
VABM-L1-14HWS2-G14-8-GR	234	192	112
VABM-L1-14HWS2-G14-12-GR	298	256	176
VABM-L1-14HWS2-G14-16-GR	362	320	240
VABM-L1-14HWS2-G14-24-GR	490	448	368
VABM-L1-14HWS2-H-G14-8-GR	234	192	112
VABM-L1-14HWS2-H-G14-12-GR	298	256	176
VABM-L1-14HWS2-H-G14-16-GR	362	320	240
VABM-L1-14HWS2-H-G14-24-GR	490	448	368



Datasheet – Manifold rail VABM

Dimensions – Manifold rail outlet direction to the front

Download CAD data → [www.festo.com](http://www.festo.com)

Size 10, I-Port interface on top

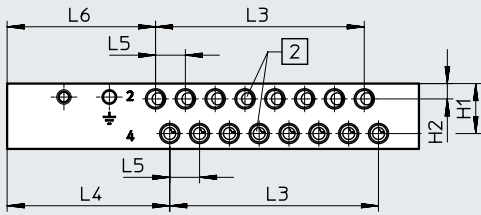

Size 14, I-Port interface on top

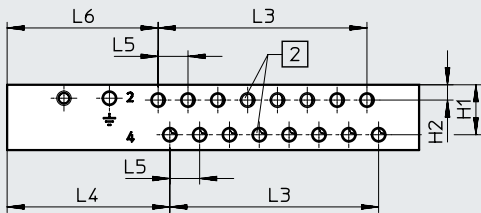
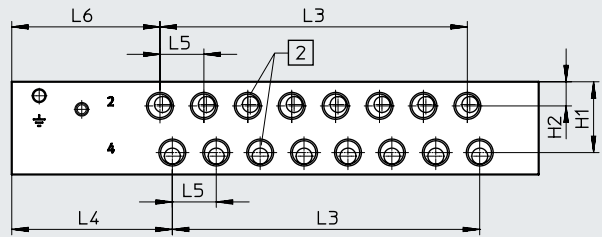

[2] Port 2 and 4

[2] Port 2 and 4

Sizes 10, 14, I-Port interface on the side

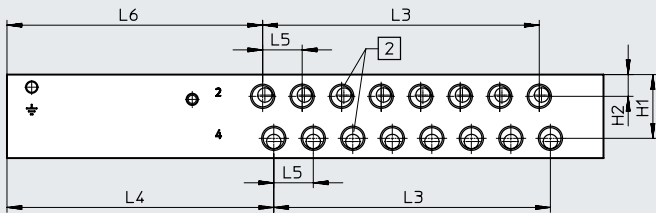

[2] Port 2 and 4

Size	Port 2 and 4	Manifold rail with I-Port interface on top				
		H1	H2	L4	L5	L6
10	M7 thread	17.6	5.4	57.3	10.5	52.3
	M5 thread					53.2
14	Thread G1/8	25.8	8.8	58.5	16	54

Size	Port 2 and 4	Manifold rail with I-Port interface on the side				
		H1	H2	L4	L5	L6
10	M7 thread	17.6	5.4	106.8	10.5	101.8
	M5 thread					102.7
14	Thread G1/8	25.8	8.8	108	16	103.5

## Datasheet – Manifold rail VABM

Type	Number of valve positions	Size 10	Size 14
		L3	L3
VABM	4	31.5	48
	5	42	64
	6	52.5	80
	7	63	96
	8	73.5	112
	9	84	128
	10	94.5	144
	12	115.5	176
	16	157.5	240
	20	199.5	304
	24	241.5	368

Datasheet – Manifold rail VABM

Dimensions – Manifold rail outlet direction underneath

Control cabinet installation

Download CAD data → [www.festo.com](http://www.festo.com)

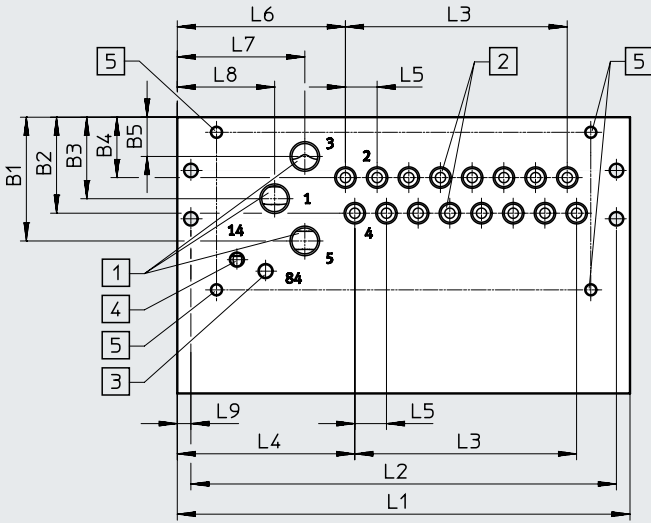

**Note**  
 Dimensions of the manifold rail I-Port interface on the side for control cabinet installation  
 → page 48

- [1] Port 1, 3 and 5: size 10: G1/8
- [2] Ports 2 and 4: size 10: M5/M7, size 14: G1/8
- [3] Port 82/84: size 10 and 14: M5
- [4] Port 12/14: size 10 and 14: M5
- [5] Mounting holes, outlet direction underneath: M4x8

Type	Manifold rail with I-Port interface on top, size 10										
	B1	B2	B3	B4	B5	L4	L5	L6	L7	L8	L9
VABM	41	31.8	27	20	13	58.8	10.5	55.7	42.3	32.3	4.5

Type	Manifold rail with I-Port interface on top, size 14										
	B1	B2	B3	B4	B5	L4	L5	L6	L7	L8	L9
VABM	53.5	45.1	35.2	27.8	17	58.5	16	58.5	43	33	5

Type	Number of valve positions	Size 10			Size 14		
		L1 +5	L2 +5	L3	L1	L2	L3
VABM	4	103	94	31.5	128	118	48
	5	113.5	104.5	42	144	134	64
	6	124	115	52.5	160	150	80
	7	134.5	125.5	63	176	166	96
	8	145	136	73.5	192	182	112
	9	155.5	146.5	84	208	198	128
	10	166	157	94.5	224	214	144
	12	187	178	115.5	256	246	176
	16	229	220	157.5	320	310	240
	20	271	262	199.5	384	374	304
	24	313	304	241.5	448	438	368

Datasheet – Manifold rail VABM

Type	Manifold rail with I-Port interface, size 10										
	B1	B2	B3	B4	B5	L4	L5	L6	L7	L8	L9
VABM	41	31.8	27	20	13	108.3	10.5	105.2	91.8	81.8	4.5

Type	Manifold rail with I-Port interface, size 14										
	B1	B2	B3	B4	B5	L4	L5	L6	L7	L8	L9
VABM	53.5	45.1	35.2	27.8	17	108	16	108	92.5	82.5	5

Type	Number of valve positions	Manifold rail with I-Port interface Size 10			Manifold rail with I-Port interface Size 14		
		L1 +5	L2 +5	L3	L1	L2	L3
		VABM	4	152.5	143.5	31.5	177.5
	5	163	154	42	193.5	183.5	64
	6	173.5	164.5	52.5	209.5	199.5	80
	7	184	175	63	225.5	215.5	96
	8	194.5	185.5	73.5	241.5	231.5	112
	9	205	196	84	257.5	247.5	128
	10	215.5	206.5	94.5	273.5	263.5	144
	12	236.5	227.5	115.5	305.5	295.5	176
	16	278.5	269.5	157.5	369.5	359.5	240
	20	320.5	311.5	199.5	433.5	423.5	304
	24	362.5	353.5	241.5	497.5	487.5	368

Datasheet – Manifold rail VABM

Dimensions – Manifold rail outlet direction to the front

Download CAD data → [www.festo.com](http://www.festo.com)

Control cabinet installation/control cabinet installation with shut-off function (hot swap)

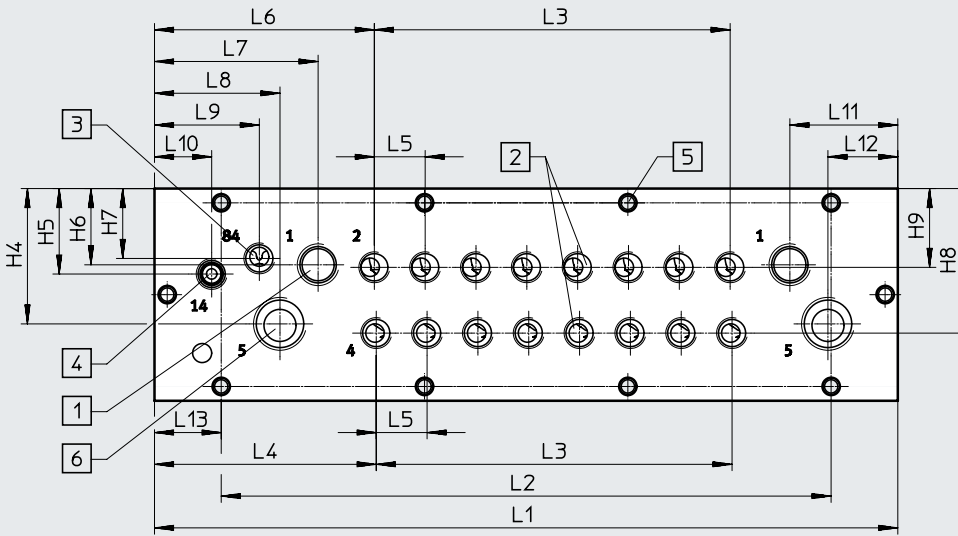

- [1] Port 1, 3 and 5: size 10: G1/8
- [2] Port 2 and 4: size 10: M5/M7, size 14: G1/8
- [3] Port 82/84: sizes 10 and 14: G1/8
- [4] Port 12/14: sizes 10 and 14: G1/8
- [5] Mounting holes, outlet direction underneath: M5
- [6] Port 3/5

Type	Size 10															
	B1	B2	B3	B4	B5	B6	L4	L5	L6	L7	L8	L9	L10	L11	L12	L13
VABM-L1-10HWS1	111.5	73.9	72.4	58.8	44.6	29.9	69.8	10.5	63	33.8	20	42	49.4	33.8	20	16.1
VABM-L1-10HWS2																8

Type	Size 10								
	H1	H2	H3	H4	H5	H6	H7	H8	H9
VABM-L1-10HWS1	54	15.5	23	31.9	19.8	19.8	34.3	34.5	19.1
VABM-L1-10HWS2									

Type	Size 14															
	B1	B2	B3	B4	B5	B6	L4	L5	L6	L7	L8	L9	L10	L11	L12	L13
VABM-L1-14HWS1	130	91	78.8	74.5	53.5	34.1	69.8	16	96.2	51.5	39.5	33	18	34	22	35.5
VABM-L1-14HWS2																21

Type	Size 14								
	H1	H2	H3	H4	H5	H6	H7	H8	H9
VABM-L1-14HWS1	66.8	16.5	33.8	42.6	26.9	24	22	45.5	24.8
VABM-L1-14HWS2									

Datasheet – Manifold rail VABM

Number of valve positions	L1	L2	L3	L13
VABM-L1-10HWS1-G18-4-GR	116.2	84	31.5	16.1
VABM-L1-10HWS1-G18-8-GR	158.2	126	73.5	16.1
VABM-L1-10HWS2-G18-8-GR	184	168	73.5	8
VABM-L1-10HWS2-G18-12-GR	226	210	115.5	8
VABM-L1-10HWS2-G18-16-GR	268	252	157.5	8
VABM-L1-10HWS2-G18-24-GR	352	336	241.5	8
VABM-L1-10HWS2-H-G18-8-GR	184	168	73.5	8
VABM-L1-10HWS2-H-G18-8-GR	226	210	115.5	8
VABM-L1-10HWS2-H-G18-8-GR	268	252	157.5	8
VABM-L1-10HWS2-H-G18-8-GR	352	336	241.5	8
VABM-L1-14HWS1-G14-4-GR	135	64	48	35.5
VABM-L1-14HWS1-G14-8-GR	199	128	112	35.5
VABM-L1-14HWS2-G14-8-GR	234	192	112	21
VABM-L1-14HWS2-G14-12-GR	298	256	176	21
VABM-L1-14HWS2-G14-16-GR	362	320	240	21
VABM-L1-14HWS2-G14-24-GR	490	448	368	21
VABM-L1-14HWS2-H-G14-8-GR	234	192	112	21
VABM-L1-14HWS2-H-G14-12-GR	298	256	176	21
VABM-L1-14HWS2-H-G14-16-GR	362	320	240	21
VABM-L1-14HWS2-H-G14-24-GR	490	448	368	21

Datasheet – Manifold rail VABM

Dimensions – Manifold rail outlet direction to the front

Download CAD data → [www.festo.com](http://www.festo.com)

Control cabinet installation/control cabinet installation with shut-off function (hot swap)

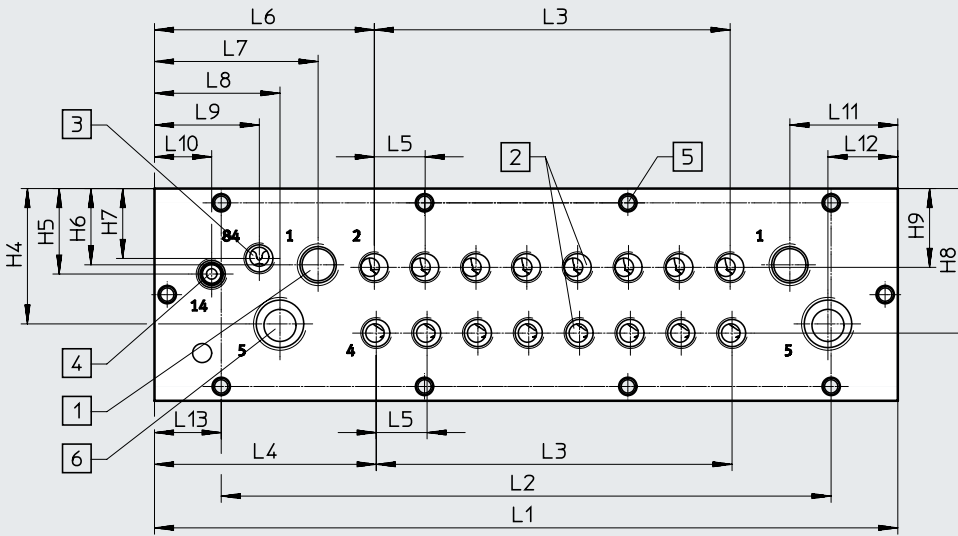

- [1] Port 1, 3 and 5: size 10: G1/8
- [2] Port 2 and 4: size 10: M5/M7, size 14: G1/8
- [3] Port 82/84: sizes 10 and 14: G1/8
- [4] Port 12/14: sizes 10 and 14: G1/8
- [5] Mounting holes, outlet direction underneath: M5
- [6] Port 3/5

Type	Size 10															
	B1	B2	B3	B4	B5	B6	L4	L5	L6	L7	L8	L9	L10	L11	L12	L13
VABM-L1-10HWS1	111.5	73.9	72.4	58.8	44.6	29.9	69.8	10.5	63	33.8	20	42	49.4	33.8	20	16.1
VABM-L1-10HWS2																8

Type	Size 10								
	H1	H2	H3	H4	H5	H6	H7	H8	H9
VABM-L1-10HWS1	54	15.5	23	31.9	19.8	19.8	34.3	34.5	19.1
VABM-L1-10HWS2									

Type	Size 14															
	B1	B2	B3	B4	B5	B6	L4	L5	L6	L7	L8	L9	L10	L11	L12	L13
VABM-L1-14HWS1	130	91	78.8	74.5	53.5	34.1	69.8	16	96.2	51.5	39.5	33	18	34	22	35.5
VABM-L1-14HWS2																21

Type	Size 14								
	H1	H2	H3	H4	H5	H6	H7	H8	H9
VABM-L1-14HWS1	66.8	16.5	33.8	42.6	26.9	24	22	45.5	24.8
VABM-L1-14HWS2									

Datasheet – Manifold rail VABM

Dimensions – Manifold rail outlet direction to the front

Download CAD data → [www.festo.com](http://www.festo.com)

Control cabinet installation/control cabinet installation with shut-off function (hot swap)

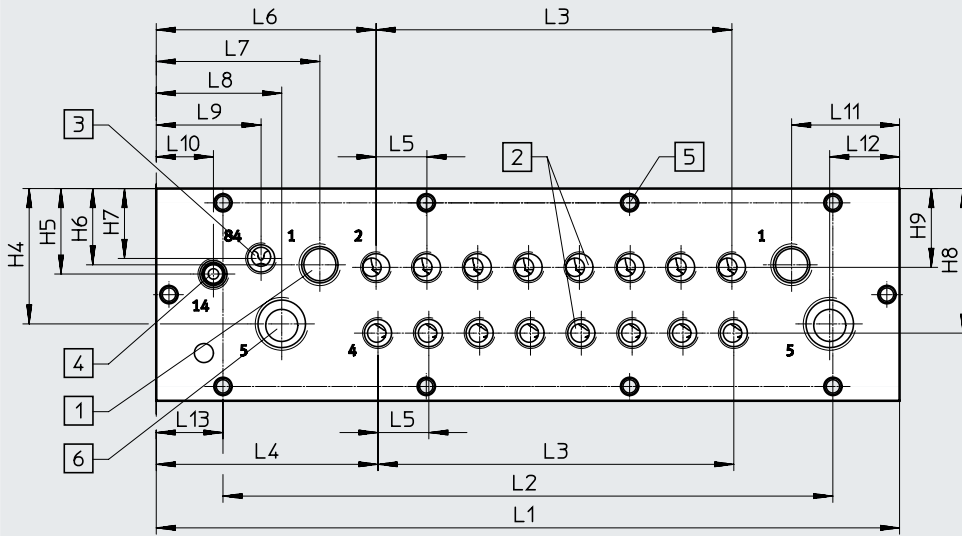

- [1] Port 1, 3 and 5: size 10: G1/8
- [2] Port 2 and 4: size 10: M5/M7, size 14: G1/8
- [3] Port 82/84: sizes 10 and 14: G1/8
- [4] Port 12/14: sizes 10 and 14: G1/8
- [5] Mounting holes, outlet direction underneath: M5
- [6] Port 3/5

Type	Size 10															
	B1	B2	B3	B4	B5	B6	L4	L5	L6	L7	L8	L9	L10	L11	L12	L13
VABM-L1-10HWS1	111.5	73.9	72.4	58.8	44.6	29.9	69.8	10.5	63	33.8	20	42	49.4	33.8	20	16.1
VABM-L1-10HWS2																8

Type	Size 10								
	H1	H2	H3	H4	H5	H6	H7	H8	H9
VABM-L1-10HWS1	54	15.5	23	31.9	19.8	19.8	34.3	34.5	19.1
VABM-L1-10HWS2									

Type	Size 14															
	B1	B2	B3	B4	B5	B6	L4	L5	L6	L7	L8	L9	L10	L11	L12	L13
VABM-L1-14HWS1	130	91	78.8	74.5	53.5	34.1	69.8	16	96.2	51.5	39.5	33	18	34	22	35.5
VABM-L1-14HWS2																21

Type	Size 14								
	H1	H2	H3	H4	H5	H6	H7	H8	H9
VABM-L1-14HWS1	66.8	16.5	33.8	42.6	26.9	24	22	45.5	24.8
VABM-L1-14HWS2									



## Datasheet – Manifold rail VABM

Number of valve positions	L1	L2	L3	L13
VABM-L1-10HWS1-G18-4-GR	116.2	84	31.5	16.1
VABM-L1-10HWS1-G18-8-GR	158.2	126	73.5	16.1
VABM-L1-10HWS2-G18-8-GR	184	168	73.5	8
VABM-L1-10HWS2-G18-12-GR	226	210	115.5	8
VABM-L1-10HWS2-G18-16-GR	268	252	157.5	8
VABM-L1-10HWS2-G18-24-GR	352	336	241.5	8
VABM-L1-10HWS2-H-G18-8-GR	184	168	73.5	8
VABM-L1-10HWS2-H-G18-8-GR	226	210	115.5	8
VABM-L1-10HWS2-H-G18-8-GR	268	252	157.5	8
VABM-L1-10HWS2-H-G18-8-GR	352	336	241.5	8
VABM-L1-14HWS1-G14-4-GR	135	64	48	35.5
VABM-L1-14HWS1-G14-8-GR	199	128	112	35.5
VABM-L1-14HWS2-G14-8-GR	234	192	112	21
VABM-L1-14HWS2-G14-12-GR	298	256	176	21
VABM-L1-14HWS2-G14-16-GR	362	320	240	21
VABM-L1-14HWS2-G14-24-GR	490	448	368	21
VABM-L1-14HWS2-H-G14-8-GR	234	192	112	21
VABM-L1-14HWS2-H-G14-12-GR	298	256	176	21
VABM-L1-14HWS2-H-G14-16-GR	362	320	240	21
VABM-L1-14HWS2-H-G14-24-GR	490	448	368	21

## Datasheet – Manifold rail VABM

### Dimensions – Recess for control cabinet installation, outlet direction underneath, size 10

Up to 8 valves

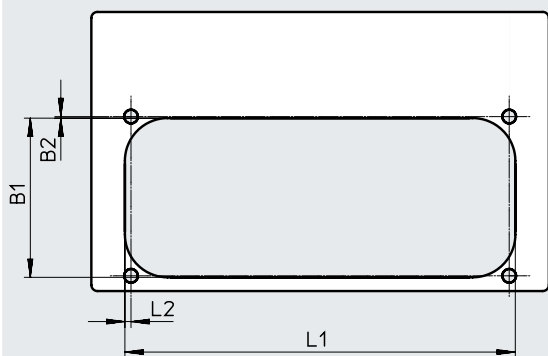

9 or more valves

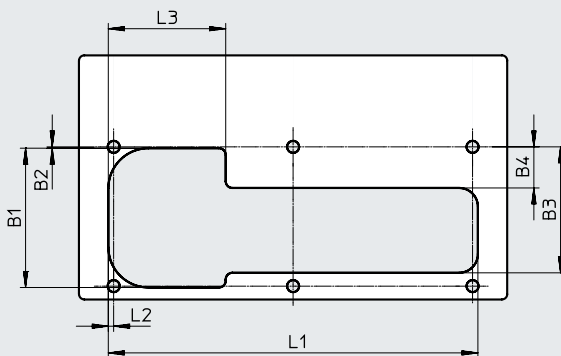

Type	B1	B2	L1	L2
VABM-L1-10...G18-4	52.7	0.5	86	2
VABM-L1-10...G18-5			96.5	
VABM-L1-10...G18-6			107	
VABM-L1-10...G18-7			117.5	
VABM-L1-10...G18-8			128	

Type	B1	B2	B3	B4	L1	L2	L3
VABM-L1-10...G18-9	52.7	0.5	47.2	15.4	138.5	2	44
VABM-L1-10...G18-10					149		
VABM-L1-10...G18-12					170		
VABM-L1-10...G18-16					212		
VABM-L1-10...G18-20					254		
VABM-L1-10...G18-24					296		

### Dimensions – Recess for control cabinet installation, outlet direction underneath, size 14

Up to 7 valves

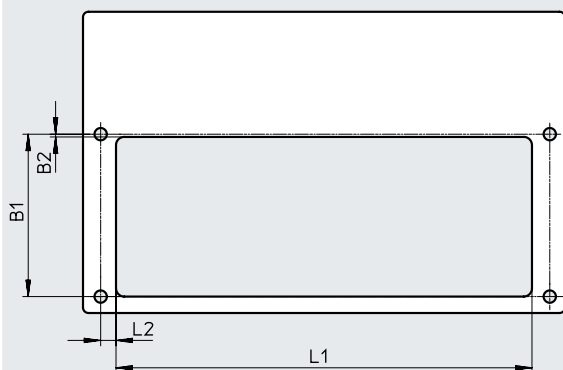

8 or more valves

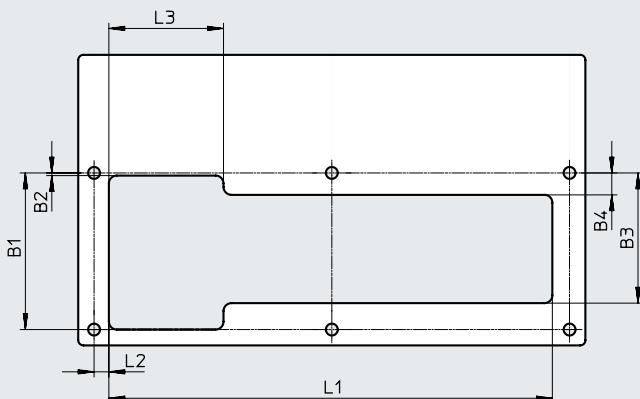

Type	B1	B2	L1	L2
VABM-L1-14...G14-4	59.3	1	103.9	5.6
VABM-L1-14...G14-5			119.9	
VABM-L1-14...G14-6			135.9	
VABM-L1-14...G14-7			151.9	

Type	B1	B2	B3	B4	L1	L2	L3
VABM-L1-14...G14-8	59.3	1	49.3	8.3	167.9	5.6	43.4
VABM-L1-14...G14-9					183.9		
VABM-L1-14...G14-10					199.9		
VABM-L1-14...G14-12					231.9		
VABM-L1-14...G14-16					295.9		
VABM-L1-14...G14-20					359.9		
VABM-L1-14...G14-24					423.9		

### Datasheet – Manifold rail VABM

**Dimensions – Recess for control cabinet installation, outlet direction to the front, size 10**

Single supply, up to 8 valves

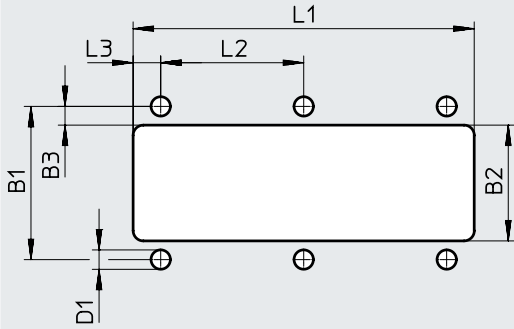

Type	B1	B2	B3	D1	L1	L2	L3
VABM-L1-10HWS1-G18-4-GR	45	34	5.5	5.7	100.2	42	8.1
VABM-L1-10HWS1-G18-8-GR					143.2		

Double supply, 8 or more valves

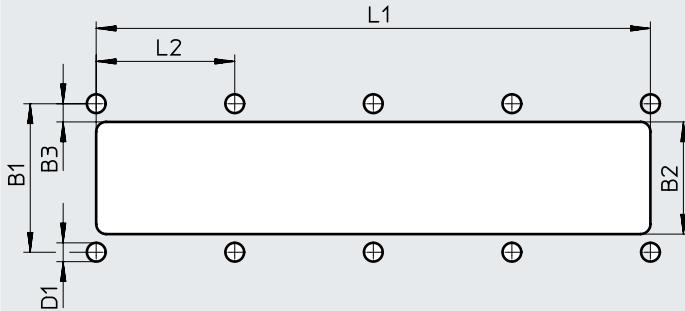

Type	B1	B2	B3	D1	L1	L2
VABM-L1-10HWS2-...G18-8-GR	45	34	5.5	5.7	168	42
VABM-L1-10HWS2-...G18-12-GR					210	
VABM-L1-10HWS2-...G18-16-GR					252	
VABM-L1-10HWS2-...G18-24-GR					336	

**Dimensions – Recess for control cabinet installation, outlet direction to the front, size 14**

Single supply, up to 8 valves

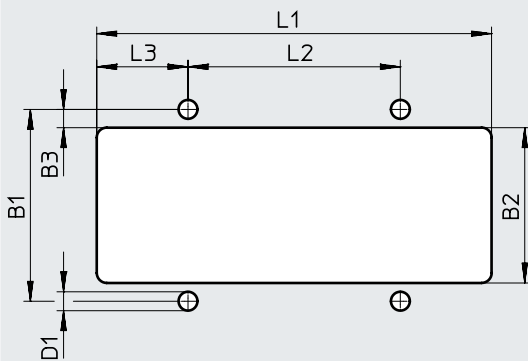

Type	B1	B2	B3	D1	L1	L2	L3
VABM-L1-14HWS1-G14-4-GR	57.8	46.8	5.5	5.7	119	64	27.5
VABM-L1-14HWS1-G14-8-GR					183		

## Datasheet – Manifold rail VABM

### Dimensions – Recess for control cabinet installation, outlet direction to the front, size 14

Double supply, 8 or more valves

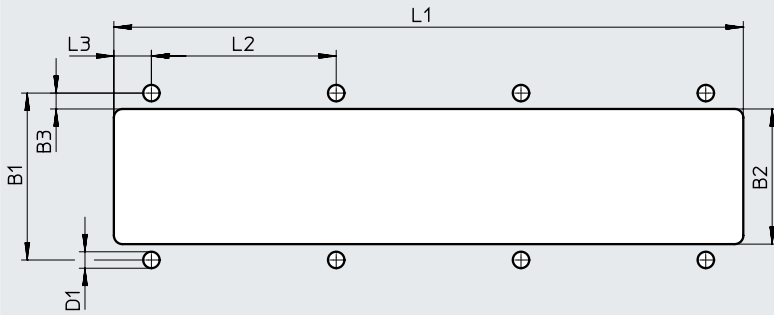

Type	B1	B2	B3	D1	L1	L2	L3
VABM-L1-14HWS2-G14-...-8-GR	57.8	46.8	5.5	5.7	218	64	13
VABM-L1-14HWS2-G14-...-12-GR					282		
VABM-L1-14HWS2-G14-...-16-GR					346		
VABM-L1-14HWS2-G14-...-24-GR					474		

### Dimensions – Mounting holes for control cabinet installation, size 10

Download CAD data → [www.festo.com](http://www.festo.com)

Outlet direction underneath

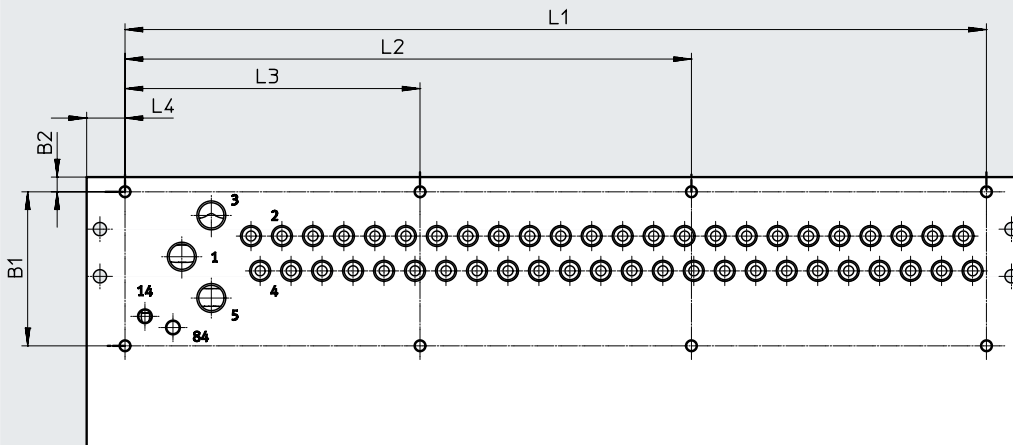

Type		Outlet direction of electrical components on top						I-Port interface on the side
		B1	B2	L1	L2	L3	L4	L4
VABM-L1-10...-G18-4	Up to 8 valves	52.2	5	82	-	-	13	62.5
VABM-L1-10...-G18-5				92.5	-	-		
VABM-L1-10...-G18-6				103	-	-		
VABM-L1-10...-G18-7				113.5	-	-		
VABM-L1-10...-G18-8				124	-	-		
VABM-L1-10...-G18-9	Up to 20 valves	52.2	5	134.5	-	67.25	13	62.5
VABM-L1-10...-G18-10				145	-	72.5		
VABM-L1-10...-G18-12				166	-	83		
VABM-L1-10...-G18-16				208	-	104		
VABM-L1-10...-G18-20				250	-	125		
VABM-L1-10...-G18-24				24 valves	52.2	5		

Datasheet – Manifold rail VABM

Dimensions – Mounting holes for control cabinet installation, size 10

Download CAD data → [www.festo.com](http://www.festo.com)

Outlet direction to the front

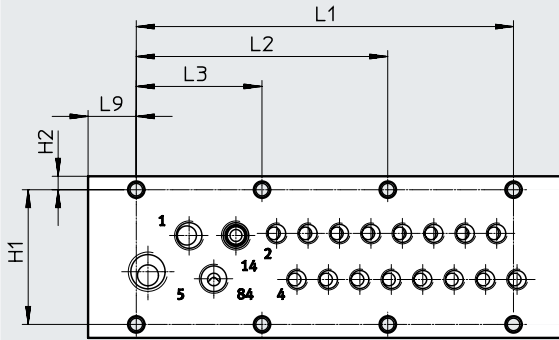

Type	H1	H2	L1	L2	L3	L9
VABM-L1-10HWS1-G18-4-GR	45	4.5	84	–	42	16.1
VABM-L1-10HWS1-G18-8-GR	45	4.5	126	84	42	16.1

Type	No. of valve positions	No. of mounting holes
VABM-L1-10HWS1-G18-4-GR	4	3
VABM-L1-10HWS1-G18-8-GR	8	4

Dimensions – Mounting holes for control cabinet installation, size 10

Download CAD data → [www.festo.com](http://www.festo.com)

Outlet direction to the front

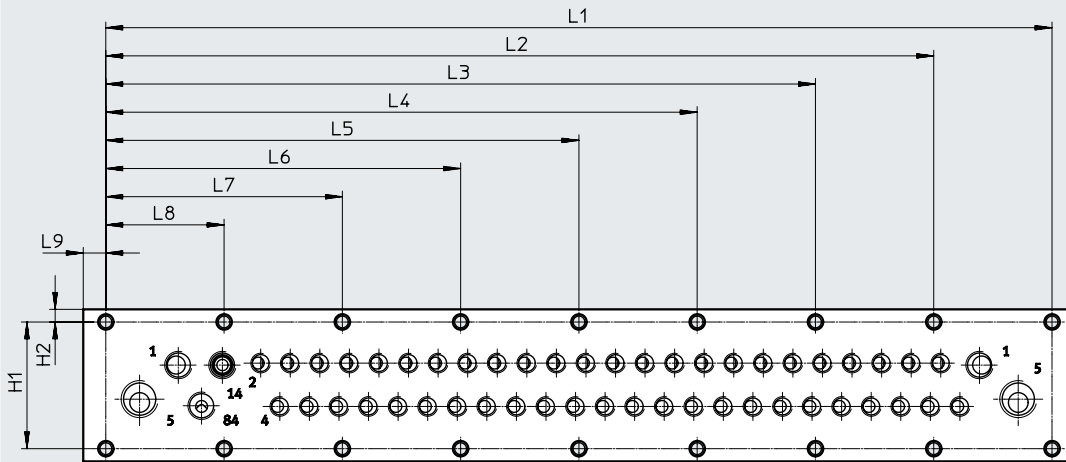

Type	H1	H2	L1	L2	L3	L4	L5	L6	L7	L8	L9
VABM-L1-10HWS2-...-8-GR	45	4.5	168	–	–	–	–	126	84	42	8
VABM-L1-10HWS2-...-12-GR	45	4.5	210	–	–	–	168	126	84	42	8
VABM-L1-10HWS2-...-16-GR	45	4.5	252	–	–	210	168	126	84	42	8
VABM-L1-10HWS2-...-24-GR	45	4.5	336	294	252	210	168	126	84	42	8

Type	No. of valve positions	No. of mounting holes
VABM-L1-10HWS2-...-8-GR	8	5
VABM-L1-10HWS2-...-12-GR	12	6
VABM-L1-10HWS2-...-16-GR	16	7
VABM-L1-10HWS2-...-24-GR	24	9

### Datasheet – Manifold rail VABM

Dimensions – Mounting holes for control cabinet installation, size 14

Download CAD data → [www.festo.com](http://www.festo.com)

Outlet direction underneath

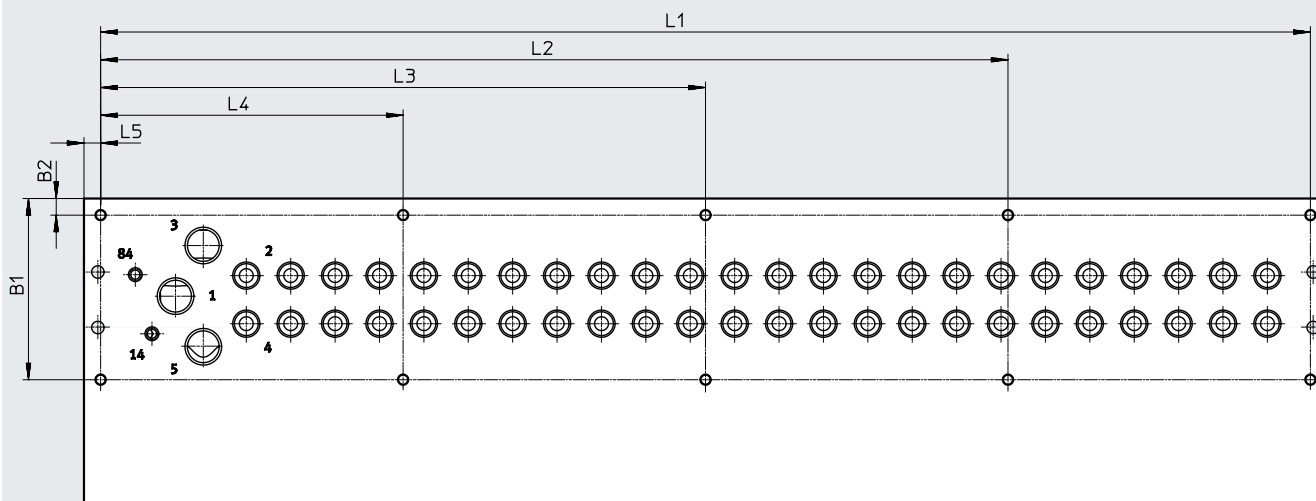

Type		Outlet direction of electrical components on top							I-Port interface on the side
		B1	B2	L1	L2	L3	L4	L5	L4
VABM-L1-14...-G14-4	Up to 8 valves	59.3	6	116	–	–	–	6	55.5
VABM-L1-14...-G14-5				132	–	–	–		
VABM-L1-14...-G14-6				148	–	–	–		
VABM-L1-14...-G14-7				164	–	–	–		
VABM-L1-14...-G14-8	8 to 10 valves	59.3	6	180	–	–	90	6	55.5
VABM-L1-14...-G14-9				196	–	–	98		
VABM-L1-14...-G14-10				212	–	–	106		
VABM-L1-14...-G14-12	12 valves and 16 valves	59.3	6	244	–	162	82	6	55.5
VABM-L1-14...-G14-16				308	–	204	104		
VABM-L1-14...-G14-20	20 valves and 24 valves	59.3	6	372	279	186	93	6	55.5
VABM-L1-14...-G14-24				436	327	218	109		

Datasheet – Manifold rail VABM

Dimensions – Mounting holes for control cabinet installation, size 14

Download CAD data → [www.festo.com](http://www.festo.com)

Outlet direction to the front

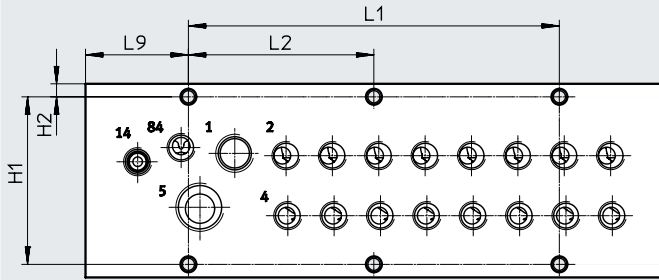

Type	H1	H2	L1	L2	L9
VABM-L1-14HWS1-G14-4-GR	57.8	4.5	64	–	35.5
VABM-L1-14HWS1-G14-8-GR	57.8	4.5	128	64	35.5

Type	No. of valve positions	No. of mounting holes
VABM-L1-14HWS1-G14-4-GR	4	2
VABM-L1-14HWS1-G14-8-GR	8	3

Dimensions – Mounting holes for control cabinet installation, size 14

Download CAD data → [www.festo.com](http://www.festo.com)

Outlet direction to the front

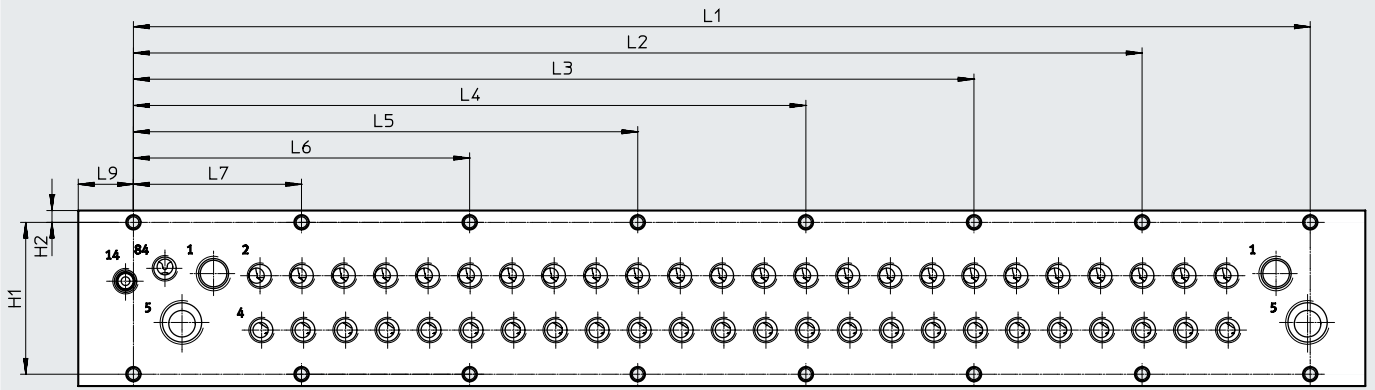

Type	H1	H2	L1	L2	L3	L4	L5	L6	L7	L9
VABM-L1-14HWS2-...-8-GR	57.8	4.5	192	–	–	–	–	128	64	21
VABM-L1-14HWS2-...-12-GR	57.8	4.5	256	–	–	–	192	128	64	21
VABM-L1-14HWS2-...-16-GR	57.8	4.5	320	–	–	256	192	128	64	21
VABM-L1-14HWS2-...-24-GR	57.8	4.5	448	384	320	256	192	128	64	21

Type	No. of valve positions	No. of mounting holes
VABM-L1-14HWS2-...-8-GR	8	4
VABM-L1-14HWS2-...-12-GR	12	5
VABM-L1-14HWS2-...-16-GR	16	6
VABM-L1-14HWS2-...-24-GR	24	8

## Ordering data

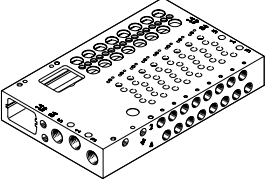
Ordering data	Description	Part no.	Type	
<b>Manifold rail for sub-base valve</b>				
	<b>Size 10 mm</b>			
	Ports 2, 4 at the front	4 valve positions	573434	VABM-L1-10HW-G18-4-GR
		5 valve positions	573435	VABM-L1-10HW-G18-5-GR
		6 valve positions	573436	VABM-L1-10HW-G18-6-GR
		7 valve positions	573437	VABM-L1-10HW-G18-7-GR
		8 valve positions	573438	VABM-L1-10HW-G18-8-GR
		9 valve positions	573439	VABM-L1-10HW-G18-9-GR
		10 valve positions	573440	VABM-L1-10HW-G18-10-GR
		12 valve positions	573441	VABM-L1-10HW-G18-12-GR
		16 valve positions	573442	VABM-L1-10HW-G18-16-GR
		20 valve positions	573443	VABM-L1-10HW-G18-20-GR
		24 valve positions	573444	VABM-L1-10HW-G18-24-GR
		8 double solenoid + 8 single solenoid valves	573930	VABM-L1-10HW-G18-16-M-GR
		4 double solenoid + 16 single solenoid valves	573931	VABM-L1-10HW-G18-20-M-GR
		24 single solenoid valves	573932	VABM-L1-10HW-G18-24-M-GR
	<b>Size 14 mm</b>			
	Ports 2, 4 at the front	4 valve positions	573500	VABM-L1-14W-G14-4-GR
		5 valve positions	573501	VABM-L1-14W-G14-5-GR
		6 valve positions	573502	VABM-L1-14W-G14-6-GR
		7 valve positions	573503	VABM-L1-14W-G14-7-GR
		8 valve positions	573504	VABM-L1-14W-G14-8-GR
		9 valve positions	573505	VABM-L1-14W-G14-9-GR
		10 valve positions	573506	VABM-L1-14W-G14-10-GR
		12 valve positions	573507	VABM-L1-14W-G14-12-GR
		16 valve positions	573508	VABM-L1-14W-G14-16-GR
20 valve positions		573509	VABM-L1-14W-G14-20-GR	
24 valve positions		573510	VABM-L1-14W-G14-24-GR	
8 double solenoid + 8 single solenoid valves		573936	VABM-L1-14W-G14-16-M-GR	
4 double solenoid + 16 single solenoid valves		573937	VABM-L1-14W-G14-20-M-GR	
24 single solenoid valves		573938	VABM-L1-14W-G14-24-M-GR	

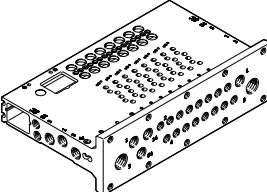
Ordering data	Description	Part no.	Type	
<b>Manifold rail for sub-base valve, for control cabinet installation, outlet direction to the front</b>				
	<b>Size 10 mm</b>			
	Ports 2, 4 at the front, single supply	4 valve positions	8058335	VABM-L1-10HWS1-G18-4-GR
		8 valve positions	8058336	VABM-L1-10HWS1-G18-8-GR
	Ports 2, 4 at the front, double supply	8 valve positions	8058338	VABM-L1-10HWS2-G18-8-GR
		12 valve positions	8058339	VABM-L1-10HWS2-G18-12-GR
		16 valve positions	8058340	VABM-L1-10HWS2-G18-16-GR
		24 valve positions	8058341	VABM-L1-10HWS2-G18-24-GR
	<b>Size 14 mm</b>			
	Ports 2, 4 at the front, single supply	4 valve positions	8058342	VABM-L1-14HWS1-G14-4-GR
		8 valve positions	8058343	VABM-L1-14HWS1-G14-8-GR
	Ports 2, 4 at the front, double supply	8 valve positions	8058344	VABM-L1-14HWS2-G14-8-GR
		12 valve positions	8058345	VABM-L1-14HWS2-G14-12-GR
		16 valve positions	8058346	VABM-L1-14HWS2-G14-16-GR
		24 valve positions	8058347	VABM-L1-14HWS2-G14-24-GR



## Datasheet – Multi-pin plug connection

The following multi-pin plug connections are available for the valve terminal VTUG:

- Sub-D (25-pin)
- Sub-D (44-pin)
- Ribbon cable (26-pin)
- Ribbon cable (50-pin)



### Electrical multi-pin

Each pin on the multi-pin plug can actuate exactly one solenoid coil.

If the maximum configurable number of valve positions is 24, this means that 48 valve functions can be addressed.

The valves can be switched using positive or negative logic (positive switching or negative switching).

Mixed operation is generally not possible; however, an exception is made for the V22 ... V25 variants with 25-pin Sub-D. With these variants, a specific range of valve positions (e.g. Com 16...19) is supplied with common voltage.

This allows these ranges to be switched with positive or negative logic and valve groups to be switched off independently of the other ranges. Mixed operation within a range is not permitted.

#### Note

A double solenoid valve occupies one valve position and two pins on the multi-pin plug. This means that the number of double solenoid valves per manifold rail is limited.

General technical data				
Type	VAEM-L1-S-M1-25	VAEM-L1-S-M1-44	VAEM-L1-S-M3-26	VAEM-L1-S-M3-50
Number of pins	25-pin	44-pin	26-pin	50-pin
Electrical connection	Sub-D plug		Ribbon cable plug	
Max. no. of valve positions	24		24	
Degree of protection to EN 60529	IP67		IP40	
Material	PA		PA	
Note on materials	RoHS-compliant		RoHS-compliant	
Certification	c UL us - Recognized (OL)			
CE marking (see declaration of conformity) <sup>1)</sup>	To EU EMC Directive			
Corrosion resistance class CRC <sup>2)</sup>	2			
LABS (PWIS) conformity	VDMA24364-B1/B2-L			
Weight [g]	53		45	48

1) For information about the area of use, see the EC declaration of conformity at: [www.festo.com/catalogue/...](http://www.festo.com/catalogue/...) → Support/Downloads.

If the devices are subject to usage restrictions in residential, commercial or light-industrial environments, further measures for the reduction of the emitted interference may be necessary.

2) More information: [www.festo.com/x/topic/crc](http://www.festo.com/x/topic/crc)

Datasheet – Multi-pin plug connection

Pin allocation – Sub-D plug, 25-pin												
	Pin	Wire colour <sup>1)</sup>	M1-25 (V20)								M1-25V1 (V22)	
			12x double solenoid		8x double solenoid 8x single solenoid		4x double solenoid 16x single solenoid		24x single solenoid			
	1	WH	VP0	14	VP0	14	VP0	14	VP0	14	VP0	14
	2	BN	VP0	12	VP0	12	VP0	12	VP23	14	VP0	12
	3	GN	VP1	14	VP1	14	VP1	14	VP1	14	VP1	14
	4	YE	VP1	12	VP1	12	VP1	12	VP22	14	VP1	12
	5	GY	VP2	14	VP2	14	VP2	14	VP2	14	VP2	14
	6	PK	VP2	12	VP2	12	VP2	12	VP21	14	VP2	12
	7	BU	VP3	14	VP3	14	VP3	14	VP3	14	VP3	14
	8	RD	VP3	12	VP3	12	VP3	12	VP20	14	VP3	12
	9	BK	VP4	14	VP4	14	VP4	14	VP4	14	VP4	14
	10	VT	VP4	12	VP4	12	VP19	14	VP19	14	VP4	12
	11	GY PK	VP5	14	VP5	14	VP5	14	VP5	14	VP5	14
	12	RD BU	VP5	12	VP5	12	VP18	14	VP18	14	VP5	12
	13	GN WH	VP6	14	VP6	14	VP6	14	VP6	14	VP6	14
	14	BN GN	VP6	12	VP6	12	VP17	14	VP17	14	VP6	12
	15	YE WH	VP7	14	VP7	14	VP7	14	VP7	14	VP7	14
	16	BN YE	VP7	12	VP7	12	VP16	14	VP16	14	VP7	12
	17	GY WH	VP8	14	VP8	14	VP8	14	VP8	14	VP8	14
	18	BN GY	VP8	12	VP15	14	VP15	14	VP15	14	VP8	12
	19	WH PK	VP9	14	VP9	14	VP9	14	VP9	14	VP9	14
	20	BN PK	VP9	12	VP14	14	VP14	14	VP14	14	VP9	12
	21	BU WH	VP10	14	VP10	14	VP10	14	VP10	14	Com 16...19	
	22	BN BU	VP10	12	VP13	14	VP13	14	VP13	14	Com 12...15	
	23	RD WH	VP11	14	VP11	14	VP11	14	VP11	14	Com 8...11	
	24	BN RD	VP11	12	VP12	14	VP12	14	VP12	14	Com 4...7	
	25	BK WH	Com		Com		Com	Com	Com		Com 0...3	

1) According to IEC 60757  
VP Valve position

 **Note**  
A grey field means that a double solenoid valve can be used. Only single solenoid valves can be used for fields with a white background.

Datasheet – Multi-pin plug connection

Pin allocation – Sub-D plug, 25-pin						Pin allocation – Sub-D plug, 44-pin					
Pin	Wire colour <sup>1)</sup>	M1-25V2 (V23)	M1-25V3 (V24)	M1-25V4 (V25)		Pin	Wire colour <sup>1)</sup>	M1-44 (V21)			
								18x double solenoid, 6x single solenoid			
1	WH	VP0	14	VP0	14	VP0	14	1	WH	VP0	14
2	BN	VP0	12	VP0	12	VP1	14	2	BN	VP0	12
3	GN	VP1	14	VP1	14	VP2	14	3	GN	VP1	14
4	YE	VP1	12	VP1	12	VP3	14	4	YE	VP1	12
5	GY	VP2	14	VP2	14	VP4	14	5	GY	VP2	14
6	PK	VP2	12	VP2	12	VP5	14	6	PK	VP2	12
7	BU	VP3	14	VP3	14	VP6	14	7	BU	VP3	14
8	RD	VP3	12	VP3	12	VP7	14	8	RD	VP3	12
9	BK	VP4	14	VP4	14	VP8	14	9	BK	VP4	14
10	VT	VP4	12	VP5	14	VP9	14	10	VT	VP4	12
11	GY PK	VP5	14	VP6	14	VP10	14	11	GY PK	VP5	14
12	RD BU	VP5	12	VP7	14	VP11	14	12	RD BU	VP5	12
13	GN WH	VP6	14	VP8	14	VP12	14	13	GN WH	VP6	14
14	BN GN	VP6	12	VP9	14	VP13	14	14	BN GN	VP6	12
15	YE WH	VP7	14	VP10	14	VP14	14	15	YE WH	VP7	14
16	BN YE	VP7	12	VP11	14	VP15	14	16	BN YE	VP7	12
17	GY WH	VP8	14	VP12	14	VP16	14	17	GY WH	VP8	14
18	BN GY	VP9	14	VP13	14	VP17	14	18	BN GY	VP8	12
19	WH PK	VP10	14	VP14	14	VP18	14	19	WH PK	VP9	14
20	BN PK	VP11	14	VP15	14	VP19	14	20	BN PK	VP9	12
21	BU WH	Com 16...19		Com 16...19		Com 16...19		21	BU WH	VP10	14
22	BN BU	Com 12...15		Com 12...15		Com 12...15		22	BN BU	VP10	12
23	RD WH	Com 8...11		Com 8...11		Com 8...11		23	RD WH	VP11	14
24	BN RD	Com 4...7		Com 4...7		Com 4...7		24	BN RD	VP11	12
25	BK WH	Com 0...3		Com 0...3		Com 0...3		25	BK WH	VP12	14
–								26	BK BN	VP12	12
–								27	GN GY	VP13	14
–								28	YE GY	VP13	12
–								29	GN PK	VP14	14
–								30	YE PK	VP14	12
–								31	GN BU	VP15	14
–								32	YE BU	VP15	12
–								33	RD GN	VP16	14
–								34	RD YE	VP16	12
–								35	BK GN	VP17	14
–								36	BK YE	VP17	12
–								37	BU GY	VP18	14
–								38	BU PK	VP19	14
–								39	RD GY	VP20	14
–								40	RD PK	VP21	14
–								41	BK GY	VP22	14
–								42	BK PK	VP23	14
–								43	BK BU	com	
–								44	BK RD		

1) According to IEC 60757  
VP Valve position

 **Note**  
A grey field means that a double solenoid valve can be used. Only single solenoid valves can be used for fields with a white background.





Datasheet – Multi-pin plug connection

**Dimensions**

Multi-pin plug connection, Sub-D

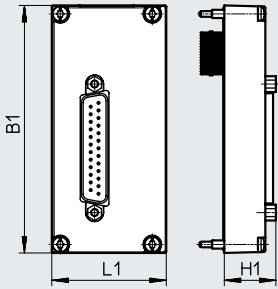
Download CAD data → [www.festo.com](http://www.festo.com)



-  - **Note**  
 Dimensions of the manifold rail with electrical connection  
 (→ page 63)

Type	B1	L1	H1
VAEM-L1-S-M1-...	90.5	41.9	18.9

**Dimensions**

Multi-pin plug connection, ribbon cable

Download CAD data → [www.festo.com](http://www.festo.com)

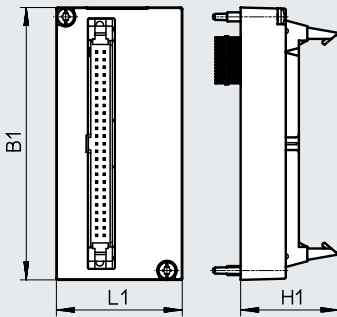

-  - **Note**  
 Dimensions of the manifold rail with electrical connection  
 (→ page 63)

Type	B1	L1	H1
VAEM-L1-S-M3-...	90.5	41.9	32.7

## Accessories – Multi-pin plug connection

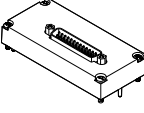
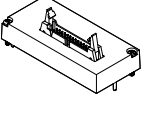
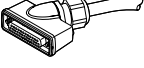
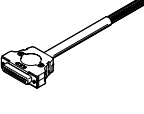
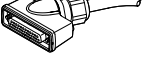
Ordering data		Description	Part no.	Type	
<b>Electrical interface, Sub-D</b>					
	25-pin	For variant M1-25 (V20)	573445	VAEM-L1-S-M1-25	
		For variant M1-25V1 (V22)	573447	VAEM-L1-S-M1-25V1	
		For variant M1-25V2 (V23)	573448	VAEM-L1-S-M1-25V2	
		For variant M1-25V3 (V24)	573449	VAEM-L1-S-M1-25V3	
		For variant M1-25V4 (V25)	573450	VAEM-L1-S-M1-25V4	
44-pin	For variant M1-44 (V21)	573446	VAEM-L1-S-M1-44		
<b>Electrical interface, ribbon cable plug</b>					
	26-pin	For variant M3-26 (V20)	573452	VAEM-L1-S-M3-26	
	50-pin	For variant M3-50 (V26)	573451	VAEM-L1-S-M3-50	
<b>Connecting cable for multi-pin, for the EX2 variant</b>					
	Sub-D socket, angled	<ul style="list-style-type: none"> <li>• 25-pin, up to 24 coils, IP65</li> <li>• Open cable end, 25-core</li> </ul>	2.5 m	575423	NEBV-S1WA25-K-2.5-N-LE25-S9
			5 m	575424	NEBV-S1WA25-K-5-N-LE25-S9
			10 m	575425	NEBV-S1WA25-K-10-N-LE25-S9
		<ul style="list-style-type: none"> <li>• 44-pin, up to 42 coils, IP65</li> <li>• Open cable end, 44-core</li> </ul>	2.5 m	575420	NEBV-S1WA44-K-2.5-N-LE44-S9
			5 m	575421	NEBV-S1WA44-K-5-N-LE44-S9
			10 m	575422	NEBV-S1WA44-K-10-N-LE44-S9
<b>Connecting cable for multipole, for the EX2E variant</b>					
	Sub-D socket, straight	<ul style="list-style-type: none"> <li>• 25-pin, up to 24 coils, IP40</li> <li>• Open cable end, 25-core</li> </ul>	2.5 m	575417	NEBV-S1G25-K-2.5-N-LE25-S6
			5 m	575418	NEBV-S1G25-K-5-N-LE25-S6
			10 m	575419	NEBV-S1G25-K-10-N-LE25-S6
		<ul style="list-style-type: none"> <li>• 44-pin, up to 42 coils, IP40</li> <li>• Open cable end, 44-core</li> </ul>	2.5 m	575113	NEBV-S1G44-K-2.5-N-LE44-S6
			5 m	575114	NEBV-S1G44-K-5-N-LE44-S6
			10 m	575115	NEBV-S1G44-K-10-N-LE44-S6
	Sub-D socket, angled	<ul style="list-style-type: none"> <li>• 25-pin, up to 24 coils, IP65</li> <li>• Open cable end, 25-core</li> </ul>	2.5 m	575423	NEBV-S1WA25-K-2.5-N-LE25-S9
			5 m	575424	NEBV-S1WA25-K-5-N-LE25-S9
			10 m	575425	NEBV-S1WA25-K-10-N-LE25-S9
		<ul style="list-style-type: none"> <li>• 44-pin, up to 42 coils, IP65</li> <li>• Open cable end, 44-core</li> </ul>	2.5 m	575420	NEBV-S1WA44-K-2.5-N-LE44-S9
			5 m	575421	NEBV-S1WA44-K-5-N-LE44-S9
			10 m	575422	NEBV-S1WA44-K-10-N-LE44-S9

## Datasheet – I-Port interface/IO-Link®

Festo-specific, standardised interface for direct connection to the fieldbus by mounting the bus node CTEU or via an IO-Link master via a cable (in IO-Link® mode).



### Approved protocols for the I-Port interface/IO-Link®

Versions:

- I-Port interface for bus nodes (CTEU)
- IO-Link® mode for direct connection to a higher-level IO-Link master

The following protocols are supported in connection with the associated CTEU bus node:

- CTEU-EP-EX1C (only with EX2E)
- CTEU-PB-EX1C (only with EX2E)
- CTEU-PN-EX1C (only with EX2E)

The electrical supply/transmission of communication takes place via an M12 plug.

The valve terminal can be equipped with 4 ... 24 (double solenoid) valves.

### General technical data

Types of communication			IO-Link®
Electrical connection			<ul style="list-style-type: none"> <li>• M12 plug, 5-pin</li> <li>• A-coded</li> <li>• Metal thread for shielding</li> </ul>
Baud rates	COM3	[kbps]	230.4
	COM2	[kbps]	38.4
Intrinsic current consumption, logic supply PS		[mA]	30
Intrinsic current consumption, valve supply PL		[mA]	30
Max. number of solenoid coils	VAEM-L1-S-8-PT		16
	VAEM-L1-S-16-PT		32
	VAEM-L1-S-24-PT		48
Max. no. of valve positions	VAEM-L1-S-8-PT		8
	VAEM-L1-S-16-PT		16
	VAEM-L1-S-24-PT		24
Ambient temperature		[°C]	-5 ... +50
Product weight	Outlet on top	[g]	49
	Outlet on the side	[g]	100
Degree of protection to EN 60529			IP67
Certification			c UL us - Recognized (OL)
CE marking (see declaration of conformity) <sup>1)</sup>			To EU EMC Directive
Corrosion resistance class CRC <sup>2)</sup>			2
LABS (PWIS) conformity			VDMA24364-B1/B2-L

1) For information about the area of use, see the EC declaration of conformity at: [www.festo.com/catalogue/...](http://www.festo.com/catalogue/...) → Support/Downloads.

If the devices are subject to usage restrictions in residential, commercial or light-industrial environments, further measures for the reduction of the emitted interference may be necessary.

2) More information: [www.festo.com/x/topic/crc](http://www.festo.com/x/topic/crc)

## Datasheet – I-Port interface/IO-Link®

Status LED X1	Meaning (up to Rev. 07)	Meaning (from Rev. 08)
Illuminated green	Normal operating status	Data communication faulty
Flashes green	Data communication faulty	Normal operating status
Flashes alternately between red/green	24 V load voltage supply faulty	-
Flashes red	Device error	
Illuminated red	24 V load voltage supply and data communication faulty	24 V load voltage supply faulty. Data communication may be faulty
Off	No 24 V operating voltage supply or undervoltage	

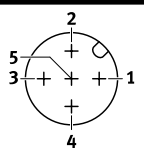
Pin allocation – I-Port interface/IO-Link®			
	Pin	Allocation	Description
	1	24V <sub>EL/SEN</sub>	Operating voltage supply (electronics, sensors/inputs)
	2	24V <sub>VAL/OUT</sub>	Load voltage supply (valves/outputs)
	3	0V <sub>EL/SEN</sub>	Operating voltage supply (electronics, sensors/inputs)
	4	C/Q	Data communication
	5	0V <sub>VAL/OUT</sub>	Load voltage supply (valves/outputs)

### System overview – IO-Link®

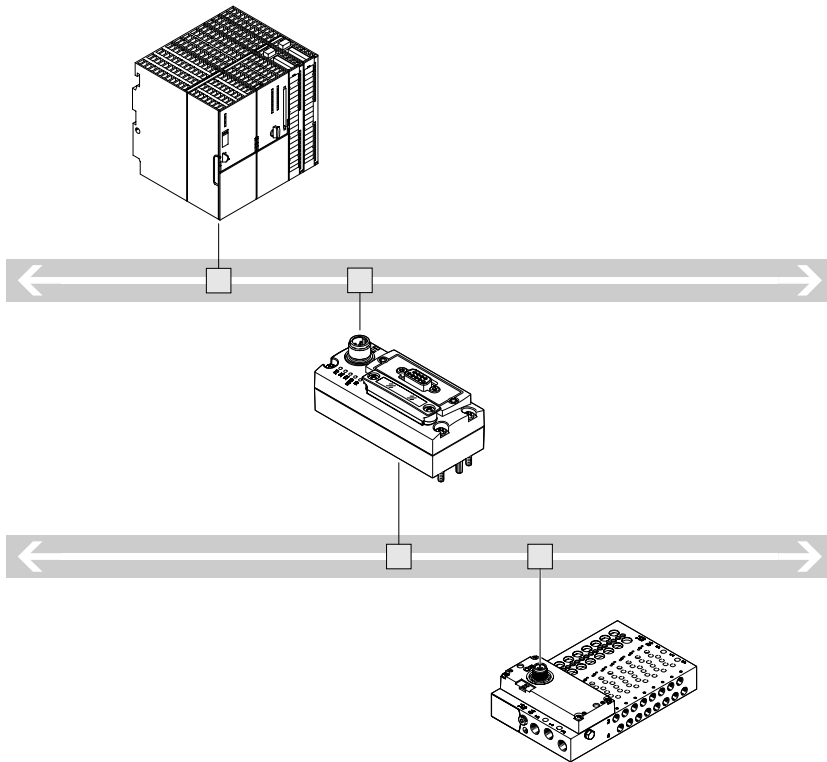

- Communication with the higher-order controller via fieldbus
- Use a bus node CTEU compatible with the fieldbus protocol
- Up to 64 inputs/outputs (solenoid coils), depending on the valve terminal
- No preprocessing





## Datasheet – I-Port interface/IO-Link®

### Dimensions

Download CAD data → [www.festo.com](http://www.festo.com)

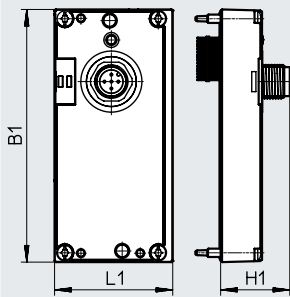
I-Port interface, outlet on top



-  - **Note**

Dimensions of the manifold rail with electrical connection → page 67

I-Port interface, outlet on side

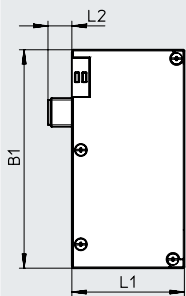





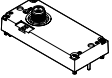

-  - **Note**

Dimensions of the manifold rail with electrical connection → page 67

Type	Outlet on top			Outlet on the side		
	B1	L1	H1	B1	L1	L2
VAEM-L1-S-...	91	42.5	25	91.5	47.1	10

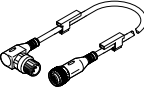
Datasheet – I-Port interface/IO-Link®

Ordering data				
	Description	Part no.	Type	
<b>Electrical interface for I-Port interface/IO-Link®, outlet on top</b>				
	Actuation of up to 8 double solenoid valve positions	573384	VAEM-L1-S-8-PT	
	Actuation of up to 16 double solenoid valve positions	573939	VAEM-L1-S-16-PT	
	Actuation of up to 24 double solenoid valve positions	573940	VAEM-L1-S-24-PT	
<b>Connection technology for IO-Link®</b>				
	T-adapter M12, 5-pin for IO-Link® and load supply	171175	FB-TA-M12-5POL	
	Straight plug, M12, 5-pin, for T adapter FB-TA	175487	SEA-M12-5GS-PG7	
	Y-distributor with cable on controller side, M12x1 A-coded, for IO-Link®	Cable length 1 m	8091516	NEBU-L1R2-M12G5-M12LE-1R
	M12x1 A-coded, for IO-Link®, straight cable outlet	Cable length 0.5 m	8000208	NEBU-M12G5-K-0.5-M12G4
	M12x1 A-coded, for IO-Link®, straight cable outlet	Cable length 5 m	574321	NEBU-M12G5-E-5-Q8N-M12G5
	M12x1 A-coded, for IO-Link®, straight cable outlet	Cable length 7.5 m	574322	NEBU-M12G5-E-7.5-Q8N-M12G5
	M12x1 A-coded, for IO-Link®, straight cable outlet	Cable length 0.5 m	8003617	NEBU-M12G5-K-0.5-M12W5
	M12x1 A-coded, for IO-Link®, straight cable outlet	Cable length 2 m	8003618	NEBU-M12G5-K-2-M12W5
	M12x1 A-coded, for IO-Link®, angled cable outlet	Cable length 0.5 m	570733	NEBU-M12W5-K-0.5-M12W5
	M12x1 A-coded, for IO-Link®, angled cable outlet	Cable length 2 m	570734	NEBU-M12W5-K-2-M12W5
<b>Inscription label for I-Port interface/IO-Link®</b>				
	40 pieces in frame	565306	ASLR-C-E4	