

Solenoid valves VUVS/valve manifold assembly VTUS, NPT

FESTO

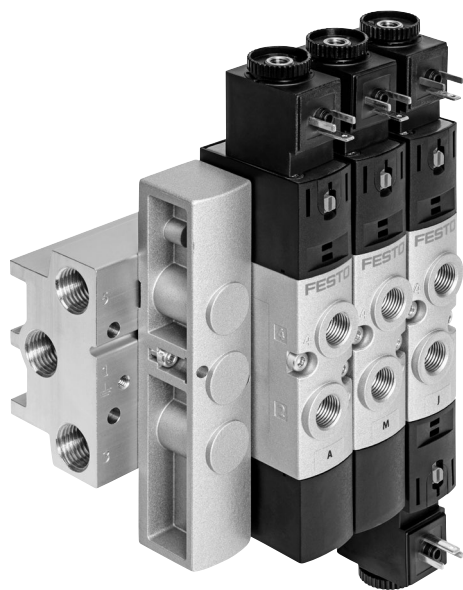

Key features



Innovative

- A reliable, robust valve with a long service life
- Design principle:
 - Poppet seat, soft-sealing (VUVS-LT)
 - Piston spool with sealing cartridge (VUVS-L)
- Flow rate up to 1800 l/min with VUVS-LT
- Flow rate up to 2300 l/min with VUVS-L
- Wide range of valve functions

Versatile

- Operating voltage can be easily altered by changing the solenoid coil
- In-line valves can be used as individual valves or manifold valves
- Variable pressure zones
- Wide range of mounting options

Reliable

- Ergonomic and safe operation
- Reliable servicing thanks to valves that can be replaced quickly and easily

Easy to mount

- Pre-assembled units on rails
- Individual valves assembled ready for installation
- Common supply manifolds for mounting on both sides
- Secure wall mounting or H-rail

Ordering data – Product options

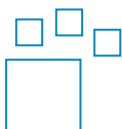

Configurable product
This product and all its product options can be ordered using the configurator.

The configurator can be found at
→ www.festo.com/catalogue/...
Enter the part number or the type.

Part no.	Type
576516	VUVS-20
8022014	VUVS-25
8022017	VUVS-30
577304	VTUS-20
8022016	VTUS-25
8022019	VTUS-30

Key features

Solenoid valves VUVS

In-line valve VUVS-L as individual valve (piston spool valve)

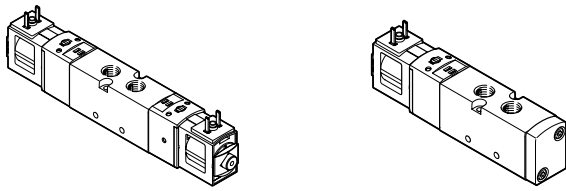

In-line valve VUVS-LT as individual valve (poppet seat valve)

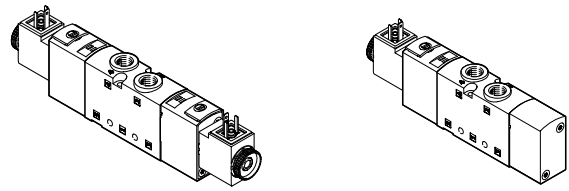

In-line valves are designed to be used without common pneumatic links. All pneumatic connections are on the valve and can be equipped with fittings/tubing. By using a special seal set, the in-line valves can also be

mounted on a manifold rail (pneumatic links) as semi in-line valves.

Valve manifold assembly VTUS

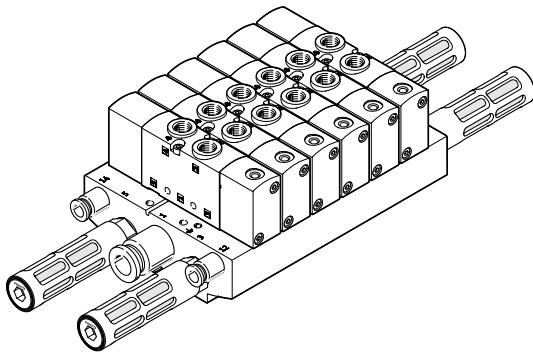

Key features

Equipment options

VUVS-LT

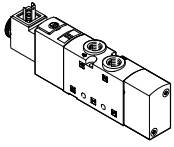

- 3/2-, 2x 3/2- and 5/2-way valves, with or without solenoid coil
- Size 20 (21 mm), size 25 (26.5 mm) and size 30 (31 mm)

Valve functions

3/2-way valve, normally open, single solenoid:

- Internal/external pilot air supply
- Reset via mechanical spring
- Flow direction not reversible

3/2-way valve, normally closed, single solenoid:

- Internal/external pilot air supply
- Reset via mechanical spring
- flow direction not reversible

2x 3/2-way valve, normally open, single solenoid:

- Internal/external pilot air supply
- Reset via mechanical spring
- Flow direction not reversible

2x 3/2-way valve, normally closed, single solenoid:

- Internal/external pilot air supply
- Reset via mechanical spring
- Flow direction not reversible

2x 3/2-way valve, 1x normally open, 1x normally closed, single solenoid:

- Internal/external pilot air supply
- Reset via mechanical spring
- Flow direction not reversible

5/2-way single solenoid valve:

- Internal/external pilot air supply
- Reset via mechanical spring
- Flow direction not reversible

5/2-way double solenoid valve:

- Internal/external pilot air supply
- Flow direction not reversible

Key features

Equipment options

VUVS-L

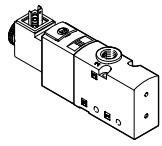

- 3/2-, 5/2- and 5/3-way valves, with or without solenoid coil
- Size 20 (21 mm), size 25 (26.5 mm) and size 30 (31 mm)

Valve functions

3/2-way valve, normally open, single solenoid:

- Internal/external pilot air supply
- Reset via pneumatic/mechanical spring
- Flow direction can be reversed in the case of external pilot air supply

3/2-way valve, normally closed, single solenoid:

- Internal/external pilot air supply
- Reset via pneumatic/mechanical spring
- Flow direction can be reversed in the case of external pilot air supply

5/2-way single solenoid valve:

- Internal/external pilot air supply
- Reset via pneumatic/mechanical spring
- Flow direction can be reversed in the case of external pilot air supply

5/2-way double solenoid valve:

- Internal/external pilot air supply
- Flow direction can be reversed in the case of external pilot air supply

5/3-way valve, mid-position

exhausted, pressurised or closed:

- Internal/external pilot air supply
- Reset via mechanical spring
- Flow direction can be reversed in the case of external pilot air supply

 **Note**

The operating voltage of valves VUVS-L and VUVS-LT can be varied by changing the solenoid coil on the armature guide tube.

Key features

- A maximum of 16 valve positions can be configured in the standard version
- A maximum of 12 valve positions can be configured in the compact version
- Valve positions 2 ... 10 in increments of 1, valve positions 10 ... 16 in increments of 2
- Manifold block with a maximum of 10 valve positions
- Common supply manifold with a maximum of 10 valve positions
- Creation of pressure zones (maximum 9 pressure zones in the case of a valve manifold assembly with 16 valve positions)

Design

Valve replacement

Each valve is attached to the manifold block using two screws. The appropriate seal is mounted on the valve.

This means that the valves can be easily replaced.

Extension

Valve positions covered with cover plates can be replaced with valves at a later date. The dimensions, mounting points and existing pneumatic

installation remain unchanged.

Key features

Standard manifold block

For 3/2-way valves

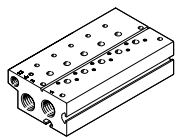

- Connection
Size 20: 3/8 NPT
Size 25: 1/2 NPT
Size 30: 3/4 NPT
- For valves with external pilot air supply
- Maximum 10 valve positions

For 5/2- and 5/3-way valves

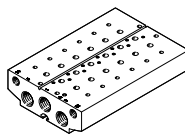

- Connection
Size 20: 3/8 NPT
Size 25: 1/2 NPT
Size 30: 3/4 NPT
- For valves with external pilot air supply
- Maximum 10 valve positions

Compact manifold block

For 3/2-way valves

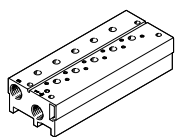

- Connection
Size 20: 1/4 NPT
Size 25: 3/8 NPT
Size 30: 1/2 NPT
- Maximum 10 valve positions

For 5/2- and 5/3-way valves

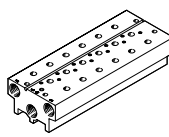

- Connection
Size 20: 1/4 NPT
Size 25: 3/8 NPT
Size 30: 1/2 NPT
- Maximum 10 valve positions

Common supply manifold

Mounting on both sides

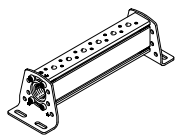

- Connection
Size 20: 3/8 NPT
Size 25: 1/2 NPT
Size 30: 3/4 NPT
- Maximum 10 valve positions

Cover plate for vacant position

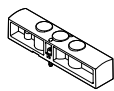

For covering vacant valve positions

Supply plate

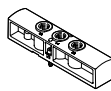

For additional air supply and exhaust via a valve position

Separator for pressure zones



For creating pressure zones (maximum 9 pressure zones permitted)

Note

A filter must be installed upstream of valves operated in vacuum mode. This prevents any foreign matter in the intake air getting into the valve (e.g. when operating a suction cup).

Key features – Pneumatics

Creating pressure zones and separating exhaust air

Compressed air is supplied and exhausted via the manifold block/common supply manifold and via supply plates.

The position of the supply plates and duct separations can be freely selected with the VTUS.

A pressure zone is created by isolating the internal ducts between the valve positions with an appropriate separator.

The separator can be used in the following ducts:

- Duct 1
- Duct 3
- Duct 5

 **Note**

- Use a separator if the exhaust air pressures are high
- Use at least one supply plate/supply for each pressure zone
- Pressure zone separation is not possible in ducts 12 and 14 (pilot air supply)

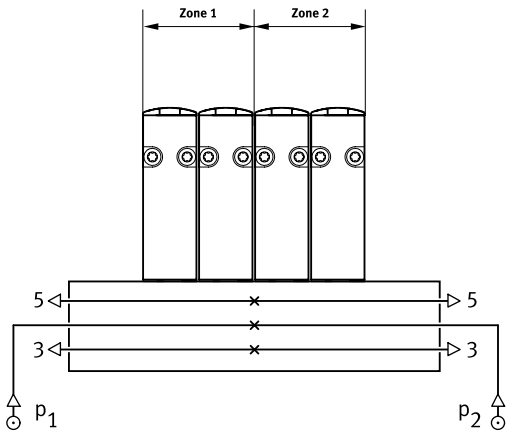
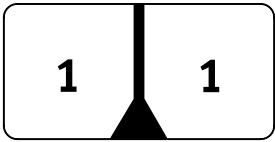
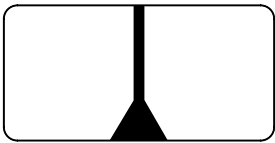
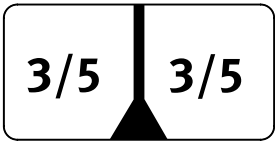
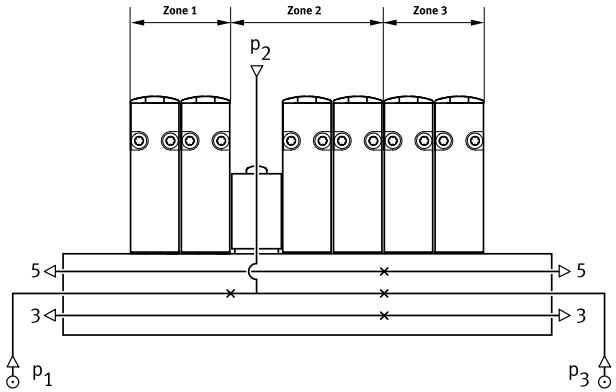
Duct separation	Description	
	<p>The pressure zones can be freely configured with the VTUS. The following duct separations are possible:</p> <ul style="list-style-type: none"> • Duct 1 closed 	
	<ul style="list-style-type: none"> • Duct 1/3/5 closed 	
	<ul style="list-style-type: none"> • Duct 3/5 closed 	
	<p>The number of pressure zones with the VTUS is limited by the number of valve positions on the manifold block/common supply manifold. Note that each supply plate occupies one valve position. There must always be at least two valve positions between two separators. In the case of a maximum extension of 16 valve positions, a maximum of 9 pressure zones can be created.</p>	

Key features – Pneumatics, VUVS-LT

Size 20 – Standard nominal flow rate q_{nN} , with several valves n switched in parallel

For 3/2-way valves

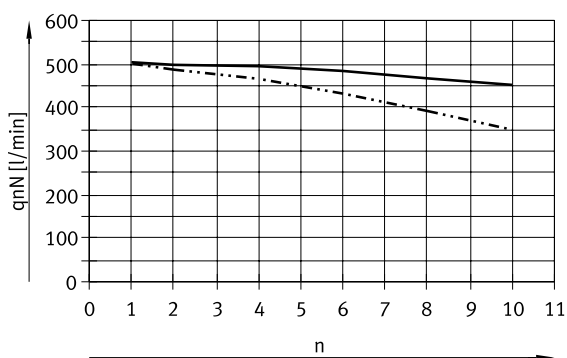

- Standard nominal flow rate per valve on standard manifold rail
- - - Standard nominal flow rate per valve on compact manifold rail

For 5/2-way valves, flow direction 1 → 2

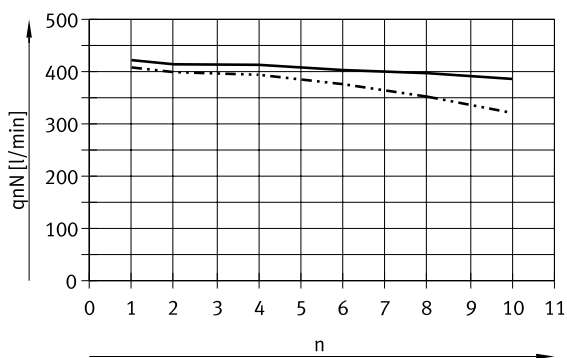

- Standard nominal flow rate per valve on standard manifold rail
- - - Standard nominal flow rate per valve on compact manifold rail

For 5/2-way valves, flow direction 1 → 4

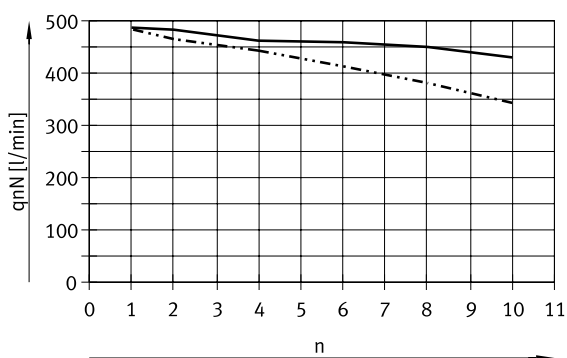

- Standard nominal flow rate per valve on standard manifold rail
- - - Standard nominal flow rate per valve on compact manifold rail

Key features – Pneumatics, VUVS-LT

Size 20 – Standard nominal flow rate q_{nN} , with several valves n switched in parallel

For 2x 3/2-way valves

One valve function per valve position in open switching position

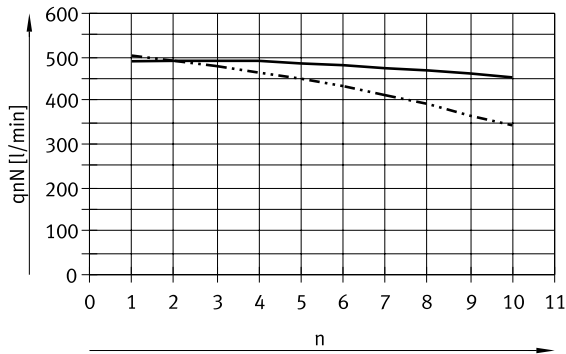

— Standard nominal flow rate per valve on standard manifold rail

- - - Standard nominal flow rate per valve on compact manifold rail

For 2x 3/2-way valves

Both valve functions per valve position simultaneously in open switching position

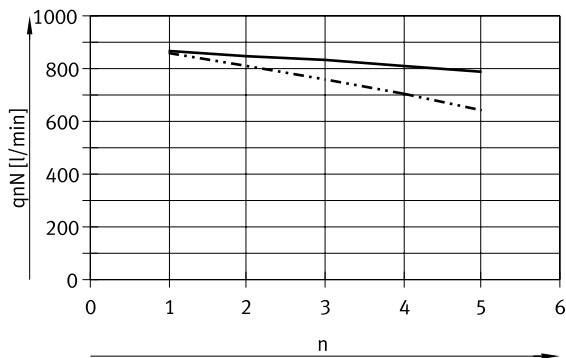

— Standard nominal flow rate per valve on standard manifold rail

- - - Standard nominal flow rate per valve on compact manifold rail

Key features – Pneumatics, VUVS-LT

Size 25 – Standard nominal flow rate q_{nN} , with several valves n switched in parallel

For 3/2-way valves

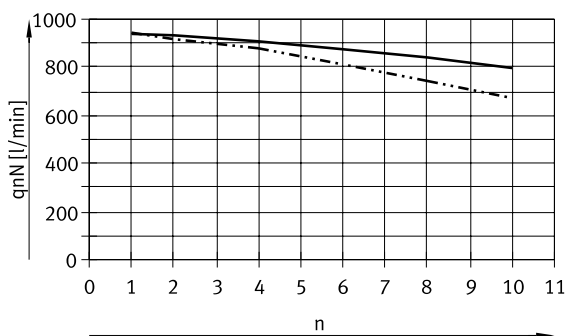

- Standard nominal flow rate per valve on standard manifold rail
- - - Standard nominal flow rate per valve on compact manifold rail

For 5/2-way valves, flow direction 1 → 2

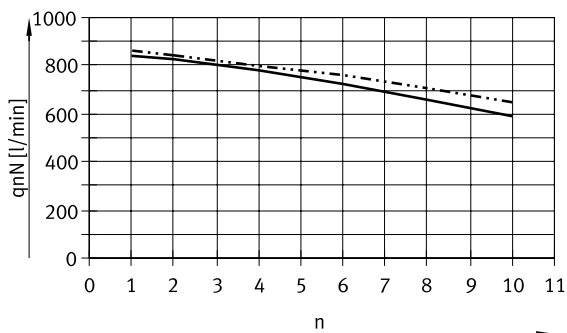

- Standard nominal flow rate per valve on standard manifold rail
- - - Standard nominal flow rate per valve on compact manifold rail

For 5/2-way valves, flow direction 1 → 4

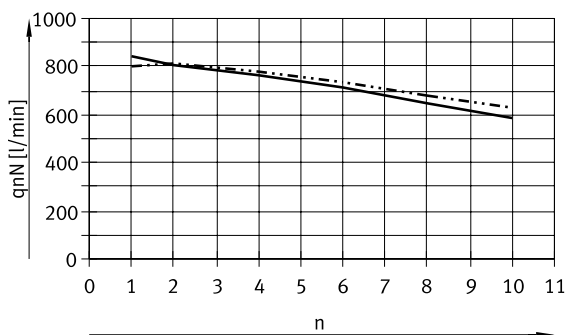

- Standard nominal flow rate per valve on standard manifold rail
- - - Standard nominal flow rate per valve on compact manifold rail

Key features – Pneumatics, VUVS-LT

Size 25 – Standard nominal flow rate q_{nN} , with several valves n switched in parallel

For 2x 3/2-way valves

One valve function per valve position in open switching position

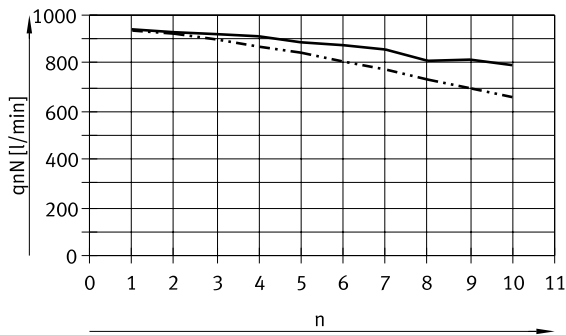

— Standard nominal flow rate per valve on standard manifold rail

⋯ Standard nominal flow rate per valve on compact manifold rail

For 2x 3/2-way valves

Both valve functions per valve position simultaneously in open switching position

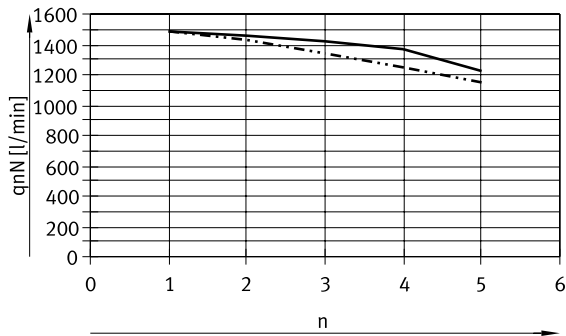

— Standard nominal flow rate per valve on standard manifold rail

⋯ Standard nominal flow rate per valve on compact manifold rail

Key features – Pneumatics, VUVS-LT

Size 30 – Standard nominal flow rate q_{nN} , with several valves n switched in parallel

For 3/2-way valves

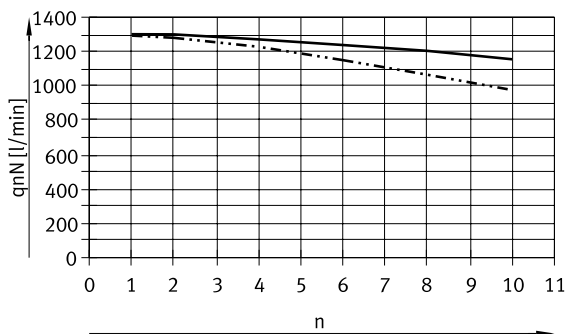

- Standard nominal flow rate per valve on standard manifold rail
- - - Standard nominal flow rate per valve on compact manifold rail

For 5/2-way valves, flow direction 1 → 2

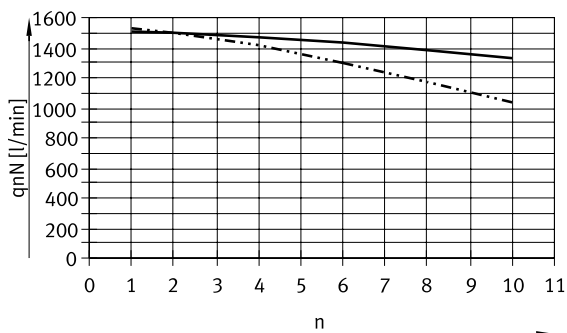

- Standard nominal flow rate per valve on standard manifold rail
- - - Standard nominal flow rate per valve on compact manifold rail

For 5/2-way valves, flow direction 1 → 4

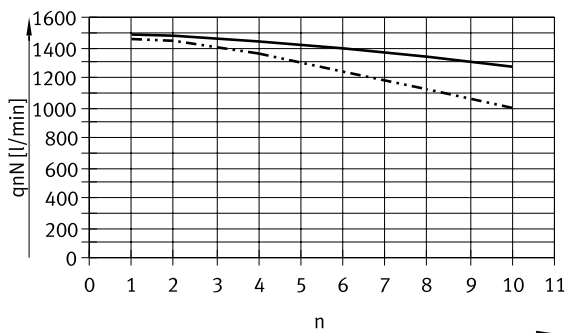

- Standard nominal flow rate per valve on standard manifold rail
- - - Standard nominal flow rate per valve on compact manifold rail

Key features – Pneumatics, VUVS-LT

Size 30 – Standard nominal flow rate q_{nN} , with several valves n switched in parallel

For 2x 3/2-way valves

One valve function per valve position in open switching position

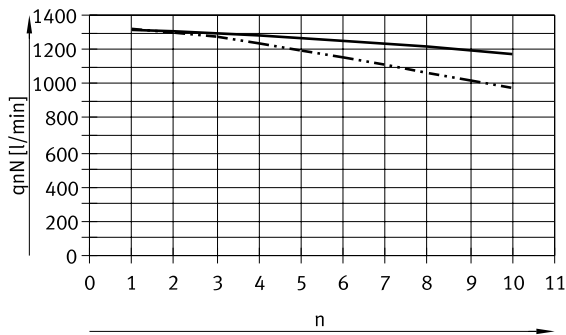

— Standard nominal flow rate per valve on standard manifold rail

- - - Standard nominal flow rate per valve on compact manifold rail

For 2x 3/2-way valves

Both valve functions per valve position simultaneously in open switching position

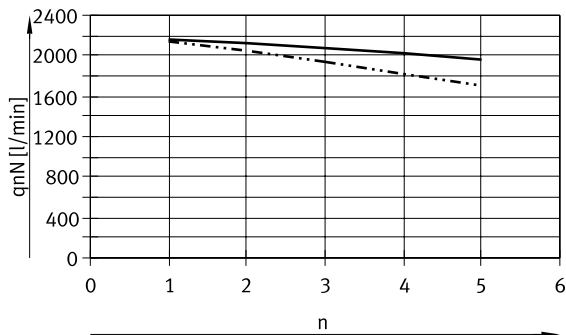

— Standard nominal flow rate per valve on standard manifold rail

- - - Standard nominal flow rate per valve on compact manifold rail

Key features – Pneumatics, VUVS-L

Size 20 – Standard nominal flow rate q_{nN} , with several valves n switched in parallel

For 3/2-way valves

For 5/2- and 5/3-way valves

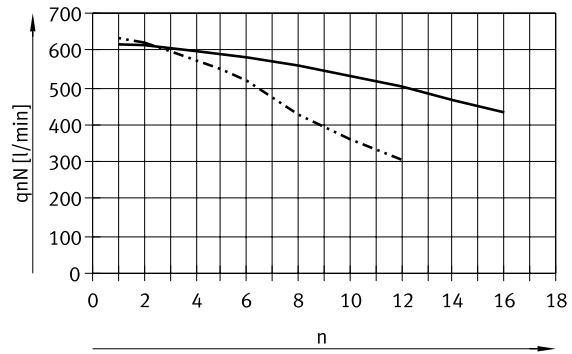
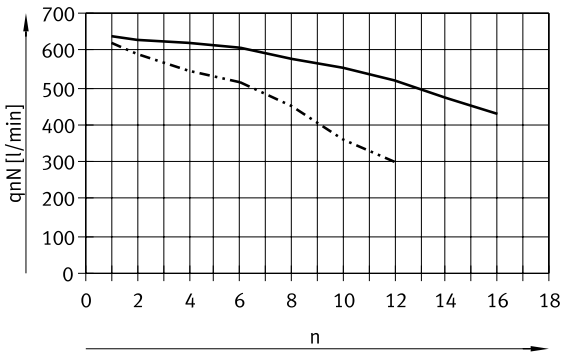

— Standard nominal flow rate per valve on standard manifold rail

- · - · - · Standard nominal flow rate per valve on compact manifold rail

— Standard nominal flow rate per valve on standard manifold rail

- · - · - · Standard nominal flow rate per valve on compact manifold rail

Size 25 – Standard nominal flow rate q_{nN} , with several valves n switched in parallel

For 3/2-way valves

For 5/2- and 5/3-way valves

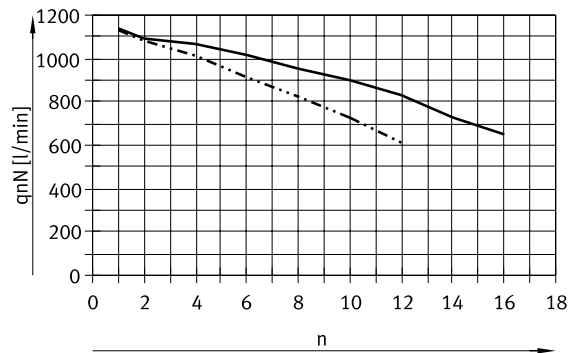
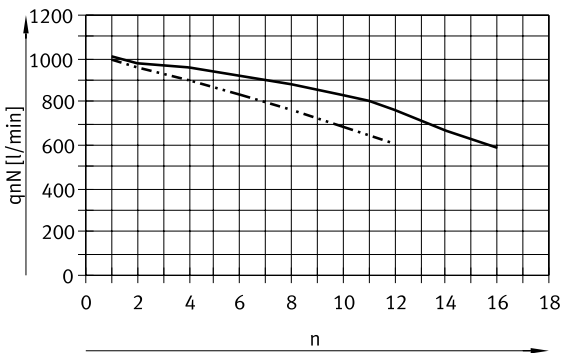

— Standard nominal flow rate per valve on standard manifold rail

- · - · - · Standard nominal flow rate per valve on compact manifold rail

— Standard nominal flow rate per valve on standard manifold rail

- · - · - · Standard nominal flow rate per valve on compact manifold rail

Key features – Pneumatics, VUVS-L

Size 30 – Standard nominal flow rate q_{nN} , with several valves n switched in parallel

For 3/2-way valves

For 5/2- and 5/3-way valves

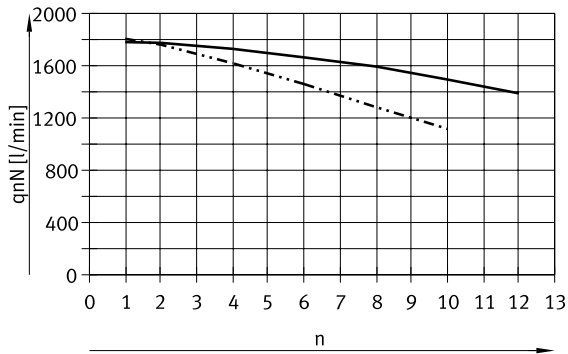

— Standard nominal flow rate per valve on standard manifold rail

- · - · - · Standard nominal flow rate per valve on compact manifold rail

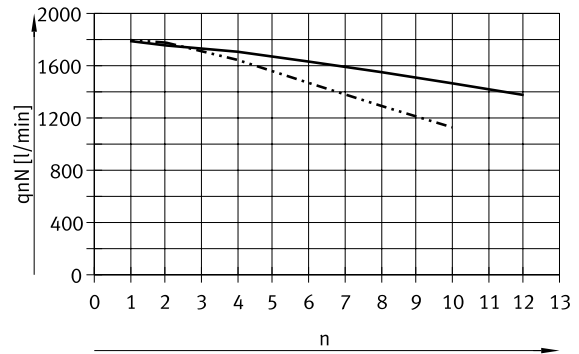

— Standard nominal flow rate per valve on standard manifold rail

- · - · - · Standard nominal flow rate per valve on compact manifold rail

Key features – Pneumatics, VUVS-LT

Size 20 – Pilot pressure p_2 as a function of working pressure p_1 with external pilot air supply

For 3/2-way valves

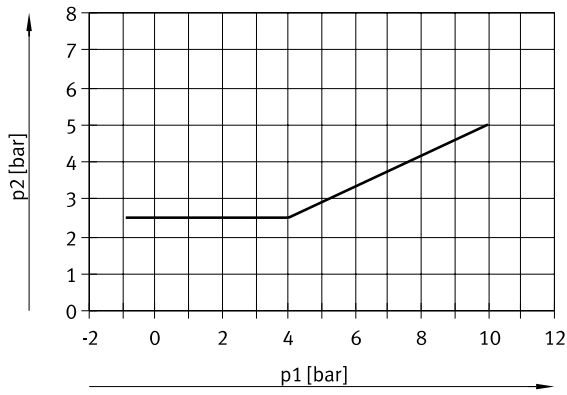

For 5/2-way single solenoid valves

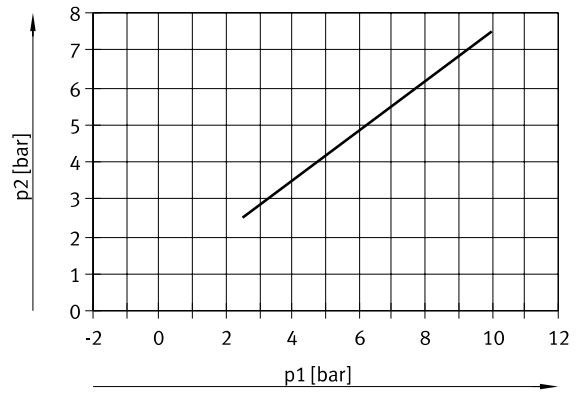

For 5/2-way double solenoid valves

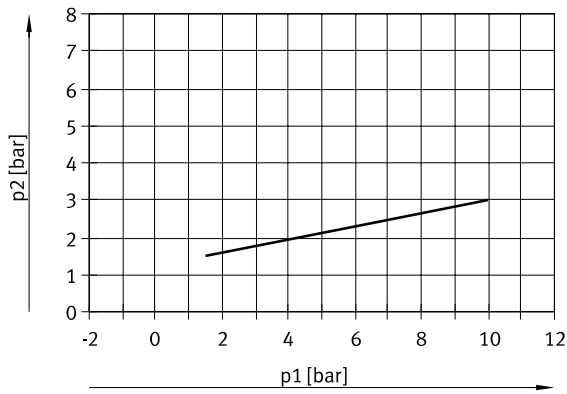

Key features – Pneumatics, VUVS-LT

Size 25 – Pilot pressure p_2 as a function of working pressure p_1 with external pilot air supply

For 3/2-way valves

For 5/2-way single solenoid valves

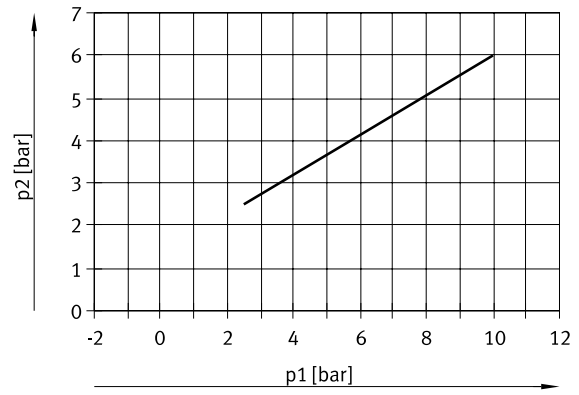
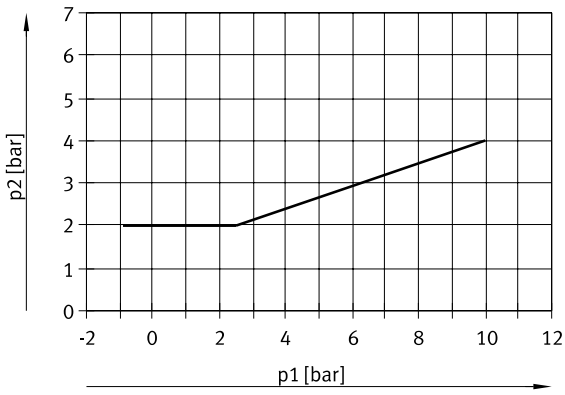

For 5/2-way double solenoid valves

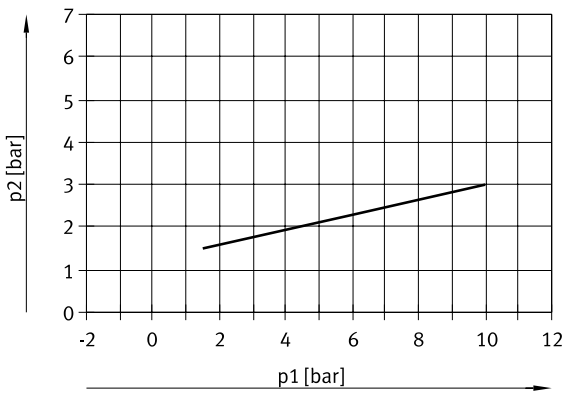

Key features – Pneumatics, VUVS-LT

Size 30 – Pilot pressure p_2 as a function of working pressure p_1 with external pilot air supply

For 3/2-way valves

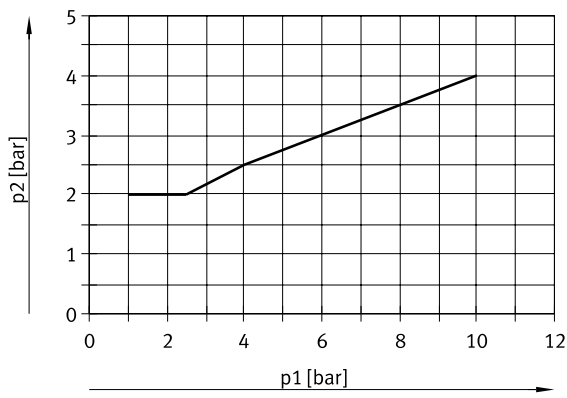

For 5/2-way double solenoid valves

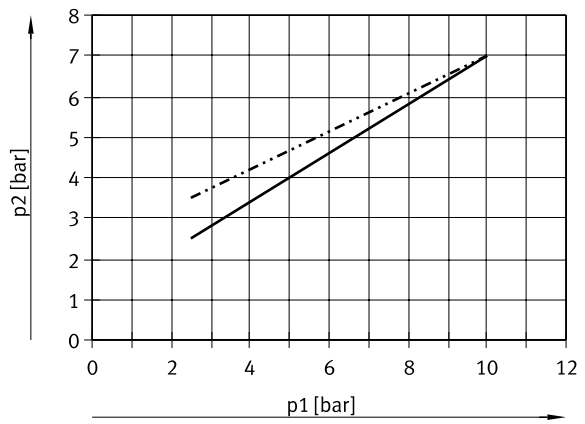

For 5/2-way single solenoid valves

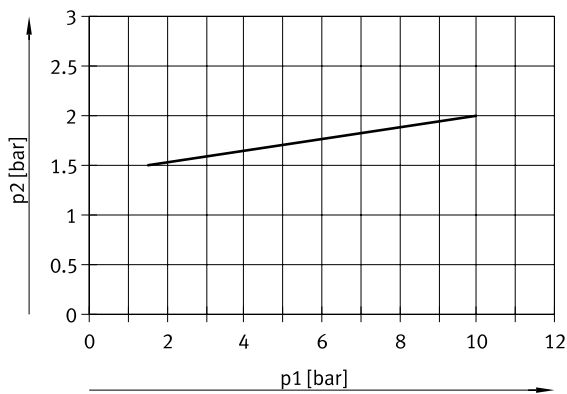

- VUVS-LT30-M52-MZD (0-60°C)
- · - · - VUVS-LT30-M52-MZD (-10-0°C)

Key features – Pneumatics

Mounting – Valve manifold assembly VTUS

Sturdy manifold assembly thanks to:

- Four through-holes for wall mounting
- H-rail mounting

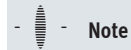

Use the thread M4/M5 provided on the manifold block for earthing the valve manifold assembly.

Wall mounting

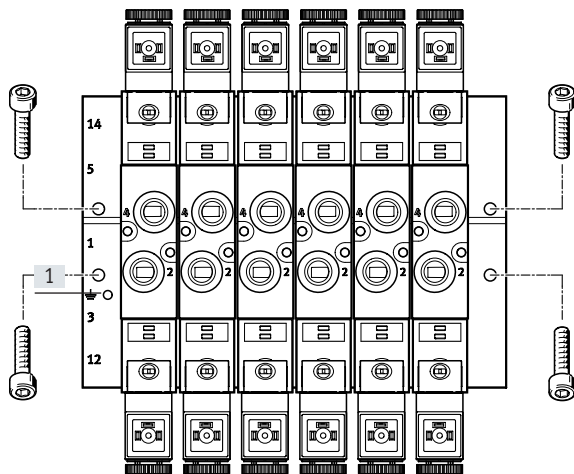

Sturdy wall mounting of the manifold block using four through-holes.

[1] Earth terminal

H-rail mounting

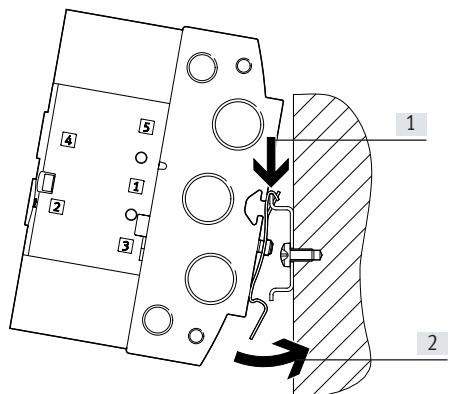

[1] Arrow A

[2] Arrow B

The H-rail mounting VAME-T-M... consists of two mounting clips. These are screwed to the manifold block on the left and right.

The valve manifold assembly VTUS is then lowered onto the H-rail from above (arrow A) and clipped into the H-rail at the bottom (arrow B).



- Note the max. tightening torque of the screws for H-rail mounting.
- Only horizontal H-rail mounting is permissible
- Mounting only permissible on H-rail TH 35-... to EN 60715
- Vibration/shock loads are not permissible with H-rail mounting.
- Further note on assembly → Assembly instructions for H-rail mounting VAME-T-M...

Key features – Mounting

Mounting – Individual valve VUVS

Wall mounting

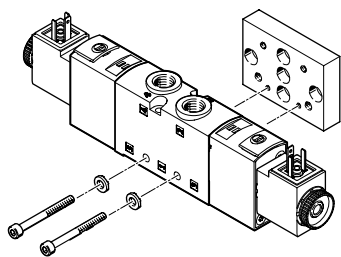

For mounting individual valves on a flat surface, e.g. aluminium profile systems.

The solenoid valves are provided with two through-holes for attaching to the wall mounting VAME-B10-20-W.

The relevant screw set is included when the wall mounting VAME-B10-20-W is ordered.

The wall mounting VAME-B10-20-W can be used for sizes 20, 25 and 30.

Foot mounting

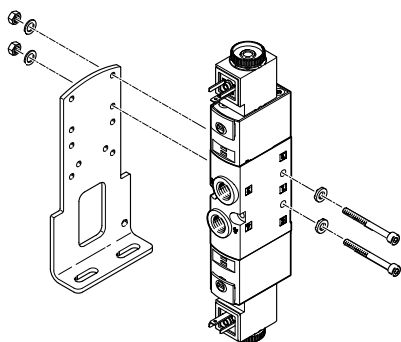

For mounting individual valves on a flat surface, e.g. aluminium profile systems.

The solenoid valves are provided with two through-holes for attaching to the foot mounting VAME-B10-...-A.

The relevant screw set is included when the foot mounting VAME-B10-...-A is ordered.

Note

Further mounting options for foot mounting VAME-B10-...

→ Data sheet – Solenoid valves, dimensions

Cylinder mounting

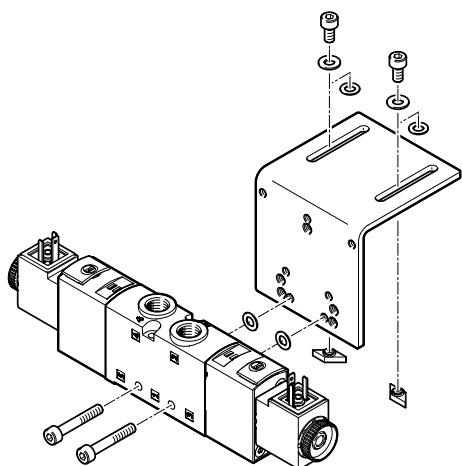

For mounting individual valves directly on a drive.

The solenoid valves are provided with two through-holes for attaching to the cylinder mounting DAVM-MW-V1...-V. Mounting is only possible on the side on which the pneumatic connections are located.

The relevant screw set is included when the cylinder mounting DAVM-MW-V1...-V is ordered.

Product range overview

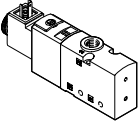
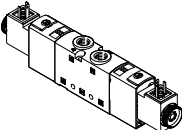
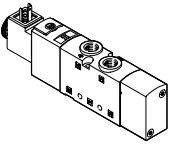
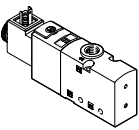
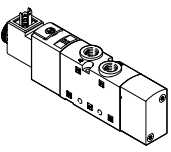
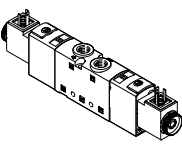
Valve	Size	Working port	Order code for valves and flow rate [l/min]										→ Page/ Internet	
			M32C	M32U	T32C	T32U	T32H	M52	B52	P53C	P53U	P53E		
3/2-way valve VUUS-LT														
	20	1/8 NPT	■ 600	■ 600	-	-	-	-	-	-	-	-	-	44
	25	1/4 NPT	■ 1000	■ 1000	-	-	-	-	-	-	-	-	-	54
	30	3/8 NPT	■ 1600	■ 1600	-	-	-	-	-	-	-	-	-	65
2x 3/2-way valve VUUS-LT														
	20	1/8 NPT	-	-	■ 600	■ 600	■ 600	-	-	-	-	-	-	44
	25	1/4 NPT	-	-	■ 1000	■ 1000	■ 1000	-	-	-	-	-	-	54
	30	3/8 NPT	-	-	■ 1600	■ 1600	■ 1600	-	-	-	-	-	-	65
5/2-way valve VUUS-LT														
	20	1/8 NPT	-	-	-	-	-	■ 500	■ 500	-	-	-	-	44
	25	1/4 NPT	-	-	-	-	-	■ 1000	■ 1000	-	-	-	-	54
	30	3/8 NPT	-	-	-	-	-	■ 1800	■ 1800	-	-	-	-	65
3/2-way valve VUUS-L														
	20	1/8 NPT	■ 700	■ 700	-	-	-	-	-	-	-	-	-	76
	25	1/4 NPT	■ 1000	■ 1000	-	-	-	-	-	-	-	-	-	87
	30	3/8 NPT	■ 2300	■ 2300	-	-	-	-	-	-	-	-	-	99
5/2-way valve VUUS-L														
	20	1/8 NPT	-	-	-	-	-	■ 700	■ 700	-	-	-	-	76
	25	1/4 NPT	-	-	-	-	-	■ 1300	■ 1300	-	-	-	-	87
	30	3/8 NPT	-	-	-	-	-	■ 2300	■ 2300	-	-	-	-	99
5/3-way valve VUUS-L														
	20	1/8 NPT	-	-	-	-	-	-	-	■ 700	■ 600	■ 600	76	
	25	1/4 NPT	-	-	-	-	-	-	-	■ 1200	■ 1000	■ 1000	87	
	30	3/8 NPT	-	-	-	-	-	-	-	■ 2000	■ 1600	■ 1600	99	

Product range overview

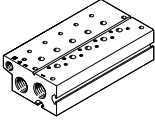
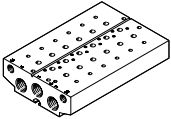
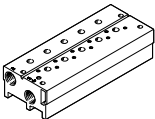
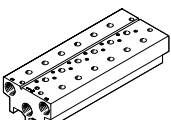
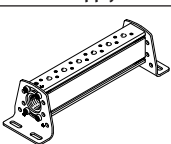
Design type	Size	Description		→ Page/ Internet
Manifold block for 3/2-way valves, standard				
	20	VABM-B10-20E-N38- ... P3	Connection size 3/8 NPT	111
	25	VABM-B10-25E-N12- ... P3	Connection size 1/2 NPT	121
	30	VABM-B10-30E-N34- ... P3	Connection size 3/4 NPT	131
Manifold block for 5/2- and 5/3-way valves, standard				
	20	VABM-B10-20E-N38- ...	Connection size 3/8 NPT	111
	25	VABM-B10-25E-N12- ...	Connection size 1/2 NPT	121
	30	VABM-B10-30E-N34- ...	Connection size 3/4 NPT	131
Manifold block for 3/2-way valves, compact				
	20	VABM-B10-20S-N14- ... P3	Connection size 1/4 NPT	111
	25	VABM-B10-25S-N38- ... P3	Connection size 3/8 NPT	121
	30	VABM-B10-30S-N12- ... P3	Connection size 1/2 NPT	131
Manifold block for 5/2- and 5/3-way valves, compact				
	20	VABM-B10-20S-N14- ...	Connection size 1/4 NPT	111
	25	VABM-B10-25S-N38- ...	Connection size 3/8 NPT	121
	30	VABM-B10-30S-N12- ...	Connection size 1/2 NPT	131
Common supply manifold, for mounting on both sides				
	20	VABM-B10-20-N38- ... -P53	Connection size 3/8 NPT	111
	25	VABM-B10-25-N12- ... -P53	Connection size 1/2 NPT	121
	30	VABM-B10-30-N34- ... -P53	Connection size 3/4 NPT	131

Overview of valve functions

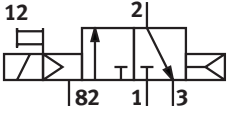
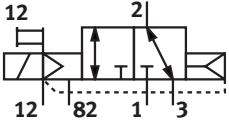
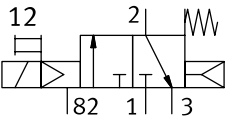
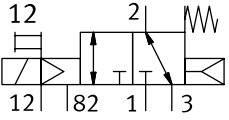
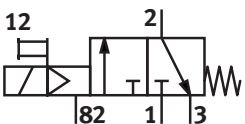
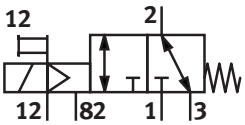
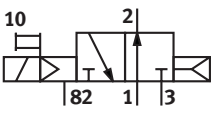
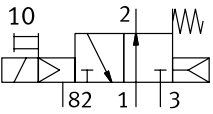
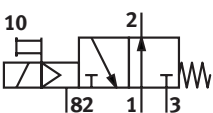
Valve	Order code for valves	Description	VUVS-LT			VUVS-L		
			Size			Size		
			20	25	30	20	25	30
3/2-way valve, normally closed, pneumatic spring								
	M32C-A	Internal pilot air supply, not reversible	-	-	-	■	■	■
		External pilot air supply, reversible	-	-	-	■	■	-
3/2-way valve, normally closed, pneumatic/mechanical spring								
	M32C-M	<ul style="list-style-type: none"> Internal pilot air supply, not reversible Reset: mechanical spring, supported internally by pneumatic spring 	-	-	-	■	-	-
		<ul style="list-style-type: none"> External pilot air supply, reversible Reset: mechanical spring, supported internally by pneumatic spring 	-	-	-	■	-	-
3/2-way valve, normally closed, mechanical spring								
	M32C-M	Internal pilot air supply, not reversible	■	■	■	■	■	■
		External pilot air supply, reversible	-	-	-	■	■	-
3/2-way valve, normally open, pneumatic spring								
	M32U-A	Internal pilot air supply, not reversible	-	-	-	■	■	■
3/2-way valve, normally open, pneumatic/mechanical spring								
	M32C-M	<ul style="list-style-type: none"> Internal pilot air supply, not reversible Reset: mechanical spring, supported internally by pneumatic spring 	-	-	-	■	-	-
3/2-way valve, normally open, mechanical spring								
	M32U-M	Internal pilot air supply, not reversible	■	■	■	-	■	■

Overview of valve functions

Valve	Order code for valves	Description	VUVS-LT			VUVS-L		
			Size			Size		
			20	25	30	20	25	30
2x 3/2-way valve, normally closed, mechanical spring								
	T32C	Internal pilot air supply, not reversible	■	■	■	-	-	-
2x 3/2-way valve, normally open, mechanical spring								
	T32U	Internal pilot air supply, not reversible	■	■	■	-	-	-
2x 3/2-way valve, 1x normally open, 1x normally closed, mechanical spring								
	T32H	Internal pilot air supply, not reversible	■	■	■	-	-	-

Overview of valve functions

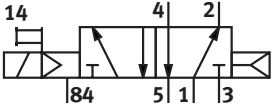
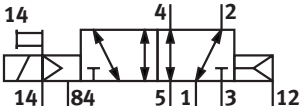
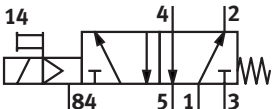
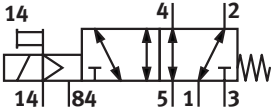
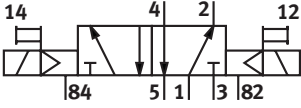
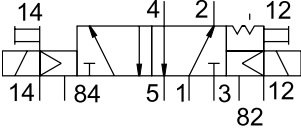
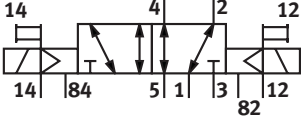
Valve	Order code for valves	Description	VUVS-LT			VUVS-L		
			Size			Size		
			20	25	30	20	25	30
5/2-way valve, monostable, pneumatic spring								
	M52-A	Internal pilot air supply, not reversible	-	-	-	■	■	■
	M52-AZ	External pilot air supply, reversible	-	-	-	■	■	-
5/2-way valve, single solenoid, mechanical spring								
	M52-M	Internal pilot air supply, not reversible	■	■	■	■	■	■
	M52-MZ	External pilot air supply, reversible	-	-	-	■	■	-
5/2-way double solenoid valve								
	B52	Internal pilot air supply, not reversible	-	-	■	■	■	■
		<ul style="list-style-type: none"> Internal pilot air supply, not reversible Holding the switching position via latch 	■	■	-	-	-	-
	B52-Z	External pilot air supply, reversible	-	-	-	■	■	-

Overview of valve functions

Valve	Order code for valves	Description	VUVS-L		
			Size		
			20	25	30
5/3-way valve, mechanical spring, closed					
	P53C-M	Internal pilot air supply, not reversible	■	■	■
	P53C-MZ	External pilot air supply, reversible	■	■	-
5/3-way valve, mechanical spring, pressurised					
	P53U	Internal pilot air supply, not reversible	■	■	■
5/3-way valve, mechanical spring, exhausted					
	P53E	Internal pilot air supply, not reversible	■	■	■

Peripherals overview VUVS-LT, VUVS-L

Manifold block for 3/2-way valves

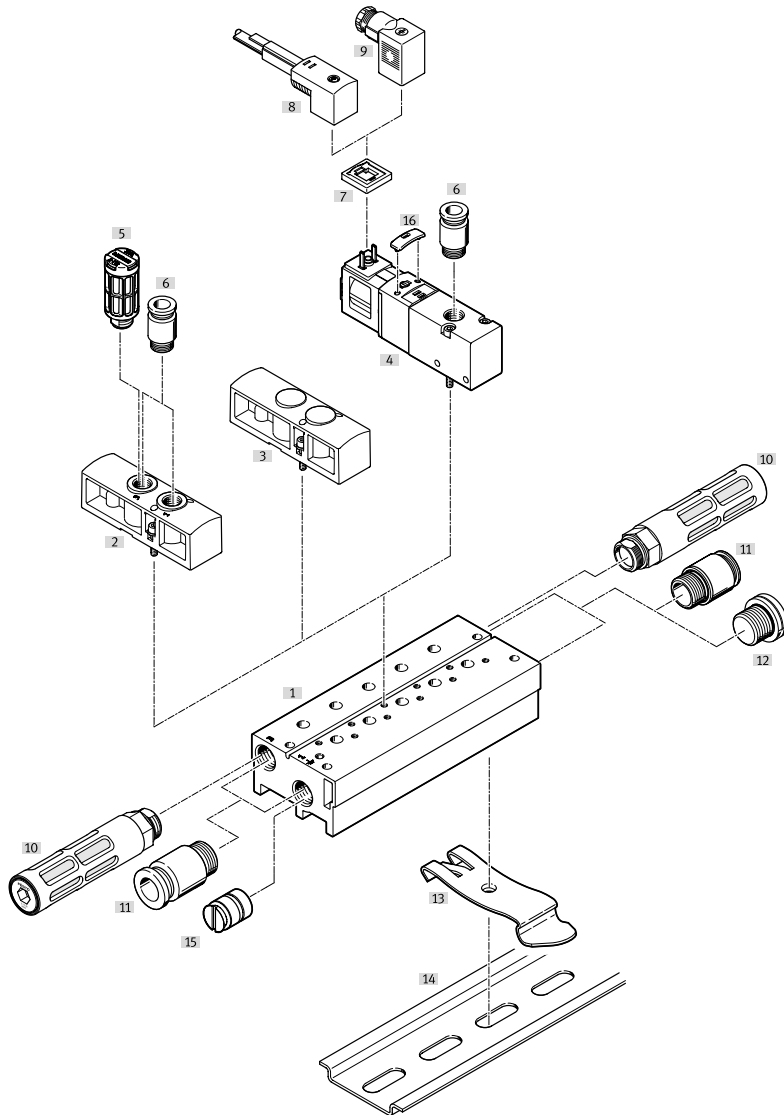

Designation	Description	→ Page/Internet
[1] Compact manifold block	For 3/2-way valves, no port for external pilot air supply	116
[2] Supply plate	For additional air supply and exhaust via a valve position	117
[3] Cover plate	For covering unused valve positions	117
[4] Solenoid valve	3/2-way valve (without solenoid coil)	61
[5] Silencer	For port 3, exhaust	119
[6] Push-in fitting	For ports 1 and 3, supply and exhaust ports with supply plate, for port 2, working port, on the valve	117
[7] Illuminating seal	For indicating the switching status	85
[8] Plug socket with cable	For solenoid valves VUVS	85
[9] Plug socket	For solenoid valves VUVS	85
[10] Silencer	For port 3, exhaust	119
[11] Push-in fitting	For ports 1 and 3, supply and exhaust ports	117
[12] Blanking plug	For ports 1 and 3, supply and exhaust ports	120
[13] H-rail mounting	For H-rail mounting	120
[14] H-rail	–	–
[15] Separator	For creating pressure zones in ports 1 and 3	120
[16] Cover cap	For manual override, non-detenting or covered	51

Peripherals overview VUVS-LT, VUVS-L

Manifold block for 5/2 and 5/3-way valves

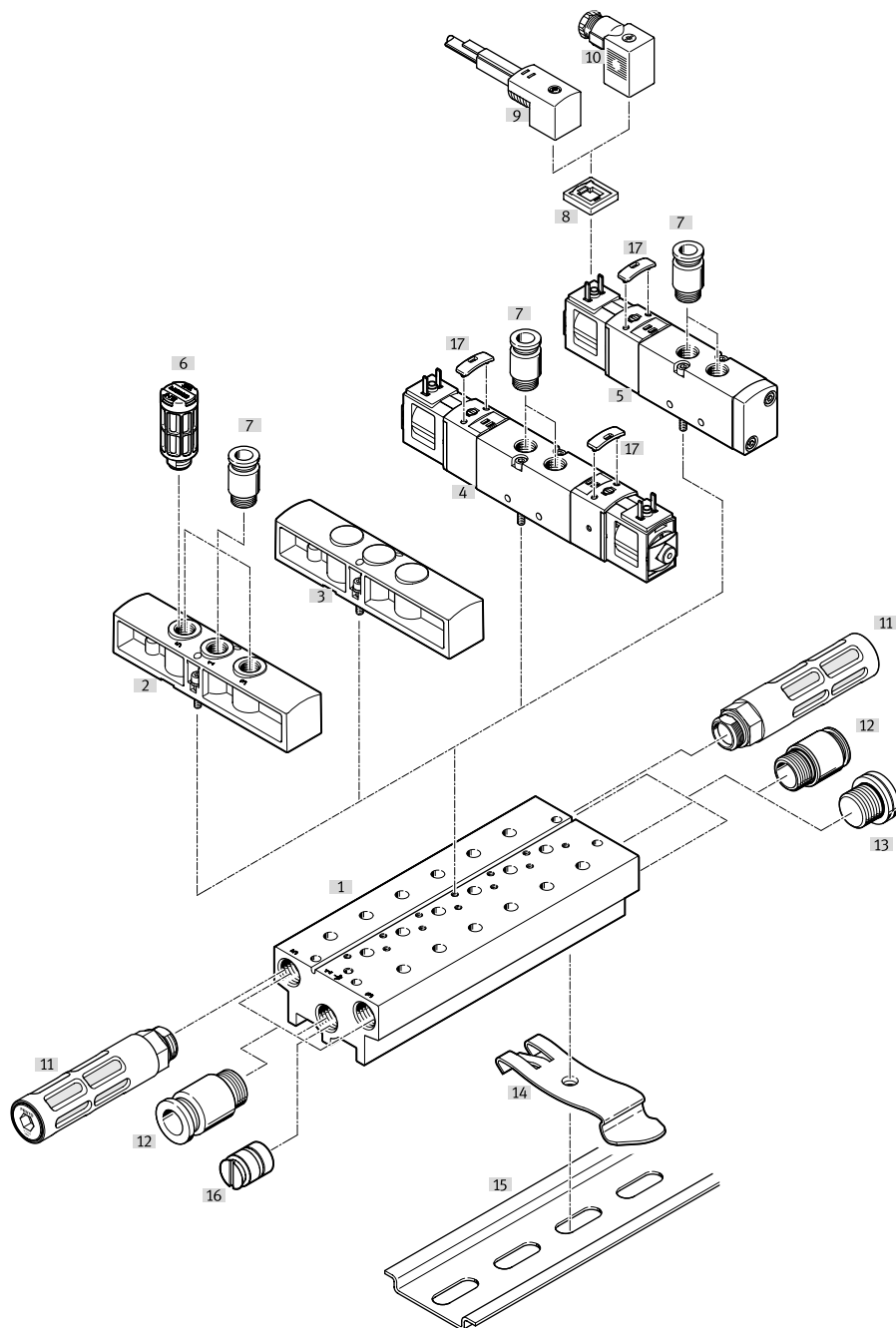

Designation	Description	→ Page/Internet
[1] Compact manifold block	For 5/2- and 5/3-way valves, no port for external pilot air supply	116
[2] Supply plate	For additional air supply and exhaust via a valve position	117
[3] Cover plate	For covering unused valve positions	117
[4] Solenoid valve	5/3-way valve and 5/2-way valve, double solenoid (without solenoid coil)	61
[5] Solenoid valve	5/2-way valve, single solenoid (without solenoid coil)	61
[6] Silencer	For ports 3 and 5, exhaust	119
[7] Push-in fitting	For ports 1, 3 and 5, supply and exhaust ports with supply plate, for ports 2 and 4, working port, on the valve	117
[8] Illuminating seal	For indicating the switching status	85

Peripherals overview VUVS-LT, VUVS-L

Designation	Description	→ Page/Internet
[9] Plug socket with cable	For solenoid valves VUVS	85
[10] Plug socket	For solenoid valves VUVS	85
[11] Silencer	For ports 3 and 5, exhaust	119
[12] Push-in fitting	For ports 1, 3 and 5, supply and exhaust ports	117
[13] Blanking plug	For ports 1, 3 and 5, supply and exhaust ports	120
[14] H-rail mounting	For H-rail mounting	120
[15] H-rail	–	–
[16] Separator	For creating pressure zones in ports 1, 3 and 5	120
[17] Cover cap	For manual override, non-detenting or covered	51

Peripherals overview VUVS-LT, VUVS-L

Common supply manifold for mounting on both sides

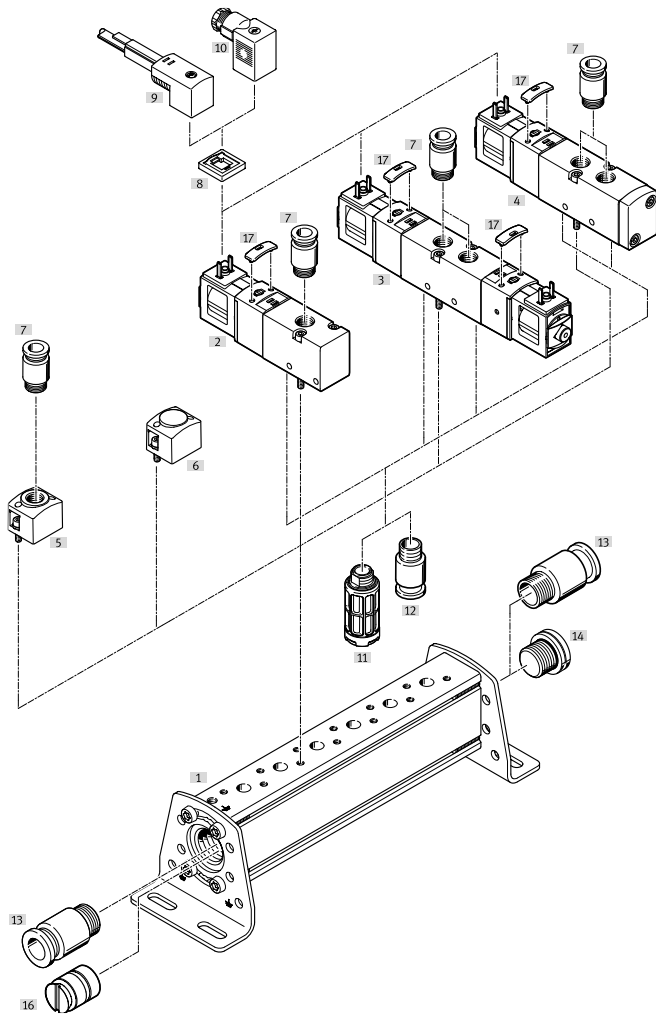

Designation	Description	→ Page/Internet
[1] Common supply manifold	–	116
[2] Solenoid valve	3/2-way valve (without solenoid coil)	61
[3] Solenoid valve	5/3-way valve and 5/2-way double solenoid valve (without solenoid coil) 2x 3/2-way valve (without solenoid coil)	61
[4] Solenoid valve	5/2-way valve, single solenoid (without solenoid coil)	84
[5] Supply plate	For additional air supply via a valve position	117
[6] Cover plate	For covering unused valve positions	117
[7] Push-in fitting	For port 1, working port	117
[8] Illuminating seal	For indicating the switching status	85
[9] Plug socket with cable	For solenoid valves VUVS	85
[10] Plug socket	For solenoid valves VUVS	85
[11] Silencer	For ports 3 and 5, exhaust, on the valve	119
[12] Push-in fitting	For ports 3 and 5, exhaust, on the valve	117
[13] Push-in fitting	For port 1, supply port	117
[14] Blanking plug	For port 1, supply port	120
[16] Separator	For creating pressure zones	120
[17] Cover cap	For manual override, non-detenting or covered	51

Data sheet – Valve manifold assembly

-  - Flow rate
 Size 20:
 up to 700 l/min
 Size 25:
 up to 1300 l/min
 Size 30
 up to 2300 l/min

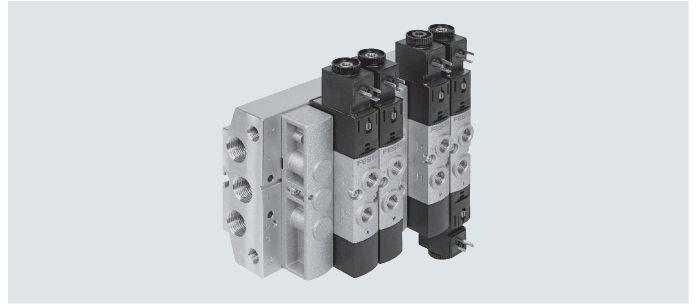

General technical data			20	25	30
Size			20	25	30
Valve manifold assembly design			Fixed grid		
Valve width		[mm]	21	26.5	31
Valve design	VUVS-L		Piston spool with sealing cartridge		
	VUVS-LT		Poppet seat		
Electrical actuation			Individual connection		
Reset method for valves	VUVS-L		Pneumatic or mechanical spring		
	VUVS-LT		Mechanical spring		
Pilot air supply			Internal or external		
Flow direction	VUVS-L		Reversible with restrictions		
	VUVS-LT		Not reversible		
Suitable for vacuum	VUVS-L		Yes, with external pilot air supply		
	VUVS-LT		No		
Overlap	VUVS-L		Positive overlap		
	VUVS-LT		Negative overlap		
Sealing principle			Soft		
Max. no. of valve positions			16 (a maximum of 18 valve positions with extension for standard manifold block)		
Max. number of pressure zones			9		
Exhaust air function			Can be throttled		
Actuation type			Electrical		
Nominal operating voltage		[V DC]	12, 24		
		[V AC]	24, 110, 120, 230, 240		
Standard nominal flow rate q _N		[l/min]	500 ... 700	1000 ... 1300	1600 ... 2300
Pilot air connection	Standard manifold block	12/14	1/8 NPT	1/8 NPT	1/8 NPT
	Compact manifold block	12/14	On the valve	On the valve	On the valve
	Common supply manifold	12/14	On the valve	On the valve	On the valve
Pilot exhaust air port		82/84	10-32 UNF-2B		
Mounting position			Any		
Degree of protection			IP65, IP67		
Permissible voltage fluctuations		[%]	± 10		
Materials					
Seals	VUVS-L		HNBR, NBR		
	VUVS-LT		HNBR, NBR, TPE-U(PU)		
Note on materials			RoHS-compliant		

Data sheet – Valve manifold assembly

ATEX	
ATEX category for gas	II 3G
Type of ignition protection for gas	Ex ec IICT4 Gc X
ATEX category for dust	II 3D
Type of ignition protection for dust	Ex tc IIICT115°C Dc X
Explosion-proof ambient temperature [°C]	-10 ≤ Ta ≤ +50
CE marking (see declaration of conformity) ¹⁾	To EU Explosion Protection Directive (ATEX)
UKCA marking (see declaration of conformity) ¹⁾	To UK EX instructions
Explosion protection certification outside the EU	EPL Dc (GB)
	EPL Gc (GB)

1) For information about the area of use, see the EC declaration of conformity at: www.festo.com/catalogue/... → Support/Downloads.
If the devices are subject to usage restrictions in residential, commercial or light-industrial environments, further measures for the reduction of the emitted interference may be necessary.

Operating and environmental conditions		
Valve design	Piston spool	Poppet seat
Operating medium	Compressed air to ISO 8573-1:2010 [7:4:4]	
Pilot medium	Compressed air to ISO 8573-1:2010 [7:4:4]	
Note on the operating/pilot medium	Lubricated operation possible (in which case lubricated operation will always be required)	
Operating pressure		
With external pilot air [bar]	-0.9 ... +10	+1.5 ... +10 (B52) +2.5 ... +10 (M52)
With internal pilot air [bar]	+1.5 ... +10 +2.5 ... +10 (M32...-A, M32...-M, M52-A)	+1.5 ... +10 (B52) +2.5 ... +10 (M52, M32, T32)
Pilot pressure [bar]	+1.5 ... +10 (B52) +2.5 ... +10	+1.5 ... +10 (B52) +2.5 ... +10 (M52)
Ambient temperature [°C]	-10 ... +60	-5 ... +60 (M32, T32) -10 ... +60 (B52, M52)
Temperature of medium [°C]	-10 ... +60	-5 ... +60 (M32, T32) -10 ... +60 (B52, M52)
Certification	c UL us - Recognized (OL)	
Corrosion resistance class CRC ¹⁾	2	

1) Corrosion resistance class CRC 2 to Festo standard FN 940070
Moderate corrosion stress. Indoor applications in which condensation can occur. External visible parts with primarily decorative surface requirements which are in direct contact with a normal industrial environment.

Data sheet – Valve manifold assembly

Dimensions – Valve manifold assembly

Download CAD data → www.festo.com

With 3/2-way valves, standard manifold block

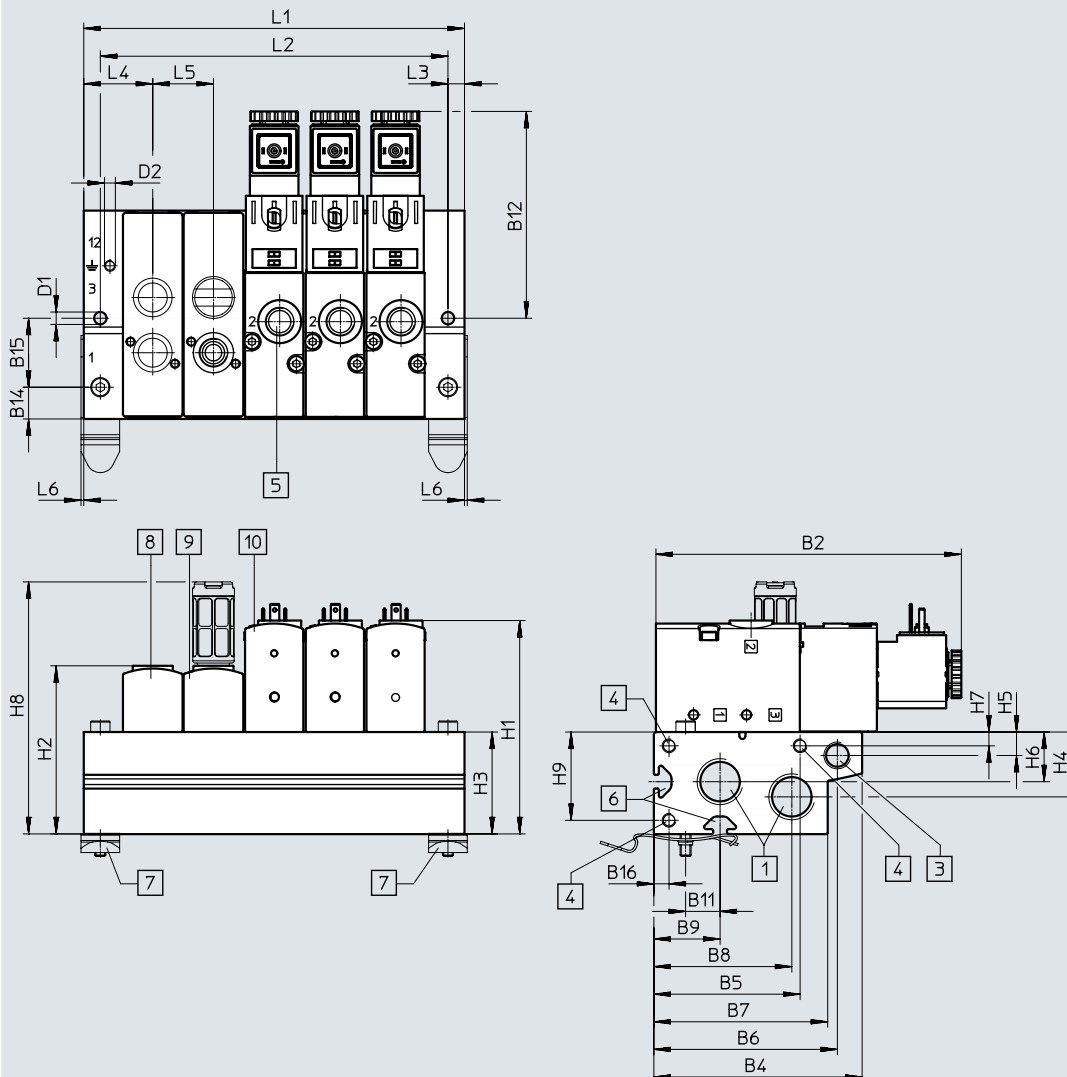

- | | | | |
|---|---|---|--|
| [1] Port 1 and 3
(on both sides):
3/8 NPT for VTUS-20
1/2 NPT for VTUS-25
3/4 NPT for VTUS-30 | [4] Thread for extension module:
M5x15.5 for VTUS-20
M5x18 for VTUS-25
M5x18 for VTUS-30 | [6] Profile slot IPM-05 system 5 for
VTUS-20 and VTUS-25, profile
slot IPM-08 system 8 for
VTUS-30 | [9] Supply plate,
port 1 and 3:
G1/8 for VTUS-20
G1/4 for VTUS-25
G3/8 for VTUS-30 |
| [3] Port 12 (on both sides):
1/8 NPT for VTUS-20
1/8 NPT for VTUS-25
1/8 NPT for VTUS-30 | [5] Port 2:
1/8 NPT for VTUS-20
1/4 NPT for VTUS-25
3/8 NPT for VTUS-30 | [7] H-rail mounting
VAME-T-M4 for VTUS-20
VAME-T-M5 for VTUS-25
VAME-T-M6 for VTUS-30 | [10] 3/2-way valve |
| | | [8] Cover plate | |

Data sheet – Valve manifold assembly

Type	B2	B4	B5	B6	B7	B8	B9	B11	B12	B14	B15	B16
VTUS-20	110.7	75.5	53	66.5	63	50	24	12.5	75	11.5	25	5.5
VTUS-25	129.2	93	67.5	80.5	78	62	30	16	84.2	14	32	6
VTUS-30	144.9	108.2	79	93.2	94.7	75.7	36.2	19	91.2	17.2	38	6.5

Type	D1 ø	D2	H1	H2	H3	H4	H5	H6	H7	H8	H9	L3	L4	L5	L6
VTUS-20	4.5	M4x6.5	77.4	61	37	23.5	8.5	18	5	91.4	32	6	25	22	1
VTUS-25	5.5	M4x9	95.5	71	45	25	9	22	5	123.4	39	6	29.8	27.5	1
VTUS-30	4.5	M5x11	118	91	61	35	9	28.5	6.5	170.1	54.5	7.5	34	32	–

Type	Valve positions	2	3	4	5	6	7	8	9	10
VTUS-20	L1 [mm]	72	94	116	138	160	182	204	226	248
	L2 [mm]	60	82	104	126	148	170	192	214	236
VTUS-25	L1 [mm]	87	114.5	142	169.5	197	224.5	252	279.5	307
	L2 [mm]	75	102.5	130	157.5	185	212.5	240	267.5	295
VTUS-30	L1 [mm]	100	132	164	196	228	260	292	324	356
	L2 [mm]	85	117	149	181	213	245	277	309	341

Data sheet – Valve manifold assembly

Dimensions – Valve manifold assembly

Download CAD data → www.festo.com

With 3/2-way valves, compact manifold block

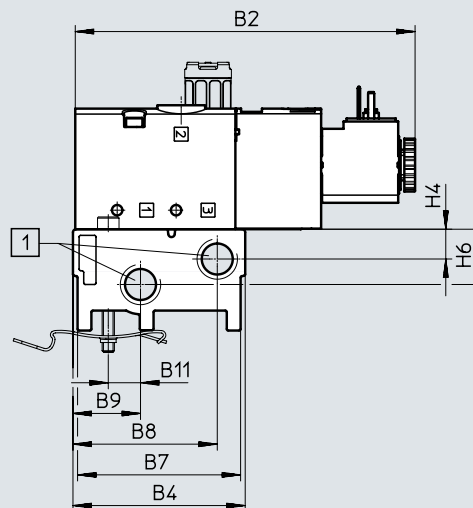
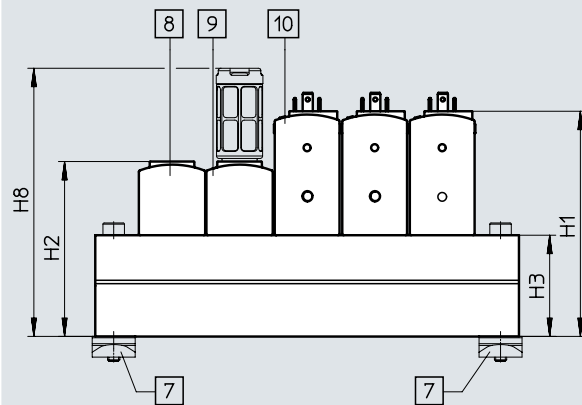
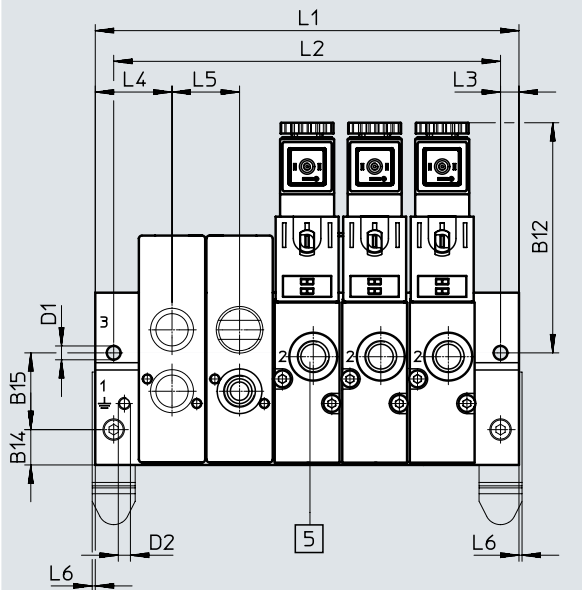

[1] Port 1 and 3
(on both sides):
1/4 NPT for VTUS-20
3/8 NPT for VTUS-25
1/2 NPT for VTUS-30

[5] Port 2:
1/8 NPT for VTUS-20
1/4 NPT for VTUS-25
3/8 NPT for VTUS-30

[7] H-rail mounting
VAME-T-M4 for VTUS-20
VAME-T-M5 for VTUS-25
VAME-T-M6 for VTUS-30

[8] Cover plate

[9] Supply plate,
port 1 and 3:
G1/8 for VTUS-20
G1/4 for VTUS-25
G3/8 for VTUS-30

[10] 3/2-way valve

Data sheet – Valve manifold assembly

Type	B2	B4	B7	B8	B9	B11	B12	B14	B15
VTUS-20	110.7	56.1	53.1	47	22	10.5	75	11.5	25
VTUS-25	129.2	70.3	67.3	58.8	30	16	84	14	32
VTUS-30	144.9	83	80	69.4	36	19	91.2	17	38

Type	D1 ø	D2	H1	H2	H3	H4	H6	H8	L3	L4	L5	L6
VTUS-20	4.5	M4x6.5	73.4	57	33	9.7	18	87.4	6	25	22	1
VTUS-25	5.5	M4x9	84.5	60	34	13.5	20	112.4	6	29.8	27.5	1
VTUS-30	6.3	M5x11	99.5	72.5	42.5	17.5	26	151.6	7.5	38	32	-

Type	Valve positions	2	3	4	5	6	7	8	9	10
VTUS-20	L1 [mm]	72	94	116	138	160	182	204	226	248
	L2 [mm]	60	82	104	126	148	170	192	214	236
VTUS-25	L1 [mm]	87	114.5	142	169.5	197	224.5	252	279.5	307
	L2 [mm]	75	102.5	130	157.5	185	212.5	240	267.5	295
VTUS-30	L1 [mm]	100	132	164	196	228	260	292	324	356
	L2 [mm]	85	117	149	181	213	245	277	309	341

Data sheet – Valve manifold assembly

Dimensions – Valve manifold assembly

Download CAD data → www.festo.com

With 5/2-, 5/3-, and 2x 3/2-way valves, standard manifold block

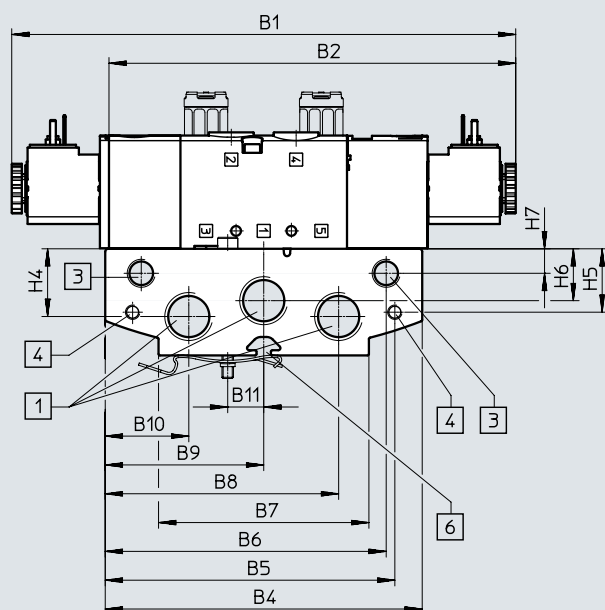
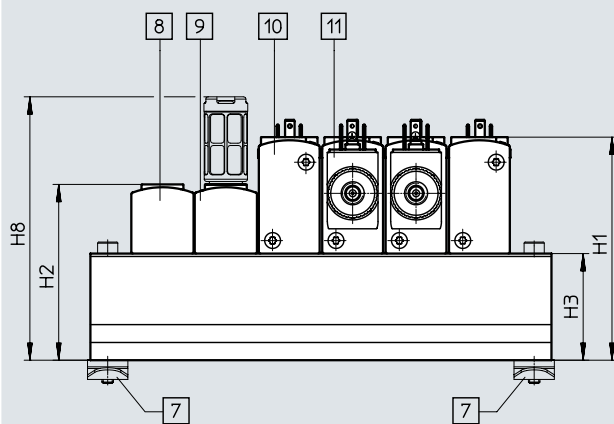
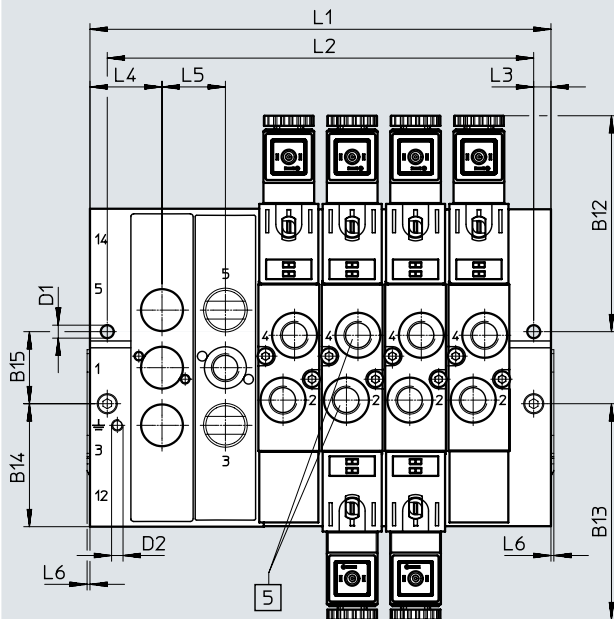

- | | | | |
|--|--|--|--|
| <p>[1] Port 1, 3 and 5
(on both sides):
3/8 NPT for VTUS-20
1/2 NPT for VTUS-25
3/4 NPT for VTUS-30</p> <p>[3] Port 12 and 14
(on both sides):
1/8 NPT for VTUS-20
1/8 NPT for VTUS-25
1/8 NPT for VTUS-30</p> | <p>[4] Thread for extension module:
M5x15.5 for VTUS-20
M5x18 for VTUS-25
M5x18 for VTUS-30</p> <p>[5] Port 2 and 4:
1/8 NPT for VTUS-20
1/4 NPT for VTUS-25
3/8 NPT for VTUS-30</p> <p>[6] Profile slot IPM-08 system 8</p> | <p>[7] H-rail mounting
VAME-T-M4 for VTUS-20
VAME-T-M5 for VTUS-25
VAME-T-M6 for VTUS-30</p> <p>[8] Cover plate</p> <p>[9] Supply plate.
port 1, 3 and 5:
G1/8 for VTUS-20
G1/4 for VTUS-25
G3/8 for VTUS-30</p> | <p>[10] 5/2-way single solenoid valve</p> <p>[11] 5/2-way double solenoid valve
or 5/3-way valve or 2x 3/2-way valve</p> |
|--|--|--|--|

Data sheet – Valve manifold assembly

Type	B1	B2	B4	B5	B6	B7	B8	B9	B10	B11	B12	B13	B14	B15
VTUS-20	174.9	141.2	110	100.5	97.5	73	81	55	29	12.5	75	75	42.5	25
VTUS-25	200.3	162.2	126	119	113.5	80	95	63	31	16	84.2	84.2	47	32
VTUS-30	220.3	180.7	144	137	129	104	111.5	72	32.5	19	91.2	91.2	38	25

Type	D1 ø	D2	H1	H2	H3	H4	H5	H6	H7	H8	L3	L4	L5	L6
VTUS-20	4.5	M4x6.5	77.4	61	37	23.5	22	18	8.5	91.4	6	25	22	1
VTUS-25	5.5	M4x9	95.5	71	45	25	22	22	9	123.4	6	29.8	27.5	1
VTUS-30	6.3	M5x11	118	91	61	35	22	28.5	9	170.1	7.5	34	32	–

Type	Valve positions	2	3	4	5	6	7	8	9	10
VTUS-20	L1 [mm]	72	94	116	138	160	182	204	226	248
	L2 [mm]	60	82	104	126	148	170	192	214	236
VTUS-25	L1 [mm]	87	114.5	142	169.5	197	224.5	252	279.5	307
	L2 [mm]	75	102.5	130	157.5	185	212.5	240	267.5	295
VTUS-30	L1 [mm]	100	132	164	196	228	260	292	324	356
	L2 [mm]	85	117	149	181	213	245	277	309	341

Data sheet – Valve manifold assembly

Dimensions – Valve manifold assembly

Download CAD data → www.festo.com

with 5/2-, 5/3-, and 2x 3/2-way valve, compact manifold block

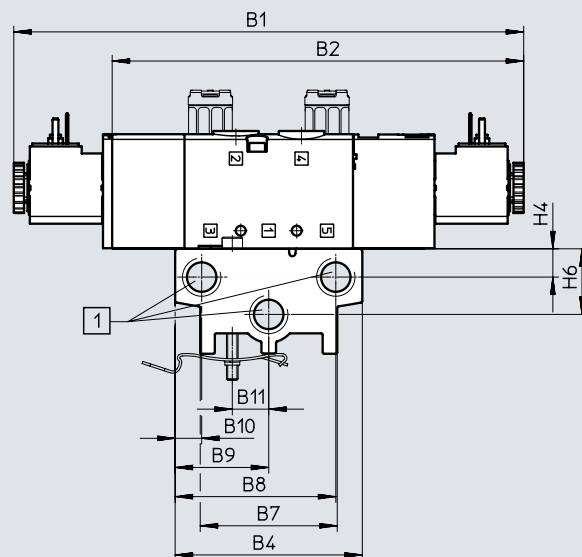
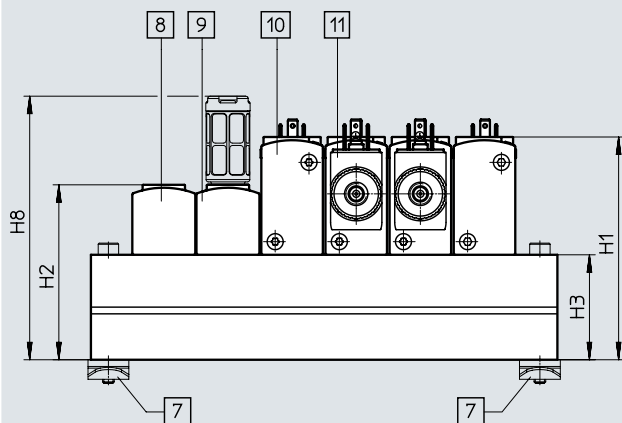
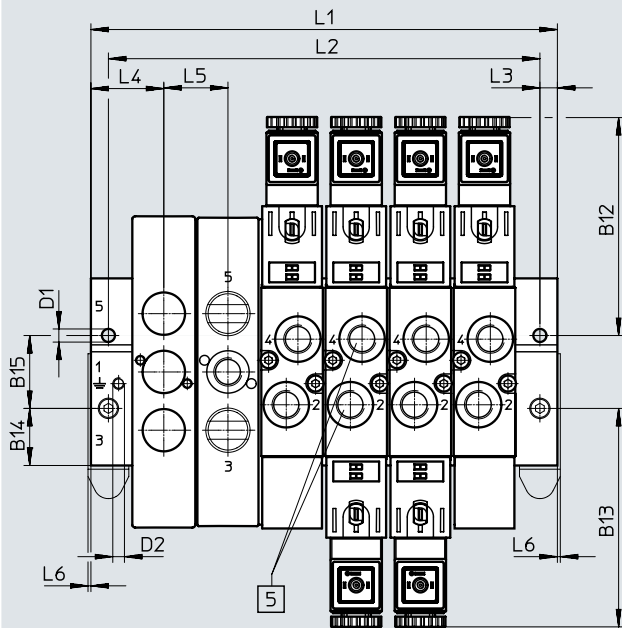

- | | | | |
|---|--|---|--|
| [1] Port 1, 3 and 5:
1/4 NPT for VTUS-20
3/8 NPT for VTUS-25
1/2 NPT for VTUS-30 | [7] H-rail mounting
VAME-T-M4 for VTUS-20
VAME-T-M5 for VTUS-25
VAME-T-M6 for VTUS-30 | [9] Supply plate,
port 1, 3 and 5:
G1/8 for VTUS-20
G1/4 for VTUS-25
G3/8 for VTUS-30 | [10] 5/2-way single solenoid valve
[11] 5/2-way double solenoid valve
or 5/3-way valve or 2x 3/2-way valve |
| [5] Port 2 and 4:
1/8 NPT for VTUS-20
1/4 NPT for VTUS-25
3/8 NPT for VTUS-30 | [8] Cover plate | | |

Data sheet – Valve manifold assembly

Type	B1	B2	B4	B7	B8	B9	B10	B11	B12	B13	B14	B15
VTUS-20	174.9	141.2	64.2	47	55.1	32.1	9.1	12.5	75	75	19.6	25
VTUS-25	200.3	162.2	80.5	61.5	69	40.3	11.5	16	84.2	84.2	24.3	32
VTUS-30	220.3	180.7	94	77	80.4	47	13.6	19	91.2	91.2	28	38

Type	D1 ø	D2	H1	H2	H3	H4	H6	H8	L3	L4	L5	L6
VTUS-20	4.5	M4x6.5	76.4	60	36	9.7	22.5	90.4	6	25	22	1
VTUS-25	5.5	M4x9	84.5	60	34	13.5	20	112.4	6	29.8	27.5	1
VTUS-30	6.3	M5x11	99.5	72.5	42.5	17.5	26	151.6	7.5	34	32	-

Type	Valve positions	2	3	4	5	6	7	8	9	10
VTUS-20	L1 [mm]	72	94	116	138	160	182	204	226	248
	L2 [mm]	60	82	104	126	148	170	192	214	236
VTUS-25	L1 [mm]	87	114.5	142	169.5	197	224.5	252	279.5	307
	L2 [mm]	75	102.5	130	157.5	185	212.5	240	267.5	295
VTUS-30	L1 [mm]	100	132	164	196	228	260	292	324	356
	L2 [mm]	85	117	149	181	213	245	277	309	341

Data sheet – Valve manifold assembly

Dimensions – Common supply manifold

Download CAD data → www.festo.com

Mounting on both sides

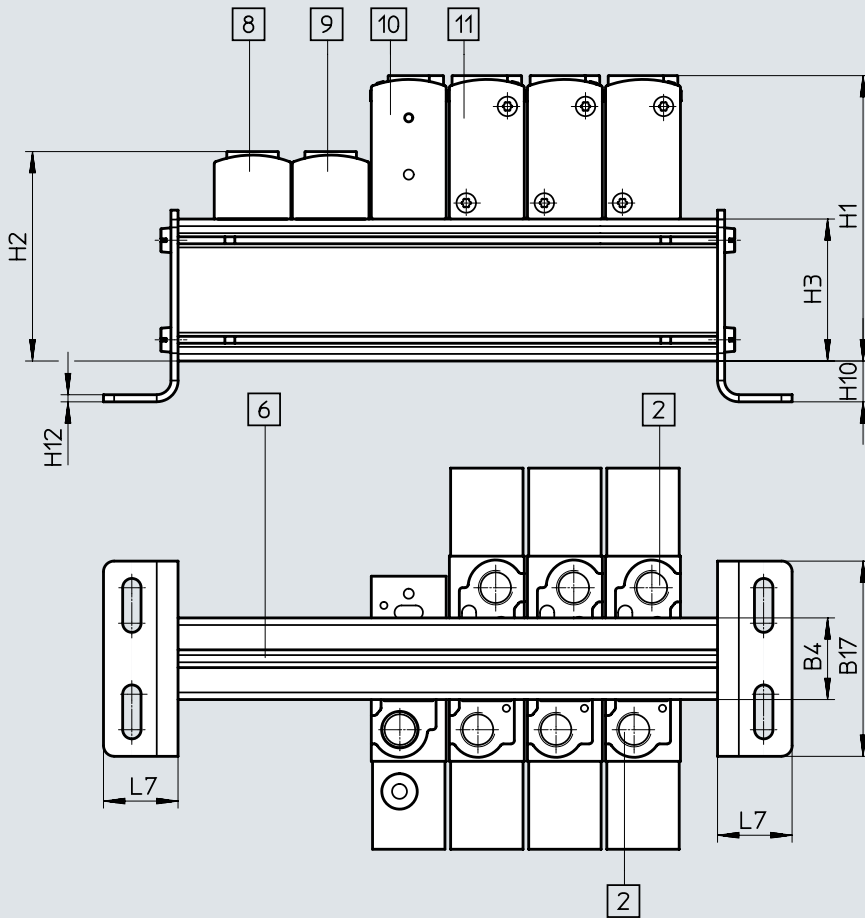

- | | | | |
|--|--|---|--|
| [2] Port 3 and 5:
1/8 NPT for VTUS-20
1/4 NPT for VTUS-25
3/4 NPT for VTUS-30 | [3] Port 12/14:
10-32 UNF-2B for VTUS-20
10-32 UNF-2B for VTUS-25
1/8 NPT for VTUS-30 | [8] Cover plate
[9] Air supply plate,
port 1:
G1/8 for VTUS-20
G1/4 for VTUS-25
G3/8 for VTUS-30 | [10] 3/2-way valve
[11] 5/2-way single solenoid valve
[12] 5/2-way double solenoid valve
or 5/3-way valve or 2x 3/2-way valve |
|--|--|---|--|

Type	B4	B17	H1	H2	H3	H10	H11	H12	L7
VTUS-20	23	55	80.4	59	40	11.5	6.3	2	21
VTUS-25	28.7	75	102.5	78	52	18	6.7	2	24
VTUS-30	34	85	122	95	65	17.5	6.7	2.5	26

Data sheet – Valve manifold assembly

Dimensions – Common supply manifold

Download CAD data → www.festo.com

Mounting on both sides

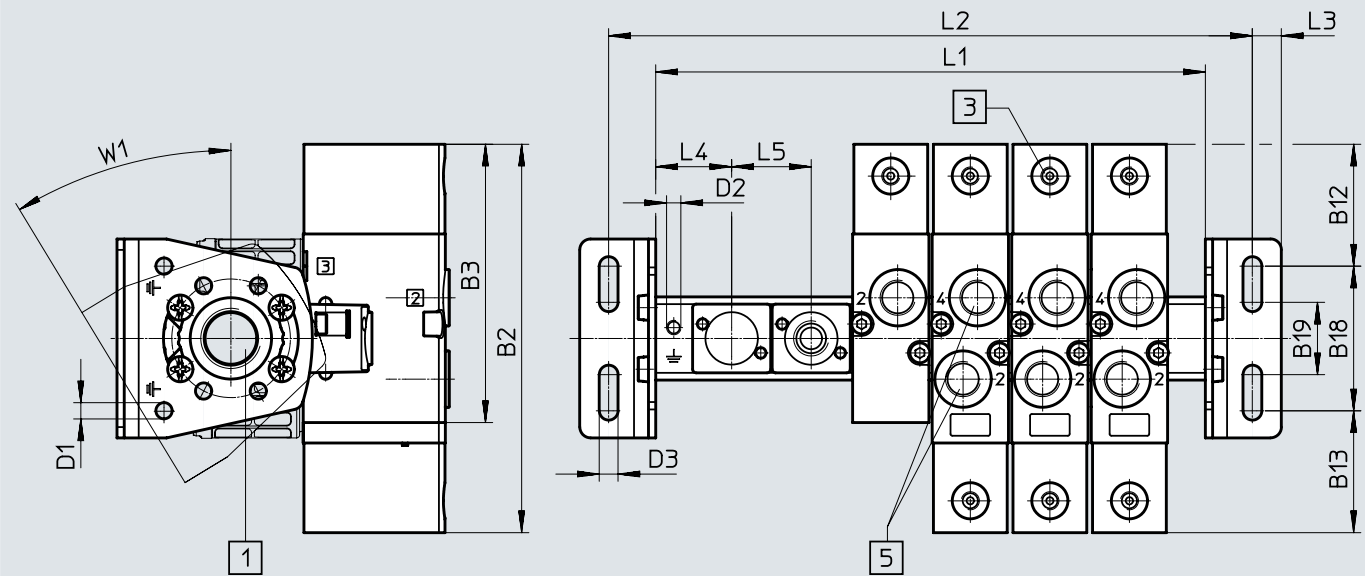

- [1] Port 1 (at both ends):
3/8 NPT for VTUS-20
1/2 NPT for VTUS-25
3/4 NPT for VTUS-30
- [2] Port 2 and 4:
1/8 NPT for VTUS-20
1/4 NPT for VTUS-25
3/8 NPT for VTUS-30

Note
Mounting bracket can be adjusted through ±30°.

Type	B1	B2	B3	B12	B13	B18	B19
VTUS-20	174.9	141.2	110.7	67.5	67.5	40	20
VTUS-25	200.3	162.2	129.2	70.2	70.2	60	35
VTUS-30	220.3	180.7	144.9	77.7	77.7	65	35

Type	D1 ø	D2	D3 ø	L3	L4	L5	W1
VTUS-20	4.5	M4x6.5	5.2	8	21	22	30°
VTUS-25	4.5	M4x9	6.6	8	29.8	27.5	30°
VTUS-30	5.5	M5x11	8.6	9	34	32	30°



Type	Valve positions	2	3	4	5	6	7	8	9	10
VTUS-20	L1 [mm]	64	86	108	130	152	174	196	218	240
	L2 [mm]	90	112	134	156	178	200	222	244	266
VTUS-25	L1 [mm]	87	114.5	142	169.5	197	224.5	252	279.5	307
	L2 [mm]	119	146.5	174	201.5	229	256.5	284	311.5	339
VTUS-30	L1 [mm]	100	132	164	196	228	260	292	324	356
	L2 [mm]	134	166	198	230	262	294	326	358	390

Type codes – Solenoid valves

001	Series
VUVS	Solenoid valve, universal
002	Directional control valve type
L	In-line valve
003	Design principle
	Piston spool
K	Piston spool with sealing ring
T	Poppet valve
004	Size
20	Size 20
25	Size 25
30	Size 30
005	Valve function
M32U	3/2-way valve, normally open
T32U	2x3/2-way valve, normally open
T32C	2x3/2-way valve, normally closed
T32H	2x3/2-way valve, 1x normally closed, 1x normally open
B52	5/2-way valve, double solenoid/bistable
M52	5/2-way valve, single solenoid/monostable
M32C	3/2-way valve, normally closed
P53U	5/3-way valve, mid-position pressurised
P53E	5/3-way valve, mid-position exhausted
P53C	5/3-way valve, mid-position closed
006	Reset method for monostable/single solenoid valves
	None
A	Pneumatic spring
M	Mechanical spring
007	Pilot air
	Internal
Z	External
008	Manual override
D	Non-detenting, detenting
H	Non-detenting
S	Covered
009	Pneumatic connection
G18	G1/8
G14	G1/4
G38	G3/8
N18	1/8 NPT
N14	1/4 NPT
N38	3/8 NPT
Q4	Push-in connector 4 mm
Q6	Push-in connector 6 mm
Q8	Push-in connector 8 mm
Q10	Push-in connector 10 mm
Q12	Push-in connector 12 mm
T38	Push-in connector 3/8"
T14	Push-in connector 1/4"
T12	Push-in connector 1/2"
T532	Push-in connector 5/32"
T516	Push-in connector 5/16"

010	Exhaust
	No fitting
QN	With fitting
U1	Silencer with metallic housing
U3	Silencer with polymer housing
U5	Sintered silencer, long
011	Valve pilot control interface
	Standard
F8	With armature tube 8 mm, long
F7	With armature tube 8 mm, short
FN	With armature tube 9 mm
012	Nominal operating voltage
	None
1	24 V DC
1A	24 V AC/50-60 Hz
3A	230 V AC/50-60 Hz
3W	230 V AC/240 V AC/50-60 Hz
5	12 V DC
16B	120 V AC/60 Hz and 110V AC/50-60 Hz
013	Electrical connection
	None
A1	Plug pattern type A, to EN 175301-803
B2	Connection pattern type B, industry standard
C1	Plug pattern type C, to EN 175301-803
014	Degree of protection, electrical system
	Standard
S1	IP65
S8	IP67
015	EU certification
	None
EX2	II 3GD
EX4	II 2GD
016	Electrical valve accessories
	None
G	Connector socket, without LED
GL	Connector socket, with LED
GS	Connector socket, with protective circuit
017	Version
	Expanded properties
S	Focused properties

Data sheet

-  - Flow rate
up to 600 l/min
-  - Valve width
21 mm
-  - Voltage
24 V DC

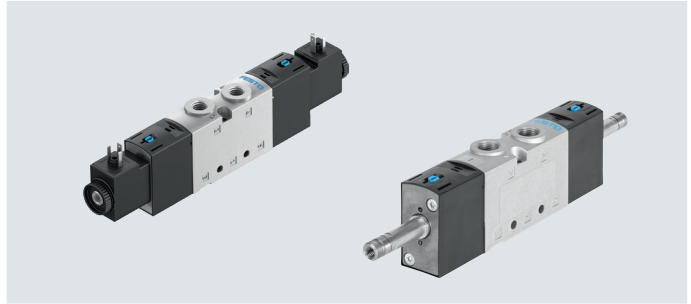

General technical data

Valve function	3/2-way valve					5/2-way valve	
Order code for valves	M32C	M32U	T32C	T32U	T32H	M52	B52
Valve width [mm]	21						
Nominal size [mm]	5.2	5.2	5.2	5.2	5.2	5	5
Design	Poppet seat						
Flow direction	Not reversible						
Pilot air supply	Internal						
Type of control	Piloted						
Manual override	Non-detenting, detenting						
Sealing principle	Soft						
Overlap	Negative overlap						
Type of mounting	Optionally via through-hole or on manifold rail						
Standard nominal flow rate q _N [l/min]	600					500	
Actuation type	Electrical						
Mounting position	Any						
Exhaust air function	Can be throttled						
Port for venting hole	Not ducted						
b value	0.39	0.29	0.39	0.29	0.34	0.31	0.27
c value	2.3	2.3	2.3	2.3	2.3	2.1	2.1
Pneumatic connection	1, 2, 3	1/8 NPT	1/8 NPT	1/8 NPT	1/8 NPT	1/8 NPT	1/8 NPT
	4, 5	-	-	1/8 NPT	1/8 NPT	1/8 NPT	1/8 NPT
Pilot exhaust air port 82, 84	10-32 UNF-2B						
Corrosion resistance ¹⁾	2						

1) Corrosion resistance class CRC 2 to Festo standard FN 940070

Moderate corrosion stress. Indoor applications in which condensation can occur. External visible parts with primarily decorative surface requirements which are in direct contact with a normal industrial environment.

ATEX

Type	VUVS-LT-...-EX2
ATEX category for gas	II 3G
Type of ignition protection for gas	Ex ec IICT4 Gc X
ATEX category for dust	II 3D
Type of ignition protection for dust	Ex tc IIIC T115°C Dc X
Explosion-proof ambient temperature [°C]	-10°C ≤ Ta ≤ +60°C
CE marking (see declaration of conformity) ¹⁾	To EU Explosion Protection Directive (ATEX)
UKCA marking (see declaration of conformity) ¹⁾	To UK EX instructions
Explosion protection certification outside the EU	EPL Dc (GB) EPL Gc (GB)

1) For information about the area of use, see the EC declaration of conformity at: www.festo.com/catalogue/... → Support/Downloads.

If the devices are subject to usage restrictions in residential, commercial or light-industrial environments, further measures for the reduction of the emitted interference may be necessary.

Data sheet

Technical data		M32C	M32U	T32C	T32U	T32H	M52	B52
Order code for valves		M32C	M32U	T32C	T32U	T32H	M52	B52
Normal position		Closed	Open	2x closed	2x normally open	1x open/ 1x closed	–	–
Stable position		Monostable	Monostable	Monostable	Monostable	Monostable	Monostable	Bistable
Reset method		Mechanical spring		Mechanical spring			Mechanical spring	–
Switching times in [ms]	On	9	10	9	9	9	15	–
	Off	23	24	25	23	23	19	–
	Change over	–	–	–	–	–	–	8
Product weight (without solenoid coil)	[g]	112	112	180	180	180	167	181

Safety characteristics		
Max. positive test pulse with logic 0	[s]	1900 (valves with VACS)
Max. negative test pulse with logic 1	[s]	2700 (valves with VACS)
Shock resistance		Shock test with severity level 2 to FN 942017-5 and EN 60068-2-27
Vibration resistance		Transport application test with severity level 2 to FN 942017-4 and EN 60068-2-6

Operating and environmental conditions		M32C	M32U	T32C	T32U	T32H	M52	B52	
Order code for valves		M32C	M32U	T32C	T32U	T32H	M52	B52	
Operating medium		Compressed air to ISO 8573-1:2010 [7:4:4]							
Pilot medium		Compressed air to ISO 8573-1:2010 [7:4:4]							
Note on the operating/pilot medium		Lubricated operation possible (in which case lubricated operation will always be required)							
Operating pressure	[MPa]	0.25 ... 1					0.3 ... 1	0.15 ... 1	
	[bar]	2.5 ... 10					3 ... 10	1.5 ... 10	
Ambient temperature	[°C]	–5 ... +60					–10 ... +60		
Temperature of medium	[°C]	–10 ... +60					–10 ... +60		
Certification		c UL us - Recognized (OL)							
Corrosion resistance class CRC ¹⁾		2							

1) Corrosion resistance class CRC 2 to Festo standard FN 940070

Moderate corrosion stress. Indoor applications in which condensation can occur. External visible parts with primarily decorative surface requirements which are in direct contact with a normal industrial environment.

Electrical data		
Electrical connection		Via solenoid coil
Operating voltage	[V DC]	→ Internet: vacs
Permissible voltage fluctuations	[%]	
Power	[W]	
Duty cycle	[%]	
Degree of protection to EN 60529		

Materials		
Housing		Die-cast aluminium (painted)
Seals		HNBR, NBR, TPE-U(PU)
Screws		Galvanised steel
Note on materials		RoHS-compliant

Data sheet

Dimensions

Download CAD data → www.festo.com

3/2-way valves, with solenoid coil

3/2-way valves, without solenoid coil

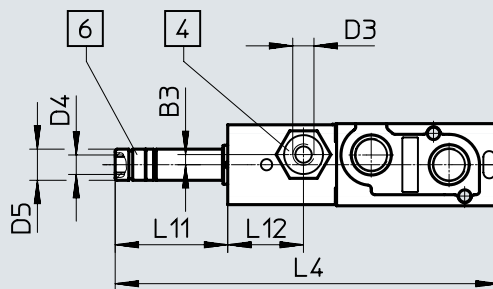
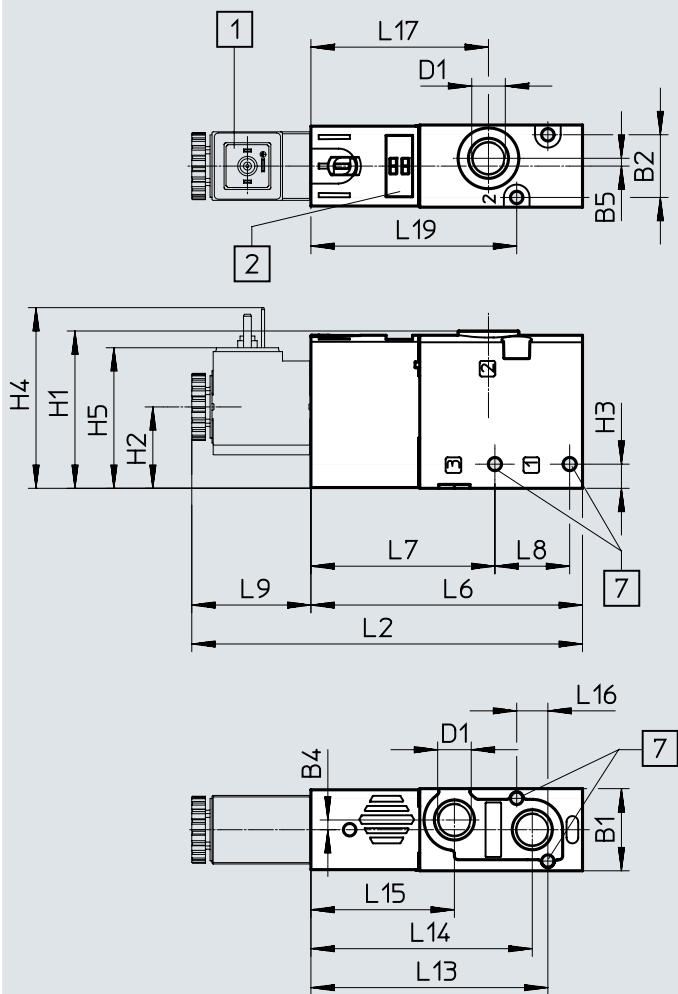

[1] Solenoid coil interface type C
[2] Space for inscription label

[4] Port 10/12 for pilot air supply

[6] Port 82 for pilot exhaust air

[7] For screw M3

Type	B1	B2	B3	B4	B5	D1	D3	D4	D5 ∅	H1	H2	H3	H4	H5
VUVS-LT20-M32...MD-N18-...	21.1	16.1	-	2.5	2	1/8 NPT	-	10-32 UNF-2B	8	40.4	20.9	6.2	46.7	36.4

Type	L2	L4	L6	L7	L8	L9	L11	L12	L13	L14	L15	L16	L17	L19
VUVS-LT20-M32...MD-N18-...	100.4	98.8	69.8	47.3	19.2	30.6	29	-	60.9	56.9	36.9	8	45.6	52.9

Data sheet

Dimensions

Download CAD data → www.festo.com

5/2-way single solenoid valves, with solenoid coil

5/2-way single solenoid valves, without solenoid coil

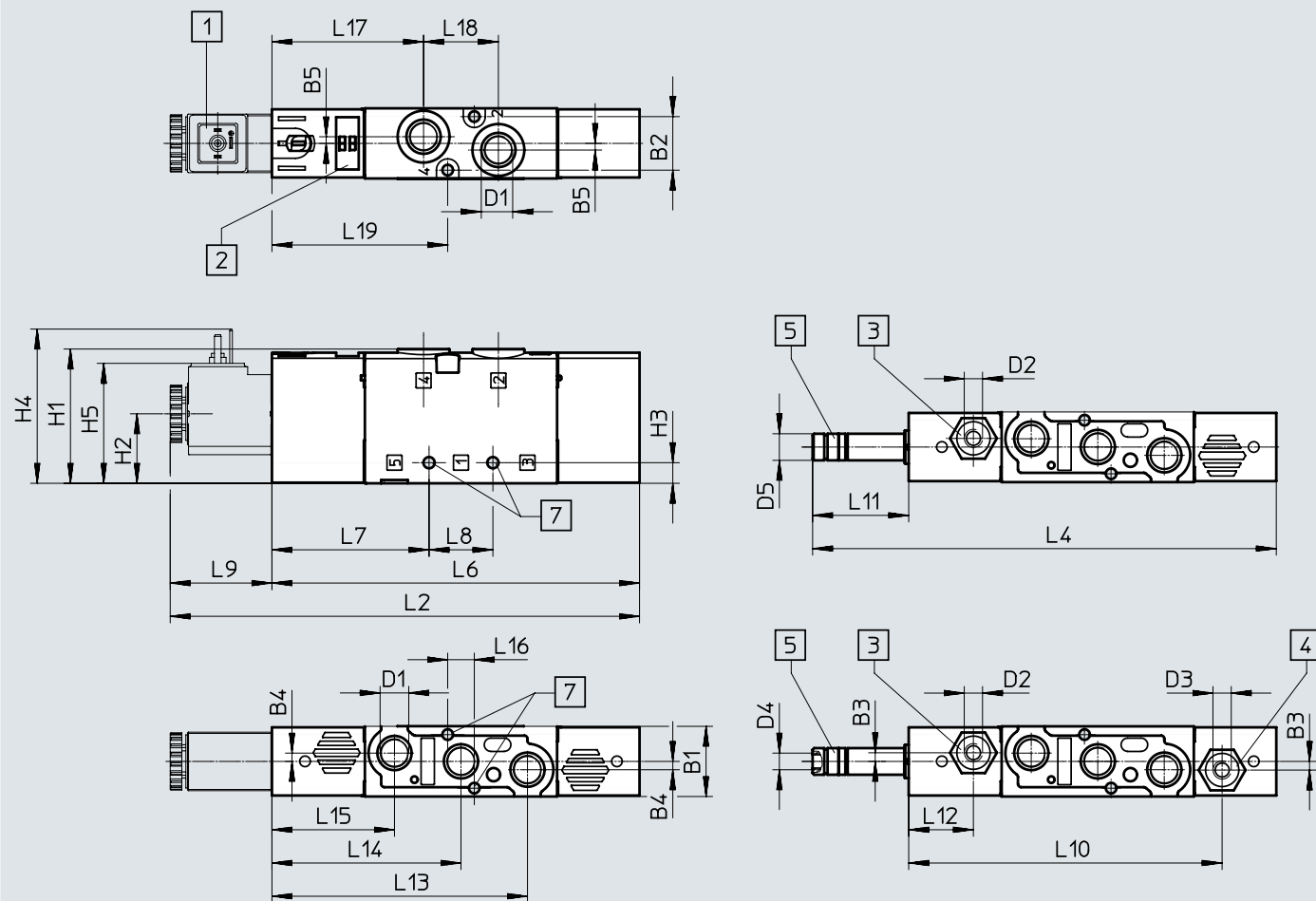

- [1] Solenoid coil for interface type C
- [2] Space for inscription label
- [3] Port 14 for pilot air supply
- [4] Port 12 for pilot air supply (pneumatic spring)
- [5] Port 84 for pilot exhaust air
- [6] For screw M3
- [7] For screw M4

Type	B1	B2	B3	B4	B5	D1	D2	D3	D4	D5 ∅	H1	H2	H3	H4	H5
VUVS-LT20-M52-...MD-N18-...	21.1	16.1	-	2.5	2	1/8 NPT	-	-	10-32 UNF-2B	8	40.4	20.9	5.8	46.7	36.4

Type	L2	L4	L6	L7	L8	L9	L10	L11	L12	L13	L14	L15	L16	L17	L18	L19	L20
VUVS-LT20-M52-...MD-N18-...	141.2	139.6	110.6	47.9	18	30.6	-	29	-	76.9	56.9	36.9	8	45.6	22.5	52.9	2

Data sheet

Dimensions

Download CAD data → www.festo.com

2x 3/2-way valves and 5/2-way double solenoid valves, with solenoid coil

2x 3/2-way valves and 5/2-way double solenoid valves, without solenoid coil

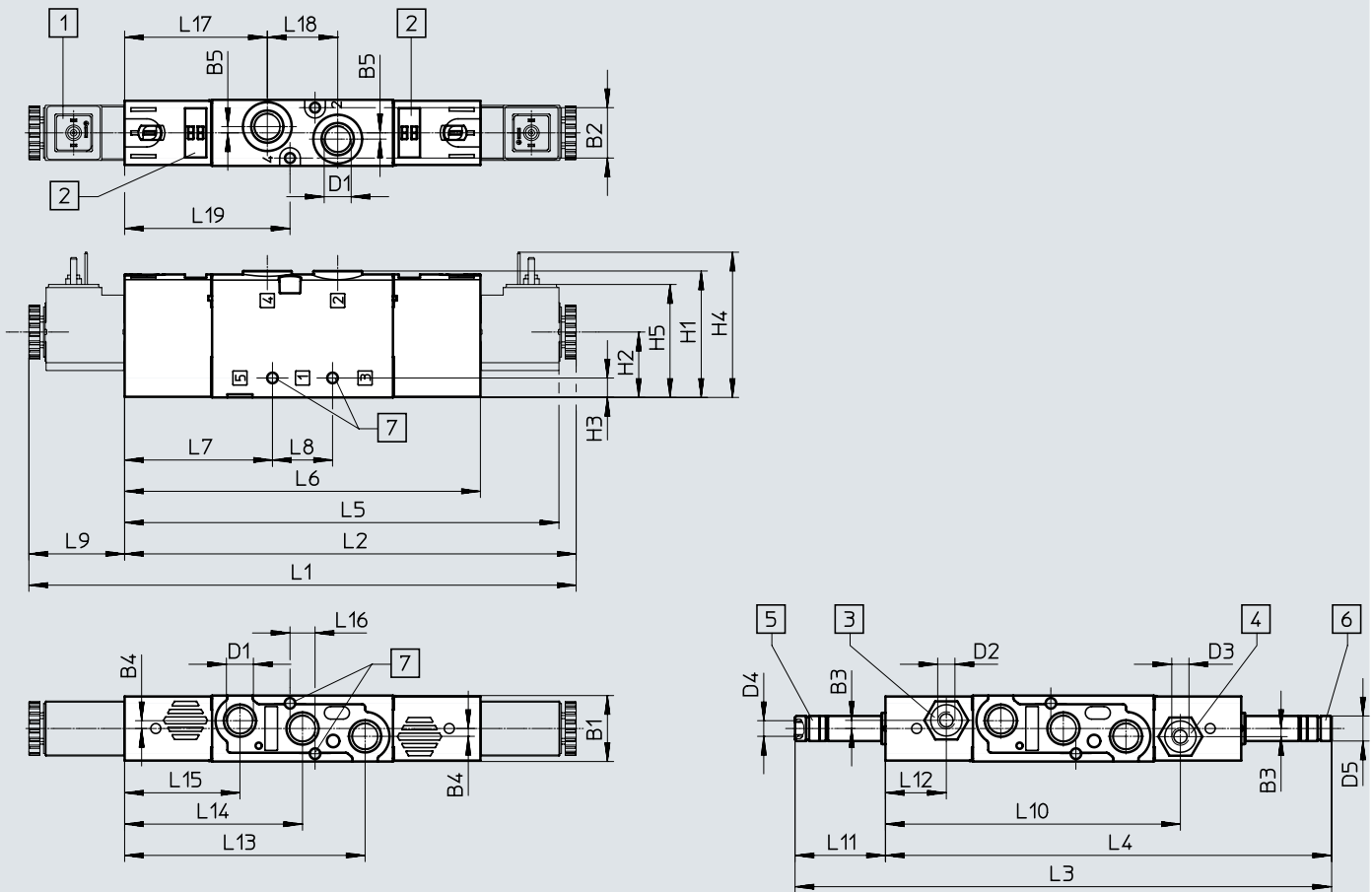

- [1] Solenoid coil interface type C
- [2] Space for inscription label
- [3] Port 14 for pilot air supply
- [4] Port 12 for pilot air supply
- [5] Port 84 for pilot exhaust air
- [6] Port 82 for pilot exhaust air
- [7] For screw M3
- [8] For screw M4

Type	B1	B2	B3	B4	B5	D1	D2	D3	D4	D5	H1
VUVS-LT20-B52-D-N18-...	21.1	16.1	-	2.5	2	1/8 NPT	-	-	10-32 UNF-2B	8	40.4
VUVS-LT20-T32...-MD-N18-...											

Type	H2	H3	H4	H5	L1	L2	L3	L4	L5	L6	L7	L8
VUVS-LT20-B52-D-N18-...	20.9	5.8	46.7	36.4	174.9	144.3	171.7	142.7	139.1	113.7	47.9	18
VUVS-LT20-T32...-MD-N18-...												

Type	L9	L10	L11	L12	L13	L14	L15	L16	L17	L18	L19	L20
VUVS-LT20-B52-D-N18-...	30.6	-	29	-	76.9	56.9	36.9	8	45.6	22.5	52.9	2
VUVS-LT20-T32...-MD-N18-...												

Accessories

Dimensions

Foot mounting

Download CAD data → www.festo.com

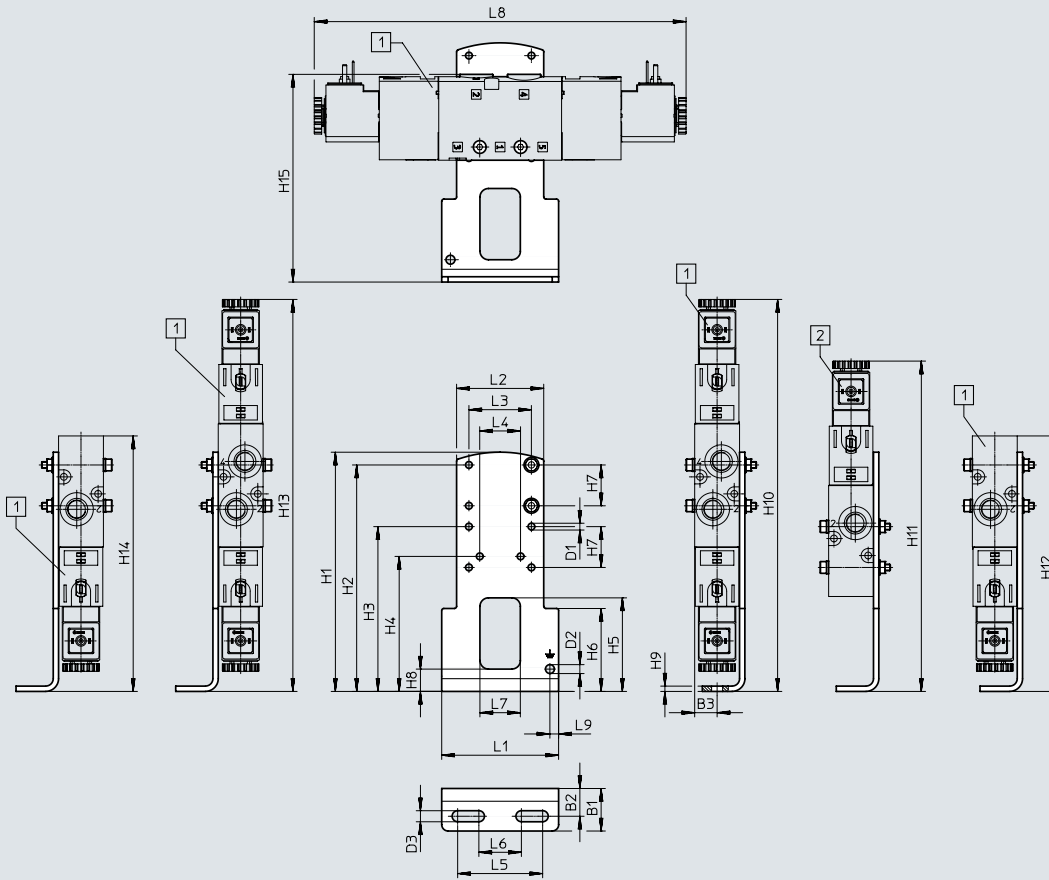

[1] VUVS-LT20-B52/T32
 VUVS-LT20-M52
 VUVS-LT20-M32

[2] VUVS-LT20-M52
 VUVS-LT20-M32

Type		B1	B2	B3	D1 ∅	D2 ∅	D3	H1	H2	H3	H4
VAME-B10-20-A	VUVS-LT20-B52/T32	20	13.1	10.6	3.2	4.2	5.2	112.5	106.5	77.5	63.5
	VUVS-LT20-M52										
	VUVS-LT20-M32										

Type		H5	H6	H7	H8	H9	H10	H11	H12	H13	H14
VAME-B10-20-A	VUVS-LT20-B52/T32	44	39	19.2	10.5	2.5	184.4	–	184.4	184.4	184.4
	VUVS-LT20-M52							155.4	150.6	150.6	
	VUVS-LT20-M32							109.8	109.8	109.8	

Type		H15	L1	L2	L3	L4	L5	L6	L7	L8	L9
VAME-B10-20-A	VUVS-LT20-B52/T32	97.7	55	41	29.4	19.2	40	20	19	174.9	4.1
	VUVS-LT20-M52									141.2	
	VUVS-LT20-M32									100.4	

Accessories

Dimensions

Download CAD data → www.festo.com

Wall mounting

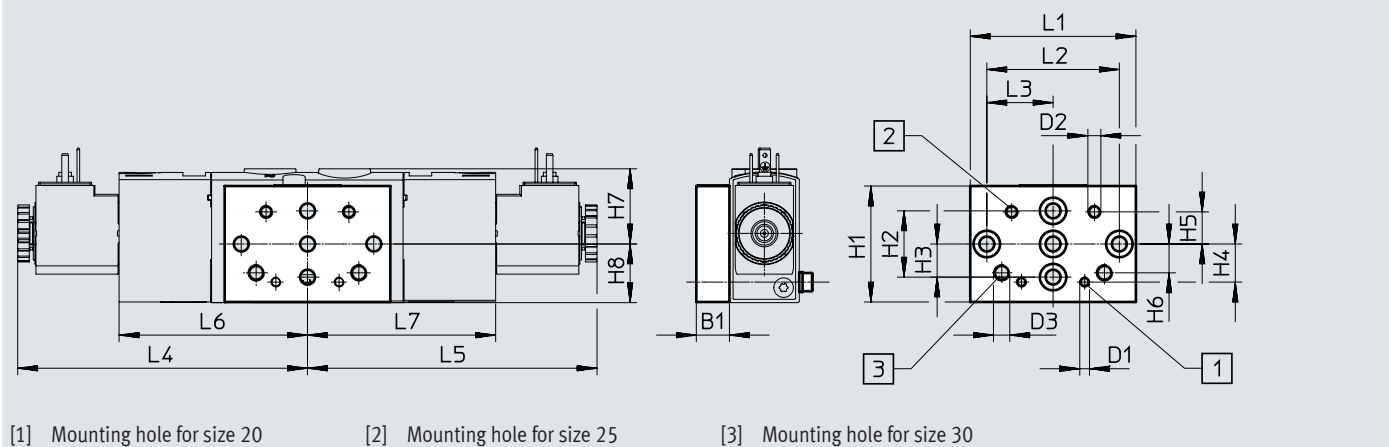



Type		B1	D1	D2	D3	H1	H2	H3	H4	H5	H6
VAME-B10-20-W	VUVS-LT20-B52/T32	10	M3	M4	M5	35	20	10	11.5	9.7	8.7
	VUVS-LT20-M52										
	VUVS-LT20-M32										



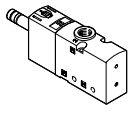
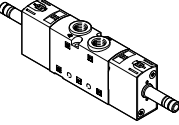
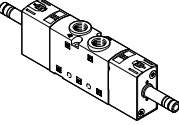
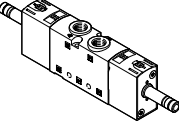
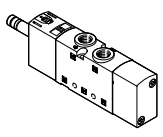
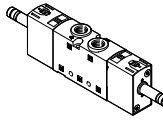

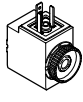
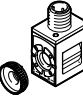
Type		H7	H8	L1	L2	L3	L4	L5	L6	L7
VAME-B10-20-W	VUVS-LT20-B52/T32	22.7	17.7	50	40	20	87.5	87.5	56.9	56.9
	VUVS-LT20-M52							53.7		-
	VUVS-LT20-M32							12.9		-

Accessories



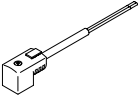

Ordering data		Code	Valve function	Part no.	Type	
3/2-way valve without solenoid coil						
	Single solenoid, normally closed					
	M32C-M	Reset via mechanical spring, internal pilot air supply, flow direction not reversible	577504	VUVS-LT20-M32C-MD-N18-F7		
	Single solenoid, normally open					
	M32U-M	Reset via mechanical spring, internal pilot air supply, flow direction not reversible	577505	VUVS-LT20-M32U-MD-N18-F7		
	Single solenoid, normally closed					
	T32C	Reset via mechanical spring, internal pilot air supply, flow direction not reversible	577508	VUVS-LT20-T32C-MD-N18-F7		
	T32U	Reset via mechanical spring, internal pilot air supply, flow direction not reversible	577509	VUVS-LT20-T32U-MD-N18-F7		
	Single solenoid, 1x normally open, 1x normally closed					
	T32H	Reset via mechanical spring, internal pilot air supply, flow direction not reversible	577510	VUVS-LT20-T32H-MD-N18-F7		
	5/2-way valve without solenoid coil					
		Single solenoid				
M52		Reset via mechanical spring, internal pilot air supply, flow direction not reversible	577506	VUVS-LT20-M52-MD-N18-F7		
	Double solenoid					
	B52	Internal pilot air supply, flow direction not reversible	577507	VUVS-LT20-B52-D-N18-F7		

Ordering data		Description	Part no.	Type
Solenoid coils for valves				
	Plug pattern type C, to DIN EN 175301-803	12 V DC	8025331	VACS-C-C1-5
		24 V DC	8025330	VACS-C-C1-1
		48 V DC	8025336	VACS-C-C1-7
		24 V AC/50-60 Hz	8025335	VACS-C-C1-1A
		48 V AC/50-60 Hz	8025337	VACS-C-C1-7A
		110/120 V AC/50-60 Hz	8025334	VACS-C-C1-16B
		230/240 V AC/50-60 Hz	8025338	VACS-C-C1-3W
	M8 individual plug, 3-pin	24 V DC	8135909	VACS-C-R8-1RAL
	M8 individual plug, 4-pin	24 V DC	8135910	VACS-C-R1-1RAL
	Single plug M12, A-coded, according to EN 61076-2-101	24 V DC	8194567	VACS-C-R3-1RAL
	Single plug M12, A-coded, pin assignment to DESINA	24 V DC	8135911	VACS-C-R4-1RAL
Seal set				
	For solenoid coil to guarantee degree of protection IP67		2643771	VAMC-B10-C-B-S8
Cover cap				
	For manual override, non-detenting or covered		8028240	VAMC-B10-20-CH2

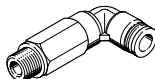
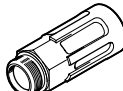

Accessories

Ordering data		Description	Part no.	Type		
Plug socket						
	Plug pattern type C, to DIN EN 175301-803					
	3-pin, screw terminal	Cable connector M12	0 ... 250 V AC/DC	IP65	539712	MSSD-EB-M12
		Cable connector Pg7			151687	MSSD-EB
	4-pin, insulation displacement connector	Cable connector M14	0 ... 250 V AC/DC	IP67	192745	MSSD-EB-S-M14
3-pin, angled socket	Cable connector M12	0 ... 24 V DC	IP65	570367	MSSD-EB-M12-24VDC-SD-EX	
Adapter						
	Socket type C, to EN 175301-803	Plug M12x1, 2-pin, A-coded	12 ... 24 V AC/DC	IP65	188024	MSSD-EB-M12-MONO
Plug socket with cable						
	Plug pattern type C, to DIN EN 175301-803					
	Angled socket, 3-pin Cable, open end, 3-wire	24 V DC	LED	2.5 m	151688	KMEB-1-24-2.5-LED
				5 m	151689	KMEB-1-24-5-LED
		230 V AC	-	10 m	193457	KMEB-1-24-10-LED
				2.5 m	151690	KMEB-1-230AC-2.5
5 m				151691	KMEB-1-230AC-5	
Illuminating seal						
	Plug pattern type C, to DIN EN 175301-803	24 V DC		151717	MEB-LD-12-24DC	
		230 V AC		151718	MEB-LD-230AC	

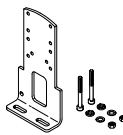
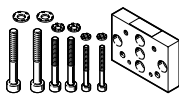
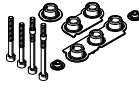

Accessories

Ordering data	Description	Part no.	Type	PJ ¹⁾	
Push-in fitting with internal hex					
	Connecting thread 10-32 UNF for tubing O.D.	5/32 "	572312	QBM-10-32-UNF-5/32-I-U	10
	Connecting thread 1/8 NPT for tubing O.D.	5/32 "	572317	QB-1/8-5/32-I-U	10
		1/4 "	572318	QB-1/8-1/4-I-U	10
		5/16 "	572319	QB-1/8-5/16-I-U	10
Angled push-in fitting with external hex					
	Connecting thread 1/8 NPT for tubing O.D.	5/32 "	533290	QBL-1/8-5/32-U	10
		1/4 "	533292	QBL-1/8-1/4-U	10
		5/16 "	533293	QBL-1/8-5/16-U	10
Angled push-in fitting, long, with external hex					
	Connecting thread 1/8 NPT for tubing O.D.	5/32 "	564668	QBL-1/8-5/32-U	10
		1/4 "	564670	QBL-1/8-1/4-U	10
		5/16 "	564671	QBL-1/8-5/16-U	10
Silencer					
	With connecting thread NPT, metal design	1/8 NPT	12638	U-1/8-B-NPT	1
	With connecting thread NPT, sintered design, long	1/8 NPT	1206989	AMTE-M-LH-N18	20

1) Packaging unit

Ordering data	Description	Weight [g]	Part no.	Type
Foot mounting				
	With screw set for attaching the valve to the foot mounting	130	576412	VAME-B10-20-A
Wall mounting				
	With screw set for attaching the valve to the wall mounting	53	576413	VAME-B10-20-W
Assortment of spare parts				
	Set comprising seals and screws	12	8026203	VAME-B10-20-MK
Inscription label				
	40 pieces in frame	-	565306	ASLR-C-E4

Data sheet

-  - Flow rate
up to 1000 l/min (±20%)
-  - Valve width
26.5 mm
-  - Voltage
24 V DC

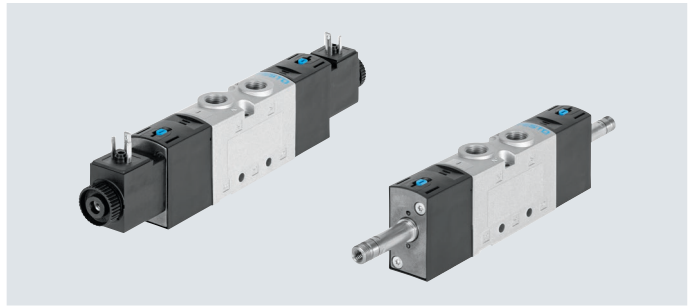

General technical data								
Valve function	3/2-way valve						5/2-way valve	
Order code for valves	M32C	M32U	T32C	T32U	T32H	M52	B52	
Valve width [mm]	26.5							
Nominal size [mm]	6.9	6.6	6.9	6.6	6.9	6.6	6.6	
Design	Poppet seat							
Flow direction	Not reversible							
Pilot air supply	Internal							
Type of control	Piloted							
Manual override	Non-detenting, detenting							
Overlap	Negative overlap							
Sealing principle	Soft							
Type of mounting	Optionally via through-hole or on manifold rail							
Standard nominal flow rate q _{nN} [l/min]	1000							
Actuation type	Electrical							
Mounting position	Any							
Exhaust air function	Can be throttled							
Port for venting hole	Not ducted							
b value	0.4	0.3	0.4	0.3	0.4	0.3	0.2	
c value [l/sbar]	4.4	4.2	4.5	4.4	4.4	4.5	4.6	
Pneumatic connection	1, 2, 3 4, 5	1/4 NPT	1/4 NPT	1/4 NPT	1/4 NPT	1/4 NPT	1/4 NPT	1/4 NPT
Pilot exhaust air port 82, 84	10-32 UNF-2B							

ATEX	
Type	VUVS-LT-...-EX2
ATEX category for gas	II 3G
Type of ignition protection for gas	Ex ec IIC T4 Gc X
ATEX category for dust	II 3D
Type of ignition protection for dust	Ex tc IIIC T115°C Dc X
Explosion-proof ambient temperature [°C]	-10°C ≤ Ta ≤ +60°C
CE marking (see declaration of conformity) ¹⁾	To EU Explosion Protection Directive (ATEX)
UKCA marking (see declaration of conformity) ¹⁾	To UK EX instructions
Explosion protection certification outside the EU	EPL Dc (GB)
	EPL Gc (GB)

¹⁾ For information about the area of use, see the EC declaration of conformity at: www.festo.com/catalogue/... → Support/Downloads.
If the devices are subject to usage restrictions in residential, commercial or light-industrial environments, further measures for the reduction of the emitted interference may be necessary.

Data sheet

Technical data		M32C	M32U	T32C	T32U	T32H	M52	B52
Order code for valves		M32C	M32U	T32C	T32U	T32H	M52	B52
Normal position		Closed	Open	2x closed	2x normally open	1x open/ 1x closed	–	–
Stable position		Monostable	Monostable	Monostable	Monostable	Monostable	Monostable	Bistable
Reset method		Mechanical spring		Mechanical spring			Mechanical spring	–
Switching times in [ms]	On	10	10	10	10	10	13	–
	Off	23	27	25	25	25	22	–
	Change-over	–	–	–	–	–	–	10
Product weight without solenoid coil	[g]	208	208	312	312	312	299	310

Safety characteristics		
Max. positive test pulse with logic 0	[s]	2000 (valves with VACF)
Max. negative test pulse with logic 1	[s]	3600 (valves with VACF)
Shock resistance		Shock test with severity level 2 to FN 942017-5 and EN 60068-2-27
Vibration resistance		Transport application test with severity level 2 to FN 942017-4 and EN 60068-2-6

Operating and environmental conditions		M32C	M32U	T32C	T32U	T32H	M52	B52	
Order code for valves		M32C	M32U	T32C	T32U	T32H	M52	B52	
Operating medium		Compressed air to ISO 8573-1:2010 [7:4:4]							
Pilot medium		Compressed air to ISO 8573-1:2010 [7:4:4]							
Note on the operating/pilot medium		Lubricated operation possible (in which case lubricated operation will always be required)							
Operating pressure	[MPa]	0.25 ... 1					0.25 ... 1	0.15 ... 1	
	[bar]	2.5 ... 10					2.5 ... 10	1.5 ... 10	
Pilot pressure	[MPa]	0.25 ... 1					0.25 ... 1	0.15 ... 1	
	[bar]	2.5 ... 10					2.5 ... 10	1.5 ... 10	
Ambient temperature	[°C]	–5 ... +60					–10 ... +60		
Temperature of medium	[°C]	–5 ... +60					–10 ... +60		
Certification		c UL us - Recognized (OL)							
Corrosion resistance class CRC ¹⁾		2							

1) Corrosion resistance class CRC 2 to Festo standard FN 940070

Moderate corrosion stress. Indoor applications in which condensation can occur. External visible parts with primarily decorative surface requirements which are in direct contact with a normal industrial environment.

Electrical data		
Electrical connection		Via solenoid coil
Operating voltage	[V DC]	→ Internet: vacf
Permissible voltage fluctuations	[%]	
Power	[W]	
Duty cycle	[%]	
Degree of protection to EN 60529		

Materials		
Housing		Die-cast aluminium (painted)
Seals		HNBR, NBR, TPE-U(PU)
Screws		Galvanised steel
Note on materials		RoHS-compliant

Data sheet

Dimensions

Download CAD data → www.festo.com

3/2-way valves, with solenoid coil

3/2-way valves, without solenoid coil

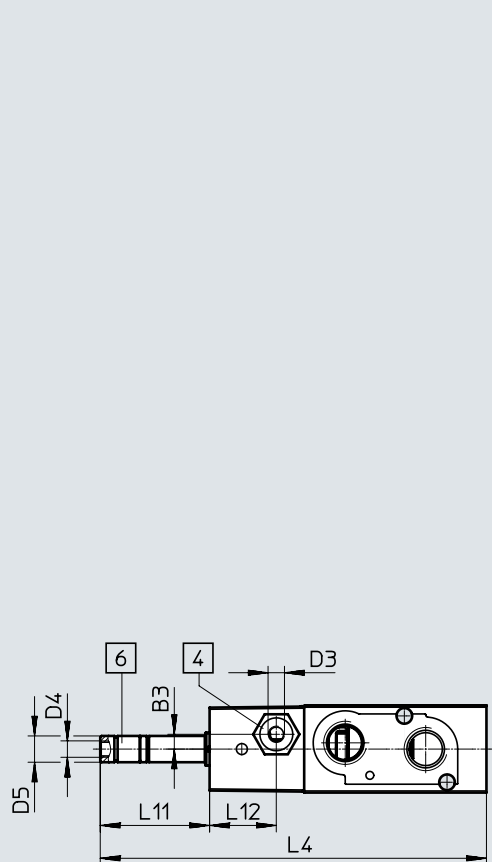
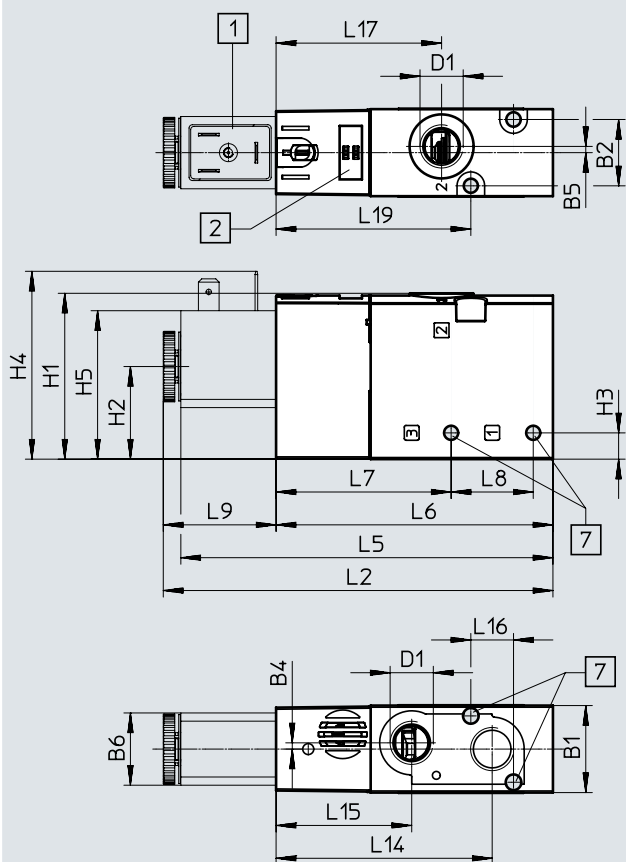

- [1] Solenoid coil interface type B/
type C
- [2] Space for inscription label
- [4] Port 10/12 for pilot air supply
- [6] Port 82 for pilot exhaust air
- [7] For screw M4

Type	B1	B2	B3	B4	B5	B6	D1	D3	D4	D5 ø	H1	H2	H3	H4	H5
VUVS-LT25-M32...D-N14-...	26.5	20.2	-	1.9	1.9	22	1/4 NPT	-	10-32 UNF-2B	8	50.5	28.2	8	57.2	45.2

Type	L2	L4	L5	L6	L7	L8	L9	L11	L12	L14	L15	L16	L17	L19
VUVS-LT25-M32...D-N14-...	118.7	117.6	113.3	84.3	53.3	25	34.4	33.3	-	65.8	41.3	13	50.4	59.3

Data sheet

Dimensions

Download CAD data → www.festo.com

5/2-way single solenoid valves, with solenoid coil

5/2-way single solenoid valves, without solenoid coil

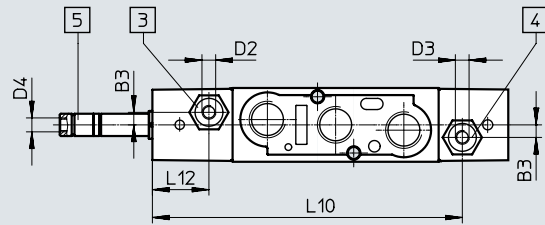
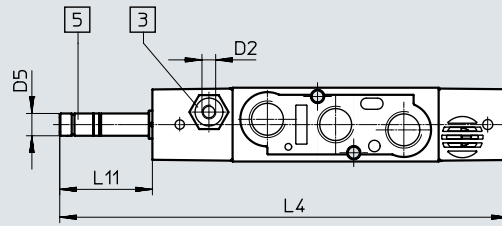
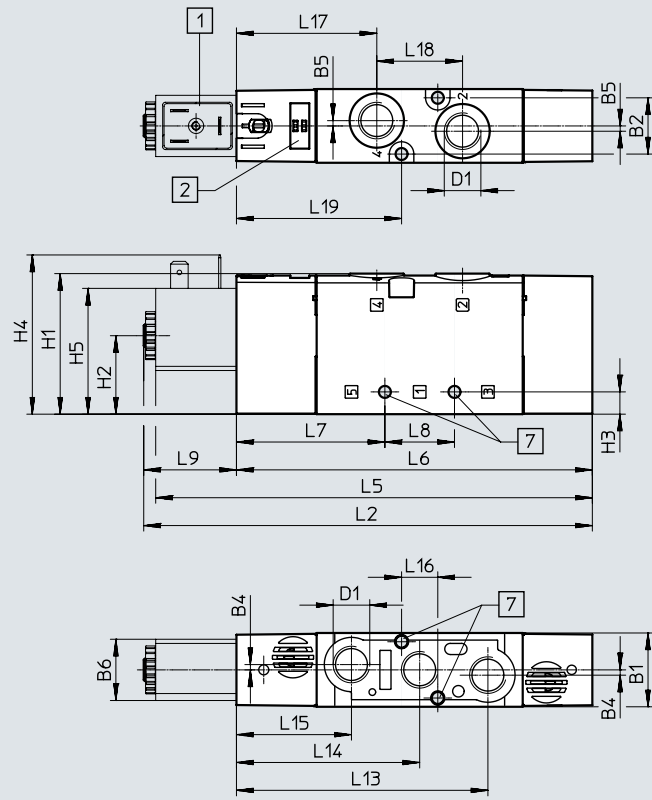

- [1] Solenoid coil
- [2] Space for inscription label
- [3] Port 14 for pilot air supply
- [4] Port 12 for pilot air supply
- [5] Port 84 for pilot exhaust air
- [7] For screw M4

Type	B1	B2	B3	B4	B5	B6	D1	D2	D3	D4	D5 ∅	H1	H2	H3	H4	H5
VUVS-LT25-M52...D-N14-...	26.5	20.2	-	1.9	1.9	22	1/4 NPT	-	-	10-32 UNF-2B	8	50.5	28.2	8	57.2	45.2

Type	L2	L4	L5	L6	L7	L8	L9	L10	L11	L12	L13	L14	L15	L16	L17	L18	L19
VUVS-LT25-M52...D-N14-...	162.2	161.1	156.8	127.8	53.3	25	34.4	-	33.3	-	90.3	65.8	41.3	13	50.4	30.8	59.3

Data sheet

Dimensions

Download CAD data → www.festo.com

2x 3/2-way valves and 5/2-way double solenoid valves, with solenoid coil

2x 3/2-way valves and 5/2-way double solenoid valves, without solenoid coil

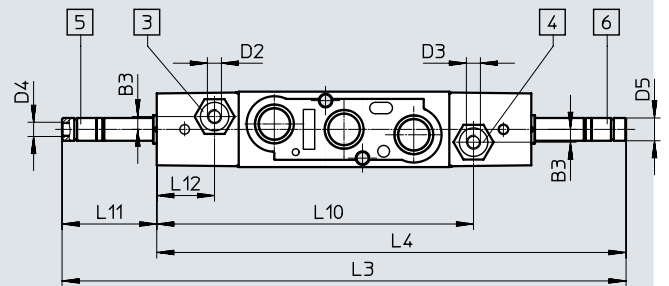
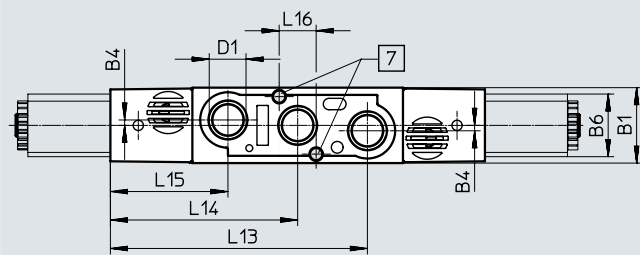
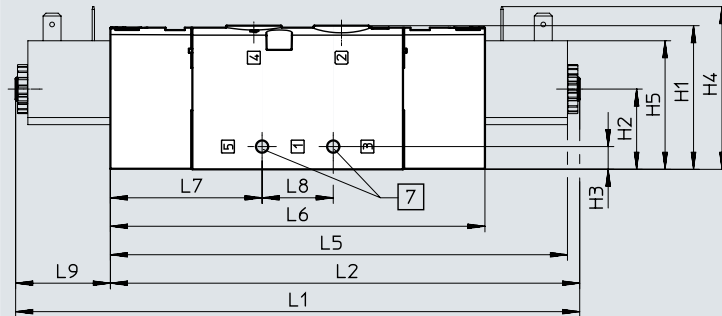
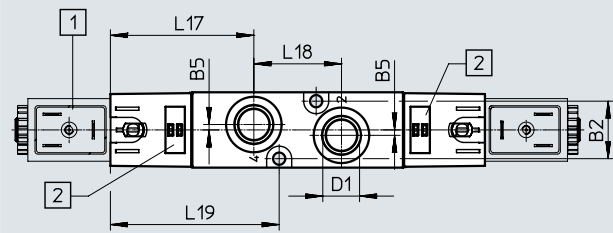

- [1] Solenoid coil interface type B/
type C
- [2] Space for inscription label
- [3] Port 14 for pilot air supply
- [4] Port 12 for pilot air supply
- [5] Port 84 for pilot exhaust air
- [6] Port 82 for pilot exhaust air
- [7] For screw M4

Type	B1	B2	B3	B4	B5	B6	D1	D2	D3	D4	D5	H1
VUVS-LT25-B52-D-N14-...	26.5	20.2	-	1.9	1.9	22	1/4 NPT	-	-	10-32 UNF-2B	8	50.5
VUVS-LT25-T32...D-N14-...												

Type	H2	H3	H4	H5	L1	L2	L3	L4	L5	L6	L7	L8
VUVS-LT25-B52-D-N14-...	28.2	8	57.2	45.2	200.3	166	198.2	164.9	160.6	131.6	53.3	25
VUVS-LT25-T32...D-N14-...												

Type	L9	L10	L11	L12	L13	L14	L15	L16	L17	L18	L19
VUVS-LT25-B52-D-N14-...	33.3	-	33.3	-	90.3	65.8	41.3	13	50.4	30.8	59.3
VUVS-LT25-T32...D-N14-...											

Accessories

Dimensions

Download CAD data → www.festo.com

Foot mounting

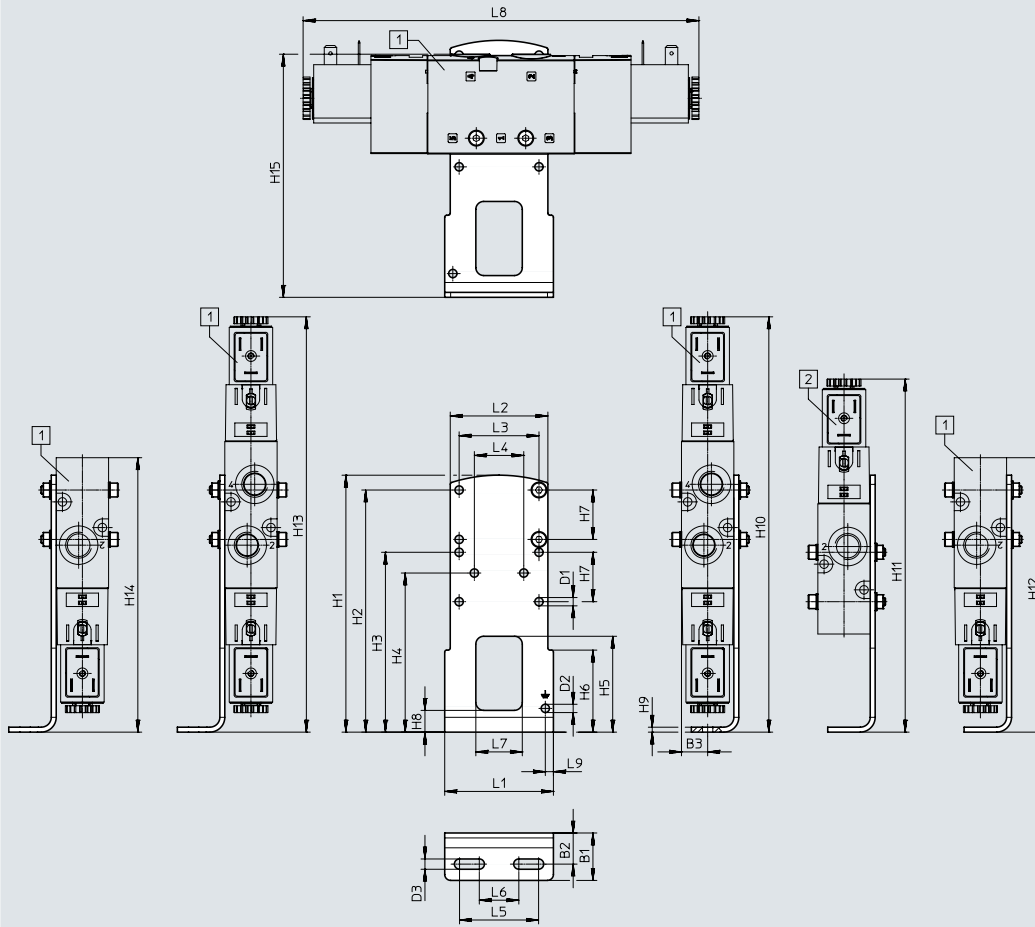

[1] VUVS-LT25-B52
 VUVS-LT25-T32
 VUVS-LT25-M52
 VUVS-LT25-M32

[2] VUVS-LT25-M52,
 VUVS-LT25-M32

Type		B1	B2	B3	D1 ∅	D2 ∅	D3	H1	H2	H3	H4
VAME-B10-25-A	VUVS-LT25-B52/T32	24	15.8	13.3	4.2	4.2	5.2	130	122.5	91	80.5
	VUVS-LT25-M52										
	VUVS-LT25-M32										

Type		H5	H6	H7	H8	H9	H10	H11	H12	H13	H14	
VAME-B10-25-A	VUVS-LT25-B52/T32	48.5	41.5	25	11	2.5	210.2	-	210.2	210.2	210.2	
	VUVS-LT25-M52							178.7				172
	VUVS-LT25-M32											138.9

Type		H15	L1	L2	L3	L4	L5	L6	L7	L8	L9
VAME-B10-25-A	VUVS-LT25-B52/T32	123	55	49.4	40.4	25	40	20	23.5	200.3	4.1
	VUVS-LT25-M52									162.2	
	VUVS-LT25-M32									118.7	

Accessories

Dimensions

Download CAD data → www.festo.com

Wall mounting

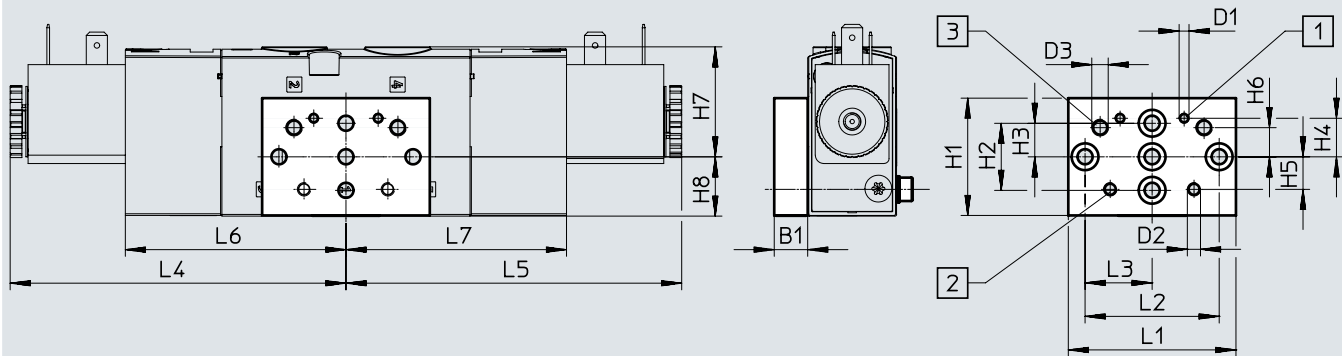

[1] Mounting hole for size 20 [2] Mounting hole for size 25 [3] Mounting hole for size 30



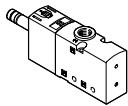
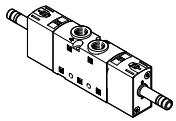
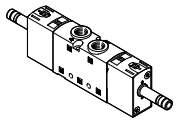
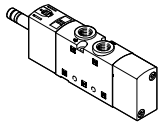
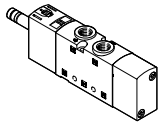
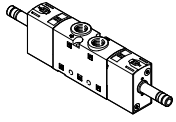

Type		B1	D1	D2	D3	H1	H2	H3	H4	H5	H6
VAME-B10-20-W	VUVS-LT25-B52/T32	10	M3	M4	M5	35	20	10	11.5	9.7	8.7
	VUVS-LT25-M52										
	VUVS-LT25-M32										

Type		H7	H8	L1	L2	L3	L4	L5	L6	L7
VAME-B10-20-W	VUVS-LT25-B52/T32	32.8	17.7	50	40	20	100.2	100.2	65.8	65.8
	VUVS-LT25-M52							62		
	VUVS-LT25-M32							18.5		





Accessories

Ordering data				
	Code	Valve function	Part no.	Type
3/2-way valve without solenoid coil				
	Single solenoid, normally closed			
	M32C-M	Reset via mechanical spring, internal pilot air supply, flow direction not reversible	8035216	VUVS-LT25-M32C-MD-N14-F8
	Single solenoid, normally open			
	M32U-M	Reset via mechanical spring, internal pilot air supply, flow direction not reversible	8035218	VUVS-LT25-M32U-MD-N14-F8
2x 3/2-way valve without solenoid coil				
	Single solenoid, normally closed			
	T32C	Reset via mechanical spring, internal pilot air supply, flow direction not reversible	8035224	VUVS-LT25-T32C-MD-N14-F8
	Single solenoid, normally open			
T32U	Reset via mechanical spring, internal pilot air supply, flow direction not reversible	8035226	VUVS-LT25-T32U-MD-N14-F8	
	Single solenoid, 1x normally open, 1x normally closed			
	T32H	Reset via mechanical spring, internal pilot air supply, flow direction not reversible	8035228	VUVS-LT25-T32H-MD-N14-F8
5/2-way valve without solenoid coil				
	Single solenoid			
	M52	Reset via mechanical spring, internal pilot air supply, flow direction not reversible	8035220	VUVS-LT25-M52-MD-N14-F8
	Double solenoid			
	B52	Internal pilot air supply, flow direction not reversible	8035222	VUVS-LT25-B52-D-N14-F8



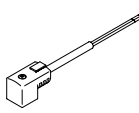

Accessories

Ordering data	Description	Part no.	Type	
Solenoid coils for valves				
	Plug pattern type C, to DIN EN 175301-803	12 V DC	8030810	VACF-B-C1-5
		24 V DC	8030811	VACF-B-C1-1
		48 V DC	8030812	VACF-B-C1-7
		24 V AC/50-60 Hz	8030813	VACF-B-C1-1A
		48 V AC/50-60 Hz	8030814	VACF-B-C1-7A
		110/120 V AC/50-60 Hz	8030815	VACF-B-C1-16B
		230/240 V AC/50-60 Hz	8030817	VACF-B-C1-3W
	Plug pattern type B, industry standard	12 V DC	8030801	VACF-B-B2-5
		24 V DC	8030802	VACF-B-B2-1
		48 V DC	8030803	VACF-B-B2-7
		24 V AC/50-60 Hz	8030804	VACF-B-B2-1A
		48 V AC/50-60 Hz	8030805	VACF-B-B2-7A
		110/120 V AC/50-60 Hz	8030806	VACF-B-B2-16B
		230/240 V AC/50-60 Hz	8030808	VACF-B-B2-3W
	M8 individual plug, 3-pin	24 V DC	8135909	VACS-C-R8-1RAL
	M8 individual plug, 4-pin	24 V DC	8135910	VACS-C-R1-1RAL
	Single plug M12, A-coded, according to EN 61076-2-101	24 V DC	8194567	VACS-C-R3-1RAL
	Single plug M12, A-coded, pin assignment to DESINA	24 V DC	8135911	VACS-C-R4-1RAL
Seal set for solenoid coil				
	Plug pattern type C to guarantee degree of protection IP67	2643771	VAMC-B10-C-B-S8	
	Plug pattern type B to guarantee degree of protection IP67	8034609	VAMC-B10-B-B-S8	
Cover cap				
	For manual override, non-detenting or covered	8028240	VAMC-B10-20-CH2	

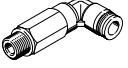
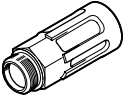

Accessories

Ordering data		Description	Part no.	Type		
Plug socket						
	Plug pattern type C, to DIN EN 175301-803					
	3-pin, screw terminal	Cable connector M12	0 ... 250 V AC/DC	IP65	539712	MSSD-EB-M12
		Cable connector Pg7			151687	MSSD-EB
	4-pin, insulation displacement connector	Cable connector M14	0 ... 250 V AC/DC	IP67	192745	MSSD-EB-S-M14
	3-pin, angled socket	Cable connector M12	0 ... 24 V DC	IP65	570367	MSSD-EB-M12-24VDC-SD-EX
	Plug pattern type B, industry standard					
	3-pin, screw terminal	Cable connector M16	0 ... 250 V AC/DC	IP65	539710	MSSD-F-M16
Cable connector Pg9		34431			MSSD-F	
3-pin, insulation displacement connector	–	0 ... 250 V AC/DC	IP67	192746	MSSD-FS-M16	
Adapter						
	Socket type C, to EN 175301-803	Plug M12x1, 2-pin, A-coded	12 ... 24 V AC/DC	IP65	188024	MSSD-EB-M12-MONO
Plug socket with cable						
	Plug pattern type C, to DIN EN 175301-803					
	Angled socket, 3-pin Cable, open end, 3-wire	24 V DC	LED	2.5 m	151688	KMEB-1-24-2.5-LED
				5 m	151689	KMEB-1-24-5-LED
				10 m	193457	KMEB-1-24-10-LED
	230 V AC	–	2.5 m	151690	KMEB-1-230AC-2.5	
			5 m	151691	KMEB-1-230AC-5	
	Plug pattern type B, industry standard					
	Angled socket, 3-pin Cable, open end, 3-wire	24 V DC	LED	2.5 m	30935	KMF-1-24DC-2.5-LED
				5 m	30937	KMF-1-24DC-5-LED
				10 m	193458	KMF-1-24-10-LED
230 V AC	–	2.5 m	30936	KMF-1-230AC-2.5		
		5 m	30938	KMF-1-230AC-5		
Illuminating seal						
	Plug pattern type C, to DIN EN 175301-803	24 V DC	151717	MEB-LD-12-24DC		
		230 V AC	151718	MEB-LD-230AC		
	Plug pattern type B, industry standard	24 V DC	19143	MF-LD-12-24DC		
		230 V AC	19144	MF-LD-230AC		

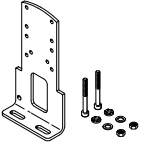
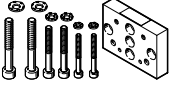

Accessories

Ordering data	Description	Part no.	Type	PU ¹⁾	
Push-in fitting with internal hex					
	Connecting thread 10-32 UNF for tubing O.D.	5/32 "	572312	QBM-10-32-UNF-5/32-I-U	10
	Connecting thread 1/4 NPT for tubing O.D.	1/4 "	572320	QB-1/4-1/4-I-U	10
		5/16 "	572321	QB-1/4-5/16-I-U	10
		3/8 "	572322	QB-1/4-3/8-I-U	10
Angled push-in fitting with external hex					
	Connecting thread 1/4 NPT for tubing O.D.	1/4 "	533295	QBL-1/4-1/4-U	10
		5/16 "	533296	QBL-1/4-5/16-U	10
		3/8 "	533297	QBL-1/4-3/8-U	5
Angled push-in fitting, long, with external hex					
	Connecting thread 1/4 NPT for tubing O.D.	1/4 "	564674	QBLL-1/4-1/4-U	10
		5/16 "	564675	QBLL-1/4-5/16-U	10
		3/8 "	564676	QBLL-1/4-3/8-U	5
Silencer					
	With connecting thread NPT, metal design	1/4 NPT	12639	U-1/4-B-NPT	1
	With connecting thread NPT, sintered design, long	1/4 NPT	1206990	AMTE-M-LH-N14	20

1) Packaging unit

Ordering data	Description	Weight [g]	Part no.	Type
Foot mounting				
	With screw set for attaching the valve to the foot mounting	130	2293485	VAME-B10-25-A
Wall mounting				
	With screw set for attaching the valve to the wall mounting	53	576413	VAME-B10-20-W
Assortment of spare parts				
	Set comprising seals and screws	12	8035636	VAME-B10-25-MK
Inscription label				
	40 pieces in frame	-	565306	ASLR-C-E4

Data sheet

-  - Flow rate
up to 1800 l/min ($\pm 20\%$)
-  - Valve width
31 mm
-  - Voltage
24 V DC

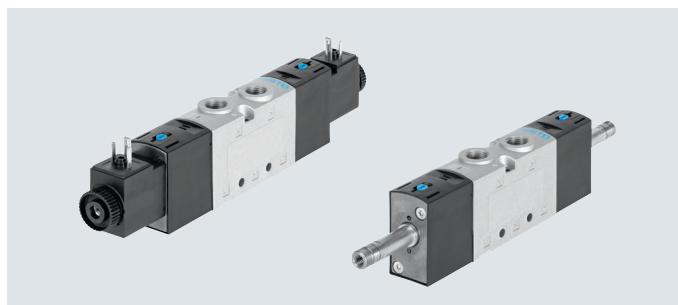

General technical data		3/2-way valve					5/2-way valve	
Valve function		M32C	M32U	T32C	T32U	T32H	M52	B52
Order code for valves								
Valve width	[mm]	31						
Nominal size	[mm]	7.9	7.9	7.9	7.8	7.8	8.1	8.7
Design		Poppet seat						
Flow direction		Not reversible						
Pilot air supply		Internal						
Type of control		Piloted						
Manual override		Non-detenting, detenting						
Overlap		Negative overlap						
Sealing principle		Soft						
Type of mounting		Optionally via through-hole or on manifold rail						
Standard nominal flow rate q _N	[l/min]	1600					1800	
Actuation type		Electrical						
Mounting position		Any						
Exhaust air function		Can be throttled						
Port for venting hole		Not ducted						
b value		0.4	0.2	0.4	0.3	0.3	0.3	0.3
c value	[l/sbar]	6.0	7.0	6.0	6.7	6.7	9.9	9.9
Pneumatic connection	1, 2, 3 4, 5	3/8 NPT	3/8 NPT	3/8 NPT	3/8 NPT	3/8 NPT	3/8 NPT	3/8 NPT
Pilot exhaust air port 82, 84		10-32 UNF-2B						

ATEX	
Type	VUVS-LT-...-EX2
ATEX category for gas	II 3G
Type of ignition protection for gas	Ex ec IICT4 Gc X
ATEX category for dust	II 3D
Type of ignition protection for dust	Ex tc IIIC T115°C Dc X
Explosion-proof ambient temperature [°C]	-10°C ≤ Ta ≤ +60°C
CE marking (see declaration of conformity) ¹⁾	To EU Explosion Protection Directive (ATEX)
UKCA marking (see declaration of conformity) ¹⁾	To UK EX instructions
Explosion protection certification outside the EU	EPL Dc (GB) EPL Gc (GB)

¹⁾ For information about the area of use, see the EC declaration of conformity at: www.festo.com/catalogue/... → Support/Downloads.

If the devices are subject to usage restrictions in residential, commercial or light-industrial environments, further measures for the reduction of the emitted interference may be necessary.

Data sheet

Technical data								
Order code for valves	M32C	M32U	T32C	T32U	T32H	M52	B52	
Normal position	Closed	Open	2x closed	2x normally open	1x open/ 1x closed	–	–	
Stable position	Monostable	Monostable	Monostable	Monostable	Monostable	Monostable	Bistable	
Reset method	Mechanical spring		Mechanical spring			Mechanical spring	–	
Switching times in [ms]	On	13	14	13	14	13	17	–
	Off	32	36	33	35	37	26	–
	Change-over	–	–	–	–	–	–	13
Product weight without solenoid coil [g]	305	305	422	422	422	432	438	

Safety characteristics	
Max. positive test pulse with logic 0 [is]	2000 (valves with VACF)
Max. negative test pulse with logic 1 [is]	3600 (valves with VACF)
Shock resistance	Shock test with severity level 2 to FN 942017-5 and EN 60068-2-27
Vibration resistance	Transport application test with severity level 2 to FN 942017-4 and EN 60068-2-6

Operating and environmental conditions									
Order code for valves	M32C	M32U	T32C	T32U	T32H	M52	B52		
Operating medium	Compressed air to ISO 8573-1:2010 [7:4:4]								
Pilot medium	Compressed air to ISO 8573-1:2010 [7:4:4]								
Note on the operating/pilot medium	Lubricated operation possible (in which case lubricated operation will always be required)								
Operating pressure	[MPa]	0.25 ... 1				0.25 ... 1		0.15 ... 1	
	[bar]	2.5 ... 10				2.5 ... 10		1.5 ... 10	
Pilot pressure	[MPa]	0.25 ... 1				0.25 ... 1		0.15 ... 1	
	[bar]	2.5 ... 10				2.5 ... 10		1.5 ... 10	
Ambient temperature [°C]	–10 ... +60								
Temperature of medium [°C]	–10 ... +60								
Certification	c UL us - Recognized (OL)								
Corrosion resistance class CRC ¹⁾	2								

1) Corrosion resistance class CRC 2 to Festo standard FN 940070

Moderate corrosion stress. Indoor applications in which condensation can occur. External visible parts with primarily decorative surface requirements which are in direct contact with a normal industrial environment.

Electrical data	
Electrical connection	Via solenoid coil
Operating voltage [V DC]	→ Internet: vacf
Permissible voltage fluctuations [%]	
Power [W]	
Duty cycle [%]	
Degree of protection to EN 60529	

Materials								
Order code for valves	M32C	M32U	T32C	T32U	T32H	M52	B52	
Housing	Die-cast aluminium (painted)							
Seals	HNBR, NBR, TPE-U(PU)							
Piston spool	Wrought aluminium alloy					POM	POM	
Screws	Galvanised steel							
Note on materials	RoHS-compliant							

Data sheet

Dimensions

Download CAD data → www.festo.com

3/2-way valves, with solenoid coil

3/2-way valves, without solenoid coil

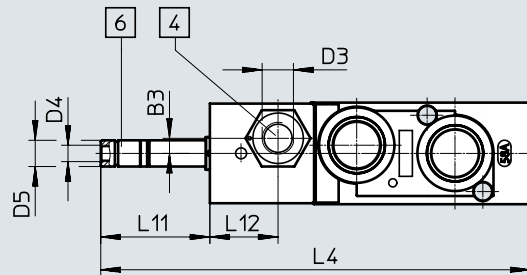
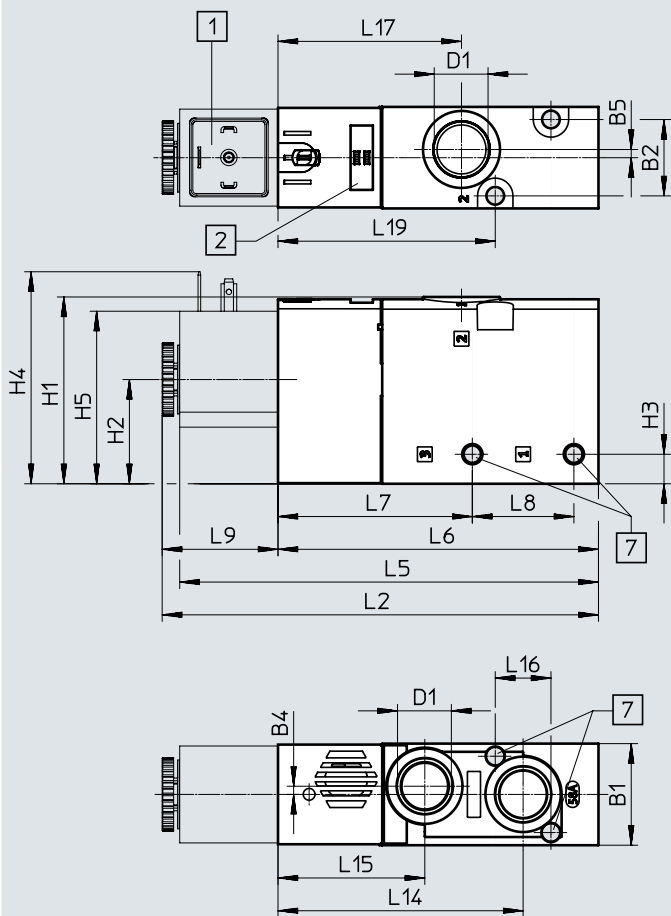

[1] Solenoid coil

[4] Port 10/12 for pilot air supply

[6] Port 82 for pilot exhaust air

[7] For screw M5

[2] Space for inscription label

Type	B1	B2	B3	B4	B5	D1	D3	D4	D5 ∅	H1	H2	H3	H4	H5
VUVS-LT30-M32...-D-N38-...	31	23.3	-	2.5	2.5	3/8 NPT	-	10-32 UNF-2B	8	57	31.8	9	64.7	52.6

Type	L2	L4	L5	L6	L7	L8	L9	L11	L12	L14	L15	L16	L17	L19
VUVS-LT30-M32...-D-N38-...	133.2	131.1	127.8	97.8	59.3	31	35.4	33.3	-	74.8	44.8	17	56	66.3

Data sheet

Dimensions

Download CAD data → www.festo.com

5/2-way single solenoid valves, with solenoid coil

5/2-way single solenoid valves, without solenoid coil

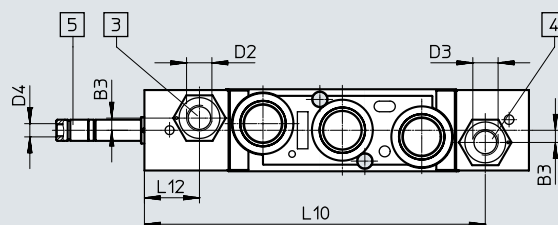
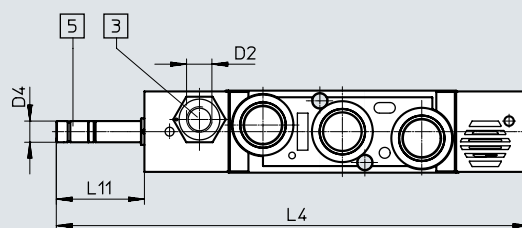
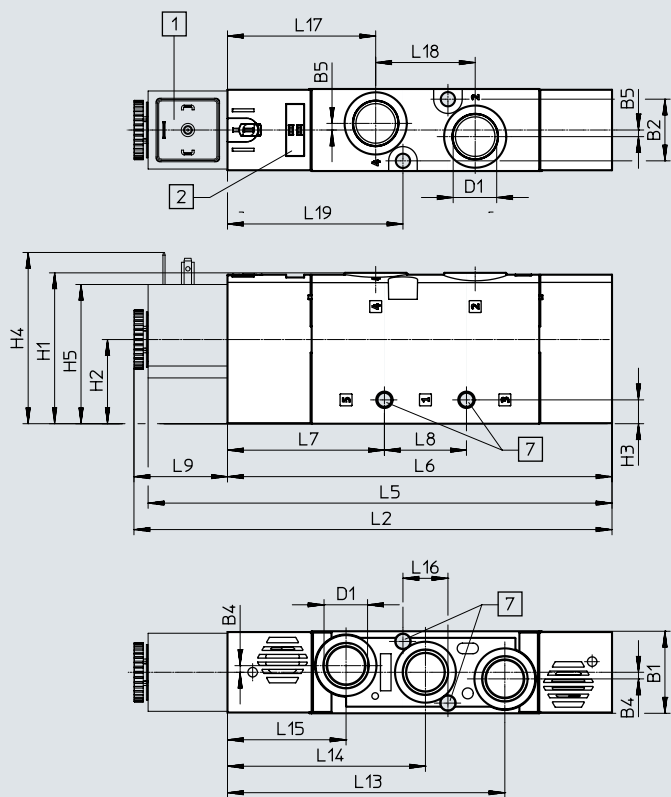

- [1] Solenoid coil
- [2] Space for inscription label
- [3] Port 14 for pilot air supply
- [4] Port 12 for pilot air supply
- [5] Port 84 for pilot exhaust air
- [7] For screw M5

Type	B1	B2	B3	B4	B5	D1	D2	D3	D4	D5	H1	H2	H3	H4	H5
VUVS-LT30-M52-...D-N38-...	31	23.3	-	2.5	2.5	3/8 NPT	-	-	10-32 UNF-2B	8	57	31.8	9	64.7	52.6

Type	L2	L4	L5	L6	L7	L8	L9	L10	L11	L12	L13	L14	L15	L16	L17	L18	L19
VUVS-LT30-M52-...D-N38-...	180.7	178.6	179.6	145.3	59.3	31	35.4	-	33.3	-	104.8	74.8	44.8	17	56	37.6	66.3

Data sheet

Dimensions

Download CAD data → www.festo.com

2x 3/2-way valves and 5/2-way double solenoid valves, with solenoid coil

2x 3/2-way valves and 5/2-way double solenoid valves, without solenoid coil

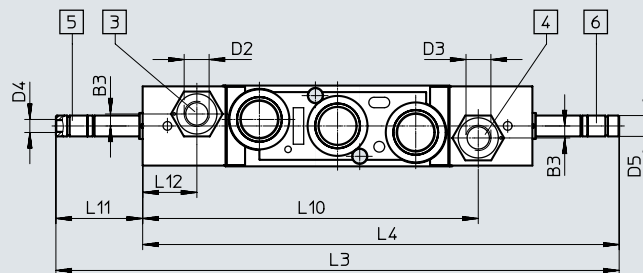
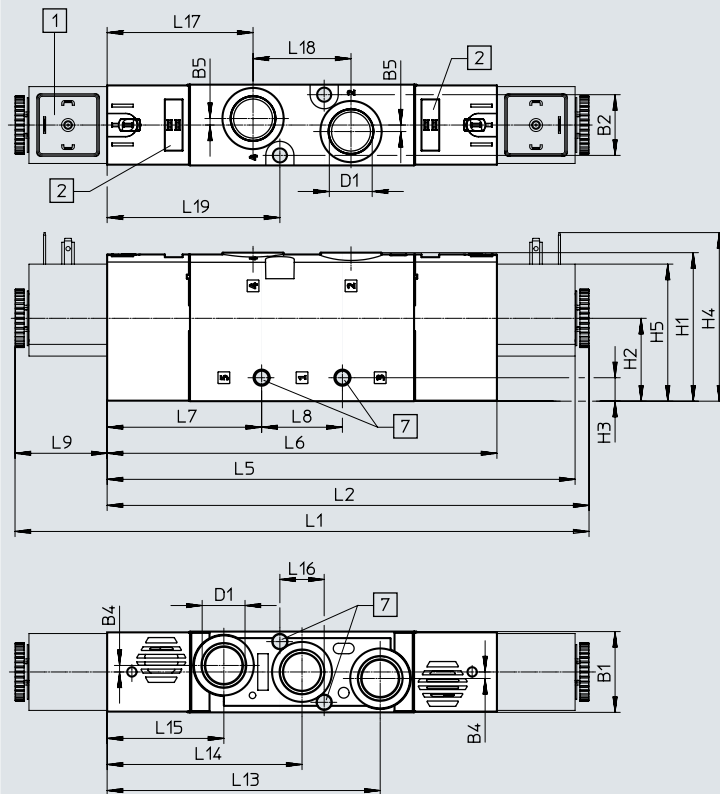

- [1] Solenoid coil
- [2] Space for inscription label
- [3] Port 14 for pilot air supply
- [4] Port 12 for pilot air supply
- [5] Port 84 for pilot exhaust air
- [6] Port 82 for pilot exhaust air
- [7] For screw M5

Type	B1	B2	B3	B4	B5	D1	D2	D3	D4	D5 ∅	H1	H2	H3	H4	H5
VUVS-LT30-T32...-MD-N38-...	31	23.3	-	2.5	2.5	3/8 NPT	-	-	10-32 UNF-2B	8	57	31.8	9	64.7	52.6
VUVS-LT30-B52-D-N38-...															

Type	L1	L2	L3	L4	L5	L6	L7	L8	L9	L10
VUVS-LT30-T32...-MD-N38-...	220.3	185	216.2	182.9	179.6	149.6	59.3	31	35.4	-
VUVS-LT30-B52-D-N38-...										

Type	L11	L12	L13	L14	L15	L16	L17	L18	L19
VUVS-LT30-T32...-MD-N38-...	33.3	-	104.8	74.8	44.8	17	56	37.6	66.3
VUVS-LT30-B52-D-N38-...									

Accessories

Dimensions

Download CAD data → www.festo.com

Foot mounting

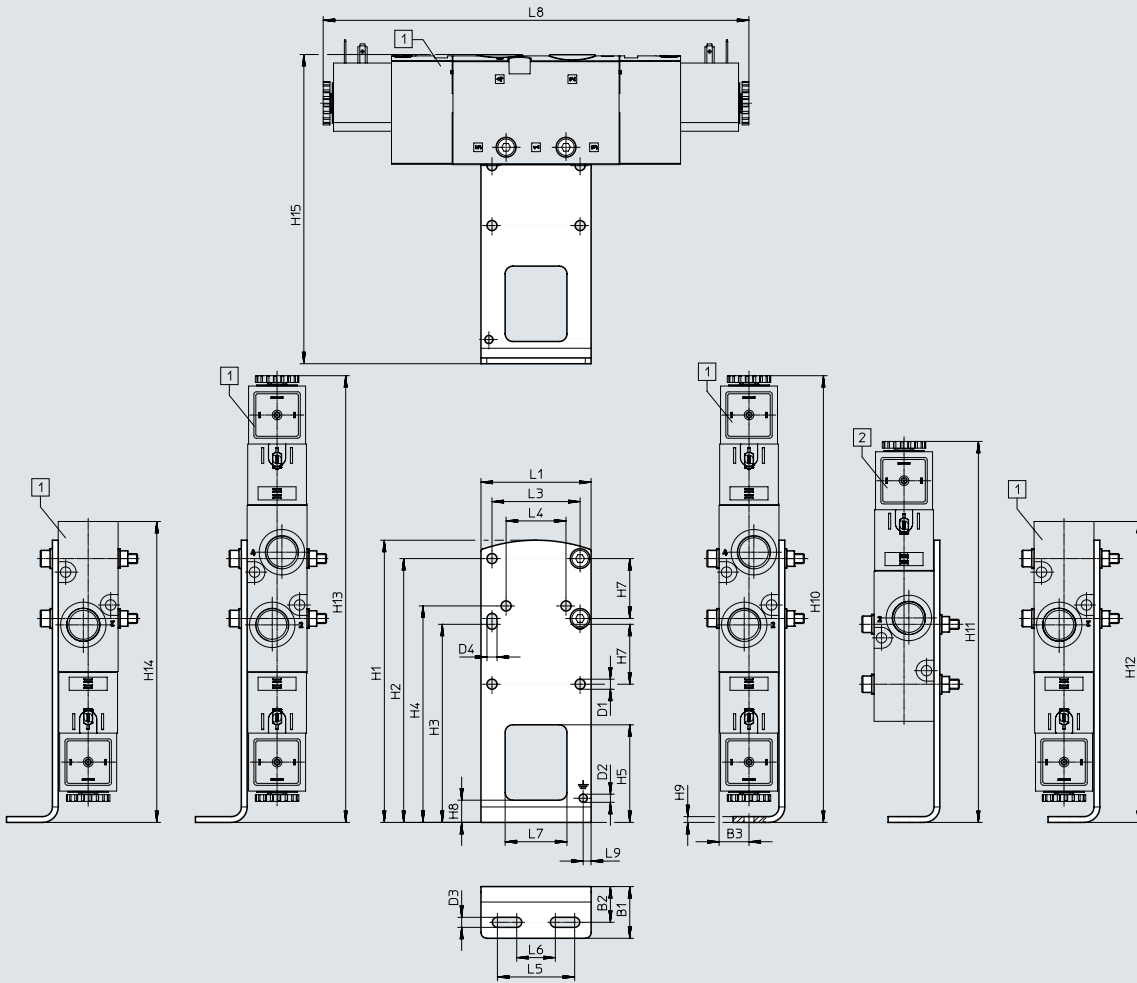

[1] VUVS-LT30-B52
 VUVS-LT30-T32
 VUVS-LT30-M52
 VUVS-LT30-M32

[2] VUVS-LT30-M52,
 VUVS-LT30-M32

Type		B1	B2	B3	D1 ∅	D2 ∅	D3	D4	H1	H2	H3
VAME-B10-30-A	VUVS-LT30-B52/T32	26.8	18.5	15.5	5.2	4.2	5.2	5.2	146	136.5	102.5
	VUVS-LT30-M52										
	VUVS-LT30-M32										

Type		H4	H5	H7	H8	H9	H10	H11	H12	H13	H14
VAME-B10-30-A	VUVS-LT30-B52/T32	112	50.5	31	11.5	3	231.2	–	231.2	231.2	231.2
	VUVS-LT30-M52							197.2	191.5	191.5	
	VUVS-LT30-M32							144	144	144	

Type		H15	L1	L3	L4	L5	L6	L7	L8	L9
VAME-B10-30-A	VUVS-LT30-B52/T32	160	57	45.6	31	40	20	32	220.3	4.1
	VUVS-LT30-M52								180.7	
	VUVS-LT30-M32								133.2	

Accessories

Dimensions

Download CAD data → www.festo.com

Wall mounting

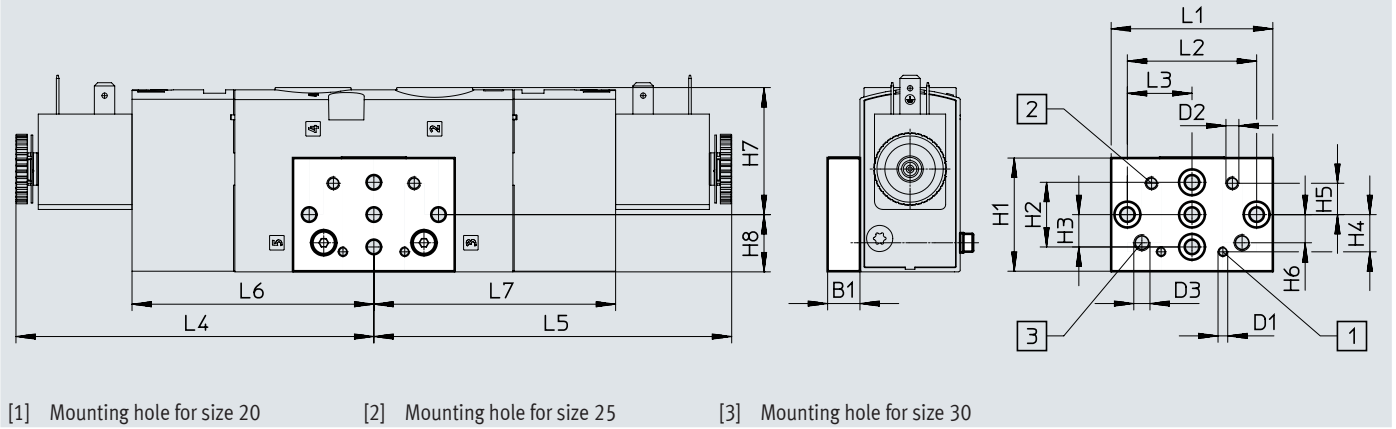



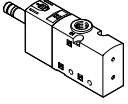
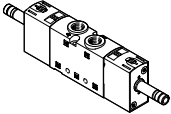
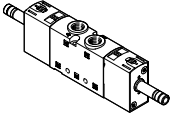
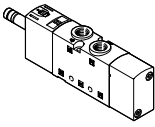
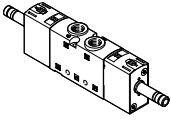

Type		B1	D1	D2	D3	H1	H2	H3	H4	H5	H6
VAME-B10-20-W	VUVS-LT30-B52/T32	10	M3	M4	M5	35	20	10	11.5	9.7	8.7
	VUVS-LT30-M52										
	VUVS-LT30-M32										

Type		H7	H8	L1	L2	L3	L4	L5	L6	L7
VAME-B10-20-W	VUVS-LT30-B52/T32	39.3	17.7	50	40	20	110.2	110.2	74.8	74.8
	VUVS-LT30-M52									
	VUVS-LT30-M32									





Accessories

Ordering data		Code	Valve function	Part no.	Type
3/2-way valve without solenoid coil					
	Single solenoid, normally closed				
	M32C-M	Reset via mechanical spring, internal pilot air supply, flow direction not reversible	8036721	VUVS-LT30-M32C-MD-N38-F8	
	Single solenoid, normally open				
	M32U-M	Reset via mechanical spring, internal pilot air supply, flow direction not reversible	8036723	VUVS-LT30-M32U-MD-N38-F8	
2x 3/2-way valve without solenoid coil					
	Single solenoid, normally closed				
	T32C	Reset via mechanical spring, internal pilot air supply, flow direction not reversible	8036729	VUVS-LT30-T32C-MD-N38-F8	
	Single solenoid, normally open				
T32U	Reset via mechanical spring, internal pilot air supply, flow direction not reversible	8036731	VUVS-LT30-T32U-MD-N38-F8		
Single solenoid, 1x normally open, 1x normally closed					
T32H	Reset via mechanical spring, internal pilot air supply, flow direction not reversible	8036733	VUVS-LT30-T32H-MD-N38-F8		
5/2-way valve without solenoid coil					
	Single solenoid				
	M52	Reset via mechanical spring, internal pilot air supply, flow direction not reversible	8036725	VUVS-LT30-M52-MD-N38-F8	
	Double solenoid				
	B52	Internal pilot air supply, flow direction not reversible	8036727	VUVS-LT30-B52-D-N38-F8	

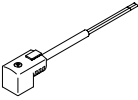

Accessories

Ordering data		Description	Part no.	Type		
Solenoid coils for valves						
	Plug pattern type C, to DIN EN 175301-803	12 V DC	8030810	VACF-B-C1-5		
		24 V DC	8030811	VACF-B-C1-1		
		48 V DC	8030812	VACF-B-C1-7		
		24 V AC/50-60 Hz	8030813	VACF-B-C1-1A		
		48 V AC/50-60 Hz	8030814	VACF-B-C1-7A		
		110/120 V AC/50-60 Hz	8030815	VACF-B-C1-16B		
		230/240 V AC/50-60 Hz	8030817	VACF-B-C1-3W		
	Plug pattern type B, industry standard	12 V DC	8030801	VACF-B-B2-5		
		24 V DC	8030802	VACF-B-B2-1		
		48 V DC	8030803	VACF-B-B2-7		
		24 V AC/50-60 Hz	8030804	VACF-B-B2-1A		
		48 V AC/50-60 Hz	8030805	VACF-B-B2-7A		
		110/120 V AC/50-60 Hz	8030806	VACF-B-B2-16B		
		230/240 V AC/50-60 Hz	8030808	VACF-B-B2-3W		
	Plug pattern type A, to EN 175301-803	12 V DC	8030821	VACF-A-A1-5		
		24 V DC	8030822	VACF-A-A1-1		
		48 V DC	8030823	VACF-A-A1-7		
		24 V AC/50-60 Hz	8030824	VACF-A-A1-1A		
48 V AC/50-60 Hz		8030825	VACF-A-A1-7A			
110/120 V AC/50-60 Hz		8030826	VACF-A-A1-16B			
230/240 V AC/50-60 Hz		8030828	VACF-A-A1-3W			
	M8 individual plug, 3-pin	24 V DC	8135909	VACS-C-R8-1RAL		
	M8 individual plug, 4-pin	24 V DC	8135910	VACS-C-R1-1RAL		
	Single plug M12, A-coded, according to EN 61076-2-101	24 V DC	8194567	VACS-C-R3-1RAL		
	Single plug M12, A-coded, pin assignment to DESINA	24 V DC	8135911	VACS-C-R4-1RAL		
Seal set for solenoid coil						
	Plug pattern type C to guarantee degree of protection IP67		2643771	VAMC-B10-C-B-S8		
	Plug pattern type B to guarantee degree of protection IP67		8034609	VAMC-B10-B-B-S8		
	Plug pattern type A to guarantee degree of protection IP67		8034611	VAMC-B10-A-B-S8		
Cover cap						
	For manual override, non-detenting or covered		8028240	VAMC-B10-20-CH2		
Plug socket						
	Plug pattern type C, to DIN EN 175301-803					
	3-pin, screw terminal	Cable connector M12	0 ... 250 V AC/DC	IP65	539712	MSSD-EB-M12
		Cable connector Pg7			151687	MSSD-EB
	4-pin, insulation displacement connector	Cable connector M14	0 ... 250 V AC/DC	IP67	192745	MSSD-EB-S-M14
	3-pin, angled socket	Cable connector M12	0 ... 24 V DC	IP65	570367	MSSD-EB-M12-24VDC-SD-EX
	Plug pattern type B, industry standard					
	3-pin, screw terminal	Cable connector M16	0 ... 250 V AC/DC	IP65	539710	MSSD-F-M16
Cable connector Pg9		34431			MSSD-F	
3-pin, insulation displacement connector	–	0 ... 250 V AC/DC	IP67	192746	MSSD-FS-M16	

Accessories

Ordering data		Description	Part no.	Type		
Plug socket						
	Plug pattern type A, to EN 175301-803					
	3-pin, angled socket	Cable connector Pg9	0 ... 250 V AC/DC	IP65	34583	MSSD-C
	3-pin, angled socket	Cable connector M16	0 ... 250 V AC/DC	IP65	539709	MSSD-C-M16
	4-pin, angled socket	Cable connection, insulation displacement	0 ... 250 V AC/DC	IP67	192748	MSSD-C-S-M16
Adapter						
	Socket type C, to EN 175301-803	Plug M12x1, 2-pin, A-coded	12 ... 24 V AC/DC	IP65	188024	MSSD-EB-M12-MONO
Plug socket with cable						
	Plug pattern type C, to DIN EN 175301-803					
	Angled socket, 3-pin Cable, open end, 3-wire	24 V DC	LED	2.5 m	151688	KMEB-1-24-2.5-LED
				5 m	151689	KMEB-1-24-5-LED
				10 m	193457	KMEB-1-24-10-LED
	Cable, open end, 3-wire	230 V AC	-	2.5 m	151690	KMEB-1-230AC-2.5
				5 m	151691	KMEB-1-230AC-5
	Plug pattern type B, industry standard					
	Angled socket, 3-pin Cable, open end, 3-wire	24 V DC	LED	2.5 m	30935	KMF-1-24DC-2.5-LED
				5 m	30937	KMF-1-24DC-5-LED
				10 m	193458	KMF-1-24-10-LED
	Cable, open end, 3-wire	230 V AC	-	2.5 m	30936	KMF-1-230AC-2.5
				5 m	30938	KMF-1-230AC-5
	Plug pattern type A, to EN 175301-803					
	Angled socket, 3-pin Cable, open end, 3-wire	24 V DC	LED	2.5 m	30931	KMC-1-24DC-2.5-LED
5 m				30933	KMC-1-24DC-5-LED	
10 m				193459	KMC-1-24-10-LED	
230 V AC		-	2.5 m	30932	KMC-1-230AC-2.5	
			5 m	30934	KMC-1-230AC-5	
Illuminating seal						
	Plug pattern type C, to DIN EN 175301-803	24 V DC		151717	MEB-LD-12-24DC	
		230 V AC		151718	MEB-LD-230AC	
	Plug pattern type B, industry standard	24 V DC		19143	MF-LD-12-24DC	
		230 V AC		19144	MF-LD-230AC	

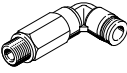
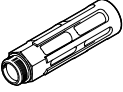

Accessories

Ordering data	Description		Part no.	Type	PU ¹⁾
Push-in fitting with internal hex					
	Connecting thread 10-32 UNF for tubing O.D.	5/32 "	572312	QBM-10-32-UNF-5/32-I-U	10
	Connecting thread 3/8 NPT for tubing O.D.	5/16 "	572323	QB-3/8-5/16-I-U	10
		3/8 "	572324	QB-3/8-3/8-I-U	10
		1/2 "	572325	QB-3/8-1/2-I-U	10
Angled push-in fitting with external hex					
	Connecting thread 3/8 NPT for tubing O.D.	5/16 "	533299	QBL-3/8-5/16-U	5
		3/8 "	533300	QBL-3/8-3/8-U	5
		1/2 "	533301	QBL-3/8-1/2-U	5
Angled push-in fitting, long, with external hex					
	Connecting thread 3/8 NPT for tubing O.D.	5/16 "	564679	QBLL-3/8-5/16-U	5
		3/8 "	564680	QBLL-3/8-3/8-U	5
		1/2 "	564681	QBLL-3/8-1/2-U	5
Silencer					
	With connecting thread NPT, metal design	3/8 NPT	12740	U-3/8-B-NPT	1

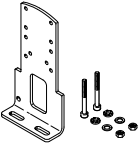
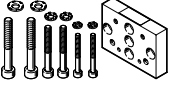
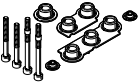
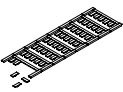
1) Packaging unit

Ordering data	Description	Weight [g]	Part no.	Type
Foot mounting				
	With screw set for attaching the valve to the foot mounting	239	8026337	VAME-B10-30-A
Wall mounting				
	With screw set for attaching the valve to the wall mounting	53	576413	VAME-B10-20-W
Assortment of spare parts				
	Set comprising seals and screws	22	8035637	VAME-B10-30-MK
Inscription label				
	40 pieces in frame	-	565306	ASLR-C-E4

Data sheet

-  Flow rate
up to 700 l/min (±20%)
-  Valve width
21 mm
-  Voltage
12, 24 V DC
24, 110, 120, 230, 240 V AC

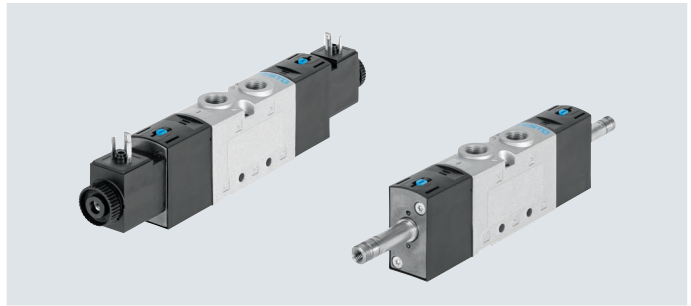

General technical data									
Valve function	3/2		5/2		5/3				
Order code for valves	M32C	M32U	M52	B52	P53C	P53U	P53E		
Valve width [mm]	21								
Design	Piston spool								
Flow direction	Reversible with external pilot air supply								
Pilot air supply	Internal or external								
Type of control	Piloted								
Manual override	Non-detenting, detenting								
Overlap	Positive overlap								
Sealing principle	Soft								
Type of mounting	Optionally via through-hole or on manifold rail								
Standard nominal flow rate qnN [l/min]	700					600			
Through-holes (nominal width) [mm]	5.7	5.7	5.7	5.7	5.0	4.8	4.5		
b value	0.35								
c value [l/sbar]	2.9	2.9	2.9	2.9	2.9	2.5	2.5		
Actuation type	Electrical								
Mounting position	Any								
Exhaust air function	Can be throttled								
Pneumatic connection	1, 2, 3	1/8 NPT	1/8 NPT	1/8 NPT	1/8 NPT	1/8 NPT	1/8 NPT	1/8 NPT	
	4, 5	-	-	1/8 NPT	1/8 NPT	1/8 NPT	1/8 NPT	1/8 NPT	
Pilot exhaust air port 82/84	10-32 UNF-2B								

ATEX	
Type	VUVS-L...EX2
ATEX category for gas	II 3G
Type of ignition protection for gas	Ex ec IICT4 Gc X
ATEX category for dust	II 3D
Type of ignition protection for dust	Ex tc IIIC T115°C Dc X
Explosion-proof ambient temperature [°C]	-10°C ≤ Ta ≤ +60°C
CE marking (see declaration of conformity) ¹⁾	To EU Explosion Protection Directive (ATEX)
UKCA marking (see declaration of conformity) ¹⁾	To UK EX instructions
Explosion protection certification outside the EU	EPL Dc (GB) EPL Gc (GB)

¹⁾ For information about the area of use, see the EC declaration of conformity at: www.festo.com/catalogue/... → Support/Downloads.
If the devices are subject to usage restrictions in residential, commercial or light-industrial environments, further measures for the reduction of the emitted interference may be necessary.

Data sheet

Technical data – 3/2-way valves					
Order code for valves		M32C		M32U	
Normal position		Closed		Open	
Stable position		Monostable		Monostable	
Reset method		Pneumatic spring	Mechanical spring	Pneumatic spring	Mechanical spring
Switching times in [ms]	On	14	14	14	15
	Off	21	32	21	28
	Change-over	–	–	–	–
Product weight without solenoid coil	[g]	138	136	138	136
Product weight with solenoid coil	[g]	172	170	172	170

Technical data – 5/2-way valves					
Order code for valves		M52		B52	
Normal position		–		–	
Stable position		Monostable		Bistable	
Reset method		Pneumatic spring	Mechanical spring	–	
Switching times in [ms]	On	20	12	–	
	Off	29	44	–	
	Change-over	–	–	10	
Product weight without solenoid coil	[g]	188	183	225	
Product weight with solenoid coil	[g]	222	217	259	

Technical data – 5/3-way valves					
Order code for valves		P53C		P53U	P53E
Normal position/mid-position		Closed		Pressurised	Exhausted
Stable position		Monostable			
Reset method		Mechanical spring			
Switching times in [ms]	On	13	13	13	
	Off	42	42	44	
	Change-over	24	21	24	
Product weight without solenoid coil	[g]	229	229	229	
Product weight with solenoid coil	[g]	263	263	263	

Safety characteristics		
Max. positive test pulse with logic 0	[s]	1900 (valves with VACS-C-C1-1)
Max. negative test pulse with logic 1	[s]	2700 (valves with VACS-C-C1-1)
Shock resistance		Shock test with severity level 2 to FN 942017-5 and EN 60068-2-27
Vibration resistance		Transport application test with severity level 2 to FN 942017-4 and EN 60068-2-6

Data sheet

Operating and environmental conditions		M32	M52	B52	P53
Order code for valves					
Operating medium		Compressed air to ISO 8573-1:2010 [7:4:4]			
Pilot medium		Compressed air to ISO 8573-1:2010 [7:4:4]			
Note on the operating/pilot medium		Lubricated operation possible (in which case lubricated operation will always be required)			
Operating pressure with internal pilot air supply	[MPa]	0.25 ... 1		0.15 ... 1	0.25 ... 1
	[bar]	2.5 ... 10		1.5 ... 10	2.5 ... 10
Operating pressure with external pilot air supply	[MPa]	-0.09 ... +1			
	[bar]	-0.9 ... +10			
Pilot pressure	[MPa]	0.25 ... 1		0.15 ... 1	0.25 ... 1
	[bar]	2.5 ... 10		1.5 ... 10	2.5 ... 10
Ambient temperature	[°C]	-10 ... +60			
Temperature of medium	[°C]	-10 ... +60			
Certification		cUL us - Recognized (OL)			
Corrosion resistance class CRC ¹⁾		2			

1) Corrosion resistance class CRC 2 to Festo standard FN 940070

Moderate corrosion stress. Indoor applications in which condensation can occur. External visible parts with primarily decorative surface requirements which are in direct contact with a normal industrial environment.

Electrical data	
Electrical connection	Via solenoid coil
Operating voltage [V DC]	→ Internet: vacs
Permissible voltage fluctuations [%]	
Power [W]	
Duty cycle [%]	
Degree of protection to EN 60529	

Materials	
Housing	Die-cast aluminium (painted)
Seals	HNBR, NBR
Piston spool	Wrought aluminium alloy (P53 types: High-alloy stainless steel)
Screws	Galvanised steel
Note on materials	RoHS-compliant

Data sheet

Dimensions

Download CAD data → www.festo.com

3/2-way valves, with solenoid coil

3/2-way valves, without solenoid coil

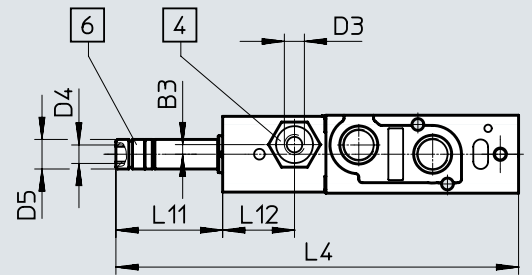
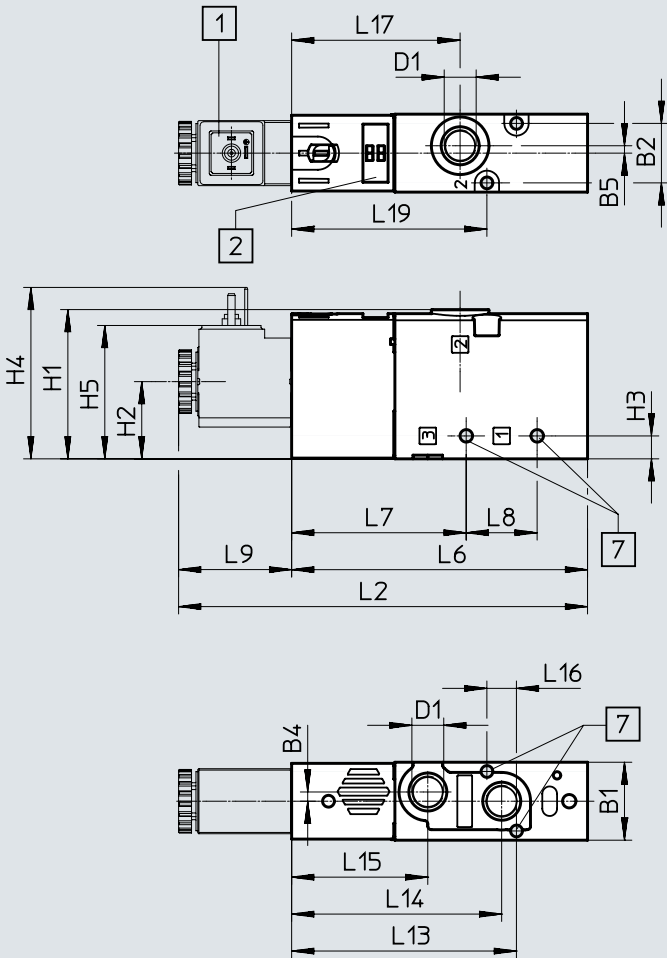

[1] Solenoid coil interface type C
[2] Space for inscription label

[3] Port 10/12 for pilot air supply
[4] Port 82 for pilot exhaust air

[5] For screw M3

[6] For screw M4

Type	B1	B2	B3	B4	B5	D1	D3	D4	D5 ∅	H1	H2	H3	H4	H5
VUVS-L20-M32-...D-N18-...	21.1	16.1	-	2.5	2	1/8 NPT	-	10-32 UNF-2B	8	40.4	20.9	5.8	46.7	36.4
VUVS-L20-M32-...ZD-N18-...			2.6				10-32 UNF-2B							

Type	L2	L4	L6	L7	L8	L9	L11	L12	L13	L14	L15	L16	L17	L19	L20
VUVS-L20-M32-...D-N18-...	110.7	109.1	80.1	47.9	18	30.6	29	-	60.9	56.9	36.9	8	45.6	52.9	2
VUVS-L20-M32-...ZD-N18-...								19.5							

Data sheet

Dimensions

Download CAD data → www.festo.com

5/2-way valves, with solenoid coil

5/2-way valves, without solenoid coil

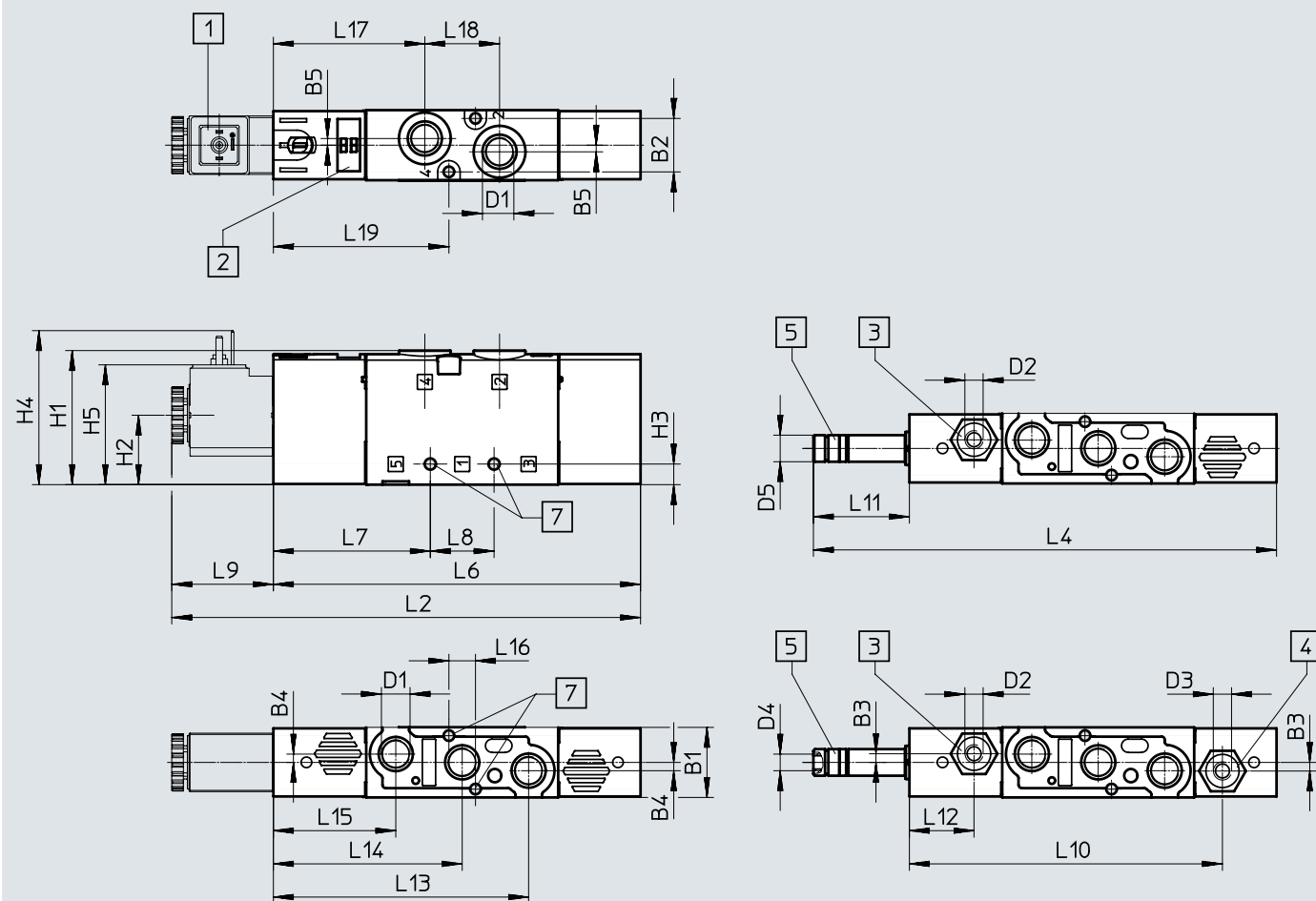

- [1] Solenoid coil interface type C
- [2] Space for inscription label
- [3] Port 14 for pilot air supply
- [4] Port 12 for pilot air supply
- [5] Port 84 for pilot exhaust air
- [6] For screw M3
- [7] For screw M4

Type	B1	B2	B3	B4	B5	D1	D2	D3	D4
VUVS-L20-M52-...D-N18-...	21.1	16.1	-	2.5	2	1/8 NPT	-	-	10-32 UNF-2B
VUVS-L20-M52-...ZD-N18-...			2.6				10-32 UNF-2B	10-32 UNF-2B	

Type	D5 ø	H1	H2	H3	H4	H5	L2	L4	L6	L7	L8	L9
VUVS-L20-M52-...D-N18-...	8	40.4	20.9	5.8	46.7	36.4	141.2	139.6	110.6	47.9	18	30.6
VUVS-L20-M52-...ZD-N18-...												

Type	L10	L11	L12	L13	L14	L15	L16	L17	L18	L19	L20
VUVS-L20-M52-...D-N18-...	-	29	-	76.9	56.9	36.9	8	45.6	22.5	52.9	2
VUVS-L20-M52-...ZD-N18-...	94.3		19.5								

Data sheet

Dimensions

Download CAD data → www.festo.com

5/3-way valves and 5/2-way double solenoid valves, with solenoid coil

5/3-way valves and 5/2-way valves, double solenoid, without solenoid coil

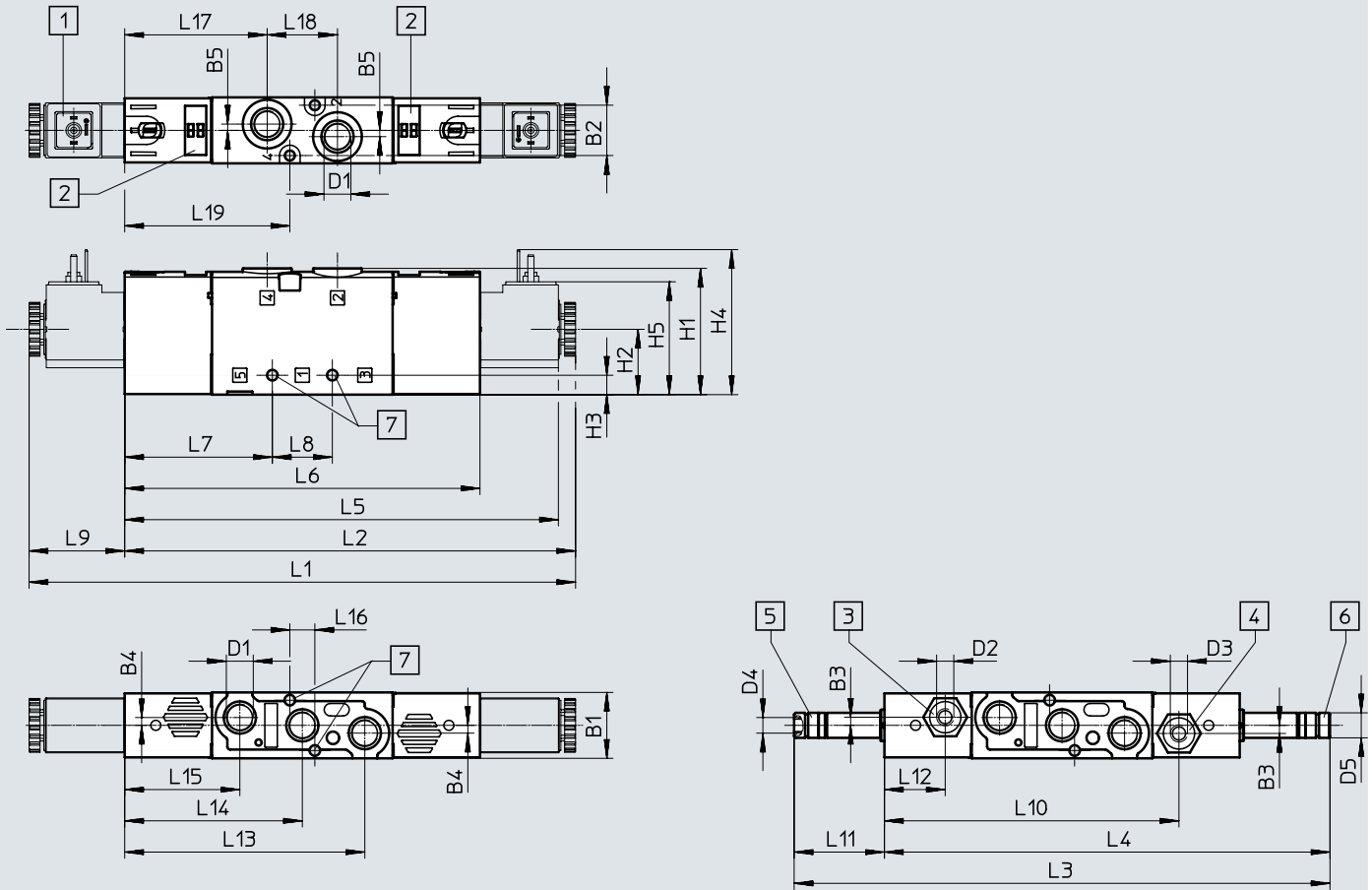

- [1] Solenoid coil interface type C
- [2] Space for inscription label
- [3] Port 14 for pilot air supply
- [4] Port 12 for pilot air supply
- [5] Port 84 for pilot exhaust air
- [6] Port 82 for pilot exhaust air
- [7] For screw M3
- [8] For screw M4

Type	B1	B2	B3	B4	B5	D1	D2	D3	D4	D5 ∅	H1	H2
VUVS-L20-P53...D-N18-...	21.1	16.1	-	2.5	2	1/8 NPT	-	-	10-32 UNF-2B	8	40.4	20.9
VUVS-L20-P53...ZD-N18-...			2.6				10-32 UNF-2B	10-32 UNF-2B				
VUVS-L20-B52-D-N18-...			-				-	-				
VUVS-L20-B52-ZD-N18-...			2.6				10-32 UNF-2B	10-32 UNF-2B				

Type	H3	H4	H5	L1	L2	L3	L4	L5	L6	L7	L8	L9	L10	L11
VUVS-L20-P53...D-N18-...	5.8	46.7	36.4	174.9	144.3	171.7	142.7	139.1	113.7	47.9	18	30.6	-	29
VUVS-L20-P53...ZD-N18-...													94.3	
VUVS-L20-B52-D-N18-...													-	
VUVS-L20-B52-ZD-N18-...													94.3	

Type	L12	L13	L14	L15	L16	L17	L18	L19	L20
VUVS-L20-P53...D-N18-...	-	76.9	56.9	36.9	8	45.6	22.5	52.9	2
VUVS-L20-P53...ZD-N18-...	19.5								
VUVS-L20-B52-D-N18-...	-								
VUVS-L20-B52-ZD-N18-...	19.5								

Data sheet

Dimensions

Foot mounting

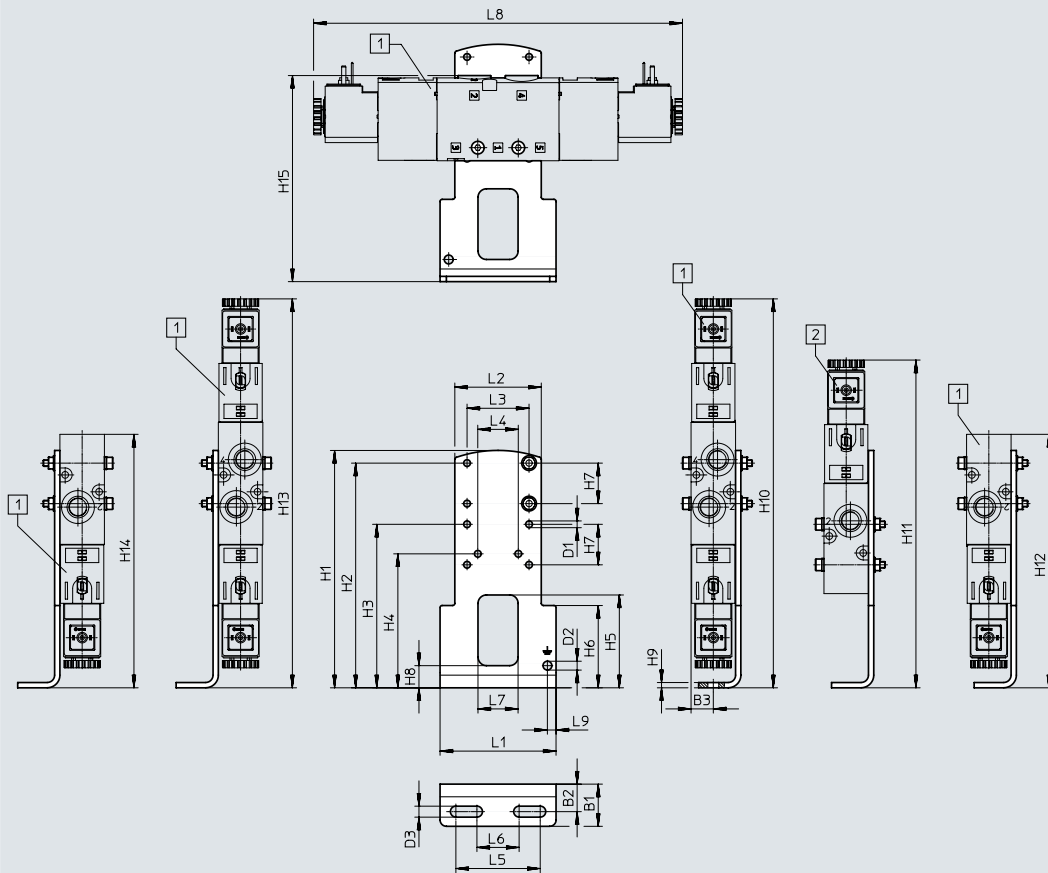

[1] VUVS-L20-B52,
VUVS-L20-P53,
VUVS-L20-M52,
VUVS-L20-M32

[2] VUVS-L20-M52,
VUVS-L20-M32

Type		B1	B2	B3	D1 ∅	D2 ∅	D3	H1	H2	H3	H4
VAME-B10-20-A	VUVS-L20-B52/P53	20	13.1	10.6	3.2	4.2	5.2	112.5	106.5	77.5	63.5
	VUVS-L20-M52										
	VUVS-L20-M32										

Type		H5	H6	H7	H8	H9	H10	H11	H12	H13	H14
VAME-B10-20-A	VUVS-L20-B52/P53	44	39	19.2	10.5	2.5	184.4	–	184.4	184.4	184.4
	VUVS-L20-M52							155.4	150.6	150.6	
	VUVS-L20-M32								120.2	120.2	

Type		H15	L1	L2	L3	L4	L5	L6	L7	L8	L9
VAME-B10-20-A	VUVS-L20-B52/P53	97.7	55	41	29.4	19.2	40	20	19	174.9	4.1
	VUVS-L20-M52									141.2	
	VUVS-L20-M32									110.7	

Data sheet

Dimensions

Wall mounting

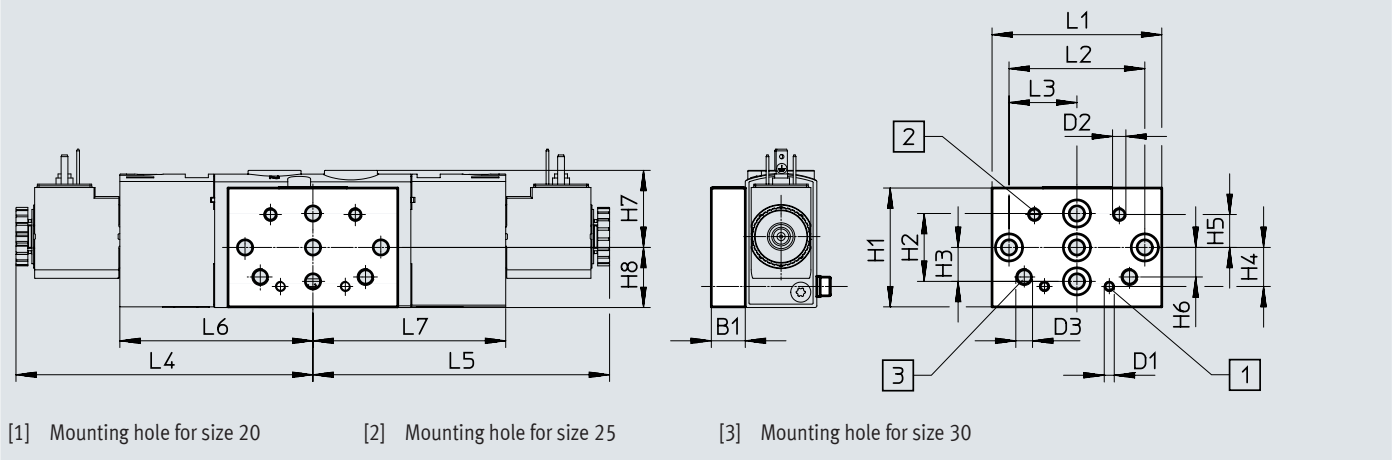







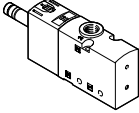
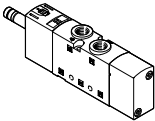
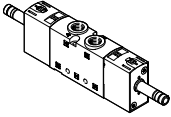
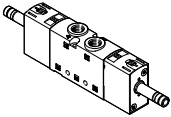

Type		B1	D1	D2	D3	H1	H2	H3	H4	H5	H6
VAME-B10-20-W	VUVS-L20-B52/P53	10	M3	M4	M5	35	20	10	11.5	9.7	8.7
	VUVS-L20-M52										
	VUVS-L20-M32										

Type		H7	H8	L1	L2	L3	L4	L5	L6	L7
VAME-B10-20-W	VUVS-L20-B52/P53	22.7	17.7	50	40	20	87.5	87.4	56.9	56.9
	VUVS-L20-M52							53.7		-
	VUVS-L20-M32							23.3		-



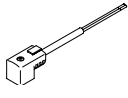

Accessories

Ordering data				
	Code	Valve function	Part no.	Type
3/2-way valve without solenoid coil				
	Single solenoid, closed			
	M32C-A	Pneumatic spring return, internal pilot air supply, flow direction not reversible	575694	VUVS-L20-M32C-AD-N18-F7
	M32C-AZ	Pneumatic spring return, external pilot air supply, flow direction reversible	8065570	VUVS-L20-M32C-AZD-N18-F7
	M32C-M	Reset via mechanical spring, internal pilot air supply, flow direction not reversible	575695	VUVS-L20-M32C-MD-N18-F7
	M32C-MZ	Reset via mechanical spring, external pilot air supply, flow direction reversible	8065571	VUVS-L20-M32C-MZD-N18-F7
	Single solenoid, open			
M32U-A	Pneumatic spring return, internal pilot air supply, flow direction not reversible	575698	VUVS-L20-M32U-AD-N18-F7	
M32U-M	Reset via mechanical spring, internal pilot air supply, flow direction not reversible	575699	VUVS-L20-M32U-MD-N18-F7	
5/2-way valve without solenoid coil				
	Single solenoid			
	M52-A	Pneumatic spring return, internal pilot air supply, flow direction not reversible	575702	VUVS-L20-M52-AD-N18-F7
	M52-AZ	Pneumatic spring return, external pilot air supply, flow direction reversible	8065574	VUVS-L20-M52-AZD-N18-F7
	M52-M	Reset via mechanical spring, internal pilot air supply, flow direction not reversible	575704	VUVS-L20-M52-MD-N18-F7
M52-MZ	Reset via mechanical spring, external pilot air supply, flow direction reversible	8065575	VUVS-L20-M52-MZD-N18-F7	
	Double solenoid			
	B52	Internal pilot air supply, flow direction not reversible	575706	VUVS-L20-B52-D-N18-F7
B52-Z	External pilot air supply, flow direction reversible	8065576	VUVS-L20-B52-ZD-N18-F7	
5/3-way valve without solenoid coil				
	Closed			
	P53C-M	Reset via mechanical spring, internal pilot air supply, flow direction not reversible	575708	VUVS-L20-P53C-MD-N18-F7
	P53C-MZ	Reset via mechanical spring, external pilot air supply, flow direction reversible	8065577	VUVS-L20-P53C-MZD-N18-F7
	Exhausted			
	P53E	Reset via mechanical spring, internal pilot air supply, flow direction not reversible	575712	VUVS-L20-P53E-MD-N18-F7
Pressurised				
P53U	Reset via mechanical spring, internal pilot air supply, flow direction not reversible	575710	VUVS-L20-P53U-MD-N18-F7	



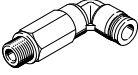

Accessories

Ordering data		Description	Part no.	Type			
Solenoid coils for valves							
	Plug pattern type C, to DIN EN 175301-803	12 V DC	8025331	VACS-C-C1-5			
		24 V DC	8025330	VACS-C-C1-1			
		48 V DC	8025336	VACS-C-C1-7			
		24 V AC/50-60 Hz	8025335	VACS-C-C1-1A			
		48 V AC/50-60 Hz	8025337	VACS-C-C1-7A			
		110/120 V AC/50-60 Hz	8025334	VACS-C-C1-16B			
		230/240 V AC/50-60 Hz	8025338	VACS-C-C1-3W			
	M8 individual plug, 3-pin	24 V DC	8135909	VACS-C-R8-1RAL			
	M8 individual plug, 4-pin	24 V DC	8135910	VACS-C-R1-1RAL			
	Single plug M12, A-coded, according to EN 61076-2-101	24 V DC	8194567	VACS-C-R3-1RAL			
	Single plug M12, A-coded, pin assignment to DESINA	24 V DC	8135911	VACS-C-R4-1RAL			
Seal set							
	For valves to guarantee degree of protection IP67		2643771	VAMC-B10-C-B-S8			
Cover cap							
	For manual override, non-detenting or covered		8028240	VAMC-B10-20-CH2			
Plug socket							
	Plug pattern type C, to DIN EN 175301-803						
	3-pin, screw terminal	Cable connector M12	0 ... 250 V AC/DC	IP65	539712	MSSD-EB-M12	
		Cable connector Pg7			151687	MSSD-EB	
	4-pin, insulation displacement connector	Cable connector M14	0 ... 250 V AC/DC	IP67	192745	MSSD-EB-S-M14	
3-pin, angled socket	Cable connector M12	0 ... 24 V DC	IP65	570367	MSSD-EB-M12-24VDC-SD-EX		
Adapter							
	Socket type C, to EN 175301-803	Plug M12x1, 2-pin, A-coded	12 ... 24 V AC/DC	IP65	188024	MSSD-EB-M12-MONO	
Plug socket with cable							
	Plug pattern type C, to DIN EN 175301-803						
	Angled socket, 3-pin	Cable, open end, 3-wire	24 V DC	LED	2.5 m	151688	KMEB-1-24-2.5-LED
					5 m	151689	KMEB-1-24-5-LED
					10 m	193457	KMEB-1-24-10-LED
	230 V AC		-		2.5 m	151690	KMEB-1-230AC-2.5
				5 m	151691	KMEB-1-230AC-5	
Illuminating seal							
	Plug pattern type C, to DIN EN 175301-803	24 V DC	151717	MEB-LD-12-24DC			
		230 V AC	151718	MEB-LD-230AC			

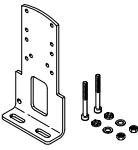
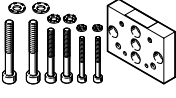

Accessories

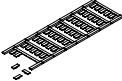
Ordering data	Description	Part no.	Type	PU ¹⁾	
Push-in fitting with internal hex					
	Connecting thread 10-32 UNF for tubing O.D.	5/32 "	572312	QBM-10-32-UNF-5/32-I-U	10
	Connecting thread 1/8 NPT for tubing O.D.	5/32 "	572317	QB-1/8-5/32-I-U	10
		1/4 "	572318	QB-1/8-1/4-I-U	10
		5/16 "	572319	QB-1/8-5/16-I-U	10
Angled push-in fitting with external hex					
	Connecting thread 1/8 NPT for tubing O.D.	5/32 "	533290	QBL-1/8-5/32-U	10
		1/4 "	533292	QBL-1/8-1/4-U	10
		5/16 "	533293	QBL-1/8-5/16-U	10
Angled push-in fitting, long, with external hex					
	Connecting thread 1/8 NPT for tubing O.D.	5/32 "	564668	QBL-1/8-5/32-U	10
		1/4 "	564670	QBL-1/8-1/4-U	10
		5/16 "	564671	QBL-1/8-5/16-U	10
Silencer					
	With connecting thread NPT, metal design	1/8 NPT	12638	U-1/8-B-NPT	1
	With connecting thread NPT, sintered design, long	1/8 NPT	1206989	AMTE-M-LH-N18	20

1) Packaging unit

Ordering data	Description	Weight [g]	Part no.	Type	
Foot mounting					
	With screw set for attaching the valve to the foot mounting	97	576412	VAME-B10-20-A	
Wall mounting					
	With screw set for attaching the valve to the wall mounting (for size 20, 25, 30)	53	576413	VAME-B10-20-W	
Assortment of spare parts					
	Set comprising seals and screws	10	8026203	VAME-B10-20-MK	
Inscription label					
	40 pieces in frame	-	565306	ASLR-C-E4	
Mounting kit					
	With mounting bracket for lateral valve mounting	For standards-based cylinder DSBC-32...40	76	2568514	DAVM-MW-V1-32-V

Data sheet

-  - Flow rate
up to 1300 l/min ($\pm 20\%$)
-  - Valve width
26.5 mm
-  - Voltage
12, 24 V DC
24, 110, 120, 230, 240 V AC

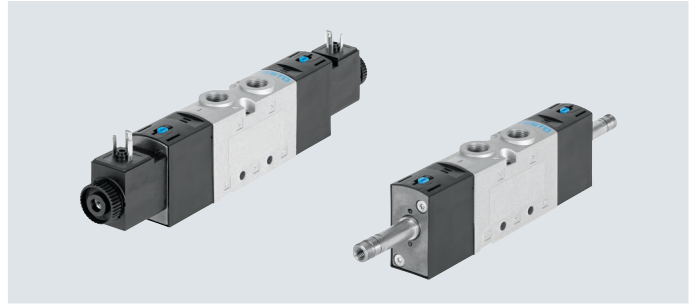

General technical data								
Valve function	3/2			5/2		5/3		
Order code for valves	M32C	M32U	M52	B52	P53C	P53U	P53E	
Valve width [mm]	26.5							
Design	Piston spool							
Flow direction	Reversible with external pilot air supply							
Pilot air supply	Internal or external							
Type of control	Piloted							
Manual override	Non-detenting, detenting							
Overlap	Positive overlap							
Sealing principle	Soft							
Type of mounting	Optionally via through-hole or on manifold rail							
Standard nominal flow rate qnN [l/min]	1000		1300	1300	1200	1000		
Through-holes (nominal width) [mm]	6.3	6.3	6.9	6.9	6.5	6.3	6.3	
b value	0.3	0.3	0.4	0.4	0.4	0.4	0.4	
c value [l/sbar]	4.7, 4.8 ¹⁾	4.2, 4.3 ²⁾	5.3	5.6	5.2	4.3	4.3	
Actuation type	Electrical							
Mounting position	Any							
Exhaust air function	Can be throttled							
Port for venting hole	Not ducted							
Pneumatic connection	1, 2, 3	1/4 NPT	1/4 NPT	1/4 NPT	1/4 NPT	1/4 NPT	1/4 NPT	1/4 NPT
	4, 5	-	-	1/4 NPT	1/4 NPT	1/4 NPT	1/4 NPT	1/4 NPT
Pilot exhaust air port 82/84	10-32 UNF-2B							

1) Reset via mechanical spring

ATEX	
Type	VUVS-L...-EX2
ATEX category for gas	II 3G
Type of ignition protection for gas	Ex ec IICT4 Gc X
ATEX category for dust	II 3D
Type of ignition protection for dust	Ex tc IIIC T115°C Dc X
Explosion-proof ambient temperature [°C]	-10°C ≤ Ta ≤ +60°C
CE marking (see declaration of conformity) ¹⁾	To EU Explosion Protection Directive (ATEX)
UKCA marking (see declaration of conformity) ¹⁾	To UK EX instructions
Explosion protection certification outside the EU	EPL Dc (GB)
	EPL Gc (GB)

1) For information about the area of use, see the EC declaration of conformity at: www.festo.com/catalogue/... → Support/Downloads.

If the devices are subject to usage restrictions in residential, commercial or light-industrial environments, further measures for the reduction of the emitted interference may be necessary.

Data sheet

Technical data – 3/2-way valves					
Order code for valves		M32C		M32U	
Normal position		Closed		Open	
Stable position		Monostable		Monostable	
Reset method		Pneumatic spring	Mechanical spring	Pneumatic spring	Mechanical spring
Switching times in [ms]	On	13	11	12	11
	Off	26	40	26	39
	Change-over	–	–	–	–
Product weight without solenoid coil	[g]	244	244	244	244
Product weight with solenoid coil	[g]	297	297	297	297

Technical data – 5/2-way valves					
Order code for valves		M52		B52	
Normal position		–		–	
Stable position		Monostable		Bistable	
Reset method		Pneumatic spring	Mechanical spring	–	
Switching times in [ms]	On	19	12	–	
	Off	35	47	–	
	Change-over	–	–	11	
Product weight without solenoid coil	[g]	311	311	322	
Product weight with solenoid coil	[g]	363	363	428	

Technical data – 5/3-way valves					
Order code for valves		P53C		P53U	P53E
Normal position/mid-position		Closed		Pressurised	Exhausted
Stable position		Monostable			
Reset method		Mechanical spring			
Switching times in [ms]	On	13	14	14	
	Off	42	48	48	
	Change-over	26	25	25	
Product weight without solenoid coil	[g]	324	324	324	
Product weight with solenoid coil	[g]	430	430	430	

Safety characteristics		
Max. positive test pulse with logic 0	[s]	2000 (valves with VACF-B-...-1)
Max. negative test pulse with logic 1	[s]	3600 (valves with VACF-B-...-1)
Shock resistance		Shock test with severity level 2 to FN 942017-5 and EN 60068-2-27
Vibration resistance		Transport application test with severity level 2 to FN 942017-4 and EN 60068-2-6

Data sheet

Operating and environmental conditions		M32	M52	B52	P53
Order code for valves					
Operating medium		Compressed air to ISO 8573-1:2010 [7:4:4]			
Pilot medium		Compressed air to ISO 8573-1:2010 [7:4:4]			
Note on the operating/pilot medium		Lubricated operation possible (in which case lubricated operation will always be required)			
Operating pressure with internal pilot air supply	[MPa]	0.25 ... 1		0.15 ... 1	0.25 ... 1
	[bar]	2.5 ... 10		1.5 ... 10	2.5 ... 10
Operating pressure with external pilot air supply	[MPa]	-0.09 ... +1			
	[bar]	-0.9 ... +10			
Pilot pressure	[MPa]	0.25 ... 1		0.15 ... 1	0.25 ... 1
	[bar]	2.5 ... 10		1.5 ... 10	2.5 ... 10
Ambient temperature	[°C]	-10 ... +60			
Temperature of medium	[°C]	-10 ... +60			
Certification		cUL us - Recognized (OL)			
Maritime classification ¹⁾		See certificate (for VUVS-...-F8 and VUVS-...-F8-...-B2 only)			
Corrosion resistance class CRC ²⁾		2			

1) Additional information is available at www.festo.com/catalogue/... → Support/Downloads.

2) Corrosion resistance class CRC 2 to Festo standard FN 940070

Moderate corrosion stress. Indoor applications in which condensation can occur. External visible parts with primarily decorative surface requirements which are in direct contact with a normal industrial environment.

Electrical data	
Electrical connection	Via solenoid coil
Operating voltage [V DC]	→ Internet: vacf
Permissible voltage fluctuations [%]	
Power [W]	
Duty cycle [%]	
Degree of protection to EN 60529	

Materials	
Housing	Die-cast aluminium
Seals	HNBR, NBR
Piston spool	Wrought aluminium alloy
Screws	Galvanised steel
Note on materials	RoHS-compliant

Data sheet

Dimensions

Download CAD data → www.festo.com

3/2-way valves, with solenoid coil

3/2-way valves, without solenoid coil

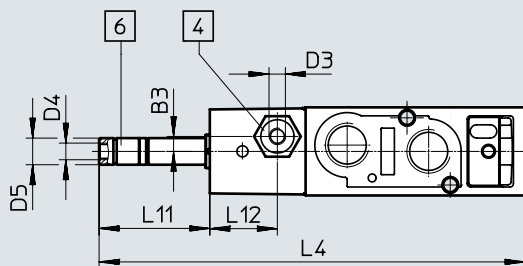
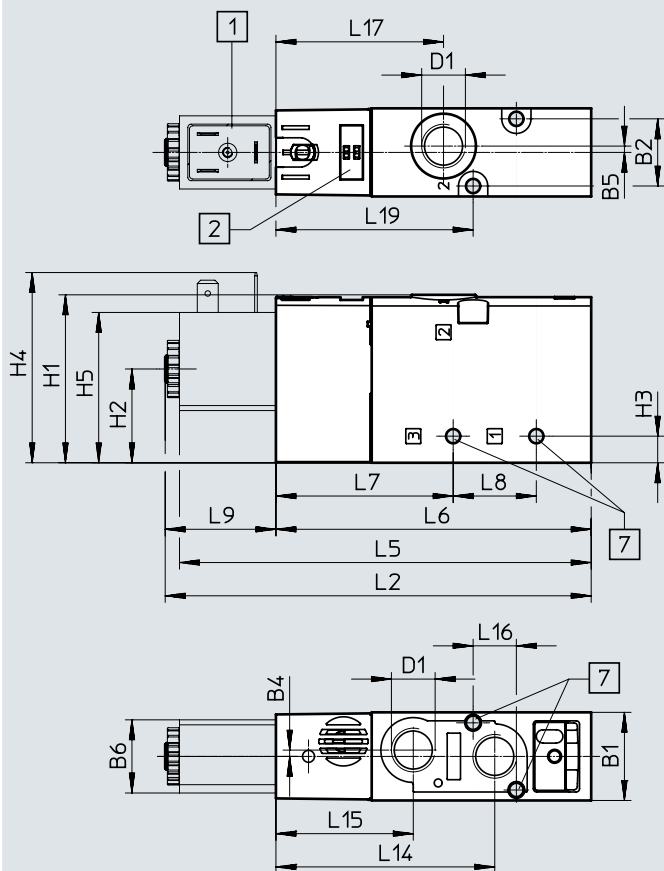

- [1] Solenoid coil interface type B/
type C
- [2] Space for inscription label
- [4] Port 10/12 for pilot air supply
- [6] Port 82 for pilot exhaust air
- [7] For screw M4

Type	B1	B2	B3	B4	B5	B6	D1	D3	D4	D5 ø	H1	H2	H3	H4	H5
VUVS-L25-M32-...D-N14-...	26.5	20.2	-	1.9	1.9	22	1/4 NPT	-	10-32 UNF-2B	8	50.5	28.2	8	57.2	45.2
VUVS-L25-M32-...ZD-N14-...			4.5					10-32 UNF-2B							

Type	L2	L4	L5	L6	L7	L8	L9	L11	L12	L14	L15	L16	L17	L19
VUVS-L25-M32-...D-N14-...	129.2	128.1	123.8	94.8	53.3	25	34.4	33.3	-	65.8	41.3	13	50.4	59.3
VUVS-L25-M32-...ZD-N14-...									20.3					

Data sheet

Dimensions

5/2-way valves, with solenoid coil

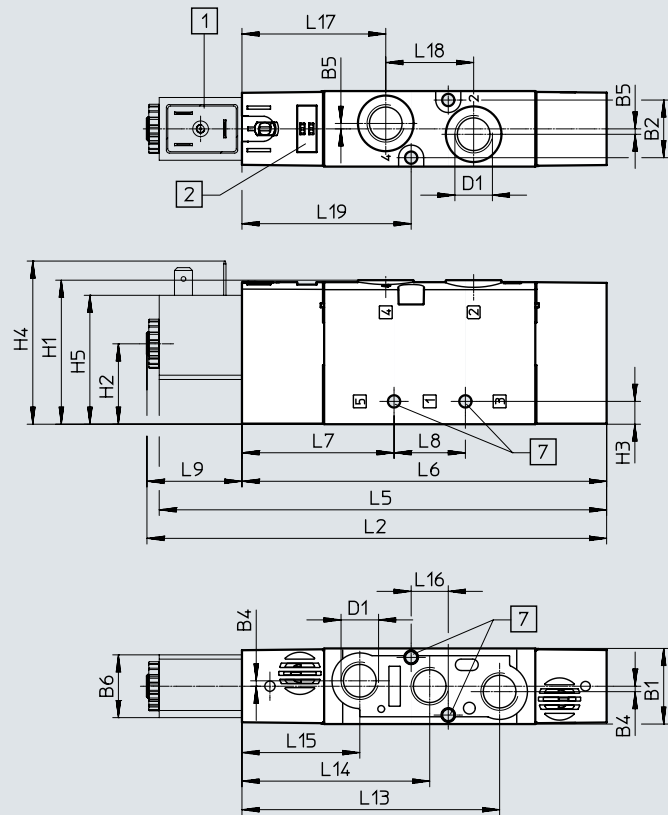

5/2-way valves, without solenoid coil

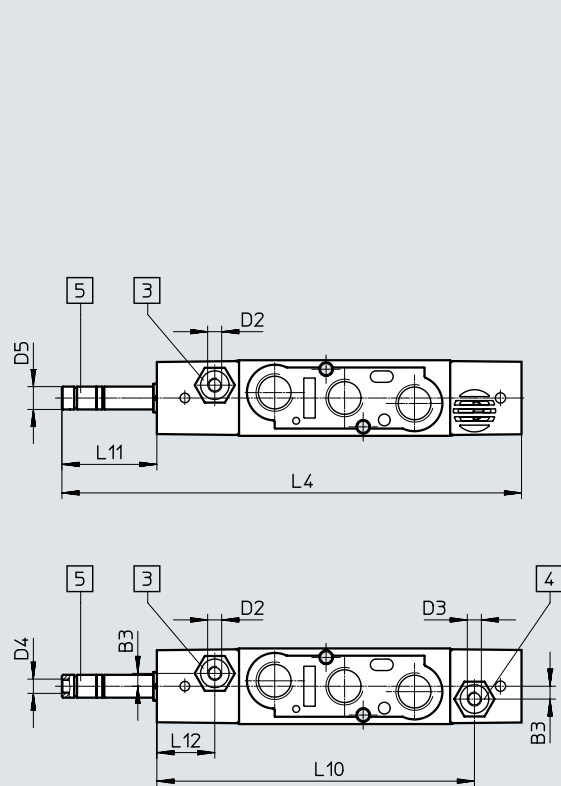

- [1] Solenoid coil interface type B/
type C
- [2] Space for inscription label

- [3] Port 14 for pilot air supply
- [4] Port 12 for pilot air supply

- [5] Port 84 for pilot exhaust air

- [7] For screw M4

Type	B1	B2	B3	B4	B5	B6	D1	D2	D3	D4
VUVS-L25-M52-...D-N14-...	26.5	20.2	-	1.9	1.9	22	1/4 NPT	-	-	10-32 UNF-2B
VUVS-L25-M52-...ZD-N14-...			4.5					10-32 UNF-2B	10-32 UNF-2B	

Type	D5 ø	H1	H2	H3	H4	H5	L2	L4	L5	L6	L7	L8	L9
VUVS-L25-M52-...D-N14-...	8	50.5	28.2	8	57.2	45.2	162.2	161.1	156.8	127.8	53.3	25	34.4
VUVS-L25-M52-...ZD-N14-...													

Type	L10	L11	L12	L13	L14	L15	L16	L17	L18	L19
VUVS-L25-M52-...D-N14-...	-	33.3	-	90.3	65.8	41.3	13	50.4	30.8	59.3
VUVS-L25-M52-...ZD-N14-...	111.3		20.3							

Data sheet

Dimensions

Download CAD data → www.festo.com

5/3-way valves and 5/2-way double solenoid valves, with solenoid coil

5/3-way valves and 5/2-way double solenoid valves, without solenoid coil

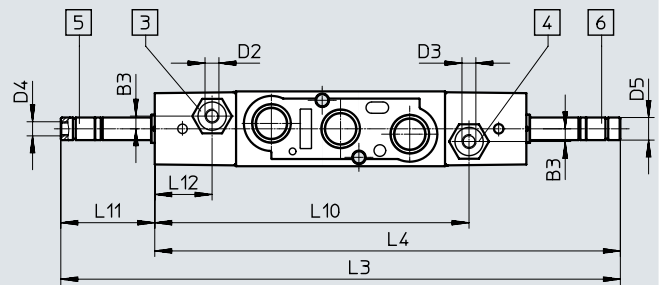
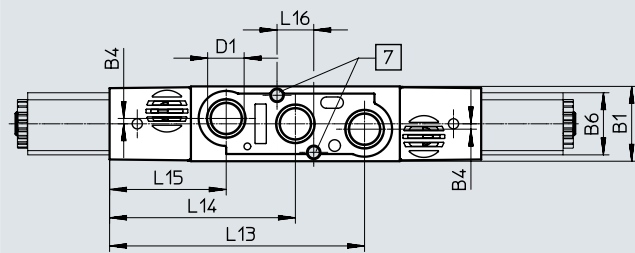
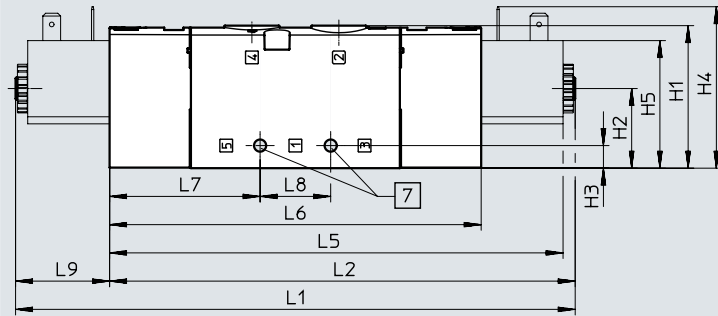
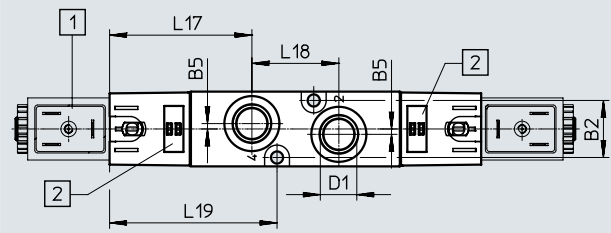

[1] Solenoid coil interface type B/
type C
[2] Space for inscription label

[3] Port 14 for pilot air supply
[4] Port 12 for pilot air supply

[5] Port 84 for pilot exhaust air
[6] Port 82 for pilot exhaust air
[7] For screw M4

Type	B1	B2	B3	B4	B5	B6	D1	D2	D3	D4
VUVS-L25-P53...D-N14-...	26.5	20.2	-	1.9	1.9	22	1/4 NPT	-	-	10-32 UNF-2B
VUVS-L25-P53...ZD-N14-...			4.5					10-32 UNF-2B	10-32 UNF-2B	
VUVS-L25-B52-D-N14-...			-					-	-	
VUVS-L25-B52-ZD-N14-...			4.5					10-32 UNF-2B	10-32 UNF-2B	

Type	D5 ∅	H1	H2	H3	H4	H5	L1	L2	L3	L4	L5	L6	L7	L8
VUVS-L25-P53...D-N14-...	8	50.5	28.2	8	57.2	45.2	200.3	166	198.2	164.9	160.6	131.6	53.3	25
VUVS-L25-P53...ZD-N14-...														
VUVS-L25-B52-D-N14-...														
VUVS-L25-B52-ZD-N14-...														

Type	L9	L10	L11	L12	L13	L14	L15	L16	L17	L18	L19
VUVS-L25-P53...D-N14-...	33.3	-	33.3	-	90.3	65.8	41.3	13	50.4	30.8	59.3
VUVS-L25-P53...ZD-N14-...		111.3		20.3							
VUVS-L25-B52-D-N14-...		-		-							
VUVS-L25-B52-ZD-N14-...		111.3		20.3							

Data sheet

Dimensions

Foot mounting

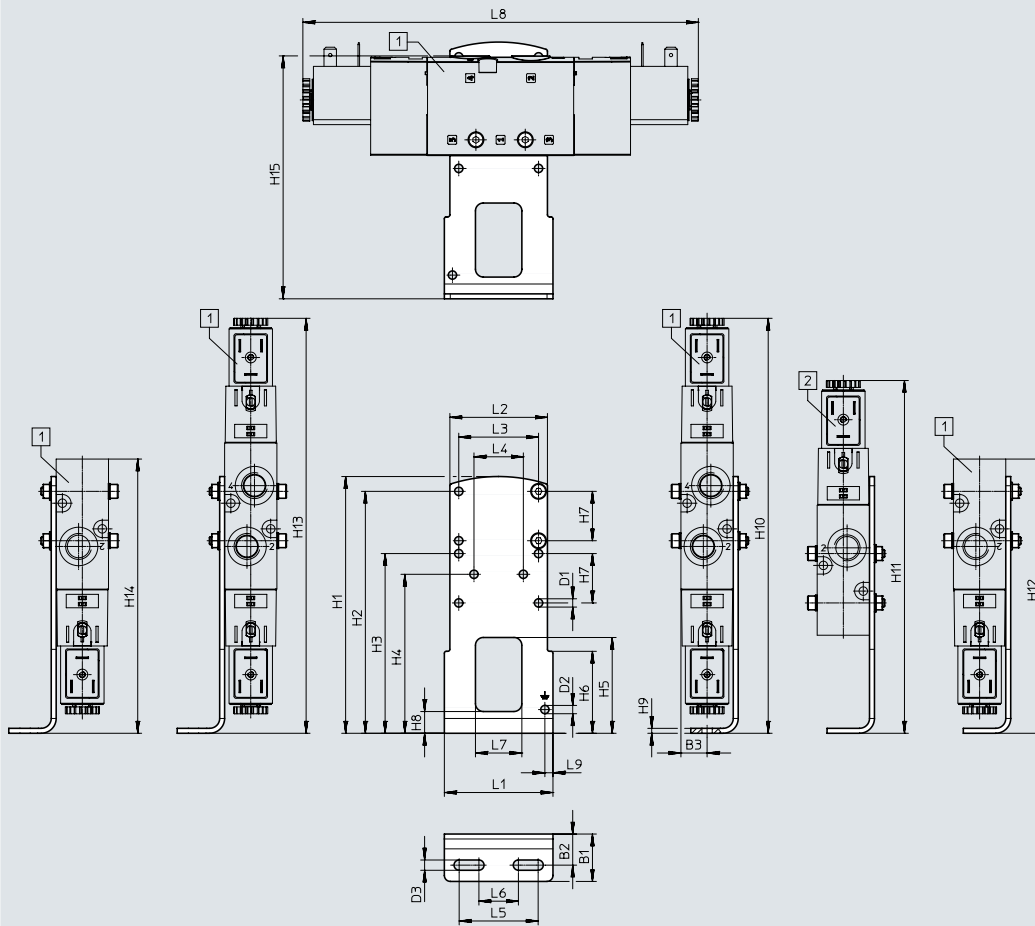

[1] VUVS-L25-B52,
VUVS-L25-P53,
VUVS-L25-M52,
VUVS-L25-M32

[2] VUVS-L25-M52,
VUVS-L25-M32

Type		B1	B2	B3	D1 ∅	D2 ∅	D3	H1	H2	H3	H4
VAME-B10-25-A	VUVS-L25-B52/P53	24	15.8	13.3	4.2	4.2	5.2	130	122.5	91	80.5
	VUVS-L25-M52										
	VUVS-L25-M32										

Type		H5	H6	H7	H8	H9	H10	H11	H12	H13	H14	
VAME-B10-25-A	VUVS-L25-B52/P53	48.5	41.5	25	11	2.5	210.2	–	210.2	210.2	210.2	
	VUVS-L25-M52							178.7				172
	VUVS-L25-M32											138.9

Type		H15	L1	L2	L3	L4	L5	L6	L7	L8	L9
VAME-B10-25-A	VUVS-L25-B52/P53	123	55	49.4	40.4	25	40	20	23.5	200.3	4.1
	VUVS-L25-M52									162.2	
	VUVS-L25-M32									129	

Data sheet

Dimensions

Wall mounting

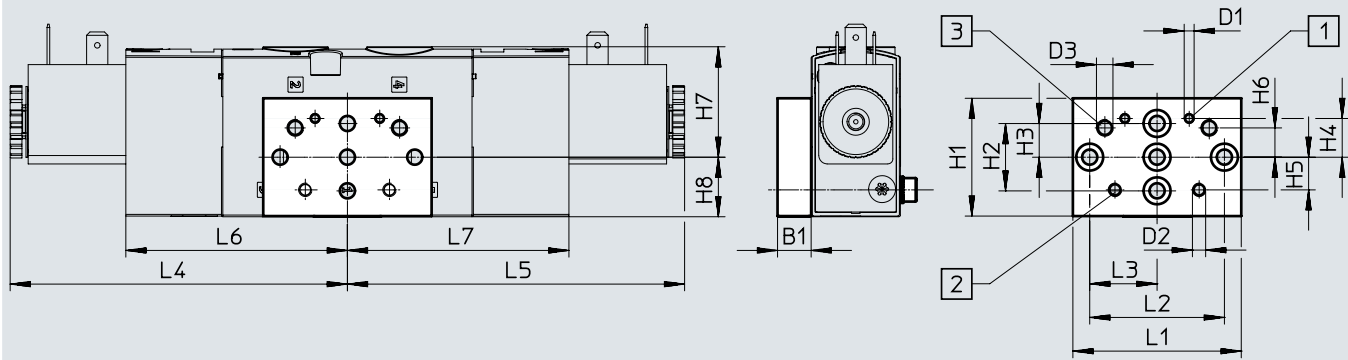

[1] Mounting hole for size 25

[2] Mounting hole for size 20

[3] Mounting hole for size 30





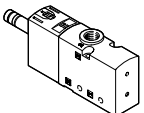
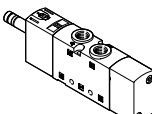
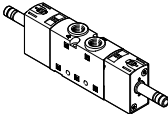
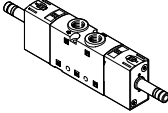

Type		B1	D1	D2	D3	H1	H2	H3	H4	H5	H6
VAME-B10-20-W	VUVS-L25-B52/P53	10	M3	M4	M5	35	20	10	11.5	9.7	8.7
	VUVS-L25-M52										
	VUVS-L25-M32										

Type		H7	H8	L1	L2	L3	L4	L5	L6	L7
VAME-B10-20-W	VUVS-L25-B52/P53	32.8	17.7	50	40	20	100.2	100.2	65.8	65.8
	VUVS-L25-M52							62		-
	VUVS-L25-M32							28.9		-



Accessories



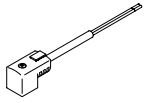

Ordering data				
	Code	Valve function	Part no.	Type
3/2-way valve without solenoid coil				
	Single solenoid, closed			
	M32C-A	Pneumatic spring return, internal pilot air supply, flow direction not reversible	575544	VUVS-L25-M32C-AD-N14-F8
	M32C-AZ	Pneumatic spring return, external pilot air supply, flow direction reversible	578182	VUVS-L25-M32C-AZD-N14-F8
	M32C-M	Reset via mechanical spring, internal pilot air supply, flow direction not reversible	575545	VUVS-L25-M32C-MD-N14-F8
	M32C-MZ	Reset via mechanical spring, external pilot air supply, flow direction reversible	578183	VUVS-L25-M32C-MZD-N14-F8
	Single solenoid, open			
M32U-A	Pneumatic spring return, internal pilot air supply, flow direction not reversible	575548	VUVS-L25-M32U-AD-N14-F8	
M32U-M	Reset via mechanical spring, internal pilot air supply, flow direction not reversible	575549	VUVS-L25-M32U-MD-N14-F8	
5/2-way valve without solenoid coil				
	Single solenoid			
	M52-A	Pneumatic spring return, internal pilot air supply, flow direction not reversible	575552	VUVS-L25-M52-AD-N14-F8
	M52-AZ	Pneumatic spring return, external pilot air supply, flow direction reversible	578197	VUVS-L25-M52-AZD-N14-F8
	M52-M	Reset via mechanical spring, internal pilot air supply, flow direction not reversible	575554	VUVS-L25-M52-MD-N14-F8
M52-MZ	Reset via mechanical spring, external pilot air supply, flow direction reversible	578198	VUVS-L25-M52-MZD-N14-F8	
	Double solenoid			
	B52	Internal pilot air supply, flow direction not reversible	575556	VUVS-L25-B52-D-N14-F8
B52-Z	External pilot air supply, flow direction reversible	578199	VUVS-L25-B52-ZD-N14-F8	
5/3-way valve without solenoid coil				
	Closed			
	P53C-M	Reset via mechanical spring, internal pilot air supply, flow direction not reversible	575558	VUVS-L25-P53C-MD-N14-F8
	P53C-MZ	Reset via mechanical spring, external pilot air supply, flow direction reversible	578206	VUVS-L25-P53C-MZD-N14-F8
	Exhausted			
	P53E	Reset via mechanical spring, internal pilot air supply, flow direction not reversible	575562	VUVS-L25-P53E-MD-N14-F8
Pressurised				
P53U	Reset via mechanical spring, internal pilot air supply, flow direction not reversible	575560	VUVS-L25-P53U-MD-N14-F8	

Accessories

Ordering data				Part no.	Type	
Solenoid coils for valves						
	Plug pattern type C, to DIN EN 175301-803	12 V DC		8030810	VACF-B-C1-5	
		24 V DC		8030811	VACF-B-C1-1	
		48 V DC		8030812	VACF-B-C1-7	
		24 V AC/50-60 Hz		8030813	VACF-B-C1-1A	
		48 V AC/50-60 Hz		8030814	VACF-B-C1-7A	
		110/120 V AC/50-60 Hz		8030815	VACF-B-C1-16B	
		230/240 V AC/50-60 Hz		8030817	VACF-B-C1-3W	
	Plug pattern type B, industry standard	12 V DC		8030801	VACF-B-B2-5	
		24 V DC		8030802	VACF-B-B2-1	
		48 V DC		8030803	VACF-B-B2-7	
		24 V AC/50-60 Hz		8030804	VACF-B-B2-1A	
		48 V AC/50-60 Hz		8030805	VACF-B-B2-7A	
		110/120 V AC/50-60 Hz		8030806	VACF-B-B2-16B	
		230/240 V AC/50-60 Hz		8030808	VACF-B-B2-3W	
	M8 individual plug, 3-pin	24 V DC		8150878	VACF-B-R8-1RAL	
	M8 individual plug, 4-pin	24 V DC		8150879	VACF-B-R1-1RAL	
	Single plug M12, A-coded, according to EN 61076-2-101	24 V DC		8150873	VACF-B-R3-1RAL	
	Single plug M12, A-coded, pin assignment to DESINA	24 V DC		8150880	VACF-B-R4-1RAL	
Seal set for solenoid coil						
	Plug pattern type C to guarantee degree of protection IP67			2643771	VAMC-B10-C-B-S8	
	Plug pattern type B to guarantee degree of protection IP67			8034609	VAMC-B10-B-B-S8	
Cover cap						
	For valves			8028240	VAMC-B10-20-CH2	
Ordering data						
Description				Part no.	Type	
Plug socket						
	Plug pattern type C, to DIN EN 175301-803					
	3-pin, screw terminal	Cable connector M12	0 ... 250 V AC/DC	IP65	539712	MSSD-EB-M12
		Cable connector Pg7			151687	MSSD-EB
	4-pin, insulation displacement connector	Cable connector M14	0 ... 250 V AC/DC	IP67	192745	MSSD-EB-S-M14
	3-pin, angled socket	Cable connector M12	0 ... 24 V DC	IP65	570367	MSSD-EB-M12-24VDC-SD-EX
	Plug pattern type B, industry standard					
	3-pin, screw terminal	Cable connector M16	0 ... 250 V AC/DC	IP65	539710	MSSD-F-M16
		Cable connector Pg9			34431	MSSD-F
3-pin, insulation displacement connector	–	0 ... 250 V AC/DC	IP67	192746	MSSD-F-S-M16	
Adapter						
	Socket type C, to EN 175301-803	Plug M12x1, 2-pin, A-coded	12 ... 24 V AC/DC	IP65	188024 MSSD-EB-M12-MONO	



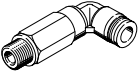

Accessories

Ordering data		Description	Part no.	Type		
Plug socket with cable						
	Plug pattern type C, to DIN EN 175301-803					
	Angled socket, 3-pin Cable, open end, 3-wire	24 V DC	LED	2.5 m	151688	KMEB-1-24-2.5-LED
				5 m	151689	KMEB-1-24-5-LED
				10 m	193457	KMEB-1-24-10-LED
	230 V AC	-	2.5 m	151690	KMEB-1-230AC-2.5	
			5 m	151691	KMEB-1-230AC-5	
	Plug pattern type B, industry standard					
	Angled socket, 3-pin Cable, open end, 3-wire	24 V DC	LED	2.5 m	30935	KMF-1-24DC-2.5-LED
				5 m	30937	KMF-1-24DC-5-LED
				10 m	193458	KMF-1-24-10-LED
230 V AC		-	2.5 m	30936	KMF-1-230AC-2.5	
			5 m	30938	KMF-1-230AC-5	
Illuminating seal						
	Plug pattern type C, to DIN EN 175301-803	24 V DC	151717	MEB-LD-12-24DC		
		230 V AC	151718	MEB-LD-230AC		
	Plug pattern type B, industry standard	24 V DC	19143	MF-LD-12-24DC		
		230 V AC	19144	MF-LD-230AC		

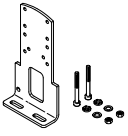
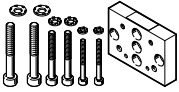

Ordering data		Description	Part no.	Type	PU ¹⁾	
Push-in fitting with internal hex						
	Connecting thread 10-32 UNF for tubing O.D.		5/32 "	572312	QBM-10-32-UNF-5/32-I-U	10
	Connecting thread 1/4 NPT for tubing O.D.		1/4 "	572320	QB-1/4-1/4-I-U	10
			5/16 "	572321	QB-1/4-5/16-I-U	10
			3/8 "	572322	QB-1/4-3/8-I-U	10
Angled push-in fitting with external hex						
	Connecting thread 1/4 NPT for tubing O.D.		1/4 "	533295	QBL-1/4-1/4-U	10
			5/16 "	533296	QBL-1/4-5/16-U	10
			3/8 "	533297	QBL-1/4-3/8-U	5
Angled push-in fitting, long, with external hex						
	Connecting thread 1/4 NPT for tubing O.D.		1/4 "	564674	QBLL-1/4-1/4-U	10
			5/16 "	564675	QBLL-1/4-5/16-U	10
			3/8 "	564676	QBLL-1/4-3/8-U	5
Silencer						
	With connecting thread NPT, metal design		1/4 NPT	12639	U-1/4-B-NPT	1
	With connecting thread NPT, sintered design, long		1/4 NPT	1206990	AMTE-M-LH-N14	20

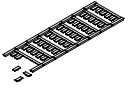
1) Packaging unit

Accessories

Ordering data		Weight	Part no.	Type	
Description		[g]			
Foot mounting					
	With screw set for attaching the valve to the foot mounting	130	2293485	VAME-B10-25-A	
Wall mounting					
	With screw set for attaching the valve to the wall mounting (for size 20, 25, 30)	53	576413	VAME-B10-20-W	
Assortment of spare parts					
	Set comprising seals and screws	12	8035636	VAME-B10-25-MK	
Inscription label					
	40 pieces in frame	-	565306	ASLR-C-E4	
Mounting kit					
	With mounting bracket for lateral valve mounting	For standards-based cylinder DSBC-50...125	160	2612128	DAVM-MW-V1-50-V

Data sheet

-  Flow rate
up to 2300 l/min ($\pm 20\%$)
-  Valve width
31 mm
-  Voltage
12, 24 V DC
24, 110, 120, 230, 240 V AC

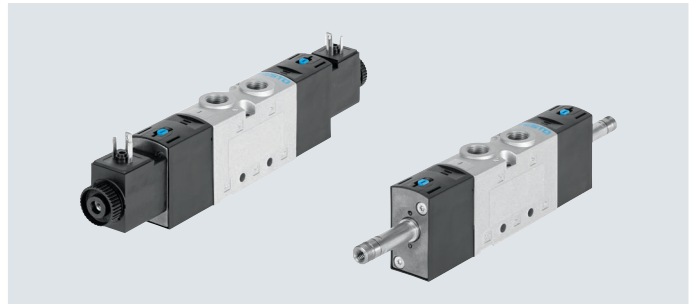

General technical data							
Valve function	3/2		5/2		5/3		
Order code for valves	M32C	M32U	M52	B52	P53C	P53U	P53E
Valve width [mm]	31						
Nominal size [mm]	9.4				8.9	8.1	
Design	Piston spool						
Flow direction	Reversible with external pilot air supply						
Pilot air supply	Internal or external						
Type of control	Piloted						
Manual override	Non-detenting, detenting						
Overlap	Positive overlap						
Sealing principle	Soft						
Type of mounting	Optionally via through-hole or on manifold rail						
Standard nominal flow rate q _N [l/min]	2300	2300	2300		2000	1600	1600
Actuation type	Electrical						
Mounting position	Any						
Exhaust air function	Can be throttled						
Pneumatic connection	1, 2, 3 4, 5	3/8 NPT –	3/8 NPT –	3/8 NPT 3/8 NPT	3/8 NPT 3/8 NPT	3/8 NPT 3/8 NPT	3/8 NPT 3/8 NPT
Pilot exhaust air port 82/84	10-32 UNF-2B						

ATEX	
Type	VUVS-L...-EX2
ATEX category for gas	II 3G
Type of ignition protection for gas	Ex ec IICT4 Gc X
ATEX category for dust	II 3D
Type of ignition protection for dust	Ex tc IIIC T115°C Dc X
Explosion-proof ambient temperature [°C]	-10°C ≤ Ta ≤ +60°C
CE marking (see declaration of conformity) ¹⁾	To EU Explosion Protection Directive (ATEX)
UKCA marking (see declaration of conformity) ¹⁾	To UK EX instructions
Explosion protection certification outside the EU	EPL Dc (GB)
	EPL Gc (GB)

¹⁾ For information about the area of use, see the EC declaration of conformity at: www.festo.com/catalogue/... → Support/Downloads.

If the devices are subject to usage restrictions in residential, commercial or light-industrial environments, further measures for the reduction of the emitted interference may be necessary.

Data sheet

Technical data – 3/2-way valves					
Order code for valves		M32C		M32U	
Normal position		Closed		Open	
Stable position		Monostable		Monostable	
Reset method		Pneumatic spring	Mechanical spring	Pneumatic spring	Mechanical spring
Switching times in [ms]	On	19	16	19	15
	Off	36	58	37	57
	Change-over	–	–	–	–
Product weight without solenoid coil	[g]	354	354	354	354
Product weight with solenoid coil	[g]	405	405	405	405

Technical data – 5/2-way valves					
Order code for valves		M52		B52	
Normal position		–		–	
Stable position		Monostable		Bistable	
Reset method		Pneumatic spring	Mechanical spring	–	
Switching times in [ms]	On	24	17	–	
	Off	49	62	–	
	Change-over	–	–	13	
Product weight without solenoid coil	[g]	450	450	464	
Product weight with solenoid coil	[g]	500	500	565	

Technical data – 5/3-way valves					
Order code for valves		P53C		P53U	P53E
Normal position/mid-position		Closed		Pressurised	Exhausted
Stable position		Monostable			
Reset method		Mechanical spring			
Switching times in [ms]	On	17	18	20	
	Off	76	75	74	
	Change-over	39	31	36	
Product weight without solenoid coil	[g]	461	461	461	
Product weight with solenoid coil	[g]	562	562	562	

Safety characteristics		
Max. positive test pulse with logic 0	[s]	2000 (valves with VACF-B-...-1)
Max. negative test pulse with logic 1	[s]	3600 (valves with VACF-B-...-1)
Shock resistance		Shock test with severity level 2 to FN 942017-5 and EN 60068-2-27
Vibration resistance		Transport application test with severity level 2 to FN 942017-4 and EN 60068-2-6

Data sheet

Operating and environmental conditions		M32	M52	B52	P53
Order code for valves		M32	M52	B52	P53
Operating medium		Compressed air to ISO 8573-1:2010 [7:4:4]			
Pilot medium		Compressed air to ISO 8573-1:2010 [7:4:4]			
Note on the operating/pilot medium		Lubricated operation possible (in which case lubricated operation will always be required)			
Operating pressure	[MPa]	0.25 ... 1		0.15 ... 1	0.25 ... 1
	[bar]	2.5 ... 10		1.5 ... 10	2.5 ... 10
Pilot pressure	[MPa]	0.25 ... 1		0.15 ... 1	0.25 ... 1
	[bar]	2.5 ... 10		1.5 ... 10	2.5 ... 10
Ambient temperature		-10 ... +60			
Temperature of medium		-10 ... +60			
Certification		c UL us - Recognized (OL)			
Maritime classification ¹⁾		See certificate (for VUVS-...-F8 and VUVS-...-F8-...-B2 only)			
Corrosion resistance class CRC ²⁾		2			

1) Additional information is available at www.festo.com/catalogue/... → Support/Downloads.

2) Corrosion resistance class CRC 2 to Festo standard FN 940070

Moderate corrosion stress. Indoor applications in which condensation can occur. External visible parts with primarily decorative surface requirements which are in direct contact with a normal industrial environment.

Electrical data	
Electrical connection	Via solenoid coil
Operating voltage	[V DC] → Internet: vacf
Permissible voltage fluctuations	[%]
Power	[W]
Duty cycle	[%]
Degree of protection to EN 60529	

Materials	
Housing	Die-cast aluminium
Seals	HNBR, NBR
Piston spool	Wrought aluminium alloy
Screws	Nickel-plated steel
Note on materials	RoHS-compliant

Data sheet

Dimensions

Download CAD data → www.festo.com

3/2-way valves, with solenoid coil

3/2-way valves, without solenoid coil

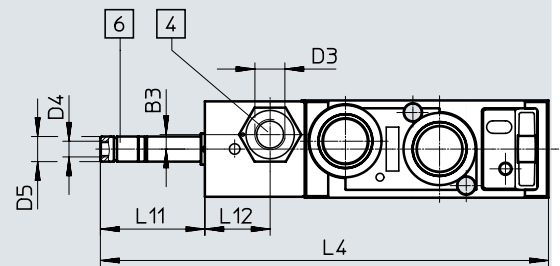
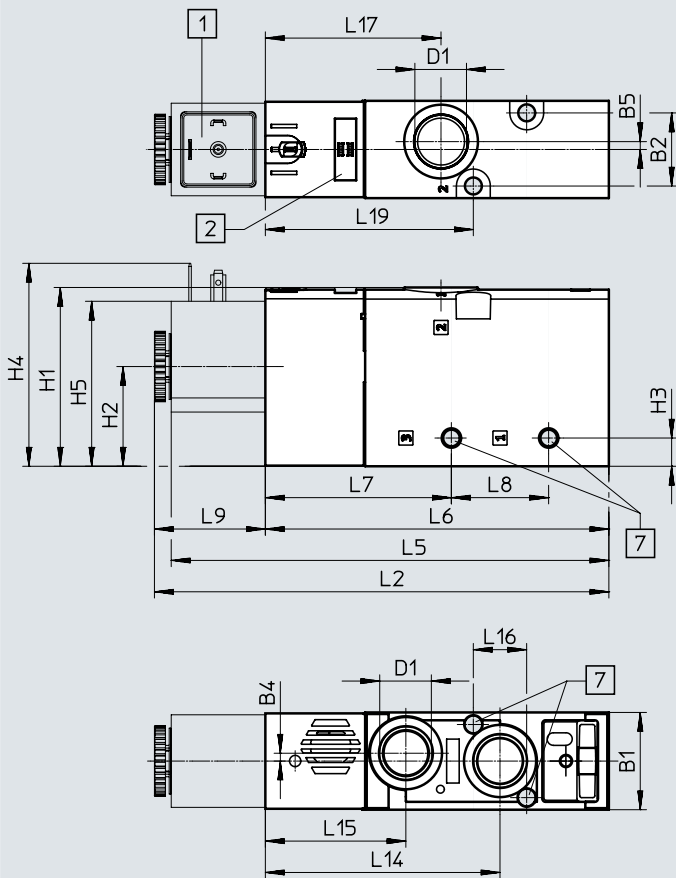

[1] Solenoid coil interface type B/
type C

[4] Port 10/12 for pilot air supply

[6] Port 82 for pilot exhaust air

[7] For screw M5

[2] Space for inscription label

Type	B1	B2	B3	B4	B5	D1	D3	D4	D5 ∅	H1	H2	H3	H4	H5
VUVS-L30-M32.....D-N38-...	31	23.3	-	2.5	2.5	3/8 NPT	-	10-32 UNF-2B	8	57	31.8	9	63.7	51.6

Type	L2	L4	L5	L6	L7	L8	L9	L11	L12	L14	L15	L16	L17	L19
VUVS-L30-M32.....D-N38-...	144.9	142.8	139.5	109.5	59.3	31	35.4	33.3	-	74.8	44.8	17	56	66.3

Data sheet

Dimensions

Download CAD data → www.festo.com

5/2-way valves, with solenoid coil

5/2-way valves, without solenoid coil

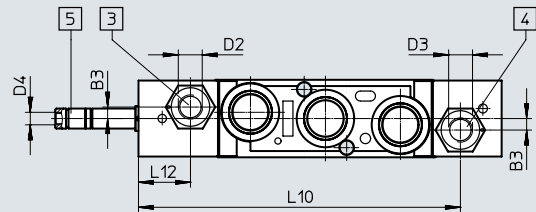
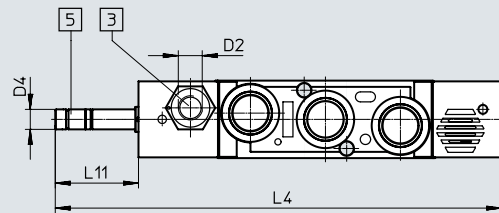
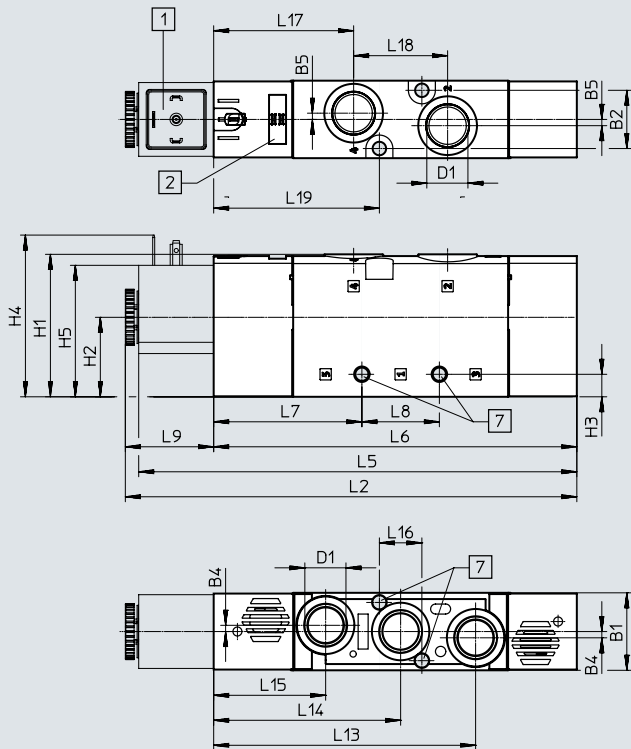

- [1] Solenoid coil interface type B/
type C
- [2] Space for inscription label

- [3] Port 14 for pilot air supply
- [4] Port 12 for pilot air supply

- [5] Port 84 for pilot exhaust air

- [7] For screw M5

Type	B1	B2	B3	B4	B5	D1	D2	D3	D4	D5 ∅	H1	H2	H3	H4	H5
VUVS-L30-M52-...D-N38-...	31	23.3	-	2.5	2.5	3/8 NPT	-	-	10-32 UNF-2B	8	57	31.8	9	63.7	51.6

Type	L2	L4	L5	L6	L7	L8	L9	L10	L11	L12	L13	L14	L15	L16	L17	L18	L19
VUVS-L30-M52-...D-N38-...	180.7	178.6	179.6	145.3	59.3	31	35.4	-	33.3	-	104.8	74.8	44.8	17	56	37.6	66.3

Data sheet

Dimensions

Download CAD data → www.festo.com

5/3-way valves and 5/2-way valves, double solenoid, with solenoid coil

5/3-way valves and 5/2-way valves, double solenoid, without solenoid coil

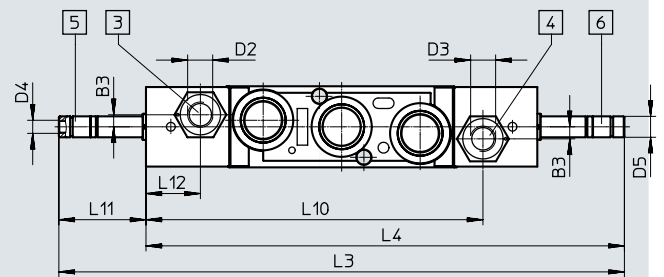
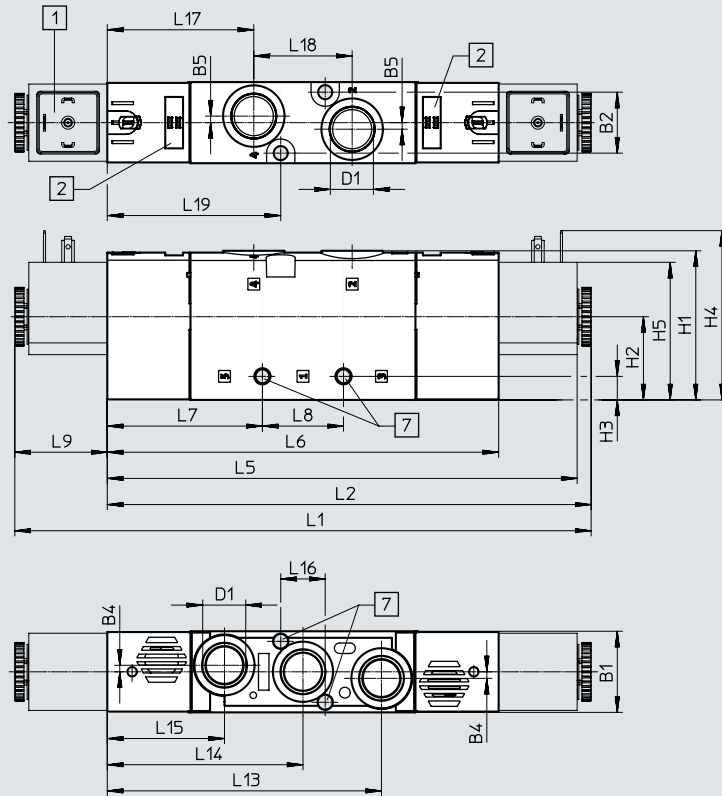

- [1] Solenoid coil interface type B/ type C
- [2] Space for inscription label
- [3] Port 14 for pilot air supply
- [4] Port 12 for pilot air supply
- [5] Port 84 for pilot exhaust air
- [6] Port 82 for pilot exhaust air
- [7] For screw M5

Type	B1	B2	B4	B5	D1	D4	D5 ø	H1	H2	H3	H4	H5
VUVS-L30-P53...-MD-N38-F8	31	23.3	2.5	2.5	3/8 NPT	10-32 UNF-2B	8	57	31.8	9	63.7	51.6
VUVS-L30-B52-D-N38-F8												

Type	L1	L2	L3	L4	L5	L6	L7	L8	L9	L11
VUVS-L30-P53...-MD-N38-F8	220.3	185	216.2	182.9	179.6	149.6	59.3	31	35.4	33.3
VUVS-L30-B52-D-N38-F8										

Type	L13	L14	L15	L16	L17	L18	L19
VUVS-L30-P53...-MD-N38-F8	104.8	74.8	44.8	17	56	37.6	66.3
VUVS-L30-B52-D-N38-F8							

Data sheet

Dimensions

Foot mounting

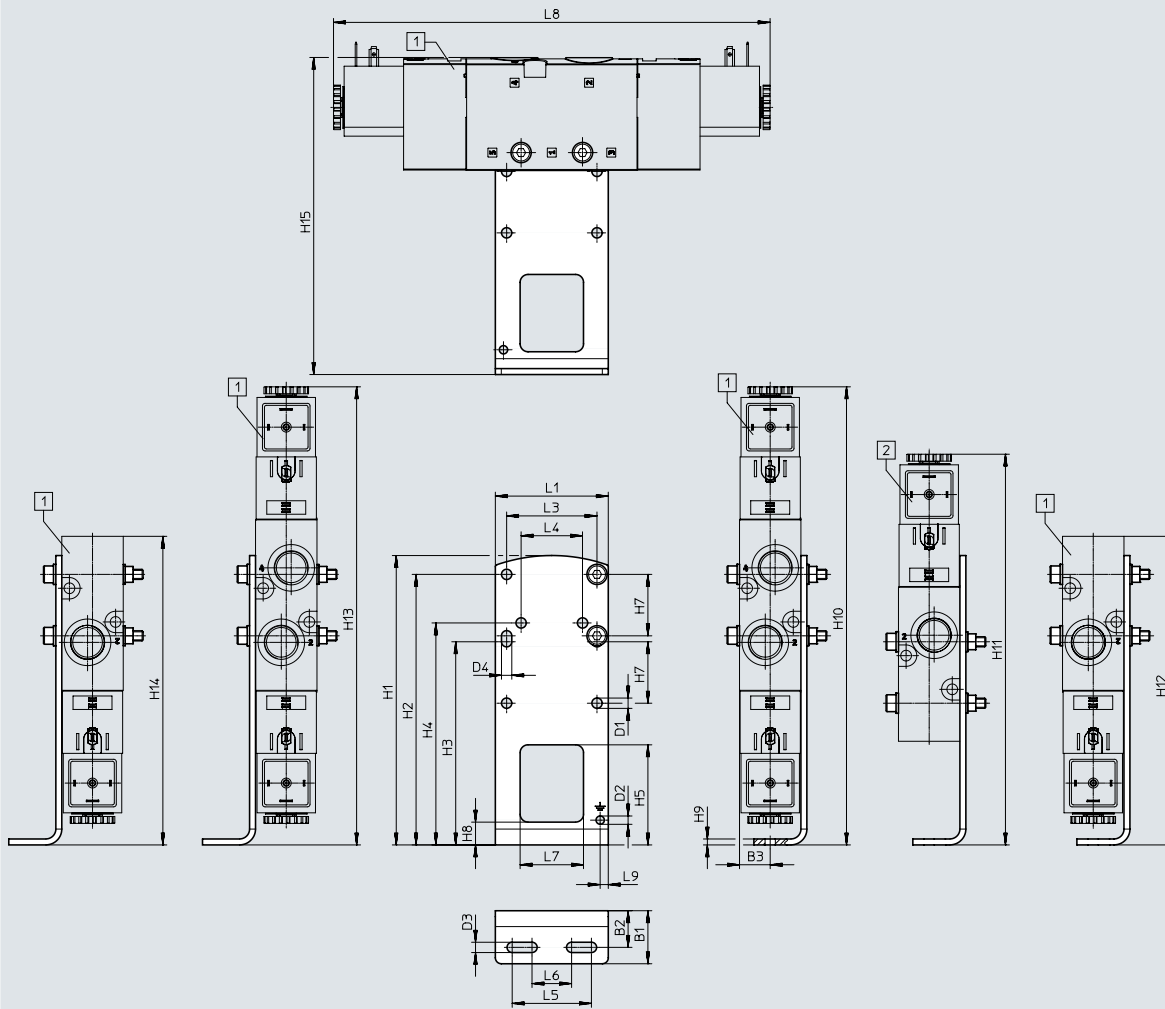

[1] VUVS-L30-B52,
VUVS-L30-P53,
VUVS-L30-M52,
VUVS-L30-M32

[2] VUVS-L30-M52,
VUVS-L30-M32

Type		B1	B2	B3	D1 ∅	D2 ∅	D3	D4	H1	H2	H3
VAME-B10-30-A	VUVS-L30-B52/P53	26.8	18.5	15.5	5.2	4.2	5.2	5.2	146	136.5	102.5
	VUVS-L30-M52										
	VUVS-L30-M32										

Type		H4	H5	H7	H8	H9	H10	H11	H12	H13	H14
VAME-B10-30-A	VUVS-L30-B52/P53	112	50.5	31	11.5	3	231.2	-	231.2	231.2	231.2
	VUVS-L30-M52							197.2	191.5		191.5
	VUVS-L30-M32							155.7	155.7		155.7

Type		H15	L1	L3	L4	L5	L6	L7	L8	L9
VAME-B10-30-A	VUVS-L30-B52/P53	160	57	45.6	31	40	20	32	220.3	4.1
	VUVS-L30-M52								180.7	
	VUVS-L30-M32								144.9	

Data sheet

Dimensions

Wall mounting

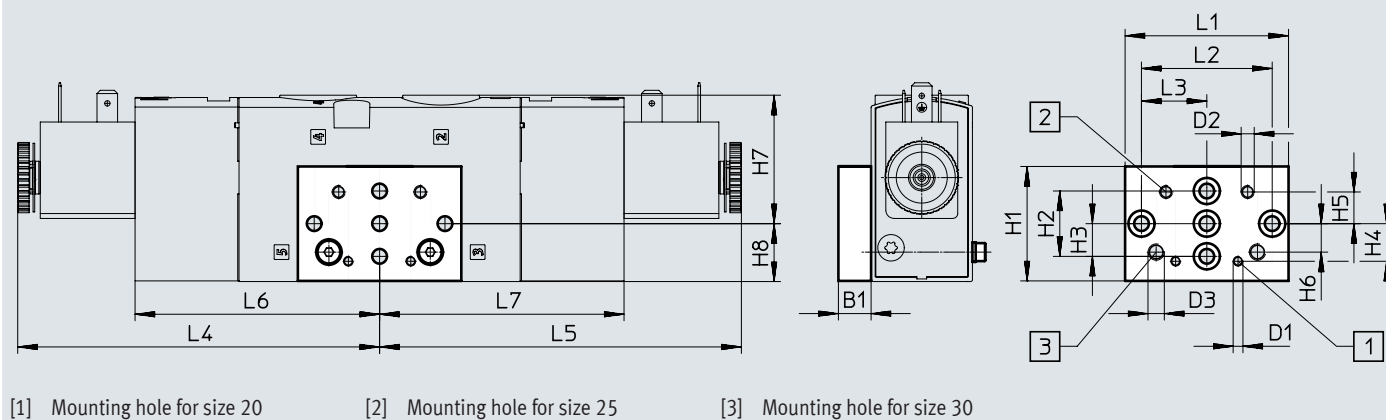



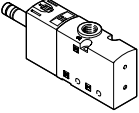
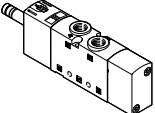
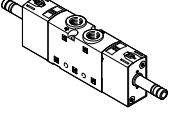
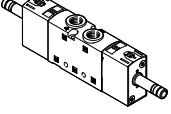

Type		B1	D1	D2	D3	H1	H2	H3	H4	H5	H6
VAME-B10-20-W	VUVS-L30-B52/P53	10	M3	M4	M5	35	20	10	11.5	9.7	8.7
	VUVS-L30-M52										
	VUVS-L30-M32										

Type		H7	H8	L1	L2	L3	L4	L5	L6	L7
VAME-B10-20-W	VUVS-L30-B52/P53	39.3	17.7	50	40	20	110.2	110.2	74.8	74.8
	VUVS-L30-M52							70.5		-
	VUVS-L30-M32							34.7		-





Accessories

Ordering data				
	Code	Valve function	Part no.	Type
3/2-way valve without solenoid coil				
	Single solenoid, closed			
	M32C-A	Pneumatic spring return, internal pilot air supply, flow direction not reversible	575637	VUVS-L30-M32C-AD-N38-F8
	M32C-M	Reset via mechanical spring, internal pilot air supply, flow direction not reversible	575638	VUVS-L30-M32C-MD-N38-F8
	Single solenoid, open			
	M32U-A	Pneumatic spring return, internal pilot air supply, flow direction not reversible	575641	VUVS-L30-M32U-AD-N38-F8
	M32U-M	Reset via mechanical spring, internal pilot air supply, flow direction not reversible	575642	VUVS-L30-M32U-MD-N38-F8
5/2-way valve without solenoid coil				
	Single solenoid			
	M52-A	Pneumatic spring return, internal pilot air supply, flow direction not reversible	575645	VUVS-L30-M52-AD-N38-F8
	M52-M	Reset via mechanical spring, internal pilot air supply, flow direction not reversible	575647	VUVS-L30-M52-MD-N38-F8
	Double solenoid			
	B52	Internal pilot air supply, flow direction not reversible	575649	VUVS-L30-B52-D-N38-F8
5/3-way valve without solenoid coil				
	Closed			
	P53C	Reset via mechanical spring, internal pilot air supply, flow direction not reversible	575651	VUVS-L30-P53C-MD-N38-F8
	Exhausted			
	P53E	Reset via mechanical spring, internal pilot air supply, flow direction not reversible	575655	VUVS-L30-P53E-MD-N38-F8
	Pressurised			
P53U	Reset via mechanical spring, internal pilot air supply, flow direction not reversible	575653	VUVS-L30-P53U-MD-N38-F8	



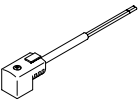

Accessories

Ordering data		Description	Part no.	Type		
Solenoid coils for valves						
	Plug pattern type C, to DIN EN 175301-803	12 V DC	8030810	VACF-B-C1-5		
		24 V DC	8030811	VACF-B-C1-1		
		48 V DC	8030812	VACF-B-C1-7		
		24 V AC/50-60 Hz	8030813	VACF-B-C1-1A		
		48 V AC/50-60 Hz	8030814	VACF-B-C1-7A		
		110/120 V AC/50-60 Hz	8030815	VACF-B-C1-16B		
		230/240 V AC/50-60 Hz	8030817	VACF-B-C1-3W		
	Plug pattern type B, industry standard	12 V DC	8030801	VACF-B-B2-5		
		24 V DC	8030802	VACF-B-B2-1		
		48 V DC	8030803	VACF-B-B2-7		
		24 V AC/50-60 Hz	8030804	VACF-B-B2-1A		
		48 V AC/50-60 Hz	8030805	VACF-B-B2-7A		
		110/120 V AC/50-60 Hz	8030806	VACF-B-B2-16B		
		230/240 V AC/50-60 Hz	8030808	VACF-B-B2-3W		
	Plug pattern type A, to EN 175301-803	12 V DC	8030821	VACF-A-A1-5		
		24 V DC	8030822	VACF-A-A1-1		
		48 V DC	8030823	VACF-A-A1-7		
		24 V AC/50-60 Hz	8030824	VACF-A-A1-1A		
		48 V AC/50-60 Hz	8030825	VACF-A-A1-7A		
		110/120 V AC/50-60 Hz	8030826	VACF-A-A1-16B		
		230/240 V AC/50-60 Hz	8030828	VACF-A-A1-3W		
	M8 individual plug, 3-pin	24 V DC	8135909	VACS-C-R8-1RAL		
	M8 individual plug, 4-pin	24 V DC	8135910	VACS-C-R1-1RAL		
	Single plug M12, A-coded, according to EN 61076-2-101	24 V DC	8194567	VACS-C-R3-1RAL		
	Single plug M12, A-coded, pin assignment to DESINA	24 V DC	8135911	VACS-C-R4-1RAL		
Seal set for solenoid coil						
	Plug pattern type C to guarantee degree of protection IP67		2643771	VAMC-B10-C-B-S8		
	Plug pattern type B to guarantee degree of protection IP67		8034609	VAMC-B10-B-B-S8		
	Plug pattern type A to guarantee degree of protection IP67		8034611	VAMC-B10-A-B-S8		
Cover cap						
	For manual override, non-detenting or covered		8028240	VAMC-B10-20-CH2		
Plug socket						
	Plug pattern type C, to DIN EN 175301-803					
	3-pin, screw terminal	Cable connector M12	0 ... 250 V AC/DC	IP65	539712	MSSD-EB-M12
		Cable connector Pg7			151687	MSSD-EB
	4-pin, insulation displacement connector	Cable connector M14	0 ... 250 V AC/DC	IP67	192745	MSSD-EB-S-M14
	3-pin, angled socket	Cable connector M12	0 ... 24 V DC	IP65	570367	MSSD-EB-M12-24VDC-SD-EX
	Plug pattern type B, industry standard					
	3-pin, screw terminal	Cable connector M16	0 ... 250 V AC/DC	IP65	539710	MSSD-F-M16
		Cable connector Pg9			34431	MSSD-F
	3-pin, insulation displacement connector	–	0 ... 250 V AC/DC	IP67	192746	MSSD-FS-M16



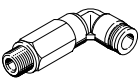
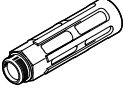

Accessories

Ordering data		Description	Part no.	Type		
Plug socket						
	Plug pattern type A, to EN 175301-803					
	3-pin, angled socket	Cable connector Pg9	0 ... 250 V AC/DC	IP65	34583	MSSD-C
	3-pin, angled socket	Cable connector M16	0 ... 250 V AC/DC	IP65	539709	MSSD-C-M16
	4-pin, angled socket	Cable connection, insulation displacement	0 ... 250 V AC/DC	IP67	192748	MSSD-CS-M16
Adapter						
	Socket type C, to EN 175301-803	Plug M12x1, 2-pin, A-coded	12 ... 24 V AC/DC	IP65	188024	MSSD-EB-M12-MONO
Plug socket with cable						
	Plug pattern type C, to DIN EN 175301-803					
	Angled socket, 3-pin Cable, open end, 3-wire	24 V DC	LED	2.5 m	151688	KMEB-1-24-2.5-LED
				5 m	151689	KMEB-1-24-5-LED
				10 m	193457	KMEB-1-24-10-LED
		230 V AC	-	2.5 m	151690	KMEB-1-230AC-2.5
				5 m	151691	KMEB-1-230AC-5
				Plug pattern type B, industry standard		
	Angled socket, 3-pin Cable, open end, 3-wire	24 V DC	LED	2.5 m	30935	KMF-1-24DC-2.5-LED
				5 m	30937	KMF-1-24DC-5-LED
				10 m	193458	KMF-1-24-10-LED
		230 V AC	-	2.5 m	30936	KMF-1-230AC-2.5
				5 m	30938	KMF-1-230AC-5
				Plug pattern type A, to EN 175301-803		
	Angled socket, 3-pin Cable, open end, 3-wire	24 V DC	LED	2.5 m	30931	KMC-1-24DC-2.5-LED
				5 m	30933	KMC-1-24DC-5-LED
				10 m	193459	KMC-1-24-10-LED
	230 V AC	-	2.5 m	30932	KMC-1-230AC-2.5	
			5 m	30934	KMC-1-230AC-5	
			Illuminating seal			
	Plug pattern type C, to DIN EN 175301-803	24 V DC		151717	MEB-LD-12-24DC	
		230 V AC		151718	MEB-LD-230AC	
	Plug pattern type B, industry standard	24 V DC		19143	MF-LD-12-24DC	
		230 V AC		19144	MF-LD-230AC	

Accessories

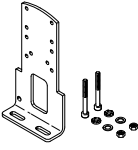
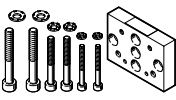
Ordering data		Description	Part no.	Type	PU ¹⁾
Push-in fitting with internal hex					
	Connecting thread 10-32 UNF for tubing O.D.	5/32 "	572312	QBM-10-32-UNF-5/32-I-U	10
	Connecting thread 3/8 NPT for tubing O.D.	5/16 "	572323	QB-3/8-5/16-I-U	10
		3/8 "	572324	QB-3/8-3/8-I-U	10
		1/2 "	572325	QB-3/8-1/2-I-U	10
Angled push-in fitting with external hex					
	Connecting thread 3/8 NPT for tubing O.D.	5/16 "	533299	QBL-3/8-5/16-U	5
		3/8 "	533300	QBL-3/8-3/8-U	5
		1/2 "	533301	QBL-3/8-1/2-U	5
Angled push-in fitting, long, with external hex					
	Connecting thread 3/8 NPT for tubing O.D.	5/16 "	564679	QBLL-3/8-5/16-U	5
		3/8 "	564680	QBLL-3/8-3/8-U	5
		1/2 "	564681	QBLL-3/8-1/2-U	5
Silencer					
	With connecting thread NPT, metal design	3/8 NPT	12740	U-3/8-B-NPT	1
	With connecting thread NPT, sintered design, long	3/8 NPT	1206991	AMTE-M-LH-N38	10

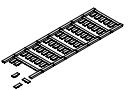
1) Packaging unit

Ordering data		Description	Weight [g]	Part no.	Type
Foot mounting					
	With screw set for attaching the valve to the foot mounting	239	8026337	VAME-B10-30-A	
Wall mounting					
	With screw set for attaching the valve to the wall mounting (for size 20, 25, 30)	53	576413	VAME-B10-20-W	
Assortment of spare parts					
	Set comprising seals and screws	22	8035637	VAME-B10-30-MK	
Inscription label					
	40 pieces in frame	-	565306	ASLR-C-E4	
Mounting kit					
	With mounting bracket for lateral valve mounting	For standards-based cylinder DSBC-50...125	160	2612128	DAVM-MW-V1-50-V

Data sheet – Manifold block, size 20

-  - Flow rate
up to 700 l/min

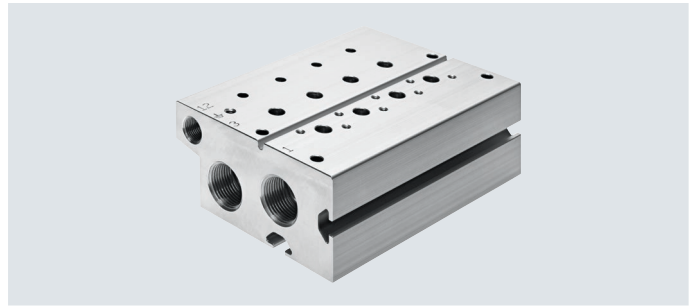

General technical data					
Valve function	Manifold block standard		Manifold block compact		Common supply manifold on both sides
		3/2	5/2, 5/3	3/2	5/2, 5/3
Grid dimension [mm]	22				
Type of mounting	With through-hole				With mounting bracket
Max. number of valve positions	10	10	10		10
Port 1	3/8 NPT	3/8 NPT	1/4 NPT	1/4 NPT	3/8 NPT
Port 3	3/8 NPT	3/8 NPT	1/4 NPT	1/4 NPT	–
Port 5	–	3/8 NPT	–	1/4 NPT	–
Port 12	1/8 NPT	1/8 NPT	–	–	–
Port 14	–	1/8 NPT	–	–	–
CRC ¹⁾	21)				

1) Corrosion resistance class CRC 2 to Festo standard FN 940070

Moderate corrosion stress. Indoor applications in which condensation can occur. External visible parts with primarily decorative surface requirements which are in direct contact with a normal industrial environment.

Weight [g]									
Valve positions	2	3	4	5	6	7	8	9	10
Manifold block for 3/2-way valves, standard									
VABM-B10-20E-...N38-...-P3	449	574	699	825	950	1075	1200	1326	1451
Manifold block for 5/2- and 5/3-way valves, standard									
VABM-B10-20E-...N38-...	680	866	1053	1239	1425	1612	1798	1985	2171
Manifold block for 3/2-way valves, compact									
VABM-B10-20S-...N14-...-P3	280	360	441	521	601	681	762	842	922
Manifold block for 5/2- and 5/3-way valves, compact									
VABM-B10-20S-...N14-...	344	439	535	630	726	821	917	1012	1108
Common supply manifold for mounting on both sides									
VABM-B10-20-N38-...-P53	226	268	310	352	395	437	479	521	563

Materials	
Manifold rail	Wrought aluminium alloy
Note on materials	RoHS-compliant

Data sheet – Manifold block, size 20

Dimensions

Manifold block for 3/2-way valves, standard

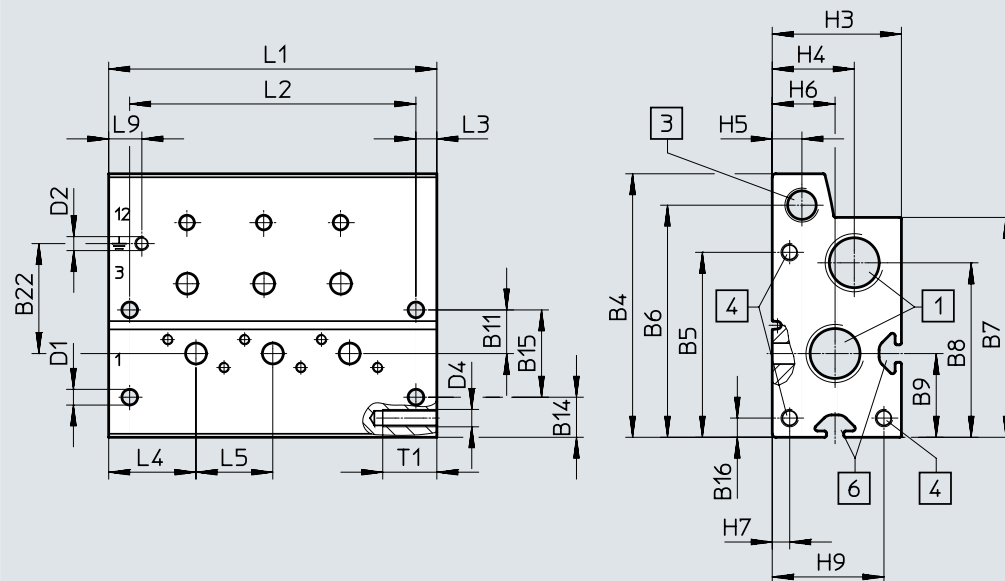

[1] Ports 1 and 3: 3/8 NPT

[3] Port 12: 1/8 NPT

[4] Thread M5x15.5 for extension module

[6] Profile slot IPM-05, system 5

Type	B4	B5	B6	B7	B8	B9	B11	B14	B15	B16	B22
VABM-B10-20E-...N38-...-P3	75.5	53	66.5	63	50	24	12.5	11.5	25	5.5	31.5

Type	D1 ø	D2	D4	H3	H4	H5	H6	H7	H9	L3	L4	L5	L9	T1
VABM-B10-20E-...N38-...-P3	4.5	M4x6.5	M5	37	23.5	8.5	18	5	32	6	25	22	9.5	15.5

Valve positions	2	3	4	5	6	7	8	9	10
L1 [mm]	72	94	116	138	160	182	204	226	248
L2 [mm]	60	82	104	126	148	170	192	214	236

Data sheet – Manifold block, size 20

Dimensions

Manifold block for 5/2- and 5/3-way valves, standard

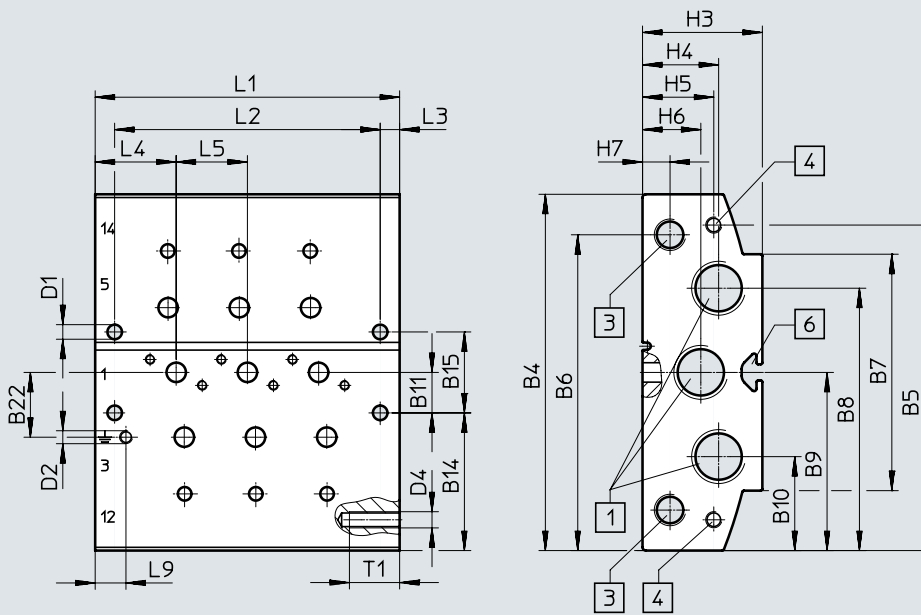

[1] Ports 1, 3 and 5: 3/8 NPT

[3] Ports 12 and 14: 1/8 NPT

[4] Thread M5x15.5 for extension

[6] Profile slot IPM-05 system 5 module

Type	B4	B5	B6	B7	B8	B9	B10	B11	B14	B15	B22
VABM-B10-20E...N38-...	110	100.5	97.5	73	81	55	29	12.5	42.5	25	20

Type	D1 ø	D2	D4	H3	H4	H5	H6	H7	L3	L4	L5	L9	T1
VABM-B10-20E...N38-...	4.5	M4x6.5	M5	37	23.5	22	18	8.5	6	25	22	9.5	15.5

Valve positions	2	3	4	5	6	7	8	9	10
L1 [mm]	72	94	116	138	160	182	204	226	248
L2 [mm]	60	82	104	126	148	170	192	214	236

Data sheet – Manifold block, size 20

Dimensions

Manifold block for 3/2-way valves, compact

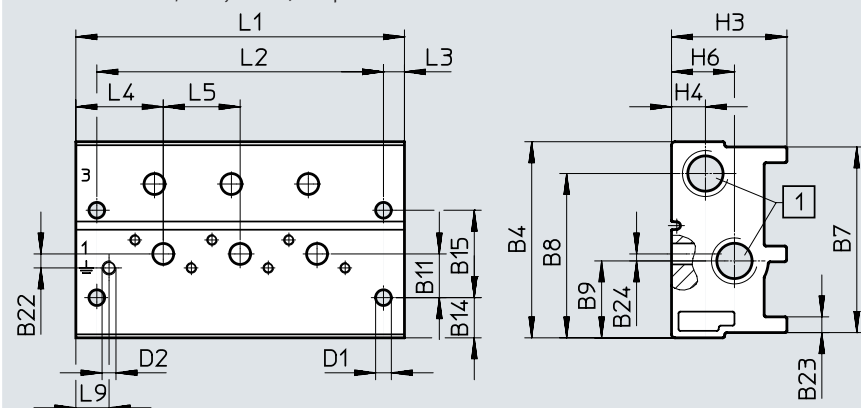

[1] Ports 1 and 3: 1/4 NPT

Type	B4	B7	B8	B9	B11	B14	B15	B22	B23	B24
VABM-B10-20S-...N14-...-P3	56.1	53.1	47	22	12.5	11.5	25	4	4.5	2

Type	D1 ø	D2	H3	H4	H6	L3	L4	L5	L9
VABM-B10-20S-...N14-...-P3	4.5	M4x6.5	33	9.7	18	6	25	22	9.5

Valve positions	2	3	4	5	6	7	8	9	10
L1 [mm]	72	94	116	138	160	182	204	226	248
L2 [mm]	60	82	104	126	148	170	192	214	236

Dimensions

Manifold block for 5/2- and 5/3-way valves, compact

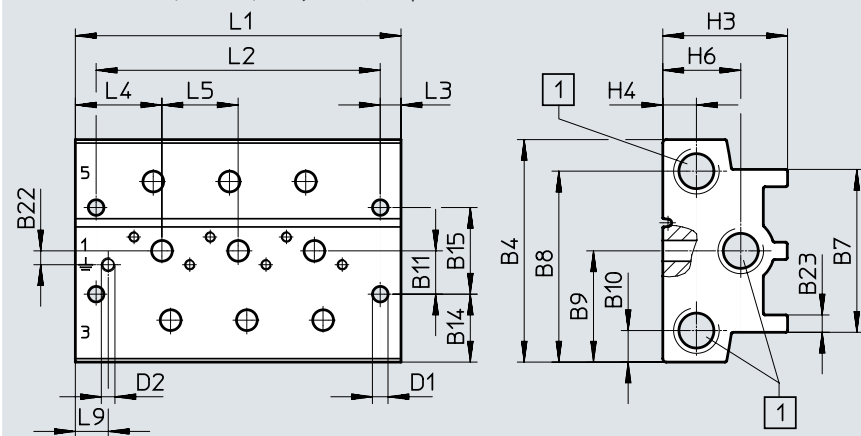

[1] Ports 1, 3 and 5: 1/4 NPT

Type	B4	B7	B8	B9	B10	B11	B14	B15	B22	B23
VABM-B10-20S-...N14-...	64.2	47	55.1	32.1	9.1	12.5	19.6	25	4	5

Type	D1 ø	D2	H3	H4	H6	L3	L4	L5	L9
VABM-B10-20S-...N14-...	4.5	M4x6.5	36	9.7	22.5	6	25	22	9.5

Valve positions	2	3	4	5	6	7	8	9	10
L1 [mm]	72	94	116	138	160	182	204	226	248
L2 [mm]	60	82	104	126	148	170	192	214	236

Data sheet – Manifold block, size 20

Dimensions

Common supply manifold, mounting on both sides

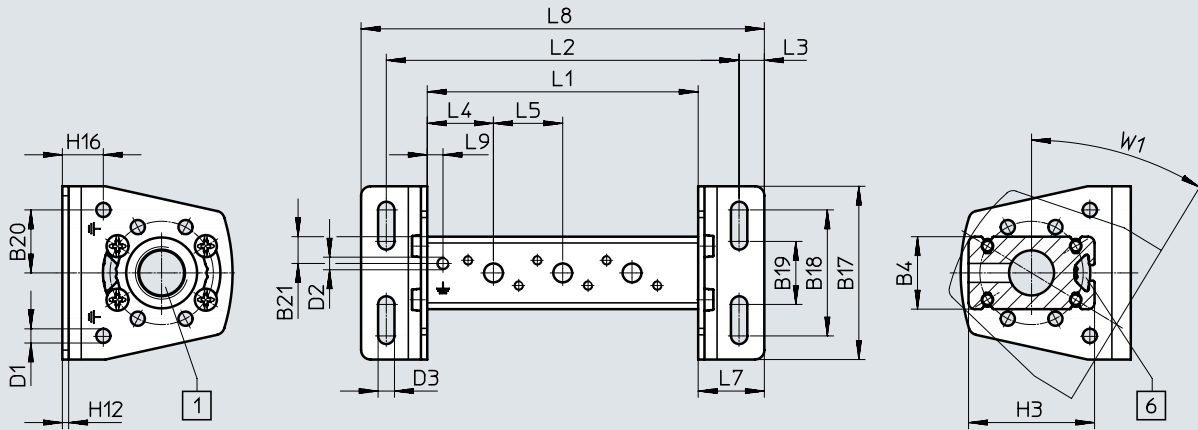

[1] Port 1: 3/8 NPT

[6] Profile slot IPM-05 system 5

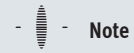









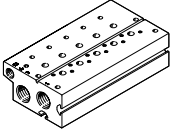

Note

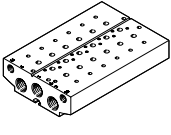
Mounting bracket can be adjusted through $\pm 30^\circ$.

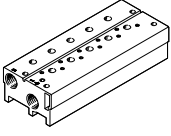

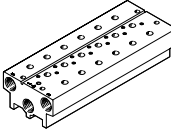

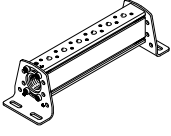

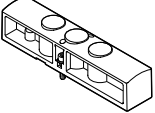
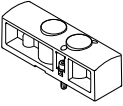

Type	B4	B17	B18	B19	B20	B21	D1 \varnothing	D2	D3 \varnothing	H3	H12	H16	L3	L4	L5	L7	L9	W1
VABM-B10-20-N38-...-P53	23	55	40	20	20	8.5	4.5	M4x6.5	5.2	40	2	13	8	21	22	21	5	30°

Valve positions	2	3	4	5	6	7	8	9	10
L1 [mm]	64	86	108	130	152	174	196	218	240
L2 [mm]	90	112	134	156	178	200	222	244	266
L8 [mm]	106	128	150	172	194	216	238	260	282

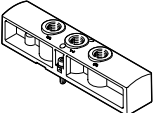
Ordering data – Manifold block, size 20

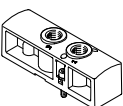
Ordering data – Manifold block		Valve positions	Part no.	Type
Standard manifold block				
 <p>For 3/2-way valves, incl. seals and screws for valve assembly</p> <p>-  - Note Blanking plugs for sealing the supply ports (1, 3 and 14) at one end are included in the scope of delivery.</p>		2	576453	VABM-B10-20E-N38-2-P3
		3	576454	VABM-B10-20E-N38-3-P3
		4	576455	VABM-B10-20E-N38-4-P3
		5	576456	VABM-B10-20E-N38-5-P3
		6	576457	VABM-B10-20E-N38-6-P3
		7	576458	VABM-B10-20E-N38-7-P3
		8	576459	VABM-B10-20E-N38-8-P3
		9	576460	VABM-B10-20E-N38-9-P3
		10	576461	VABM-B10-20E-N38-10-P3
	 <p>For 5/2 and 5/3-way valves, incl. seals and screws for valve assembly</p> <p>-  - Note Blanking plugs for sealing the supply ports (1, 3, 5, 12 and 14) at one end are included in the scope of delivery.</p>		2	576351
		3	576352	VABM-B10-20E-N38-3
		4	576353	VABM-B10-20E-N38-4
		5	576354	VABM-B10-20E-N38-5
		6	576355	VABM-B10-20E-N38-6
		7	576356	VABM-B10-20E-N38-7
		8	576357	VABM-B10-20E-N38-8
		9	576358	VABM-B10-20E-N38-9
		10	576359	VABM-B10-20E-N38-10
Compact manifold block				
 <p>For 3/2-way valves, incl. seals and screws for valve assembly</p> <p>-  - Note Blanking plugs for sealing the supply ports (1 and 3) at one end are included in the scope of delivery.</p>		2	576477	VABM-B10-20S-N14-2-P3
		3	576478	VABM-B10-20S-N14-3-P3
		4	576479	VABM-B10-20S-N14-4-P3
		5	576480	VABM-B10-20S-N14-5-P3
		6	576481	VABM-B10-20S-N14-6-P3
		7	576482	VABM-B10-20S-N14-7-P3
		8	576483	VABM-B10-20S-N14-8-P3
		9	576484	VABM-B10-20S-N14-9-P3
		10	576485	VABM-B10-20S-N14-10-P3
	 <p>For 5/2 and 5/3-way valves, incl. seals and screws for valve assembly</p> <p>-  - Note Blanking plugs for sealing the supply ports (1, 3 and 5) at one end are included in the scope of delivery.</p>		2	576429
		3	576430	VABM-B10-20S-N14-3
		4	576431	VABM-B10-20S-N14-4
		5	576432	VABM-B10-20S-N14-5
		6	576433	VABM-B10-20S-N14-6
		7	576434	VABM-B10-20S-N14-7
		8	576435	VABM-B10-20S-N14-8
		9	576436	VABM-B10-20S-N14-9
		10	576437	VABM-B10-20S-N14-10
Common supply manifold				
 <p>For mounting on both sides, incl. seals and screws for valve assembly</p> <p>-  - Note Blanking plug for sealing the supply port (1) at one end included in the scope of delivery.</p>		2	576375	VABM-B10-20-N38-2-P53
		3	576376	VABM-B10-20-N38-3-P53
		4	576377	VABM-B10-20-N38-4-P53
		5	576378	VABM-B10-20-N38-5-P53
		6	576379	VABM-B10-20-N38-6-P53
		7	576380	VABM-B10-20-N38-7-P53
		8	576381	VABM-B10-20-N38-8-P53
		9	576382	VABM-B10-20-N38-9-P53
		10	576383	VABM-B10-20-N38-10-P53

Accessories – Manifold block, size 20

Ordering data		Weight [g]	Part no.	Type
Description				
Cover plate				
	For valve position on manifold block for 5/2-, 5/3-way valves	78	576410	VABB-B10-20-E
	For valve position on manifold block for 3/2-way valves	56	576411	VABB-B10-20-E-P3
	For valve position on common supply manifold	13	576409	VABB-B10-20-A
Supply plate				
	For valve position on manifold block for 5/2-, 5/3-way valves -  - Note Supply plates and air supply plates are available with G thread only.	78	576492	VABF-B10-20-P1A4-G18
	For valve position on manifold block for 3/2-way valves -  - Note Supply plates and air supply plates are available with G thread only.	56	576493	VABF-B10-20-P1A4-G18-P3
Air supply plate				
	For valve position on common supply manifold -  - Note Supply plates and air supply plates are available with G thread only.	13	576491	VABF-B10-20-P1-G18





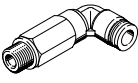

Ordering data		Description of NPT thread	Part no.	Type	PU ¹⁾
Push-in fitting with internal hex					
	Connecting thread 1/8 NPT for tubing O.D.	5/32 "	572317	QB-1/8-5/32-I-U	10
		1/4 "	572318	QB-1/8-1/4-I-U	10
		5/16 "	572319	QB-1/8-5/16-I-U	10
	Connecting thread 1/4 NPT for tubing O.D.	5/16 "	572321	QB-1/4-5/16-I-U	10
		3/8 "	572322	QB-1/4-3/8-I-U	10
		1/2 "	567771	QB-1/4-1/2-U	10
	Connecting thread 3/8 NPT for tubing O.D.	5/16 "	572323	QB-3/8-5/16-I-U	10
		3/8 "	572324	QB-3/8-3/8-I-U	10
		1/2 "	572325	QB-3/8-1/2-I-U	10

1) Packaging unit

Accessories – Manifold block, size 20

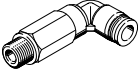

Ordering data					
	Description of NPT thread		Part no.	Type	PU ¹⁾
Angled push-in fitting with external hex					
	Connecting thread 1/8 NPT for tubing O.D.	5/32 "	533290	QBL-1/8-5/32-U	10
		1/4 "	533292	QBL-1/8-1/4-U	10
		5/16 "	533293	QBL-1/8-5/16-U	10
	Connecting thread 1/4 NPT for tubing O.D.	5/16 "	533296	QBL-1/4-5/16-U	10
		3/8 "	533297	QBL-1/4-3/8-U	5
		1/2 "	567775	QBL-1/4-1/2-U	5
	Connecting thread 3/8 NPT for tubing O.D.	5/16 "	533299	QBL-3/8-5/16-U	5
		3/8 "	533300	QBL-3/8-3/8-U	5
		1/2 "	533301	QBL-3/8-1/2-U	5
Angled push-in fitting, long, with external hex					
	Connecting thread 1/8 NPT for tubing O.D.	5/32 "	564668	QBLL-1/8-5/32-U	10
		1/4 "	564670	QBLL-1/8-1/4-U	10
		5/16 "	564671	QBLL-1/8-5/16-U	10

1) Packaging unit





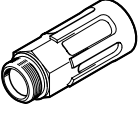

Ordering data					
	Description of G thread		Part no.	Type	PU ¹⁾
Push-in fitting with internal hex					
	 Note Push-in fittings with G thread are for supply plates and air supply plates only.	4 mm	186106	QS-G1/8-4-I	10
			133008	QS-G1/8-4-I-100	100
		6 mm	186107	QS-G1/8-6-I	10
			133009	QS-G1/8-6-I-100	100
		8 mm	186109	QS-G1/8-8-I	10
			133010	QS-G1/8-8-I-100	100
Angled push-in fitting with external hex					
	 Note Push-in fittings with G thread are for supply plates and air supply plates only.	4 mm	186116	QSL-G1/8-4	10
			132048	QSL-G1/8-4-100	100
		6 mm	186117	QSL-G1/8-6	10
			132049	QSL-G1/8-6-100	100
		8 mm	186119	QSL-G1/8-8	10
			132050	QSL-G1/8-8-50	50
Angled push-in fitting, long, with external hex					
	 Note Push-in fittings with G thread are for supply plates and air supply plates only.	4 mm	186127	QSSL-G1/8-4	10
			133015	QSSL-G1/8-4-100	100
		6 mm	186128	QSSL-G1/8-6	10
			133016	QSSL-G1/8-6-100	100
		8 mm	186130	QSSL-G1/8-8	10
			133017	QSSL-G1/8-8-100	100

1) Packaging unit

Accessories – Manifold block, size 20

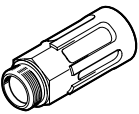

Ordering data		Description of NPT thread	Part no.	Type	PU ¹⁾
Silencer					
	With connecting thread NPT, metal design	1/4 NPT	12639	U-1/4-B-NPT	1
		3/8 NPT	12740	U-3/8-B-NPT	1
	With connecting thread NPT, sintered design, long	1/4 NPT	1206990	AMTE-M-LH-N14	20
		3/8 NPT	1206991	AMTE-M-LH-N38	20

1) Packaging unit

Ordering data		Description of G thread	Part no.	Type	PU ¹⁾
Silencer					
	With connecting thread G, polymer design -  - Note Silencers with G thread are for supply plates and air supply plates only.	G1/8	2307	U-1/8	1
			534222	U-1/8-50	50
	With connecting thread G, metal design -  - Note Silencers with G thread are for supply plates and air supply plates only.	G1/8	6841	U-1/8-B	1
			1205860	AMTE-M-LH-G18	20
	With connecting thread G, sintered design, long -  - Note Silencers with G thread are for supply plates and air supply plates only.	G1/8	1205860	AMTE-M-LH-G18	20

1) Packaging unit

Accessories – Manifold block, size 20

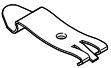
Ordering data	Description	Part no.	Type	PU ¹⁾	
Blanking plug					
	With connecting thread NPT	1/8 NPT	173985	B-1/8-NPT	1
		1/4 NPT	174165	B-1/4-NPT	1
		3/8 NPT	174169	B-3/8-NPT	1
Separator					
	For creating pressure zones	G1/8 1/8 NPT	569995	VABD-8-B	1
		G1/4 1/4 NPT	569996	VABD-10-B	1
		G3/8 3/8 NPT	574483	VABD-14-B	1
H-rail mounting					
	For mounting the valve manifold assembly on standard H-rail TH 35-7.5 or TH 35-15, to EN 60715	569998	VAME-T-M4	1	

1) Packaging unit

Data sheet – Manifold block, size 25

-  - Flow rate
up to 1300 l/min

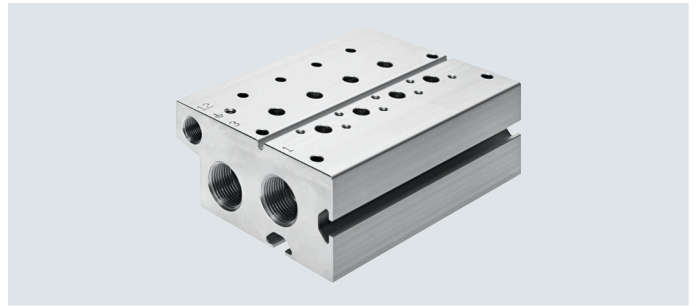

General technical data					
For valves	Manifold block standard		Manifold block compact		Common supply manifold on both sides
		3/2	5/2, 5/3	3/2	5/2, 5/3
Grid dimension [mm]	27.5				
Type of mounting	With through-hole				With mounting bracket
Maximum number of valve positions	10	10	10	10	10
Port 1	1/2 NPT	1/2 NPT	3/8 NPT	3/8 NPT	1/2 NPT
Port 3	1/2 NPT	1/2 NPT	3/8 NPT	3/8 NPT	–
Port 5	–	1/2 NPT	–	3/8 NPT	–
Port 12	1/8 NPT	1/8 NPT	–	–	–
Port 14	–	1/8 NPT	–	–	–
CRC ¹⁾	21)				

1) Corrosion resistance class CRC 2 to Festo standard FN 940070

Moderate corrosion stress. Indoor applications in which condensation can occur. External visible parts with primarily decorative surface requirements which are in direct contact with a normal industrial environment.

Weight [g]									
Valve positions	2	3	4	5	6	7	8	9	10
Manifold block for 3/2-way valves, standard									
VABM-B10-25E-...N12-...-P3	729	963	1197	1431	1665	1899	2133	2367	2601
Manifold block for 5/2- and 5/3-way valves, standard									
VABM-B10-25E-...N12-...	932	1229	1526	1823	2120	2417	2714	3011	3308
Manifold block for 3/2-way valves, compact									
VABM-B10-25S-...N38-...-P3	371	490	609	728	847	966	1085	1204	1323
Manifold block for 5/2- and 5/3-way valves, compact									
VABM-B10-25S-...N38-...	440	581	722	863	1004	1145	1286	1427	1568
Common supply manifold for mounting on both sides									
VABM-B10-25-...N12-...-P53	260	342	424	506	588	670	752	834	916

Materials	
Manifold rail	Wrought aluminium alloy
Note on materials	RoHS-compliant

Data sheet – Manifold block, size 25

Dimensions

Manifold block for 3/2-way valves, standard

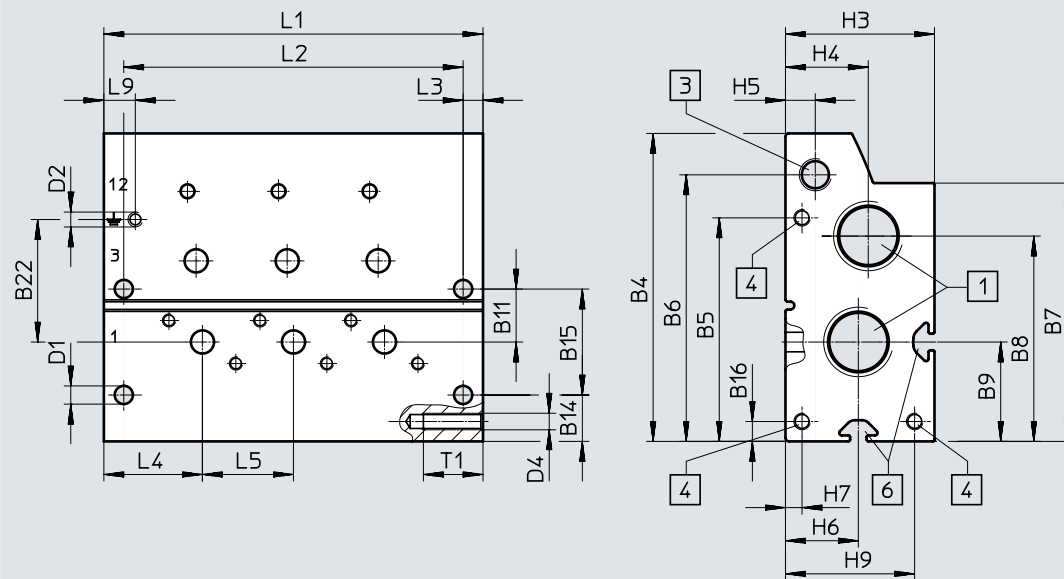

[1] Ports 1 and 3
(at both ends): 1/2 NPT

[3] Ports 12 (at both ends): 1/8 NPT

[4] Thread M5x18 for extension
module

[6] Profile slot IPM-05, system 5

Type	B4	B5	B6	B7	B8	B9	B11	B14	B15	B16	B22
VABM-B10-25-E...N12-...-P3	93	67.5	80.5	78	62	30	16	14	32	6	37

Type	D1 ø	D2	D4	H3	H4	H5	H6	H7	H9	L3	L4	L5	L9	T1
VABM-B10-25-E...N12-...-P3	5.5	M4x9	M5	45	25	9	22	5	39	6	29.8	27.5	9.5	18

Valve positions	2	3	4	5	6	7	8	9	10
L1 [mm]	87	114.5	142	169.5	197	224.5	252	279.5	307
L2 [mm]	75	102.5	130	157.5	185	212.5	240	267.5	295

Data sheet – Manifold block, size 25

Dimensions

Manifold block for 5/2- and 5/3-way valves, standard

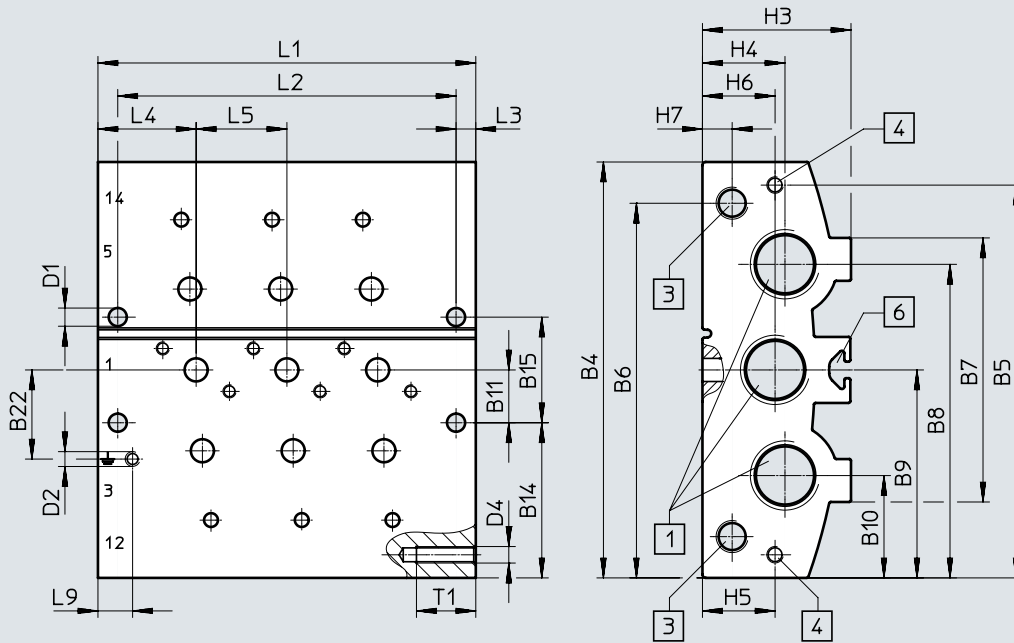

- [1] Ports 1, 3 and 5 (at both ends): 1/2 NPT
- [3] Ports 12 and 14 (at both ends): 1/8 NPT
- [4] Thread M5x18 for extension module
- [6] Profile slot IPM-05, system 5

Type	B4	B5	B6	B7	B8	B9	B10	B11	B14	B15	B22
VABM-B10-25E-...-N12-...	126	119	113.5	80	95	63	31	16	47	32	27

Type	D1 ø	D2	D4	H3	H4	H5	H6	H7	L3	L4	L5	L9	T1
VABM-B10-25E-...-N12-...	5.5	M4x9	M5	45	25	22	22	9	6	29.8	27.5	10.5	18

Valve positions	2	3	4	5	6	7	8	9	10
L1 [mm]	87	114.5	142	169.5	197	224.5	252	279.5	307
L2 [mm]	75	102.5	130	157.5	185	212.5	240	267.5	295

Data sheet – Manifold block, size 25

Dimensions

Manifold block for 3/2-way valves, compact

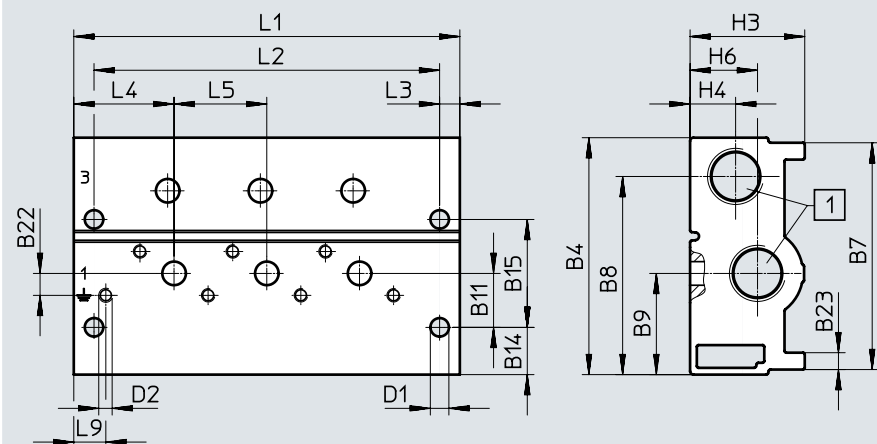

[1] Ports 1 and 3 (at both ends):
3/8 NPT

Type	B4	B7	B8	B9	B11	B14	B15	B22	B23
VABM-B10-25S-...N38-...-P3	70.3	67.3	58.8	30	16	14	32	6.5	5

Type	D1 ø	D2	H3	H4	H6	L3	L4	L5	L9
VABM-B10-25S-...N38-...-P3	5.5	M4x9	34	13.5	20	6	29.8	27.5	9.5

Valve positions	2	3	4	5	6	7	8	9	10
L1 [mm]	87	114.5	142	169.5	197	224.5	252	279.5	307
L2 [mm]	75	102.5	130	157.5	185	212.5	240	267.5	295

Data sheet – Manifold block, size 25

Dimensions

Manifold block for 5/2- and 5/3-way valves, compact

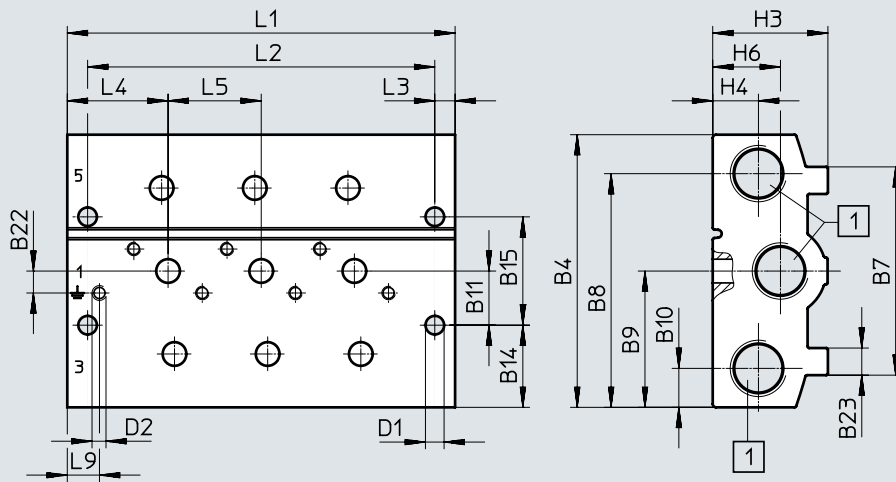

[1] Ports 1, 3 and 5 (at both ends):
3/8 NPT

Type	B4	B7	B8	B9	B10	B11	B14	B15	B22	B23
VABM-B10-25S-...N38-...	80.5	61.5	69	40.3	11.5	16	24.3	32	6.5	8

Type	D1 \varnothing	D2	H3	H4	H6	L3	L4	L5	L9
VABM-B10-25S-...N38-...	5.5	M4x9	34	13.5	20	6	29.8	27.5	9.5

Valve positions	2	3	4	5	6	7	8	9	10
L1 [mm]	87	114.5	142	169.5	197	224.5	252	279.5	307
L2 [mm]	75	102.5	130	157.5	185	212.5	240	267.5	295

Data sheet – Manifold block, size 25

Dimensions

Common supply manifold, mounting on both sides

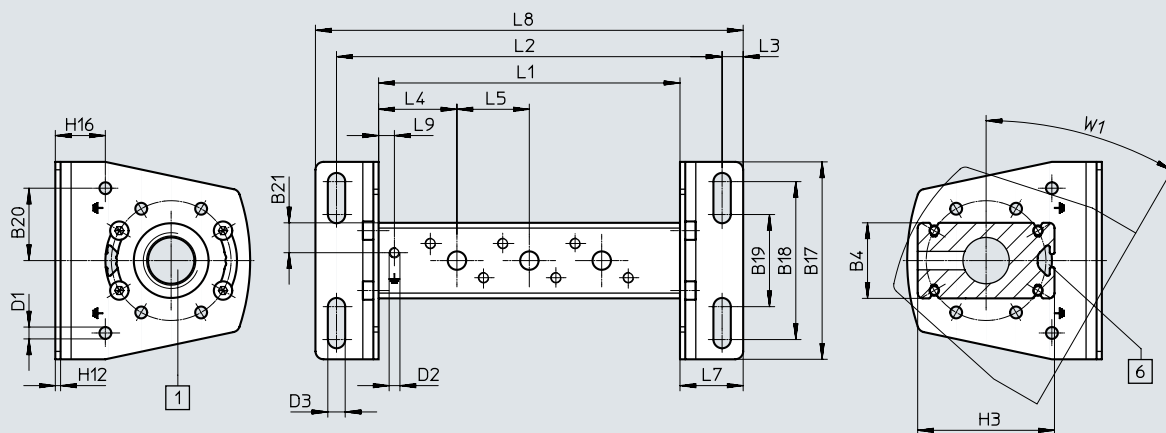

[1] Port 1: (at both ends): 1/2 NPT

[6] Profile slot IPM-05, system 5









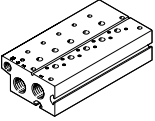

-  - **Note**

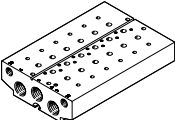
Mounting bracket can be adjusted through $\pm 30^\circ$

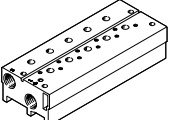

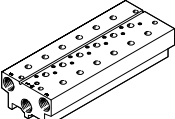

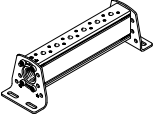

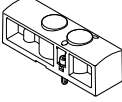
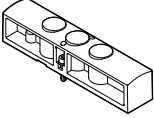

Type	B4	B17	B18	B19	B20	B21	D1 \varnothing	D2	D3 \varnothing	H3	H12	H16	L3	L4	L5	L7	L9	W1
VABM-B10-25-N12-...-P53	28.7	75	60	35	27.5	11.4	4.5	M4x9	6.6	52	2	19	8	29.8	27.5	24	6	30

Valve positions	2	3	4	5	6	7	8	9	10
L1 [mm]	87	114.5	142	169.5	197	224.5	252	279.5	307
L2 [mm]	119	146.5	174	201.5	229	256.5	284	311.5	339
L8 [mm]	135	162.5	190	217.5	245	272.5	300	327.5	355

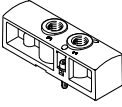

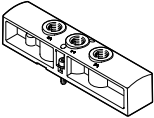
Ordering data – Manifold block, size 25

Ordering data		Valve positions	Part no.	Type
Description				
Standard manifold block				
 <p>For 3/2-way valves, incl. seals and screws for valve assembly</p> <p>-  - Note Blanking plugs for sealing the supply ports (1, 3 and 14) at one end are included in the scope of delivery.</p>		2	8026288	VABM-B10-25E-N12-2-P3
		3	8026289	VABM-B10-25E-N12-3-P3
		4	8026290	VABM-B10-25E-N12-4-P3
		5	8026291	VABM-B10-25E-N12-5-P3
		6	8026292	VABM-B10-25E-N12-6-P3
		7	8026293	VABM-B10-25E-N12-7-P3
		8	8026294	VABM-B10-25E-N12-8-P3
		9	8026295	VABM-B10-25E-N12-9-P3
		10	8026296	VABM-B10-25E-N12-10-P3
	 <p>For 5/2 and 5/3-way valves, incl. seals and screws for valve assembly</p> <p>-  - Note Blanking plugs for sealing the supply ports (1, 3, 5, 12 and 14) at one end are included in the scope of delivery.</p>		2	8026252
		3	8026253	VABM-B10-25E-N12-3
		4	8026254	VABM-B10-25E-N12-4
		5	8026255	VABM-B10-25E-N12-5
		6	8026256	VABM-B10-25E-N12-6
		7	8026257	VABM-B10-25E-N12-7
		8	8026258	VABM-B10-25E-N12-8
		9	8026259	VABM-B10-25E-N12-9
		10	8026260	VABM-B10-25E-N12-10
Compact manifold block				
 <p>For 3/2-way valves, incl. seals and screws for valve assembly</p> <p>-  - Note Blanking plugs for sealing the supply ports (1 and 3) at one end are included in the scope of delivery.</p>		2	8026306	VABM-B10-25S-N38-2-P3
		3	8026307	VABM-B10-25S-N38-3-P3
		4	8026308	VABM-B10-25S-N38-4-P3
		5	8026309	VABM-B10-25S-N38-5-P3
		6	8026310	VABM-B10-25S-N38-6-P3
		7	8026311	VABM-B10-25S-N38-7-P3
		8	8026312	VABM-B10-25S-N38-8-P3
		9	8026313	VABM-B10-25S-N38-9-P3
		10	8026314	VABM-B10-25S-N38-10-P3
	 <p>For 5/2 and 5/3-way valves, incl. seals and screws for valve assembly</p> <p>-  - Note Blanking plugs for sealing the supply ports (1, 3 and 5) at one end are included in the scope of delivery.</p>		2	8026270
		3	8026271	VABM-B10-25S-N38-3
		4	8026272	VABM-B10-25S-N38-4
		5	8026273	VABM-B10-25S-N38-5
		6	8026274	VABM-B10-25S-N38-6
		7	8026275	VABM-B10-25S-N38-7
		8	8026276	VABM-B10-25S-N38-8
		9	8026277	VABM-B10-25S-N38-9
		10	8026278	VABM-B10-25S-N38-10
Common supply manifold				
 <p>For mounting on both sides, incl. seals and screws for valve assembly</p> <p>-  - Note Blanking plug for sealing the supply port (1) at one end included in the scope of delivery.</p>		2	8026228	VABM-B10-25-N12-2-P53
		3	8026229	VABM-B10-25-N12-3-P53
		4	8026230	VABM-B10-25-N12-4-P53
		5	8026231	VABM-B10-25-N12-5-P53
		6	8026232	VABM-B10-25-N12-6-P53
		7	8026233	VABM-B10-25-N12-7-P53
		8	8026234	VABM-B10-25-N12-8-P53
		9	8026235	VABM-B10-25-N12-9-P53
		10	8026236	VABM-B10-25-N12-10-P53







Accessories – Manifold block, size 25

Ordering data		Weight [g]	Part no.	Type
Description				
Cover plate				
	For valve position on manifold block for 3/2-way valves	84	8026210	VABB-B10-25-E-P3
	For valve position on manifold block for 5/2-, 5/3-way valves	117	8026209	VABB-B10-25-E
	For valve position on common supply manifold	28	8026208	VABB-B10-25-A
Supply plate				
	For valve position on manifold block for 3/2-way valves -  - Note Supply plates and air supply plates are available with G thread only.	80	8026319	VABF-B10-25-P1A4-G14-P3
	For valve position on manifold block for 5/2-, 5/3-way valves -  - Note Supply plates and air supply plates are available with G thread only.	110	8026318	VABF-B10-25-P1A4-G14
Air supply plate				
	For valve position on common supply manifold -  - Note Supply plates and air supply plates are available with G thread only.	26	8026317	VABF-B10-25-P1-G14

Accessories – Manifold block, size 25

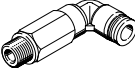

Ordering data					
	Description of NPT thread		Part no.	Type	PU ¹⁾
Push-in fitting with internal hex					
	Connecting thread 1/8 NPT for tubing O.D.	1/4 "	572318	QB-1/8-1/4-I-U	10
	Connecting thread 3/8 NPT for tubing O.D.	5/16 "	572323	QB-3/8-5/16-I-U	10
		3/8 "	572324	QB-3/8-3/8-I-U	10
		1/2 "	572325	QB-3/8-1/2-I-U	10
	Connecting thread 1/2 NPT for tubing O.D.	1/2 "	572326	QB-1/2-1/2-I-U	10
Push-in fitting with external hex					
	Connecting thread 1/2 NPT for tubing O.D.	3/8 "	533283	QB-1/2-3/8-U	5
Angled push-in fitting with external hex					
	Connecting thread 3/8 NPT for tubing O.D.	5/16 "	533299	QBL-3/8-5/16-U	5
		3/8 "	533300	QBL-3/8-3/8-U	5
		1/2 "	533301	QBL-3/8-1/2-U	5
	Connecting thread 1/2 NPT for tubing O.D.	3/8 "	533302	QBL-1/2-3/8-U	5
		1/2 "	533303	QBL-1/2-1/2-U	5

1) Packaging unit

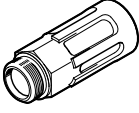

Ordering data						
	Description of G thread		Part no.	Type	PU ¹⁾	
Push-in fitting with internal hex						
	Connecting thread G1/4 for tubing O.D.	6 mm	186108	QS-G1/4-6-I	10	
	 - Note Push-in fittings with G thread are for supply plates and air supply plates only.	8 mm	186110	QS-G1/4-8-I	10	
		10 mm	186112	QS-G1/4-10-I	10	
Angled push-in fitting with external hex						
	 - Note Push-in fittings with G thread are for supply plates and air supply plates only.	Connecting thread G1/4 for tubing O.D.	6 mm	186118	QSL-G1/4-6	10
				132051	QSL-G1/4-6-100	100
		8 mm	186120	QSL-G1/4-8	10	
			132052	QSL-G1/4-8-50	50	
		10 mm	186122	QSL-G1/4-10	10	
			132053	QSL-G1/4-10-50	50	
Angled push-in fitting, long, with external hex						
	 - Note Push-in fittings with G thread are for supply plates and air supply plates only.	Connecting thread G1/4 for tubing O.D.	6 mm	186129	QSL-G1/4-6	10
			8 mm	186131	QSL-G1/4-8	10
			10 mm	186133	QSL-G1/4-10	10

1) Packaging unit

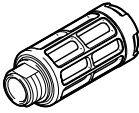

Accessories – Manifold block, size 25

Ordering data		Description of NPT thread	Part no.	Type	PU ¹⁾
Silencer					
	With connecting thread NPT, metal design	3/8 NPT	12740	U-3/8-B-NPT	1
		1/2 NPT	12741	U-1/2-B-NPT	1
	With connecting thread NPT, sintered design, long	3/8 NPT	1206991	AMTE-M-LH-N38	20
		1/2 NPT	1206992	AMTE-M-LH-N12	10

1) Packaging unit

Ordering data		Description of G thread	Part no.	Type	PU ¹⁾
Silencer					
	With connecting thread G, polymer design	G1/4	2316	U-1/4	1
			534223	U-1/4-20	20
	With connecting thread G, sintered design, long	G1/4	1205861	AMTE-M-LH-G1	20

1) Packaging unit

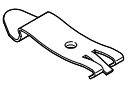
Ordering data		Description	Part no.	Type	PU ¹⁾
Blanking plug					
	With connecting thread NPT	1/8 NPT	173985	B-1/8-NPT	1
		3/8 NPT	174169	B-3/8-NPT	1
		1/2 NPT	31785	B-1/2-NPT	1
Separator					
	For creating pressure zones for port	G1/8	569995	VABD-8-B	1
		1/8 NPT			
		G1/4	569996	VABD-10-B	1
		1/4 NPT			
G3/8	574483	VABD-14-B	1		
3/8 NPT					
H-rail mounting					
	For size 25, for mounting on standard H-rails TH 35-7.5 or TH 35-15 to EN 60715		2636436	VAME-T-M5	2

1) Packaging unit

Data sheet – Manifold block, size 30

-  - Flow rate
up to 2300 l/min

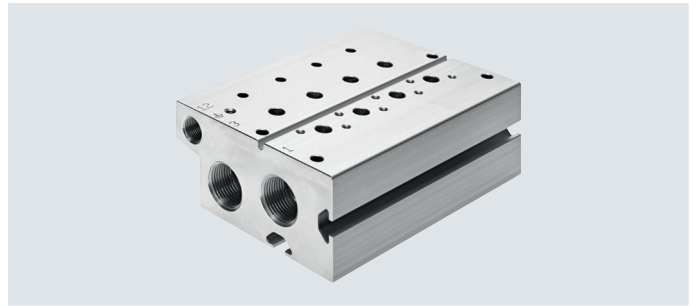

General technical data					
Valve function	Manifold block standard		Manifold block compact		Common supply manifold on both sides
		3/2	5/2, 5/3	3/2	5/2, 5/3
Grid dimension [mm]	32				
Type of mounting	With through-hole				With mounting bracket
Max. number of valve positions	10	10	10		10
Port 1	3/4 NPT	3/4 NPT	1/2 NPT	1/2 NPT	3/4 NPT
Port 3	3/4 NPT	3/4 NPT	1/2 NPT	1/2 NPT	–
Port 5	–	3/4 NPT	–	1/2 NPT	–
Port 12	1/8 NPT	1/8 NPT	–	–	–
Port 14	–	1/8 NPT	–	–	–
CRC ¹⁾	21)				

1) Corrosion resistance class CRC 2 to Festo standard FN 940070

Moderate corrosion stress. Indoor applications in which condensation can occur. External visible parts with primarily decorative surface requirements which are in direct contact with a normal industrial environment.

Weight [g]									
Valve positions	2	3	4	5	6	7	8	9	10
Manifold block for 3/2-way valves, standard									
VABM-B10-30E-N34-...-P3	1411	1828	2245	2662	3079	3496	3913	4330	4747
Manifold block for 5/2- and 5/3-way valves, standard									
VABM-B10-30E-N34-...	1722	2213	2703	3194	3684	4175	4665	5156	5646
Manifold block for 3/2-way valves, compact									
VABM-B10-30S-N12-...-P3	652	872	1093	1313	1533	1753	1973	2193	2413
Manifold block for 5/2- and 5/3-way valves, compact									
VABM-B10-30S-N12-...	759	1013	1267	1522	1776	2030	2285	2539	2793
Common supply manifold for mounting on both sides									
VABM-B10-30-N34-...-P53	818	977	1135	1293	1452	1610	1768	1927	2085

Materials	
Manifold rail	Wrought aluminium alloy
Note on materials	RoHS-compliant

Data sheet – Manifold block, size 30

Dimensions

Manifold block for 3/2-way valves, standard

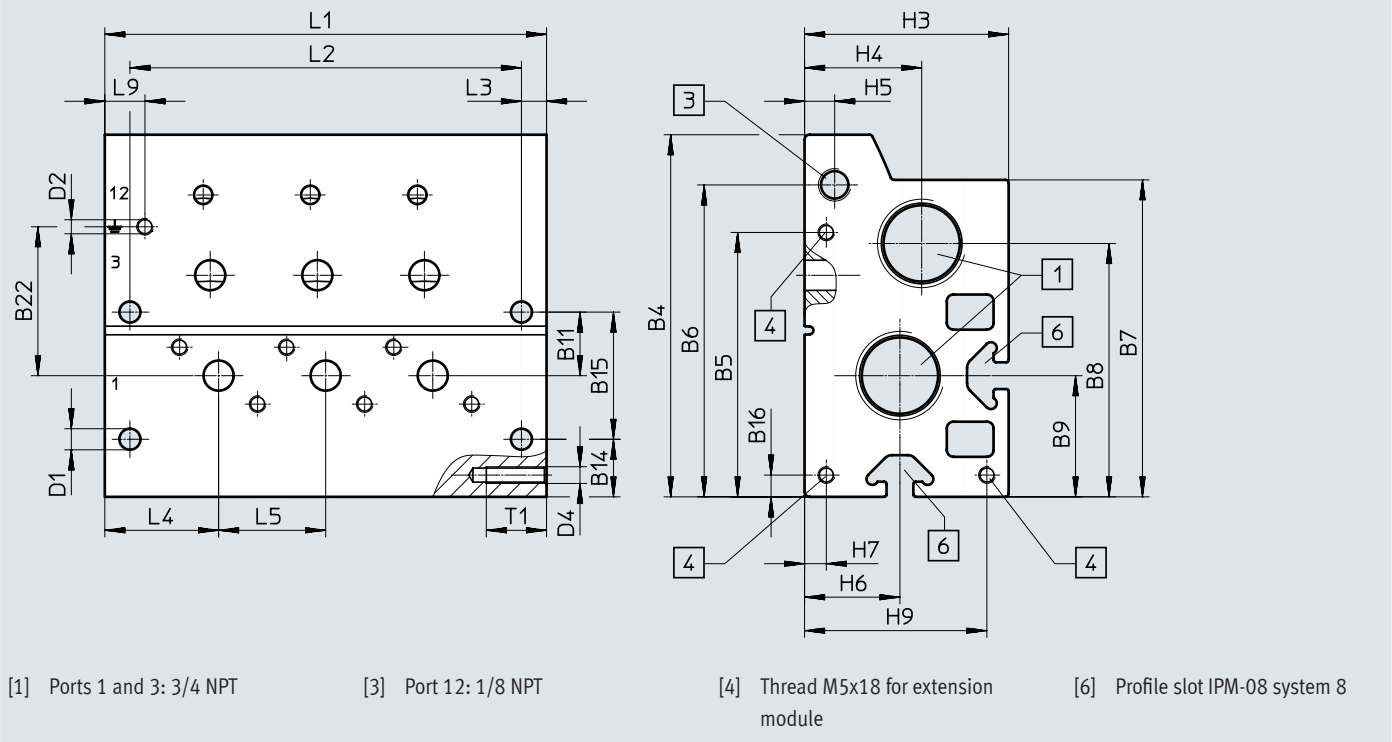

Type	B4	B5	B6	B7	B8	B9	B11	B14	B15	B16	B22
VABM-B10-30E-N34-...-P3	108.2	79	93.2	94.7	75.7	36.2	19	17.2	38	6.5	44.5

Type	D1 ø	D2	D4	H3	H4	H5	H6	H7	H9	L3	L4	L5	L9	T1
VABM-B10-30E-N34-...-P3	6.3	M5x11	M5	61	35	9	28.5	6.5	54.5	7.5	34	32	12	18

Valve positions	2	3	4	5	6	7	8	9	10
L1 [mm]	100	132	164	196	228	260	292	324	356
L2 [mm]	85	117	149	181	213	245	277	309	341

Data sheet – Manifold block, size 30

Dimensions

Manifold block for 5/2- and 5/3-way valves, standard

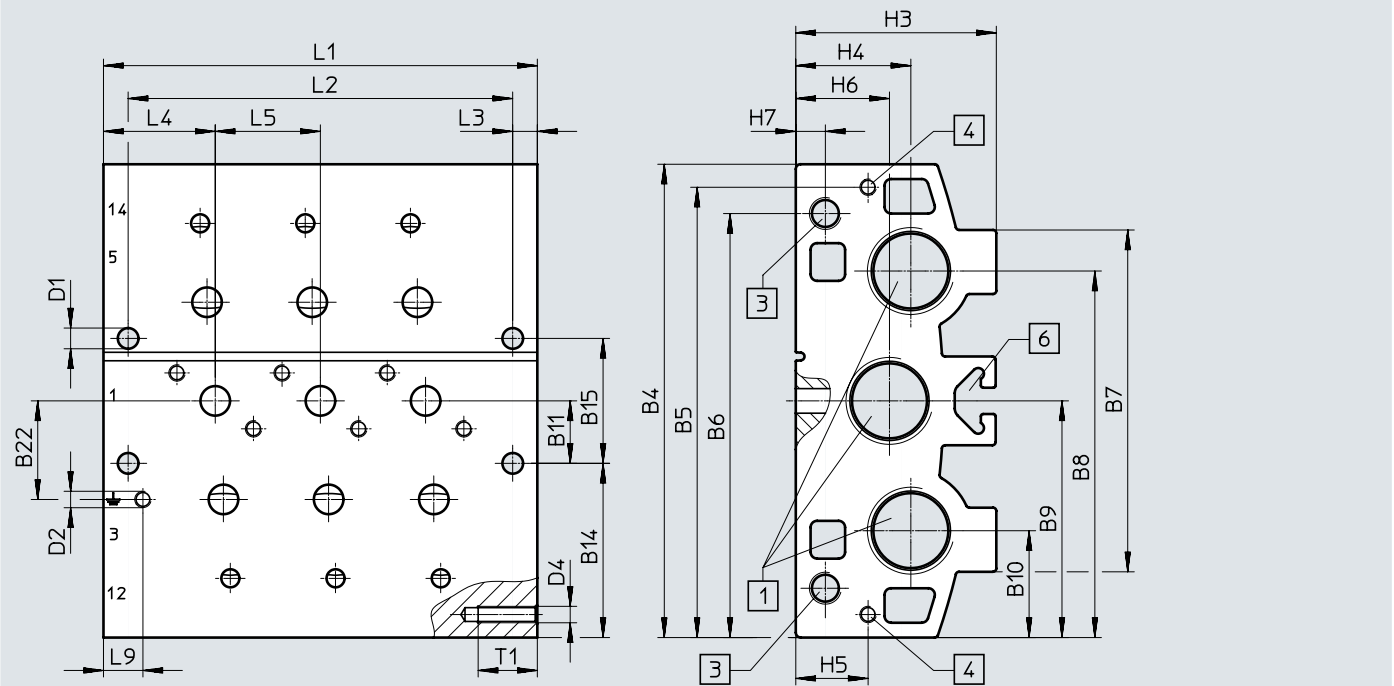

[1] Ports 1, 3 and 5: 3/4 NPT

[3] Ports 12 and 14: 1/8 NPT

[4] Thread M5x18 for extension module

[6] Profile slot IPM-08 system 8

Type	B4	B5	B6	B7	B8	B9	B10	B11	B14	B15	B22
VABM-B10-30E-N34-...	144	137	129	104	111.5	72	32.5	19	53	38	30

Type	D1 \varnothing	D2	D4	H3	H4	H5	H6	H7	L3	L4	L5	L9	T1
VABM-B10-30E-N34-...	6.3	M5x11	M5	61	35	22	28.5	9	7.5	34	32	12	18

Valve positions	2	3	4	5	6	7	8	9	10
L1 [mm]	100	132	164	196	228	260	292	324	356
L2 [mm]	85	117	149	181	213	245	277	309	341

Data sheet – Manifold block, size 30

Dimensions

Manifold block for 3/2-way valves, compact

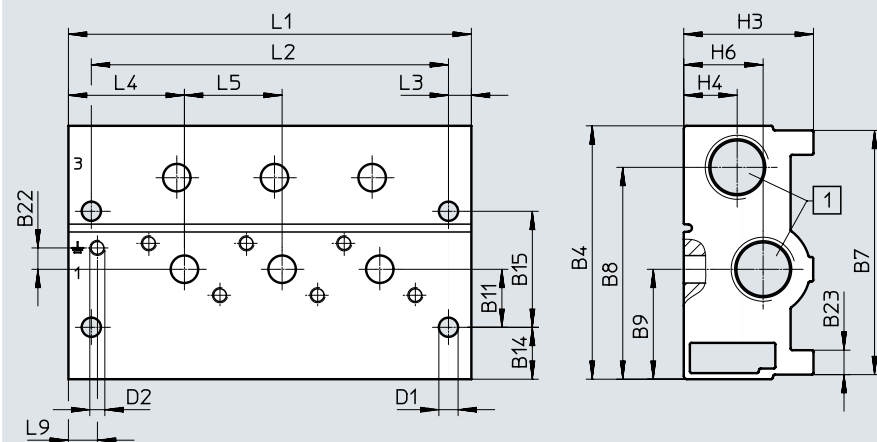

[1] Ports 1 and 3: 1/2 NPT

Type	B4	B7	B8	B9	B11	B14	B15	B22	B23
VABM-B10-30S-N12....-P3	83	80	69.4	36	19	17	38	7	8

Type	D1 ø	D2	H3	H4	H6	L3	L4	L5	L9
VABM-B10-30S-N12....-P3	6.3	M5x11	42.5	17.5	26	7.5	38	32	12

Valve positions	2	3	4	5	6	7	8	9	10
L1 [mm]	100	132	164	196	228	260	292	324	356
L2 [mm]	85	117	149	181	213	245	277	309	341

Dimensions

Manifold block for 5/2- and 5/3-way valves, compact

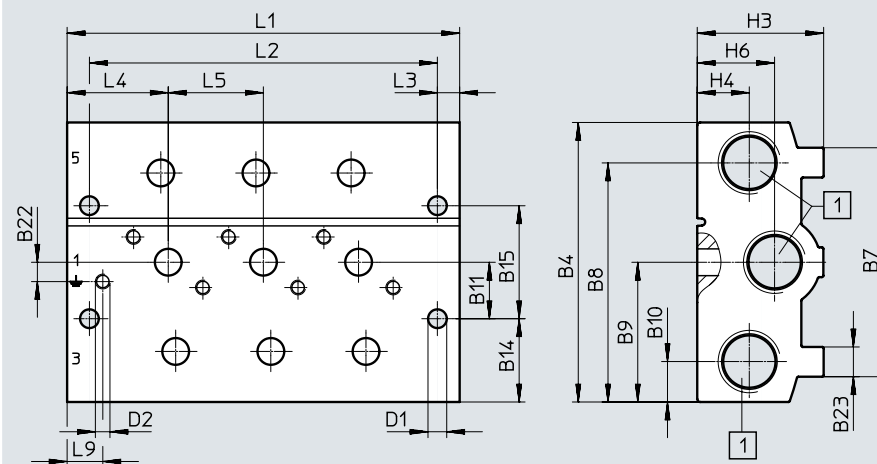

[1] Ports 1, 3 and 5: 1/2 NPT

Type	B4	B7	B8	B9	B10	B11	B14	B15	B22	B23
VABM-B10-30S-N12....	94	77	80.4	47	13.6	19	28	38	6.5	10

Type	D1 ø	D2	H3	H4	H6	L3	L4	L5	L9
VABM-B10-30S-N12....	6.3	M5x11	42.5	17.5	26	7.5	34	32	12

Valve positions	2	3	4	5	6	7	8	9	10
L1 [mm]	100	132	164	196	228	260	292	324	356
L2 [mm]	85	117	149	181	213	245	277	309	341

Data sheet – Manifold block, size 30

Dimensions

Common supply manifold, mounting on both sides

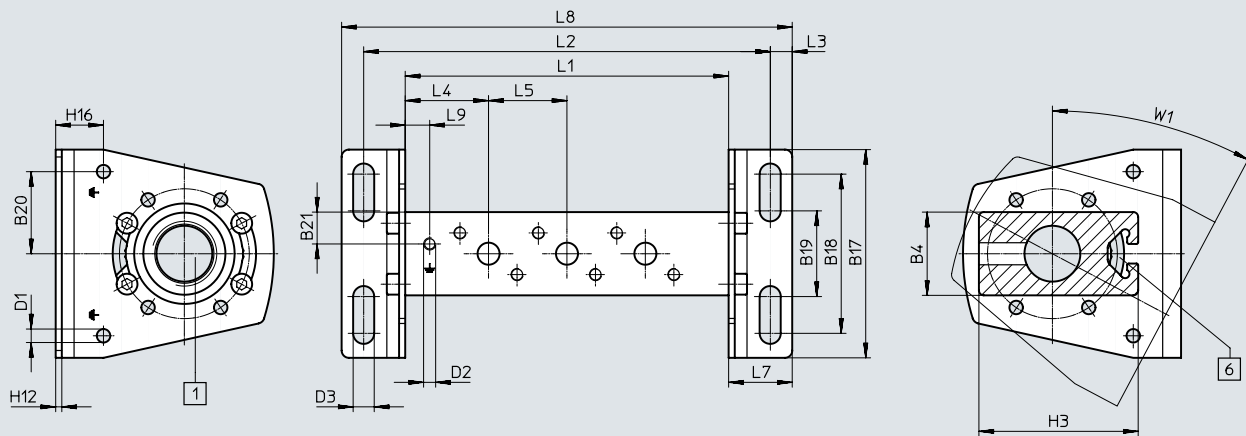

[1] Port 1: 3/4 NPT

[6] Profile slot IPM-08 system 8











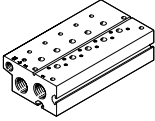

Note

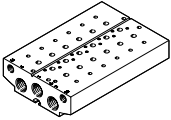
Mounting bracket can be adjusted through $\pm 30^\circ$.

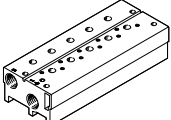

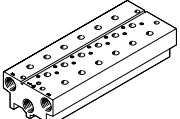

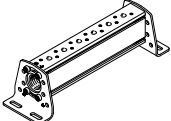

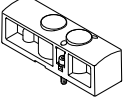
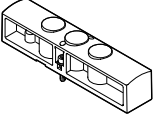

Type	B4	B17	B18	B19	B20	B21	D1 \varnothing	D2	D3 \varnothing	H3	H12	H16	L3	L4	L5	L7	L9	W1
VABM-B10-30-N34-...-P53	34	85	65	35	33.5	13	5.5	M5x11	8.6	65	2.5	19.5	9	34	32	26	10	30°

Valve positions	2	3	4	5	6	7	8	9	10
L1 [mm]	100	132	164	196	228	260	292	324	356
L2 [mm]	134	166	198	230	262	294	326	358	390
L8 [mm]	152	184	216	248	280	312	344	376	408

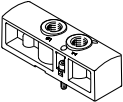

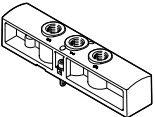

Ordering data – Manifold block, size 30

Ordering data – Manifold block		Valve positions	Part no.	Type
Standard manifold block				
 <p>For 3/2-way valves, incl. seals and screws for valve assembly</p> <p>-  - Note Blanking plugs for sealing the supply ports (1, 3 and 14) at one end are included in the scope of delivery.</p>		2	8026404	VABM-B10-30E-N34-2-P3
		3	8026405	VABM-B10-30E-N34-3-P3
		4	8026406	VABM-B10-30E-N34-4-P3
		5	8026407	VABM-B10-30E-N34-5-P3
		6	8026408	VABM-B10-30E-N34-6-P3
		7	8026409	VABM-B10-30E-N34-7-P3
		8	8026410	VABM-B10-30E-N34-8-P3
		9	8026411	VABM-B10-30E-N34-9-P3
		10	8026412	VABM-B10-30E-N34-10-P3
	 <p>For 5/2 and 5/3-way valves, incl. seals and screws for valve assembly</p> <p>-  - Note Blanking plugs for sealing the supply ports (1, 3, 5, 12 and 14) at one end are included in the scope of delivery.</p>		2	8026368
		3	8026369	VABM-B10-30E-N34-3
		4	8026370	VABM-B10-30E-N34-4
		5	8026371	VABM-B10-30E-N34-5
		6	8026372	VABM-B10-30E-N34-6
		7	8026373	VABM-B10-30E-N34-7
		8	8026374	VABM-B10-30E-N34-8
		9	8026375	VABM-B10-30E-N34-9
		10	8026376	VABM-B10-30E-N34-10
Compact manifold block				
 <p>For 3/2-way valves, incl. seals and screws for valve assembly</p> <p>-  - Note Blanking plugs for sealing the supply ports (1 and 3) at one end are included in the scope of delivery.</p>		2	8026422	VABM-B10-30S-N12-2-P3
		3	8026423	VABM-B10-30S-N12-3-P3
		4	8026424	VABM-B10-30S-N12-4-P3
		5	8026425	VABM-B10-30S-N12-5-P3
		6	8026426	VABM-B10-30S-N12-6-P3
		7	8026427	VABM-B10-30S-N12-7-P3
		8	8026428	VABM-B10-30S-N12-8-P3
		9	8026429	VABM-B10-30S-N12-9-P3
		10	8026430	VABM-B10-30S-N12-10-P3
	 <p>For 5/2 and 5/3-way valves, incl. seals and screws for valve assembly</p> <p>-  - Note Blanking plugs for sealing the supply ports (1, 3 and 5) at one end are included in the scope of delivery.</p>		2	8026386
		3	8026387	VABM-B10-30S-N12-3
		4	8026388	VABM-B10-30S-N12-4
		5	8026389	VABM-B10-30S-N12-5
		6	8026390	VABM-B10-30S-N12-6
		7	8026391	VABM-B10-30S-N12-7
		8	8026392	VABM-B10-30S-N12-8
		9	8026393	VABM-B10-30S-N12-9
		10	8026394	VABM-B10-30S-N12-10
Common supply manifold				
 <p>For mounting on both sides, incl. seals and screws for valve assembly</p> <p>-  - Note Blanking plug for sealing the supply port (1) at one end included in the scope of delivery.</p>		2	8026347	VABM-B10-30-N34-2-P53
		3	8026348	VABM-B10-30-N34-3-P53
		4	8026349	VABM-B10-30-N34-4-P53
		5	8026350	VABM-B10-30-N34-5-P53
		6	8026351	VABM-B10-30-N34-6-P53
		7	8026352	VABM-B10-30-N34-7-P53
		8	8026353	VABM-B10-30-N34-8-P53
		9	8026354	VABM-B10-30-N34-9-P53
		10	8026355	VABM-B10-30-N34-10-P53







Accessories – Manifold block, size 30

Ordering data				
Description		Weight [g]	Part no.	Type
Cover plate				
	For valve position on manifold block for 3/2-way valves	128	8026336	VABB-B10-30-E-P3
	For valve position on manifold block for 5/2-, 5/3-way valves	179	8026335	VABB-B10-30-E
	For valve position on common supply manifold	43	8026334	VABB-B10-30-A
Supply plate				
	For valve position on manifold block for 3/2-way valves -  - Note Supply plates and air supply plates are available with G thread only.	121	8026435	VABF-B10-30-P1A4-G38-P3
	For valve position on manifold block for 5/2-, 5/3-way valves -  - Note Supply plates and air supply plates are available with G thread only.	167	8026434	VABF-B10-30-P1A4-G38
Air supply plate				
	For valve position on common supply manifold -  - Note Supply plates and air supply plates are available with G thread only.	40	8026433	VABF-B10-30-P1-G38

Accessories – Manifold block, size 30

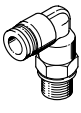

Ordering data		Description of NPT thread	Part no.	Type	PU ¹⁾
Push-in fitting with internal hex					
	Connecting thread 1/8 NPT for tubing O.D.	1/4 "	572318	QB-1/8-1/4-I-U	10
	Connecting thread 1/2 NPT for tubing O.D.	1/2 "	572326	QB-1/2-1/2-I-U	10
Push-in fitting with external hex					
	Connecting thread 1/2 NPT for tubing O.D.	3/8 "	533283	QB-1/2-3/8-U	5
Angled push-in fitting with external hex					
	Connecting thread 1/2 NPT for tubing O.D.	3/8 "	533302	QBL-1/2-3/8-U	5
		1/2 "	533303	QBL-1/2-1/2-U	5
Barbed fitting with external hex					
	Connecting thread 3/4 NPT for tubing I.D. Aluminium design	19 mm	564848	N-3/4-P-19-NPT	1

1) Packaging unit



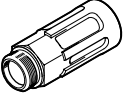

Ordering data		Description of G thread	Part no.	Type	PU ¹⁾
Push-in fitting with internal hex					
	Connecting thread G3/8 for tubing O.D.  - Note Push-in fittings with G thread are for supply plates and air supply plates only.	8 mm	186111	QS-G3/8-8-I	10
		10 mm	186113	QS-G3/8-10-I	10
		12 mm	186114	QS-G3/8-12-I	10
Angled push-in fitting with external hex					
	Connecting thread G3/8 for tubing O.D.  - Note Push-in fittings with G thread are for supply plates and air supply plates only.	8 mm	186121	QSL-G3/8-8	10
			132055	QSL-G3/8-8-50	50
		10 mm	186123	QSL-G3/8-10	10
			132056	QSL-G3/8-10-20	20
			186124	QSL-G3/8-12	10
132057	QSL-G3/8-12-20	20			
Angled push-in fitting, long, with external hex					
	Connecting thread G3/8 for tubing O.D.  - Note Push-in fittings with G thread are for supply plates and air supply plates only.	8 mm	186132	QSL-G3/8-8	10
		10 mm	186134	QSL-G3/8-10	10
		12 mm	186135	QSL-G3/8-12	10

1) Packaging unit



Accessories – Manifold block, size 30

Ordering data		Description of NPT thread	Part no.	Type	PU ¹⁾
Silencer					
	With connecting thread NPT, metal design	3/8 NPT	12740	U-3/8-B-NPT	1
		1/2 NPT	12741	U-1/2-B-NPT	1
		3/4 NPT	566823	U-3/4-B-NPT	1
	With connecting thread NPT, sintered design, long	1/2 NPT	1206992	AMTE-M-LH-N12	10

1) Packaging unit

Ordering data		Description of G thread	Part no.	Type	PU ¹⁾
Silencer					
	With connecting thread G, metal design	G3/8	6843	U-3/8-B	1
		<p>-  - Note</p> <p>Silencers with G thread are for supply plates and air supply plates only.</p>			
	With connecting thread G, sintered design, long	3/8 NPT	1206991	AMTE-M-LH-N38	20
<p>-  - Note</p> <p>Silencers with G thread are for supply plates and air supply plates only.</p>					

1) Packaging unit

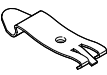
Ordering data		Description	Part no.	Type	PU ¹⁾
Blanking plug					
	With connecting thread NPT	1/8 NPT	173985	B-1/8-NPT	1
		1/2 NPT	31785	B-1/2-NPT	1
		3/4 NPT	31786	B-3/4-NPT	1
Separator					
	For creating pressure zones	G1/8	569995	VABD-8-B	1
		1/8 NPT			
		G1/2	8022483	VABD-17.5-B	1
		1/2 NPT			
		G3/4	8022484	VABD-22.7-B	1
		3/4 NPT			
H-rail mounting					
	For size 30, for mounting on standard H-rails TH 35-7.5 or TH 35-15 to EN 60715		3488412	VAME-T-M6	2

1) Packaging unit