

Valve plug connectors for self-assembly

FESTO



Festo Core Range
Solves the majority of your automation tasks

With the Festo Core Range, we have selected the most important products and functions from our broad product catalogue, and added the quickest delivery.

Worldwide: Quickest delivery – wherever, whenever
Simply good: Expected high Festo quality
Fast: Easy and fast to select

The Core Range offers you the best value for your automation tasks.

Just look
for the
star!

Product range overview

Function	Design	Type	Number of pins/wires	→ Page/ Internet
Plug connector	Electrical connection 1, socket type A			
	To EN 175301-803	MSSD-C	3-pin	4
		MSSD-N		
		MSSD-C	4-pin	6
	Electrical connection 1, socket type B			
	To EN 175301-803	MSSD-V	3-pin	8
	To industry standard, 11 mm	MSSD-F	3-pin	10
	Electrical connection 1, socket type C			
	To EN 175301-803	MSSD-EB	3-pin	12
			4-pin	14
	To industry standard, 9.4 mm	MSSD-E	3-pin	16
	Electrical connection 1, socket plug pattern ZB/ZC			
	–	MSSD-ZBZC	4-pin	18

Type codes

001	Series	
MSSD	Plug socket	

002	Electrical connection 1, connection technology	
C	Type A to EN 175301-803	
F	Type B as per industry standard 11 mm	
E	Type C as per industry standard 9.4 mm	
EB	Type C to EN 175301-803	
N	Type A to EN 175301-803	
V	Type B to EN 175301-803	
ZBZC	Connection pattern ZB/ZC	

003	Electrical connection 1, number of pins/wires	
	Standard	
4P	4-pin	

004	Electrical connection 2, connection technology	
	Standard	
S	Insulation displacement connector	

005	Cable connector	
	Standard	
M12	M12	
M14	M14	
M16	M16	
TY	Pg11	

006	Operating voltage range	
	Standard	
24DC	0 ... 30 V DC, 0 ... 24 V AC	
24VDC	0 ... 30 V DC, 0 ... 24 V AC	

007	Version	
	Standard	
SD	Special design	

008	EU certification	
	None	
EX2	II 3GD	

Datasheet

Plug socket

MSSD-C

MSSD-N

- For valves with D solenoid coil
- For valves with N1 solenoid coil
- For valves with H solenoid coil
- For valve series VZWM-L
- Cable connection with screw terminal

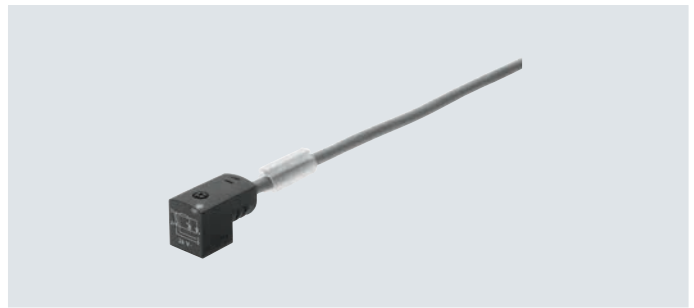

General technical data				
Type	MSSD-C	MSSD-C-M16	MSSD-N	MSSD-C-TY-24DC
Based on norm	–	–	EN 175301-803	–
Electrical connection 1				
Connection type	Socket	Socket	Socket	–
Cable outlet	Angled	Angled	Angled	–
Note on cable outlet	Can be rotated 90°	–	–	–
Protective earth connection	Available	–	–	–
Design	Square	Square	Square	–
Connection technology	Plug pattern type A to DIN EN 175301-803	Plug pattern type A to DIN EN 175301-803	Plug pattern type A to EN 175301-803	–
Number of pins/wires	3	3	3	–
Type of mounting	On solenoid valve with M3 central screw	On solenoid valve with M3 central screw	On solenoid valve with M3 central screw	–
Mounting position	Any	–	Any	–
Contact durability	–	50	–	–
Electrical connection 2				
Connection technology	Screw terminal	–	Screw terminal	–
Cable connector	Pg9	M16	M20x1.5	–
Cable diameter [mm]	6 ... 8	6 ... 8	8 ... 10	–
Nominal conductor cross section [mm ²]	1.5	1.5	1.5	–
Technical data – Electrics				
Type	MSSD-C	MSSD-C-M16	MSSD-N	MSSD-C-TY-24DC
Operating voltage range	[V DC]	0 ... 300	–	0 ... 24
	[V AC]	0 ... 250	–	0 ... 250
Acceptable current load at 40°C	[A]	16	–	16
Materials				
Type	MSSD-C	MSSD-C-M16	MSSD-N	MSSD-C-TY-24DC
Housing	Polymer	Reinforced PA	Reinforced PA	–
Housing colour	Black	–	Black	–
Screws	–	–	Steel	–
Seals	NBR	HNBR	VMQ	–
Note on materials	RoHS-compliant	RoHS-compliant	RoHS-compliant	–
	–	–	Contains paint-wetting impairment substances	–
LABS (PWIS) conformity	VDMA24364-B2-L	–	–	–

Datasheet

Operating and environmental conditions		MSSD-C	MSSD-C-M16	MSSD-N	MSSD-C-TY-24DC
Type					
Ambient temperature [°C]		-25 ... +90	-20 ... +115	-25 ... +80	-40 ... +90
Storage temperature [°C]		-40 ... +90	-	-	-
CE marking (see declaration of conformity)	To EU Low Voltage Directive ¹⁾	-	-	-	-
	To EU RoHS Directive ¹⁾	-	-	-	-
UKCA marking (see declaration of conformity)	To UK regulations for electrical equipment ¹⁾	-	-	-	-
	To UK RoHS regulations ¹⁾	-	-	-	-
Degree of protection	IP65	IP65	IP65	IP65	IP65
	-	To IEC 60529	-	-	To IEC 60529
Note on degree of protection	In mounted state	-	-	In mounted state	-
Certification	Germanischer Lloyd	-	-	-	-
Maritime classification ²⁾	See certificate	-	-	-	-

- 1) For information about the area of use, see the EC declaration of conformity at: www.festo.com/catalogue/... → Support/Downloads.
If the devices are subject to usage restrictions in residential, commercial or light-industrial environments, further measures for the reduction of the emitted interference may be necessary.
- 2) Additional information: www.festo.com/catalogue/... → Support/Downloads.

Dimensions

 Download CAD data → www.festo.com

Pin allocation

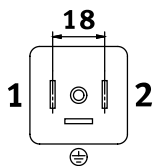

MSSD-C

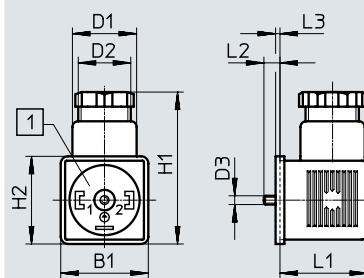

[1] Insert can be rotated 90°

MSSD-N

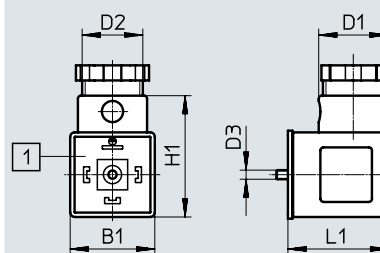

[1] Plug pattern type A to EN 175301-803

Type	B1	D1 ∅	D2 ∅	D3 ∅	H1	H2	L1	L2	L3
MSSD-C	28	22	PG9	M3	52	28	26.5	5.5	1.5
MSSD-C-M16	27	22	M16x 1.5	M3	52	27	27	5.5	1.5
MSSD-C-TY-24DC	30	22	PG11	M3	52	30	30	5.5	1.5
MSSD-N	27.9	22.8	M20x1.5	M3	40	-	33.2	-	-

Ordering data

Description	Signal status indication	Nominal conductor cross section [mm ²]	Weight [g]	Part no.	Type
Socket, plug pattern type A to EN 175301-803, 3-pin, angled	-	6 ... 8	22	34583	MSSD-C
			38	539709	MSSD-C-M16
		8 ... 10	30	550067	MSSD-N
	LED	≤ 1.5	-	177617	MSSD-C-TY-24DC

Datasheet

Plug socket MSSD-C

- For valves with D and N1 solenoid coils
- Cable connection with screw terminal or insulation displacement technology



Special features of insulation displacement technology (MSSD-C-S-M16)

With these plug sockets, the cable is no longer connected using individual clamping screws.

Instead, the flying leads are pressed into the patented insulation displacement contact when the screw is tightened.

- Strip the cable sheath
- Push it in
- Screw it in tightly
- And you're done!

General technical data		
Type	MSSD-C-4P	MSSD-C-S-M16
Electrical connection 1		
Connection type	Socket	Socket
Cable outlet	Angled	–
Design	Square	Square
Connection technology	Plug pattern type A to DIN EN 175301-803	Plug pattern type A to DIN EN 175301-803
Number of pins/wires	3	4
Type of mounting	On solenoid valve with M3 central screw	On solenoid valve with M3 central screw
Mounting position	Any	
Contact durability	–	10
Electrical connection 2		
Connection technology	Screw terminal	Insulation displacement connector
Cable connector	Pg9	–
Cable diameter [mm]	6 ... 8	5.5 ... 8
Nominal conductor cross section [mm ²]	≤ 1.5	0.5 ... 1
Materials		
Type	MSSD-C-4P	MSSD-C-S-M16
Housing	Polymer	PA
Housing colour	Black	Black
Note on materials	RoHS-compliant	RoHS-compliant
Operating and environmental conditions		
Type	MSSD-C-4P	MSSD-C-S-M16
Ambient temperature [°C]	–25 ... +90	–20 ... +90
Degree of protection	IP65	IP67
	–	To IEC 60529

Datasheet

Dimensions

Download CAD data → www.festo.com

Pin allocation

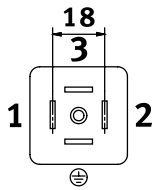

MSSD-C-4P

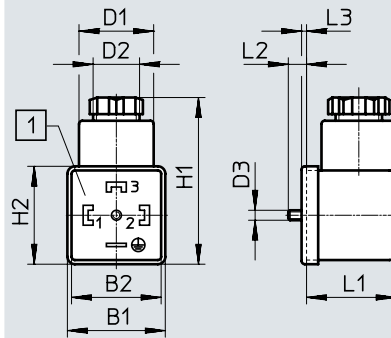

[1] Insert can be rotated 90°

MSSD-C-S-M16

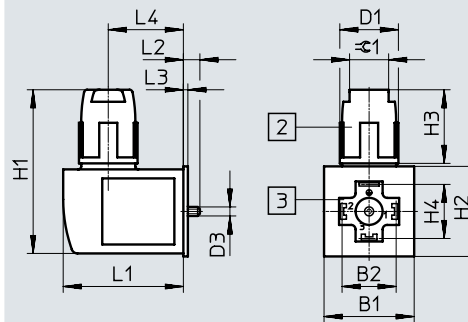

[2] Union nut M16x1

[3] Connection side can be rotated 90°

Type	B1	B2	D1 ∅	D2 ∅	D3 ∅	H1	H2	H3	H4	L1	L2	L3	L4	∅1
MSSD-C-4P	29.5	27	23.8	Pg9	M3	49	29.5	42	–	27	5.5	1.5	–	–
MSSD-C-S-M16	30	18	19.5	–	M3	54.5	30	24.5	18	40	5.5	1.5	25	13

Ordering data

Description	Cable connection	Weight [g]	Part no.	Type
Socket, plug pattern type A to DIN EN 175301-803, 4-pin, angled	Screw terminal	22	171157	MSSD-C-4P
	Insulation displacement connector	38	192748	MSSD-C-S-M16

Datasheet

Plug socket MSSD-V

- For valves with V solenoid coil
- Cable connection with screw terminal



General technical data		
Type	MSSD-V-M16	MSSD-V
Electrical connection 1		
Connection type	Socket	Socket
Cable outlet	Angled	Angled
Note on cable outlet	–	Can be rotated 180°
Protective earth connection	–	Available
Design	Square	Square
Mounting position	Any	Any
Connection technology	Plug pattern type B to DIN EN 175301-803	Plug pattern type B to DIN EN 175301-803
Number of pins/wires	3	3
Type of mounting	On solenoid valve with M3 central screw	On solenoid valve with M3 central screw
Contact durability	50	–
Electrical connection 2		
Connection technology	Screw terminal	Screw terminal
Cable connector	M16	Pg9
Cable diameter [mm]	–	6 ... 8
Permissible cable diameter [mm]	6 ... 8	–
Nominal conductor cross section [mm ²]	–	Max. 1.5
Connection cross section [mm ²]	0.75	–
Technical data – Electrics		
Type	MSSD-V-M16	MSSD-V
Operating voltage range	[V DC]	–
	[V AC]	–
Acceptable current load at 40°C [A]	–	16
Materials		
Type	MSSD-V-M16	MSSD-V
Housing	Reinforced PA	Polymer
Housing colour	–	Black
Seals	HNBR	NBR
LABS (PWIS) conformity	–	VDMA24364-B2-L
Operating and environmental conditions		
Type	MSSD-V-M16	MSSD-V
Ambient temperature [°C]	–20 ... +115	–25 ... +90
CE marking (see declaration of conformity) ¹⁾	–	To EU Low Voltage Directive
	–	To EU RoHS Directive
UKCA marking (see declaration of conformity) ¹⁾	–	–
	–	–
Degree of protection	IP65	IP65
	To IEC 60529	–
Note on degree of protection	–	In mounted state

1) For information about the area of use, see the EC declaration of conformity at: www.festo.com/catalogue/... → Support/Downloads.

If the devices are subject to usage restrictions in residential, commercial or light-industrial environments, further measures for the reduction of the emitted interference may be necessary.

Datasheet

Dimensions

Download CAD data → www.festo.com

Pin allocation

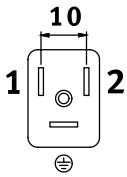

MSSD-V-M16

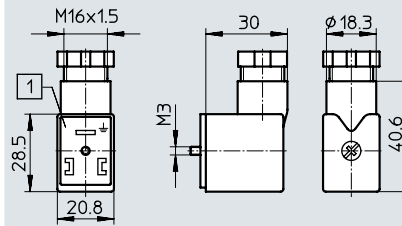

[1] Insert can be rotated 180°

MSSD-V

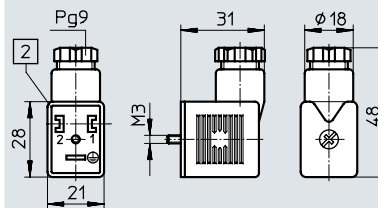

[2] Insert can be rotated 180°

Ordering data

Description	Cable connection	Nominal conductor cross section [mm ²]	Weight [g]	Part no.	Type
Socket, plug pattern type B to DIN EN 175301-803, 3-pin, angled	Screw terminal	Max. 0.75	35 g	539713	MSSD-V-M16
		Max. 1.5	18 g	33295	MSSD-V

Datasheet

Plug socket MSSD-F

- For valves with F solenoid coils
- Cable connection with screw terminal or insulation displacement technology



General technical data				
Type	MSSD-F-M16	MSSD-F	MSSD-FS-M16	
Electrical connection 1				
Connection type	Socket	Socket	Socket	
Cable outlet	Angled	Angled	–	
Note on cable outlet	Can be rotated 180°	Can be rotated 180°	–	
Design	Square	Square	Square	
Mounting position	–	Any	Any	
Connection technology	Plug pattern type B to industry standard, 11 mm	Plug pattern type B to industry standard, 11 mm	Plug pattern type B to industry standard, 11 mm	
Number of pins/wires	3	3	3	
Type of mounting	On solenoid valve with M3 central screw	On solenoid valve with M3 central screw	On solenoid valve with M3 central screw	
Note on cable outlet	Can be rotated 180°	–	–	
Contact durability	50	–	10	
Protective earth connection	Available	Available	–	
Electrical connection 2				
Connection technology	Screw terminal	Screw terminal	Insulation displacement connector	
Cable connector	M16x1.5	Pg9	M16x1.5	
Cable diameter [mm]	6 ... 8	6 ... 8	5.5 ... 8	
Nominal conductor cross section [mm ²]	Max. 0.75	Max. 1.5	0.5 ... 1	
Technical data – Electrics				
Type	MSSD-F-M16	MSSD-F	MSSD-FS-M16	
Operating voltage range	[V DC]	0 ... 250	0 ... 250	
	[V AC]	0 ... 250	0 - 250 V	
Surge resistance [kV]	2	–	–	
Acceptable current load at 40°C [A]	6	16	–	
Materials				
Type	MSSD-F-M16	MSSD-F	MSSD-FS-M16	
Housing	Reinforced PA	Polymer	PA	
Housing colour	Black	Black	Black	
Seals	HNBR	NBR	–	
Note on materials	RoHS-compliant	–	–	
LABS (PWIS) conformity	–	VDMA24364-B2-L	–	

Datasheet

Operating and environmental conditions			
Type	MSSD-F-M16	MSSD-F	MSSD-F-S-M16
Ambient temperature [°C]	-20 ... +115	-25 ... +90	-25 ... +90
Corrosion resistance class CRC ¹⁾	1	-	-
Pollution degree	3	-	-
CE marking (see declaration of conformity) ²⁾	-	To EU Low Voltage Directive	-
	-	To EU RoHS Directive	-
UKCA marking (see declaration of conformity) ²⁾	-	To UK regulations for electrical equipment	-
	-	To UK RoHS regulations	-
Degree of protection	IP65	IP65	IP67
	-	-	To IEC 60529
Note on degree of protection	In mounted state	In mounted state	In mounted state

1) Corrosion resistance class CRC 1 to Festo standard FN 940070

Low corrosion stress. Dry internal application or transport and storage protection. Also applies to parts behind covers, in the non-visible interior area, or parts that are covered in the application (e.g. drive trunnions).

2) For information about the area of use, see the EC declaration of conformity at: www.festo.com/catalogue/... → Support/Downloads.

If the devices are subject to usage restrictions in residential, commercial or light-industrial environments, further measures for the reduction of the emitted interference may be necessary.

Dimensions

Download CAD data → www.festo.com

Pin allocation

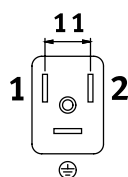

MSSD-F-M16

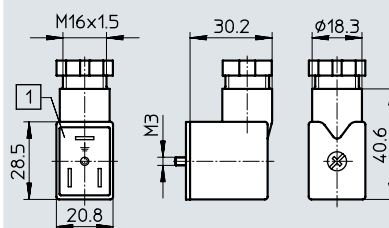

[1] Insert can be rotated 180°

MSSD-F

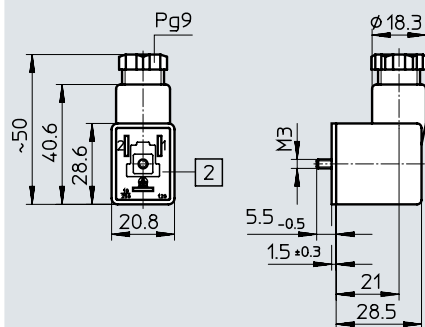

[2] Insert can be rotated 180°

MSSD-F-S-M16

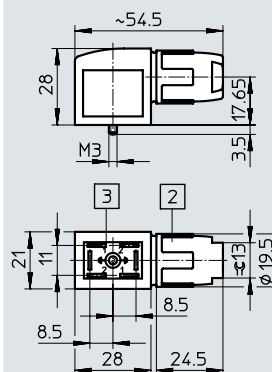

[2] Union nut M16x1

[3] Connection side can be rotated 90°

With these plug sockets, instead of the cable being connected using individual clamping screws, the flying leads are pressed into the patented insulation displacement contact when the screw is tightened:

- Strip the cable sheath
- Push it in
- Screw it in tightly
- And you're done!

Ordering data

Description	Cable connection	Nominal conductor cross section [mm ²]	Weight [g]	Part no.	Type
Socket, plug pattern type B, to industry standard, 11 mm, 3-pin, angled	Screw terminal	Max. 0.75	35	539710	MSSD-F-M16
		Max. 1.5	17	★ 34431	MSSD-F
	Insulation displacement connector	0.5 ... 1	35	192746	MSSD-F-S-M16

Datasheet

Plug socket MSSD-EB

- For valves with EB and N2 solenoid coils



General technical data		MSSD-EB-M12-24VDC-SD-EX	MSSD-EB	MSSD-EB-M12
Type				
Electrical connection 1				
Connection type		Socket	Socket	Socket
Cable outlet		Angled	Angled	Angled
Protective earth connection		–	Available	–
Switching position indication		–	–	–
Design		Square	Square	Square
Mounting position		–	Any	Any
Connection technology		Plug pattern type C to DIN EN 175301-803	Plug pattern type C to DIN EN 175301-803, to DIN EN 61984	Plug pattern type C to DIN EN 175301-803
Number of pins/wires		3	3	3
Type of mounting		On solenoid valve with M2.5 central screw	On solenoid valve with M2.5 central screw	On solenoid valve with M2.5 central screw
Note on cable outlet		Can be rotated 180°	Can be rotated 90°	–
Contact durability		–	–	50
Electrical connection 2				
Connection technology		Screw terminal	Screw terminal	Insulation displacement connector
Cable connector		M12	Pg7	M12
Cable diameter	[mm]	4 ... 6	6 ... 8	4 ... 6
Permissible cable diameter	[mm]	4 ... 6	7.5	4 ... 6
Nominal conductor cross section	[mm ²]	–	≤ 0.75	–
Connection cross section	[mm ²]	0.25 ... 0.5	0.75	1.5
Technical data – Electrics				
Type		MSSD-EB-M12-24VDC-SD-EX	MSSD-EB	MSSD-EB-M12
Nominal operating voltage	[V DC]	–	300	–
	[V AC]	–	250	–
Operating voltage range	[V DC]	0 ... 30	300	–
	[V AC]	0 ... 24	250	–
Surge resistance	[kV]	0.8	4	–
Current rating	[A]	–	6	–
Acceptable current load at 40°C	[A]	6	6	–
Materials				
Type		MSSD-EB-M12-24VDC-SD-EX	MSSD-EB	MSSD-EB-M12
Housing		Reinforced PA	Polymer	Reinforced PA
Housing colour		–	Black	–
Seals		HNBR	NBR	HNBR
Note on materials		RoHS-compliant	–	–
LABS (PWIS) conformity		–	VDMA24364-B2-L	–

Datasheet

Operating and environmental conditions		MSSD-EB-M12-24VDC-SD-EX	MSSD-EB	MSSD-EB-M12
Type				
Ambient temperature [°C]		-25 ... +125	-45 ... +90	-40 ... +125
Pollution degree		3	3	-
CE marking (see declaration of conformity) ¹⁾		-	To EU Low Voltage Directive	-
		-	To EU RoHS Directive	-
UKCA marking (see declaration of conformity) ¹⁾		-	To UK regulations for electrical equipment	-
		-	To UK RoHS regulations	-
Degree of protection		IP65	IP65	IP65
		To IEC 60529	To IEC 60529	To IEC 60529
Note on degree of protection		-	In mounted state	-

1) For information about the area of use, see the EC declaration of conformity at: www.festo.com/catalogue/... → Support/Downloads.
If the devices are subject to usage restrictions in residential, commercial or light-industrial environments, further measures for the reduction of the emitted interference may be necessary.

Dimensions

Download CAD data → www.festo.com

Pin allocation

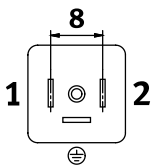

MSSD-EB-M12-24VDC-SD-EX

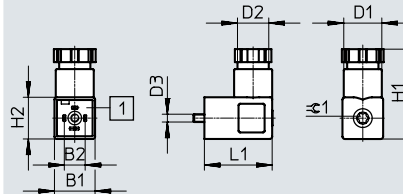

[1] Insert can be rotated 90°

MSSD-EB

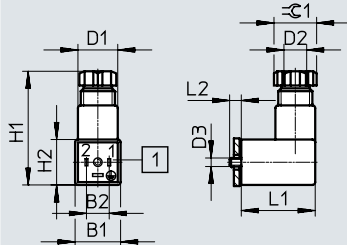

[1] Insert can be rotated 90°

MSSD-EB-M12

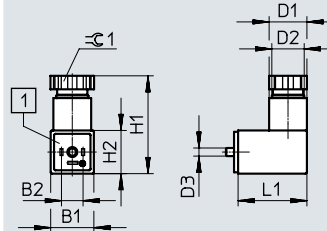

[1] Insert can be rotated 90°

Type	B1	B2	D1 ∅	D2 ∅	D3 ∅	H1	H2	L1	L2	⊖ 1
MSSD-EB-M12-24VDC-SD-EX	15.6	8	14.6	M12x 1.5	2.5	34.5	16	26	-	T8
MSSD-EB	15.5	8	15	Pg7	2.5	40	15.5	26	4.1	13
MSSD-EB-M12	15.5	8	15	M12x 1.5	M2.5	33	15.5	25.5	-	13

Ordering data

Description	Cable connection	Nominal conductor cross section [mm²]	Weight [g]	Part no.	Type
Socket, plug pattern type C to DIN EN 175301-803, 3-pin, angled	Screw terminal	0.25 ... 0.5	-	570367	MSSD-EB-M12-24VDC-SD-EX
		≤ 0.75	11 g	★ 151687	MSSD-EB
		1.5	11 g	539712	MSSD-EB-M12

Datasheet

Plug socket MSSD-EB

- For valves with EB and N2 solenoid coils



General technical data

Electrical connection 1

Connection type	Socket
Cable outlet	Angled
Mounting position	Any
Design	Square
Connection technology	Plug pattern type C
Number of pins/wires	4
Type of mounting	On solenoid valve with M2.5 central screw
Contact durability	10

Electrical connection 2

Connection technology	Insulation displacement connector
Cable diameter [mm]	4 ... 6
Nominal conductor cross section [mm ²]	0.25 ... 0.5

Materials

Housing	PA
Housing colour	Black

Operating and environmental conditions

Ambient temperature [°C]	-25 ... +90
Degree of protection	IP67
	To IEC 60529

Datasheet

Dimensions

Download CAD data → www.festo.com

Pin allocation

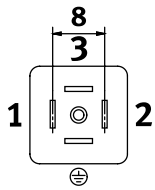

MSSD-EB-S-M14

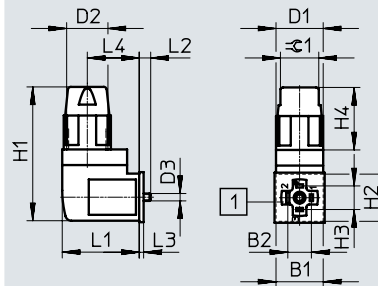

[1] Insert can be rotated 90°

With these plug sockets, instead of the cable being connected using individual clamping screws, the flying leads are pressed into the patented insulation displacement contact when the screw is tightened.

- Strip the cable sheath
- Push it in
- Screw it in tightly
- And you're done!

Type	B1	B2	D1 ∅	D2	D3 ∅	H1	H2	H3	H4	L1	L2	L3	L4	≈∅ 1
MSSD-EB-S-M14	16	8	16	M14x1	2.5	45	16	8	21.2	26	4	1.5	17.6	13

Ordering data

Description	Cable connection	Nominal conductor cross section [mm ²]	Weight [g]	Part no.	Type
Socket, plug pattern type C to DIN EN 175301-803, 4-pin, angled	Insulation displacement connector	0.25 ... 0.5	17	192745	MSSD-EB-S-M14

Datasheet

Plug socket MSSD-E

- For valves with E solenoid coils



General technical data		
Type	MSSD-E	MSSD-E-M12
Electrical connection 1		
Connection type	Socket	Socket
Cable outlet	Angled	Angled
Design	Square	Square
Mounting position	–	Any
Connection technology	Plug pattern type C to industry standard, 9.4 mm	Plug pattern type C to industry standard, 9.4 mm
Number of pins/wires	3	3
Type of mounting	On solenoid valve with M3 central screw	On solenoid valve with M3 central screw
Mounting position	Any	–
Contact durability	–	50
Electrical connection 2		
Connection technology	Screw terminal	Screw terminal
Cable connector	Pg7	M12
Cable diameter [mm]	6 ... 8	–
Permissible cable diameter [mm]	–	4 ... 6
Nominal conductor cross section [mm ²]	0.75	0.75
Connection cross section [mm ²]	–	0.75
Technical data – Electrics		
Operating voltage range	[V DC]	0 ... 300
	[V AC]	0 ... 250
Acceptable current load at 40°C	[A]	6
Materials		
Type	MSSD-E	MSSD-E-M12
Housing	Reinforced PA	Reinforced PA
Housing colour	Black	Black
Seals	NBR	HNBR
Note on materials	–	RoHS-compliant
Operating and environmental conditions		
Type	MSSD-E	MSSD-E-M12
Ambient temperature [°C]	–25 ... +90	–20 ... +115
Corrosion resistance class CRC ¹⁾	–	1
Pollution degree	3	3
Degree of protection	IP65	IP65
	–	To IEC 60529
Note on degree of protection	In mounted state	In mounted state

1) Corrosion resistance class CRC 1 to Festo standard FN 940070

Low corrosion stress. Dry internal application or transport and storage protection. Also applies to parts behind covers, in the non-visible interior area, or parts that are covered in the application (e.g. drive trunnions).

Datasheet

Dimensions

Download CAD data → www.festo.com

Pin allocation

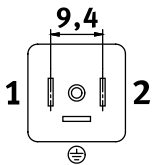

MSSD-E

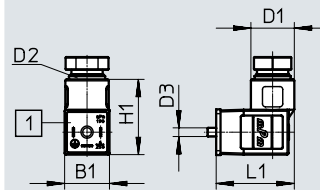

[1] Insert can be rotated 90°

MSSD-E-M12

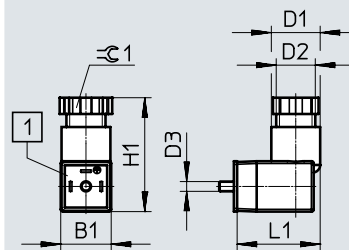

[1] Insert can be rotated 90°

Type	B1	D1 \varnothing	D2	D3	H1	L1	$\varnothing 1$
MSSD-E	15.5	14	Pg7	M3	24.5	25	–
MSSD-E-M12	15.5	15	M12x 1.5	M3	33	25.5	13

Ordering data

Description	Cable connection	Cable diameter [mm]	Weight [g]	Part no.	Type
Socket, plug pattern type C, to industry standard, 9.4 mm, 3-pin, angled	Screw terminal	6 ... 8	8	14098	MSSD-E
		4 ... 6	11	539711	MSSD-E-M12

Datasheet

Plug socket MSSD-ZBZC

- For valves with ZB and ZC solenoid coils



General technical data

Electrical connection 1

Connection type	Socket
Cable outlet	Angled
Mounting position	Any
Design	Square
Connection technology	Plug pattern ZB/ZC
Number of pins/wires	4
Type of mounting	On solenoid valve via self-tapping screw

Electrical connection 2

Connection technology	Insulation displacement connector
Nominal conductor cross section [mm ²]	0.22 ... 0.34

Technical data – Electrics

Nominal operating voltage [V DC]	24
Operating voltage range [V DC]	3 ... 36

Materials

Housing	PA
Note on materials	RoHS-compliant

Operating and environmental conditions

Ambient temperature [°C]	-10 ... +50
Corrosion resistance class CRC ¹⁾	1
Degree of protection	IP50
Note on degree of protection	In mounted state
Maritime classification ²⁾	See certificate

1) Corrosion resistance class CRC 1 to Festo standard FN 940070

Low corrosion stress. Dry internal application or transport and storage protection. Also applies to parts behind covers, in the non-visible interior area, or parts that are covered in the application (e.g. drive trunnions).

2) Additional information: www.festo.com/catalogue/... → Support/Downloads.

Datasheet

Dimensions

Pin allocation

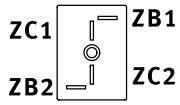

Download CAD data → www.festo.com

MSSD-ZBZC

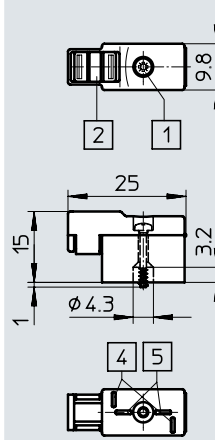

- [1] Retaining screw
- [2] Inscription label IBS-6x10
- [4] Plug pattern for ZB solenoid coil
- [5] Plug pattern for ZC solenoid coil

Ordering data

Description	Cable connection	Nominal conductor cross section [mm ²]	Weight [g]	Part no.	Type
Socket, connection pattern ZB/ZC, 4-pin, angled	Insulation displacement connector	0.22 ... 0.34	11	185521	MSSD-ZBZC

Festo - Your Partner in Automation



1 Festo Inc.
5300 Explorer Drive
Mississauga, ON L4W 5G4
Canada

Festo Customer Interaction Center
Tel: 1 877 463 3786
Fax: 1 877 393 3786
Email: customer.service.ca@festo.com



2 Festo Pneumatic
Av. Ceylán 3,
Col. Tequesquináhuac
54020 Tlalnepantla,
Estado de México

Multinational Contact Center
01 800 337 8669
ventas.mexico@festo.com



3 Festo Corporation
1377 Motor Parkway
Suite 310
Islandia, NY 11749

Festo Customer Interaction Center
1 800 993 3786
1 800 963 3786
customer.service.us@festo.com



4 Regional Service Center
7777 Columbia Road
Mason, OH 45040

Connect with us



www.festo.com/socialmedia



www.festo.com

Subject to change