

Proportional-pressure regulators MPPE/MPPES

FESTO

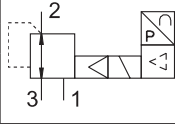
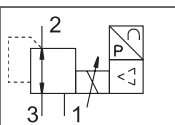
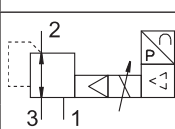

Product range overview

Function	Type	Circuit symbol	Design	Pneumatic connection 1	Nominal width pressurisation/exhaust [mm]	Pressure regulation range ¹⁾		Setpoint value input		→ Page/Internet			
						[MPa]	[bar]	Voltage type	Current type				
Proportional-pressure regulators	With switching valves												
	MPPE		Pilot-actuated valve	G1/8	5/5	0 ... 0.1	0 ... 1	■	■	4			
				G1/4	7/7	0 ... 0.25	0 ... 2.5	■	■				
				G1/2	11/12	0 ... 0.6	0 ... 6	■	■				
	MPPE		Directly actuated valve	G1/8	3/2	0 ... 0.2	0 ... 2	■	■	12			
				MPPEs		Pilot-actuated valve	G1/4	7/7	0 ... 0.6		0 ... 6	■	■
							G1/2	11/12	0 ... 1		0 ... 10	■	■

1) Pressure regulation range also on customer request

Peripherals overview

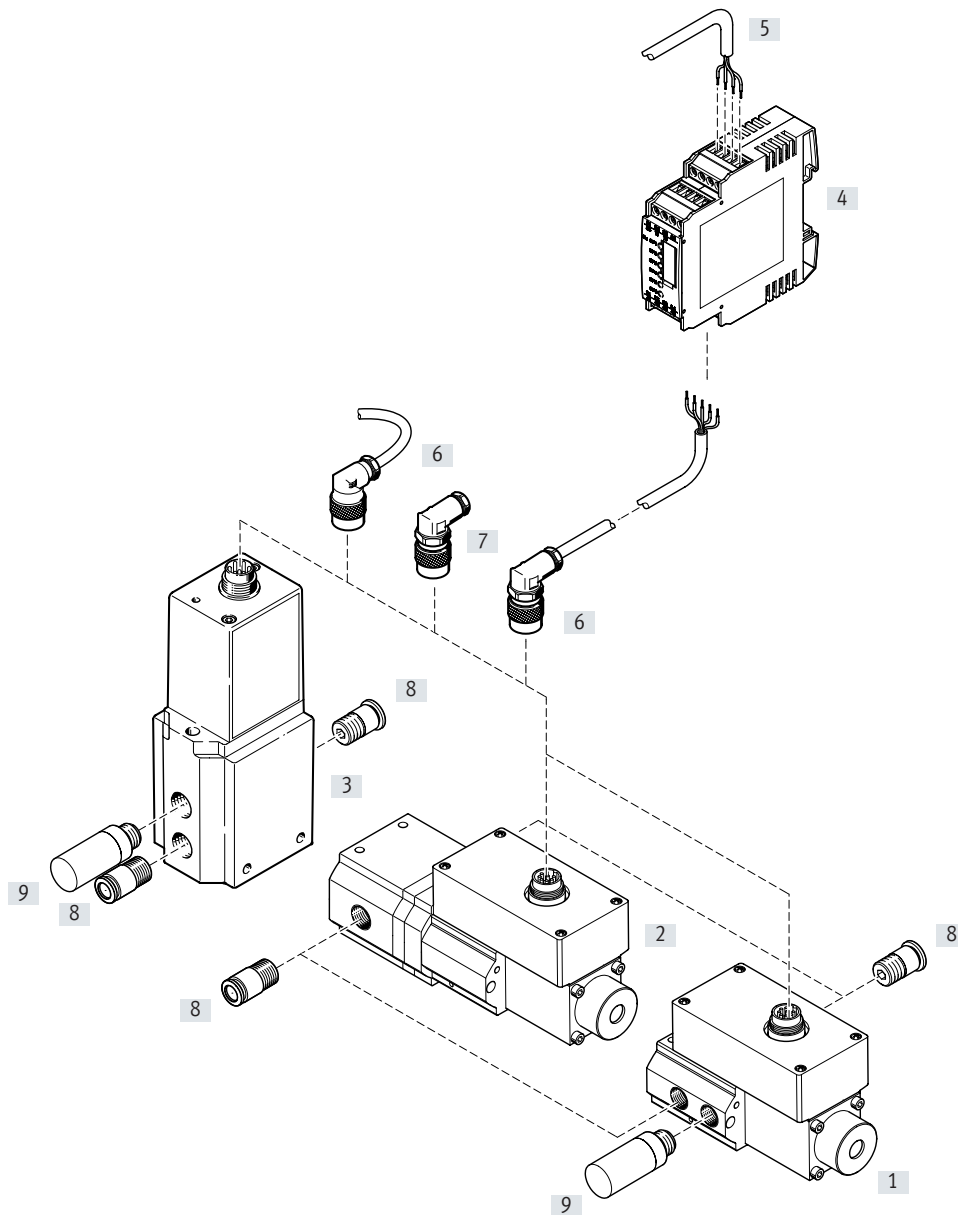

Accessories

		Type	Description	→ Page/Internet
[1]	Proportional-pressure regulator	MPPES	Directly actuated	13
[2]	Proportional-pressure regulator	MPPES	Indirectly actuated	13
[3]	Proportional-pressure regulator	MPPE	Indirectly actuated	5
[4]	Setpoint module	MPZ	For generating 6+1 analogue voltage signals	20
[5]	Digital input/output	–	For controlling the setpoint module	–
[6]	Plug socket with cable	KMPE-B	–	20
[7]	Angled plug socket	MPPE-3-B	–	20
[8]	Push-in fitting	QS	For connecting compressed air tubing	qs
[9]	Silencer	U	For fitting in exhaust ports	u

Type codes

001	Series	
MPPE	Proportional-pressure regulator	

002	Valve function	
3	3/3-way valve, normally closed	

003	Pneumatic connection	
G18	G1/8	
G14	G1/4	
G12	G1/2	

004	Upper pressure value of control range	
1H	1 bar	
10H	10 bar	
6H	6 bar	
2,5H	2.5 bar	

005	Setpoint input for individual valves	
A4	4 ... 20 mA	
V1	0 ... 10 V	

006	Generation	
B	Series B	

Data sheet

-  Flow rate
350 ... 8800 l/min

-  Voltage
18 ... 30 V DC

-  Pressure regulation ranges
0 ... 0.1 MPa
0 ... 0.25 MPa
0 ... 0.6 MPa
0 ... 1 MPa

- Variants
- Setpoint input as analogue voltage signal 0 ... 10 V
 - Setpoint input as analogue current signal 4 ... 20 mA



General technical data			G1/8	G1/4	G1/2
Pneumatic connection			G1/8	G1/4	G1/2
Design			Pilot-actuated piston regulator		
Valve function			3-way proportional-pressure regulator, closed		
Pneumatic connection 1, 2, 3			G1/8	G1/4	G1/2
Sealing principle			Soft		
Actuation type			Electrical		
Type of mounting			Via through-hole		
Mounting position			Any		
Nominal width	Pressurisation	[mm]	5	7	11
	Exhaust port	[mm]	5	7	12
Standard nominal flow rate			→ Graphs		
Product weight			710	920	2400

Flow rate qn as a function of output pressure p2

Pneumatic connection G1/8

Pressure regulation range 0 ... 1 bar

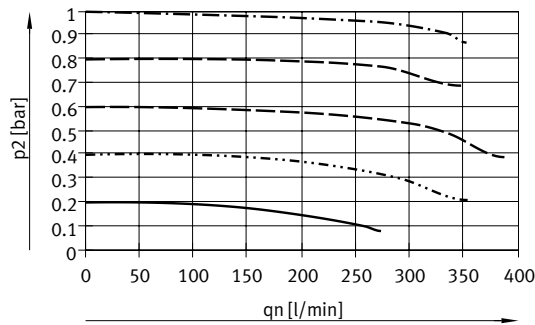

Pressure regulation range 0 ... 2.5 bar

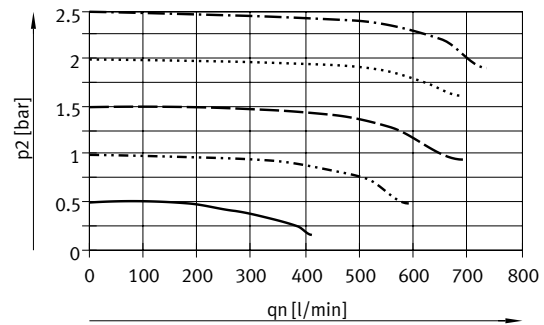

Pressure regulation range 0 ... 6 bar

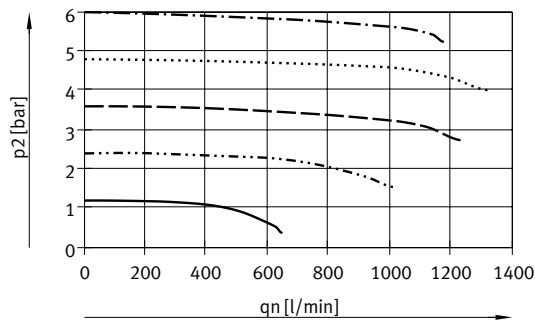

Pressure regulation range 0 ... 10 bar

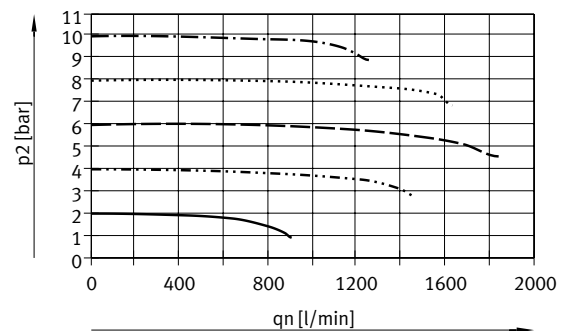

Data sheet

Flow rate q_n as a function of output pressure p_2

Pneumatic connection G1/4

Pressure regulation range 0 ... 1 bar

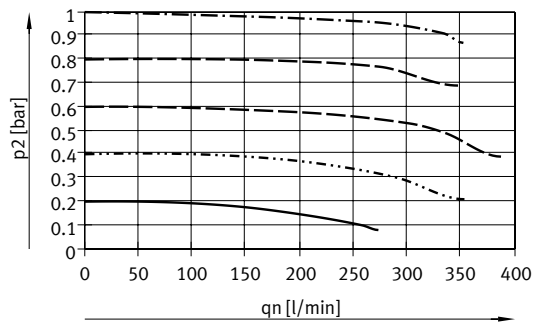

Pressure regulation range 0 ... 2.5 bar

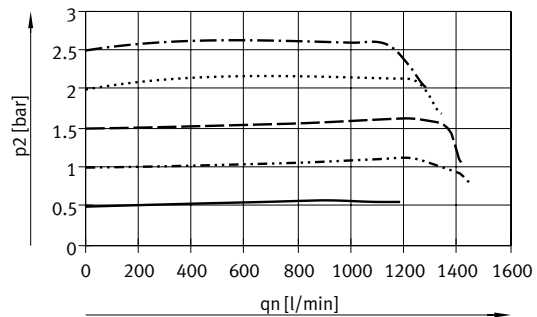

Pressure regulation range 0 ... 6 bar

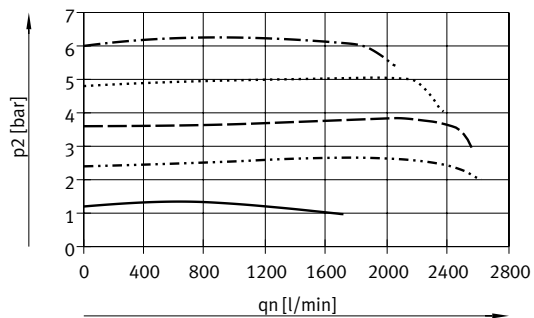

Pressure regulation range 0 ... 10 bar

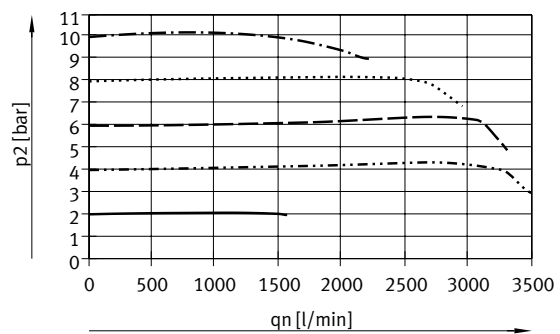

Data sheet

Flow rate q_n as a function of output pressure p_2

Pneumatic connection G1/2

Pressure regulation range 0 ... 1 bar

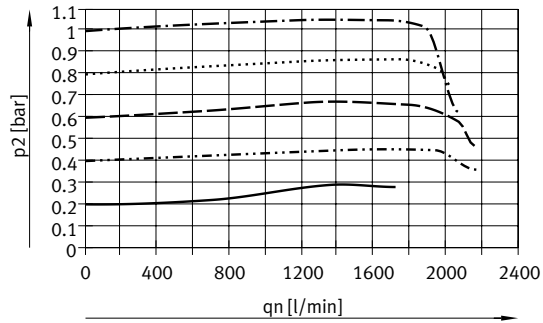

Pressure regulation range 0 ... 2.5 bar

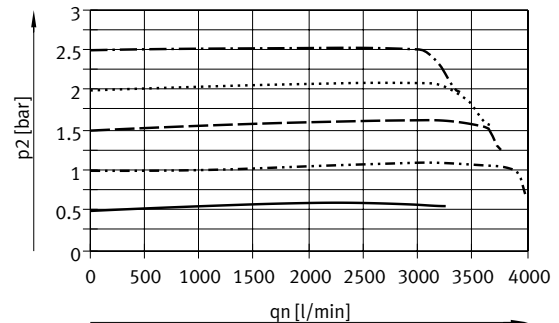

Pressure regulation range 0 ... 6 bar

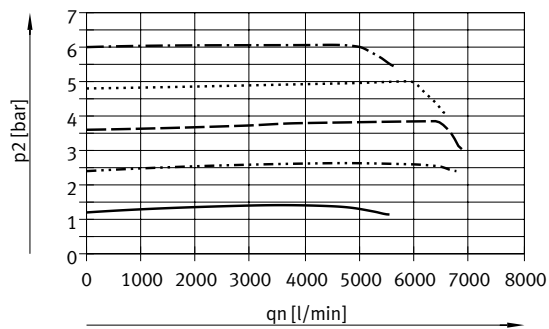

Pressure regulation range 0 ... 10 bar

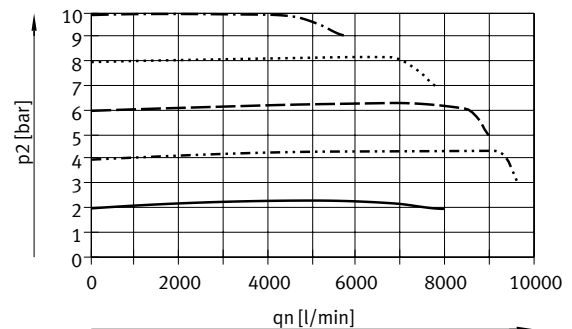

Data sheet

Operating and environmental conditions						
Pressure regulation range		[MPa]	0 ... 0.1	0 ... 0.25	0 ... 0.6	0 ... 1
		[bar]	0 ... 1	0 ... 2.5	0 ... 6	0 ... 10
Operating medium		Compressed air to ISO 8573-1:2010 [7:4:4]				
		Inert gases				
Note on the operating/pilot medium		Basic version	Lubricated operation possible (in which case lubricated operation will always be required)			
Input pressure 1		[MPa]	0.15 ... 0.2	0.35 ... 0.45	0.7 ... 0.8	1.1 ... 1.2
		[bar]	1.5 ... 2	3.5 ... 4.5	7 ... 8	11 ... 12
Max. pressure hysteresis		[MPa]	0.003	0.004	0.004	0.005
		[bar]	0.03	0.04	0.04	0.05
Ambient temperature		[°C]	0 ... 50			
Temperature of medium		[°C]	0 ... 60			
Corrosion resistance class CRC ¹⁾		2 ¹⁾				
Certification		RCM compliance mark				
CE marking (see declaration of conformity)		To EU EMC Directive ²⁾				
		To EU RoHS Directive ²⁾				
UKCA marking (see declaration of conformity)		To UK instructions for EMC ²⁾				
		To UK RoHS instructions ²⁾				
KC mark		Basic version	KC EMC			

1) Corrosion resistance class CRC 2 to Festo standard FN 940070

Moderate corrosion stress. Indoor applications in which condensation can occur. External visible parts with primarily decorative surface requirements which are in direct contact with a normal industrial environment.

2) For information about the area of use, see the EC declaration of conformity at: www.festo.com/catalogue/... → Support/Downloads.

If the devices are subject to usage restrictions in residential, commercial or light-industrial environments, further measures for the reduction of the emitted interference may be necessary.

Electrical data						
Pressure regulation range		[MPa]	0 ... 0.1	0 ... 0.25	0 ... 0.6	0 ... 1
		[bar]	0 ... 1	0 ... 2.5	0 ... 6	0 ... 10
Electrical connection		Plug, round design to DIN 45326, M16 x 0.75, 8-pin				
Operating voltage range		U_B	[V DC]	18 ... 30		
Residual ripple		10%				
Setpoint input signal		Voltage	U_w	[V DC]	0 ... 10	
		Current	I_w	[mA]	4 ... 20	
Actual value output signal		Voltage	U_x	[V DC]	0 ... 10	
		Current	I_x	[mA]	4 ... 20	
Degree of protection		IP65				
Safety remark		Safety position MPPE-B: If the setpoint cable (current) or the supply voltage cable breaks, the output pressure is unregulated. Leakage will result in different deviations over time. In case of a setpoint cable break (voltage), the output pressure is set to 0 MPa.				
Reverse polarity protection		Basic version For all electrical connections				
Short circuit current rating		Basic version For all electrical connections				
Reference voltage		10 V				

Pressure range							
Pressure regulation range		[MPa]	0 ... 0.1	0 ... 0.25	0 ... 0.6	0 ... 1	
		[bar]	0 ... 1	0 ... 2.5	0 ... 6	0 ... 10	
Operating pressure		Basic version	[MPa]	≤ 0.2	≤ 0.45	≤ 0.8	≤ 1.2
			[bar]	≤ 2 bar	≤ 4.5	≤ 8	≤ 12
Input pressure 1		Special adaptation type	[bar]	–	–	–	0 ... 10
		[MPa]	0.15 ... 0.2	0.35 ... 0.45	0.7 ... 0.8	1.1 ... 1.2	
Max. pressure hysteresis		[bar]	1.5 ... 2	3.5 ... 4.5	7 ... 8	11 ... 12	
		[MPa]	0.003	0.004	0.004	0.005	
		[bar]	0.03	0.04	0.04	0.05	

Data sheet

Switching times – Basic type						
Pressure regulation range		[MPa]	0 ... 0.1	0 ... 0.25	0 ... 0.6	0 ... 1
		[bar]	0 ... 1	0 ... 2.5	0 ... 6	0 ... 10
Switching time on	G1/8	[ms]	95	140	100	125
	G1/4	[ms]	140	150	150	160
	G1/2	[ms]	70	85	170	140
Switching time off	G1/8	[ms]	165	250	190	220
	G1/4	[ms]	225	260	260	280
	G1/2	[ms]	500	205	510	535

Switching times – Special adaptation type			
Pressure regulation range		[MPa]	0 ... 1
		[bar]	0 ... 10
Switching time on	G1/8	[ms]	140
	G1/4	[ms]	160
	G1/2	[ms]	170
Switching time off	G1/8	[ms]	220
	G1/4	[ms]	280
	G1/2	[ms]	535

Information on materials		
Housing		Wrought aluminium alloy
Diaphragm		NBR
Note on materials	Basic version	RoHS-compliant
PWIS conformity		VDMA24364-B2-L

Data sheet

Dimensions

Download CAD data → www.festo.com

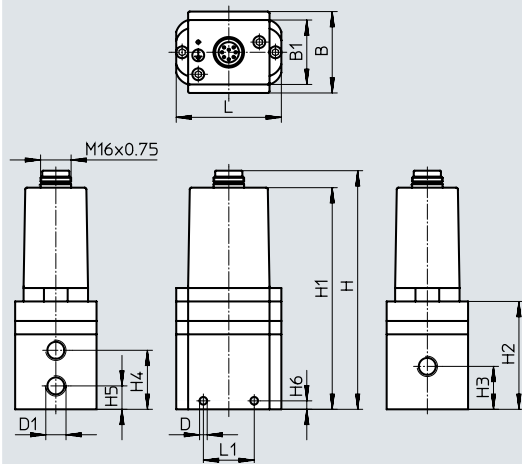

Connection D1	B	B1	∅D	H	H1	H2	H3	H4	H5	H6	L	L1
G1/8	38	-	4.5	129.1	100	60.2	18.8	26.8	9.3	4	62	34
G1/4	48	38	4.5	170.2	140.7	63.6	25.3	34.8	13.8	5	62	30
G1/2	76	38	7	227.1	194.6	117.5	53	74	32	18	86	50

Connections

Terminal allocation

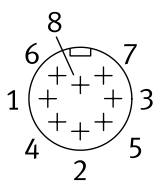

- 1 $X_{ext,in}$
- 2 GND
- 3 GND
- 4 W_{in} (setpoint input)
- 5 $10 V_{OUT}$
- 6 X_{out} (actual value output)
- 7 24 V DC (supply voltage)
- 8 GND

Switching function

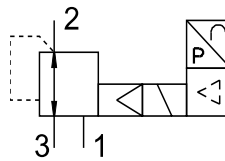

Data sheet

Ordering data						
Pneumatic connection 1, 2, 3	Pressure regulation range		Voltage type 0 ... 10 V		Current type 4 ... 20 mA	
	[MPa]	[bar]	Part no.	Type	Part no.	Type
Basic version						
G1/8	0 ... 0.1	0 ... 1	161160	MPPE-3-1/8-1-010-B	161163	MPPE-3-1/8-1-420-B
	0 ... 0.25	0 ... 2.5	164315	MPPE-3-1/8-2.5-010-B	164316	MPPE-3-1/8-2.5-420-B
	0 ... 0.6	0 ... 6	161161	MPPE-3-1/8-6-010-B	161164	MPPE-3-1/8-6-420-B
	0 ... 1	0 ... 10	161162	MPPE-3-1/8-10-010-B	161165	MPPE-3-1/8-10-420-B
G1/4	0 ... 0.1	0 ... 1	161166	MPPE-3-1/4-1-010-B	161169	MPPE-3-1/4-1-420-B
	0 ... 0.25	0 ... 2.5	164317	MPPE-3-1/4-2.5-010-B	164318	MPPE-3-1/4-2.5-420-B
	0 ... 0.6	0 ... 6	161167	MPPE-3-1/4-6-010-B	161170	MPPE-3-1/4-6-420-B
	0 ... 1	0 ... 10	161168	MPPE-3-1/4-10-010-B	161171	MPPE-3-1/4-10-420-B
G1/2	0 ... 0.1	0 ... 1	161172	MPPE-3-1/2-1-010-B	161175	MPPE-3-1/2-1-420-B
	0 ... 0.25	0 ... 2.5	164319	MPPE-3-1/2-2.5-010-B	164320	MPPE-3-1/2-2.5-420-B
	0 ... 0.6	0 ... 6	161173	MPPE-3-1/2-6-010-B	161176	MPPE-3-1/2-6-420-B
	0 ... 1	0 ... 10	161174	MPPE-3-1/2-10-010-B	161177	MPPE-3-1/2-10-420-B
Special adaptation type¹⁾						
G1/8	-	0 ... 10	164330	MPPE-3-1/8- -B ¹⁾	164330	MPPE-3-1/8- -B ¹⁾
G1/4	-	0 ... 10	164331	MPPE-3-1/4- -B ¹⁾	164331	MPPE-3-1/4- -B ¹⁾
G1/2	-	0 ... 10	164332	MPPE-3-1/2- -B ¹⁾	164332	MPPE-3-1/2- -B ¹⁾

1) The special adaptation type allows a pressure PU to be assigned to the setpoint value 0 V or 4 mA and an upper pressure PO to be assigned to the setpoint value 10 V or 20 mA.

Type codes

001	Series
MPPEs	Proportional pressure regulator with proportional solenoid

002	Valve function
1	3/2-way valve, normally closed

003	Pneumatic connection
G18	G1/8
G14	G1/4
G12	G1/2

004	Upper pressure value of control range
2H	2 bar
10H	10 bar
6H	6 bar

005	Setpoint input for individual valves
A4	4 ... 20 mA
V1	0 ... 10 V

Data sheet

 Flow rate
 230 ... 8500 l/min

 Voltage
 18 ... 30 V DC

 Pressure regulation ranges
 0 ... 0.2 MPa
 0 ... 0.6 MPa
 0 ... 1 MPa

Variants

- Setpoint input as analogue voltage signal 0 ... 10 V
- Setpoint input as analogue current signal 4 ... 20 mA



General technical data			G1/8	G1/4	G1/2
Pneumatic connection			G1/8	G1/4	G1/2
Design			Directly actuated piston regulator	Pilot-actuated piston regulator	
Valve function			3-way proportional-pressure regulator, closed		
Pneumatic connection 1, 2, 3			G1/8	G1/4	G1/2
Sealing principle			Soft		
Actuation type			Electrical		
Type of mounting			Via through-hole		
Mounting position			Any		
Nominal width	Pressurisation	[mm]	3	7	11
	Exhaust port	[mm]	2	7	12
Standard nominal flow rate		[l/min]	→ Graphs		
Product weight		[g]	915	1310	2670

 Flow rate q_n as a function of output pressure p_2

Pneumatic connection G1/8

Pressure regulation range 0 ... 2 bar

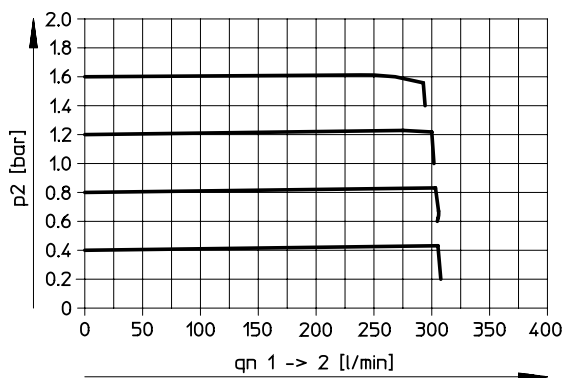

Pressure regulation range 0 ... 6 bar

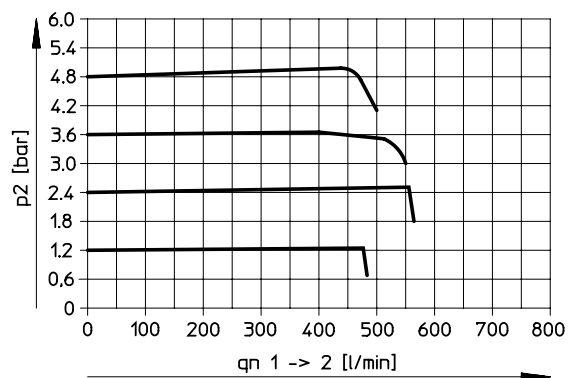

Pressure regulation range 0 ... 10 bar

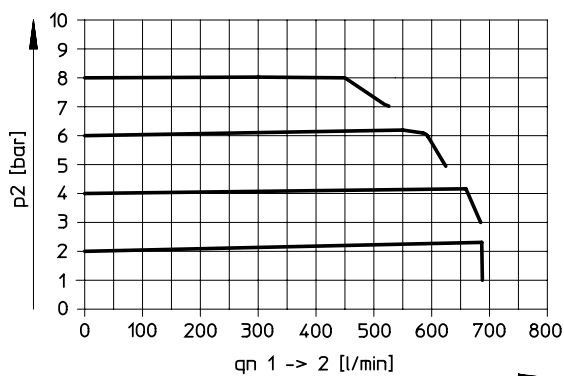

Data sheet

Flow rate q_n as a function of output pressure p_2

Pneumatic connection G1/4

Pressure regulation range 0 ... 2 bar

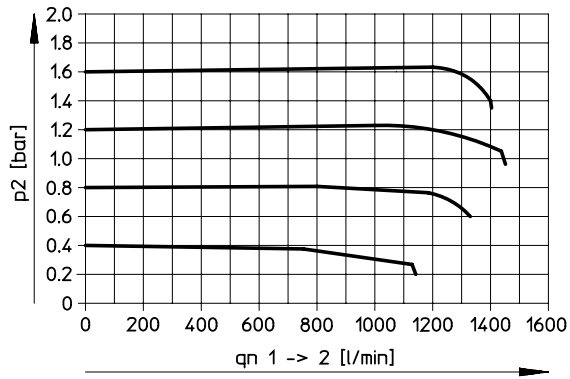

Pressure regulation range 0 ... 6 bar

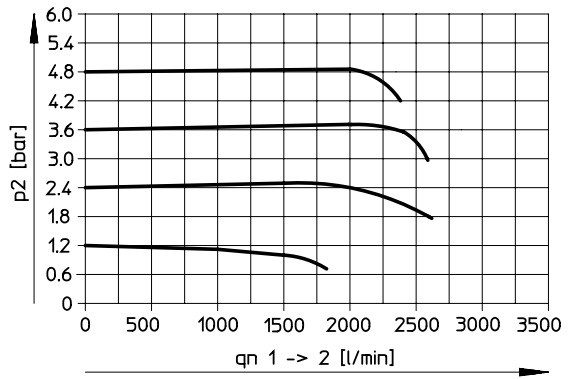

Pressure regulation range 0 ... 10 bar

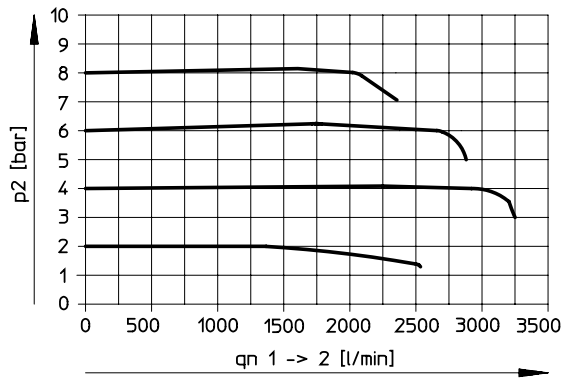

Data sheet

Flow rate q_n as a function of output pressure p_2

Pneumatic connection G1/2

Pressure regulation range 0 ... 2 bar

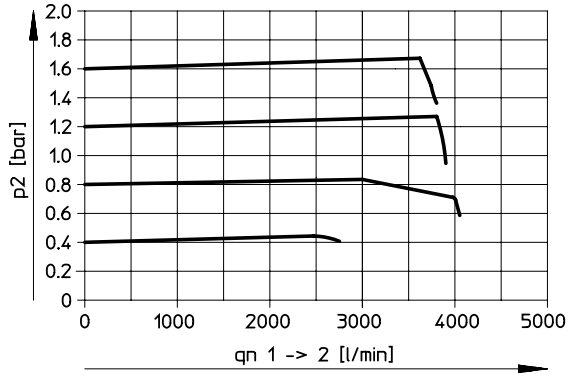

Pressure regulation range 0 ... 6 bar

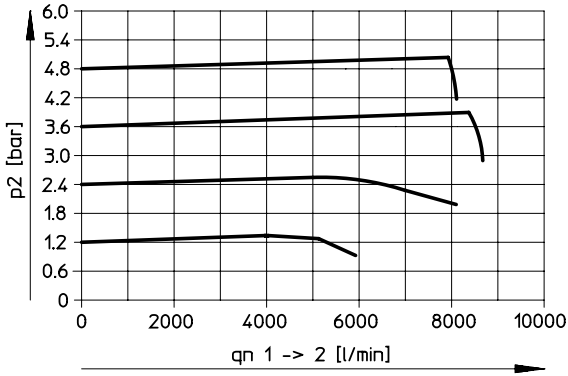

Pressure regulation range 0 ... 10 bar

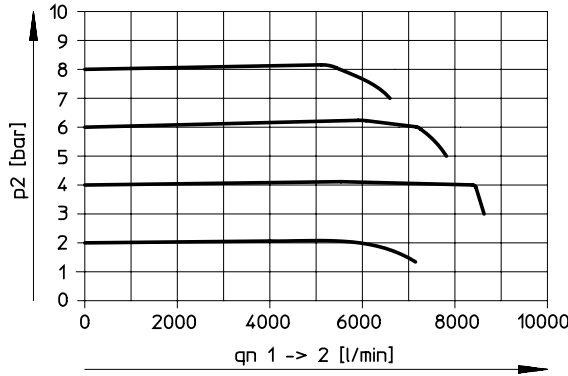

Data sheet

Operating and environmental conditions					
Pressure regulation range		[MPa]	0 ... 0.2	0 ... 0.6	0 ... 1
		[bar]	0 ... 2	0 ... 6	0 ... 10
Operating medium		Compressed air to ISO 8573-1:2010 [7:4:4]			
		Inert gases			
Note on the operating/pilot medium		Lubricated operation possible (in which case lubricated operation will always be required)			
Input pressure 1		[MPa]	0.3 ... 0.4	0.7 ... 0.8	1.1 ... 1.2
		[bar]	3 ... 4	7 ... 8	11 ... 12
Max. pressure hysteresis	1/8"	[MPa]	0.001		
		[bar]	0.01		
	1/4"	[MPa]	0.005		
		[bar]	0.05		
	1/2"	[MPa]	0.005		
		[bar]	0.05		
Ambient temperature		[°C]	0 ... 50		
Temperature of medium		[°C]	0 ... 60		
Corrosion resistance class CRC ¹⁾		2 ¹⁾			
Certification		RCM compliance mark			
CE marking (see declaration of conformity)		To EU EMC Directive ²⁾			
		To EU RoHS Directive ²⁾			
UKCA marking (see declaration of conformity)		To UK instructions for EMC ²⁾			
		To UK RoHS instructions ²⁾			
KC mark		KC EMC			

1) Corrosion resistance class CRC 2 to Festo standard FN 940070

Moderate corrosion stress. Indoor applications in which condensation can occur. External visible parts with primarily decorative surface requirements which are in direct contact with a normal industrial environment.

2) For information about the area of use, see the EC declaration of conformity at: www.festo.com/catalogue/... → Support/Downloads.

If the devices are subject to usage restrictions in residential, commercial or light-industrial environments, further measures for the reduction of the emitted interference may be necessary.

Electrical data					
Pressure regulation range		[MPa]	0 ... 0.2	0 ... 0.6	0 ... 1
		[bar]	0 ... 2	0 ... 6	0 ... 10
Electrical connection		Plug, round design to DIN 45326, M16 x 0.75, 8-pin			
Operating voltage range	U_B	[V DC]	18 ... 30		
Residual ripple		10%			
Setpoint input signal	Voltage	U_w	[V DC]	0 ... 10	
	Current	I_w	[mA]	4 ... 20	
Actual value output signal	Voltage	U_x	[V DC]	0 ... 10	
	Current	I_x	[mA]	4 ... 20	
Degree of protection		IP65			
Safety remark		Safety position MPPES-B: If the setpoint cable (voltage and current variant) and the supply voltage cable break, the output pressure changes to 0 MPa.			
Reverse polarity protection		For all electrical connections			
Short circuit current rating		For all electrical connections			

Pressure range					
Pressure regulation range		[MPa]	0 ... 0.2	0 ... 0.6	0 ... 1
		[bar]	0 ... 2	0 ... 6	0 ... 10
Operating pressure		[MPa]	≤ 0.4	≤ 0.8	≤ 1.2
		[bar]	≤ 4	≤ 8	≤ 12
Input pressure 1		[MPa]	0.3 ... 0.4	0.7 ... 0.8	1.1 ... 1.2
		[bar]	3 ... 4	7 ... 8	11 ... 12
Max. pressure hysteresis	Basic version	[MPa]	0.001 ... 0.005		
		[bar]	0.01 ... 0.05		
	Special adaptation type	[bar]	-		
		[bar]	-		

Data sheet

Switching times – Basic type					
Pressure regulation range		[MPa]	0 ... 0.2	0 ... 0.6	0 ... 1
		[bar]	0 ... 2	0 ... 6	0 ... 10
Switching time on	G1/8	[ms]	220	210	200
	G1/4	[ms]	200	200	200
	G1/2	[ms]	220	230	230
Switching time off	G1/8	[ms]	410	280	220
	G1/4	[ms]	890	640	360
	G1/2	[ms]	1000	660	450

Switching times – Special adaptation type					
Pressure regulation range		[MPa]	0 ... 1		
		[bar]	0 ... 10		
Switching time on	G1/8	[ms]	220		
	G1/4	[ms]	200		
	G1/2	[ms]	230		
Switching time off	G1/8	[ms]	410		
	G1/4	[ms]	890		
	G1/2	[ms]	1000		

Information on materials	
Housing	Wrought aluminium alloy
Diaphragm	NBR
Note on materials	RoHS-compliant
PWIS conformity	VDMA24364-B2-L

Data sheet

Dimensions

Download CAD data → www.festo.com

MPPES-3-1/8-...

MPPES-3-1/4-...

MPPES-3-1/4-...

MPPES-3-1/8-...

MPPES-3-1/2-...

MPPES-3-1/2-...

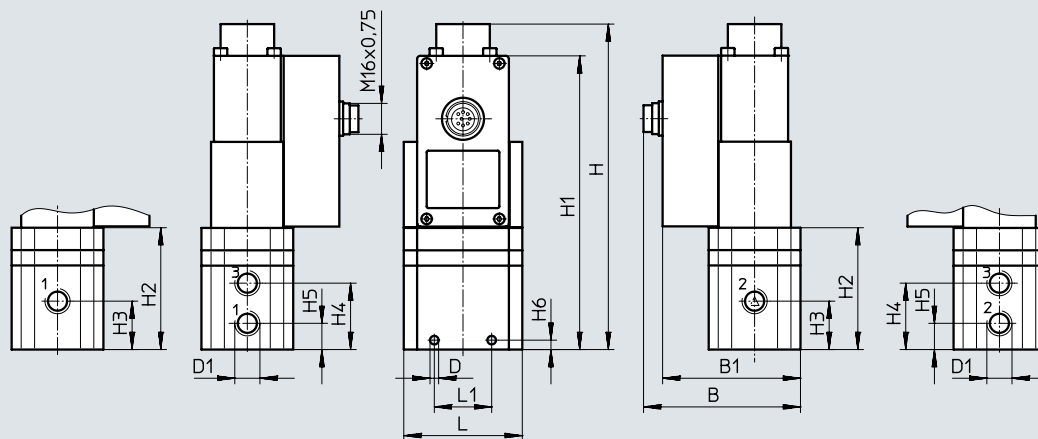

Connection D1	B	B1	øD	H	H1	H2	H3	H4	H5	H6	L	L1
G1/8	77.1	67.1	4.4	116.5	100	55	34	45	23	4	62	34
G1/4	82.1	72.1	4.5	170.2	153.7	63.7	25.3	34.8	13.8	5	62	30
G1/2	96.1	86.1	7	227.1	210.6	120.6	53	74	32	18	86	50

Connections

Terminal allocation

Switching function

MPPES-3-1/8-...

MPPES-3-1/4-.../MPPES-3-1/2-...

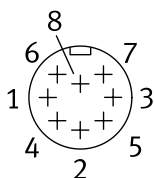

- 1 n. c.
- 2 GND
- 3 GND
- 4 W_{in} (setpoint input)
- 5 n. c.
- 6 X_{out} (actual value output)
- 7 24 V DC (supply voltage)
- 8 GND

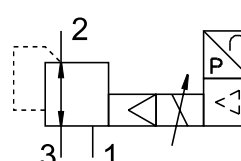
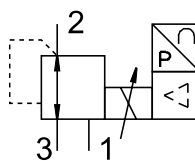



Data sheet

Ordering data						
Pneumatic connection 1, 2, 3	Pressure regulation range		Voltage type 0 ... 10 V		Current type 4 ... 20 mA	
	[MPa]	[bar]	Part no.	Type	Part no.	Type
Basic version						
G1/8	0 ... 0.2	0 ... 2	187350	MPPES-3-1/8-2-010	187351	MPPES-3-1/8-2-420
	00.6	0 ... 6	187352	MPPES-3-1/8-6-010	187353	MPPES-3-1/8-6-420
	0 ... 1	0 ... 10	187348	MPPES-3-1/8-10-010	187349	MPPES-3-1/8-10-420
G1/4	0 ... 0.2	0 ... 2	187335	MPPES-3-1/4-2-010	187336	MPPES-3-1/4-2-420
	00.6	0 ... 6	187337	MPPES-3-1/4-6-010	187338	MPPES-3-1/4-6-420
	0 ... 1	0 ... 10	187333	MPPES-3-1/4-10-010	187334	MPPES-3-1/4-10-420
G1/2	0 ... 0.2	0 ... 2	187328	MPPES-3-1/2-2-010	187329	MPPES-3-1/2-2-420
	00.6	0 ... 6	187330	MPPES-3-1/2-6-010	187331	MPPES-3-1/2-6-420
	0 ... 1	0 ... 10	187326	MPPES-3-1/2-10-010	187327	MPPES-3-1/2-10-420
Special adaptation type¹⁾						
G1/8	–	0 ... 10	187347	MPPES-3-1/8-PU-PO-010	187762	MPPES-3-1/8-PU-PO-420
G1/4	–	0 ... 10	187339	MPPES-3-1/4-PU-PO-010	187744	MPPES-3-1/4-PU-PO-420
G1/2	–	0 ... 10	187332	MPPES-3-1/2-PU-PO-010	187735	MPPES-3-1/2-PU-PO-420

1) The special adaptation type allows a lower pressure PU to be assigned to the setpoint value 0 V or 4 mA and an upper pressure PO to be assigned to the setpoint value 10 V or 20 mA.

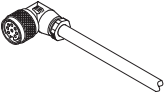
Accessories

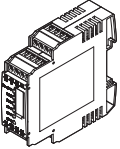
Ordering data	Description	Cable length [m]	Part no.	Type
Plug socket with cable Data sheets → Internet: kmppe-b				
	<ul style="list-style-type: none"> • Angled socket, M16x0.75, 8-pin • Open end, 8-wire 	2.5	161879	KMPPE-B-2.5
		5	161878	KMPPE-B-5
Angled plug socket Data sheets → Internet: mppe				
	<ul style="list-style-type: none"> • Angled socket, M16x0.75, 8-pin • Soldered connection, 8-pin 	–	161839	MPPE-3-B
Setpoint module Data sheets → Internet: mpz				
	Setpoint module for generating 6 + 1 analogue voltage signals	–	546224	MPZ-1-24DC-SGH-6-SW

Festo - Your Partner in Automation



1 Festo Inc.
5300 Explorer Drive
Mississauga, ON L4W 5G4
Canada

Festo Customer Interaction Center
Tel: 1 877 463 3786
Fax: 1 877 393 3786
Email: customer.service.ca@festo.com



2 Festo Pneumatic
Av. Ceylán 3,
Col. Tequesquináhuac
54020 Tlalneantla,
Estado de México

Multinational Contact Center
01 800 337 8669
ventas.mexico@festo.com



3 Festo Corporation
1377 Motor Parkway
Suite 310
Islandia, NY 11749

Festo Customer Interaction Center
1 800 993 3786
1 800 963 3786
customer.service.us@festo.com



4 Regional Service Center
7777 Columbia Road
Mason, OH 45040

Connect with us



www.festo.com/socialmedia



www.festo.com

Subject to change