

Parallel gripper HGPL-B, heavy-duty with long stroke

FESTO



Key features

At a glance

- Heavy-duty
The T-slot in combination with the long guide length allows for high forces and torques
- Space-saving
Two parallel and opposing pistons move the gripper jaws directly and without loss of force
- Position sensing
With the position transmitter SDAT every position of the gripper jaws can be sensed using an analogue signal
- Connections for lubrication nipples on the top and underneath of the gripper
- Double-acting gripper – suitable for external and internal gripping

The technology in detail

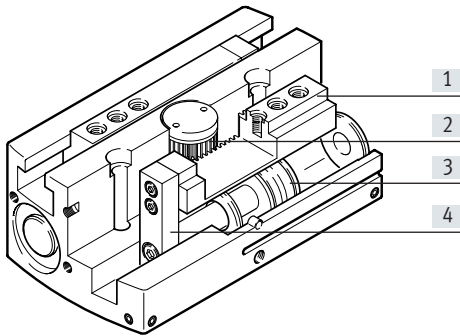

- [1] Gripper jaws
- [2] Synchronising element
- [3] Piston with magnet
- [4] Moment compensator

Note
Engineering software
Gripper selection
→ www.festo.com

Wide range of supply ports

Direct from the front

Via adapter plate from underneath

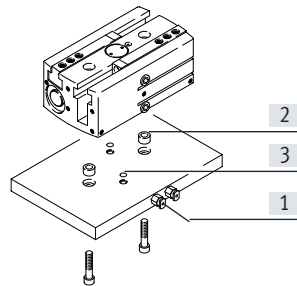
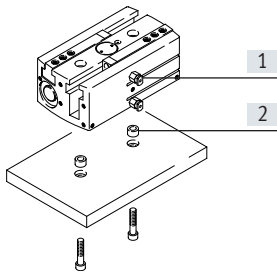

- [1] Supply ports
- [2] Centring sleeves
- [3] O-rings

Mounting options

Direct mounting from above

from underneath

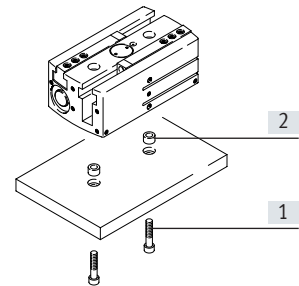
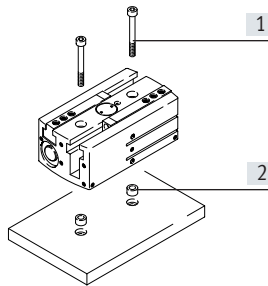

- [1] Retaining screws
- [2] Centring sleeves

Key features and type codes

Connections for lubrication nipples

Top

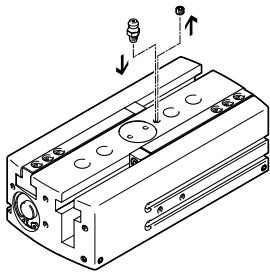

Underneath

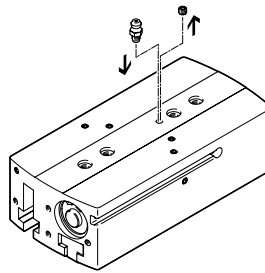

 **Note**
These grippers are not suitable for the following or similar applications:

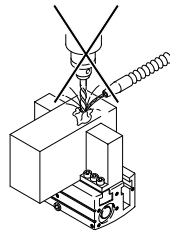

Aggressive media
Machining

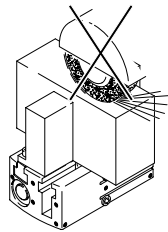

Grinding dust

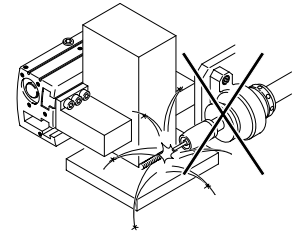

Welding spatter

Type codes

001	Series
HGPL	Parallel gripper, sturdy with long stroke

002	Size
14	14
25	25
40	40
63	63

003	Stroke per gripper jaw [mm]
20	20
40	40
60	60
80	80
100	100
150	150

004	Position sensing
A	For proximity sensor

005	Generation
B	Function-optimised

Peripherals overview

Peripherals overview

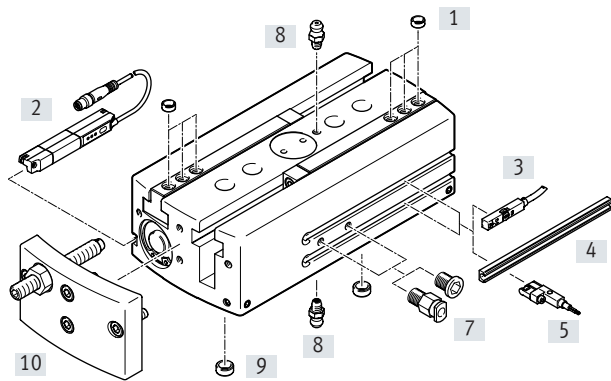

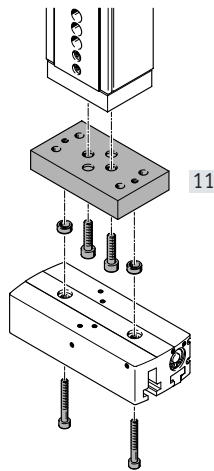

System product for handling and assembly technology

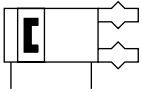
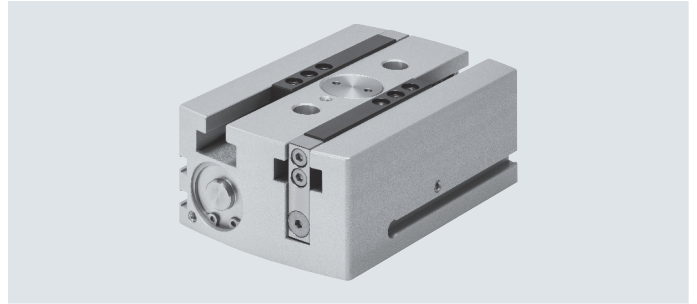

Accessories			
Type	Description		→ Page/Internet
[1] Centring sleeve ZBH	<ul style="list-style-type: none"> For centring the gripper jaw blanks/gripper fingers on the gripper jaws 4 included in the scope of delivery 		18
[2] Position transmitter SDAT, SMAT	<ul style="list-style-type: none"> For sensing the piston position at any location The position transmitter must only be inserted into this slot 		21
[3] Proximity switch SME/SMT-8	For sensing the piston position in the end positions		19
[4] Sensor rail DASP	By gluing this into the sensor slot, proximity switches SME/SMT-10 can be used		20
[5] Proximity switch SME/SMT-10	For sensing the piston position in the end positions		20
[6] Blanking plug B	For sealing the supply ports when using the ports at the front		18
[7] Push-in fitting QS	For connecting compressed air tubing with standard O.D.		qs
[8] Lubrication nipple	<ul style="list-style-type: none"> For relubricating the guide 1 included in the scope of delivery 		–
[9] Centring sleeve ZBH	<ul style="list-style-type: none"> For centring the gripper during mounting 2 included in the scope of delivery 		18
[10] Stroke reduction HGPL-HR...	For reducing the opening stroke		17
[11] Adapter kit DHAA, HMSV, HAPG, HMVA	Drive/gripper connections		15
– Gripper jaw blank BUB-HGPL	Unmachined parts specially matched to the gripper jaws for custom production of gripper fingers		18

Data sheet

www.festo.com

-  Size
14 ... 63
-  Total stroke
40 ... 300 mm

General technical data				
Size	14	25	40	63
Design	Rack and pinion			
	Twin piston, piston spool valve			
	T-shape			
Mode of operation	Double-acting			
Gripper function	Parallel			
Number of gripper jaws	2			
Stroke per gripper jaw [mm]	20, 40, 60, 80	20, 40, 60, 80	20, 40, 60, 80, 100	60, 100, 150
Pneumatic connection	M5			G1/8
Max. weight per gripper finger ¹⁾ [g]	80	250	420	940
Repetition accuracy ²⁾ [mm]	< 0.03			
Max. interchangeability [mm]	< 0.2			
Max. operating frequency [Hz]	< 1			
Rotational symmetry [mm]	< \varnothing 0.2			
Position sensing	Via proximity switch			
Type of mounting	Via through-holes and centring sleeves			
	Via female thread and centring sleeves			
Mounting position	Any			

- 1) Valid for unthrottled operation
- 2) End-position drift under constant operating conditions with 100 consecutive strokes in the direction of movement of the gripper jaws

Operating and environmental conditions	
Operating pressure [bar]	3 ... 8
Operating medium	Compressed air to ISO 8573-1:2010 [7:4:4]
Note on the operating/pilot medium	Lubricated operation possible (in which case lubricated operation will always be required)
Ambient temperature ¹⁾ [°C]	+5 ... +60
Corrosion resistance CRC ²⁾	2

- 1) Note operating range of proximity switches
- 2) Corrosion resistance class CRC 2 to Festo standard FN 940070
Moderate corrosion stress. Indoor applications in which condensation can occur. External visible parts with primarily decorative surface requirements which are in direct contact with a normal industrial environment.

Data sheet

Weights [g]					
Size		14	25	40	63
Stroke per gripper jaw	20 mm	305	1015	2560	–
	40 mm	440	1400	3300	–
	60 mm	595	1780	4165	10460
	80 mm	720	2200	4800	–
	100 mm	–	–	5340	13800
	150 mm	–	–	–	18100

Materials

Sectional view

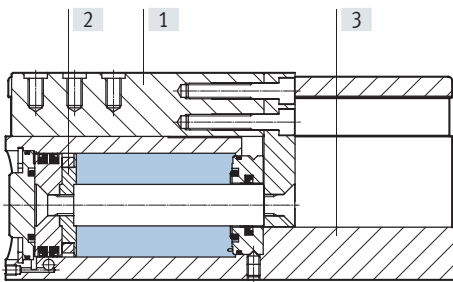

Parallel gripper		
[1]	Gripper jaw	Nitrided steel
[2]	Piston	High-alloy steel
[3]	Housing	Smooth anodised aluminium
–	Seals	NBR, polyurethane
–	Note on materials	Free of copper and PTFE RoHS-compliant

Measured gripping force [N] at 6 bar (→ also graphs starting on page 9)

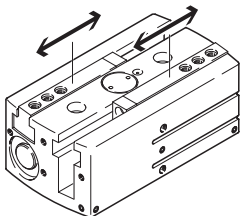

Size	14	25	40	63
Gripping force per gripper jaw				
Opening	63	206	519	1233
Closing	79	256	608	1371
Total gripping force				
Opening	126	412	1038	2466
Closing	158	512	1216	2742

Data sheet

Characteristic load values at the gripper jaws

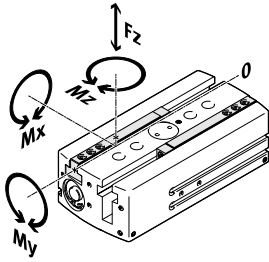

The indicated permissible forces and torques apply to a single gripper jaw. They include the lever arm, additional weight forces due to the workpiece or external gripper fingers and acceleration forces during movement.

The zero coordinate line (gripper jaw guide slot) must be taken into consideration when calculating the torques.

Size		14	25	40	63
Max. permissible force F_z	[N]	500	1500	2500	9000
Max. permissible torque M_x	[Nm]	35	100	125	300
Max. permissible torque M_y	[Nm]	35	60	80	200
Max. permissible torque M_z	[Nm]	35	70	100	250

Gripper jaw backlash

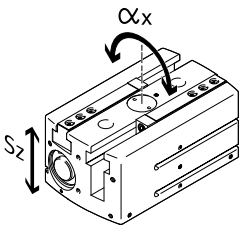

The plain-bearing guide used in the grippers means that there is backlash between the gripper jaws and the housing.

The values listed in the table apply when new

Size		14	25	40	63
Gripper jaw backlash s_z	[mm]	< 0.05			
Gripper jaw angular backlash α_x	[°]	< 0.2			

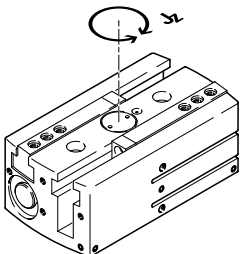
 Mass moments of inertia [$\text{kgm}^2 \times 10^{-4}$]

Mass moment of inertia of the parallel gripper in relation to the central axis, without external gripper fingers, with no load.

Size		14	25	40	63
Stroke per gripper jaw	20 mm	1.40	11.98	27.60	–
	40 mm	6.69	18.88	66.83	–
	60 mm	11.43	39.95	118.30	470.07
	80 mm	21.93	78.70	198.87	–
	100 mm	–	–	318.25	1018.17
	150 mm	–	–	–	2247.54

Data sheet

Opening and closing times [ms] at 6 bar

Without external gripper fingers

With external gripper fingers

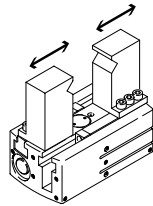
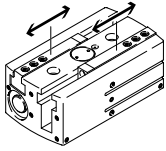

The opening and closing times [ms] given were measured at room temperature at an operating pressure of 6 bar with the gripper horizontally mounted and without additional gripper fingers. The grippers must be throttled for larger weights [g]. Opening and closing times must then be adjusted accordingly.

Size		14				25			
Stroke	[mm]	20	40	60	80	20	40	60	80

Without external gripper fingers

Opening times	120	171	270	286	170	225	370	423
Closing times	110	163	230	270	150	230	370	418

Max. permissible opening and closing times with external gripper fingers (as a function of the weight per gripper finger)

Weight of the gripper fingers	100 g	123	192	257	243	–	–	–	–
	200 g	174	272	364	343	–	–	–	–
	300 g	213	333	445	420	164	210	405	401
	400 g	246	385	514	485	190	243	468	463
	500 g	–	–	–	–	212	272	523	518

Size		40				63			
Stroke	[mm]	20	40	60	80	100	60	100	150

Without external gripper fingers

Opening times	190	238	430	414	620	410	650	1020
Closing times	180	205	430	438	690	330	600	850

Max. permissible opening and closing times with external gripper fingers (as a function of the weight per gripper finger)

Weight of the gripper fingers	500 g	196	260	469	478	676	–	–	–
	600 g	215	284	514	524	741	–	–	–
	700 g	232	307	555	565	800	–	–	–
	800 g	248	328	593	604	856	–	–	–
	900 g	–	–	–	–	–	323	587	832
	1000 g	–	–	–	–	–	340	619	877
	1100 g	–	–	–	–	–	357	649	919
	1200 g	–	–	–	–	–	373	678	960

Data sheet

Gripping force F_h per gripper jaw as a function of the operating pressure and lever arm x

The gripping forces as a function of the operating pressure and lever arm can be determined from the following graphs.

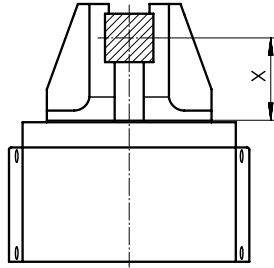

External gripping (closing)

HGPL-14

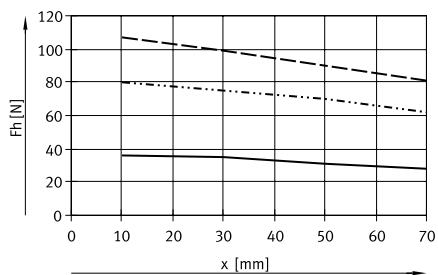

HGPL-25

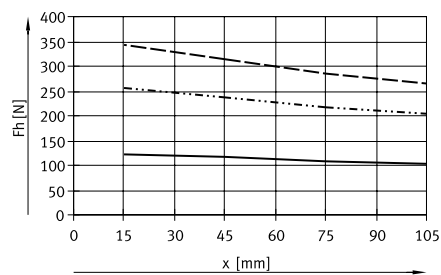

HGPL-40

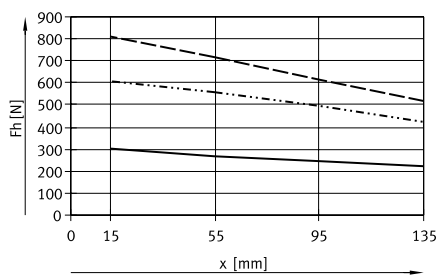

HGPL-63

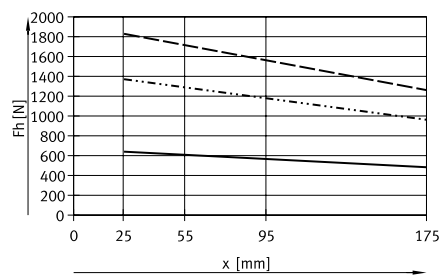

- 3 bar
- · - · - 6 bar
- - - 8 bar

Data sheet

Gripping force F_h per gripper jaw as a function of the operating pressure and lever arm x

The gripping forces as a function of the operating pressure and lever arm can be determined from the following graphs.

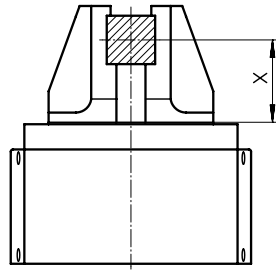

Internal gripping (opening)

HGPL-14

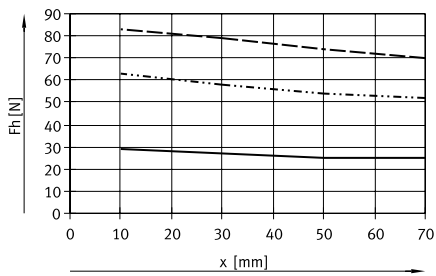

HGPL-25

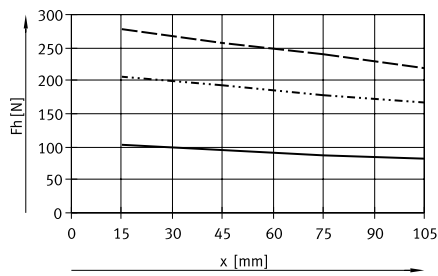

HGPL-40

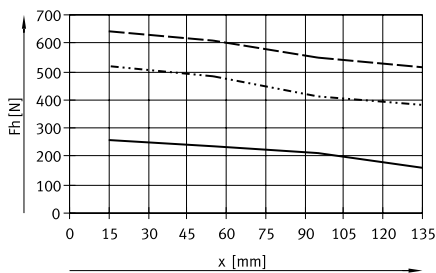

HGPL-63

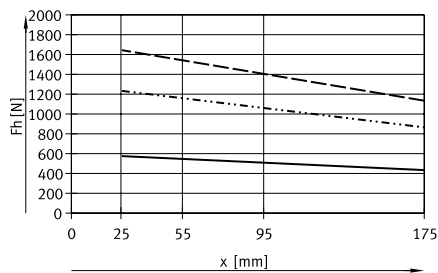

— 3 bar
 ····· 6 bar
 - - - 8 bar

Data sheet

Gripping force F_h per gripper jaw at 6 bar as a function of lever arm x and eccentricity a and b

The following formula must be used to calculate the lever arm x with eccentric gripping:

$$x = \sqrt{a^2 + b^2}$$

The gripping force F_h can be read from the graphs (→ page 9) using the calculated value x .

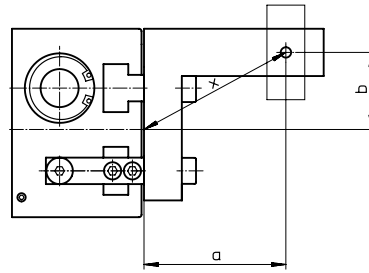

Calculation example

Given:

Distance $a = 45$ mm

Distance $b = 40$ mm

To be calculated:

The gripping force at 6 bar with an HGPL-25, used as an external gripper

Approach:

Calculating the lever arm x

$$x = \sqrt{45^2 + 40^2}$$

$x = 60$ mm

The graph (→ page 9) gives a value of $F_h = 225$ N for the gripping force.

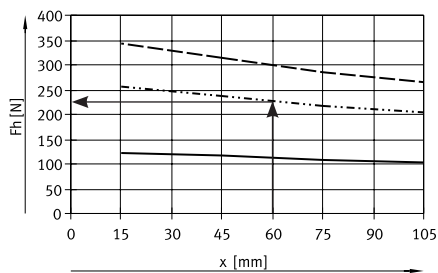

Data sheet

Dimensions

Download CAD data → www.festo.com

Size 14/25

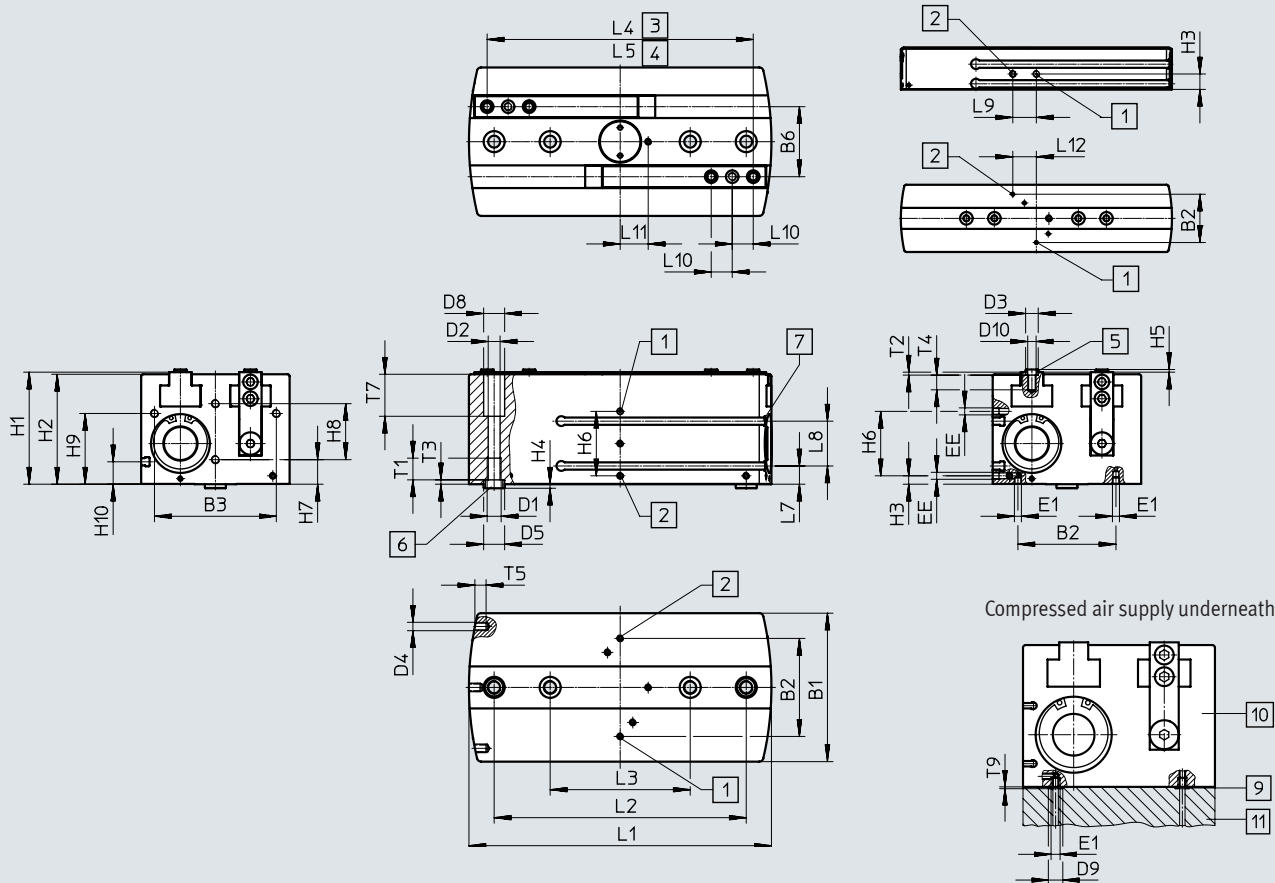

Compressed air supply underneath

- | | | |
|---|---|--|
| [1] Supply port, opening, either on the side or underneath (bottom connection sealed on delivery) | [3] Gripper jaws open | [9] O-ring for parallel gripper
HGPL-14: $\varnothing 3 \times 1.5$
HGPL-25: $\varnothing 5 \times 1.5$
HGPL-40: $\varnothing 5 \times 1.5$
HGPL-63: $\varnothing 12 \times 1.5$ |
| [2] Supply port, closing, either on the side or underneath (bottom connection sealed on delivery) | [4] Gripper jaws closed | |
| | [5] Centring sleeves ZBH
(4 included in the scope of delivery) | |
| | [6] Centring sleeves ZBH
(2 included in the scope of delivery) | [10] Gripper |
| | [7] Slot for proximity switch | [11] Bearing surface |

Data sheet

Type	B1 ±0.05	B2	B3	B6 ±0.01	D1	D2 ∅ +0.1	D3 ∅ H8/h7	D4	D5 ∅ H8/h7	D8 ∅ H13	D9	D10	EE	E1
HGPL-14	48	34.5±0.1	40±0.2	22	M5	4.2	5	M3	9	7.4	6	M3	M5	M3
HGPL-25	80	60±0.2	65±0.1	38	M6	5.1	7	M5	9	10	8	M5	M5	M5
HGPL-40	106	70±0.2	87±0.1	50	M10	8.5	9	M6	15	15	8	M6	M5	M5
HGPL-63	154	116±0.2	130±0.1	78	M12	10.4	15	M 8	15	16.5	15	M10	G1/8	G1/8

Type	H1	H2 ±0.05	H3 ±0.1	H4 -0.3	H5 -0.3	H6	H7 ±0.1	H8 ±0.1	H9 ±0.1	H10 ±0.1	L1 ±0.05	L2 ¹⁾²⁾	L3 ¹⁾²⁾	L4 ±0.5
HGPL-14-20	30	29	11	1.9	1.2	-	10	12	24.4	4	73.6	36	-	62
HGPL-14-40											113.6	60	-	102
HGPL-14-60											153.6	100	60	142
HGPL-14-80											193.6	100	60	182
HGPL-25-20	50	49	18	1.9	1.4	-	18	20	30	11	86	60	-	64
HGPL-25-40											126	60	-	104
HGPL-25-60											166	100	60	144
HGPL-25-80											206	100	60	184
HGPL-40-20	80	78.5	6	2.9	1.9	46±0.2	17.5	40	50.5	16	96	66	-	70
HGPL-40-40											136	100	-	110
HGPL-40-60											176	100	-	150
HGPL-40-80											216	180	100	190
HGPL-40-100											256	200	100	230
HGPL-63-60	121.5	120	14	2.9	2.9	60±0.1	30	58	75	28.5	190.8	100	-	160
HGPL-63-100											270	200	100	240
HGPL-63-150											370	300	100	340

Type	L5 ±0.5	L7 ±0.1	L8 ±0.1	L9	L10 ¹⁾²⁾	L11	L12 ±0.1	T1 Max.	T2 +0.1	T3 +0.1	T4 Min.	T5 Min.	T7 +0.1	T9
HGPL-14-20	22	4.2	14	16.8±0.2	8	7.5±0.1	16.8	12.5	1.3	2.1	5.5	6.5	10	1
HGPL-14-40						9±0.1								
HGPL-14-60						9±0.1								
HGPL-14-80						9±0.1								
HGPL-25-20	24	11	14	20±0.1	10	17±0.2	20	12.5	1.6	2.1	8.5	7.5	17	1
HGPL-25-40														
HGPL-25-60														
HGPL-25-80														
HGPL-40-20	30	13	32	-	15	20±0.1	-	15.5	2.1	3.1	10.5	8	30	1
HGPL-40-40											12.6			
HGPL-40-60											10.5			
HGPL-40-80											10.5			
HGPL-40-100											10.5			
HGPL-63-60	40	28.5	30	-	22	28±0.1	-	18	3.1	3.1	17.5	12	45	1
HGPL-63-100														
HGPL-63-150														

- 1) ±0.02 for centring
2) ±0.1 for through-hole

Data sheet

Ordering data			
Size	Stroke [mm]	Part no.	Type
14			
	20	3361479	HGPL-14-20-A-B
	40	3361480	HGPL-14-40-A-B
	60	3361481	HGPL-14-60-A-B
	80	3361482	HGPL-14-80-A-B
25			
	20	3361483	HGPL-25-20-A-B
	40	3361484	HGPL-25-40-A-B
	60	3361485	HGPL-25-60-A-B
	80	3361486	HGPL-25-80-A-B
40			
	20	3361487	HGPL-40-20-A-B
	40	3361488	HGPL-40-40-A-B
	60	3361489	HGPL-40-60-A-B
	80	3361490	HGPL-40-80-A-B
	100	3361491	HGPL-40-100-A-B
63			
	60	3361492	HGPL-63-60-A-B
	100	3361493	HGPL-63-100-A-B
	150	3361494	HGPL-63-150-A-B



Accessories

Adapter kit
DHAA, HAPG, HMSV, HMVA

Material:
Wrought aluminium alloy
Free of copper and PTFE
RoHS-compliant

 **Note**
The kit includes the individual mounting interface as well as the necessary mounting material.

Download CAD data → www.festo.com

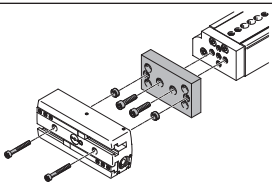
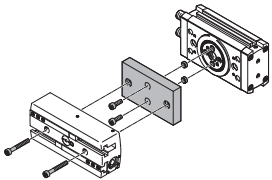
Permissible drive/gripper combinations with adapter kit								
Combination	Drive Size	Gripper Size	Mounting option		Adapter kit			
					KBK ¹⁾	Part no.	Type	
	DGSL	HGPL			2	DHAA, HAPG		
	16	14-20	■	■			2406159	DHAA-G-G6-16-B6-14
	20, 25	14-20	■	■			2410181	DHAA-G-G6-20-B6-14
	16	14-40, 14-60, 14-80	■	■			538055	HAPG-89
	20, 25	14-40, 14-60, 14-80	■	■			539274	HAPG-90
25	25	■	■	539274	HAPG-90			
	16	14-20	■	■	2	DHAA, HAPG		
	16	14-40	■	■			2019271	DHAA-G-Q11-16-B6-14-20
	16	14-60, 14-80	■	■			2019618	DHAA-G-Q11-16-B6-14-40
	20	14-20	■	■			2019640	DHAA-G-Q11-16-B6-14-60/80
	20	14-40	■	■			2018509	DHAA-G-Q11-20-B6-14-20
	20	14-60, 14-80	■	■			2018553	DHAA-G-Q11-20-B6-14-40
	25	14-20	■	■			2018986	DHAA-G-Q11-20-B6-14-60/80
	25	14-40	■	■			1813646	DHAA-G-Q11-25-B6-14-20
	25	14-60, 14-80	■	■			1734087	DHAA-G-Q11-25-B6-14-40
	25	25-20, 25-40	■	■			2018453	DHAA-G-Q11-25-B6-14-6 0/80
	25	25-60, 25-80	■	■			1794882	DHAA-G-Q11-25-B6-25-20/40
	32	25-20, 25-40	■	■			2020149	DHAA-G-Q11-25-B6-25-60/80
	32	25-60, 25-80	■	■			2021733	DHAA-G-Q11-32-B6-25-20/40
	35	25-20, 25-40	■	■			2022377	DHAA-G-Q11-32-B6-25-60/80
	35	25-60, 25-80	■	■			2022892	DHAA-G-Q11-35-B6-25-20/40
	35, 40	40-20	■	■			2023095	DHAA-G-Q11-35-B6-25-60/80
	35, 40	40-40, 40-60	■	■			2023665	DHAA-G-Q11-35/40-B6-40-20
	35, 40	40-80, 40-100	■	■			2024121	DHAA-G-Q11-35/40-B6-40-40/60
	50	40-20	■	■			2024947	DHAA-G-Q11-35/40-B6-40-80/100
	50	40-40, 40-60, 40-80, 40-100	■	■			2387903	DHAA-G-Q11-50-B6-40-20
50	63-60, 63-100, 63-150	■	■	2431288	DHAA-G-Q11-50-B6-40-40/60/80/100			
				2431624	DHAA-G-Q11-50-B6-63-60/100/150			

1) Corrosion resistance class CRC 2 to Festo standard FN 940070

Moderate corrosion stress. Indoor applications in which condensation can occur. External visible parts with primarily decorative surface requirements which are in direct contact with a normal industrial environment.

Accessories

Adapter kit
DHAA, HAPG



Material:
Wrought aluminium alloy
Free of copper and PTFE
RoHS-compliant

 **Note**

The kit includes the individual mounting interface as well as the necessary mounting material.

Permissible drive/gripper combinations with adapter kit

Download CAD data → www.festo.com

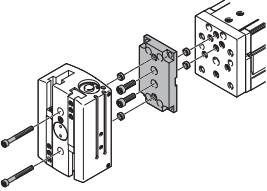
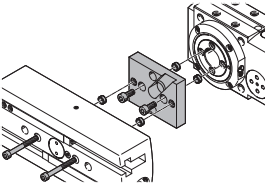
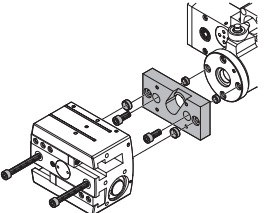
Combination	Drive Size	Gripper Size	Mounting option		Adapter kit		
					KBK ¹⁾	Part no.	Type
EGSL/HGPL	EGSL	HGPL			DHAA, HAPG		
	45, 55	14-20	■	■	2	2406159	DHAA-G-G6-16-B6-14
	75	14-20	■	■		2410181	DHAA-G-G6-20-B6-14
	45, 55	14-40, 14-60, 14-80	■	■		538055	HAPG-89
	75	14-40, 14-60, 14-80	■	■		539274	HAPG-90
	75	25	■	■		539274	HAPG-90
ERMB/HGPL	ERMB	HGPL			HAPG		
	20	14-40, 14-60, 14-80	■	■	2	537310	HAPG-SD2-31
	25, 32	25	■	■		537311	HAPG-SD2-29
EHMB/HGPL	EHMB	HGPL			DHAA, HAPG		
	25	40-20	■	■	2	2436852	DHAA-G-H2-25-B6-40
	20	25	■	■		537311	HAPG-SD2-29
	25	40-40, 40-60, 40-80, 40-100	■	■		537312	HAPG-SD2-30

1) Corrosion resistance class CRC 2 to Festo standard FN 940070

Moderate corrosion stress. Indoor applications in which condensation can occur. External visible parts with primarily decorative surface requirements which are in direct contact with a normal industrial environment.

Accessories

Stroke reduction HGPL-HR

Material:
Aluminium
Free of copper and PTFE

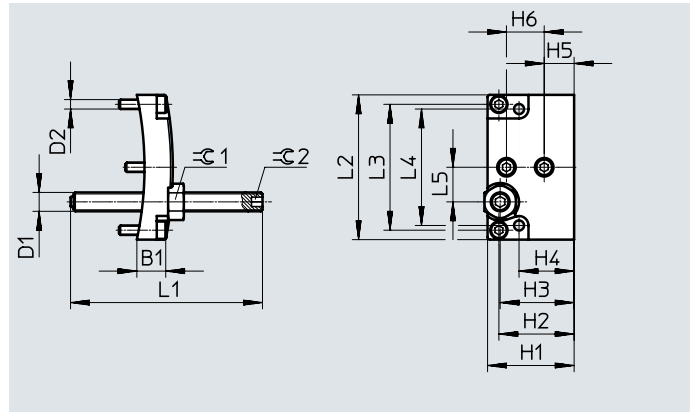

Dimensions and ordering data

For size	B1	D1	D2	H1	H2	H3	H4	H5	H6
	±0.1			±0.1	±0.1	±0.1	±0.1	±0.1	±0.1
14	9	M6	M3	27.5	23.9	23.5	17.5	9.5	12
25	12	M 8	M5	47.5	-	37.5	29.5	17.5	20
40	18	M12	M6	77	-	63	50	17	40
63	19	M14	M 8	118.5	-	94.5	74.5	29.5	58

For size	L1	L2	L3	L4	L5	⌀C1	⌀C2	Weight	Part no.	Type
	±1	±0.1	±0.1	±0.1	±0.1			[g]		
14	61	46	40	37	11	10	3	45	539092	HGPL-HR-14
25	61	77	-	65	19	13	4	150	539093	HGPL-HR-25
40	61	103	-	87	25	19	6	455	539094	HGPL-HR-40
63	81	151	-	130	39	22	6	1060	567831	HGPL-HR-63

Accessories

Gripper jaw blank BUB-HGPL

(2 included in the scope of delivery)

Material:

Aluminium

Free of copper and PTFE

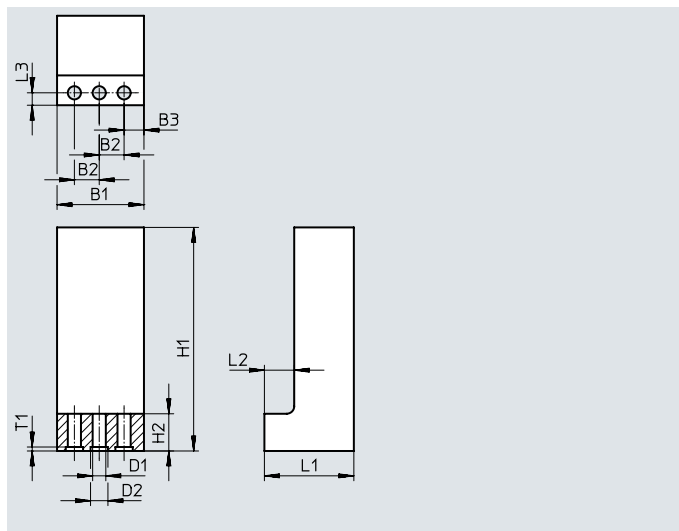

Dimensions and ordering data

For size	B1	B2	B3	D1 ∅	D2 ∅	H1	H2
	±0.1	+0.02		+0.1	H8	±0.1	
14	25	8	4	3.2	5	80	11
25	35	10	8	5.3	7	120	15
40	50	15	10	6.4	9	150	18
63	68	22	12	10.5	15	200	20



For size	L1	L2	L3	T1	Weight per blank [g]	Part no.	Type
	±0.1	+0.1	+0.1	+0.1			
14	20.5	8	3.3	1.3	75	537316	BUB-HGPL-14
25	36	12	5	1.6	295	537317	BUB-HGPL-25
40	49.5	16.5	8	2.1	720	537318	BUB-HGPL-40
63	77	27	12	3.1	1960	567830	BUB-HGPL-63

Ordering data

	For size [mm]	Weight [g]	Part no.	Type	PE ¹⁾
Centring sleeve for the gripper jaws ZBH Data sheets → Internet: zbh					
	14	1	8146543	ZBH-5-B	10
	25	1	8146544	ZBH-7-B	
	40	1	8137184	ZBH-9-B	
	63	3	191409	ZBH-15	
Centring sleeve for the gripper ZBH Data sheets → Internet: zbh					
	14, 25	1	8137184	ZBH-9-B	10
	40, 63	3	191409	ZBH-15	
Blanking plug B Data sheets → Internet: blanking plug					
	14, 25, 40	2	174308	B-M5-B	10
	63	5	3568	B-1/8	

1) Packaging unit

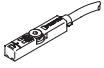
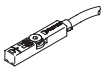
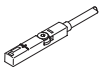
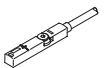
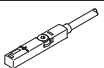
Accessories

Ordering data – Proximity switch for T-slot, magneto-resistive							Data sheets → Internet: smt
	Type of mounting	Electrical connection outlet direction of connection	Switching output	Cable length [m]	Part no.	Type	
N/O contact							
	Inserted in the slot from above, short design	Cable, 3-wire, in-line	PNP	2.5	574335	SMT-8M-A-PS-24V-E-2,5-OE	
		Plug M8x1, 3-pin, in-line		0.3	574334	SMT-8M-A-PS-24V-E-0,3-M8D	
		Plug M12x1, 3-pin, in-line		0.3	574337	SMT-8M-A-PS-24V-E-0,3-M12	
		Cable, 3-wire, in-line	NPN	2.5	574338	SMT-8M-A-NS-24V-E-2,5-OE	
		Plug M8x1, 3-pin, in-line		0.3	574339	SMT-8M-A-NS-24V-E-0,3-M8D	
N/C contact							
	Inserted in the slot from above, short design	Cable, 3-wire, in-line	PNP	7.5	574340	SMT-8M-A-PO-24V-E-7,5-OE	
Ordering data – Proximity switches for T-slot, magnetic reed							Data sheets → Internet: sme
	Type of mounting	Electrical connection outlet direction of connection	Switching output	Cable length [m]	Part no.	Type	
N/O contact							
	Insertable in the slot from above	Cable, 3-wire, in-line	Contact- ing	2.5	543862	SME-8M-DS-24V-K-2,5-OE	
		Cable, 2-wire, in-line		5.0	543863	SME-8M-DS-24V-K-5,0-OE	
		Plug M8x1, 3-pin, in-line		2.5	543872	SME-8M-ZS-24V-K-2,5-OE	
		Plug M8x1, 3-pin, in-line		0.3	543861	SME-8M-DS-24V-K-0,3-M8D	
	Inserted in the slot lengthwise	Cable, 3-wire, in-line		2.5	150855	SME-8-K-LED-24	
		Plug M8x1, 3-pin, in-line		0.3	150857	SME-8-S-LED-24	
N/C contact							
	Inserted in the slot lengthwise	Cable, 3-wire, in-line	Contact- ing	7.5	160251	SME-8-O-K-LED-24	
Ordering data – Proximity switch for T-slot, magneto-resistive							Data sheets → Internet: smt
	Type of mounting	Electrical connection, outlet direction of connection	Switching output	Cable length [m]	Part no.	Type	
N/O contact							
	Inserted in the slot lengthwise	Cable, 3-wire, crosswise	PNP	2.5	547859	SMT-8G-PS-24V-E-2,5Q-OE	
		Plug M8x1, 3-pin, crosswise		0.3	547860	SMT-8G-PS-24V-E-0,3Q-M8D	

Accessories

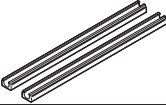

Ordering data	Description	Weight [g]	Part no.	Type	PE ¹⁾
Sensor rail for using the proximity switch SME/SMT-10					
	<ul style="list-style-type: none"> For a gripper stroke of max. 60 mm To be glued into the slot 	6	3528767	DASP-B6-60-C-SR	2
	<ul style="list-style-type: none"> For a gripper stroke of max. 80 mm To be glued into the slot 	8	3528768	DASP-B6-80-C-SR	

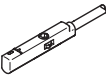
1) Packaging unit

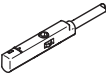
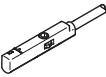
Ordering data – Proximity switches for C-slot, magneto-resistive							Data sheets → Internet: smt
	Type of mounting	Electrical connection, outlet direction of connection	Switching output	Cable length [m]	Part no.	Type	
N/O contact							
	Insertable in the slot from above	Cable, 3-wire, in-line	PNP	2.5	551373	SMT-10M-PS-24V-E-2,5-L-OE	
		Plug M8x1, 3-pin, in-line		0.3	551375	SMT-10M-PS-24V-E-0,3-L-M8D	
		Cable, 3-wire, crosswise		2.5	551374	SMT-10M-PS-24V-E-2,5-Q-OE	
		Plug M8x1, 3-pin, crosswise		0.3	551376	SMT-10M-PS-24V-E-0,3-Q-M8D	

Ordering data – Proximity switches for C-slot, magnetic reed							Data sheets → Internet: sme
	Type of mounting	Electrical connection, outlet direction of connection	Switching output	Cable length [m]	Part no.	Type	
N/O contact							
	Insertable in the slot from above	Cable, 3-wire, in-line	Contacting	2.5	551365	SME-10M-DS-24V-E-2,5-L-OE	
		Plug M8x1, 3-pin, in-line		0.3	551367	SME-10M-DS-24V-E-0,3-L-M8D	
		Cable, 3-wire, crosswise		2.5	551366	SME-10M-DS-24V-E-2,5-Q-OE	
		Plug M8x1, 3-pin, crosswise		0.3	551368	SME-10M-DS-24V-E-0,3-Q-M8D	
	Inserted in the slot lengthwise	Cable, 3-wire, in-line		2.5	173210	SME-10-KL-LED-24	
		Plug M8x1, 3-pin, in-line		0.3	173212	SME-10-SL-LED-24	

Ordering data – Proximity switch for C-slot, magneto-resistive							Data sheets → Internet: smt
	Type of mounting	Electrical connection, outlet direction of connection	Switching output	Cable length [m]	Part no.	Type	
N/O contact							
	Inserted in the slot lengthwise	Cable, 3-wire, crosswise	PNP	2.5	547862	SMT-10G-PS-24V-E-2,5Q-OE	
		Plug M8x1, 3-pin, crosswise		0.3	547863	SMT-10G-PS-24V-E-0,3Q-M8D	

Ordering data – Connecting cables							Data sheets → Internet: nebu
	Electrical connection, left	Electrical connection, right	Cable length [m]	Part no.	Type		
	Straight socket, M8x1, 3-pin	Cable, open end, 3-wire	2.5	541333	NEBU-M8G3-K-2.5-LE3		
			5	541334	NEBU-M8G3-K-5-LE3		
	Straight socket, M12x1, 5-pin	Cable, open end, 3-wire	2.5	541363	NEBU-M12G5-K-2.5-LE3		
			5	541364	NEBU-M12G5-K-5-LE3		
	Angled socket, M8x1, 3-pin	Cable, open end, 3-wire	2.5	541338	NEBU-M8W3-K-2.5-LE3		
			5	541341	NEBU-M8W3-K-5-LE3		
	Angled socket, M12x1, 5-pin,	Cable, open end, 3-wire	2.5	541367	NEBU-M12W5-K-2.5-LE3		
			5	541370	NEBU-M12W5-K-5-LE3		

Accessories

Position transmitter

The position transmitter continuously senses the position of the piston.
It has an analogue output with an output signal in proportion to the piston position.

Ordering data – Position transmitter for T-slot

Data sheets → Internet: position transmitters

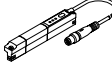
	Position measuring range	Analogue output		Type of mounting	Electrical connection	Cable length [m]	Part no.	Type
		[V]	[mA]					
	0 ... 50	–	0 ... 20	Insertable in the slot from above	Plug M8x1, 4-pin, in-line	0.3	1531265	SDAT-MHS-M50-1L-SA-E-0.3-M8
	0 ... 80						1531266	SDAT-MHS-M80-1L-SA-E-0.3-M8
	0 ... 100						1531267	SDAT-MHS-M100-1L-SA-E-0.3-M8
	0 ... 125						1531268	SDAT-MHS-M125-1L-SA-E-0.3-M8
	0 ... 160						1531269	SDAT-MHS-M160-1L-SA-E-0.3-M8

Ordering data – Position transmitter for T-slot

Data sheets → Internet: position transmitters

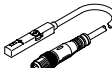
	Position measuring range	Analogue output		Type of mounting	Electrical connection	Cable length [m]	Part no.	Type
		[V]	[mA]					
	0 ... 40	0 ... 10		Insertable in the slot from above	Plug M8x1, 4-pin, in-line	0.3	553744	SMAT-8M-U-E-0,3-M8D

Ordering data – Connecting cables

Data sheets → Internet: nebu

	Electrical connection, left	Electrical connection, right	Cable length [m]	Part no.	Type
	5	541343	NEBU-M8G4-K-5-LE4		
	Angled socket, M8x1, 4-pin	Cable, open end, 4-wire	2.5	541344	NEBU-M8W4-K-2.5-LE4
			5	541345	NEBU-M8W4-K-5-LE4

Festo - Your Partner in Automation



1 Festo Inc.
5300 Explorer Drive
Mississauga, ON L4W 5G4
Canada

Festo Customer Interaction Center
Tel: 1 877 463 3786
Fax: 1 877 393 3786
Email: customer.service.ca@festo.com



2 Festo Pneumatic
Av. Ceylán 3,
Col. Tequesquináhuac
54020 Tlalneantla,
Estado de México

Multinational Contact Center
01 800 337 8669
ventas.mexico@festo.com



3 Festo Corporation
1377 Motor Parkway
Suite 310
Islandia, NY 11749

Festo Customer Interaction Center
1 800 993 3786
1 800 963 3786
customer.service.us@festo.com



4 Regional Service Center
7777 Columbia Road
Mason, OH 45040

Connect with us



www.festo.com/socialmedia



www.festo.com

Subject to change