

Service units FRC/FRCS, D series

FESTO

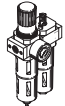

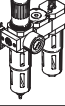

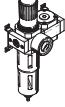
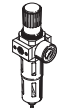
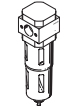
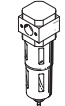
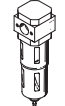
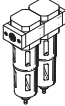
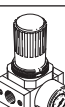

Product range overview – Service unit components, D series, metal

Type	Size	Pneumatic connection										Pressure regulation range [bar]			Grade of filtration [µm]			
		M5	M7	G1/8	G1/4	G3/8	G1/2	G3/4	G1	QS4	QS6	0.5 ...	0.5 ...	2.5 ...	0.01	1	5	40
Service units																		
FRC/FRCS 	Mini	-	-	■	■	■	-	-	-	-	-	■	■	-	-	-	■	■
	Midi	-	-	-	■	■	■	■	-	-	-	■	■	-	-	-	■	■
	Maxi	-	-	-	-	-	■	■	■	-	-	■	■	-	-	-	■	■
FRC-K 	Micro	-	-	-	-	-	-	-	-	-	-	-	-	-	-	-	-	
	Mini	-	-	■	■	-	-	-	-	-	-	■	■	-	-	-	-	■
	Midi	-	-	-	■	■	■	-	-	-	-	■	■	-	-	-	-	■
	Maxi	-	-	-	-	-	■	■	-	-	-	■	■	-	-	-	-	■
LFR-K 	Micro	-	-	-	-	-	-	-	-	-	-	-	-	-	-	-	-	
	Mini	-	-	■	■	-	-	-	-	-	-	■	■	-	-	-	-	■
	Midi	-	-	-	■	■	■	-	-	-	-	■	■	-	-	-	-	■
	Maxi	-	-	-	-	-	■	■	-	-	-	■	■	-	-	-	-	■
Individual devices																		
Filter regulators LFR/LFRS 	Mini	-	-	■	■	■	-	-	-	-	-	■	■	-	-	-	■	■
	Midi	-	-	-	■	■	■	■	-	-	-	■	■	-	-	-	■	■
	Maxi	-	-	-	-	-	■	■	■	-	-	■	■	-	-	-	■	■
Filters LF 	Mini	-	-	■	■	■	-	-	-	-	-	-	-	-	-	-	■	■
	Midi	-	-	-	■	■	■	■	-	-	-	-	-	-	-	-	■	■
	Maxi	-	-	-	-	-	■	■	■	-	-	-	-	-	-	-	■	■
Fine and micro filters LFMA/LFMB 	Micro	-	-	-	-	-	-	-	-	-	-	-	-	-	-	-	-	
	Mini	-	-	■	■	■	-	-	-	-	-	-	-	-	■	■	-	-
	Midi	-	-	-	■	■	■	■	-	-	-	-	-	-	■	■	-	-
	Maxi	-	-	-	-	-	■	■	■	-	-	-	-	-	■	■	-	-
Activated carbon filters LFX 	Micro	-	-	-	-	-	-	-	-	-	-	-	-	-	-	-	-	
	Mini	-	-	■	■	■	-	-	-	-	-	-	-	-	-	-	-	-
	Midi	-	-	-	■	■	■	■	-	-	-	-	-	-	-	-	-	-
Filter combinations LFMBA 	Micro	-	-	-	-	-	-	-	-	-	-	-	-	-	-	-	-	
	Mini	-	-	■	■	■	-	-	-	-	-	-	-	-	■	■	-	-
	Midi	-	-	-	■	■	■	■	-	-	-	-	-	-	■	■	-	-
Pressure regulators LRL/LRS 	Mini	-	-	■	■	■	-	-	-	-	-	■	■	-	-	-	-	-
	Midi	-	-	-	■	■	■	■	-	-	-	■	■	-	-	-	-	-
	Maxi	-	-	-	-	-	■	■	■	-	-	■	■	-	-	-	-	-

Product range overview – Service unit components, D series, metal

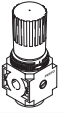
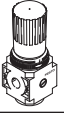
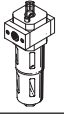
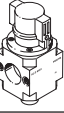
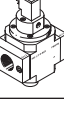
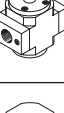
Type	Size	Bowl guard		Condensate drain			Pressure indication		Actuator lock		Supply voltage			Options			→ Page/ Internet
		Metal bowl guard	Plastic bowl	Manual, rotary	Semi-automatic	Fully automatic	With pressure gauge	Without pressure gauge	Rotary knob with latch	Rotary knob with integrated lock	24 V DC	110 V AC	230 V AC	Directly actuated pressure regulator with integrated return flow function	Pilot actuated pressure regulator with integrated return flow function	Differential pressure display	
Service units																	
FRC/FRCS	Mini	■	-	■	-	■	■	■	■	■	-	-	-	-	-	-	6
	Midi	■	-	■	-	■	■	■	■	■	-	-	-	-	-	-	
	Maxi	■	-	■	-	■	■	■	■	■	-	-	-	■	■	-	
FRC-K	Micro	-	-	-	-	-	-	-	-	-	-	-	-	-	-	-	frc
	Mini	■	-	■	-	■	■	-	■	-	■	-	-	-	-	-	
	Midi	■	-	■	-	■	■	-	■	-	■	-	-	-	-	-	
	Maxi	■	-	■	-	■	■	-	■	-	■	-	-	■	■	-	
LFR-K	Micro	-	-	-	-	-	-	-	-	-	-	-	-	-	-	-	lfr
	Mini	■	-	■	-	■	■	-	■	■	■	-	-	-	-	-	
	Midi	■	-	■	-	■	■	-	■	■	■	-	-	-	-	-	
	Maxi	■	-	■	-	■	■	-	■	■	■	-	-	■	■	-	
Individual devices																	
Filter regulators LFR/LFRS	Mini	■	-	■	-	■	■	■	■	■	-	-	-	-	-	-	lfr
	Midi	■	-	■	-	■	■	■	■	■	-	-	-	-	-	-	
	Maxi	■	-	■	-	■	■	■	■	■	-	-	-	■	■	-	
Filters LF	Mini	■	-	■	-	■	-	-	-	-	-	-	-	-	-	-	lf
	Midi	■	-	■	-	■	-	-	-	-	-	-	-	-	-	-	
	Maxi	■	-	■	-	■	-	-	-	-	-	-	-	-	-	-	
Fine and micro filters LFMA/LFMB	Micro	-	-	-	-	-	-	-	-	-	-	-	-	-	-	-	lfma, lfmb
	Mini	■	-	■	-	■	-	-	-	-	-	-	-	-	-	■	
	Midi	■	-	■	-	■	-	-	-	-	-	-	-	-	-	■	
	Maxi	■	-	■	-	■	-	-	-	-	-	-	-	-	-	■	
Activated carbon filters LFX	Micro	-	-	-	-	-	-	-	-	-	-	-	-	-	-	-	lfx
	Mini	■	-	-	-	-	-	-	-	-	-	-	-	-	-	-	
	Midi	■	-	-	-	-	-	-	-	-	-	-	-	-	-	-	
	Maxi	■	-	-	-	-	-	-	-	-	-	-	-	-	-	-	
Filter combinations LFMBA	Micro	-	-	-	-	-	-	-	-	-	-	-	-	-	-	-	lfmba
	Mini	■	-	■	-	■	-	-	-	-	-	-	-	-	-	■	
	Midi	■	-	■	-	■	-	-	-	-	-	-	-	-	-	■	
	Maxi	■	-	■	-	■	-	-	-	-	-	-	-	-	-	■	
Pressure regulators LR/LRS	Mini	-	-	-	-	-	■	■	■	■	-	-	-	■	-	-	lr
	Midi	-	-	-	-	-	■	■	■	■	-	-	-	■	-	-	
	Maxi	-	-	-	-	-	■	■	■	■	-	-	-	■	■	-	

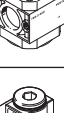
Product range overview – Service unit components, D series, metal

Type	Size	Pneumatic connection										Pressure regulation range [bar]		
		M5	M7	G1/8	G1/4	G3/8	G1/2	G3/4	G1	QS4	QS6	0.5 ... 7	0.5 ... 12	
Individual devices														
Pressure regulators LRB/LRBS		Micro	–											
		Mini	–	–	–	■	–	–	–	–	–	–	■	■
		Midi	–	–	–	–	■	–	–	–	–	–	■	■
		Maxi	–											
Pressure regulator manifolds LRB-K		Micro	–											
		Mini	–	–	–	■	■	–	–	–	–	–	■	■
		Midi	–	–	–	–	■	■	–	–	–	–	■	■
		Maxi	–											
Lubricators LOE		Mini	–	–	■	■	■	–	–	–	–	–	–	
		Midi	–	–	–	■	■	■	■	–	–	–	–	
		Maxi	–	–	–	–	–	■	■	■	–	–	–	
On/off valves HE		Micro	–											
		Mini	–	–	■	■	■	–	–	–	–	–	–	
		Midi	–	–	–	■	■	■	■	–	–	–	–	
		Maxi	–	–	–	–	–	■	■	■	–	–	–	
On/off valves HEE		Micro	–											
		Mini	–	–	■	■	■	–	–	–	–	–	–	
		Midi	–	–	–	■	■	■	■	–	–	–	–	
		Maxi	–	–	–	–	–	■	■	■	–	–	–	
On/off valves HEP		Micro	–											
		Mini	–	–	■	■	■	–	–	–	–	–	–	
		Midi	–	–	–	■	■	■	■	–	–	–	–	
		Maxi	–	–	–	–	–	■	■	■	–	–	–	
Soft-start valves HEL		Micro	–											
		Mini	–	–	■	■	■	–	–	–	–	–	–	
		Midi	–	–	–	■	■	■	■	–	–	–	–	
		Maxi	–	–	–	–	–	■	■	■	–	–	–	
Membrane air dryers LDM1		Micro	–											
		Mini	–											
		Midi	–											
		Maxi	–	–	–	–	–	■	■	■	–	–	–	
Branching modules FRM		Micro	–											
		Mini	–	–	■	■	■	–	–	–	–	–	–	
		Midi	–	–	–	■	■	■	■	–	–	–	–	
		Maxi	–	–	–	–	–	■	■	■	–	–	–	
Distributor block FRZ		Mini	–	–	–	–	–	–	–	–	–	–	–	
		Midi	–	–	–	–	–	–	–	–	–	–	–	
		Maxi	–	–	–	–	–	–	–	–	–	–	–	

Product range overview – Service unit components, D series, metal

Type	Size	Bowl guard		Pressure indication		Actuator lock		Supply voltage			Options		→ Page/ Internet	
		Metal bowl guard	Plastic bowl	With pressure gauge	Without pressure gauge	Rotary knob with latch	Rotary knob with integrated lock	24 V DC	110 V AC	230 V AC	With non-return function	Pressure switch		
Individual devices														
Pressure regulators LRB/LRBS	Micro	-				■	■	■	-	-	-	-	-	lrb
	Mini	-	-	-	■	■	■	-	-	-	-	-	-	
	Midi	-	-	-	■	■	■	-	-	-	-	-	-	
	Maxi	-	-											
Pressure regulator manifolds LRB-K	Micro	-												lrb
	Mini	-	-	-	■	■	-	-	-	-	-	-	-	
	Midi	-	-	-	■	■	-	-	-	-	-	-	-	
	Maxi	-	-											
Lubricators LOE	Mini	■	-	-	■	-	-	-	-	-	-	-	-	loe
	Midi	■	-	-	■	-	-	-	-	-	-	-	-	
	Maxi	■	-	-	■	-	-	-	-	-	-	-	-	
On/off valves HE	Micro	-												he
	Mini	-	-	-	■	■	-	-	-	-	-	-	-	
	Midi	-	-	-	■	■	-	-	-	-	-	-	-	
	Maxi	-	-	-	■	■	-	-	-	-	-	-	-	
On/off valves HEE	Micro	-												hee
	Mini	-	-	-	■	-	-	■	■	■	-	-	-	
	Midi	-	-	-	■	-	-	■	■	■	-	-	-	
	Maxi	-	-	-	■	-	-	■	■	■	-	-	-	
On/off valves HEP	Micro	-												hep
	Mini	-	-	-	■	-	-	-	-	-	-	-	-	
	Midi	-	-	-	■	-	-	-	-	-	-	-	-	
	Maxi	-	-	-	■	-	-	-	-	-	-	-	-	
Soft-start valves HEL	Micro	-												hel
	Mini	-	-	-	■	-	-	-	-	-	-	-	-	
	Midi	-	-	-	■	-	-	-	-	-	-	-	-	
	Maxi	-	-	-	■	-	-	-	-	-	-	-	-	
Membrane air dryers LDM1	Micro	-												ldm1
	Mini	-												
	Midi	-												
	Maxi	■	-	-	■	-	-	-	-	-	-	-	-	
Branching modules FRM	Micro	-												frm
	Mini	-	-	-	■	-	-	-	-	-	■	■		
	Midi	-	-	-	■	-	-	-	-	-	■	■		
	Maxi	-	-	-	■	-	-	-	-	-	■	■		
Distributor block FRZ	Mini	-	-	-	■	-	-	-	-	-	-	-	-	frz
	Midi	-	-	-	■	-	-	-	-	-	-	-	-	
	Maxi	-	-	-	■	-	-	-	-	-	-	-	-	

Peripherals overview

Mini/Midi/Maxi

Service unit FRC

Service unit FRCS, lockable

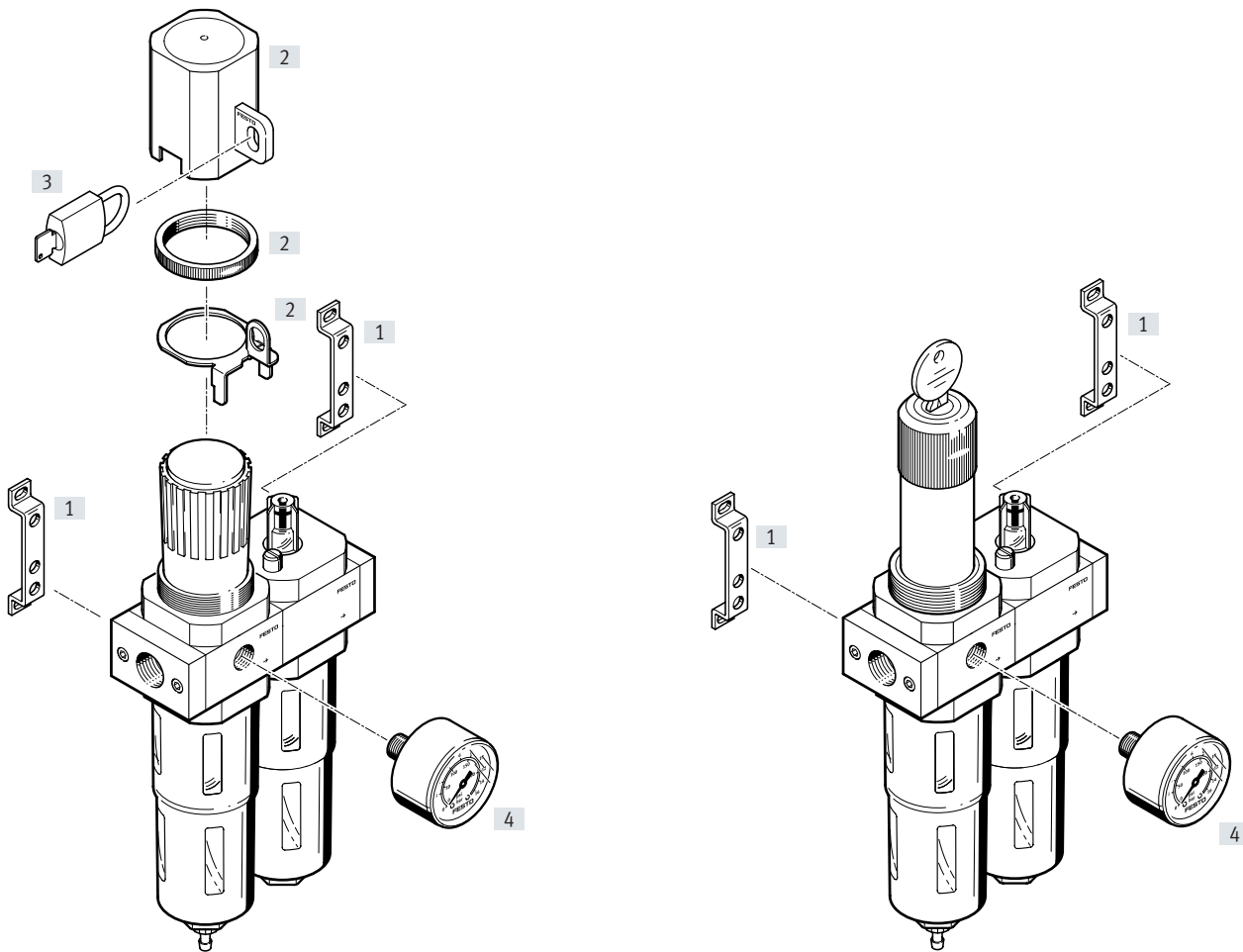

Mounting attachments and accessories

	Rotary knob with latch	Rotary knob, lockable	→ Page/Internet
[1] Mounting bracket HFOE	■	■	hfoe-d
[2] Regulator lock LRVS	■	-	lrvs-d
[3] Padlock LRVS-D	■	-	lrvs-d
[4] Pressure gauge MA	■	■	26

Type codes

001	Series
FRC	Service unit
FRCS	Service unit, lockable

002	Pneumatic connection
1/8	Female thread G1/8
1/4	Female thread G1/4
3/8	Female thread G3/8
1/2	Female thread G1/2
3/4	Female thread G3/4
1	Female thread G1

003	Version
D	D series, metal

004	Pressure regulation range
7	0.5 ... 7 bar (0.05 ... 0.7 MPa)
	0.5 ... 12 bar (0.05 ... 1.2 MPa)

005	Grade of filtration
	40 µm
5M	5 µm

006	Pressure gauge
	With pressure gauge
O	Without pressure gauge

007	Size
MINI	Grid dimension 40 mm (without connecting plates)
MIDI	Grid dimension 55 mm (without connecting plates)
MAXI	Grid dimension 66 mm (without connecting plates)

008	Condensate drain
A	Fully automatic
	Manually rotating

009	Display unit
	Bar/psi/without
MPA	MPa

Datasheet



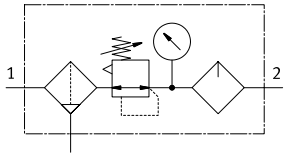

FRC/FRCS

Condensate drain, manually rotating, with pressure gauge

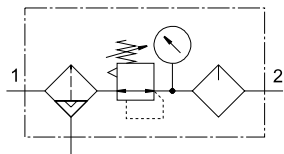

Condensate drain, semi- or fully automatic, with pressure gauge



-  Flow rate
80 ... 8700 l/min
-  Temperature range
-10 ... +60 °C
-  Operating pressure
1 ... 16 bar
-  www.festo.com

- Filter, regulator and lubricator functions in a single unit
- High flow rate and highly efficient at removing contaminants
- Good regulation characteristics with minimal pressure hysteresis
- Setting values are secured by latching the rotary knob
- Lockable rotary knob
- Two pressure regulation ranges: 0.5°... 7 bar and 0.5 ... 12 bar
- Two pressure gauge connections for different installation options
- Choice of manual, semi-automatic or fully automatic condensate drain
- Choice of filter inserts 5 µm or 40 µm
- New filter cartridges → page 25

- The following oils are recommended for Festo components:
Viscosity range to ISO 3448 class VG 32
32 mm²/s (cSt) at 40 °C
- Festo special oil → page 26
 - ARAL Vitam GF 32
 - BP Energol HLP 32
 - Esso Nuto H 32
 - Mobil DTE 24
 - Shell Tellus Oil DO 32

General technical data			
Size	Mini	Midi	Maxi
Pneumatic connection 1, 2 ¹⁾	G1/8, G1/4, G3/8	G1/4, G3/8, G1/2, G3/4	G1/2, G3/4, G1
Design	Filter regulator with/without pressure gauge Proportional standard mist lubricator		
Type of mounting	Via accessories In-line installation		
Mounting position	Vertical ±5°		
Grade of filtration [µm]	5 40		
Air purity class at the output	Compressed air to ISO 8573-1:2010 [6:8:-] (grade of filtration 5 µm) Compressed air to ISO 8573-1:2010 [7:8:-] (grade of filtration 40 µm) Inert gases		
Bowl guard	Metal bowl guard		
Condensate drain	Manual, rotary Fully automatic		
Actuator lock	Rotary knob with latch Rotary knob with integrated lock		
Pressure regulation range [bar]	0.5 ... 7 0.5 ... 12		
Max. pressure hysteresis [bar]	0.2		0.4
Pressure indication	With pressure gauge Prepared for G1/8 Prepared for G1/4 Prepared for G1/4		
Max. condensate volume [cm ³]	22	43	80 ²⁾

1) Connecting plates with threaded connection

2) The max. condensate volume for FRC/FRCS-...-DI-MAXI is 43 cm³.

† Note: This product conforms to ISO 1179-1 and ISO 228-1.

Datasheet

Standard nominal flow rate $q_{nN}^{1)}$ [l/min]											
Size		Mini			Midi			Maxi			
Pneumatic connection 1, 2		G1/8	G1/4	G3/8	G1/4	G3/8	G1/2	G3/4	G1/2	G3/4	G1
Pressure regulation range, grade of filtration	0.5 ... 7 bar, 40 μ m	800	1300	1500	1700	2000	2800	2800	7700 (4500) ²⁾	8500 (5000) ²⁾	8700 (5200) ²⁾
	0.5 ... 12 bar, 5 μ m	600	850	1050	1300	1700	1800	2100	6800 (3000) ²⁾	7000 (3600) ²⁾	7200 (3800) ²⁾
	0.5 ... 12 bar, 40 μ m	700	1000	1200	1500	2000	2600	2600	7600 (3300) ²⁾	8300 (3800) ²⁾	8500 (4000) ²⁾

1) Measured at $p_1 = 10$ bar, $p_2 = 6$ bar and $\Delta p = 1$ bar.

2) With FRC/FRCS-...-DI.

† 125 l/min must be available for the fully automatic condensate drain to close correctly.

Operating and environmental conditions		
Condensate drain	Manual, rotary	Fully automatic
Operating pressure [bar]	1 ... 16	2 ... 12
Operating medium	Compressed air to ISO 8573-1:2010 [--:9:-]	Compressed air to ISO 8573-1:2010 [7:9:-]
	Inert gases	Inert gases
Note on the operating/pilot medium	Lubricated operation possible (in which case lubricated operation will always be required)	Lubricated operation possible (in which case lubricated operation will always be required)
Ambient temperature [°C]	-10 ... +60	
Temperature of medium [°C]	-10 ... +60	
Storage temperature [°C]	-10 ... +60	
Corrosion resistance class CRC ¹⁾	2	

1) More information www.festo.com/x/topic/crc

Weight [g]				
Size	Mini	Midi	Maxi	
			Connection G1/2, G3/4	Connection G1
With pressure gauge				
FRC...	660	1440	2390	2520
FRCS...	760	1680	2490	2620
Without pressure gauge				
FRC...	600	1350	2280	2460
FRCS...	700	1590	2380	2560

Datasheet

Materials

Sectional view

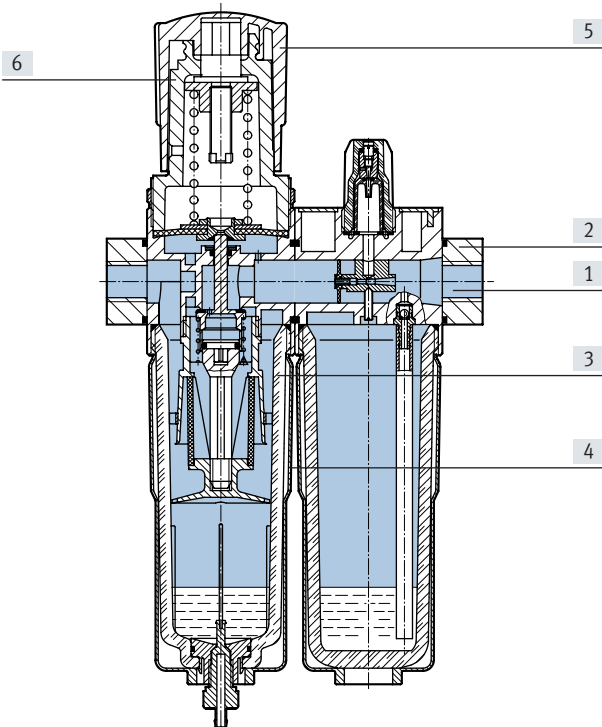

[1]	Housing	Die-cast zinc
[2]	Connecting plates	Die-cast zinc/aluminium
[3]	Bowl	PC
[4]	Metal bowl guard	Aluminium
[5]	Rotary knob	POM
[6]	Support	–
–	Seals	NBR
Note on materials		RoHS-compliant

Datasheet

Standard flow rate q_n as a function of output pressure p_2

FRC/FRCS-1/4-D-MINI

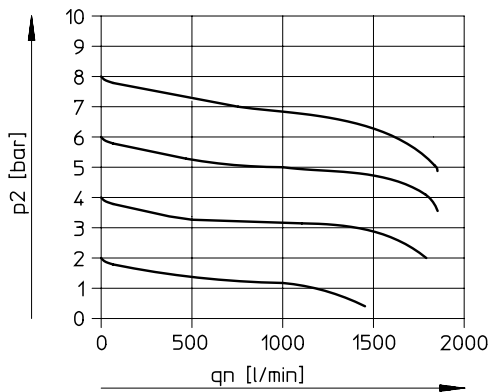

FRC/FRCS-1/2-D-MIDI

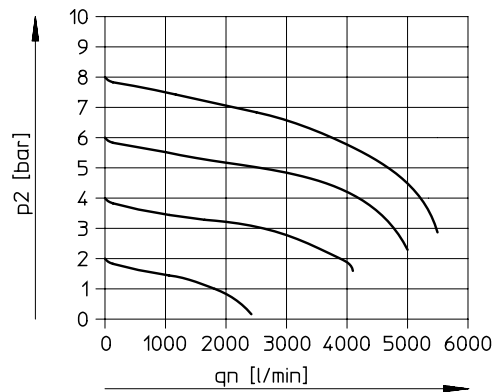

FRC-1-D-MAXI

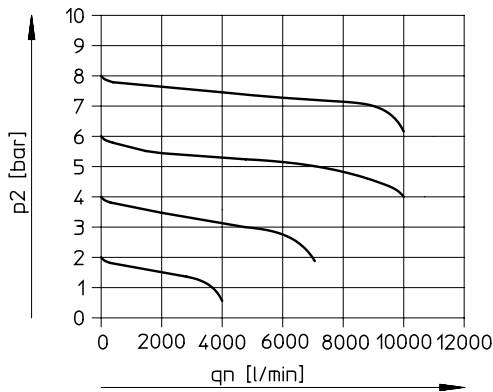

Primary pressure $p_1 = 10$ bar

Note

In order to improve the control performance, internal air consumption depending on the primary pressure is integrated into the design with the FRC/FRCS-...-MAXI.

Datasheet

Dimensions

Download CAD data → www.festo.com

Mini/Midi/Maxi

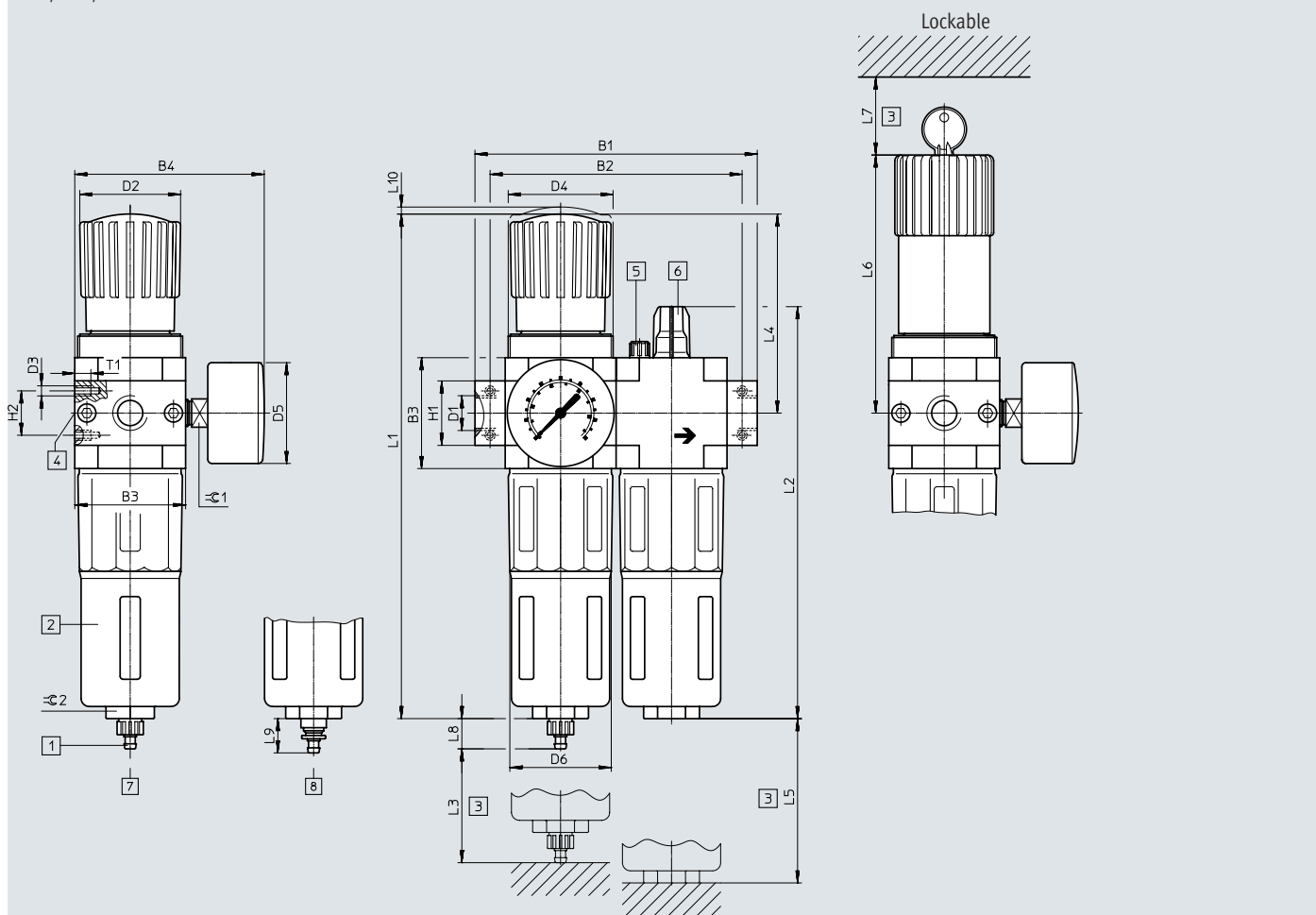

- [1] Barbed connector for plastic tubing PUN(-H)-8x1.25
 - [2] Metal bowl guard
 - [3] Installation dimension
 - [4] Second pressure gauge connection
 - [5] Bleed screw for oil reservoir
 - [6] Oil adjusting screw
 - [7] Manual Condensate drain
 - [8] Fully automatic condensate drain
- Flow direction

Type	B1	B2	B3	B4	D1	D2 Ø	D3	D4	D5 Ø	D6 Ø
Mini										
FRC-1/8-D-MINI	104	92	40	76	G1/8	31	M4	M36x1.5	39	38
FRC/FRCS-1/4-D-MINI					G1/4					
FRC-3/8-D-MINI	110				G3/8					
Midi										
FRC/FRCS-1/4-D-MIDI	140	125	55	95	G1/4	50	M5	M52x1.5	39	52
FRC-3/8-D-MIDI					G3/8					
FRC/FRCS-1/2-D-MIDI					G1/2					
FRC-3/4-D-MIDI					G3/4					
Maxi										
FRC/FRCS-1/2-D-MAXI	162	146	66	106	G1/2	31	M5	M36x1.5	39	65
FRC-3/4-D-MAXI				106	G3/4			M36x1.5		
FRC-1-D-MAXI				106	G1			M36x1.5		

• Note: This product conforms to ISO 1179-1 and ISO 228-1.

Datasheet

Type	H1	H2	L1	L2	L3	L4	L5	L6	L7	L8	L9	L10	T1	≅ 1	≅ 2
Mini															
FRC-1/8-D-MINI	20	11	193	169	60	69	100	98	60	15	19	3	7	14	22
FRC/FRCS-1/4-D-MINI															
FRC-3/8-D-MINI															
Midi															
FRC/FRCS-1/4-D-MIDI	32	22	250	204	80	99	120	130	60	15	19	3	8	14	24
FRC-3/8-D-MIDI															
FRC/FRCS-1/2-D-MIDI															
FRC-3/4-D-MIDI															
Maxi															
FRC/FRCS-1/2-D-MAXI	32	22	252	228	90	82	150	111	60	15	19	3	8	14	24
FRC-3/4-D-MAXI	32		252			82		111							
FRC-1-D-MAXI	40		252			82		111							

Datasheet

Ordering data

Pressure regulation range 0.5 ... 12 bar, rotary knob with latch, connecting plates with threaded connection

Condensate drain	Size	Connection	Grade of filtration 5 µm		Grade of filtration 40 µm	
			Part no.	Type	Part no.	Type

With pressure gauge, outer scale in bar, inner scale in psi

Manual, rotary	Mini	G1/8	162770	FRC-1/8-D-5M-MINI	159604	FRC-1/8-D-MINI	
		G1/4	162771	FRC-1/4-D-5M-MINI	159605	FRC-1/4-D-MINI	
		G3/8	162772	FRC-3/8-D-5M-MINI	162734	FRC-3/8-D-MINI	
	Midi	G1/4	186499	FRC-1/4-D-5M-MIDI	186497	FRC-1/4-D-MIDI	
		G3/8	162773	FRC-3/8-D-5M-MIDI	159588	FRC-3/8-D-MIDI	
		G1/2	162774	FRC-1/2-D-5M-MIDI	159590	FRC-1/2-D-MIDI	
		G3/4	162775	FRC-3/4-D-5M-MIDI	162735	FRC-3/4-D-MIDI	
	Maxi	G1/2	186507	FRC-1/2-D-5M-MAXI	186505	FRC-1/2-D-MAXI	
		G3/4	162776	FRC-3/4-D-5M-MAXI	159606	FRC-3/4-D-MAXI	
		G1	162777	FRC-1-D-5M-MAXI	159607	FRC-1-D-MAXI	
	Fully automatic	Mini	G1/8	162778	FRC-1/8-D-5M-MINI-A	159608	FRC-1/8-D-MINI-A
			G1/4	162779	FRC-1/4-D-5M-MINI-A	159609	FRC-1/4-D-MINI-A
G3/8			162780	FRC-3/8-D-5M-MINI-A	162736	FRC-3/8-D-MINI-A	
Midi		G1/4	186502	FRC-1/4-D-5M-MIDI-A	186500	FRC-1/4-D-MIDI-A	
		G3/8	162781	FRC-3/8-D-5M-MIDI-A	159589	FRC-3/8-D-MIDI-A	
		G1/2	162782	FRC-1/2-D-5M-MIDI-A	159591	FRC-1/2-D-MIDI-A	
		G3/4	162783	FRC-3/4-D-5M-MIDI-A	162737	FRC-3/4-D-MIDI-A	
Maxi		G1/2	186510	FRC-1/2-D-5M-MAXI-A	186508	FRC-1/2-D-MAXI-A	
		G3/4	162784	FRC-3/4-D-5M-MAXI-A	159610	FRC-3/4-D-MAXI-A	
		G1	162785	FRC-1-D-5M-MAXI-A	159611	FRC-1-D-MAXI-A	

Without pressure gauge

Manual, rotary	Mini	G1/8	192650	FRC-1/8-D-5M-O-MINI	162738	FRC-1/8-D-O-MINI	
		G1/4	192651	FRC-1/4-D-5M-O-MINI	162739	FRC-1/4-D-O-MINI	
		G3/8	192652	FRC-3/8-D-5M-O-MINI	162740	FRC-3/8-D-O-MINI	
	Midi	G1/4	192653	FRC-1/4-D-5M-O-MIDI	186498	FRC-1/4-D-O-MIDI	
		G3/8	192654	FRC-3/8-D-5M-O-MIDI	162741	FRC-3/8-D-O-MIDI	
		G1/2	192655	FRC-1/2-D-5M-O-MIDI	162742	FRC-1/2-D-O-MIDI	
		G3/4	192656	FRC-3/4-D-5M-O-MIDI	162743	FRC-3/4-D-O-MIDI	
	Maxi	G1/2	192657	FRC-1/2-D-5M-O-MAXI	186506	FRC-1/2-D-O-MAXI	
		G3/4	192658	FRC-3/4-D-5M-O-MAXI	162744	FRC-3/4-D-O-MAXI	
		G1	192659	FRC-1-D-5M-O-MAXI	162745	FRC-1-D-O-MAXI	
	Fully automatic	Mini	G1/8	192660	FRC-1/8-D-5M-O-MINI-A	162746	FRC-1/8-D-O-MINI-A
			G1/4	192661	FRC-1/4-D-5M-O-MINI-A	162747	FRC-1/4-D-O-MINI-A
G3/8			192662	FRC-3/8-D-5M-O-MINI-A	162748	FRC-3/8-D-O-MINI-A	
Midi		G1/4	192663	FRC-1/4-D-5M-O-MIDI-A	186501	FRC-1/4-D-O-MIDI-A	
		G3/8	192664	FRC-3/8-D-5M-O-MIDI-A	162749	FRC-3/8-D-O-MIDI-A	
		G1/2	192665	FRC-1/2-D-5M-O-MIDI-A	162750	FRC-1/2-D-O-MIDI-A	
		G3/4	192666	FRC-3/4-D-5M-O-MIDI-A	162751	FRC-3/4-D-O-MIDI-A	
Maxi		G1/2	192667	FRC-1/2-D-5M-O-MAXI-A	186509	FRC-1/2-D-O-MAXI-A	
		G3/4	192668	FRC-3/4-D-5M-O-MAXI-A	162752	FRC-3/4-D-O-MAXI-A	
		G1	192669	FRC-1-D-5M-O-MAXI-A	162753	FRC-1-D-O-MAXI-A	

Datasheet

Ordering data					
Pressure regulation range 0.5 ... 7 bar, rotary knob with latch, connecting plates with threaded connection					
Condensate drain	Size	Connection	Grade of filtration 40 µm		
			Part no.	Type	
With pressure gauge, outer scale in bar, inner scale in psi					
Manual, rotary	Mini	G1/8	162754	FRC-1/8-D-7-MINI	
		G1/4	162755	FRC-1/4-D-7-MINI	
		G3/8	162756	FRC-3/8-D-7-MINI	
	Midi	G1/4	186503	FRC-1/4-D-7-MIDI	
		G3/8	162757	FRC-3/8-D-7-MIDI	
		G1/2	162758	FRC-1/2-D-7-MIDI	
		G3/4	162759	FRC-3/4-D-7-MIDI	
	Maxi	G1/2	186511	FRC-1/2-D-7-MAXI	
		G3/4	162760	FRC-3/4-D-7-MAXI	
		G1	162761	FRC-1-D-7-MAXI	
Fully automatic	Mini	G1/8	162762	FRC-1/8-D-7-MINI-A	
		G1/4	162763	FRC-1/4-D-7-MINI-A	
		G3/8	162764	FRC-3/8-D-7-MINI-A	
	Midi	G1/4	186504	FRC-1/4-D-7-MIDI-A	
		G3/8	162765	FRC-3/8-D-7-MIDI-A	
		G1/2	162766	FRC-1/2-D-7-MIDI-A	
		G3/4	162767	FRC-3/4-D-7-MIDI-A	
	Maxi	G1/2	186512	FRC-1/2-D-7-MAXI-A	
		G3/4	162768	FRC-3/4-D-7-MAXI-A	
		G1	162769	FRC-1-D-7-MAXI-A	
	Without pressure gauge				
	Manual, rotary	Mini	G1/8	192630	FRC-1/8-D-7-O-MINI
G1/4			192631	FRC-1/4-D-7-O-MINI	
G3/8			192632	FRC-3/8-D-7-O-MINI	
Midi		G1/4	192633	FRC-1/4-D-7-O-MIDI	
		G3/8	192634	FRC-3/8-D-7-O-MIDI	
		G1/2	192635	FRC-1/2-D-7-O-MIDI	
		G3/4	192636	FRC-3/4-D-7-O-MIDI	
Maxi		G1/2	192637	FRC-1/2-D-7-O-MAXI	
		G3/4	192638	FRC-3/4-D-7-O-MAXI	
		G1	192639	FRC-1-D-7-O-MAXI	
Fully automatic	Mini	G1/8	192640	FRC-1/8-D-7-O-MINI-A	
		G1/4	192641	FRC-1/4-D-7-O-MINI-A	
		G3/8	192642	FRC-3/8-D-7-O-MINI-A	
	Midi	G1/4	192643	FRC-1/4-D-7-O-MIDI-A	
		G3/8	192644	FRC-3/8-D-7-O-MIDI-A	
		G1/2	192645	FRC-1/2-D-7-O-MIDI-A	
		G3/4	192646	FRC-3/4-D-7-O-MIDI-A	
	Maxi	G1/2	192647	FRC-1/2-D-7-O-MAXI-A	
		G3/4	192648	FRC-3/4-D-7-O-MAXI-A	
		G1	192649	FRC-1-D-7-O-MAXI-A	

Datasheet

Ordering data

Pressure regulation range 0.5 ... 12 bar, rotary knob with integrated lock, connecting plates with threaded connection



Condensate drain	Size	Connection	Grade of filtration 40 µm	
			Part no.	Type

With pressure gauge, outer scale in bar, inner scale in psi

Manual, rotary	Mini	G1/4	194864	FRCS-1/4-D-MINI
	Midi	G1/4	194888	FRCS-1/4-D-MIDI
		G1/2	194912	FRCS-1/2-D-MIDI
	Maxi	G1/2	194936	FRCS-1/2-D-MAXI
Fully automatic	Midi	G1/2	194913	FRCS-1/2-D-MIDI-A
	Maxi	G1/2	194937	FRCS-1/2-D-MAXI-A

Datasheet

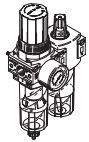
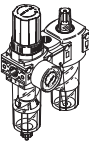
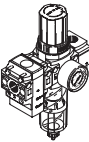
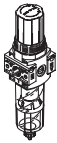
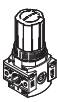
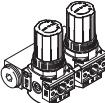
Product range overview – Service unit components, D series, polymer

Type	Size	Pneumatic connection		Pressure regulation range [bar]	Grade of filtration [µm]		
		G1/4	G1/2		5	40	
Service units							
FRC		Mini	■	-	■	■	■
Service unit combinations							
FRC-K		Mini	■	-	■	-	■
LFR-K		Mini	■	-	■	-	■
Individual devices							
Filter regulators LFR		Mini	■	-	■	■	■
Pressure regulators LR		Mini	■	-	■	-	-
Pressure regulator manifolds LRB-K		Mini	-	■	■	-	-
On/off valves HE		Mini	■	-	-	-	-

Product range overview – Service unit components, D series, polymer

Type	Size	Condensate drain		Pressure indication		Actuator lock	Regulator functions		→ Page/ Internet
		Manual, rotary	Semi-automatic	With pressure gauge	Without pressure gauge		With secondary exhausting	With return flow function	
Service units									
FRC	Mini	■	■	■	-	■	■	■	20
Service unit combinations									
FRC-K	Mini	■	-	■	-	■	■	■	frc
LFR-K	Mini	■	-	■	-	■	■	■	lfr
Individual devices									
Filter regulators LFR	Mini	■	■	■	■	■	■	■	lfr
Pressure regulators LR	Mini	-	-	■	■	■	■	■	lr
Pressure regulator manifolds LRB-K	Mini	-	-	-	■	■	■	■	lrb
On/off valves HE	Mini	-	-	-	■	-	-	-	he

Peripherals overview

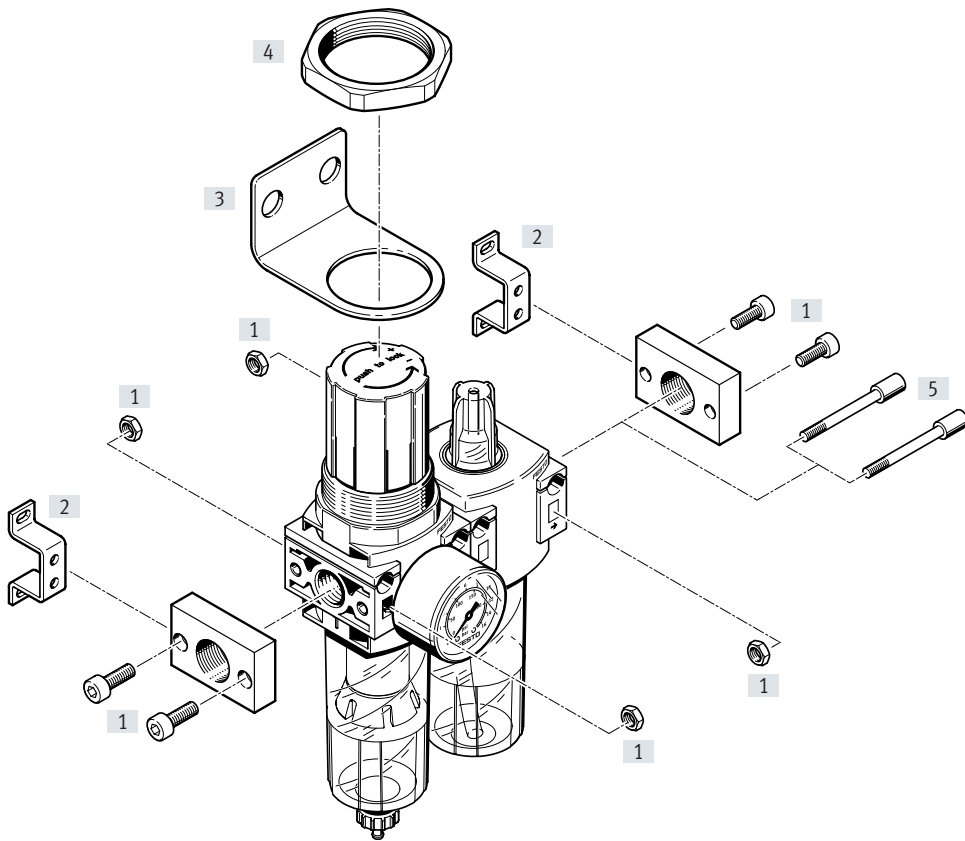

Mounting attachments and accessories

		→ Page/Internet
[1]	Connection set PBL	pbl
[2]	Mounting bracket HFOE	hfoe-d
[3]	Mounting bracket HR-D	hr-d
[4]	Hex nut HMR	hmr-d
[5]	Threaded bolt FRB	frb-db

Type codes

001	Series
FRC	Service unit
002	Pneumatic connection
1/4	Female thread G1/4
003	Version
DB	D series, polymer
004	Pressure regulation range
7	0.5 ... 7 bar (0.05 ... 0.7 MPa)

005	Grade of filtration
	40 µm
5M	5 µm
006	Size
MINI	Grid dimension 40 mm (without connecting plates)
007	Condensate drain
	Manually rotating
H	Semi-automatic



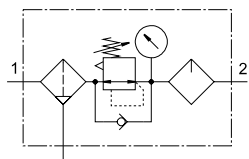

Datasheet

Condensate drain, manual

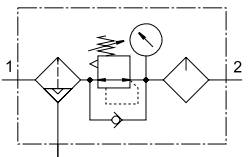

Condensate drain, semi-automatic



-  - Flow rate
400 ... 650 l/min
-  - Temperature range
-5 ... +50 °C
-  - Operating pressure
1.5 ... 10 bar
-  - www.festo.com



- Filter, regulator and lubricator functions in a single unit
 - High flow rate and highly efficient at removing contaminants
 - Good regulation characteristics with minimal pressure hysteresis
 - Setting values are secured by locking the rotary knob
 - Choice of manual or semi-automatic condensate drain
 - New filter cartridges
- page 25
- The following oils are recommended for Festo components:
 - Viscosity range to ISO 3448 class VG 32
 - 32 mm²/s (cSt) at 40 °C
 - Festo special oil → page 26
 - ARAL Vitam GF 32
 - BP Energol HLP 32
 - Esso Nuto H 32
 - Mobil DTE 24
 - Shell Tellus Oil DO 32

General technical data	
Size	Mini
Pneumatic connection 1, 2	G1/4
Design	Filter regulators/lubricators
Regulator function	With return flow function, with secondary exhaust
Type of mounting	In-line installation Via through-hole With mounting bracket
Mounting position	Vertical ±5°
Grade of filtration [µm]	5 40
Air purity class at the output	Compressed air to ISO 8573-1:2010 [6:8:-] (grade of filtration 5 µm) Compressed air to ISO 8573-1:2010 [7:8:-] (grade of filtration 40 µm) Inert gases
Condensate drain	Manual, rotary Semi-automatic
Actuator lock	Rotary knob with latch
Pressure regulation range [bar]	0.5 ... 7
Max. pressure hysteresis [bar]	0.5
Pressure indication	With pressure gauge
Pressure gauge connection	G1/8

Standard nominal flow rate ¹⁾ qnN [l/min]		
Size	Mini	
Grade of filtration	5 µm	≥ 550
	40 µm	≥ 650

1) Measured at p1 = 10 bar, p2 = 6 bar and Δp = 1 bar.

† 125 l/min must be available for the semi-automatic condensate drain to close correctly.

Datasheet

Operating and environmental conditions	
Size	Mini
Operating pressure [bar]	1.5 ... 10
Operating medium	Compressed air to ISO 8573-1:2010 [-:-:-] Inert gases
Ambient temperature [°C]	-5 ... +50
Temperature of medium [°C]	-5 ... +50
Storage temperature [°C]	-5 ... +50
Corrosion resistance class CRC ¹⁾	1

1) More information www.festo.com/x/topic/crc

Weight [g]	
Size	Mini
Service unit	300

Materials

Sectional view

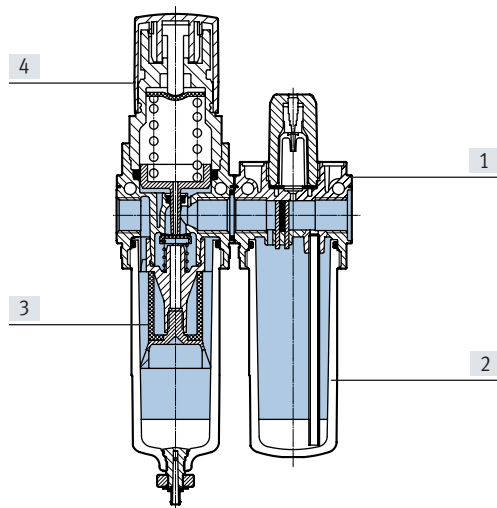

Size	Mini
[1] Housing	Reinforced PA
[2] Bowl	PC
[3] Filters	PE
[4] Rotary knob	POM
- Seals	NBR

Standard flow rate q_n as a function of output pressure p_2

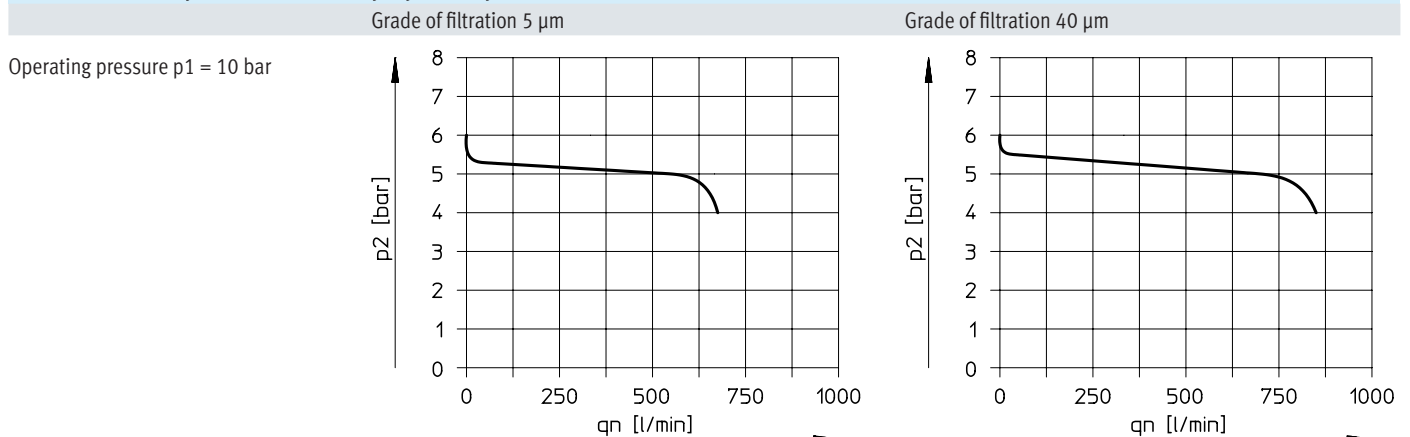

Note
 Minor leakage at the output is intended by design. It improves the control behaviour of the regulator which is not compensated for input pressure.
 In rare cases, however, the leakage can be up to 500 l/h.

Datasheet

Dimensions

Download CAD data → www.festo.com

Mini

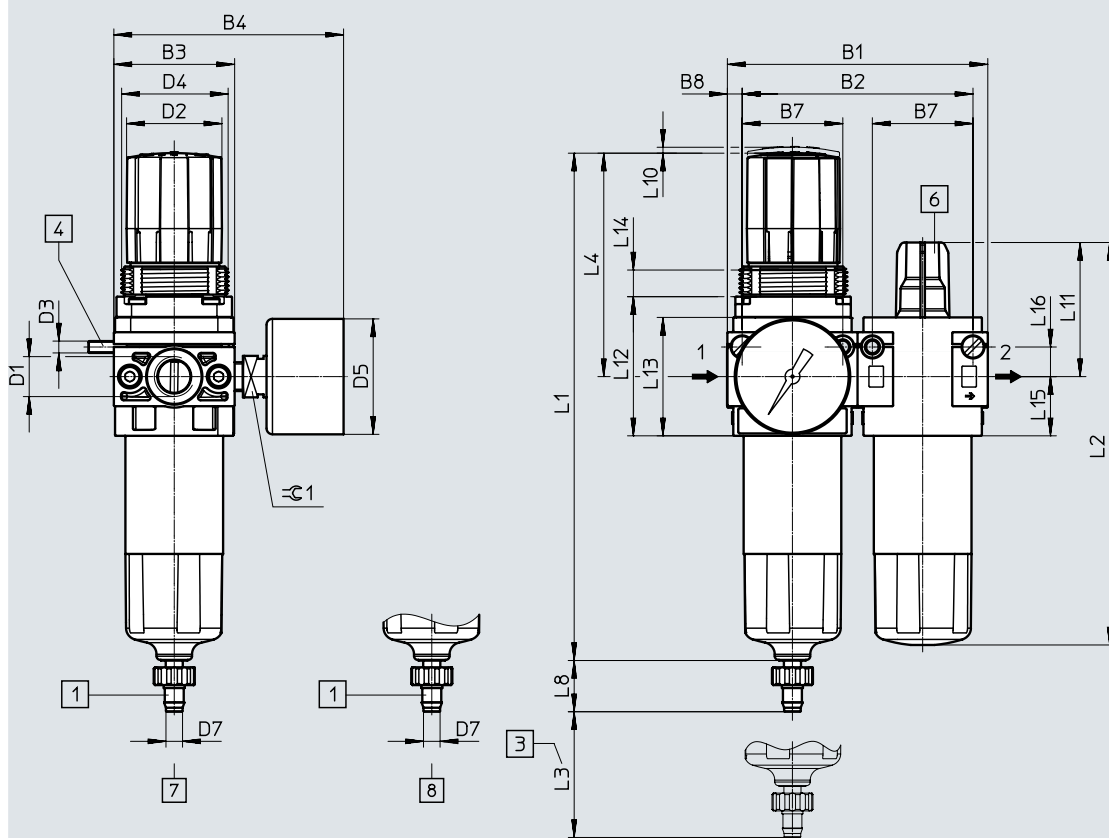

- [1] Barbed connector for plastic tubing PUN(-H)-8x1.25
 - [3] Installation dimension
 - [4] Socket head screw for wall mounting (2 included in the scope of delivery)
 - [6] Oil adjusting screw
 - [7] Manual condensate drain
 - [8] Semi-automatic condensate drain
- Flow direction

Type	B1	B2	B3	B4	B7	B8	D1	D2 ∅	D3	D4	D5 ∅	D7 ∅
FRC-1/4-DB	88	78	41	78	34	5	G1/4	32	M4	M36x1.5	39	5.6

Type	L1	L2	L3 min.	L4	L8	L10	L11	L12	L13	L14	L15	L16	≈∅ 1
FRC-1/4-DB	171.7	136	12	76	17.3	2	45	47	40	9	20	10	14

Ordering data

Pressure regulation range 0.5 ... 7 bar

Condensate drain	Size	Connection	Grade of filtration 5 µm		Grade of filtration 40 µm	
			Part no.	Type	Part no.	Type

With pressure gauge, outer scale in bar, inner scale in psi

Manual, rotary	Mini	G1/4	537658	FRC-1/4-DB-7-5M-MINI	537654	FRC-1/4-DB-7-MINI
Semi-automatic	Mini	G1/4	537660	FRC-1/4-DB-7-5M-MINI-H	537656	FRC-1/4-DB-7-MINI-H

Accessories

Filter cartridges, D series, metal



Ordering data

Size	Grade of filtration [μm]	Part no.	Type
Mini	5 (colour: blue)	159640	LFP-D-MINI-5M
	40 (colour: white)	363665	LFP-D-MINI-40M
Midi	5 (colour: blue)	159594	LFP-D-MIDI-5M
	40 (colour: white)	363667	LFP-D-MIDI-40M
Maxi	5 (colour: blue)	159641	LFP-D-MAXI-5M
	40 (colour: white)	363664	LFP-D-MAXI-40M

Filter cartridges, D series, polymer



Ordering data

Size	Grade of filtration [μm]	Part no.	Type
Mini	5	547957	LFP-DB-MINI-5M
	40	534502	MS4-LFP-E

Accessories

Special oil



Ordering data

Scope of delivery	Part no.	Type
1 litre	152811	OFSW-32

Ordering data – Pressure gauge MA

	Nominal size	Pneumatic connection	Display range		Part no.	Type
			[bar]	[psi]		
	Pressure gauge MA					
	40	G1/8	0 ... 10	0 ... 145	359874	MA-40-10-1/8
			0 ... 16	0 ... 232	345395	MA-40-16-1/8
	50	G1/4	0 ... 10	0 ... 145	359873	MA-50-10-1/4
0 ... 16			0 ... 232	356759	MA-50-16-1/4	

Datasheets → Internet: ma

Festo - Your Partner in Automation



1 Festo Inc.
5300 Explorer Drive
Mississauga, ON L4W 5G4
Canada

Festo Customer Interaction Center
Tel: 1 877 463 3786
Fax: 1 877 393 3786
Email: customer.service.ca@festo.com

2 Festo Pneumatic
Av. Ceylán 3,
Col. Tequesquináhuac
54020 Tlalneantla,
Estado de México

Multinational Contact Center
01 800 337 8669
ventas.mexico@festo.com

3 Festo Corporation
1377 Motor Parkway
Suite 310
Islandia, NY 11749

Festo Customer Interaction Center
1 800 993 3786
1 800 963 3786
customer.service.us@festo.com

4 Regional Service Center
7777 Columbia Road
Mason, OH 45040

Connect with us



www.festo.com/socialmedia



www.festo.com

Subject to change