

Rotary lifting modules EHMB, electric

FESTO

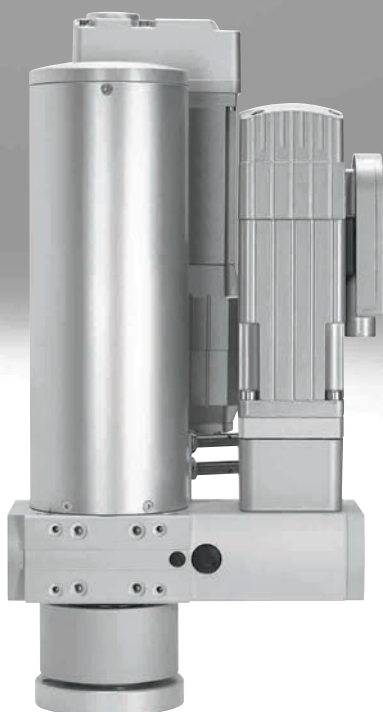

Characteristics

At a glance

The rotary lifting module EHMB combines rotary and linear motion in one compact unit. The rotation motion is always transferred via a toothed belt to a hollow shaft by an electric motor while the linear motion is generated either by a pneumatic cylinder DSBC or an electric cylinder ESBF. Both movements act on the output flange.

Cables and tubing can be easily routed to the front unit of the rotary lifting module through the large hollow shaft.

The movement range can also be sensed using proximity switches at the rotary unit and the cylinder.

Advantages:

- Large hollow axis
- Stable bearing
- Various motors and cylinders enable the performance to be adapted easily to the application

The technology in detail

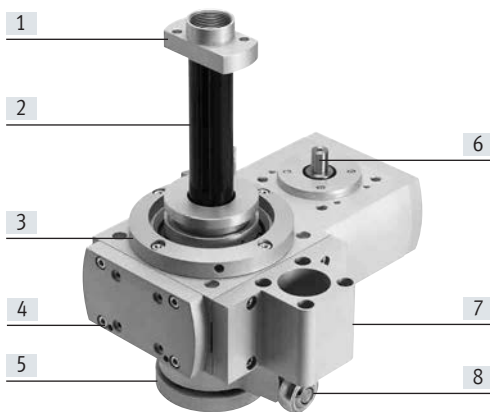

- [1] Stop nut
- [2] Grooved shaft guide
- [3] Through-hole for mounting
- [4] Mounting threads/mounting holes
- [5] Output flange with centring and threaded holes for payload
- [6] Drive shaft for rotation
- [7] Cylinder holder
- [8] Rod eye and connecting bolt for linear motion

Flexible connection

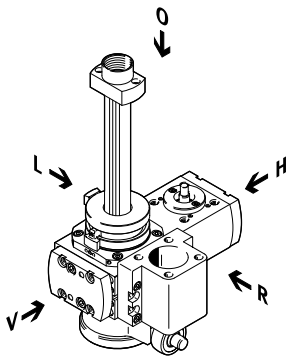

- O= top
 U= underneath
 R= right
 V= front
 L= left
 H= rear

- The rotary lifting module EHMB can be mounted on 4 sides:
 - On the right or left of the housing (L, R)
 - On the front cover (V)
 - Underneath the housing (U)
- The cylinder holder can be mounted on 3 sides:
 - On the right or left of the housing (L, R)
 - On the front, after removing the front cover (V)
- The side where the cylinder holder is mounted cannot be used for mounting the rotary lifting module
- A pneumatic standards-based cylinder DSBC or an electric cylinder ESBF can be attached to the cylinder holder. (These cylinders must be ordered separately)

Note

Eccentric loads can destroy the bearing.
 The front side (V) may be used only to attach a symmetrical applied load.

Characteristics

Complete system consisting of rotary lifting module, motor and axial kit

Rotary lifting module

→ Page 6

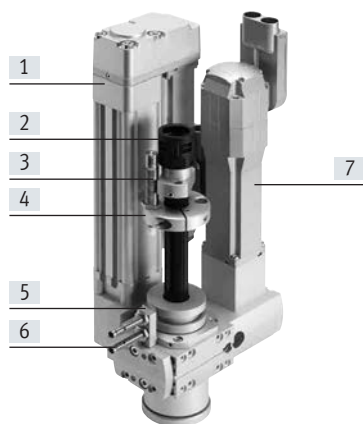

- [1] Electric cylinder ESBF, alternatively standards-based cylinder DSBC¹⁾
- [2] Protective conduit fitting¹⁾
- [3] Shock absorber¹⁾
- [4] Shock absorber retainer¹⁾
- [5] Sensor bracket
- [6] Proximity switch SIEN¹⁾
- [8] Motor for rotation¹⁾

1) These parts must be ordered separately as accessories.

Motors

→ Page 17



- Servo motor EMME-AS, EMMT-AS
- Stepper motor EMMS-ST
- Integrated drive EMCA



Note

A range of specially matched complete solutions is available for the rotary lifting module EHMB and motors.

Motor controllers

Data sheets → Internet: motor controller



- Servo motor controller CMM-AS
- Stepper motor controller CMMT-ST

Motor mounting kit

→ Page 17

Axial kit

Parallel kit

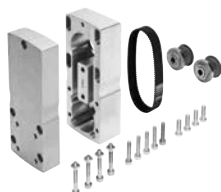

Complete kits are available for both parallel and axial motor mounting.

Peripherals overview and type codes

Accessories			
Type	Description		→ Page/Internet
[10] Shock absorber DYSW	<ul style="list-style-type: none"> Hydraulic shock absorber with path-controlled flow control function 		22
[11] Standards-based cylinder DSBC	<ul style="list-style-type: none"> Pneumatic drive for the linear motion of the rotary lifting module 		16
[12] Electric cylinder ESBF	<ul style="list-style-type: none"> Electric drive for the linear motion of the rotary lifting module 		16
[13] Axial kit EAMM-A	<ul style="list-style-type: none"> For the linear motion of the rotary lifting module For axial motor mounting Alternatively parallel kit [15] (Consisting of: coupling, coupling housing and motor flange) 		esbf
[14] Motor EMMS, EMME, EMCA	<ul style="list-style-type: none"> For the linear motion of the rotary lifting module Motors specially matched to the axis, with or without brake The motor can be turned 90° when mounting, depending on the requirement. This means the connection side can be freely selected 		esbf
[15] Parallel kit EAMM-U	<ul style="list-style-type: none"> For the linear motion of the rotary lifting module For parallel motor mounting Alternatively axial kit [13] (consisting of: housing, clamping part, clamping sleeve, toothed belt pulley, toothed belt) 		esbf
[16] Motor EMMS, EMME, EMCA	<ul style="list-style-type: none"> For the linear motion of the rotary lifting module Motors specially matched to the axis, with or without brake The motor can be turned 90° when mounting, depending on the requirement. This means the connection side can be freely selected 		esbf
[17] Adapter plate kit EHAM	<ul style="list-style-type: none"> For attaching the EHMB to the axes EGC and DGC Screws and centring sleeves are included in the scope of delivery of the adapter plate kit 		22
– Adapter	For drive/drive connections		24
	For drive/gripper connections		gripper

 **Note**

When routing electrical cables or compressed air tubing through the hollow shaft of the grooved shaft guide, the rotation angle of the EHMB must be limited to a rotation angle appropriate to the cables or compressed air tubing.

Infinite rotation damages cables and tubing

Type codes

001	Series	
EHMB	Rotary/lifting module	

002	Size	
20	20	
25	25	
32	32	

003	Stroke	
100	100	
200	200	

Data sheet

⊗ Size
 20, 25, 32

⊗ **Note**
 All values are based on a room temperature of 23°C.

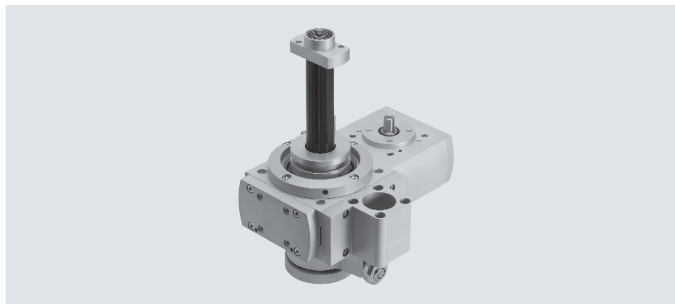

General technical data				
Size		20	25	32
Design		Electromechanical rotary lifting module with toothed belt		
Drive pinion diameter	[mm]	6	8	12
Rotation angle		Infinite		
Stroke, linear	[mm]	100, 200		
Repetition accuracy, rotary ¹⁾				
with servo motor EMMT-AS/EMME-AS	[°]	±0.03		
with stepper motor EMMS-ST ²⁾	[°]	±0.08		
with integrated drive EMCA	[°]	±0.05		
Max. speeds, linear				
with standards-based cylinder DSBC	[m/s]	→ Page 10		
with electric cylinder ESBF	[m/s]	1.1		1.2
Positioning times, rotary		→ Page 11		
Gear ratio		4.5:1	4:1	3:1
Position sensing		Via proximity switch		
Mounting position		Optional		

1) When the travel profile remains the same. The specifications apply only when the motor is directly mounted. If a gear unit is also installed, the repetition accuracy will be different

2) Dependent on the encoder resolution

⊗ **Note**
 The connection between the drive for the linear motion and the EHMB is not backlash-free.

Mechanical data				
Size		20	25	32
Max. driving torque	[Nm]	0.7	2.2	6.7
Max. output torque ¹⁾	[Nm]	3.15	8.8	20
Average no-load driving torque ²⁾	[Nm]	< 0.07	< 0.18	< 0.5
Max. input speed	[rpm]	1350	1200	900
Max. output speed	[rpm]	300	300	300
Max. payload, horizontal	[kg]	3	5	8
Max. payload, vertical	[kg]	3	5	15 ³⁾
Toothed belt pitch		2	3	5

1) Output torque minus friction is dependent on rotational speed

2) At maximum rotational speed

3) With symmetrical and non-eccentric configuration

Data sheet

Mechanical data				
Size		20	25	32
Max. mass moment of inertia ¹⁾	[kgcm ²]	1000	5000	10000
Max. inertia factor ²⁾				
for servo motor EMMT-AS/EMME-AS		45		
for stepper motor EMMS-ST		30		
for integrated drive EMCA		16		

1) These values specify the upper limit independently of what is determined using the inertia factor.

2) The inertia factor represents the maximum controllable ratio between the inertia of the load and the intrinsic inertia of the motor with brake.

Example:

Rotary lifting module EHMB-20 → transmission ratio $i = 4.5$

Motor EMME-AS-40-S with brake → intrinsic inertia 0.055 kgcm^2

Gear unit EMGA-40-P-G3-40 → transmission ratio $i = 3$

Limit for inertia of the load (+ intrinsic inertia) on output side:

$$0.055 \text{ kgcm}^2 \times 45 \times 3^2 \times 4.5^2 = 451 \text{ kgcm}^2$$

Operating and environmental conditions				
Size		20	25	32
Ambient temperature	[°C]	-10 ... +60		
Sound pressure level with covering	[dB (A)]	57	56	53
Sound pressure level without covering	[dB (A)]	54	51	51

Weight [g]							
Size		20		25		32	
Stroke	[mm]	100	200	100	200	100	200
Product weight							
Total		1716	1851	3347	3620	6112	6388
Moving mass for linear motion							
Guide rod		501	681	1251	1651	1332	1732
Stop nut		25	25	53	53	53	53
Shock absorber retainer		64	64	99	99	99	99
Shock absorber		42	42	66	66	66	66
Rod eye		73	73	73	73	108	108
Moving mass of standards-based cylinder DSBC		200	290	200	290	365	525

Materials

Sectional view

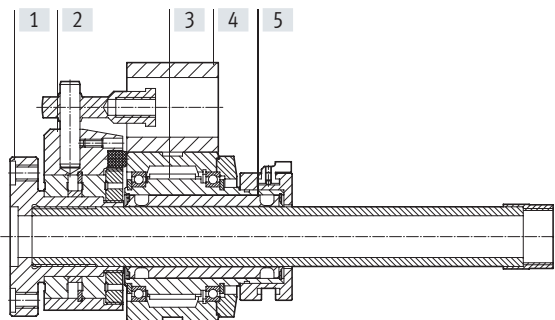

Rotary lifting module		
[1]	Flange	Anodised aluminium
[2]	Holder	Anodised wrought aluminium alloy
[3]	Toothed belt	Polychloroprene with glass fibre
[4]	Retaining bracket	Anodised aluminium
[5]	Output shaft	Steel
-	Drive shaft	High-alloy stainless steel
-	Note on materials	RoHS-compliant
		Contains paint-wetting impairment substances

Data sheet

Maximum radial and axial force F_y/F_z at the output shaft as a function of distance x/z

If the rotary module is simultaneously subjected to several forces, the following equation must be satisfied in addition to the maximum loads indicated below.

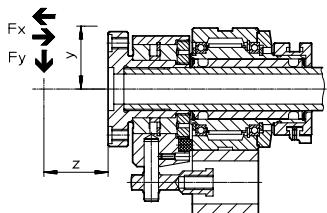

$$\frac{|F_{x1}|}{F_{x2}} + \frac{|F_{y1}|}{F_{y2}} + \frac{|F_{z1}|}{F_{z2}} \leq 1$$

F_1 = dynamic value

F_2 = maximum value

Max. radial force F_y , dynamic

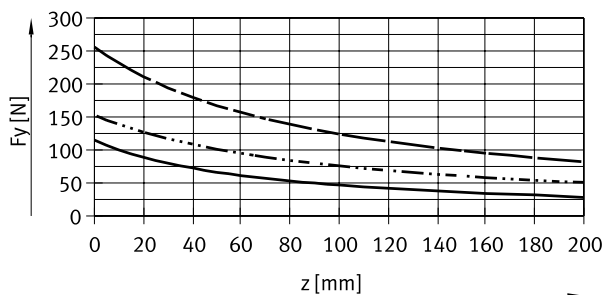

Max. axial force F_x , dynamic, pushing and pulling

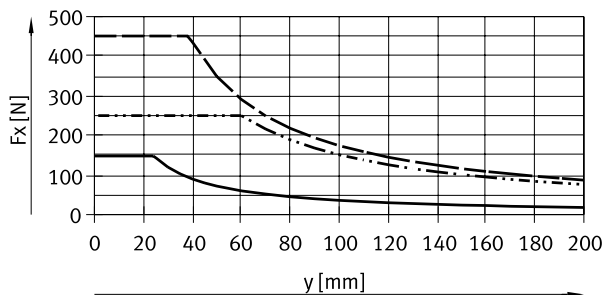

- EHMB-20
- EHMB-25
- - - EHMB-32

Data sheet

Deflection f as a function of transverse load F and stroke l

The following graphs show the deflection f of the rotary lifting module under radial forces and with two strokes.

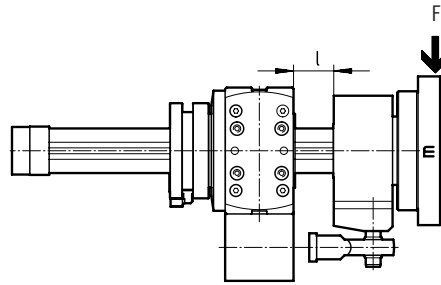

EHMB-20

EHMB-25

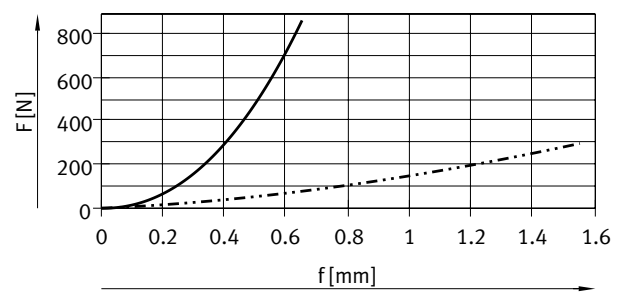
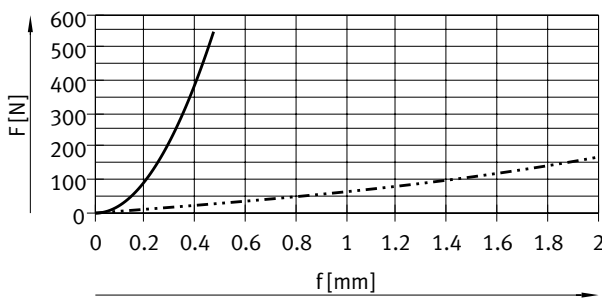

EHMB-32

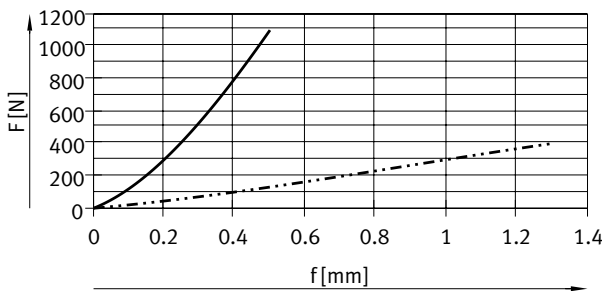

— $l = 10$ mm
 - - - $l = 200$ mm

Data sheet

Max. velocity v as a function of payload m , in combination with the pneumatic standards-based cylinder DSBC

Mounting position:

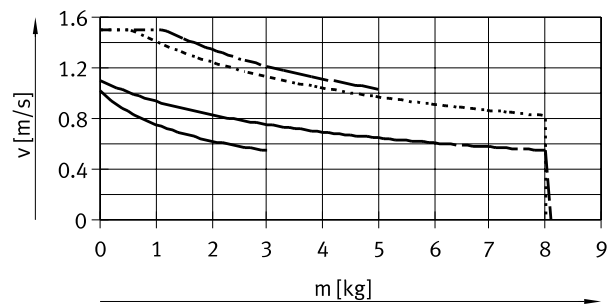
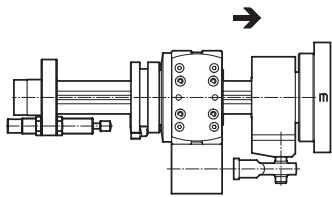
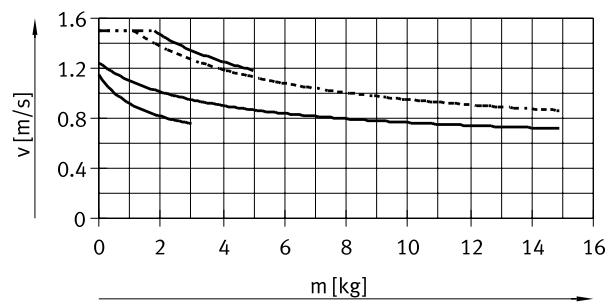
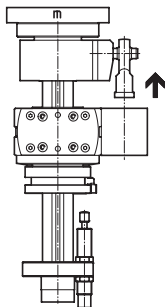
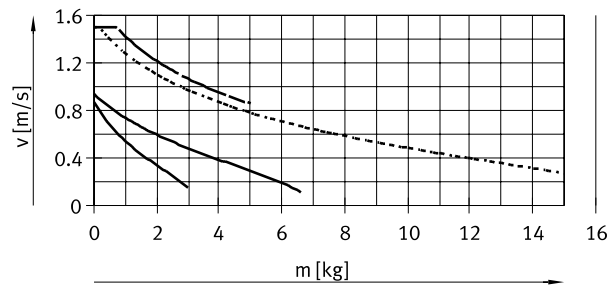
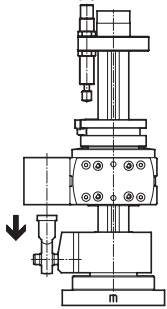

- EHMB-20
- - - EHMB-25
- · - · EHMB-32, with one shock absorber
- · · · · EHMB-32, with two shock absorbers



Data sheet

Positioning time t as a function of the rotation angle α

Size 20

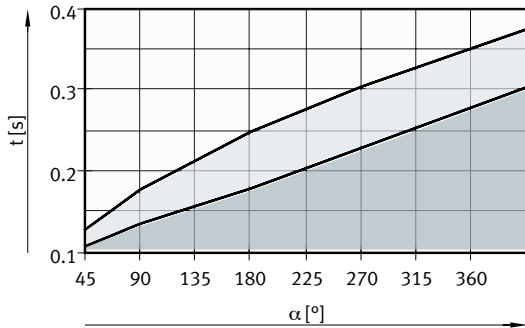

Example with servo motor EMMS-AS

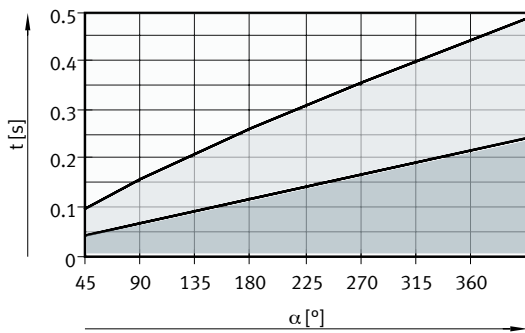

-  Permissible range
-  Typical operating range, depending on motor size and inertia of the load
-  Non-viable range

Example with stepper motor EMMS-ST



-  Permissible range
-  Typical operating range, depending on motor size and inertia of the load
-  Non-viable range

Data sheet

Positioning time t as a function of the rotation angle α

Size 25

Example with servo motor EMMS-AS

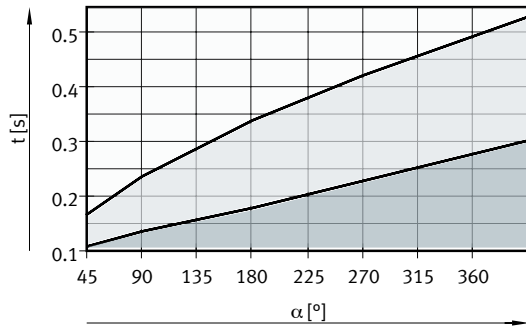

- Permissible range
- Typical operating range, depending on motor size and inertia of the load
- Non-viable range

Example with stepper motor EMMS-ST

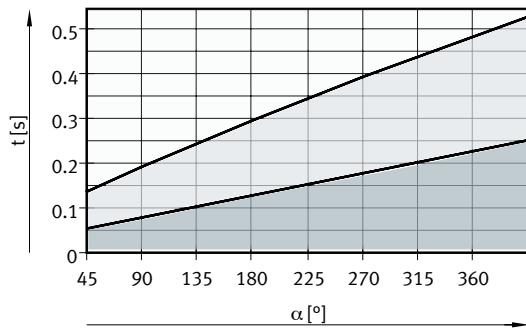

- Permissible range
- Typical operating range, depending on motor size and inertia of the load
- Non-viable range

Data sheet

Positioning time t as a function of the rotation angle α

Size 32

Example with servo motor EMMS-AS

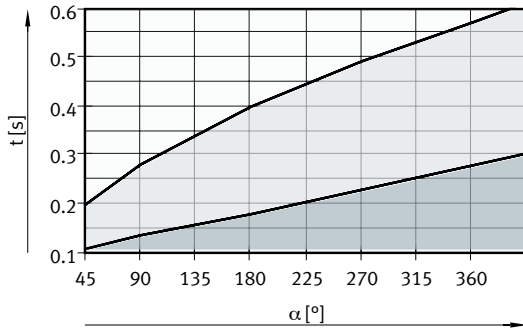

- Permissible range
- Typical operating range, depending on motor size and inertia of the load
- Non-viable range

Example with stepper motor EMMS-ST

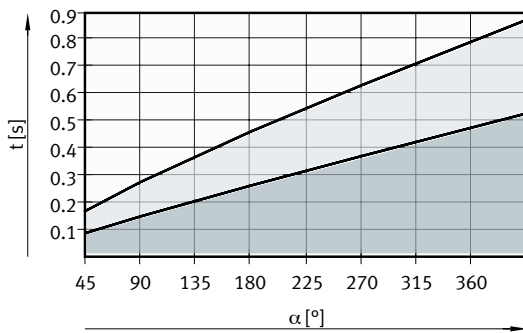

- Permissible range
- Typical operating range, depending on motor size and inertia of the load
- Non-viable range

Data sheet

Dimensions

Download CAD data → www.festo.com

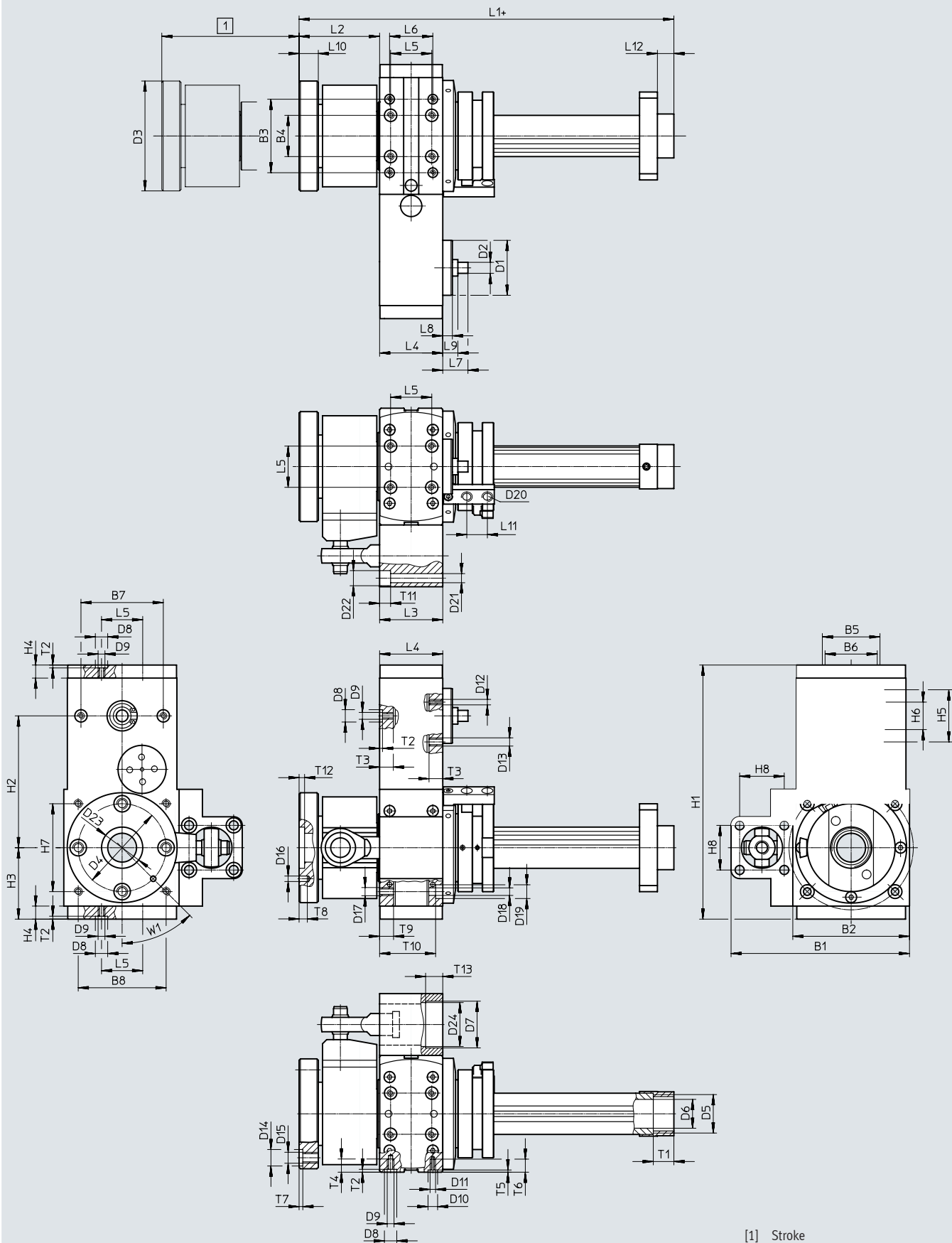

[1] Stroke
+ = plus stroke length

Data sheet

Size	B1 ±0.5	B2 ±0.2	B3 ¹⁾	B4 ¹⁾	B5 ±0.15	B6 ±0.15	B7 ¹⁾	B8 ±0.15	D1 ∅ g7	D2 ∅ h6	D3 ∅	D4 ∅ ±0.05
20	110	65	54	34	32	32.5	30	52	32	6	58	45
25	130	85	53.5	30	42	38	60	64	40	8	80	64
32	169.5	115	70	40	62	56.5	80	88	60	12	80	64

Size	D5	D6 ∅	D7 ∅ H8	D8 ∅ H7	D9	D10 ∅ H7	D11	D12	D13	D14 ∅ H7	D15	D16 ∅ H7	D17
20	Pg16	14	34/30 ²⁾	9	M5	7	M4	M3	M6	9	M6	4	M5
25	Pg21	21	34/30 ²⁾	9	M5	7	M4	M4	M6	12	M8	4	M6
32	Pg21	21	39/35 ²⁾	9	M5	–	M5	M5	M8	12	M8	4	M6

Size	D18 ∅	D19 ∅	D20	D21 ∅	D22 ∅	D23 ∅	D24 ∅	H1 ±0.5	H2 ±0.05	H3	H4	H5 ±0.15	H6 ±0.15
20	–	–	M8x1	6.6	11	19 ^{H8}	32	149	72	45	9.5	32.5	19
25	5.5	10	M8x1	6.6	11	30 ^{H7}	32	185	96	52	9.5	38	20
32	6.2	10	M8x1	6.6	11	30 ^{H7}	37	229.5	108	70.5	13	56.5	31

Size	H7 ±0.15	H8	L1	L2 min.	L3 ±0.1	L4 ±0.1	L5 ¹⁾	L6 ¹⁾	L7	L8	L9	L10	L11 ±0.1	L12
20	44	32.5	147.5	40.5	52	40	30	30	15.8	5	7.8	9	15	12
25	64	32.5	173	58.6	46	46	30	31.5	18.35	7	–	14	15	12
32	88	38	183	61.4	60	60	40	47	23.3	6	–	14	15	12

Size	T1	T2 +0.1	T3	T4	T5 +0.2	T6	T7 +0.1	T8	T9	T10 ±0.2	T11	T12 ±0.5	T13 +0.4	W1
20	14	2.1	10	9	1.6	9.5	2.1	6	8.5	–	11	3	12.5	45°
25	15	2.1	10	9.6	1.6	9.5	2.7	6	10	40.8	8	4	12.5	45°
32	15	2.1	10	9	–	9.5	2.7	6	10	54.3	15	4	14.5	45°

1) Tolerance for centring hole ±0.02 mm
Tolerance for thread ±0.1 mm

 - Note

2) The diameter can be reduced using a centring ring (included in the scope of delivery of the EHMB).

Data sheet

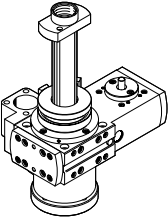
Ordering data				
	Size	Stroke [mm]	Part no.	Type
	20	100	1107096	EHMB-20-100
		200	1107097	EHMB-20-200
	25	100	1095933	EHMB-25-100
		200	1095934	EHMB-25-200
	32	100	1098558	EHMB-32-100
		200	1098559	EHMB-32-200

Cylinder connection for linear motion

Ordering data

In combination with pneumatic standards-based cylinder DSBC

Data sheets → Internet: dsbc

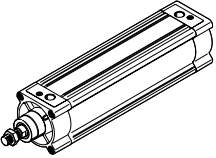
	For rotary lifting module	Standards-based cylinder DSBC	
		Part no.	Type
	EHMB-20-100	1376426	DSBC-32-100-PPVA-N3
	EHMB-20-200	1376429	DSBC-32-200-PPVA-N3
	EHMB-25-100	1376426	DSBC-32-100-PPVA-N3
	EHMB-25-200	1376429	DSBC-32-200-PPVA-N3
	EHMB-32-100	1376660	DSBC-40-100-PPVA-N3
	EHMB-32-200	1376663	DSBC-40-200-PPVA-N3

In combination with electric cylinder ESBF

Data sheets → Internet: esbf

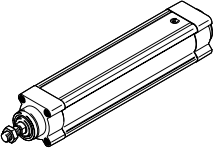
	For rotary lifting module	Electric cylinder ESBF	
		Part no.	Type
	EHMB-20-100	1)	ESBF-...-32-100-...
	EHMB-20-200	1)	ESBF-...-32-200-...
	EHMB-25-100	1)	ESBF-...-32-100-...
	EHMB-25-200	1)	ESBF-...-32-200-...
	EHMB-32-100	1)	ESBF-...-40-100-...
	EHMB-32-200	1)	ESBF-...-40-200-...

1) Ordering data → Internet: esbf

Accessories

Motor connection for rotary motion

Permissible axis/motor combinations with axial kit – Without gear unit

Data sheets → Internet: eamm-a

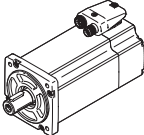
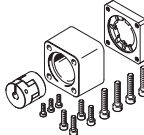
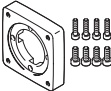
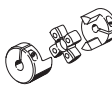
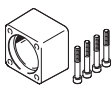
Motor ¹⁾	Axial kit	Axial kit comprises:		
		Motor flange	Coupling	Coupling housing
				
Type	Part no. Type	Part no. Type	Part no. Type	Part no. Type
EHMB-20				
With servo motor				
EMME-AS-40-...	2207441 EAMM-A-D32-35A-40P	–	533708 EAMC-30-32-6-8	2207509 EAMK-A-D32-35A-40P
EMMT-AS-60-..., EMME-AS-60-...	1956054 EAMM-A-D32-60P	1956846 EAMF-A-44C-60P	1233256 EAMC-30-32-6-14	551006 EAMK-A-D32-44A/C
With stepper motor				
EMMS-ST-42-...	543148 EAMM-A-D32-42A	552164 EAMF-A-28B-42A	543419 EAMC-16-20-5-6	552155 EAMK-A-D32-28B
EMMS-ST-57-...	550980 EAMM-A-D32-57A	530081 EAMF-A-44A/B-57A	551002 EAMC-30-32-6-6.35	551006 EAMK-A-D32-44A/C
With integrated drive				
EMCA-EC-67-...	1454239 EAMM-A-D32-67A	1476305 EAMF-A-44A/B/C-67A-S1	551003 EAMC-30-32-6-9	551006 EAMK-A-D32-44A/C
EHMB-25				
With servo motor				
EMMT-AS-60-..., EMME-AS-60-...	1977000 EAMM-A-D40-60P	1956846 EAMF-A-44C-60P	562682 EAMC-30-32-8-14	552157 EAMK-A-D40-44A/C
With stepper motor				
EMMS-ST-57-...	543154 EAMM-A-D40-57A	530081 EAMF-A-44A/B-57A	543421 EAMC-30-32-6.35-8	552157 EAMK-A-D40-44A/C
EMMS-ST-87-...	550982 EAMM-A-D40-87A	530082 EAMF-A-44A/B-87A	551004 EAMC-30-32-8-11	552157 EAMK-A-D40-44A/C
With integrated drive				
EMCA-EC-67-...	1454243 EAMM-A-D40-67A	1476305 EAMF-A-44A/B/C-67A-S1	543423 EAMC-30-32-8-9	552157 EAMK-A-D40-44A/C

1) The input torque must not exceed the maximum permissible transferable torque of the axial kit.

 **Note**

Note the maximum permissible driving torque of the EHMB.
The motor current may need to be limited.

Accessories

Motor connection for rotary motion

Permissible axis/motor combinations with axial kit – Without gear unit

Data sheets → Internet: eamm-a

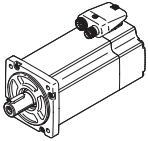
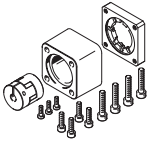
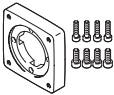
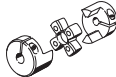
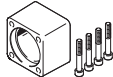
Motor ¹⁾	Axial kit	Axial kit comprises:		
		Motor flange 	Coupling 	Coupling housing 
Type	Part no. Type	Part no. Type	Part no. Type	Part no. Type
EHMB-32				
With servo motor				
EMMT-AS-80-..., EMME-AS-80-...	1977073 EAMM-A-D60-80P	1977113 EAMF-A-64A/C-80P	551005 EAMC-42-50-12-19	551007 EAMK-A-D60-64C
EMMT-AS-100-..., EMME-AS-100-...	550983 EAMM-A-D60-100A	529947 EAMF-A-64A/C/D-100A	551005 EAMC-42-50-12-19	551007 EAMK-A-D60-64C
With stepper motor				
EMMS-ST-87-...	543162 EAMM-A-D60-87A	533140 EAMF-A-64A/B-87A	543424 EAMC-42-50-11-12	552160 EAMK-A-D60-64B

1) The input torque must not exceed the maximum permissible transferable torque of the axial kit.

 **Note**
 Note the maximum permissible driving torque of the EHMB.
 The motor current may need to be limited.

Accessories

Motor connection for rotary motion

Permissible axis/motor combinations with axial kit – With gear unit

Data sheets → Internet: eamm-a

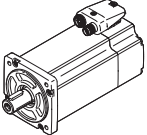
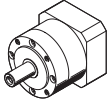
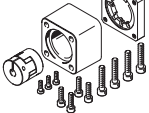
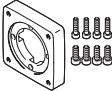
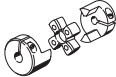
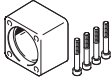
Motor ¹⁾	Gear unit	Axial kit	Axial kit comprises:		
			Motor flange	Coupling	Coupling housing
					
Type	Type	Part no. Type	Part no. Type	Part no. Type	Part no. Type
EHMB-20					
With servo motor					
EMME-AS-40-...	EMGA-40-P-G...-EAS-40	1454238 EAMM-A-D32-40G	1460095 EAMF-A-44C-40G-S1	562681 EAMC-30-32-6-10	551006 EAMK-A-D32-44A/C
EMMT-AS-60-..., EMME-AS-60-...	EMGA-60-P-G...-EAS-60	2946760 EAMM-A-D32-60H	1460105 EAMF-A-44C-60G/H-S1	1233256 EAMC-30-32-6-14	551006 EAMK-A-D32-44A/C
With stepper motor					
EMMS-ST-42-...	EMGA-40-P-G...-SST-42	1454238 EAMM-A-D32-40G	1460095 EAMF-A-44C-40G-S1	562681 EAMC-30-32-6-10	551006 EAMK-A-D32-44A/C
EMMS-ST-57-...	EMGA-60-P-G...-SST-57	2946758 EAMM-A-D32-60G	1460105 EAMF-A-44C-60G/H-S1	3187577 EAMC-30-32-6-11	551006 EAMK-A-D32-44A/C
With integrated drive					
EMCA-EC-67-...	EMGC-40-...	1454238 EAMM-A-D32-40G	1460095 EAMF-A-44C-40G-S1	562681 EAMC-30-32-6-10	551006 EAMK-A-D32-44A/C
	EMGC-60-...	2946760 EAMM-A-D32-60H	1460105 EAMF-A-44C-60G/H-S1	1233256 EAMC-30-32-6-14	551006 EAMK-A-D32-44A/C

1) The input torque must not exceed the maximum permissible transferable torque of the axial kit.

 - Note

Note the maximum permissible driving torque of the EHMB.

The motor current may need to be limited.

Accessories

Permissible axis/motor combinations with axial kit – With gear unit

Data sheets → Internet: eamm-a

Motor ¹⁾	Gear unit	Axial kit	Axial kit comprises:		
			Motor flange	Coupling	Coupling housing
Type	Type	Part no. Type	Part no. Type	Part no. Type	Part no. Type
EHMB-25					
With servo motor					
EMME-AS-40-...	EMGA-40-P-G...-EAS-40	560282 EAMM-A-D40-40G	550986 EAMF-A-44A/B-40G	558029 EAMC-30-32-8-10	552157 EAMK-A-D40-44A/C
		2256398 EAMM-A-D40-40G-G2 ²⁾	1460095 EAMF-A-44C-40G-S1	558029 EAMC-30-32-8-10	552157 EAMK-A-D40-44A/C
EMMT-AS-60-..., EMME-AS-60-...	EMGA-60-P-G...-EAS-60	1454242 EAMM-A-D40-60H	1460105 EAMF-A-44C-60G/H-S1	562682 EAMC-30-32-8-14	552157 EAMK-A-D40-44A/C
With stepper motor					
EMMS-ST-42-...	EMGA-40-P-G...-SST-42	560282 EAMM-A-D40-40G	550986 EAMF-A-44A/B-40G	558029 EAMC-30-32-8-10	552157 EAMK-A-D40-44A/C
EMMS-ST-57-...	EMGA-60-P-G...-SST-57	2256400 EAMM-A-D40-60G	1460105 EAMF-A-44C-60G/H-S1	551004 EAMC-30-32-8-11	552157 EAMK-A-D40-44A/C
With integrated drive					
EMCA-EC-67-...	EMGC-40-...	560282 EAMM-A-D40-40G	550986 EAMF-A-44A/B-40G	558029 EAMC-30-32-8-10	552157 EAMK-A-D40-44A/C
		2256398 EAMM-A-D40-40G-G2 ²⁾	1460095 EAMF-A-44C-40G-S1	558029 EAMC-30-32-8-10	552157 EAMK-A-D40-44A/C
	EMGC-60-...	1454242 EAMM-A-D40-60H	1460105 EAMF-A-44C-60G/H-S1	562682 EAMC-30-32-8-14	552157 EAMK-A-D40-44A/C

1) The input torque must not exceed the maximum permissible transferable torque of the axial kit.
 2) The axial kit can be retrofitted from IP40 to IP65 with the help of a seal set EADS-F. Additional information → eamm-a

 **Note**
 Note the maximum permissible driving torque of the EHMB.
 The motor current may need to be limited.

Accessories

Permissible axis/motor combinations with axial kit – With gear unit

Data sheets → Internet: eamm-a

Motor ¹⁾	Gear unit	Axial kit	Axial kit comprises:		
			Motor flange	Coupling	Coupling housing
Type	Type	Part no. Type	Part no. Type	Part no. Type	Part no. Type
EHMB-32					
With servo motor					
EMMT-AS-60-..., EMME-AS-60-...	EMGA-60-P-G...-EAS-60	1454245 EAMM-A-D60-60H	2256289 EAMF-A-64B-60G/H-S1	1455671 EAMC-42-50-12-14	552160 EAMK-A-D60-64B
EMMT-AS-80-..., EMME-AS-80-...	EMGA-80-P-G...-EAS-80	1499402 EAMM-A-D60-80G	2843290 EAMF-A-64C-80G-S1	2138701 EAMC-42-50-12-20	551007 EAMK-A-D60-64C
EMMT-AS-100-..., EMME-AS-100-...	EMGA-80-P-G...-SAS-100	1499402 EAMM-A-D60-80G	2843290 EAMF-A-64C-80G-S1	2138701 EAMC-42-50-12-20	551007 EAMK-A-D60-64C
With stepper motor					
EMMS-ST-57-...	EMGA-60-P-G...-SST-57	560283 EAMM-A-D60-60G	550987 EAMF-A-64A/B-60G	543424 EAMC-42-50-11-12	552160 EAMK-A-D60-64B
		2256696 EAMM-A-D60-60G-G2 ²⁾	2256289 EAMF-A-64B-60G/H-S1	543424 EAMC-42-50-11-12	552160 EAMK-A-D60-64B
EMMS-ST-87-...	EMGA-80-P-G...-SST-87	1499402 EAMM-A-D60-80G	2843290 EAMF-A-64C-80G-S1	2138701 EAMC-42-50-12-20	551007 EAMK-A-D60-64C
With integrated drive					
EMCA-EC-67-...	EMGC-60-...	1454245 EAMM-A-D60-60H	2256289 EAMF-A-64B-60G/H-S1	1455671 EAMC-42-50-12-14	552160 EAMK-A-D60-64B

1) The input torque must not exceed the maximum permissible transferable torque of the axial kit.

2) The axial kit can be retrofitted from IP40 to IP65 with the help of a seal set EADS-F. Additional information → eamm-a

 **Note**

Note the maximum permissible driving torque of the EHMB.
The motor current may need to be limited.

Accessories

Rod eye SGS

Scope of delivery:

1 rod eye, 1 hex nut to DIN 439

Material:

Galvanised steel

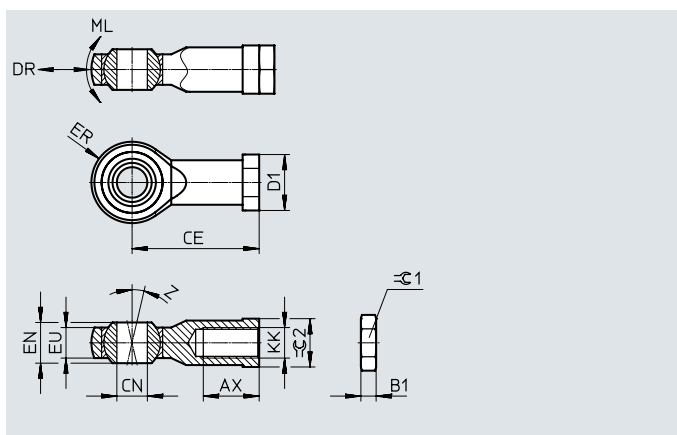
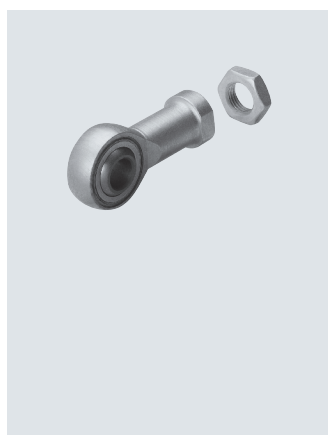

Dimensions and ordering data

For size	AX	B1	CE	CN ∅ H7	D1 ∅ max.	DR max.	EN	ER ±0.5	EU
20, 25	20 -2	5	43 ±1.2	10	20	40	14	14	10.5
32	22 -2	6	50 ±1.2	12	23	45	16	16	12



For size	KK	ML max.	Z	±0.1	±0.2	Part no.	Type
20, 25	M10x1.25	0.23	13°	17	17	9261	SGS-M10x1,25
32	M12x1.25	0.28	13°	19	19	9262	SGS-M12x1,25

Ordering data

	For size	Brief description	Weight [g]	Part no.	Type	PU ¹⁾
Covering EASC						
	20	<ul style="list-style-type: none"> For protecting the grooved shaft guide Cannot be used in combination with parallel kit EAMM-U 	303	1099901	EASC-H1-20-100	1
			388	1099902	EASC-H1-20-200	
	25	For protecting the grooved shaft guide	385	1096387	EASC-H1-25-100	
			482	1096388	EASC-H1-25-200	
	32	For protecting the grooved shaft guide	383	1107235	EASC-H1-32-100	
			481	1107236	EASC-H1-32-200	
Shock absorber retainer EAYH						
	20	For mounting the shock absorbers	68	1153896	EAYH-H1-20	1
	25, 32		106	1153905	EAYH-H1-25	
Shock absorber DYSW						
	20	Progressive shock absorbers	42	548073	DYSW-8-14-Y1F	1
	25, 32		67	548074	DYSW-10-17-Y1F	
Adapter plate kit EHAM						
	20	For attaching the EHMB to the axes EGC and DGC	288	1132369	EHAM-H1-20-L2-80	1
	25		292	1132402	EHAM-H1-25-L2-80	
	32		668	1132529	EHAM-H1-32-L2-120	

1) Packaging unit

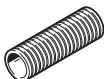
Accessories

Ordering data						
	For size	Brief description	Weight [g]	Part no.	Type	PJ ¹⁾
Protective conduit fitting EASA						
	20	For mounting the protective conduit	8	1157774	EASA-H1-20-PG16	1
	25, 32		12	1096549	EASA-H1-25-PG21	
Protective conduit MKR						
	20	For protecting cables and tubing	-	177566	MKR-16.5-PG-16	-
	25, 32		-	177567	MKR-23-PG-21	
Cam EAPS						
	20	For sensing positions (2 cams included in the scope of delivery)	11	1234887	EAPS-H1-20-CK	2
	25, 32		11	1234888	EAPS-H1-25-CK	
Centring sleeve ZBH						
	- 2)	For centring loads and attachments	1	8146544	ZBH-7-B	10
			1	8137184	ZBH-9-B	
			1	8137185	ZBH-12-B	

1) Packaging unit

2) → Dimensional drawing on page 14

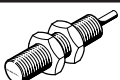
Ordering data – Proximity switches, inductive					Data sheets → Internet: sien
	Contact	Connection	Part no.	Type	
	N/O	Cable, 2.5 m	150386	SIEN-M8B-PS-K-L	
		Plug	150387	SIEN-M8B-PS-S-L	
	N/C	Cable, 2.5 m	150390	SIEN-M8B-PO-K-L	
		Plug	150391	SIEN-M8B-PO-S-L	

-  - **Note**

The retaining bracket for the proximity switch SIEN is included in the scope of delivery of the rotary lifting module.

Ordering data – Connecting cables						Data sheets → Internet: nebu
	Electrical connection, left	Electrical connection, right	Cable length [m]	Part no.	Type	
	Straight socket, M8x1, 3-pin	Cable, open end, 3-wire	2.5	541333	NEBU-M8G3-K-2.5-LE3	
			5	541334	NEBU-M8G3-K-5-LE3	

Accessories

Adapter kit EHAM

Material:
Wrought aluminium alloy
Free of copper and PTFE
RoHS-compliant



Note

The kit includes the individual mounting interface as well as the necessary mounting material.

Permissible drive/drive combinations with adapter kit

Download CAD data → www.festo.com

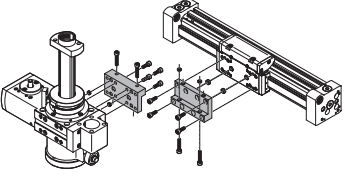
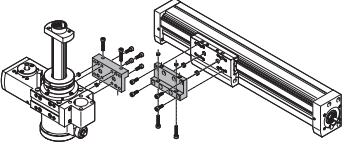
Combination	[1] Drive Size	[2] Drive Size	Adapter kit CRC ¹⁾		
			Part no.	Type	
	DGC	EHMB	EHAM		
	25	20	2	1132369	EHAM-H1-20-L2-80
	25	25		1132402	EHAM-H1-25-L2-80
	40	32		1132529	EHAM-H1-32-L2-120
	EGC	EHMB	EHAM		
	80	20	2	1132369	EHAM-H1-20-L2-80
	80	25		1132402	EHAM-H1-25-L2-80
	120	32		1132529	EHAM-H1-32-L2-120

1) Corrosion resistance class CRC 2 to Festo standard FN 940070

Moderate corrosion stress. Indoor applications in which condensation can occur. External visible parts with primarily decorative surface requirements which are in direct contact with a normal industrial environment.

Festo - Your Partner in Automation



1 Festo Inc.
5300 Explorer Drive
Mississauga, ON L4W 5G4
Canada

Festo Customer Interaction Center
Tel: 1 877 463 3786
Fax: 1 877 393 3786
Email: customer.service.ca@festo.com

2 Festo Pneumatic
Av. Ceylán 3,
Col. Tequesquináhuac
54020 Tlalnepantla,
Estado de México

Multinational Contact Center
01 800 337 8669
ventas.mexico@festo.com

3 Festo Corporation
1377 Motor Parkway
Suite 310
Islandia, NY 11749

Festo Customer Interaction Center
1 800 993 3786
1 800 963 3786
customer.service.us@festo.com

4 Regional Service Center
7777 Columbia Road
Mason, OH 45040

Connect with us



www.festo.com/socialmedia



www.festo.com

Subject to change